

# ETSI TS 100 528 V8.2.0 (2000-09)

---

*Technical Specification*

**Digital cellular telecommunications system (Phase 2+);  
GSM Public Land Mobile Network (PLMN) connection types  
(3GPP TS 03.10 version 8.2.0 Release 1999)**

---



---

**Reference**

RTS/TSGN-030310Q8R1

---

**Keywords**

GSM

**ETSI**

---

650 Route des Lucioles  
F-06921 Sophia Antipolis Cedex - FRANCE

Tel.: +33 4 92 94 42 00 Fax: +33 4 93 65 47 16

Siret N° 348 623 562 00017 - NAF 742 C  
Association à but non lucratif enregistrée à la  
Sous-Préfecture de Grasse (06) N° 7803/88

---

**Important notice**

Individual copies of the present document can be downloaded from:  
<http://www.etsi.org>

The present document may be made available in more than one electronic version or in print. In any case of existing or perceived difference in contents between such versions, the reference version is the Portable Document Format (PDF). In case of dispute, the reference shall be the printing on ETSI printers of the PDF version kept on a specific network drive within ETSI Secretariat.

Users of the present document should be aware that the document may be subject to revision or change of status. Information on the current status of this and other ETSI documents is available at <http://www.etsi.org/tb/status/>

If you find errors in the present document, send your comment to:  
[editor@etsi.fr](mailto:editor@etsi.fr)

---

**Copyright Notification**

No part may be reproduced except as authorized by written permission.  
The copyright and the foregoing restriction extend to reproduction in all media.

© European Telecommunications Standards Institute 2000.

All rights reserved.

---

## Intellectual Property Rights

IPRs essential or potentially essential to the present document may have been declared to ETSI. The information pertaining to these essential IPRs, if any, is publicly available for **ETSI members and non-members**, and can be found in ETSI SR 000 314: "*Intellectual Property Rights (IPRs); Essential, or potentially Essential, IPRs notified to ETSI in respect of ETSI standards*", which is available from the ETSI Secretariat. Latest updates are available on the ETSI Web server (<http://www.etsi.org/ipr>).

Pursuant to the ETSI IPR Policy, no investigation, including IPR searches, has been carried out by ETSI. No guarantee can be given as to the existence of other IPRs not referenced in ETSI SR 000 314 (or the updates on the ETSI Web server) which are, or may be, or may become, essential to the present document.

---

## Foreword

This Technical Specification (TS) has been produced by the ETSI 3<sup>rd</sup> Generation Partnership Project (3GPP).

The present document may refer to technical specifications or reports using their 3GPP identities, UMTS identities or GSM identities. These should be interpreted as being references to the corresponding ETSI deliverables.

The cross reference between GSM, UMTS, 3GPP and ETSI identities can be found under [www.etsi.org/key](http://www.etsi.org/key).

# Contents

Foreword.....	5
1 Scope .....	6
2 References .....	6
3 Definitions, symbols and abbreviations.....	9
3.1 Definitions.....	9
3.2 Abbreviations.....	9
4 General considerations.....	9
4.1 Relationship between lower layer capabilities and radio traffic channels.....	9
4.2 Transparent and non-transparent lower layer capabilities.....	10
4.3 The GSM environment.....	10
4.3.1 The hand-over procedure.....	10
4.3.2 DTX procedure.....	10
5 Framework for the description of connection types .....	11
5.1 Introduction.....	11
5.2 Purpose of GSM PLMN connection types.....	11
5.3 Functions associated with a GSM PLMN connection.....	12
5.4 Applications of GSM PLMN connection types .....	12
5.5 GSM PLMN connection involving several networks .....	13
6 GSM PLMN connection types.....	14
6.1 Description of GSM PLMN connection types .....	14
6.1.1 Rate adaptation .....	14
6.1.2 Radio Link Protocol .....	16
6.1.3 Layer 2 Relay function .....	16
6.1.4 Resources allocated by the GSM network.....	16
6.2 GSM PLMN connection elements .....	17
6.3 Rules of association for the attribute values of connection elements and connection types .....	17
6.3.1 Information transfer mode.....	17
6.3.2 Information transfer rate (kbit/s) .....	17
6.3.3 Information transfer susceptance.....	18
6.3.4 Establishment of connection.....	18
6.3.5 Symmetry .....	18
6.3.6 Connection configuration Topology.....	19
6.3.7 Structure .....	19
6.3.8 Channels.....	19
6.3.8.1 Information channel (rate).....	19
6.3.8.2 Signalling channel (rate) .....	19
6.3.9 Connection control protocol.....	19
6.3.10 Information transfer coding/protocol.....	20
6.3.11 Further attributes and attribute values .....	20
6.4 Limited set of GSM PLMN connection types (all channel codings excluding TCH/F14.4).....	21
6.5 Limited set of GSM PLMN connection types (for TCH/F14.4 channel coding) .....	22
6.6 Limited set of GSM PLMN connection types (for EDGE channels) .....	38
7 Relationship between Telecommunication services and connection types .....	41
7.1 General.....	41
7.2 Relationship between Bearer services and connection types .....	41
7.3 Relationship between Teleservices and connection types.....	42
7.4 Network capability to support in-call modification .....	42
7.5 Network capability to support channel mode modification .....	42

<b>Annex A (informative): List of definitions of GSM PLMN connection type attributes and values .....</b>	<b>50</b>
A.1 Attribute definition and their values .....	50
A.2 Definition of values .....	58
<b>Annex B (informative): Location of the transcoding, multiplexing and RA2 functions.....</b>	<b>59</b>
<b>Annex C (informative): Change History.....</b>	<b>63</b>

---

# Foreword

This Technical Specification has been produced by the 3<sup>rd</sup> Generation Partnership Project (3GPP).

The contents of the present document are subject to continuing work within the TSG and may change following formal TSG approval. Should the TSG modify the contents of the present document, it will be re-released by the TSG with an identifying change of release date and an increase in version number as follows:

Version x.y.z

where:

- x the first digit:
  - 1 presented to TSG for information;
  - 2 presented to TSG for approval;
  - 3 or greater indicates TSG approved document under change control.
- y the second digit is incremented for all changes of substance, i.e. technical enhancements, corrections, updates, etc.
- z the third digit is incremented when editorial only changes have been incorporated in the document.

---

# 1 Scope

A GSM PLMN may be described by a limited set of access interfaces (refer to 3GPP TS 04.02 and 02.01) and a limited set of GSM PLMN connection types to support the telecommunication services described in the 3GPP 02-series of specifications. This Global System for Mobile communications Technical Specification (TS) identifies and defines these connection types in so far as they relate to the particular network capabilities for a GSM PLMN.

The basic lower layer capabilities of a GSM PLMN are represented by a set of GSM PLMN connection types. The definition of a set of GSM PLMN connection types provides the necessary input to identify network capabilities of a GSM PLMN. In addition to describing network capabilities of a GSM PLMN, the identification of connection types facilitates the specification of network-to-network interfaces. It may also assist in the allocation of network performance parameters.

This specification should be considered in conjunction with other 3GPP specifications with particular reference to 3GPP TS 01.02, 02.01, 22.002, 02.03, 03.01, 23.002, 04.02 and 04.03.

This specification provides a bridge between the service specification in the 3GPP TS 02 and 22-series of specifications and the more detailed specifications such as the 3GPP TS 03, 04, 23, 24, 27 and 29 series. As such, it establishes a framework for the specification and understanding of the more detailed specifications. It is therefore not a specification against which detailed conformance testing can be performed. However, it shall be considered mandatory for the understanding of the more detailed specifications and used to resolve issues of conflict in these specifications.

From GSM R99 onwards the following services are no more required to be provided by a GSM PLMN:

- the dual Bearer Services “alternate speech/data” and “speech followed by data”
- the dedicated services for PAD and Packet access
- the single asynchronous and synchronous Bearer Services (BS 21..26, BS 31..34)

If a PLMN network still provides these services it has to fulfil the specification of GSM R98.

---

# 2 References

The following documents contain provisions which, through reference in this text, constitute provisions of the present document.

- References are either specific (identified by date of publication, edition number, version number, etc.) or non-specific.
- For a specific reference, subsequent revisions do not apply.
- For a non-specific reference, the latest version applies.

- [1] 3GPP TS 01.02: "Digital cellular telecommunications system (Phase 2+); General description of a GSM Public Land Mobile Network (PLMN)".
- [2] 3GPP TS 01.04: "Digital cellular telecommunications system (Phase 2+); Abbreviations and acronyms".
- [3] 3GPP TS 02.01: "Digital cellular telecommunications system (Phase 2+); Principles of telecommunications services supported by a GSM Public Land Mobile Network (PLMN)".
- [4] 3GPP TS 22.002: "Bearer Services (BS) supported by a Public Land Mobile Network (PLMN)".
- [5] 3GPP TS 02.03: "Digital cellular telecommunications system (Phase 2+); Teleservices supported by a GSM Public Land Mobile Network (PLMN)".
- [6] 3GPP TS 03.01: "Digital cellular telecommunications system (Phase 2+); Network functions".
- [7] 3GPP TS 23.002: " Network architecture".
- [8] 3GPP TS 23.009: "Handover procedures".
- [9] 3GPP TS 23.034: " High Speed Circuit Switched Data (HSCSD) - Stage 2 Service Description".

- [10] 3GPP TS 23.040: " Technical realization of the Short Message Service (SMS) Point-to-Point (PP)".
- [11] 3GPP TS 23.041: " Technical realization of Short Message Service Cell Broadcast (SMSCB)".
- [12] 3GPP TS 03.45: "Digital cellular telecommunications system (Phase 2+); Technical realization of facsimile group 3 transparent".
- [13] 3GPP TS 04.01: "Digital cellular telecommunications system (Phase 2+); Mobile Station - Base Station System (MS - BSS) interface General aspects and principles".
- [14] 3GPP TS 04.02: "Digital cellular telecommunications system (Phase 2+); GSM Public Land Mobile Network (PLMN) access reference configuration".
- [15] 3GPP TS 04.03: "Digital cellular telecommunications system (Phase 2+); Mobile Station - Base Station System (MS - BSS) interface Channel structures and access capabilities".
- [16] 3GPP TS 04.05: "Digital cellular telecommunications system (Phase 2+); Data Link (DL) layer; General aspects".
- [17] 3GPP TS 04.06: "Digital cellular telecommunications system (Phase 2+); Mobile Station - Base Station System (MS - BSS) interface Data Link (DL) layer specification".
- [18] 3GPP TS 24.007: " Mobile radio interface signalling layer 3; General aspects".
- [19] 3GPP TS 24.008: " Mobile radio interface layer 3 specification".
- [20] 3GPP TS 24.011: "Point-to-Point (PP) Short Message Service (SMS) support on mobile radio interface".
- [21] 3GPP TS 24.012: " Short Message Service Cell Broadcast (SMSCB) support on the mobile radio interface".
- [22] 3GPP TS 04.21: "Digital cellular telecommunications system (Phase 2+); Rate adaption on the Mobile Station - Base Station System (MS - BSS) interface".
- [23] 3GPP TS 24.022: " Radio Link Protocol (RLP) for data and telematic services on the Mobile Station - Base Station System (MS - BSS) interface and the Base Station System - Mobile-services Switching Centre (BSS - MSC) interface".
- [24] 3GPP TS 05.01: "Digital cellular telecommunications system (Phase 2+); Physical layer on the radio path General description".
- [25] 3GPP TS 05.03: "Digital cellular telecommunications system (Phase 2+); Channel coding".
- [26] 3GPP TS 05.08: "Digital cellular telecommunications system (Phase 2+); Radio subsystem link control".
- [27] 3GPP TS 06.31: "Digital cellular telecommunications system; Full rate speech; Discontinuous Transmission (DTX) for full rate speech traffic channels".
- [28] 3GPP TS 27.001: " General on Terminal Adaptation Functions (TAF) for Mobile Stations (MS)".
- [29] 3GPP TS 27.002: " Terminal Adaptation Functions (TAF) for services using asynchronous bearer capabilities".
- [30] 3GPP TS 27.003: " Terminal Adaptation Functions (TAF) for services using synchronous bearer capabilities".
- [31] 3GPP TS 08.04: "Digital cellular telecommunications system (Phase 2+); Base Station System - Mobile-services Switching Centre (BSS - MSC) interface Layer 1 specification".
- [32] 3GPP TS 08.06: "Digital cellular telecommunications system (Phase 2+); Signalling transport mechanism specification for the Base Station System - Mobile-services Switching Centre (BSS - MSC) interface".
- [33] 3GPP TS 08.08: "Digital cellular telecommunications system (Phase 2+); Mobile Switching Centre - Base Station System (MSC - BSS) interface Layer 3 specification".
- [34] 3GPP TS 08.20: "Digital cellular telecommunications system (Phase 2+); Rate adaption on the Base Station System - Mobile-services Switching Centre (BSS - MSC) interface".



- [35] 3GPP TS 29.006: " Interworking between a Public Land Mobile Network (PLMN) and a Packet Switched Public Data Network/Integrated Services Digital Network (PSPDN/ISDN) for the support of packet switched data transmission services".
- [36] 3GPP TS 29.007: "General requirements on interworking between the Public Land Mobile Network (PLMN) and the Integrated Services Digital Network (ISDN) or Public Switched Telephone Network (PSTN)".
- [37] ITU-T Recommendation I.460: "Multiplexing, rate adaption and support of existing interfaces".
- [38] ITU-T Recommendation V.110: "Support of Data Terminal Equipments (DTEs) with V-Series interfaces by an integrated services digital network".
- [39] ITU-T Recommendation V.21: "300 bits per second duplex modem standardised for use in the general switched telephone network".
- [40] ITU-T Recommendation V.22: "1 200 bits per second duplex modem standardised for use in the general switched telephone network and on point-to-point 2-wire leased telephone-type circuits".
- [41] ITU-T Recommendation V.22bis: "2 400 bits per second duplex modem using the frequency division technique standardised for use on the general switched telephone network and on point-to-point 2-wire leased telephone-type circuits".
- [42] ITU-T Recommendation V.24: "List of definitions for interchange circuits between Data Terminal Equipment (DTE) and Data Circuit-terminating Equipment (DCE)".
- [43] ITU-T Recommendation V.26ter: "2 400 bits per second duplex modem using the echo cancellation technique standardised for use on the general switched telephone network and on point-to-point 2-wire leased telephone-type circuits".
- [44] ITU-T Recommendation V.32: "A family of 2-wire, duplex modems operating at data signalling rates of up to 9 600 bit/s for use on the general switched telephone network and on leased telephone-type circuits".
- [45] ITU-T Recommendation V.42bis: "Data Compression for Data Circuit terminating Equipment (DCE) using Error Correction Procedures".
- [46] ITU-T Recommendation V.120: "Support by an ISDN of data terminal equipment with V-Series type interfaces with provision for statistical multiplexing".
- [47] ITU-T Recommendation X.21: "Interface between Data Terminal Equipment (DTE) and Data Circuit-terminating Equipment (DCE) for synchronous operation on public data networks".
- [48] ITU-T Recommendation X.21bis: "Use on public data networks of Data Terminal Equipment (DTE) which is designed for interfacing to synchronous V-series modems".
- [49] ITU-T Recommendation X.25: "Interface between Data Terminal Equipment (DTE) and Data Circuit-terminating Equipment (DCE) for terminals operating in the packet mode and connected to public data networks by dedicated circuit".
- [50] ITU-T Recommendation X.28: "DTE/DCE interface for a start-stop mode data terminal equipment accessing the Packet Assembly/Disassembly facility (PAD) in a public data network situated in the same country".
- [51] ITU-T Recommendation X.30: "Support of X.21, X.21bis and X.20bis based Data Terminal Equipments (DTEs) by an Integrated Services Digital Network (ISDN)".
- [52] ITU-T Recommendation X.31: "Support of packet mode terminal equipment by an ISDN".
- [53] ITU-T Recommendation X.32: "Interface between Data Terminal Equipment (DTE) and Data Circuit-terminating Equipment (DCE) for terminals operating in the packet mode and accessing a packet switched public data network through a public switched telephone network or an integrated services digital network or a circuit switched public data network".
- [54] ITU-T Recommendation V.34 (1994): "A modem operating at data signalling rates of up to 28 800 bits for use on the general switched telephone network and on leased point-to-point 2-wire telephone-type circuits".
- [55] ITU-T Recommendation I.440 (1989): "ISDN user-network interface data link layer - General aspects".
- [56] ITU-T Recommendation I.450 (1989): "ISDN user-network interface layer 3 General aspects".

- [57] ISO/IEC 6429 (1992): "Information technology - Control functions for coded character sets".
- [58] 3GPP TS 23.060: " General Packet Radio Service (GPRS)".
- [59] ITU-T Recommendation V.90 - A digital modem and analogue modem pair for use on the public switched telephone network (PSTN) at data signalling rates of up to 56 000 bit/s downstream and up to 33 600 bit/s upstream.

---

## 3 Definitions, symbols and abbreviations

### 3.1 Definitions

For the purposes of this specification, the following definitions apply.

**(DIGITAL) connection:** A concatenation of (digital) transmission channels or (digital) telecommunication circuits, switching and other functional units set up to provide for the transfer of (digital) signals between two or more points in a telecommunication network to support a single communication.

**GSM PLMN connection:** A connection that is established through a GSM PLMN between specified GSM PLMN reference points.

**GSM PLMN connection type:** A description of a set of GSM PLMN connections which have the same characteristics.

**EDGE channels:** A general term referring to channels based on 8PSK modulation; i.e. TCH/F28.8, TCH/F32.0, and TCH/F43.2.

### 3.2 Abbreviations

Abbreviations used in this specification are listed in 3GPP TS 01.04.

---

## 4 General considerations

Low layer capabilities are defined in 3GPP TS 02.01 and characterized in 3GPP TS 22.002 for Bearer Services and 3GPP TS 02.03 for Teleservices. Apart from the short message service and GPRS, all Bearer Services and Teleservices are provided using low layer capabilities in the connection mode.

Network capabilities to support the short message services are defined in 3GPP TS 23.040 and 3GPP TS 24.011 for the point-to-point service, and in 3GPP TS 23.041 and 3GPP TS 24.012 for the cell broadcast service. Network capabilities to support GPRS are described in 3GPP TS 23.060.

### 4.1 Relationship between lower layer capabilities and radio traffic channels

The realization of low layer capabilities for the provision of telecommunication services will make use of a physical medium consisting of a traffic channel TCH (refer to 3GPP TS 04.03) or a combination of several full rate traffic channels (Multislot configuration for data) except for the short message point-to-point which uses a dedicated control channel DCCH (see 3GPP TS 24.011) or the cell broadcast service which uses the CBCH (see 3GPP TS 24.012). No multiplexing of data connections on one TCH is allowed.

Either a full rate or a half rate channel may be used depending on the requirements of the individual service. User data rates below or equal to 4 800 bit/s may be supported either on a full rate channel or on a half rate channel. Single slot configurations of 9.6Kbit/s and above are always supported on a full rate channel. Multislot configurations for data use combinations of 4.8 kbit/s or 9.6 kbit/s or 14.4 kbit/s full rate traffic channels only.

Technically every MS, regardless of whether it uses a half or a full rate TCH for speech transmission, should be able to use both half and full rate TCHs for data transmission and telematic services. However, particular designs of MS may only provide access to a limited set of services and therefore only use limited options.

For the alternate speech and group 3 facsimile teleservice, when a full rate traffic channel is required for the speech or data portion of the service, a full rate traffic channel will be used for the duration of the call, see 3GPP TS 22.002.

Within a GSM PLMN, the transport of user data and access interface status information (if present) will use a rate adaptation method based on ITU-T Recommendation V.110 except on TCH/F14.4 or EDGE channels for which GSM specific rate adaptation is used between the mobile station and the interworking function. For the access interface, the rate adaptation schemes used are referenced in the 3GPP TS 27-series.

On the radio path, rate adaptation leads to rates of 43.5, 32.0, 29.0, 14.5, 12.0, 6.0 and 3.6 kbit/s per TCH (see 3GPP TS 04.21). However, in multislot configurations for data the 3.6 kbit/s per TCH/F rate is excluded. At the BSS to MSC interface, the rate adaptation scheme used is described in 3GPP TS 08.20.

Protection of information from errors on the radio path (i.e. between MS and BSS) will be implemented by use of FEC techniques (see 3GPP TS 05.03).

## 4.2 Transparent and non-transparent lower layer capabilities

Two classes of low layer capabilities have been identified (see 3GPP TS 22.002 and 3GPP TS 02.03):

- a transparent class which is characterized by constant throughput, constant transit delay and variable error rate;
- a non-transparent class for which an ARQ technique is used (see 3GPP TS 24.022) on the radio path and extended to an appropriate interworking function. This class is characterized by improved error rate with variable transit delay and throughput. Data compression can optionally be used in combination of non-transparent lower layer capability, to increase the data rate on the DTE/DCE interface (or the equivalent interface depending on the TE type).

The considerations described above provide the basis for the definition of a limited set of connection types to be implemented by a GSM PLMN.

## 4.3 The GSM environment

### 4.3.1 The hand-over procedure

The GSM connection is heterogeneous and merges PCM links and radio path as a unit for the user.

One of the most specific characteristics of the mobile networks is the hand-over procedure (see 3GPP TS 23.009, 24.008, 05.08, 08.08) which result in a temporary break of the TCH, and consequently in a loss of information.

The GSM makes it possible to use one TCH slot for signalling (frame stealing for FACCH) in one TDMA frame resulting in a loss of information.

For the transparent data calls, this will result in a period of highly errored stream. For the non-transparent services, the use of the ARQ procedure (3GPP TS 24.022) will overcome this problem.

After a hand-over, in case of loss of synchronization, the process to recover synchronization, as described in 3GPP TS 29.007 and 04.21 should apply. If data compression is used, V.42bis procedure should apply.

### 4.3.2 DTX procedure

For the full rate speech traffic channel, DTX function goes along with other procedures such as voice activity detection, generation of comfort noise, and is described in 3GPP TS 06.31.

For the non-transparent traffic channels, DTX apply according to 3GPP TS 08.20.

# 5 Framework for the description of connection types

## 5.1 Introduction

A GSM PLMN provides a set of network capabilities, which enable telecommunication services to be offered to a user.

A GSM PLMN connection is a connection established between GSM PLMN reference points. A GSM PLMN connection type is a way of referring to and describing a GSM PLMN connection. Thus a GSM PLMN connection is a physical or a logical realization of a GSM PLMN connection type. Each GSM PLMN connection can be characterized as belonging to a connection type.

Figure 1 illustrates the concepts (see also figure 1 of 3GPP TS 02.01).

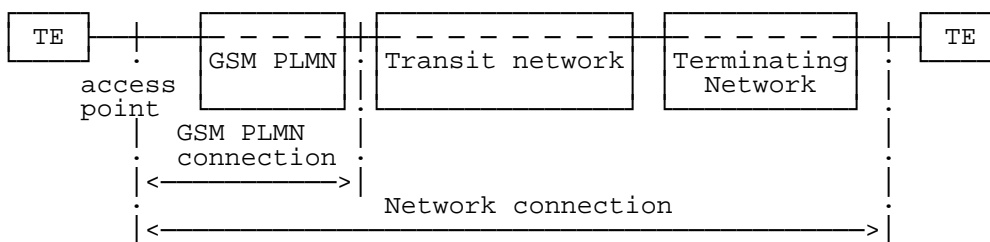

Figure 1: Framework for the description of GSM PLMN connections

## 5.2 Purpose of GSM PLMN connection types

The definition of a set of GSM PLMN connection types provides the necessary input to identify the network capabilities of a GSM PLMN. Other key requirements of a GSM PLMN are contained in other GSM specifications, in particular 3GPP TS 03.01, 04.01 and 04.02. In addition to describing network capabilities of a GSM PLMN, the identification of connection types facilitates the specification of network-to-network interfaces. It may also assist in the allocation of network performance parameters.

NOTE 1: The user specifies only the telecommunication service required while the GSM PLMN allocates the resources to set up a connection of the specific type as necessary to support the requested service. It is further noted that, for certain service offerings, additional network functions, e.g. additional lower layer functions and/or higher layer functions, may be required (see figure 2).

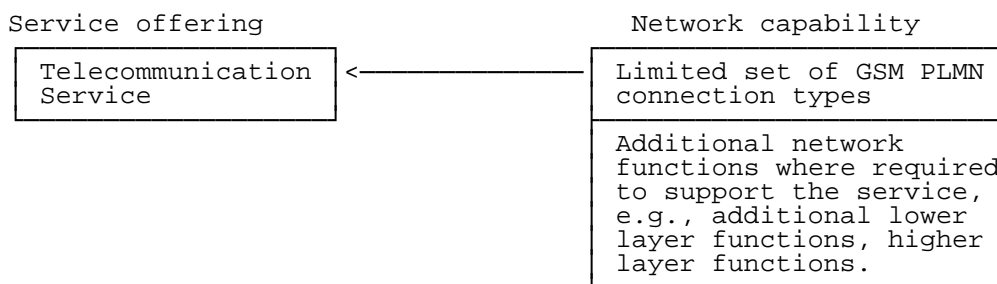

Figure 2: The role of network capabilities in supporting service offerings

### 5.3 Functions associated with a GSM PLMN connection

Any GSM PLMN connection involves an association of functions to support telecommunication services as shown in figure 3. Three sets of functions are required.

- i) Connection means - including transmission and switching.
- ii) Control functions and protocols - including signalling, flow/congestion control and routing functions.
- iii) Operations and management functions - including network management and maintenance functions.

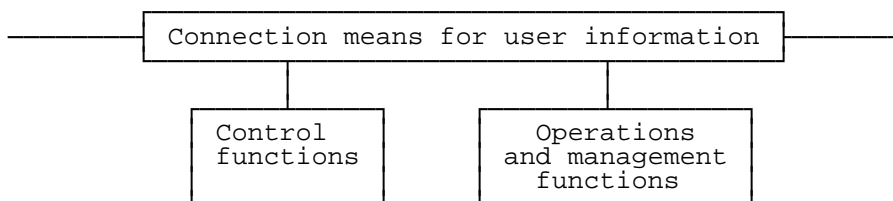

Figure 3: Functional description

### 5.4 Applications of GSM PLMN connection types

The following situations to which GSM PLMN connection types apply (see figure 4) may arise:

- Between two GSM PLMN user access points (refer to 3GPP TS 02.01 and 04.02): see figure 4a.
- Between a GSM PLMN user access point and a network-to-network interface: see figure 4b.
- Between a GSM PLMN user access point and an interface to a specialized resource within the GSM PLMN: see figure 4c.
- Between a GSM PLMN user access point and an interface to a specialized resource outside the GSM PLMN: see figure 4d.

a)

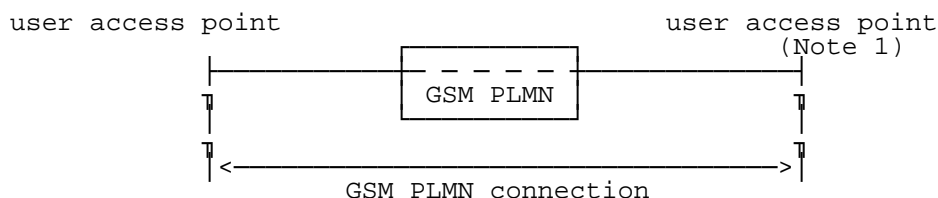

b)

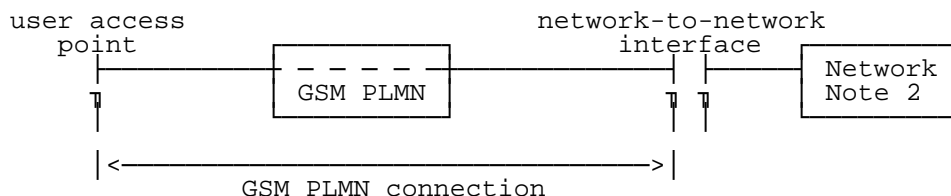

c)

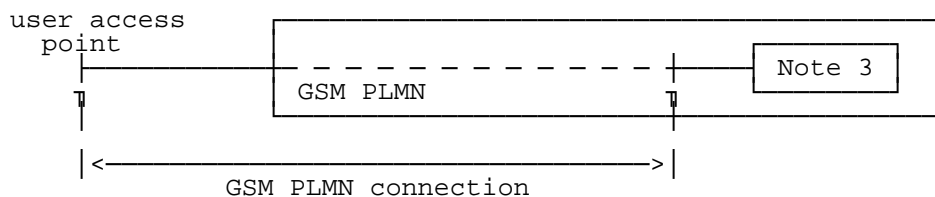

d)

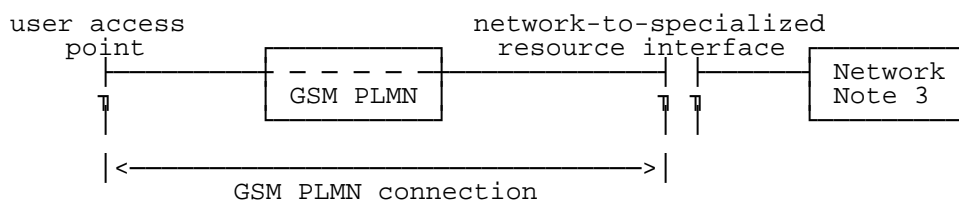

NOTE 1: See 3GPP TS 02.01.

NOTE 2: Network means here any fixed network as described in 3GPP TS 02.01.

NOTE 3: The box represents a specialized resource. Its use originates from a service request. Further study is required to give some examples.

**Figure 4: Applications of GSM PLMN connection types**

## 5.5 GSM PLMN connection involving several networks

A GSM PLMN connection may comprise a number of tandem network connections. Figure 5 shows an example in which each end network is a GSM PLMN. The intermediate network(s) must offer the appropriate network capabilities for the service provided by the (overall) GSM PLMN connection. In (overall) GSM PLMN connections involving several networks, each network provides a part of the connection and may be categorized by different attribute values.

The IWF/MSC can interwork with different type of networks, e.g.:

- analogue (A);
- digital circuit (D) with V.110/X.31 in band protocol;
- packet (P) with X.25 in band protocol.

Examples of such networks are:

- GSM (D);
- PSPDN (P);
- ISDN (A, D, P);
- PSTN (A).

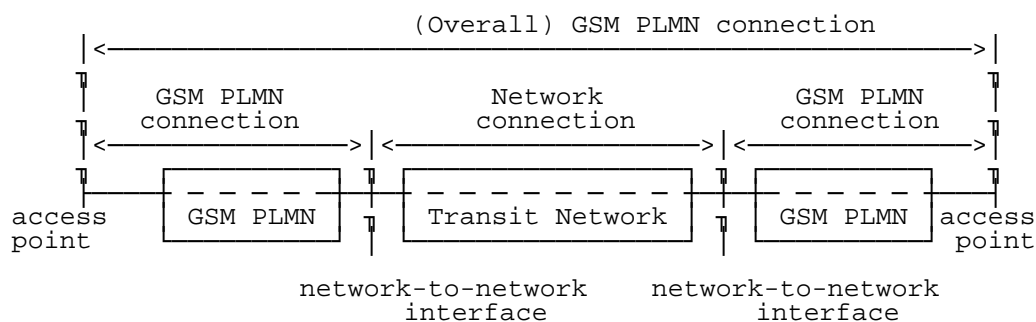

**Figure 5: Example of a GSM PLMN connection involving several networks**

---

## 6 GSM PLMN connection types

### 6.1 Description of GSM PLMN connection types

The characterization of GSM PLMN connection types is done by using a set of attributes. A GSM PLMN connection type attribute is a specific characteristic of a GSM PLMN connection type whose values distinguish it from another GSM PLMN connection type. Particular values are assigned to each attribute when a given GSM PLMN connection type is described and specified.

A list of definitions of attributes and values is contained in the annex A to this specification.

A GSM PLMN connection type is partitioned into connection elements. This partitioning is based on the two most critical transitions of a connection, firstly, the change of signalling system, secondly, the type of transmission system. In a GSM PLMN, the change in signalling and transmission between the radio interface and the A interface leads to two connection elements, the radio interface connection element and the A interface connection element. Subclause 6.3 describes the relationship between the attribute values of connection elements and connection types.

To complete the description of GSM PLMN connection types, the definition of functions within the different entities of a GSM PLMN which are involved in the realization of a GSM PLMN Connection is needed. These functions will be used in subclauses 6.4 and 6.5 to describe the limited set of GSM PLMN connection types.

The following functions have been identified:

- rate adaptation functions;
- the radio link protocol function;
- the forward error correction function;
- the Layer 2 relay function.

#### 6.1.1 Rate adaptation

The RA0 rate adaptation is only used with asynchronous interfaces. Incoming asynchronous data is padded by the addition of stop elements to fit the same or nearest higher synchronous rate defined by  $2$  to the power  $n$  (where  $n \leq 6$ ) times 600 bit/s, 14.4 kbit/s or 28.8 kbit/s. Thus 300 bit/s user data signalling rate shall be adapted to a synchronous 600 bit/s stream. This function is described in 3GPP TS 04.21. The RA0 used in GSM is not identical to that described in ITU-T Recommendation V.110 which converts the 14,4 and 28,8 kbit/s user rates to 19,2 and 38,4 kbit/s, respectively.

The intermediate rate adaptation function (RA1) is a rate adaptation function which turns either the output of the RA0 function or a synchronous user data stream into a data stream at 8, 16, or 32 kbit/s by bit repetition and frame addition. This function is described in 3GPP TS 04.21.

The adaptation of intermediate rates to 64 kbit/s (RA2) performs the final conversion from the intermediate rates generated by the RA1 function to 64 kbit/s.

The radio interface intermediate rate adaptation function (RA1') is in the case of transparent data transmission a variant of the RA1 function and it adapts synchronous user data stream or the output of the RA0 function to one of the following data rates: 3.6, 6.0 or 12.0 or 14.5 kbit/s over the radio path. In case of a TCH/F28.8 channel two 14.5 kbit/s substreams produced by the RA1' function are multiplexed into a 29.0 kbit/s air interface channel by an EDGE multiplexing function. For the non-transparent case, the RA1' function provides direct access to the 12.0 or 6.0 kbit/s data rates. This is achieved by allowing the V.110 frame status bits to be used as additional data bits. This function is described in 3GPP TS 04.21 and 3GPP TS 08.20. RA1' is not applied in TCH/F14.4 or EDGE non-transparent operation.

For TCH/F14.4 channel coding three GSM-specific adaptation functions are used: namely, RA1'/RAA', RAA', and RAA'' (3GPP TS 08.20). On the network side of the air interface, the 14.5 kbit/s substreams multiplexed into a 29.0 or 43.5 kbit/s air interface channel are transferred just as in a multislot connection of TCH/F14.4 substreams. RA1'/RAA' adapts between the 14.5 air-interface rate and the 16 kbit/s rate used across the Abis-interface. RAA' adapts between the 16 kbit/s Abis Interface-rate and 16.0 kbit/s A-interface substream. (Up to four such A-interface substreams may be multiplexed into the 64kbit/s A-interface stream). RAA'' converts between the A-interface data substream(s) and the

overall synchronous stream. In non-transparent operation the RAA'' converts between the A-interface stream and the 290-bit blocks containing bits M1, M2, and 288 data bits as described in 3GPP TS 04.21.

In multislot data configurations the intermediate rates 16, 32, and 64 kbit/s are supported on those sections of the network where the overall data stream is not split into multiple channels (3GPP TS 04.21 and 08.20). RA1-adaptation is not applied to rates higher than 38.4 kbit/s. Instead, a GSM-specific rate adaptation function RA1'' to user rates 48 and 56 kbit/s is applied; this function adapts between these rates and the 64 kbit/s "intermediate" rate. The RA2 function passes rate 64 kbit/s on as such.

In multislot data connections, the rate adaptation functions are performed per TCH/F between the Split/Combine-functions. On the A-interface up to four TCH/Fs are multiplexed into one 64 kbit/s channel according to the procedures defined in 3GPP TS 08.20. However, multiplexing is not applied to those user rates which make use of more than four TCH/Fs; for such rates the Split/Combine-function is located at the BSS.

The splitting and recombining of the data flow into/from TCH/Fs takes place at the RA1-function or RAA'' function (transparent service) at the MSC/IWF and at the MS's RA1/RA1'- or RA1'-function, or between the RLP and RA1' (RA1' not applied to TCH/F14.4) (non-transparent service) at the MS and between RA1 or RAA'' and RLP at MSC/IWF (figures 6 and 7). The TCH/Fs are treated as independent channels between the Split/Combine-functions.

For user rates requiring more than four TCH/Fs (transparent only) the Split/Combine-function is located at the RA1/RA1'-or RA1'-function at the MS and at the RA1'/RA1-function at the BSS (figures 6 and 7). The rate adaptation functions for the various user data rates are summarized in tables 1 to 3. It should be noted that in the case of synchronous data transmission, the RA0 is not present.

For 56 and 64 kbit/s connections using a 2xTCH/F32.0 channel configuration across the radio interface, no rate adaptation is applied as the PLMN offers a '64 kbit/s pipe' between TE and an external network.

For 32 kbit/s connections using a 1xTCH/F32.0 channel configuration across the radio interface, the ITU-T I.460 rate adaptation is applied as described in GSM TS 04.21.

**Table 1: Rate adaptation functions for the support of TE2 in the transparent case**

R I/F	RA0		RA1'		Radio I/F
async	<----->	sync		<----->	
≤ 2.4	<----->	≤ 2.4		<----->	3.6
4.8	<----->	4.8		<----->	6.0
9.6	<----->	9.6		<----->	12.0 or 2 × 6.0
14.4	<----->	14.4		<----->	14.5 or 2 × 12.0 or 3 × 6.0
19.2	<----->	19.2		<----->	2 × 12.0 or 4 × 6.0
28.8	<----->	28.8		<----->	1 × 29.0 or 2 × 14.5 or 3 × 12.0
		32		<----->	1 × 32
38.4	<----->	38.4		<----->	3 × 14.5 or 4 × 12.0
		48.0		<----->	4 × 14.5 or 5 × 12.0
		56.0		<----->	2 × 32.0 or 4 × 14.5 or 5 × 12.0 note 1
		64.0		<----->	2 × 32.0 or 5 × 14.5 or 6 × 12.0 note 1

NOTE 1: AIUR of 11.2 kbit/s per 12.0 kbit/s air interface channel (3GPP TS 04.21).



**Table 2: Rate adaptation functions for the support of TE1/TA in the transparent case**

	RA0		RA1		RA2	S I/F	RA2		RA1/RA1'	Radio I/F
<b>async</b>		<b>sync</b>								
≤ 2.4	<----->	≤ 2.4	<----->	8	<----->	64	<----->	8	<----->	3.6
4.8	<----->	4.8	<----->	8	<----->	64	<----->	8	<----->	6.0
9.6	<----->	9.6	<----->	16	<----->	64	<----->	16	<----->	12.0 or 2 × 6.0
14.4	<----->	14.4	<----->	32	<----->	64	<----->	32	<----->	14.5 or 2 × 12.0 or 3 × 6.0
19.2	<----->	19.2	<----->	32	<----->	64	<----->	32	<----->	2 × 12.0 or 4 × 6.0
28.8	<----->	28.8	<----->	64	<----->	64	<----->	64	<----->	1 × 29.0 or 2 × 14.5 or 3 × 12.0
38.4	<----->	38.4	<----->	32	<----->	64	<----->	32	<----->	1 × 32
				64	<----->	64	<----->	64	<----->	3 × 14.5 or 4 × 12.0
			<b>RA1''</b>		<b>RA2</b>	<b>S I/F</b>	<b>RA2</b>		<b>RA1/RA1'</b>	<b>Radio I/F</b>
		48.0	<----->	64	<----->	64	<----->	64	<----->	4 × 14.5 or 5 × 12.0 note 1
		56.0	<----->	64	<----->	64	<----->	64	<----->	2 × 32.0 or 4 × 14.5 or 5 × 12.0 notes 1, 2
				64	<----->	64	<----->	64	<----->	2 × 32.0 or 5 × 14.5 or 6 × 12.0 notes 1, 2

NOTE 1: RA2 not applicable.

NOTE 2: AIUR of 11.2 kbit/s per 12.0 kbit/s air interface channel (3GPP TS 04.21).

**Table 3: RA1' function in the non-transparent case**

	RA1'	
6.0	<----->	6.0
12.0	<----->	12.0

NOTE: RA1' not applicable to TCH/F14.4, TCH/F28.8, or TCH/F43.2

## 6.1.2 Radio Link Protocol

The Radio Link Protocol (RLP) is a layer 2 LAPB based protocol which performs grouping of user data for the purpose of implementing error control and retransmission mechanisms in the case of non-transparent low layer capabilities. The RLP layer is in charge of the transmission of the data compression parameters to the peer RLP entity and to the L2R layer, when those parameters have to be negotiated. The function that realizes the implementation of the protocol (described in 3GPP TS 24.022) takes place at both ends of the GSM connection in the MT and the IWF/MSC.

## 6.1.3 Layer 2 Relay function

The Layer 2 Relay function (L2R) performs protocol conversion between the user data structure (e.g. characters or X.25 Layer 2 frames) and a structure more adapted to the radio link protocol. This function is described in the relevant 3GPP TS 27-series specifications.

The L2R function includes the data compression function.

## 6.1.4 Resources allocated by the GSM network

Part of the GSM connection concerns the resources allocated by the GSM network on the basis of the attribute values of the connection elements.

For the speech calls, the GSM codec is allocated.

For data calls, resources are provided at the IWF/MSC such as:

- V.110 based rate adaptation for such channel codings as TCH/F 4,8 and TCH/F9,6 and GSM specific rate adaption for channel codings TCH/F14.4, TCH/F28.8, TCH/F43.2 (3GPP TS 04.21, 08.20);
- filtering of status bits (TS 27.001);
- RLP for non-transparent services (TS 24.022);
- Data compression (TS 24.022, 27.002).

These are sufficient for data services such as:

- asynchronous circuit (bearer service series 20), used with unrestricted digital information transfer capability;
- synchronous circuit (bearer service series 30), used with unrestricted digital information transfer capability when interworking with circuit switched digital networks.

In addition to the above listed resources, further resources are allocated in the other cases:

- modems for asynchronous circuit (bearer service series 20) or synchronous circuit (bearer service series 30) used with 3.1 kHz information transfer capability;
- fax adaptor for the fax group 3 (teleservice series 60);
- flag stuffing for synchronous packet using bearer service series 30 with unrestricted digital information transfer capability when interworking with packet switched networks.

## 6.2 GSM PLMN connection elements

The radio interface connection element is the portion of the connection spanning from the Mobile Termination to an appropriate internal reference point within the Base Station System.

The A interface connection element is the portion of the connection from the above internal reference point within the base station to an appropriate internal reference point within the interworking function (IWF) of the MSC.

By using connection elements and attributes which have a layered nature the construction of a connection type is more easily viewed. The use of different values for the same attribute allows a greater degree of description and flexibility.

## 6.3 Rules of association for the attribute values of connection elements and connection types

This subclause describes the relationship between the attribute values of connection elements and connection types. For each attribute the various possible values recommended are listed. The definitions of the attributes and attribute values are contained in the annex A. In addition to the (possible) attribute values applicable to the connection elements, an association law is given (where appropriate) for each attribute to show how the value of the attribute for the overall connection type is obtained from the values of the attribute applicable to the connection elements.

### 6.3.1 Information transfer mode

Attribute values for connection elements:

Circuit.

Attribute values for overall connection type:

Circuit.

Association Law:

Circuit.

### 6.3.2 Information transfer rate (kbit/s)

Attribute values for connection elements:

3.6 or 6.0 or 12.0 or 13.0 or 14.5 or 29.0 or 32.0 or 43.5 or 64.0

or  $n \times 6.0$  ( $1 \leq n \leq 4$ ) or  $n \times 12.0$  ( $1 \leq n \leq 6$ ) or  $n \times 14.5$  ( $1 \leq n \leq 5$ ) or  $2 \times 29.0$  or  $2 \times 32.0$

Attribute values for overall connection type:

3.6 or 6.0 or 12.0 or 13.0 or 14.5 29.0 or 32.0 or 43.5 or 64.0;

or  $n \times 6.0$  ( $1 \leq n \leq 4$ ) or  $n \times 12.0$  ( $1 \leq n \leq 6$ ) or  $n \times 14.5$  ( $1 \leq n \leq 5$ ) or  $2 \times 29.0$  or  $2 \times 32.0$ ..

Association Law:

The value for the overall connection type will be equal to the lowest value of any of its connection elements.

### 6.3.3 Information transfer susceptance

Attribute values for connection elements:

Speech processing functions (e.g. GSM Speech Coding/A Law conversion, Discontinuous Transmission) and/or Echo suppression functions and/or Multiple satellite hops or null.

Attribute values for overall connection types:

Unrestricted Digital Information or Speech.

Association Law:

For an overall connection type to have the value Unrestricted digital no connection element may contain speech processing functions or echo suppression functions. Connection elements containing speech processing devices having the flexibility to change operation between speech and unrestricted digital would on the other hand be allowed to be part of a number of different connection types.

For an overall connection type to have the value speech it must contain GSM Speech Coding/A Law conversion equipment and echo suppression functions when appropriate.

### 6.3.4 Establishment of connection

Attribute values for connection elements:

Demand.

Attribute values for overall connection type:

Demand.

Association Law:

If any of the connection elements are Demand, then the overall connection type is Demand.

### 6.3.5 Symmetry

Attribute values for connection elements:

Bidirectional Symmetric.

Bidirectional Asymmetric (Multislot connections for data).

Attribute values for overall connection type:

Bidirectional Symmetric.

Bidirectional Asymmetric (Multislot connections for data).

Association Law:

The overall symmetry can only be generated from the connection elements by analysis of the connection element values in the context of the architecture of the connection.

## 6.3.6 Connection configuration Topology

Attribute values for connection elements:

Point-to-point.

Attribute values for the overall connection type:

Not applicable.

Association Law:

Not applicable.

## 6.3.7 Structure

Attribute values for connection elements:

Unstructured or Service Data Unit Integrity.

Attribute values for the overall connection type:

As per values for connection elements.

Association Law:

Unspecified.

## 6.3.8 Channels

### 6.3.8.1 Information channel (rate)

Attribute values for connection elements:

Radio interface connection element: Full rate TCH or Full rate TCHs or Half rate TCH.

A interface connection element: 64.0 kbit/s.

Attribute values for the overall connection type:

Not applicable.

### 6.3.8.2 Signalling channel (rate)

Attribute values for connection elements:

Radio interface connection element: Dm.

A interface connection element: Common channel signalling system (64.0 kbit/s).

Attribute values for the overall connection type:

Not applicable.

## 6.3.9 Connection control protocol

Attribute values for connection elements:

Radio interface connection element:

Layer 1: 3GPP TS 04.03 and 3GPP TS 05-series.

Layer 2: 3GPP TS 04.05 and 04.06.

Layer 3: 3GPP TS 24.007 and 24.008, 24.011.

A interface connection element:

Layer 1: 3GPP TS 08.04.

Layer 2: 3GPP TS 08.06.

Layer 3: TS 24.007, 24.008 and 08.08.

Attribute values for the overall connection type:

Not applicable.

### 6.3.10 Information transfer coding/protocol

Attribute values for connection elements:

Radio interface connection elements:

Layer 1: 3GPP TS 04.21, 3GPP TS 05-series and 06-series.

Layer 2: 3GPP TS 04.06, 24.022 and 3GPP TS 27.002 or 3GPP TS 24.022 and 3GPP TS 27.003 or transparent.

Layer 3: Transparent, 3GPP TS 24.011.

A interface connection element:

Layer 1: 3GPP TS 08.04 and 3GPP TS 08.20.

Layer 2: 3GPP TS 24.022 and 3GPP TS 27.002 or 3GPP TS 24.022 and 3GPP TS 27.003 or transparent.

Layer 3: Transparent.

Attribute values for the overall connection type:

Not applicable.

### 6.3.11 Further attributes and attribute values

This subclause has outlined the relationships between those attributes values presently existing, the possibility for new values being added remains.

Table 4 summarizes the attributes values for GSM PLMN connection elements.

Table 4: Values for attributes for GSM PLMN connection elements

Attributes	Values for attributes	
	Radio interface connection element	A interface connection element
1 Information Transfer Mode	Circuit	Circuit
2 Information Transfer Rate Layer 1	3.6 or 6.0 or 12.0 or 13.0 or 14.5 or 29.0 or 32.0 or 43.5 or $n \times 6.0$ ( $1 \leq n \leq 4$ ) or $n \times 12.0$ ( $1 \leq n \leq 6$ ) or $n \times 14.5$ ( $1 \leq n \leq 5$ ) or $2 \times 29.0$ or $2 \times 32.0$ kbit/s	64.0 kbit/s
3 Information Transfer Susceptance	Speech processing equipment, Echo suppression equipment, Null	Speech processing equipment, Echo suppression equipment, Null
4 Establishment of Connection	Demand	Demand
5 Symmetry	Bidirectional symmetric Bidirectional asymmetric	Bidirectional symmetric Bidirectional asymmetric
6 Connection Configuration Topology	Point-to-point	Point-to-point
7 Structure	Unstructured SDU integrity	Unstructured SDU integrity
8 Channel Rate Information Channel Signalling Channel	TCH/F(s) or TCH/H Dm	64.0 kbit/s  Common channel signalling system
9 Connection Control Protocol Layer 1 Layer 2 Layer 3	3GPP TS 04.03 and 05 series 3GPP TS 04.05 and 04.06 3GPP TS 24.007, 24.008, 24.011	3GPP TS 08.04 3GPP TS 08.06 3GPP TS 24.007, 24.008, 08.08
10 Information Transfer Coding/Protocol Layer 1 Layer 2 Layer 3	3GPP TS 04.21 05 and 06 series 3GPP TS 24.022 and 27.002 or 24.022 and 27.003 04.06 or transparent Transparent, 24.011	3GPP TS 08.04 and 08.20 3GPP TS 24.022 and 27.002 or 24.022 and 27.003 or transparent Transparent

## 6.4 Limited set of GSM PLMN connection types (all channel codings excluding TCH/F14.4)

From the two connection elements defined in subclause 6.2, the list of attributes and their possible values given in subclause 6.3, and from the service requirements defined in 3GPP TS 22.002 and 02.03, a limited set of GSM PLMN connection types have been identified (see also table 5 and table 6 for the relationship between connection elements and telecommunication services).

Figure 6 gives the information transfer protocol models for the identified set of GSM PLMN connection types. The S bits correspond to status bits and the D bits to data bits (3GPP TS 04.21); S\* indicates that S bits are used only when 3.1 kHz audio ex PLMN. D' bits corresponds to user bits passed in the place of status bits in the non transparent case. Moreover, it should be noted that the RLP rate of 6 and 12 kbit/s correspond to the 8 and 16 Kbit/s intermediate rate in the transparent case.

Protocol Models 1 a and b are the models for asynchronous data transmission in the transparent mode. Models 1d and 1e are for multislot transparent asynchronous data configurations.

Protocol Models 2 a and b are the models for synchronous data transmission in the transparent mode. Models 2d and 2e are for multislot transparent synchronous data.

Protocol Models 3 a and b are the models for character "asynchronous" mode data transmission in the non-transparent mode. In this case, L2RCOP represents the protocol used between the Layer 2 Relay functions (L2R) to convey characters between the MS and the IWF (see 3GPP TS 27.002). The data compression function is located in the L2R COP function. Models 3d and 3e are for multislot character "asynchronous" data transmission in the non-transparent mode.

Protocol Models 4 a, b, and c are the models for synchronous data transmission using the ITU-T Recommendation X.25 PSPDN access protocol in the non-transparent mode. In this case, L2RBOP represents the protocol used between the Layer 2 Relay functions (L2R) to convey the LAP-B information between the MS and the IWF (see 3GPP TS 27.003).

Models 4d, 4e, and 4f are for multislot synchronous data transmission using the ITU-T Recommendation X.25 PSPDN access protocol in the non-transparent mode.

In all the above models, the a, d and b, e variants indicate alternative access arrangements at the MS, i.e. access at the S interface or at the R interface. The c and f variants indicate a further alternative access arrangement where rate adaptation at the S interface is performed by flag stuffing as defined in ITU-T Recommendation X.31.

Protocol Model 5a is the model for the transparent support of group 3 facsimile transmission. Model 5b is for transparent support of group 3 facsimile transmission in multislot data configurations.

Protocol Models 6 a and b are the models for speech transmission. As in models 1-4, the a and b variants indicate alternative access arrangements at the MS, i.e. access at the S interface or direct access of the telephony teleservice.

Protocol model 7 a is the model for the non-transparent support of group 3 facsimile transmission. Model 7b is for non-transparent support of group 3 facsimile transmission in multislot data configurations.

In the multislot-data models the data is split into parallel substreams between the Split/Combine-functions (S/C). These substreams are transmitted through parallel TCH/Fs which are treated as independent channels. Between the S/C-functions parallel RA- and FEC-functions are used.

For all the models, only the minimum functionality of the IWF is shown. Additional functions will be required for various interworking situations. These additional functions are described in specifications 3GPP TS 29.006 and 3GPP TS 29.007.

It should be noted that, in Figure 6, the representation of the transcoding and rate adaptation from the intermediate rate on the radio interface to the 64 kbit/s rate required by the MSC is not intended to indicate a particular implementation. The annex B to 3GPP TS 03.10 identifies alternative arrangements.

## 6.5 Limited set of GSM PLMN connection types (for TCH/F14.4 channel coding)

Figure 7 provides the information transfer protocol models for the identified set of GSM PLMN connection types for support of TCH/F14.4. The description of models given in subclause 6.4 applies also to figure 7.

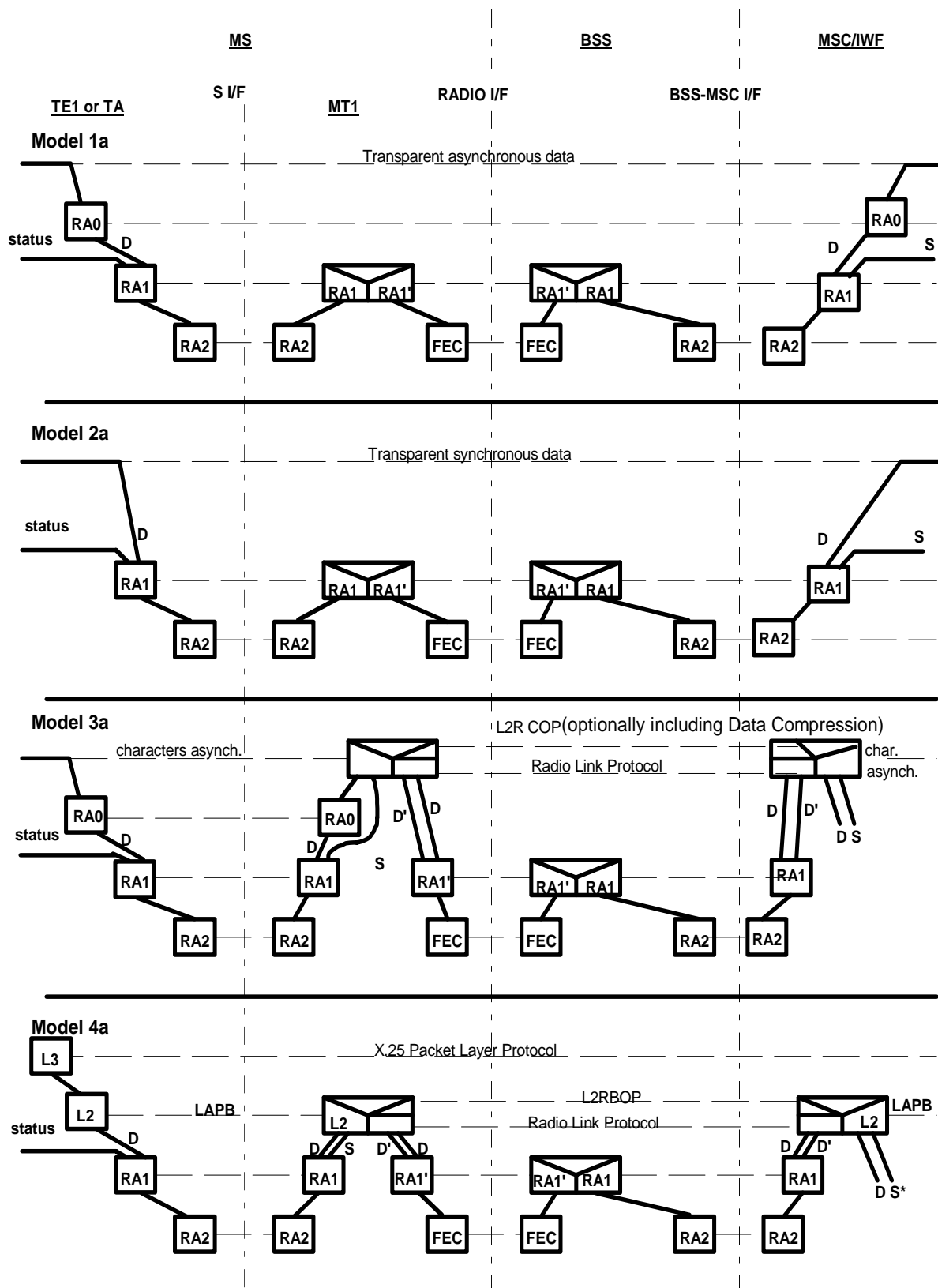

Figure 6: Information transfer protocol models for GSM PLMN connections



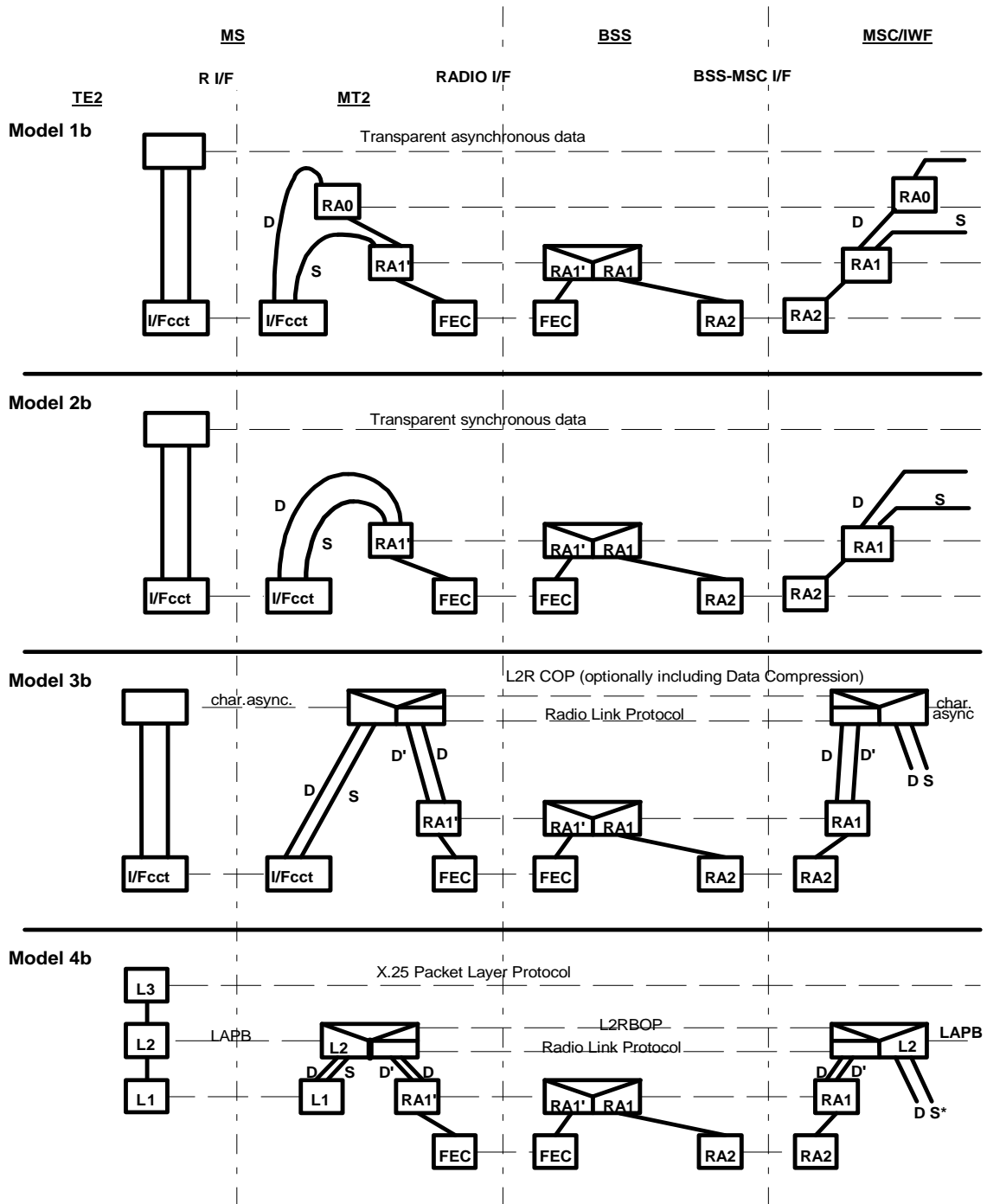

Figure 6 (continued): Information transfer protocol models for GSM PLMN connections

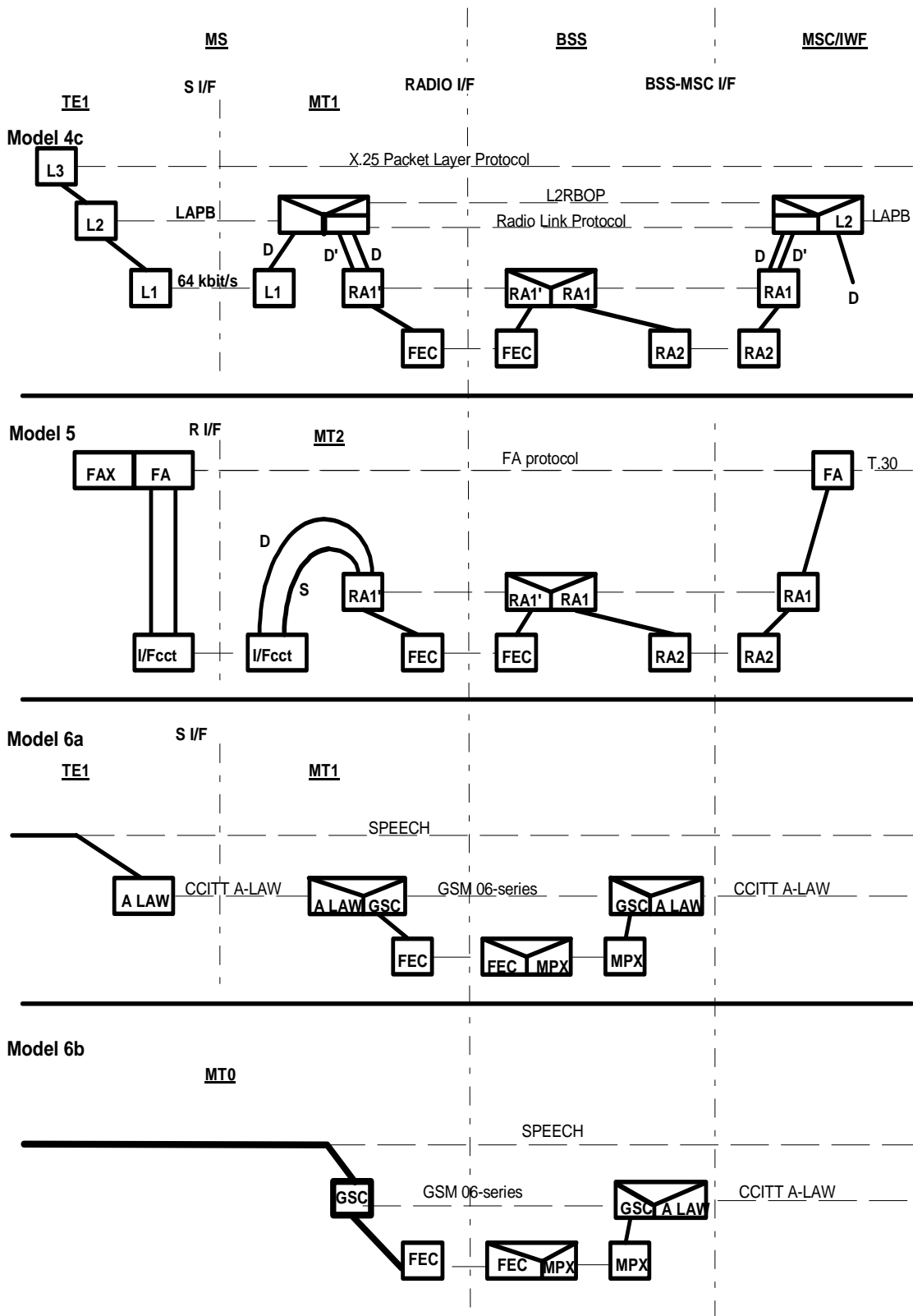

Figure 6 (continued): Information transfer protocol models for GSM PLMN connections

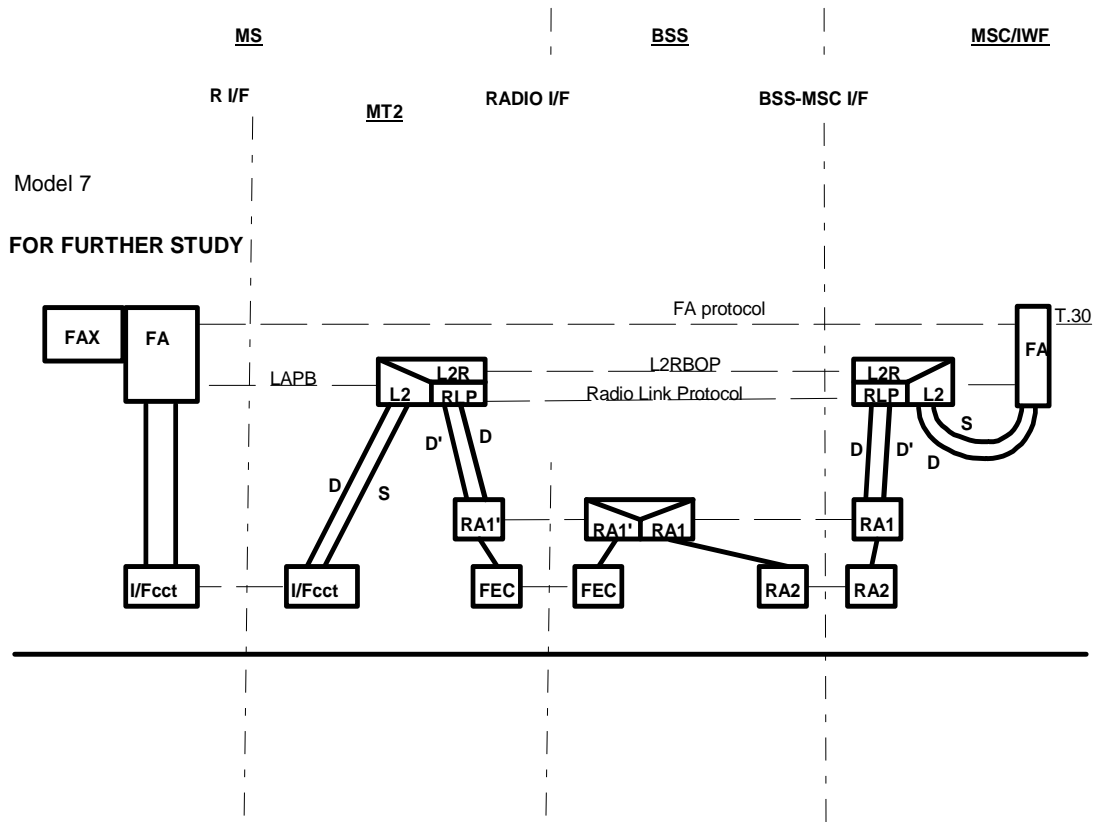

Figure 6 (continued): Information transfer protocol models for GSM PLMN connections

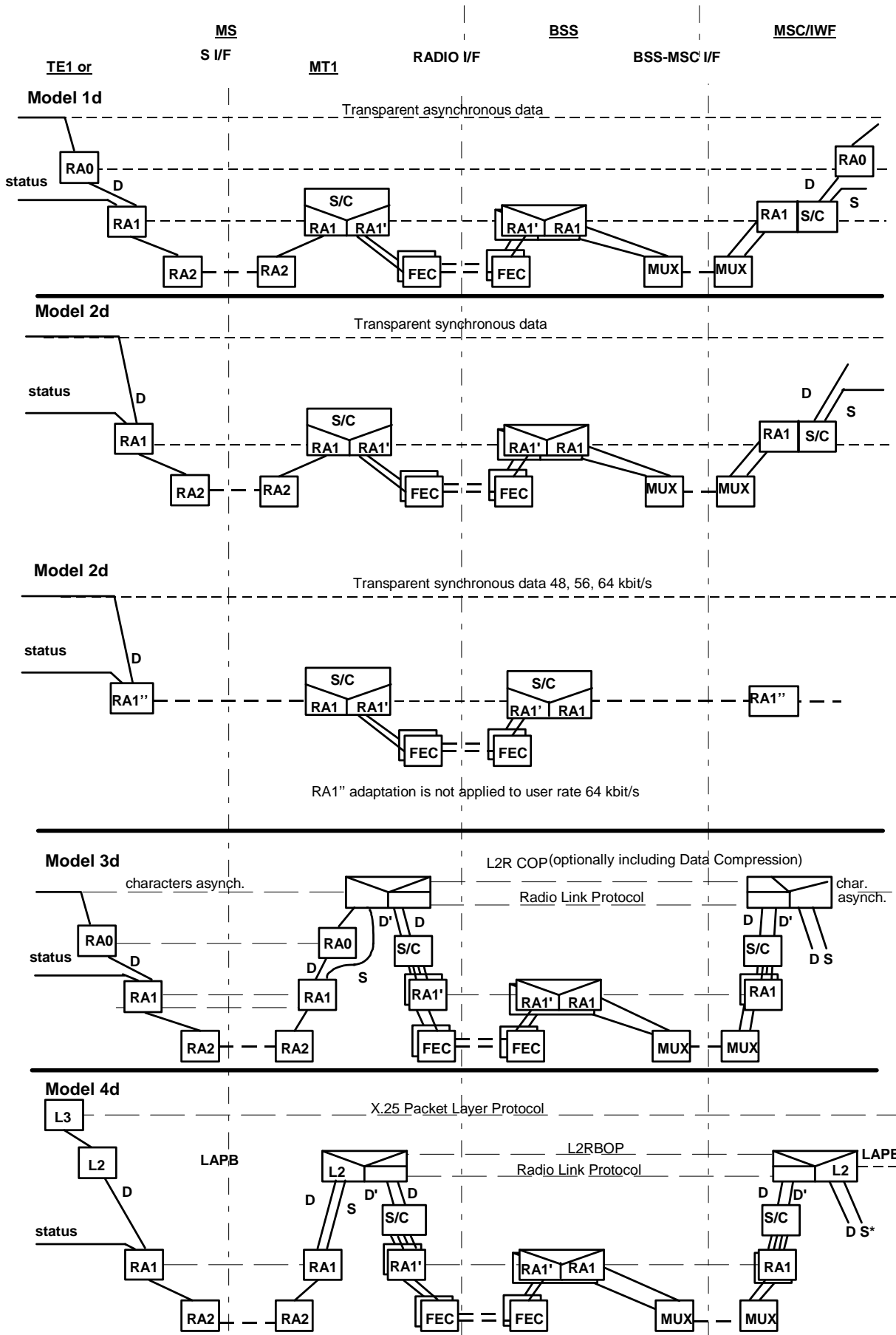

Figure 6 (continued): Information transfer protocol models for GSM PLMN connections

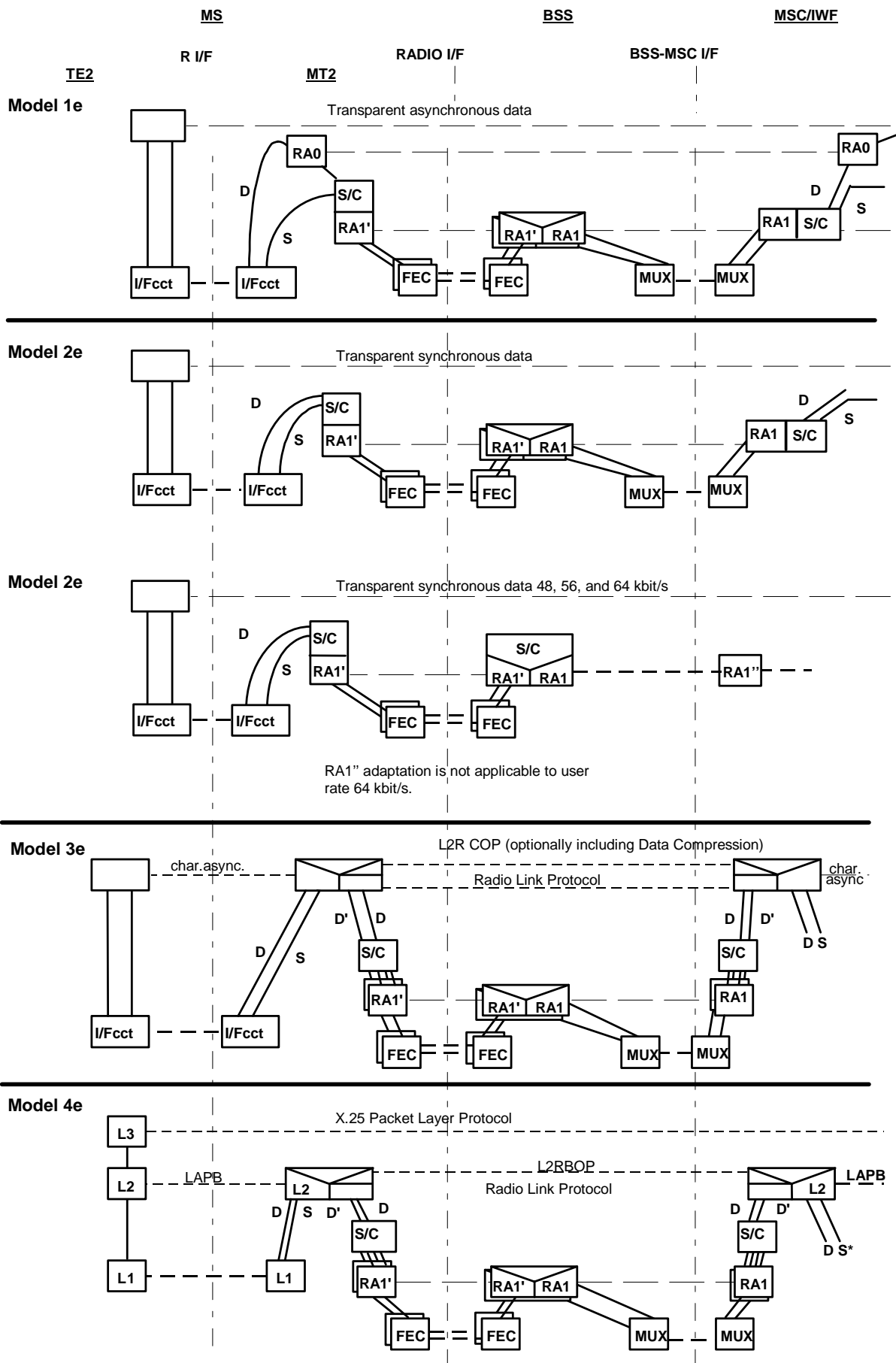

Figure 6 (continued): Information transfer protocol models for GSM PLMN connections

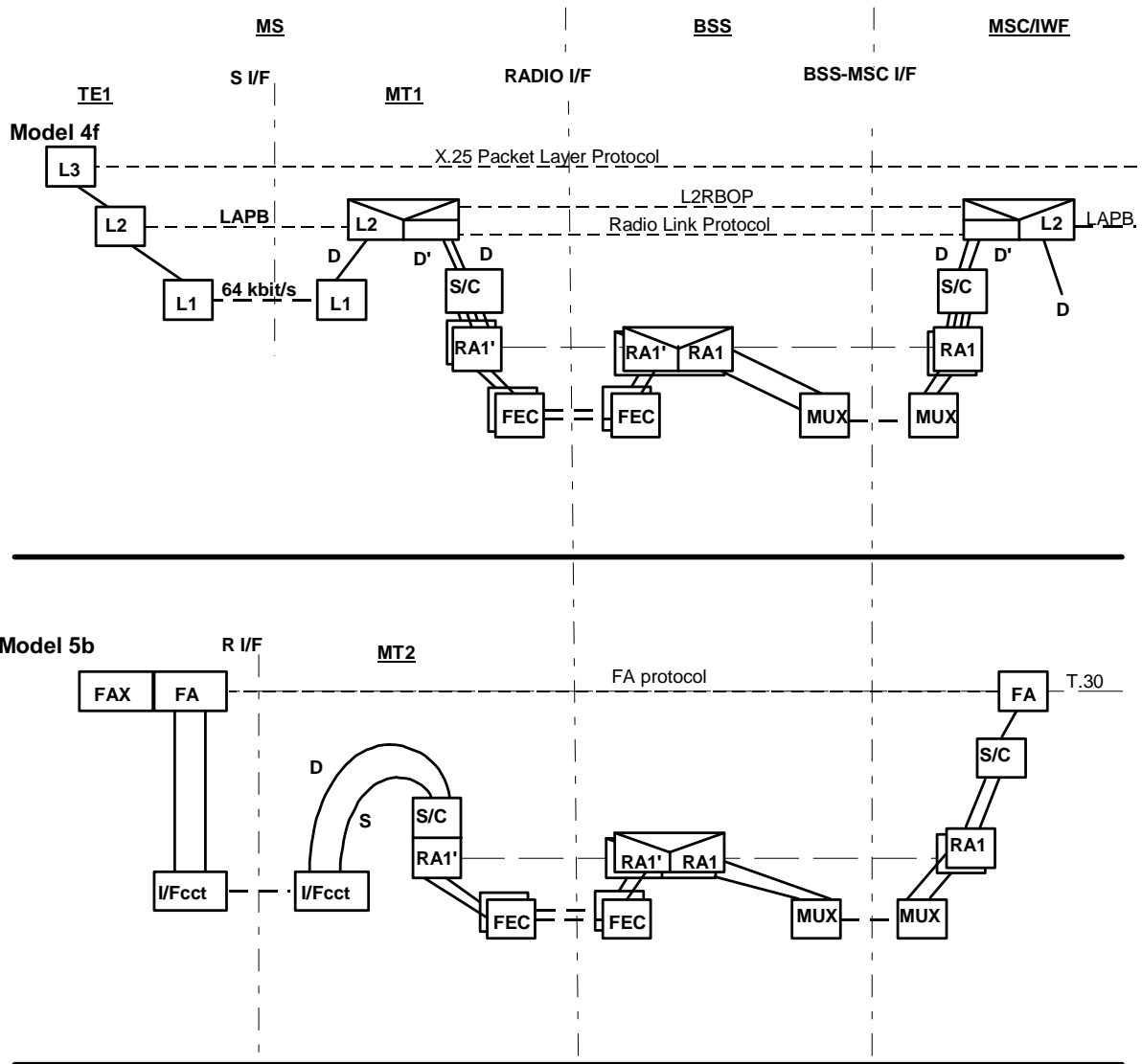

Figure 6 (continued): Information transfer protocol models for GSM PLMN connections

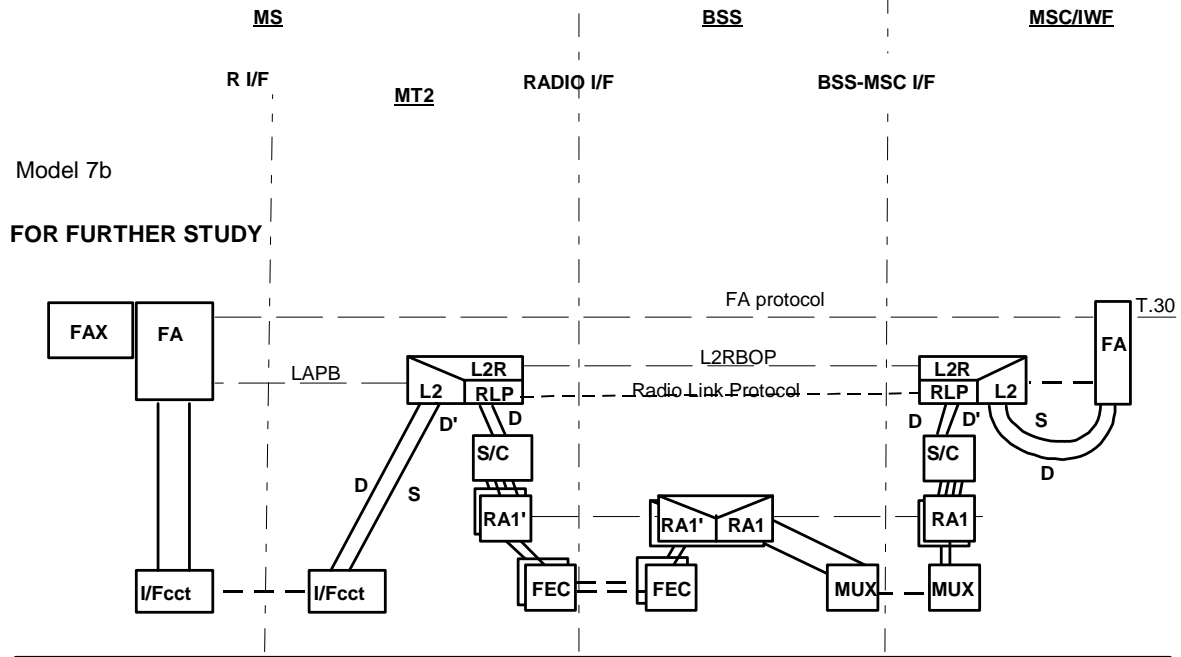

Figure 6 (concluded): Information transfer protocol models for GSM PLMN connections

Legend	to Figure 6:
FA	= Fax Adaptor
GSC	= GSM Speech Codec
FEC	= Forward Error Correction
MPX	= Multiplex/Demultiplex
MUX	= Multiplex/Demultiplex
S/C	= Split/ Combine

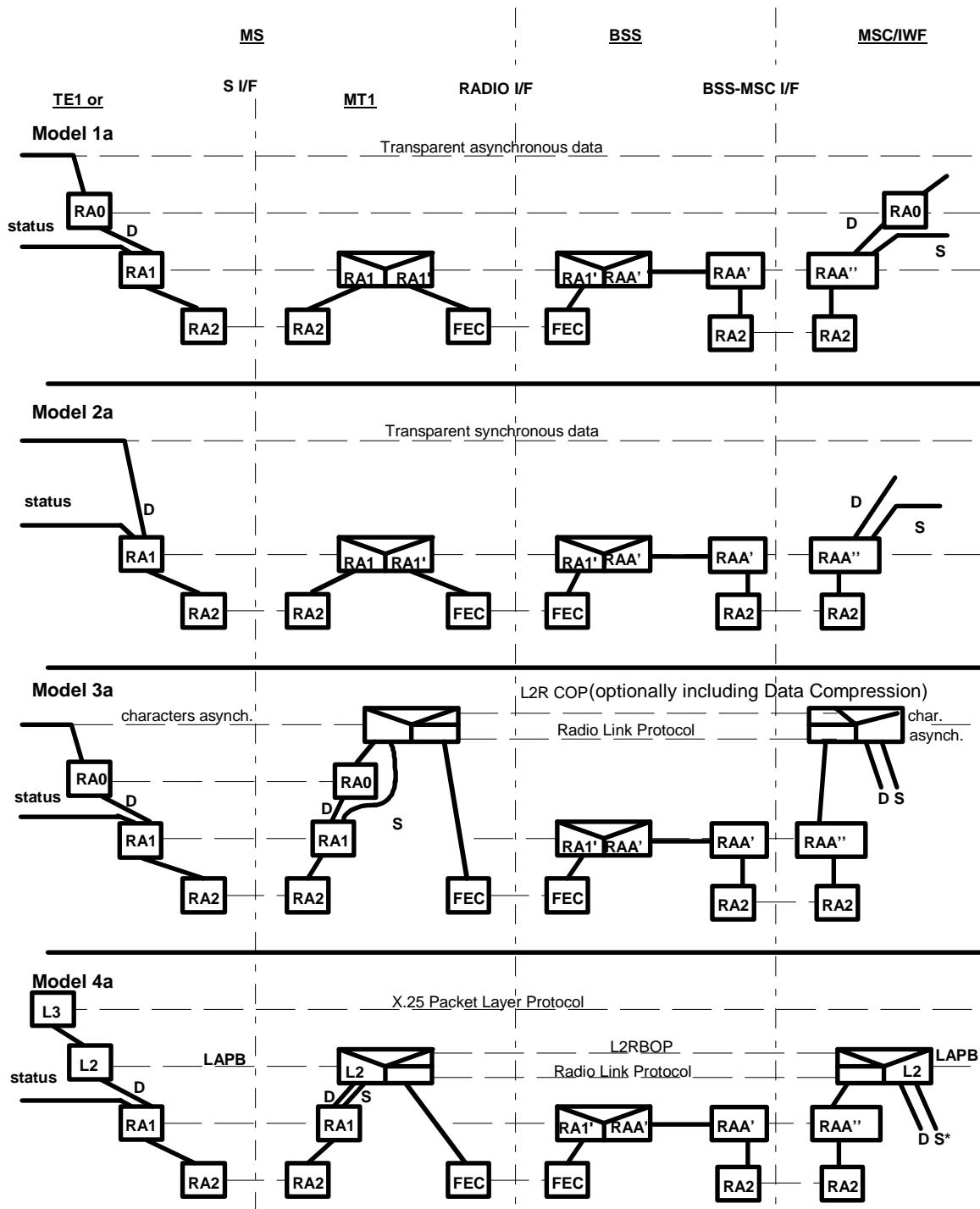

Figure 7: Information transfer protocol models for GSM PLMN connections using 14.4 channels



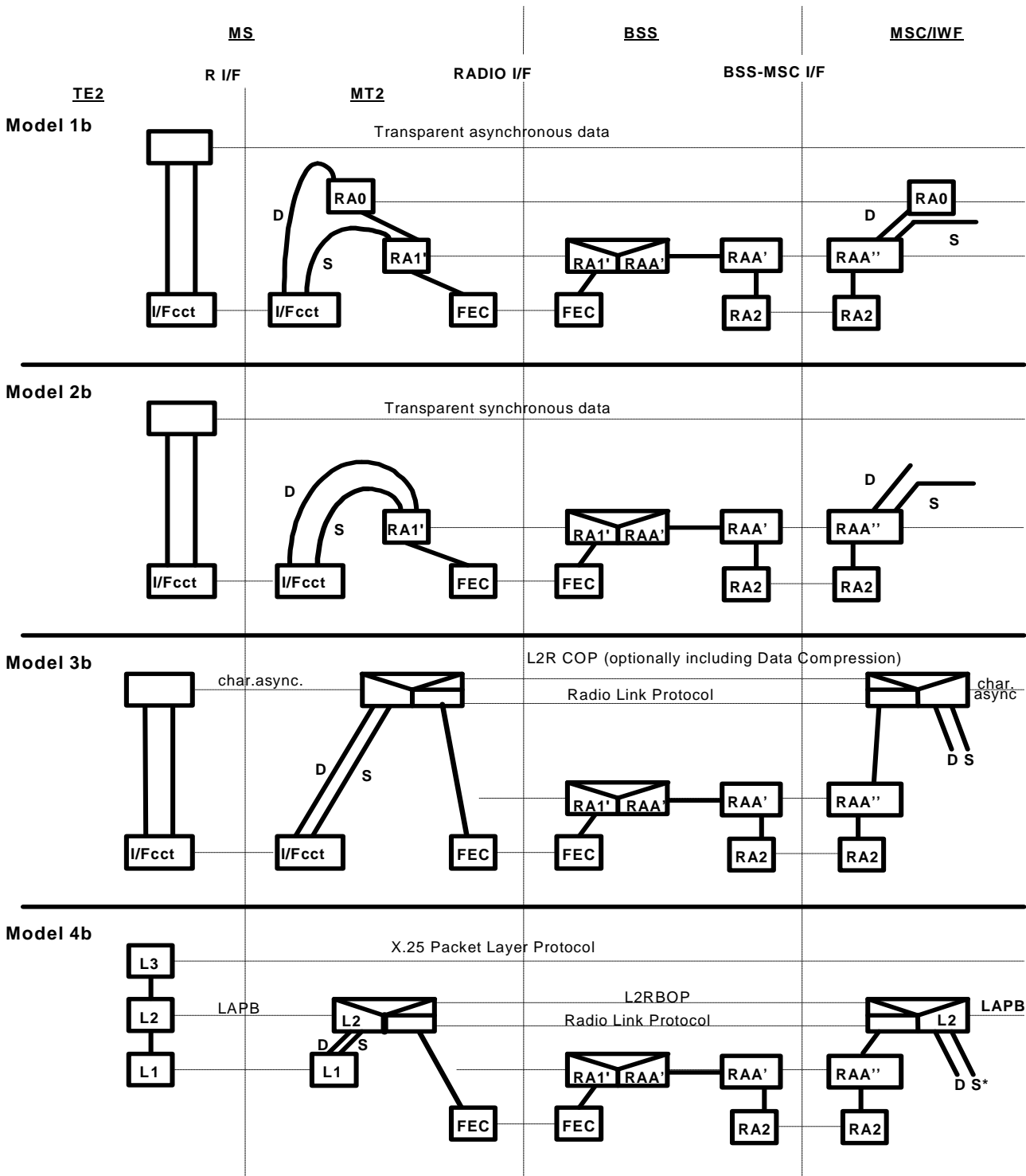

Figure 7 (continued) : Information transfer protocol models for GSM PLMN connections using 14.4 channels

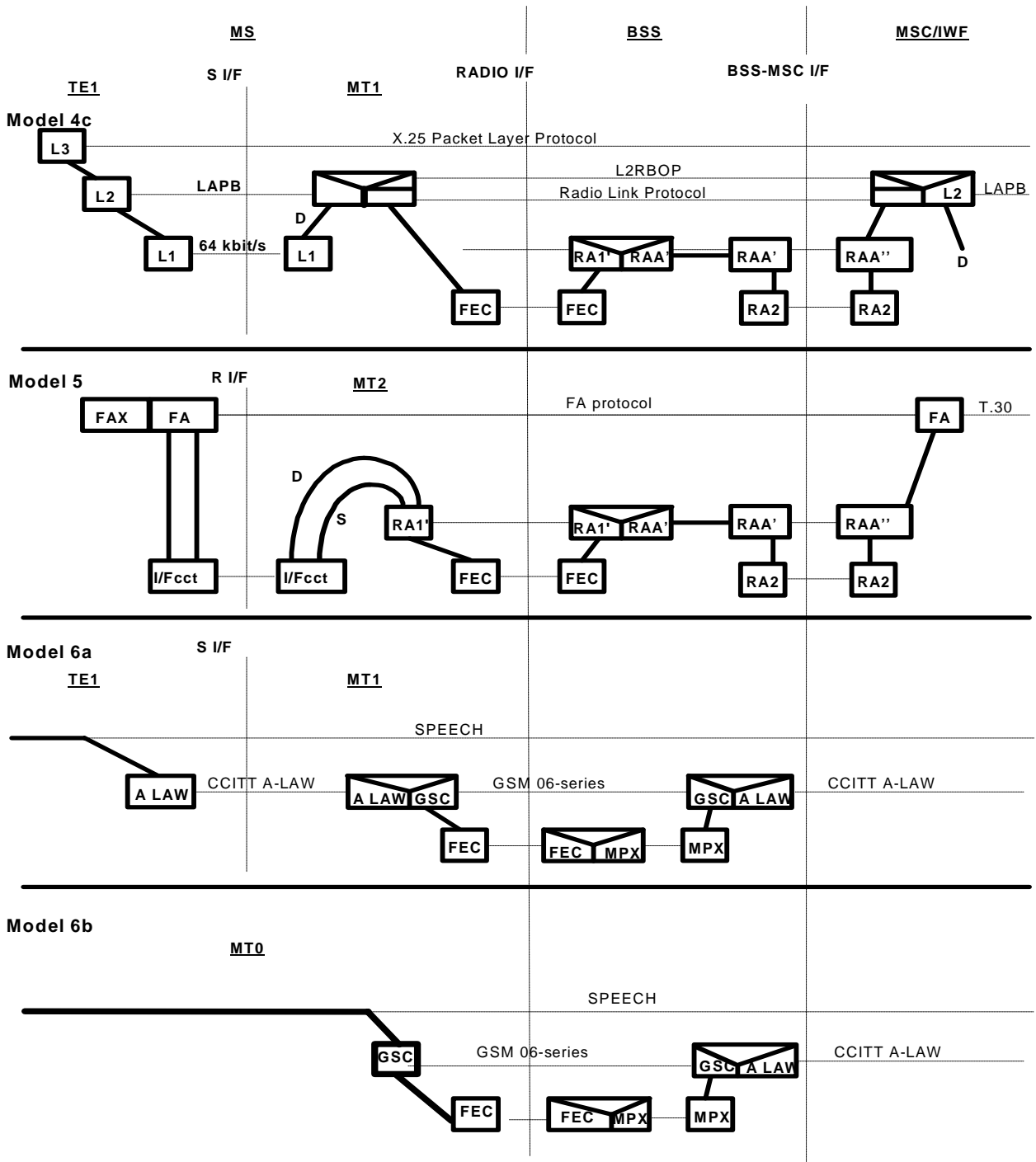

Figure 7 (continued) : Information transfer protocol models for GSM PLMN connections using 14.4 channels

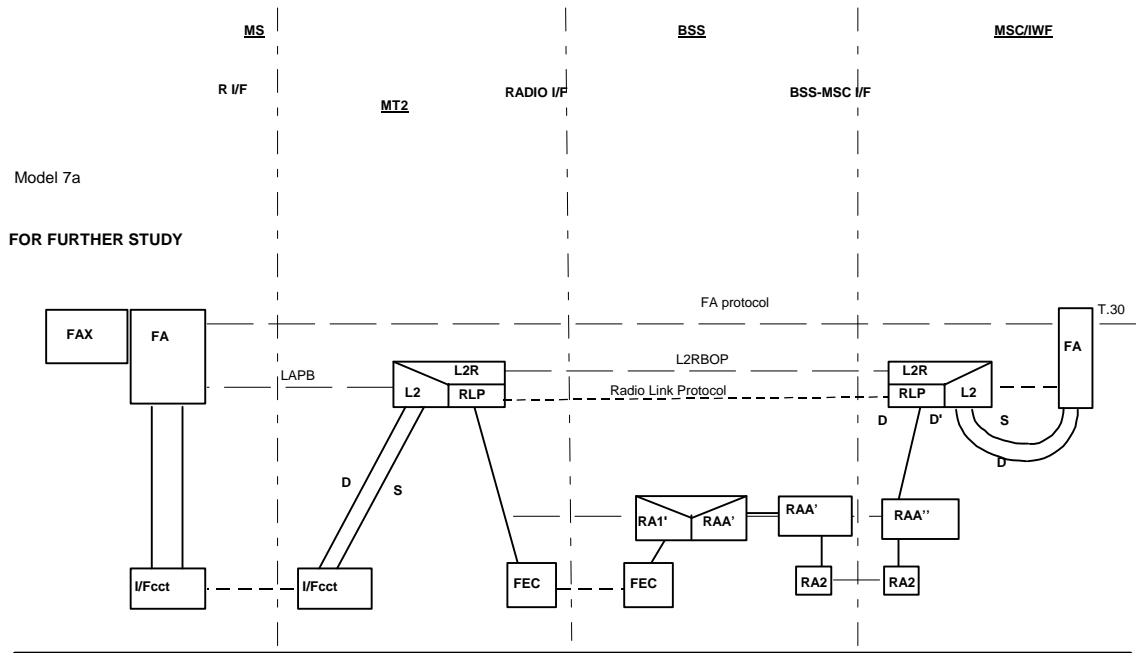

Figure 7 (continued) : Information transfer protocol models for GSM PLMN connections using 14.4 channels

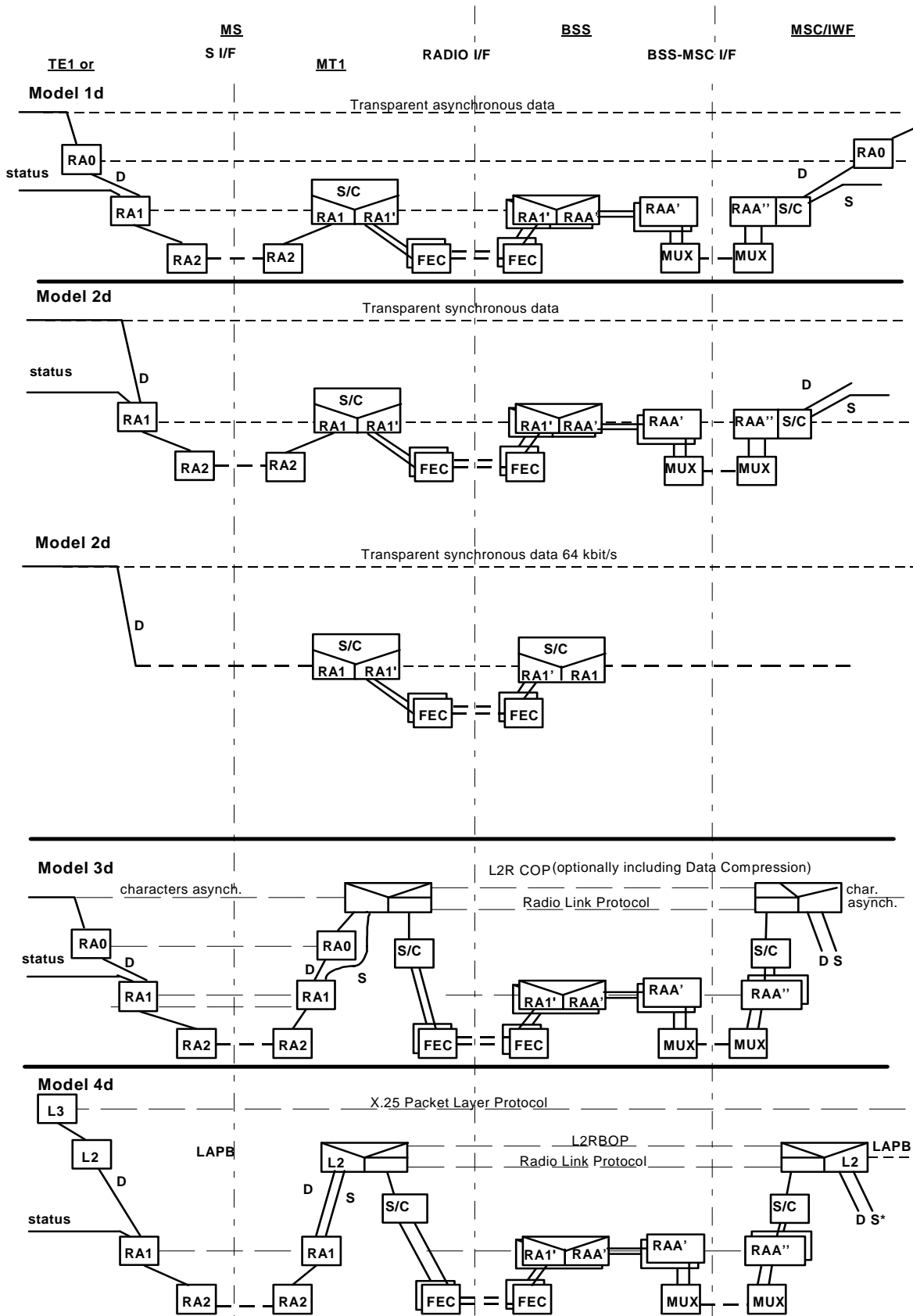

Figure 7 (continued) : Information transfer protocol models for GSM PLMN connections using 14.4 channels

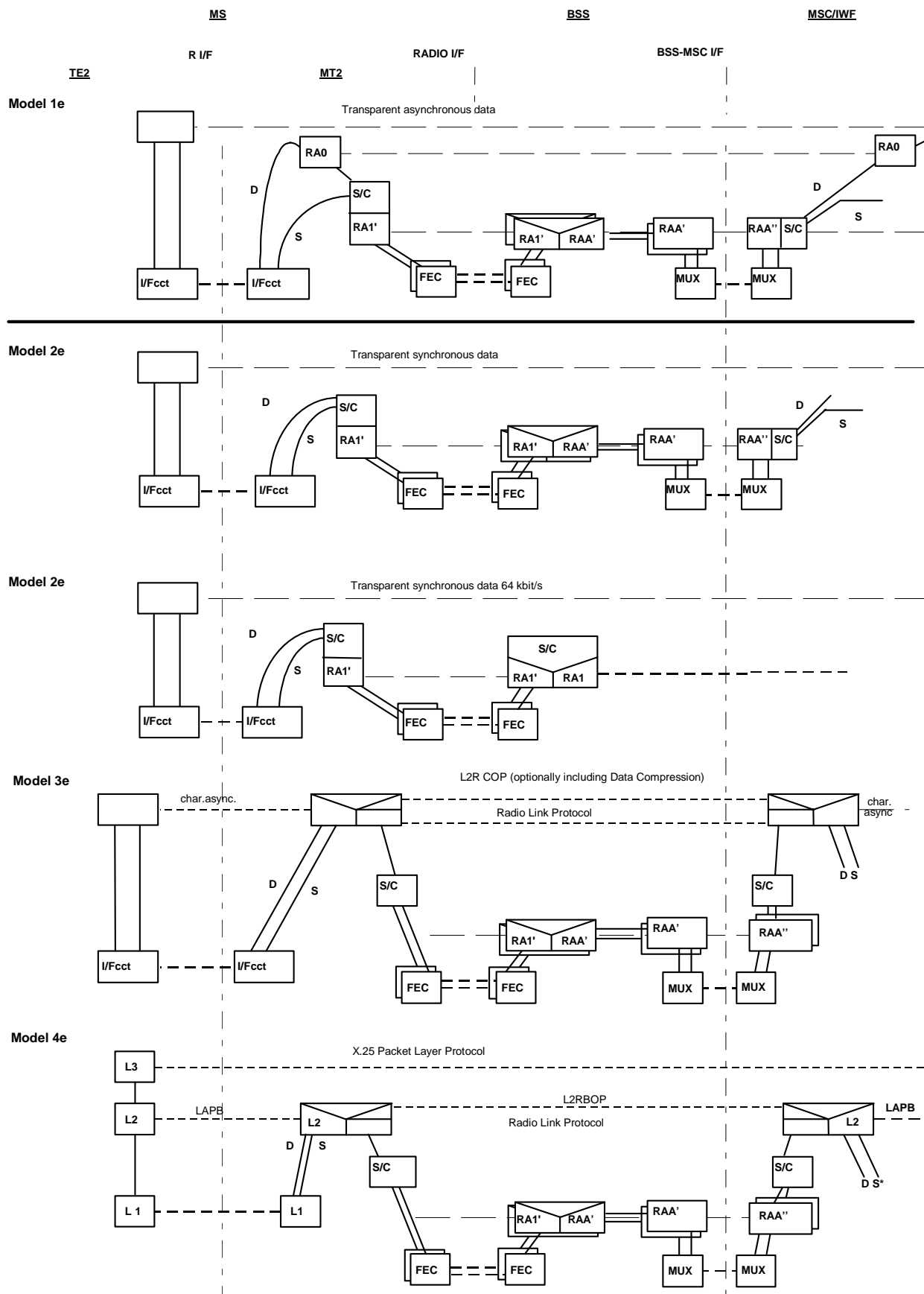

Figure 7 (continued) : Information transfer protocol models for GSM PLMN connections using 14.4 channels

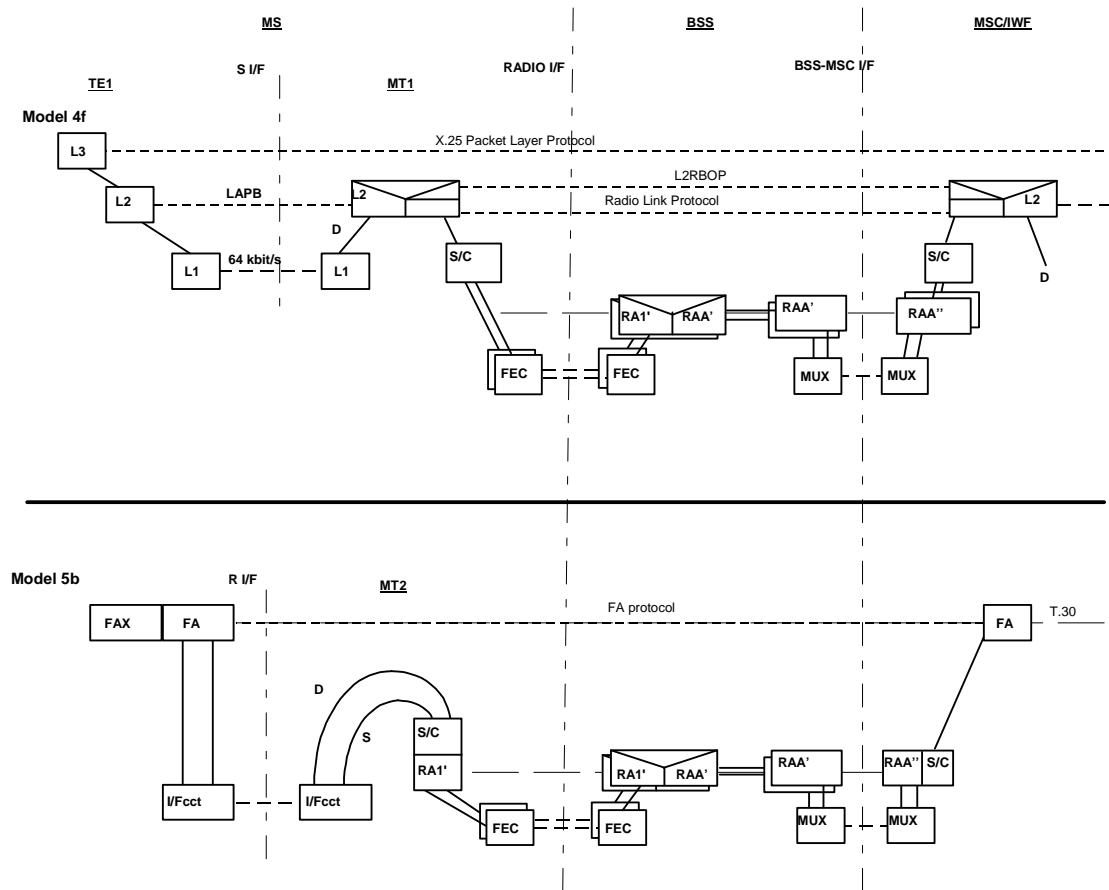
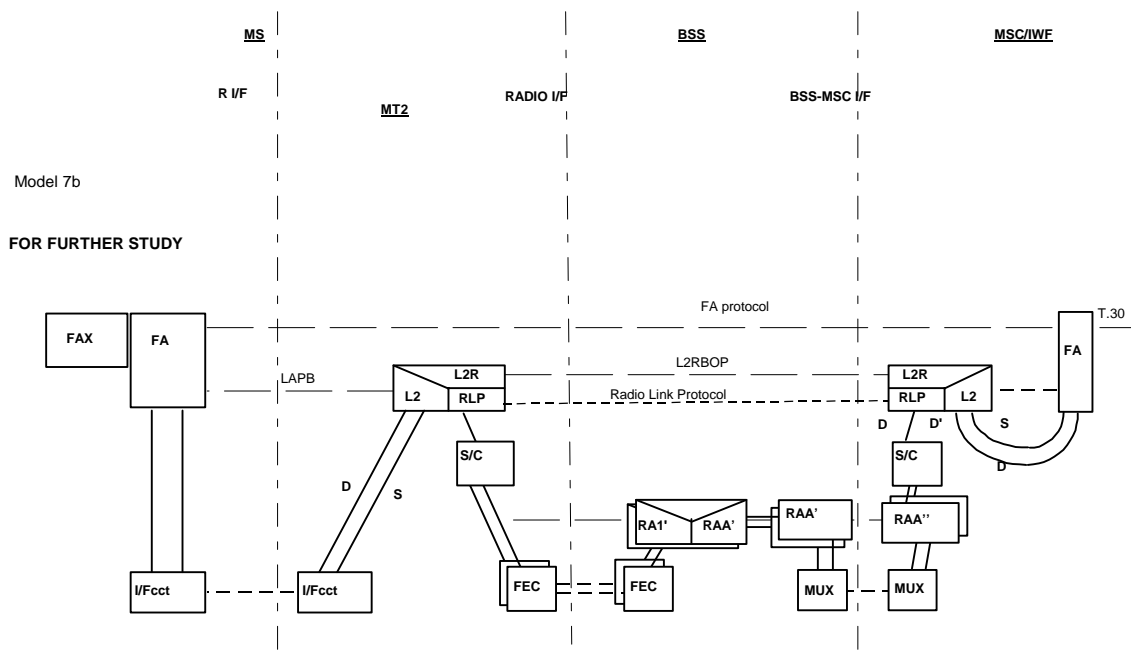

Figure 7 (continued) : Information transfer protocol models for GSM PLMN connections using 14.4 channels



**Figure 7 (concluded) : Information transfer protocol models for GSM PLMN connections using 14.4 channels**

Legend to Figure 7:	
FA	= Fax Adaptor
GSC	= GSM Speech Codec
FEC	= Forward Error Correction
MPX	= Multiplex/Demultiplex
MUX	= Multiplex/Demultiplex
S/C	= Split/ Combine

## 6.6 Limited set of GSM PLMN connection types (for EDGE channels)

Figure 8 provides the information transfer protocol models for the identified set of GSM PLMN connection types for support of TCH/F28.8 or TCH/F43.2. The description of models given in subclause 6.4 applies also to figure 8.

When a TCH/F28.8 channel is used in multislot configurations, multiple EDGE multiplexing functions are applied on both sides of the air-interface; i.e. one multiplexing function — on each side of the air interface — is associated with each air-interface channel.

When TCH/F32.0 channels are used in double slot configurations, no rate adaptation is applied as the PLMN offers a '64 kbit/s pipe' between TE and an external network. When TCH/F32.0 channels are used in single slot configurations, the ITU-T I.460 rate adaptation is applied. (For details refer to 3GPP TS 04.21).

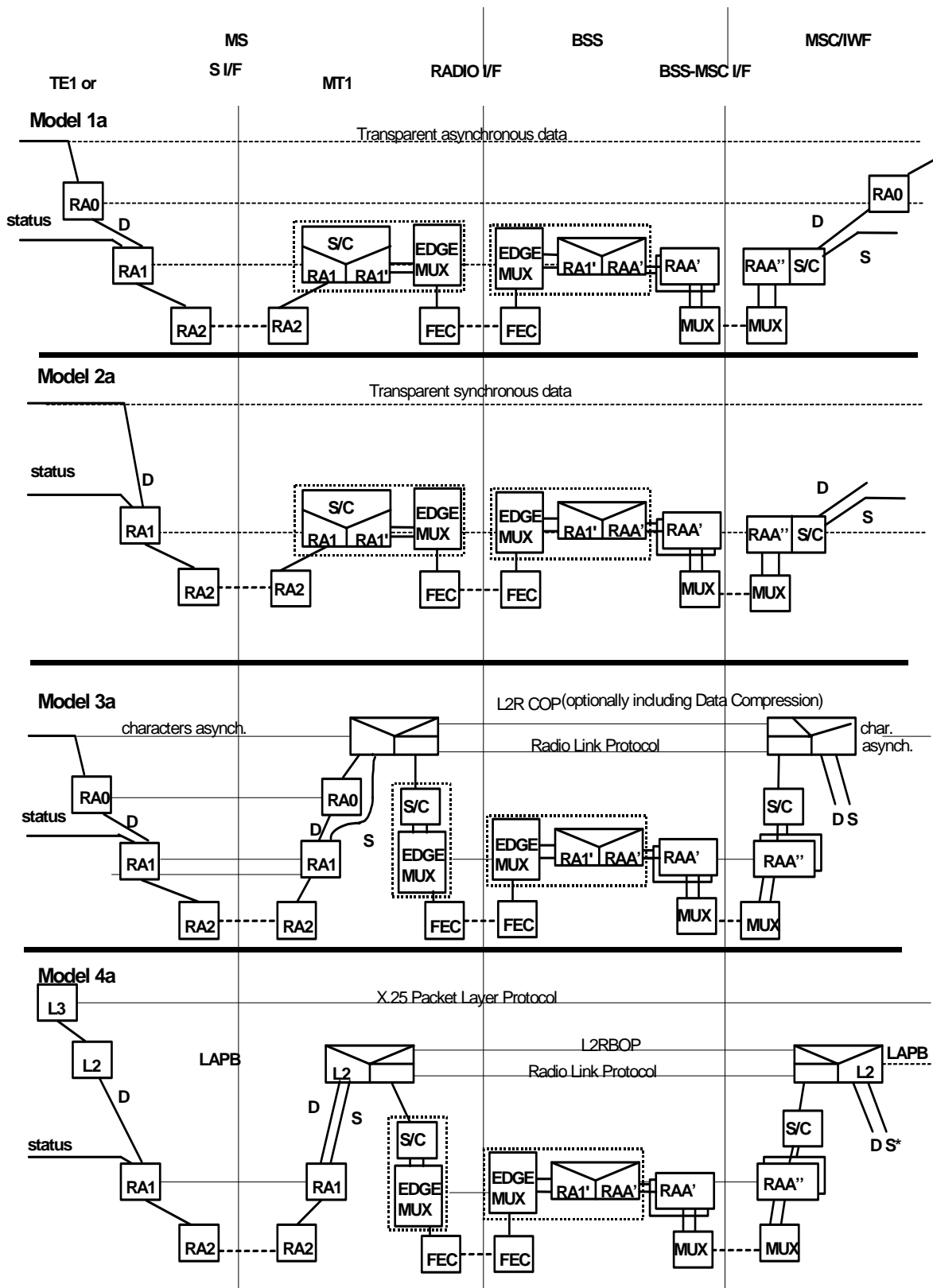
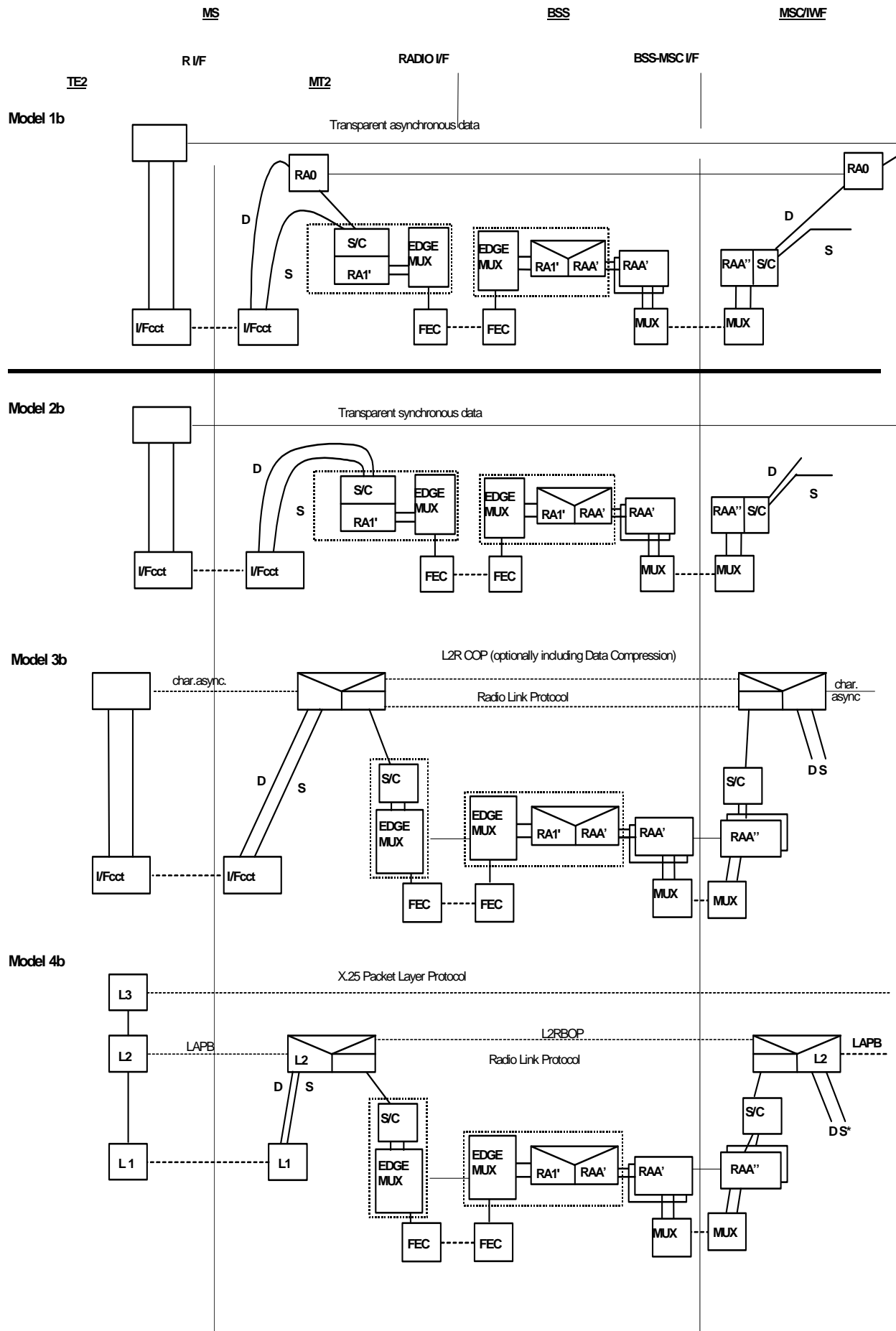
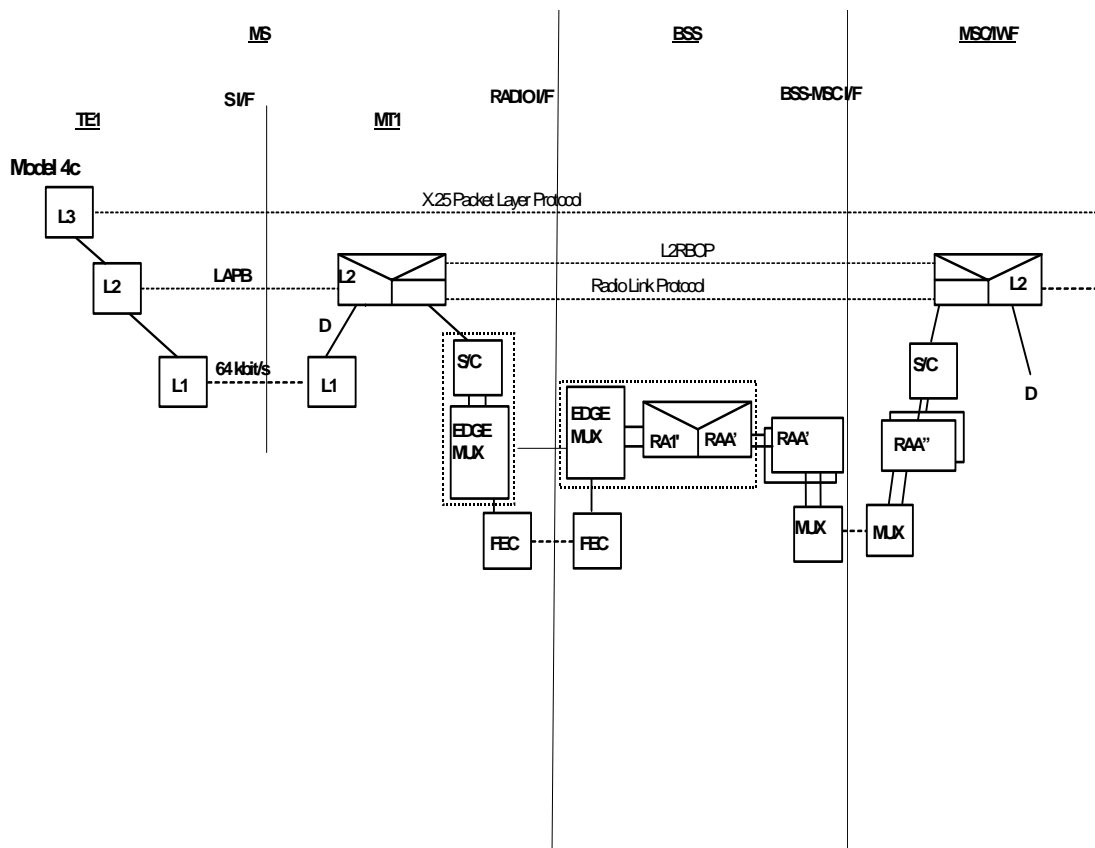

Figure 8 (continued) : Information transfer protocol models for GSM PLMN connections using EDGE channels





**Figure 8 (continued) : Information transfer protocol models for GSM PLMN connections using EDGE channels**



**Figure 8 (continued) : Information transfer protocol models for GSM PLMN connections using EDGE channels**

## 7 Relationship between Telecommunication services and connection types

### 7.1 General

Given a request for a telecommunication service at the initiation of a call, the GSM PLMN must establish a connection of a connection type that supports the attributes of the service requested. This establishment of a connection is effected at the time of call set up.

It should be noted that GSM PLMN connection types represent the technical capabilities of a GSM PLMN and provide a basis for the definition of performance and interworking with other networks. Telecommunication services supported by a GSM PLMN are the packages offered to customers and the definition of their attributes is the means to standardize the service offerings in all GSM PLMNs.

Quality of service and commercial attributes are relevant to telecommunication services whereas connection types are characterized by network performance, network operations and maintenance attributes.

### 7.2 Relationship between Bearer services and connection types

Table 5 shows the relationship between Bearer services and GSM PLMN connection types. In table 5, the connection elements for each connection type related to a Bearer service are shown.

Dominant attributes of the connection elements, such as information transfer mode, information transfer rate, information transfer capability and structure are indicated. The type of radio traffic channel used is also shown (half rate and full rate). In the multislot cases the minimum number of timeslots per connection (n) is 1.

### 7.3 Relationship between Teleservices and connection types

Table 6 shows the relationship between teleservices and connection type elements, for those teleservices having a GSM PLMN connection type which does not correspond to the GSM PLMN connection type of a bearer service. As in table 5/3GPP TS 03.10, dominant attributes of the connection elements and the type of radio traffic channel are shown. In the multislot cases the minimum number of timeslots per connection (n) is 1.

### 7.4 Network capability to support in-call modification

Specifications 3GPP TS 22.002 and 02.03 identify a particular need for a GSM PLMN to support the Alternate speech and group 3 facsimile.

This service allows the use of in-call modification to change the mode of service. The network capability to support in-call modification is described in 3GPP TS 24.008. An in-call modification of the service mode is not possible for other services.

### 7.5 Network capability to support channel mode modification

Specification 3GPP TS 03.45 (Technical Realization of the Group 3 Facsimile Teleservice) identifies a need for a GSM PLMN to support channel mode modification within the facsimile phase of the alternate speech and facsimile group 3 service. The network capability to support channel modification is described in 3GPP TS 24.008. Channel mode modification is not possible for other services. A channel mode modification results in a change of connection element over the radio interface with resultant change in access at the mobile station.

Table 5: Relationship between Bearer services and GSM PLMN Connection elements

Connection description	Bearer service user data rate	Radio interface connection element	Intermediate rate at the BSS-MSC interface	BSS-MSC connection element	Protocol model in figure 6, 7 or 8
Circuit mode unstructured with unrestricted digital capability transparent.	Data circuit duplex async $n \times 4\,800$ ( $n \leq 4$ ) or $n \times 9\,600$ bit/s ( $n \leq 4$ ). Data circuit duplex sync $n \times 4\,800$ ( $n \leq 4$ ) or $n \times 9\,600$ bit/s ( $n \leq 5$ ) or $n \times 1\,200$ bit/s ( $n = 5$ or 6).	cct mode unstructured unrestricted $n \times 6$ kbit/s ( $n \leq 4$ ) or $n \times 12$ kbit/s ( $n \leq 6$ ) on n full rate channels.	8 or 16 kbit/s per TCH/F.  For data connections using 5 or 6 TCH/Fs no intermediate rate(s).	cct mode unstructured unrestricted 64 kbit/s.	Fig 6 : 1 d, 1 e, 2 d, 2 e
	Data circuit duplex async $n \times 14\,400$ bit/s ( $n \leq 3$ ). Data circuit duplex sync $n \times 14\,400$ bit/s ( $n \leq 5$ )	cct mode unstructured unrestricted $n \times 14.5$ kbit/s ( $n \leq 5$ ) on n full rate channels	16 kbit/s per TCH/F.	cct mode unstructured unrestricted 64 kbit/s.	Fig 7 : 1 d, 1 e, 2 d, 2 e
	Data circuit duplex async 28 800 bit/s. Data circuit duplex sync 28 800 bit/s Data circuit duplex Sync 32 000 bit/s Data circuit duplex sync 64 000 bit/s	cct mode unstructured unrestricted 29.0 kbit/s on full rate channel  cct mode unstructured unrestricted 32 kbit/s on full rate channel cct mode unstructured unrestricted 2 x 32.0 kbit/s on full rate channels	16 kbit/s per TCH/F.  32 kbit/s  No intermediate rate for the 64 000 bit/s rate	cct mode unstructured unrestricted 64 kbit/s.	Fig 8 : 1 a, 1 b, 2 a, 2 b  None
	Data circuit duplex async 14 400 bit/s Data circuit duplex sync 14 400 bit/s	cct mode unstructured unrestricted 14.5 kbit/s on full rate Channel	16 kbit/s	cct mode unstructured unrestricted 64 kbit/s.	Fig 7 : 1 a, 1 b, 2 a, 2 b
	Data circuit duplex async 9 600 bit/s. Data circuit duplex sync 9 600 bit/s.	cct mode unstructured unrestricted 12 kbit/s on full rate channel.	16 kbit/s.	cct mode unstructured unrestricted 64 kbit/s.	Fig 6 : 1 a, 1 b, Fig 6 2 a, 2 b
	Data circuit duplex async 4 800 bit/s. Data circuit duplex sync 4 800 bit/s.	cct mode unstructured unrestricted 6 kbit/s on full rate channel and half rate channel.	8 kbit/s.	cct mode unstructured unrestricted 64 kbit/s.	Fig 6 1 a, 1 b, Fig 6 2 a, 2 b
	Data circuit duplex async 300. Data circuit duplex async 1 200. Data circuit duplex async 2 400. Data circuit duplex sync 1 200. Data circuit duplex sync 2 400.	cct mode unstructured unrestricted 3.6 kbit/s on full rate channel and half rate channel.	8 kbit/s.	cct mode unstructured unrestricted 64 kbit/s.	Fig 6 : 1 a, 1 b, Fig 6 1 a, 1 b, Fig 6 1 a, 1 b, Fig 6 2 a, 2 b, Fig 6 2 a, 2 b

Connection description	Bearer service user data rate	Radio interface connection element	Intermediate rate at the BSS-MS interface	BSS-MS connection element	Protocol model in figure 6, 7 or 8
Circuit mode unstructured with unrestricted digital capability non transparent.	Data circuit duplex async $n \times 4\,800$ ( $n \leq 4$ ) or $n \times 9\,600$ bit/s ( $n \leq 4$ ).	cct mode SDU unrestricted $n \times 6$ kbit/s ( $n \leq 4$ ) or $n \times 12$ kbit/s ( $n \leq 4$ ) on full rate channels.	8 or 16 kbit/s per TCH/F.	cct mode unstructured unrestricted 64 kbit/s.	Fig 6 3 d, 3 e
	Data circuit duplex async $n \times 14\,400$ bit/s ( $n \leq 4$ ).	cct mode SDU unrestricted $n \times 14.5$ kbit/s ( $n \leq 4$ ) on full rate channels.	16 kbit/s	cct mode unstructured unrestricted 64 kbit/s.	Fig 7 : 3 d, 3e
	Data circuit duplex async $n \times 28\,800$ bit/s ( $n \leq 2$ ).	cct mode SDU unrestricted $n \times 29.0$ kbit/s ( $n \leq 2$ ) on full rate channels.	16 kbit/s per TCH/F.	cct mode unstructured unrestricted 64 kbit/s.	Fig 8 : 3a, 3 b
	Data circuit duplex async 43 200 bit/s	cct mode SDU unrestricted 43.5 kbit/s on a full rate channel.	16 kbit/s per TCH/F.		
	Data circuit duplex async 14 400 bit/s	cct mode SDU unrestricted 14.5 kbit/s on full rate channel	16 kbit/s	cct mode unstructured unrestricted 64 kbit/s.	Fig 7 : 3 a, 3 b
	Data circuit duplex async 9 600 bit/s.	cct mode SDU unrestricted 12 kbit/s on full rate channel.	16 kbit/s.	cct mode unstructured unrestricted 64 kbit/s.	Fig 6 : 3 a, 3 b
	Data circuit duplex async 4 800 bit/s.	cct mode SDU unrestricted full rate channel, 12 kbit/s or half rate channel, 6 kbit/s.	16 kbit/s FR 8 kbit/s HR.	cct mode unstructured unrestricted 64 kbit/s.	Fig 6 : 3 a, 3 b
	Data circuit duplex async 300. Data circuit duplex async 1 200. Data circuit duplex async 2 400.	cct mode SDU unrestricted full rate channel, 12 kbit/s or half rate channel, 6 kbit/s.	16 kbit/s FR 8 kbit/s HR.	cct mode unstructured unrestricted 64 kbit/s.	Fig 6: 3 a, 3 b Fig 6 : 3 a, 3 b Fig 6 3 a, 3 b

Connection description	Bearer service user data rate	Radio interface connection element	Intermediate rate at the BSS-MSC interface	BSS-MSC connection element	Protocol model in figure 6, 7 or 8
Circuit mode unstructured with 3.1 kHz audio ex PLMN transparent.	Data circuit duplex asynch $n \times 4\,800$ bit/s ( $n \leq 4$ ) or $n \times 9\,600$ bit/s ( $n \leq 3$ ). Data circuit duplex synch $n \times 4\,800$ bit/s ( $n \leq 4$ ) or $n \times 9\,600$ bit/s ( $n \leq 3$ ).	cct mode unstructured unrestricted $n \times 6$ kbit/s ( $n \leq 4$ ) or $n \times 12$ kbit/s ( $n \leq 3$ ) on $n$ full rate channels.	8 or 16 kbit/s TCH/F.	cct mode unstructured unrestricted 64 kbit/s.	Fig 6 : 1 d, 1 e, 2 d, 2 e
	Data circuit duplex asynch $n \times 14\,400$ bit/s ( $n \leq 2$ ). Data circuit duplex synch $n \times 14\,400$ bit/s ( $n \leq 2$ )	cct mode unstructured unrestricted $x \times 14.5$ kbit/s ( $n \leq 2$ ) on $n$ full rate channels	16 kbit/s per TCH/F	cct mode unstructured unrestricted 64 kbit/s.	Fig 7 : 1 d, 1 e, 2 d, 2e
	Data circuit duplex asynch 28 800 bit/s. Data circuit duplex synch 28 800 bit/s	cct mode unstructured unrestricted 29.0 kbit/s on a full rate channel	16 kbit/s per TCH/F.	cct mode unstructured unrestricted 64 kbit/s.	Fig 8 : 1 a, 1 b, 2 a, 2 b
	Data circuit duplex asynch 14 400 bit/s synch 14 400 bit/s	cct mode unstructured unrestricted 14.5 kbit/s on full rate channels	16 kbit/s	cct mode unstructured unrestricted 64 kbit/s.	Fig 7 : 1 a, 1 b for asynch Fig 7 2 a 2 b for synch
	Data circuit duplex asynch 9.6 kbit/s synch 9.6 kbit/s.	cct mode unstructured unrestricted 12 kbit/s full rate channel.	16 kbit/s.	cct mode unstructured unrestricted 64 kbit/s.	Fig 6 : 1 a, 1 b for asynch.  Fig 6 : 2 a, 2 b for synch.
	Data circuit duplex asynch 4.8 kbit/s synch 4.8 kbit/s.	cct mode unstructured unrestricted 6 kbit/s full and half rate channel.	8 kbit/s.		
	Data circuit duplex asynch $\leq 2\,400$ synch $\leq 2\,400$ .	cct mode unstructured unrestricted 3.6 kbit/s full and half rate channel.	8 kbit/s.		

Connection description	Bearer service user data rate	Radio interface connection element	Intermediate rate at the BSS-MSC interface	BSS-MSC connection element	Protocol model in figure 6, 7 or 8
Circuit mode unstructured with 3.1 kHz audio ex PLMN non transparent.	Data circuit duplex asynch $n \times 4\,800$ ( $n \leq 4$ ) or $n \times 9\,600$ ( $n \leq 4$ ) bit/s. Data circuit duplex synch $n \times 4\,800$ ( $n \leq 4$ ) or $n \times 9\,600$ bit/s ( $n \leq 4$ ).	cct mode SDU unrestricted $n \times 6$ kbit/s ( $n \leq 4$ ) or $n \times 12$ kbit/s ( $n \leq 4$ ) on full rate channels.	8 or 16 kbit/s per TCH/F.	cct mode unstructured unrestricted 64 kbits/s.	Fig 6 : 3 d, 3 e for asynch. Fig 6 : 4 d, 4 e, 4 f for synch.
	Data circuit duplex asynch $n \times 14\,400$ bit/s ( $n \leq 4$ ). Data circuit duplex synch $n \times 14\,400$ bit/s ( $n \leq 4$ )	cct mode SDU unrestricted $n \times$ 14.5 kbit/s ( $n \leq 4$ ) on n full rate channels	16 kbit/s per TCH/F	cct mode unstructured unrestricted 64 kbits/s.	Fig 7 : 3 d, 3 e for asynch Fig 7 : 4 d, 4 e 4 f for synch
	Data circuit duplex asynch 28 800 bit/s. Data circuit duplex asynch 43 200 bit/s	cct mode SDU unrestricted 29.0 kbit/s on a full rate channel.  cct mode SDU unrestricted 43.5 kbit/s on a full rate channel.	16 kbit/s per TCH/F.  16 kbit/s per TCH/F.	cct mode unstructured unrestricted 64 kbits/s.	Fig 8 : 3a, 3 b
	Data circuit duplex synch 28 800 bit/s	cct mode SDU unrestricted 29.0 kbit/s on a full rate channel.	16 kbit/s per TCH/F.	cct mode unstructured unrestricted 64 kbits/s.	Fig 8 : 4a, 4 b, 4c
	Data circuit duplex asynch 14 400 bit/s synch 14 400 bit/s	cct mode SDU unrestricted 14.5 kbit/s full rate channel	16 kbit/s	cct mode unstructured unrestricted 64 kbits/s.	Fig 7 : 3a, 3b for asynch Fig 7 : 4 a, 4 b, 4 c for synch
	Data circuit duplex asynch 9.6 kbit/s synch 9.6 kbit/s.	cct mode SDU unrestricted 12 kbit/s full rate channel.	16 kbit/s.	cct mode unstructured unrestricted 64 kbit/s.	Fig 6 : 3 a, 3 b for asynch. Fig 6 : 4 a, 4 b, 4 c for synch.
	Data circuit duplex asynch 4.8 kbit/s synch 4.8 kbit/s.	cct mode SDU unrestricted half rate channel, 6 kbit/s or full rate channel, 12 kbit/s.	16 kbit/s FR 8 kbit/s HR.		
	Data circuit duplex asynch $\leq 2\,400$ synch $\leq 2\,400$ .	cct mode SDU unrestricted half rate channel, 6 kbit/s or full rate channel, 12 kbit/s.			

Table 5 (continued): Relationship between Bearer services and GSM PLMN Connection elements

Connection description	Bearer service user data rate	Radio interface connection element	Intermediate rate at the BSS-MSC interface	BSS-MSC connection element	Protocol model in figure 6, 7 or 8
Packet services basic access transparent.	Data circuit duplex sync $n \times 4\,800$ ( $n \leq 4$ ) or $n \times 9\,600$ bit/s ( $n \leq 5$ ) or $n \times 11\,200$ bit/s ( $n = 5$ or 6).	cct mode unstructured unrestricted $n \times 6$ kbit/s ( $n \leq 4$ ) or $n \times 12$ kbit/s ( $n \leq 6$ ) on n full rate channels.	8 or 16 kbit/s per TCH/F.  For data connections using 5 or 6 TCH/Fs no intermediate rate(s).	cct mode unstructured unrestricted 64 kbit/s.	Fig 6 : 2 d, 2 e
	Data circuit duplex sync $n \times 14\,400$ bit/s ( $n \leq 5$ )	cct mode unstructured unrestricted $n \times 14.5$ kbit/s ( $n \leq 5$ ) on n full rate channels.	16 kbit/s per TCH/F	cct mode unstructured unrestricted 64 kbit/s.	Fig 7 : 2 d, 2 e
	Data circuit duplex synch 14 400 bit/s	cct mode unstructured unrestricted 14.5 kbit/s on full rate channel.	16 kbit/s.	cct mode unstructured unrestricted 64 kbit/s.	Fig 7 : 2 a, 2 b
	Data circuit duplex sync 9 600 bit/s.	cct mode unstructured unrestricted 12 kbit/s on full rate channel.	16 kbit/s.	cct mode unstructured unrestricted 64 kbit/s.	Fig 6 : 2 a, 2 b
	Data circuit duplex sync 4 800 bit/s.	cct mode unstructured unrestricted 6 kbit/s on full rate channel and half rate channel.	8 kbit/s.	cct mode unstructured unrestricted 64 kbit/s.	Fig 6 : 2 a, 2 b
	Data circuit duplex sync 2 400 bit/s.	cct mode unstructured unrestricted 3.6 kbit/s on full rate channel and half rate channel.	8 kbit/s.	cct mode unstructured unrestricted 64 kbit/s.	Fig 6 : 2 a, 2 b



Connection description	Bearer service user data rate	Radio interface connection element	Intermediate rate at the BSS-MSC interface	BSS-MSC connection element	Protocol model in figure 6, 7 or 8
Packet services basic access non transparent.	Data circuit duplex sync $n \times 4\,800$ ( $n \leq 4$ ) or $n \times 9\,600$ bit/s ( $n \leq 4$ ).	cct mode SDU unrestricted $n \times 6$ kbit/s ( $n \leq 4$ ) or $n \times 12$ kbit/s ( $n \leq 4$ ) on full rate channels.	8 or 16 kbit/s per TCH/F.	cct mode unstructured unrestricted 64 kbits/s.	Fig 6 : 4 d, 4 e, 4 f
	Data circuit duplex sync $n \times 14\,400$ bit/s ( $n \leq 4$ ).	cct mode SDU unrestricted $n \times 14.5$ kbit/s ( $n \leq 4$ ) on full rate channels	16 kbit/s per TCH/F	cct mode unstructured unrestricted 64 kbits/s.	Fig 7 : 4 d, 4 e, 4 f
	Data circuit duplex sync $n \times 28\,800$ bit/s ( $n \leq 2$ ).	cct mode SDU unrestricted $n \times 29.0$ kbit/s ( $n \leq 2$ ) on full rate channels	16 kbit/s per TCH/F	cct mode unstructured unrestricted 64 kbits/s.	Fig 8 : 4 a, 4 b, 4 c
	Data circuit duplex sync 43 200 bit/s.	cct mode SDU unrestricted 43.5 kbit/s on a full rate channel	16 kbit/s per TCH/F		Fig 8 : 4 a, 4 b, 4 c
	Data circuit duplex synch 14 400 bit/s	cct mode SDU unrestricted 14.5 kbit/s on full rate channel	16 kbit/s	cct mode unstructured unrestricted 64 kbits/s.	Fig 7 : 4 a, 4 b, 4 c
	Data circuit duplex sync 9 600 bit/s.	cct mode SDU unrestricted 12 kbit/s on full rate channel.	16 kbit/s.	cct mode unstructured unrestricted 64 kbit/s.	Fig 6 : 4 a, 4 b, 4 c
	Data circuit duplex sync 4 800 bit/s.	cct mode SDU unrestricted full rate channel, 12 kbit/s or half rate channel, 6 kbit/s.	16 kbit/s FR 8 kbit/s HR.	cct mode unstructured unrestricted 64 kbit/s.	4 a,b,c
	Data circuit duplex sync 2 400 bit/s.	cct mode SDU unrestricted full rate channel, 12 kbit/s or half rate channel, 6 kbit/s.	16 kbit/s FR 8 kbit/s HR.	cct mode unstructured unrestricted 64 kbit/s.	4 a,b,c

Table 6: Relationship between Teleservices and GSM PLMN connection types

Teleservice in GSM PLMN	Access at mobile station	Radio interface connection element	Intermediate rate at the BSS-MSC interface	BSS-MSC connection element	Protocol model in figure 6 or 7
Telephony.		cct mode speech.	NA.	cct mode structured 64 kbit/s speech.	Fig 6 : 6 a or 6 b
Emergency calls.		cct mode speech.	NA.	cct mode structured 64 kbit/s speech.	Fig 6 : 6 a or 6 b
Alternate Speech/ Facsimile Group 3.	Data cct duplex synchronous access alternate speech/ group 3 fax.	cct mode speech alternating with unstructured unrestricted 3.6 or 6 or 12 kbit/s or $n \times 6$ kbit/s ( $n \leq 3$ ) or $n \times 12$ kbit/s ( $n \leq 2$ ) on FR transparent.	Speech NA 8 or 16 kbit/s per TCH/F.	cct mode structured 64 kbit/s alternate speech/unrestricted.	Fig 6 : 5, 5b and 6 a or 6 b
		cct mode speech alternating with unstructured unrestricted 14.5 kbit/s or $n \times 14.5$ kbit/s ( $n \leq 2$ ) on FR transparent	Speech NA 16 kbit/s per TCH/F.		
Automatic Facsimile Group 3.	Data cct duplex synchronous access group 3 fax.	cct mode unstructured unrestricted 3.6 or 6 or 12 kbit/s or $n \times 6$ kbit/s ( $n \leq 3$ ) or $n \times 12$ kbit/s ( $n \leq 2$ ) on FR transparent.	8 or 16 kbit/s per TCH/F.	cct mode structured 64 kbit/s unrestricted.	Fig 6 : 5, 5b
		cct mode unstructured unrestricted 14.5 kbit/s or $n \times 14.5$ kbit/s ( $n \leq 2$ ) on FR transparent	16 kbit/s per TCH/F.		
Alternate speech/ Facsimile Group 3.	Data cct duplex synchronous access alternate speech/ group 3 fax.	cct mode speech alternating with SDU unrestricted 6 or 12 kbit/s or $n \times 6$ kbit/s ( $n \leq 3$ ) or $n \times 12$ kbit/s ( $n \leq 2$ ) on FR non transparent.	Speech NA 8 or 16 kbit/s per TCH/F.	cct mode structured 64 kbit/s alternate speech/unrestricted.	Fig 6 : 6 a or 6 b, 7 a and 7 b
		cct mode speech alternating with SDU unrestricted 14.5 kbit/s or $n \times 14.5$ kbit/s ( $n \leq 2$ ) on FR non transparent.	16 kbit/s per TCH/F.		
Automatic Facsimile Group 3.	Data cct duplex synchronous access group 3 fax.	cct mode SDU unrestricted 6 or 12 kbit/s or $n \times 6$ kbit/s ( $n \leq 3$ ) or $n \times 12$ kbit/s ( $n \leq 2$ ) on FR non transparent.	8 or 16 kbit/s per TCH/F.	cct mode structured 64 kbit/s unrestricted.	Fig 6 : 7 a and 7 b
		cct mode SDU unrestricted 14.5 kbit/s or $n \times 14.5$ kbit/s ( $n \leq 2$ ) on FR non transparent.	16 kbit/s per TCH/F.		

NA: Not Applicable

NOTE: The multislot data connections and the connections using TCH/F14.4 coding belong to the General Bearer Services (Classes 20 and 30 in 3GPP TS 22.002).

---

# Annex A (informative): List of definitions of GSM PLMN connection type attributes and values

## A.1 Attribute definition and their values

### Information transfer mode:

This attribute describes the operational mode for transferring (transportation and switching) user information through a GSM PLMN connection in the network.

Value: - Circuit

### Information transfer capability:

This attribute describes the capability associated with the transfer of different types of information through a GSM PLMN connection.

Values: - Unrestricted digital information

- Speech

- Group 3 facsimile

- 3.1 kHz audio ex PLMN

- Restricted digital information (Note: this value is signalled in the "Other ITC" element, due to a lack of further code points in the "ITC" element.)

### Information transfer rate:

This attribute describes either the bit rate (circuit mode) or the throughput (packet mode, for further study). It refers to the transfer of digital information on a GSM PLMN connection.

Values: - Appropriate bit rate

- Throughput rate

### Establishment of connection:

This attribute describes the mode of establishment used to establish and release GSM PLMN connections.

Value: - Demand

### Symmetry:

This attribute describes the relationship of information flow between two (or more) access points or reference points involved in a GSM PLMN connection.

Values: - Bidirectional symmetric

- Bidirectional asymmetric (Multislot configurations for data)

### Connection configuration:

This attribute describes the spatial arrangement for transferring information on a given GSM PLMN connection.

Value: - Point-to-point

### Structure:

This attribute refers to the capability of a GSM PLMN connection to deliver information to the destination access point or reference point in a structure that was presented in a corresponding signal structured at the origin (access point or reference point).

Values: - Service data unit integrity (see note 1)  
- Unstructured (see note 2)

NOTE 1: Applicable for connection element "non transparent".

NOTE 2: Applicable for connection element "transparent".

#### Channel rate:

This attribute describes the channels and their bit rate used to transfer the user information and/or signalling information.

Value: - Name of channel (designation) and/or the corresponding bit rate

NOTE 3: This attribute can be used several times for connection characterization.

#### Connection control protocol, information transfer coding/protocol (layer 1 to 3):

These attributes characterize the protocols on the connection control and/or user information transfer channel.

Value: - Appropriate protocol for each layer

NOTE 4: This attribute can be used several times for connection characterization.

#### Synchronous/Asynchronous:

This attribute describes the type of transmission between the reference access points.

Values: - Synchronous  
- Asynchronous

#### Negotiation:

This attribute describes the possibility of inband parameter exchange (according to V.110) between reference access points.

Value: - In band negotiation not possible

#### User Rate:

This element is relevant between the IWF and the fixed network.

Values: - 0.3 kbit/s  
- 1.2 kbit/s  
- 2.4 kbit/s  
- 4.8 kbit/s  
- 9.6 kbit/s

#### Intermediate rate:

This attribute defines the intermediate rate (according to 3GPP TS 08.20 and ITU-T V.110) at the A interface connection element part.

Values: - 8 kbit/s  
- 16 kbit/s

Fixed network user rate FNUR:

This element is relevant between the MSC and the fixed network.

- Values: - 9.6 kbit/s  
- 14.4 kbit/s  
- 19.2 kbit/s  
- 28.8 kbit/s  
- 32.0 kbit/s  
- 38.4 kbit/s  
- 48.0 kbit/s  
- 56.0 kbit/s  
- 64.0 kbit/s

Acceptable channel coding(s) ACC:

This attribute indicates the channel codings acceptable to the MS. This parameter is given at call set-up and it is non negotiable.

- Values: 4.8 kbit/s  
and/or 9.6 kbit/s  
and/or 14.4 kbit/s  
and/or 28.8 kbit/s  
and/or 32.0 kbit/s  
and/or 43.2 kbit/s

Maximum number of TCH/Fs (Multislot configurations for data):

This attribute is given at call set-up and it enables the mobile user to limit the number of TCH/Fs used during the call.

- Values: 1  
2  
3  
4  
5  
6  
7 (note 5)  
8 (note 5)

NOTE 5: Not used by the currently specified services.

Wanted air interface user rate (AIUR):

This attribute is applicable to non-transparent services only, and it gives the AIUR that the mobile user wants and which the network tries to achieve but which it is not allowed to exceed.

- Values: Not applicable  
9.6 kbit/s

14.4 kbit/s  
 19.2 kbit/s  
 28.8 kbit/s  
 38.4 kbit/s  
 43.2 kbit/s  
 57.6 kbit/s

User initiated modification indication (Multislot configurations for data):

This element is relevant between the MT and the IWF.

- Values:
- User initiated modification not requested
  - User initiated modification up to 1 TCH/F requested
  - User initiated modification up to 2 TCH/F requested
  - User initiated modification up to 3 TCH/F requested
  - User initiated modification up to 4 TCH/F requested

The parameters where it is indicated that they are related to Multislot configurations for data are optional.

For multislot configuration, the following applies to the parameters contained in the BC-IE:

- Half rate channels are not supported. The MS shall code the radio channel requirement as "Full rate support only MS" or "Dual rate support MS, full rate preferred". In the second case, the network shall assign full rate channel(s) only.
- The "fixed network user rate" and "other modem type" take precedence over the "user rate" and "modem type", except for modem types "autobauding", "modem for undefined interface" or "none".
- The "intermediate rate" parameter is overridden. The intermediate rate used per each TCH/F is derived from the chosen channel type:

channel type	IR per TCH/F
TCH/F4.8	8 kbit/s
TCH/F9.6	16 kbit/s
TCH/F14.4	16 kbit/s (on the A interface but 32 kbit/s inside the MS)

- The user rate per TCH is derived from the chosen channel type:

channel type	user rate per TCH
TCH/F4.8	4.8 kbit/s
TCH/F9.6	9.6 kbit/s
TCH/F14.4	14.4 kbit/s

For CE: T, the padding procedure described in 3GPP TS 04.21 can be applied.

Network independent clocking on Tx:

This attribute defines the usage of NIC at the reference access point in the transmit direction.

- Values:
- Not required
  - Required

Network independent clocking on Rx:

This attribute defines the usage of NIC at the reference access point in the receive direction.

- Values:
- Not accepted
  - Accepted

Number of stop bits:

This attribute describes the number of stop bits for the asynchronous type of transmission between reference access points.

- Values:
- 1 bit
  - 2 bit

Number of data bits excluding parity if present:

This attribute describes the number of data bits for a character oriented mode of transmission between reference access points.

- Values:
- 7 bit
  - 8 bit

Parity information:

This attribute describes the type of parity information for a character oriented mode of transmission between the reference access points.

- Values:
- Odd
  - Even
  - None
  - Forced to 0
  - Forced to 1

Duplex mode:

This attribute describes the kind of transmission of the GSM PLMN between reference access points.

- Value:
- Full duplex

Modem type:

This attribute describes the modem allocated by the IWF/MSC in the case of a 3.1 kHz audio used outside the GSM PLMN information transfer capability.

- Values:
- V.21
  - V.22
  - V.22bis
  - V.26ter
  - V.32
  - Autobauding type 1
  - None
  -

Other Modem Type (OMT):

This element is relevant between the MS and IWF.

- Values: - No other modem type  
- V.34

#### Compression

This attribute describes the possible usage of data compression between the reference access points. In the network to MS direction, it indicates the possibility of using data compression. In the MS to network direction, it indicates the allowance of data compression.

- Values: - Data compression not possible/not allowed  
- Data compression possible/allowed (see note 6)

NOTE 6: Only applicable for the asynchronous transmission between the reference access points, if connection element is "non transparent".

#### Radio channel requirement:

This attribute describes the available channels for the transfer of the user information between the reference access points.

- Values: - Full rate channel (Bm)  
- Half rate channel (Lm)  
- dual rate/full rate preferred  
- Dual rate/half rate preferred

#### Negotiation of Intermediate Rate Requested (NIRR)

This attribute indicates if 6 kbit/s radio interface rate is requested.

- Values: - NIRR not requested/not accepted  
- NIRR requested/accepted

#### Connection element:

This attribute describes the possible usage of GSM layer 2 protocol between the reference access points.

- Values: - Transparent  
- Non-transparent (RLP)  
- Both, transparent preferred  
- Both, non transparent preferred

#### User information layer 2 protocol:

This attribute describes the layer 2 relay protocol used between the reference access points in non-transparent transmissions.

- Values: - ISO 6429, code set 0  
- X.25  
- Character oriented protocol with no flow control



Signalling access protocol:

This attribute characterizes the protocol on the signalling or user information transfer channel at the mobile reference access point.

- Values:
- I.440/450
  - X.21
  - X.28, dedicated PAD, individual NUI (note 7)
  - X.28, dedicated PAD, universal NUI(note 7)
  - X.28, non dedicated PAD
  - X.32
  - X.32

NOTE 7: This value was used by services defined for former GSM releases and does not need to be supported.

Rate adaptation:

This attribute describes the rate adaptation used at the fixed reference access point.

- Values:
- V.110/X.30
  - X.31 flag stuffing
  - No rate adaptation
  - V.120 (Note: This value is signalled in the "Other Rate Adaption" element, due to a lack of further code points in the "Rate Adaptation" element.)

Coding standard:

This attribute refers to the structure of the BC-IE defined in the 3GPP TS 24.008.

- Value:
- GSM

User information layer 1 protocol:

This attribute characterizes the layer 1 protocol to be used at the Um interface according to the 3GPP TS 05.01.

- Value:
- Default

Rate adaption header/no header:

This attribute is relevant between IWF and the fixed network. It is only applicable for V.120 rate adaptation.

- Values:
- Rate adaption header not included
  - Rate adaption header included

Multiple frame establishment support in data link:

This attribute is relevant between IWF and the fixed network. It is only applicable for V.120 rate adaptation.

- Values:
- Multiple frame establishment not supported. Only UI frames allowed
  - Multiple frame establishment supported

Mode of operation:

This attribute is relevant between IWF and the fixed network. It is only applicable for V.120 rate adaptation.

- Values:
- Bit transparent mode of operation
  - Protocol sensitive mode of operation

Logical link identifier negotiation:

This attribute is relevant between IWF and the fixed network. It is only applicable for V.120 rate adaptation.

- Values:
- Default, LLI=256 only
  - Full protocol negotiation (note 8)

NOTE 8: A connection over which protocol negotiation will be executed is indicated in the "In-band/out-band negotiation" parameter.

Assignor/assignee:

This attribute is relevant between IWF and the fixed network. It is only applicable for V.120 rate adaptation.

- Values:
- Message originator is "default assignee"
  - Message originator is "assignor only"

In-band/out-band negotiation:

This attribute is relevant between IWF and the fixed network. It is only applicable for V.120 rate adaptation.

- Values:
- Negotiation is done with USER INFORMATION messages on a temporary signalling connection
  - Negotiation is done in-band using logical link zero.

---

## A.2 Definition of values

Unrestricted digital data information:

Transfer of information sequence of bits at its specified bit rate without alteration.

This implies: - bit sequence independence;

- digit sequence integrity;

- bit integrity.

Speech:

Digital representation of speech coded according to a specified encoding rule (e.g. A Law, 3GPP TS 06-series).

Demand connection:

A GSM PLMN connection is set up at any time on demand via a digital channel in response to signalling information received from subscriber, other MSCs or other networks, i.e. on a per call basis.

Bidirectional symmetric:

This value applies when the information flow characteristics provided by the GSM PLMN connection are the same between two (or more) access points or reference points in the forward and backward directions.

Bidirectional asymmetric (Multislot configurations for data):

This value applies when the information flow characteristics provided by the GSM PLMN connection differ between two (or more) access points or reference points in the forward and backward directions on one or more TCH/Fs. In Multislot configurations for data the asymmetry is downlink biased, i.e. the MS may receive at a greater rate than it transmits.

Point-to-point connection:

This value applies when only two end points are provided by the connection.

Service data unit integrity:

This value applies when:

- i) at each user-network interface, protocols provide a mechanism for identifying the boundaries of service data units (e.g. X.25 complete packet sequence); and
- ii) all bits submitted within a single service data unit are delivered in a corresponding service data unit.

Unstructured:

This value is applicable when the GSM PLMN connection neither provides structural boundaries nor preserves structural integrity.

---

## Annex B (informative): Location of the transcoding, multiplexing and RA2 functions

The location of the transcoding and data rate adaptation functions used to convert from the data rate used on the radio interface to the 64 kbits/s required by the MSC, is considered in this annex B. There are four alternatives which are equally valid from a connection type point of view. The selection of which alternative to use is not considered in 3GPP TS 03.10. The alternatives are shown in figure 8.

Alternative 1 assumes that all the transcoding and data rate adaptation is located at the BSS end of the A interface.

Alternative 2 assumes that all the transcoding and data rate adaptation is located at the MSC end of the A interface and gives no indication how the information is carried on the link.

Alternative 3 assumes that the information is transferred on the A interface in 8 or 16 kbit/s channels using one of the sub-multiplexing schemes described in CCITT Recommendation I.460. The same sub-multiplexing scheme is used for both speech and data.

Alternative 4 illustrates a multislot connection in which the information is transferred on the A-interface in 64 kbit/s channel into which up to four channels of intermediate rate 16 kbit/s have been multiplexed (refer to 3GPP TS 08.20). Alternative 4 also shows a situation in which a multislot connection of 5 or 6 TCH/Fs is used; the rate between the RA1'/RA1- and RA1''-functions is 64 kbit/s.

The alternatives explained above correspond to all channels excluding TCH/F14.4 and EDGE.

Alternatives 1b, 2b, 3b, and 4b show similar approaches for channel codings TCH/F14.4, TCH/F28.8, and TCH/F43.2.

It should be noted that in all of the alternatives the transcoding and data rate adaptation are performed on the BSS side of the A-interface and is therefore considered to be a function of the BSS.

In the first three alternatives, the interface at the MSC is always based on 64 kbit/s without sub-multiplexing.

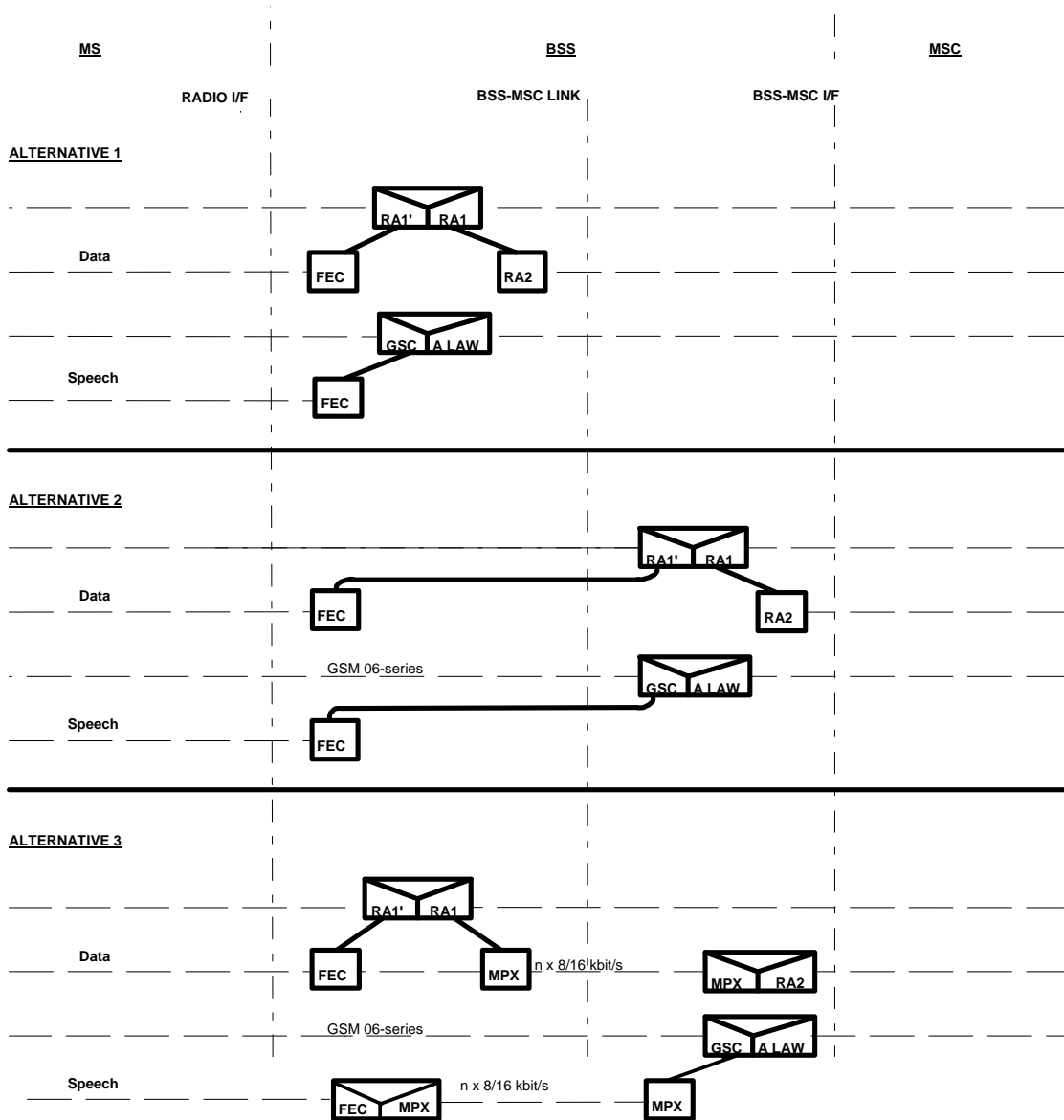

Figure 8: Location of transcoding and rate adaptation

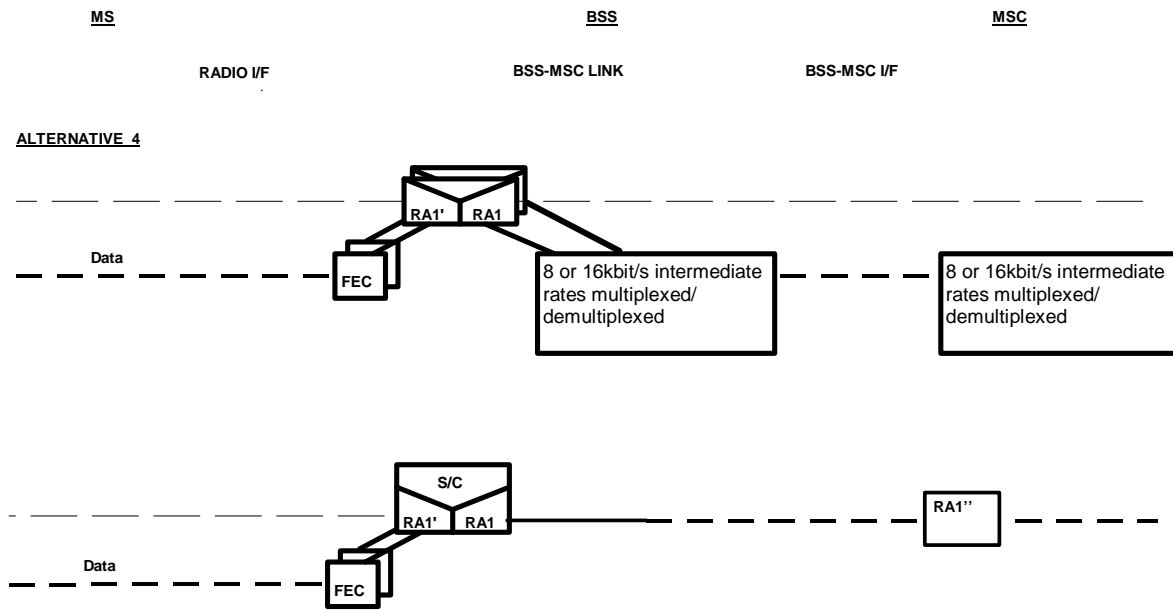

Figure 8 (continued): Location of transcoding and rate adaptation

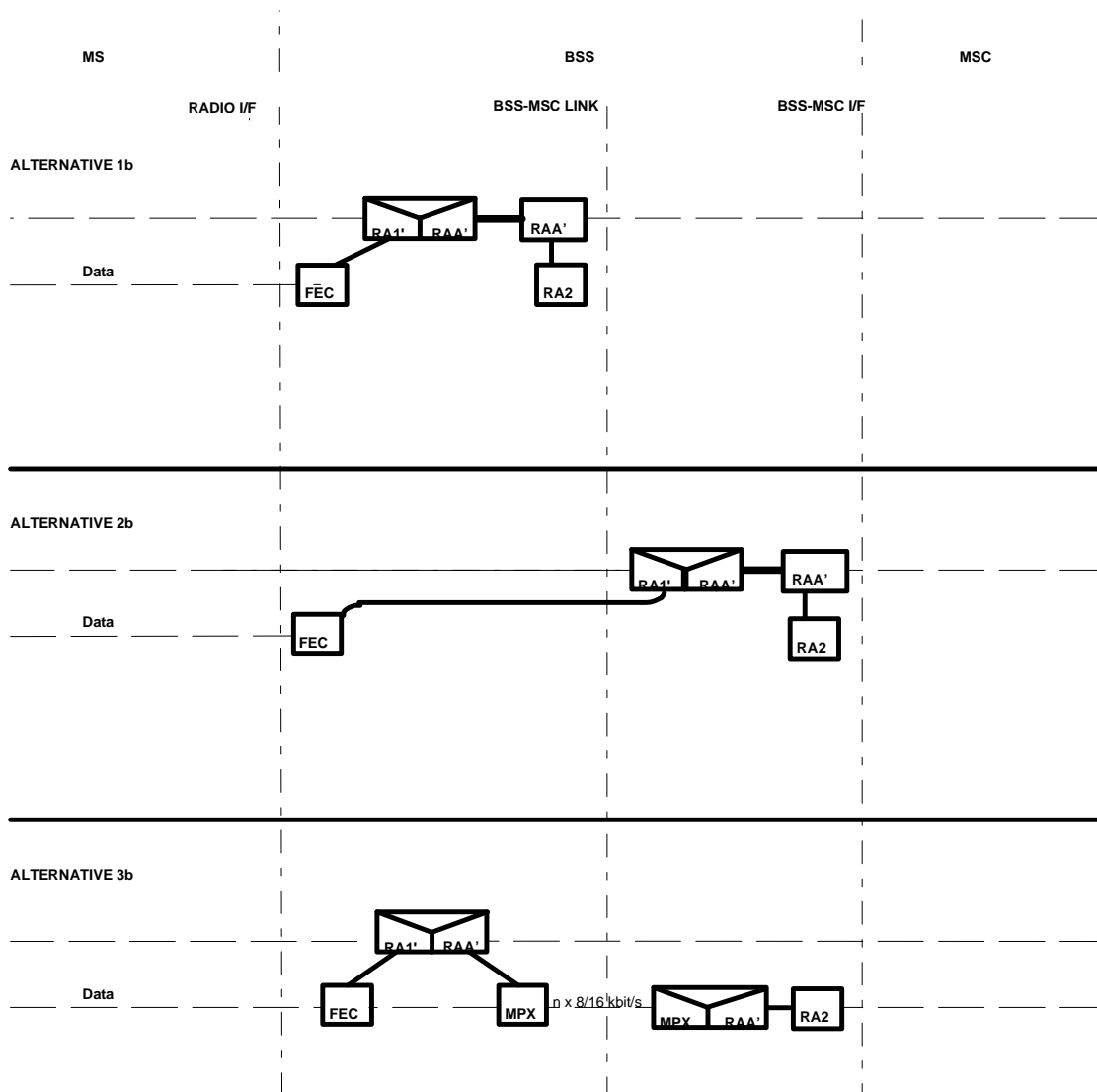
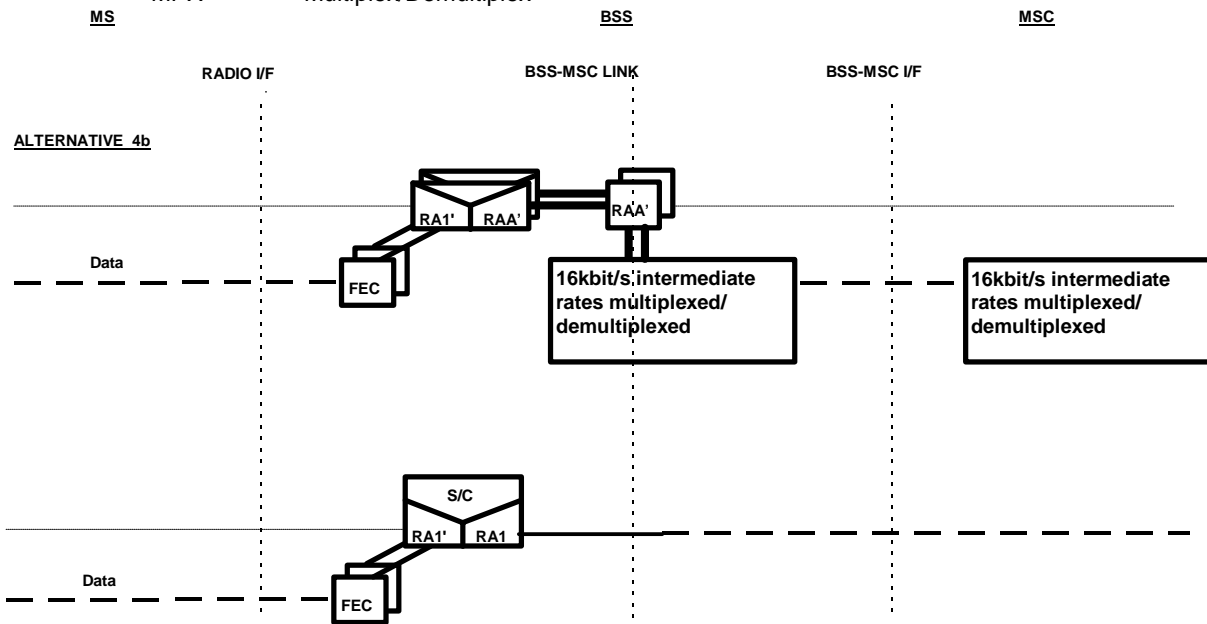

Figure 8 (concluded): Location of transcoding and rate adaptation

**Legend to Figure 8**

- GSC = GSM Speech Codec
- FEC = Forward Error Correction
- MPX = Multiplex/Demultiplex



**Figure 8 (concluded): Location of transcoding and rate adaptation**

## Annex C (informative): Change History

Change history							
Date	TSG #	TSG Doc.	CR	Rev	Subject/Comment	Old	New
-	S16		A001	2	Data Compression		5.0.0
-	S16		A002		Editorial correction to Channel Mode Modify		5.0.0
-	s21		A003		V.120 Interworking and RDI	5.0.0	5.1.0
-	s21		A004		HSCSD	5.0.0	5.1.0
-	s22		A005		Introduction of 14.4 kbit/s	5.1.0	5.2.0
-	s23		A006		Editorial modifications	5.2.0	5.3.0
-	s24		A007		Removal of 2*14.4=19.2 Transparent configuration	5.3.0	5.4.0
-	s27		A008		Clarification of RA0 adaptation function	5.4.0	7.0.0
-	s27		A009		Information transfer protocol model updates	5.4.0	7.0.0
-	s29		A010		Introduction of EDGE channel codings into the specifications	7.0.0	8.0.0
12-1999	TSG#06		A011		Service Clean up R99	8.0.0	8.1.0
09-2000	TSG#09	NP-000551	A012		32 kbit/s UDI/RDI multimedia in GSM	8.1.0	8.2.0



---

## History

<b>Document history</b>		
V8.2.0	September 2000	Publication