

ETSI TS 100 901 V7.5.0 (2001-12)

Technical Specification

**Digital cellular telecommunications system (Phase 2+);
Technical realization of the Short Message Service (SMS)
Point-to-Point (PP)
(3GPP TS 03.40 version 7.5.0 Release 1998)**

GSM®
GLOBAL SYSTEM FOR
MOBILE COMMUNICATIONS

3GPP

ETSI 

Reference

RTS/TSGT-020340Q7R3

Keywords

GSM

ETSI

650 Route des Lucioles
F-06921 Sophia Antipolis Cedex - FRANCE

Tel.: +33 4 92 94 42 00 Fax: +33 4 93 65 47 16

Siret N° 348 623 562 00017 - NAF 742 C
Association à but non lucratif enregistrée à la
Sous-Préfecture de Grasse (06) N° 7803/88

Important notice

Individual copies of the present document can be downloaded from:

<http://www.etsi.org>

The present document may be made available in more than one electronic version or in print. In any case of existing or perceived difference in contents between such versions, the reference version is the Portable Document Format (PDF). In case of dispute, the reference shall be the printing on ETSI printers of the PDF version kept on a specific network drive within ETSI Secretariat.

Users of the present document should be aware that the document may be subject to revision or change of status. Information on the current status of this and other ETSI documents is available at

<http://portal.etsi.org/tb/status/status.asp>

If you find errors in the present document, send your comment to:

editor@etsi.fr

Copyright Notification

No part may be reproduced except as authorized by written permission.
The copyright and the foregoing restriction extend to reproduction in all media.

© European Telecommunications Standards Institute 2001.
All rights reserved.

Intellectual Property Rights

IPRs essential or potentially essential to the present document may have been declared to ETSI. The information pertaining to these essential IPRs, if any, is publicly available for **ETSI members and non-members**, and can be found in ETSI SR 000 314: "*Intellectual Property Rights (IPRs); Essential, or potentially Essential, IPRs notified to ETSI in respect of ETSI standards*", which is available from the ETSI Secretariat. Latest updates are available on the ETSI Web server (<http://webapp.etsi.org/IPR/home.asp>).

Pursuant to the ETSI IPR Policy, no investigation, including IPR searches, has been carried out by ETSI. No guarantee can be given as to the existence of other IPRs not referenced in ETSI SR 000 314 (or the updates on the ETSI Web server) which are, or may be, or may become, essential to the present document.

Foreword

This Technical Specification (TS) has been produced by ETSI 3rd Generation Partnership Project (3GPP).

The present document may refer to technical specifications or reports using their 3GPP identities, UMTS identities or GSM identities. These should be interpreted as being references to the corresponding ETSI deliverables.

The cross reference between GSM, UMTS, 3GPP and ETSI identities can be found under www.etsi.org/key.

Contents

Intellectual Property Rights	2
Foreword.....	2
Foreword.....	6
Introduction	6
1 Scope	7
2 References	7
2.1 Definitions and abbreviations.....	9
2.1.1 Definitions	9
2.1.2 Abbreviations.....	11
3 Services and service elements	11
3.1 Basic services	11
3.2 Short Message Service elements	12
3.2.1 Validity-Period	13
3.2.2 Service-Centre-Time-Stamp	13
3.2.3 Protocol-Identifier.....	13
3.2.4 More-Messages-to-Send	13
3.2.5 Delivery of Priority and non-Priority Messages	13
3.2.6 Messages-Waiting.....	13
3.2.7 Alert-SC.....	16
3.2.8 Options concerning MNRG, MNRF, MNRR, MCEF and MWD	16
3.2.9 Status report capabilities	17
3.2.10 Reply Path.....	18
3.3 Unsuccessful short message TPDU transfer SC -> MS.....	18
3.3.1 Errors occurring during transfer of TPDU to MS	18
3.3.2 Errors occurring after TPDU arrives at MS	18
3.4 Unsuccessful short message TPDU transfer MS -> SC.....	20
3.4.1 Errors occurring during transfer of TPDU to SC	20
3.4.2 Errors occurring after TPDU arrives at SC	20
3.5 Use of Supplementary Services in combination with the Short Message Service.....	20
3.6 Applicability of Operator Determined Barring to the Short Message Service	21
3.7 Multiple short message transfer.....	21
3.8 SMS and Internet Electronic Mail interworking	21
3.8.1 Basic Format.....	21
3.8.2 Optional Fields.....	22
3.8.2.1 Subject.....	22
3.8.2.2 Real Name.....	22
3.8.2.3 Optional Control Flag	22
3.8.3 Text concatenation.....	22
3.8.4 Alternative characters for Internet email addresses in MO SMS.....	23
3.9 SMS COMPRESSION	23
4 Network architecture	24
4.1 Basic network structure	24
4.2 Transfer on link 3	25
5 Service Centre and PLMN interconnection.....	25
5.1 Service centre connection.....	25
5.2 Routing requirements	25
5.2.1 Mobile terminated short message	25
5.2.2 Mobile originated short message	25
6 Service Centre functionality	25
6.1 Service Centre capabilities	26
6.2 SC functional requirements	26

7	MS functionality.....	26
7.1	MS capabilities.....	26
7.2	MS configuration.....	27
8	Node functionality.....	27
8.1	Node functionality related to SM MT.....	27
8.1.1	Functionality of the SMS-GMSC.....	27
8.1.2	Functionality of the MSC.....	29
8.1.3	Functionality of the SGSN.....	30
8.2	Node functionality related to SM MO.....	31
8.2.1	Functionality of the MSC.....	31
8.2.2	Functionality of the SMS-IWMSC.....	31
8.2.3	Functionality of the SGSN.....	31
8.3	SMS-IWMSC functionality related to alerting.....	32
9	Protocols and protocol architecture.....	32
9.1	Protocol element features.....	33
9.1.1	Octet and Bit transmission order.....	33
9.1.2	Numeric and alphanumeric representation.....	33
9.1.2.1	Integer representation.....	33
9.1.2.2	Octet representation.....	34
9.1.2.3	Semi-octet representation.....	34
9.1.2.4	Alphanumeric representation.....	34
9.1.2.5	Address fields.....	34
9.2	Service provided by the SM-TL.....	36
9.2.1	General.....	36
9.2.2	PDU Type repertoire at SM-TL.....	36
9.2.2.1	SMS-DELIVER type.....	37
9.2.2.1a	SMS-DELIVER-REPORT type.....	39
9.2.2.2	SMS-SUBMIT type.....	41
9.2.2.2a	SMS-SUBMIT-REPORT type.....	44
9.2.2.3	SMS-STATUS-REPORT type.....	47
9.2.2.4	SMS-COMMAND type.....	49
9.2.3	Definition of the TPDU parameters.....	50
9.2.3.1	TP-Message-Type-Indicator (TP-MTI).....	50
9.2.3.2	TP-More-Messages-to-Send (TP-MMS).....	50
9.2.3.3	TP-Validity-Period-Format (TP-VPF).....	51
9.2.3.4	TP-Status-Report-Indication (TP-SRI).....	51
9.2.3.5	TP-Status-Report-Request (TP-SRR).....	51
9.2.3.6	TP-Message-Reference (TP-MR).....	51
9.2.3.7	TP-Originating-Address (TP-OA).....	52
9.2.3.8	TP-Destination-Address (TP-DA).....	52
9.2.3.9	TP-Protocol-Identifier (TP-PID).....	52
9.2.3.10	TP-Data-Coding-Scheme (TP-DCS).....	54
9.2.3.11	TP-Service-Centre-Time-Stamp (TP-SCTS).....	54
9.2.3.12	TP-Validity-Period (TP-VP).....	54
9.2.3.12.1	TP-VP (Relative format).....	54
9.2.3.12.2	TP-VP (Absolute format).....	54
9.2.3.12.3	TP-VP (Enhanced format).....	55
9.2.3.13	TP-Discharge-Time (TP-DT).....	55
9.2.3.14	TP-Recipient-Address (TP-RA).....	56
9.2.3.15	TP-Status (TP-ST).....	56
9.2.3.16	TP-User-Data-Length (TP-UDL).....	57
9.2.3.17	TP-Reply-Path (TP-RP).....	57
9.2.3.18	TP-Message-Number (TP-MN).....	57
9.2.3.19	TP-Command-Type (TP-CT).....	57
9.2.3.20	TP-Command-Data-Length (TP-CDL).....	58
9.2.3.21	TP-Command-Data (TP-CD).....	58
9.2.3.22	TP-Failure-Cause (TP-FCS).....	58
9.2.3.23	TP-User-Data-Header-Indicator (TP-UDHI).....	60
9.2.3.24	TP-User Data (TP-UD).....	60
9.2.3.24.1	Concatenated Short Messages.....	63

9.2.3.24.2	Special SMS Message Indication	65
9.2.3.24.3	Application Port Addressing 8 bit address	66
9.2.3.24.4	Application Port Addressing 16 bit address	66
9.2.3.24.5	SMSC Control Parameters.....	67
9.2.3.24.6	UDH Source Indicator	68
9.2.3.24.7	SIM Toolkit Security Headers	68
9.2.3.24.8	Concatenated short messages, 16-bit reference number	68
9.2.3.24.9	Wireless Control Message Protocol.....	69
9.2.3.25	TP-Reject-Duplicates (TP-RD).....	69
9.2.3.26	TP-Status-Report-Qualifier (TP-SRQ).....	70
9.2.3.27	TP-Parameter-Indicator (TP-PI).....	70
9.3	Service provided by the SM-RL.....	70
9.3.1	General.....	70
9.3.2	Protocol element repertoire at SM-RL.....	70
9.3.2.1	RP-MO-DATA	71
9.3.2.2	RP-MT-DATA	71
9.3.2.3	RP-ACK.....	72
9.3.2.4	RP-ERROR	72
9.3.2.5	RP-ALERT-SC	72
9.3.2.6	RP-SM-MEMORY-AVAILABLE	72
10	Fundamental procedures within the point-to-point SMS	73
10.1	Short message mobile terminated.....	73
10.2	Short message mobile originated.....	84
10.3	Alert transfer	90
11	Mapping of error causes between RP layers	92
11.1	Mobile Terminated short message transfer	92
11.2	Memory available notification	93
11.3	Mobile Originated short message transfer.....	93
Annex A (informative): Protocol stacks for interconnecting SCs and MSCs		95
Annex B (informative): Information now contained in GSM 03.38.....		96
Annex C (informative): Short message information flow		97
Annex D (informative): Mobile Station reply procedures		115
D.1	Introduction	115
D.2	The scope of applicability	115
D.3	Terminology	115
D.4	The reply path requesting procedure	115
D.5	The reception of an original MT SM.....	116
D.6	The submission of the reply MO SM	116
D.7	Usage of SCs for replying	116
D.8	Replying possibilities for Phase 1 mobile stations	117
D.9	The resulting service for originating SMEs.....	117
Annex E (informative): Change History.....		118
History		119

Foreword

This Technical Specification has been produced by the 3rd Generation Partnership Project (3GPP).

The contents of the present document are subject to continuing work within the TSG and may change following formal TSG approval. Should the TSG modify the contents of the present document, it will be re-released by the TSG with an identifying change of release date and an increase in version number as follows:

Version x.y.z

where:

- x the first digit:
 - 1 presented to TSG for information;
 - 2 presented to TSG for approval;
 - 3 or greater indicates TSG approved document under change control.
- y the second digit is incremented for all changes of substance, i.e. technical enhancements, corrections, updates, etc.
- z the third digit is incremented when editorial only changes have been incorporated in the document.

Introduction

The Point-to-Point Short Message Service (SMS) provides a means of sending messages of limited size to and from GSM mobiles. The provision of SMS makes use of a Service Centre, which acts as a store and forward centre for short messages. Thus a GSM PLMN needs to support the transfer of short messages between Service Centres and mobiles.

Two different point-to-point services have been defined: mobile originated and mobile terminated. Mobile originated messages will be transported from an MS to a Service Centre. These may be destined for other mobile users, or for subscribers on a fixed network. Mobile terminated messages will be transported from a Service Centre to an MS. These may be input to the Service Centre by other mobile users (via a mobile originated short message) or by a variety of other sources, e.g. speech, telex, or facsimile.

The present document includes references to features which were introduced into the GSM Technical specifications after Release 96 of GSM Phase 2+.

The following table lists all features that were introduced after Release 96 and have impacted the present document:

Feature	Designator
Optional SMSC Control Parameters - Selective Status Report	not used
Optional Source Indicator in the User Data Header	not used
Optional Status Report PDU Enhancement	not used
Optional UDH in all PDUs containing user data.	not used
Optional SMS Secured Messaging	not used
Optional Transmission of the SME Originating Address between the SMSC and the SMS-GMSC	not used
GPRS	not used
Mobile phone management	not used

1 Scope

The present document describes the point-to-point Short Message Service (SMS) of the GSM PLMN system. It defines:

- the services and service elements;
- the network architecture;
- the Service Centre functionality;
- the MSC functionality (with regard to the SMS);
- the SGSN functionality (with regard to the SMS);
- the routing requirements;
- the protocols and protocol layering;

for the Teleservices 21 and 22, as specified in the GSM 02.03.

The use of radio resources for the transfer of short messages between the MS and the MSC or the SGSN is described in GSM 04.11 "Point-to-Point Short Message Service Support on Mobile Radio Interface", and is dealt with in that specification.

The network aspects of Short Message Service provision are outside the scope of the present document (i.e. the provision of network connectivity between the PLMN subsystems). There is no technical restriction within the present document for the transfer of short messages between different PLMN's. Any such restriction is likely to be subject to commercial arrangements and PLMN operators must make their own provision for interworking or for preventing interworking with other PLMN's as they see fit.

The required and assumed network service offered to the higher layers is defined in the present document.

The Cell Broadcast Short Message Service (Teleservice 23) is a separate service, and is described in GSM 03.41 "Technical Realization of the Short Message Service - Cell Broadcast".

2 References

The following documents contain provisions which, through reference in this text, constitute provisions of the present document.

- References are either specific (identified by date of publication, edition number, version number, etc.) or non-specific.
- For a specific reference, subsequent revisions do not apply.
- For a non-specific reference, the latest version applies. In the case of a reference to a 3GPP document (including a GSM document), a non-specific reference implicitly refers to the latest version of that document *in the same Release as the present document*.

- [1] GSM 01.04: "Digital cellular telecommunication system (Phase 2+); Abbreviations and acronyms".
- [2] GSM 02.03: "Digital cellular telecommunication system (Phase 2+); Teleservices supported by a GSM Public Land Mobile Network (PLMN)".
- [3] GSM 02.04: "Digital cellular telecommunication system (Phase 2+); General on supplementary services".
- [4] GSM 02.41: "Digital cellular telecommunication system (Phase 2+); Operator determined barring".
- [5] GSM 03.02: "Digital cellular telecommunication system (Phase 2+); Network architecture".

- [6] GSM 03.08: "Digital cellular telecommunication system (Phase 2+); Organization of subscriber data".
- [7] GSM 03.11: "Digital cellular telecommunication system (Phase 2+); Technical realization of supplementary services".
- [8] GSM 03.15: "Digital cellular telecommunication system (Phase 2+); Technical realization of operator determined barring".
- [9] GSM 03.38: "Digital cellular telecommunication system (Phase 2+); Alphabets and language-specific information".
- [10] GSM 03.41: "Digital cellular telecommunication system (Phase 2+); Technical realization of Short Message Service Cell Broadcast (SMSCB)".
- [11] GSM 03.47 (ETR 354): "Digital cellular telecommunication system; Example protocol stacks for interconnecting Service Centre(s) (SC) and Mobile-services Switching Centre(s) (MSC)".
- [12] GSM 04.08: "Digital cellular telecommunication system (Phase 2); Mobile radio interface layer 3 specification".
- [13] GSM 04.11: "Digital cellular telecommunication system (Phase 2+); Point-to-Point (PP) Short Message Service (SMS) support on mobile radio interface".
- [14] GSM 07.05: "Digital cellular telecommunication system (Phase 2+); Use of Data Terminal Equipment - Data Circuit terminating Equipment (DTE - DCE) interface for Short Message Service (SMS) and Cell Broadcast Service (CBS)".
- [15] GSM 09.02: "Digital cellular telecommunication system (Phase 2+); Mobile Application Part (MAP) specification".
- [16] GSM 11.11: "Digital cellular telecommunication system (Phase 2+); Specification of the Subscriber Identity Module - Mobile Equipment (SIM - ME) interface".
- [17] CCITT Recommendation E.164 (Blue Book): "Numbering plan for the ISDN era".
- [18] CCITT Recommendation E.163 (Blue Book): "Numbering plan for the international telephone service".
- [19] CCITT Recommendation Q.771: "Specifications of Signalling System No.7; Functional description of transaction capabilities".
- [20] CCITT Recommendation T.100 (Blue Book): "International information exchange for interactive videotex".
- [21] CCITT Recommendation T.101 (Blue Book): "International interworking for videotex services".
- [22] CCITT Recommendation X.121 (Blue Book): "International numbering plan for public data networks".
- [23] CCITT Recommendation X.400 (Blue Book): "Message handling system and service overview".
- [24] ISO/IEC10646, "Universal Multiple-Octet Coded Character Set (USC); UCS2, 16 bit coding".
- [25] GSM 02.22: "Digital cellular telecommunication system (Phase 2+); Personalization of GSM Mobile Equipment (ME); Mobile functionality specification".
- [26] GSM 03.42: "Digital cellular telecommunication system (Phase 2+); Compression Algorithm for Text Messaging Services"
- [27] GSM 03.60: "Digital cellular telecommunications system (Phase 2+); General Packet Radio Service (GPRS); Service description; Stage 2".
- [28] GSM 03.48: "Digital cellular telecommunications system (Phase 2+); Security Mechanisms for the SIM application toolkit; Stage 2".

2.1 Definitions and abbreviations

NOTE: Use of hyphens and full stops:

Care is needed when reading the present document as names containing words separated by hyphens have different meaning than when separated with full stops. E.g. TS-Status-Report-Request is a parameter within a TS-Submit primitive, whilst TS-Status-Report. Request is a primitive in its own right.

2.1.1 Definitions

For the purposes of the present document, the following terms and definitions apply.

active MS: A switched-on mobile station with a SIM module attached.

alert-SC: Service element provided by a GSM PLMN to inform an SC which has previously initiated unsuccessful short message delivery attempt(s) to a specific MS, that the MS is now recognized by the PLMN to have recovered operation.

status report: SC informing the originating MS of the outcome of a short message submitted to an SME.

Gateway MSC For Short Message Service (SMS-GMSC): A function of an MSC capable of receiving a short message from an SC, interrogating an HLR for routing information and SMS info, and delivering the short message to the VMSC or the SGSN of the recipient MS.

Interworking MSC For Short Message Service (SMS-IWMSC): A function of an MSC capable of receiving a short message from within the PLMN and submitting it to the recipient SC.

Messages-Waiting (MW): Service element that makes a PLMN store information (Messages-Waiting-Indication), listing those SCs that have made unsuccessful short message delivery attempts to MSs in that PLMN.

Messages-Waiting-Indication (MWI): Data to be stored in the HLR and VLR with which an MS is associated, indicating that there is one or more messages waiting in a set of SCs to be delivered to the MS (due to unsuccessful delivery attempt(s)).

Messages-Waiting-Data (MWD): A part of the MWI to be stored in the HLR. MWD consists of an address list of the SCs which have messages waiting to be delivered to the MS.

Mobile-services Switching Centre (MSC): The Mobile-services Switching Centre is an exchange which performs switching functions for mobile stations located in a geographical area designated as the MSC area.

Mobile-Station-Memory-Capacity-Exceeded-Flag (MCEF): A part of the MWI to be stored in the HLR. MCEF is a Boolean parameter indicating if the address list of MWD contains one or more entries because an attempt to deliver a short message to an MS has failed with a cause of MS Memory Capacity Exceeded.

Mobile-Station-Not-Reachable-Flag (MNRF): The part of the MWI to be stored in the VLR and the HLR. MNRF is a Boolean parameter indicating if the address list of MWD contains one or more entries because an attempt to deliver a short message to an MS has failed with a cause of Absent Subscriber.

Mobile-station-Not-Reachable-for-GPRS (MNRG): The part of the MWI to be stored in the SGSN and the HLR. MNRG is a Boolean parameter indicating if the address list of MWD contains one or more entries because an attempt to deliver a short message to an MS has failed with a cause of Absent Subscriber.

Mobile-Station-Not-Reachable-Reason (MNRR): The part of the MWI in the HLR which stores the reason for an MS being absent when an attempt to deliver a short message to an MS fails at the MSC with a cause of Absent Subscriber.

More-Messages-To-Send (MMS): Information element offering an MS receiving a short message from an SC the information whether there are still more messages waiting to be sent from that SC to the MS. The TP-MMS element (conveyed in the Transfer layer) is copied into the RP-MMS element (conveyed in the Relay layer). It is possible with Phase 2 and later versions of MAP (GSM TS 09.02) for the RP-MMS element to keep an SM transaction open between the GMSC and the MS in the case where there are more-messages-to-send. Earlier versions of MAP will support the transport of the TP-MMS element.

priority: Service element enabling the SC or SME to request a short message delivery attempt to an MS irrespective of whether or not the MS has been identified as temporarily absent.

protocol-identifier: Information element by which the originator of a short message (either an SC or an MS) may refer to a higher layer protocol.

reply path procedure: A mechanism which allows an SME to request that an SC should be permitted to handle a reply sent in response to a message previously sent from that SME to another SME. This may happen even though the SC may be unknown to the SME which received the initial message.

report: Response from either the network or the recipient upon a short message being sent from either an SC or an MS. A report may be a delivery report, which confirms the delivery of the short message to the recipient, or it may be a failure report, which informs the originator that the short message was never delivered and the reason why.

When issued by the Service Centre, the delivery report confirms the reception of the Short Message by the SC, and not the delivery of the Short Message to the SME.

When issued by the Mobile Station, the delivery report confirms the reception of the Short Message by the Mobile Station, and not the delivery of the Short Message to the user.

replace short message type: A range of values in the Protocol Identifier which allows an indication to be sent with a short message (MT or MO) that the short message is of a particular type allowing the receiving MS or the SC to replace an existing message of the same type held in the SC, the ME or on the SIM, provided it comes:

- in MT cases: from the same SC and originating address;
- in MO cases: from the same MS.

Service Centre (SC): Function responsible for the relaying and store-and-forwarding of a short message between an SME and an MS. The SC is not a part of the GSM PLMN, however MSC and SC may be integrated.

Serving GPRS Support Node (SGSN): The Serving GPRS Support Node is an exchange which performs packet switching functions for mobile stations located in a geographical area designated as the SGSN area.

short message: Information that may be conveyed by means of the Short Message Service described in the present document.

Short Message Entity (SME): An entity which may send or receive Short Messages. The SME may be located in a fixed network, an MS, or an SC.

SMS-STATUS-REPORT: Short message transfer protocol data unit informing the receiving MS of the status of a mobile originated short message previously submitted by the MS, i.e. whether the SC was able to forward the message or not, or whether the message was stored in the SC for later delivery.

SMS-COMMAND: Short message transfer protocol data unit which enables an MS to invoke an operation at the SC. An MS may then, for example, delete a short message, cancel a Status Report Request, enquire about the status of a short message or request another function to be performed by the SC.

The type of operation is indicated by the TP-Command-Type and the particular SM to operate on is indicated by the TP-Message-Number and the TP-Destination-Address. Receipt of an SMS-COMMAND is confirmed by an RP-ACK or RP-ERROR. In the case of certain SMS-COMMANDs, an SMS-STATUS-REPORT may be sent, where the outcome of the SMS-COMMAND is passed in its TP-Status field.

SMS-DELIVER: Short message transfer protocol data unit containing user data (the short message), being sent from an SC to an MS.

SMS-SUBMIT: Short message transfer protocol data unit containing user data (the short message), being sent from an MS to an SC.

Service-Centre-Time-Stamp (SCTS): Information element offering the recipient of a short message the information of when the message arrived at the SM-TL entity of the SC. The time of arrival comprises the year, month, day, hour, minute, second and time zone.

Validity-Period (VP): Information element enabling the originator MS to indicate the time period during which the originator considers the short message to be valid.

2.1.2 Abbreviations

For the purposes of the present document, the following abbreviations apply:

ACSE	Association Control Service Element
E.163	CCITT Rec. E.163 (Blue Book)
E.164	CCITT Rec. E.164 (Blue Book)
SM MT	Short Message Mobile Terminated Point-to-Point
SM MO	Short Message Mobile Originated Point-to-Point
SM-AL	Short Message Application Layer
SM-TL	Short Message Transfer Layer
SM-RL	Short Message Relay Layer
SM-LL	Short Message Lower Layers
SM-TP	Short Message Transfer Layer Protocol
SM-RP	Short Message Relay Layer Protocol
SM-TS	Short Message Transfer Service
SM-RS	Short Message Relay Service
T.100	CCITT Rec. T.100 (Blue Book)
T.101	CCITT Rec. T.101 (Blue Book)
TPDU	Transfer protocol data unit
X.121	CCITT Rec. X.121 (Blue Book)
X.400	CCITT Rec. X.400 (Blue Book)

In addition to those above, definitions used in the present document are listed in GSM 01.04.

3 Services and service elements

The SMS provides a means to transfer short messages between a GSM MS and an SME via an SC. The SC serves as an interworking and relaying function of the message transfer between the MS and the SME.

The present document describes only the short message point-to-point services between the MS and SC. It may, however, refer to possible higher layer applications.

3.1 Basic services

The short message point-to-point services comprise two basic services:

SM MT (Short Message Mobile Terminated Point-to-Point);

SM MO (Short Message Mobile Originated Point-to-Point).

SM MT denotes the capability of the GSM system to transfer a short message submitted from the SC to one MS, and to provide information about the delivery of the short message either by a delivery report or a failure report with a specific mechanism for later delivery; see figure 03.40/1.

SM MO denotes the capability of the GSM system to transfer a short message submitted by the MS to one SME via an SC, and to provide information about the delivery of the short message either by a delivery report or a failure report. The message must include the address of that SME to which the SC shall eventually attempt to relay the short message; see figure 03.40/2.

The text messages to be transferred by means of the SM MT or SM MO contain up to 140 octets.

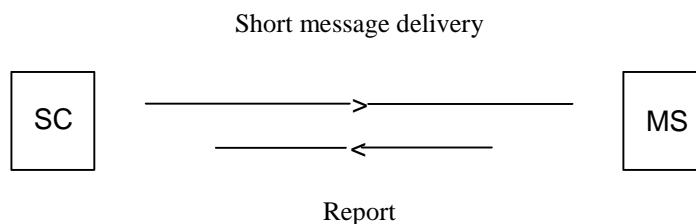

Figure 03.40/1: The Short Message Service mobile terminated, point-to-point

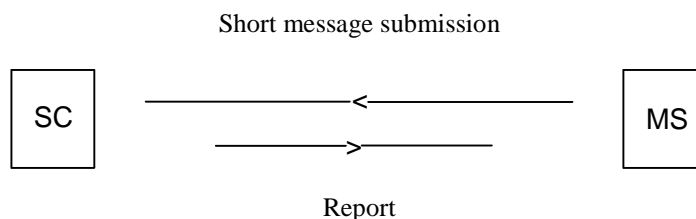

Figure 03.40/2: The Short Message Service mobile originated, point-to-point

An active MS shall be able to receive a short message TPDU (SMS-DELIVER) at any time, independently of whether or not there is a speech or data call in progress. A report will always be returned to the SC; either confirming that the MS has received the short message, or informing the SC that it was impossible to deliver the short message TPDU to the MS, including the reason why.

An active MS shall be able to submit a short message TPDU (SMS-SUBMIT) at any time, independently of whether or not there is a speech or data call in progress. A report will always be returned to the MS; either confirming that the SC has received the short message TPDU, or informing the MS that it was impossible to deliver the short message TPDU to the SC, including the reason why.

NOTE: When the transmission or reception of a short message coincide with a change of state in the MS, i.e. from busy to idle or from idle to busy, or during a handover, the short message transfer might be aborted.

It is also possible for two short messages to be received in sequence having the same originating address and identification, i.e. message reference number (MO) or SC Timestamp (MT). Such a situation may be due to errors at the RP or CP layers (e.g. during inter MSC handover) where it may be a duplicated message or otherwise it may be a valid new message.

The receiving entity should therefore make provision to check other parameters contained in the short message to decide whether the second short message is to be discarded.

3.2 Short Message Service elements

The SMS comprises 7 elements particular to the submission and reception of messages:

- Validity-Period;
- Service-Centre-Time-Stamp;
- Protocol-Identifier;
- More-Messages-to-Send;
- Priority;
- Messages-Waiting;
- Alert-SC.

3.2.1 Validity-Period

The Validity-Period is the information element which gives an MS submitting an SMS-SUBMIT to the SC the possibility to include a specific time period value in the short message (TP-Validity-Period field, see clause 9). The TP-Validity-Period parameter value indicates the time period for which the short message is valid, i.e. for how long the SC shall guarantee its existence in the SC memory before delivery to the recipient has been carried out.

3.2.2 Service-Centre-Time-Stamp

The Service-Centre-Time-Stamp is the information element by which the SC informs the recipient MS about the time of arrival of the short message at the SM-TL entity of the SC. The time value is included in every SMS-DELIVER (TP-Service-Centre-Time-Stamp field, see clause 9) being delivered to the MS.

3.2.3 Protocol-Identifier

The Protocol-Identifier is the information element by which the SM-TL either refers to the higher layer protocol being used, or indicates interworking with a certain type of telematic device.

The Protocol-Identifier information element makes use of a particular field in the message types SMS-SUBMIT, SMS-SUBMIT-REPORT for RP-ACK, SMS-DELIVER DELIVER, SMS-DELIVER-REPORT for RP-ACK, SMS_STATUS_REPORT and SMS-COMMAND TP-Protocol-Identifier (TP-PID).

3.2.4 More-Messages-to-Send

The More-Messages-to-Send is the information element by which the SC informs the MS that there is one or more messages waiting in that SC to be delivered to the MS. The More-Messages-to-Send information element makes use of a Boolean parameter in the message SMS-DELIVER, TP-More-Messages-to-Send (TP-MMS).

3.2.5 Delivery of Priority and non-Priority Messages

Priority is the information element provided by an SC or SME to indicate to the PLMN whether or not a message is a priority message.

Delivery of a non-priority message will not be attempted if the MS has been identified as temporarily absent (see subclause 3.2.6).

Delivery of a non-priority message will be attempted if the MS has not been identified as temporarily absent irrespective of whether the MS has been identified as having no free memory capacity (see subclause 3.2.6).

Delivery of a priority message will be attempted irrespective of whether or not the MS has been identified as temporarily absent, or having no free memory capacity.

3.2.6 Messages-Waiting

The Messages-Waiting is the service element that enables the PLMN to provide the HLR, SGSN and VLR with which the recipient MS is associated with the information that there is a message in the originating SC waiting to be delivered to the MS. The service element is only used in case of previous unsuccessful delivery attempt(s) due to temporarily absent mobile or MS memory capacity exceeded. This information, denoted the Messages-Waiting-Indication (MWI), consists of Messages-Waiting-Data (MWD), , the Mobile-station-Not-Reachable-for-GPRS (MNRG), the Mobile-Station-Not-Reachable-Flag (MNRF), the Mobile-Not-Reachable-Reason (MNRR) and the Mobile-Station-Memory-Capacity-Exceeded-Flag (MCEF) located in the HLR; the Mobile-station-Not Reachable-for-GPRS (MNRG) located in the SGSN, and the Mobile-Station-Not-Reachable-Flag (MNRF) located in the VLR. figure 03.40/3 shows an example.

HLR;

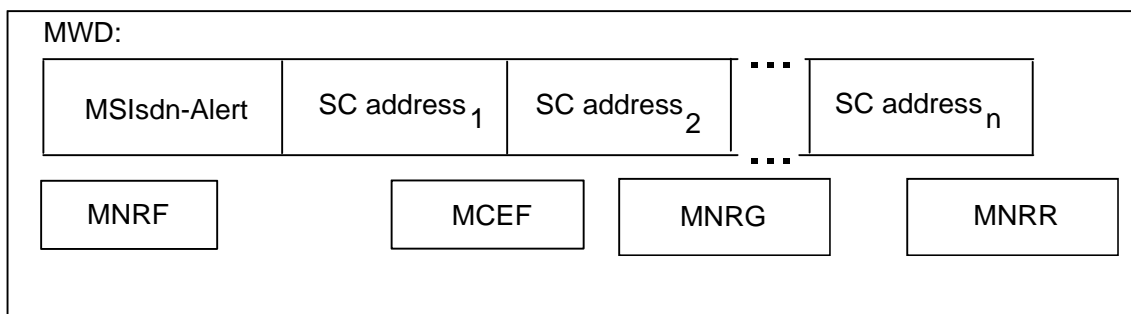

VLR;

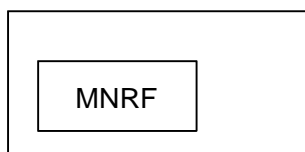

SGSN;

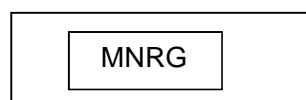

Figure 03.40/3: Example of how information on one MS can be put in relation to SC(s) in order to fulfil the requirement of Alert-SC mechanism

The MWD shall contain a list of addresses (SC-Addr) of SCs which have made previous unsuccessful delivery attempts of a message (see clause 5). In order to be able to send alert messages to every SC which has made unsuccessful delivery attempts to an MS, the HLR shall store the MSIsdn-Alert (see subclause 3.2.7) together with references to the SC addresses. The requirements placed upon the HLR are specified in GSM 03.08. The description of how the HLR is provided with SC and MS address information is given in GSM 09.02.

The Mobile-Station-Memory-Capacity-Exceeded-Flag (MCEF) within the HLR is a Boolean parameter with the value TRUE an attempt to deliver a short message to an MS has failed with a cause of MS Memory Capacity Exceeded, and with the value FALSE otherwise.

The Mobile-station-Not Reachable-for-GPRS (MNRG) within the HLR and the SGSN is a Boolean parameter with the value TRUE when an attempt to deliver a short message to an MS has failed with a cause of Absent Subscriber, and with the value FALSE otherwise (except as described in note 1 below).

The Mobile-Station-Not-Reachable-Flag (MNRF) within the HLR and the VLR is a Boolean parameter with the value TRUE when the list MWD contains one or more list elements because an attempt to deliver a short message to an MS has failed with a cause of Absent Subscriber, and with the value FALSE otherwise.

The Mobile-Station-Not-Reachable-Reason (MNRR) within the HLR stores the reason for the MS being absent when an attempt to deliver a short message to an MS fails at the MSC, SGSN or both with the cause Absent Subscriber. The HLR updates the MNRR with the reason for absence when an absent subscriber diagnostic information is received from the GMSC and the MNRF, MNRG or both are set. The HLR clears the MNRR when the MNRF and MNRG are cleared. If the MNRF is set due to a failure at the MSC with cause Absent Subscriber and information pertaining to the absence of the MS is not available from the GMSC, the MNRR will remain in a cleared state. Also, if the MNRG is set due to a failure at the SGSN with cause Absent Subscriber and information pertaining to the absence of the MS is not available from the GMSC, the MNRR will remain in a cleared state. The MNRR shall either be in a cleared state or contain one of the following reasons:

- No Paging Response via the MSC;
- No Paging Response via the SGSN;
- IMSI Detached;
- GPRS Detached.

NOTE 1: The MNRG can also be set in the HLR and in the SGSN after an unsuccessful attempt to invoke the network requested PDP-Context Activation procedure. In this case, no SC address is stored in MWD list (see TS GSM 03.60).

NOTE 2: When a short message delivery attempt fails at the HLR due to Roaming being Restricted, the MS being deregistered in HLR or the MS being Purged the absent subscriber diagnostic reason is returned to the SC, however the reason is not stored in the MNRR.

The MWD, MCEF, MNRR, MNRG and MNRF are updated in the following way:

- 1a) When a mobile terminated short message delivery fails due to the MS being temporarily absent (i.e. either IMSI DETACH flag is set or there is no response from the MS to a paging request via the MSC), the SC address is inserted into the MWD list (if it is not already present), the MNRF is set (if it is not already set) and the MNRR via the MSC is updated (if the information is available), as described in clause 10.
- 1b) When a mobile terminated short message delivery fails due to the MS being temporarily absent (i.e. either GPRS DETACH flag is set or there is no response from the MS to a paging request via the SGSN), the SC address is inserted into the MWD list (if it is not already present), the MNRG is set (if it is not already set) and the MNRR via the SGSN is updated (if the information is available), as described in clause 10.
- 1c) When a mobile terminated short message delivery fails due to the MS memory capacity via the MSC being exceeded, the SC address is inserted into the MWD list (if it is not already present), the MCEF is set (if it is not already set), the MNRF is cleared and the MNRR via the MSC is updated as described in clause 10.
- 1d) When a mobile terminated short message delivery fails due to the MS memory capacity via the SGSN being exceeded, the SC address is inserted into the MWD list (if it is not already present), the MCEF is set (if it is not already set), the MNRG is cleared and the MNRR via the SGSN is updated as described in clause 10.
- 1e) If the MSISdn used by the SC to address the recipient MS for alerting purposes is different from the MSISdn-Alert of the MS (see subclause 3.2.7), the HLR returns the MSISdn-Alert to the SC within the failure report, see "1c Failure report" in figures 03.40/15 and /16.
- 2a) When either the HLR or VLR detects that the MS (with a non-empty MWD and the MCEF clear in the HLR and the MNRF set in the VLR) has recovered operation (e.g. has responded to a paging request over MSC), the HLR directly or on request of the VLR will invoke operations to alert the SCs within the MWD (see subclause 3.2.7 and clause 10). Once the Alert SC operations have been invoked, the MNRF and MNRR via the MSC are cleared. After each SC is alerted by the HLR, the address for that SC is deleted from the MWD. If the MCEF is set in the HLR, the HLR clears the MNRF and MNRR via the MSC, but does not invoke operations to alert the SCs within the MWD and data are not cleared from the MWD.
- 2b) When either the HLR or SGSN detects that the MS (with a non-empty MWD and the MCEF clear in the HLR and the MNRG set in the SGSN) has recovered operation (e.g. has responded to a paging request via the SGSN), the HLR directly or on request of the SGSN will invoke operations to alert the SCs within the MWD (see subclause 3.2.7 and clause 10). Once the Alert SC operations have been invoked, the MNRG and MNRR via the SGSN are cleared. After each SC is alerted by the HLR, the address for that SC is deleted from the MWD. If the MCEF is set in the HLR, the HLR clears the MNRG and MNRR via the SGSN, but does not invoke operations to alert the SCs within the MWD and data are not cleared from the MWD.
- 2c) When the HLR receives (via the MSC and the VLR) a notification that the MS (with a non-empty MWD and the MCEF set in the HLR) has memory capacity available to receive one or more short messages, the HLR will invoke operations to alert the SCs within the MWD (see subclause 3.2.7 and clause 10). Once the Alert SC operations have been invoked, the MNRF is cleared in the VLR and the MCEF, MNRF and MNRR via the MSC are cleared in the HLR. After each SC is alerted by the HLR, the address for that SC is deleted from the MWD.
- 2d) When the HLR receives (via the SGSN) a notification that the MS (with a non-empty MWD and the MCEF set in the HLR) has memory capacity available to receive one or more short messages, the HLR will invoke operations to alert the SCs within the MWD (see subclause 3.2.7 and clause 10). Once the Alert SC operations have been invoked, the MNRG is cleared in the SGSN and the MCEF, MNRG and MNRR via the SGSN are cleared in the HLR. After each SC is alerted by the HLR, the address for that SC is deleted from the MWD.
- 2e) When the HLR receives from the SMS-GMSC a notification that a short message has been successfully delivered from an SC to an MS via the MSC for which the MCEF is set and the MWD are not empty, the HLR will invoke operations to alert other SCs within the MWD (see subclause 3.2.7 and clause 10). Once the Alert SC operations have been invoked, the MCEF, MNRF and MNRR via the MSC are cleared in the HLR. After each SC is alerted by the HLR, the address for that SC is deleted from the MWD. The SC which successfully delivered the message is also deleted from the MWD, if present.

2f) When the HLR receives from the SMS-GMSC a notification that a short message has been successfully delivered from an SC to an MS via the SGSN for which the MCEF is set and the MWD are not empty, the HLR will invoke operations to alert other SCs within the MWD (see subclause 3.2.7 and clause 10). Once the Alert SC operations have been invoked, the MCEF, MNRG and MNRR via the SGSN are cleared in the HLR. After each SC is alerted by the HLR, the address for that SC is deleted from the MWD. The SC which successfully delivered the message is also deleted from the MWD, if present.

2g) When the HLR receives (via the MSC and the VLR, or the SGSN) a notification that the MS has memory capacity available to receive one or more short messages but the MCEF is not set and the MWD are empty, the HLR acknowledges the notification but does not alert any service centre.

NOTE 1: The HLR can be in a situation where the MWD list is empty but where either MNRF or MNRG (with the related MNRR) is still set. This enables the HLR to return the correct address (MSC or SGSN address) at the next Send Routing Information Request from the SMS-GMSC.

NOTE 2: If the SMS delivery failed on first attempt via the MSC or the SGSN (see cases 1a for IMSI Detach and 1b for GPRS Detach), and is successful on the second attempt (see cases 2e and 2f), the SC address shall not be inserted into the MWD list

3.2.7 Alert-SC

The Alert-SC is the service element, which may be provided by some GSM PLMNs, to inform the SC that an MS

1) to which a delivery attempt has failed because the MS is not reachable or because the MS memory capacity was exceeded;

and

2) which is now recognized by the PLMN:

a) to have resumed operation (e.g. to have responded to a paging request); or

b) to have memory newly available (which implies that the mobile is reachable).

is again ready to receive one or more short messages. The SC may - on reception of an Alert-SC - initiate the delivery attempt procedure for the queued messages destined for this MS.

To each MS there may be allocated several MSIsdns. When the HLR is to alert an SC that an MS is again attainable it will use a specific MSIsdn value for this purpose; in the present document called MSIsdn-Alert.

NOTE: Repeated delivery attempts from the SC may be of two types:

i) A repeated delivery attempt because the SC has been informed that the MS is active and available to receive short messages.

ii) An autonomous repeated delivery attempt by the SC.

The application of these two options is defined by the providers of the SC and the network.

3.2.8 Options concerning MNRG, MNRF, MNRR, MCEF and MWD

Setting the Mobile-Station-Not-Reachable-Flag (MNRF) in the VLR is mandatory. Setting the Mobile-station-Not-Reachable-for-GPRS (MNRG) in the SGSN is mandatory. It is mandatory for the VLR or the SGSN to send the "MS Reachable" message (see clause 10) to the HLR when the MS has been detected as becoming active and then to clear MNRF in the VLR or the MNRG in SGSN.

The Messages-Waiting-Data (MWD), the Mobile-Station-Not-Reachable-Flag (MNRF), the Mobile-station-Not-Reachable-for-GPRS (MNRG), the Mobile-Station-Not-Reachable-Reason (MNRR) and the Mobile-Station-Memory-Capacity-Exceeded-Flag (MCEF) within the HLR are optional, but if one is implemented all must be implemented (except MNRG if the HLR does not support GPRS). This is linked to the transmission of the "Alert SC" message.

The following describes what happens when a delivery fails.

Case 1: MWD, MNRF, MNRG, MNRR and MCEF are implemented in the HLR

In the case of a delivery failure (to an MS) with cause Absent Subscriber, the SMS-GMSC requests the HLR to add, if needed, a new entry in the MWD with cause Absent Subscriber. This new entry contains the SC address. The HLR sets its copy of the MNRF, MNRG or both and updates the MNRR (if the information is available). The SC is notified of the failure, the reason for the MS being absent and also of the MWD setting in the HLR within the Report message (see clause 10).

In the case of a delivery failure (to an MS) with cause Mobile Station Memory Capacity Exceeded via the SGSN or the MSC, the SMS-GMSC requests the HLR to add, if needed, a new entry in the MWD with cause Mobile Station Memory Capacity Exceeded. This new entry contains the SC address. The HLR sets the MCEF and reset MNRF or MNRG. The SC is notified of the failure and also of the MWD setting in the HLR within the Report message (see clause 10).

If the HLR indicates that it is able to store the SC address, then the SC will receive an Alert SC message when the MS becomes active.

If the HLR indicates that it is unable to store the SC address (e.g. because MWD is full), then the only way to ensure delivery is for the SC to try to retransmit the message periodically.

When the HLR receives the MS Reachable message, if the MCEF is clear it sends an Alert SC message to the concerned SC, updates MWD and clears MNRF (if the MS is reachable via the MSC) or MNRG (if the MS is reachable via the SGSN).

When the HLR receives the MS Memory Capacity Available message, it sends an Alert SC message to the concerned SC, updates MWD, clears the MCEF and clears MNRF (if the MS is reachable via the MSC) or MNRG (if the MS is reachable via the SGSN).

Case 2: MWD, MNRF, MNRG, MNRR and MCEF are not implemented in the HLR

In the case of a delivery failure, the SC is notified that the HLR is unable to store its address in the MWD. In case of a delivery failure (to a MS) with cause Absent Subscriber, the SC is notified of the reason for the MS being absent (if the information is available). The SC must retransmit the short message periodically in order to ensure delivery.

The HLR discards the MS Reachable message received from the VLR or SGSN without any failure or error report.

The HLR discards the MS Memory Capacity Available message received from the MS via the MSC and the VLR or SGSN without any failure or error report.

3.2.9 Status report capabilities

The SMS also offers to the SC the capabilities of informing the MS of the status of a previously sent mobile originated short message. The status of the message can be:

- Successfully delivered to the SME;
- The SC was not able to forward the message to the SME. The reason can be an error of permanent or temporary nature. Permanent errors can be e.g. validity period expired, invalid SME address. Errors of temporary nature can be e.g. SC-SME connection being down, SME temporarily unavailable.

This is achieved by the SC returning a status report TPDU (SMS-STATUS-REPORT) to the originating MS when the SC has concluded the status of the short message. The status report may be initiated by a status report request within the mobile originated short message. The status report TPDU is treated as an SMS-DELIVER TPDU by the SC when it comes to delivery procedures e.g. the alerting mechanism.

The SC may also return to a non-MS SME the status of a mobile terminated short message. This is however outside the scope of the present document.

The status report capabilities of the SMS are optional, i.e. the choice of whether to offer status report or not is left to the SC operator.

For reasons of resilience and/or load sharing architecture of SMSC's by network operators, the SMSC address (the RP-OA) used by the SMSC to send the Status Report to the MS cannot be guaranteed to be the same SMSC address (RP-

DA) used by the MS to submit the SM to which the Status Report refers. Where an MS wishes to implement a check that these addresses correlate, a means of disabling the correlation check shall be provided at the MS through MMI.

3.2.10 Reply Path

Reply Path specified in the present document provides a way of both requesting and indicating a service centre's commitment to deliver a reply from the replying MS to the originating SME.

Annex D deals with MS procedures, which in general are outside the scope of GSM specifications. However, for advanced use of the SMS, including both application level protocols and human responses, it is of vital importance to guarantee that a reply-supporting MS is able to reply on every SM, to every SME capable of receiving such reply short messages.

3.3 Unsuccessful short message TPDU transfer SC -> MS

Unsuccessful message transfer SC -> MS may be caused by a variety of different errors. The description of the occurrence of the different errors and how to handle and transfer the error indications is given in GSM 04.08, GSM 04.11 and GSM 09.02.

The different error indications which the SMS-GMSC shall be capable of returning to the SC following an unsuccessful short message TPDU transfer SC -> MS, are given in table 03.40/1. In some cases, additional diagnostic information may be provided.

3.3.1 Errors occurring during transfer of TPDU to MS

These errors are generally due to barring or unsupported service in the PLMN or MS. An error indication is returned to the SC from the SMS-GMSC, but further diagnostic information from the MS will not be available.

3.3.2 Errors occurring after TPDU arrives at MS

These errors may occur due to the MS not supporting optional short message service features, or in connection with a short message application. An error indication shall be returned to the SC from the SMS-GMSC. Additionally, a TPDU (SMS-DELIVER-REPORT) containing diagnostic information may be conveyed from the MS to the originating SC, transparently through the PLMN, by means defined in GSM 04.11 and GSM 09.02. The sending of the diagnostic information is optional at the MS, but when it is sent, the PLMN shall convey the information to the SC, and the SC shall support reception of the information.

Table 03.40/1: Error indications related to mobile terminated short message transfer which may be transferred to the originating SC

Error indication	§1)	Meaning
Unknown subscriber	P	The PLMN rejects the short message TPDU because there is not allocated an IMSI or a directory number for the mobile subscriber in the HLR (see GSM 09.02).
Teleservice not provisioned	P	The PLMN rejects the short message TPDU because the recipient MS has no SMS subscription (see GSM 09.02).
Call barred	T	The PLMN rejects the short message TPDU due to barring of the MS (see GSM 09.02, description of the Barring supplementary service, GSM 02.04 and 03.11), description of Call barred due to Unauthorised Message Originator, GSM 09.02, and description of Operator Determined Barring, GSM 02.41 and 03.15).
Facility not supported	T	The VPLMN rejects the short message TPDU due to no provision of the SMS in the VPLMN (see GSM 09.02).
Absent subscriber	T	The PLMN rejects the short message TPDU because <ul style="list-style-type: none"> - there was no paging response via the SGSN, MSC or both, (see GSM 04.08 & GSM 09.02) - the IMSI GPRS or both records are marked detached (see GSM 09.02), - the MS is subject to roaming restrictions (see "Roaming not allowed", GSM 09.02). - deregistered in the HLR. The HLR does not have an MSC, SGSN or both numbers stored for the target MS, (see GSM 09.02) - Unidentified subscriber (see GSM 09.02) - MS purged, (see GSM 09.02) <p>(The reasons for absence are assigned integer values in table 03.40/1a. The appropriate integer value is sent with the absent subscriber error indication as defined in GSM 09.02)</p>
MS busy for MT SMS	T	The PLMN rejects the short message TPDU because of congestion encountered at the visited MSC or the SGSN. Possible reasons include any of the following events in progress: <ul style="list-style-type: none"> - short message delivery from another SC; - IMSI or GPRS detach - Location Update or Inter SGSN Routing Area Update; - paging; - emergency call; - call setup.
SMS lower layers capabilities not provisioned	T	The PLMN rejects the short message TPDU due to MS not being able to support the Short Message Service. The short message transfer attempt is rejected either due to information contained in the class-mark, or the MSC not being able to establish connection at SAPI = 3 (see GSM 04.08 and GSM 09.02).
Error in MS	T	The PLMN rejects the short message TPDU due to an error occurring within the MS at reception of a short message, e.g. lack of free memory capacity or protocol error.
Illegal Subscriber	P	The PLMN rejects the short message TPDU because the MS failed authentication
Illegal Equipment	P	The PLMN rejects the short message TPDU because the IMEI of the MS was black-listed in the EIR
System failure	T	The PLMN rejects the short message TPDU due to network or protocol failure others than those listed above (see GSM 09.02)
Memory Capacity Exceeded	T	The MS rejects the short message since it has no memory capacity available to store the message

1) : Status (Permanent or Temporary)

The relation between the two sets of error indications is given in the table 03.40/1. Each error is classified as either "Temporary" or "Permanent". This classification gives an indication of whether or not it is probable that the MS becomes attainable within a reasonable period, and so provides the recommended action to be taken by the SC, i.e. either to store the message for later transfer, or to discard it.

Table 03.40/1a: Assignment of values to reasons for absence (values must be in the range of 0 to 255, see GSM 09.02)

Values	Reason for absence
0	- no paging response via the MSC
1	- IMSI detached
2	- roaming restriction
3	- deregistered in the HLR for non GPRS
4	- MS purged for non GPRS
5	- no paging response via the SGSN
6	- GPRS detached
7	- deregistered in the HLR for GPRS
8	- MS purged for GPRS
9	- Unidentified subscriber via the MSC
10	- Unidentified subscriber via the SGSN
All 'non GPRS' reasons (except for roaming restriction) can be combined with all 'GPRS' reasons and vice-versa	
All other integer values are reserved.	

3.4 Unsuccessful short message TPDU transfer MS -> SC

The error indications related to mobile originated short message transfer which may be transferred to the originating MS are given in GSM 04.11. In some cases, additional diagnostic information may be provided.

3.4.1 Errors occurring during transfer of TPDU to SC

These errors are generally due to barring or unsupported service in the PLMN. An error indication is returned to the MS from the MSC or the SGSN, but further diagnostic information from the SC will not be available.

3.4.2 Errors occurring after TPDU arrives at SC

These errors may occur due to the SC not supporting optional short message service features, or in connection with a short message application. An error indication shall be returned to the MS from the MSC or from the SGSN. Additionally, a TPDU (SMS-SUBMIT-REPORT) containing diagnostic information may be conveyed from the SC to the originating MS, transparently through the PLMN, as defined in GSM 09.02 and GSM 04.11. The sending of the diagnostic information is optional at the SC, but when it is sent, the PLMN shall convey the information to the MS, and the MS shall support reception of the information.

NOTE: The SMS-SUBMIT-REPORT is part of the negative acknowledgement to the mobile originated short message, and is not part of the status report capabilities described in subclause 3.2.9.

3.5 Use of Supplementary Services in combination with the Short Message Service

Only a sub-set of the Supplementary Services defined in GSM 02.04 and 03.11 may be used in combination with the Short Message Service. This sub-set comprises the following Supplementary Services:

All the 5 Barring services

3.6 Applicability of Operator Determined Barring to the Short Message Service

The network feature Operator Determined Barring (see GSM 02.41) applies to the Short Message Service.

If a short message fails due to operator determined barring then an appropriate error cause is returned to the originator.

3.7 Multiple short message transfer

To avoid the need for a mobile to be paged, authenticated etc. for each message waiting in the Service Centre, the SC may indicate to the SMS-GMSC that there are more messages to send. When this indication is given, MAP procedures are invoked such that this indication is passed to the VMSC, and the VMSC does not release the MS until all short messages waiting in the SC have been transferred.

3.8 SMS and Internet Electronic Mail interworking

The interworking between Internet electronic mail and SMS is offered in both directions which enables new and old mobiles to send/receive Internet electronic mails via SMS. The interworking is according to the following procedures:

- An SMS message which is required to interwork with Internet email may have its TP-PID value set for Internet electronic mail;
- Either single or concatenated SMS can be used to transport the email;
- Concatenation may be achieved by the TPUDH mechanism or text-based means described below;
- Email cc fields are not supported;
- Where multiple fields are present, additional spaces may be inserted by the sender to improve presentation of the message. Spaces may not be inserted into the actual email address (e.g. user@domain1.domain2).

3.8.1 Basic Format

The basic format for transferring email in either direction consists of the following:

MT SMS:

[<from-address><space>]<message>

MO SMS:

[<to-address><space>]<message>

where [] denote optional fields and <> delimit fields.

The to-address or from address may take the form

user@domain1.domain2

or

User Name <user@domain1.domain2>

In the latter case the angle brackets <> are part of the address and are actually transmitted.

Depending on the nature of the gateway, the destination/origination address is either derived from the content of the SMS TP-OA or TP-DA field, or the TP-OA/TP-DA field contains a generic gateway address and the to/from address is added at the beginning as shown above.

Multiple addresses may be identified in MO messages by separating each address by a comma like this:

address1,address2,address3<space><message>

It is optional for the receiving gateway to support this. If the receiving gateway does not support multiple messages then it shall reject the original message by returning an appropriate error in a text message.

3.8.2 Optional Fields

The following further optional fields are supported. An email <-> SMS gateway may insert additional spaces in the MT message for presentation to the user, and must accept additional spaces in the MO message from the user.

3.8.2.1 Subject

The subject is placed between the address and the message, delimited by round brackets () or preceded by ##, for example:

```
[<to-address>](<subject><message>
```

or

```
[<to-address>##<subject>#<message>
```

An MO message may contain either format. An MT message may contain either format. Developers must ensure that both forms are supported for full compatibility.

3.8.2.2 Real Name

The Real Name field contains the real name of the sender and is used only in MO messages. The SC or email gateway will generate an email message according to standard email procedures containing Real Name <user@domain1.domain2> (the angle brackets being part of the address and hence transmitted). If a subject is to be included with the Real Name then only the ## prefix is used.

The syntax is:

```
[<to-address>]#<real-name>[##<subject>]#<message>
```

3.8.2.3 Optional Control Flag

An optional control flag may be added to the start of the message in MO messages only. This consists of a single character <CF> following a # symbol as follows:

```
[#<CF>#][<to-address>]<space><message>
```

This may also be used in combination with the above fields. It is intended for use where a particular SC or email gateway specific function is required to be invoked. For example, the control flag #A# might add a particular (pre-stored) signature to the end of the message or #R# might change the from-address to a pre-stored value or #5# might add the text "Please phone me at the office". All of these functions are open for definition by Service Centre or email gateway operators.

3.8.3 Text concatenation

If the GSM binary concatenation protocol is not supported by the transmitting or receiving entity, the following textual concatenation mechanism may be used. The first message is ended with a + sign, and each subsequent message start and end with + signs until the final message which starts with a + sign but does not end with a + sign.

```
<message1>+
+<message2>+
+<message3>
```

Any header fields placed on the front of an MO or MT message are not added to the second and subsequent messages.

This provides a simple mechanism which is completely backward compatible. There is no indication of the number of messages and should a message be lost by the system or arrive out of sequence then the original message cannot be reconstructed. Therefore, wherever possible the GSM binary concatenation mechanism specified in subclause 9.2.3.24.1 should be used instead.

3.8.4 Alternative characters for Internet email addresses in MO SMS

It is difficult or impossible to generate some characters on a mobile phone and so the following alternatives may be used:

@ may be replaced by *

_ (underscore) may be replaced by \$

3.9 SMS COMPRESSION

Short Messages may be compressed in accordance with the compression algorithm described in GSM 03.42.

Compression and Decompression may take place between SME's or between an SME and the SC.

The compression only applies to the TP-User-Data part of the TPDU and excludes any TP-User-Data-Header which may be present. The Compression Header (see GSM 03.42) must commence at the first octet of the TP-User-Data field immediately following any TP-User-Data-Header field which may be present.

The TP-UDL value must be set in accordance with that value defined for the compressed TP-User-Data case in subclause 9.2.3.16.

The TP-DCS parameter indicates whether or not a short message is compressed. If the TP-DCS parameter indicates that the short message is compressed then the alphabet encoding values (bits 2 and 3 in GSM 03.38) must be ignored by the receiving entity.

In the case where a short message after compression is greater than 140 octets (including the Compression Header and Footer (see GSM 03.42) and any TP-User-Data-Header which may be present) then the sending entity must concatenate the short message in the normal way as described in subclause 9.2.3.24.1 if it wishes to continue to send the short message. Only the first segment of the concatenated short message must contain the Compression Header defined in GSM TS 03.42. All segments other than the final segment must be 140 octets in length. Only the final segment contains the Compression Footer (see GSM 03.42).

For mobile terminated compressed messages, where the MMI or the Message Class indicated in the TP-DCS requires the message to be stored in the MS then the MS shall store the compressed message as received. In the case where the MS is capable of decompression then the MS may display the decompressed message. Such an MS may optionally store the message in decompressed form subject to the MS being configured to do this via MMI. However, prior to storing the message in decompressed form, the MS may have to create a concatenated SM and carry out component modification on the TP-UDL and TP-DCS values to indicate the correct length values and that the message is no longer compressed. Transfer of messages direct from the radio interface or those stored in the MS to a TE is according to the procedure defined in GSM 07.05 and is independent of whether the message is compressed or uncompressed.

For mobile originated compressed messages, an MS capable of compression may compress a short message generated within the MS itself prior to sending it to the radio interface. An MS capable of compression may optionally compress an uncompressed message received from a TE subject to the MS being configured to do this via MMI. In such a case the MS would have to carry out component modification on the TP-UDL and TP-DCS values to indicate the correct length values and that the message is compressed. A TE may send a message (compressed or uncompressed) to the MS using the procedures defined in GSM 07.05. The MS will store the compressed message as received and/or transfer it directly to the radio interface.

4 Network architecture

4.1 Basic network structure

The exchange of messages between an MS and an SME involves the entities shown in figure 03.40/4.

The basic network structure of the SMS is depicted in figure 03.40/5.

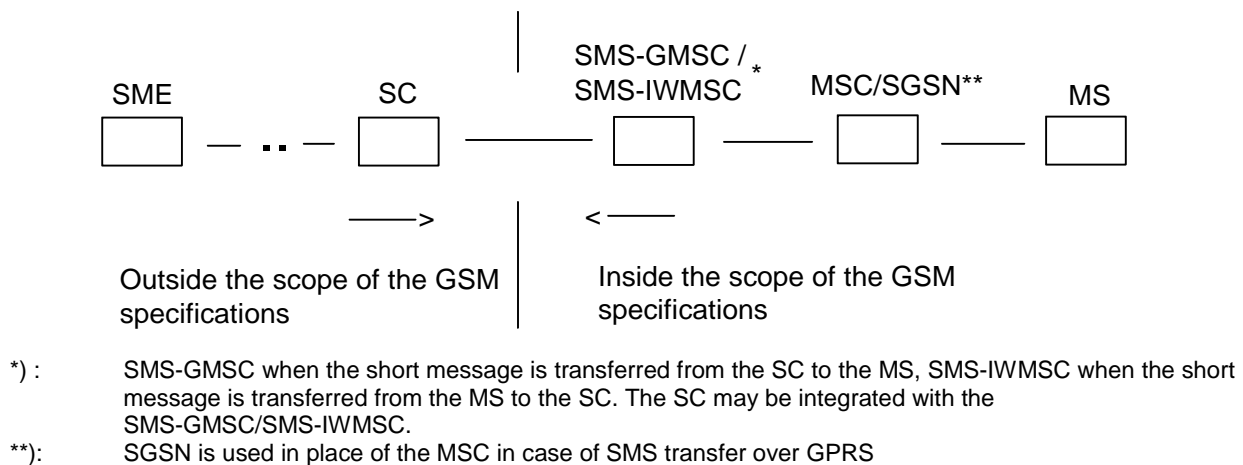
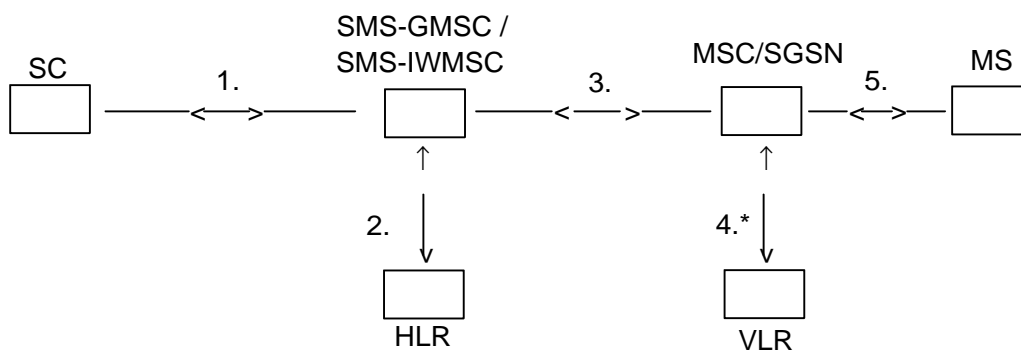

Figure 03.40/4: Entities involved in the provision of SM MT and SM MO: SC, SMS-GMSC/SMS-IWMSC, SGSN, MSC and MS

The links of figure 03.40/5 support the short message transfer in the following way:

- message transfer on link 1 is described in clause 5;
- the operations performed on links 2 and 4 is described in GSM 09.02;
- message transfer on link 3 is described in subclause 4.2;
- message transfer on link 5 is supported by protocol described in GSM 04.11.



*) : This interface is not used in case of SMS transfer via the SGSN

Figure 03.40/5: The main network structure serving as a basis for the short message transfer

4.2 Transfer on link 3

The link 3 is used to support communications between MSC, SMS-GMSC and SMS-IWMSC, or between SGSN, SMS-GMSC and SMS-IWMSC. Two cases can be distinguished according to whether or not the MSC, SMS-GMSC, SMS-IWMSC and SGSN are located in the same PLMN.

In the first case, the link definition is left to the operators. For example, this link may use:

- PSPDN or
- CCITT SS no 7 (according to GSM 09.02).

In the second case, CCITT SS no 7 shall be used over link 3 according to GSM 09.02, unless otherwise bilaterally agreed.

5 Service Centre and PLMN interconnection

The present document deals with the SC only with regard to the interchange of messages between SC and MS. Only the requirements put upon the SC by the SMS functionality are specified in the present document.

5.1 Service centre connection

One SC may be connected to several PLMNs, and may be connected to several MSCs (SMS-GMSCs or SMS-IWMSCs) within one and the same PLMN.

The SC is addressed from the mobile by an E.164 number in the numbering plan of the PLMN to which the SC is connected. This E.164 number shall uniquely identify the SC to that PLMN.

There may be an intermediate network between the PLMN and the SC; in this case the PLMN must autonomously make a connection to the SC using the SC address in this intermediate network.

No mandatory protocol between the SC and the MSC below the transfer layer is specified by GSM; this is a matter for agreement between SC and PLMN operators. However, annex A provides an example protocol stack which could be used.

5.2 Routing requirements

5.2.1 Mobile terminated short message

The SC sends the short message to the SMS-GMSC. The SMS-GMSC interrogates the HLR to retrieve routing information necessary to forward the short message, and then sends the message to the relevant MSC or SGSN, transiting other networks if necessary. The MSC or SGSN then sends the short message to the MS.

5.2.2 Mobile originated short message

The MS sends the short message to the MSC or the SGSN. The MS will always address the required SC by an E.164 address. The visited PLMN will route the message to the appropriate SMS-IWMSC in the SC's PLMN, transiting other networks if necessary.

6 Service Centre functionality

In the present document, only the SC functionality related to the short message point-to-point service between the SC and the MS is specified.

6.1 Service Centre capabilities

The SC should be capable of

- submitting a short message to an MS, retaining the responsibility of the message until
 - 1) the report has been received; or
 - 2) the Validity-Period expires.
- receiving a report from the PLMN;
- receiving a short message from an MS;
- returning a report to the PLMN for a previously received short message.

6.2 SC functional requirements

The detailed functionality of the SC is outside the scope of the present document, and is for the SC operator to define. However, the following functional requirements are mandatory for all SCs in order to support the SM-TP (see clause 9) towards the PLMN:

- 1) To identify each SMS-DELIVER sent to an MS in a unique way, a time stamp value is included in the field TP-Service-Centre-Time-Stamp, TP-SCTS, of the SMS-DELIVER. The time stamp gives the time when the message arrived at the SC with the accuracy of a second. If two or more messages to the same MS arrive at the SC within one second, the SC shall modify the time stamp of those messages in such a way that
 - a) all messages to the MS contain different time stamps;
 - b) the modification of the time stamps is kept to a minimum.
- 2) The SC is only allowed to have one outstanding SMS-DELIVER (i.e. a message for which a report has not been received) to a specific MS at a given time.
- 3) The SC shall be able to initiate overwriting of short messages previously received by the SC if requested by the same originating address (MS or any other source) by use of the same message type.

7 MS functionality

In the present document, only the MS functionality related to the short message point-to-point service between the SC and the MS is specified.

7.1 MS capabilities

The MS, when equipped for SMS, should be capable of

- submitting a short message TPDU to an SC, retaining the responsibility of the message until:
 - 1) the report arrives from the network; or
 - 2) a timer expires.
- receiving a short message TPDU from an SC;
- returning a delivery report to the network for a previously received short message;
- receiving a report from the network;
- notifying the network when it has memory capacity available to receive one or more short messages when it has previously rejected a short message because its memory capacity was exceeded;

- notifying the SC when a short message is intended to replace a short message the MS has previously submitted to the same destination address.

It is recommended that an MS supporting both replying and automatic SC selection (as specified in clause D.2 of annex D) follows procedures specified in annex D when replying to MT short messages with MO short messages.

It is recommended that an MS supporting a capability for requesting a reply path follows procedures specified in annex D.

7.2 MS configuration

The reference configuration is assumed as in figure 03.40/6, i.e. only the case where the terminal is integrated in the MS is considered.

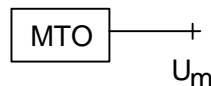

Figure 03.40/6: Reference configuration of the MS which apply to the SMS

NOTE: It is foreseen that a terminal interface may be offered, e.g. for higher layer protocols, memory capacity reasons or to be able to type in mobile originated messages. This terminal interface is regarded as an implementation option, although, where offered, it must be based upon an R- or S-reference point. GSM 07.05 provides an example based on the R reference point.

8 Node functionality

The overall requirements to the MSC, SMS-GMSC, SMS-IWMSC and SGSN with respect to handling of the Short Message Service point-to-point is to cater for the routing and necessary intermediate buffering of the short messages.

8.1 Node functionality related to SM MT

8.1.1 Functionality of the SMS-GMSC

When receiving a short message TPDU from the SC, the SMS-GMSC is responsible for the following operations:

- reception of the short message TPDU;
- inspection of the parameters.

NOTE: The SMS-GMSC may be identical to the MSC.

if parameters are incorrect:

- returning the appropriate error information to the SC in a failure report (see clauses 9 and 10);

if errors are not found within parameters:

- interrogating the HLR ("sendRoutingInfoForShortMsg", see clause 10); retrieving routing information or possible error information;

if HLR is returning error information:

- returning the appropriate error information to the SC in a failure report (see clauses 9 and 10);

if no errors are indicated by the HLR:

- transferring the short message TPDU to the MSC or SGSN using the routing information obtained from the HLR ("forwardShortMessage", see clause 10).

NOTE: In case where two addresses (SGSN and MSC) are received from HLR, the SMS-GMSC may choose (operator dependant) via which nodes (SGSN or MSC) the SMS is first to be sent. The SMS delivery via the SGSN is normally more radio resource efficient than the SMS delivery via the MSC.

if one address (SGSN or MSC) is received from HLR:

- When receiving the report associated with the short message from the MSC or SGSN (positive or negative outcome of "forwardShortMessage", see clause 10), the SMS-GMSC is responsible for the following operations:

if the report indicates successful delivery:

- notifying the HLR of the successful delivery via the MSC or the SGSN, which will cause the HLR to alert any service centres whose addresses are stored in the MWD for the MS;
- creating and sending the successful report to the SC;

if the report is a failure report indicating "absent subscriber" via the MSC or the SGSN (see subclause 3.3):

- requesting the HLR to insert the address of the originating SC into the MWD (if implemented) with cause Absent Subscriber ("SM_DeliveryReportStatus", see clauses 9 and 10);
- informing the HLR of the reason for the MS being absent via the MSC or the SGSN (if this information is available);
- establishing, where necessary, a link with the addressed SC (see clause 5);
- creating and sending the negative report to the SC which should include the reason for the MS being absent (if this information is available) so that the SC may adjust any retry algorithm appropriately (see clauses 9 and 10);

if the report is a failure report indicating "MS memory capacity exceeded" via the MSC or the SGSN (see subclause 3.3):

- requesting the HLR to insert the address of the originating SC into the MWD (if implemented) with cause MS Memory Capacity Exceeded via the MSC or the SGSN ("SM_DeliveryReportStatus", see clauses 9 and 10);
- establishing, where necessary, a link with the addressed SC (see clause 5);
- creating and sending the report to the SC (see clauses 9 and 10).

if two addresses (SGSN and MSC) are received from HLR:

- When receiving the first report associated with the short message from the MSC or SGSN (positive or negative outcome of "forwardShortMessage", see clause 10), the SMS-GMSC is responsible for the following operations:

if the first report indicates successful delivery:

- notifying the HLR of the successful delivery via the MSC or the SGSN, which will cause the HLR to alert any service centres whose addresses are stored in the MWD for the MS;
- creating and sending the successful report to the SC;

if the first report is a failure report indicating

- Unidentified subscriber
- Facility not supported
- Absent subscriber with indication: GPRS or IMSI Detach
- System failure
- Unexpected data value
- Data missing

- GPRS connection suspended (see TS GSM 09.02) :
 - transferring the short message TPDU to the second path using the routing information obtained from HLR.
- if the second report indicates successful delivery:
- notifying the HLR of the successful delivery of the second transfer via the MSC or SGSN, which will cause the HLR to alert any service centres whose addresses are stored in the MWD for the MS;
 - notifying the HLR of the unsuccessful delivery at first transfer only with cause "absent subscriber";
 - notifying the HLR of the reason for the MS being absent via the MSC or the SGSN (if this information is available);
 - establishing, when necessary, a link with the addressed SC (see clause 5);
 - creating and sending the successful report to the SC;
- if the second report is a failure report:
- requesting the HLR to insert the address of the originating SC into the MWD (if implemented) only if at least one of the first or second report failed due to "MS Memory Capacity Exceeded" or "Absent Subscriber" ("SM_DeliveryReportStatus", see clauses 9 and 10);
 - notifying the HLR only with the causes "Absent Subscriber", "Memory Capacity Exceeded" via the MSC or the SGSN, or both;
 - notifying the HLR of the reason for the MS being absent via the MSC, SGSN or both (if this information is available);
 - establishing, where necessary, a link with the addressed SC (see clause 5);
 - creating and sending the negative report to the SC with errors from first and second path (see clauses 9 and 10);

8.1.2 Functionality of the MSC

When receiving a short message TPDU from the SMS-GMSC ("forwardShortMessage", see clause 10), the MSC is responsible for the following operations:

- reception of the short message TPDU;
- retrieving information from the VLR ("sendInfoFor-MT-SMS", see clause 10); location area address and, when appropriate, error information;

if errors are indicated by the VLR:

- returning the appropriate error information to the SMS-GMSC in a failure report (negative outcome of "forwardShortMessage" see clauses 10 and 11);

if no errors are indicated by the VLR:

- transferring the short message to the MS (see GSM 04.11).

When receiving a confirmation that the message is received by the MS (see GSM 04.11):

- relaying the delivery confirmation to the SMS-GMSC in a delivery report (positive outcome of "forwardShortMessage", see clauses 10 and 11).

When receiving a failure report of the short message transfer to the MS (see GSM 04.11):

- returning the appropriate error information to the SMS-GMSC in a failure report (negative outcome of "forwardShortMessage", see clause 10).

When receiving a notification from the MS that it has memory available to receive one or more short messages (see GSM 04.11):

- relaying the notification to the VLR ("mSMemoryCapacityAvailable", see clause 10);

if errors are indicated by the VLR:

- returning the appropriate error information to the MS in a failure report (negative outcome of "ReadyForSM", see clauses 10 and 11).

When there is an ongoing MT-SMS transfer to the MS (see GSM 04.11), or other busy condition for MT-SMS, the MSC has the option to store the TPDU in a queue for a short time (which must be shorter than the supervision timer defined in GSM 09.02). The maximum time that a message may be queued is related to the permitted delay for the MSC to respond to the SMS-GMSC. When the MS becomes available for MT-SMS transfer, the stored TPDU's are delivered to the MS on a first-in first-out basis. If a message is not successfully transferred to the MS within the permitted time, the MSC returns an appropriate error to the SMS-GMSC.

8.1.3 Functionality of the SGSN

When receiving a short message TPDU from the SMS-GMSC ("forwardShortMessage", see clause 10), the SGSN is responsible for the following operations:

- reception of the short message TPDU;

if errors are detected by the SGSN:

- returning the appropriate error information to the SMS-GMSC in a failure report (negative outcome of "forwardShortMessage" see clauses 10 and 11);

if no errors are detected by the SGSN:

- transferring the short message to the MS (see GSM 04.11).

When receiving a confirmation that the message is received by the MS (see GSM 04.11):

- relaying the delivery confirmation to the SMS-GMSC in a delivery report (positive outcome of "forwardShortMessage", see clauses 10 and 11).

When receiving a failure report of the short message transfer to the MS (see GSM 04.11):

- returning the appropriate error information to the SMS-GMSC in a failure report (negative outcome of "forwardShortMessage", see clause 10).

When receiving a notification from the MS that it has memory available to receive one or more short messages (see GSM 04.11):

if errors are detected by the SGSN:

- returning the appropriate error information to the MS in a failure report (negative outcome of "ReadyForSM", see clauses 10 and 11).

if no errors are detected by the SGSN:

- notifying the HLR of memory available in the MS via the SGSN with "ReadyForSM" (see clauses 10 and 11).

When the MS is becoming reachable again (see GSM 04.08):

- notifying the HLR of MS being reachable via the SGSN (and via the MSC if any) with "ReadyForSM" (see clauses 10).

When there is an ongoing MT-SMS transfer to the MS (see GSM 04.11), or other busy condition for MT-SMS, the SGSN has the option to store the TPDU in a queue for a short time (which must be shorter than the supervision timer defined in GSM 09.02). The maximum time that a message may be queued is related to the permitted delay for the SGSN to respond to the SMS-GMSC. When the MS becomes available for MT-SMS transfer, the stored TPDU's are delivered to the MS on a first-in first-out basis. If a message is not successfully transferred to the MS within the permitted time, the SGSN returns an appropriate error to the SMS-GMSC.

8.2 Node functionality related to SM MO

8.2.1 Functionality of the MSC

When receiving a short message TPDU from the MS, the MSC is responsible for the following operations:

- reception of the short message TPDU (see GSM 04.11);
- retrieving information from the VLR ("sendInfoForMO-SMS", see clause 10); the MSISDN of the MS and, when appropriate, error information. The retrieval of information from the VLR is followed by the VLR investigating the MNRF (to be used in the alerting procedure, see clause 10)

if errors are indicated by the VLR:

- returning the appropriate error information to the MS in a failure report (negative outcome of "sendInfoForMO-SMS" see clauses 10 and 11);

if no errors are indicated by the VLR:

- inspection of the RP-DA parameter;

if parameters are incorrect:

- returning the appropriate error information to the MS in a failure report (see GSM 04.11);

if no parameter errors are found:

NOTE: The SMS-IWMSC may be identical to the MSC.

- transferring the short message TPDU to the SMS-IWMSC ("forwardShortMessage", see clause 10).

When receiving the report of the short message from the SMS-IWMSC (positive or negative outcome of the "forwardShortMessage", see clause 10), the MSC is responsible for the following operations:

- relaying the report to the MS (see GSM 04.11).

8.2.2 Functionality of the SMS-IWMSC

When receiving a short message TPDU from the MSC or SGSN ("forwardShortMessage", see clause 10), the SMS-IWMSC is responsible for the following operations:

- reception of the short message TPDU;
- establishing, where necessary, a link with the addressed SC (see clause 5);
- transferring the short message TPDU to the SC (if the address is valid).

If a report associated with the short message is received from the SC, the SMS-IWMSC is responsible for the following operations:

- relaying of the report to the MSC or SGSN (positive or negative outcome of "forwardShortMessage", see clause 10).

If a report associated with the short message is not received from the SC before a timer expires or if the SC address is invalid, the SMS-IWMSC is responsible for the following operations:

- returning the appropriate error information to the MSC or SGSN in a failure report (negative outcome of "forwardShortMessage", see clause 10).

The value of the timer is dependent on the protocol between the SC and the SMS-IWMSC.

8.2.3 Functionality of the SGSN

When receiving a short message TPDU from the MS, the SGSN is responsible for the following operations:

- reception of the short message TPDU (see GSM 04.11);
- inspection of the RP-DA parameter;

if parameters are incorrect:

- returning the appropriate error information to the MS in a failure report (see GSM 04.11);

if no parameter errors are found:

- transferring the short message TPDU to the SMS-IWMSC ("forwardShortMessage", see clause 10).

When receiving the report of the short message from the SMS-IWMSC (positive or negative outcome of the "forwardShortMessage", see clause 10), the SGSN is responsible for the following operations:

- relaying the report to the MS (see GSM 04.11).

8.3 SMS-IWMSC functionality related to alerting

When receiving an alert from the HLR ("alertServiceCentre", see clause 10), the SMS-IWMSC is responsible for the following operations:

- inspect the SC address;
- generate an RP-Alert-SC (see clause 9);
- transferring the RP-Alert-SC to the SC.

NOTE: If the SC address is not valid, then no further action will be taken.

9 Protocols and protocol architecture

The protocol layers of the SMS are structured as shown in figure 03.40/7.

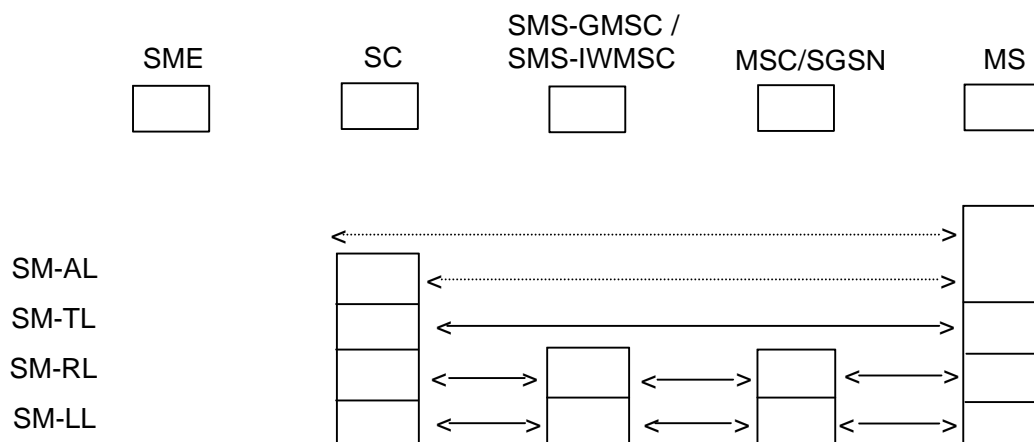

Figure 03.40/7: Protocol layer overview for the Short Message Service point-to-point

The present document specifies the protocol at the SM-TL, the service offered by the SM-TL at the MS and the SC, and the service offered by the SM-RL at the SC.

9.1 Protocol element features

9.1.1 Octet and Bit transmission order

The octets are transmitted according to their individual numbering; the octet with the lowest number being transmitted first. The bits within each octet are transmitted according to their individual numbering also; the bits with the lowest internal number being transmitted first.

9.1.2 Numeric and alphanumeric representation

For parameters within the TPDU's, there are four ways of numeric representation: Integer representation, octet, semi-octet and alphanumeric representation.

9.1.2.1 Integer representation

Wherever the bits from a number of octets, complete or in fractions, are to represent an integer, the interpretation will be according to the following:

- 1) Between octets: The octets with the lowest octet numbers will contain the most significant bits.
- 2) Within an octet: The bits with the highest bit numbers will be the most significant.

Below is given an example of octet and bit representation and transmission order of an integer represented field.

Let the 2 rightmost bits of octet no 5, the complete octet no 6 and 7, and the 3 leftmost bits of octet no 8 represent an integer, as shown in figure 03.40/8.

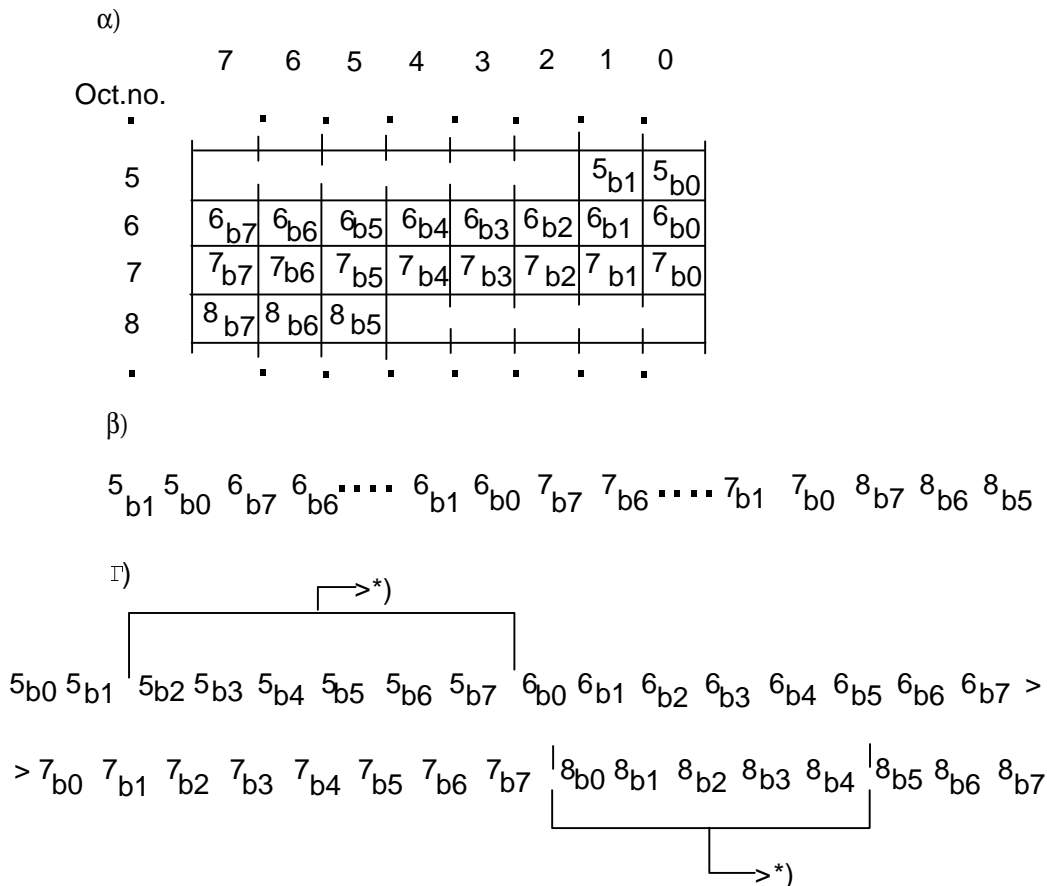

*) : Bits not representing the integer.

Figure 03.40/8: 21 bits from the octets 5, 6, 7, and 8 in a short message α) will represent an integer as shown in β), and will be transmitted in an order as shown in Γ)

9.1.2.2 Octet representation

A field which is octet represented, will always consist of a number of complete octets. Each octet within the field represents one decimal digit. The octets with the lowest octet numbers will contain the most significant decimal digits.

9.1.2.3 Semi-octet representation

A field which is semi-octet represented, will consist of a number of complete octets and - possibly - one half octet. Each half octet within the field represents one decimal digit. The octets with the lowest octet numbers will contain the most significant decimal digits. Within one octet, the half octet containing the bits with bit numbers 0 to 3, will represent the most significant digit.

In the case where a semi-octet represented field comprises an odd number of digits, the bits with bit numbers 4 to 7 within the last octet are fill bits and shall always be set to "1111".

If a mobile receives an address field containing non-integer information in the semi-octets other than "1111" (e.g. 1110) it shall display the semi-octet as the representation given in GSM 04.08 under "called BCD number", viz 1010="*", 1011="#", 1100="a", 1101="b", 1110="c". In the event of a discrepancy between the values quoted here and the values specified in GSM 04.08 then GSM 04.08 shall take precedence. If a mobile receives "1111" in a position prior to the last semi-octet then processing shall commence with the next semi-octet and the intervening semi-octet will be ignored.

Within each semi octet, the bits with the highest bit numbers will be the most significant.

Below is given an example:

Octet no:

n+1	Digit 2	Digit 1
n+2	Digit 4	Digit 3
n+3	1 1 1 1	Digit 5

9.1.2.4 Alphanumeric representation

A field which uses alphanumeric representation will consist of a number of 7-bit characters represented as the default alphabet defined in GSM 03.38.

9.1.2.5 Address fields

Address fields used by SM-RL are specified in GSM 04.11 and 09.02.

Each address field of the SM-TL consists of the following sub-fields: An Address-Length field of one octet, a Type-of-Address field of one octet, and one Address-Value field of variable length; as shown below:

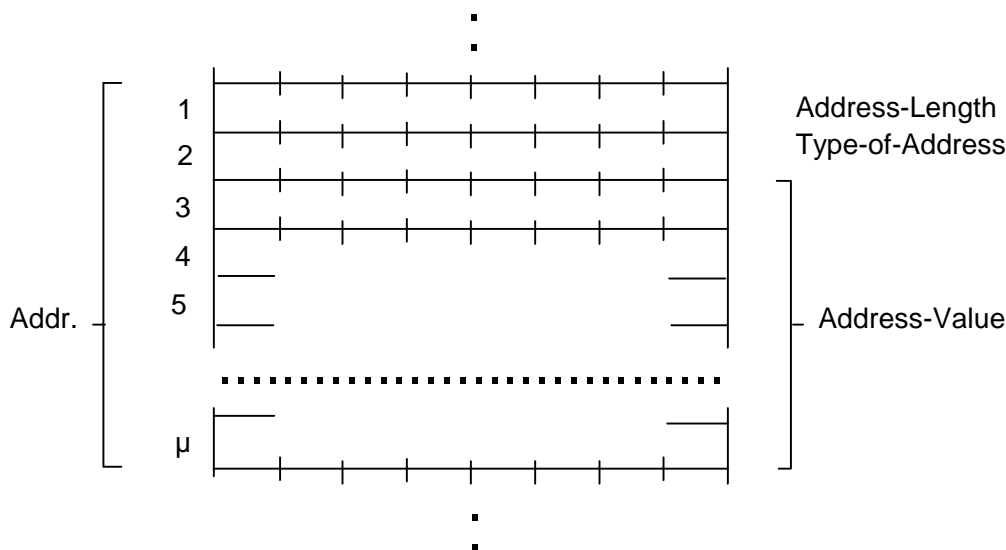

The Address-Length field is an integer representation of the number of useful semi-octets within the Address-Value field, i.e. excludes any semi octet containing only fill bits.

The Type-of-Address field format is as follows:

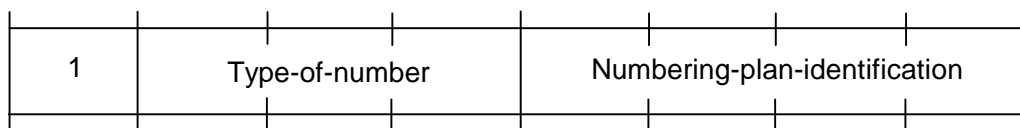

Type-of-number:

Bits	6 5 4	
	0 0 0	Unknown ¹⁾
	0 0 1	International number ²⁾
	0 1 0	National number ³⁾
	0 1 1	Network specific number ⁴⁾
	1 0 0	Subscriber number ⁵⁾
	1 0 1	Alphanumeric, (coded according to GSM TS 03.38 7-bit default alphabet)
	1 1 0	Abbreviated number
	1 1 1	Reserved for extension

The MS will interpret reserved values as "Unknown" but will store them exactly as received.

The SC may reject messages with a type of number containing a reserved value or one which is not supported.

- 1) "Unknown" is used when the user or network has no a priori information about the numbering plan. In this case, the Address-Value field is organized according to the network dialling plan, e.g. prefix or escape digits might be present.
- 2) The international format shall be accepted also when the message is destined to a recipient in the same country as the MSC or as the SGSN.
- 3) Prefix or escape digits shall not be included.
- 4) "Network specific number" is used to indicate administration/service number specific to the serving network, e.g. used to access an operator.
- 5) "Subscriber number" is used when a specific short number representation is stored in one or more SCs as part of a higher layer application. (Note that "Subscriber number" shall only be used in connection with the proper PID referring to this application).

Numbering-plan-identification (applies for Type-of-number = 000,001,010)

Bits	3 2 1 0	
	0 0 0 0	Unknown
	0 0 0 1	ISDN/telephone numbering plan (E.164/E.163)
	0 0 1 1	Data numbering plan (X.121)
	0 1 0 0	Telex numbering plan
	1 0 0 0	National numbering plan
	1 0 0 1	Private numbering plan
	1 0 1 0	ERMES numbering plan (ETSI DE/PS 3 01-3)
	1 1 1 1	Reserved for extension
		All other values are reserved.

For Type-of-number = 101 bits 3,2,1,0 are reserved and shall be transmitted as 0000. Note that for addressing any of the entities SC, MSC, SGSN or MS, Numbering-plan-identification = 0001 will always be used. However, for addressing the SME, any specified Numbering-plan-identification value may be used.

The MS will interpret reserved values as "Unknown" but will store them exactly as received.

The SC may reject messages with a type of number containing a reserved value or one which is not supported.

Within the Address-Value field, either a semi-octet or an alphanumeric¹⁾ representation applies.

The maximum length of the full address field (Address-Length, Type-of-Address and Address-Value) is 12 octets.

1) Applies only to addressing at the SM-TL.

9.2 Service provided by the SM-TL

9.2.1 General

The Short Message Transfer Layer (SM-TL) provides a service to the Short Message Application Layer (SM-AL). This service enables the SM-AL to transfer short messages to its peer entity, receive short messages from its peer entity and receive reports about earlier requests for short messages to be transferred.

In order to keep track of messages and reports about those messages, primitives between the SM-AL and SM-TL contain a Short Message Identifier (SMI), which is a reference number for the message associated with the primitive. This Short Message Identifier is mapped to and from the Short Message Identifier used between the SM-TL and the Short Message Relay Layer (SM-RL). The Short Message Identifier is not carried between entities and therefore a given message may have different SMIs at the MS and SC sides (see subclause 9.3.1 below).

The SM-TL communicates with its peer entity by the protocol described in the following subclauses.

9.2.2 PDU Type repertoire at SM-TL

The SM-TL comprises the following six PDUs:

SMS-DELIVER, conveying a short message from the SC to the MS;

SMS-DELIVER-REPORT, conveying

- a) a failure cause (if necessary);
- b) information as part of a positive or negative acknowledgement to an SMS-DELIVER or SMS-STATUS-REPORT

SMS-SUBMIT, conveying a short message from the MS to the SC;

SMS-SUBMIT-REPORT, conveying

- a) a failure cause (if necessary);

b) information as part of a positive or negative acknowledgement to an SMS-SUBMIT or SMS-COMMAND SMS-STATUS-REPORT, conveying a status report from the SC to the MS;
SMS-COMMAND, conveying a command from the MS to the SC.

9.2.2.1 SMS-DELIVER type

Basic elements of the SMS-DELIVER type:

Abbr.	Reference	P1)	R2)	Description
TP-MTI	TP-Message-Type-Indicator	M	2b	Parameter describing the message type.
TP-MMS	TP-More-Messages-to-Send	M	b	Parameter indicating whether or not there are more messages to send
TP-RP	TP-Reply-Path	M	b	Parameter indicating that Reply Path exists.
TP-UDHI	TP-User-Data-Header-Indicator	O	b	Parameter indicating that the TP-UD field contains a Header
TP-SRI	TP-Status-Report-Indication	O	b	Parameter indicating if the SME has requested a status report.
TP-OA	TP-Originating-Address	M	2-12o	Address of the originating SME.
TP-PID	TP-Protocol-Identifier	M	o	Parameter identifying the above layer protocol, if any.
TP-DCS	TP-Data-Coding-Scheme	M	o	Parameter identifying the coding scheme within the TP-User-Data.
TP-SCTS	TP-Service-Centre-Time-Stamp	M	7o	Parameter identifying time when the SC received the message.
TP-UDL	TP-User-Data-Length	M	I	Parameter indicating the length of the TP-User-Data field to follow.
TP-UD	TP-User-Data	O	3)	

1) Provision; Mandatory (M) or Optional (O).

2) Representation; Integer (I), bit (b), 2 bits (2b), Octet (o), 7 octets (7o), 2-12 octets (2-12o)

3) Dependent on the TP-DCS

Layout of SMS-DELIVER:

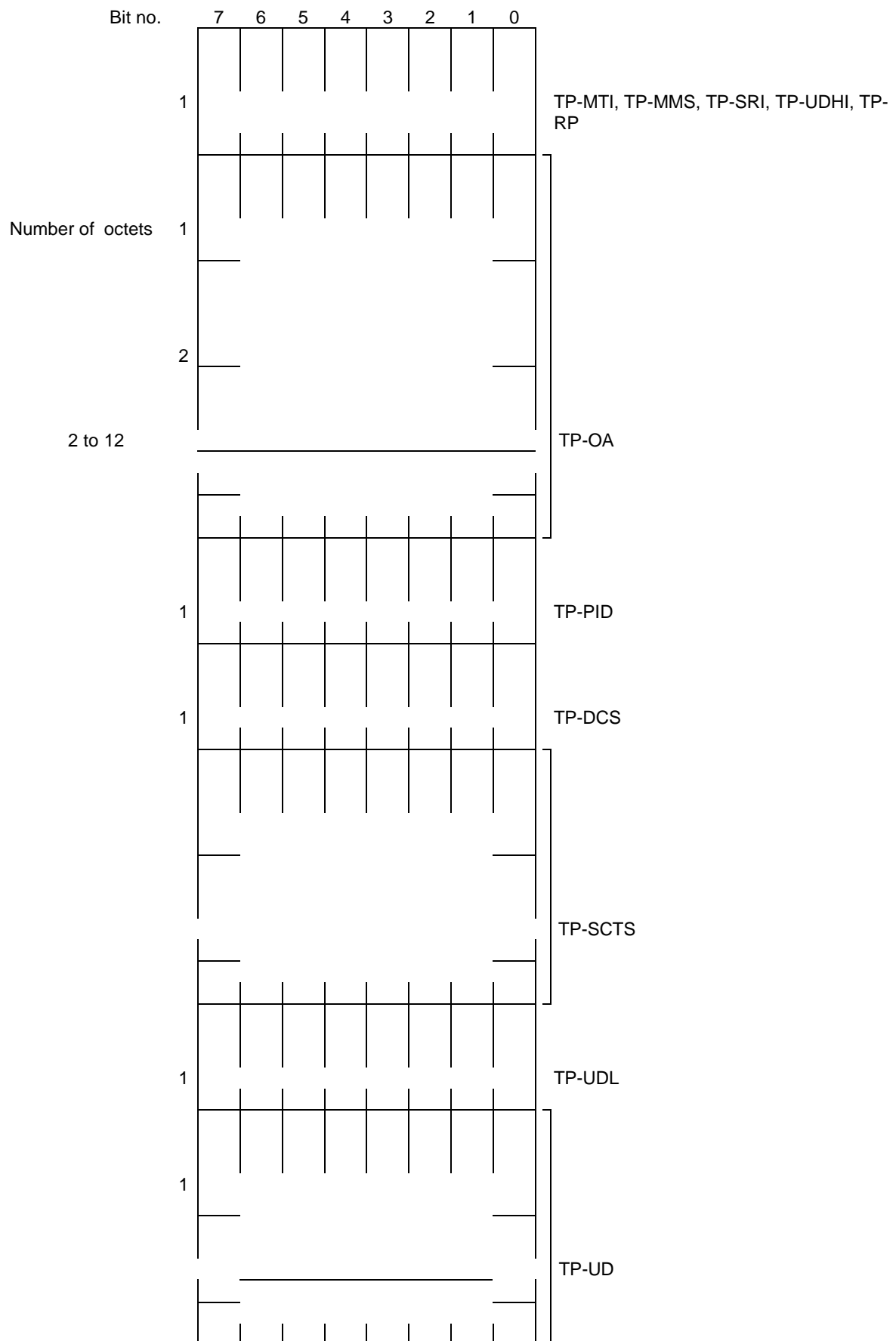

NOTE: Any unused bits will be set to zero by the sending entity and will be ignored by the receiving entity.

9.2.2.1a SMS-DELIVER-REPORT type

An SMS-DELIVER-REPORT TPDU is carried as a RP-User-Data element within an RP-ERROR PDU and is part of the negative acknowledgement to an SMS-DELIVER or SMS-STATUS-REPORT.

An SMS-DELIVER-REPORT TPDU is also carried as a RP-User-Data element within an RP-ACK PDU and is part of a positive acknowledgement to a SMS-DELIVER or SMS-STATUS REPORT

(i) SMS-DELIVER-REPORT for RP-ERROR

Basic elements of the SMS-DELIVER-REPORT type:

Abbr.	Reference	p1)	p2)	Description
TP-MTI	TP-Message-Type-Indicator	M	2b	Parameter describing the message type
TP-UDHI	TP-User-Data-Header-Indication	O	b	Parameter indicating that the TP-UD field contains a Header
TP-FCS	TP-Failure-Cause	M	I	Parameter indicating the reason for SMS-DELIVER failure
TP-PI	TP-Parameter-Indicator	M	o	Parameter indicating the presence of any of the optional parameters which follow
TP-PID	TP-Protocol-Identifier	O	o	see subclause 9.2.3.9
TP-DCS	TP-Data-Coding-Scheme	O	o	see subclause 9.2.3.10
TP-UDL	TP-User-Data-Length	O	o	see subclause 9.2.3.16
TP-UD	TP-User-Data	O	3) 4)	see subclause 9.2.3.24

1) Provision: Mandatory (M) or Optional (O)

2) Representation: Integer (I), bit (b), 2bits (2b), octet (o)

3) Dependent upon the TP-DCS

4) The TP-User-Data field in the SMS-DELIVER-REPORT is only available for use by the MT.

Layout of SMS-DELIVER-REPORT:

Number of Octets	Bit Number								
	7	6	5	4	3	2	1	0	
1									TP-MTI, TP-UDHI
1									TP-FCS
1									TP-PI
0,1									TP-PID
0,1									TP-DCS
0,1									TP-UDL
0 to 158									TP-UD

Bits 7 and 5 - 2 in octet 1 are presently unused and the sender shall set them to zero. If any of these bits is non-zero, the receiver shall not examine the other field and shall treat the TP-Failure-Cause as "Unspecified error cause".

(ii) SMS-DELIVER-REPORT for RP-ACK

Basic elements of the SMS-DELIVER-REPORT type:

Abbr	Reference	p1)	p2)	Description
TP-MTI	TP-Message Type Indicator	M	2b	Parameter describing the message type
TP-UDHI	TP-User-Data-Header-Indication	O	b	Parameter indicating that the TP-UD field contains a Header
TP-PI	TP-Parameter-Indicator	M	o	Parameter indicating the presence of any of the optional parameters which follow
TP-PID	TP-Protocol-Identifier	O	o	see subclause 9.2.3.9
TP-DCS	TP-Data-Coding-Scheme	O	o	see subclause 9.2.3.10
TP-UDL	TP-User-Data-Length	O	o	see subclause 9.2.3.16
TP-UD	TP-User-Data	O	3) 4)	see subclause 9.2.3.24

1) Provision: Mandatory (M) or Optional (O)

2) Representation: Integer (I), Bit (b), 2 bits (2b), octet (o)

3) Dependent upon the TP-DCS

4) The TP-User-Data field in the SMS-DELIVER-REPORT is only available for use by the MT.

Layout of SMS-DELIVER-REPORT:

Number of Octets	Bit Number								
	7	6	5	4	3	2	1	0	
1									TP-MTI, TP-UDHI
1									TP-PI
0,1									TP-PID
0,1									TP-DCS
0,1									TP-UDL
0 to 159									TP-UD

Bits 7 - 2 in the TP-MTI are presently unused in the SMS-DELIVER-REPORT and the sender shall set them to zero. If any of these bits is non-zero, the receiver shall ignore them.

9.2.2.2 SMS-SUBMIT type

Basic elements of the SMS-SUBMIT type:

Abbr.	Reference	p1)	p2)	Description
TP-MTI	TP-Message-Type-Indicator	M	2b	Parameter describing the message type.
TP-RD	TP-Reject-Duplicates	M	b	Parameter indicating whether or not the SC shall accept an SMS-SUBMIT for an SM still held in the SC which has the same TP-MR and the same TP-DA as a previously submitted SM from the same OA
TP-VPF	TP-Validity-Period-Format	M	2b	Parameter indicating whether or not the TP-VP field is present.
TP-RP	TP-Reply-Path	M	b	Parameter indicating the request for Reply Path.
TP-UDHI	TP-User-Data-Header-Indicator	O	b	Parameter indicating that the TP-UD field contains a Header.
TP-SRR	TP-Status-Report-Request	O	b	Parameter indicating if the MS is requesting a status report.
TP-MR	TP-Message-Reference	M	I	Parameter identifying the SMS-SUBMIT.
TP-DA	TP-Destination-Address	M	2-12o	Address of the destination SME.
TP-PID	TP-Protocol-Identifier	M	o	Parameter identifying the above layer protocol, if any.
TP-DCS	TP-Data-Coding-Scheme	M	o	Parameter identifying the coding scheme within the TP-User-Data.
TP-VP	TP-Validity-Period	O	o/7o	Parameter identifying the time from where the message is no longer valid.
TP-UDL	TP-User-Data-Length	M	I	Parameter indicating the length of the TP-User-Data field to follow.
TP-UD	TP-User-Data	O	3)	

--	--	--	--	--

- 1) Provision; Mandatory (M) or Optional (O).
- 2) Representation; Integer (I), bit (b), 2 bits (2b), Octet (o), 7 octets (7o), 2-12 octets (2-12o).
- 3) Dependent on the TP-DCS

Layout of SMS-SUBMIT:

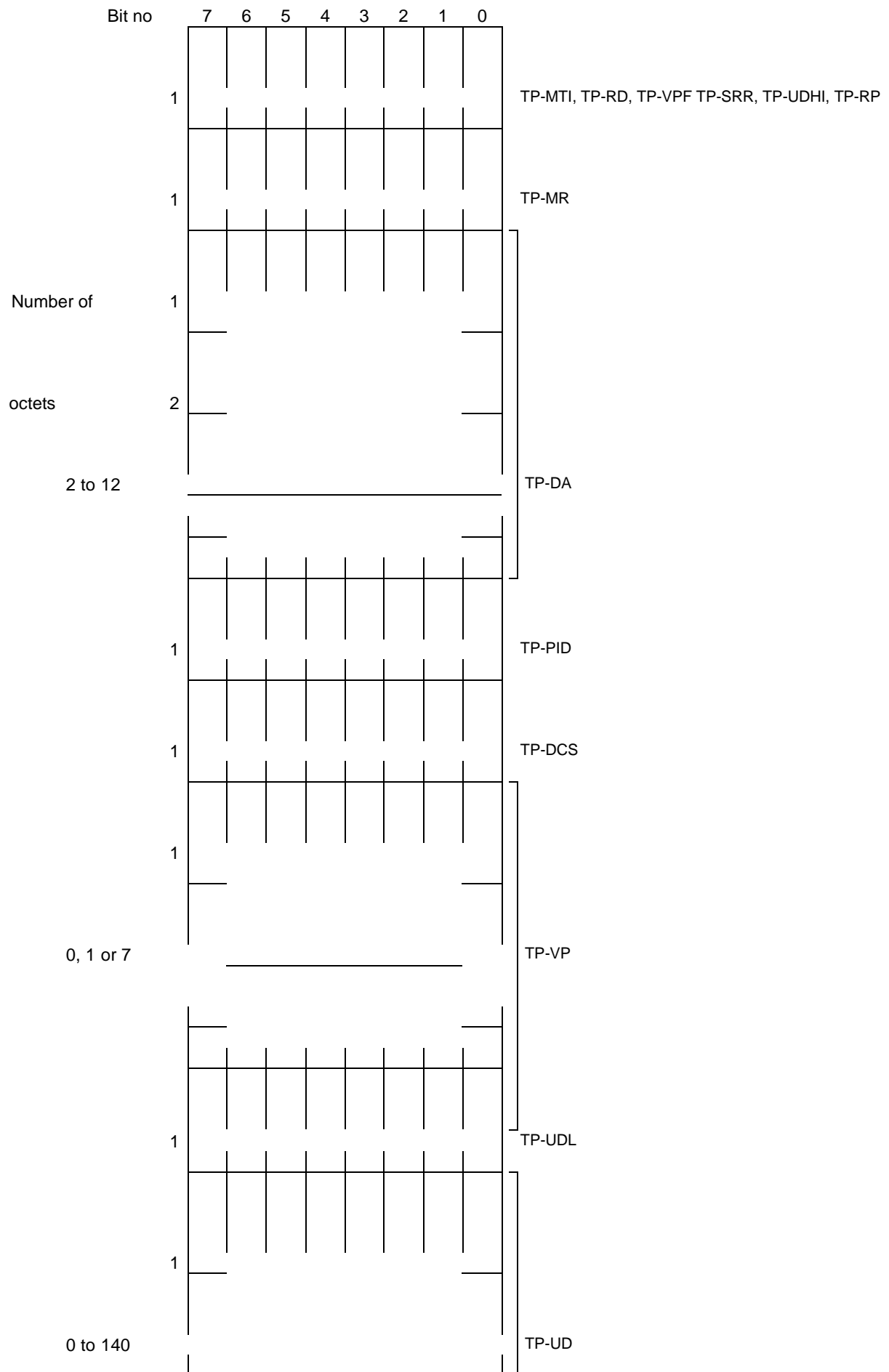

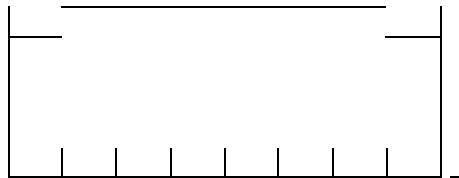

NOTE: Any unused bits will be set to zero by the sending entity and will be ignored by the receiving entity.

9.2.2.2a SMS-SUBMIT-REPORT type

An SMS-SUBMIT-REPORT TPDU is carried as a RP-User-Data element within an RP-ERROR PDU and is part of the negative acknowledgement to an SMS-SUBMIT or SMS-COMMAND.

An SMS-SUBMIT-REPORT TPDU is also carried as a RP-User-Data element with an RP-ACK PDU and is part of a positive acknowledgement to a SMS-SUBMIT or SMS-COMMAND.

(i) SMS-SUBMIT-REPORT for RP-ERROR

Basic elements of the SMS-SUBMIT-REPORT type:

Abbr.	Reference	p1)	p2)	Description
TP-MTI	TP-Message-Type-Indicator	M	2b	Parameter describing the message type
TP-UDHI	TP-User-Data-Header-Indication	O	b	Parameter indicating that the TP-UD field contains a Header
TP-FCS	TP-Failure-Cause	M	I	Parameter indicating the reason for SMS-SUBMIT failure
TP-PI	TP-Parameter-Indicator	M	o	Parameter indicating the presence of any of the optional parameters which follow
TP-SCTS	TP-Service-Centre-Time-Stamp	M	7o 5)	Parameter identifying the time when the SC received the SMS-SUBMIT See subclause 9.2.3.11
TP-PID	TP-Protocol-Identifier	O	o	See subclause 9.2.3.9
TP-DCS	TP-Data-Coding-Scheme	O	o	see subclause 9.2.3.10
TP-UDL	TP-User-Data-Length	O	o	see subclause 9.2.3.16
TP-UD	TP-User-Data	O	3) 4)	see subclause 9.2.3.24

1) Provision: Mandatory (M) or Optional (O)

2) Representation: Integer (I), bit (b), 2bits (2b), octet (o)

3) Dependent upon the TP-DCS;

4) The TP-User-Data field in the SMS-SUBMIT-REPORT is only available for use by the SC.;

5) This same time value will also be carried in the SMS-STATUS-REPORT relating to a particular SM. See subclause 9.2.2.3. This will allow the submitting SME to associate a particular SMS-SUBMIT with a subsequent SMS-STATUS-REPORT by correlating the TP-SCTS values.

Layout of SMS-SUBMIT-REPORT:

Number of Octets	Bit Number								
	7	6	5	4	3	2	1	0	
1									TP-MTI, TP-UDHI
1									TP-FCS
1									TP-PI
7									TP-SCTS
0,1									TP-PID
0,1									TP-DCS
0,1									TP-UDL
0 to 151									TP-UD

Bits 7 and 5 - 2 in octet 1 are presently unused and the sender shall set them to zero. If any of these bits is non-zero, the receiver shall not examine the other field and shall treat the TP-Failure-Cause as "Unspecified error cause".

(ii) SMS-SUBMIT-REPORT for RP-ACK

Basic elements of the SMS-SUBMIT_REPORT type:

Abbr	Reference	p1)	p2)	Description
TP-MTI	TP-Message Type-Indicator	M	2b	Parameter describing the message type
TP-UDHI	TP-User-Data-Header-Indication	O	b	Parameter indicating that the TP-UD field contains a Header
TP-PI	TP-Parameter-Indicator	M	o	Parameter indicating the presence of any of the optional parameters which follow
TP-SCTS	TP-Service-Centre-Time-Stamp	M	7o 5)	Parameter identifying the time when the SC received the SMS-SUBMIT See subclause 9.2.3.11
TP-PID	TP-Protocol-Identifier	O	o	See subclause 9.2.3.9
TP-DCS	TP-Data-Coding-Scheme	O	o	see subclause 9.2.3.10
TP-UDL	TP-User-Data-Length	O	o	see subclause 9.2.3.16
TP-UD	TP-User-Data	O	3) 4)	see subclause 9.2.3.24

1) Provision: Mandatory (M) or Optional (O);

2) Representation: Integer (I), Bit (B), 2bits (2b), octet (o);

3) Dependent upon the TP-DCS;

4) The TP-User-Data field in the SMS-SUBMIT-REPORT is only available for use by the SC.;

5) This same time value will also be carried in the SMS-STATUS-REPORT relating to a particular SM. See subclause 9.2.2.3. This will allow the submitting SME to associate a particular SMS-SUBMIT with a subsequent SMS-STATUS-REPORT by correlating the TP-SCTS values.

Layout of SMS-SUBMIT REPORT

Number of Octets	Bit Number								
	7	6	5	4	3	2	1	0	
1									TP-MTI, TP-UDHI
1									TP-PI
7									TP-SCTS
0,1									TP-PID
0,1									TP-DCS
0,1									TP-UDL
0 to 152									TP-UD

Bits 7 - 2 in the TP-MTI are presently unused in the SMS-SUBMIT-REPORT and the sender shall set them to zero. If any of these bits is non-zero, the receiver shall ignore them.

9.2.2.3 SMS-STATUS-REPORT type

Basic elements of the SMS-STATUS-REPORT type:

Abbr.	Reference	P1)	R2)	Description
TP-MTI	TP-Message-Type-Indicator	M	2b	Parameter describing the message type
TP-UDHI	TP-User-Data-Header-Indication	O	b	Parameter indicating that the TP-UD field contains a Header
TP-MMS	TP-More-Messages-to-Send	M	b	Parameter indicating whether or not there are more messages to send
TP-SRQ	TP-Status-Report-Qualifier	M	b	Parameter indicating whether the previously submitted TPDU was an SMS-SUBMIT or an SMS-COMMAND
TP-MR	TP-Message-Reference ³⁾	M	I	Parameter identifying the previously submitted SMS-SUBMIT or SMS-COMMAND
TP-RA	TP-Recipient-Address	M	2-12o	Address of the recipient of the previously submitted mobile originated short message
TP-SCTS	TP-Service-Centre-Time-Stamp	M	7o	Parameter identifying time when the SC received the previously sent SMS-SUBMIT
TP-DT	TP-Discharge-Time	M	7o	Parameter identifying the time associated with a particular TP-ST outcome
TP-ST	TP-Status	M	o	Parameter identifying the status of the previously sent mobile originated short message
TP-PI	TP-Parameter-Indicator	O 4)	o	Parameter indicating the presence of any of the optional parameters which follow
TP-PID	TP-Protocol-Identifier	O	o	see subclause 9.2.3.9. TP-PID of original SMS-SUBMIT
TP-DCS	TP-Data-Coding-Scheme	O	o	see subclause 9.2.3.10
TP-UDL	TP-User-Data-Length	O	o	see subclause 9.2.3.16
TP-UD	TP-User-Data	O	5)	see subclause 9.2.3.24

1) Provision: Mandatory (M) or Optional (O).

2) Representation: Integer (I), bit (b), 2 bits (2b), Octet (o), 7 octets (7o), 2-12 octets (2-12o)

3) Where the SMS-STATUS-REPORT is the result of an SMS-COMMAND and the TP-Command-Type was an Enquiry, the TP-MR returned in the SMS-STATUS-REPORT shall be the TP-MN which was sent in the SMS-COMMAND (i.e. the TP-MR of the previously submitted SM to which the Enquiry refers).

4) Mandatory if any of the optional parameters following TP-PI is present, otherwise optional.

5) TP-UD contains information related to a SMS-DELIVER; can contain information transported in the TP-UD of SMS-DELIVER-REPORT, and information inserted by the SMSC. The length of the TP-UD field is limited and might not be long enough to fit information both from the original receiving terminal (as included into the SMS-

DELIVER-REPORT) and information added by the SMSC. In these cases the former information has higher priority, and the latter will be truncated.

Layout of SMS-STATUS-REPORT:

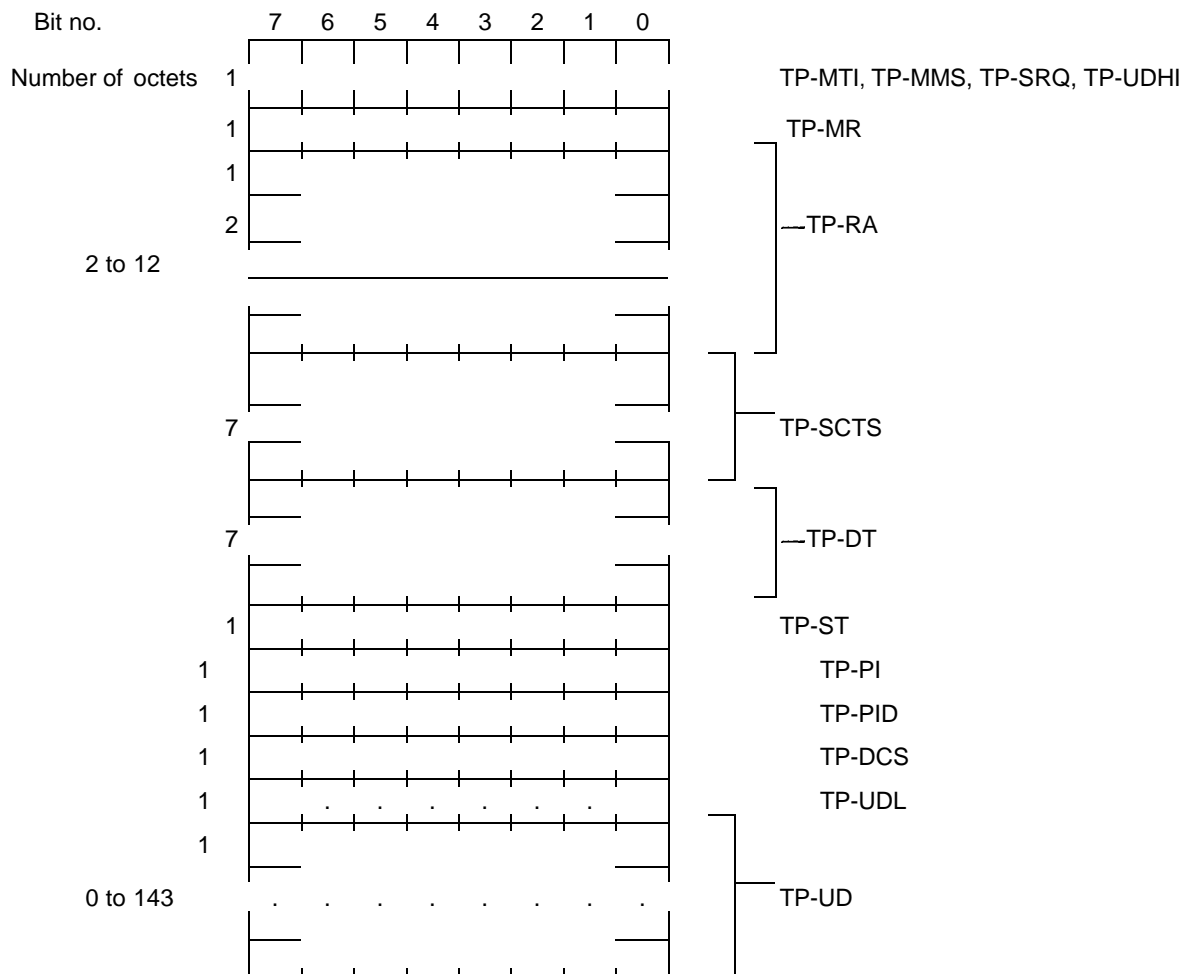

NOTE: Any unused bits will be set to zero by the sending entity and will be ignored by the receiving entity.

The maximum guaranteed length of TP-UD is 131 octets. In order to achieve the maximum stated above (143 octets), the TP-RA field must have a length of 2 octets and TP-PID and TP-DCS must not be present.

9.2.2.4 SMS-COMMAND type

Basic elements of the SMS-COMMAND type:

Abbr.	Reference	P1)	R2)	Description
TP-MTI	TP-Message-Type-Indicator	M	2b	Parameter describing the type
TP-UDHI	TP-User-Data-Header-Indication	O	b	Parameter indicating that the TP-CD field contains a Header
TP-SRR	TP-Status-Report-Request	O	b	Parameter indicating if the SMS Command is requesting a status report.
TP-MR	TP-Message Reference	M	I	Parameter identifying the SMS-COMMAND
TP-PID	TP-Protocol- Identifier	M	o	Parameter identifying the above layer protocol, if any
TP-CT	TP-Command-Type	M	o	Parameter specifying which operation is to be performed on a SM
TP-MN	TP-Message-Number	M ³⁾	o	Parameter indicating which SM in the SC to operate on
TP-DA	TP-Destination-Address	M ⁴⁾	2-12o	Parameter indicating the Destination Address to which the TP-Command refers
TP-CDL	TP-Command-Data-Length	M	o	Parameter indicating the length of the TP-CD field in octets
TP-CD	TP-Command-Data	O	o	Parameter containing user data

- 1) Provision: Mandatory (M) or Optional (O).
- 2) Representation: Integer (I), bit (b), 2bits (2b), octet (o)
- 3) For TP-Command-Types which are not for a specific SM this field shall be ignored when received. Its value is of no concern but the field must be present to maintain the structure.
- 4) For certain TP-Command-Types which operate on a specific SM (e.g. Enquire, Delete etc.) the full TP-DA must be specified. For TP-Command-Types which do not operate on a specific SM, the address length must be set to zero indicating that the Address-Value fields are not present. The Type-of-Address field must be present (see 9.1.2.5) and shall be set to zero and ignored.

Layout of SMS-COMMAND:

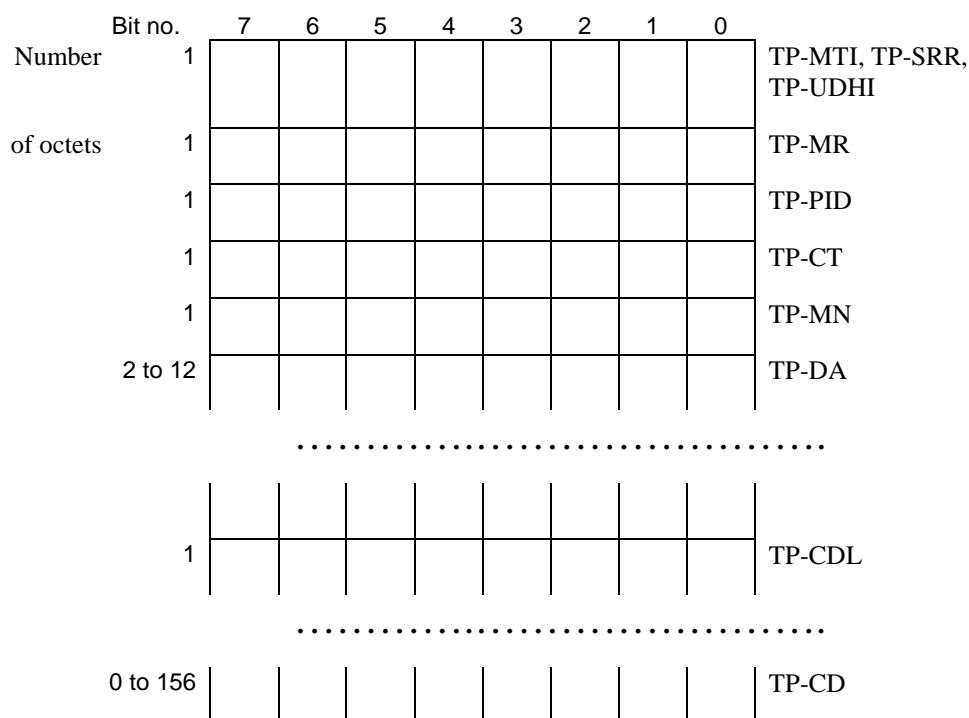

NOTE: The maximum guaranteed length of TP-CD is 146 octets. In order to achieve the maximum stated above (156 octets), the TP-DA field must have a length of 2 octets.

9.2.3 Definition of the TPDU parameters

9.2.3.1 TP-Message-Type-Indicator (TP-MTI)

The TP-Message-Type-Indicator is a 2-bit field, located within bits no 0 and 1 of the first octet of all PDUs which can be given the following values:

bit1	bit0	Message type
0	0	SMS-DELIVER (in the direction SC to MS)
0	0	SMS-DELIVER REPORT (in the direction MS to SC)
1	0	SMS-STATUS-REPORT (in the direction SC to MS)
1	0	SMS-COMMAND (in the direction MS to SC)
0	1	SMS-SUBMIT (in the direction MS to SC)
0	1	SMS-SUBMIT-REPORT (in the direction SC to MS)
1	1	Reserved

If an MS receives a TPDU with a "Reserved" value in the TP-MTI it shall process the message as if it were an "SMS-DELIVER" but store the message exactly as received.

9.2.3.2 TP-More-Messages-to-Send (TP-MMS)

The TP-More-Messages-to-Send is a 1-bit field, located within bit no 2 of the first octet of SMS-DELIVER and SMS-STATUS-REPORT, and to be given the following values:

Bit no 2:	0	More messages are waiting for the MS in this SC
	1	No more messages are waiting for the MS in this SC

NOTE: In the case of SMS-STATUS-REPORT this parameter refers to messages waiting for the mobile to which the status report is sent. The term message in this context refers to SMS-messages or status reports.

9.2.3.3 TP-Validity-Period-Format (TP-VPF)

The TP-Validity-Period-Format is a 2-bit field, located within bit no 3 and 4 of the first octet of SMS-SUBMIT, and to be given the following values:

bit4	bit3	
0	0	TP-VP field not present
1	0	TP-VP field present - relative format
0	1	TP-VP field present - enhanced format
1	1	TP-VP field present - absolute format

Any unsupported value may be rejected by the SC by returning the 'TP-VPF not supported' TP-FCS value in the SMS Submit Report for RP-Error.

9.2.3.4 TP-Status-Report-Indication (TP-SRI)

The TP-Status-Report-Indication is a 1-bit field, located within bit no. 5 of the first octet of SMS-DELIVER, and to be given the following values:

Bit no. 5: 0	A status report will not be returned to the SME
1	A status report will be returned to the SME

9.2.3.5 TP-Status-Report-Request (TP-SRR)

The TP-Status-Report-Request is a 1-bit field, located within bit no. 5 of the first octet of SMS-SUBMIT and SMS-COMMAND, and to be given the following values:

Bit no. 5: 0	A status report is not requested
1	A status report is requested

9.2.3.6 TP-Message-Reference (TP-MR)

The TP-Message-Reference field gives an integer representation of a reference number of the SMS-SUBMIT or SMS-COMMAND submitted to the SC by the MS. The MS increments TP-Message-Reference by 1 for each SMS-SUBMIT or SMS-COMMAND being submitted. The value to be used for each SMS-SUBMIT is obtained by reading the Last-Used-TP-MR value from the SMS Status data field in the SIM (see GSM 11.11) and incrementing this value by 1. After each SMS-SUBMIT has been submitted to the network, the Last-Used-TP-MR value in the SIM is updated with the TP-MR that was used in the SMS-SUBMIT operation. The reference number may possess values in the range 0 to 255. The value in the TP-MR assigned by the MS is the same value which is received at the SC.

In the case where no acknowledgement or an appropriate RP-Error is received in response to an SMS-SUBMIT or SMS-COMMAND, then the MS may automatically repeat the SMS-SUBMIT or SMS-COMMAND but must use the same TP-MR value. The number of times the MS may repeat the SMS-SUBMIT or SMS-COMMAND is an implementation matter.

If all automatic attempts fail (including the case where no automatic repeat is provided), the user shall be informed. The failed message shall be stored in the mobile in such a way that the user can request a retransmission using the same TP-MR value, without needing to re-enter any information. Such storage need only be provided for a single failed message, the one most recently attempted.

The SC may discard an SMS-SUBMIT or SMS-COMMAND which has the same TP-MR value as the previous SMS-SUBMIT or SMS-COMMAND received from the same originating address.

A Phase 2 or later ME using a Phase 1 SIM cannot read or update the TP-Message-Reference from/to the SIM, and so the ME shall always retain the Last-Used-TP-MR value in its own memory, to be used only in the case of a Phase 1 SIM.

The SMS-STATUS-REPORT also contains a TP-Message-Reference field. The value sent to the MS will be the same as the TP-Message-Reference value generated by the MS in the earlier SMS-SUBMIT or SMS-COMMAND to which the status report relates.

9.2.3.7 TP-Originating-Address (TP-OA)

The TP-Originating-Address field is formatted according to the formatting rules of address fields.

9.2.3.8 TP-Destination-Address (TP-DA)

The TP-Destination-Address field is formatted according to the formatting rules of address fields.

9.2.3.9 TP-Protocol-Identifier (TP-PID)

The TP-Protocol-Identifier parameter serves the purposes indicated in subclause 3.2.3. It consists of one octet, and the bits in the octet are used as follows:

The MS will interpret reserved or unsupported values as the value 00000000 but shall store them exactly as received.

The SC may reject messages with a TP-Protocol-Identifier containing a reserved value or one which is not supported.

bits	usage
7 6	
0 0	Assigns bits 0..5 as defined below
0 1	Assigns bits 0..5 as defined below
1 0	reserved
1 1	Assigns bits 0-5 for SC specific use

In the case where bit 7 = 0 and bit 6 = 0,

bit 5 indicates telematic interworking:

value = 0 : no interworking, but SME-to-SME protocol

value = 1 : telematic interworking

In the case of telematic interworking, the following five bit patterns in bits 4..0 are used to indicate different types of telematic devices:

4.. 0	
00000	implicit - device type is specific to this SC, or can be concluded on the basis of the address
00001	telex (or teletex reduced to telex format)
00010	group 3 telefax
00011	group 4 telefax
00100	voice telephone (i.e. conversion to speech)
00101	ERMES (European Radio Messaging System)
00110	National Paging system (known to the SC)
00111	Videotex (T.100/T.101)
01000	teletex, carrier unspecified
01001	teletex, in PSPDN
01010	teletex, in CSPDN
01011	teletex, in analog PSTN
01100	teletex, in digital ISDN
01101	UCI (Universal Computer Interface, ETSI DE/PS 3 01-3)
01110..01111	(reserved, 2 combinations)
10000	a message handling facility (known to the SC)
10001	any public X.400-based message handling system
10010	Internet Electronic Mail
10011..10111	(reserved, 5 combinations)
11000..11110	values specific to each SC, usage based on mutual agreement between the SME and the SC (7 combinations available for each SC)
11111	A GSM mobile station. The SC converts the SM from the received TP-Data-Coding-Scheme to any data coding scheme supported by that MS (e.g. the default).

If bit 5 has value 1 in an SMS-SUBMIT PDU, it indicates that the SME is a telematic device of a type which is indicated in bits 4..0, and requests the SC to convert the SM into a form suited for that device type. If the destination network is ISDN, the SC must also select the proper service indicators for connecting to a device of that type.

If bit 5 has value 1 in an SMS-DELIVER PDU, it indicates that the SME is a telematic device of a type which is indicated in bits 4..0.

If bit 5 has value 0 in an SMS-DELIVER PDU, the value in bits 4..0 identifies the SM-AL protocol being used between the SME and the MS.

Note that for the straightforward case of simple MS-to-SC short message transfer the Protocol Identifier is set to the value 0.

In the case where bit 7 = 0, bit 6 = 1, bits 5..0 are used as defined below

5 .. .0	
000000	Short Message Type 0
000001	Replace Short Message Type 1
000010	Replace Short Message Type 2
000011	Replace Short Message Type 3
000100	Replace Short Message Type 4
000101	Replace Short Message Type 5
000110	Replace Short Message Type 6
000111	Replace Short Message Type 7
001000..011110	Reserved
011111	Return Call Message
100000..111100	Reserved
111101	ME Data download
111110	ME De-personalization Short Message
111111	SIM Data download

A short message type 0 indicates that the ME must acknowledge receipt of the short message but may discard its contents.

The Replace Short Message feature is optional for the ME and the SIM but if implemented it shall be performed as described here.

For MT short messages, on receipt of a short message from the SC, the MS shall check to see if the associated Protocol Identifier contains a Replace Short Message Type code.

If such a code is present, then the MS will check the originating address and replace any existing stored message having the same Protocol Identifier code and originating address with the new short message and other parameter values. If there is no message to be replaced, the MS shall store the message in the normal way. The MS may also check the SC address as well as the Originating Address. However, in a network which has multiple SCs, it is possible for a Replace Message type for a SM to be sent via different SCs and so it is recommended that the SC address should not be checked by the MS unless the application specifically requires such a check.

If a Replace Short Message Type code is not present then the MS will store the message in the normal way.

In MO short messages the SC reacts similarly but only the address of the originating MS or any other source is checked.

A Return Call Message indicates to the MS to inform the user that a call (e.g. a telephone call) can be established to the address specified within the TP-OA. The RP-OA contains the address of the SC as usual. The message content (if present) gives displayable information (e.g. the number of waiting voice messages). The message is handled in the same way as all other messages of the Replace Short Message Types.

The ME De-personalization Short Message is a ME-specific message which instructs the ME to de-personalities the ME (see GSM 02.22 [25]). The TP-DCS shall be set to Uncompressed, Default Alphabet, and Message Class 1 (ME-specific), which corresponds to a bit coding of 00010001. The TP-UD field contains de-personalization information coded according to GSM 02.22 [25]. This information shall not be displayed by an ME which supports the scheme. The acknowledgement to this message is a SMS-DELIVER-REPORT for RP-ACK in which the TP-User-Data shall be coded according to GSM 02.22.

SIM Data download is a facility whereby the ME must pass the short message in its entirety including all SMS elements contained in the SMS deliver to the SIM using the mechanism described in GSM 11.11. The DCS shall be set to 8 bit message class 2 (either bit coding 1111 0110 or 00010110). The entire user data field is available for SIM Data download.

ME Data download is a facility whereby the ME shall process the short message in its entirety including all SMS elements contained in the SMS deliver to the ME. The DCS shall be set to message class 1. The entire user data field is available for ME data download.

9.2.3.10 TP-Data-Coding-Scheme (TP-DCS)

The TP-Data-Coding-Scheme is defined in GSM 03.38.

9.2.3.11 TP-Service-Centre-Time-Stamp (TP-SCTS)

The TP-Service-Centre-Time-Stamp field is given in semi-octet representation, and represents the local time in the following way:

	Year:	Month:	Day:	Hour:	Minute:	Second:	Time Zone
Digits: (Semi-octets)	2	2	2	2	2	2	2

The Time Zone indicates the difference, expressed in quarters of an hour, between the local time and GMT. In the first of the two semi-octets, the first bit (bit 3 of the seventh octet of the TP-Service-Centre-Time-Stamp field) represents the algebraic sign of this difference (0 : positive, 1 : negative).

The Service-Centre-Time-Stamp, and any other times coded in this format that are defined in the present document, represent the time local to the sending entity.

If the MS has knowledge of the local time zone, then any time received (e.g. Service-Centre-Time-Stamp) at the MS may be displayed in the local time rather than the time local to the sending entity. Messages shall be stored as received without change to any time contained therein.

The Time Zone code enables the receiver to calculate the equivalent time in GMT from the other semi-octets in the Service-Centre-Time-Stamp, or indicate the time zone (GMT, GMT+1H etc.), or perform other similar calculations as required by the implementation.

If the MS receives a non-integer value in the SCTS, it shall assume that the digit is set to 0 but shall store the entire field exactly as received.

9.2.3.12 TP-Validity-Period (TP-VP)

9.2.3.12.1 TP-VP (Relative format)

The TP-Validity-Period comprises 1 octet in integer representation, giving the length of the validity period, counted from when the SMS-SUBMIT is received by the SC.

The representation of time is as follows:

TP-VP value	Validity period value
0 to 143	$(TP-VP + 1) \times 5$ minutes (i.e. 5 minutes intervals up to 12 hours)
144 to 167	12 hours + $((TP-VP - 143) \times 30)$ minutes
168 to 196	$(TP-VP - 166) \times 1$ day
197 to 255	$(TP-VP - 192) \times 1$ week

9.2.3.12.2 TP-VP (Absolute format)

The TP-Validity Period comprises 7 octets in semi octet representation giving the absolute time of the validity period termination

The representation of time is identical to the representation of the TP-Service-Centre-Time-Stamp.

9.2.3.12.3 TP-VP (Enhanced format)

The TP-Validity Period comprises 7 octets. The presence of all octets is mandatory although they may not all be used. The first octet indicates the way in which the following 6 octets are used. Any reserved/unused bits or octets must be set to zero.

Octet 1 TP-VP functionality indicator

bit 7 Extension bit

Set to 1 if the TP-VP functionality indicator is to be extended to another octet. A setting of 0 indicates that there are no more TP-VP functionality indicator extension octets to follow.

Any such extension octet will immediately follow the previous TP-VP functionality indicator.

bit 6 Single shot SM.

Set to 1 if the SC is required to make up to one delivery attempt. The TP-Validity Period, where present, will be applicable to the Single shot SM.

bits 5, 4, 3 Reserved

bits 2, 1, 0 Validity Period Format.

Value bits 2 1 0

0	0	0	No Validity Period specified
0	0	1	Validity Period is as specified for the relative case. The following octet contains the TP-VP value as described in 9.2.3.12.1
0	1	0	Validity period is relative in integer representation and the following octet contains the TP-VP value in the range 0 to 255 representing 0 to 255 seconds. A TP-VP value of zero is undefined and reserved for future use.
0	1	1	Validity period is relative in semi-octet representation. The following 3 octets contain the relative time in Hours, Minutes and Seconds giving the length of the validity period counted from when the SMS-SUBMIT is received by the SC. The representation of time uses the same representation as the Hours, Minutes and Seconds in the TP-Service-Centre-Time-Stamp.
1	0	0	Reserved
1	0	1	Reserved
1	1	0	Reserved
1	1	1	Reserved

The SC will reject any Unsupported/ Reserved values received by returning the 'TP-VP not supported' TP-FCS value in the Submit SM Report for RP-Error

9.2.3.13 TP-Discharge-Time (TP-DT)

The TP-Discharge-Time field indicates the time at which a previously submitted SMS-SUBMIT was successfully delivered to or attempted to deliver to the recipient SME or disposed of by the SC.

In the case of "transaction completed" the time shall be the time of the completion of the transaction. In the case of "SC still trying to transfer SM" the time shall be the time of the last transfer attempt. In the case of "permanent or temporary error - SC not making any more transfer attempts" the time shall be the time of either the last transfer attempt or the time at which the SC disposed of the SM according to the Status outcome in TP-ST.

The TP-Discharge-Time is given in semi-octet representation in a format identical to the TP-SCTS.

9.2.3.14 TP-Recipient-Address (TP-RA)

The TP-Recipient-Address field indicates the address of the SME that was the destination of the previously submitted mobile originated short message being subject to the status report. The field is formatted according to the formatting rules of address fields.

9.2.3.15 TP-Status (TP-ST)

The TP-Status field indicates the status of a previously submitted SMS-SUBMIT and certain SMS COMMANDS for which a Status -Report has been requested. It consists of one octet and the bits in the octet are used as follows:

The MS will interpret any reserved values as "Service Rejected" (01100011) but shall store them exactly as received.

bits value/usage

7 0 Bits 0..6 as defined below:

6...0 Indicate whether the previously submitted short message was successfully forwarded to the SME, or whether an error condition has been encountered, as follows:

Short message transaction completed

0000000	Short message received by the SME
0000001	Short message forwarded by the SC to the SME but the SC is unable to confirm delivery
0000010	Short message replaced by the SC

Reserved values

0000011..0001111	Reserved
0010000..0011111	Values specific to each SC

Temporary error, SC still trying to transfer SM

0100000	Congestion
0100001	SME busy
0100010	No response from SME
0100011	Service rejected
0100100	Quality of service not available
0100101	Error in SME

0100110..0101111	Reserved
0110000..0111111	Values specific to each SC

Permanent error, SC is not making any more transfer attempts

1000000	Remote procedure error
1000001	Incompatible destination
1000010	Connection rejected by SME
1000011	Not obtainable
1000100	Quality of service not available
1000101	No interworking available
1000110	SM Validity Period Expired
1000111	SM Deleted by originating SME
1001000	SM Deleted by SC Administration
1001001	SM does not exist (The SM may have previously existed in the SC but the SC no longer has knowledge of it or the SM may never have previously existed in the SC)
1001010..1001111	Reserved
1010000..1011111	Values specific to each SC

Temporary error, SC is not making any more transfer attempts

1100000	Congestion
1100001	SME busy
1100010	No response from SME
1100011	Service rejected
1100100	Quality of service not available
1100101	Error in SME
1100110..1101001	Reserved
1101010..1101111	Reserved
1110000..1111111	Values specific to each SC

bits	value/usage
7	1 Bits 0..6 reserved

9.2.3.16 TP-User-Data-Length (TP-UDL)

If the TP-User-Data is coded using the GSM 7 bit default alphabet, the TP-User-Data-Length field gives an integer representation of the number of septets within the TP-User-Data field to follow. If the 7bit default-alphabet extension mechanism is used within the TP-User-Data (see GSM 03.38), the actual number of characters in the message will be less than the number of septets. If a TP-User-Data-Header field is present, then the TP-User-Data-Length value is the sum of the number of septets in the TP-User-Data-Header field (including any padding) and the number of septets in the TP-User-Data field which follows. See figure 9.2.3.24.(a). If the TP-User-Data is coded using 8-bit data, the TP-User-Data-Length field gives an integer representation of the number of octets within the TP-User-Data field to follow. If a TP-User-Data-Header field is present, then the TP-User-Data-Length value is the sum of the number of octets in the TP-User-Data-Header field and the number of octets in the TP-User-Data field which follows. See figure 9.2.3.24.(b).

If the TP-User-Data is coded using UCS2 [24] data, the TP-User-Data-Length field gives an integer representation of the number of octets within the TP-User-Data field to follow. If a TP-User-Data-Header field is present, then the TP-User-Data-Length value is the sum of the number of octets in the TP-User-Data-Header field and the number of octets in the TP-User-Data field which follows. See figure 9.2.3.24.(b).

If the TP-User-Data is coded using compressed GSM 7 bit default alphabet or compressed 8 bit data or compressed UCS2 [24] data, the TP-User-Data-Length field gives an integer representation of the number of octets after compression within the TP-User-Data field to follow. If a TP-User-Data-Header field is present, then the TP-User-Data-Length value is the sum of the number of uncompressed octets in the TP-User-Data-Header field and the number of octets in the compressed TP-User-Data field which follows. See figure 9.2.3.24.(c)

For other Data Coding Schemes, see GSM 03.38. If this field is zero, the TP-User-Data field will not be present.

9.2.3.17 TP-Reply-Path (TP-RP)

The TP-Reply-Path is a 1-bit field, located within bit no 7 of the first octet of both SMS-DELIVER and SMS-SUBMIT, and to be given the following values:

Bit no 7:	0	TP-Reply-Path parameter is not set in this SMS-SUBMIT/DELIVER
	1	TP-Reply-Path parameter is set in this SMS-SUBMIT/DELIVER

Please refer to annex D for details about the Reply procedures.

9.2.3.18 TP-Message-Number (TP-MN)

The TP-Message-Number is an 8-bit field allowing an MS to refer uniquely to an SM in the SC which that MS has previously submitted. The TP-MN value is the TP-MR value of a previously submitted SM.

9.2.3.19 TP-Command-Type (TP-CT)

The TP-Command-Type is an 8-bit field specifying the type of operation that the SC is to perform. It has the following values:

Value (bit 7 .. 0)	Command Description	Status Report Request Value
00000000	Enquiry relating to previously submitted short message	1
00000001	Cancel Status Report Request relating to previously submitted short message	0
00000010	Delete previously submitted Short Message	0
00000011	Enable Status Report Request relating to previously submitted short message	0
00000100..00011111	Reserved	unspecified
11100000..11111111	Values specific for each SC	1 or 0

The SC will return an RP-Error with an appropriate TP-Failure-Cause for any TP-Command value which is reserved, unsupported or invalid or the actioning of the command has failed.

The SC will return an RP-ACK if the actioning of the Command has succeeded.

A successful Enquiry will result in the SC sending a SMS-STATUS-REPORT for the SM to which the Enquiry refers. In the case where the SC has a number of SMs which have the same TP-MR, the same TP-DA and have come from the same originating address the SC will send a SMS-STATUS-REPORT for each SM.

In the case where a TP-Command is to Delete a previously submitted short message, the SC will send a Status Report indicating that the SM has been deleted if the original Submit SM request requested a status Report.

9.2.3.20 TP-Command-Data-Length (TP-CDL)

The TP-Command-Data-Length field is used to indicate the number of octets contained within the TP-Command-Data-field. If this field is set to zero, the TP-Command-Data field will not be present.

9.2.3.21 TP-Command-Data (TP-CD)

The TP-Command-Data field contains data relating to the operation requested by the MS which is to be performed at the SC. The maximum length of this field is 157 octets. The usage and provision of the optional TP-Command-Data field will be determined by the function selected by the TP-Command-Type field.

9.2.3.22 TP-Failure-Cause (TP-FCS)

The TP-Failure-Cause field is used to report the reason for failure to transfer or process a short message. It consists of a single octet used as follows:

TP-FCS Value (Hex)	Meaning	When used	
		MO	MT
00 - 7F	Reserved		
80 - 8F	TP-PID errors		
80	Telematic interworking not supported	x	
81	Short message Type 0 not supported	x	x
82	Cannot replace short message	x	x
83 - 8E	Reserved		
8F	Unspecified TP-PID error	x	x
90 - 9F	TP-DCS errors		
90	Data coding scheme (alphabet) not supported	x	
91	Message class not supported		x
92 - 9E	Reserved		
9F	Unspecified TP-DCS error	x	x
A0 - AF	TP-Command Errors		
A0	Command cannot be actioned	x	
A1	Command unsupported	x	
A2 - AE	Reserved		
AF	Unspecified TP-Command error	x	
B0	TPDU not supported	x	x
B1 - BF	Reserved		
C0	SC busy	x	
C1	No SC subscription	x	
C2	SC system failure	x	
C3	Invalid SME address	x	
C4	Destination SME barred	x	
C5	SM Rejected-Duplicate SM	x	
C6	TP-VPF not supported	X	
C7	TP-VP not supported	X	
C8 - CF	Reserved		
D0	SIM SMS storage full		x
D1	No SMS storage capability in SIM		x
D2	Error in MS		x
D3	Memory Capacity Exceeded		X
D4	SIM Application Toolkit Busy		x
D5	SIM data download error		x
D6 - DF	Reserved		
E0 - FE	Values specific to an application	x	x
FF	Unspecified error cause	x	x

NOTE: Any reserved codes which are received should be treated as an unspecified error cause.
 MT and MO refer to the overall mobile terminated and mobile originated services; not the direction of transmission of TP-FCS.

9.2.3.23 TP-User-Data-Header-Indicator (TP-UDHI)

The TP-User-Data-Header-Indicator is a 1 bit field within bit 6 of the first octet of the following six PDUs:

- SMS-SUBMIT,
- SMS-SUBMIT-REPORT
- SMS-DELIVER,
- SMS-DELIVER-REPORT
- SMS-STATUS-REPORT
- SMS-COMMAND.

TP-UDHI has the following values.

Bit no. 6 0 The TP-UD field contains only the short message

1 The beginning of the TP-UD field contains a Header in addition to the short message

9.2.3.24 TP-User Data (TP-UD)

The length of the TP-User-Data field is defined in the PDU's of the SM-TL (see subclause 9.2.2).

The TP-User-Data field may comprise just the short message itself or a Header in addition to the short message depending upon the setting of TP-UDHI.

Where the TP-UDHI value is set to 0 the TP-User-Data field comprises the short message only, where the user data can be 7 bit (default alphabet) data, 8 bit data, or 16 bit (UCS2) data.

Where the TP-UDHI value is set to 1 the first octets of the TP-User-Data field contains a Header in the following order starting at the first octet of the TP-User-Data field.

Irrespective of whether any part of the User Data Header is ignored or discarded, the MS shall always store the entire TPDU exactly as received.

FIELD	LENGTH
Length of User Data Header	1 octet
Information-Element-Identifier "A"	1 octet
Length of Information-Element "A"	1 octet
Information-Element "A" Data	0 to "n" octets
Information-Element-Identifier "B"	1 octet
Length of Information-Element "B"	1 octet
Information-Element "B" Data	0 to "n" octets
Information-Element-Identifier "X"	1 octet
Length of Information-Element "X"	1 octet
Information-Element "X" Data	0 to "n" octets

The diagram below shows the layout of the TP-User-Data-Length and the TP-User-Data for uncompressed GSM 7 bit default alphabet data. The UDHL field is the first octet of the TP-User-Data content of the Short Message.

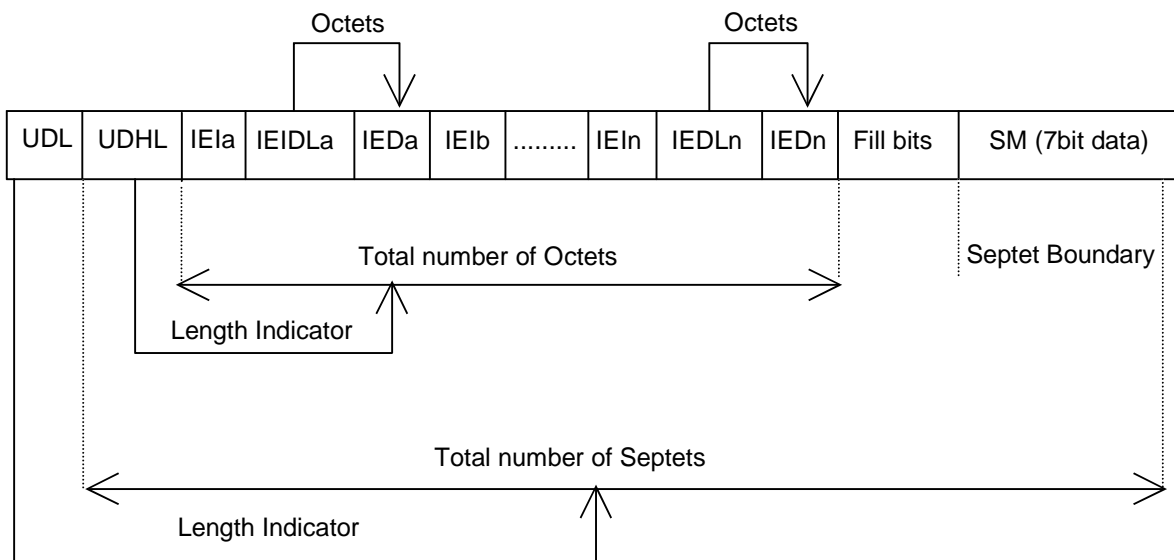

Figure 9.2.3.24 (a)

The diagram below shows the layout of the TP-User-Data-Length and the TP-User-Data for uncompressed 8 bit data or uncompressed UCS2 data. The UDHL field is the first octet of the TP-User-Data content of the Short Message.

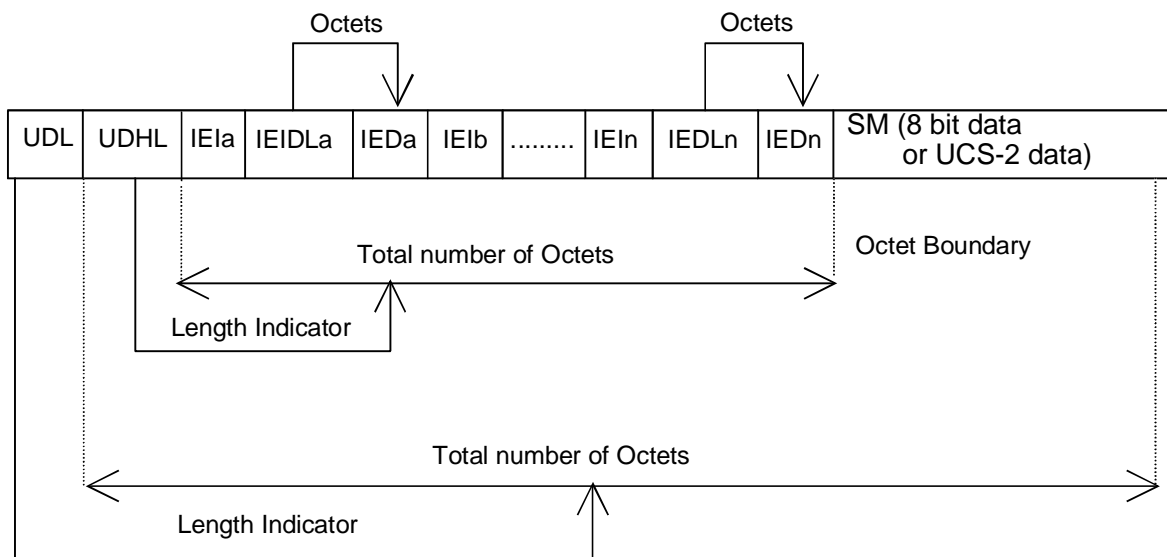

Figure 9.2.3.24 (b)

The diagram below shows the layout of the TP-User-Data-Length and the TP-User-Data for compressed GSM 7 bit default alphabet data, compressed 8 bit data or compressed UCS2 data. The UDHL field is the first octet of the TP-User-Data content of the Short Message.

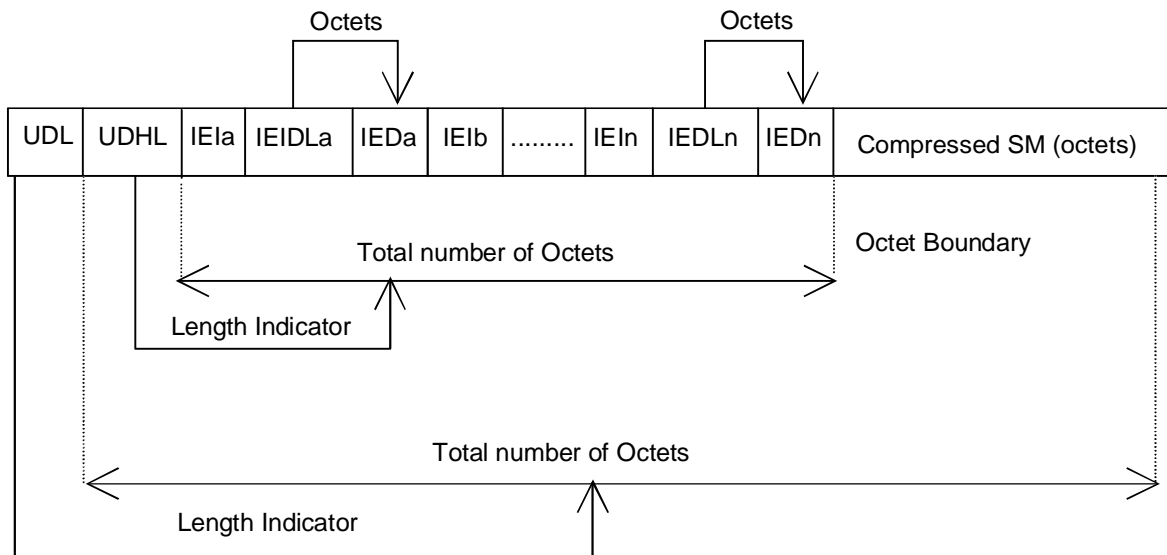

Figure 9.2.3.24 (c)

The definition of the TP-User-Data-Length field which immediately precedes the "Length of User Data Header" is unchanged and will therefore be the total length of the TP-User-Data field including the Header, if present. (see 9.2.3.16)

The "Length-of-Information-Element" fields shall be the integer representation of the number of octets within its associated "Information-Element-Data" field which follows and shall not include itself in its count value.

The "Length-of-User-Data-Header" field shall be the integer representation of the number of octets within the "User-Data-Header" information fields which follow and shall not include itself in its count or any fill bits which may be present (see text below).

Information Elements may appear in any order and need not necessarily follow the order used in the present document. If Information Elements are duplicated (either with the same or different content) then the contents of the last occurrence of the Information Element shall be used. If the length of the User Data Header overall is such that there appear to be too few or too many octets in the final Information Element then the whole User Data Header shall be ignored.

If any reserved values are received within the content of any Information Element then that part of the Information Element shall be ignored.

The Information Element Identifier octet shall be coded as follows:

VALUE (hex)	MEANING
00	Concatenated short messages, 8-bit reference number
01	Special SMS Message Indication
02	Reserved
03	Value not used to avoid misinterpretation as <LF> character
04	Application port addressing scheme, 8 bit address
05	Application port addressing scheme, 16 bit address
06	SMSC Control Parameters
07	UDH Source Indicator
08	Concatenated short message, 16-bit reference number
09	Wireless Control Message Protocol
0A-6F	Reserved for future use
70-7F	SIM Toolkit Security Headers
80 - 9F	SME to SME specific use
A0 - BF	Reserved for future use
C0 - DF	SC specific use
E0 - FF	Reserved for future use

A receiving entity shall ignore (i.e. skip over and commence processing at the next information element) any information element where the IEI is Reserved or not supported. The receiving entity calculates the start of the next information element by looking at the length of the current information element and skipping that number of octets.

The SM itself may be coded as 7, 8 or 16 bit data.

If 7 bit data is used and the TP-UD-Header does not finish on a septet boundary then fill bits are inserted after the last Information Element Data octet up to the next septet boundary so that there is an integral number of septets for the entire TP-UD header. This is to ensure that the SM itself starts on an septet boundary so that an earlier Phase mobile will be capable of displaying the SM itself although the TP-UD Header in the TP-UD field may not be understood.

It is optional to make the first character of the SM itself a Carriage Return character encoded according to the default 7 bit alphabet so that earlier Phase mobiles, which do not understand the TP-UD-Header, will over-write the displayed TP-UD-Header with the SM itself.

If 16 bit (USC2) data is used then padding octets are not necessary. The SM itself will start on an octet boundary.

If 8 bit data is used then padding is not necessary. An earlier Phase mobile will be able to display the SM itself although the TP-UD header may not be understood.

It is also possible for mobiles not wishing to support the TP-UD header to check the value of the TP-UDHI bit in the SMS-Deliver PDU and the first octet of the TP-UD field and skip to the start of the SM and ignore the TP-UD header.

9.2.3.24.1 Concatenated Short Messages

This facility allows short messages to be concatenated to form a longer message.

In the case of uncompressed 8-bit data, the maximum length of the short message within the TP-UD field is 134 (140-6) octets.

In the case of uncompressed GSM Default 7 bit data, the maximum length of the short message within the TP-UD field is 153 (160-7) characters.

In the case of 16 bit uncompressed USC2 data, the maximum length of the short message within the TP-UD field is 67 $((140-6)/2)$ characters. A UCS2 character must not be split in the middle; if the length of the User Data Header is odd, the maximum length of the whole TP-UD field is 139 octets.

In the case of compressed GSM Default alphabet 7 bit data, 8 bit data or UCS2 the maximum length of the compressed short message within the TP-UD field is 134 $(140-6)$ octets including the Compression Header and Compression Footer, both or either of which may be present (See subclause 3.9).

The maximum length of an uncompressed concatenated short message is 39015 $(255*153)$ default alphabet characters, 34170 $(255*134)$ octets or 17085 $(255*67)$ UCS2 characters.

The maximum length of a compressed concatenated message is 34170 $(255*134)$ octets including the Compression Header and Compression Footer (see subclause 3.9 and Fig 9.2.3.24.1(a) below).

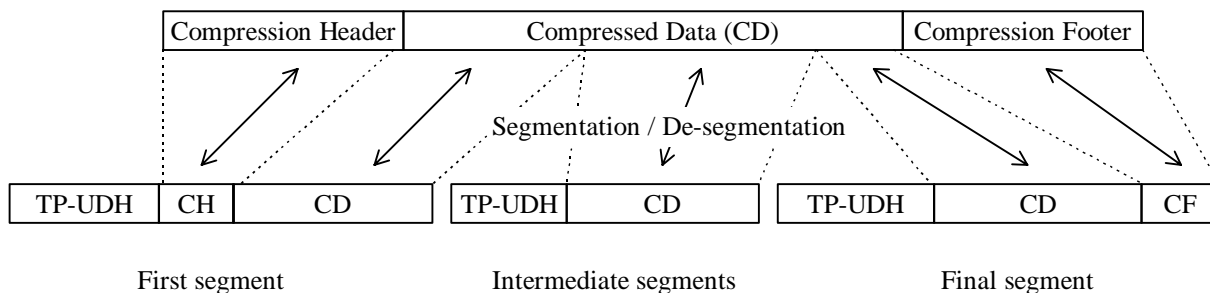

Figure 9.2.3.24.1.(a) Concatenation of a Compressed short message

The Information-Element-Data field contains information set by the application in the SMS-SUBMIT so that the receiving entity is able to re-assemble the short messages in the correct order. Each concatenated short message contains a reference number which together with the originating address and Service Centre address allows the receiving entity to discriminate between concatenated short messages sent from different originating SMEs and/or SCs. In a network which has multiple SCs, it is possible for different segments of a concatenated SM to be sent via different SCs and so it is recommended that the SC address should not be checked by the MS unless the application specifically requires such a check.

The TP elements in the SMS-SUBMIT PDU, apart from TP-MR, TP-SRR, TP-UDL and TP-UD, should remain unchanged for each SM which forms part of a concatenated SM, otherwise this may lead to irrational behaviour. TP-MR must be incremented for every segment of a concatenated message as defined in subclause 9.2.3.6. A SC will handle segments of a concatenated message like any other short message. The relation between segments of a concatenated message is made only at the originator, where the message is segmented, and at the recipient, where the message is reassembled. SMS-COMMANDs identify messages by TP-MR and therefore apply to only one segment of a concatenated message. It is up to the originating SME to issue SMS-COMMANDs for all the required segments of a concatenated message.

The Information-Element-Data octets shall be coded as follows.

Octet 1 Concatenated short message reference number

This octet shall contain a modulo 256 counter indicating the reference number for a particular concatenated short message. This reference number shall remain constant for every short message which makes up a particular concatenated short message.

Octet 2 Maximum number of short messages in the concatenated short message.

This octet shall contain a value in the range 0 to 255 indicating the total number of short messages within the concatenated short message. The value shall start at 1 and remain constant for every short message which makes up the concatenated short message. If the value is zero then the receiving entity shall ignore the whole Information Element.

Octet 3 Sequence number of the current short message.

This octet shall contain a value in the range 0 to 255 indicating the sequence number of a particular short message within the concatenated short message. The value shall start at 1 and increment by one for every short message sent within the concatenated short message. If the value is zero or the value is greater than the value in octet 2 then the receiving entity shall ignore the whole Information Element.

9.2.3.24.2 Special SMS Message Indication

There are three levels of "Message Waiting" indication provided within the present document. The first level is to set the Protocol Identifier to "Return Call message", which indicates that a message is waiting and relies on the text of the message to supply the detail. The second level uses the Data Coding Scheme with or without Return Call Message (see GSM 03.38) to indicate the type of message waiting and whether there are some messages or no messages. The third level is described here, and provides the maximum detail level for analysis by the mobile, i.e. an indication of the number and type of messages waiting in systems connected to the PLMN. This third level is provided for future flexibility, as it cannot immediately be used without compatibility problems with the earliest Phase mobiles. It is envisaged that this scheme can start to be used once mobiles supporting TP-UDH become widely available.

This information may be stored by the MS in a form other than an SMS message, for example an indicator may be shown if the number of messages is non-zero or removed if the number of messages is zero. The MS may also store actual number of messages waiting and provide some other MMI to access this information. Text may be included by the SMS Service Centre for backward compatibility with the earliest Phase mobiles and the Data Coding Scheme may also be used to convey this information in parallel for backward compatibility with "middle" Phase mobiles (which support the use of Data Coding Scheme for Message Waiting Indication but not the use of TP-UDH for Message Waiting Indication).

The information-Element octets shall be coded as follows:

Octet 1 Message Indication type and Storage

Bit 7 Indicates whether or not the message shall be stored.

Bit 7

0 Discard message after updating indication

1 Store message

In the event of a conflict between this setting and the setting of the Data Coding Scheme (see GSM 03.38) then the message shall be stored if either the DCS indicates this, or Octet 1 above indicates this.

Bits 6..0 show the message indication type

000 0000	Voice Message Waiting
000 0001	Fax Message Waiting
000 0010	Electronic Mail Message Waiting
000 0011	Other Message Waiting (see GSM 03.38 for definition of "other")

Other values are reserved for future use

Octet 2 Message Count

This octet shall contain a value in the range 0 to 255 indicating the number of messages of the type specified in Octet 1 waiting. The value 255 shall be taken to mean 255 or greater. In the event of a conflict between this setting and the setting of the Data Coding Scheme (see GSM 03.38) then the Message Count in the TP-UDH shall override the indication in the TP-DCS.

If more than one type of message is required to be indicated within one SMS message, then further octets must be used, as in the following example:

- [00] TP-UDL [1E] (30 decimal septets)
- [01] Length of TP-UDH [08]
- [02] IEI = Special SMS Message Indication [01]
- [03] Length = 02
- [04] Octet 1 = Voice Mail, do not store [00]
- [05] Octet 2 = 04 Messages
- [06] IEI = Special SMS Message Indication [01]

[07] Length = 02

[08] Octet 1 = Fax Mail, Store [81]

[09] Octet 2 = 02 Messages

+ 5 Fill bits

+ 19 seven-bit character message text

The Total number of bits is 210.

9.2.3.24.3 Application Port Addressing 8 bit address

This facility allows short messages to be routed to one of multiple applications in the TE (terminal equipment), using a method similar to TCP/UDP ports in a TCP/IP network. An application entity is uniquely identified by the pair of TP-DA/TP-OA and the port address. The port addressing is transparent to the transport, and also useful in Status Reports.

The total length of the IE is 2 octets

octet 1 Destination port

This octet contains a number indicating the receiving port, i.e. application, in the receiving device.

octet 2 Originator port

This octet contains a number indicating the sending port, i.e. application, in the sending device.

The port range is up to 255 using 8 bit addressing space. The Integer value of the port number is presented as in GSM 03.40 subclause 9.1.2.1.

VALUE (port number)	MEANING
0 - 239	Reserved
240 - 255	Available for allocation by applications

A receiving entity shall ignore (i.e. skip over and commence processing at the next information element) any information element where the value of the Information-Element-Data is Reserved or not supported.

In the case where this IE is to be used in a concatenated SM then the IEI, its associated IEI length and IEI data shall be contained in the first segment of the concatenated SM. The IEI, its associated IEI length and IEI data shall also be contained in every subsequent segment of the concatenated SM.

9.2.3.24.4 Application Port Addressing 16 bit address

This facility allows short messages to be routed to one of multiple applications in the TE (terminal equipment), using a method similar to TCP/UDP ports in a TCP/IP network. An application entity is uniquely identified by the pair of TP-DA/TP-OA and the port address. The port addressing is transparent to the transport, and also useful in Status Reports.

The total length of the IE is 4 octets

octet 1,2 Destination port

These octets contain a number indicating the receiving port, i.e. application, in the receiving device.

octet 3,4 Originator port

These octets contain a number indicating the sending port, i.e. application, in the sending device.

The port range is up to 65535 using 16 bit addressing space. The Integer value of the port number is presented as in GSM 03.40 subclause 9.1.2.1.

VALUE (port number)	MEANING
0 - 15999	As allocated by IANA (http://www.IANA.com/)

16000 - 16999	Available for allocation by applications
17000 - 65535	Reserved

A receiving entity shall ignore (i.e. skip over and commence processing at the next information element) any information element where the value of the Information-Element-Data is Reserved or not supported.

In the case where this IE is to be used in a concatenated SM then the IEI, its associated IEI length and IEI data shall be contained in the first segment of the concatenated SM. The IEI, its associated IEI length and IEI data shall also be contained in every subsequent segment of the concatenated SM.

9.2.3.24.5 SMSC Control Parameters

The facility enables the SMS protocol headers to be expanded using a flexible method. It may be used to control the SMSC, but is also passed transparently to the receiving mobile. The Information Element must be present in every short message affected by it, i.e. in every short message in a concatenated message.

The Information Element data octets shall be coded as follows:

octet 1 Selective Status Report

This facility is used to control the creation of Status Reports, depending on the error code of the particular message. It is also used by the sending entity to request inclusion of the original UDH into the Status Report. In this case the original UDH must be separated from the rest of the UDH using the Source Indicator. The TP-SRR must be set in order for the Selective Status Report to be enabled. The bits are defined as follows

bit 0

- 0 No Status Report for short message transaction completed
- 1 Status Report for short message transaction completed

bit 1

- 0 No Status Report for permanent error when SC is not making any more transfer attempts
- 1 Status Report for permanent error when SC is not making any more transfer attempts

bit 2

- 0 No Status Report for temporary error when SC is not making any more transfer attempts
- 1 Status Report for temporary error when SC is not making any more transfer attempts

bit 3

- 0 No Status Report for temporary error when SC is still trying to transfer SM
- 1 Status Report for temporary error when SC is still trying to transfer SM

bits 4 and 5

reserved for future use.

bit 6

- 0 No activation
- 1 A Status Report generated by this Short Message, due to a permanent error or last temporary error, cancels the SRR of the rest of the Short Messages in a concatenated message. This feature can only be used where a SC is aware of the segmentation of a concatenated SM and is therefore an implementation matter.

bit 7

- 0 Do not include original UDH into the Status Report

- 1 Include original UDH into the Status Report

9.2.3.24.6 UDH Source Indicator

The facility is used to separate the UDH of the original message, a UDH created by the SMSC, and a UDH provided by the original receiving entity. The Source Indicator is placed in front of the content inserted by the source. The indicated content (one or more Information-Elements) ends at the next UDH-Source-Indicator, or at the end of the UDH. The Separator is intended to be used especially in Status Reports, but can also be used by the SMSC to add information into Short Message (for example Message waiting). The default content for a UDH in a SMS-DELIVERY is the headers inserted by the sending device, and the default content for a UDH in a SMS-STATUS-REPORT is the headers copied from the SMS-DELIVERY-REPORT.

Values of octet:

- 01 The following part of the UDH is created by the original sender (valid in case of Status Report)
- 02 The following part of the UDH is created by the original receiver (valid in case of Status Report)
- 03 The following part of the UDH is created by the SMSC (can occur in any message or report)

9.2.3.24.7 SIM Toolkit Security Headers

There are no IEI data values associated with these IEI values and so the associated Length of Information element field is present but set to zero.

These IEI values implicitly define that a Security Header is always present at the start of the TP-User-Data field which immediately follows the TP-User-Data-Header. Details of the Security Header will be found in GSM 03.48.

In the case where a concatenated message contains a Security Header then the Security Header will only be present in the first segment of a concatenated message.

In the case where SMS compression is applied to a TP-User-Data field which contains a Security Header then the SMS compression header (GSM 03.42) will immediately precede the Security Header.

9.2.3.24.8 Concatenated short messages, 16-bit reference number

This facility is an enhanced variant of the Concatenated Short Message facility (see subclause 9.2.3.24.1). The enhancement is a 16-bit reference number, instead of the short 8-bit reference number. The larger reference number reduces the probability that two different concatenated messages are mistakenly sent with identical reference numbers to a receiver. Except for the size of the reference number this facility is identical to the Concatenated Short Message facility (see subclause 9.2.3.24.1).

In the case of uncompressed 8-bit data, the maximum length of the short message within the TP-UD field is 133 (140-7) octets.

In the case of uncompressed GSM Default 7 bit data, the maximum length of the short message within the TP-UD field is 151 (160-9) characters.

In the case of 16 bit uncompressed USC2 data, the maximum length of the short message within the TP-UD field is 66 ((140-7)/2) characters. A UCS2 character must not be split in the middle; if the length of the User Data Header is odd, the maximum length of the whole TP-UD field is 139 octets.

In the case of compressed GSM Default alphabet 7 bit data, 8 bit data or UCS2 the maximum length of the compressed short message within the TP-UD field is 133 (140-7) octets including the Compression Header and Compression Footer, both or either of which may be present (see subclause 3.9).

The relation between compression and concatenation is the same as for Concatenated Short Messages (see subclause 9.2.3.24.1).

The Information-Element-Data field contains information set by the application in the SMS-SUBMIT so that the receiving entity is able to re-assemble the short messages in the correct order. Each concatenated short message contains a reference number which together with the originating address and Service Centre address allows the receiving entity to discriminate between concatenated short messages sent from different originating SMEs and/or SCs. In a network which has multiple SCs, it is possible for different segments of a concatenated SM to be sent via different

SCs and so it is recommended that the SC address should not be checked by the MS unless the application specifically requires such a check.

The TP elements in the SMS-SUBMIT PDU, apart from TP-MR, TP-UDL and TP-UD, should remain unchanged for each SM which forms part of a concatenated SM, otherwise this may lead to irrational behaviour. TP-MR must be incremented for every segment of a concatenated message as defined in subclause 9.2.3.6. A SC will handle segments of concatenated message like any other short message. The relation between segments of a concatenated message is made at the originator, where the message is segmented, and at the recipient, where the message is reassembled. SMS-COMMANDs identify messages by TP-MR and therefore apply to only one segment of a concatenated message. It is up to the originating SME to issue SMS-COMMANDs for all the required segments of a concatenated message.

The Information-Element-Data octets shall be coded as follows.

Octet 1-2 Concatenated short messages, 16-bit reference number

This octet shall contain a modulo 65536 counter indicating the reference number for a particular enhanced concatenated short message. This reference number shall remain constant for every short message which makes up a particular enhanced concatenated short message.

Octet 3 Maximum number of short messages in the enhanced concatenated short message.

This octet shall contain a value in the range 0 to 255 indicating the total number of short messages within the concatenated short message. The value shall start at 1 and remain constant for every short message which makes up the enhanced concatenated short message. If the value is zero then the receiving entity shall ignore the whole Information Element.

Octet 4 Sequence number of the current short message.

This octet shall contain a value in the range 0 to 255 indicating the sequence number of a particular short message within the concatenated short message. The value shall start at 1 and increment by one for every short message sent within the concatenated short message. If the value is zero or the value is greater than the value in octet 3 then the receiving entity shall ignore the whole Information Element.

9.2.3.24.9 Wireless Control Message Protocol

The Wireless Control Message Protocol (WCMP) is part of the WAP suite of protocols; an open standard specified by the WAP Forum Ltd.

The protocol specifies a set of messages that can be used by the receiver to notify the sender if an error occurs. This can be due to routing problems, no application listening at the destination port number, or due to insufficient buffer capacity. The error messages can be used by the sender to avoid retransmitting packets, that can not be properly handled at the receiver. WCMP can also be used for diagnostics and informational purposes. WCMP messages are usually generated by a datagram transport layer or a management entity.

The Information-Element-Data octet(s) shall be coded as follows.

Octet 1-n Protocol Data Unit of WCMP

This octet(s) shall contain a WCMP protocol data unit.

In the case where this IE is to be used in a concatenated SM then the IEI, its associated IEI length and IEI data shall be contained in the first segment of the concatenated SM. The IEI, its associated IEI length and IEI data shall also be contained in every subsequent segment of the concatenated SM.

9.2.3.25 TP-Reject-Duplicates (TP-RD)

The TP-Reject-Duplicates is a 1 bit field located within bit 2 of the first octet of SMS-SUBMIT and has the following values.

Bit no. 2: 0 Instruct the SC to accept an SMS-SUBMIT for an SM still held in the SC which has the same TP-MR and the same TP-DA as a previously submitted SM from the same OA.

1 Instruct the SC to reject an SMS-SUBMIT for an SM still held in the SC which has the same TP-MR and the same TP-DA as the previously submitted SM from the same OA. In this case an appropriate TP-FCS value will be returned in the SMS-SUBMIT-REPORT.

9.2.3.26 TP-Status-Report-Qualifier (TP-SRQ)

The TP-Status-Report-Qualifier is a 1 bit field located within bit 5 of the first octet of SMS-STATUS-REPORT and has the following values

Bit no. 5: 0 The SMS-STATUS-REPORT is the result of a SMS-SUBMIT.
 1 The SMS-STATUS-REPORT is the result of an SMS-COMMAND e.g. an Enquiry.

9.2.3.27 TP-Parameter-Indicator (TP-PI)

The TP-Parameter-Indicator comprises a number of octets between 1 and n where each bit when set to a 1 indicates that a particular optional parameter is present in the fields which follow. The TP-PI is present as part of the RP-User-Data in the RP-ACK for both the SMS-DELIVER TPDU and the SMS-SUBMIT TPDU.

The structure of the TP-PI is as follows:

Octet 1

bit 7	bit 6	bit 5	bit 4	bit 3	bit 2	bit 1	bit 0
Extension bit	Reserved	Reserved	Reserved	Reserved	TP-UDL	TP-DCS	TP-PID

The most significant bit in octet 1 and any other TP-PI octets which may be added later is reserved as an extension bit which when set to a 1 will indicate that another TP-PI octet follows immediately afterwards.

If the TP-UDL bit is set to zero then by definition then neither the TP-UDL field or the TP-UD field can be present.

If a Reserved bit is set to "1" then the receiving entity shall ignore the setting. The setting of this bit will mean that additional information will follow the TP-User-Data, so a receiving entity shall discard any octets following the TP-User-Data.

9.3 Service provided by the SM-RL

9.3.1 General

The Short Message Relay Layer (SM-RL) provides a service to the Short Message Transfer Layer (SM-TL). This service enables the SM-TL to send Transfer Protocol Data Units (TPDUs) to its peer entity, receive TPDUs from its peer entity and receive reports about earlier requests for TPDUs to be transferred.

In order to keep track of TPDUs and reports about those TPDUs, primitives between the SM-TL and SM-RL contain a Short Message Identifier (SMI), which is a reference number for the TPDU associated with the primitive. This Short Message Identifier is not carried via the SM-RL protocol of subclause 9.3.2. It is carried via the relay layer service between the SC and GMSC. It is also carried by SM-RL of GSM 04.11, between the visited MSC and MS. The parameter is not carried by MAP but is mapped to and from the TCAP dialogue Identifier (see CCITT recommendation Q.771, "Blue Book") at the GMSC and the visited MSC (therefore the Message Identifier at the SC/GMSC interface is not the same as at the visited MSC/MS interface).

The SM-RL communicates with its peer entity by the protocol described in the following subclauses.

9.3.2 Protocol element repertoire at SM-RL

Different protocols are required between different pairs of SM-RL entities. Those are described in other GSM specifications. This subclause gives a survey of the different information elements which have to be conveyed between

those entities. (Note that the notation of the protocol and information elements may vary between different GSM specifications).

The SM-RL comprises the following 6 protocol elements:

- RP-MO-DATA for transferring a TPDU from MS to SC
- RP-MT-DATA for transferring a TPDU from SC to MS
- RP-ACK for acknowledging an RP-MO-DATA, an RP-MT-DATA or an RP-SM-MEMORY-AVAILABLE
- RP-ERROR for informing of an unsuccessful RP-MO-DATA or an RP-MT-DATA transfer attempt
- RP-ALERT-SC for alerting the SC that the MS has recovered operation (information sent from the HLR to the SC)
- RP-SM-MEMORY-AVAILABLE for notifying the network that the MS has memory available to accept one or more short messages (information sent from the MS to the HLR)

9.3.2.1 RP-MO-DATA

Basic elements of the RP-MO-DATA type.

Abbr.	Reference	p1)	Description
RP-OA	RP-Originating-Address	++-	Address of the originating MS.
RP-DA	RP-Destination-Address	+++	Address of the destination SC.
RP-UD	RP-User-Data	+++	Parameter containing the TPDU

- 1) Provision on the links SC<->MSC, MSC<->MSC or MSC<->SGSN, and MSC<->MS or SGSN<->MS indicated by "xxx", where x may be either "+" or "-", dependent on whether the parameter is mandatory or not on the respective link.

9.3.2.2 RP-MT-DATA

Basic elements of the RP-MT-DATA type.

Abbr.	Reference	p1)	Description
RP-PRI	RP-Priority-Request	++-	Parameter indicating whether or not the short message transfer should be stopped if the originator SC address is already contained in the MWD.
RP-MMS	RP-More-Messages-To-Send	OO-	Parameter indicating that there are more messages waiting in the SC
RP-OA	RP-Originating-Address	+++	Address of the originating SC.
RP-DA	RP-Destination-Address	++-	Address of the destination MS.
RP-UD	RP-User-Data	+++	Parameter containing the TPDU
RP-MTI	RP-Message Type Indicator	O--	Parameter indicating if the TPDU is a SMS Deliver or a SMS Status Report ²⁾
RP-SMEA	RP-originating SME-Address	O--	Address of the originating SME ²⁾

- 1) Provision on the links SC<->MSC, MSC<->MSC or MSC<->SGSN, and MSC<->MS or SGSN<->MS indicated by "xxx", where x may be "+", "-" or "O", dependent on whether the parameter is mandatory, not present or optional on the respective link.

- 2) These information elements may be included in the "Send Routing Information for SM" sent by the SMS-GMSC to the HLR.

When transmitted, the RP-SMEA shall take the TP-OA value.

When transmitted, the RP-MTI shall be given the following values:

- 0 SMS Deliver
- 1 SMS Status Report.

This may be used by the HLR to distinguish the two cases in order not to apply any filtering mechanism based on the RP-SMEA value in case of a SMS-Status Report transmission.

9.3.2.3 RP-ACK

The RP-ACK contains the RP-User-Data which is a parameter containing the TPDU (see 9.2.2.1a and 9.2.2.2a).

9.3.2.4 RP-ERROR

Basic elements of the RP-ERROR type.

Abbr.	Reference	p1)	Description
RP-MSI	RP-MW-Set-Indication	+++	Parameter indicating whether or not the MWI has been up-dated. ²⁾
RP-CS	RP-Cause	+++	Parameter identifying the error type. The RP-Cause parameter gives the reason why a short message transfer attempt fails. In practice three relay layer protocols are used - SC to GMSC/IWMSC (see GSM 03.47), MAP (see GSM 09.02) and via the radio interface (see GSM 04.11)
RP-MSIsdn	RP-international--MS-ISDN-number	+++	MSIsdn-Alert of the MS, see subclause 3.2.7 ³⁾
RP-UD	RP-User-Data	OO O	Parameter containing a TPDU

1) Provision on the links SC<->MSC, MSC<->MSC or MSC<->SGSN, and MSC<->MS or SGSN<->MS indicated by "xxx", where x may be "+", "-" or "O" dependent on whether the parameter is mandatory, not present or optional on the respective link.

2) Only present when the RP-ERROR is transferred from the SMS-GMSC to the SC.

3) Only present when the RP-MT-DATA transfer attempt failed because the MS is not reachable or because the MS memory capacity was exceeded and the MSIsdn-Alert is different from the MSIsdn used by the SC to address the recipient MS

9.3.2.5 RP-ALERT-SC

Basic elements of the RP-ALERT-SC type:

Abbr.	Reference	p1)	Description
RP-MSIsdn	RP-International-MS-ISDN-Number	M	MSIsdn of the MS.

1) Provision; Mandatory (M).

9.3.2.6 RP-SM-MEMORY-AVAILABLE

Basic elements of the RP-SM-MEMORY-AVAILABLE type:

Abbr.	Reference	p1)	Description
RP-IMSI	RP-International-Mobile-Subscriber-Identity	++-	IMSI of the MS.

- 1) Provision on the links HLR<->VLR or HLR<->SGSN, VLR<->MSC and MSC<->MS or SGSN<->MS indicated by "xxx", where x may be either "+" or "-", dependent on whether the parameter is mandatory or not present on the respective link.

10 Fundamental procedures within the point-to-point SMS

The point-to-point SMS comprises 3 fundamental procedures:

- 1) Short message mobile terminated. This procedure consists of all necessary operations to:
 - a) transfer a short message or status report from the SC to the MS;
 - b) return a report to the SC, containing the result of the message transfer attempt.
- 2) Short message mobile originated. This procedure consists of all necessary operations to:
 - a) transfer a short message from the MS to the SC;
 - b) return a report to the MS, containing the result of the message transfer attempt.
- 3) Transfer of an Alert. This procedure consists of all necessary operations for an HLR or a VLR to initiate a transfer of an Alert to a specific SC, informing the SC that the MS has recovered operation.

GSM 09.02 defines operations necessary for the provision of the Short Message Service point-to-point. The operations defined in clause 10 describe the requirement that the Short Message Service puts upon the network functionality. If discrepancies exist in nomenclature, it is the GSM 09.02 that will be the reference.

Annex C indicates the flow of primitives and parameters during the short message transfer between the SC and the MS. Both the Mobile terminated and the Mobile originated cases are covered.

10.1 Short message mobile terminated

The entities involved in this procedure are depicted in figure 03.40/14.

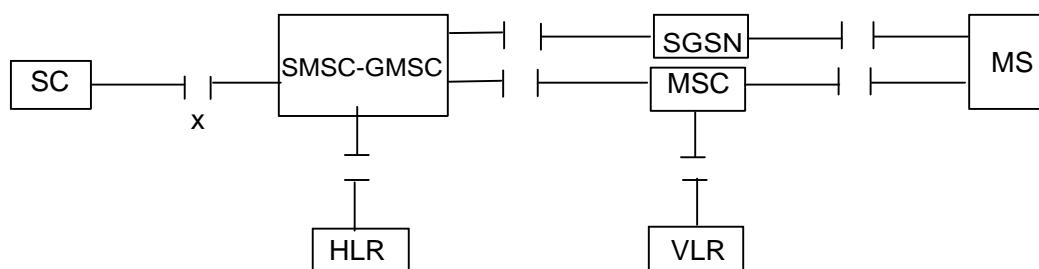

NOTE: Since the short message mobile terminated procedure covers the functionality required at SM-RL for transferring TPDUs from SC to MS, the procedure described covers both short message (SMS-DELIVER) and status report (SMS-STATUS-REPORT) transfer. The term "short message transfer" therefore, in this clause, covers both cases.

Figure 03.40/14: Interfaces involved in the Short message mobile terminated procedure. GSM 03.02. X is the interface between an MSC and an SC as defined in clause 5.

In figure 03.40/15, sequence diagrams are shown for the following basic situations of short message mobile terminated transfer attempt:

- Successful short message transfer via the MSC or the SGSN;
- Short message transfer attempt failing due to error at the SMS-GMSC;
- Short message transfer attempt failing due to negative outcome of HLR information retrieval;
- Short message transfer attempt failing due to error at the MSC or SGSN;
- Short message transfer attempt failing due to negative outcome of VLR information retrieval;
- Short message transfer attempt failing due to erroneous message transfer on the radio path.
- Short message transfer attempt failing over the first path (e.g. SGSN) and succeeding over the second path (e.g. MSC)
- Short message transfer attempt failing over the first path (e.g. SGSN) and over the second path (e.g. MSC)

References to the relevant specifications of the different operations are given in clause 4.

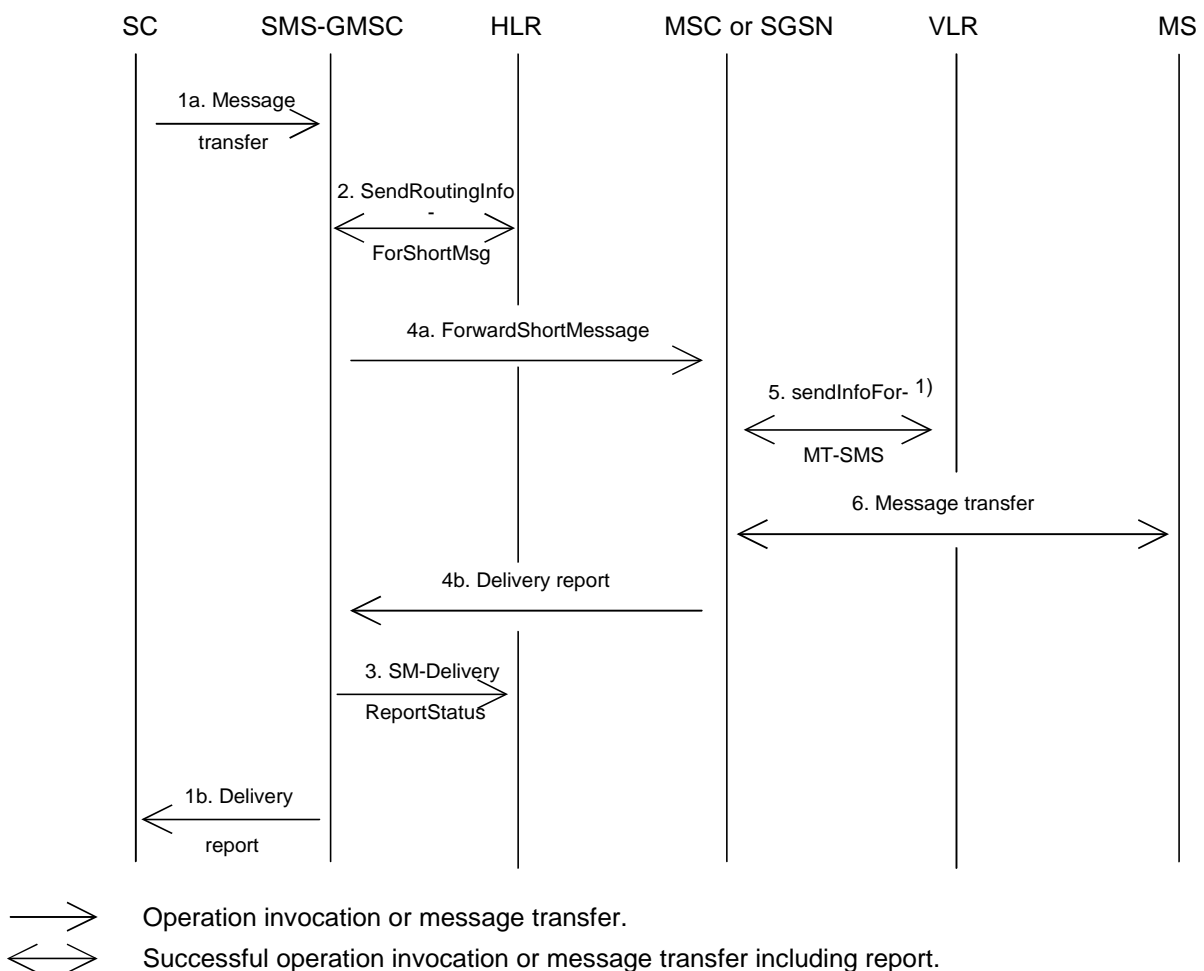

NOTE:

1): This operation is not used by the SGSN

Figure 03.40/15a): Successful short message transfer attempt via the MSC or the SGSN

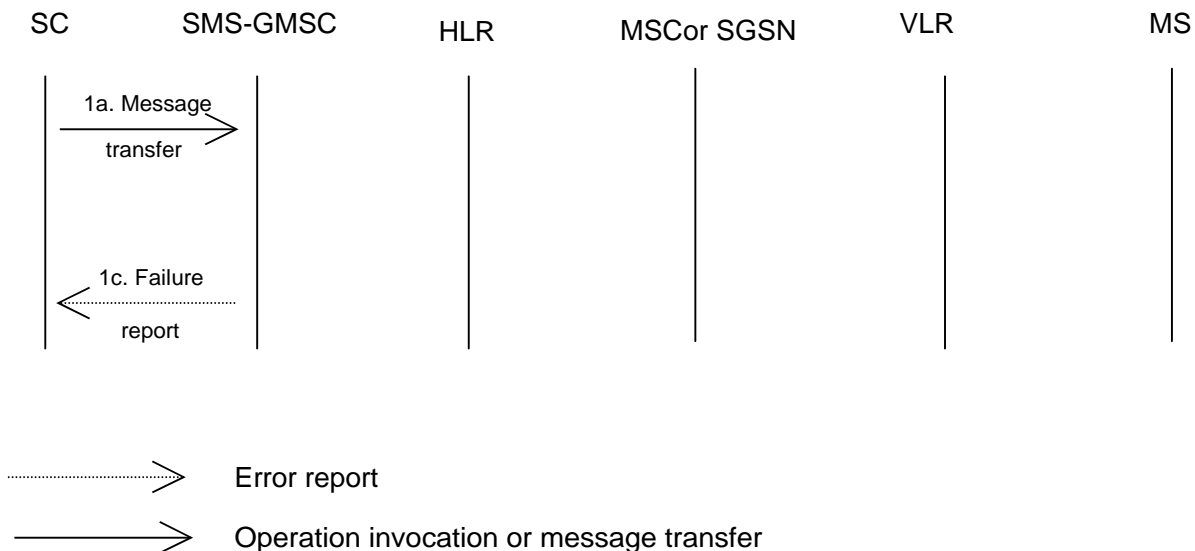

Figure 03.40/15b): Short message transfer attempt failing due to error at the SMS-GMSC

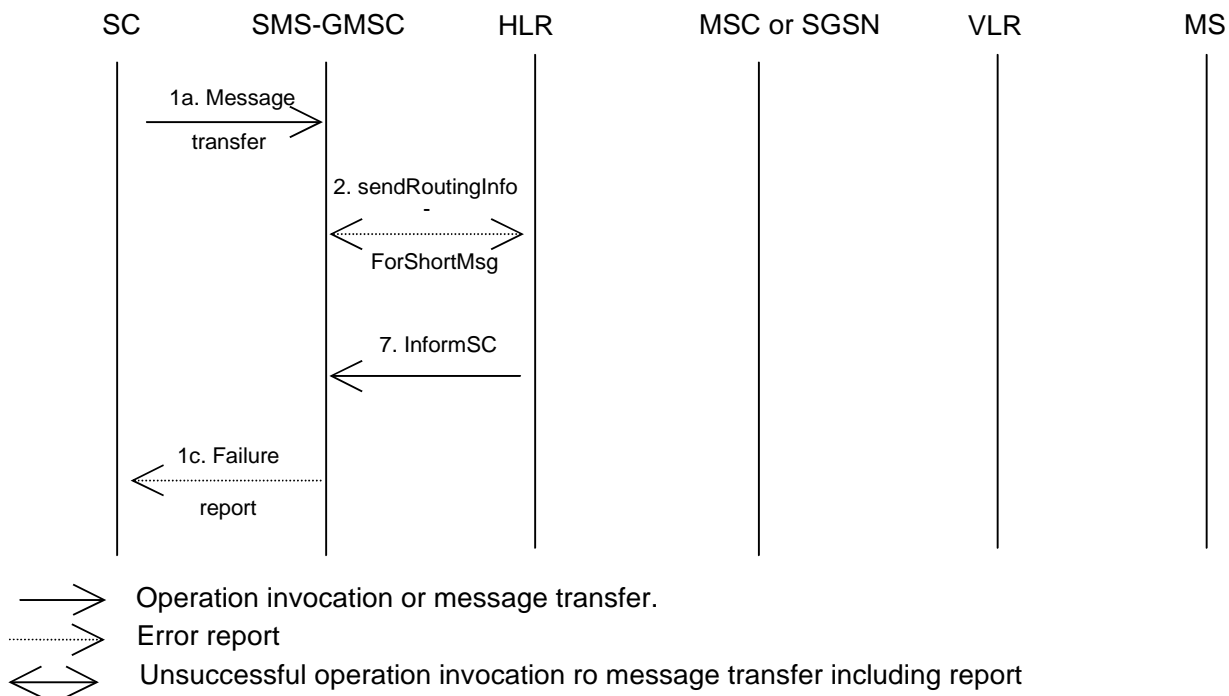

Figure 03.40/15c): Short message transfer attempt failing due to negative outcome of HLR information retrieval

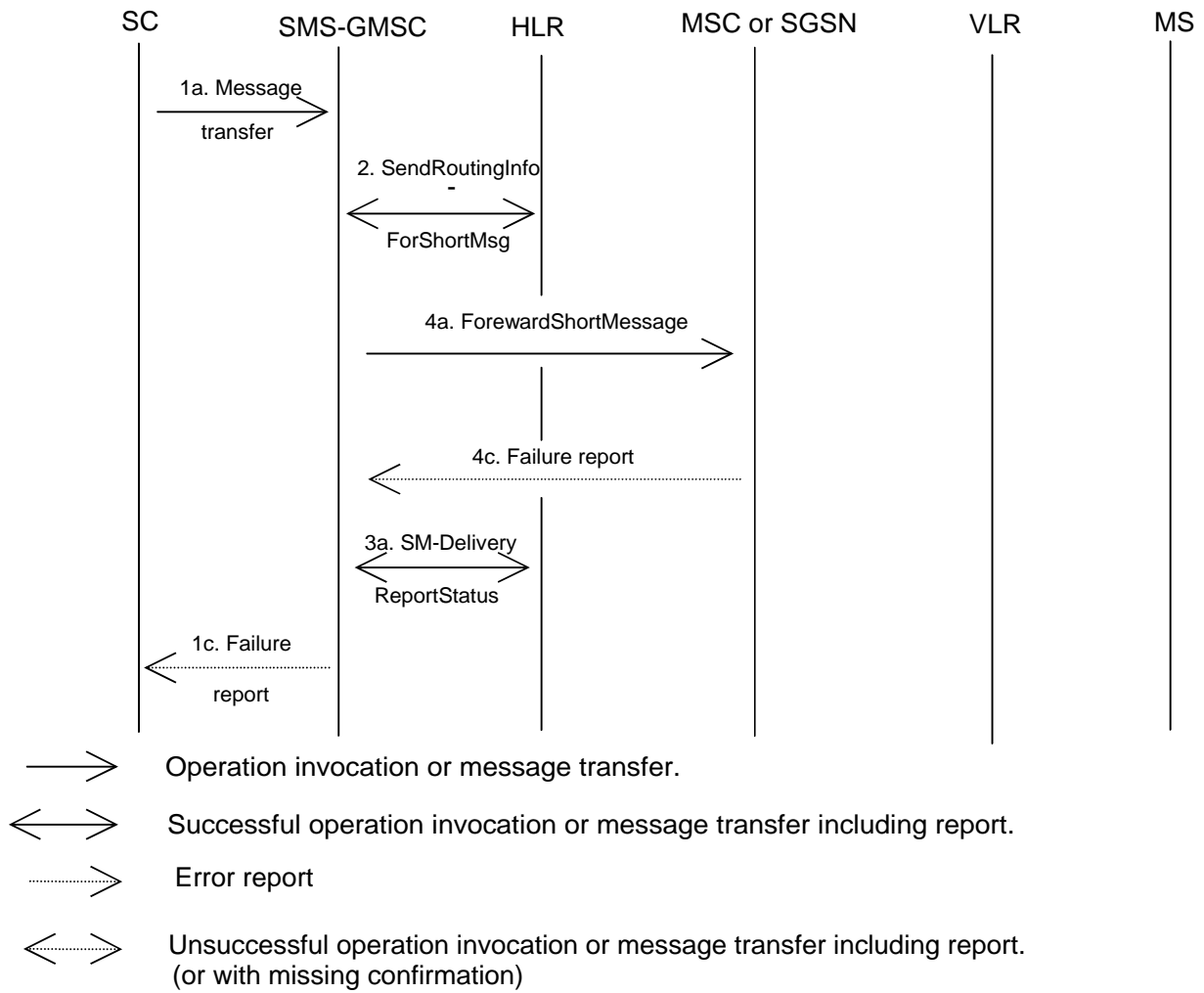

Figure 03.40/15d): Short message transfer attempt failing due to error at the MSC or SGSN

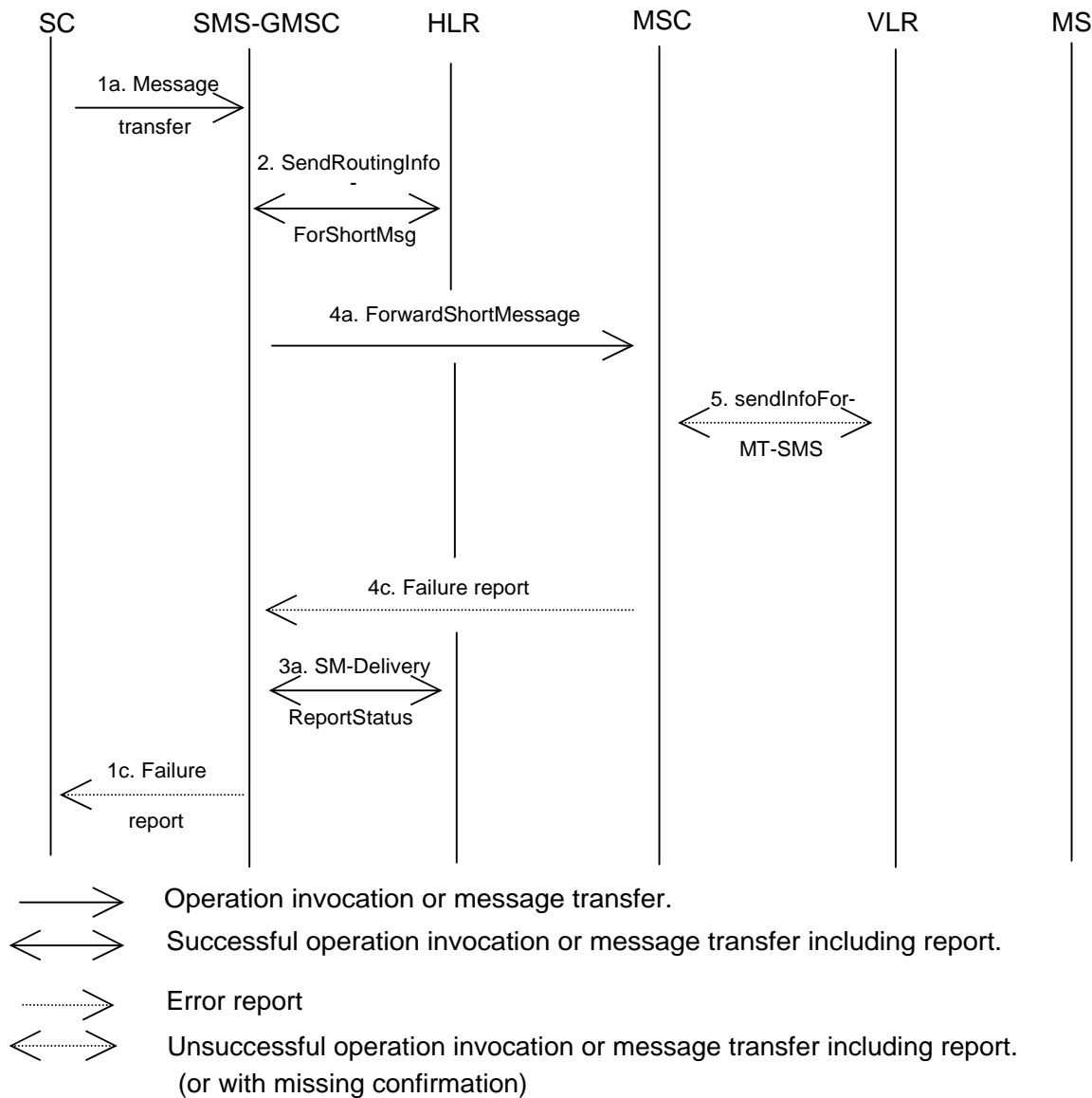
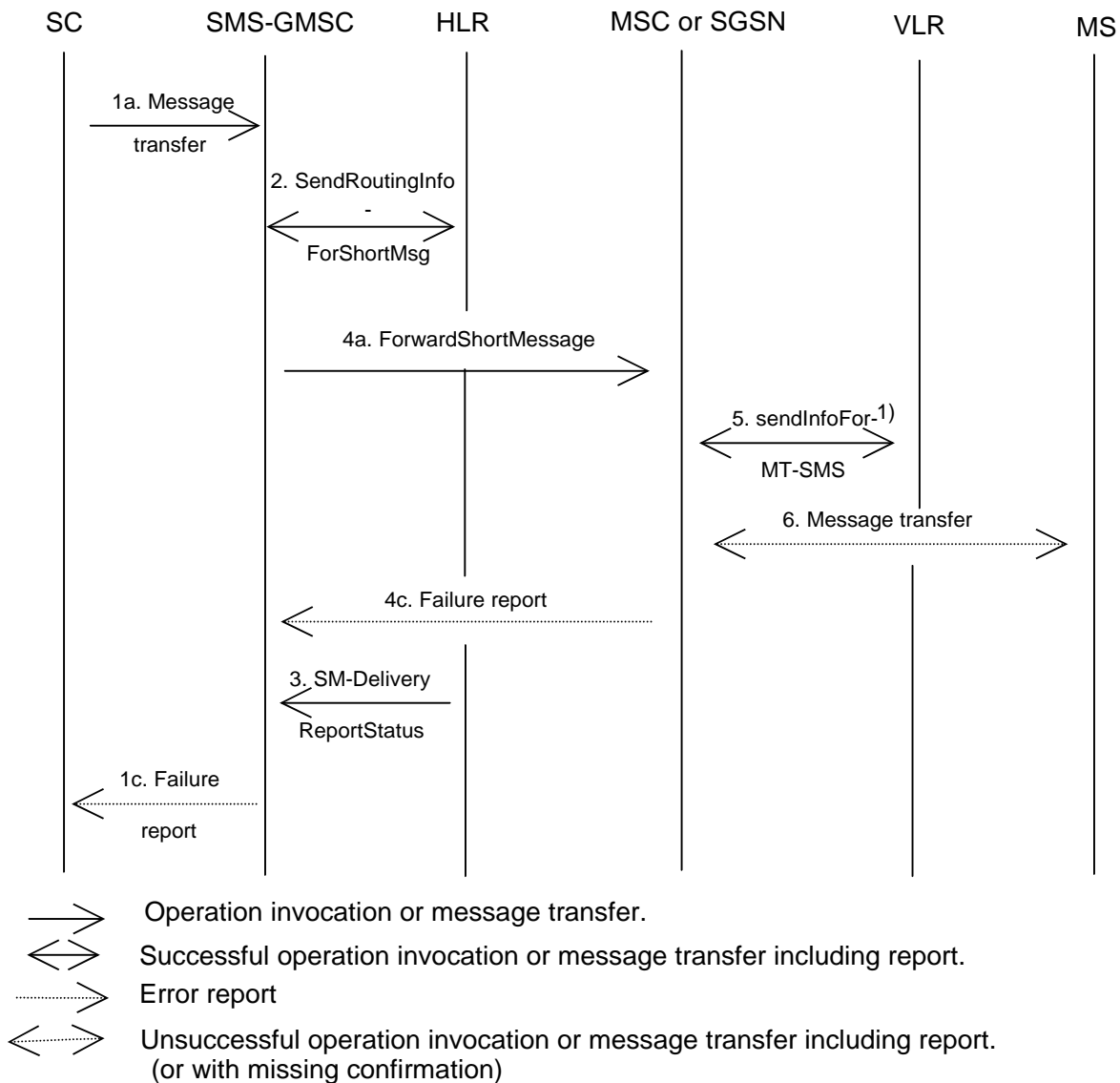

Figure 03.40/15e): Short message transfer attempt failing due to negative outcome of VLR information retrieval



NOTE:

1): This operation is not used by the SGSN

Figure 03.40/15f): Short message transfer attempt failing due to erroneous message transfer on the radio path

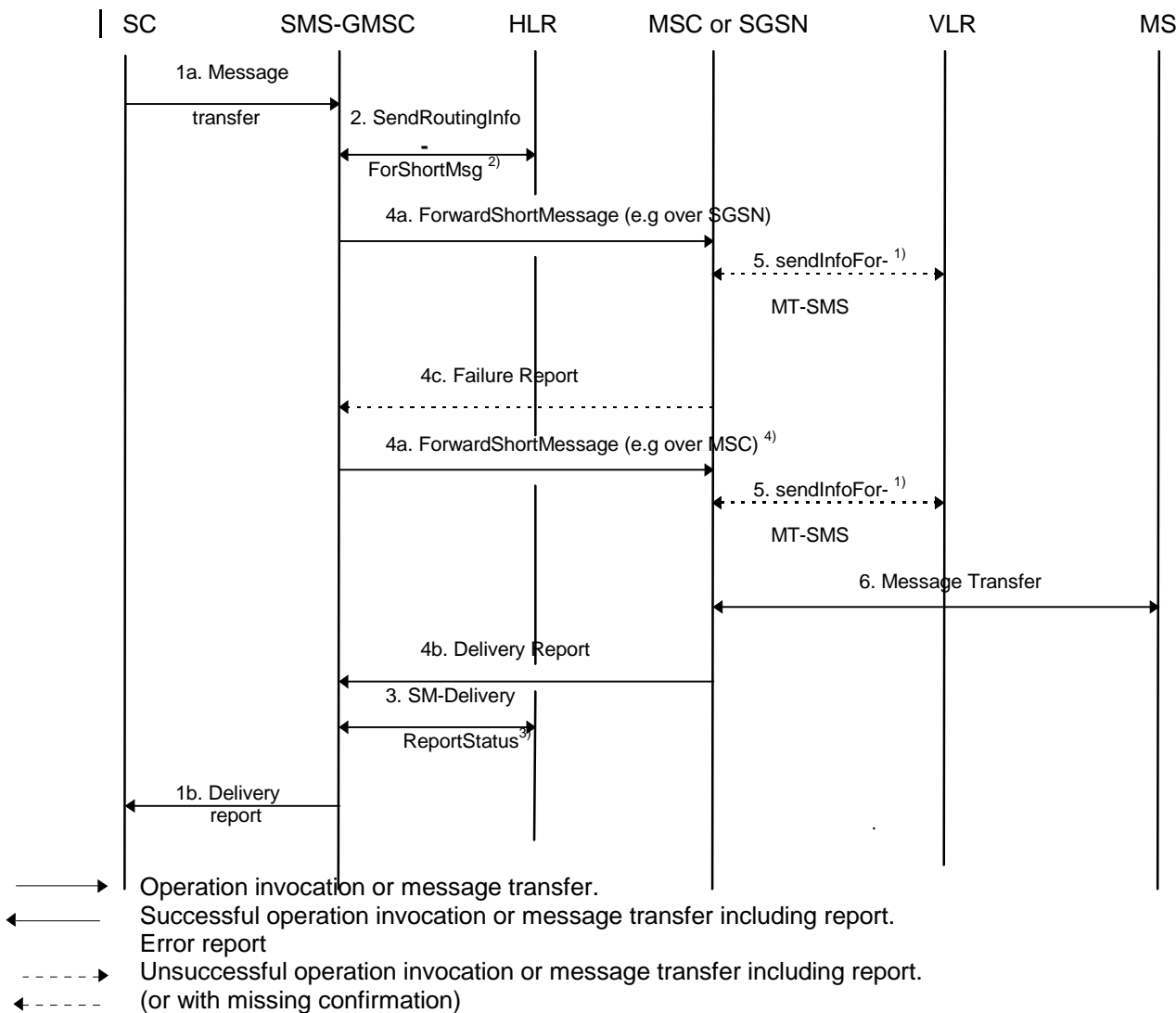

NOTES:

- 1): This operation is not used by the SGSN
- 2): Two addresses (SGSN and MSC) are received from HLR
- 3): Successful transfer over second path and unsuccessful transfer over first path (e.g. Absent subscriber) are sent to HLR
- 4): The SMS transfer towards the second path is only triggered by the reception of some MAP errors on the first path as described in chapter 8.1.1.

Figure 03.40/15g): Short message transfer attempt failing over the first path (e.g. SGSN) and succeeding over the second path (e.g. MSC)

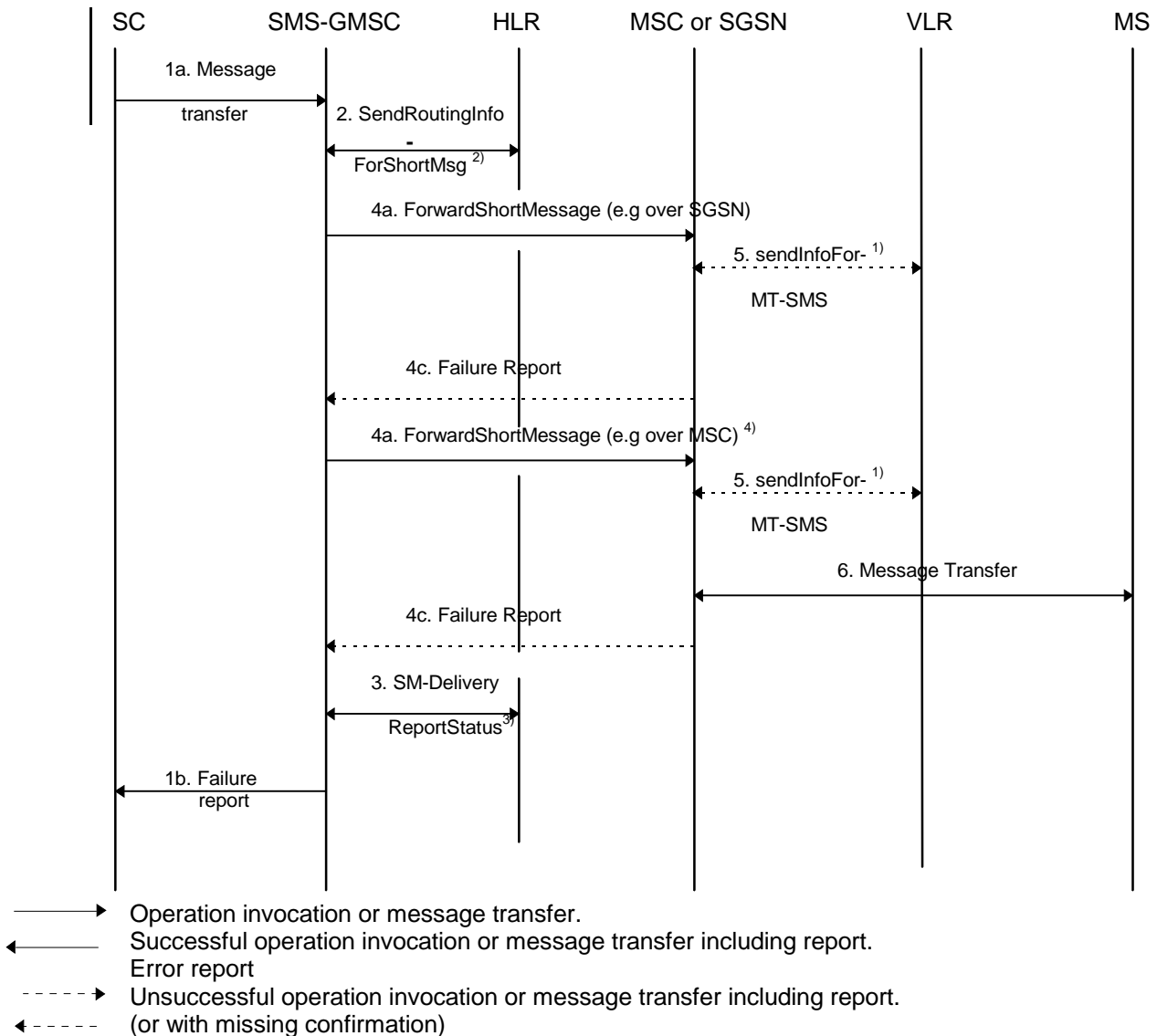

NOTES:

- 1): This operation is not used by the SGSN
- 2): Two addresses (SGSN and MSC) are received from HLR
- 3): Unsuccessful transfer over the second path (e.g. MemoryCapacityExceeded) and over the first path (e.g. Absent subscriber) are sent to HLR
- 4): The SMS transfer towards the second path is only triggered by the reception of some MAP errors on the first path as described in chapter 8.1.1.

Figure 03.40/15h): Short message transfer attempt failing over the first path (e.g. SGSN) and over the second path (e.g. MSC)

Operation 1: Message transfer SC -> SMS-GMSC

This operation is used to transfer a short message from an SC to an SMS-GMSC.

The operation consists of:

- the transfer of a message containing the TPDU from the SC to the SMS-GMSC (see "1a. Message transfer" in figure 03.40/15); and
- the return of either a "Failure report" (see 1c. in figure 03.40/15) or a "Delivery report" (see 1b. in figure 03.40/15).

"Failure report" is returned to the SC when the SMS-GMSC has received indication from another entity (MSC, SGSN or HLR) the procedure was unsuccessful. The error indications which the SMS-GMSC may receive from the MSC, SGSN, HLR, VLR or MS enable the SMS-GMSC to return one of the error indications given in subclause 3.3 back to the SC.

Operation 2: sendRoutingInfoForShortMsg

The operation is an interrogation of the HLR by the SMS-GMSC to retrieve information necessary to forward the short message.

The result may contain the MSC, SGSN or both addresses, and shall also indicate which address belongs to the MSC and the SGSN.

Operation 3: SM-DeliveryReportStatus

The operation provides a means for the SMS-GMSC to request the HLR to add an SC address to the MWD, and is activated when the SMS-GMSC receives an absent subscriber indication from the MSC, SGSN or both, and/or when the SMS-GMSC receives a failure report for a short message transfer with cause MS Memory Capacity Exceeded via the MSC or SGSN. The Return Result optionally contains the MSIsdn-Alert.

This operation is also activated at successful delivery short message when the MNRF, MNRG or both are set in HLR.

The operation consists of:

- the transfer of a message, containing the MSISDN of the MS to which the short message was addressed, the SC-address, the successful outcome and/or the causes (Absent Subscriber, MS memory capacity exceeded or both) for updating the MWD, from the SMS-GMSC to the HLR (see 3. in figure 03.40/15).

Operation 4: forwardShortMessage

The operation provides a means for the SMS-GMSC to transfer a short message to the MSC or to the SGSN at which the MS is currently located.

The operation works in tandem with the forwarding of the short message from the MSC or from the SGSN to the MS. Thus, the outcome of the operation comprises either success, i.e. that the message has been delivered to the MS; or a failure that may be caused by several reasons, e.g. failure in the transfer SMS-GMSC -> MSC or SMS-GMSC -> SGSN, MS being detached, or no paging response.

It should be noted that the MNRG setting is implicitly carried out in SGSN when the message transfer is denied due to GPRS DETACH

Operation 5: sendInfoForMT-SMS

The operation provides a means for the MSC to retrieve subscriber information from VLR for mobile terminated short message transfer. The operation may be associated with an authentication procedure, as shown in figure 03.40/16. Unsuccessful retrieval (e.g. absent subscriber) is indicated by a cause indication to the SMS-GMSC.

An overall depiction of how operation 5 interacts with signalling on the radio path is given in figure 03.40/16.

It should be noted that the MNRF setting is implicitly carried out when the message transfer is denied due to IMSI DETACH.

NOTE: This operation is not used by the SGSN.

Operation 6: Message transfer MSC -> MS

The operation is used to transfer a short message from the MSC to the MS.

If the transfer is not successful, e.g. due to the MS losing radio coverage after having successfully authenticated, a failure report (RP-ERROR) is returned to the SMS-GMSC. In this case, MWD and MCEF in the HLR will be updated only for the case where the transfer fails with cause MS Memory Capacity Exceeded.

If the MS notifies the network that the MS has been unable to accept a short message because its memory capacity has been exceeded, then the ME will set the memory capacity Exceeded Notification flag if present.

Operation 7: InformSC

The operation is used to transfer the MSIsdn-Alert from the HLR to the SMS-GMSC in case of the error Absent Subscriber or positive result given as an answer to the operation SendRoutingInfoForSM.

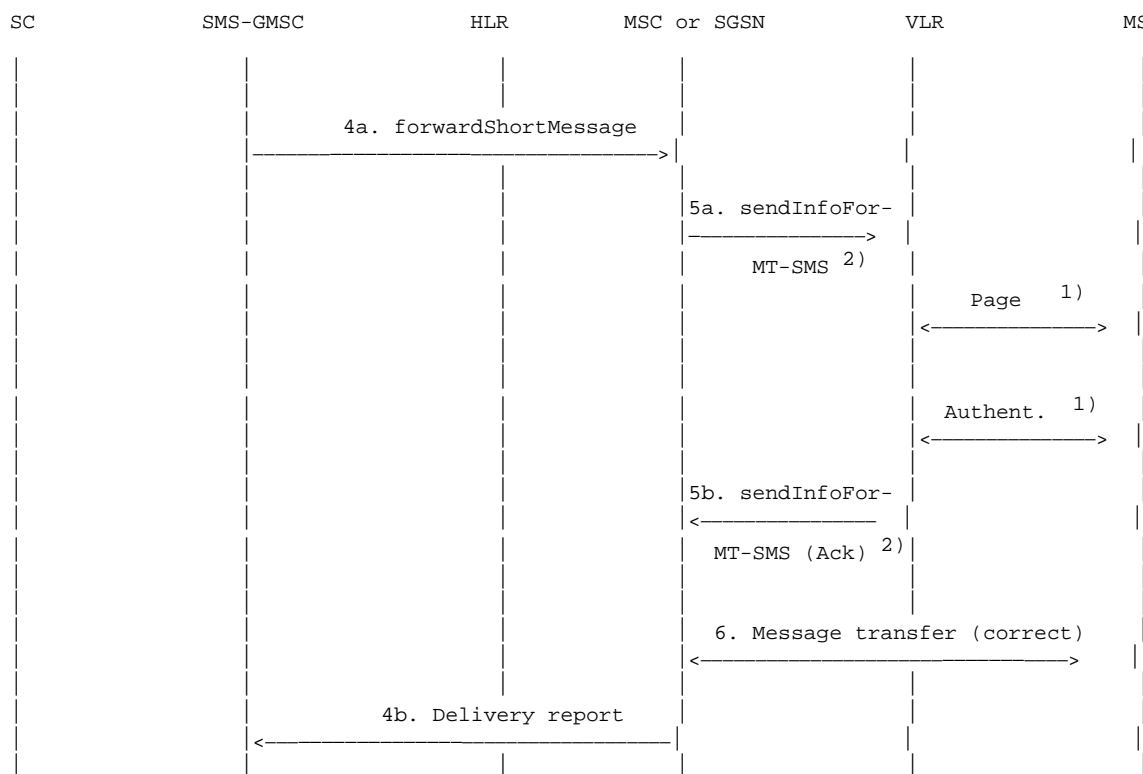

—————> : Operation invocation or message transfer
 <—————> : Successful operation invocation or message transfer incl. report

NOTES:

1): Described in GSM 04.08 and GSM 09.02

If the SGSN is used, Paging and Authentication are performed from SGSN

2): This operation is not used by the SGSN

Figure 03.40/16a): "Send information for MT SMS" procedure; error free case

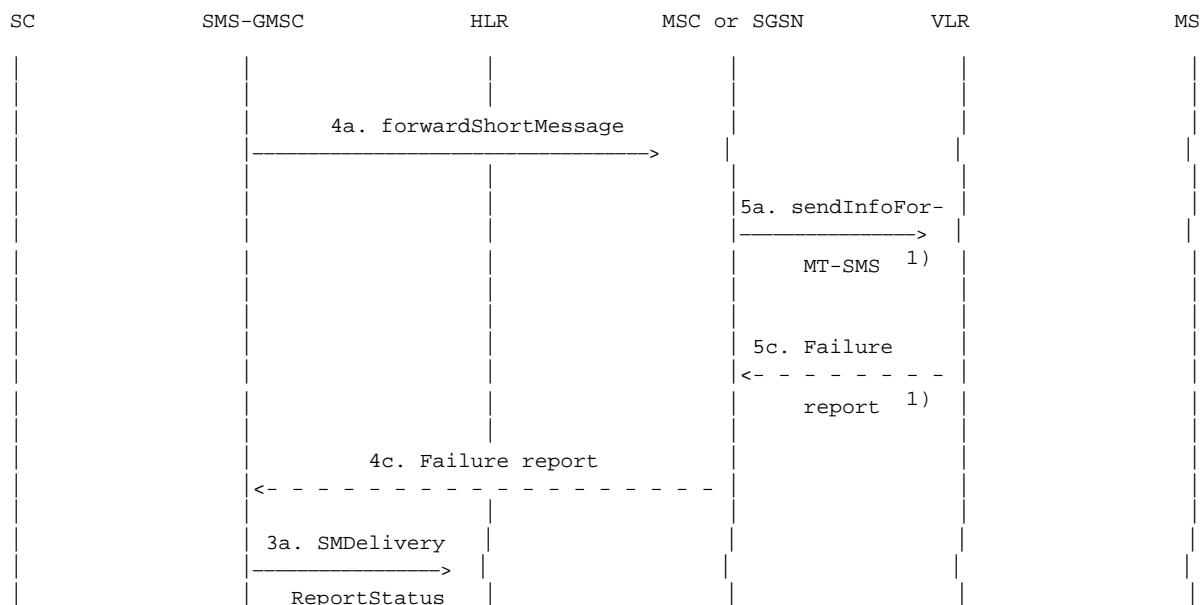

—————>: Operation invocation or message transfer
 - - - -> : Error report

NOTE:

1): The GPRS DETACH information is in the SGSN

This operation is not used by the SGSN

Figure 03.40/16b): "Send information for MT SMS" procedure; erroneous case: absent subscriber (e.g. IMSI DETACH or GPRS DETACH)

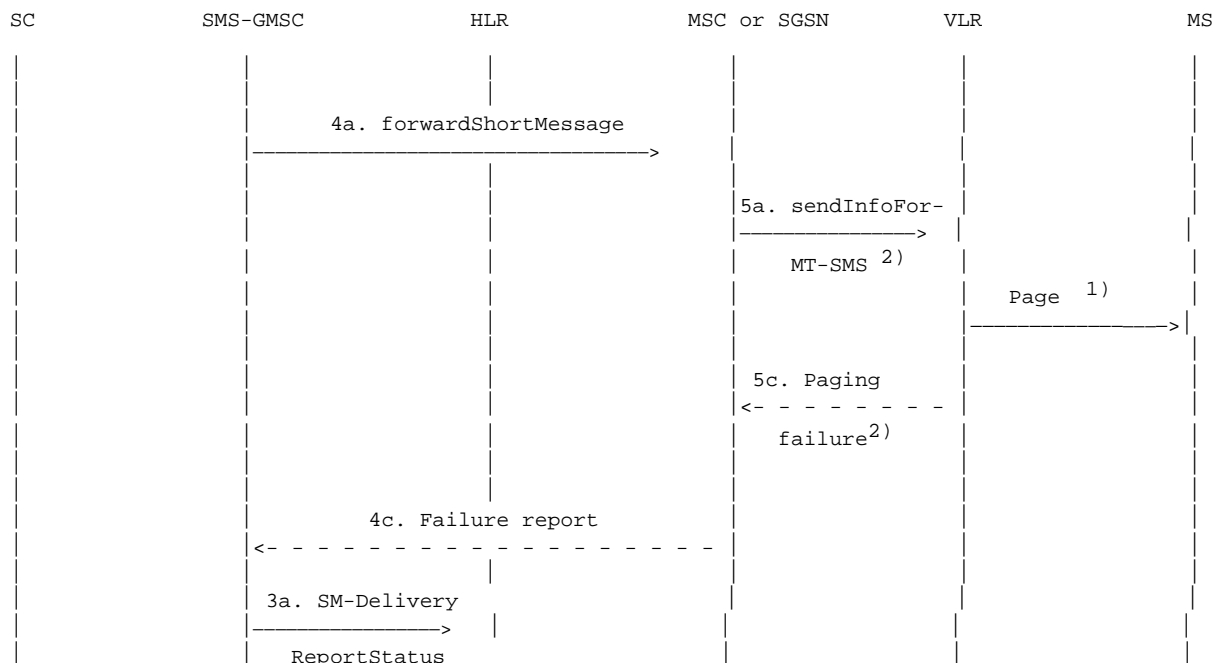

—————>: Operation invocation or message transfer
 - - - -> : Error report

NOTES:

- 1): Described in GSM 04.08 and GSM 09.02
If the SGSN is used, Paging is performed from SGSN
- 2): This operation is not used by the SGSN

Figure 03.40/16c): "Send information for MT SMS" procedure; erroneous case: Absent subscriber (e.g. no paging response)

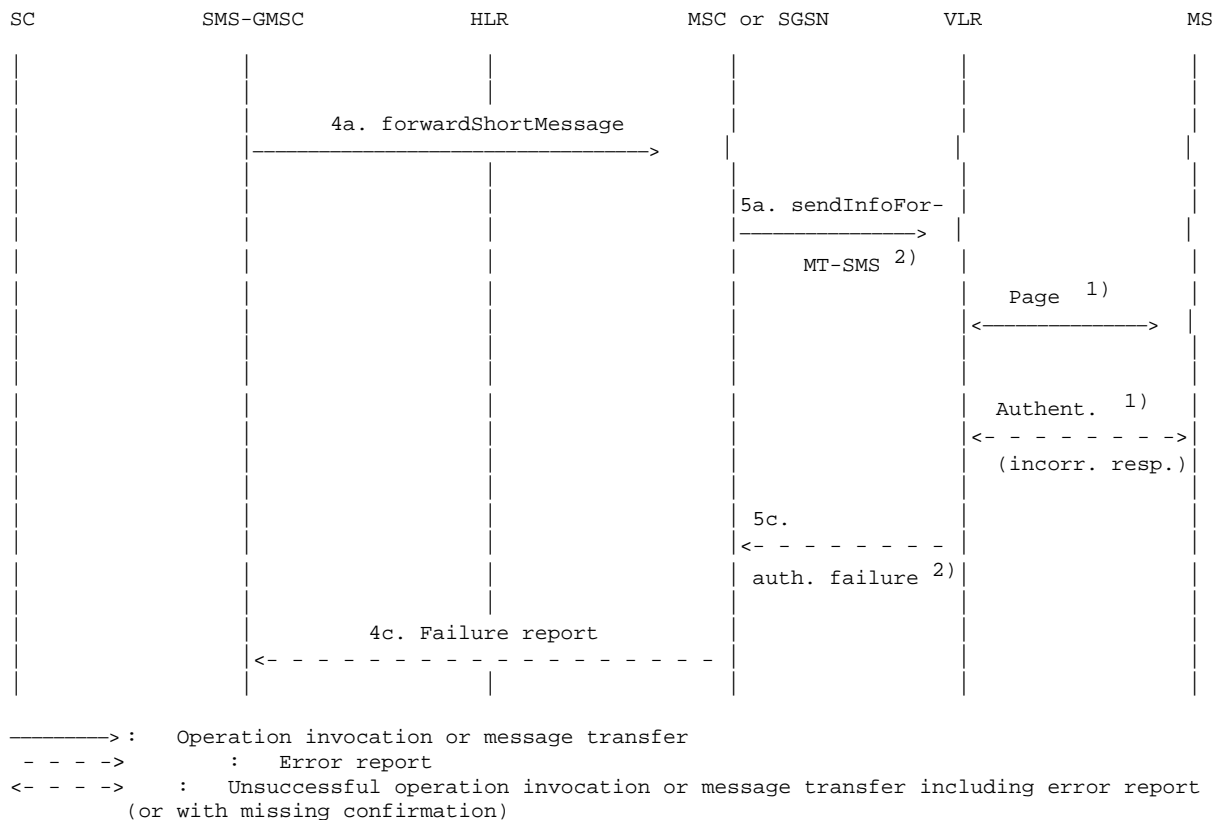

NOTES:

- 1): Described in GSM 04.08 and GSM 09.02
If the SGSN is used, Paging and Authentication are performed from SGSN
- 2): This operation is not used by the SGSN

Figure 03.40/16d): "Send information for MT SMS" procedure; incorrect authentication

10.2 Short message mobile originated

The entities involved in this procedure is depicted in figure 03.40/17.

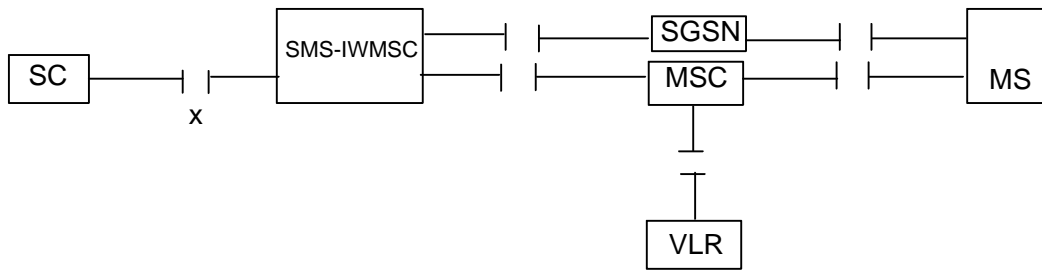

Figure 03.40/17: Interfaces involved in the Short message mobile originated procedure

GSM 03.02. X is the interface between an MSC or an SGSN and an SC as defined in chapter 5

Note that since the short message mobile originated procedure covers the functionality required at SM-RL for transferring TPDU's from SC to MS, the procedure described covers both short message (SMS-SUBMIT) and command (SMS-COMMAND) transfer. The term "short message transfer" therefore in this subclause, covers both cases.

In figure 03.40/18, sequence diagrams for the following basic situations of short message mobile terminated transfer attempt:

- Successful short message transfer;
- Short message transfer attempt failing due to error at the MSC or SGSN;
- Short message transfer attempt failing due to negative outcome of VLR information retrieval;
- Short message transfer attempt failing due to error at the SMS-IW MSC;
- Short message transfer attempt failing due to error at the SC.

References to the relevant specifications of the different operations are given in clause 4.

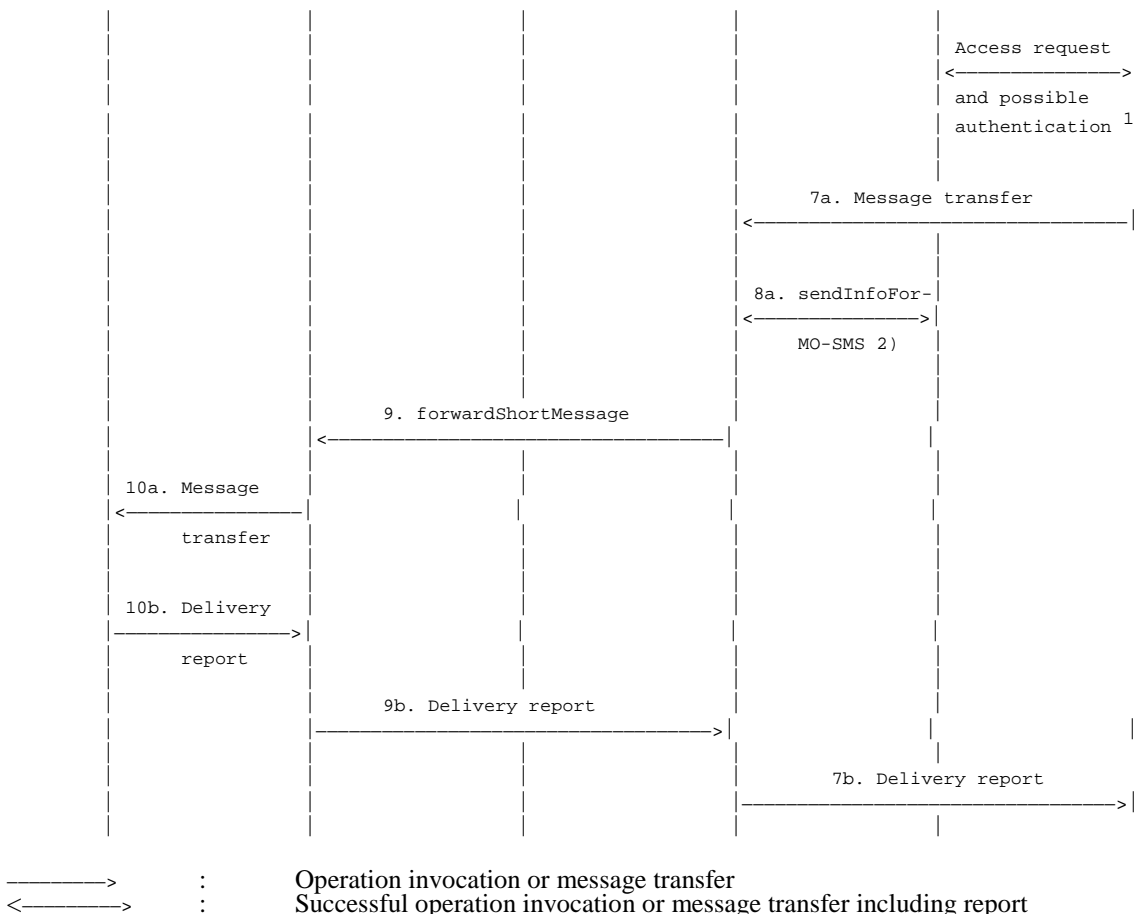

NOTES:

- 1): Described in GSM 04.08 and GSM 09.02.
- 2): This operation is not used by the SGSN

Figure 03.40/18a): Successful short message transfer attempt

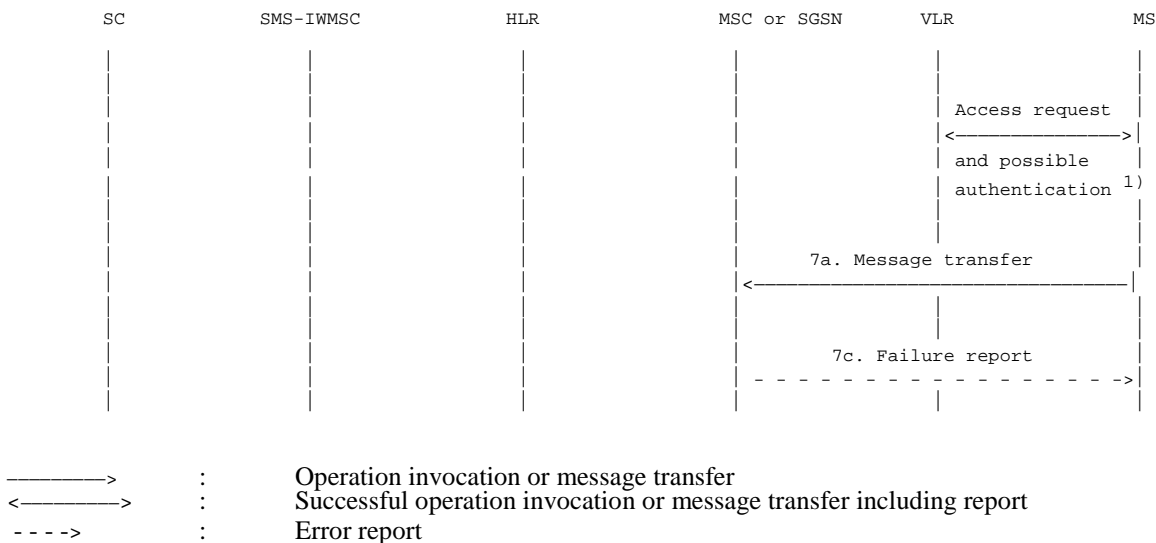

NOTE:

1) :Described in GSM 04.08 and GSM 09.02

Figure 03.40/18b): Short message transfer attempt failing due to error at the MSC or SGSN

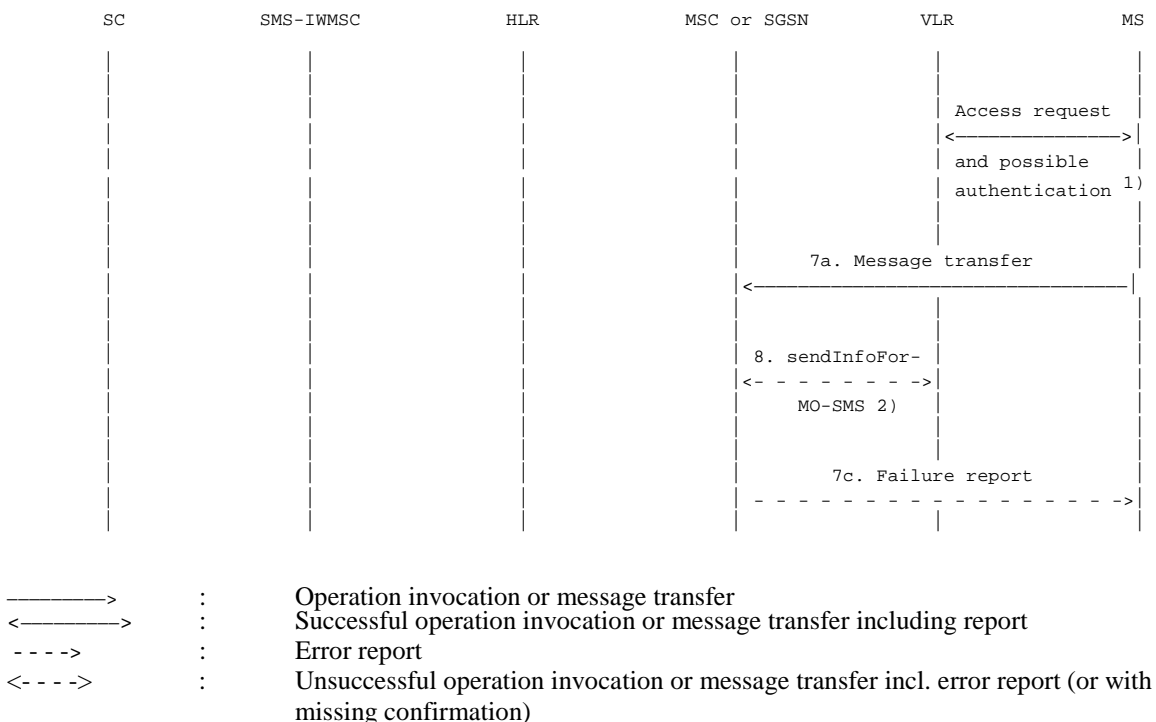

NOTES:

1): Described in GSM 04.08 and GSM 09.02

2): This operation is not used by the SGSN

Figure 03.40/18c): Short message transfer attempt failing due to negative outcome of VLR information retrieval

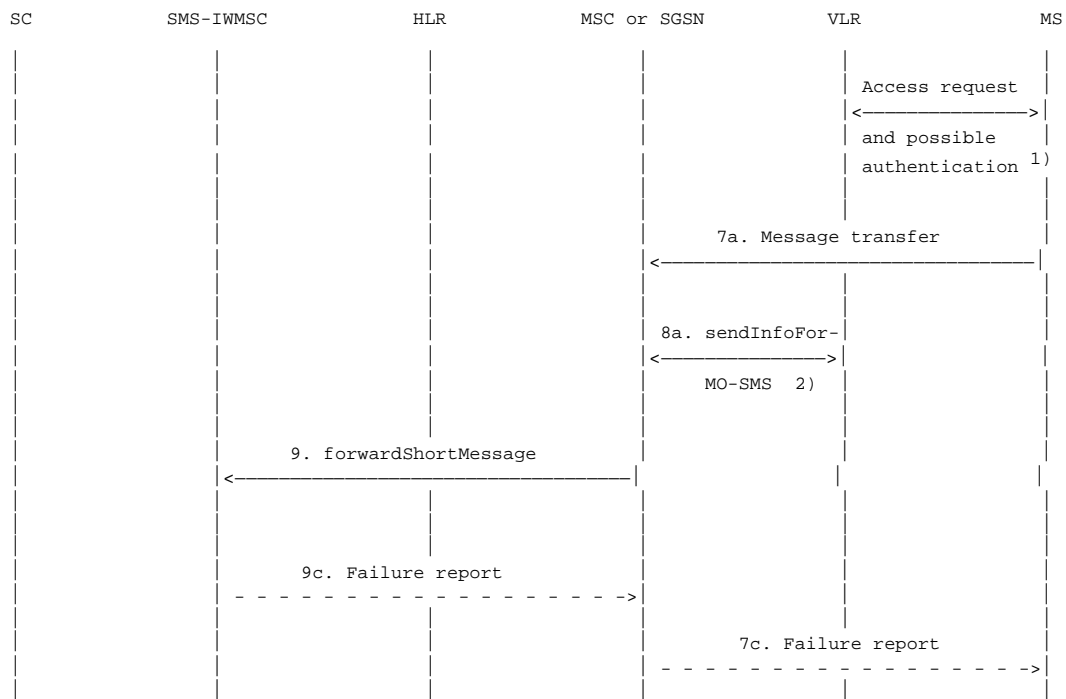

————> : Operation invocation or message transfer
 <————> : Successful operation invocation or message transfer including report
 - - - -> : Error report

NOTES:

1): Described in GSM 04.08 and GSM 09.02

2): This operation is not used by the SGSN

Figure 03.40/18d): Short message transfer attempt failing due to error at the SMS-IW MSC

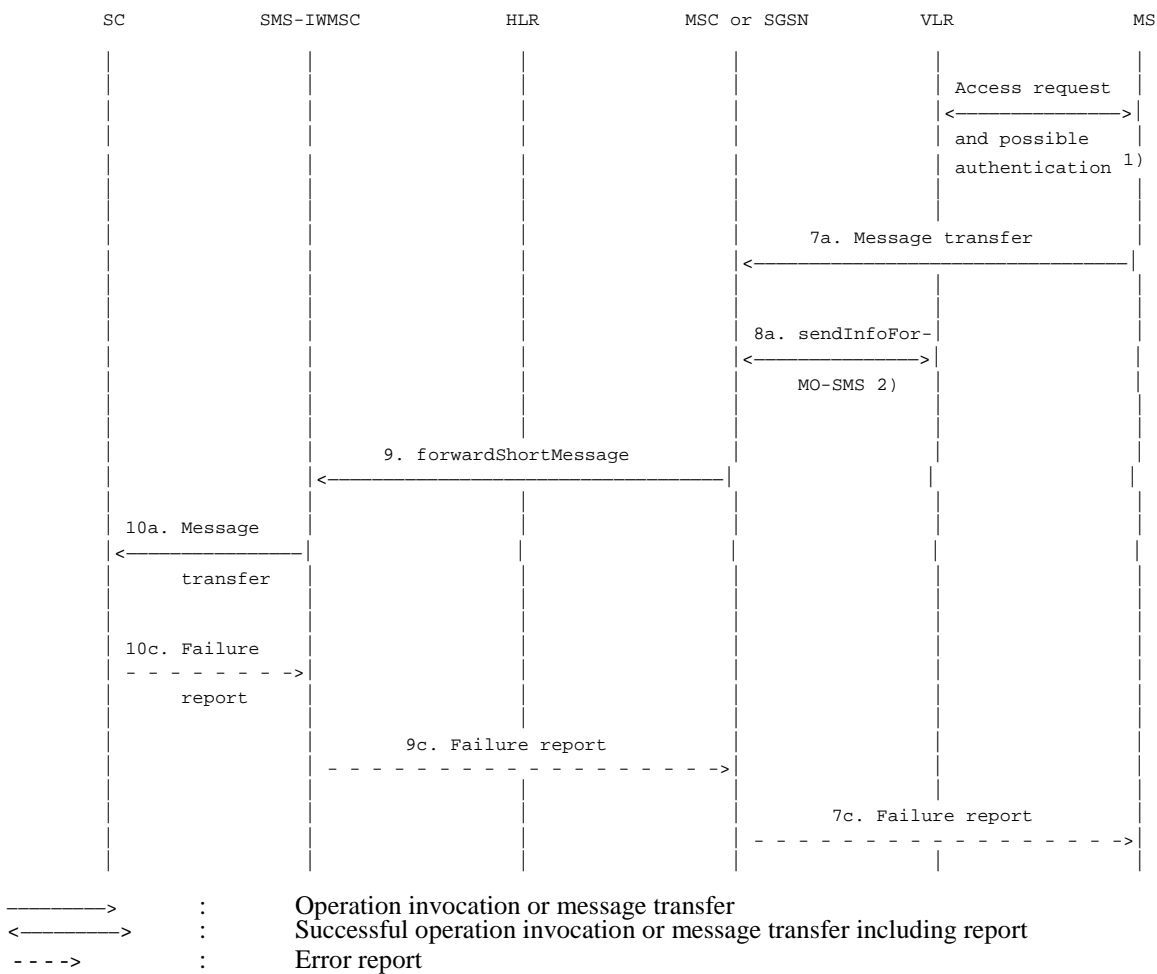

NOTES:

1): Described in GSM 04.08 and GSM 09.02.

2): This operation is not used by the SGSN

Figure 03.40/18e): Short message transfer attempt failing due to error at the SC

Operation 7: Message transfer MS -> MSC or MS -> SGSN

The operation is used to transfer a short message from the MS to the MSC or to the SGSN.

Operation 8: sendInfoForMO-SMS

The operation provides a means for the MSC to verify from the VLR that the mobile originated short message transfer does not violate supplementary services invoked or restrictions imposed using the network feature Operator Determined Barring.

A successful VLR response carries the MSISdn of the originating MS being transferred to the SC at SM-RL.

NOTE: This operation is not used by SGSN.

Operation 9: forwardShortMessage

The operation provides a means for the MSC or for the SGSN to transfer a short message to the SMS-IW MSC.

The procedure is required if the serving MSC or SGSN cannot access the SC directly, e.g. because it has no connection to SC (see clause 5).

The procedure works in tandem with the forwarding of the short message from the SMS-IW MSC to the SC. Thus, the outcome of the operation comprises either success, i.e. that the message has been delivered to the SC; or a failure that may be caused by several reasons, e.g. failure in the transfer MSC --> SMS-IW MSC or SGSN --> SMS-IW MSC, SC does not comply.

Operation 10: Message transfer SMS-IW MSC -> SC

The operation is used to transfer a short message from an SMS-IW MSC to an SC, and consists of:

- the transfer of a message containing the TPDU from the SMS-IW MSC to the SC (see "10a. Message transfer" in figure 03.40/18); and
- the return of either a "Failure report" (see 10c. in figure 03.40/18) or a "Delivery report" (see 10b. in figure 03.40/18).

"Failure report" is returned to the MS when the SMS-IW MSC has received indication from the network or the SC that the procedure was unsuccessful.

10.3 Alert transfer

The entities involved in this procedure are depicted in figure 03.40/19.

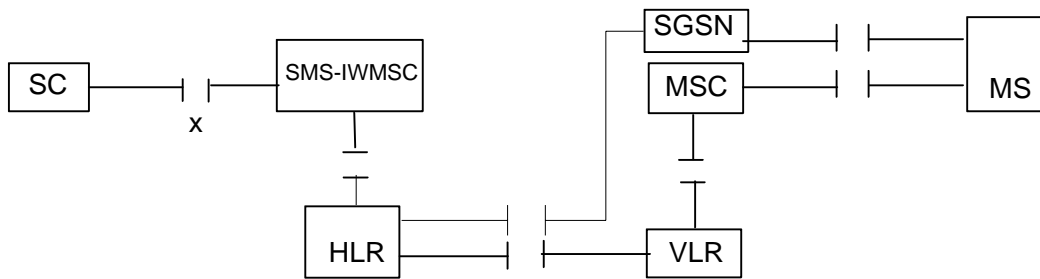

Figure 03.40/19: Interfaces involved in the Alert procedure. X is the interface between an SC and an MSC as defined in clause 5

This procedure consists of the operations shown in figure 03.40/20.

Three cases are distinguished:

- the MS becomes reachable when the MNRF, MNRG or both are set but the MCEF is not set (figure 03.40/20a);
- the MS becomes reachable when the MNRF, MNRG or both, and the MCEF are set (figure 03.40/20b);
- the MS notifies the network that it has memory available to receive one or more short messages when the MCEF is set (figure 03.40/20c).

The operations between MSC and VLR, between HLR and VLR or SGSN and between HLR and SMS-IW MSC are specified in GSM 09.02. The operation between MS and MSC or SGSN is specified in GSM 04.11. References to specifications of other operations are given in clause 4.

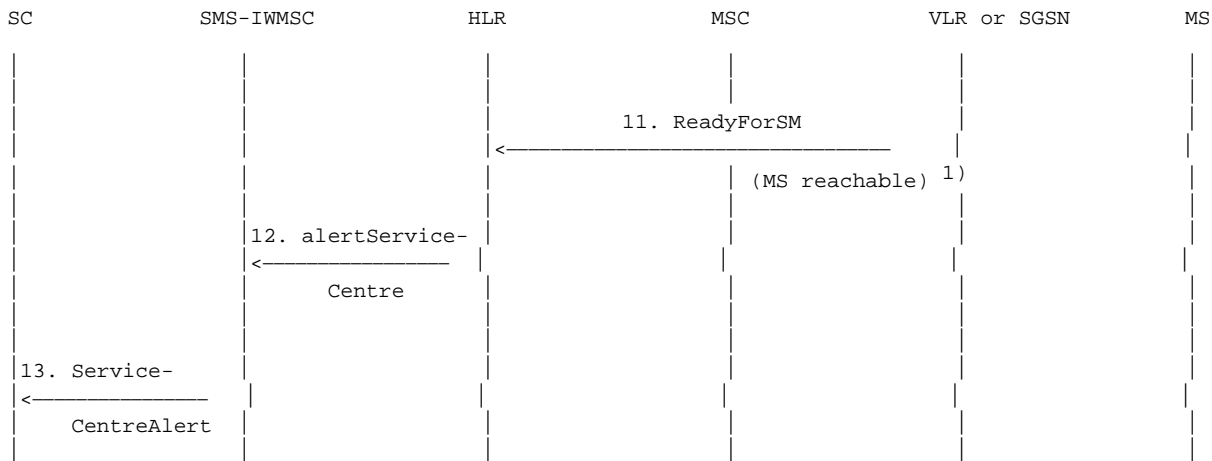

——>: Operation invocation or message transfer
 NOTE:1): In case ReadyForSM is sent by the SGSN, the reason may be MS reachable via the SGSN, or MS reachable via the SGSN and the MSC (see GSM 03.60).

Figure 03.40/20a: The alert procedure when the MS becomes reachable, MNRf, MNRg or both are set and MCEf is not set

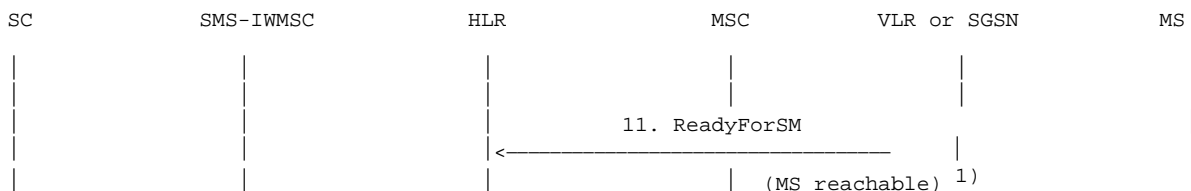

——>: Operation invocation or message transfer
 NOTE:1): In case ReadyForSM is sent by the SGSN, the reason may be MS reachable via the SGSN, or MS reachable via the SGSN and the MSC (see GSM 03.60).

Figure 03.40/20b: The alert procedure when the MS becomes reachable, MNRf, MNRg or both are set and MCEf is set

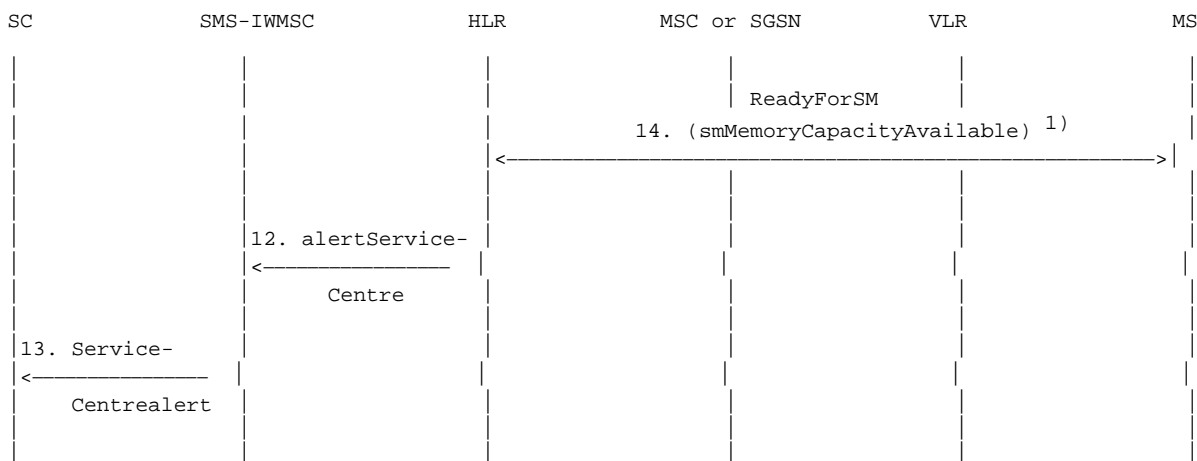

——> : Operation invocation or message transfer
 <——> : Successful operation invocation or message transfer including report

NOTE:1): Described in GSM 04.11 and GSM 09.02.

Figure 03.40/20c: The alert procedure when the MS notifies the network that it has memory available to receive one or more short messages and MCEf is set

Operation 11: ReadyForSM (MS reachable)

The operation provides a means to transfer alert information from VLR or SGSN to HLR.

The procedure is activated when the VLR or the SGSN detects that the MS is active, i.e. when the MS responds to a paging request.

Operation 12: alertServiceCentre

The operation provides a means to transfer alert information from HLR to MSC.

Operation 13: ServiceCentreAlert

The operation provides a means to transfer alert information from an SMS-IW MSC to an SC.

The operation consists of transfer of a message ("RP-ALERT-SC") from the SMS-IW MSC to the SC.

Operation 14: ReadyForSM (smMemoryCapacityAvailable)

The operation provides a means for the MS to notify the network that it has memory available to receive one or more short messages.

The following applies if the memory capacity available notification flag is implemented in the SIM.

The operation consists of transfer of a message ("RP-SM-MEMORY-AVAILABLE") from the MS to the HLR, and the return of an acknowledgement to the MS. When the MS rejects a short message due to lack of available memory capacity the need to transfer notification shall be stored in the SIM. After a attempt to transfer the RP-SM-Memory-Available message the following applies:

If the MS receives a positive acknowledgement it will unset the memory capacity exceeded notification flag in the SIM and exit this procedure.

If the MS receives a negative acknowledgement indicating a permanent failure condition (as specified in GSM 04.11) it will unset the memory capacity exceeded notification flag in the SIM and exit the procedure.

If the MS receives a negative acknowledgement indicating a temporary failure condition (as specified in GSM 04.11) or receives no acknowledgement or an indication of failure by lower layers, it will repeat the attempt to transfer the message in accordance with procedures defined in GSM 04.11. If these repeat procedures fail, the mobile will unset the memory capacity exceeded notification flag in the SIM and exit this procedure.

If memory capacity has become available because memory is cleared, the value of the memory capacity exceeded notification flag is read. If the flag is set, the MS notifies the network that memory capacity is now available as described above.

When the mobile is powered up or the SIM is inserted, the mobile shall check the memory capacity exceeded notification flag in the SIM; if the flag is set and the SIM has memory available to receive a short message the mobile shall attempt to notify the network that it has memory available, as described above.

11 Mapping of error causes between RP layers

This clause describes the interworking between the relay layers on the radio interface (i.e. between the servicing MSC/SGSN and the mobile station), and within the network (i.e. between servicing MSC/SGSN, VLR, HLR, or GMSC).

11.1 Mobile Terminated short message transfer

If errors are indicated by the VLR after invocation of the "sendInfoFor-MT-SMS" operation, the appropriate error information is returned to the SMS-GMSC in a failure report as specified in GSM 09.02 (negative outcome of "forwardShortMessage" see clause 10),

If errors are detected by the MSC or by the SGSN during the transfer on the radio interface, the error cause returned in the return error of the MAP procedure ForwardShortMessage shall be set as follows:

Failure at the MSC or SGSN	Return error to be included in the MAP-proc
RP-ERROR message with error cause: 22 Memory capacity exceeded Other error causes	SM_DeliveryFailure with cause "MemoryCapacityExceeded" ¹⁾ SM_DeliveryFailure with cause "equipmentProtocolError" ¹⁾
CP or lower layer error (e.g. RR, layer 2 failure) ²⁾ Mobile has no SM capability	SM_DeliveryFailure with cause "equipmentProtocolError" ¹⁾ SM_DeliveryFailure with cause "equipmentNotSM-Equipped" ¹⁾ ⁰⁾
TR1N timeout ²⁾ MNSMS-error-ind (No SAPI 3)	SM_DeliveryFailure with cause "equipmentProtocolError" ¹⁾

1) For definition of MAP error SM_DeliveryFailure and its parameter "cause" see GSM 09.02.

2) The error causes of the RP-ERROR message, the CP layer and timer TR1N are defined in GSM 04.11.

11.2 Memory available notification

If errors are indicated by the HLR (via the VLR or the SGSN) after invocation of the "ReadyForSM" operation, the MSC or the SGSN shall return the appropriate error information to the MS in a failure report (i.e. a RP-ERROR message) containing the following error cause:

Return error from ReadyForSM (Alert Reason is "memory available")	Cause value in the RP-ERROR message
DataMissing UnexpectedDataValue UnknownSubscriber FacilityNotSupported System Failure	38 Network out of order 38 Network out of order 30 Unknown Subscriber 69 Requested facility not implemented 38 Network out of order
Local or lower layer failure (e.g. reject condition, timer expired or transaction abort)	38 Network out of order

NOTE: The coding and the use of the RP-ERROR message is specified in GSM 04.11.

11.3 Mobile Originated short message transfer

If errors are indicated by the VLR after invocation of the "sendInfoForMO-SMS" operation.(see clause 10), the MSC shall return the appropriate error information to the MS in a failure report (i.e. a RP-ERROR message) containing the following error cause:

Return error from SendInfoForMO-SMS	Cause value in the RP-ERROR message
DataMissing UnexpectedDataValue TeleserviceNotProvisioned	38 Network out of order 38 Network out of order 50 Requested facility not subscribed
CallBarred - barringServiceActive - operatorBarring	10 Call barred 8 Operator determined barring

NOTE: The coding and the use of the RP-ERROR message is specified in GSM 04.11. The operation SendInfoForMO-SMS is not used by the SGSN.

If errors are indicated by the SMS-IWMSC (negative outcome of the "forwardShortMessage"), the MSC or the SGSN shall send a failure report (i.e. a RP-ERROR message) to the MS, with the error cause coded as follows:

Return error from ForwardShortMessage	Cause value in the RP-ERROR message
DataMissing FacilityNotSupported	38 Network out of order 69 Requested facility not implemented
UnexpectedDataValue	38 Network out of order
SM-DeliveryFailure cause: unknownSC	1 Unassigned number
SM-DeliveryFailure cause: SC-Congestion	42 Congestion
SM-DeliveryFailure cause: invalidSME-Addr	21 Short message transfer rejected
SM-DeliveryFailure cause: subscriberNotSC-Subscriber	28 Unidentified subscriber
Local or lower layer failure (e.g. reject condition, timer expired or transaction abort)	38 Network out of order

NOTE: The coding and the use of the RP-ERROR message is specified in GSM 04.11.

Annex A (informative): Protocol stacks for interconnecting SCs and MSCs

No mandatory protocol between the Service Centre (SC) and the Mobile Switching Centre (MSC) below the transfer layer is specified by GSM; this is a matter of agreement between SC and PLMN operators.

Some example protocols are provided in GSM 03.47 to assist SC and PLMN operators. These are based on the following principles, which SC and PLMN operators are recommended to follow even if they choose not to use one of the examples given in GSM 03.47:

The protocol(s) between SC and MSC below transfer layer should:

- a) provide the service defined for SM-RL (see Section 9.3);
- b) be based on widely accepted telecommunications protocols in the public domain;
- c) permit open interconnection.

Annex B (informative): Information now contained in GSM 03.38

Annex B held information that is now contained in GSM 03.38.

Annex C (informative): Short message information flow

The diagrams in this annex describe the flow of primitives and parameters during the short message transfer. These diagrams refer to specifications GSM 03.40, 04.11 and 09.02. The parameters in dotted lines are optional. The abbreviations used in diagrams are listed below. The relevant specifications are given in parentheses. (*) stands for a common GSM abbreviations and (-) for a general abbreviation.

CM	Call Management (*)
CS	CauSe (-)
DA	Destination Address (-)
DCS	Data Coding Scheme (03.40)
DI	Dialogue Identifier TCAP
GMSCA	Gateway MSC Address
GPRS	General Packet Radio Services (03.60)
HLR	Home Location Register (*)
IMSI	International Mobile Subscriber Identity (*)
MAL	MSISdn-Alert (03.40)
MMS	More Messages to Send (03.40)
MR	Message Reference (03.40)
MS	Mobile Station (*)
MSC	Mobile services Switching Centre (*)
MSCA	MSC Address
MSI	Mobile waiting Set Indication (03.40)
MSISdn	Mobile Station ISDN number (*)
MSM	More Short Messages (09.02)
MSRN	Mobile Station Roaming Number (*)
MT	Message Type (04.11)
MTI	Message Type Indicator (04.11)
MWS	Message Waiting Set (03.40)
OA	Originating Address (-)
OC	Operation Code (09.02)
PCI	Protocol Control Information (-)
PDI	Protocol DIscriminator (*)
PRI	PRIority (03.40)
RCT	ReCeption Time (03.40)
REA	REcipient Address (03.40)
RL	ReLay function (04.11)
RP	Reply Path (03.40)
SC	Service Centre (03.40)
SCA	Service Centre Address (03.40)
SCTS	Service Centre Time Stamp (03.40)
SGSN	Serving GPRS Support Node (03.0)
SM	Short Message (03.40)
SM-AL	Short Message Application Layer (03.40)
SME	Short Message Entity (03.40)
SMI	Short Message Identifier (03.40)
SM-RL	Short Message Relay Layer (03.40, 04.11)
SMS-GMSC	Short Message Service Gateway MSC (03.40)
SMS-IW MSC	Short Message Service Interworking MSC (03.40)
SoR	Status of Report (03.40)
SM-TL	Short Message Transfer Layer (03.40)
SRI	Status Report Indication (03.40)
SRR	Status Report Request (03.40)
ST	STatus (03.40)
TCAP	Transaction Capabilities Application Part (-)
TID	Transaction Identifier (*)
UD	User Data (-)
UDL	User Data Length (03.40)

VLR	Visitor Location Register (*)
VP	Validity Period (03.40)
VPF	Validity Period Format (03.40)

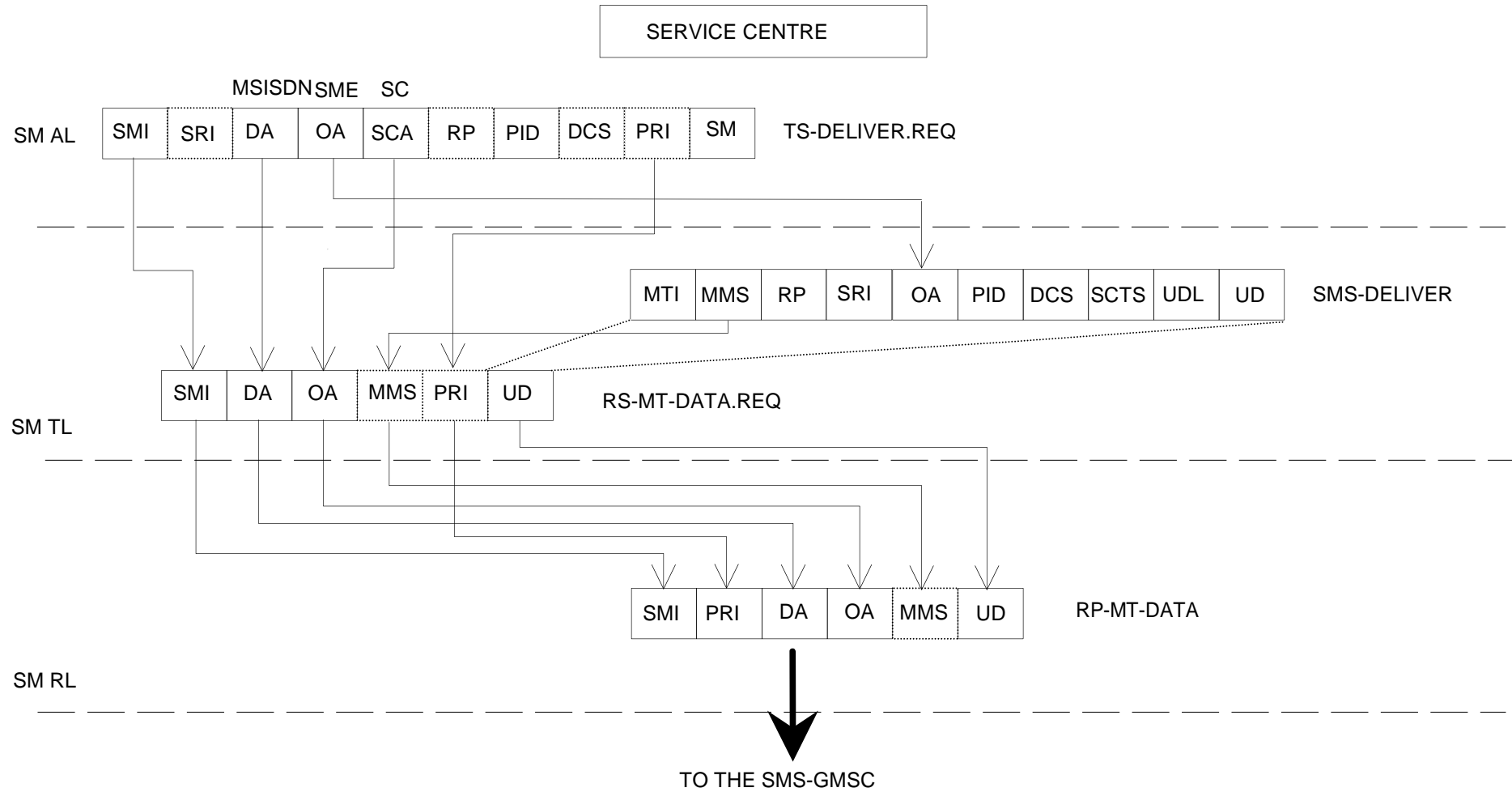

NOTE: SMI is not carried via SM-RL of subclause 9.3.5 but is carried via the relay service between the SC and GMSC (see subclause 9.3.4.1).

Figure 1.1: Mobile terminated short message

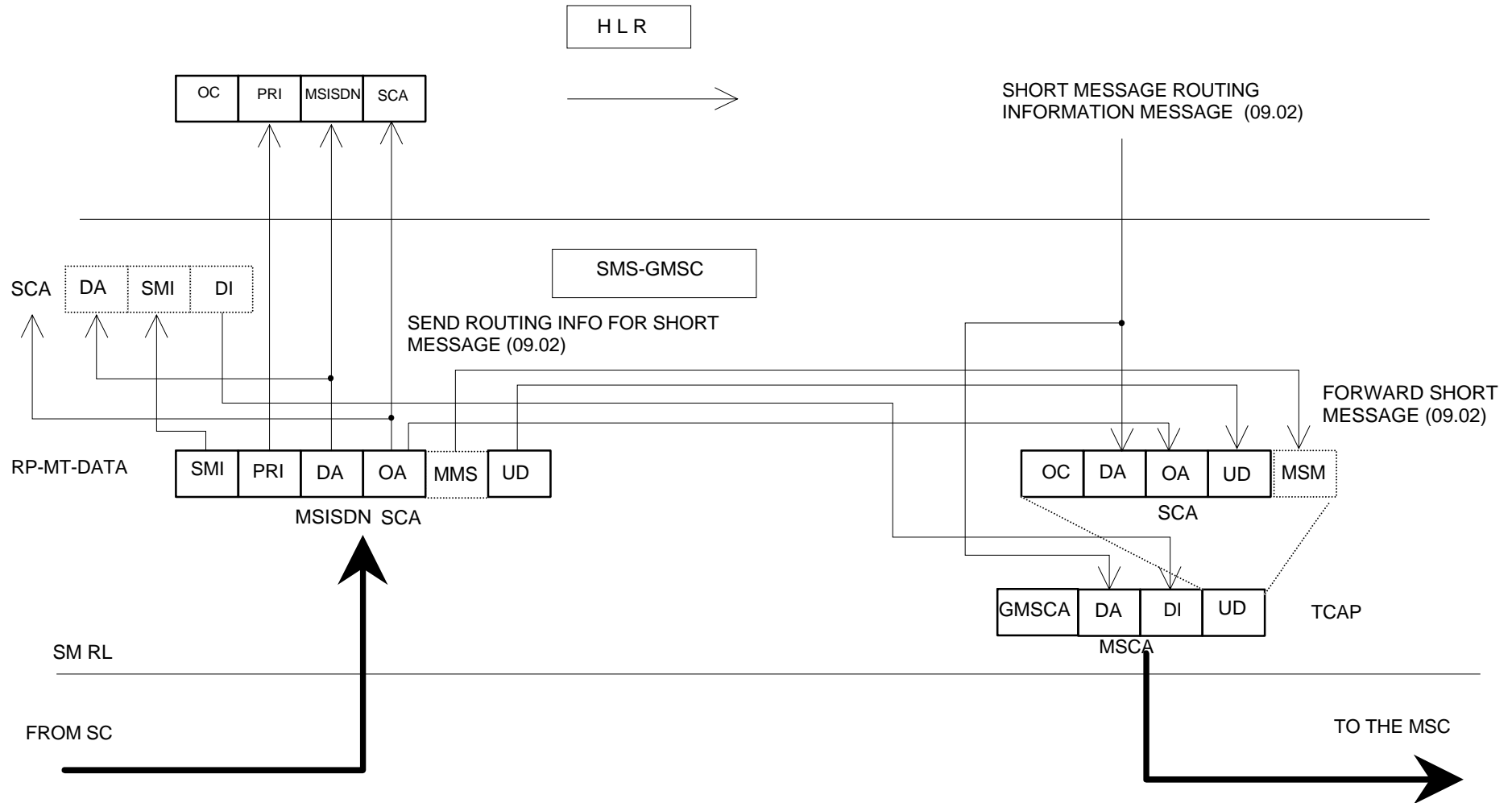

NOTE: A sequence of short messages will have MMS set to 1 in each RP-MT-DATA except the last (last will have MMS set to 0). Each RP-MT-DATA will be carried via FORWARD SHORT MESSAGE via TCAP and will be assigned the same Dialogue Identifier as previous RP-MT-DATAS in the sequence.

Figure 1.2: Mobile terminated short message

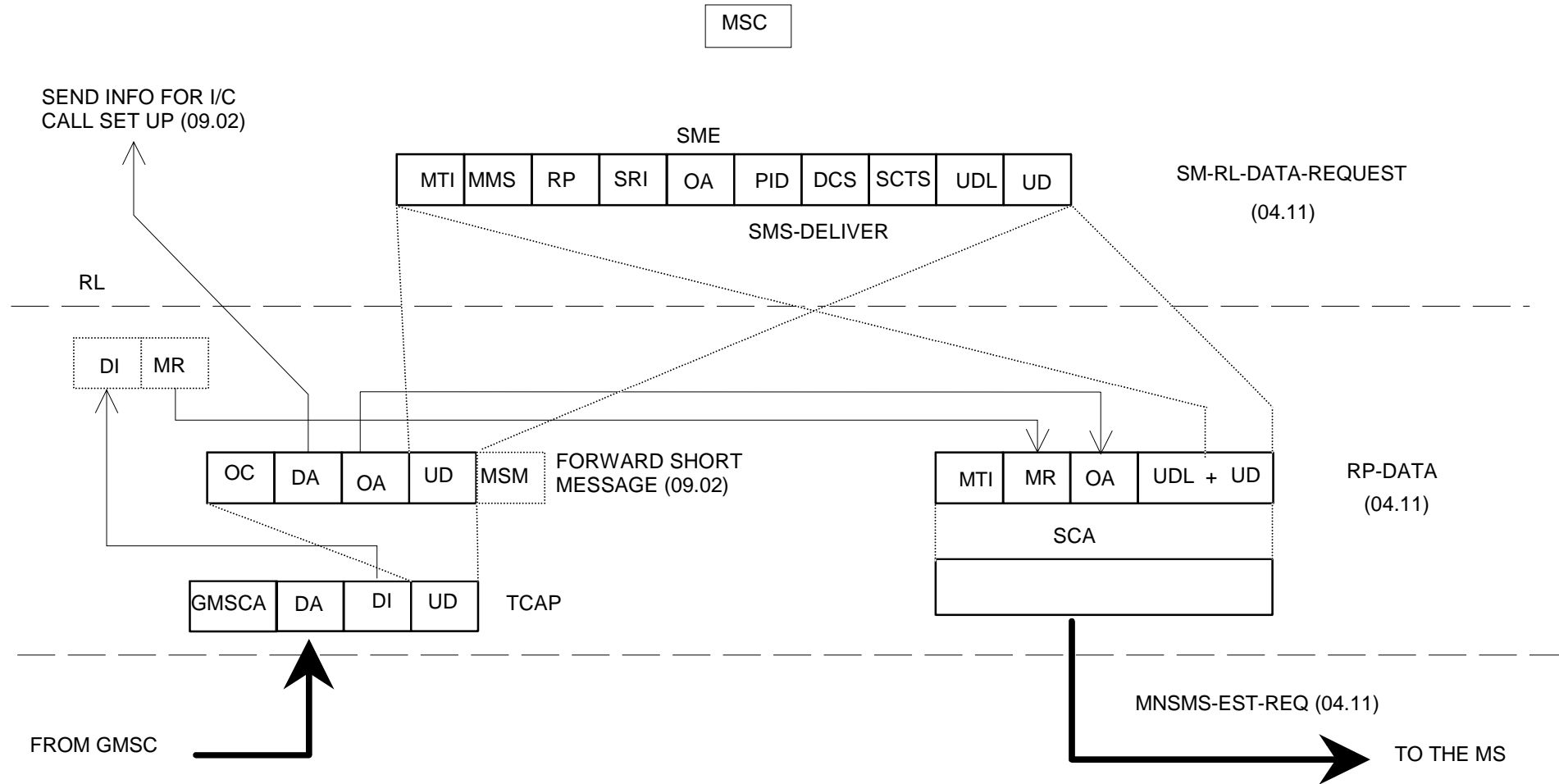

NOTE: MR is of local significance to the MSC/MS interface and is not the value supplied to the MSC

Figure 1.3: Mobile terminated short message

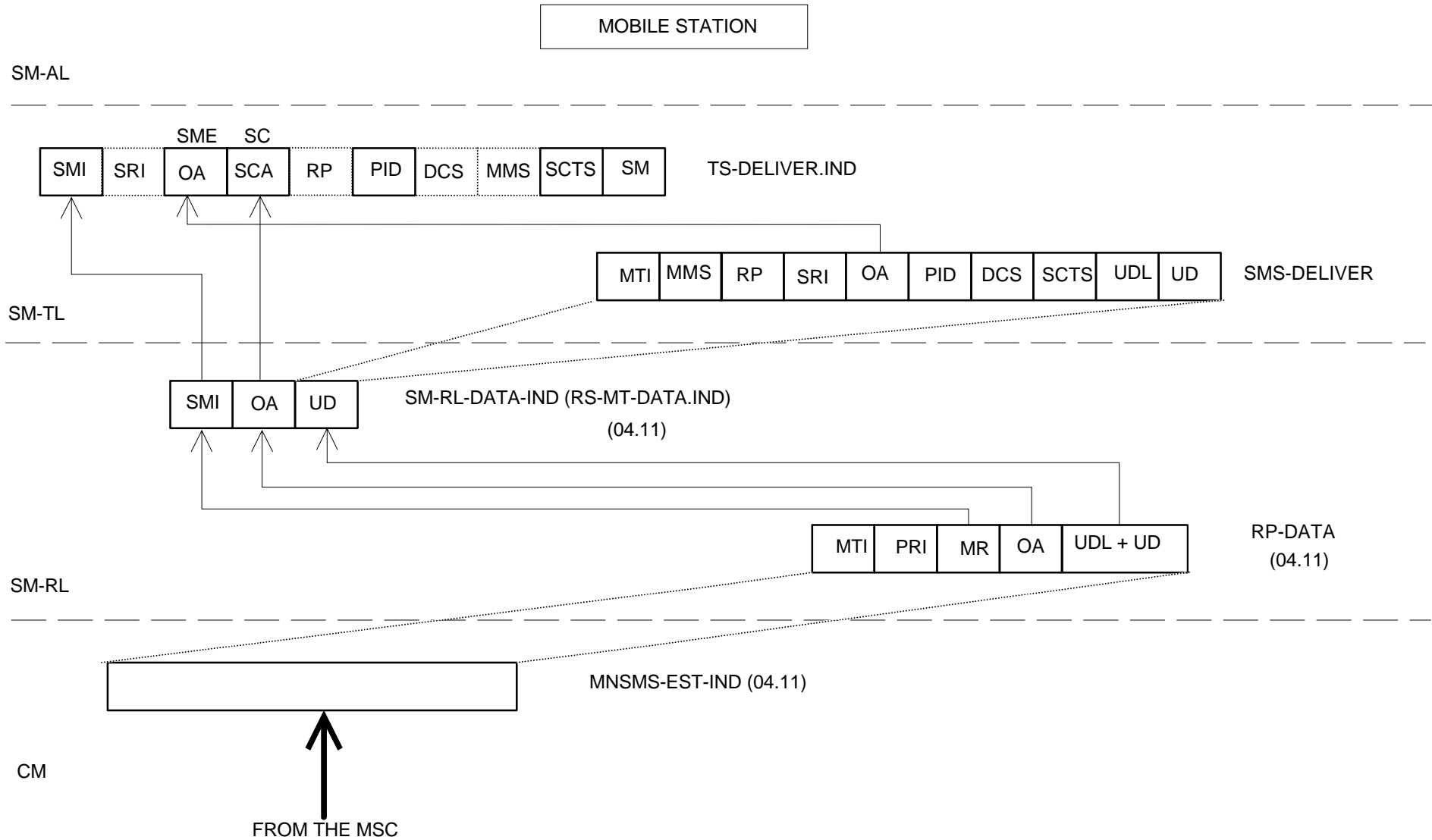

Figure 1.4: Mobile terminated short message

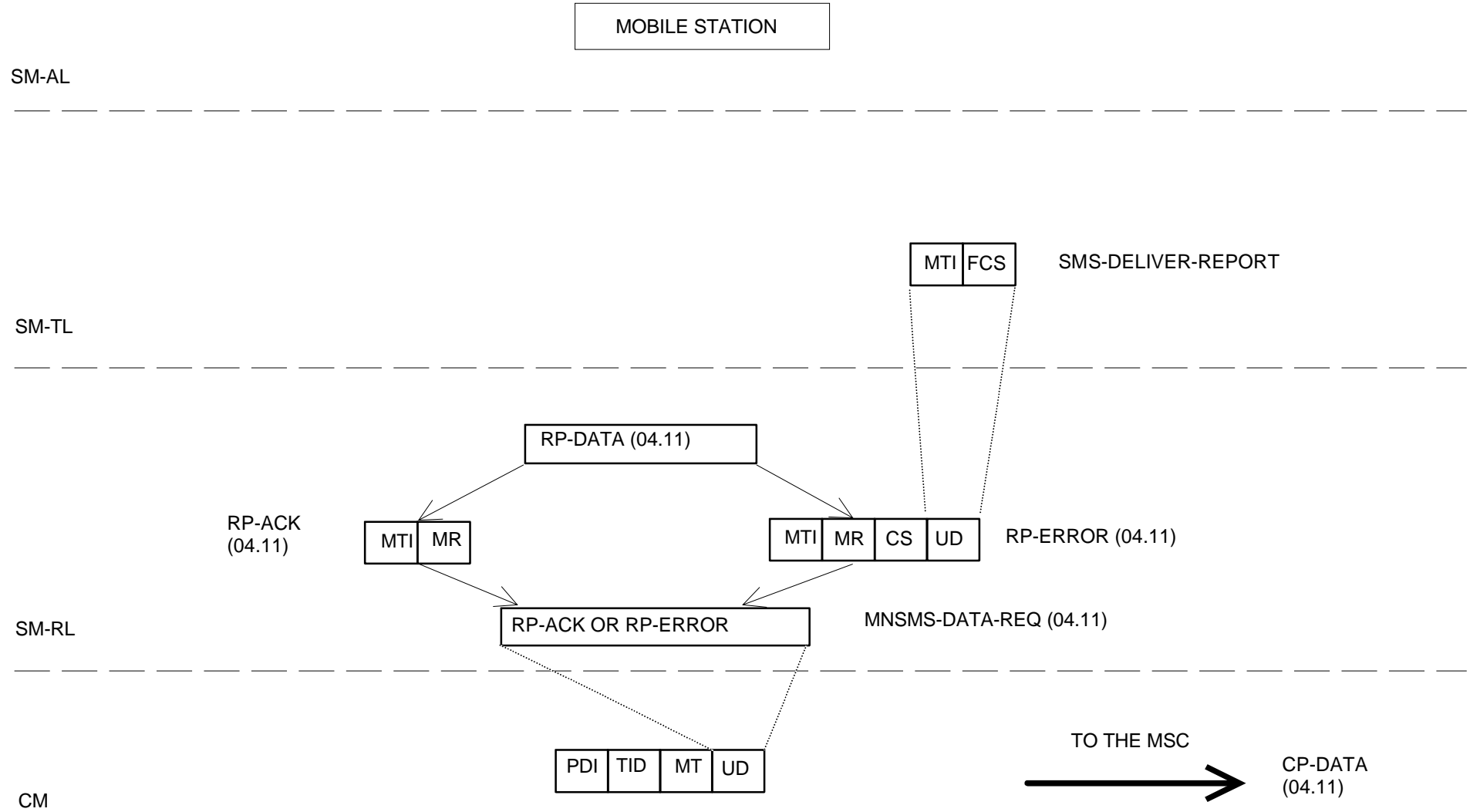
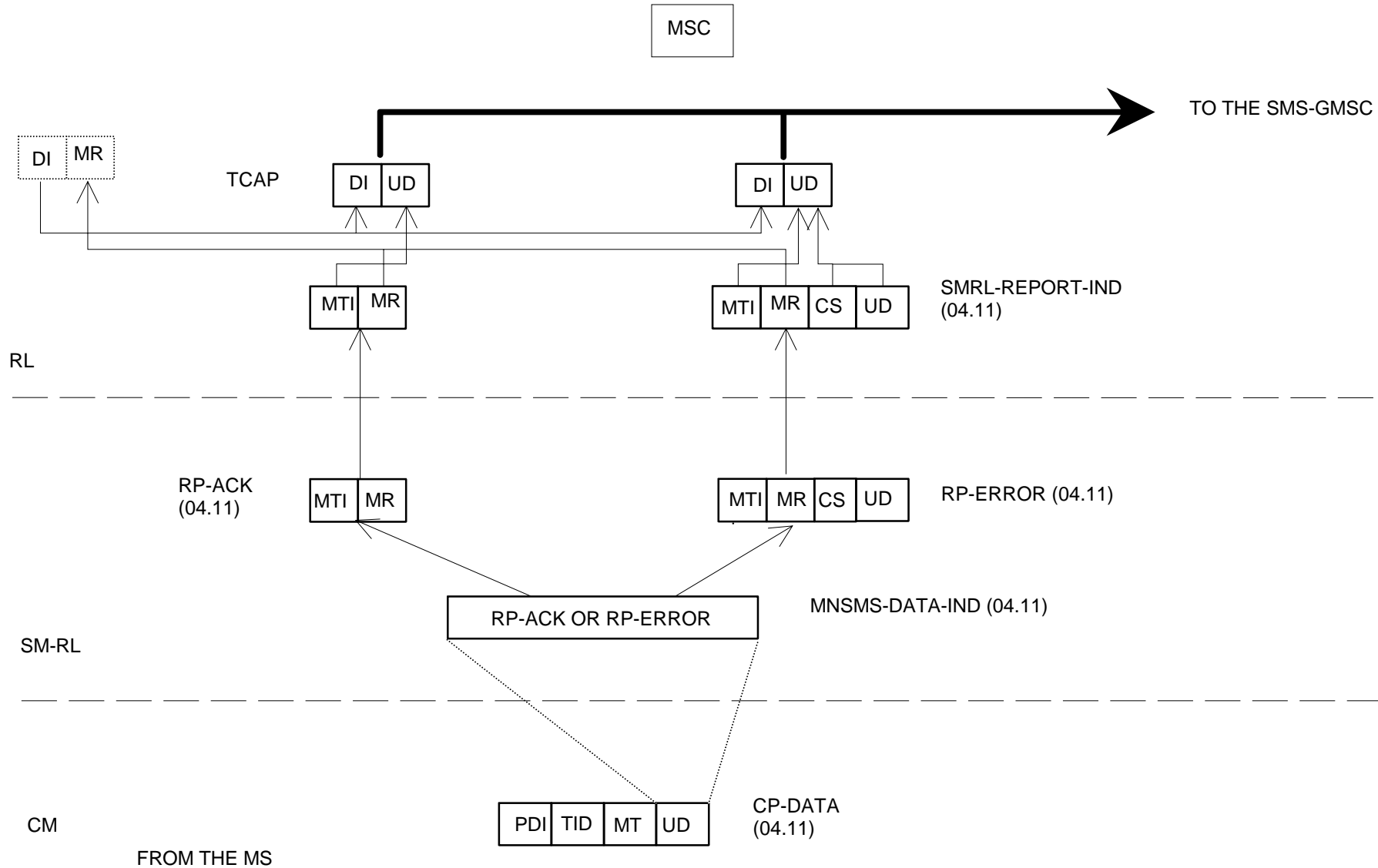
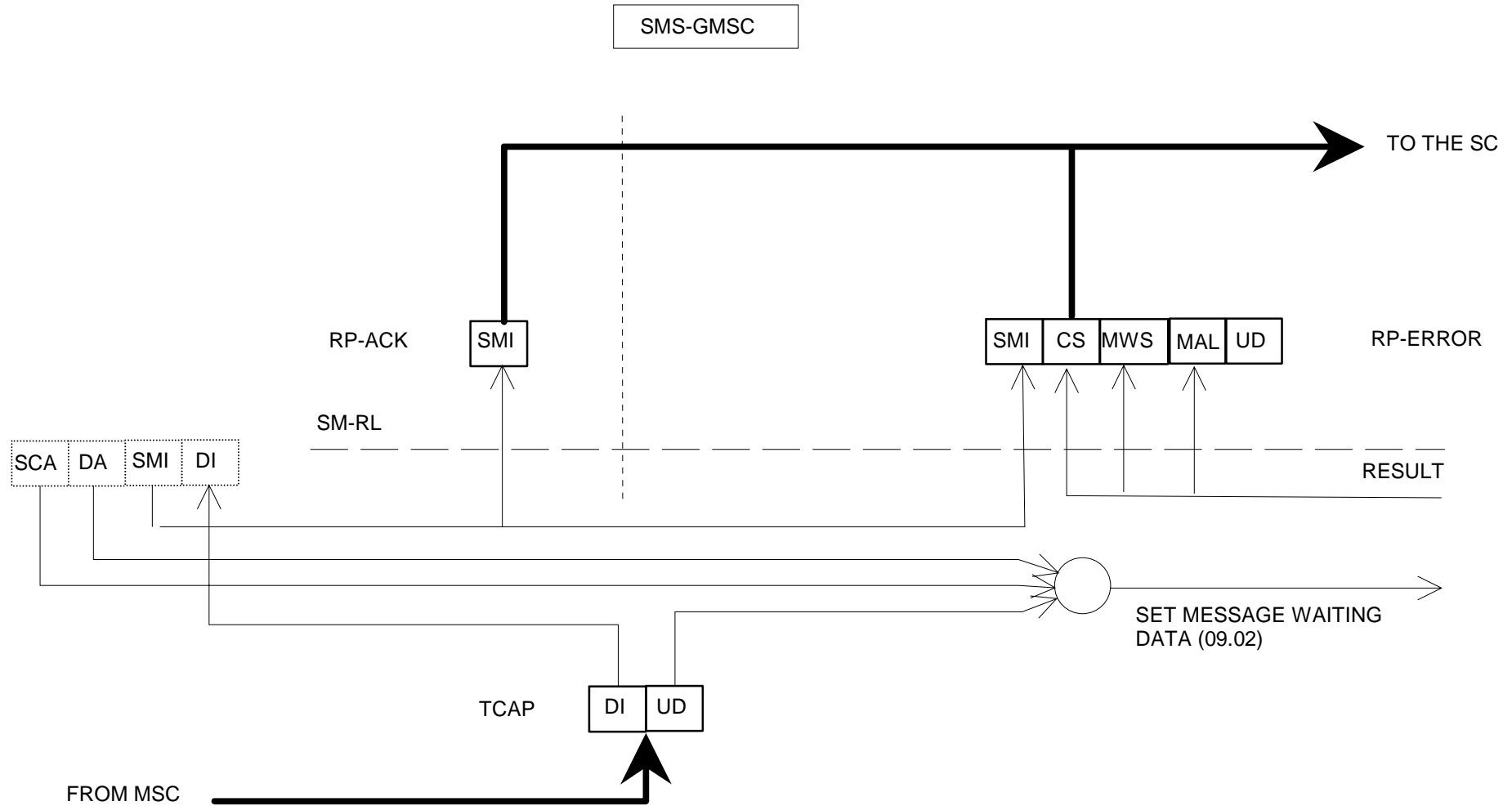

Figure 2.1: Acknowledgement in the MT case



NOTE: The cause carried via UD of TCAP is not the cause supplied via RP-ERROR but is the cause resulting from application of the mapping specified by table 8.5 of 04.11.

Figure 2.2: Acknowledgement in the MT case



NOTE 1: The MAP operation "SetMessageWaitingData" is invoked only if a cause "Absent Subscriber" is carried in TCAP UD.

NOTE 2: The cause delivered to the SC is not necessarily the cause carried via TCAP but is one of the set specified by table 03.40/1.

Figure 2.3a: Acknowledgement in the MT case

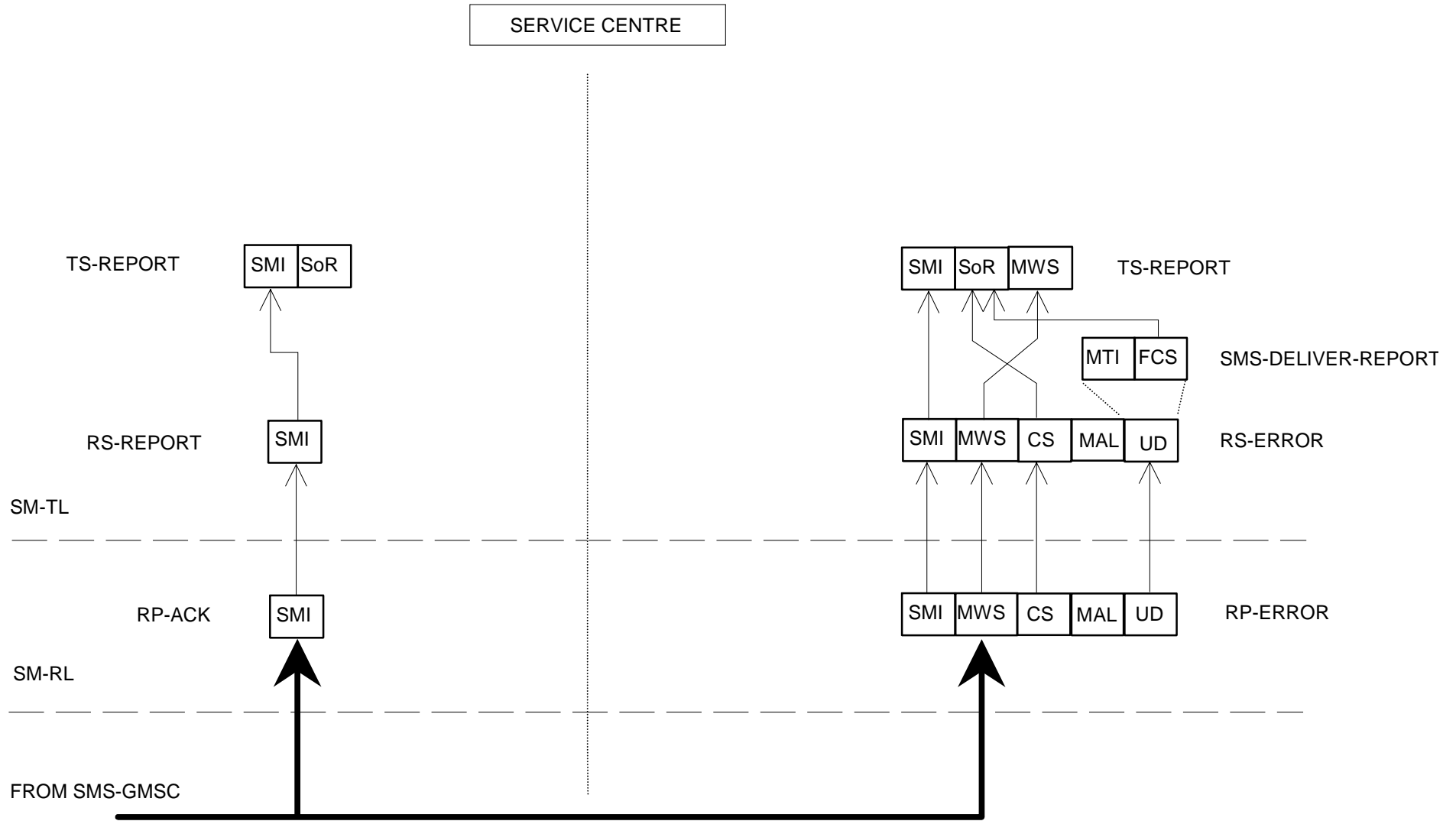
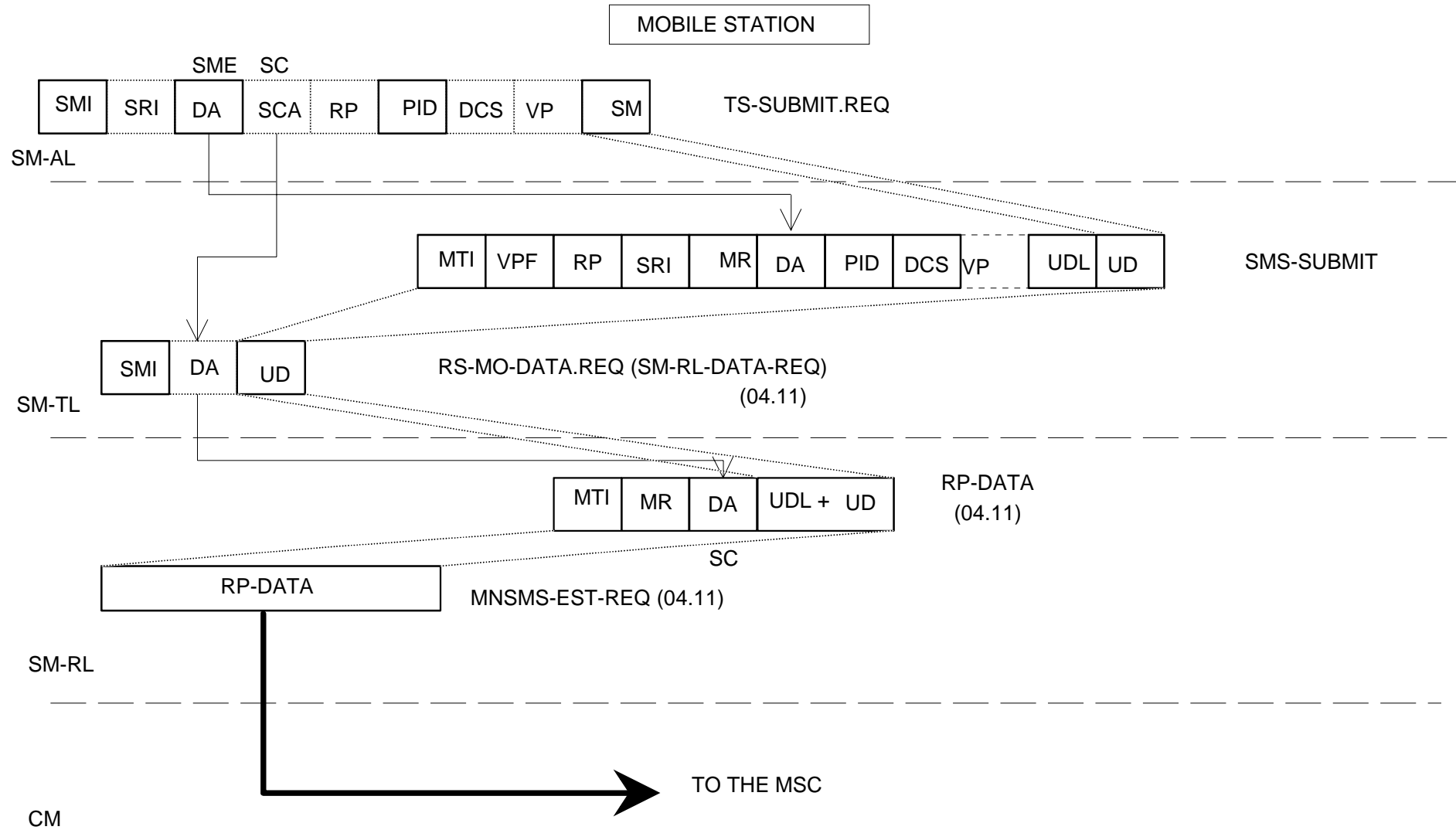

Figure 2.3b: Acknowledgement in the MT case



NOTE: The mapping of SMI to MR by the MS is a local matter.

Figure 3.1: Mobile originated short message

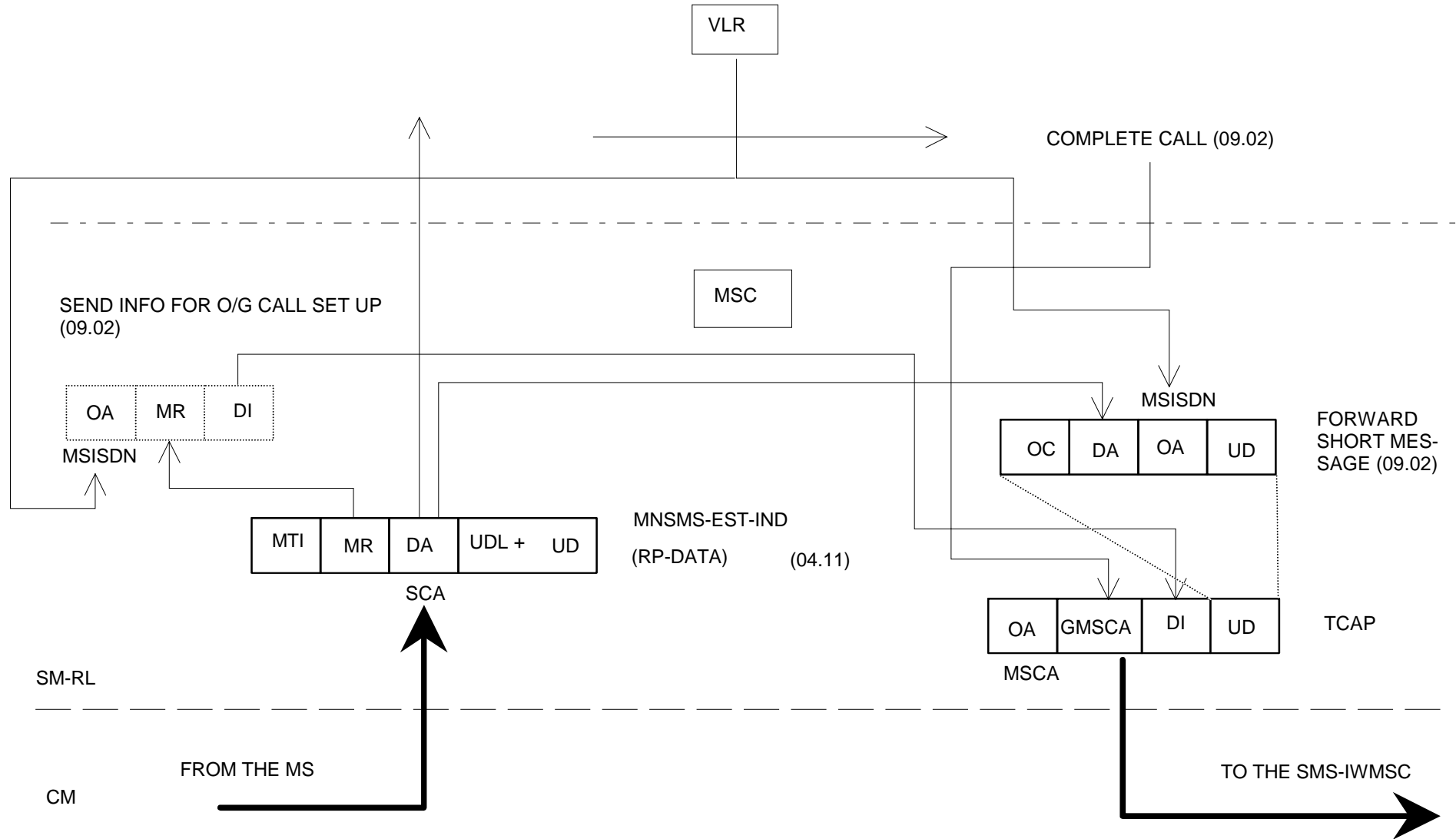
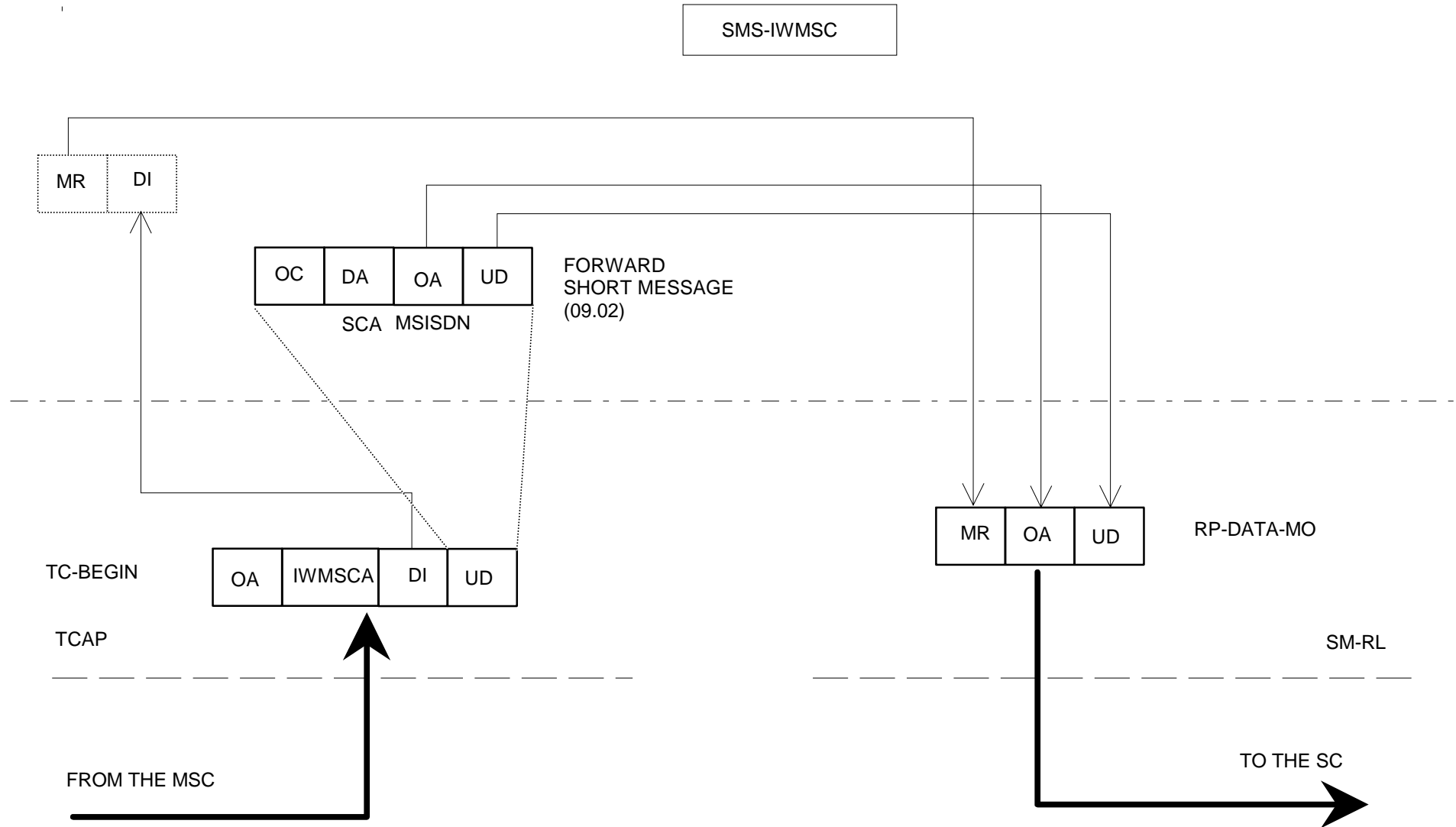

Figure 3.2: Mobile originated short message



NOTE: MR is of local significance to the IW MSC/SC interface and is not the value supplied by the MS via the MS/MSC interface

Figure 3.3: Mobile originated short message

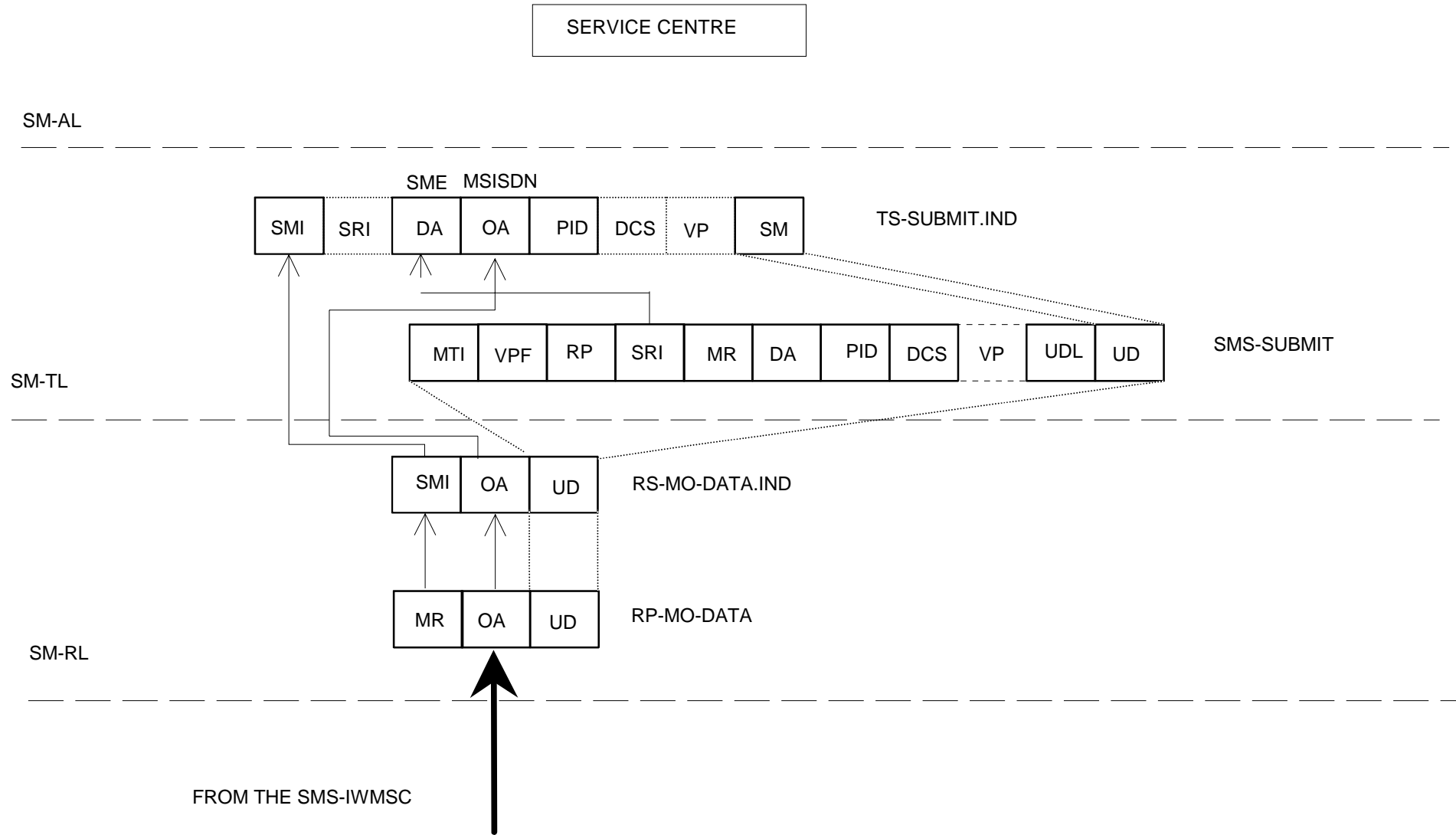

Figure 3.4: Mobile originated short message

SERVICE CENTRE

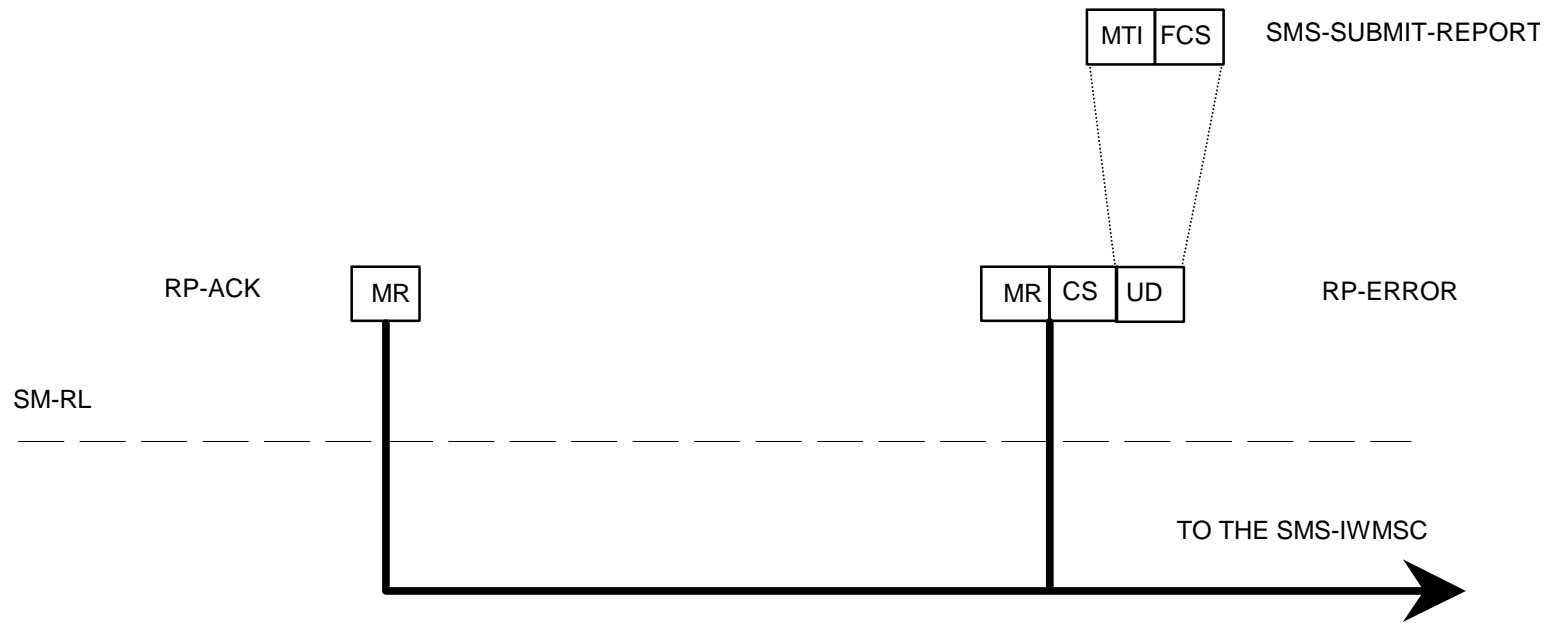

Figure 4.1a: Acknowledgement in the MO case

SMS-IWMSC

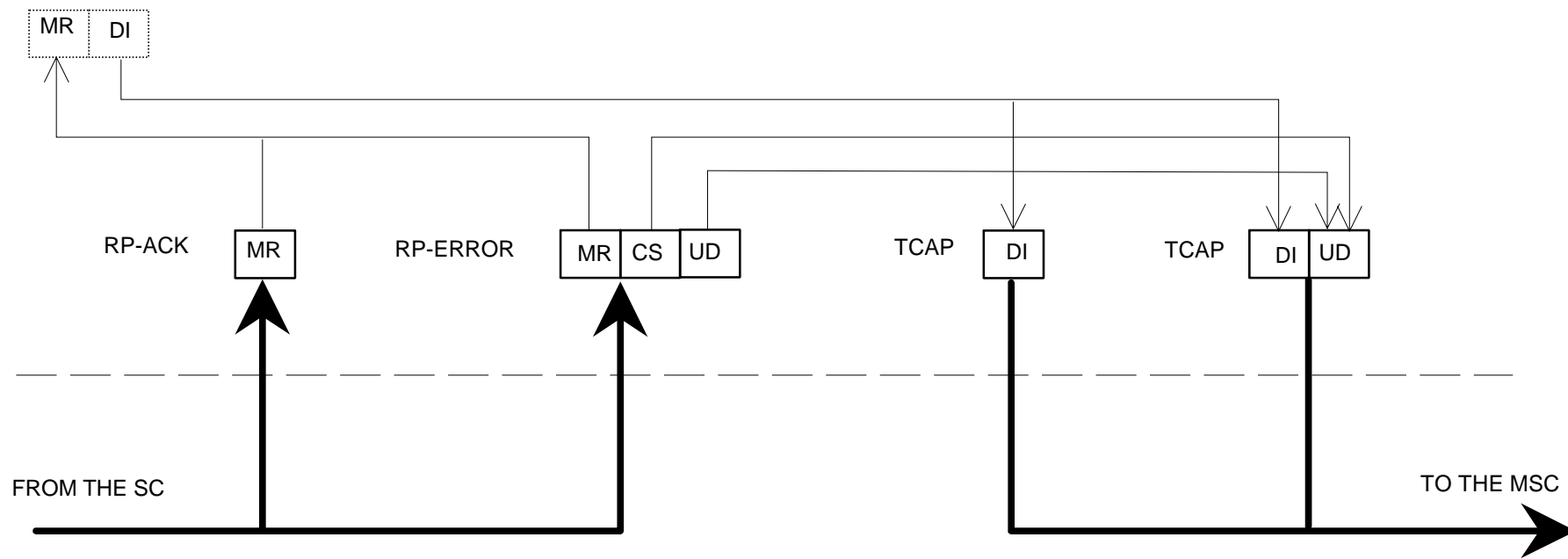

Figure 4.1b: Acknowledgement in the MO case

MSC

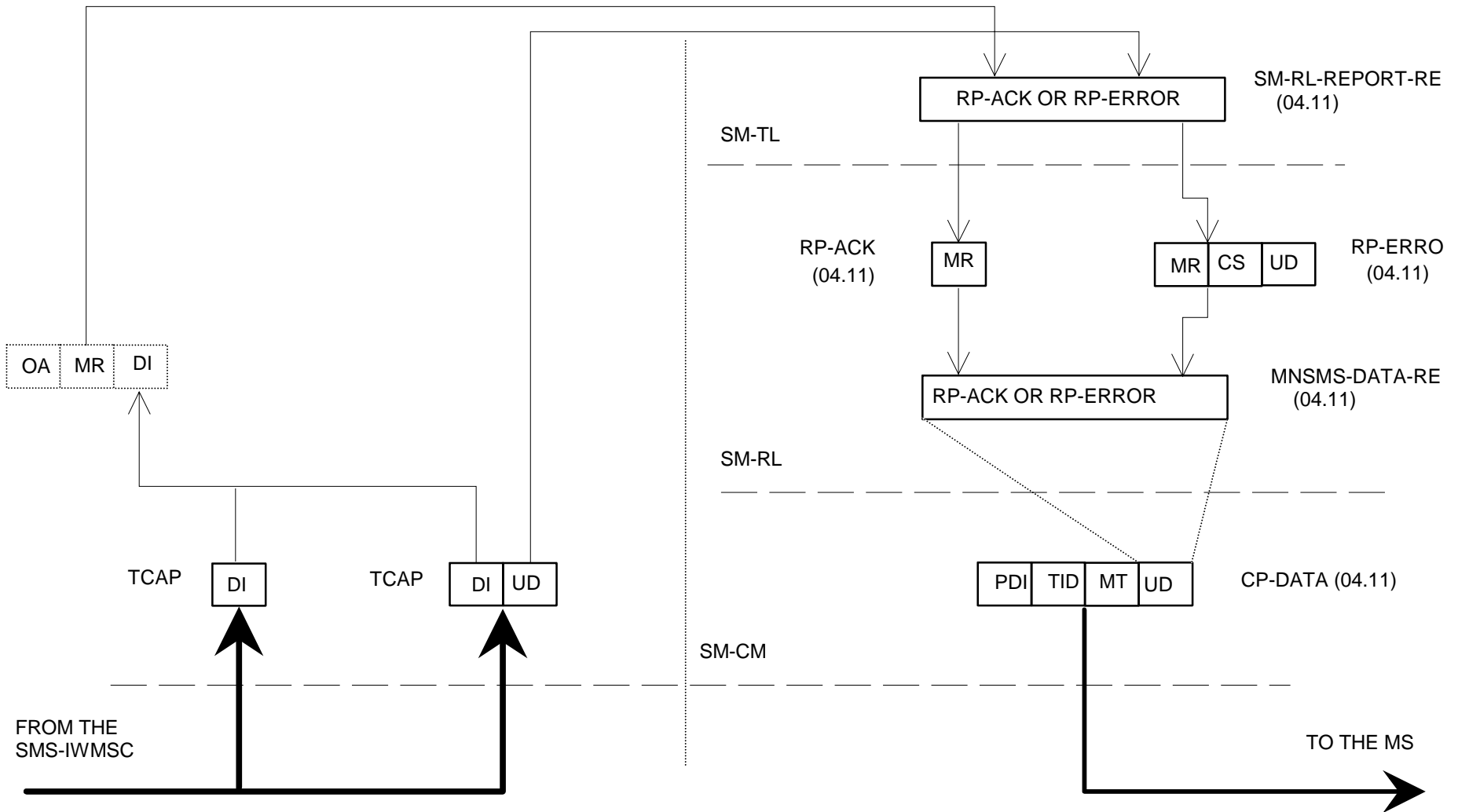

Figure 4.2: Acknowledgement in the MO case

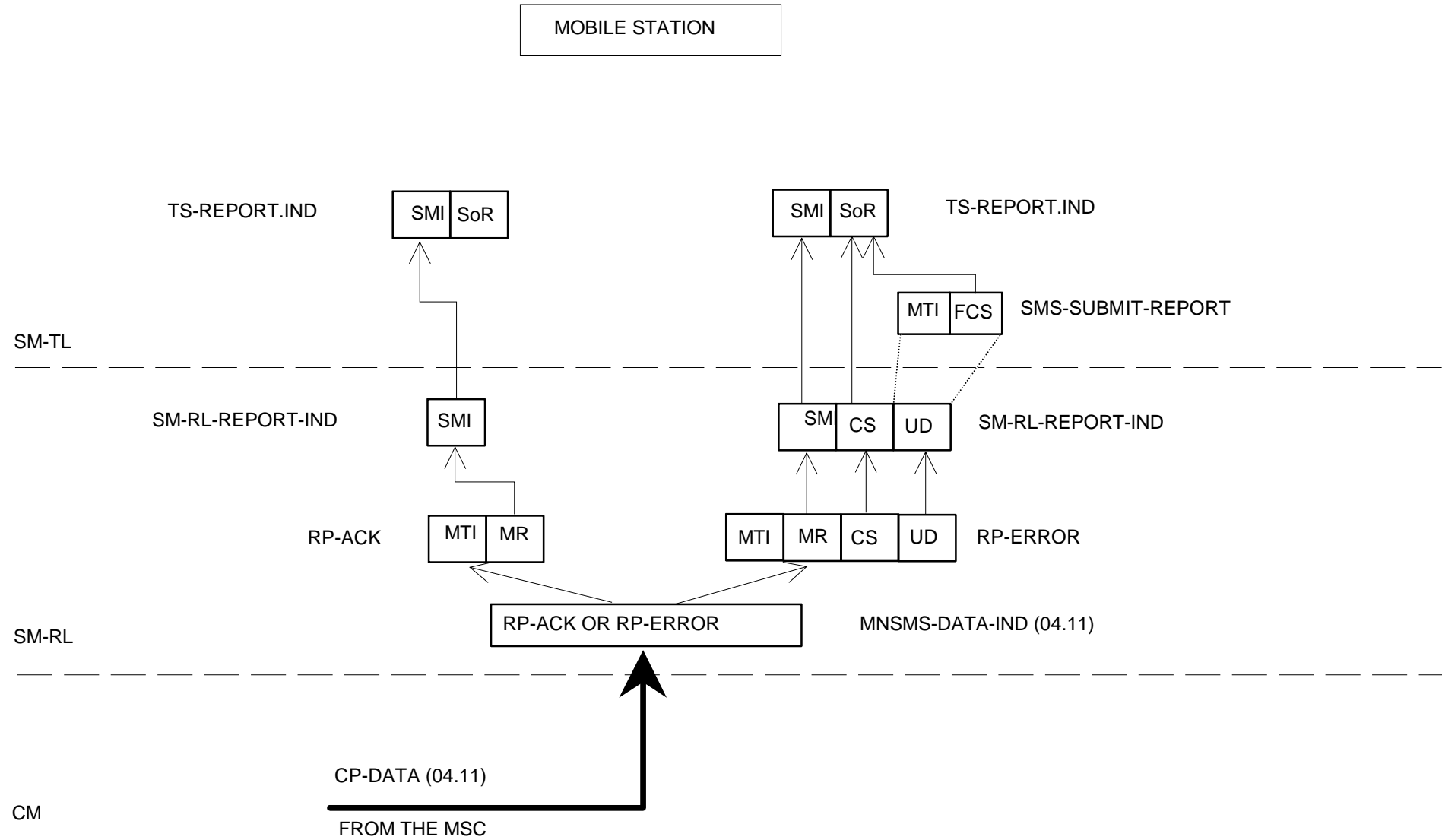

Figure 4.3: Acknowledgement in the MO case

Annex D (informative): Mobile Station reply procedures

D.1 Introduction

The reply procedures specified in this annex should be followed by a mobile station when replying to a short message, i.e. when generating a MO SM in response to a received MT SM, addressed to the originator of that MT SM. The main purpose of this annex is to specify how the MS selects the service centre for delivering that MO SM: an arbitrary SME may only be reached by submitting the reply SM to a specific SC, known to be able of delivering to that SME.

D.2 The scope of applicability

The reply procedures in clauses 5 and 6 of this annex should be followed by every MS which fulfils the following criteria:

- 1) The MS automatically selects the value for the RP-Destination-Address parameter in RP-MO-DATA, or the MS has the SC address within the SM-RL entity. (That is to say: the human user is not obliged to manually key in the SC address for every MO short message).
- 2) The MS or an application within it supports some form of replying to a MT SM with a MO SM. (That is to say: in the process of generating the reply MO SM, any reference whatsoever, implicit or explicit, is made to the original MT SM.).
- 3) The replying support of (2) is to be equally available towards every SME.

When an SME submits an SM to an SC for delivery, it may request that the SC sets the TP-Reply-Path parameter in the SM to be delivered. If the submitting SME is an MS, the reply path requesting procedure; in clause 4 of this annex may be applied. However, an SC may support the reply procedures without supporting the reply path requesting procedure; in that case, the SC sets the TP-Reply-Path parameter on another basis, which must be the case if the SM originates from an SME which is not an MS.

D.3 Terminology

An originating SME submits an original SM to an original SC, which delivers the original MT SM to a replying MS. The replying MS sends back a reply MO SM, a MO SM which is generated (automatically or by human operations) in response to the original MT SM, and which is addressed to the originating SME.

If the originating SME is an MS, the original MT SM is submitted within an SMS-SUBMIT PDU; we say that reply path is requested if the TP-Reply-Path parameter is set in the SMS-SUBMIT PDU of the original MT SM.

We say that reply path exists if the TP-Reply-Path parameter was set in the SMS-DELIVER PDU of the original MT SM; we say that reply path does not exist otherwise.

The replying MS may have a default SC which is normally used for delivering all the MO short messages originated from the replying MS. Alternatively, a human user or automatic application may specify a selected SC for delivering a particular SM (thus the term selected SC refers to an SC address selected for one short message only).

D.4 The reply path requesting procedure

The discussion in this clause applies to cases when the originating SME is a mobile station only. The reply procedures discussed in the clauses to follow this one are independent of the type of the originating SME.

The reply path is requested by the originating SME (an MS) by setting the TP-Reply-Path parameter in the SMS SUBMIT PDU of the original SM. If the original SC supports reply path requesting for the originating SME (an MS), it

will take notice of the TP-Reply-Path parameter in the SMS-SUBMIT PDU and set the TP-Reply-Path parameter in the SMS-DELIVER PDU of the original MT SM towards the replying MS. Hence, reply path exists for the replying MS towards the originating SME (an MS).

D.5 The reception of an original MT SM

When a replying MS receives an original MT SM, it then has:

- 1) originating SME = TP-Originating-Address in the SMS-DELIVER PDU,
- 2) original SC = RP-Originating-Address in RPS-MT-DATA, and
- 3) reply path exists / reply path does not exist = TP-Reply-Path in SMS-DELIVER PDU (set / not set).

D.6 The submission of the reply MO SM

According to clause 5, the replying MS knows if:

- a) reply path exists or
- b) reply path does not exist.

We then specify that when submitting the reply MO SM, the replying MS should use parameters as follows:

- 1) TP-Destination-Address in SMS-SUBMIT PDU = originating SME,
- 2a) If reply path exists:
RP-Destination-Address in RP-MO-DATA = original SC,
- 2b) If reply path does not exist:
RP-Destination-Address in RS-MO-DATA = selected SC or default SC or original SC,
- 3a) If reply path exists:
after submitting one reply MO SM, the reply path does not exist any more.

In case (2b), it is allowed to use the original SC or the default SC, but then there is no guarantee that the original/default SC will deliver the reply MO SM. (The original SC may refuse to deliver, if the replying MS is not its subscriber; the default SC may be unable to deliver, if it has no access path to the originating SME.)

Requirement (3a) states that the case (a), reply path exists, holds for one reply MO SM only (per original MT SM).

D.7 Usage of SCs for replying

The specification in this annex supports the following way of replying.

The original MT SM and the reply MO SM are delivered by the same SC, the original SC. This principle maximizes the probability that the SC can e.g. route the reply MO SM to the proper data network for reaching the originating SME; this principle is a must, if the originating SME is integrated within the original SC.

If the original SC by any means whatsoever knows that it is both willing and able to deliver one (potential) reply MO SM, it may indicate this fact by setting the TP-Reply-Path parameter in the original MT SM. The original SC thus commits itself to delivering one reply MO SM; let us call this reply delivery commitment.

One reason for the SC to make the reply delivery commitment may be the reply path requesting procedure specified in clause 4 on this annex.

The reply path commitment is not valid forever, but the original SC pay have e.g. a time limit for maintaining this commitment.

D.8 Replying possibilities for Phase 1 mobile stations

The Phase 2 mobile stations should support the procedures in this annex (if they fulfil the criteria in clause 2 of it). Yet, Phase 1 mobile stations, too, may apply steps (1) and (2a) in clause 6 of this annex, i.e. reply via the original SC, automatically or manually (by choosing selected SC = original SC), despite the fact that the TP-Reply-Path parameter will be ignored by them. The delivery of the reply MO SM cannot be guaranteed in this case, yet the possibility of delivery may be improved (especially if the originating SME is not an MS).

D.9 The resulting service for originating SMEs

As the consequence of the replying procedures specified in this annex, all SMEs and applications within them may assume that replying from all mobile stations is always possible, provided that the mobile stations do support the proper replying mechanism itself (human response in context with the original MT SM, automatic replying by an application, application level protocols, etc.).

Annex E (informative): Change History

Plenary#	TDoc	VERS	CR	R E V	REL	CAT	SUBJECT	NEW_VERS	WORKITEM
s23	97-696	5.7.0	A060		R97	B	Code points for SIM Toolkit secure messaging Draft 1.0 of V6.0.0 (PT SMG internal)	6.0.0d1.0	SIM Toolkit Security
s23	97-696	5.7.0	A062		R97	F	User Data Header Indicator Draft 1.0 of V6.0.0 (PT SMG internal)	6.0.0d1.0	
s23	97-706	5.7.0	A063		R97	B	SMS transfer over GPRS Draft 1.0 of V6.0.0 (PT SMG internal)	6.0.0d1.0	GPRS
s24	97-918	5.7.0	A064		R97	B	Security headers Draft 2.0 of V6.0.0 (PT SMG internal)	6.0.0d2.0	SIM Toolkit Security
s24	97-918	5.7.0	A065		R97	B	Transmission of the SME OA Draft 2.0 of V6.0.0 (PT SMG internal)	6.0.0d2.0	SMS Enh.: Filtering
s25	98-096	5.7.0	A066		R97	B	MS Management PID R97	6.0.0	MS Management
s26	98-291	6.0.0	A071		R97	A	Queuing of MT SMS at the VMSC and SGSN	6.1.0	SMS Mobile Busy
s26	98-291	6.0.0	A074		R97	F	Status-Report-Request for concatenated short messages	6.1.0	SMS Concatenated Messages
s26	98-291	6.0.0	A075		R97	F	TP-User Data (TP-UD), SMSC Control Parameters	6.1.0	SMS Concatenated Messages
s26	98-291	6.0.0	A076		R97	F	Redefinition SMS status report user data length	6.1.0	SMS
s26	98-291	6.0.0	A077		R97	B	Use of TP-UD and other TP parameters with RP-ERROR	6.1.0	SIM Toolkit
s26	98-291	6.0.0	A079		R97	F	TP-User Data (TP-UD), Concatenated Short Messages	6.1.0	SMS Concatenated Messages
s26	98-291	6.1.0	A072		R98	D	Alignment of 03.40 concerning inclusion of 7bit default-alphabet extension mechanism in 03.38	7.0.0	TEI
s27	98-0738	7.0.0	A083		R98	B	User Data Header Identifier value for Concatenated Short Message, 16-bit reference number	7.1.0	TEI
s27	98-0738	7.0.0	A084		R98	B	User Data Header Identifier value for Wireless Control Message Protocol (WCMP)	7.1.0	TEI
s27	98-0738	7.0.0	A085		R98	D	Insertion of padding bits to a user data header	7.1.0	TEI
s29	99-0482	7.1.0	A086		R98	C	Clarification concerning SMSC address checking in the MS for concatenated messages and replace message types	7.2.0	TEI
s29	99-0482	7.1.0	A087		R98	D	Guidance regarding the SMSC address in a Status Report	7.2.0	TEI
s30	99-0675	7.2.0	A088		R98	C	Change to reserved port number range for SMS	7.3.0	TEI
T#6	TP-99236	7.3.0	A089		R98	F	Concatenated Short Message	7.4.0	TEI
T#14	TP-010280	7.4.0	A091		R98	A	Correction on SMS Information Element Data Length	7.5.0	TEI

History

Document history		
V7.2.0	July 1999	Publication
V7.3.0	November 1999	Publication
V7.4.0	December 1999	Publication
V7.5.0	December 2001	Publication