

ETSI TS 101 503 V8.6.0 (2000-10)

Technical Specification

**Digital cellular telecommunications system (Phase 2+);
Mobile radio interface layer 3 specification;
Radio Resource Control Protocol
(3GPP TS 04.18 version 8.6.0 Release 1999)**



Reference

RTS/TSGG-020418Q8R3

Keywords

GSM

ETSI

650 Route des Lucioles
F-06921 Sophia Antipolis Cedex - FRANCE

Tel.: +33 4 92 94 42 00 Fax: +33 4 93 65 47 16

Siret N° 348 623 562 00017 - NAF 742 C
Association à but non lucratif enregistrée à la
Sous-Préfecture de Grasse (06) N° 7803/88

Important notice

Individual copies of the present document can be downloaded from:

<http://www.etsi.org>

The present document may be made available in more than one electronic version or in print. In any case of existing or perceived difference in contents between such versions, the reference version is the Portable Document Format (PDF). In case of dispute, the reference shall be the printing on ETSI printers of the PDF version kept on a specific network drive within ETSI Secretariat.

Users of the present document should be aware that the document may be subject to revision or change of status. Information on the current status of this and other ETSI documents is available at <http://www.etsi.org/tb/status/>

If you find errors in the present document, send your comment to:
editor@etsi.fr

Copyright Notification

No part may be reproduced except as authorized by written permission.
The copyright and the foregoing restriction extend to reproduction in all media.

© European Telecommunications Standards Institute 2000.

All rights reserved.

Intellectual Property Rights

IPRs essential or potentially essential to the present document may have been declared to ETSI. The information pertaining to these essential IPRs, if any, is publicly available for **ETSI members and non-members**, and can be found in ETSI SR 000 314: "*Intellectual Property Rights (IPRs); Essential, or potentially Essential, IPRs notified to ETSI in respect of ETSI standards*", which is available from the ETSI Secretariat. Latest updates are available on the ETSI Web server (<http://www.etsi.org/ipr>).

Pursuant to the ETSI IPR Policy, no investigation, including IPR searches, has been carried out by ETSI. No guarantee can be given as to the existence of other IPRs not referenced in ETSI SR 000 314 (or the updates on the ETSI Web server) which are, or may be, or may become, essential to the present document.

Foreword

This Technical Specification (TS) has been produced by the ETSI 3rd Generation Partnership Project (3GPP).

The present document may refer to technical specifications or reports using their 3GPP identities, UMTS identities or GSM identities. These should be interpreted as being references to the corresponding ETSI deliverables.

The cross reference between GSM, UMTS, 3GPP and ETSI identities can be found under www.etsi.org/key .

Contents

Foreword.....	14
1 Scope	15
1.1 Scope of the Technical Specification	15
1.2 Application to the interface structures	15
1.3 Structure of layer 3 procedures	15
1.4 Test procedures	15
1.5 Use of logical channels	16
1.6 Overview of control procedures.....	16
1.6.1 List of procedures.....	16
1.7 Applicability of implementations.....	17
1.7.1 Voice Group Call Service (VGCS) and Voice Broadcast Service (VBS).....	17
1.7.2 General Packet Radio Service (GPRS).....	18
2 References	18
2.1 Definitions and abbreviations	22
2.1.1 Random values	22
2.1.2 Vocabulary	22
3 Radio Resource management procedures.....	24
3.1 Overview/General	24
3.1.1 General	24
3.1.2 Services provided to upper layers.....	24
3.1.2.1 Idle mode.....	24
3.1.2.2 Dedicated mode.....	24
3.1.2.3 Group receive mode	25
3.1.2.4 Group transmit mode.....	25
3.1.2.5 Packet idle mode	25
3.1.2.6 Packet transfer mode	26
3.1.2.7 Dual transfer mode (DTM).....	26
3.1.3 Services required from data link and physical layers	26
3.1.4 Change of dedicated channels	26
3.1.4.1 Change of dedicated channels using SAPI = 0.....	26
3.1.4.2 Change of dedicated channels using other SAPIs than 0.....	27
3.1.4.3 Sequenced message transfer operation	27
3.1.4.3.1 Variables and sequence numbers	27
3.1.4.3.1.1 Send state variable V(SD).....	27
3.1.4.3.1.2 Send sequence number N(SD).....	27
3.1.4.3.2 Procedures for the initiation, transfer execution and termination of the sequenced message transfer operation.....	27
3.1.4.3.2.1 Initiation	27
3.1.4.3.2.2 Transfer Execution.....	28
3.1.4.3.2.3 Termination.....	28
3.1.5 Procedure for Service Request and Contention Resolution.....	28
3.1.6 Preemption	29
3.2 Idle mode procedures and general procedures in packet idle and packet transfer modes	30
3.2.1 Mobile Station side.....	30
3.2.2 Network side	30
3.2.2.1 System information broadcasting	30
3.2.2.2 Paging.....	31
3.3 RR connection establishment.....	32
3.3.1 RR connection establishment initiated by the mobile station.....	32
3.3.1.1 Entering the dedicated mode : immediate assignment procedure.....	32
3.3.1.1.1 Permission to access the network	32
3.3.1.1.2 Initiation of the immediate assignment procedure	32
3.3.1.1.3 Answer from the network	33
3.3.1.1.3.1 On receipt of a CHANNEL REQUEST message	33
3.3.1.1.3.2 Assignment rejection	34

3.3.1.1.4	Assignment completion	35
3.3.1.1.4.1	Early classmark sending	35
3.3.1.1.5	Abnormal cases.....	36
3.3.1.2	Entering the group transmit mode: uplink access procedure.....	36
3.3.1.2.1	Mobile station side.....	36
3.3.1.2.1.1	Uplink investigation procedure.....	36
3.3.1.2.1.2	Uplink access procedure	37
3.3.1.2.2	Network side.....	37
3.3.1.2.3	Abnormal cases.....	37
3.3.1.3	Dedicated mode and GPRS	38
3.3.2	Paging procedure for RR connection establishment.....	38
3.3.2.1	Paging initiation by the network.....	38
3.3.2.1.1	Paging initiation using paging subchannel on CCCH.....	38
3.3.2.1.2	Paging initiation using paging subchannel on PCCCH.....	40
3.3.2.1.3	Paging initiation using PACCH.....	40
3.3.2.2	Paging response.....	40
3.3.2.3	Abnormal cases	40
3.3.3	Notification procedure.....	40
3.3.3.1	Notification of a call.....	41
3.3.3.2	Joining a VGCS or VBS call.....	41
3.3.3.3	Reduced NCH monitoring mechanism.....	41
3.3.3.4	Notification response procedure.....	42
3.4	Procedures in dedicated mode and in group transmit mode.....	42
3.4.1	SACCH procedures	43
3.4.1.1	General	43
3.4.1.2	Measurement report and Enhanced Measurement Report.....	43
3.4.1.2.1	The Use of parameters from the Measurement Information/SI2quarter messages.....	44
3.4.1.2.1.1	Deriving the 3G Neighbour Cell list from the 3G Neighbour Cell Description:	44
3.4.1.2.1.2	Deriving the GSM Neighbour Cell list from the BSICs and the BA (list).....	45
3.4.1.2.1.3	Deriving the Neighbour Cell list from the GSM Neighbour Cell list and the 3G Neighbour Cell list	45
3.4.1.2.1.4	Real Time Differences	45
3.4.1.2.1.5	Report Priority Description.....	45
3.4.1.2.1.6	GPRS Report Priority Description, GPRS BSIC Description, GPRS Real Time Differences Description, GPRS Measurement Parameters, GPRS 3G Measurement Parameters and NC Measurement Parameters.....	45
3.4.1.3	Extended measurement report \$(MAFA)\$.....	46
3.4.2	Transfer of messages and link layer service provision.....	46
3.4.3	Channel assignment procedure.....	46
3.4.3.1	Channel assignment initiation	47
3.4.3.2	Assignment completion.....	48
3.4.3.3	Abnormal cases	48
3.4.4	Handover procedure	49
3.4.4.1	Handover initiation.....	49
3.4.4.2	Physical channel establishment	51
3.4.4.2.1	Finely synchronized cell case	51
3.4.4.2.2	Non synchronized cell case.....	51
3.4.4.2.3	Pseudo-synchronized cell case.....	52
3.4.4.2.4	Pre-synchronized cell case.....	52
3.4.4.3	Handover completion	53
3.4.4.4	Abnormal cases	53
3.4.4a	Handover to UMTS procedure	54
3.4.4a.1	Handover to UMTS initiation	54
3.4.4a.2	Handover to UMTS completion.....	55
3.4.4a.3	Abnormal cases.....	55
3.4.5	Frequency redefinition procedure.....	55
3.4.5.1	Abnormal cases	55
3.4.6	Channel mode modify procedure	56
3.4.6.1	Normal channel mode modify procedure	56
3.4.6.1.1	Initiation of the channel mode modify procedure	56
3.4.6.1.2	Completion of channel mode modify procedure.....	56
3.4.6.1.3	Abnormal cases.....	56
3.4.6.2	Channel mode modify procedure for a voice group call talker	57

3.4.6.2.1	Initiation of the channel mode modify procedure	57
3.4.6.2.2	Completion of mode change procedure	57
3.4.6.2.3	Abnormal cases.....	57
3.4.7	Ciphering mode setting procedure.....	57
3.4.7.1	Ciphering mode setting initiation	57
3.4.7.2	Ciphering mode setting completion.....	58
3.4.8	Additional channel assignment procedure.....	58
3.4.8.1	Additional assignment procedure initiation.....	59
3.4.8.2	Additional assignment procedure completion	59
3.4.8.3	Abnormal cases	59
3.4.9	Partial channel release procedure	59
3.4.9.1	Partial release procedure initiation	59
3.4.9.2	Abnormal cases	59
3.4.10	Classmark change procedure.....	60
3.4.11	Classmark interrogation procedure.....	60
3.4.11.1	Classmark interrogation initiation.....	60
3.4.11.2	Classmark interrogation completion	60
3.4.12	Indication of notifications and paging information	60
3.4.13	RR connection release procedure	61
3.4.13.1	Normal release procedure	61
3.4.13.1.1	Channel release procedure initiation in dedicated mode and in group transmit mode.....	61
3.4.13.1.2	Abnormal cases.....	62
3.4.13.2	Radio link failure in dedicated mode or dual transfer mode.....	62
3.4.13.2.1	Mobile side	63
3.4.13.2.2	Network side	63
3.4.13.3	RR connection abortion in dedicated mode or dual transfer mode	63
3.4.13.4	Uplink release procedure in group transmit mode	63
3.4.13.5	Radio link failure in group transmit mode	63
3.4.13.5.1	Mobile side	64
3.4.13.5.2	Network side	64
3.4.14	Receiving a RR STATUS message by a RR entity.....	64
3.4.15	Group receive mode procedures	64
3.4.15.1	Mobile station side.....	64
3.4.15.1.1	Reception of the VGCS or VBS channel	64
3.4.15.1.2	Monitoring of downlink messages and related procedures.....	65
3.4.15.1.2.1	Spare 65	
3.4.15.1.2.2	Spare 65	
3.4.15.1.2.3	Channel mode modify procedure	65
3.4.15.1.2.4	Notification and paging information	65
3.4.15.1.2.4.1	Use of Reduced NCH monitoring	65
3.4.15.1.2.5	Uplink status messages	66
3.4.15.1.2.6	Channel release message.....	66
3.4.15.1.2.7	Information on paging channel restructuring	66
3.4.15.1.3	Uplink reply procedure	66
3.4.15.1.4	Leaving the group receive mode.....	66
3.4.15.1.4.1	Returning to idle mode.....	66
3.4.15.1.4.2	Going to group transmit mode	67
3.4.15.2	Network side	67
3.4.15.2.1	Provision of messages on the VGCS or VBS channel downlink.....	67
3.4.15.2.1.1	General	67
3.4.15.2.1.2	Provision of general information messages.....	67
3.4.15.2.1.3	Provision of messages related to the voice group call uplink channel	67
3.4.15.2.2	Release of the VGCS or VBS Channels	68
3.4.15.3	Failure cases.....	68
3.4.16	Configuration change procedure	68
3.4.16.1	Configuration change initiation	68
3.4.16.2	Configuration change completion.....	68
3.4.16.3	Abnormal cases.....	68
3.4.17	Mapping of user data substreams onto timeslots in a multislot configuration.....	69
3.4.18	Handling of classmark information at band change	69
3.4.19	Assignment to a Packet Data channel.....	69
3.4.19.1	Assignment to PDCH initiation	70

3.4.19.2	Completion of the Assignment to PDCH procedure.....	71
3.4.19.3	Abnormal cases.....	71
3.4.20	RR-Network Commanded Cell Change Order.....	71
3.4.20.1	RR-network commanded cell change order initiation	72
3.4.20.2	Network controlled cell reselection completion	72
3.4.20.3	Abnormal cases.....	72
3.4.21	Application Procedures	73
3.4.21.1	General.....	73
3.4.21.2	Location Services (LCS).....	73
3.4.21.3	Application Information Transfer.....	73
3.4.21.3.1	Normal Procedure without Segmentation.....	73
3.4.21.3.2	Normal Procedure with Segmentation	74
3.4.21.3.3	Abnormal Cases.....	74
3.4.22	RR procedures related to packet resource establishment while in dedicated mode.....	75
3.4.22.1	Packet request procedure while in dedicated mode	75
3.4.22.1.1	Entering the dual transfer mode.....	75
3.4.22.1.1.1	Permission to access the network.....	75
3.4.22.1.1.2	Initiation of establishment of the packet request procedure	75
3.4.22.1.1.3	Answer from the network.....	76
3.4.22.1.1.3.1	Packet assignment.....	76
3.4.22.1.1.3.2	RR reallocation only	76
3.4.22.1.1.3.3	Packet request rejection.....	76
3.4.22.1.1.4	Packet request completion.....	76
3.4.22.1.1.5	Abnormal cases	77
3.4.22.2	Packet notification procedure in dedicated mode	77
3.4.22.2.1	Packet notification initiation by the network	77
3.4.22.2.2	Packet notification response	77
3.4.22.3	Packet downlink assignment in dedicated mode.....	77
3.4.22.3.1	Initiation of the packet downlink assignment procedure in dedicated mode	78
3.4.22.3.2	Packet downlink assignment completion.....	78
3.4.22.3.3	Abnormal cases.....	78
3.4.22.4	Modification of packet resources while in DTM.....	79
3.4.23	RR procedures related to packet resource maintenance while in dual transfer mode.....	79
3.4.24	RR procedures related to packet resource release while in dual transfer mode.....	79
3.4.25	GPRS suspension procedure	79
3.4.25.1	General.....	79
3.4.25.2	MS in class B mode of operation.....	79
3.4.25.3	Dual transfer mode not supported.....	80
3.4.26	GPRS Transparent Transport Procedure	80
3.5	RR procedures on CCCH related to temporary block flow establishment.....	80
3.5.1	Packet paging procedure using CCCH	80
3.5.1.1	Packet paging initiation by the network	81
3.5.1.2	On receipt of a packet paging request	81
3.5.2	Packet access procedure using CCCH.....	81
3.5.2.1	Entering the packet transfer mode: packet access procedure	81
3.5.2.1.1	Permission to access the network	82
3.5.2.1.2	Initiation of the packet access procedure: channel request	82
3.5.2.1.3	Packet immediate assignment.....	83
3.5.2.1.3.1	On receipt of a CHANNEL REQUEST or EGPRS PACKET CHANNEL REQUEST message	83
3.5.2.1.3.2	One phase packet access	84
3.5.2.1.3.3	Single block packet access.....	85
3.5.2.1.3.3a	Multiblock packet access	86
3.5.2.1.3.4	Packet access rejection.....	86
3.5.2.1.4	Packet access completion.....	87
3.5.2.1.5	Abnormal cases.....	87
3.5.2.2	Sending an RLC/MAC control message: single block packet access procedure.....	87
3.5.3	Packet downlink assignment procedure using CCCH	87
3.5.3.1	Entering the packet transfer mode: packet downlink assignment procedure.....	88
3.5.3.1.2	Initiation of the packet downlink assignment procedure	88
3.5.3.1.3	Packet downlink assignment completion.....	90
3.5.3.1.4	Abnormal cases.....	90
3.5.3.2	Sending an RLC/MAC control message: single block packet downlink assignment procedure	90

4	Elementary procedures for Mobility Management.....	91
5	Elementary procedures for circuit-switched Call Control.....	91
6	Support for packet services	91
7	Examples of structured procedures	91
8	Handling of unknown, unforeseen, and erroneous protocol data.....	91
8.1	General.....	91
8.2	Message too short	92
8.3	Unknown or unforeseen transaction identifier.....	92
8.4	Unknown or unforeseen message type.....	92
8.5	Non-semantic mandatory information element errors.....	92
8.5.1	Radio resource management.....	93
8.6	Unknown and unforeseen IEs in the non-imperative message part.....	93
8.6.1	IEs unknown in the message.....	93
8.6.2	Out of sequence IEs.....	93
8.6.3	Repeated IEs.....	93
8.7	Non-imperative message part errors	94
8.7.1	Syntactically incorrect optional IEs.....	94
8.7.2	Conditional IE errors.....	94
8.8	Messages with semantically incorrect contents.....	94
8.9	Incomplete rest octets.....	94
9	Message functional definitions and contents.....	95
9.1	Messages for Radio Resources management	97
9.1.1	Additional assignment.....	98
9.1.1.1	Mobile Allocation.....	99
9.1.1.2	Starting Time.....	99
9.1.2	Assignment command	99
9.1.2.1	Mode of the First Channel (Channel Set 1) and Mode of Channel Set "X" (2= X =<8).....	101
9.1.2.2	Description of the Second Channel	101
9.1.2.3	Mode of the Second Channel	101
9.1.2.4	Mobile Allocation and Frequency List, after the starting time.....	101
9.1.2.5	Starting Time.....	101
9.1.2.6	Reference cell frequency list	102
9.1.2.7	Cell Channel Description	102
9.1.2.8	Cipher Mode Setting	102
9.1.2.9	VGCS target mode Indication	102
9.1.2.10	Description of the multislot allocation.....	102
9.1.2.11	Multi Rate configuration.....	103
9.1.3	Assignment complete	103
9.1.4	Assignment failure	103
9.1.5	Channel mode modify	104
9.1.5.1	Channel Description.....	104
9.1.5.2	VGCS target mode Indication	104
9.1.5.3	Multi Rate configuration	104
9.1.6	Channel mode modify acknowledge	104
9.1.7	Channel release	105
9.1.7.1	Channel description and mobile allocation	105
9.1.7.2	Group Cipher Key Number	106
9.1.7.3	UMTS Frequency List.....	106
9.1.8	Channel request.....	106
9.1.9	Ciphering mode command	108
9.1.10	Ciphering mode complete	108
9.1.10.1	Mobile Equipment Identity.....	108
9.1.11	Classmark change.....	108
9.1.11.1	Additional Mobile Station Classmark Information.....	109
9.1.11.2	Mobile Station Classmark.....	109
9.1.11a	UTRAN Classmark Change	109
9.1.11b	cdma2000 Classmark Change	110
9.1.11c	UE RAB PRE-CONFIGURATION	112

9.1.12	Classmark enquiry	112
9.1.12a	Spare.....	113
9.1.12b	Configuration change command.....	113
9.1.12b.1	Description of the multislot allocation.....	113
9.1.12b.2	Mode of Channel Set "X" (1=<X<=8).....	113
9.1.12c	Configuration change acknowledge	114
9.1.12d	Configuration change reject	114
9.1.12e	DTM Assignment Command	115
9.1.12e.1	TBF starting time	115
9.1.12e.2	RR Packet Uplink Assignment and RR Packet Downlink Assignment IEs.....	115
9.1.12f	DTM Assignment Failure.....	116
9.1.12g	DTM Information.....	116
9.1.12h	DTM Reject.....	116
9.1.12i	DTM Request	117
9.1.13	Frequency redefinition	117
9.1.13.1	Cell Channel Description.....	118
9.1.13a	PDCH Assignment command.....	118
9.1.13a.1	Mobile Allocation and Frequency List, after the starting time	119
9.1.13a.2	Starting Time	119
9.1.13a.3	Reference cell frequency list.....	120
9.1.13a.4	Cell Channel Description.....	120
9.1.13a.5	Packet Assignment.....	120
9.1.13b	GPRS suspension request.....	120
9.1.14	Handover access	121
9.1.15	Handover command	121
9.1.15.1	Synchronization Indication	123
9.1.15.2	Mode of the First Channel (Channel Set 1) and Mode of Channel Set "X" (2=<X<=8)	123
9.1.15.3	Description of the Second Channel.....	123
9.1.15.4	Mode of the Second Channel.....	123
9.1.15.5	Frequency Channel Sequence, Frequency List, Frequency short list and Mobile Allocation, after time.	123
9.1.15.6	Starting Time	124
9.1.15.7	Reference cell frequency list.....	124
9.1.15.8	Real Time Difference.....	124
9.1.15.9	Timing Advance	125
9.1.15.10	Cipher Mode Setting.....	125
9.1.15.11	VGCS target mode indication.....	125
9.1.15.12	Description of the multislot allocation.....	125
9.1.15.13	MultiRateconfiguration.....	125
9.1.15a	Inter System To UTRAN Handover Command	126
9.1.15b	Inter System To cdma2000 Handover Command	126
9.1.16	Handover complete.....	126
9.1.16.1	Mobile Observed Time Difference	127
9.1.17	Handover failure.....	127
9.1.18	Immediate assignment.....	127
9.1.18.0a	Dedicated mode or TBF.....	128
9.1.18.0b	Channel Description	128
9.1.18.0c	Packet Channel Description.....	128
9.1.18.0d	Request Reference	128
9.1.18.0e	Timing Advance	129
9.1.18.1	Mobile Allocation.....	129
9.1.18.2	Starting Time	129
9.1.18.3	IA Rest Octets (Frequency parameters, before time).....	129
9.1.18.4	IA Rest Octets (assignment of uplink or downlink TBF)	129
9.1.19	Immediate assignment extended.....	129
9.1.19.1	Unnecessary IEs.....	130
9.1.19.2	Mobile Allocation.....	130
9.1.19.3	Starting Time	130
9.1.19.4	Maximum message length	130
9.1.19.5	IAX Rest Octets	131
9.1.20	Immediate assignment reject	131
9.1.20.1	Use of the indexes.....	131

9.1.20.2	Filling of the message	131
9.1.20.2a	Request reference	132
9.1.20.3	Wait Indication	132
9.1.20.4	IAR Rest Octets	132
9.1.21	Measurement report	132
9.1.21a	Notification/FACCH	132
9.1.21a.1	Spare	134
9.1.21a.2	Spare	134
9.1.21a.3	Spare	134
9.1.21a.4	Spare	134
9.1.21b	Notification/NCH	134
9.1.21b.1	Spare	134
9.1.21b.2	Spare	134
9.1.21c	Spare	134
9.1.21d	Notification response	134
9.1.21e	RR-Cell Change Order	135
9.1.21e.1	3G Target Cell	135
9.1.21f	Packet Assignment	135
9.1.21f.1	RR Packet Uplink Assignment and RR Packet Downlink Assignment IEs	136
9.1.21g	Packet Notification	136
9.1.22	Paging request type 1	136
9.1.22.1	Unnecessary IE	137
9.1.22.2	Channels needed for Mobiles 1 and 2	137
9.1.22.3	Mobile Identities	137
9.1.22.4	P1 Rest Octets	137
9.1.23	Paging request type 2	137
9.1.23.1	Channels needed for Mobiles 1 and 2	138
9.1.23.2	Mobile Identity 3	138
9.1.23.3	P2 Rest Octets	138
9.1.24	Paging request type 3	138
9.1.24.1	Channels needed for Mobiles 1 and 2	139
9.1.24.2	P3 Rest Octets	139
9.1.25	Paging response	139
9.1.25.1	Mobile Station Classmark	140
9.1.26	Partial release	140
9.1.26.1	Channel Description	140
9.1.27	Partial release complete	140
9.1.28	Physical information	141
9.1.28a	RR Initialisation Request	141
9.1.29	RR Status	142
9.1.30a	Synchronization channel information	142
9.1.30b	COMPACT Synchronization channel information	143
9.1.31	System information Type 1	143
9.1.32	System information type 2	144
9.1.33	System information type 2bis	144
9.1.34	System information type 2ter	145
9.1.34a	System information type 2quater	146
9.1.35	System information type 3	146
9.1.36	System information type 4	147
9.1.36.1	CBCH Channel description	148
9.1.36.2	CBCH Mobile Allocation	148
9.1.36.3	SI 4 Rest Octets	148
9.1.37	System information type 5	148
9.1.38	System information type 5bis	148
9.1.39	System information type 5ter	149
9.1.40	System information type 6	150
9.1.40.1	Cell Identity	150
9.1.40.2	Location Area Identification	150
9.1.40.3	Cell Options	150
9.1.40.4	NCC permitted	150
9.1.41	System information type 7	151
9.1.42	System information type 8	151

9.1.43	System information Type 9	152
9.1.43a	System information Type 13	152
9.1.43b	[Spare]	152
9.1.43c	[Spare]	153
9.1.43d	System information type 16	153
9.1.43e	System information type 17	153
9.1.43f	System information type 19	154
9.1.43g	System information type 18	154
9.1.43h	System information type 20	155
9.1.44	Talker indication	155
9.1.45	Uplink access.....	155
9.1.46	Uplink busy	156
9.1.47	Uplink free.....	157
9.1.48	Uplink release.....	157
9.1.49	VGCS uplink grant.....	158
9.1.50	System information type 10 \$(ASCII)\$.....	158
9.1.51	EXTENDED MEASUREMENT ORDER.....	158
9.1.52	Extended measurement report	159
9.1.53	Application Information	159
9.1.54	MEASUREMENT INFORMATION.....	160
9.1.55	ENHANCED MEASUREMENT REPORT	169
9.2	Messages for mobility management.....	170
9.3	Messages for circuit-switched call control.....	170
9.4	GPRS Mobility Management Messages	170
9.5	GPRS Session Management Messages	171
9.6	GTTP Messages	171
9.6.1	GPRS Information.....	171
9.6.1.1	TLLI 171	
9.6.1.2	LLC PDU Container.....	171
10	General message format and information elements coding	172
10.1	Overview	172
10.2	Protocol Discriminator	172
10.3	Skip indicator	172
10.3.1	Skip indicator	172
10.4	Message Type.....	173
10.5	Other information elements.....	174
10.5.1	Common information elements.	176
10.5.2	Radio Resource management information elements.	176
10.5.2.1a	BA Range	176
10.5.2.1b	Cell Channel Description.....	177
10.5.2.1b.1	General description	178
10.5.2.1b.2	Bit map 0 format	179
10.5.2.1b.3	Range 1024 format.....	179
10.5.2.1b.4	Range 512 format.....	180
10.5.2.1b.5	Range 256 format.....	181
10.5.2.1b.6	Range 128 format.....	182
10.5.2.1b.7	Variable bit map format	183
10.5.2.1c	BA List Pref.....	183
10.5.2.1d	UMTS Frequency List	184
10.5.2.2	Cell Description	185
10.5.2.3	Cell Options (BCCH).....	185
10.5.2.3a	Cell Options (SACCH)	185
10.5.2.4	Cell Selection Parameters	187
10.5.2.4a	MAC Mode and Channel Coding Requested.....	189
10.5.2.5	Channel Description	189
10.5.2.5a	Channel Description 2	191
10.5.2.6	Channel Mode.....	193
10.5.2.7	Channel Mode 2.....	194
10.5.2.7a	UTRAN pre-defined configuration status information / START-CS / UE Capability information element.....	195
10.5.2.7b	UTRAN pre-configuration set	195

10.5.2.7c	Classmark Enquiry Mask.....	196
10.5.2.8	Channel Needed.....	196
10.5.2.8a	Channel Request Description.....	197
10.5.2.8b	Channel Request Description 2.....	198
10.5.2.9	Cipher Mode Setting.....	199
10.5.2.10	Cipher Response.....	199
10.5.2.11	Control Channel Description.....	200
10.5.2.11a	DTM Information Rest Octets.....	202
10.5.2.12	Frequency Channel Sequence.....	203
10.5.2.13	Frequency List.....	203
10.5.2.13.1	General description.....	204
10.5.2.13.2	Bit map 0 format.....	204
10.5.2.13.3	Range 1024 format.....	205
10.5.2.13.4	Range 512 format.....	207
10.5.2.13.5	Range 256 format.....	209
10.5.2.13.6	Range 128 format.....	211
10.5.2.13.7	Variable bit map format.....	213
10.5.2.14	Frequency Short List.....	214
10.5.2.14a	Frequency Short List 2.....	214
10.5.2.14b	Group Channel Description.....	214
10.5.2.14c	GPRS Resumption.....	217
10.5.2.14d	GPRS broadcast information.....	217
10.5.2.15	Handover Reference.....	218
10.5.2.16	IA Rest Octets.....	218
10.5.2.17	IAR Rest Octets.....	224
10.5.2.18	IAX Rest Octets.....	224
10.5.2.19	L2 Pseudo Length.....	224
10.5.2.20	Measurement Results.....	225
10.5.2.20a	GPRS Measurement Results.....	229
10.5.2.21	Mobile Allocation.....	229
10.5.2.21a	Mobile Time Difference.....	230
10.5.2.21aa	MultiRate configuration.....	231
10.5.2.21b	Multislot Allocation.....	233
10.5.2.21c	NC mode.....	235
10.5.2.22	Neighbour Cells Description.....	235
10.5.2.22a	Neighbour Cells Description 2.....	236
10.5.2.22b	Spare.....	237
10.5.2.22c	NT/N Rest Octets.....	237
10.5.2.23	P1 Rest Octets.....	237
10.5.2.24	P2 Rest Octets.....	239
10.5.2.25	P3 Rest Octets.....	240
10.5.2.25a	Packet Channel Description.....	240
10.5.2.25b	Dedicated mode or TBF.....	242
10.5.2.25c	RR Packet Uplink Assignment.....	242
10.5.2.25d	RR Packet Downlink Assignment.....	246
10.5.2.26	Page Mode.....	248
10.5.2.26a	Spare.....	249
10.5.2.26b	Spare.....	249
10.5.2.26c	Spare.....	249
10.5.2.26d	Spare.....	249
10.5.2.27	NCC Permitted.....	249
10.5.2.28	Power Command.....	249
10.5.2.28a	Power Command and access type.....	250
10.5.2.29	RACH Control Parameters.....	250
10.5.2.30	Request Reference.....	252
10.5.2.31	RR Cause.....	252
10.5.2.32	SI 1 Rest Octets.....	253
10.5.2.33	SI 2bis Rest Octets.....	254
10.5.2.33a	SI 2ter Rest Octets.....	255
10.5.2.33b	SI 2quater Rest Octets.....	257
10.5.2.34	SI 3 Rest Octets.....	263
10.5.2.35	SI 4 Rest Octets.....	264

10.5.2.35a	SI 6 Rest Octets	267
10.5.2.36	SI 7 Rest Octets	269
10.5.2.37	SI 8 Rest Octets	269
10.5.2.37a	SI 9 Rest Octets	269
10.5.2.37b	SI 13 Rest Octets	271
10.5.2.37c	[Spare]	273
10.5.2.37d	[Spare]	273
10.5.2.37e	SI 16 Rest Octets	273
10.5.2.37f	SI 17 Rest Octets	274
10.5.2.37g	SI 19 Rest Octets	274
10.5.2.37h	SI 18 Rest Octets	277
10.5.2.37i	SI 20 Rest Octets	279
10.5.2.38	Starting Time	279
10.5.2.39	Synchronization Indication	280
10.5.2.40	Timing Advance	280
10.5.2.41	Time Difference	281
10.5.2.41a	TLLI.....	281
10.5.2.42	TMSI/P-TMSI	282
10.5.2.42a	VGCS target mode Indication.....	282
10.5.2.43	Wait Indication	283
10.5.2.44	SI10 rest octets \$(ASCII)\$.....	283
10.5.2.45	EXTENDED MEASUREMENT RESULTS.....	286
10.5.2.46	Extended Measurement Frequency List.....	288
10.5.2.47	Suspension Cause	289
10.5.2.48	APDU ID	289
10.5.2.49	APDU Flags.....	290
10.5.2.50	APDU Data	290
10.5.2.51	Handover To UTRAN Command.....	291
10.5.2.52	Handover To cdma2000 Command	291
10.5.2.53	UTRAN Pre-configuration INDEX/COUNT	292
10.5.2.54	UTRAN Pre-configuration identity	292
10.5.2.55	Predefined configuration value tag	293
10.5.2.56	3G Target Cell	293
10.5.3	Mobility management information elements.....	294
10.5.4	Call control information elements.....	294
10.5.5	GPRS mobility management information elements	294
10.5.6	Session management information elements	294
10.5.7	GPRS Common information elements	294
10.5.8	GTTP information elements.....	294
10.5.8.1	LLC PDU Container	294
11	List of system parameters.....	294
11.1	Timers and counters for radio resource management.....	294
11.1.1	Timers on the mobile station side.....	294
11.1.2	Timers on the network side	297
11.1.3	Other parameters	298
11.2	Timers of mobility management	298
11.3	Timers of circuit-switched call control.....	298

Annex A (informative): Example of subaddress information element coding	299
Annex B (normative): Compatibility checking	300
Annex C (normative): Low layer information coding principles	301
Annex D (informative): Examples of bearer capability information element coding	302
Annex E (informative): Comparison between call control procedures specified in 3GPP TS 24.008 and CCITT Recommendation Q.931	303
Annex F (informative): GSM specific cause values for radio resource management	304
Annex G (informative): GSM specific cause values for mobility management	306
Annex H (informative): GSM specific cause values for call control	307
Annex I (informative): GSM specific cause values for session management	308
Annex J (informative): Algorithm to encode frequency list information elements	309
J.1 Introduction.....	309
J.2 General principle.....	309
J.3 Performances.....	311
J.4 Encoding algorithm.....	312
J.5 Decoding.....	314
J.6 A detailed example.....	315
Annex K (informative): Default Codings of Information Elements	317
K.1 Common information elements.....	317
K.2 Radio Resource management information elements.....	318
Annex L (normative): Additional Requirements for backward compatibility with PCS 1900 for NA revision 0 ME	319
Annex M (informative): Change history	320

Foreword

This Technical Specification has been produced by the 3rd Generation Partnership Project (3GPP).

The contents of the present document are subject to continuing work within the TSG and may change following formal TSG approval. Should the TSG modify the contents of the present document, it will be re-released by the TSG with an identifying change of release date and an increase in version number as follows:

Version x.y.z

where:

- x the first digit:
 - 1 presented to TSG for information;
 - 2 presented to TSG for approval;
 - 3 or greater indicates TSG approved document under change control.
- y the second digit is incremented for all changes of substance, i.e. technical enhancements, corrections, updates, etc.
- z the third digit is incremented when editorial only changes have been incorporated in the document.

1 Scope

This EN specifies the procedures used at the radio interface (Reference Point Um, see 3GPP TS 04.02) for Radio Resource (RR) management.

Notation "Reserved section number" is used to indicate which sections of the specification were moved from this part of the standard to the other part when this standard was split between RAN and CN parts.

When the notations for "further study" or "FS" or "FFS" are present in this specification they mean that the indicated text is not a normative portion of this standard.

These procedures are defined in terms of messages exchanged over the control channels of the radio interface. The control channels are described in 3GPP TS 04.03.

The structured functions and procedures of this protocol and the relationship with other layers and entities are described in general terms in 3GPP TS 24.007.

1.1 Scope of the Technical Specification

The procedures currently described in this EN are for radio resource management for circuit-switched and GPRS services.

3GPP TS 24.010 contains functional procedures for support of supplementary services.

3GPP TS 04.11 contains functional procedures for support of point-to-point short message services.

3GPP TS 04.12 contains functional description of short message - cell broadcast.

3GPP TS 04.60 contains procedures for radio link control and medium access control (RLC/MAC) of packet data physical channels.

3GPP TS 24.071 contains functional descriptions and procedures for support of location services.

3GPP TS 24.008 contains the procedures for CN protocols.

NOTE: "layer 3" includes the functions and protocols described in this Technical Specification. The terms "data link layer" and "layer 2" are used interchangeably to refer to the layer immediately below layer 3.

1.2 Application to the interface structures

The layer 3 procedures apply to the interface structures defined in 3GPP TS 04.03. They use the functions and services provided by layer 2 defined in 3GPP TS 04.05 and 3GPP TS 04.06. 3GPP TS 24.007 gives the general description of layer 3 including procedures, messages format and error handling.

1.3 Structure of layer 3 procedures

A building block method is used to describe the layer 3 procedures.

The basic building blocks are "elementary procedures" provided by the protocol control entities of the three sublayers, i.e. radio resource management, mobility management and connection management sublayer.

Complete layer 3 transactions consist of specific sequences of elementary procedures. The term "structured procedure" is used for these sequences.

1.4 Test procedures

Test procedures of the GSM radio interface signalling are described in 3GPP TS 11.10 and 3GPP TS 11.2x series.

1.5 Use of logical channels

The logical control channels are defined in 3GPP TS 05.02. In the following those control channels are considered which carry signalling information or specific types of user packet information:

- i) Broadcast Control CHannel (BCCH): downlink only, used to broadcast Cell specific information;
- ii) Synchronization CHannel (SCH): downlink only, used to broadcast synchronization and BSS identification information;
- iii) Paging CHannel (PCH): downlink only, used to send page requests to Mobile Stations (MSs);
- iv) Random Access CHannel (RACH): uplink only, used to request a Dedicated Control CHannel;
- v) Access Grant CHannel (AGCH): downlink only, used to allocate a Dedicated Control CHannel;
- vi) Standalone Dedicated Control CHannel (SDCCH): bi-directional;
- vii) Fast Associated Control CHannel (FACCH): bi-directional, associated with a Traffic CHannel;
- viii) Slow Associated Control CHannel (SACCH): bi-directional, associated with a SDCCH or a Traffic CHannel;
- ix) Cell Broadcast CHannel (CBCH): downlink only used for general (not point to point) short message information;
- x) Notification CHannel (NCH): downlink only, used to notify mobile stations of VBS (Voice Broadcast Service) calls or VGCS (Voice Group Call Service) calls.

Two service access points are defined on signalling layer 2 which are discriminated by their Service Access Point Identifiers (SAPI) (see 3GPP TS 04.06):

- i) SAPI 0: supports the transfer of signalling information including user-user information;
- ii) SAPI 3: supports the transfer of user short messages.

Layer 3 selects the service access point, the logical control channel and the mode of operation of layer 2 (acknowledged, unacknowledged or random access, see 3GPP TS 04.05 and 3GPP TS 04.06) as required for each individual message.

1.6 Overview of control procedures

1.6.1 List of procedures

The following procedures are specified in this Technical Specification:

- a) Clause 3 specifies elementary procedures for Radio Resource management:
 - system information broadcasting (subclause 3.2.2)
 - RR connection establishment (subclause 3.3)
 - entering the dedicated mode : immediate assignment procedure (subclause 3.3.1.1)
 - paging procedure for RR connection establishment (subclause 3.3.2)
 - notification procedure (subclause 3.3.3)
 - Procedures in dedicated mode and in group transmit mode (subclause 3.4)
 - measurement report procedure (subclause 3.4.1.2)
 - intracell change of channels (subclause 3.4.3)
 - intercell change of channels (subclause 3.4.4)

- frequency redefinition procedure (subclause 3.4.5)
- channel mode change procedure (subclause 3.4.6)
- ciphering mode setting procedure (subclause 3.4.7)
- additional channel assignment procedure (subclause 3.4.8)
- partial channel release procedure (subclause 3.4.9)
- radio resources connection release (subclause 3.4.13)
- specific RR procedures for voice broadcast channels and voice group call channels (subclause 3.4.15)
- application procedures (subclause 3.4.21)
- RR procedures on CCCH related to temporary block flow establishment (subclause 3.5)
 - packet paging procedure using CCCH (subclause 3.5.1)
 - packet access procedure using CCCH (subclause 3.5.2)
 - packet downlink assignment procedure using CCCH (subclause 3.5.3)
- RR procedures on DCCH related to temporary block flow establishment
 - Assignment to Packet Data Channel procedure (subclause 3.4.19)
 - Network commanded cell reselection (subclause 3.4.20)

Clause 8 specifies actions to be taken on various error conditions and also provides rules to ensure compatibility with future enhancements of the protocol.

1.7 Applicability of implementations

The applicability of procedures of this technical specification for the mobile station is dependent on the services and functions which are to be supported by a mobile station. For the MS, the Revision level indicating Release '99 is linked to the full support of the RR protocol and procedures in 3GPP TS 04.18 Release '99.

1.7.1 Voice Group Call Service (VGCS) and Voice Broadcast Service (VBS)

For mobile stations supporting the Voice Group Call Service or the Voice Broadcast Service, it is explicitly mentioned throughout this technical specification if a certain procedure is applicable only for such a service and, if necessary, how mobile stations not supporting such a service shall behave.

For VGCS and VBS, the following possible mobile station implementations exist:

- support of listening to voice broadcast calls (VBS listening)
- support of originating a voice broadcast call (VBS originating)
- support of listening to voice group calls (VGCS listening)
- support of talking in voice group calls (VGCS talking. This always includes the implementation for VGCS listening)
- support of originating a voice group call (VGCS originating. This always includes the implementation for VGCS talking)

Apart from the explicitly mentioned combinations, all possible combinations are optional and supported by this technical specification.

The related terms are used in this technical specification, if information on these implementation options is required.

1.7.2 General Packet Radio Service (GPRS)

For mobile stations supporting the General Packet Radio Service (GPRS), it is explicitly mentioned throughout the technical specification if a certain procedure is applicable only for such a service and, if necessary, how mobile stations not supporting such a service shall behave.

A GPRS MS may operate in one of the following MS operation modes, see 3GPP TS 23.060 [74]:

- MS operation mode A;
- MS operation mode B; or
- MS operation mode C.

The MS operation mode depends on the services that the MS is attached to, i.e., only GPRS or both GPRS and non-GPRS services, and upon the MS's capabilities to operate GPRS and other GSM services simultaneously. Mobile stations that are capable to operate GPRS services are referred to as GPRS MSs.

NOTE: Other GSM technical specifications may refer to the MS operation modes A, B, and C as GPRS class-A MS, GPRS class-B MS, and GPRS class-C MS.

It should be noted that it is possible that for a GPRS MS, the GMM procedures currently described in the present document do not support combinations of VGCS, VBS and GPRS. The possible interactions are not studied yet.

2 References

The following documents contain provisions which, through reference in this text, constitute provisions of the present document.

- References are either specific (identified by date of publication, edition number, version number, etc.) or non-specific.
- For a specific reference, subsequent revisions do not apply.
- For a non-specific reference, the latest version applies.

- [1] 3GPP TS 01.02: "Digital cellular telecommunications system (Phase 2+); General description of a GSM Public Land Mobile Network (PLMN)".
- [2] 3GPP TS 01.04: "Digital cellular telecommunications system (Phase 2+); Abbreviations and acronyms".
- [3] 3GPP TS 22.002: "Digital cellular telecommunications system (Phase 2+); Bearer Services (BS) supported by a GSM Public Land Mobile Network (PLMN)".
- [4] 3GPP TS 02.03: "Digital cellular telecommunications system (Phase 2+); Teleservices supported by a GSM Public Land Mobile Network (PLMN)".
- [5] 3GPP TS 02.09: "Digital cellular telecommunications system (Phase 2+); Security aspects".
- [6] 3GPP TS 22.011: "Digital cellular telecommunications system (Phase 2+); Service accessibility".
- [7] 3GPP TS 02.17: "Digital cellular telecommunications system (Phase 2+); Subscriber identity modules Functional characteristics".
- [8] 3GPP TS 02.40: "Digital cellular telecommunications system (Phase 2+); Procedures for call progress indications".
- [9] 3GPP TS 03.01: "Digital cellular telecommunications system (Phase 2+); Network functions".
- [10] 3GPP TS 23.003: "Digital cellular telecommunications system (Phase 2+); Numbering, addressing and identification".

- [11] 3GPP TS 03.13: "Digital cellular telecommunications system (Phase 2+); Discontinuous Reception (DRX) in the GSM system".
- [12] 3GPP TS 23.014: "Digital cellular telecommunications system (Phase 2+); Support of Dual Tone Multi-Frequency signalling (DTMF) via the GSM system".
- [12a] 3GPP TS 23.071: "Digital cellular telecommunications system (Phase 2+); Location Services; Functional description – Stage 2".
- [13] 3GPP TS 03.20: "Digital cellular telecommunications system (Phase 2+); Security related network functions".
- [14] 3GPP TS 23.022: "Digital cellular telecommunications system (Phase 2+); Functions related to Mobile Station (MS) in idle mode".
- [15] 3GPP TS 04.02: "Digital cellular telecommunications system (Phase 2+); GSM Public Land Mobile Network (PLMN) access reference configuration".
- [16] 3GPP TS 04.03: "Digital cellular telecommunications system (Phase 2+); Mobile Station - Base Station System (MS - BSS) interface Channel structures and access capabilities".
- [17] 3GPP TS 04.04: "Digital cellular telecommunications system (Phase 2+); layer 1 General requirements".
- [18] 3GPP TS 04.05: "Digital cellular telecommunications system (Phase 2+); Data Link (DL) layer General aspects".
- [19] 3GPP TS 04.06: "Digital cellular telecommunications system (Phase 2+); Mobile Station - Base Station System (MS - BSS) interface Data Link (DL) layer specification".
- [20] 3GPP TS 24.007: "Digital cellular telecommunications system (Phase 2+); Mobile radio interface signalling layer 3; General aspects".
- [21] 3GPP TS 24.010: "Digital cellular telecommunications system ; Mobile radio interface layer 3 Supplementary services specification; General aspects".
- [22] 3GPP TS 04.11: "Digital cellular telecommunications system (Phase 2); Point-to-Point (PP) Short Message Service (SMS) support on mobile radio interface".
- [23] 3GPP TS 04.12: "Digital cellular telecommunications system (Phase 2+); Short Message Service Cell Broadcast (SMSCB) support on the mobile radio interface".
- [23a] 3GPP TS 24.071: "Digital cellular telecommunications system (Phase 2+); Mobile radio interface layer 3 location services specification.
- [23b] 3GPP TS 04.31 "Digital cellular telecommunication system (Phase 2+);Location Services;Mobile Station (MS) – Serving Mobile Location Centre (SMLC); Radio Resource LCS Protocol (RRLP)".
- [24] 3GPP TS 24.080: "Digital cellular telecommunications system (Phase 2+); Mobile radio interface layer 3 supplementary services specification Formats and coding".
- [25] 3GPP TS 24.081: "Digital cellular telecommunications system (Phase 2+); Line identification supplementary services - Stage 3".
- [26] 3GPP TS 24.082: "Digital cellular telecommunications system (Phase 2+); Call Forwarding (CF) supplementary services - Stage 3".
- [27] 3GPP TS 24.083: "Digital cellular telecommunications system (Phase 2+); Call Waiting (CW) and Call Hold (HOLD) supplementary services - Stage 3".
- [28] 3GPP TS 24.084: "Digital cellular telecommunications system (Phase 2+); MultiParty (MPTY) supplementary services - Stage 3".
- [29] 3GPP TS 24.085: "Digital cellular telecommunications system (Phase 2+); Closed User Group (CUG) supplementary services - Stage 3".

- [30] 3GPP TS 24.086: "Digital cellular telecommunications system (Phase 2+); Advice of Charge (AoC) supplementary services - Stage 3".
- [31] 3GPP TS 04.88: "Digital cellular telecommunications system (Phase 2+); Call Barring (CB) supplementary services - Stage 3".
- [32] 3GPP TS 05.02: "Digital cellular telecommunications system (Phase 2+); Multiplexing and multiple access on the radio path".
- [33] 3GPP TS 05.05: "Digital cellular telecommunications system (Phase 2+); Radio transmission and reception".
- [34] 3GPP TS 05.08: "Digital cellular telecommunications system (Phase 2+); Radio subsystem link control".
- [35] 3GPP TS 05.10: "Digital cellular telecommunications system (Phase 2+); Radio subsystem synchronization".
- [36] 3GPP TS 27.001: "Digital cellular telecommunications system (Phase 2+); General on Terminal Adaptation Functions (TAF) for Mobile Stations (MS)".
- [37] 3GPP TS 29.002: "Digital cellular telecommunications system (Phase 2+); Mobile Application Part (MAP) specification".
- [38] 3GPP TS 29.007: "Digital cellular telecommunications system (Phase 2+); General requirements on interworking between the Public Land Mobile Network (PLMN) and the Integrated Services Digital Network (ISDN) or Public Switched Telephone Network (PSTN)".
- [39] 3GPP TS 11.10: "Digital cellular telecommunications system (Phase 2+); Mobile Station (MS) conformity specification".
- [40] 3GPP TS 11.21: "Digital cellular telecommunications system (Phase 2); The GSM Base Station System (BSS) equipment specification".
- [41] ISO/IEC 646 (1991): "Information technology - ISO 7-bit coded character set for information interchange".
- [42] ISO/IEC 6429: "Information technology - Control functions for coded character sets".
- [43] ISO 8348 (1987): "Information processing systems - Data communications - Network service definition".
- [44] CCITT Recommendation E.163: "Numbering plan for the international telephone service".
- [45] CCITT Recommendation E.164: "Numbering plan for the ISDN era".
- [46] CCITT Recommendation E.212: "Identification plan for land mobile stations".
- [47] ITU-T Recommendation F.69 (1993): "Plan for telex destination codes".
- [48] CCITT Recommendation I.330: "ISDN numbering and addressing principles".
- [49] CCITT Recommendation I.440 (1989): "ISDN user-network interface data link layer - General aspects".
- [50] CCITT Recommendation I.450 (1989): "ISDN user-network interface layer 3 General aspects".
- [51] ITU-T Recommendation I.500 (1993): "General structure of the ISDN interworking recommendations".
- [52] CCITT Recommendation T.50: "International Alphabet No. 5".
- [53] CCITT Recommendation Q.931: ISDN user-network interface layer 3 specification for basic control".
- [54] CCITT Recommendation V.21: "300 bits per second duplex modem standardized for use in the general switched telephone network".

- [55] CCITT Recommendation V.22: "1200 bits per second duplex modem standardized for use in the general switched telephone network and on point-to-point 2-wire leased telephone-type circuits".
- [56] CCITT Recommendation V.22bis: "2400 bits per second duplex modem using the frequency division technique standardized for use on the general switched telephone network and on point-to-point 2-wire leased telephone-type circuits".
- [57] CCITT Recommendation V.23: "600/1200-baud modem standardized for use in the general switched telephone network".
- [58] CCITT Recommendation V.26ter: "2400 bits per second duplex modem using the echo cancellation technique standardized for use on the general switched telephone network and on point-to-point 2-wire leased telephone-type circuits".
- [59] CCITT Recommendation V.32: "A family of 2-wire, duplex modems operating at data signalling rates of up to 9600 bit/s for use on the general switched telephone network and on leased telephone-type circuits".
- [60] CCITT Recommendation V.110: "Support of data terminal equipments (DTEs) with V-Series interfaces by an integrated services digital network".
- [61] CCITT Recommendation V.120: "Support by an ISDN of data terminal equipment with V-Series type interfaces with provision for statistical multiplexing".
- [62] CCITT Recommendation X.21: "Interface between data terminal equipment (DTE) and data circuit-terminating equipment (DCE) for synchronous operation on public data networks".
- [63] CCITT Recommendation X.25: "Interface between data terminal equipment (DTE) and data circuit-terminating equipment (DCE) for terminals operating in the packet mode and connected to public data networks by dedicated circuit".
- [64] CCITT Recommendation X.28: "DTE/DCE interface for a start-stop mode data terminal equipment accessing the packet assembly/disassembly facility (PAD) in a public data network situated in the same country".
- [65] CCITT Recommendation X.30: "Support of X.21, X.21 bis and X.20 bis based data terminal equipments (DTEs) by an integrated services digital network (ISDN)".
- [66] CCITT Recommendation X.31: "Support of packet mode terminal equipment by an ISDN".
- [67] CCITT Recommendation X.32: "Interface between data terminal equipment (DTE) and data circuit-terminating equipment (DCE) for terminals operating in the packet mode and accessing a packet switched public data network through a public switched telephone network or an integrated services digital network or a circuit switched public data network".
- [68] CCITT Recommendation X.75 (1988): "Packet-switched signalling system between public networks providing data transmission services".
- [69] CCITT Recommendation X.121: "International numbering plan for public data networks".
- [70] ETS 300 102-1: "Integrated Services Digital Network (ISDN); User-network interface layer 3 Specifications for basic call control".
- [71] ETS 300 102-2: "Integrated Services Digital Network (ISDN); User-network interface layer 3 Specifications for basic call control".
- [72] ISO/IEC10646: "Universal Multiple-Octet Coded Character Set (UCS)"; UCS2, 16 bit coding.
- [73] 3GPP TS 22.060: "Digital cellular telecommunications system (Phase 2+); General Packet Radio Service (GPRS); Service Description; Stage 1".
- [74] 3GPP TS 23.060: "Digital cellular telecommunications system (Phase 2+); General Packet Radio Service (GPRS); Service Description; Stage 2".
- [75] 3GPP TS 03.64: "Digital cellular telecommunications system (Phase 2+); General Packet Radio Service (GPRS); Overall description of the GPRS radio interface; Stage 2".

- [76] 3GPP TS 04.60: "Digital cellular telecommunications system (Phase 2+); General Packet Radio Service (GPRS); Mobile Station - Base Station System (MS-BSS) interface; Radio Link Control and Medium Access Control (RLC/MAC) layer specification".
- [77] IETF RFC 1034: "Domain names - Concepts and Facilities " (STD 7).
- [78] 3GPP TS 04.65: "Digital cellular telecommunications system (Phase 2+); General Packet Radio Service (GPRS); Subnetwork Dependent Convergence Protocol (SNDTCP)".
- [79] 3GPP TS 24.008: "3rd Generation Partnership Project; Technical Specification Group Core Network; Mobile Radio Interface Layer 3 specification; Core Network Protocols - Stage 3".
- [80] TIA/EIA/IS-2000-5-A: "Upper Layer (Layer 3) Signaling Standard for cdma2000 Spread Spectrum Systems".
- [81] TIA/EIA/IS-833: "Multi-Carrier Specification for Spread Spectrum Systems on GSM MAP (MC-MAP) (Lower Layers Air Interface)"
- [82] TIA/EIA/IS-2000-4-A: "Signaling Link Access Control (LAC) Standard for cdma2000 Spread Spectrum Systems"

2.1 Definitions and abbreviations

Abbreviations used in this specification are listed in 3GPP TS 01.04

2.1.1 Random values

In a number of places in this Technical Specification, it is mentioned that some value must take a "random" value, in a given range, or more generally with some statistical distribution. Such cases interest only the Mobile Station.

It is required that there is a low probability that two MSs in the same conditions (including the case of two MSs of the same type from the same manufacturer) will choose the same value. Moreover, it is required that, if it happens that two MSs in similar conditions choose the same value, the probability of their choices being identical at the next occasion is the same as if their first choices had been different.

The meaning of such a specification is that any statistical test for these values, done on a series of similar events, will obtain a result statistically compatible with the specified distribution. This shall hold even in the cases where the tests are conducted with a subset of possible events, with some common parameters. Moreover, basic tests of independence of the values within the series shall pass.

Data against which correlation with the values shall not be found are the protocol state, or the IMSI, or identities or other unrelated information broadcast by the network, or the current TDMA frame number.

2.1.2 Vocabulary

The following terms are used in this Technical Specification:

- **idle mode:** In this mode, the mobile station is not allocated any dedicated channel; it listens to the CCCH and the BCCH.
- **group receive mode:** (only applicable for mobile stations supporting VGCS listening or VBS listening) In this mode, the mobile station is not allocated a dedicated channel with the network; it listens to the downlink of a voice broadcast channel or voice group call channel allocated to the cell. Occasionally, the mobile station has to listen to the BCCH of the serving cell as defined in 3GPP TS 23.022 and 3GPP TS 05.08.
- **dedicated mode:** In this mode, the mobile station is allocated at least two dedicated channels, only one of them being a SACCH.
- **group transmit mode:** (only applicable for mobile stations supporting VGCS talking) In this mode, one mobile station of a voice group call is allocated two dedicated channels, one of them being a SACCH. These channels can be allocated to one mobile station at a time but to different mobile stations during the voice group call.

- **packet idle mode:** (only applicable for mobile stations supporting GPRS) In this mode, mobile station is not allocated any radio resource on a packet data physical channel; it listens to the PBCCH and PCCCH or, if those are not provided by the network, to the BCCH and the CCCH, see 3GPP TS 04.60.
- **packet transfer mode:** (only applicable for mobile stations supporting GPRS) In this mode, the mobile station is allocated radio resource on one or more packet data physical channels for the transfer of LLC PDUs.
- **dual transfer mode:** (only applicable for mobile stations supporting GPRS and DTM) In this mode, the mobile station is allocated radio resources providing an RR connection and a Temporary Block Flow (3GPP TS 04.60) on one or more physical channels. The allocation of radio resource for the RR connection and the Temporary Block Flow is co-ordinated by the network to comply with the capabilities of the mobile station in dual transfer mode.
- **main DCCH:** In Dedicated mode and group transmit mode, only two channels are used as DCCH, one being a SACCH, the other being a SDCCH or a FACCH; the SDCCH or FACCH is called here "the main DCCH".
- A channel is **activated** if it can be used for transmission, in particular for signalling, at least with UI frames. On the SACCH, whenever activated, it must be ensured that a contiguous stream of layer 2 frames is sent.
- A TCH is **connected** if circuit mode user data can be transferred. A TCH cannot be connected if it is not activated. A TCH which is activated but not connected is used only for signalling, i.e. as a DCCH.
- The data link of SAPI 0 on the main DCCH is called the **main signalling link**. Any message specified to be sent on the main signalling link is sent in acknowledged mode except when otherwise specified.
- The term "**to establish**" a link is a short form for "**to establish the multiframe mode**" on that data link. It is possible to send UI frames on a data link even if it is not established as soon as the corresponding channel is activated. Except when otherwise indicated, a data link layer establishment is done without an information field.
- "**channel set**" is used to identify TCHs that carry related user information flows, e.g., in a multislot configuration used to support circuit switched connection(s), which therefore need to be handled together.
- A **temporary block flow** (TBF) is a physical connection used by the two RR peer entities to support the uni-directional transfer of LLC PDUs on packet data physical channels, see 3GPP TS 04.60.
- **RLC/MAC block:** A RLC/MAC block is the protocol data unit exchanged between RLC/MAC entities, see 3GPP TS 04.60.
- A **GMM context** is established when a GPRS attach procedure is successfully completed.
- **Network operation mode**

The three different network operation modes I, II, and III are defined in 3GPP TS 23.060 [74].

The network operation mode shall be indicated as system information. For proper operation, the network operation mode should be the same in each cell of one routing area.

- **GPRS MS operation mode**

The three different GPRS MS operation modes A, B, and C are defined in 3GPP TS 23.060 [74].

- **Anonymous access** refers to limited service provisioning to an MS whose identity is unknown in the network.

3 Radio Resource management procedures

3.1 Overview/General

3.1.1 General

Radio Resource management procedures include the functions related to the management of the common transmission resources, e.g. the physical channels and the data link connections on control channels.

The general purpose of Radio Resource procedures is to establish, maintain and release RR connections that allow a point-to-point dialogue between the network and a mobile station. This includes the cell selection/reselection and the handover procedures. Moreover, Radio Resource management procedures include the reception of the uni-directional BCCH and CCCH when no RR connection is established. This permits automatic cell selection/reselection.

If VGCS listening or VBS listening are supported, the radio resource management also includes the functions for the reception of the voice group call channel or the voice broadcast channel, respectively, and the automatic cell reselection of the mobile station in Group receive mode.

If VGCS talking is supported, the radio resource management also includes the functions for the seizure and release of the voice group call channel.

If GPRS point-to-point services are supported, the radio resource management procedures includes functions related to the management of transmission resources on packet data physical channels. This includes the broadcast of system information to support a mobile station in packet idle and packet transfer modes, see also 3GPP TS 04.60.

NOTE 1: This chapter includes some procedures used for multislot operation and for the TCH/H + TCH/H configuration which need not be supported by simple mobile stations.

NOTE 2: The procedures and the information content relating to the TCH/H + TCH/H configuration in RR messages is for further study.

3.1.2 Services provided to upper layers

A RR connection is a physical connection used by the two peer entities to support the upper layers' exchange of information flows.

3.1.2.1 Idle mode

In idle mode no RR connection exists.

The RR procedures include (on the mobile station side) those for automatic cell selection/reselection. The RR entity indicates to upper layers the unavailability of a BCCH/CCCH and the cell change when decided by the RR entity. Upper layers are advised of the BCCH broadcast information when a new cell has been selected, or when a relevant part of this information changes.

In Idle mode, upper layers can require the establishment of an RR connection.

3.1.2.2 Dedicated mode

In dedicated mode, the RR connection is a physical point-to-point bi-directional connection, and includes a SAPI 0 data link connection operating in multiframe mode on the main DCCH. If dedicated mode is established, RR procedures provide the following services:

- establishment/release of multiframe mode on data link layer connections other than SAPI 0, on the main DCCH or on the SACCH associated with the channel carrying the main signalling link;
- transfer of messages on any data link layer connection;
- indication of temporary unavailability of transmission (suspension, resuming);

- indication of loss of RR connection;
- automatic cell reselection and handover to maintain the RR connection;
- setting/change of the transmission mode on the physical channels, including change of type of channel, change of the coding/decoding/transcoding mode and setting of ciphering;
- allocation/release of an additional channel (for the TCH/H + TCH/H configuration);
- allocation/release of additional channels for multislot operation;
- release of an RR connection.

3.1.2.3 Group receive mode

Only applicable for mobile stations supporting VGCS listening or VBS listening.

In this mode, the RR procedures on the mobile station side provide the services:

- local connection to the voice broadcast channel or voice group call channel;
- reception of messages in unacknowledged mode;
- automatic cell reselection for the mobile station in Group receive mode;
- local disconnection from the received voice group call or broadcast call channels.

For mobile stations supporting both VGCS listening and VGCS transmit, in addition, the RR procedures on the mobile station side provide the service:

- uplink access procedures to establish the RR connection.

3.1.2.4 Group transmit mode

Only applicable for mobile stations supporting VGCS talking.

In group transmit mode, the RR connection is a physical point-to-point bi-directional connection, and includes a SAPI 0 data link connection operating in multiframe mode on the main DCCH. If the group transmit mode is established, RR procedures provide the following services:

- transfer of messages on the SAPI 0 of the data link layer connection;
- indication of loss of RR connection;
- automatic cell reselection and handover to maintain the RR connection;
- setting of the transmission mode on the physical channels, change of type of channel and setting of ciphering;
- release of the RR connection.

3.1.2.5 Packet idle mode

Only applicable for mobile stations supporting GPRS.

In packet idle mode, no temporary block flow exists (see 3GPP TS 04.60). Upper layers may require the transfer of a LLC PDU, which implicitly triggers the establishment of a temporary block flow.

3.1.2.6 Packet transfer mode

Only applicable for mobile stations supporting GPRS.

In packet transfer mode, the mobile station is allocated radio resource providing a temporary block flow on one or more packet data physical channels. The RR sublayer provides the following services, see also 3GPP TS 04.60:

- transfer of LLC PDUs in acknowledged mode;
- transfer of LLC PDUs in unacknowledged mode.

Depending on the GPRS mode of operation (class A or B), the mobile station may leave both packet idle mode and packet transfer mode before entering dedicated mode, group receive mode or group transmit mode.

Cell reselection in packet idle and packet transfer modes is specified in 3GPP TS 05.08. The RR entity on the mobile station side indicates to the upper layers the availability of a cell and a cell change when decided by the RR sublayer. Upper layers are advised of system information broadcast in the cell when a new cell has been selected, or when a relevant part of this information changes.

3.1.2.7 Dual transfer mode (DTM)

In dual transfer mode, the mobile station is simultaneously in dedicated mode and in packet transfer mode. This feature is optional for the mobile station and the network. It is only applicable for a mobile station supporting GPRS or EGPRS. Dual transfer mode is a subset of class A mode of operation, only possible if there is radio resource allocation co-ordination in the network.

3.1.3 Services required from data link and physical layers

The RR sublayer uses the services provided by the data link layer as defined in 3GPP TS 04.05.

Moreover, the RR sublayer directly uses services provided by the physical layer such as BCCH searching and transfer of RLC/MAC blocks, as defined in 3GPP TS 04.04.

3.1.4 Change of dedicated channels

3.1.4.1 Change of dedicated channels using SAPI = 0

In case a change of dedicated channels is required using a dedicated assignment and handover procedure, respectively, the RR sublayer will request the data link layer to suspend multiple frame operation before the mobile station leaves the old channel. When the channel change has been completed, layer 3 will request the data link layer to resume multiple frame operation again. The layer 2 suspend/resume procedures are described in 3GPP TS 04.05 and 04.06.

These procedures are specified in such a way that a loss of a layer 3 message cannot occur on the radio interface. However, messages sent from the mobile station to the network may be duplicated by the data link layer if a message has been transmitted but not yet completely acknowledged before the mobile station leaves the old channel (see 3GPP TS 04.06).

As the RR sublayer is controlling the channel change, a duplication of RR messages does not occur. However, there are some procedures for which a duplication is possible, e.g. DTMF procedures. For all upper layer procedures using the transport service of the GSM RR sub-layer (e.g., MM and CM procedures but not GMM or Session Management procedures), the request messages sent by the mobile station contain a sequence number in order to allow the network to detect duplicated messages, which are then ignored by the network. The same sequence number is used to protect against message duplication caused by channel changes between GSM and UMTS and also by other UMTS procedures (eg hard handover). The procedures for sequenced transmission on layer 3 are described in subclause 3.1.4.2.

3.1.4.2 Change of dedicated channels using other SAPIs than 0

For SAPIs other than 0, the data link procedures described in 3GPP TS 04.06 do not provide any guarantee against message loss or duplication.

Therefore, if an application uses a SAPI other than 0 and if this application is sensitive to message loss or duplication, then it has to define its own protection mechanism. No general protection mechanism is provided by the protocol defined in this Technical Specification.

3.1.4.3 Sequenced message transfer operation

Upper layer messages sent using the RR sub-layer transport service from the mobile station to the network can be duplicated by the data link layer in at least the following cases:

- a channel change of dedicated channels is required (assignment or handover procedure) and the last layer 2 frame has not been acknowledged by the peer data link layer before the mobile station leaves the old channel.
- a channel change from UMTS to GSM is performed and the UMTS layer 2 protocol has not acknowledged the layer 2 frames carrying one or more upper layer messages.

In this case, the mobile station does not know whether the network has received the message correctly. Therefore, the mobile station has to send the message again after the new dedicated channel is established (see 3GPP TS 04.06).

The network must be able to detect the duplicated received message. Therefore, each concerned upper layer message must be marked with a send sequence number.

To allow for different termination points in the infrastructure of the messages of different PDs, the sequence numbering is specific to each PD. For historical reasons, an exception is that messages sent with the CC, SS and MM PDs share the same sequence numbering. In the following, the phrase **upper layer message flow** refers to a flow of messages sharing the same sequence numbering. The different upper layer flows are MM+CC+SS, GCC, BCC, RRLP and GTTP. The GMM, SM and SMS protocols do not use layer 3 sequence numbering.

3.1.4.3.1 Variables and sequence numbers

3.1.4.3.1.1 Send state variable V(SD)

The RR (GSM case) and/or RRC (UMTS case) sublayer of the mobile station shall have one associated send state variable V(SD) ("Send Duplicated") for each upper layer message flow. The send state variable denotes the sequence number of the next in sequence numbered message in the flow to be transmitted. The value of the corresponding send state variable shall be incremented by one with each numbered message transmission. When the RR or RRC connection starts with a core network of release '98 or earlier arithmetic operations on V(SD) are performed modulo 2. When the RR or RRC connection starts with a core network of Release '99 or later, arithmetic operations on V(SD) are performed modulo 4.

3.1.4.3.1.2 Send sequence number N(SD)

At the time when such a message to be numbered is designated for transmission, the value of N(SD) for the message to be transferred is set equal to the value of the send state variable V(SD). See 3GPP TS 24.007.

3.1.4.3.2 Procedures for the initiation, transfer execution and termination of the sequenced message transfer operation

3.1.4.3.2.1 Initiation

The sequenced message transfer operation is initiated by establishing a RR connection. The send state variables V(SD) are set to 0.

3.1.4.3.2.2 Transfer Execution

A release '98 or earlier core network must compare the send sequence numbers of pairs of subsequent messages in the same upper layer messages flow. In case the send sequence numbers of two subsequent messages in a flow are not identical, no duplication has occurred. In case the send sequence numbers are identical, the network must ignore the second one of the received messages.

A release '99 or later core network shall discard any message whose N(SD) is not greater (modulo 4) than the N(SD) of the last accepted message.

3.1.4.3.2.3 Termination

The sequenced message transfer operation is terminated by the RR connection release procedure.

Handover from GSM to UMTS or from UMTS to GSM shall not terminate the sequenced message transfer. UMTS SRNC relocation shall not terminate the sequenced message transfer.

3.1.5 Procedure for Service Request and Contention Resolution

Upon seizure of the assigned dedicated channel, the mobile station establishes the main signalling link on this channel by sending a layer 2 SABM frame containing a layer 3 service request message. The data link layer will store this message to perform the contention resolution. The service request message will be returned by the network in the UA frame.

The data link layer in the mobile station compares the content of the information field (i.e. the layer 3 service request message) received in the UA frame with the stored message and leaves the channel in case they do not match. This procedure resolves contentions in the case where several mobile stations have accessed at the same random access slot and with the same random reference and one has succeeded due to capture. The full description of the procedure is given in 3GPP TS 04.06.

The purpose of the service request message is to indicate to the network which service the mobile station is requesting. This then allows the network to decide how to proceed (e.g. to authenticate or not).

The service request message must contain the identity of the mobile station and may include further information which can be sent without encryption.

The layer 3 service request message is typically one of the following:

- CM SERVICE REQUEST
- LOCATION UPDATING REQUEST
- IMSI DETACH
- PAGING RESPONSE
- CM RE-ESTABLISHMENT REQUEST
- NOTIFICATION RESPONSE
- IMMEDIATE SETUP
- RR INITIALISATION REQUEST

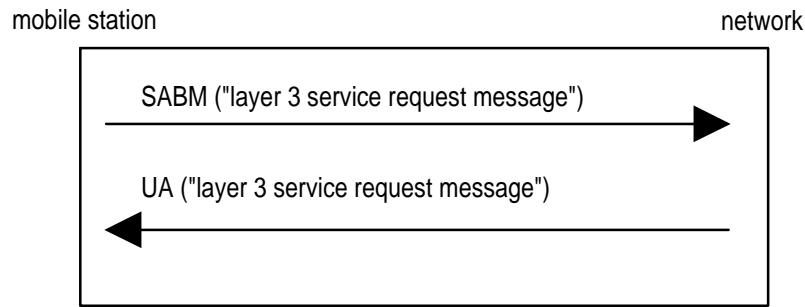

Figure 3.1/3GPP TS 04.18 Service request and contention resolution

3.1.6 Preemption

The datalink layer provides the capability to assign a priority to any message transferred in dedicated mode on SAPI 0 with multiframe operation. The available message priorities defined in 3GPP TS 04.06 are "high", "normal" and "low". Messages assigned a "high" priority are enabled to preempt, in the data link layer, all preceeding untransmitted and partially transmitted messages assigned a "low" priority that are using the same data link connection (same SAPI and logical channel). Messages or message portions that are preempted are discarded without notification to higher layers except that the first 2*N201 octets of any partially transmitted message are not discarded. The following priority assignments are defined for those Radio Resource, Mobility Management and Connection Management messages that use SAPI 0.

Table 2.1/3GPP TS 04.18: Priority Values of Layer 3 Messages

Priority	Messages
Low	RR Application Information message
Normal	All MM messages All CM messages All GTTP messages All other RR messages using SAPI 0 not listed here
High	RR Channel Establishment: RR INITIALISATION REQUEST ADDITIONAL ASSIGNMENT IMMEDIATE ASSIGNMENT IMMEDIATE ASSIGNMENT EXTENDED IMMEDIATE ASSIGNMENT REJECT RR Configuration Change: CONFIGURATION CHANGE COMMAND CONFIGURATION CHANGE ACK. CONFIGURATION CHANGE REJECT RR Handover related ASSIGNMENT COMMAND ASSIGNMENT COMPLETE ASSIGNMENT FAILURE HANDOVER COMMAND HANDOVER COMPLETE HANDOVER FAILURE PHYSICAL INFORMATION RR-CELL CHANGE ORDER PDCH ASSIGNMENT COMMAND RR Channel release CHANNEL RELEASE PARTIAL RELEASE PARTIAL RELEASE COMPLETE

Use of the preemption capability by layer 3 is not required in a BSS or MS that does not send any "low" priority message. In this case, all messages may be treated as having "normal" priority.

3.2 Idle mode procedures and general procedures in packet idle and packet transfer modes

3.2.1 Mobile Station side

In idle mode, the MS listens to the BCCH and to the paging sub-channel for the paging group the MS belongs to in idle mode (cf. 3GPP TS 03.13); it measures the radio propagation for connection with other cells.

In packet idle and packet transfer modes (applicable only to a GPRS mobile station), the mobile station listens to either the PBCCH, if that is present in the cell, or BCCH. The requirements for the monitoring of system information is further specified in 3GPP TS 04.60. Moreover, the mobile station measures the radio propagation for connection with other cells.

In packet idle mode (applicable only to a GPRS mobile station), the mobile station listens to the paging sub-channels on the PCCCH or CCCH. Paging sub-channels are monitored according to the paging group determined for the mobile station and its current discontinuous reception (DRX) mode. The determination of paging group for the mobile station is defined in 3GPP TS 05.02. The DRX procedures are defined in 3GPP TS 04.60 and 3GPP TS 05.02.

Measurements are treated to assess the need of a cell change as specified in 3GPP TS 05.08. When the decision to change cells is made, the mobile station switches to the BCCH or PBCCH of the new cell. The broadcast information is then checked to verify the allowance to camp on this cell (cf. section 3.2.2). Dependent on the mobile station type and configuration, the mobile station may be required to try to read further BCCH and PBCCH information. If allowed, the cell change is confirmed, and the broadcast information is then treated for Mobility Management actions (cf. section 4). Similarly, physical contexts are updated (list of neighbouring cells frequencies, thresholds for some actions, etc. (cf. 3GPP TS 05.08 and section 3.2.2)).

3.2.2 Network side

3.2.2.1 System information broadcasting

SYSTEM INFORMATION TYPE 2 to 4 messages, and optionally TYPE 1, 2bis, 2ter, 7, 8, 13, 16 and 17 and further types are regularly broadcast by the network on the BCCH. Based on this information the mobile station is able to decide whether and how it may gain access to the system via the current cell. The SYSTEM INFORMATION TYPE 2bis message shall be sent if and only if the EXT-IND bit in the Neighbour Cells Description IE in both the TYPE 2 and TYPE 2bis messages indicates that each IE only carries part of the BA. SYSTEM INFORMATION TYPE 2ter message shall be sent if and only if this is indicated in SYSTEM INFORMATION TYPE 3 message.

A GSM 900 mobile station which only supports the primary GSM band P-GSM 900 (cf. 3GPP TS 05.05) may consider the EXT-IND bit in the Neighbour Cells Description IE in the SYSTEM INFORMATION TYPE 2 message as a spare bit. If it does so it shall assume that the information element carries the complete BA and it shall ignore any SYSTEM INFORMATION TYPE 2bis and 2ter messages.

SYSTEM INFORMATION TYPE 2quater messages are only sent if there are UTRAN Neighbour cells.

SI2ter Rest Octet information element in the SI2ter message may provide information on UTRAN Cells and 3G Measurement Parameters. Information received in this message is only used for cell reselection in idle mode.

When the SI2terRO_MP_CHANGE_MARK parameter is changed in this information element, the MS shall re-read 3G Measurement parameters in all instances (by using SI2terRO_INDEX and SI2terRO_COUNT). When the 3G_CHANGE_MARK is changed in this information element, the MS shall re-read UMTS FDD Description and UMTS TDD Description parameters in all instances (by using SI2terRO_INDEX and SI2terRO_COUNT).

If the additional cell reselection parameters are broadcast then SYSTEM INFORMATION TYPE 3 message shall always contain these parameters. In addition to SYSTEM INFORMATION TYPE 3 at least either SYSTEM INFORMATION TYPE 4 or SYSTEM INFORMATION TYPE 7 and 8 messages shall contain these parameters too.

If additional SoLSA specific parameters are broadcast then SYSTEM INFORMATION TYPE 16 and 17 messages, shall always contain these parameters. In addition to SYSTEM INFORMATION TYPE 16 and 17 messages at least either SYSTEM INFORMATION TYPE 4 or SYSTEM INFORMATION TYPE 7 and 8 messages shall contain these SoLSA specific parameters too.

The SYSTEM INFORMATION TYPE 18 and 20 messages are sent when non-GSM broadcast information must be transmitted. The scheduling and repetition rate of these messages is determined by the system operator and is indicated in SYSTEM INFORMATION TYPE 9 message. Mobile stations without non-GSM capabilities defined for SI 18 and SI 20 should ignore these messages. An MS with non-GSM capabilities shall decode and identify information related to the respective Non-GSM protocol by reading the Non-GSM Protocol Discriminator field.

SYSTEM INFORMATION TYPE 19 messages shall be provided if COMPACT neighbour cells exist (see 3GPP TS 05.08). The presence of SI 19 messages shall be indicated in SI 9 message.

The support of GPRS shall be indicated in SYSTEM INFORMATION TYPE 3 message. In addition, the support of GPRS shall be indicated in either SYSTEM INFORMATION TYPE 4 or SYSTEM INFORMATION TYPE 7 and 8 messages. If GPRS is supported, SYSTEM INFORMATION TYPE 13 message shall be sent. SI 13 message shall not be sent if GPRS is not supported. Additional requirements for the broadcast of system information in a cell supporting GPRS are specified in 3GPP TS 04.60.

NOTE 1: The allowed scheduling of SYSTEM INFORMATION messages on the BCCH are specified in 3GPP TS 05.02.

NOTE 2: The network should take into account limitations of certain mobile stations to understand SYSTEM INFORMATION TYPE 2bis, TYPE 2ter, the EXT-IND bit in the Neighbour Cells Description, the indication of 2ter in SYSTEM INFORMATION TYPE 3 and formats used in the Neighbour Cells Description IE and Cell Channel Description IE used in SYSTEM INFORMATION messages, see this section, section 10.5.2.1b, and section 10.5.2.22.

NOTE 3: The network should take into account the limitations of earlier version of mobile equipments to understand the 3-digit MNC format of the location area identification, see section 10.5.1.3.

The information broadcast may be grouped in the following classes:

- information giving unique identification of the current network, location area and cell;
- information used for candidate cell measurements for handover and cell selection procedures;
- information describing the current control channel structure;
- information controlling the random access channel utilization;
- information defining different options supported within the cell; and
- information about the length of the part of the message belonging to the phase 1 protocol.

The network may send to the mobile station BCCH scheduling information as specified below:

- 1) The BCCH scheduling information may be contained in the SYSTEM INFORMATION TYPE 9 messages. If so, SYSTEM INFORMATION TYPE 3 specifies where to find SYSTEM INFORMATION TYPE 9 messages carrying BCCH scheduling information.
- 2) If the mobile station has received BCCH scheduling information, it shall assume that this BCCH scheduling information is valid in the location area until new scheduling information is received. It may store the information in the ME and assume its validity after switch on in the same location area.
- 3) The network need not indicate the schedule of all SYSTEM INFORMATION messages in SYSTEM INFORMATION 9. For any System Information message, the MS shall monitor all blocks specified in 3GPP TS 05.02 for that System Information message and all blocks specified in the SYSTEM INFORMATION TYPE 9 message for that System Information message.
- 4) When the mobile station detects that the BCCH information is not scheduled as defined in the last received SI 9 message, it shall read the SYSTEM INFORMATION TYPE 3 message. If presence of BCCH scheduling information in SYSTEM INFORMATION TYPE 9 message is indicated, it shall try to read the information and continue as in 2 above. If presence of BCCH scheduling information in SYSTEM INFORMATION TYPE 9 message is not indicated, it shall assume that there is no valid BCCH scheduling information.

3.2.2.2 Paging

The network is required to send valid layer 3 messages continuously on all paging subchannels on CCCH.

3.3 RR connection establishment

3.3.1 RR connection establishment initiated by the mobile station

The purpose of the immediate assignment procedure is to establish an RR connection between the mobile station and the network.

3.3.1.1 Entering the dedicated mode : immediate assignment procedure

The immediate assignment procedure can only be initiated by the RR entity of the mobile station. Initiation is triggered by request from the MM sublayer or LLC layer to enter the dedicated mode or by the RR entity in response to a PAGING REQUEST message or to initiate a notification response procedure. Upon such a request,

- if access to the network is allowed (as defined in 3.3.1.1.1), the RR entity of the mobile station initiates the immediate assignment procedure as defined in section 3.3.1.1.2;
- otherwise, it rejects the request.

The request from the MM sublayer to establish an RR connection specifies an establishment cause. Similarly, the request from the RR entity to establish a RR connection in response to a PAGING REQUEST 1, 2 or 3 message specifies one of the establishment causes "answer to paging"; the request from the RR entity to establish an RR connection in order to initiate a notification response procedure specifies one of the establishment causes "procedures that can be completed with a SDCCH".

3.3.1.1.1 Permission to access the network

All mobile stations with an inserted SIM are members of one out of 10 access classes numbered 0 to 9. The access class number is stored in the SIM. In addition, mobile stations may be members of one or more out of 5 special access classes (access classes 11 to 15) (see 3GPP TS 22.011), this is also held on the SIM card.

The system information messages on the BCCH broadcast the list of authorized access classes and authorized special access classes in the system information messages, and whether emergency calls are allowed in the cell to all mobile stations or only to the members of authorized special access classes.

If the establishment cause for the request of the MM sublayer is not "emergency call", access to the network is allowed if and only if the mobile station is a member of at least one authorized:

- access class; or
- special access class.

If the establishment cause for the request of the MM sublayer is "emergency call", access to the network is allowed if and only if:

- emergency calls are allowed to all mobile stations in the cell or the mobile station is a member of at least one authorized special access class
- the network support voice services.

If requesting emergency call access in a cell where voice services are not available (CELL_BAR_QUALIFY_2 parameter indicates no voice service), the mobile station shall immediately go to "Any Cell Selection" state as defined in 3GPP TS 03.22, prior to establishing the emergency call.

3.3.1.1.2 Initiation of the immediate assignment procedure

The RR entity of the mobile station initiates the immediate assignment procedure by scheduling the sending on the RACH and leaving idle mode (in particular, the mobile station shall ignore PAGING REQUEST messages).

It then sends maximally $M + 1$ CHANNEL REQUEST or EGPRS PACKET CHANNEL REQUEST messages on the RACH in a way such that:

- the number of slots belonging to the mobile station's RACH between initiation of the immediate assignment procedure and the first CHANNEL REQUEST or EGPRS PACKET CHANNEL REQUEST message (excluding

the slot containing the message itself) is a random value drawn randomly for each new initial assignment initiation with uniform probability distribution in the set $\{0, 1, \dots, \max(T,8) - 1\}$;

- the number of slots belonging to the mobile station's RACH between two successive CHANNEL REQUEST or EGPRS PACKET CHANNEL REQUEST messages (excluding the slots containing the messages themselves) is a random value drawn randomly for each new transmission with uniform probability distribution in the set $\{S, S + 1, \dots, S + T - 1\}$;

Here, T is the value of the parameter "Tx-integer" broadcast on the BCCH;

M is the value of the parameter "max retrans" broadcast on the BCCH;

S is a parameter depending on the CCCH configuration and on the value of Tx-integer as defined in table 3.1/3GPP TS 04.18.

The CHANNEL REQUEST messages are sent on the RACH (cf. section 1.5) and contain as parameters:

- an establishment cause which corresponds to the establishment cause given by the MM sublayer and the broadcast NECI value, or which corresponds to one of the establishment causes "answer to paging" given by the RR entity in response to a PAGING REQUEST message including the Channel Needed information, or which corresponds to one of the establishment causes "procedures that can be completed with a SDCCH" given by the RR entity in order to initiate a notification response procedure;
- a random reference which is drawn randomly from a uniform probability distribution for every new transmission.

After sending the first CHANNEL REQUEST message, the mobile station shall start listening to the BCCH; it shall also listen to the full downlink CCCH timeslot corresponding to its CCCH group.

Having sent $M + 1$ CHANNEL REQUEST messages, the RR entity of the mobile station starts timer T3126. At expiry of timer T3126, the immediate assignment procedure is aborted; if the immediate assignment procedure was triggered by a request from the MM sublayer, a random access failure is indicated to the MM sublayer.

Table 3.1/3GPP TS 04.18: Values of parameter S

TX-integer	non combined CCCH	combined CCH/SDCCH
3,8,14,50	55	41
4,9,16	76	52
5,10,20	109	58
6,11,25	163	86
7,12,32	217	115

3.3.1.1.3 Answer from the network

3.3.1.1.3.1 On receipt of a CHANNEL REQUEST message

The network may allocate a dedicated channel to the mobile station by sending an IMMEDIATE ASSIGNMENT message or IMMEDIATE ASSIGNMENT EXTENDED message in unacknowledged mode on the same CCCH timeslot on which it has received the CHANNEL REQUEST. There is no further restriction on what part of the downlink CCCH an IMMEDIATE ASSIGNMENT message or IMMEDIATE ASSIGNMENT EXTENDED message can be sent. The type of channel allocated (SDCCH or TCH; the channel mode shall be set to signalling only) is a network operator decision. Timer T3101 is then started on the network side.

NOTE: There are two types of immediate assignment messages:

- IMMEDIATE ASSIGNMENT message, containing assignment information for one mobile station only;
- IMMEDIATE ASSIGNMENT EXTENDED message, containing assignment information for two mobile stations at the same time.

The IMMEDIATE ASSIGNMENT or IMMEDIATE ASSIGNMENT EXTENDED message contains:

- the description of the assigned channel;
- the information field of the CHANNEL REQUEST message and the frame number of the frame in which the CHANNEL REQUEST message was received;
- the initial timing advance (cf. 3GPP TS 04.04);
- optionally, a starting time indication.

If frequency hopping is applied, the mobile station uses the last CA received on the BCCH to decode the Mobile Allocation.

On receipt of an IMMEDIATE ASSIGNMENT or IMMEDIATE ASSIGNMENT EXTENDED message corresponding to one of its 3 last CHANNEL REQUEST messages, the mobile station stops T3126 (if running), stops sending CHANNEL REQUEST messages, switches to the assigned channels, sets the channel mode to signalling only and activates the assigned channels. It then establishes the main signalling link with an SABM containing an information field (see section 3.1.5).

An IMMEDIATE ASSIGNMENT or IMMEDIATE ASSIGNMENT EXTENDED message may indicate a frequency change in progress, with a starting time and possibly alternative channel descriptions.

In the case of the reception of an IMMEDIATE ASSIGNMENT EXTENDED message, or of an IMMEDIATE ASSIGNMENT message which contains only the description of a channel to be used after the starting time, the mobile station shall wait up to the starting time before accessing the channel. If the starting time has already elapsed, the mobile shall access the channel as an immediate reaction to the reception of the message (see 3GPP TS 05.10 for the timing constraints).

If the message contains both the description of a channel to be used after the indicated time and of a channel to be used before, the mobile station accesses a channel as an immediate reaction to the reception of the message. If the moment the mobile station is ready to access is before the indicated time, the mobile station accesses the channels described for before the starting time. The mobile station then changes to the channel described for after the starting time at the indicated time. New parameters can be frequency list and MAIO. Other parameters describing the channel to be used before the starting time are taken from the description of the channel defined for use after the starting time. If the moment the mobile station is ready to access is after the starting time, the mobile station accesses the channel described for after the starting time.

If frequency hopping is applied, the mobile station uses the last CA received on the BCCH.

3.3.1.1.3.2 Assignment rejection

If no channel is available for assignment, the network may send to the mobile station an IMMEDIATE ASSIGNMENT REJECT message in unacknowledged mode on the same CCCH timeslot on which the channel request message was received. There is no further restriction on what part of the downlink CCCH timeslot an IMMEDIATE ASSIGNMENT REJECT message can be sent. This message contains the request reference and a wait indication.

On receipt of an IMMEDIATE ASSIGNMENT REJECT message corresponding to one of its 3 last CHANNEL REQUEST messages, the mobile station, stops sending CHANNEL REQUEST messages, starts timer T3122 with the indicated value, ("wait indication" information element), starts T3126 if it has not already been started, and listens to the downlink CCCH until T3126 expires. During this time, additional IMMEDIATE ASSIGNMENT REJECT messages are ignored, but any immediate assignment corresponding to any other of its 3 last CHANNEL REQUEST messages make the mobile station follow the procedure in section 3.3.1.2. If no such immediate assignment is received, the mobile station returns to CCCH idle mode (listening to its paging channel).

As an option the mobile station may return to CCCH idle mode as soon as it has received responses from the network on all, or in case more than 3 were sent the last 3, of its CHANNEL REQUEST messages.

The mobile station is not allowed to make a new attempt to establish a non emergency RR connection in the same cell until T3122 expires. Provided that an IMMEDIATE ASSIGNMENT REJECT message has not been received for an emergency RR connection attempt, the mobile station may attempt to enter the dedicated mode for an emergency call in the same cell before T3122 has expired.

The Wait Indication IE (i.e. T3122) relates to the cell from which it was received.

The mobile station in packet idle mode (only applicable to mobile station supporting GPRS) may initiate packet access in the same cell before T3122 has expired, see 3GPP TS 04.60 and section 3.5.2.1.3.4.

After T3122 expiry, no CHANNEL REQUEST message shall be sent as a response to a page until a PAGING REQUEST message for the mobile station is received.

3.3.1.1.4 Assignment completion

The immediate assignment procedure is terminated on the network side when the main signalling link is established. Timer T3101 is stopped and the MM sublayer on the network side is informed that the RR entity has entered the dedicated mode.

On the mobile station side, the procedure is terminated when the establishment of the main signalling link is confirmed. The MM sublayer is informed that the RR entity has entered the dedicated mode.

3.3.1.1.4.1 Early classmark sending

Early classmark sending consists in the mobile station sending as early as possible after access a CLASSMARK CHANGE message to provide the network with additional classmark information. In addition a MS supporting UMTS sends a UTRAN Classmark Change message; an MS supporting CDMA2000 sends a CDMA2000 Classmark Change. When a CLASSMARK CHANGE message and one or more additional UMTS or CDMA2000 Classmark Change messages are to be sent, the CLASSMARK CHANGE message shall be sent first.

A mobile station which implements the « Controlled Early Classmark Sending » option shall perform the early classmark sending if and only if explicitly accepted by the network, as indicated in the last reception in the accessed cell of the SYSTEM INFORMATION TYPE 3 message.

A mobile station which implements support for multiple band shall also implement the « Controlled Early Classmark Sending » option.

A mobile station which implements the support of one or more 3G Radio Access Technology shall also implement the « Controlled Early Classmark Sending » option; in this case neither UTRAN CLASSMARK CHANGE nor CDMA2000 CLASSMARK CHANGE message shall be sent by the mobile if prohibited by the 3G Early Classmark Sending Restriction parameter in the last reception in the accessed cell of the SYSTEM INFORMATION TYPE 3 message.

A mobile station which implements the « multislot capability » option shall also implement the « Controlled Early Classmark Sending » option.

A mobile station that implements some form of treatment of UCS2 alphabet (see 3GPP TS 03.38) encoded character string (e.g., in short message, or in USSD string) may indicate so in the classmark. (An example is a Mobile Equipment able to display UCS2 encoded character string.) In such a case, it should also implement the « Controlled Early Classmark Sending » option. It is the mobile station responsibility to provide the UCS2 support information in due time. If the network needs this information and the mobile station did not provide it, the network may assume that the Mobile Equipment does not support UCS2.

A mobile station which implements the R-GSM band (see 3GPP TS 05.05) shall also implement the « Controlled Early Classmark Sending » option.

A mobile station which implements the extended measurement function shall also implement the « Controlled Early Classmark Sending » option.

A mobile station which implements the «GPRS» option shall also implement the « Controlled Early Classmark Sending » option.

A mobile station which implements the «SoLSA» option shall also implement the « Controlled Early Classmark Sending» option.

A mobile station which implements the «EDGE» option shall also implement the « Controlled Early Classmark Sending » option.

A mobile station which implements the «LCS» option shall also implement the « Controlled Early Classmark Sending» option.

A mobile station which implements the « Controlled Early Classmark Sending » option shall indicate it in the classmark (ES IND bit).

3.3.1.1.5 Abnormal cases

If a lower layer failure occurs on the mobile station side on the new channel before the successful establishment of the main signalling link, the allocated channels are released; the subsequent behaviour of the mobile station depends on the type of failure and previous actions.

- If the failure is due to information field mismatch in the contention resolution procedure, see section 3.1.5, and no repetition as described in this paragraph has been performed, the immediate assignment procedure shall be repeated.
- If the failure is due to any other reason or if a repetition triggered by a contention resolution failure has been performed. The mobile station returns to idle mode (RR connection establishment failure), transactions in progress are aborted and cell reselection then may take place.

If the information available in the mobile station, after the reception of an IMMEDIATE ASSIGNMENT message does not satisfactorily define a channel, an RR connection establishment failure has occurred.

If the Mobile Allocation IE indexes frequencies in more than one frequency band then a RR connection establishment failure has occurred.

If an IMMEDIATE ASSIGNMENT message indicates (a) channel(s) in a different frequency band to which the CHANNEL REQUEST message was sent then, if the frequency band is supported by the mobile station, the mobile station shall access the indicated channel(s) with the same power control level as used for the CHANNEL REQUEST message.

If an IMMEDIATE ASSIGNMENT message indicates a channel in non-supported frequency band then a RR connection establishment failure has occurred.

On the network side, if timer T3101 elapses before the main signalling link is established, the newly allocated channels are released and the request is forgotten. Note that the network has no means to distinguish repeated attempts from initial attempts from a mobile station.

3.3.1.2 Entering the group transmit mode: uplink access procedure

Only applicable for mobile stations supporting « VGCS transmit ».

The purpose of the uplink control procedure is to establish an RR connection on a VGCS channel between a mobile station which is in group receive mode on that channel and the network.

The mobile station enters the group transmit mode when a successful establishment of the RR connection is indicated. The channel mode assumed by the mobile station is the one derived from the channel description.

3.3.1.2.1 Mobile station side

3.3.1.2.1.1 Uplink investigation procedure

The mobile station in group receive mode shall consider the uplink as free if the last message indicating the uplink as being free was received less than 480 ms ago and if no UPLINK BUSY message has been received since the last message indicating the uplink as free.

On receipt of a request from the upper layer to access the uplink and if the uplink is not free, the mobile station starts the timer T3128.

If the uplink is free or becomes free before expiry of timer T3128, then the uplink investigation procedure is terminated, the mobile station shall stop T3128, and start the uplink access procedure.

NOTE: The start of the uplink access procedure is not subject to the access class of the mobile station.

If the uplink is not indicated free before the timer expires, the mobile station shall remain in the group receive mode and indicate a reject of the uplink request to the upper layer.

3.3.1.2.1.2 Uplink access procedure

The mobile station shall send UPLINK ACCESS messages on the voice group call channel with the appropriate establishment cause. The first UPLINK ACCESS message shall be transmitted by the mobile station with a random delay between 0 and 20ms. The UPLINK ACCESS messages shall be repeated after a further period of 100ms plus a random delay between 0 and 20ms.

The UPLINK ACCESS messages contain a random reference which is drawn randomly from a uniform probability distribution. The UPLINK ACCESS messages repetitions shall contain the same random reference as the one contained in the first message.

If an uplink identity code (UIC) of the current cell has been provided by the network in the UPLINK FREE message, the mobile station shall use this UIC IE for the coding of the UPLINK ACCESS messages (see 3GPP TS 05.03). If no UIC is provided, the mobile station shall use the BSIC received from the current cell, for instance from the initial synchronization.

Having sent the first UPLINK ACCESS message, the mobile station starts timer T3130. At expiry of timer T3130, the mobile station shall repeat the same procedure if the uplink is free. A maximum of three attempts is allowed and after that a rejection of the uplink request is indicated to the upper layers.

If no VGCS UPLINK GRANT or UPLINK BUSY message is received by the mobile station 480 ms after having sent the first UPLINK ACCESS message, the mobile station shall stop sending UPLINK ACCESS messages and wait in order to receive a VGCS UPLINK GRANT or UPLINK BUSY message.

On receipt of an VGCS UPLINK GRANT message corresponding to one of its UPLINK ACCESS messages, the mobile station stops T3130, stops sending UPLINK ACCESS messages, and establishes the main signalling link with an SABM containing the TALKER INDICATION message in the information field. Early classmark sending shall be performed if applicable. If a UA is received containing the message sent, the mobile station enters the group transmit mode and indicates the successful seizure of the uplink to the upper layer. If a UA is received with a message different from the message sent, the mobile station shall remain in the group receive mode and indicate the rejection of the uplink request to the upper layers.

When receiving an UPLINK BUSY message or a VGCS UPLINK GRANT message aimed to another mobile station (i.e. not corresponding to one of its UPLINK ACCESS messages), the mobile station stops T3130 and stops sending UPLINK ACCESS messages. The mobile shall remain in the group receive mode and shall indicate a rejection of the uplink request to the upper layers.

3.3.1.2.2 Network side

On receipt of an UPLINK ACCESS message the network shall perform, if necessary, contention resolution and grant the uplink to one mobile station by sending a VGCS UPLINK GRANT message to the mobile station in unacknowledged mode on the main signalling link. Furthermore, the network shall provide UPLINK BUSY messages on the main signalling link in all cells of the group call area. After having sent the first message, the network starts T3115. If the timer expires before the reception of a correctly decoded frame from the MS, the network repeats the VGCS UPLINK GRANT message to the mobile station, reset and restarts timer T3115. If the VGCS UPLINK GRANT message has been repeated N_{y2} times without a correctly decoded frame being received from the MS, the network shall stop sending VGCS UPLINK GRANT messages and provide an UPLINK FREE message on the main signalling channel and wait for a new UPLINK ACCESS message. The correct decoding of a frame means that the decoding algorithm and the error detection tests, if any, indicate no error.

After the data link layer is established, the RR entity of the network shall analyse the TALKER INDICATION message received from the mobile station, adapt the RR procedures to the new classmark if necessary and provide the mobile subscriber identity to the upper layer.

3.3.1.2.3 Abnormal cases

If a lower link failure has occurred or an indication of the release of the data link layer was provided by the lower layer and no RR release request was previously received from the upper layer, the network shall provide an UPLINK FREE message on the main signalling channel and wait for a new UPLINK ACCESS message.

3.3.1.3 Dedicated mode and GPRS

A mobile station whose Channel Request message contained a packet access establishment cause may receive an Immediate Assignment message to a Channel which is to be used in dedicated mode. A mobile station supporting the <<GPRS>> option shall obey this command. When establishing the main signalling link the information field in the SABM shall contain an RR INITIALISATION REQUEST message.

This message contains:

- TLLI;
- MS Classmark type 2;
- Ciphering Key Sequence Number;
- MAC Mode and Channel Coding Requested;
- Channel Request Description.

Following a successful contention resolution procedure, the mobile station shall implement the Early Classmark Sending option. Then, the upper layers in the mobile station shall wait for commands from the network, eg for the allocation of a GPRS resource.

While on the dedicated channel the mobile station shall obey the RR management procedures of 04.18, in particular the mobile station shall send measurement reports on the SACCH.

3.3.2 Paging procedure for RR connection establishment

The network can initiate the establishment of an RR connection by the paging procedure for RR connection establishment. Such a procedure can only be initiated by the network.

3.3.2.1 Paging initiation by the network

The network initiates the paging procedure to trigger RR connection establishment by broadcasting a paging request message on the appropriate paging subchannel on CCCH or PCCCH, and starts timer T3113. The paging subchannels on CCCH and PCCCH are specified in 3GPP TS 05.02 and 3GPP TS 03.13.

The network may also send paging related information on PACCH to a mobile station in packet transfer mode, see section 3.3.2.1.3.

The network may also broadcast paging related information on any voice broadcast or voice group call channel downlink.

3.3.2.1.1 Paging initiation using paging subchannel on CCCH

Paging initiation using the paging subchannel on CCCH is used when sending paging information to a mobile station in idle mode. It is also used when sending paging information to a mobile station in packet idle mode, if PCCCH is not present in the cell.

NOTE 1: There are 3 types of paging messages which may be used on CCCH:

- PAGING REQUEST TYPE 1;
- PAGING REQUEST TYPE 2; and
- PAGING REQUEST TYPE 3.

In a PAGING REQUEST message on CCCH to trigger RR connection establishment, the mobile station shall be identified by the TMSI (non-GPRS TMSI) or its IMSI. If the mobile station is identified by the TMSI, it shall proceed as specified in section 3.3.2.2.

If the mobile station in packet idle mode is identified by its IMSI, it shall parse the message for a corresponding *Packet Page Indication* field:

- if the *Packet Page Indication* field indicates a paging procedure for RR connection establishment, or the field is not present in the message, the mobile station shall proceed as specified in section 3.3.2.2;
- if the *Packet Page Indication* field indicates a packet paging procedure, the mobile station shall proceed as specified in section 3.5.1.2.

A PAGING REQUEST message on CCCH includes for each mobile station that is paged to trigger RR connection establishment an indication which defines how mobiles of different capabilities shall code the establishment cause field in the CHANNEL REQUEST message. The information received in the CHANNEL REQUEST can be used by the network to assign a suitable channel.

A PAGING REQUEST message on CCCH may include more than one mobile station identification.

A PAGING REQUEST TYPE 1 message on CCCH may have additionally a notification message coded in the P1 rest octets information element.

A PAGING REQUEST message on CCCH may also include priority levels related to the mobile station identifications. A mobile station in group receive mode supporting eMLPP shall take into account this information to decide whether to respond to this PAGING REQUEST and, if the call is answered, the mobile station shall store the priority level for the duration of the call. A mobile station not supporting eMLPP shall ignore this information element when received in a PAGING REQUEST message.

NOTE 2: A mobile station not supporting VGCS or VBS may ignore this information element when received in a PAGING REQUEST message, since the priority level is also provided in the SETUP message.

If VGCS or VBS is supported by the network and the network supports reduced NCH monitoring, messages sent on the PCH may also include an indication of the change of the information sent on the NCH (see section 3.3.3.2).

The choice of the message type depends on the number of mobile stations to be paged and of the types of identities that are used. The maximum number of paged mobile stations per message is 4 when using only TMSIs for identification of the mobile stations.

The mobile station in idle mode is required to receive and analyse the paging messages and immediate assignment messages sent on the paging subchannel corresponding to its paging subgroup, as specified in 3GPP TS 05.02.

NOTE 3: The possible immediate assignment messages are: the IMMEDIATE ASSIGNMENT, the IMMEDIATE ASSIGNMENT EXTENDED and the IMMEDIATE ASSIGNMENT REJECT messages.

The paging and immediate assignment type messages contain a page mode information element. This information element controls possible additional requirements on mobile stations belonging to the paging subgroup corresponding to the paging subchannel the message was sent on. This implies that a given mobile station shall take into account the page mode information element of any message sent on its own paging subchannel whatever the nature of this message (paging messages or immediate assignment messages). This further implies that the mobile station does not take into account page mode information element of messages sent on paging subchannels other than its own paging subchannel. The requirements yielded by the page mode information element are as follows:

- a) normal paging: no additional requirements;
- b) extended paging: the mobile station is required in addition to receive and analyse the next but one message on the PCH;
- c) paging reorganization: The mobile station shall receive all messages on the CCCH regardless of the BS-AG-BLKS-RES setting. It is required to receive all BCCH messages. When the mobile station receives the next message to its (possibly new) paging subgroup the subsequent action is defined in the page mode information element in that message;
- d) same as before: No change of page mode from the previous page mode.

Note that a mobile station takes into account the page mode information only in messages of its own paging subchannel whatever the currently applied requirements (a, b, c or d).

When the mobile station selects a new PCH, the initial page mode in the mobile station shall be set to paging reorganization. If a message in the paging subchannel is not received correctly, the message is ignored and the previous page mode is assumed.

3.3.2.1.2 Paging initiation using paging subchannel on PCCCH

Paging initiation using a paging subchannel on PCCCH, see 3GPP TS 04.60, applies when sending paging information to a mobile station in packet idle mode and PCCCH is provided in the cell.

The paging initiation procedure and the paging request message used on PCCCH are specified in 3GPP TS 04.60.

3.3.2.1.3 Paging initiation using PACCH

Paging initiation using PACCH, see 3GPP TS 04.60, applies to a mobile station in packet transfer mode.

The paging initiation procedure and the message used to carry paging related information on PACCH are specified in 3GPP TS 04.60.

3.3.2.2 Paging response

Upon receipt of a paging request message, or other message containing information to trigger the establishment of a RR connection, and if access to the network is allowed, the addressed mobile station shall, when camped on a cell as specified in 3GPP TS 23.022, initiate the immediate assignment procedure as specified in 3.3.1. The establishment of the main signalling link is then initiated by use of an SABM with information field containing the PAGING RESPONSE message (see section 3.1.5). The MM sublayer in the mobile station is informed that the RR entity has entered the dedicated mode.

Upon receipt of the PAGING RESPONSE message the network stops timer T3113. The MM sublayer in the network is informed that an RR connection exists.

3.3.2.3 Abnormal cases

Lower layer failure occurring during the immediate assignment procedure is treated as specified for that procedure.

If timer T3113 expires and a PAGING RESPONSE message has not been received, the network may repeat the paging request message and start timer T3113 again. The number of successive paging attempts is a network dependent choice.

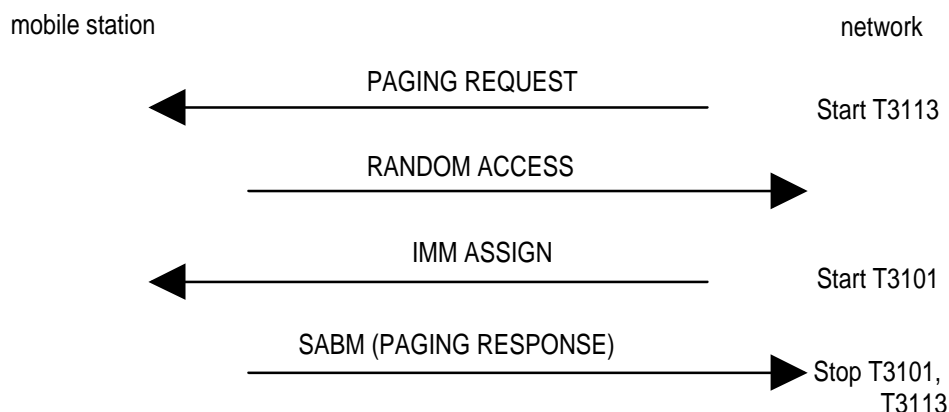

Figure 3.2/3GPP TS 04.18 Paging sequence

3.3.3 Notification procedure

The support of notification procedure is mandatory for mobile stations supporting « VGCS receive » and/or « VBS receive ».

The network informs the mobile station of starting or on-going voice broadcast calls and voice group calls with the notification procedure.

In cases where the mobile station has initiated a VGCS call, if the channel mode modify procedure is applied to turn the dedicated channel into a VGCS channel and ciphering may be applied for that call, in this case the network should suspend transmission of notification messages until ciphering with the group cipher key has started on the dedicated channel.

3.3.3.1 Notification of a call

The mobile station may receive a notification that a voice broadcast call or a voice group call is established. Notifications may be sent on the NCH, on the PCH, or on the FACCH when in dedicated mode or group receive mode. The presence of an NCH is indicated on the PCH in the Pi Rest Octets IE. A notification contains the group call reference and possibly other related information. This notification may be contained:

- in a NOTIFICATION/NCH message sent on the NCH to notify mobile stations of VBS or VGCS calls in the current cell, possibly together with a description of the related VBS or VGCS channel;
- in a NOTIFICATION/FACCH message sent in unacknowledged mode on the main DCCH to notify mobile stations in dedicated mode or on the main DCCH of a VGCS or VBS channel, of other VBS or VGCS calls in the current cell, possibly together with a description of the related VBS or VGCS channel;
- in the rest octets part of a PAGING REQUEST TYPE 1 message.

A mobile station supporting neither VGCS listening nor VBS listening may ignore the notifications sent on the NCH or PCH. It may also ignore the notifications sent on the main DCCH except that a RR-STATUS message shall be sent to the network with cause #97, "message not existent or not implemented".

Upon receipt of every notification message a mobile station supporting VGCS listening or VBS listening shall give an indication containing the notified group call reference(s) to upper layers in the mobile station which may then decide:

- not to react on the notification, or
- join the voice broadcast call or the voice group call, if needed after having stopped on going activities.

3.3.3.2 Joining a VGCS or VBS call

In order to join a VGCS or a VBS call the following procedures apply.

In this subclause, the term **notification** refers to the notification which has triggered the decision to join a VGCS or VBS call.

If the notification on the main DCCH concerns a VBS or VGCS in the current cell and does not contain a description of the VGCS or VBS channel, the mobile station shall read the corresponding notification on the NCH.

If the description of the VGCS or VBS channel was included in the notification for the current cell, RR connection establishment shall not be initiated, instead, the mobile station shall enter the group receive mode.

If no description for the VGCS or VBS channel is included in the notification, the mobile station shall establish a RR connection in dedicated mode in order to initiate the notification response procedure.

3.3.3.3 Reduced NCH monitoring mechanism

This section applies to mobile stations which read the NCH in idle mode in order to receive the notification messages for the voice broadcast call and the voice group call, which read the PCH to receive pagings and which aim at reducing the reception load.

A reduced NCH monitoring mechanism may be used on the NCH. When the mobile station in idle mode enters a cell and deduces from the BCCH that an NCH is present, it shall read the NCH until it has received at least two messages on the NCH indicating NLN, with the two last received NLN being identical. Then it may stop reading the NCH until it receives on the PCH an NLN(PCH) different from the last previously received NLN or on the SACCH an NLN(SACCH) different from the last previously received NLN..

A mobile is able to determine the reduced NCH monitoring is active in the network if it receives an NLN in any message. Once received, the mobile shall assume that NCH monitoring is active for a certain period of time which is not specified.

For this, parameters are provided:

- **NLN:** Notification List Number;
- The NLN is a modulo 4 counter which is changed every time a notification for a new VGCS or VBS call is started on the NCH. If the reduced NCH monitoring is indicated, the NLN provides information on new notifications provided on the NCH.
- NLN status :
The NLN status is a single bit field which indicates the status of the content of the NOTIFICATION/NCH messages for a particular NLN value. A change of the NLN status field indicates a change of information on the NCH which is not related to new calls (e.g. There may have been a release of a previous notified call or change of priority, etc ...).

If the reduced NCH monitoring is active in the network, the network has to provide both NLN and NLN status parameters.

These parameters may be provided on the NCH, PCH and SACCH:

NLN(NCH):	Notification List Number (received on the NCH)
NLN(PCH):	Notification List Number (received on the PCH)
NLN(SACCH):	Notification List Number (received on the SACCH)
NLN status(PCH):	NLN status (received on the PCH)
NLN status(SACCH):	NLN status (received on the SACCH)

A mobile station supporting neither VGCS listening nor VBS listening shall ignore the NLN(NCH),NLN(PCH), NLN(SACCH) and NLN status fields.

If a mobile station (supporting VGCS listening and/or VBS listening) receives a NLN parameters on the NLN(PCH) or NLN(SACCH) field different from the last received NLN value it shall read the NCH until it has received at least two messages on the NCH indicating NLN with the two last received NLN being identical.

If a message in the paging subchannel is not received correctly, or if a paging message does not contain the information on the notification status, the mobile station shall read the NCH until it has received at least two messages on the NCH indicating NLN, with the two last received NLN being identical.

3.3.3.4 Notification response procedure

In order to initiate the notification response procedure, if access to the network is allowed, the mobile station shall, when camped on a cell as specified in 3GPP TS 03.22, initiate the immediate assignment procedure as specified in 3.3.1. The establishment of the main signalling link is then initiated by use of an SABM with information field containing the NOTIFICATION RESPONSE message (see section 3.1.5). The MM sublayer in the mobile station is informed that the RR entity has entered the dedicated mode.

Upon receipt of the NOTIFICATION RESPONSE message the network stops timer T3101. The MM sublayer in the network may be informed that an RR connection exists; in this case, the MM sublayer may initiate MM common procedures.

The network may use the dedicated connection to order the mobile station to enter the group receive mode.

3.4 Procedures in dedicated mode and in group transmit mode

Procedures described in this section apply to the dedicated mode and/or the group transmit mode.

Those procedures which are specific for group transmit mode or refer to transitions to the group transmit mode are only applicable for mobile stations supporting VGCS talking.

Direct transition between dedicated mode and group transmit mode is possible in both directions by use of the following procedures:

- Channel assignment procedure;
- Handover procedure;

- Channel mode modify procedure.

3.4.1 SACCH procedures

3.4.1.1 General

In dedicated mode and group transmit mode, the SACCH is used in signalling layer at least for measurement results transmission from the mobile station.

The SACCH has the particularity that continuous transmission must occur in both directions at least on the channel carrying the main signalling link. For that purpose, in the mobile station to network direction, measurement result messages are sent at each possible occasion when nothing else has to be sent (see section 3.4.1.2). Similarly, SYSTEM INFORMATION TYPE 5, 6 and optionally 5bis and 5ter messages are sent in the network to mobile station direction in UI frames when nothing else has to be sent.

The network may in addition send MEASUREMENT INFORMATION messages on the SACCH, which may order the MS to use the enhanced measurement report.

In a multislot configuration the SYSTEM INFORMATION TYPE 5, 6 and optionally 5bis, 5ter and MEASUREMENT INFORMATION messages shall be sent on the SACCH associated with the channel carrying the main signalling link.

In a multislot configuration the mobile station shall ignore all messages received on the SACCH(s) that are not associated with the channel carrying the main signalling link.

On a VGCS channel, the network may send additional or alternative system information messages for both mobile stations in group transmit mode and those in group receive mode (see section 3.4.15.2.1).

A mobile station with extended measurement capabilities which receives EXTENDED MEASUREMENT ORDER (EMO) messages on the SACCH, shall perform and report extended measurements, see section 3.4.1.3.

The SYSTEM INFORMATION TYPE 5bis message shall be sent if and only if the EXT IND bit in the Neighbour Cell Description information element in both the SYSTEM INFORMATION TYPE 5 and TYPE 5bis messages indicates that each information element only carries part of the BA.

A GSM 900 mobile station which only supports the primary GSM band P-GSM 900 (cf. 3GPP TS 05.05) may consider the EXT-IND bit in the Neighbour Cells Description IE in the SYSTEM INFORMATION TYPE 5 message bit as a spare bit, assume that the information element carries the complete BA, and ignore any SYSTEM INFORMATION TYPE 5bis messages.

NOTE: The network should take into account limitations of certain mobile stations to understand SYSTEM INFORMATION TYPE 5ter and TYPE 5bis messages, the EXT-IND bit in the Neighbour Cells Description, and formats used in the Neighbour Cells Description information element and Cell Channel Description information element used in SYSTEM INFORMATION messages, see section 10.5.2.1b, and section 10.5.2.22.

As specified in 3GPP TS 05.08, problems occurring in the reception of SACCH frames are interpreted as a loss of communication means and appropriate procedures are then triggered as specified in section 3.4.13.

3.4.1.2 Measurement report and Enhanced Measurement Report

When in dedicated mode or group transmit mode, the mobile station regularly sends either MEASUREMENT REPORT or ENHANCED MEASUREMENT REPORT messages to the network. These messages contain measurement results about reception characteristics from the current cell and from neighbour cells. The BA (list) which is the basis for the measurements is derived from information received on the BCCH in System Information 2 and optionally 2bis and/or 2ter and on the SACCH in System Information 5 and optionally 5bis and/or 5ter. The MEASUREMENT INFORMATION message may add information for the GSM Neighbour Cell List and provide 3G Neighbour Cell list. The SI2 quater message may provide the 3G Neighbour Cell list. The Mobile Station shall use ENHANCED MEASUREMENT REPORT messages instead of MEASUREMENT REPORT messages if that is indicated by the parameter Report_Type and if at least one BSIC is allocated to each BA (list) frequency.

In addition, the MS which implements ECSD options shall use fast inband procedure for downlink quality reporting if the use of such procedure has been ordered by the BSC.

When the information is received in more than one message the mobile station shall only combine information relating to the BA (list) from messages received on the same channel and indicating the same value of the BCCH allocation sequence number without any message indicating a different value of the BCCH allocation sequence number received in between. If neighbouring cell information for the serving cell is not available, the mobile station indicates this in the MEASUREMENT REPORT message. These measurement results are obtained as specified in 3GPP TS 05.08.

These messages are sent on the slow ACCH, in unacknowledged mode.

If no other message is scheduled on the SACCH at the instant when a layer 2 frame is due to be sent, then the mobile station shall send a MEASUREMENT REPORT message or an ENHANCED MEASUREMENT REPORT or an extended measurement report message (see section 3.4.1.3) in that frame. The interval between two successive layer 2 frames containing measurement report messages shall not exceed one layer 2 frame.

3.4.1.2.1 The Use of parameters from the Measurement Information/SI2quarter messages

Parameters from the Measurement Information or SI2quarter messages allow to build lists which is used for Measurement reporting and Enhanced Measurement reporting.

A full set/all instances of MEASUREMENT INFORMATION (respectively: SI2quarter) messages is defined by a number of different instances indicated by the parameter MI_COUNT (respectively SI2quarter_COUNT). Two different instances of MEASUREMENT INFORMATION (respectively: SI2quarter) messages are two MEASUREMENT INFORMATION (respectively: SI2quarter) messages with different MI_INDEX (respectively: SI2quarter_INDEX) parameter values.

In Idle mode a multi-RAT MS shall read and decode a full set of SI2quarter messages to form a 3G Neighbour Cell list (each instance can be used as received). When the 3G-BA-IND parameter is changed in idle mode, the MS shall re-read all instances and rebuild the 3G Neighbour Cell list. This list shall then be used for reporting when the MS enters dedicated mode, until the MS has received a given number of instances of MEASUREMENT INFORMATION messages that contain 3G Neighbour Cell Description. This number of instances is defined by the 3G-WAIT parameter. When the 3G-BA-IND parameter is changed when on SACCH, the MS shall also re-read all instances, rebuild the 3G Neighbour Cell list, and use the new list for reporting based on the parameter 3G-Wait. For the GSM neighbour cell list the MS shall combine the BA (list) received in SI5/SI5bis/SI5ter with the BSIC list received in one or more instances of the MEASUREMENT INFORMATION message. When the BA-IND is changed the MS shall rebuild the combined list (the BSIC list shall also be rebuilt). When the BA-IND is changed the MS shall also re-read the Real Time Differences parameters and Rep_Priority parameters in all instances.

If the MP_CHANGE_MARK parameter is changed after a full set of MEASUREMENT INFORMATION message instances is received, the MS shall re-read and decode the Real Time differences, Rep_Priority, Measurement Parameters and 3G Measurement Parameters in all instances. The MS shall start using the parameters as soon as they have been received. In the case that not all the parameters have been received in a full set of instances, then the default values shall be used.

3.4.1.2.1.1 Deriving the 3G Neighbour Cell list from the 3G Neighbour Cell Description:

This applies only to a multi-RAT MS. One or more instances of the Measurement Information message or SI2quarter message may provide 3G Neighbour Cell Description information. This is used to build the 3G Neighbour Cell list. The 3G Neighbour Cell list may contain up to 96 3G Neighbour Cells.

Building of the 3G Neighbour Cell list:

For each 3G Neighbour Cell Description received:

The order of indices is FDD Cell indices followed by the TDD Cell indices followed by CDMA 2000 Cell indices. The ordering of Cell indices within the same radio Access Technology shall be based on:

- 1 For UMTS FDD: FDD ARFCNs are included as received in the order of each 3G Neighbour Cell description. Then for each FDD ARFCN, the concatenated Scrambling codes / Time Diversity parameters are ordered by increasing numbers.
- 2 For UMTS TDD: TDD ARFCNs are included as received in the order of each 3G Neighbour Cell description. Then for each TDD ARFCN, the concatenated Cell Parameter / Sync Case / Time diversity parameters are ordered by increasing numbers.

- 3 For CDMA 2000: Parameters defining each cell are included as received in the order of each 3G Neighbour Cell description.

Any *3G Neighbour Cell Description* received is added to the 3G Neighbour Cell list, starting with the index equal to the parameter `Index_Start_3G`. If this parameter is not present then the value 0 shall be used.

If the MS receives some *3G Neighbour Cell Description* on some non-supported frequencies or Radio Access Technologies, this shall not be considered as an error. However, indices in the 3G Neighbour Cell list are incremented accordingly.

3.4.1.2.1.2 Deriving the GSM Neighbour Cell list from the BSICs and the BA (list)

One or more instances of the Measurement Information message may provide BSIC information. This is used to build the GSM Neighbour Cell list. The GSM Neighbour Cell list may contain up to 96 Neighbour Cells.

The BSICs are associated to the frequencies in the BA (list). The BSICs may be received before the corresponding BA (list). The first BSIC in each instance applies to the frequency in the BA (list) referenced by the parameter `BA_Index_Start_BSIC`. For each successive BSIC, one bit indicates if the BSIC applies to the same frequency as the previous BSIC or to the next frequency in the BA (list), as defined in sub-clause 9.1.54, Measurement Information message.

3.4.1.2.1.3 Deriving the Neighbour Cell list from the GSM Neighbour Cell list and the 3G Neighbour Cell list

For report with the ENHANCED MEASUREMENT REPORT message, the Neighbour Cell list is the concatenation of the GSM Neighbour Cell list and the 3G Neighbour Cell list (if any). In this concatenation the value of the parameter `Absolute_Index_Start_EMR` is added to the 3G Neighbour Cell list indices. The Neighbour Cell list may contain up to 96 Neighbour Cells.

NOTE: For report with the MEASUREMENT REPORT MESSAGE, the concatenated list is not used. Instead, the two lists are used separately, as defined in sub-clause 10.5.2.20, 'Measurement Results'.

3.4.1.2.1.4 Real Time Differences

One or more instances of the Measurement Information message may provide Real Time Difference information. This is used to build the Real Time Difference list. The Real Time Difference list may contain up to 96 Real Time Difference parameters.

Each frequency in the BA (list) can be associated to 0, 1 or more Real Time Difference parameters. The Real Time Difference parameters may be received before the corresponding BA (list). The parameter(s) `BA_Index_Start_RTD` in the structure indicate(s) the index of the frequency in the BA (list) to be taken as a starting reference. A structure is included for each frequency referenced. Each of those structures indicates if 0, 1 or more RTD parameters are present for this frequency. If the last frequencies in the BA (list) do not contain RTD information, the structure may not include the remaining frequencies, see sub-clause 9.1.54 'Measurement Information message'.

3.4.1.2.1.5 Report Priority Description

Report Priority information can be received in one instance of the MEASUREMENT INFORMATION message. Each `Rep_Priority` bit of this field relates to indices of the Neighbour Cell list, starting with index 0. The Report Priority information may be received before the corresponding Neighbour Cell list.

Indices exceeding the value 95 shall be ignored. If there are less indices than the number of Neighbour Cells, the value 0 shall be assumed for the missing bits.

3.4.1.2.1.6 GPRS Report Priority Description, GPRS BSIC Description, GPRS Real Time Differences Description, GPRS Measurement Parameters, GPRS 3G Measurement Parameters and NC Measurement Parameters

This set of information may be received in SI2quater message(s) and is used for GPRS neighbour cell measurement or enhanced (NC) Measurement reporting when the cell has no PBCCH allocated, see 3GPP TS 04.60 sub-clause 5.6 ("Measurement reports"). The use of the parameters is similar to parameters without the term "GPRS".

3.4.1.3 Extended measurement report \$(MAFA)\$

Only applicable to mobile stations which support extended measurement.

When in dedicated mode or group transmit mode, a mobile station may receive an EXTENDED MEASUREMENT ORDER (EMO) message, from the network. The mobile station shall then, as defined in 3GPP TS 05.08, for one reporting period perform measurements on the frequencies specified by this EMO message. The mobile station shall thereafter send an EXTENDED MEASUREMENT REPORT message. This message contains the measurement results as defined in 3GPP TS 05.08.

If the mobile station has not started to send its EXTENDED MEASUREMENT REPORT within 10 seconds after the reception of the EMO message, no EXTENDED MEASUREMENT REPORT shall be sent. The mobile station shall after a successful channel change abort any pending measurements or reporting related to an EMO message received on the old channel.

If a mobile station receives an EMO message indicating the same value of the sequence code as an EMO message received earlier on the same channel without having received any EMO message indicating a different value of the sequence code in between, that EMO message shall be ignored. If the mobile station, before the reporting related to an EMO message has started, receives a new EMO message with a different value of the sequence code, any pending measurements or reporting related to the earlier EMO message shall be aborted and the new message treated.

The EMO message and the EXTENDED MEASUREMENT REPORT message are sent on the SACCH, in unacknowledged mode.

3.4.2 Transfer of messages and link layer service provision

When in dedicated mode or in group transmit mode, upper layers can send messages in multiframe or unacknowledged mode on SAPI 0.

Moreover, but only when in dedicated mode, upper layers have access to the full link layer services for SAPIs other than 0, with the exception of the error indication and local end release that are directly treated by the RR sublayer, as specified in particular places of section 3.

3.4.3 Channel assignment procedure

In dedicated mode, dual transfer mode or in group transmit mode, an intracell change of channel can be requested by upper layers for changing the channel type, or decided by the RR sublayer, e.g. for an internal handover. This change may be performed through the dedicated channel assignment procedure.

The purpose of the channel assignment procedure is to completely modify the physical channel configuration of the mobile station without frequency redefinition or change in synchronization while staying in the same cell.

This procedure shall not be used for changing between dependent configurations, i.e. those sharing Radio Resource for the main signalling link. An example of dependent channels is a full rate channel and one of the corresponding half rate channels. In multislot operation however, it is allowed to use the same timeslots before and after the assignment, as long as the main signalling link has been changed. The only procedures provided for changing between dependent configurations for the main signalling link are the additional assignment and the partial release procedures.

The channel assignment procedure happens only in dedicated mode, dual transfer mode and in group transmit mode. This procedure cannot be used in the idle mode; in this case the immediate assignment procedure is used.

The channel assignment procedure includes:

- the suspension of normal operation except for RR management (layer 3);
- the release of the main signalling link, and of the other data links as defined in section 3.1.4, the disconnection of TCHs if any, and the release of packet resources, if in dual transfer mode;
- the deactivation of previously assigned channels (layer 1);
- the activation of the new channels and their connection if applicable;
- The triggering of the establishment of the data link connections for SAPI = 0.

The channel assignment procedure is always initiated by the network.

3.4.3.1 Channel assignment initiation

The network initiates the channel assignment procedure by sending an ASSIGNMENT COMMAND message to the mobile station on the main signalling link. It then starts timer T3107.

NOTE: The network should take into account limitations of certain mobile stations to understand formats used in the Frequency List IE and Cell Channel Description IE used in the ASSIGNMENT COMMAND message, see section 10.5.2.13 and section 10.5.2.1b.

When sending this message on the network side, and when receiving it on the mobile station side, all transmission of signalling layer messages except for those RR messages needed for this procedure and for abnormal cases is suspended until resumption is indicated. These RR messages can be deduced from sections 3.4.3 and 8.8 Radio Resource management.

Upon receipt of the ASSIGNMENT COMMAND message, the mobile station initiates a local end release of link layer connections and packet resources, if in dual transfer mode, disconnects the physical channels, commands the switching to the assigned channels and initiates the establishment of lower layer connections (this includes the activation of the channels, their connection and the establishment of the main signalling links).

The ASSIGNMENT COMMAND message contains the description of the new configuration, including for the multislot configuration and the TCH/H + TCH/H + ACCHs configuration, the exact ACCHs to be used and a power command. The power level defined in this power command shall be used by the mobile station for the initial power on the new channel(s). It shall not affect the power used on the old channel(s). The message may also contain definitions of the channel mode to be applied for one or several channel sets. If a previously undefined channel set is defined by the ASSIGNMENT COMMAND message, a definition of the channel mode for the new channel set shall be included in the message.

If the channel mode to be applied corresponds to a multi-rate speech codec, the ASSIGNMENT COMMAND message may contain the MultiRate Configuration IE, which defines the set of codec modes and related information to use on the new channel. For an initial assignment of a multi-rate speech codec, the MS shall expect in the ASSIGNMENT COMMAND the MultiRate Configuration IE. After reception of the ASSIGNMENT COMMAND, the mobile station shall use the Initial Codec Mode specified in the MultiRate Configuration IE, if present, or apply the implicit rule defined in 3GPP TS 05.09.

An ASSIGNMENT COMMAND message may indicate a frequency change in progress, with a starting time and possibly alternative channel descriptions.

In the case of the reception of an ASSIGNMENT COMMAND message which contains only the description of a channel to be used after the starting time, the mobile station shall wait up to the starting time before accessing the channel. If the starting time has already elapsed, the mobile shall access the channel as an immediate reaction to the reception of the message (see 3GPP TS 05.10 for the timing constraints).

If the message contains both the description of a channel to be used after the indicated time and of a channel to be used before, the mobile station accesses a channel as an immediate reaction to the reception of the message. If the moment the mobile station is ready to access is before the indicated time, the mobile station accesses the channels described for before the starting time. The mobile station then changes to the channel described for after the starting time at the indicated time. New parameters can be frequency list, MAIO and HSN. Other parameters describing the allocated channels must be identical to the parameters described for before the starting time. If the moment the mobile station is ready to access is after the starting time, the mobile station accesses the channel described for after the starting time.

If frequency hopping is applied, the cell allocation if present in the message is used to decode the mobile allocation. If the cell allocation is not included, the mobile station uses its current cell allocation, the current CA is the last CA received on the BCCH. Afterward, the current CA may be changed by some messages sent on the main signalling link containing a CA (the possible messages are: ASSIGNMENT COMMAND, HANDOVER COMMAND and FREQUENCY REDEFINITION). Note that there are cases in which the current CA is undefined, see section 3.4.3.3.

The ASSIGNMENT COMMAND message may contain a cipher mode setting IE. In that case, this ciphering mode has to be applied on the new channel. If no such information is present, the ciphering mode is the same as on the previous channel. In either case the ciphering key shall not be changed. The ASSIGNMENT COMMAND message shall not contain a cipher mode setting IE that indicates "start ciphering" unless a CIPHERING MODE COMMAND message has been transmitted earlier in the RR connection: if such an ASSIGNMENT COMMAND message is received it shall

be regarded as erroneous, an ASSIGNMENT FAILURE with cause "Protocol error unspecified" message shall be returned immediately, and no further action taken.

In a voice group call, the ASSIGNMENT COMMAND message may contain a VGCS target mode information element defining which RR mode is to be used on the new channel (i.e. dedicated mode or group transmit mode). If this information element is not present, the mode shall be assumed to be the same as on the previous channel. The VGCS target mode information element shall also indicate the group cipher key number for the group cipher key to be used on the new channel or if the new channel is non ciphered. If the information element is not present, the ciphering mode and group cipher key shall be the same as on the previous channel. Mobile stations not supporting VGCS talking shall ignore the ASSIGNMENT COMMAND message if the VGCS target mode information element is included in the message and shall send an RR STATUS message to the network with cause #96. If a VGCS target mode information element and a cipher mode setting information element is included in the same message, then a mobile station supporting VGCS talking mobile shall regard the ASSIGNMENT COMMAND message as erroneous, an ASSIGNMENT FAILURE message with cause "Protocol error unspecified" shall be returned immediately, and no further action taken.

3.4.3.2 Assignment completion

After the main signalling link is successfully established, the mobile station returns an ASSIGNMENT COMPLETE message, specifying cause "normal event", to the network on the main DCCH.

The sending of this message on the mobile station side and its receipt on the network side allow the resumption of the transmission of signalling layer messages other than those belonging to RR management.

At the receipt of the ASSIGNMENT COMPLETE message, the network releases the previously allocated resources and stops timer T3107.

3.4.3.3 Abnormal cases

If the mobile station has no current CA and if it needs a CA to analyse the ASSIGNMENT COMMAND message, it stays on the current channel(s) and sends an ASSIGNMENT FAILURE message with cause "no cell allocation available".

If the ASSIGNMENT COMMAND message instructs the mobile station to use a Channel Description or Mode that it does not support, or if the Channel Mode to use is not defined for all channel sets, then the mobile station shall return an ASSIGNMENT FAILURE message with cause "channel mode unacceptable", and the mobile station shall remain on the current channel(s) and uses the old Channel Description or Channel Mode(s).

If the mobile station receives an ASSIGNMENT COMMAND message containing an inconsistent MultiRate Configuration IE, then the mobile station shall return an ASSIGNMENT FAILURE message with cause "channel mode unacceptable", and the mobile station shall remain on the current channel(s) and uses the old Channel Description or Channel Mode(s).

If during the initial assignment of the multirate speech the mobile station receives an ASSIGNMENT COMMAND message and the MultiRate Configuration IE is not present, then the mobile station shall return an ASSIGNMENT FAILURE message with cause "channel mode unacceptable", and the mobile station shall remain on the current channel(s) and uses the old Channel Description or Channel Mode(s).

If the ASSIGNMENT COMMAND message instructs the mobile station to use a frequency that it is not capable of, then the mobile station shall return an ASSIGNMENT FAILURE message with cause "frequency not implemented", and the mobile station shall remain on the current channel(s).

If the mobile station receives an ASSIGNMENT COMMAND message with a Frequency List IE indicating frequencies that are not all in one band, then the mobile station shall stay on the current channel(s) and send an ASSIGNMENT FAILURE message with cause "frequency not implemented". If the mobile station receives an ASSIGNMENT COMMAND message with a Mobile Allocation IE indexing frequencies that are not all in one band, then the mobile station shall stay on the current channel(s) and send an ASSIGNMENT FAILURE message with cause "frequency not implemented".

NOTE: An ASSIGNMENT COMMAND message sent to a multi band mobile station shall not be considered invalid because it indicates frequencies that are all in a different frequency band to that of the current channel.

On the mobile station side, if a lower layer failure happens on the new channel before the ASSIGNMENT COMPLETE message has been sent, the mobile station deactivates the new channels, reactivates the old channels, reconnects the TCHs if any and triggers the establishment of the main signalling link. It then sends a ASSIGNMENT FAILURE message, cause "protocol error unspecified" on the main DCCH and resumes the normal operation, as if no assignment attempt had occurred. The operational parameters (e.g. ciphering mode) when returning on the old channel are those applied before the procedure.

When receiving the ASSIGNMENT FAILURE message, the network stops T3107.

If a lower layer failure happens while attempting to connect back to the old channels, the radio link failure procedure is applied (see section 3.4.13.2 for dedicated mode and 3.4.13.5 for group transmit mode).

On the network side, if timer T3107 elapses before either the ASSIGNMENT COMPLETE message has been received on the new channels or an ASSIGNMENT FAILURE message is received on the old channels, the old channels and the new channels are released if they both were dedicated channels and, unless the mobile station has re-established the call, all contexts related to the connections with that mobile station are cleared. If one of the channels was a VGCS channel, it shall be maintained and the uplink shall be set free. If both channels were VGCS channels, the network shall maintain one of the channels and the uplink shall be set free.

On the network side, lower layer failure occurring on the old channels after the sending of the ASSIGNMENT COMMAND message are ignored. Lower layer failures occurring after the receipt of the SABM Frame on the new main signalling link are treated following the general rules (cf. section 3.5.2).

3.4.4 Handover procedure

In dedicated mode, dual transfer mode or group transmit mode, an intercell or intracell change of channel(s) can be requested by the network RR sublayer. This change may be performed through the handover procedure

NOTE: The decision to do a handover and the choice of the new cell is out of the scope of this technical specification.

The purpose of the handover procedure is to completely modify the channels allocated to the mobile station e.g. when the cell is changed. A change in the channel configuration nature is possible. This procedure is used only while in dedicated mode, dual transfer mode or group transmit mode.

The handover procedure is also used by Location Services as described in 3GPP TS 23.071.

The handover procedure shall not be used for changing between dependent configurations (see section 3.4.3). An exception to this is when the handover procedure is used by Location Services. In this case the mobile may be commanded to attempt a handover to the same channel as currently assigned to the MS. The MS shall attempt to perform a handover to this unchanged channel, which includes the transmission of access bursts.

The handover procedure includes:

- The suspension of normal operation except for RR management (layer 3).
- The disconnection of the main signalling link, and of the other links via local end release (layer 2), and the disconnection of the TCH(s) if any.
- The abortion of the packet resources (see 3GPP TS 04.60), if in class A mode of operation.
- The disconnection and the deactivation of previously assigned channels and their release (layer 1).
- The activation of the new channels, and their connection if applicable.
- The triggering of the establishment of data link connection for SAPI = 0 on the new channels.

The handover procedure is always initiated by the network.

3.4.4.1 Handover initiation

The network initiates the handover procedure by sending a HANDOVER COMMAND message to the mobile station on the main DCCH. It then starts timer T3103.

NOTE: The network should take into account limitations of certain mobile stations to understand formats used in the Frequency List IE, Frequency Short List IE, and Cell Channel Description IE used in the HANOVER COMMAND message, see section 10.5.2.13, section 10.5.2.14, and section 10.5.2.1b.

When sending this message on the network side, and when receiving it on the mobile station side, all transmission of signalling layer messages except for those RR messages needed for this procedure and for abnormal cases, is suspended until resuming is indicated. These RR messages can be deduced from section 3.4.3 and 8.5.1 "Radio Resource management".

Upon receipt of the HANOVER COMMAND message, the mobile station initiates, as described in section 3.1.4, the release of link layer connections, disconnects the physical channels channels (including the packet resources, if in class A mode of operation), commands the switching to the assigned channels and initiates the establishment of lower layer connections (this includes the activation of the channels, their connection and the establishment of the data links).

The HANOVER COMMAND message contains:

- The characteristics of the new channels, including for the multislot configuration and the TCH/H + TCH/H + ACCHs configuration the exact ACCHs to be used. The message may also contain definitions of the channel mode to be applied for one or several channel sets. If a previously undefined channel set is defined by the HANOVER COMMAND message, a definition of the channel mode for the new channel set shall be included in the message.
- The characteristics of the new cell that are necessary to successfully communicate (e.g. frequency list in the case of slow frequency hopping), including the data that allows the mobile station to use the pre-knowledge about synchronization it acquires by the measurement process (i.e. BSIC + BCCH frequency).
- A power command (cf. 3GPP TS 05.08). The power level defined in this power command shall be used by the mobile station for the initial power on the new channel(s). It shall not affect the power used on the old channel(s).
- An indication of the physical channel establishment procedure to be used.
- A handover reference, used as specified in the following section. The choice of the handover reference by the network is out of the scope of this specification and left to the manufacturers.
- Optionally a timing advance to be used on the new cell.
- Optionally a cipher mode setting. In that case, this ciphering mode has to be applied on the new channel. If no such information is present, the ciphering mode is the same as on the previous channel. In either case the ciphering key shall not be changed. The HANOVER COMMAND message shall not contain a cipher mode setting IE that indicates "start ciphering" unless a CIPHERING MODE COMMAND message has been transmitted previously in this instance of the dedicated mode: if such a HANOVER COMMAND message is received it shall be regarded as erroneous, a HANOVER FAILURE message with cause "Protocol error unspecified" shall be returned immediately, and no further action taken.
- Optionally, in a voice group call, a VGCS target mode information element defining which RR mode is to be used on the new channel (i.e. dedicated mode or group transmit mode). If this information element is not present, the mode shall be assumed to be the same as on the previous channel. The VGCS target mode information element shall also indicate the group cipher key number for the group cipher key to be used on the new channel or if the new channel is non ciphered. If the information element is not present, the ciphering mode and ciphering key shall be the same as on the previous channel. Mobile stations not supporting VGCS talking shall ignore the HANOVER COMMAND message if the VGCS target mode information element is included in the message and shall send an RR STATUS message to the network with cause #96. If a VGCS target mode information element and a cipher mode setting information element is included in the same message, then a mobile station supporting VGCS talking shall regard the HANOVER COMMAND message as erroneous, an HANOVER FAILURE message with cause "Protocol error unspecified" shall be returned immediately, and no further action taken.
- Optionally, when the channel mode indicates that a multi-rate speech codec must be applied, the MultiRate configuration to be used in the new cell. The MultiRate Configuration IE defines the set of codec mode and related information to use after the handover. When accessing the new channel, the mobile station shall use for the Initial Codec Mode the mode specified in the MultiRate Configuration IE, if present, or apply by default the implicit rule defined in 3GPP TS 05.09.

In addition, a HANOVER COMMAND message may indicate a frequency change in progress, with a starting time and possibly alternative channel descriptions.

In the case of the reception of a HANOVER COMMAND message which contains only the description of a channel to be used after the starting time, the mobile station shall wait up to the starting time before accessing the channel. If the starting time has already elapsed, the mobile shall access the channel as an immediate reaction to the reception of the message (see 3GPP TS 05.10 for the timing constraints).

If the message contains both the description of a channel to be used after the indicated time and of a channel to be used before, the mobile station accesses a channel as an immediate reaction to the reception of the message. If the moment the mobile station is ready to access is before the indicated time, the mobile station accesses the channels described for before the starting time. The mobile station then changes to the channel described for after the starting time at the indicated time. New parameters can be frequency list, MAIO and HSN. Other parameters describing the allocated channels must be identical to the parameters described for before the starting time. If the moment the mobile station is ready to access is after the starting time, the mobile station accesses the channel described for after the starting time.

If the channel mode indicates that a multi-rate speech codec must be applied, and the MultiRateConfiguration IE is not included in the HANOVER COMMAND message, then the mobile station shall assume that the MultiRateconfiguration has not changed. For the Initial Codec Mode, the mobile station shall use the previously received Initial Codec Mode, if any, or apply by default the implicit rule defined in 3GPP TS 05.09.

3.4.4.2 Physical channel establishment

Four procedures are defined. The support of three of them is mandatory in the mobile station. The pseudo-synchronization case is optional in the mobile station. A pseudo-synchronized handover can be commanded only to a mobile station that can support it, as indicated in the classmark.

3.4.4.2.1 Finely synchronized cell case

If the mobile station knows that the timing advance with the new cell is not out of range, i.e. smaller than or equal to the maximum timing advance that can be coded as specified in 3GPP TS 04.04, or if the new cell does accept out of range timing advance as indicated in the HANOVER COMMAND message, the mobile station proceeds as follows.

After having switched to the assigned channels, the mobile station sends four times the HANOVER ACCESS message in four successive layer 1 frames on the main DCCH. This message is sent in an access burst. Its content is reduced to the handover reference information element. The transmission of these four messages is optional if so indicated by the network in the HANOVER COMMAND message.

Before completion of the 4 access bursts on the DCCH, additional access bursts may also be sent on the SACCH.

In those cells that support extended TA values if TA value in new cell is greater than 63 and the HANOVER COMMAND message indicates that the transmission of four HANOVER ACCESS messages is optional the MS shall not transmit these four messages. MS shall not send additional bursts on the SACCH.

It then activates the channels in sending and receiving mode and connects the channels if need be.

If applicable, ciphering is immediately started . The access bursts are not ciphered.

3.4.4.2.2 Non synchronized cell case

After having switched to the assigned channels, the mobile station starts repeating the HANOVER ACCESS message in successive layer 1 frames on the main DCCH and optionally on the SACCH. This message is sent in an access burst. Its content is reduced to the handover reference information element. The mobile station starts timer T3124 at the start point of the timeslot in which the HANOVER ACCESS message is sent the first time on the main DCCH.

The mobile station then activates the channels in receiving mode and connects the channels if need be (only for reception).

If applicable, deciphering is then immediately started . The access bursts are not ciphered.

When the network has the RF characteristics that are necessary, it sends in unacknowledged mode a PHYSICAL INFORMATION message to the mobile station on the main DCCH. If applicable, ciphering and deciphering is immediately started (i.e., before even the reception of a correct access burst), and the message is sent enciphered.

The PHYSICAL INFORMATION message contains various physical layer related information, allowing a proper transmission by the mobile station.

When sending the PHYSICAL INFORMATION message, the network starts timer T3105. If this timer times out before the reception of a correctly decoded layer 2 frame in format A or B (see 3GPP TS 04.06), or a correctly decoded TCH frame from the mobile station, the network repeats the PHYSICAL INFORMATION message and restarts timer T3105. The maximum number of repetitions is N_{Y1}.

The correct decoding of a frame means that the decoding algorithm and the error detection tests, if any, indicate no error.

When the mobile station receives a PHYSICAL INFORMATION message, it stops timer T3124, stops sending access bursts, activates the physical channels in sending and receiving mode and connects the channels if need be. If the allocated channel is an SDCCH (+ SACCH), performance of the mobile station must enable the mobile station to accept a correct PHYSICAL INFORMATION message sent by the network in any block while T3124 is running.

3.4.4.2.3 Pseudo-synchronized cell case

The details of the use of this procedure are described in 3GPP TS 05.10. The mobile station computes the timing advance to be used with the new cell from the real time difference value given in the HANDOVER COMMAND message. If the mobile station knows that the timing advance with the new cell is not out of range, i.e. smaller or equal to the maximum timing advance that can be coded as specified in 3GPP TS 04.04, or if the new cell accepts an out of range timing advance as indicated in the HANDOVER COMMAND message, the mobile station switches to the new channel and proceeds as follows.

After having switched to the assigned channels, the mobile station sends in four successive slots on the main DCCH a HANDOVER ACCESS message. This message is sent in random mode and thus does not follow the basic format. Its content is reduced to the handover reference information element. The transmission of these four messages is optional if so indicated by the network in the HANDOVER COMMAND message.

Before completion of the 4 access bursts on the DCCH, additional access bursts may also be sent on the SACCH.

In those cells that support extended TA values if TA value in new cell is greater than 63 and the HANDOVER COMMAND message indicates that the transmission of four HANDOVER ACCESS messages is optional the MS shall not transmit these four messages. The MS shall not send additional bursts on the SACCH.

The mobile station then activates the channels in sending and receiving mode and connects the channels if need be. The mobile station may activate the channels in receiving mode and connect the channels while sending access bursts.

If applicable, ciphering is then immediately started. The access bursts are not ciphered.

3.4.4.2.4 Pre-synchronized cell case

The details of the use of this procedure are described in 3GPP TS 05.10. The mobile station switches to the new channel and proceeds as follows.

After having switched to the assigned channels, the mobile station sends in four successive slots on the main DCCH a HANDOVER ACCESS message. This message is sent in an access burst and thus does not follow the basic format. Its content is reduced to the handover reference information element. The transmission of these four messages is optional if so indicated by the network in the HANDOVER COMMAND message.

Before completion of the 4 access bursts on the DCCH, additional access bursts may also be sent on the SACCH.

In those cells that support extended TA values if TA value in new cell is greater than 63 and the HANDOVER COMMAND message indicates that the transmission of four HANDOVER ACCESS messages is optional the MS shall not transmit these four messages. MS shall not send additional bursts on the SACCH.

The mobile station then activates the channel in sending and receiving mode and connects the channels if need be. The timing advance value to be used with the new cell is:

- either the value contained in the HANDOVER COMMAND message if the timing advance information element is present;

- or the default value for pre-synchronized handover as defined in 3GPP TS 05.10, if the timing advance information element is not included in the HANOVER COMMAND message. The MS may activate the channels in receiving mode and connect the channels while sending access bursts.

If applicable, ciphering is immediately started. The access bursts are not ciphered.

3.4.4.3 Handover completion

After lower layer connections are successfully established, the mobile station returns a HANOVER COMPLETE message, specifying cause "normal event", to the network on the main DCCH.

The sending of this message on the mobile station side and its receipt on the network side allow the resumption of the transmission of signalling layer messages other than those for RR management.

When receiving the HANOVER COMPLETE message, the network stops timer T3103 and releases the old channels.

If requested to do so in the HANOVER COMMAND message, the mobile station includes the observed time difference it has measured when performing the handover, corrected by half the timing advance, in the HANOVER COMPLETE message (detailed specifications are given in 3GPP TS 05.10).

If the new cell supports DTM and the mobile station was in DTM in the old cell or the network does not have enough information about the RR mode in the old cell, the network sends the DTM INFORMATION message on the main DCCH after the HANOVER COMPLETE message has been received.

3.4.4.4 Abnormal cases

In the case of a synchronous or pseudo-synchronous handover, if the mobile station knows that the timing advance with the new cell is out of range, i.e. is bigger than the maximum timing advance that can be coded as specified in 3GPP TS 04.04, and if the new cell does not accept out of range timing advance as indicated in the HANOVER COMMAND message, the mobile station sends a HANOVER FAILURE message, cause "handover impossible, timing advance out of range", on the main signalling link and does not attempt that handover.

If the HANOVER COMMAND message instructs the mobile station to use a Channel Description or Mode that it does not support, or if the Channel Mode to use is not defined for all channel sets, then the MS shall return a HANOVER FAILURE message with cause "channel mode unacceptable", and the MS shall remain on the current channel(s) and uses the old Channel Description or Mode(s).

If the mobile station receives a HANOVER COMMAND message containing an inconsistent MultiRateConfiguration IE, then the mobile station shall return a HANOVER FAILURE message with cause "channel mode unacceptable", and the mobile station shall remain on the current channel(s) and uses the old Channel Description or Mode(s).

If the HANOVER COMMAND message instructs the mobile station to use a frequency that it is not capable of, then the mobile station shall return a HANOVER FAILURE message with cause "frequency not implemented", and the mobile station shall remain on the current channel(s).

If the mobile station receives a HANOVER COMMAND message with a Frequency List IE or Frequency Short List IE indicating frequencies that are not all in one band, then the mobile station shall stay on the current channel(s) and send a HANOVER FAILURE message with cause "frequency not implemented". If the mobile station receives a HANOVER COMMAND message with a Mobile Allocation IE indexing frequencies that are not all in one band, then the mobile station shall stay on the current channel(s) and send a HANOVER FAILURE message with cause "frequency not implemented".

NOTE: A HANOVER COMMAND message sent to a multi band mobile station shall not be considered invalid because it indicates target channel frequencies that are all in a different frequency band to that of the ARFCN in the Cell Description IE.

On the mobile station side, if timer T3124 times out (only in the non-synchronized case) or if a lower layer failure happens on the new channel before the HANOVER COMPLETE message has been sent, the mobile station deactivates the new channels, reactivates the old channels, reconnects the TCHs if any and triggers the establishment of the main signalling link. It then sends a HANOVER FAILURE message on the main signalling link and resumes normal operation as if no handover attempt had occurred. The operational parameters (e.g. ciphering mode) when returning on the old channel are those applied before the HANOVER COMMAND message was received.

When the HANOVER FAILURE message has been received, the network releases the new channels if they were dedicated channels and stops timers T3105 and stops T3103 in the non-synchronized case. If the new channels were VGCS channels, they shall be maintained.

If a lower layer failure happens while attempting to connect back to the old channels, the standard rules are applied (cf. section 3.4.13.2 for dedicated mode and 3.4.13.5 for group transmit mode).

On the network side, if timer T3103 elapses before either the HANOVER COMPLETE message is received on the new channels, or a HANOVER FAILURE message is received on the old channels, or the mobile station has re-established the call, the old channels are released if they were dedicated channels and all contexts related to the connections with that mobile station are cleared. If the old channel was a VGCS channel, it shall be maintained and the uplink shall be set free.

On the network side, if neither a correctly layer 2 frame in format A or B nor a correctly TCH frame have been received from the mobile station on the new channel, the newly allocated channels are released if they were dedicated channels. If the new channels were VGCS channels, they shall be maintained and the uplink shall be set free..

On the network side, lower layer failures occurring on the old channels after the sending of the HANOVER COMMAND message are ignored. Lower layer failures occurring after the receipt of the SABM frame on the new main signalling link are treated following a general scheme (cf. section 3.4.13.2 for dedicated mode and 3.4.13.5 for group transmit mode).

3.4.4a Handover to UMTS procedure

Only valid for a UMTS multi-RAT MS. In dedicated mode or dual transfer mode, a change to UMTS channel(s) can be requested by the network RR sublayer. This change is performed through the handover to UMTS procedure.

NOTE: The decision to do a handover to UMTS and the choice of the new cell is out of the scope of this technical specification.

The handover to UMTS procedure includes:

- The suspension of normal operation except for RR management (layer 3).
- The disconnection of the main signalling link, and of the other links via local end release (layer 2), and the disconnection of the TCH(s) if any.
- The disconnection and the deactivation of previously assigned channels and their release (layer 1).
- The establishment of UMTS channel(s), see 3G3GPP TS 25.331.

The handover to UMTS procedure is always initiated by the network.

3.4.4a.1 Handover to UMTS initiation

The network initiates the handover to UMTS procedure by sending an INTER SYSTEM TO UTRAN HANOVER COMMAND message to the mobile station on the main DCCH. It then starts timer T3121.

If the INTER SYSTEM TO UTRAN HANOVER COMMAND refers to a cell not synchronised to, this shall not be considered as an error.

When sending this message on the network side, and when receiving it on the mobile station side, all transmission of signalling layer messages except for those RR messages needed for this procedure and for abnormal cases, is suspended until resuming is indicated. These RR messages can be deduced from section 3.4.3 and 8.5.1 "Radio Resource management".

Upon receipt of the INTER SYSTEM TO UTRAN HANOVER COMMAND message, the mobile station initiates, as described in section 3.1.4, the release of link layer connections and disconnects the physical channels. Switching to the assigned cell(s) and physical channel establishment is described in 3G3GPP TS 25.331.

3.4.4a.2 Handover to UMTS completion

NOTE: After lower layer connections are successfully established, the mobile station returns a Handover to UTRAN Complete message on UMTS channel(s), see 3G3GPP TS 25.331.

When receiving the Handover to UTRAN Complete message (3G3GPP TS 25.331), the network stops timer T3121 and releases the old channels.

3.4.4a.3 Abnormal cases

If the INTER SYSTEM TO UTRAN HANDOVER COMMAND message instructs the mobile station to use a frequency that it is not capable of, then the mobile station shall return a HANDOVER FAILURE message with cause "frequency not implemented", and the mobile station shall remain on the current channel(s).

If connection is not possible on the UMTS channel(s) (see 3G3GPP TS 25.331), the MS reactivates the old channels and reconnects TCHs.

When the HANDOVER FAILURE message has been received, the network releases the UMTS channel(s) if they were dedicated channels and stops timer T3121.

If a lower layer failure happens while attempting to connect back to the old channels, the standard rules are applied (cf. section 3.4.13.2 for dedicated mode).

On the network side, if timer T3121 elapses before either the Handover to UTRAN Complete (3G3GPP TS 25.331) message is received on the UMTS channel(s), or a HANDOVER FAILURE message is received on the old channels, or the mobile station has re-established the call, the old channels are released if they were dedicated channels and all contexts related to the connections with that mobile station are cleared.

On the network side, lower layer failures occurring on the old channels after the sending of the INTER SYSTEM TO UTRAN HANDOVER COMMAND message are ignored.

3.4.5 Frequency redefinition procedure

In dedicated mode and group transmit mode, this procedure is used by the network to change the frequencies and hopping sequences of the allocated channels. This is meaningful only in the case of frequency hopping.

The network sends to the mobile station a FREQUENCY REDEFINITION message containing the new parameters together with a starting time indication.

NOTE: The network should take into account limitations of certain mobile stations to understand formats used in the Cell Channel Description IE used in the FREQUENCY REDEFINITION message, see section 10.5.2.13.

When receiving such a message, the mobile station modifies the frequencies/hopping sequences it uses at the exact indicated time slot, i.e. the indicated time slot is the first with new parameters. All other functions are not disturbed by this change. New parameters can be the cell channel description, the mobile allocation and the MAIO. In case of multislot configuration, the Channel Description IE shall describe the channel carrying the main signalling link, the new parameters however, shall be used for all assigned timeslots. Other parameters describing the allocated channels must be identical to the current parameters.

3.4.5.1 Abnormal cases

If the mobile station receives a FREQUENCY REDEFINITION message with a Mobile Allocation IE indexing frequencies that are not all in one band and a Starting Time IE indicating a time that has not elapsed, then the mobile station shall stay on the current channel(s) and send a RR STATUS message with cause "frequency not implemented".

If the mobile station receives a FREQUENCY REDEFINITION message with a Mobile Allocation IE indexing frequencies that are not all in one band and a Starting Time IE indicating a time that has elapsed, then the mobile station shall locally abort the radio connection and, if permitted, attempt Call Re-establishment.

If the mobile station receives a FREQUENCY REDEFINITION message on a channel for which it has a pending redefinition (defined by the immediate assignment, assignment or handover procedure or a previous frequency

redefinition procedure) the frequencies, hopping and starting time parameters defined by the new frequency redefinition procedure supersedes those of the pending one.

NOTE: A FREQUENCY REDEFINITION message sent to a multi band mobile station shall not be considered invalid because it indicates new frequencies that are all in a different frequency band to that of the ARFCN of the serving cell.

3.4.6 Channel mode modify procedure

In dedicated mode or group transmit mode, higher layers can request the setting of the channel mode.

The channel mode modify procedure allows the network to request the mobile station to set the channel mode for one channel or one channel set. The procedure shall not be used if the multislot configuration contains more than one channel set. The channel mode covers the coding, decoding and transcoding mode used on the indicated channel.

This message shall not be used to modify the mode of a non-multislot configured traffic channel when the MS has requested a multislot configuration, ie it cannot be used to modify the mode of a traffic channel when the channel was assigned during the immediate assignment procedure and the user has requested a multislot configuration.

This procedure is always initiated by the network.

NOTE: Direct transitions between full rate speech coder version 1 and full rate speech coder version 2 (and vice versa) may cause unpleasant audio bursts.

3.4.6.1 Normal channel mode modify procedure

3.4.6.1.1 Initiation of the channel mode modify procedure

The network initiates the procedure by sending a CHANNEL MODE MODIFY message to the mobile station. This message contains:

- a channel description of the channel(s) on which the mode in the CHANNEL MODE MODIFY message shall be applied; and
- the mode to be used on that channel, or on all the channels of a channel set in a multislot configuration.
- Optionally, when the channel mode indicates that a multi-rate speech codec must be applied, the MultiRateconfiguration to be used. The MultiRateConfiguration IE defines the set of codec mode and related information to use after the mode modify procedure. When initiating the new mode, the mobile station shall use for the Initial Codec Mode the mode specified in the MultiRateConfiguration IE, if present, or apply by default the implicit rule defined in 3GPP TS 05.09.

3.4.6.1.2 Completion of channel mode modify procedure

When it has received the CHANNEL MODE MODIFY message, the mobile station sets the mode for the indicated channel, and if that is in a multislot configuration, the whole channel set and then replies by a CHANNEL MODE MODIFY ACKNOWLEDGE message indicating the ordered channel mode.

This applies whether the mode commanded by the CHANNEL MODE MODIFY is different from the one used by the mobile station or whether it is already in use.

3.4.6.1.3 Abnormal cases

No specific action for a lower layer failure is specified in this section. If the mobile station does not support the indicated mode, it shall retain the old mode and return the associated channel mode information in the CHANNEL MODE MODIFY ACKNOWLEDGE message.

3.4.6.2 Channel mode modify procedure for a voice group call talker

3.4.6.2.1 Initiation of the channel mode modify procedure

The network initiates the procedure by sending a CHANNEL MODE MODIFY message to the mobile station. This message contains:

- a channel description of the channel on which the CHANNEL MODE MODIFY message is sent; and
- the new channel mode to be used on the channel; and
- optionally, the VGCS target mode information element defining which RR mode is to be used with the new channel mode (i.e. dedicated mode or group transmit mode). If this information element is not present, the RR mode shall be assumed to be the same as with the previous channel mode. The VGCS target mode information element shall also indicate the group cipher key number for the group cipher key to be used on the new channel or if the new channel is non ciphered. If the information element is not present, the ciphering mode and ciphering key shall be the same as with the previous channel mode. Mobile stations not supporting VGCS talking shall ignore the CHANNEL MODE MODIFY message if the VGCS target mode information element is included in the message and shall send an RR STATUS message to the network with cause #96.

The start of ciphering with a group cipher key with the new channel mode is only possible when the mode on the old channel was not ciphered.

If a VGCS target mode information element indicating a group cipher key number is included in the message and the previous mode is not non ciphered and the group cipher key number is different to the previous cipher key number, the mobile station shall behave as if it would not support the indicated channel mode.

3.4.6.2.2 Completion of mode change procedure

When it has received the CHANNEL MODE MODIFY message, the mobile station changes the mode for the indicated channel and then replies by a CHANNEL MODE MODIFY ACKNOWLEDGE message indicating the new channel mode.

3.4.6.2.3 Abnormal cases

No specific action for a lower layer failure is specified in this section. If the mobile station does not support the indicated mode, it shall retain the old mode and return the associated channel mode information in the CHANNEL MODE MODIFY ACKNOWLEDGE message.

3.4.7 Ciphering mode setting procedure

In dedicated mode, the ciphering mode setting procedure is used by the network to set the ciphering mode, i.e. whether or not the transmission is ciphered, and if so which algorithm to use. The procedure shall only be used to change from "not ciphered" mode to "ciphered" mode, or vice-versa, or to pass a CIPHERING MODE COMMAND message to the mobile station while remaining in the "not ciphered" mode. The ciphering mode setting procedure is always triggered by the network and it only applies to dedicated resources.

The cipher mode setting procedure shall not be applied in group transmit mode.

3.4.7.1 Ciphering mode setting initiation

The network initiates the ciphering mode setting procedure by sending a CIPHERING MODE COMMAND message to the mobile station on the main signalling link, indicating whether ciphering shall be used or not, and if yes which algorithm to use.

Additionally, the network may, by the use of the cipher response information element, request the mobile station to include its IMEISV in the CIPHERING MODE COMPLETE message.

The new mode is applied for reception on the network side after the message has been sent.

3.4.7.2 Ciphering mode setting completion

Whenever the mobile station receives a valid CIPHERING MODE COMMAND message, it shall, if a SIM is present and considered valid by the ME and the ciphering key sequence number stored on the SIM indicates that a ciphering key is available, load the ciphering key stored on the SIM into the ME. A valid CIPHERING MODE COMMAND message is defined to be one of the following:

- one that indicates "start ciphering" and is received by the mobile station in the "not ciphered" mode;
- one that indicates "no ciphering" and is received by the MS in the "not ciphered" mode; or
- one that indicates "no ciphering" and is received by the mobile station in the "ciphered" mode.

Other CIPHERING MODE COMMAND messages shall be regarded as erroneous, an RR STATUS message with cause "Protocol error unspecified" shall be returned, and no further action taken.

Upon receipt of the CIPHERING MODE COMMAND message indicating ciphering, the mobile station shall start transmission and reception in the indicated mode.

When the appropriate action on the CIPHERING MODE COMMAND has been taken, the mobile station sends back a CIPHERING MODE COMPLETE message. If the "cipher response" field of the cipher response information element in the CIPHERING MODE COMMAND message specified "IMEI must be included" the mobile station shall include its IMEISV in the CIPHERING MODE COMPLETE message.

Upon receipt of the CIPHERING MODE COMPLETE message or any other correct layer 2 frame which was sent in the new mode, the network starts transmission in the new mode.

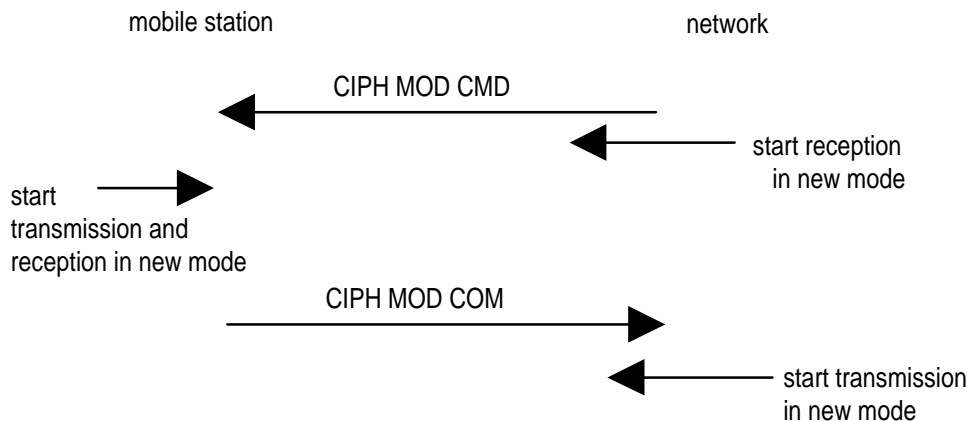

Figure 3.3/3GPP TS 04.18: Ciphering mode setting sequence

3.4.8 Additional channel assignment procedure

NOTE: In the present state of 3GPP TS 04.03, this procedure is only possible for the TCH/H + ACCHs to TCH/H + TCH/H + ACCHs transition. As a consequence it is not needed for simple mobile stations. The description of the procedure is in general terms to cope with possible evolution.

In dedicated mode, a change of channel configuration to include an additional channel can be requested by upper layers.

The additional channel assignment procedure shall not be applied in group transmit mode.

The purpose of the additional assignment procedure is to allocate an additional dedicated channel to a mobile station while keeping the previously allocated channels. In particular the main DCCH and the SACCH are not modified, and signalling exchanges are not interrupted.

The additional assignment procedure may happen only in dedicated mode. It is used for instance for the transition from the TCH/H + ACCHs configuration to the TCH/H + TCH/H + ACCHs configuration.

The additional assignment procedure is always initiated by the network.

3.4.8.1 Additional assignment procedure initiation

The network initiates the procedure by sending an ADDITIONAL ASSIGNMENT message to the mobile station on the main DCCH. The ADDITIONAL ASSIGNMENT message contains the description of the newly assigned channel.

On receipt of the message, the mobile station activates the new channel.

3.4.8.2 Additional assignment procedure completion

The mobile station sends an ASSIGNMENT COMPLETE message to the network on the channel, on which it receives the ADDITIONAL ASSIGNMENT message.

3.4.8.3 Abnormal cases

A lower layer failure occurring during the procedure is treated according to the general case (see section 3.4.13.2).

The network considers the channel as allocated from the sending of the ADDITIONAL ASSIGNMENT message. As a consequence, if a re-establishment occurs, the network will consider the context as if the mobile station has received the message, and the new configuration allocated after the re-establishment may differ from the one the mobile station had before the re-establishment.

3.4.9 Partial channel release procedure

In dedicated mode, a change of channel configuration to release one channel can be requested by upper layers.

The partial channel release procedure shall not be applied in group transmit mode.

The purpose of this procedure is to deactivate part of the dedicated channels in use. The channel configuration remains dedicated.

NOTE: In the present state of 3GPP TS 04.03, this procedure is only possible for the TCH/H + TCH/H + ACCHs to TCH/H + ACCHs transition. As a consequence it is not needed for simple mobile stations.

The partial release procedure is always initiated by the network.

3.4.9.1 Partial release procedure initiation

The network initiates the partial release by sending a PARTIAL RELEASE message to the mobile station on the main DCCH.

On receipt of the PARTIAL RELEASE message the mobile station:

- Initiates the disconnection of all the link layer connections carried by the channel to be released;
- Simultaneously initiates the connection on remaining channels of the data link layer connections that have been released;
- Deactivates the physical channels to be released.
- Sends a PARTIAL RELEASE COMPLETE to the network on the (possibly new) main signalling link.

3.4.9.2 Abnormal cases

A lower layer failure is treated following the general rules as specified in section 3.4.13.2.

Moreover, on the network side, the channel configuration nature is set from the sending of the PARTIAL RELEASE message onward. As a consequence, any new assignment after a re-establishment may concern a different channel configuration nature from the one known by the mobile station before the re-establishment.

3.4.10 Classmark change procedure

In dedicated mode or in group transmit mode, this procedure allows the mobile station to indicate to the network a change of characteristics reflected in the classmark (e.g. due to addition of power amplification). Furthermore, a mobile station which implements the « controlled early classmark sending » option may also send a CLASSMARK CHANGE message and/or a UTRAN CLASSMARK CHANGE message and/or a CDMA2000 message as described in clause 3.3.1.1.4, even if no change of characteristics has occurred. In this case if the MS sends a UTRAN CLASSMARK message, it shall include information on UTRAN pre-defined configuration status information, START-CS and UE Capability.

The mobile station sends a CLASSMARK CHANGE message to the network. This message contains the new mobile station classmark 2 information element. It may also contain a Classmark 3 Information Element. There is no acknowledgement from the network at layer 3.

A UMTS capable MS sends a UTRAN CLASSMARK CHANGE message to the network. A CDMA2000 capable MS sends a CDMA2000 CLASSMARK CHANGE message to the network.

If the CLASSMARK CHANGE and one or more of these additional messages are to be sent by the MS, the CLASSMARK CHANGE message shall be sent first.

3.4.11 Classmark interrogation procedure

This procedure allows the network to request additional classmark information from the mobile station (e.g. if the information initially sent by the mobile station is not sufficient for network decisions). For a multi-RAT MS this procedure allows in addition to request (UMTS) UE Capability and/or UTRAN pre-defined configuration status information (version numbers) and/or UMTS security information and/or CDMA2000 Capability.

3.4.11.1 Classmark interrogation initiation

The network initiates the classmark interrogation procedure by sending a CLASSMARK ENQUIRY message to the mobile station on the main DCCH.

3.4.11.2 Classmark interrogation completion

On receipt of the CLASSMARK ENQUIRY message the mobile station sends a CLASSMARK CHANGE and/or a UTRAN CLASSMARK CHANGE and/or a CDMA2000 CLASSMARK CHANGE message to the network on the main DCCH. The Classmark Enquiry Mask information element in the CLASSMARK ENQUIRY message indicates the type of request. If the Classmark Enquiry Mask information element is not included in the CLASSMARK ENQUIRY message, this indicates a request for CLASSMARK CHANGE message. The CLASSMARK CHANGE message contains the mobile station classmark 2 information element. It may also contain a Classmark 3 Information Element. The UTRAN CLASSMARK CHANGE message contains (UMTS) UE capability and/or UTRAN pre-defined configuration status information and/or information used for UMTS security. The CDMA2000 CLASSMARK CHANGE message contains CDMA2000 capability information.

If the CLASSMARK CHANGE and one or more of these additional messages are to be sent by the MS, the CLASSMARK CHANGE message shall be sent first.

3.4.12 Indication of notifications and paging information

Only applicable for mobile stations supporting VGCS listening or VBS listening:

In dedicated mode or in group transmit mode, the RR entity shall provide indications to the upper layer on all received notifications for voice group calls or voice broadcast calls according to the VGCS or VBS subscription data stored in the mobile station. The indication shall include the notified group or broadcast call reference and possibly the related priority, if provided.

In group transmit mode, if the mobile station has received a paging message with the own mobile station identity on the PCH or on the voice group call channel downlink, the RR entity shall provide an indication to the upper layers, together with the related priority, if applicable.

In group transmit mode, if the RR entity receives information on the voice group call channel of the existence of a paging message in its paging subgroup of the PCH, the RR entity shall pass this information to the upper layers together with the related priority if provided (see also section 3.3.2 and 3.3.3).

3.4.13 RR connection release procedure

3.4.13.1 Normal release procedure

The release of the RR connection can be requested by upper layers.

The purpose of this procedure is to deactivate all the dedicated channels in use. When the channels are released and the mobile station is not IMSI attached for GPRS services (section 4), the mobile station returns to the CCCH configuration, idle mode.

If the mobile station is IMSI attached for GPRS services the following three cases apply:

- If the mobile station has no radio resources (i.e., no temporary block flow) allocated on a PDCH, the mobile station returns to the PCCCH or CCCH configuration, packet idle mode.
- If the mobile station is operating in dual transfer mode when the RR connection is released, the radio resources allocated on a PDCH are released, the mobile station returns to the PCCCH or CCCH configuration, packet idle mode.
- Otherwise, if the mobile station has radio resources allocated on a PDCH, the mobile station enters packet transfer mode.

The channel release procedure can be used in a variety of cases, including TCH release after a call release, and DCCH release when a dedicated channel allocated for signalling is released.

In dedicated mode and group transmit mode, the channel release procedure is always initiated by the network.

3.4.13.1.1 Channel release procedure initiation in dedicated mode and in group transmit mode

The network initiates the channel release by sending a CHANNEL RELEASE message to the mobile station on the main DCCH, starts timer T3109 and deactivates the SACCH.

On receipt of a CHANNEL RELEASE message the mobile station starts timer T3110 and disconnects the main signalling link. When T3110 times out, or when the disconnection is confirmed, the mobile station deactivates all channels, considers the RR connection as released, and returns to CCCH idle mode, returns to PCCCH or CCCH packet idle mode or enters packet transfer mode.

NOTE: Data Links other than the main signalling link are disconnected by local end link release.

If case of dedicated mode, on the network side, when the main signalling link is disconnected, the network stops timer T3109 and starts timer T3111. When timer T3111 times out, the network deactivates the channels, they are then free to be allocated to another connection.

NOTE: The sole purpose of timer T3111 is to let some time to acknowledge the disconnection and to protect the channel in case of loss of the acknowledge frame.

If timer T3109 times out, the network deactivates the channels; they are then free to be allocated to another connection.

The CHANNEL RELEASE message will include an RR cause indication as follows:

- #0: if it is a normal release, e.g. at the end of a call or at normal release of a DCCH.
- #1: to indicate an unspecified abnormal release.
- #2, #3 or #4: to indicate a specific release event.
- #5: if the channel is to be assigned for servicing a higher priority call (e.g. an emergency call).
- #65: if e.g. a handover procedure is stopped because the call has been cleared.

The CHANNEL RELEASE message may include the information element BA Range which may be used by a mobile station in its selection algorithm (see 3GPP TS 05.08 and 3GPP TS 23.022).

Mobile stations not supporting VGCS or VBS listening shall consider Group Channel Description and Group Cipher Key Number information elements as unnecessary in the message and perform the channel release procedure as normal.

For mobile stations supporting VGCS listening, the following procedures apply:

The CHANNEL RELEASE message may include the information element Group Channel Description. In this case, the mobile station shall release the layer 2 link, enter the group receive mode and give an indication to the upper layer. If a CHANNEL RELEASE message with no Group Channel Description is received, the normal behaviour applies.

If ciphering is applied on the VGCS or VBS channel, the network shall provide in the CHANNEL RELEASE message with the Group Cipher Key Number information element for the group cipher key to be used by the mobile station for reception of the VGCS or VBS channel. If this information element is not included, no ciphering is applied on the VGCS or VBS channel.

A mobile station not supporting the « GPRS » option shall consider the GPRS Resumption information element as an information element unknown in the CHANNEL RELEASE message and perform the RR connection release procedure as normal.

For a mobile station supporting the « GPRS » option, the following additional procedures also apply:

- The CHANNEL RELEASE message may include the information element GPRS Resumption. If the GPRS Resumption information element indicates that the network has resumed GPRS services, the RR sublayer of the mobile station shall indicate a RR GPRS resumption complete to the MM sublayer, see section 4. If the GPRS Resumption information element indicates that the network has not successfully resumed GPRS services, the RR sublayer of the mobile station shall indicate a RR GPRS resumption failure to the MM sublayer, see section 4.
- If the mobile station has performed the GPRS suspension procedure (section 3.3.1.1.4.2) and the GPRS Resumption information element is not included in the message, the RR sublayer of the mobile station shall indicate a RR GPRS resumption failure to the MM sublayer, see section 4.
- If the mobile station has not performed the GPRS suspension procedure and the GPRS Resumption information element is not included in the message, the mobile station shall perform the RR connection release procedure as normal.

3.4.13.1.2 Abnormal cases

Abnormal cases are taken into account in the main part of the description of the procedure.

3.4.13.2 Radio link failure in dedicated mode or dual transfer mode

The main part of these procedures concerns the "normal" cases, i.e. those without any occurrence of loss of communication means. A separate paragraph at the end of the description of each procedure treats the cases of loss of communication, called a radio link failure. In dedicated mode, in most of the cases the reaction of the mobile station or the network is the same. Those reactions are described in this section to avoid repetitions.

A radio link failure can be detected by several ways:

- 1) By analysis of reception at layer 1, as specified in 3GPP TS 05.08 and section 3.4.1.1.
- 2) By a data link layer failure as specified in 3GPP TS 04.06, on the main signalling link. A data link failure on any other data link shall not be considered as a radio link failure.
- 3) When a lower layer failure happens while the mobile station attempts to connect back to the old channels in a channel assignment procedure, handover procedure, PDCH assignment procedure, RR-cell change order procedure or DTM assignment procedure with relocation of the RR connection.
- 4) In some cases where timers are started to detect the lack of answer from the other party, as described in section 3.

The two first cases are known by the term "lower layer failure".

3.4.13.2.1 Mobile side

When a radio link failure is detected by the mobile station,

- the MS shall perform a local end release on all signalling links unless otherwise specified;
- the mobile station shall deactivate all dedicated channels;
- if the mobile station is in dual transfer mode, it shall abort the packet resources;
- the RR sublayer of the mobile station shall indicate an RR connection failure to the MM sublayer unless otherwise specified.

NOTE: Upper layers may decide on a re-establishment (cf. section 5.5.4).

When a mobile station which has performed the GPRS suspension procedure (section 3.3.1.1.4.2) detects a radio link failure, the RR sublayer of the mobile station shall indicate a RR GPRS resumption failure to the MM sublayer, see section 4.

3.4.13.2.2 Network side

In dedicated mode, the reaction of the network to a lower layer failure depends on the context. Except when otherwise specified, it is to release the connection either with the channel release procedure as specified in section 3.5.1, or with the following procedure. The network starts timer T3109 and deactivates the SACCH (and hence to stop transmission on the SACCH). If the mobile station is in dual transfer mode, the network also aborts all the allocated packet resources.

When a radio link failure has been detected, an indication is passed to the upper Mobility Management sublayer on the network side.

When timer T3109 expires, the network can regard the channels as released and free for allocation.

This procedure relies on the fact that if a mobile station does not receive the SACCH for some time, it completely releases the channels (cf. 3GPP TS 05.08).

NOTE: The network should maintain for a while the transaction context in order to allow call re-establishment. The length of timer is for further study.

When a mobile station which has performed the GPRS suspension procedure (section 3.3.1.1.4.2) detects a radio link failure, the RR sublayer of the mobile station shall indicate a RR GPRS resumption failure to the MM sublayer, see section 4.

3.4.13.3 RR connection abortion in dedicated mode or dual transfer mode

The mobile station aborts the RR connection by initiating a normal release of the main signalling link, performing local end releases on all other signalling links, disconnecting all traffic channels, if any, and aborting all the packet resources, if any.

When a mobile station which has performed the GPRS suspension procedure (section 3.3.1.1.4.2) aborts the RR connection, the RR sublayer of the mobile station shall indicate a RR GPRS resumption failure to the MM sublayer, see section 4.

3.4.13.4 Uplink release procedure in group transmit mode

If the uplink release is requested by the upper layer the mobile station shall send an UPLINK RELEASE message on the voice group call channel uplink, perform a release of the main signalling link and go back to the group receive mode.

If the UPLINK RELEASE message is received from the network on the voice group call channel downlink, the MS shall perform a release of the main signalling link and go back to the group receive mode.

3.4.13.5 Radio link failure in group transmit mode

The main part of these procedures concerns the "normal" cases, i.e. those without any occurrence of loss of communication means. A separate paragraph at the end of the description of each procedure treats the cases of loss of

communication, called a radio link failure. In group transmit mode, in most of the cases the reaction of the mobile station or the network is the same. Those reactions are described in this section to avoid repetitions.

A radio link failure can be detected by several ways:

- 1) By analysis of reception at layer 1, as specified in 3GPP TS 05.08 and section 3.4.1.1.
- 2) By a data link layer failure as specified in 3GPP TS 04.06, on the main signalling link. A data link failure on any other data link shall not be considered as a radio link failure.
- 3) When a lower layer failure happens while the mobile station attempts to connect back to the old channels in a channel assignment procedure or handover procedure.
- 4) In some cases where timers are started to detect the lack of answer from the other party, as described in section 3.

The two first cases are known by the term "lower layer failure".

3.4.13.5.1 Mobile side

When a radio link failure is detected by the mobile station,

- the MS shall perform a local end release on all signalling links;
- the mobile station shall go back to idle mode and, when possible, to group receive mode;
- the RR sublayer of the mobile station shall indicate an RR connection failure to the MM sublayer unless otherwise specified.

3.4.13.5.2 Network side

When the uplink has been allocated and the network detects a lower layer failure, the network shall set the uplink free and provide an UPLINK FREE message on the main signalling channel, when appropriate.

When a radio link failure has been detected, an indication is passed to the upper Mobility Management sublayer on the network side.

3.4.14 Receiving a RR STATUS message by a RR entity.

If the RR entity of the mobile station receives a RR STATUS message no transition and no specific action shall be taken as seen from the radio interface, i.e. local actions are possible.

The actions to be taken on receiving a RR STATUS message in the network are an implementation dependent option see also section 8.

3.4.15 Group receive mode procedures

Only applicable for support of VGCS listening or VBS listening.

3.4.15.1 Mobile station side

3.4.15.1.1 Reception of the VGCS or VBS channel

In group receive mode, the mobile station receives the downlink of the voice broadcast channel or voice group call channel for which the channel description was provided within the notification message or in the related command message. The mobile station should also listen to the CCCH of the serving cell. Moreover, it measures the received levels on the serving cell and on the neighbour cells to assess the need for a cell reselection as specified in 3GPP TS 05.08. The general cell reselection procedure for the mobile station in group receive mode is described in 3GPP TS 23.022.

Information on neighbour cells used for cell reselection and reception of the VGCS or VBS channel in the neighbour cells may be provided on the downlink messages (see section 3.4.15.1.2). If no such information is provided or

information is missing, the mobile station shall try to read this information on the BCCH and NCH of the neighbour cells.

3.4.15.1.2 Monitoring of downlink messages and related procedures

Mobile stations in group receive mode shall monitor messages related to the following procedures on the VGCS or VBS channel downlink and act appropriately in order to be able to keep receiving the VGCS or VBS channel downlink.

All messages for mobile stations in group receive mode shall be sent in UI format on the VGCS or VBS channel downlink. Mobile stations in group receive mode shall ignore all messages which are not sent in UI format or which are not related to the following mentioned procedures.

The mobile should also monitor messages on the PCH or NCH of the current cell.

3.4.15.1.2.1 Spare

3.4.15.1.2.2 Spare

3.4.15.1.2.3 Channel mode modify procedure

The mobile station shall receive CHANNEL MODE MODIFY messages. The mobile station shall use the new channel mode but shall not transmit any response to the network.

3.4.15.1.2.4 Notification and paging information

The mobile station shall monitor messages related to notification and paging procedures.

The RR entity shall provide indications on all received notifications for voice group calls or voice broadcast calls to the upper layer. The indication shall include the notified group or broadcast call reference and, if provided, and if the mobile station supports eMLPP the related priority.

On request by the upper layer to join another voice broadcast call or voice group call for which a corresponding notification has been received on the VGCS or VBS channel downlink, the RR entity shall read the corresponding notification on the NCH.

If the mobile station has received a paging message with its own mobile station identity on the PCH or on the voice broadcast channel or voice group call channel downlink, the RR entity shall provide an indication to the upper layers, together with the related priority, if applicable.

3.4.15.1.2.4.1 Use of Reduced NCH monitoring

This section applies to mobile stations which are in group receive mode or group transmit mode of dedicated mode and which in addition want to receive notification messages for other voice broadcast calls or voice group calls and which aim at reducing the reception load.

If the reduced NCH monitoring mechanism is used on the NCH as defined in section 3.3.3.3, when the MS in group receive mode or group transmit mode enters a cell, it should read the NCH until it has received at least two messages on the NCH indicating NLN, with the two last received NLN being identical. Then it should stop reading the NCH until it receives on the SACCH an NLN(SACCH) different from the last previously received NLN.

For this, a parameter is provided on the SACCH in the SYSTEM INFORMATION TYPE 6 message:

- NLN(SACCH): Notification List Number (received on the SACCH).

If a mobile station receives on the SACCH an NLN(SACCH) different from the last received NLN it may read the NCH until it has received at least two messages on the NCH indicating NLN with the two last received NLN being identical.

If a message in the SACCH is not received correctly the MS may read the NCH until it has received at least two messages on the NCH indicating NLN, with the two last received NLN being identical.

NOTE: If the NLN(SACCH) is not provided on the SACCH, the mobile station, depending on its particular implementation, may either read the NCH while being in group receive mode or group transmit mode or may not be able to receive notifications for other voice group calls or voice broadcast calls other than those notifications provided on the FACCH.

3.4.15.1.2.5 Uplink status messages

Mobile stations supporting VGCS talking shall monitor the VGCS uplink control related messages UPLINK FREE and UPLINK BUSY.

3.4.15.1.2.6 Channel release message

The mobile station shall receive CHANNEL RELEASE messages. On receipt of a CHANNEL RELEASE message, the RR entity shall go to idle mode and give an indication to the upper layer. (See also section 3.4.15.1.4.1, 4th paragraph.)

3.4.15.1.2.7 Information on paging channel restructuring

On receipt of a SYSTEM INFORMATION TYPE 6 message indicating that paging channel restructuring has taken place, if the mobile station wants to be able to read its paging subchannel while in group receive mode or group transmit mode, the mobile station should read the related messages on the BCCH to know the position of its paging group.

3.4.15.1.3 Uplink reply procedure

In Group Receive mode, on receipt of an UPLINK FREE message with an uplink access request indication from the network on the voice group call channel downlink, the mobile station shall send two UPLINK ACCESS messages on the voice group call channel with establishment cause "Reply on uplink access request" and then stop immediately transmitting on the uplink.

The first UPLINK ACCESS message shall be transmitted by the mobile station with a random delay between 0 and 20 ms. The second UPLINK ACCESS messages shall be repeated after a further period of 100 ms plus a random delay between 0 and 20 ms.

If an uplink identity code (UIC) of the current cell has been provided by the network in the UPLINK FREE message, the mobile station shall use this UIC for the coding of the UPLINK ACCESS messages. If no UIC is provided, the mobile station shall use the BSIC received of the serving cell, for instance as received from the initial synchronization.

3.4.15.1.4 Leaving the group receive mode

3.4.15.1.4.1 Returning to idle mode

If the mobile station enters a new cell in which:

- notifications for the current group or broadcast call are sent; but
- no VGCS or VBS channel description for the current group or broadcast call is provided;

the mobile station shall go to idle mode and give an indication to the upper (sub-)layers.

NOTE: Upper (sub-)layers then can request the establishment of an RR connection in order to be informed about the channel description by the network.

If the mobile station enters a cell in which notifications for the current group or broadcast call are not sent, the mobile station shall disconnect locally the TCH, go to idle mode and give an indication to the upper (sub-)layers.

On request by the upper layer in order to respond to a paging message the RR entity shall go to the idle mode in order to establish a dedicated RR connection.

On receipt of a CHANNEL RELEASE message in UI format from the network the RR entity shall go to idle mode and give an indication to the upper layer.

If the upper layer requests to abort the group receive mode, the mobile station shall go back to idle mode.

3.4.15.1.4.2 Going to group transmit mode

Only applicable for mobile stations supporting VGCS talking.

If the upper layer requests an uplink access, the mobile station shall perform the uplink investigation procedure as defined in section 3.3.1.2.1.1.

If the uplink investigation procedure is not successful, the mobile station shall give an indication to the upper layers and remain in group receive mode.

If the uplink investigation procedure is successful, the uplink access procedure is initiated as defined in section 3.3.1.2.1.2.

If the uplink access procedure is successful, the mobile station shall give an indication to the upper layers and enter the group transmit mode.

If the uplink access procedure is not successful, the mobile station shall give an indication to the upper layers and remain in group receive mode.

3.4.15.2 Network side

3.4.15.2.1 Provision of messages on the VGCS or VBS channel downlink

3.4.15.2.1.1 General

The network shall provide all messages directed to mobile stations in group receive mode (see section 3.4.15.1.2) in unacknowledged mode. Those messages which are also sent to the mobile station in group transmit mode in acknowledged mode have therefore to be repeated in addition as UI messages on the VGCS channel downlink if they shall also be received by mobile stations in group receive mode.

3.4.15.2.1.2 Provision of general information messages

In the case where the group call area exceeds one cell, the network should provide the SYSTEM INFORMATION TYPE 6 message on the SACCH related to the voice broadcast channel or voice group call channel.

In addition, if the group call area exceeds one cell, the network should provide SYSTEM INFORMATION TYPE 5 (possibly together with TYPE 5bis and 5ter) on the SACCH related to the voice broadcast channel or voice group call channel.

- The SYSTEM INFORMATION TYPE 5, TYPE 5bis and TYPE 5ter messages provide information on the BCCH frequency of the neighbour cells.
- The SYSTEM INFORMATION TYPE 6 message provides information on the location area of the current cell, possibly the status of the NCH, and an indication of whether paging channel restructuring has taken place.
- \$(ASCII)\$ Optional messages of the SYSTEM INFORMATION TYPE 10 message type provide information improving cell re-selection in group receive mode.

The network may also provide layer 3 messages for notification on the VGCS or VBS channel downlink FACCH.

3.4.15.2.1.3 Provision of messages related to the voice group call uplink channel

Only applicable for the support of VGCS talking.

The network shall provide UPLINK FREE messages on the main signalling link of all voice group call channels when the uplink is set free. The provision of UPLINK FREE messages shall be repeated as long as no uplink is granted to a mobile station.

The network shall provide an UPLINK BUSY message on the main signalling link of all voice group call when the uplink has been granted to a mobile station.

The network may send UPLINK FREE messages containing an uplink access request on the main signalling channel of the VGCS channels in order to obtain knowledge on whether any listening mobile is present in a cell or not. If there is

no mobile station responding to the uplink access request, the network may decide to clear the VGCS channel in that cell.

3.4.15.2.2 Release of the VGCS or VBS Channels

If a release request for a voice group call is received from the upper layer, the network, after having released the RR connection with the mobile station in group transmit mode, shall stop the notification procedures for that voice group call and clear all related voice group call channels.

If a release request for a voice broadcast call is received from the upper layer, the network shall stop the notification procedures for that voice broadcast call and locally disconnect any channel related to the voice broadcast call.

3.4.15.3 Failure cases

If the mobile station loses the voice group call channel or voice broadcast channel, the mobile station shall search all possible channel positions on the current cell and the neighbour cells for which a channel description is known for that call.

3.4.16 Configuration change procedure

This is only applicable for multislot configuration. This message shall not be used to change a non-multislot configured channel to a multislot configured channel.

The configuration change procedure is used by the network to change the number of timeslots used in a multislot configuration. The procedure can also be used to change the channel mode of one or several channels and change their allocation. The main signalling link however, cannot be changed by the configuration change procedure. If a change of the main signalling link is needed, the assignment or handover procedures shall be used.

The network shall not initiate a new configuration change procedure before a response to the previous CONFIGURATION CHANGE COMMAND message has been received from the mobile station.

3.4.16.1 Configuration change initiation

The procedure starts when the network sends a CONFIGURATION CHANGE COMMAND to the mobile station on the main DCCH. The message indicates:

- which timeslots to use in uplink;
- which timeslots to use in downlink; and
- which channel set each timeslot belongs to.

The message may also contain definitions of the channel mode to be applied for one or several channel sets. If a previously undefined channel set is defined by the CONFIGURATION CHANGE COMMAND a definition of the channel mode for the new channel set shall be included in the message.

3.4.16.2 Configuration change completion

When the mobile station receives the CONFIGURATION CHANGE COMMAND it changes its configuration in accordance with the message contents and returns a CONFIGURATION CHANGE ACKNOWLEDGE on the same channel as the command message was received, confirming the new channel configuration. This applies irrespective of whether the new configuration is different from the one already in use by the mobile station or if it is the same.

3.4.16.3 Abnormal cases

If the CONFIGURATION CHANGE COMMAND message instructs the mobile station to use a Channel Configuration or Mode(s) that it does not support, or if the channel mode to use is not defined for all channel sets, the mobile station shall return a CONFIGURATION CHANGE REJECT message with cause 'channel mode unacceptable', and the mobile station shall remain on the current channel(s) and use the old Channel Configuration and Channel Mode(s).

3.4.17 Mapping of user data substreams onto timeslots in a multislots configuration

For multislots configurations the following rules for mapping of the user data substreams onto timeslots shall apply for each channel set:

- at initial assignment (using assignment procedure), the lowest numbered user data substream shall be mapped to the lowest numbered timeslot etc. in ascending order (the user data substreams are numbered 0 to (n-1), where n is the number of substreams)
- at channel changes using handover procedure or assignment procedure (where none of the timeslots are present in both the old and the new configuration), the lowest numbered user data substream shall be mapped to the lowest numbered timeslot etc. in ascending order (the user data substreams are numbered 0 to (n-1), where n is the number of substreams)
- at channel changes using assignment procedure (where at least one of the timeslots is the same in both the old and the new configuration) or configuration change procedure:
 - user data substream(s) mapped to timeslot(s) that are present in both the old and the new configuration shall continue to be mapped to the same timeslot(s) as before the channel change; and
 - possibly added timeslot(s) shall carry the lowest numbered available user data substream so that the lowest numbered data substream among the added is mapped to the lowest numbered added timeslot and so on in ascending order.

NOTE: The user data substream number is a number that need not be the same as the inband number used for transparent services. The user data substream number is only used as a point of reference to a specific user data substream.

3.4.18 Handling of classmark information at band change

The coding of some fields in the *Mobile Station Classmark 1* and in the *Mobile Station Classmark 2* information elements depends on the band in use as described in subclause 10.5.1.5 and subclause 10.5.1.6. When a command to change the frequency band (GSM 900, DCS 1800) has been received (by, e.g., an IMMEDIATE ASSIGNMENT message, an ASSIGNMENT COMMAND message, a HANDOVER COMMAND message or a FREQUENCY REDEFINITION message) the following applies:

- When an IMMEDIATE ASSIGNMENT message is received, "the band used" for the purpose of coding the classmark information in the service request message, see subclause 3.1.5, shall be understood as the band used for the CHANNEL REQUEST message or (one of) the band(s) indicated by the IMMEDIATE ASSIGNMENT message.
- For other cases "the band used" for the purpose of coding the classmark information shall be understood as one of the bands used or attempted to be used within the 2 seconds preceding the passing of the layer 3 message containing the classmark information to the layer 2 send queue as described in 3GPP TS 04.06.

NOTE: This definition means that when a band change is being done the network must take appropriate actions to handle possible ambiguities in the frequency band related information in the classmark.

3.4.19 Assignment to a Packet Data channel

This section is only applicable to mobile stations supporting the <<GPRS>> option.

When in dedicated mode or in group transmit mode, the network may wish to change the resources used by a mobile station that supports the <<GPRS option>>. This change may be performed through the assignment to a Packet Data Channel procedure.

The purpose of the assignment to PDCH channel procedure is to completely modify the physical channel configuration of the mobile station without frequency redefinition or change in synchronization while staying in the same cell.

The assignment to PDCH procedure only commences in dedicated mode or in group transmit mode. This procedure cannot be used in the idle mode.

The assignment to PDCH procedure includes:

- the suspension of normal operation;
- the release of the main signalling link, and of the other data links as defined in section 3.1.4, and the disconnection of TCHs if any;
- the deactivation of previously assigned channels (layer 1);
- The triggering of the establishment of a Temporary Block Flow.

The assignment to PDCH procedure is always initiated by the network.

3.4.19.1 Assignment to PDCH initiation

The network initiates the assignment to PDCH procedure by sending a PDCH ASSIGNMENT COMMAND message to the mobile station on the main signalling link. It then starts timer T3117.

NOTE: The network should take into account limitations of certain mobile stations to understand formats used in the Frequency List IE and Cell Channel Description IE used in the PDCH ASSIGNMENT COMMAND message, see section 10.5.2.13 and section 10.5.2.1b.

When sending this message on the network side, and when receiving it on the mobile station side, all transmission of signalling layer messages except for those RR messages needed for this procedure and for abnormal cases is suspended until resumption is indicated. These RR messages can be deduced from sections 3.4.3 and 8.8 Radio Resource management.

Upon receipt of the PDCH ASSIGNMENT COMMAND message, the mobile station initiates a local end release of dedicated mode link layer connections, disconnects the physical channels, commands the switching to the identified channels and obeys the procedures relevant to the establishment of the Temporary Block Flow. The mobile station starts timer T3190.

The PDCH ASSIGNMENT COMMAND message contains the description of either the uplink TBF or the downlink TBF.

The information on the power to be used on the target TBF shall not affect the power used on the old channel(s).

A PDCH ASSIGNMENT COMMAND message may indicate a frequency change in progress, with a starting time and possibly alternative channel descriptions.

In the case of the reception of a PDCH ASSIGNMENT COMMAND message which contains only the description of a TBF to be used after the starting time, the mobile station shall wait up to the starting time before using the TBF. If the starting time has already elapsed, the mobile shall use the TBF as an immediate reaction to the reception of the message (see 3GPP TS 05.10 for the timing constraints).

If the message contains both the description of a TBF to be used after the indicated time and of a TBF to be used before, the mobile station uses the TBF as an immediate reaction to the reception of the message. If the moment the mobile station is ready to access is before the indicated time, the mobile station uses the TBF described for before the starting time. The mobile station then changes to the TBF described for after the starting time at the indicated time. New parameters can be frequency list, MAIO and HSN. Other parameters describing the allocated channels shall be identical to the parameters described for before the starting time. If the moment the mobile station is ready to access is after the starting time, the mobile station uses the TBF described for after the starting time.

If frequency hopping is applied, the cell allocation if present in the message is used to decode the mobile allocation. If the cell allocation is not included, the mobile station uses its current cell allocation, the current CA is the last CA received on the BCCH. Afterward, the current CA may be changed by some messages sent on the main signalling link containing a CA (the possible messages are: ASSIGNMENT COMMAND, HANDOVER COMMAND and FREQUENCY REDEFINITION). Note that there are cases in which the current CA is undefined, see section 3.4.3.3.

The PDCH ASSIGNMENT COMMAND does not contain a cipher mode setting IE. Any RR layer ciphering that may have been applied in dedicated mode shall not be applied to the target TBF.

3.4.19.2 Completion of the Assignment to PDCH procedure

The network regards the procedure as successfully completed when RLC/MAC blocks are received from the mobile station on the target TBF. The network then stops timer T3117.

The mobile station regards the procedure as successfully completed when RLC/MAC blocks with any TFI are received on the new PDCH.

3.4.19.3 Abnormal cases

If the mobile station has no current CA and if it needs a CA to analyse the PDCH ASSIGNMENT COMMAND message, it stays on the current channel(s) and sends an ASSIGNMENT FAILURE message with cause "no cell allocation available".

If the PDCH ASSIGNMENT COMMAND message instructs the mobile station to use a Coding Scheme that it does not support then the mobile station shall return an ASSIGNMENT FAILURE message with cause "channel mode unacceptable", and the mobile station shall remain on the current channel(s) and uses the old Channel Description or Channel Mode(s).

If the PDCH ASSIGNMENT COMMAND message instructs the mobile station to use a frequency that it is not capable of, then the mobile station shall return an ASSIGNMENT FAILURE message with cause "frequency not implemented", and the mobile station shall remain on the current channel(s).

If the mobile station receives a PDCH ASSIGNMENT COMMAND message with a Frequency List IE indicating frequencies that are not all in one band, then the mobile station shall stay on the current channel(s) and send an ASSIGNMENT FAILURE message with cause "frequency not implemented". If the mobile station receives a PDCH ASSIGNMENT COMMAND message with a Mobile Allocation IE indexing frequencies that are not all in one band, then the mobile station shall stay on the current channel(s) and send an ASSIGNMENT FAILURE message with cause "frequency not implemented".

NOTE: A PDCH ASSIGNMENT COMMAND message sent to a multi band mobile station shall not be considered invalid because it indicates frequencies that are all in a different frequency band to that of the current channel.

On the mobile station side, if RLC/MAC blocks are not successfully received within T3190 seconds, the mobile station reactivates the old channels, reconnects the TCHs if any and triggers the establishment of the main signalling link. It then sends an ASSIGNMENT FAILURE message, cause "protocol error unspecified" on the main DCCH and resumes the normal operation, as if no assignment attempt had occurred. The operational parameters (e.g. ciphering mode) when returning on the old channel are those applied before the procedure.

When receiving the ASSIGNMENT FAILURE message, the network stops T3117.

If a lower layer failure happens while attempting to connect back to the old channels, the radio link failure procedure is applied (see section 3.4.13.2).

On the network side, if timer T3117 elapses before either the network receives an RLC/MAC block from the mobile station on the new channel, or, an ASSIGNMENT FAILURE message is received on the old channels, then the old channels and the new resources are released, except that, if the old channel was a VGCS channel, the old channel shall be maintained and the uplink shall be set free.

On the network side, lower layer failure occurring on the old channels after the sending of the PDCH ASSIGNMENT COMMAND message are ignored.

3.4.20 RR-Network Commanded Cell Change Order

This section is only applicable to mobiles supporting the <<GPRS>> option.

In dedicated mode or in group transmit mode, intracell or intercell change of channel(s) can be requested by the network RR sublayer. This change may be performed through the RR-network commanded cell change order procedure.

The purpose of the RR-network commanded cell change order procedure is to permit the complete modification of the channels allocated to the mobile station e.g. when the cell is changed. This procedure only commences while in dedicated mode or in group transmit mode.

The RR-network commanded cell change order procedure includes:

- The suspension of normal operation except for RR management (layer 3).
- The disconnection of the main signalling link, and of the other links via local end release (layer 2), and the disconnection of the TCH(s) if any.
- The disconnection and the deactivation of previously assigned channels and their release (layer 1).

The complete acquisition of BCCH or PBCCH messages of the target cell.

- The triggering of the establishment of a Temporary Block Flow.

The RR-network controlled cell change order procedure is always initiated by the network.

3.4.20.1 RR-network commanded cell change order initiation

The network initiates the RR-network controlled cell change order procedure by sending a RR-CELL CHANGE ORDER message to the mobile station on the main DCCH. The network then starts timer T3119.

When a handover has taken place during dedicated connection, the network shall send a RR-CELL CHANGE ORDER message to the mobile station in order to establish TBF. In this case the target cell is equal to the old cell.

When sending this message on the network side, and when receiving it on the mobile station side, all transmission of signalling layer messages except for those RR messages needed for this procedure and for abnormal cases, is suspended until resuming is indicated. These RR messages can be deduced from section 3.4.3 and 8.5.1 "Radio Resource management".

Upon receipt of the RR-CELL CHANGE ORDER message, the mobile station starts timer T3134, and initiates, as described in section 3.1.4, the release of link layer connections, disconnects the physical channels, commands the switching to the identified cell, performs a complete acquisition of BCCH or PBCCH messages (see 3GPP TS 04.60), and obeys the procedures relevant to the establishment of the Temporary Block Flow. The mobile station shall obey the RR-CELL CHANGE ORDER irrespective of whether or not the mobile station has any knowledge of the relative synchronisation of the target cell to the serving cell. 3G multi-RAT mobile station shall obey the RR-CELL CHANGE ORDER to a 3G Cell irrespective of whether or not the mobile station has synchronised to that cell.

The RR-CELL CHANGE ORDER message contains:

- The characteristics of the new cell that are necessary to identify it (i.e. BSIC + BCCH frequency). For a 3G multi-RAT mobile station, the RR-CELL CHANGE ORDER message may contain information on a 3G target cell; in this case BSIC and BCCH frequency shall be ignored ;
- the NC mode to be initially applied on the new cell.

The RR-CELL CHANGE ORDER does not contain a cipher mode setting IE. Any RR layer ciphering that may have been applied in dedicated mode shall not be applied to the target TBF or with the target cell.

3.4.20.2 Network controlled cell reselection completion

The network regards the procedure as successfully completed when it knows that communication has been established with that mobile station via the new cell (e.g. the network has received a RLC/MAC Block containing the mobile station's identity). The network then stops timer T3119.

The mobile station regards the procedure as successfully completed when it has received a response to a (PACKET) CHANNEL REQUEST message on the new cell which allocates it a resource on the new cell.

3.4.20.3 Abnormal cases

If the RR-CELL CHANGE ORDER message instructs the mobile station to use a frequency that it is not capable of, then the mobile station shall return a HANDOVER FAILURE message with cause "frequency not implemented", and the mobile station shall remain on the current channel(s).

On the mobile station side, if timer T3134 times out before a response to the (PACKET) CHANNEL REQUEST message has been received, or, if an IMMEDIATE ASSIGNMENT REJECT message or a PACKET ACCESS

REJECT is received from the new cell, or, if the contention resolution procedure fails on the new cell then the mobile station shall reactivate the old channels, reconnect the TCHs if any and trigger the establishment of the main signalling link. It then sends a HANOVER FAILURE message on the main signalling link and resumes normal operation as if no handover attempt had occurred. The operational parameters (e.g. ciphering mode) when returning on the old channel are those applied before the RR-CELL CHANGE ORDER message was received.

When the HANOVER FAILURE message has been received, the network stops T3119.

If a lower layer failure happens while attempting to connect back to the old channels, the standard rules are applied (cf. section 3.4.13.2).

On the network side, if timer T3119 elapses before either the mobile station has been recognised on the new cell, or a HANOVER FAILURE message is received on the old channels, then the old channels are released, except that, if the old channel was a VGCS channel, the old channel shall be maintained and the uplink shall be set free.

On the network side, lower layer failures occurring on the old channels after the sending of the RR-CELL CHANGE ORDER message are ignored.

3.4.21 Application Procedures

3.4.21.1 General

While in dedicated mode, the following applications associated with the Radio Resource management layer may be supported in the network and MS:

3.4.21.2 Location Services (LCS)

Common procedures are defined in the Radio Resource management layer to assist these applications.

3.4.21.3 Application Information Transfer

The Application Information Transfer procedure enables an Application on the network side and a peer application in the MS to exchange Application Protocol Data Units (APDUs).

3.4.21.3.1 Normal Procedure without Segmentation

The maximum size of an APPLICATION INFORMATION message is 251 octets as defined in 3GPP TS 04.06. Segmentation shall not be used when an APDU fits into a single APPLICATION INFORMATION message of maximum or smaller size.

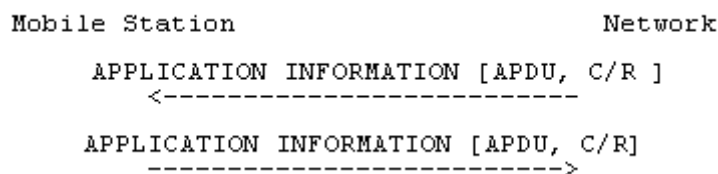

Figure 3.4/3GPP TS 04.18: Application Information Transfer without segmentation

Either the network or MS may send an APPLICATION INFORMATION message once the MS is in dedicated mode. The APDU Data in the APPLICATION INFORMATION message shall contain a complete APDU according to the protocol in use. The APDU ID IE identifies the protocol and associated application. The APDU Flags IE indicates "First or Only Segment", "Last or Only Segment" and conveys a C/R flag transparently between the communicating applications. The C/R Flag may be used to distinguish a command from other messages and a final response from a non-final response. The use of the C/R flag is defined with respect to each application. On receiving an APPLICATION INFORMATION message, the receiving layer 3 entity shall deliver the message contents to the identified local application.

3.4.21.3.2 Normal Procedure with Segmentation

Segmentation is applicable when an APDU is too large to fit into a single APPLICATION INFORMATION message. The procedure is applicable for either direction of transfer.

```

Mobile Station or Network                                Network or Mobile Station
APPLICATION INFORMATION [APDU segment, First Segment, not Last Segment]
<-----
APPLICATION INFORMATION [APDU segment, not First Segment, not Last Segment]
<-----
APPLICATION INFORMATION [APDU segment, not First Segment, Last Segment, C/R]
<-----

```

Figure 3.5/3GPP TS 04.18: Application Information Transfer with segmentation

The sending layer 3 entity shall segment an APDU by dividing it into one or more segments exactly fitting into maximum sized APPLICATION INFORMATION messages plus a final segment fitting into an APPLICATION INFORMATION message of maximum size or smaller. Once segmented, the resulting APPLICATION INFORMATION messages shall be transferred in sequence to the data link layer for transmission, without being interspersed by other level 3 messages. The first APPLICATION INFORMATION message in the sequence shall indicate "First Segment" and "Not Last Segment". Subsequent APPLICATION INFORMATION messages except for the last shall indicate "Not First Segment" and "Not Last Segment". The last APPLICATION INFORMATION message shall indicate "Not First Segment" and "Last Segment" and shall include a C/R flag as provided by the sending application.

The receiving layer 3 entity shall reassemble any segmented APDU before transfer to the local application. The receiver may employ a timer to detect possible loss of APDU segments. If employed, the timer shall be started when the first APDU segment is received and cancelled after the last segment is received.

3.4.21.3.3 Abnormal Cases

APPLICATION INFORMATION messages are sent using "low" priority at the data link layer. This can lead to message loss or truncation when preempted by other "high" priority messages. A receiving layer 3 entity shall detect APDU truncation if an APPLICATION INFORMATION message is received carrying an APDU or APDU segment that is shorter than indicated by the length indicator for the APDU Data IE. This test is reliable because preemption in the data link layer guarantees that at least the first $2 \cdot N201$ octets of any truncated message will be reliably transferred.

An APPLICATION INFORMATION transfer error shall be detected due to any of the following:

- a) Receipt of a truncated APDU or APDU segment;
- b) While performing APDU reassembly
 - receipt of any other layer 3 message defined to use SAPI 0 on the main DCCH;
 - receipt of an APDU or APDU segment indicating "First or Only Segment";
 - expiration of the reassembly timer (if supported);
- c) While not performing APDU reassembly, receipt of an APDU segment indicating "not First or only segment";
- d) Detection of any other error for a received message as defined in clause 8.

If APDU reassembly was in process when the error occurred, the receiving layer 3 entity shall discard the partially reassembled APDU and reprocess any received APDU or APDU segment that caused the error provided not an error defined in clause 8. In all other cases, any received APDU or APDU segment shall be discarded.

3.4.22 RR procedures related to packet resource establishment while in dedicated mode

The establishment of a packet resource is supported by procedures on the main DCCH when the mobile station is in dedicated mode. The procedures are only applicable to a mobile station supporting DTM with GPRS or EGPRS. The procedures are optional for the network.

These procedures constitute a complement to the corresponding procedures for temporary block flow establishment using CCCH or PCCCH while in idle mode defined in 3GPP TS 04.18 and 3GPP TS 04.60, respectively.

The packet request procedure is initiated by the MS and it is described in clause 3.4.22.1. The packet notification procedure is initiated by the network and it is described in 3.4.22.2. The packet downlink assignment is initiated by the network and it is described in clause 3.4.22.3.

3.4.22.1 Packet request procedure while in dedicated mode

The packet request procedure using the main DCCH may be used to establish a packet resource to support the transfer of LLC PDUs in the direction from the mobile station to the network.

3.4.22.1.1 Entering the dual transfer mode

While in dedicated mode, the establishment of an uplink packet resource may be initiated by the RR entity of the mobile station using the packet request procedure. The procedure is triggered by a request from upper layers to transfer an LLC PDU; see 3GPP TS 24.007. The request from upper layers specifies:

- TLLI,
- radio priority,
- RLC mode associated with the packet transfer,
- LLC frame type,
- establishment cause and
- QoS information for the requested packet session.

Upon such a request, the RR entity of the mobile station

- if access to the network is allowed (section 3.4.22.1.1.1), it initiates the packet request procedure as defined in section 3.4.22.1.1.2;
- otherwise, it rejects the request.

If the request from upper layers indicates any signalling procedure the acknowledged RLC mode shall be used.

3.4.22.1.1.1 Permission to access the network

Access to the network is allowed:

- if dual transfer mode is supported in the cell.

NOTE: belonging to an authorised access class or special class, radio priority level and LSA permission are not considered since they only apply to a mobile station in idle mode.

3.4.22.1.1.2 Initiation of establishment of the packet request procedure

The mobile station initiates the establishment of the packet resource by sending a DTM REQUEST message on the main DCCH.

The DTM REQUEST message contains:

- TLLI;

- Channel Request Description;
- Packet establishment cause which indicates, as applicable, a request to send user data, cell update, page response or a mobility management message;

Having sent the DTM REQUEST message, the mobile station starts timer T3148.

3.4.22.1.1.3 Answer from the network

3.4.22.1.1.3.1 Packet assignment

On receipt of a DTM REQUEST message the network may allocate an uplink packet resource. The packet uplink resource is assigned to the mobile station in one of the DTM assignment messages:

- DTM ASSIGNMENT COMMAND or
- PACKET ASSIGNMENT.

These messages are sent in acknowledged mode on the main DCCH. If frequency hopping is applied, the mobile station shall use the cell allocation defined for the cell to decode the mobile allocation.

The allocation of the uplink packet resource may imply the reallocation of the resource for the RR connection. In this case, the DTM ASSIGNMENT COMMAND message is used and the timer T3107 is started on the network side. The DTM ASSIGNMENT COMMAND message shall not be used to change to a dependent configuration.

The PACKET ASSIGNMENT message is only used when the packet resource is a PDCH and no reallocation of the RR connection is needed.

On receipt of:

- DTM ASSIGNMENT COMMAND message or
- PACKET ASSIGNMENT message,

the mobile station shall stop T3148, and switch to the assigned resources. The mobile station has then entered the dual transfer mode.

3.4.22.1.1.3.2 RR reallocation only

During the packet request procedure the network may send a

- HANDOVER COMMAND message or
- ASSIGNMENT COMMAND message,

upon whose receipt the timer T3148 or T3142 are stopped (if running), the handover or assignment procedure is performed.

3.4.22.1.1.3.3 Packet request rejection

If the network cannot allocate the requested packet resource it may send the mobile station a DTM REJECT message in acknowledged mode on the main DCCH. This message contains a wait time ("wait indication" information element). The mobile station is not allowed to make a new attempt for packet request during the waiting time.

On receipt of the DTM REJECT message, the mobile station stops T3148, notifies upper layers of a packet resource establishment failure and starts timer T3142 with the indicated value.

3.4.22.1.1.4 Packet request completion

The completion of the packet request procedure depends on the actual assignment message used by the network:

- when the network sends a DTM ASSIGNMENT COMMAND message (i.e. reallocation of the CS resource is required), after the main signalling link is successfully established, the mobile station returns an ASSIGNMENT COMPLETE message, specifying cause "normal event", to the network on the main DCCH. The packet request

procedure is completed for the mobile station when the ASSIGNMENT COMPLETE message is sent and for the network when it is received. The network then stops timer T3107.

- when the network sends a PACKET ASSIGNMENT message, the packet request procedure is completed for the network when assignment message is sent and for the mobile station when it is received.

When the packet request procedure is completed, the mobile station has entered the dual transfer mode.

3.4.22.1.1.5 Abnormal cases

If a failure occurs on the mobile station side before the packet request procedure is completed, all the allocated packet resources are released, the mobile station returns to dedicated mode and upper layers are notified (packet resource establishment failure). In the following cases a packet resource establishment failure has occurred and the mobile station sends a DTM ASSIGNMENT FAILURE message on the old main DCCH:

- if a DTM assignment message indicates packet resources in a non-supported frequency;
- if the information available in the mobile station after the reception of a DTM assignment message does not satisfactorily define uplink packet resources;
- if the mobile allocation indexes frequencies in more than one frequency band;
- if a DTM assignment message assigns resources not compliant with the multislot capabilities of the mobile station.

In addition:

- If the network commands the mobile station to reallocate the RR connection and the establishment of the main DCCH fails, the mobile station shall revert to the old channel and send an ASSIGNMENT FAILURE message on the old main DCCH.
- At expiry of timer T3148, the packet request procedure is aborted and a packet resource establishment failure is indicated to the upper layers.

When receiving the ASSIGNMENT FAILURE message, the network stops T3107.

3.4.22.2 Packet notification procedure in dedicated mode

The packet notification procedure is initiated by the RR entity of the network side. It is triggered by a page request from the GMM sublayer, see 3GPP TS 24.007.

3.4.22.2.1 Packet notification initiation by the network

The network initiates the packet notification procedure by sending the mobile station a PACKET NOTIFICATION message on the main DCCH.

The network shall not send the PACKET NOTIFICATION message to a mobile station that does not support dual transfer mode operation. If a mobile station not supporting dual transfer mode receives this message, it shall ignore it and remain in dedicated mode.

3.4.22.2.2 Packet notification response

Upon receipt of the PACKET NOTIFICATION message, the RR sublayer of the mobile station indicates the receipt of a packet paging request to the GMM sublayer; see 3GPP TS 24.007.

3.4.22.3 Packet downlink assignment in dedicated mode

The packet downlink assignment procedure in dedicated mode may be used to establish a packet resource to support the transfer of LLC PDUs in the direction from the network to the mobile station.

This procedure is only applicable to a mobile station in dedicated mode and with no TBF allocated. If the mobile station already has an ongoing TBF, the establishment of the downlink packet resource is performed on the PACCH; see 3GPP TS 04.60.

The establishment of a downlink packet resource is initiated by the RR entity on the network side using the packet downlink assignment procedure in dedicated mode. The procedure is triggered by a request from upper layers to transfer an LLC PDU; see 3GPP TS 24.007. The request from upper layers specifies a QoS profile, an *RLC mode*, *DRX parameters* and an *MS classmark* associated with the packet transfer.

3.4.22.3.1 Initiation of the packet downlink assignment procedure in dedicated mode

The network initiates the packet downlink assignment procedure in dedicated mode by sending a DTM assignment message (i.e. DTM ASSIGNMENT COMMAND or a PACKET ASSIGNMENT) in acknowledged mode on the main DCCH.

The allocation of the downlink packet resource may imply the reallocation of the resource for the RR connection. In this case, the DTM ASSIGNMENT COMMAND message is used and the timer T3107 is started on the network side. The DTM ASSIGNMENT COMMAND message shall not be used to change to a dependent configuration.

The network shall not send any of the DTM assignment messages to a mobile station that does not support dual transfer mode operation. If a mobile station not supporting dual transfer mode receives any of these messages, it shall ignore it and remain in dedicated mode.

When a TBF is assigned:

- The assignment message may indicate a TBF starting time.
- If the mobile station receives the message before the TBF starting time has expired, it shall wait until the frame number indicated by the TBF starting time and switch to the assigned PDCH.
- If the mobile station receives the message after the TBF starting time has expired, it shall ignore the indicated TBF starting time and switch to the assigned PDCH.

3.4.22.3.2 Packet downlink assignment completion

The completion of the packet downlink assignment procedure while in dedicated mode depends on the actual assignment message used by the network:

- when the network sends a DTM ASSIGNMENT COMMAND message (i.e. reallocation of the RR connection is required), after the main signalling link is successfully established, the mobile station returns an ASSIGNMENT COMPLETE message, specifying cause "normal event", to the network on the main DCCH. The packet downlink assignment procedure is completed for the mobile station when the ASSIGNMENT COMPLETE message is sent and for the network when it is received. The network then stops timer T3107.
- when the network sends a PACKET ASSIGNMENT message, the packet downlink assignment procedure is completed for the network when assignment message is sent and for the mobile station when it is received.

3.4.22.3.3 Abnormal cases

If a failure occurs on the mobile station side before the packet downlink assignment procedure is completed, all the allocated packet resources are released, the mobile station returns to dedicated mode and upper layers are notified (packet resource establishment failure).

In the following cases a packet resource establishment failure has occurred and the mobile station sends a DTM ASSIGNMENT FAILURE message on the old main DCCH:

- if a DTM assignment message indicates packet resources in a non-supported frequency;
- if the information available in the mobile station after the reception of a DTM assignment message does not satisfactorily define downlink packet resources;
- if the mobile allocation indexes frequencies in more than one frequency band;
- if a DTM assignment message assigns resources not compliant with the multislot capabilities of the mobile station.

In addition:

- If the network commands the mobile station to reallocate the RR connection and the establishment of the main DCCH fails, the mobile station shall revert to the old channel and send an ASSIGNMENT FAILURE message on the old main DCCH.

When receiving the ASSIGNMENT FAILURE message, the network stops T3107.

3.4.22.4 Modification of packet resources while in DTM

When the mobile station is in dual transfer mode, the network or mobile station may wish to modify the allocated packet resource. When the mobile station has an ongoing TBF, the procedures described in 3GPP TS 04.60 shall be used. When the main DCCH is the only packet resource that the mobile station has, the RR procedures related to packet resource establishment while in dedicated mode shall be used.

3.4.23 RR procedures related to packet resource maintenance while in dual transfer mode

Once the mobile station enters the dual transfer mode, the existent procedures apply (see 3GPP TS 04.60). Some exceptions to the existent procedures while in dedicated mode are:

- When all packet resources have been released (or aborted), the mobile station returns to dedicated mode.
- When the mobile station is in dual transfer mode, it shall ignore any RR-CELL CHANGE ORDER or PACKET CELL CHANGE ORDER message and shall remain in dual transfer mode.
- When the mobile station receives a HANDOVER COMMAND or an ASSIGNMENT COMMAND message, it shall abandon the packet resource immediately, enter dedicated mode and perform the handover or assignment procedure, respectively.
- As stated in 3GPP TS 05.08, no GPRS measurement reporting is performed.

The mobile station remains in dual transfer mode until the RR connection or all the packet resources are released.

3.4.24 RR procedures related to packet resource release while in dual transfer mode

The release of a TBF shall follow the procedures in 3GPP TS 04.60.

In the case of the release of the RR connection while in dual transfer mode, the mobile station shall abandon the packet resource and, once in idle mode and packet idle mode, it may start a new establishment as described in 3GPP TS 04.60.

3.4.25 GPRS suspension procedure

3.4.25.1 General

This procedure enables the network to suspend GPRS services packet flow in the downlink direction. The support of this procedure is conditional to the support of GPRS by the mobile station.

When a mobile station which is IMSI attached for GPRS services (see 3G3GPP TS 24.008) enters the dedicated mode, and when the mobile station limitations make it unable to handle both dedicated mode and either packet idle mode or packet transfer mode simultaneously, the mobile station shall perform the GPRS suspension procedure.

The RR sublayer of the mobile station shall indicate a RR GPRS suspend condition to the MM sublayer, see 3G3GPP TS 24.008.

3.4.25.2 MS in class B mode of operation

The GPRS suspension procedure shall be used to suspend GPRS services when the mobile station is in class B mode of operation and a circuit switched service is initiated. It is also used when a mobile station in CS/PS mode of operation in UMTS reverts to class B mode of operation in GSM.

The GPRS suspension procedure is initiated by the mobile station by sending a GPRS SUSPENSION REQUEST message with the appropriate suspension cause. This can be done as early as possible after access but shall be done after sending a CLASSMARK CHANGE message.

3.4.25.3 Dual transfer mode not supported

The GPRS suspension procedure shall be used to suspend GPRS services:

- a) when the mobile station in a class A mode of operation is handed over to a cell where the support of Class A mode of operation is not possible (e.g. a DTM mobile station entering a cell not supporting DTM)
- b) when the GPRS attached mobile station is in a cell that does not support DTM and a circuit switched service is initiated.

In case a), when the mobile station concludes that DTM is not supported in the new cell after the handover procedure is completed, it shall initiate the GPRS suspension procedure by sending a GPRS SUSPENSION REQUEST message with the suspension cause set to "DTM not supported in the cell".

In case b), the GPRS suspension procedure is initiated by the mobile station by sending a GPRS SUSPENSION REQUEST message with the suspension cause set to "DTM not supported in the cell". This can be done as early as possible after access but shall be done after sending a CLASSMARK CHANGE message.

3.4.26 GPRS Transparent Transport Procedure

While in dedicated mode, upper layers in the mobile station or in the network may request the transport of GPRS information transparently over the radio interface. This procedure is only applicable when

- the information from upper layers is signalling information and
- the GTTP length of the message is below the maximum indicated by the network.

In any other case, the RR procedures related to packet resource establishment while in dedicated mode apply.

The information from upper layers shall be carried inside the GTTP Information message. The GTTP Information message contains:

- the TLLI of the MS and
- the LLC PDU.

The GTTP messages are sent using "normal" priority at the data link layer.

3.5 RR procedures on CCCH related to temporary block flow establishment

The establishment of a temporary block flow (TBF) on a packet data physical channel is supported by procedures on CCCH when PCCCH is not provided in the cell. The procedures for temporary block flow establishment using CCCH are only applicable to a mobile station supporting GPRS. The procedures are optional for the network.

These procedures constitute a complement to the corresponding procedures for temporary block flow establishment using PCCCH, defined in 3GPP TS 04.60, and include the procedures using CCCH for *packet paging* (section 3.5.1), *packet access* (section 3.5.2) and *packet downlink assignment* (section 3.5.3).

3.5.1 Packet paging procedure using CCCH

The network can initiate the packet paging procedure in order to cause upper layers in the mobile station to respond, see section 4. The packet paging procedure can only be initiated by the network.

3.5.1.1 Packet paging initiation by the network

The packet paging procedure is initiated by the RR entity of the network side. It is triggered by a page request from the MM sublayer, see 3GPP TS 24.007.

The network initiates the paging procedure by sending a paging request message on an appropriate paging subchannel on CCCH or PCCCH. Paging initiation using a paging subchannel on CCCH is used when sending paging information to a mobile station and PCCCH is not present in the cell.

NOTE 1: There are three types of paging request messages that are applicable:

- PAGING REQUEST TYPE 1;
- PAGING REQUEST TYPE 2; and
- PAGING REQUEST TYPE 3.

In a PAGING REQUEST message used for the packet paging procedure, the mobile station shall be identified by the P-TMSI (GPRS TMSI) or its IMSI. If the mobile station is identified by the P-TMSI, it shall proceed as specified in section 3.5.1.2.

If the mobile station identified by its IMSI, it shall parse the message for a corresponding *Packet Page Indication* field:

- if the *Packet Page Indication* field indicates a paging procedure for RR connection establishment, or the field is not present in the message, the mobile station shall proceed as specified in section 3.3.2.2;
- if the *Packet Page Indication* field indicates a packet paging procedure, the mobile station shall proceed as specified in section 3.5.1.2.

A PAGING REQUEST message may include more than one mobile station identification.

The mobile station in packet idle mode is required to receive and analyse the paging messages and immediate assignment messages sent on the paging subchannels on CCCH corresponding to the paging groups determined for it in packet idle mode, as specified in 3GPP TS 05.02. These messages contain a page mode information element.

NOTE 2: The possible immediate assignment messages are: the IMMEDIATE ASSIGNMENT, the IMMEDIATE ASSIGNMENT EXTENDED and the IMMEDIATE ASSIGNMENT REJECT messages.

The treatment of page mode information, including the procedure when the mobile station selects a new PCH, and the procedure if a message in a paging subchannel is not received correctly are defined in section 3.3.2.1.1.

3.5.1.2 On receipt of a packet paging request

On the receipt of a paging request message, the RR sublayer of addressed mobile station indicates the receipt of a paging request to the MM sublayer, see 3GPP TS 24.007.

3.5.2 Packet access procedure using CCCH

The packet access procedure using CCCH may be used to establish a temporary block flow to support the transfer of LLC PDUs in the direction from the mobile station to the network. Establishment using one phase and two phase packet access, see 3GPP TS 04.60, are supported. The two phase packet access is supported by means of the single block or multiple block packet access option in this procedure, allowing the transfer of a PACKET RESOURCE REQUEST and possibly an ADDITIONAL MS RADIO ACCESS CAPABILITIES message to the network.

The single block packet access option in this procedure may also be used by a mobile station in packet idle mode to transfer an RLC/MAC control message other than the PACKET RESOURCE REQUEST message to the network, see section 3.5.2.2.

3.5.2.1 Entering the packet transfer mode: packet access procedure

The establishment of an uplink temporary block flow may be initiated by the RR entity of the mobile station using the packet access procedure. The procedure is triggered by a request from upper layers to transfer a LLC PDU, see 3GPP TS 24.007. The request from upper layers specifies *radio priority* and an *RLC mode* associated with the packet transfer or it indicates that the packet to be transferred contains signalling.

Upon such a request,

- if access to the network is allowed (section 3.5.2.1.1), the RR entity of the mobile station initiates the packet access procedure as defined in section 3.5.2.1.2;
- otherwise, it rejects the request.

If the request from upper layers indicates signalling, the highest *radio priority* level shall be used at determination if access to the network is allowed, and the acknowledged RLC mode shall be used.

3.5.2.1.1 Permission to access the network

Access to the network is allowed:

- if the mobile station is a member of at least one authorized access class or special access class as defined in section 3.3.1.1.1, and
- if packet access is allowed in the cell for the *radio priority* level associated with the packet transfer, as indicated by the PRIORITY_ACCESS_THR parameter broadcast in SI 13 message.
- if the cell belongs to one of the allowed LSAs for the mobile station, as indicated on the SIM, in the case where the mobile station is a LSA only access subscriber.

3.5.2.1.2 Initiation of the packet access procedure: channel request

The mobile station initiates the packet access procedure by scheduling the sending of CHANNEL REQUEST messages on RACH.

Alternatively, if the SI13 indicates that the cell is EGPRS capable and EGPRS PACKET CHANNEL REQUEST on RACH is supported in the cell, an EGPRS mobile station shall send the 11 bits EGPRS PACKET CHANNEL REQUEST messages at one-phase access attempts, two-phase access attempts and short access attempts (see 3GPP TS 04.60); if the SI 13 indicates that the cell is EGPRS capable and EGPRS PACKET CHANNEL REQUEST on RACH is not supported in the cell, the EGPRS mobile station shall use the 8 bit CHANNEL REQUEST message and shall initiate a two phase access request.

The mobile station then leaves the packet idle mode. In particular, the mobile station shall ignore PAGING REQUEST messages indicating a packet paging procedure.

A mobile station belonging to GPRS MS class A or B shall continue to monitor its paging subchannel on CCCH for PAGING REQUEST messages indicating an establishment of RR connection. A mobile station belonging to GPRS MS class B may abort the packet access procedure at the receipt of a PAGING REQUEST messages indicating an establishment of RR connection.

The mobile station schedules CHANNEL REQUEST or EGPRS PACKET CHANNEL REQUEST messages on RACH as defined in section 3.3.1.1.2.

The CHANNEL REQUEST or EGPRS PACKET CHANNEL REQUEST messages are sent on RACH and contain the parameters:

- an establishment cause which indicates packet access, and as applicable, a request for one phase packet access or single block packet access for a CHANNEL REQUEST (section 9.1.8), or a request for one phase access or two phase access or short access for a EGPRS PACKET CHANNEL REQUEST (see 3GPP TS 04.60);
- a random reference which is drawn randomly from a uniform probability distribution for every new transmission.

If the requested RLC mode is *unacknowledged mode*, the mobile station shall request a single block packet access and attempt a two phase packet access. If the requested RLC mode is *unacknowledged EGPRS mode TBF*, the mobile station shall request and attempt a two phase packet access.

If the purpose of the packet access procedure is to send a Page Response, Cell update, for a GPRS Mobility Management or a GPRS Session Management procedure, (i.e. the access is for Layer 3 signalling only, and not for a Layer 3 data transfer), the mobile station shall request a one phase packet access by sending a CHANNEL REQUEST message.

If the purpose of the packet access procedure is to send a PACKET PAUSE message the mobile station shall request a single block packet access. Upon sending the first CHANNEL REQUEST or EGPRS PACKET CHANNEL REQUEST message the mobile station shall start timer T3204. If timer T3204 expires before an IMMEDIATE ASSIGNMENT message granting a single block period on an assigned packet uplink resource is received, the packet access procedure is aborted. If the mobile station receives an IMMEDIATE ASSIGNMENT message during the packet access procedure indicating a packet downlink assignment procedure, the mobile station shall ignore the message.

After sending the first CHANNEL REQUEST or EGPRS PACKET CHANNEL REQUEST message, the mobile station shall start listening to the BCCH; it shall also listen to the full downlink CCCH timeslot corresponding to its CCCH group. The mobile station shall perform signal strength measurements as they are defined for packet idle mode, see 3GPP TS 05.08.

Having sent the maximum number of CHANNEL REQUEST messages, the mobile station starts timer T3146. At expiry of timer T3146, the packet access procedure is aborted and a packet access failure is indicated to upper layers.

If the mobile station receives an IMMEDIATE ASSIGNMENT message during the packet access procedure indicating a packet downlink assignment procedure, the mobile station shall abort the packet access procedure and respond to the IMMEDIATE ASSIGNMENT message as specified in section 3.5.3.1.2. The mobile station shall then attempt an establishment of uplink TBF, using the procedure specified in 3GPP TS 04.60 which is applicable in packet transfer mode.

3.5.2.1.3 Packet immediate assignment

3.5.2.1.3.1 On receipt of a CHANNEL REQUEST or EGPRS PACKET CHANNEL REQUEST message

On receipt of a CHANNEL REQUEST message indicating a packet access, the network may allocate a temporary flow identity and assign a packet uplink resource comprising one PDCH for an uplink temporary block flow in GPRS TBF mode. On receipt of a EGPRS PACKET CHANNEL REQUEST message, the network may allocate a temporary flow identity and assign a packet uplink resource comprising one PDCH for an uplink temporary block flow in EGPRS TBF mode or GPRS TBF mode.

If the establishment cause in the CHANNEL REQUEST message indicates a request for a single block packet access, the network shall grant only the single block period on the assigned packet uplink resource if the network allocates resource for the mobile station. If the establishment cause in the EGPRS PACKET CHANNEL REQUEST message indicates a request for a two phase access, the network shall grant one or two radio blocks for the mobile station (within a Multi Block allocation) to send a PACKET RESOURCE REQUEST and possibly an ADDITIONAL MS RADIO ACCESS CAPABILITIES messages on the assigned packet uplink resource if the network allocates resource for the mobile station.

If the establishment cause in the CHANNEL REQUEST message indicates a request for one phase packet access, the network may grant either a one phase packet access or a single block packet access for the mobile station. If a single block packet access is granted, it forces the mobile station to perform a two phase packet access. If the establishment cause in the EGPRS PACKET CHANNEL REQUEST message indicates a request for one phase packet access, the network may grant either a one phase packet access or a two phase access (within a Multi Block allocation). If a multiple block packet access is granted, it forces the mobile station to perform a two phase packet access.

The packet uplink resource is assigned to the mobile station in an IMMEDIATE ASSIGNMENT message sent in unacknowledged mode on the same CCCH timeslot on which the network has received the CHANNEL REQUEST or the EGPRS PACKET CHANNEL REQUEST message. There is no further restriction on what part of the downlink CCCH timeslot the IMMEDIATE ASSIGNMENT message can be sent. Timer T3141 is started on the network side.

The IMMEDIATE ASSIGNMENT message contains:

- the information field of the CHANNEL REQUEST or the EGPRS PACKET CHANNEL REQUEST message and the frame number of the frame in which the CHANNEL REQUEST or the EGPRS PACKET CHANNEL REQUEST message was received;
- the packet channel description;
- the initial timing advance;
- the packet uplink assignment or EGPRS packet uplink assignment construction.

If frequency hopping is applied, the network may use the indirect encoding or the direct encoding of the frequency configuration in the *Packet Channel Description* information element. If the indirect encoding is used, the mobile station uses information received in system information or stored from a previous assignment to determine the frequency parameters, see 3GPP TS 04.60. If the direct encoding is used, the mobile station uses the cell allocation defined for the cell to decode the mobile allocation.

If the *indirect encoding* is used, the IMMEDIATE ASSIGNMENT message may contain a CHANGE_MARK_1 field. If that is present, the mobile station shall verify the validity of the SI13_CHANGE_MARK associated with the GPRS mobile allocation to which the message refers, see 3GPP TS 04.60. If the CHANGE_MARK_1 field and the SI13_CHANGE_MARK do not match, the message does not satisfactorily define a PDCH.

If the mobile station receives an IMMEDIATE ASSIGNMENT message and the *Dedicated mode or TBF* information element indicates that this is the first message in a two-message assignment, the mobile station shall continue to listen to the full CCCH. The network may send a second IMMEDIATE ASSIGNMENT message to the mobile station within two multiframe periods following the first IMMEDIATE ASSIGNMENT message, specifying the packet channel description and, if required, a mobile allocation for the assignment. The two IMMEDIATE ASSIGNMENT messages in a two-message assignment shall have the same contents of the *Request Reference* information elements.

If the mobile station does not receive the second IMMEDIATE ASSIGNMENT messages in a two-message assignment within two multiframe periods following the first message, the mobile station shall discard the first IMMEDIATE ASSIGNMENT message received.

On receipt of an IMMEDIATE ASSIGNMENT message or, in case of a two-message assignment, a matching pair of IMMEDIATE ASSIGNMENT messages corresponding to one of its 3 last CHANNEL REQUEST or EGPRS PACKET CHANNEL REQUEST messages, the mobile station stops T3146 (if running), stops sending CHANNEL REQUEST or EGPRS PACKET CHANNEL REQUEST messages, and switches to the assigned PDCH.

The content of the packet uplink assignment construction (respectively EGPRS packet uplink assignment construction) indicates which type of packet access is granted: *one phase packet access* or *single (respectively multiple) block packet access*

3.5.2.1.3.2 One phase packet access

In the case the one phase packet access is granted, the packet uplink assignment construction contains:

- the temporary flow identity;
- the USF value, if the medium access method is dynamic allocation;
or
the fixed allocation bitmap, if the medium access method is fixed allocation;
- the channel coding scheme for RLC data blocks;
- the power control parameters;
- the polling bit ;- optionally, the timing advance index (see 3GPP TS 05.10);
- optionally, the TBF starting time (note: TBF starting time is mandatory if medium access method is fixed allocation).

In addition, the EGPRS packet uplink assignment construction also contains :

- the EGPRS modulation and coding scheme ;
- information whether retransmitted uplink data blocks shall be resegmented or not ;
- the EGPRS window size to be used within the transmission ;
- optionally a request for the mobile station to send its radio access capability information.

The medium access method is *dynamic allocation* or *fixed allocation* and the RLC mode is *acknowledged mode*, see 3GPP TS 04.60.

If the medium access method is *fixed allocation*, and the number of blocks allocated in the ALLOCATION_BITMAP is not sufficient to transfer all the RLC/MAC blocks that the MS has to transmit at the time the packet uplink assignment

construction is received, the MS shall request additional resources by sending a PACKET RESOURCE REQUEST on one of the allocated blocks.

If the timing advance index (TAI) is included in the packet uplink assignment construction, the mobile station shall use the continuous update timing advance mechanism, see 3GPP TS 05.10, using PTCCH in the same timeslot as the assigned PDCH. If a timing advance index (TAI) field is not included, the continuous update timing advance mechanism shall not be used.

In case the packet uplink assignment or EGPRS packet uplink assignment construction contains a TBF starting time and the mobile station receives the message before the TBF starting time has expired, it shall wait until the frame number indicated by the TBF starting time before accessing the channel. If the mobile station receives the message after the TBF starting time has expired, it shall ignore the TBF starting time and may immediately access the channel. If the medium access method is *dynamic allocation*, the mobile station shall start timer T3164. Regardless of which allocation mode is used, the mobile station shall proceed with the contention resolution at one phase access defined in 3GPP TS 04.60.

If the Polling bit is set to 1, MS shall send a PACKET CONTROL ACKNOWLEDGEMENT message (see 04.60) on the assigned PDCH, in the uplink block specified by the TBF Starting Time. In this case the TBF Starting Time is used both to indicate when the assigned PDCH becomes valid and to specify the uplink block. If the TBF Starting Time is not present or has expired, the MS shall ignore the polling request.

When the mobile station switches to the assigned PDCH, it shall take the power control parameters received in the IMMEDIATE ASSIGNMENT message into account, perform signal strength measurements and apply output power control procedures as they are defined for packet transfer mode, see 3GPP TS 05.08.

When assigning an EGPRS TBF, the network may request information about radio access capabilities of the mobile station on one or several frequency bands within the IMMEDIATE ASSIGNMENT message ; the list of frequency bands is ordered by the network starting with the most important and ending with the least important one. The mobile station shall provide the network with its radio access capabilities for the frequency bands it supports, in the same priority order as the one specified by the network, by sending a PACKET RESOURCE REQUEST message, and an ADDITIONAL MS RADIO ACCESS CAPABILITIES if all the requested informations do not fit in the PACKET RESOURCE REQUEST. If the mobile station does not support any frequency band requested by the network, it shall report its radio access capabilities for the BCCH frequency band. The mobile station shall indicate in the PACKET RESOURCE REQUEST if it will send more information about its radio access capabilities in the ADDITIONAL MS RADIO ACCESS CAPABILITIES message. The PACKET RESOURCE REQUEST and the ADDITIONAL MS RADIO ACCESS CAPABILITIES shall be sent within the one or two first radio blocks allocated for the mobile station on the assigned PDCH.

The network may request a retransmission of the PACKET RESOURCE REQUEST and the ADDITIONAL MS RADIO ACCESS CAPABILITIES messages. A request for retransmission of one or both of these messages shall be indicated in the PACKET UPLINK ACK/NACK message. The mobile station has to indicate within the PACKET RESOURCE REQUEST if the message is a retransmitted one.

3.5.2.1.3.3 Single block packet access

In the case the single block packet access is granted, the packet uplink resource description contains:

- the power control parameter setting;
- the TBF starting time.

If the mobile station receives the IMMEDIATE ASSIGNMENT message before the TBF starting time has expired, it shall wait until the block period indicated by the TBF starting time. The network shall use the TBF starting time to indicate the first frame number belonging to the single block period granted for packet access. The mobile station may either use the assigned block period to send a PACKET RESOURCE REQUEST message to initiate the two phase packet access procedure defined in 3GPP TS 04.60, or to send an RLC/MAC control message other than the PACKET RESOURCE REQUEST message to the network, see section 3.5.2.2.

If the mobile station receives the IMMEDIATE ASSIGNMENT message after the TBF starting time has expired, a failure has occurred.

If a failure occurs and the packet access attempt was due to a request from upper layers to transfer a LLC PDU, a TBF establishment failure has occurred and the mobile station proceeds as specified in section 3.5.2.1.5. If a failure occurs

and the packet access attempt was due to the sending of an RLC/MAC control message, the packet access is aborted, the mobile station returns to packet idle mode.

3.5.2.1.3.3a Multiblock packet access

In the case the multiblock packet access is granted, the EGPRS packet uplink assignment description contains:

- timeslot number of the allocation and the number of blocks allocated;
- the power control parameter setting;
- the TBF starting time.

When assigning a multiblock packet access, the network may request information about radio access capabilities of the mobile station on one or several frequency bands within the IMMEDIATE ASSIGNMENT message and allocate one or two radio blocks for uplink control messages accordingly ; the list of frequency bands is ordered by the network starting with the most important and ending with the least important one . The mobile station shall then provide the network with its radio access capabilities for the frequency bands it supports, in the same priority order as the one specified by the network, by sending a PACKET RESOURCE REQUEST message in the first radio block on the assigned PDCH, and an ADDITIONAL MS RADIO ACCESS CAPABILITIES message immediately after the PACKET RESOURCE REQUEST message on the assigned PDCH if all the requested informations do not fit in the PACKET RESOURCE REQUEST and two radio blocks have been allocated by the network. If the mobile station does not support any frequency band requested by the network, it shall report its radio access capabilities for the BCCH frequency band in the PACKET RESOURCE REQUEST message. The mobile station shall indicate in the PACKET RESOURCE REQUEST if it will send more information about its radio access capabilities in the ADDITIONAL MS RADIO ACCESS CAPABILITIES message. If the mobile station has been allocated two radio blocks and all the requested informations fit in the PACKET RESOURCE REQUEST message, no ADDITIONAL MS RADIO ACCESS CAPABILITIES message shall be sent (see 3GPP TS 04.60). Instead, some uplink control block (e.g. packet measurement report, packet uplink dummy control block) may be sent by the mobile station.

The network may indicate in the next PACKET UPLINK ASSIGNMENT message a request for retransmission of the ADDITIONAL MS RADIO ACCESS CAPABILITIES message (see 3GPP TS 04.60).

If the mobile station receives the IMMEDIATE ASSIGNMENT message before the TBF starting time has expired, it shall wait until the block period indicated by the TBF starting time. The network shall use the TBF starting time to indicate the first frame number belonging to the multi block period granted for packet access. If the mobile station receives the IMMEDIATE ASSIGNMENT message after the TBF starting time has expired, a failure has occurred.

If a failure occurs and the packet access attempt was due to a request from upper layers to transfer a LLC PDU, a TBF establishment failure has occurred and the mobile station proceeds as specified in section 3.5.2.1.5. If a failure occurs and the packet access attempt was due to the sending of an RLC/MAC control message, the packet access is aborted, the mobile station returns to packet idle mode.

3.5.2.1.3.4 Packet access rejection

The network may send to the mobile station an IMMEDIATE ASSIGNMENT REJECT message in unacknowledged mode on the same CCCH timeslot on which the channel request message was received. There is no further restriction on what part of the downlink CCCH timeslot an IMMEDIATE ASSIGNMENT REJECT message can be sent. This message contains the request reference and a wait indication.

On receipt of an IMMEDIATE ASSIGNMENT REJECT message corresponding to one of its 3 last CHANNEL REQUEST messages, the mobile station stops sending CHANNEL REQUEST messages, starts timer T3142 with the indicated value, ("wait indication" information element), starts T3146 if it has not already been started, and listens to the downlink CCCH until T3146 expires. During this time, additional IMMEDIATE ASSIGNMENT REJECT messages are ignored, but any immediate assignment corresponding to any other of its 3 last CHANNEL REQUEST messages make the mobile station follow the procedure in section 3.5.2.1.3.1. If no such immediate assignment is received, the mobile station returns to packet idle mode and notify higher layers (TBF establishment failure) and notify higher layers (TBF establishment failure).

If the purpose of the packet access procedure is to send a PACKET PAUSE message and an IMMEDIATE ASSIGNMENT REJECT message is received, the packet access procedure is aborted.

If the mobile station has received responses from the network on all, or in case more than 3 were sent the last 3, of its CHANNEL REQUEST messages, it shall immediately return to packet idle mode and notify higher layers.

The mobile station is not allowed to make a new attempt for packet access in the same cell until T3142 expires, but may attempt packet access in an other cell after successful cell reselection for radio conditions reasons (see 3GPP TS 05.08). The value of the wait indication (i.e. T3142) relates to the cell from which it was received.

The mobile station may initiate RR connection establishment in the same cell before T3142 has expired, see section 3.3.1.1.3.2.

3.5.2.1.4 Packet access completion

The one phase packet access procedure is completed at a successful contention resolution. The mobile station has entered the packet transfer mode. Timer T3141 is stopped on the network side. Timer T3164 is stopped on the mobile station side.

3.5.2.1.5 Abnormal cases

If a failure occurs on the mobile station side before a successful contention resolution procedure is completed, the allocated temporary block flow is released; the mobile station returns to packet idle mode, upper layers are notified (TBF establishment failure), transactions in progress are aborted:

- If a TLLI mismatch has occurred during the contention resolution procedure, and the repetition of the packet access has been repeated the maximum number of times as defined in 3GPP TS 04.60, a TBF establishment failure has occurred.
- If the information available in the mobile station, after the reception of an IMMEDIATE ASSIGNMENT message or the second IMMEDIATE ASSIGNMENT message of a two-message assignment, does not satisfactorily define a PDCH, a TBF establishment failure has occurred.
- If the mobile allocation indexes frequencies in more than one frequency band then a TBF establishment failure has occurred.
- If an IMMEDIATE ASSIGNMENT message indicates a PDCH in a non-supported frequency band then a TBF establishment failure has occurred.

On the network side, if timer T3141 elapses before a successful contention resolution procedure is completed, the newly allocated temporary block flow is released as specified in 3GPP TS 04.60 and the packet access is forgotten.

3.5.2.2 Sending an RLC/MAC control message: single block packet access procedure

The sending of an RLC/MAC control message other than the PACKET RESOURCE REQUEST message from a mobile station in packet idle mode to the network may be initiated by the RR entity on the mobile station side using the packet access procedure. If access to the network is allowed (section 3.5.2.1.1), the packet access is done according to the procedures defined in sections 3.5.2.1.2 and 3.5.2.1.3, using the single block packet access option defined in section 3.5.2.1.3.3.

Further action depends on the RLC/MAC control message sent by the mobile station, see 3GPP TS 04.60. Unless otherwise indicated by the RLC/MAC control message, the mobile station remains in packet idle mode.

3.5.3 Packet downlink assignment procedure using CCCH

The packet downlink assignment procedure using CCCH may be used to establish a temporary block flow to support the transfer of LLC PDUs in the direction from the network to the mobile station.

This procedure may also be used to assign a single downlink block on a PDCH to support the transfer of an RLC/MAC control message from the network to a mobile station in packet idle mode, see 3.5.3.2.

3.5.3.1 Entering the packet transfer mode: packet downlink assignment procedure

The establishment of a downlink temporary block flow may be initiated by the RR entity on the network side using the packet downlink assignment procedure. The procedure is triggered by a request from upper layers to transfer a LLC PDU, see 3GPP TS 24.007. The request from upper layers specifies an optional *Priority* level, a QoS profile including the requested *RLC mode*, optional *DRX parameters*, and optional *IMSI* and an optional *MS Radio Access Capability* associated with the packet transfer.

Upon such a request, the network shall determine whether the mobile station is in packet idle mode or packet transfer mode. The packet downlink assignment procedure using CCCH is applicable when the mobile station is in packet idle mode and when there is no PCCCH present in the cell.

The network may allocate a temporary flow identity and assign a packet downlink resource comprising one PDCH for a downlink temporary block flow.

3.5.3.1.2 Initiation of the packet downlink assignment procedure

The network initiates the packet downlink assignment procedure by sending an IMMEDIATE ASSIGNMENT message in unacknowledged mode on the CCCH timeslot corresponding to CCCH group the mobile station belongs to. appropriate CCCH group is calculated from the IMSI, see 05.02. The behaviour of the network when the RR entity does not receive the IMSI from the upper layers is implementation dependent for the calculation of the CCCH group where the IMMEDIATE ASSIGNMENT message has to be sent. If the mobile station is in non-DRX mode or if the RR entity does not receive the IMSI or the DRX parameters from the upper layers, there is no further restriction on what part of the downlink CCCH timeslot the IMMEDIATE ASSIGNMENT message, or the first part of the IMMEDIATE ASSIGNMENT message (in the case of a two-message assignment), can be sent. If the mobile station applies DRX, the IMMEDIATE ASSIGNMENT message, or the first part of the IMMEDIATE ASSIGNMENT message (in the case of a two-message assignment), shall be sent in a CCCH block corresponding to a paging group determined for the mobile station in packet idle mode, see 3GPP TS 05.02.

The IMMEDIATE ASSIGNMENT message contains:

- the packet channel description;
- the initial timing advance;
- the packet downlink assignment construction

The contents of the packet downlink assignment construction determines the further action. At the establishment of a downlink temporary block flow, the packet downlink assignment construction shall contain:

- the TLLI;
- the temporary flow identity;
- the RLC mode;
- the power control parameters;
- the polling bit ;
- the initial timing advance validity flag;
- optionally, EGPRS Window Size (see 3GPP TS 04.60) and Link Quality Measurement Mode (see 3GPP TS 04.60);
- optionally, the timing advance index (see 3GPP TS 05.10);
- optionally, the TBF starting time.

If frequency hopping is applied, the network may use the indirect encoding or the direct encoding of the frequency configuration in the *Packet Channel Description* information element. If the indirect encoding is used, the mobile station uses information received in system information or stored from a previous assignment to determine the frequency parameters, see 3GPP TS 04.60. If the direct encoding is used, the mobile station uses the cell allocation defined for the cell to decode the mobile allocation.

If the *indirect encoding* is used, the IMMEDIATE ASSIGNMENT message may contain a CHANGE_MARK_1 field. If that is present, the mobile station shall verify the validity of the SI *change mark* associated with the GPRS mobile allocation to which the message refers, see 3GPP TS 04.60. If the CHANGE_MARK_1 field and the SI *change mark* do not match, the message does not satisfactorily define a PDCH.

If the mobile station receives an IMMEDIATE ASSIGNMENT message and the *Dedicated mode or TBF* information element indicates that this is the first message in a two-message assignment, the mobile station shall start listen to the full CCCH. The network may send a second IMMEDIATE ASSIGNMENT message to the mobile station within two multiframe periods following the first IMMEDIATE ASSIGNMENT message, specifying the packet channel description and, if required, a mobile allocation for the assignment. The two IMMEDIATE ASSIGNMENT messages in a two-message assignment shall have the same contents of the *Request Reference* information elements.

If the mobile station was operating in DRX mode when it received the first message of a two-message assignment, the network shall not send the second IMMEDIATE ASSIGNMENT message within the two block periods immediately following the first message.

If the mobile station does not receive the second IMMEDIATE ASSIGNMENT messages in a two-message assignment within two multiframe periods following the first message, the mobile station shall discard the first IMMEDIATE ASSIGNMENT message received. After the two multiframe periods following the first message, the mobile station may resume to DRX mode.

On receipt of an IMMEDIATE ASSIGNMENT message or, in case of a two-message assignment, a matching pair of IMMEDIATE ASSIGNMENT messages, the mobile station stops monitoring downlink CCCH and switches to the assigned PDCH and starts listening for downlink RLC/MAC blocks identified by the assigned TFI; it starts timer T3190.

The IMMEDIATE ASSIGNMENT message may indicate a TBF starting time. If the mobile station receives the message before the TBF starting time has expired, it shall wait until the frame number indicated by the TBF starting time, start timer T3190 and switch to the assigned PDCH. If the mobile station receives the message after the TBF starting time has expired, it shall ignore the indicated TBF starting time, immediately start timer T3190 and switch to the assigned PDCH.

When the mobile station switches to the assigned PDCH, it shall take the power control parameters received in the IMMEDIATE ASSIGNMENT message into account, perform signal strength measurements and apply output power control procedures as they are defined for packet transfer mode, see 3GPP TS 05.08.

If the Polling bit is set to 1, MS shall send a PACKET CONTROL ACKNOWLEDGEMENT message (see 04.60) on the assigned PDCH, in the uplink block specified by the TBF Starting Time. In this case the TBF Starting Time is used both to indicate when the assigned PDCH becomes valid and to specify the uplink block. If the TBF Starting Time is not present or has expired, the MS shall ignore the polling request.

An IMMEDIATE ASSIGNMENT message may indicate a timing advance index (TAI) in the packet timing advance IE. The mobile station shall then use the continuous update timing advance mechanism, see 3GPP TS 05.10, using PTCCH in the same timeslot as the assigned PDCH. If there is no indication of a timing advance index, the continuous update timing advance mechanism shall not be used.

The TA_VALID flag indicates if the value of the *Timing Advance* IE is valid or not.

If the network does not have a valid timing advance value for the mobile station to include in the IMMEDIATE ASSIGNMENT message, the network shall use the procedures defined in 3GPP TS 04.60 on the assigned TBF, or the polling mechanism defined in the above paragraph if the PACKET CONTROL ACKNOWLEDGEMENT format is set to four access bursts, to obtain a timing advance value and to update the initially assigned timing advance value before the mobile station is required to transmit other than access burst on the newly assigned channel.

The packet downlink construction may optionally contain the EGPRS Window Size (see 3GPP TS 04.60) and Link Quality Measurement Mode (see 3GPP TS 04.60). The presence of these fields indicates EGPRS TBF mode (see 3GPP TS 04.60). If these fields are not present, this indicates GPRS TBF mode.

3.5.3.1.3 Packet downlink assignment completion

After having sent the packet downlink assignment, the network starts sending downlink RLC/MAC blocks on the assigned packet downlink resource and the packet downlink assignment procedure is completed at the network side.

On the mobile station side, the procedure is completed when the mobile station receives an RLC/MAC block identified by the assigned temporary flow identity. The mobile station stops timer T3190. The mobile station has entered packet transfer mode.

3.5.3.1.4 Abnormal cases

If a failure occurs on the mobile station side before the packet downlink assignment procedure is completed (TBF establishment failure), the temporary block flow is released; the mobile station returns to packet idle mode:

- If the mobile station does not receive a RLC/MAC block on the assigned PDCHs before timer T3190 expires, then a TBF establishment failure has occurred.
- If the information available in the mobile station, after the reception of an IMMEDIATE ASSIGNMENT message or the second IMMEDIATE ASSIGNMENT message of a two-message assignment, does not satisfactorily define a PDCH, then a TBF establishment failure has occurred.
- If the mobile allocation in the frequency parameters indexes frequencies in more than one frequency band, then a TBF establishment failure has occurred.

If an IMMEDIATE ASSIGNMENT message indicates a PDCH in a non-supported frequency band, then a TBF establishment failure has occurred.

3.5.3.2 Sending an RLC/MAC control message: single block packet downlink assignment procedure

The sending of an RLC/MAC control message to a mobile station in packet idle mode may be initiated by the RR entity on network side using the packet downlink assignment procedure. The procedure is used to assign a single downlink block on a PDCH for the transfer of the RLC/MAC control message. Using this procedure, the network shall not apply segmentation of the RLC/MAC control message.

The single downlink block assignment is done according to the procedure defined in 3.5.3.1.2, with the following exceptions:

The packet downlink assignment construction in the IMMEDIATE ASSIGNMENT message shall contain only:

- the TLLI; and
- the TBF starting time.

If the mobile station receives the IMMEDIATE ASSIGNMENT message before the TBF starting time has expired, it shall wait until the frame number indicated by the TBF starting time. The network shall use the TBF starting time to indicate the first frame number belonging to the single block period assigned to the mobile station. The mobile station shall switch to the assigned PDCH and attempt to decode an RLC/MAC control message in the assigned downlink block. Further action depends on the RLC/MAC control message sent by the network, see 3GPP TS 04.60. Unless otherwise indicated by the RLC/MAC control message, the mobile station remains in packet idle mode. If the mobile station remains in packet idle mode, it shall continue to monitor downlink CCCH once the block period indicated by the TBF starting time has passed.

If the mobile station fails to decode or does not receive an RLC/MAC control message in the assigned downlink block, it shall remain in packet idle mode and continue to monitor downlink CCCH once the block period indicated by the TBF starting time has passed.

If the mobile station receives the IMMEDIATE ASSIGNMENT message after the TBF starting time has expired, it shall ignore the assignment.

If a failure occurs on the mobile station side due to any other reason, the mobile station shall ignore the assignment.

4 Elementary procedures for Mobility Management

See 3GPP TS 24.008.

5 Elementary procedures for circuit-switched Call Control

See 3GPP TS 24.008.

6 Support for packet services

See 3GPP TS 24.008.

7 Examples of structured procedures

See 3GPP TS 24.008.

8 Handling of unknown, unforeseen, and erroneous protocol data

8.1 General

The procedures specified in 3GPP TS 04.18 and call-related supplementary service handling in 3GPP TS 24.010 apply to those messages which pass the checks described in this section.

This section also specifies procedures for the handling of unknown, unforeseen, and erroneous protocol data by the receiving entity. These procedures are called "error handling procedures", but in addition to providing recovery mechanisms for error situations they define a compatibility mechanism for future extensions of the protocols.

Error handling concerning the value part of the Facility IE and of the SS Version Indicator IE are not in the scope of this technical specification. It is defined in 3GPP TS 24.010 and the 3GPP TS 04.8x series.

Subsections 8.1 to 8.8 shall be applied in order of precedence.

Most error handling procedures are mandatory for the mobile station.

Detailed error handling procedures in the network are implementation dependent and may vary from PLMN to PLMN. However, when extensions of this protocol are developed, networks will be assumed to have the error handling that is indicated in this section as mandatory ("shall") and that is indicated as strongly recommended ("should"). Sections 8.2, 8.3, 8.4, 8.5 and 8.7.2 do not apply to the error handling in the network applied to the receipt of initial layer 3 message: If the network diagnoses an error described in one of these sections in the initial layer 3 message received from the mobile station, it shall either:

- try to recognize the classmark and then take further implementation dependent actions; or
- release the RR-connection.

Also, the error handling of the network is only considered as mandatory or strongly recommended when certain thresholds for errors are not reached during a dedicated connection.

In this section the following terminology is used:

- An IE is defined to be syntactically incorrect in a message if it contains at least one value defined as "reserved" in section 10, or if its value part violates rules of section 10. However it is not a syntactical error that a type 4 IE specifies in its length indicator a greater length than defined in section 10.
- A message is defined to have semantically incorrect contents if it contains information which, possibly dependent on the state of the receiver, is in contradiction to the resources of the receiver and/or to the procedural part (i.e. sections 3, 4, 5) of 3GPP TS 04.18, 3GPP TS 24.010, or relevant 3GPP TS 04.8X series.

8.2 Message too short

When a message is received that is too short to contain a complete message type information element, that message shall be ignored, cf. 3GPP TS 24.007.

8.3 Unknown or unforeseen transaction identifier

See 3GPP TS 24.008.

8.4 Unknown or unforeseen message type

If a mobile station receives an RR message with message type not defined for the PD or not implemented by the receiver in unacknowledged mode, it shall ignore the message.

If a mobile station receives an RR message with message type not defined for the PD or not implemented by the receiver in acknowledged mode, it shall return a status message (RR STATUS) with cause # 97 "message type non-existent or not implemented".

If the network receives an RR message with message type not defined for the PD or not implemented by the receiver in a protocol state where reception of an unsolicited message with the given PD from the mobile station is not foreseen in the protocol, the network actions are implementation dependent. Otherwise, if the network receives a message with message type not defined for the PD or not implemented by the receiver, it shall ignore the message except that it should return a status message (RR STATUS) with cause #97 "message type non-existent or not implemented".

NOTE: A message type not defined for the PD in the given direction is regarded by the receiver as a message type not defined for the PD, see 3GPP TS 24.007 [20].

If the mobile station receives a message not compatible with the protocol state, the mobile station shall ignore the message except for the fact that, if an RR connection exists, it returns a status message (RR STATUS) with cause #98 "Message type not compatible with protocol state".

If the network receives a message not compatible with the protocol state, the network actions are implementation dependent.

8.5 Non-semantical mandatory information element errors

When on receipt of a message,

- an "imperative message part" error; or
- a "missing mandatory IE" error

is diagnosed or when a message containing:

- a syntactically incorrect mandatory IE; or
- an IE unknown in the message, but encoded as "comprehension required" (see section 3GPP TS 24.007); or
- an out of sequence IE encoded as "comprehension required" (see section 3GPP TS 24.007)

is received,

- the mobile station shall proceed as follows:

If the message is not one of the messages listed in sections 8.5.1, 8.5.2, 8.5.3 the mobile station shall ignore the message except for the fact that, if an RR connection exists, it shall return a status message (RR STATUS) with cause # 96 "Invalid mandatory information".

- the network shall proceed as follows:

When the message is not one of the messages listed in section 8.5.3 b), c), d) or e) and 8.5.5 a), b), d) or e), the network shall either

- try to treat the message (the exact further actions are implementation dependent), or
- ignore the message except that it should return a status message (RR STATUS) with cause # 96 "Invalid mandatory information".

8.5.1 Radio resource management

For the mobile station the following procedures shall apply:

- a) If the message is a CHANNEL RELEASE message, the actions taken shall be the same as specified in 3.5 "RR connection release".
- b) If the message is a PARTIAL RELEASE message, the reactions of the MS are for further study.

8.6 Unknown and unforeseen IEs in the non-imperative message part

8.6.1 IEs unknown in the message

The MS shall ignore all IEs unknown in a message which are not encoded as "comprehension required" (see 3GPP TS 24.007).

The network shall take the same approach.

8.6.2 Out of sequence IEs

The MS shall ignore all out of sequence IEs in a message which are not encoded as "comprehension required" (see 3GPP TS 24.007).

The network should take the same approach.

8.6.3 Repeated IEs

If an information element with format T, TV, or TLV is repeated in a message in which repetition of the information element is not specified in section 9 of this technical specification, only the contents of the information element appearing first shall be handled and all subsequent repetitions of the information element shall be ignored. When repetition of information elements is specified, only the contents of specified repeated information elements shall be handled. If the limit on repetition of information elements is exceeded, the contents of information elements appearing first up to the limit of repetitions shall be handled and all subsequent repetitions of the information element shall be ignored.

The network should follow the same procedures.

8.7 Non-imperative message part errors

This category includes:

- syntactically incorrect optional IEs;
- conditional IE errors.

8.7.1 Syntactically incorrect optional IEs

The MS shall treat all optional IEs that are syntactically incorrect in a message as not present in the message.

The network shall take the same approach.

8.7.2 Conditional IE errors

When the MS upon receipt of an RR message diagnoses a "missing conditional IE" error or an "unexpected conditional IE" error or when it receives an RR message containing at least one syntactically incorrect conditional IE, it shall ignore the message except for the fact that, if an RR connection exists, it shall return a status message (RR STATUS) with cause value # 100 "conditional IE error".

When the MS upon receipt of a GMM or SM message diagnoses a "missing conditional IE" error or an "unexpected conditional IE" error or when it receives a GMM or SM message containing at least one syntactically incorrect conditional IE, it shall ignore the message and it shall return a status message (GMM STATUS or SM STATUS depending on the PD) with cause value # 100 "conditional IE error".

When the network receives a message and diagnose a "missing conditional IE" error or an "unexpected conditional IE" error or when it receives a message containing at least one syntactically incorrect conditional IE, the network shall either:

- try to treat the message (the exact further actions are implementation dependent), or
- ignore the message except that it should return a status message (RR STATUS) with cause # 100 "conditional IE error".

8.8 Messages with semantically incorrect contents

When a message with semantically incorrect contents is received, the foreseen reactions of the procedural part of 3GPP TS 04.18 (i.e. of sections 3) are performed. If however no such reactions are specified, the MS shall ignore the message except for the fact that, if an RR connection exists, it returns a status message (RR STATUS) with cause value # 95 "semantically incorrect message".

The network should follow the same procedure except that a status message is not normally transmitted.

Semantic checking of the Facility information element value part (defined in 3GPP TS 24.080) is the subject of the technical specifications 3GPP TS 24.010 and the 3GPP TS 04.8x series.

8.9 Incomplete rest octets

When the number of octets in a rest octets information element is too low to contain the complete set of components, these components may be truncated by the sending entity (i.e the network) to fit into the rest octets information element. Whether or not truncation is allowed depends on the construction of the rest octets information element and must be explicitly specified in the relevant rest octet definition.

If truncation is allowed, the mobile station shall assume the value 'L' for the missing components.

If the truncation is not specified for the relevant rest octet definition, the sending entity must ensure that the complete set of components fit into the rest octets.

{ < a > < b > < c > }

The above set may be truncated into

{ < a > < b > < c > } or { < a > < b > } or { < a > } or null
--

9 Message functional definitions and contents

This section defines the structure of the messages of those layer 3 protocols defined in 3GPP TS 04.18. These are standard L3 messages as defined in 3GPP TS 24.007 with the exception of those sent on the SCH, RACH, and the HANDOVER ACCESS message.

Each definition given in the present section includes:

- a) a brief description of the message direction and use, including whether the message has:
 1. Local significance, i.e. relevant only on the originating or terminating access;
 2. Access significance, i.e. relevant in the originating and terminating access, but not in the network;
 3. Dual significance, i.e. relevant in either the originating or terminating access and in the network;
 4. Global significance, i.e. relevant in the originating and terminating access and in the network.
- b) a table listing the information elements known in the message and their order of their appearance in the message. In messages for circuit-switched call control also a *shift* information element shall be considered as known even if not included in the table. All information elements that may be repeated are explicitly indicated. (V and LV formatted IEs, which compose the imperative part of the message, occur before T, TV, and TLV formatted IEs which compose the non-imperative part of the message, cf. 3GPP TS 24.007.) In a (maximal) sequence of consecutive information elements with half octet length, the first information element with half octet length occupies bits 1 to 4 of octet N, the second bits 5 to 8 of octet N, the third bits 1 to 4 of octet N+1 etc. Such a sequence always has an even number of elements.

For each information element the table indicates:

1. the information element identifier, in hexadecimal notation, if the IE has format T, TV, or TLV. Usually, there is a default IEI for an information element type; default IEIs of different IE types of the same protocol are different. If the IEI has half octet length, it is specified by a notation representing the IEI as a hexadecimal digit followed by a "-" (example: B-).

NOTE The same IEI may be used for different information element types in different messages of the same protocol.

2. the name of the information element (which may give an idea of the semantics of the element). The name of the information element (usually written in *italics*) followed by "IE" or "information element" is used in 3GPP TS 04.18 as reference to the information element within a message.
 3. the name of the type of the information element (which indicates the coding of the value part of the IE), and generally, the referenced subsection of section 10 of 3GPP TS 04.18 describing the value part of the information element.
 4. the presence requirement indication (M, C, or O) for the IE as defined in 3GPP TS 24.007.
 5. The format of the information element (T, V, TV, LV, TLV) as defined in 3GPP TS 24.007.
 6. The length of the information element (or permissible range of lengths), in octets, in the message, where "?" means that the maximum length of the IE is only constrained by link layer protocol, and in the case of the Facility IE by possible further conditions specified in 3GPP TS 24.010. This indication is non-normative.
- c) subsections specifying, where appropriate, conditions for IEs with presence requirement C or O in the relevant message which together with other conditions specified in 3GPP TS 04.18 define when the information elements

shall be included or not, what non-presence of such IEs means, and - for IEs with presence requirement C - the static conditions for presence and/or non-presence of the IEs (cf.3GPP TS 24.007).

9.1 Messages for Radio Resources management

Table 9.1/3GPP TS 04.18 summarizes the messages for Radio Resources management.

Table 9.1/3GPP TS 04.18: Messages for Radio Resources management

Channel establishment messages:	Reference
ADDITIONAL ASSIGNMENT	9.1.1
IMMEDIATE ASSIGNMENT	9.1.18
IMMEDIATE ASSIGNMENT EXTENDED	9.1.19
IMMEDIATE ASSIGNMENT REJECT	9.1.20
DTM ASSIGNMENT FAILURE	9.1.12f
DTM REJECT	9.1.12g
DTM REQUEST	9.1.12h
PACKET ASSIGNMENT	9.1.21f
RR INITIALISATION REQUEST	9.1.28a
Ciphering messages:	Reference
CIPHERING MODE COMMAND	9.1.9
CIPHERING MODE COMPLETE	9.1.10
Handover messages:	Reference
ASSIGNMENT COMMAND	9.1.2
ASSIGNMENT COMPLETE	9.1.3
ASSIGNMENT FAILURE	9.1.4
DTM ASSIGNMENT COMMAND	9.1.12e
INTER SYSTEM TO UTRAN HANDOVER COMMAND	9.1.15a
PDCH ASSIGNMENT COMMAND	9.1.13a
HANDOVER ACCESS	9.1.14
HANDOVER COMMAND	9.1.15
HANDOVER COMPLETE	9.1.16
HANDOVER FAILURE	9.1.17
RR-CELL CHANGE ORDER	9.1.21e
PHYSICAL INFORMATION	9.1.28
INTER SYSTEM TO CDMA2000 HANDOVER COMMAND	9.1.15b
Channel release messages:	Reference
CHANNEL RELEASE	9.1.7
PARTIAL RELEASE	9.1.26
PARTIAL RELEASE COMPLETE	9.1.27
Paging messages:	Reference
PACKET NOTIFICATION	9.1.21g
PAGING REQUEST TYPE 1	9.1.22
PAGING REQUEST TYPE 2	9.1.23
PAGING REQUEST TYPE 3	9.1.24
PAGING RESPONSE	9.1.25
System information messages:	Reference
SYSTEM INFORMATION TYPE 1	9.1.31
SYSTEM INFORMATION TYPE 2	9.1.32
SYSTEM INFORMATION TYPE 2bis	9.1.33
SYSTEM INFORMATION TYPE 2ter	9.1.34
SYSTEM INFORMATION TYPE 2quater	9.1.34a
SYSTEM INFORMATION TYPE 3	9.1.35
SYSTEM INFORMATION TYPE 4	9.1.36
SYSTEM INFORMATION TYPE 5	9.1.37
SYSTEM INFORMATION TYPE 5bis	9.1.38
SYSTEM INFORMATION TYPE 5ter	9.1.39
SYSTEM INFORMATION TYPE 6	9.1.40
SYSTEM INFORMATION TYPE 7	9.1.41
SYSTEM INFORMATION TYPE 8	9.1.42
SYSTEM INFORMATION TYPE 9	9.1.43
SYSTEM INFORMATION TYPE 13	9.1.43a
SYSTEM INFORMATION TYPE 16	9.1.43d
SYSTEM INFORMATION TYPE 17	9.1.43e
SYSTEM INFORMATION TYPE 18	9.1.43g
SYSTEM INFORMATION TYPE 19	9.1.43f

SYSTEM INFORMATION TYPE 20	9.1.43.h
Specific messages for VBS/VGCS:	Reference
NOTIFICATION/FACCH	9.1.21a
NOTIFICATION/NCH	9.1.21b
NOTIFICATION RESPONSE	9.1.21d
TALKER INDICATION	9.1.44
UPLINK ACCESS	9.1.45
UPLINK BUSY	9.1.46
UPLINK FREE	9.1.47
UPLINK RELEASE	9.1.48
VGCS UPLINK GRANT	9.1.49
Measurement specific messages:	Reference
EXTENDED MEASUREMENT ORDER	9.1.51
EXTENDED MEASUREMENT REPORT	9.1.52
MEASUREMENT REPORT	9.1.21
MEASUREMENT INFORMATION	9.1.54
ENHANCED MEASUREMENT REPORT	9.1.55
Miscellaneous messages:	Reference
CHANNEL MODE MODIFY	9.1.5
CHANNEL MODE MODIFY ACKNOWLEDGE	9.1.6
CHANNEL REQUEST	9.1.8
CLASSMARK CHANGE	9.1.11
CLASSMARK ENQUIRY	9.1.12
UTRAN CLASSMARK CHANGE	9.1.11a
cdma2000 CLASSMARK CHANGE	9.1.11b
UE RAB PRE-CONFIGURATION	9.1.11c
FREQUENCY REDEFINITION	9.1.13
MEASUREMENT REPORT	9.1.21
SYNCHRONIZATION CHANNEL INFORMATION	9.1.30
RR STATUS	9.1.29
GPRS SUSPENSION REQUEST	9.1.13b
Configuration Change messages:	Reference
CONFIGURATION CHANGE COMMAND	9.1.12b
CONFIGURATION CHANGE ACKNOWLEDGE	9.1.12c
CONFIGURATION CHANGE REJECT	9.1.12d
Application messages:	Reference
APPLICATION INFORMATION	9.1.53

9.1.1 Additional assignment

This message is sent on the main DCCH by the network to the mobile station to allocate an additional dedicated channel while keeping the previously allocated channels. See table 9.2/3GPP TS 04.18.

Message type: ADDITIONAL ASSIGNMENT

Significance: dual

Direction: network to mobile station

Table 9.2/3GPP TS 04.18: ADDITIONAL ASSIGNMENT message content

IEI	Information element	Type / Reference	Presence	Format	length
	RR management Protocol Discriminator	Protocol Discriminator 10.2	M	V	½
	Skip Indicator	Skip Indicator 10.3.1	M	V	½
	Additional Assignment Message Type	Message Type 10.4	M	V	1
	Channel Description	Channel Description 10.5.2.5	M	V	3
72	Mobile Allocation	Mobile Allocation 10.5.2.21	C	TLV	3-10
7C	Starting Time	Starting Time 10.5.2.38	O	TV	3

9.1.1.1 Mobile Allocation

This information element shall appear if the *Channel Description* information element indicates frequency hopping.

If the *Channel Description* IE does not indicate frequency hopping and the information element is present it shall be considered as an IE unnecessary in the message.

9.1.1.2 Starting Time

This information element appears in particular if e.g., a change of frequency is planned.

9.1.2 Assignment command

This message is sent on the main DCCH by the network to the mobile station to change the channel configuration to another independent dedicated channel configuration, when no timing adjustment is needed. See table 9.3/3GPP TS 04.18

Message type: ASSIGNMENT COMMAND

Significance: dual

Direction: network to mobile station

Table 9.3/3GPP TS 04.18: ASSIGNMENT COMMAND message content

IEI	Information element	Type / Reference	Presence	Format	length
	RR management Protocol Discriminator	Protocol Discriminator 10.2	M	V	½
	Skip Indicator	Skip Indicator 10.3.1	M	V	½
	Assignment command Message Type	Message Type 10.4	M	V	1
	Description of the First Channel, after time	Channel Description 2 10.5.2.5a	M	V	3
	Power Command	Power Command 10.5.2.28	M	V	1
05	Frequency List, after time	Frequency List 10.5.2.13	C	TLV	4-132
62	Cell Channel Description	Cell Channel Description 10.5.2.1b	O	TV	17
10	Description of the multislot configuration	Multislot Allocation 10.5.2.21b	C	TLV	3-12
63	Mode of the First Channel (Channel Set 1)	Channel Mode 10.5.2.6	O	TV	2
11	Mode of Channel Set 2	Channel Mode 10.5.2.6	O	TV	2
13	Mode of Channel Set 3	Channel Mode 10.5.2.6	O	TV	2
14	Mode of Channel Set 4	Channel Mode 10.5.2.6	O	TV	2
15	Mode of Channel Set 5	Channel Mode 10.5.2.6	O	TV	2
16	Mode of Channel Set 6	Channel Mode 10.5.2.6	O	TV	2
17	Mode of Channel Set 7	Channel Mode 10.5.2.6	O	TV	2
18	Mode of Channel Set 8	Channel Mode 10.5.2.6	O	TV	2
64	Description of the Second Channel, after time	Channel Description 10.5.2.5	O	TV	4
66	Mode of the Second Channel	Channel Mode 2 10.5.2.7	O	TV	2
72	Mobile Allocation, after time	Mobile Allocation 10.5.2.21	C	TLV	3-10
7C	Starting Time	Starting Time 10.5.2.38	O	TV	3
19	Frequency List, before time	Frequency List 10.5.2.13	C	TLV	4-132
1C	Description of the First Channel, before time	Channel Description 2 10.5.2.5a	O	TV	4
1D	Description of the Second Channel, before time	Channel Description 10.5.2.5	O	TV	4
1E	Frequency channel sequence before time	Frequency channel sequence 10.5.2.12	C	TV	10
21	Mobile Allocation, before time	Mobile Allocation 10.5.2.21	C	TLV	3-10
9-	Cipher Mode Setting	Cipher Mode Setting 10.5.2.9	O	TV	1
01	VGCS target mode Indication	VGCS target mode Indication 10.5.2.42a	O	TLV	3
03	Multi-Rate configuration	MultiRate configuration 10.5.2.21aa	O	TLV	4-8

9.1.2.1 Mode of the First Channel (Channel Set 1) and Mode of Channel Set "X" (2= X =8)

If this information element is not present the channel mode of the previously allocated channel or channels for Channel Set "X" (1= X =8) shall be assumed.

If Channel Set "X" is not defined for the configuration, the *Mode of Channel Set "X"* IE shall be considered as an IE unnecessary in the message.

NOTE: Clause 3.4.3.1 defines cases when one or several *Mode of Channel Set "X"* IEs shall be included in the message.

9.1.2.2 Description of the Second Channel

These information elements appear in the case of an assignment occurring if the mobile station carries two connections (on two dedicated channels, for the TCH/H + TCH/H configuration).

The connection using the channel previously defined in the *Description of the First Channel* IEs of an ASSIGNMENT COMMAND or HANDOVER COMMAND message shall use the channel defined in the *Description of the First Channel* IEs of the ASSIGNMENT COMMAND message defining the new configuration.

The channel described in the *Description of the First Channel* IEs carries the main DCCH. The SACCH used is the one associated with that channel.

9.1.2.3 Mode of the Second Channel

If no *Description of the Second Channel* IE is present but the information element is present it shall be considered as an IE unnecessary in the message.

This information element appears at least when the channel mode is changed for the channel defined in the second channel description information elements.

9.1.2.4 Mobile Allocation and Frequency List, after the starting time

If at least one of the channel descriptions for the starting time indicates frequency hopping, one and only one of the following information elements shall be present and apply to all assigned channels:

- *Mobile Allocation, after time;*
- *Frequency List, after time.*

If neither of the Channel Description IEs for after time indicate frequency hopping, if decoding of Channel Description IEs for before time does not require a frequency list for after time (see next section), and one or both of the two information elements are present they shall be considered as IEs unnecessary in the message.

9.1.2.5 Starting Time

The *starting time* information element is included when the network wants the mobile station to change the frequency parameters of the channels more or less at the moment a change of channel occurs. In this case a number of information elements may be included to give the frequency parameters to be used before the starting time.

If the *starting time* information element is present and none of the information elements referring to before the starting time are present, the mobile station waits and accesses the channels at the indicated time.

If the *starting time* information element is present and at least one of the information elements referring to before the starting time is present, the mobile station does not wait for the indicated time and accesses the channel using the frequency parameters for before the starting time.

If the *starting time* information element is not present and at some of the information elements referring to before the starting time is present, these information elements shall be considered as IEs unnecessary in the message.

If the *description of the first channel, before time* IE is not present, the channel description to apply for before the time, if needed, is given by the *description of the first channel, after time* IE.

If the *description of the second channel, after time IE* is present, the *description of the second channel, before time IE* not present, and a description of the configuration for before the time needed, the channel configuration before the starting time is nevertheless of two traffic channels, and the channel description to apply to the second channel before the starting time is given by the *description of the second channel, after time IE*.

If the *starting time IE* is present and at least one of the channel descriptions for before the starting time indicates frequency hopping, one and only one of the following information elements may be present and applies before the starting time to all assigned channels:

- *Mobile Allocation, before time IE*;
- *Frequency list, before time IE*;
- *Frequency channel sequence, before time IE*.

If the *starting time IE* is present and at least one of the channel descriptions for before the starting time indicates frequency hopping, and none of the above mentioned IE is present, a frequency list for after the starting time must be present (see 9.1.2.4), and this list applies also for the channels before the starting time.

9.1.2.6 Reference cell frequency list

If any of the *mobile allocation* information elements is present, then the network must ensure that either the mobile station has received in a previous message the proper reference cell frequency list (CA), or that the *cell channel description IE* is present.

If the *cell channel description IE* is present, it is used to decode the *mobile allocation IEs* in the message, as well as in later messages until reception of a new reference cell frequency list or the cell is left.

9.1.2.7 Cell Channel Description

If present, this information element shall be used to decode the *Mobile Allocation IE* in the same message and in subsequent messages.

9.1.2.8 Cipher Mode Setting

If this information element is omitted, the mode of ciphering is not changed after the mobile station has switched to the assigned channel.

9.1.2.9 VGCS target mode Indication

This information element is identified as "comprehension required". Only mobile stations supporting « VGCS talking » are required to accept the presence of the element. The presence of the element shall trigger an exception handling if received by a mobile station not supporting « VGCS talking ».

This IE indicates which mode is to be used on the new channel (i.e. dedicated mode or group transmit mode). If this information element is not present, the mode shall be the same as on the previous channel.

The IE also indicates the group cipher key number for the group cipher key to be used on the new channel or if the new channel is non ciphered. If the information element is not present, the ciphering mode shall be the same as on the previous channel.

NOTE: A mobile station supporting VGCS talking shall not consider a syntactical error when this IE is present and the channel mode is not speech.

9.1.2.10 Description of the multislots allocation

This information element is included if so indicated by the channel type and TDMA offset field in the *Channel Description* information element and is used to assign channels that do not carry a main signalling link in a multislots configuration. It indicates how the used timeslots are divided into separate channel sets.

If the *Channel Description IE* does not require the presence of the information element the *Description of the multislots allocation IE* shall be considered as an IE unnecessary in the message.

If multislot configuration is indicated by the *Channel Description* IE but the *Multislot Allocation* IE is not present, all channels in the configuration belong to one channel set, "Channel Set 1".

NOTE: As a change of timeslot number cannot occur for the channel described after the starting time, the *Multislot Allocation* IE does not have to be included more than once.

9.1.2.11 Multi Rate configuration

This information element appears if the Mode of the First Channel indicates a multi-rate speech codec, and if the assigned configuration is new, i.e. it is different from the MultiRateconfiguration of a previously allocated channel in the cell.

9.1.3 Assignment complete

This message is sent on the main DCCH from the mobile station to the network to indicate that the mobile station has established the main signalling link successfully. See table 9.4/3GPP TS 04.18.

Message type: ASSIGNMENT COMPLETE

Significance: dual

Direction: mobile station to network

Table 9.4/3GPP TS 04.18: ASSIGNMENT COMPLETE message content

IEI	Information element	Type / Reference	Presence	Format	length
	RR management Protocol Discriminator	Protocol Discriminator 10.2	M	V	1/2
	Skip Indicator	Skip Indicator 10.3.1	M	V	1/2
	Assignment Complete Message Type	Message Type 10.4	M	V	1
	RR Cause	RR Cause 10.5.2.31	M	V	1

9.1.4 Assignment failure

This message is sent on the main DCCH on the old channel from the mobile station to the network to indicate that the mobile station has failed to seize the new channel. See table 9.5/3GPP TS 04.18.

Message type: ASSIGNMENT FAILURE

Significance: dual

Direction: mobile station to network

Table 9.5/3GPP TS 04.18: ASSIGNMENT FAILURE message content

IEI	Information element	Type / Reference	Presence	Format	length
	RR management Protocol Discriminator	Protocol Discriminator 10.2	M	V	1/2
	Skip Indicator	Skip Indicator 10.3.1	M	V	1/2
	Assignment Failure Message Type	Message Type 10.4	M	V	1
	RR cause	RR Cause 10.5.2.31	M	V	1

9.1.5 Channel mode modify

This message is sent on the main DCCH by the network to the mobile station to request the setting of the mode for the indicated channel(s). The message can be used to change the channel mode of a Multislot Configuration which only contains one channel set. See table 9.6/3GPP TS 04.18.

Message type: CHANNEL MODE MODIFY

Significance: local

Direction: network to mobile station

Table 9.6/3GPP TS 04.18: CHANNEL MODE MODIFY message content

IEI	Information element	Type / Reference	Presence	Format	length
	RR management Protocol Discriminator	Protocol Discriminator 10.2	M	V	1/2
	Skip Indicator	Skip Indicator 10.3.1	M	V	1/2
	Channel Mode Modify Message Type	Message Type 10.4	M	V	1
	Channel Description	Channel Description 2 10.5.2.5a	M	V	3
	Channel Mode	Channel Mode 10.5.2.6	M	V	1
01	VGCS target mode Indication	VGCS target mode Indication 10.5.2.42a	O	TLV	3
03	Multi-Rate configuration	MultiRate configuration 10.5.2.21aa	O	TLV	4-8

9.1.5.1 Channel Description

This is sufficient to identify the channel in the case of a TCH/H + TCH/H configuration. If used for a multislot configuration, the IE shall describe the present channel configuration with TN indicating the main channel. The IE shall not indicate a new channel configuration when included in the Channel Mode Modify message.

9.1.5.2 VGCS target mode Indication

This information element is identified as "comprehension required". Only mobile stations supporting « VGCS talking » are required to accept the presence of the element. The presence of the element shall trigger an exception handling if received by a mobile station not supporting « VGCS talking ».

This IE indicates which RR mode is to be used with the new channel mode (i.e. dedicated mode or group transmit mode). If this information element is not present, the RR mode shall be the same as with the previous channel mode.

The IE also indicates the group cipher key number for the group cipher key to be used on the new channel or if the new channel is non ciphered. If the information element is not present, the ciphering mode shall be the same as with the previous channel mode.

NOTE: A mobile station supporting VGCS Talking shall not consider a syntactical error if this IE is present and the channel mode is not speech.

9.1.5.3 Multi Rate configuration

This information element appears if the Channel Mode IE indicates a multi-rate speech codec.

9.1.6 Channel mode modify acknowledge

This message is sent on the main DCCH by the mobile station to the network to indicate the successful or unsuccessful execution of a channel mode modify request. See table 9.7/3GPP TS 04.18.

Message type: CHANNEL MODE MODIFY ACKNOWLEDGE

Significance: local

Direction: mobile station to network

Table 9.7/3GPP TS 04.18: CHANNEL MODE MODIFY ACKNOWLEDGE message content

IEI	Information element	Type / Reference	Presence	Format	length
	RR management Protocol Discriminator	Protocol Discriminator 10.2	M	V	1/2
	Skip Indicator	Skip Indicator 10.3.1	M	V	1/2
	Channel Mode Modify Acknowledge Message Type	Message Type 10.4	M	V	1
	Channel Description	Channel Description 2 10.5.2.5a	M	V	3
	Channel Mode	Channel Mode 10.5.2.6	M	V	1

9.1.7 Channel release

This message is sent on the main DCCH from the network to the mobile station to initiate deactivation of the dedicated channel used. See table 9.8/3GPP TS 04.18

Message type: CHANNEL RELEASE

Significance: dual

Direction: network to mobile station

Table 9.8/3GPP TS 04.18: CHANNEL RELEASE message content

IEI	Information element	Type / Reference	Presence	Format	length
	RR management Protocol Discriminator	Protocol Discriminator 10.2	M	V	1/2
	Skip Indicator	Skip Indicator 10.3.1	M	V	1/2
	Channel Release Message Type	Message Type 10.4	M	V	1
	RR Cause	RR Cause 10.5.2.31	M	V	1
73	BA Range	BA Range 10.5.2.1a	O	TLV	6 - ?
74	Group Channel Description	Group Channel Description 10.5.2.14b	O	TLV	4-13
8x	Group Cipher Key Number	Group Cipher Key Number 10.5.1.10	C	TV	1
Cx	GPRS Resumption	GPRS Resumption 10.5.2.14c	O	TV	1
75	BA List Pref	BA List Pref 10.5.2.1c	O	TLV	3-?
76	UMTS Freq List	UMTS Freq List 10.5.2.1d	O	TLV	3-?

9.1.7.1 Channel description and mobile allocation

If a CHANNEL RELEASE is sent to a mobile station which is in dedicated mode and which is involved in a voice group call or has responded to a notification to a voice group call or voice broadcast call, a group channel description may be included, describing the voice group call channel or voice broadcast channel to which the mobile station shall go after the channel release procedure.

Mobile stations not supporting VGCS listening or VBS listening shall consider this information element as unnecessary.

9.1.7.2 Group Cipher Key Number

This IE may be present only if the Group channel description IE is provided. The presence of this IE indicates that the mobile station shall use the Group Cipher Key indicated by the Group Cipher Key Number IE for deciphering on the VGCS or VBS channel. If this IE is not present, no ciphering is applied on the VGCS or VBS channel.

Mobile stations not supporting VGCS listening or VBS listening shall ignore this information element.

9.1.7.3 UMTS Frequency List

This IE should only be sent to UMTS capable mobile station. This information element is used to describe the UMTS frequencies used by the network.

9.1.8 Channel request

This message is sent in random mode on the RACH. It does not follow the basic format. The possible formats are presented directly below, without reference to information fields. The order of bit transmission is defined in 3GPP TS 04.04.

The message is only one octet long, coded as shown in figure 9.1/3GPP TS 04.08 and table 9.9/3GPP TS 04.18.

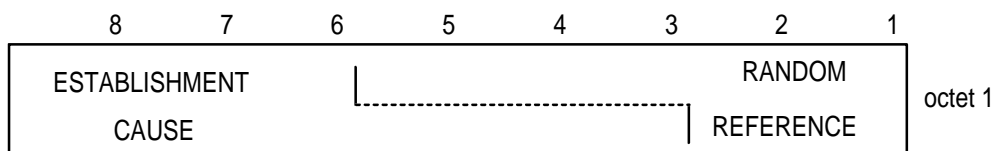

Figure 9.1/3GPP TS 04.18: CHANNEL REQUEST message content

ESTABLISHMENT CAUSE (octet 1)

This information field indicates the reason for requesting the establishment of a connection. This field has a variable length (from 3 bits up to 6 bits).

RANDOM REFERENCE (octet 1)

This is an unformatted field with variable length (from 5 bits down to 2 bits).

The Channel Request message is coded as follows:

(Random Reference field is filled with "x").

Table 9.9/3GPP TS 04.18: CHANNEL REQUEST message content

MS codes According to Establishment cause:	
bits 8 1	
101xxxxx	Emergency call
110xxxxx	Call re-establishment; TCH/F was in use, or TCH/H was in use but the network does not set NECI bit to 1
011010xx	Call re-establishment; TCH/H was in use and the network sets NECI bit to 1
011011xx	Call re-establishment; TCH/H + TCH/H was in use and the network sets NECI bit to 1
100xxxxx 0010xxxx 0011xxxx 0001xxxx	Answer to paging See table 9.9a/3GPP TS 04.18
111xxxxx 1	Originating call and TCH/F is needed, or originating call and the network does not set NECI bit to 1, or procedures that can be completed with a SDCCH and the network does not set NECI bit to 1. note
0100xxxx	Originating speech call from dual-rate mobile station when TCH/H is sufficient and supported by the MS for speech calls and the network sets NECI bit to 1. See note 5
0101xxxx	Originating data call from dual-rate mobile station when TCH/H is sufficient and supported by the MS for data calls and the network sets NECI bit to 1. See note 5
000xxxxx	Location updating and the network does not set NECI bit to 1
0000xxxx	Location updating and the network sets NECI bit to 1
0001xxxx	Other procedures which can be completed with note 1an SDCCH and the network sets NECI bit to 1
011110xx 01111x0x 01111xx0	One phase packet access with request for single timeslot uplink transmission; one PDCH is needed.
01110xxx	Single block packet access; one block period on a PDCH is needed for two phase packet access or other RR signalling purpose.
01100111	LMU establishment, see note 2
01100xx0 01100x01 01100011	Reserved for future use note 2a
01111111	Reserved, see note 2b

NOTE 1: Examples of these procedures are: IMSI detach, Short Message Service (SMS), Supplementary Service management, Location Services.

NOTE 2: If such messages are received by a network, an SDCCH shall be allocated.

NOTE 2a: If such messages are received by a network, an SDCCH may be allocated.

NOTE 2b: This value shall not be used by the mobile station on RACH. If such message is received by the network, it may be ignored. The value is used by the network to answer to a 11 bits EGPRS Packet Channel request.

Table 9.9a/3GPP TS 04.18: CHANNEL REQUEST message (when answering to paging for RR connection establishment)

MS Capability Paging Indication (NOTE 3)	Full rate only	Dual rate (NOTE 5)	SDCCH only
Any channel	100xxxxx	100xxxxx	100xxxxx
SDCCH	0001xxxx	0001xxxx	0001xxxx
TCH/F	100xxxxx	0010xxxx	0001xxxx
TCH/H or TCH/F	100xxxxx	0011xxxx	0001xxxx

NOTE 3: The Paging Indication is provided by the Channel Needed IE (or the Channel Needed field) associated with the page which triggered the sending of the CHANNEL REQUEST message.

NOTE 4: In some cases the established connection will be used only to allow a default rejection mechanism to take place (typically the mobile station will send a RELEASE COMPLETE message with cause #88 "incompatible destination" as an answer to the incoming SETUP message).

NOTE 5: In this section, "dual rate capability" means that the MS supports both full rate and half-rate channels at least for the signalling channel mode. In addition, it may support either speech channel mode, or data channel modes, or both on half-rate channels.

9.1.9 Cipherring mode command

This message is sent on the main DCCH from the network to the mobile station to indicate that the network has started deciphering and that enciphering and deciphering shall be started in the mobile station, or to indicate that cipherring will not be performed. See table 9.10/3GPP TS 04.18.

Message type: CIPHERING MODE COMMAND

Significance: dual

Direction: network to mobile station

Table 9.10/3GPP TS 04.18: CIPHERING MODE COMMAND message content

IEI	Information element	Type / Reference	Presence	Format	length
	RR management Protocol Discriminator	Protocol Discriminator 10.2	M	V	1/2
	Skip Indicator	Skip Indicator 10.3.1	M	V	1/2
	Cipher Mode Command Message Type	Message Type 10.4	M	V	1
	Cipherring Mode Setting	Cipher Mode Setting 10.5.2.9	M	V	1/2
	Cipher Response	Cipher Response 10.5.2.10	M	V	1/2

9.1.10 Cipherring mode complete

This message is sent on the main DCCH from the mobile station to the network to indicate that enciphering and deciphering has been started in the MS. See table 9.11/3GPP TS 04.18.

Message type: CIPHERING MODE COMPLETE

Significance: dual

Direction: mobile station to network

Table 9.11/3GPP TS 04.18: CIPHERING MODE COMPLETE message content

IEI	Information element	Type / Reference	Presence	Format	length
	RR management Protocol Discriminator	Protocol Discriminator 10.2	M	V	1/2
	Skip Indicator	Skip Indicator 10.3.1	M	V	1/2
	Cipher Mode Complete Message Type	Message Type 10.4	M	V	1
17	Mobile Equipment Identity	Mobile Identity 10.5.1.4	O	TLV	3-11

9.1.10.1 Mobile Equipment Identity

This information element is included if and only if the mobile station shall include its IMEISV (see section 3.4.7). This information element shall only refer to IMEISV.

9.1.11 Classmark change

This message is sent on the main DCCH by the mobile station to the network to indicate a classmark change or as a response to a classmark enquiry. See table 9.12/3GPP TS 04.18.

Message type: CLASSMARK CHANGE

Significance: dual

Direction: mobile station to network

Table 9.12/3GPP TS 04.18: CLASSMARK CHANGE message content

IEI	Information element	Type / Reference	Presence	Format	length
	RR management Protocol Discriminator	Protocol Discriminator 10.2	M	V	1/2
	Skip Indicator	Skip Indicator 10.3.1	M	V	1/2
	Classmark Change Message Type	Message Type 10.4	M	V	1
	Mobile Station Classmark	Mobile Station Classmark 2 10.5.1.6	M	LV	4
20	Additional Mobile Station Classmark Information	Mobile Station Classmark 3 10.5.1.7	C	TLV	3-14

9.1.11.1 Additional Mobile Station Classmark Information

This IE shall be included if and only if the CM3 bit in the *Mobile Station Classmark* IE is set to 1.

9.1.11.2 Mobile Station Classmark

This IE shall include for multiband MS the Classmark 2 corresponding to the frequency band in use.

9.1.11a UTRAN Classmark Change

This message is sent on the main DCCCH by the mobile station to the network to indicate a UTRAN Classmark Change or as a response to a UTRAN classmark enquiry. See table 9.11a/3GPP TS 04.18.

Message type: UTRAN CLASSMARK CHANGE

Significance: dual

Direction: mobile station to network

Table 9.11a/3GPP TS 04.18: UTRAN CLASSMARK CHANGE message content

IEI	Information element	Type / Reference	Presence	Format	length
	RR management Protocol Discriminator	Protocol Discriminator 10.2	M	V	1/2
	Skip Indicator	Skip Indicator 10.3.1	M	V	1/2
	UTRAN Classmark Change Message Type	Message Type 10.4	M	V	1
	UTRAN pre-defined configuration status information / START-CS / UE Capability	UTRAN pre-defined configuration status information / START-CS / UE Capability 10.5.2.7a	M	LV	2-n

9.1.11b cdma2000 Classmark Change

This message is sent on the main DCCH by the mobile station to the network to indicate a cdma2000 Classmark Change or as a response to a classmark enquiry with cdma2000 Capabilities specified in the Classmark Enquiry Mask. See table 9.11b/3GPP TS 04.18.

Message type: CDMA2000 CLASSMARK CHANGE

Significance: dual

Direction: mobile station to network

Table 9.11b/3GPP TS 04.18: CDMA2000 CLASSMARK CHANGE message content

IEI	Information element	Type / Reference	Presence	Format	length
	RR management Protocol Discriminator	Protocol Discriminator 10.2	M	V	1/2
	Skip Indicator	Skip Indicator 10.3.1	M	V	1/2
	cdma2000 Classmark Change Message Type	Message Type 10.4	M	V	1
	Terminal Information	Terminal Information TIA/EIA/IS-2000-5-A and TIA/EIA/IS-833	M (1)	LV	1-n
	Security Status	Security Status TIA/EIA/IS-2000-5-A and TIA/EIA/IS-833	M (1)	LV	1-n
	Band Class Information	Band Class Information TIA/EIA/IS-2000-5-A and TIA/EIA/IS-833	M (1)	LV	1-n
	Power Class Information	Power Class Information TIA/EIA/IS-2000-5-A and TIA/EIA/IS-833	M (1)	LV	1-n
	Operating Mode Information	Operating Mode Information TIA/EIA/IS-2000-5-A and TIA/EIA/IS-833	M (1)	LV	1-n
	Service Option Information	Service Option Information TIA/EIA/IS-2000-5-A and TIA/EIA/IS-833	M (1)	LV	1-n
	Multiplex Option Information	Multiplex Option Information TIA/EIA/IS-2000-5-A and TIA/EIA/IS-833	M (1)	LV	1-n
	Power Control Information	Power Control Information TIA/EIA/IS-2000-5-A and TIA/EIA/IS-833	M (1)	LV	1-n
	Capability Information	Capability Information TIA/EIA/IS-2000-5-A and TIA/EIA/IS-833	M (1)	LV	1-n
	Channel Configuration Capability Information	Channel Configuration Capability Information TIA/EIA/IS-2000-5-A and TIA/EIA/IS-833	M (1)	LV	1-n
	Extended Multiplex Option Information	Extended Multiplex Option Information TIA/EIA/IS-2000-5-A and TIA/EIA/IS-833	M (1)	LV	1-n
	Band Subclass Information	Band Subclass Information TIA/EIA/IS-2000-5-A and TIA/EIA/IS-833	M (1)	LV	1-n
	Encryption Capability	Encryption Capability TIA/EIA/IS-2000-5-A and TIA/EIA/IS-833	M (1)	LV	1-n

- 1 The variable part of the Information Element is coded as the corresponding Information Record defined in TIA/EIA/IS-2000-5-A and TIA/EIA/IS-833. The bit number 1 of the first octet of each Information Element shall be coded as the first bit of the first field of the corresponding Information Record defined in TIA/EIA/IS-2000-5-A and in TIA/EIA/IS-833, reading the fields defined in TIA/EIA/IS-2000-5-A and in TIA/EIA/IS-833 from left to right.

9.1.11c UE RAB PRE-CONFIGURATION

This message is sent on the main DCCH by the network to the mobile station to pre-configure the radio access bearer configuration in the mobile. The network may send the UE RAB PRE-CONFIGURATION message after receiving the UTRAN Classmark Change message or in conjunction with location updating. See table 9.11c/3GPP TS 04.18.

Message type: UE RAB PRE-CONFIGURATION

Significance: dual

Direction: network to mobile station

Table 9.11c/3GPP TS 04.18: UE RAB PRE-CONFIGURATION message content

IEI	Information element	Type / Reference	Presence	Format	length
	RR management Protocol Discriminator	Protocol Discriminator 10.2	M	V	1/2
	Skip Indicator	Skip Indicator 10.3.1	M	V	1/2
	UE RAB Pre-Configuration Message Type	Message Type 10.4	M	V	1
	UTRAN pre-configuration INDEX/COUNT	UTRAN pre-configuration INDEX/COUNT 10.5.2.53	M	V	1/2
	UTRAN pre-configuration Identity	UTRAN pre-configuration Identity 10.5.2.54	M	V	1/2
	Predefined configuration value tag	Predefined configuration value tag 10.5.2.55	M	V	2
	UTRAN pre-configuration set	UTRAN pre-configuration set 10.5.2.7b	M	LV	2-n

9.1.12 Classmark enquiry

This message is sent on the main DCCH by the network to the mobile station to request classmark information and/or UE Capability and/or UTRAN pre-configuration indication set and/or CDMA2000 capability information. See table 9.12a/3GPP TS 04.18.

Message type: CLASSMARK ENQUIRY

Significance: dual

Direction: network to mobile station

Table 9.12a/3GPP TS 04.18: CLASSMARK ENQUIRY message content

IEI	Information element	Type / Reference	Presence	Format	length
	RR management	Protocol Discriminator 10.2	M	V	1/2
	Skip Indicator	Skip Indicator 10.3.1	M	V	1/2
	Classmark Enquiry Message Type	Message Type 10.4	M	V	1
10	Classmark Enquiry Mask	Classmark Enquiry Mask 10.5.2.7c	O	TLV	3

9.1.12a Spare

9.1.12b Configuration change command

This message is sent on the main DCCH from the network to the mobile station to change the channel configuration of a multislot configuration. See table 9.12b/3GPP TS 04.18.

Message type: CONFIGURATION CHANGE COMMAND

Significance: dual

Direction: network to mobile station

Table 9.12b/3GPP TS 04.18: CONFIGURATION CHANGE COMMAND message contents

IEI	Information element	Type/Reference	Presence	Format	length
	RR management Protocol Discriminator	Protocol Discriminator 10.2	M	V	1/2
	Skip Indicator	Skip Indicator 10.3.1	M	V	1/2
	Configuration change Message Type	Message Type 10.4	M	V	1
	Description of the multislot configuration	Multislot Allocation 10.5.2.21b	M	LV	2-11
63	Mode of Channel Set 1	Channel Mode 10.5.2.6	O	TV	2
11	Mode of Channel Set 2	Channel Mode 10.5.2.6	O	TV	2
13	Mode of Channel Set 3	Channel Mode 10.5.2.6	O	TV	2
14	Mode of Channel Set 4	Channel Mode 10.5.2.6	O	TV	2
15	Mode of Channel Set 5	Channel Mode 10.5.2.6	O	TV	2
16	Mode of Channel Set 6	Channel Mode 10.5.2.6	O	TV	2
17	Mode of Channel Set 7	Channel Mode 10.5.2.6	O	TV	2
18	Mode of Channel Set 8	Channel Mode 10.5.2.6	O	TV	2

9.1.12b.1 Description of the multislot allocation

This information element is used to assign channels that do not carry the main signalling link in a multislot configuration. It indicates if multiple channel sets are used.

9.1.12b.2 Mode of Channel Set "X" (1=<X<=8)

If this information element is not present the channel mode of the previously allocated channel or channels for Channel Set "X" shall be assumed.

If Channel Set "X" is not defined for the configuration, the *Mode of Channel Set "X"* IE shall be considered as an IE unnecessary in the message.

NOTE: Clause 3.4.16.1 defines cases when one or several *Mode of Channel Set "X"* IEs shall be included in the message.

9.1.12c Configuration change acknowledge

This message is sent on the main DCCH from the mobile station to the network to indicate that the mobile station has changed to the ordered channel configuration successfully. See table 9.12c/3GPP TS 04.18.

Message type: CONFIGURATION CHANGE ACKNOWLEDGE

Significance: dual

Direction: mobile station to network

Table 9.12c/3GPP TS 04.18: CONFIGURATION CHANGE ACKNOWLEDGE message contents

IEI	Information element	Type/Reference	Presence	Format	length
	RR management Protocol Discriminator	Protocol Discriminator 10.2	M	V	1/2
	Skip Indicator	Skip Indicator 10.3.1	M	V	1/2
	Configuration Change Acknowledge Message Type	Message Type 10.4	M	V	1

9.1.12d Configuration change reject

This message is sent on the main DCCH from the mobile station to the network to indicate that the mobile station has not managed to switch to the channel configuration ordered by the configuration change command and is still using the previous configuration. See table 9.12d/3GPP TS 04.18.

Message type: CONFIGURATION CHANGE REJECT

Significance: dual

Direction: mobile station to network

Table 9.12d/3GPP TS 04.18: CONFIGURATION CHANGE REJECT message contents

IEI	Information element	Type/Reference	Presence	Format	length
	RR management Protocol Discriminator	Protocol Discriminator 10.2	M	V	1/2
	Skip Indicator	Skip Indicator 10.3.1	M	V	1/2
	Configuration Change Reject Message Type	Message Type 10.4	M	V	1
	RR Cause	RR Cause 10.5.2.31	M	V	1

9.1.12e DTM Assignment Command

This message is sent on the main DCCH by the network to the mobile station to change the channel configuration to a configuration with CS and packet connections when no timing adjustment is needed and reallocation of the CS timeslot is required. See table 9.12e/3GPP TS 04.18.

Message type: DTM ASSIGNMENT COMMAND

Significance: dual

Direction: network to mobile station

Table 9.12e/3GPP TS 04.18: DTM ASSIGNMENT COMMAND message content

IEI	Information element	Type / Reference	Presence	Format	Length
	RR management Protocol Discriminator	Protocol Discriminator 10.2	M	V	1/2
	Skip Indicator	Skip Indicator 10.3.1	M	V	1/2
	DTM Assignment Command Message Type	Message Type 10.4	M	V	1
	CS Power Command	Power Command 10.5.2.28	M	V	1
	Description of the CS Channel	Channel Description 10.5.2.5	M	V	3
	GPRS broadcast information	GPRS broadcast information 10.5.2.14d	M	LV	7 - n
10	Cell Channel Description	Cell Channel Description 10.5.2.1b	O	TV	17
11	Channel mode	Channel mode 10.5.2.6	O	TV	2
12	Frequency List	Frequency List 10.5.2.13	C	TLV	4 - 132
13	Mobile Allocation	Mobile Allocation 10.5.2.21	C	TLV	3 - 10
14	TBF starting time	Starting time 10.5.2.38	O	TV	3
15	Description of the Uplink Packet Channel Assignment	RR Packet Uplink Assignment 10.5.2.25c	O	TLV	3 - n
16	Description of the Downlink Packet Channel Assignment	RR Packet Downlink Assignment 10.5.2.25d	O	TLV	3 - n

9.1.12e.1 TBF starting time

If this information element is not present or has elapsed, the mobile station shall switch to the assigned PDCH(s). Otherwise, the mobile station shall wait until the point in time denoted by the TBF Starting Time and then switch to the assigned PDCH(s).

The mobile station shall establish the RR connection immediately, irrespective of the TBF starting time.

9.1.12e.2 RR Packet Uplink Assignment and RR Packet Downlink Assignment IEs

These information elements are optional, but at least one of them shall be present. If none of them is present, the mobile station shall establish the assigned CS resource and send a DTM ASSIGNMENT FAILURE message on the new main DCCH.

9.1.12f DTM Assignment Failure

This message is sent on the main DCCH from the mobile station to the network to indicate that the mobile station has failed to seize the new packet channel. See table 9.12f/3GPP TS 04.18.

Message type: DTM ASSIGNMENT FAILURE

Significance: dual

Direction: mobile station to network

Table 9.12f/3GPP TS 04.18: DTM ASSIGNMENT FAILURE message content

IEI	Information element	Type / Reference	Presence	Format	Length
	RR management Protocol Discriminator	Protocol Discriminator 10.2	M	V	1/2
	Skip Indicator	Skip Indicator 10.3.1	M	V	1/2
	DTM Assignment Failure Message Type	Message Type 10.4	M	V	1
	RR cause	RR Cause 10.5.2.31	M	V	1

9.1.12g DTM Information

This message is sent on the main DCCH by the network to the mobile station to provide the mobile station with necessary information for the operation in dual transfer mode. See table 9.12g/3GPP TS 04.18.

Message type: DTM INFORMATION

Significance: dual

Direction: network to mobile station

Table 9.12g/3GPP TS 04.18: DTM INFORMATION message content

IEI	Information element	Type / Reference	Presence	Format	Length
	RR management Protocol Discriminator	Protocol Discriminator 10.2	M	V	1/2
	Skip Indicator	Skip Indicator 10.3.1	M	V	1/2
	DTM Information Message Type	Message Type 10.4	M	V	1
	Routeing Area Identification	Routeing Area Identification 10.5.5.15	M	V	6
	DTM Information Rest Octets	DTM Information Rest Octets 10.5.2.11a	M	LV	2

9.1.12h DTM Reject

This message is sent on the main DCCH by the network to the mobile station to indicate that no radio resources are available for assignment. See table 9.12h/3GPP TS 04.18.

Message type: DTM REJECT

Significance: dual

Direction: network to mobile station

Table 9.12h/3GPP TS 04.18: DTM REJECT message content

IEI	Information element	Type / Reference	Presence	Format	Length
	RR management Protocol Discriminator	Protocol Discriminator 10.2	M	V	1/2
	Skip Indicator	Skip Indicator 10.3.1	M	V	1/2
	DTM Reject Message Type	Message Type 10.4	M	V	1
	DTM wait indication	Wait indication 10.5.2.43	M	V	1

9.1.12i DTM Request

This message is sent on the main DCCH by the mobile station to request the establishment of dual transfer mode. See table 9.12i/3GPP TS 04.18.

Message type: DTM Request

Significance: dual

Direction: mobile station to network

Table 9.12i/3GPP TS 04.18: DTM Request message content

IEI	Information element	Type / Reference	Presence	Format	length
	RR management Protocol Discriminator	Protocol Discriminator 10.2	M	V	1/2
	Skip Indicator	Skip Indicator 10.3.1	M	V	1/2
	DTM Request Message Type	Message Type 10.4	M	V	1
	TLLI	TLLI 10.5.2.41a	M	V	4
	Channel Request Description	Channel Request Description 2 10.5.2.8b	M	LV	5 - n

NOTE: the MS Radio Access capabilities IE is not present since all the relevant information has already been received by the network in Classmark 3.

9.1.13 Frequency redefinition

This message is sent on the main DCCH from the network to the MS to indicate that the frequencies and the hopping sequence of the allocated channels shall be changed. See table 9.13/3GPP TS 04.18

Message type: FREQUENCY REDEFINITION

Significance: dual

Direction: network to MS

Table 9.13/3GPP TS 04.18: FREQUENCY REDEFINITION message content

IEI	Information element	Type / Reference	Presence	Format	length
	RR management Protocol Discriminator	Protocol Discriminator 10.2	M	V	½
	Skip Indicator	Skip Indicator 10.3.1	M	V	½
	Frequency Redefinition Message Type	Message Type 10.4	M	V	1
	Channel Description	Channel Description 10.5.2.5	M	V	3
	Mobile Allocation	Mobile Allocation 10.5.2.21	M	LV	1-9
	Starting Time	Starting Time 10.5.2.38	M	V	2
62	Cell Channel Description	Cell Channel Description 10.5.2.1b	O	TV	17

9.1.13.1 Cell Channel Description

If it does not appear, the cell channel description is assumed to be unchanged.

9.1.13a PDCH Assignment command

This message is sent on the main DCCH by the network to the mobile station to change the channel configuration to a PDCH, when no timing adjustment is needed. See table 9.13a/3GPP TS 04.18.

A mobile station that does not support the <<GRPS>> option shall regard this message as an unknown message.

Message type: PDCH ASSIGNMENT COMMAND

Significance: dual

Direction: network to mobile station

Table 9.13a/3GPP TS 04.18: PDCH ASSIGNMENT COMMAND message content

IEI	Information element	Type / Reference	Presence	Format	length
	RR management Protocol Discriminator	Protocol Discriminator 10.2	M	V	1/2
	Skip Indicator	Skip Indicator 10.3.1	M	V	1/2
	PDCH Assignment command Message Type	Message Type 10.4	M	V	1
	Description of the Channel, after time	Channel Description 10.5.2.5	M	V	3
62	Cell Channel Description	Cell Channel Description 10.5.2.1b	O	TV	17
05	Frequency List, after time	Frequency List 10.5.2.13	C	TLV	4-132
72	Mobile Allocation, after time	Mobile Allocation 10.5.2.21	C	TLV	3-10
7C	Starting Time	Starting Time 10.5.2.38	O	TV	3
19	Frequency List, before time	Frequency List 10.5.2.13	C	TLV	4-132
1C	Description of the Channel, before time	Channel Description 10.5.2.5	O	TV	4
1E	Frequency channel sequence before time	Frequency channel sequence 10.5.2.12	C	TV	10
21	Mobile Allocation, before time	Mobile Allocation 10.5.2.21	C	TLV	3-10
22	RR Packet Uplink Assignment	RR Packet Uplink Assignment 10.5.2.25c	C	TLV	3-?
23	RR Packet Downlink Assignment	RR Packet Downlink Assignment 10.5.2.25d	C	TLV	3-?

9.1.13a.1 Mobile Allocation and Frequency List, after the starting time

If the channel description for after the starting time indicates frequency hopping, one and only one of the following information elements shall be present

- *Mobile Allocation, after time*
- *Frequency List, after time.*

If the Channel Description IE for after time does not indicate frequency hopping, if decoding of Channel Description IE for before time does not require a frequency list for after time (see next section), and one or both of the two information elements are present they shall be considered as IEs unnecessary in the message.

9.1.13a.2 Starting Time

The *starting time* information element is included when the network wants the mobile station to change the frequency parameters of the channels more or less at the moment the change to a TBF occurs. In this case a number of information elements may be included to give the frequency parameters to be used before the starting time.

If the *starting time* information element is present and none of the information elements referring to before the starting time are present, the mobile station waits and uses the TBF from the indicated time.

If the *starting time* information element is present and at least one of the information elements referring to before the starting time is present, the mobile station does not wait for the indicated time and uses the TBF using the frequency parameters for before the starting time.

If the *starting time* information element is not present and some of the information elements referring to before the starting time is present, these information elements shall be considered as IEs unnecessary in the message.

If the *description of the channel, before time* IE is not present, the channel description to apply for before the time, if needed, is given by the *description of the channel, after time* IE.

If the *starting time* IE is present and the channel description for before the starting time indicates frequency hopping, one and only one of the following information elements may be present and applies before the starting time

- *Mobile Allocation, before time* IE;
- *Frequency list, before time* IE;
- *Frequency channel sequence, before time* IE.

If the *starting time* IE is present and the channel description for before the starting time indicates frequency hopping, and none of the above mentioned IE is present, a frequency list for after the starting time must be present (see 9.1.2.4), and this list applies also for the TBF before the starting time.

9.1.13a.3 Reference cell frequency list

If any of the *mobile allocation* information elements are present, then the network shall ensure that either the mobile station has received in a previous message the proper reference cell frequency list (CA), or that the *cell channel description* IE is present.

If the *cell channel description* IE is present, it is used to decode the *mobile allocation* IEs in the message, as well as in later dedicated mode messages until reception of a new reference cell frequency list or the cell is left.

9.1.13a.4 Cell Channel Description

If present, this information element shall be used to decode the *Mobile Allocation* IE in the same message and in subsequent messages.

9.1.13a.5 Packet Assignment

One and only one of the following information elements shall be present:

- *RR Packet Uplink Assignment*
- *RR Packet Downlink Assignment*.

9.1.13b GPRS suspension request

This message is sent on the main DCCH by the mobile station to the network to request a suspension of GPRS services. See table 9.13b/3GPP TS 04.18.

Message type: GPRS SUSPENSION REQUEST

Significance: dual

Direction: mobile station to network

Table 9.13b/3GPP TS 04.18: GPRS SUSPENSION REQUEST message content

IEI	Information element	Type / Reference	Presence	Format	length
	RR management Protocol Discriminator	Protocol Discriminator 10.2	M	V	1/2
	Skip Indicator	Skip Indicator 10.3.1	M	V	1/2
	GPRS Suspension Request Message Type	Message Type 10.4	M	V	1
	Temporary Logical Link Identity	TLLI 10.5.2.41a	M	V	4
	Routeing Area Identification	Routeing Area Identification 10.5.5.15	M	V	6
	Suspension cause	Suspension cause 10.5.2.47	M	V	1

9.1.14 Handover access

This message is sent in random mode on the main DCCH during a handover procedure. It does not follow the basic format. The format is presented directly below without reference to information elements. The order of bit transmission is defined in 3GPP TS 04.04.

This message is only one octet long, coded as shown in figure 9.2/3GPP TS 04.18 and table 9.14/3GPP TS 04.18.

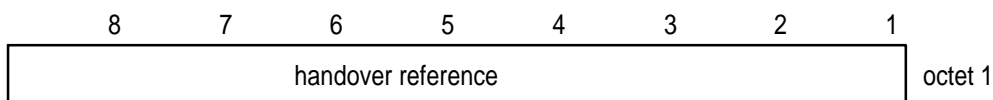

Figure 9.2/3GPP TS 04.18: HANDOVER ACCESS message content

Table 9.14/3GPP TS 04.18: HANDOVER ACCESS message content

<p>HANDOVER REFERENCE This is an unformatted 8 bit field. (also described in section 10.5.2.15)</p>
--

9.1.15 Handover command

This message is sent on the main DCCH by the network to the mobile station to change the dedicated channel configuration, timing adjustment needed. See table 9.15/3GPP TS 04.18.

Message type: HANDOVER COMMAND

Significance: dual

Direction: network to mobile station

Table 9.15/3GPP TS 04.18: HANDOVER COMMAND message content

IEI	Information element	Type / Reference	Presence	Format	length
	RR management Protocol Discriminator	Protocol Discriminator 10.2	M	V	1/2
	Skip Indicator	Skip Indicator 10.3.1	M	V	1/2
	Handover Command Message Type	Message Type 10.4	M	V	1
	Cell Description	Cell description 10.5.2.2	M	V	2
	Description of the first channel, after time	Channel Description 2 10.5.2.5a	M	V	3
	Handover Reference	Handover Reference 10.5.2.15	M	V	1
	Power Command and Access type	Power Command and Access type 10.5.2.28a	M	V	1
D-	Synchronization Indication	Synchronization Indication 10.5.2.39	O	TV	1
02	Frequency Short List, after time	Frequency Short List 10.5.2.14	C	TV	10
05	Frequency List, after time	Frequency List 10.5.2.13	C	TLV	4-131
62	Cell Channel Description	Cell Channel Description 10.5.2.1b	C	TV	17
10	Description of the multislot configuration	Multislot Allocation 10.5.2.21b	C	TLV	3-12
63	Mode of the First Channel(Channel Set 1))	Channel Mode 10.5.2.6	O	TV	2
11	Mode of Channel Set 2	Channel Mode 10.5.2.6	O	TV	2
13	Mode of Channel Set 3	Channel Mode 10.5.2.6	O	TV	2
14	Mode of Channel Set 4	Channel Mode 10.5.2.6	O	TV	2
15	Mode of Channel Set 5	Channel Mode 10.5.2.6	O	TV	2
16	Mode of Channel Set 6	Channel Mode 10.5.2.6	O	TV	2
17	Mode of Channel Set 7	Channel Mode 10.5.2.6	O	TV	2
18	Mode of Channel Set 8	Channel Mode 10.5.2.6	O	TV	2
64	Description of the Second Channel, after time	Channel Description 10.5.2.5	O	TV	4
66	Mode of the Second Channel	Channel Mode 2 10.5.2.7	O	TV	2
69	Frequency Channel Sequence, after time	Frequency Channel Sequence 10.5.2.12	C	TV	10
72	Mobile Allocation, after time	Mobile Allocation 10.5.2.21	C	TLV	3-10
7C	Starting Time	Starting Time 10.5.2.38	O	TV	3
7B	Real Time Difference	Time Difference 10.5.2.41	C	TLV	3
7D	Timing Advance	Timing Advance 10.5.2.40	C	TV	2
12	Frequency Short List, before time	Frequency Short List 10.5.2.14	C	TV	10
19	Frequency List, before time	Frequency List 10.5.2.13	C	TLV	4-131
1C	Description of the First Channel, before time	Channel Description 2 10.5.2.5a	O	TV	4
1D	Description of the Second Channel, before time	Channel Description 10.5.2.5	O	TV	4

IEI	Information element	Type / Reference	Presence	Format	length
1E	Frequency channel sequence before time	Frequency channel sequence 10.5.2.12	C	TV	10
21	Mobile Allocation, before time	Mobile Allocation 10.5.2.21	C	TLV	3-10
9-	Cipher Mode Setting	Cipher Mode Setting 10.5.2.9	O	TV	1
01	VGCS target mode Indication	VGCS target mode Indication 10.5.2.42a	O	TLV	3
03	Multi-Rate configuration	MultiRate configuration 10.5.2.21aa	O	TLV	4-8

9.1.15.1 Synchronization Indication

If this information element does not appear, the assumed value is "non-synchronized".

9.1.15.2 Mode of the First Channel (Channel Set 1) and Mode of Channel Set "X" (2=<X<=8)

If this information element is not present the channel mode of the previously allocated channel or channels for Channel Set "X" (1=<X<=8) shall be assumed.

If Channel Set "X" is not defined for the configuration, the *Mode of Channel Set "X"* IE shall be considered as an IE unnecessary in the message.

NOTE: Clause 3.4.4.1 defines cases when one or several *Mode of Channel Set "X"* IEs shall be included in the message.

9.1.15.3 Description of the Second Channel

These information element appear if the mobile station carries two connections (on two dedicated channels, for the TCH/H+TCH/H configuration).

The connection using the channel previously defined in the *Description of the First Channel* IE of an ASSIGNMENT COMMAND or HANDOVER COMMAND message shall use the channel defined in the first channel description IE of the HANDOVER COMMAND message defining the new configuration.

The channel described in the *Description of the First Channel* IE carries the main DCCH. The SACCH used is the one associated with that channel.

9.1.15.4 Mode of the Second Channel

If the *Description of the Second Channel* IE is not present and the information element is present it shall be considered as an IE unnecessary in the message.

This element appears at least when the channel mode is changed for the channel defined in the Description of the Second Channel information element.

9.1.15.5 Frequency Channel Sequence, Frequency List, Frequency short list and Mobile Allocation, after time.

If at least one of the channel descriptions for after time indicates frequency hopping, one and only one of the following information elements shall be present:

- *Frequency Channel Sequence, after time;*
- *Frequency list, after time;*
- *Frequency Short List, after time;*
- *Mobile Allocation, after time.*

If neither of the Channel Description IEs indicate frequency hopping, if they are not required for the decoding of Channel Description IEs for before time, and if any of the four information elements are present they shall be considered as IEs unnecessary in the message.

The *Frequency Channel Sequence* information element shall not be used unless all the ARFCNs that it indicates are in the P-GSM band.

9.1.15.6 Starting Time

The *starting time* information element is included when the network wants the mobile station to change the frequency parameters of the channels more or less at the moment a change of channel occurs. In this case a number of information elements may be included to give the frequency parameters to be used before the starting time.

The *starting time* information element refers to the new cell time.

If the *starting time* information element is present and none of the information elements referring to before the starting time are present, the mobile station waits and accesses the channels at the indicated time.

If the *starting time* information element is present and at least one of the information elements referring to before the starting time is present, the mobile station does not wait for the indicated time and accesses the channel using the frequency parameters for before the starting time.

If the *starting time* information element is not present and some of the information elements referring to before the starting time is present, these information elements shall be considered as IEs unnecessary in the message.

If the *description of the first channel, before time* IE is not present, the channel description to apply for before the time, if needed, is given by the *description of the first channel, after time* IE.

If the *description of the second channel, after time* IE is present, the *description of the second channel, before time* IE not present, and a description of the configuration for before the time needed, the channel configuration before the starting time is nevertheless of two traffic channels, and the channel description to apply to the second channel before the starting time is given by the *description of the second channel, after time* IE.

If the *starting time* IE is present and at least one of the channel descriptions for before the starting time indicates frequency hopping, one and only one of the following information elements may be present and applies before the starting time to all assigned channels:

- *Mobile Allocation, before time* IE;
- *Frequency Short list, before time* IE;
- *Frequency list, before time* IE;
- *Frequency channel sequence, before time* IE.

If the *starting time* IE is present and at least one of the channel descriptions for before the starting time indicates frequency hopping, and none of the above mentioned IE is present, a frequency list for after the starting time must be present (see 9.1.2.4), and this list applies also for the channels before the starting time.

9.1.15.7 Reference cell frequency list

If any of the *mobile allocation* information elements is present, then the *cell channel description* IE must be present. It is used to decode the *mobile allocation* IEs in the message.

In addition, if no information elements pertaining to before the starting time is present in the message, the frequency list defined by the *cell channel description* IE is used to decode the *mobile allocation* IEs in later messages received in the new cell until reception of a new reference cell frequency list or the new cell is left.

9.1.15.8 Real Time Difference

This information element shall appear if the *Synchronization Indication* information element indicates a pseudo-synchronous handover otherwise it shall be considered as an unnecessary information element.

9.1.15.9 Timing Advance

This information element shall appear if the "synchronization indication" element indicates a presynchronized handover. If not included for a presynchronized handover, then the default value as defined in 3GPP TS 05.10 shall be used. For other types of handover it shall be considered as an unnecessary information element.

9.1.15.10 Cipher Mode Setting

If this information element is omitted, the mode of ciphering is not changed after the mobile station has switched to the assigned channel.

Only applicable for mobile stations supporting VGCS talking:

The cipher mode setting IE shall not be included if a HANOVER COMMAND message is sent on a VGCS channel or in a HANOVER COMMAND message on a dedicated channel for a handover to a VGCS channel.

9.1.15.11 VGCS target mode indication

This information element is identified as "comprehension required". Only mobile stations supporting « VGCS talking » are required to accept the presence of the element. The presence of the element shall trigger an exception handling if received by a mobile station not supporting « VGCS talking ».

This IE indicates which mode is to be used on the new channel (i.e. dedicated mode or group transmit mode). If this information element is not present, the mode shall be the same as on the previous channel.

The IE also indicates the group cipher key number for the group cipher key to be used on the new channel or if the new channel is non ciphered. If the information element is not present, the ciphering mode shall be the same as on the previous channel.

NOTE: A mobile station supporting VGCS Talking shall not consider a syntactical error if this IE is present and the channel mode is not speech.

9.1.15.12 Description of the multislot allocation

This information element is included if so indicated by the channel type and TDMA offset field in the *Channel Description* information element and is used to assign channels that do not carry a main signalling link in a multislot configuration. It indicates how the used timeslots are divided into separate channel sets.

If the *Channel Description* IE does not require the presence the information element it shall be considered as an IE unnecessary in the message.

If multislot configuration is indicated by the *Channel Description* IE but the *Multislot Allocation* IE is not present, all channels in the configuration belong to one channel set, "Channel Set 1".

NOTE: As a change of timeslot number cannot occur for the channel described for after the starting time, the *Multislot Allocation* IE does not have to be included more than once.

9.1.15.13 MultiRateconfiguration

This information element appears if the Mode of the First Channel indicates a multi-rate speech codec, and if the assigned configuration is new, i.e. it is different from the MultiRateconfiguration used in the serving cell. If the Mode of the First Channel indicates a multi-rate speech codec, and this IE is not included, then the mobile station shall assume that the MultiRateconfiguration has not changed.

9.1.15a Inter System To UTRAN Handover Command

This message is sent on the main DCCH by the network to the mobile station to change the dedicated channel in GSM to a dedicated channel configuration in UTRAN. See table 9.15a/3GPP TS 04.18.

Message type: INTER SYSTEM TO UTRAN HANDOVER COMMAND

Significance: dual

Direction: network to mobile station

Table 9.15a/3GPP TS 04.18: INTER SYSTEM TO UTRAN HANDOVER COMMAND message content

IEI	Information element	Type / Reference	Presence	Format	length
	RR management Protocol Discriminator	Protocol Discriminator 10.2	M	V	1/2
	Skip Indicator	Skip Indicator 10.3.1	M	V	1/2
	Inter System to UTRAN Handover Command Message Type	Message Type 10.4	M	V	1
	Handover to UTRAN Command	Handover To UTRAN Command 10.5.2.51	M	LV	2-n

9.1.15b Inter System To cdma2000 Handover Command

This message is sent on the main DCCH by the network to the mobile station to change the dedicated channel in GSM to a dedicated channel configuration in cdma2000 See table 9.15b/3GPP TS 04.18.

Message type: INTER SYSTEM TO CDMA2000 HANDOVER COMMAND

Significance: dual

Direction: network to mobile station

Table 9.15b/3GPP TS 04.18: INTER SYSTEM TO CDMA2000 HANDOVER COMMAND message content

IEI	Information element	Type / Reference	Presence	Format	length
	RR management Protocol Discriminator	Protocol Discriminator 10.2	M	V	1/2
	Skip Indicator	Skip Indicator 10.3.1	M	V	½
	Inter System to cdma2000 Handover Command Type Message	Message Type 10.4	M	V	1
	Handover to cdma2000 Command	Handover To cdma2000 Command 10.5.2.52	M	LV	4 - n

9.1.16 Handover complete

This message is sent on the main DCCH from the mobile station to the network to indicate that the mobile station has established the main signalling link successfully. See table 9.16/3GPP TS 04.18.

Message type: HANDOVER COMPLETE

Significance: dual

Direction: mobile station to network

Table 9.16/3GPP TS 04.18: HANDOVER COMPLETE message content

IEI	Information element	Type / Reference	Presence	Format	length
	RR management Protocol Discriminator	Protocol Discriminator 10.2	M	V	1/2
	Skip Indicator	Skip Indicator 10.3.1	M	V	1/2
	Handover Complete Message Type	Message Type 10.4	M	V	1
	RR Cause	RR Cause 10.5.2.31	M	V	1
77	Mobile Observed Time Difference	Mobile Time Difference 10.5.2.21a	O	TLV	5

9.1.16.1 Mobile Observed Time Difference

This information element is included if and only if the Synchronization Indication IE in the HANDOVER COMMAND message requests it to be sent.

9.1.17 Handover failure

This message is sent on the main DCCCH on the old channel from the mobile station to the network to indicate that the mobile station has failed to seize the new channel. See table 9.17/3GPP TS 04.18.

Message type: HANDOVER FAILURE

Significance: dual

Direction: mobile station to network

Table 9.17/3GPP TS 04.18: HANDOVER FAILURE message content

IEI	Information element	Type / Reference	Presence	Format	length
	RR management Protocol Discriminator	Protocol Discriminator 10.2	M	V	1/2
	Skip Indicator	Skip Indicator 10.3.1	M	V	1/2
	Handover Failure Message Type	Message Type 10.4	M	V	1
	RR Cause	RR Cause 10.5.2.31	M	V	1

9.1.18 Immediate assignment

This message is sent on the CCCH by the network to the mobile station in idle mode to change the channel configuration to a dedicated configuration while staying in the same cell or to the mobile station in packet idle mode to change the channel configuration to either an uplink or a downlink packet data channel configuration in the cell. See table 9.18/3GPP TS 04.18.

The L2 pseudo length of this message is the sum of lengths of all information elements present in the message except the *IA Rest Octets* and *L2 Pseudo Length* information elements.

Message type: IMMEDIATE ASSIGNMENT

Significance: dual

Direction: network to mobile station

Table 9.18/3GPP TS 04.18: IMMEDIATE ASSIGNMENT message content

IEI	Information element	Type / Reference	Presence	Format	length
	L2 Pseudo Length	L2 Pseudo Length 10.5.2.19	M	V	1
	RR management Protocol Discriminator	Protocol Discriminator 10.2	M	V	1/2
	Skip Indicator	Skip Indicator 10.3.1	M	V	1/2
	Immediate Assignment Message Type	Message Type 10.4	M	V	1
	Page Mode	Page Mode 10.5.2.26	M	V	1/2
	Dedicated mode or TBF	Dedicated mode or TBF 10.5.2.25b	M	V	1/2
	Channel Description	Channel Description 10.5.2.5	C	V	3
	Packet Channel Description	Packet Channel Description 10.5.2.25a	C	V	3
	Request Reference	Request Reference 10.5.2.30	M	V	3
	Timing Advance	Timing Advance 10.5.2.40	M	V	1
	Mobile Allocation	Mobile Allocation 10.5.2.21	M	LV	1-9
7C	Starting Time	Starting Time 10.5.2.38	O	TV	3
	IA Rest Octets	IA Rest Octets 10.5.2.16	M	V	0-11

9.1.18.0a Dedicated mode or TBF

A mobile station not supporting GPRS may ignore the contents of this information element and regard it as an unnecessary IE. Such mobile station shall assume that this message assigns a dedicated mode resource.

9.1.18.0b Channel Description

If the *Dedicated mode or TBF* IE indicates that the message assigns a dedicated mode resource, the mobile station shall consider this information element present in the message.

9.1.18.0c Packet Channel Description

If the *Dedicated mode or TBF* IE indicates that the message assigns a Temporary Block Flow (TBF), the mobile station shall consider this information element present in the message. If the *Dedicated mode or TBF* IE indicates that this message is the first of two in a two-message assignment of an uplink or downlink TBF, the mobile station shall ignore the contents of this information element and regard it as an unnecessary IE.

9.1.18.0d Request Reference

If this message is used in an assignment of a downlink TBF, the network shall code this information element, e.g. by using a suitably offset frame number, such that the resource reference cannot be confused with any CHANNEL REQUEST message sent by a mobile station.

If the *IA Rest Octets* IE indicates that this message is the second message of a two-message assignment of an uplink or downlink TBF, this information element shall have the same contents as the first message of the assignment.

When set to the value '0111 1111', the RA information of the Request Reference IE indicates that an Extended RA field may be included in the IA Rest Octets. The mobile station shall use the information in the Extended RA field to identify the Immediate Assignment message corresponding to an EGPRS Packet Channel Request message. If the Extended RA field is not included, the mobile station shall assume that the Immediate Assignment message does not correspond to the EGPRS Packet Channel Request message.

9.1.18.0e Timing Advance

If the *IA Rest Octets* IE indicates that this message is the second message of a two-message assignment of an uplink or downlink TBF, the mobile station shall ignore the contents of this information element and regard it as an unnecessary IE.

9.1.18.1 Mobile Allocation

If this message assigns a dedicated mode resource and the *Channel Description* IE does not indicate frequency hopping, the length indicator of this information element shall be set to zero, and the mobile station shall consider the IE as an unnecessary IE.

If this message assigns a TBF and the *Packet Channel Description* IE does not indicate frequency hopping or if it uses indirect encoding of a hopping RF channel configuration, the length indicator of this information element shall be set to zero, and the mobile station shall consider the IE as an unnecessary IE.

9.1.18.2 Starting Time

This information element appears if e.g. a frequency change is in progress.

If this message is used in an assignment of an uplink or downlink TBF, the mobile station shall ignore the contents of the Starting Time information element if included and consider it as an unnecessary IE.

9.1.18.3 IA Rest Octets (Frequency parameters, before time)

The sum of the length of this IE and the L2 Pseudo Length of the message equals 22.

If the *starting time* IE is present but not the *frequency parameters, before time* construction, the mobile stations must wait until the starting time before accessing the channel.

If the *starting time* IE is present and the *Channel Description* IE does not indicate frequency hopping the mobile station shall consider the *frequency parameters, before time* construction as unnecessary in the message and the mobile must wait until the starting time before accessing the channel.

If the *starting time* IE is not present, the mobile station shall consider the *frequency parameters, before time* construction as unnecessary in the message.

9.1.18.4 IA Rest Octets (assignment of uplink or downlink TBF)

If the *Dedicated mode or TBF* IE indicates that this message is used in an assignment of a TBF, this information element shall contain a *Packet Uplink Assignment*, *Packet Downlink Assignment* or *Second Part Packet Assignment* construction.

If the *Dedicated mode or TBF* IE indicates that this message assigns a dedicated mode resource, but not that the mobile station is identified in the *IA Rest Octets* IE information element, the mobile station shall consider the *Packet Uplink Assignment*, *Packet Downlink Assignment* and *Second Part Packet Assignment* constructions as unnecessary in the message.

9.1.19 Immediate assignment extended

This message is sent on the CCCH by the network to two mobile stations in idle mode to change their channel configurations to different dedicated configurations while they stay in the same cell. See table 9.19/3GPP TS 04.18

The L2 pseudo length of this message is the sum of lengths of all information elements present in the message except the *IAX Rest Octets* and *L2 Pseudo Length* information elements.

Message type: IMMEDIATE ASSIGNMENT EXTENDED

Significance: dual

Direction: network to mobile station

Table 9.19/3GPP TS 04.18: IMMEDIATE ASSIGNMENT EXTENDED message content

IEI	Information element	Type / Reference	Presence	Format	length
	L2 Pseudo Length	L2 Pseudo Length 10.5.2.19	M	V	1
	RR management Protocol Discriminator	Protocol Discriminator 10.2	M	V	1/2
	Skip Indicator	Skip Indicator 10.3.1	M	V	1/2
	Immediate Assignment Extended Message Type	Message Type 10.4	M	V	1
	Page Mode	Page Mode 10.5.2.26	M	V	1/2
	Spare Half Octet	Spare Half Octet 10.5.1.8	M	V	1/2
	Channel Description 1	Channel Description 10.5.2.5	M	V	3
	Request Reference 1	Request Reference 10.5.2.30	M	V	3
	Timing Advance 1	Timing Advance 10.5.2.40	M	V	1
	Channel Description 2	Channel Description 10.5.2.5	M	V	3
	Request Reference 2	Request Reference 10.5.2.30	M	V	3
	Timing Advance 2	Timing Advance 10.5.2.40	M	V	1
	Mobile Allocation	Mobile Allocation 10.5.2.21	M	LV	1-5
7C	Starting Time	Starting Time 10.5.2.38	O	TV	3
	IAX Rest Octets	IAX Rest Octets 10.5.2.18	M	V	0-4

NOTE: Index 1 refers to the first mobile station, index 2 refers to the second mobile station.

9.1.19.1 Unnecessary IEs

A mobile station which reacts on the request reference 1 shall consider all information elements as unnecessary IEs except for *Requests Reference 1, Channel Description 1, Timing advance 1, Starting Time* and if *Channel Description 1* IE indicates frequency hopping mobile allocation.

A mobile station which reacts on the request reference 2 shall consider all information elements as unnecessary IE except *Requests Reference 2, Channel Description 2, Timing advance 2, Starting Time* and if *channel description 2* IE indicates frequency hopping mobile allocation.

A mobile station in idle mode shall consider all information elements as unnecessary IEs except for the *Page Mode* IE.

9.1.19.2 Mobile Allocation

If both channel description IE do not indicate frequency hopping, the length indicator shall be set to zero.

9.1.19.3 Starting Time

This information element appears if a frequency change is in progress. If included the starting time is common to the two referenced mobile stations.

9.1.19.4 Maximum message length

As the maximum length of the resulting layer 3 data cannot exceed 22 octets, it is not possible to use this message type if the total length of the value part of the *Mobile Allocation* plus, optionally, the length of the *Starting Time* IE exceeds 5 octets. In this case it is necessary to use the IMMEDIATE ASSIGNMENT message.

9.1.19.5 IAX Rest Octets

The sum of the length of this IE and the L2 Pseudo Length of the message equals 22.

9.1.20 Immediate assignment reject

This message is sent on the CCCH by the network to up to four mobile stations to indicate that no channel is available for assignment. See table 9.20/3GPP TS 04.18. This message has L2 pseudo length 19.

Message type: IMMEDIATE ASSIGNMENT REJECT

Significance: dual

Direction: network to mobile station

Table 9.20/3GPP TS 04.18: IMMEDIATE ASSIGNMENT REJECT message content

IEI	Information element	Type / Reference	Presence	Format	length
	L2 Pseudo Length	L2 Pseudo Length 10.5.2.19	M	V	1
	RR management Protocol Discriminator	Protocol Discriminator 10.2	M	V	1/2
	Skip Indicator	Skip Indicator 10.3.1	M	V	1/2
	Immediate Assignment Reject Message Type	Message Type 10.4	M	V	1
	Page Mode	Page Mode 10.5.2.26	M	V	1/2
	Spare Half Octet	Spare Half Octet 10.5.1.8	M	V	1/2
	Request Reference 1	Request Reference 10.5.2.30	M	V	3
	Wait Indication 1	Wait Indication 10.5.2.43	M	V	1
	Request Reference 2	Request Reference 10.5.2.30	M	V	3
	Wait Indication 2	Wait Indication 10.5.2.43	M	V	1
	Request Reference 3	Request Reference 10.5.2.30	M	V	3
	Wait Indication 3	Wait Indication 10.5.2.43	M	V	1
	Request Reference 4	Request Reference 10.5.2.30	M	V	3
	Wait Indication 4	Wait Indication 10.5.2.43	M	V	1
	IAR Rest Octets	IAR Rest Octets 10.5.2.17	M	V	3

NOTE: Index 1 refers to the first mobile station, index 2 refers to the second MS and so on.

9.1.20.1 Use of the indexes

A request reference information element and the following wait indication information element refer to the same mobile station. So it is possible to reject up to four channel requests with this message.

9.1.20.2 Filling of the message

If necessary the request reference information element and the wait indication information element should be duplicated to fill the message.

9.1.20.2a Request reference

When set to the value '0111 1111', the RA information of the Request Reference i IE indicates that an Extended RA i field may be included in the IAR Rest Octets. The mobile station shall use the information in the Extended RA i field to identify the Immediate Assignment Reject message corresponding to an EGPRS Packet Channel Request message. If the Extended RA i field is not included, the mobile station shall assume that the Request Reference i IE does not correspond to the EGPRS Packet Channel Request message.

9.1.20.3 Wait Indication

When IMMEDIATE ASSIGNMENT REJECT message is for RR connection establishment then this IE contains timeout value for T3122. If IMMEDIATE ASSIGNMENT REJECT message is for TBF establishment for GPRS MS then this IE contain timeout value for T3142.

9.1.20.4 IAR Rest Octets

The sum of the length of this IE and the L2 Pseudo Length of the message equals 22.

9.1.21 Measurement report

This message is sent on the SACCH by the mobile station to the network to report measurement results about the dedicated channel and about neighbour cells. See table 9.21/3GPP TS 04.18.

Message type: MEASUREMENT REPORT

Significance: dual

Direction: mobile station to network

Table 9.21/3GPP TS 04.18: MEASUREMENT REPORT message content

IEI	Information element	Type / Reference	Presence	Format	length
	RR management Protocol Discriminator	Protocol Discriminator 10.2	M	V	1/2
	Skip Indicator	Skip Indicator 10.3.1	M	V	1/2
	Measurement Report Message Type	Message Type 10.4	M	V	1
	Measurement Results	Measurement Results 10.5.2.20	M	V	16

9.1.21a Notification/FACCH

The understanding of this message is only required for mobile stations supporting VGCS listening or VBS listening.

This message is sent on the main DCCH, in unacknowledged mode using the RR short protocol discriminator by the network to notify the mobile stations in dedicated mode or in on-going voice broadcast calls or voice group calls on other voice broadcast calls or voice group calls in that cell.

Notification/FACCH messages for VBS or VGCS calls are differentiated by a flag in the call reference.

The message shall not exceed a maximum length of 20 octets.

Mobile stations not supporting VGCS listening or VBS listening shall ignore this message.

See table 9.21a/3GPP TS 04.18.

Message type: NOTIFICATION/FACCH

Significance: dual

Direction: network to mobile station

Table 9.21a/3GPP TS 04.18 NOTIFICATION/FACCH message content

<NOTIFICATION FACCH>	::= <RR short PD : bit>	-- See 3G3GPP TS 24.007
	<message type : bit(5)>	-- See 10.4
	<short layer 2 header : bit(2)>	-- See 3GPP TS 04.06
	{0 <Group Call information>	
	1 <Paging Information>	
	<spare padding> ;	
<Group Call information>	::= <Group Call Reference : bit(36)>	
	{0 1 <Group Channel Description>} ;	

<Group Call Reference>

This field is syntactically and semantically equivalent to octets 2-5 and bits 5 to 8 of octet 6 of the *Descriptive Group or Broadcast Call Reference* information element.

The <Group Channel Description> field is optionally present. When present only the Channel description is provided in the case of non hopping channels. In the case where the channel is hopping then either a mobile allocation or a frequency short list is provided.

<Group Channel Description>	::= <Channel Description : bit(24)>
	{0 -- Non hopping case
	1 {0 <Mobile Allocation : <bit string>>
	1 <Frequency Short List : bit(64)>}} ;
<bit string>	::= null bit <bit string> ;

<Channel Description>

This field is syntactically and semantically equivalent to octets 2-4 of the *Channel Description* information element. See 10.5.2.5

<Frequency Short List>

This field is syntactically and semantically equivalent to octets 1-8 of the *Frequency Short List 2* information element. See 10.5.2.14a

<Mobile Allocation>

This field is syntactically and semantically equivalent to octet 2 to n+2 of the *Mobile Allocation* information element. See 10.5.2.21

The <Paging Information> field may be used to inform the mobile station in Group Receive or in Group Transmit mode that the corresponding mobile identity is paged in that cell.

<Paging Information>	::= <mobile identity : <bit string>>
	<channel first: bit(2)>
	{0 1 <eMLPP priority : bit(3)>} ;
<bit string>	::= null bit <bit string> ;

<mobile identity>

This field is syntactically and semantically equivalent to octet 2-n of the *Mobile Identity* information element. See 10.5.1.4

<channel first>

This field is syntactically and semantically equivalent to bits 1 and 2 of the *Channel Needed* information element. See 10.5.2.8

<eMLPP priority>

This field is coded as the <Priority1> field in the *PI Rest Octets* information element. See 10.5.2.23

9.1.21a.1 Spare

9.1.21a.2 Spare

9.1.21a.3 Spare

9.1.21a.4 Spare

9.1.21b Notification/NCH

The understanding of this message is only required for mobile stations supporting VGCS listening or VBS listening.

This message is sent on the NCH by the network to notify mobile stations of VBS or VGCS calls in the current cell. The VBS or VGCS calls are identified by their broadcast call reference or group call reference, respectively. For each reference, the corresponding VBS or VGCS call channel may be indicated. See table 9.21b/3GPP TS 04.18.

Notification/NCH messages for VBS or VGCS calls are differentiated by a flag in the call reference.

The L2 pseudo length of this message has a value one

Mobile stations not supporting VGCS listening or VBS listening shall ignore this message.

Message type: NOTIFICATION/NCH

Significance: dual

Direction: network to mobile station

Table 9.21b/3GPP TS 04.18 NOTIFICATION/NCH message content

IEI	Information element	Type / Reference	Presence	Format	length
	L2 Pseudo Length	L2 Pseudo Length 10.5.2.19	M	V	1
	RR management Protocol Discriminator	Protocol Discriminator 10.2	M	V	1/2
	Skip Indicator	Skip Indicator 10.3.1	M	V	1/2
	Notification/NCH Message Type	Message Type 10.4	M	V	1
	NT/N Rest Octets	NT/N Rest Octets 10.5.2.22c	M	V	20

9.1.21b.1 Spare

9.1.21b.2 Spare

9.1.21c Spare

9.1.21d Notification response

This message is sent by the mobile station to the network to respond on a notification for a voice group call or voice broadcast call. See table 9.21d/3GPP TS 04.08.

Message type: NOTIFICATION RESPONSE

Significance: dual

Direction: mobile station to network

Table 9.21d/3GPP TS 04.08: NOTIFICATION RESPONSE message content

IEI	Information element	Type / Reference	Presence	Format	Length
	RR management Protocol discriminator	Protocol discriminator 10.2	M	V	1/2
	Skip Indicator	Skip Indicator 10.3.1	M	V	1/2
	Notification response Message type	Message type 10.4	M	V	1
	Mobile station Classmark	Mobile station classmark 2 10.5.1.6	M	LV	4
	Mobile identity	Mobile identity 10.5.1.4	M	LV	2-9
	Group or broadcast Call reference	Call reference 10.5.1.9	M	V	5

9.1.21e RR-Cell Change Order

This message is sent on the main DCCH by the network to the mobile station to order it to reselect a cell. For a 3G multi-RAT MS the target cell may be a 3G cell. See table 9.21e/3GPP TS 04.18.

A mobile station that does not support the <<GPRS>> option shall regard this message as an unknown message.

Message type: RR-CELL CHANGE ORDER

Significance: dual

Direction: network to mobile station

Table 9.21e/3GPP TS 04.18: RR-CELL CHANGE ORDER message content

IEI	Information element	Type / Reference	Presence	Format	length
	RR management Protocol Discriminator	Protocol Discriminator 10.2	M	V	1/2
	Skip Indicator	Skip Indicator 10.3.1	M	V	1/2
	RR-Cell Change Order Message Type	Message Type 10.4	M	V	1
	Cell Description	Cell description 10.5.2.2	M	V	2
	NC mode for target cell	NC mode 10.5.2.21c	M	V	1/2
	Spare half octet	Spare half octet 10.5.1.8	M	V	1/2
19	3G Target Cell	3G Target Cell 10.5.2.56	O	TLV	3-6

9.1.21e.1 3G Target Cell

If this information element is present and not ignored (see 3G Target Cell, 10.5.2.53), the content of the Cell Description information element shall be ignored.

9.1.21f Packet Assignment

This message is sent on the main DCCH by the network to the mobile station to change the channel configuration to a multislot configuration with CS and PS connections when neither timing adjustment nor reallocation of the CS timeslot is needed. See table 9.21f/3GPP TS 04.18.

Message type: PACKET ASSIGNMENT

Significance: dual

Direction: network to mobile station

Table 9.21f/3GPP TS 04.18: PACKET ASSIGNMENT message content

IEI	Information element	Type / Reference	Presence	Format	Length
	RR management Protocol Discriminator	Protocol Discriminator 10.2	M	V	1/2
	Skip Indicator	Skip Indicator 10.3.1	M	V	1/2
	Packet Assignment Message Type	Message Type 10.4	M	V	1
	GPRS broadcast information	GPRS broadcast information 10.5.2.14d	M	LV	7 - n
22	Description of the Uplink Packet Channel Assignment	RR Packet Uplink Assignment 10.5.2.25c	O	TLV	3 - n
23	Description of the Downlink Packet Channel Assignment	RR Packet Downlink Assignment 10.5.2.25d	O	TLV	3 - n

9.1.21f.1 RR Packet Uplink Assignment and RR Packet Downlink Assignment IEs

These information elements are optional, but at least one of them shall be present. If none of them is present, the mobile station shall send a DTM ASSIGNMENT FAILURE message on the main DCCH and remain in dedicated mode

9.1.21g Packet Notification

This message is sent on the main DCCH by the network to trigger the mobile station to perform a cell update procedure. See table 9.21g/3GPP TS 04.18.

Message type: PACKET NOTIFICATION

Significance: dual

Direction: network to mobile station

Table 9.21g/3GPP TS 04.18: PACKET NOTIFICATION message content

IEI	Information element	Type / Reference	Presence	Format	Length
	RR management Protocol Discriminator	Protocol Discriminator 10.2	M	V	1/2
	Skip Indicator	Skip Indicator 10.3.1	M	V	1/2
	Packet Notification Message Type	Message Type 10.4	M	V	1
10	Packet TMSI	P-TMSI 10.5.2.42	C	TV	5
11	Mobile identity	Mobile identity 10.5.1.4	C	TLV	3-11

9.1.22 Paging request type 1

This message is sent on the CCCH by the network to up to two mobile stations. It may be sent to a mobile station in idle mode to trigger channel access. It may be sent to a mobile station in packet idle mode to transfer MM information (i.e. trigger of cell update procedure). The mobile stations are identified by their TMSI/P-TMSI or IMSI. See table 9.22/3GPP TS 04.18.

The L2 pseudo length of this message is the sum of lengths of all information elements present in the message except the *PI Rest Octets* and *L2 Pseudo Length* information elements.

Message type: PAGING REQUEST TYPE 1

Significance: dual

Direction: network to mobile station

Table 9.22/3GPP TS 04.18: PAGING REQUEST TYPE 1 message content

IEI	Information element	Type / Reference	Presence	Format	length
	L2 Pseudo Length	L2 Pseudo Length 10.5.2.19	M	V	1
	RR management Protocol Discriminator	Protocol Discriminator 10.2	M	V	1/2
	Skip Indicator	Skip Indicator 10.3.1	M	V	1/2
	Paging Request Type 1 Message Type	Message Type 10.4	M	V	1
	Page Mode	Page Mode 10.5.2.26	M	V	1/2
	Channels Needed for Mobiles 1 and 2	Channel Needed 10.5.2.8	M	V	1/2
	Mobile Identity 1	Mobile Identity 10.5.1.4	M	LV	2-9
17	Mobile Identity 2	Mobile Identity 10.5.1.4	O	TLV	3-10
	P1 Rest Octets	P1 Rest Octets 10.5.2.23	M	V	0-17

9.1.22.1 Unnecessary IE

A mobile station in idle mode shall consider all information elements as unnecessary IEs except for the *Page Mode* IE.

9.1.22.2 Channels needed for Mobiles 1 and 2

The first CHANNEL field of *Channel Needed* IE is associated with *Mobile Identity 1*. The second CHANNEL field of *Channel Needed* IE is associated with *Mobile Identity 2*.

If this message is used in the packet paging procedure, the *Channel Needed* IE associated with the corresponding *Mobile Identity 1* or *2* shall be coded with the value 00 (any channel) by the network. The mobile station receiving a packet paging request shall treat this information element as unnecessary in the message.

9.1.22.3 Mobile Identities

The *Mobile Identity 1* and *2* IEs shall not refer to IMEI.

9.1.22.4 P1 Rest Octets

The sum of the length of this IE and the L2 Pseudo Length of the message equals 22.

This IE may contain a *notification list number* field and/or, referring to each one of the *Mobile Identity 1* and *2* IEs, a *Priority 1* and *2* field and/or a *Packet Page Indication 1* and *2* field.

9.1.23 Paging request type 2

This message is sent on the CCCH by the network to two or three mobile stations. It may be sent to a mobile station in idle mode to trigger channel access. It may be sent to a mobile station in packet idle mode to transfer MM information (i.e. trigger of cell update procedure). Two of the mobile stations are identified by their TMSI/P-TMSI while the third is identified by its TMSI/P-TMSI or IMSI. See table 9.23/3GPP TS 04.18.

The L2 pseudo length of this message is the sum of lengths of all information elements present in the message except the *P2 Rest Octets* and *L2 Pseudo Length* information elements.

Message type: PAGING REQUEST TYPE 2

Significance: dual

Direction: network to mobile station

Table 9.23/3GPP TS 04.18: PAGING REQUEST TYPE 2 message content

IEI	Information element	Type / Reference	Presence	Format	length
	L2 Pseudo Length	L2 Pseudo Length 10.5.2.19	M	V	1
	RR management Protocol Discriminator	Protocol Discriminator 10.2	M	V	1/2
	Skip Indicator	Skip Indicator 10.3.1	M	V	1/2
	Paging Request Type 2 Message Type	Message Type 10.4	M	V	1
	Page Mode	Page Mode 10.5.2.26	M	V	1/2
	Channels Needed for Mobiles 1 and 2	Channel Needed 10.5.2.8	M	V	1/2
	Mobile Identity 1	TMSI/P-TMSI 10.5.2.42	M	V	4
	Mobile Identity 2	TMSI/P-TMSI 10.5.2.42	M	V	4
17	Mobile Identity 3	Mobile Identity 10.5.1.4	O	TLV	3-10
	P2 Rest Octets	P2 Rest Octets 10.5.2.24	M	V	1-11

9.1.23.1 Channels needed for Mobiles 1 and 2

The first CHANNEL field of Channel Needed IE is associated with Mobile Identity 1. The second CHANNEL field of Channel Needed IE is associated with Mobile Identity 2.

If this message is used in the packet paging procedure, the Channel Needed IE associated with the corresponding Mobile Identity 1 or 2 shall be coded with the value 00 (any channel) by the network. The mobile station receiving a packet paging request shall treat this information element as unnecessary in the message.

9.1.23.2 Mobile Identity 3

The Mobile Identity 3 information element shall not refer to IMEI.

9.1.23.3 P2 Rest Octets

The sum of the length of this IE and the L2 Pseudo Length of the message equals 22.

This IE contains the channel needed indication related to the paging of Mobile Identity 3. The treatment of this indication in the case this message is used in a packet paging procedure is specified in section 9.1.23.1.

This IE may further contain a notification list number field and/or, referring to each one of the Mobile Identity 1, 2 and 3 IEs, a Priority 1, 2 and 3 field and/or, referring to the Mobile Identity 3 IE, a Packet Page Indication 3 field.

9.1.24 Paging request type 3

This message is sent on the CCCH by the network to four mobile stations. It may be sent to a mobile station in idle mode to trigger channel access. It may be sent to a mobile station in packet idle mode to transfer MM information (i.e. trigger of cell update procedure). The mobile stations are identified by their TMSIs/P-TMSIs. See table 9.24/3GPP TS 04.18.

This message has a L2 Pseudo Length of 19.

Message type: PAGING REQUEST TYPE 3

Significance: dual

Direction: network to mobile station

Table 9.24/3GPP TS 04.18: PAGING REQUEST TYPE 3 message content

IEI	Information element	Type / Reference	Presence	Format	length
	L2 Pseudo Length	L2 Pseudo Length 10.5.2.19	M	V	1
	RR management Protocol Discriminator	Protocol Discriminator 10.2	M	V	1/2
	Skip Indicator	Skip Indicator 10.3.1	M	V	1/2
	Paging Request Type 3 Message Type	Message Type 10.4	M	V	1
	Page Mode	Page Mode 10.5.2.26	M	V	1/2
	Channels Needed for Mobiles 1 and 2	Channel Needed 10.5.2.8	M	V	1/2
	Mobile Identity 1	TMSI/P-TMSI 10.5.2.42	M	V	4
	Mobile Identity 2	TMSI/P-TMSI 10.5.2.42	M	V	4
	Mobile Identity 3	TMSI/P-TMSI 10.5.2.42	M	V	4
	Mobile Identity 4	TMSI/P-TMSI 10.5.2.42	M	V	4
	P3 Rest Octets	P3 Rest Octets 10.5.2.25	M	V	3

9.1.24.1 Channels needed for Mobiles 1 and 2

The first CHANNEL field of *Channel Needed* IE is associated with *Mobile Identity 1*. The second CHANNEL field of *Channel Needed* IE is associated with *Mobile Identity 2*.

If this message is used in the packet paging procedure, the *Channel Needed* IE associated with the corresponding *Mobile Identity 1* or *2* shall be coded with the value 00 (any channel) by the network. The mobile station receiving a packet paging request shall treat this information element as unnecessary in the message.

9.1.24.2 P3 Rest Octets

This IE contains the channel needed indication related to the paging of *Mobile Identity 3* and *4*. The treatment of these indications in the case this message is used in a packet paging procedure is specified in section 9.1.24.1.

This IE may further contain a *notification list number* field and/or, referring to each one of the *Mobile Identity 1, 2, 3* and *4* IEs, a *Priority 1, 2, 3* and *4* field.

9.1.25 Paging response

This message is sent on the main DCCH by the mobile station to the network in connection with establishment of the main signalling link as a response to the paging request message. See table 9.25/3GPP TS 04.18.

Message type: PAGING RESPONSE

Significance: dual

Direction: mobile station to network

Table 9.25/3GPP TS 04.18: PAGING RESPONSE message content

IEI	Information element	Type / Reference	Presence	Format	length
	RR management Protocol Discriminator	Protocol Discriminator 10.2	M	V	1/2
	Skip Indicator	Skip Indicator 10.3.1	M	V	1/2
	Paging Response Message Type	Message Type 10.4	M	V	1
	Ciphering Key Sequence Number	Ciphering Key Sequence Number 10.5.1.2	M	V	1/2
	Spare Half Octet	Spare Half Octet 10.5.1.8	M	V	1/2
	Mobile Station Classmark	Mobile Station Classmark 2 10.5.1.6	M	LV	4
	Mobile Identity	Mobile Identity 10.5.1.4	M	LV	2-9

9.1.25.1 Mobile Station Classmark

This IE shall include for multiband mobile station the Classmark 2 corresponding to the frequency band in use.

9.1.26 Partial release

This message is sent on the main DCCH by the network to the mobile station to deactivate part of the dedicated channels in use. See table 9.26/3GPP TS 04.18.

Message type: PARTIAL RELEASE

Significance: dual

Direction: network to mobile station

Table 9.26/3GPP TS 04.18: PARTIAL RELEASE message content

IEI	Information element	Type / Reference	Presence	Format	length
	RR management Protocol Discriminator	Protocol Discriminator 10.2	M	V	1/2
	Skip Indicator	Skip Indicator 10.3.1	M	V	1/2
	Partial Release Message Type	Message Type 10.4	M	V	1
	Channel Description	Channel Description 10.5.2.5	M	V	3

9.1.26.1 Channel Description

This information element describes the channel to be released.

9.1.27 Partial release complete

This message is sent on the main DCCH by the mobile station to the network to indicate that a part of the dedicated channels has been deactivated. See table 9.27/3GPP TS 04.18.

Message type: PARTIAL RELEASE COMPLETE

Significance: dual

Direction: mobile station to network

Table 9.27/3GPP TS 04.18: PARTIAL RELEASE COMPLETE message content

IEI	Information element	Type / Reference	Presence	Format	length
	RR management Protocol Discriminator	Protocol Discriminator 10.2	M	V	1/2
	Skip Indicator	Skip Indicator 10.3.1	M	V	1/2
	Partial release Complete Message Type	Message Type 10.4	M	V	1

9.1.28 Physical information

This message is sent on the main DCCH by the network to the mobile station to stop the sending of access bursts from the mobile station. See table 9.28/3GPP TS 04.18.

Message type: PHYSICAL INFORMATION

Significance: dual

Direction: network to mobile station

Table 9.28/3GPP TS 04.18: PHYSICAL INFORMATION message content

IEI	Information element	Type / Reference	Presence	Format	length
	RR management Protocol Discriminator	Protocol Discriminator 10.2	M	V	1/2
	Skip Indicator	Skip Indicator 10.3.1	M	V	1/2
	Physical Information Message Type	Message Type 10.4	M	V	1
	Timing Advance	Timing Advance 10.5.2.40	M	V	1

9.1.28a RR Initialisation Request

This message is sent on the main DCCH by the mobile station to request establishment of dedicated mode.

Message type: RR Initialisation Request

Significance: local

Direction: mobile station to network

Table 9.28a/3GPP TS 04.18: RR Initialisation Request message content

IEI	Information element	Type / Reference	Presence	Format	length
	RR management Protocol Discriminator	Protocol Discriminator 10.2	M	V	1/2
	Skip Indicator	Skip Indicator 10.3.1	M	V	1/2
	RR Initialisation Request Message Type	Message Type 10.4	M	V	1
	Ciphering Key Sequence Number	Ciphering Key sequence Number 10.5.1.2	M	V	1/2
	MAC Mode and Channel Coding Requested	Channel Coding Requested 10.5.2.4a	M	V	1/2
	Mobile station classmark	Mobile station classmark 2 10.5.1.6	M	LV	4
	TLLI	TLLI 10.5.2.41a	M	V	4
	Channel Request Description	Channel Request Description 10.5.2.8a	M	V	5
	GPRS Measurement Results	GPRS Measurement Results 10.5.2.20a	M	V	2

9.1.29 RR Status

This message is sent by the mobile station or the network at any time to report certain error conditions as described in section 8. See table 9.28a/3GPP TS 04.18.

Message type: RR STATUS

Significance: local

Direction: both

Table 9.28a/3GPP TS 04.18: RR STATUS message content

IEI	Information element	Type / Reference	Presence	Format	length
	RR management Protocol Discriminator	Protocol Discriminator 10.2	M	V	1/2
	Skip Indicator	Skip Indicator 10.3.1	M	V	1/2
	RR Status Message Type	Message Type 10.4	M	V	1
	RR Cause	RR Cause 10.5.2.31	M	V	1

9.1.30a Synchronization channel information

This message is sent on the SCH, which is one of the broadcast channels (ref. 3GPP TS 05.02 section 3.3.2). Its purpose is to support the synchronization of a mobile station to a BSS. It does not follow the basic format. Its length is 25 bits. The order of bit transmission is defined in 3GPP TS 04.04. See figure 9.3a/3GPP TS 04.18 and table 9.29/3GPP TS 04.18.

Message type: SYNCHRONIZATION CHANNEL INFORMATION

Significance: dual

Direction: network to mobile station

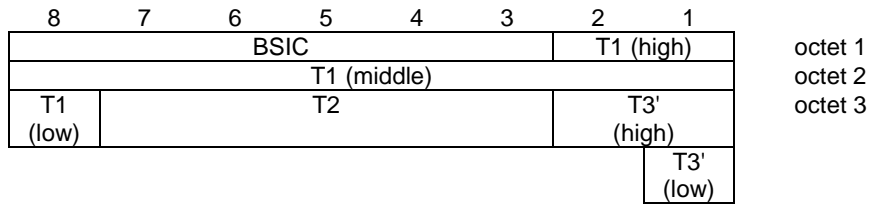

Figure 9.3a/3GPP TS 04.18: Frame synchronization information element

Table 9.29a/3GPP TS 04.18: Synchronization channel information message contents

<p>BSIC, the base station identity code of the base station</p> <p>T1, T2 and T3', the 3 parts of the reduced TDMA frame number (RFN) as specified in TS. 3GPP TS 05.02 section 3.3.2.</p>
--

9.1.30b COMPACT Synchronization channel information

This message is sent on the CSCH, which is one of the broadcast channels (ref. 3GPP TS 05.02 section 3.3.2). Its purpose is to support the synchronization of a COMPACT mobile station to a BSS. It does not follow the basic format. Its length is 25 bits. The order of bit transmission is defined in 3GPP TS 04.04. See figure 9.3b/3GPP TS 04.18 and table 9.29b/3GPP TS 04.18.

Message type: COMPACT SYNCHRONIZATION CHANNEL INFORMATION

Significance: dual

Direction: network to mobile station

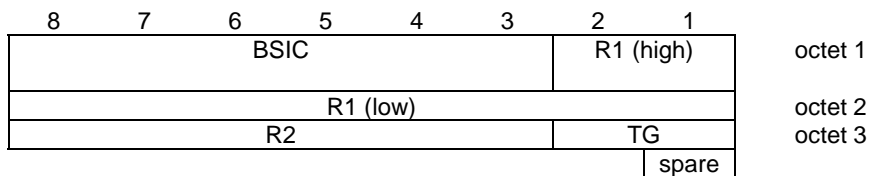

Figure 9.3b/3GPP TS 04.18: COMPACT Frame synchronization information element

Table 9.29b/3GPP TS 04.18: COMPACT Synchronization channel information message contents

<p>BSIC, the base station identity code of the base station</p> <p>R1 and R2, the 2 parts of the reduced TDMA frame number (RFN) as specified in TS. 3GPP TS 05.02 section 3.3.2.</p> <p>TG, the time group as specified in TS. 3GPP TS 05.02 section 4.3.4.</p>
--

9.1.31 System information Type 1

This message is sent on the BCCH by the network to all mobile stations within the cell giving information of control of the RACH and of the cell allocation. See table 9.30/3GPP TS 04.18. Special requirements for the transmission of this message apply, see 3GPP TS 05.02. This message has a L2 Pseudo Length of 21.

Message type: SYSTEM INFORMATION TYPE 1

Significance: dual

Direction: network to mobile station

Table 9.30/3GPP TS 04.18: SYSTEM INFORMATION TYPE 1 message content

IEI	Information element	Type / Reference	Presence	Format	length
	L2 pseudo length	L2 pseudo length 10.5.2.19	M	V	1
	RR management Protocol Discriminator	Protocol Discriminator 10.2	M	V	1/2
	Skip Indicator	Skip Indicator 10.3.1	M	V	1/2
	System Information Type 1 Message Type	Message Type 10.4	M	V	1
	Cell Channel Description	Cell Channel Description 10.5.2.1b	M	V	16
	RACH Control Parameter	RACH Control Parameters 10.5.2.29	M	V	3
	SI 1 Rest Octets	SI 1 Rest Octets 10.5.2.32	M	V	1

9.1.32 System information type 2

This message is sent on the BCCH by the network to all mobile stations within the cell giving information of control of the RACH and of the BCCH allocation in the neighbour cells. See table 9.31/3GPP TS 04.18. Special requirements for the transmission of this message apply, see 3GPP TS 05.02. This message has a L2 Pseudo Length of 22.

Message type: SYSTEM INFORMATION TYPE 2

Significance: dual

Direction: network to mobile station

Table 9.31/3GPP TS 04.18: SYSTEM INFORMATION TYPE 2 message content

IEI	Information element	Type / Reference	Presence	Format	length
	L2 Pseudo Length	L2 Pseudo Length 10.5.2.19	M	V	1
	RR management Protocol Discriminator	Protocol Discriminator 10.2	M	V	1/2
	Skip Indicator	Skip Indicator 10.3.1	M	V	1/2
	System Information Type 2 Message Type	Message Type 10.4	M	V	1
	BCCH Frequency List	Neighbour Cell Description 10.5.2.22	M	V	16
	NCC Permitted	NCC permitted 10.5.2.27	M	V	1
	RACH Control Parameter	RACH Control Parameters 10.5.2.29	M	V	3

9.1.33 System information type 2bis

This message is sent optionally on the BCCH by the network to all mobile stations within the cell giving information on control of the RACH and of the extension of the BCCH allocation in the neighbour cells. See table 9.31a/3GPP TS 04.18. Special requirements for the transmission of this message apply, see 3GPP TS 05.02.

A GSM 900 mobile station which only supports the primary GSM band P-GSM 900 (cf. 3GPP TS 05.05) may ignore this message, see section 3.2.2.1.

This message has a L2 pseudo length of 21.

Message type: SYSTEM INFORMATION TYPE 2bis

Significance: dual

Direction: network to mobile station

Table 9.31a/3GPP TS 04.18: SYSTEM INFORMATION TYPE 2bis message content

IEI	Information element	Type / Reference	Presence	Format	length
	L2 Pseudo Length	L2 Pseudo Length 10.5.2.19	M	V	1
	RR management Protocol Discriminator	Protocol Discriminator 10.2	M	V	1/2
	Skip Indicator	Skip Indicator 10.3.1	M	V	1/2
	System Information Type 2bis Message Type	Message Type 10.4	M	V	1
	Extended BCCH Frequency List	Neighbour Cell Description 10.5.2.22	M	V	16
	RACH Control Parameters	RACH Control Parameters 10.5.2.29	M	V	3
	SI 2bis Rest Octets	SI 2bis Rest Octets 10.5.2.33	M	V	1

9.1.34 System information type 2ter

This message is sent optionally on the BCCH by the network to all mobile stations within the cell giving information on the extension of the BCCH allocation in the neighbour cells. See table 9.31b/3GPP TS 04.18. Special requirements for the transmission of this message apply, see 3GPP TS 05.02.

A mobile station that supports either:

- only the primary GSM band P-GSM 900 (cf. 3GPP TS 05.05), or
- only the DCS 1800 band (cf. 3GPP TS 05.05)

may ignore this message, see section 3.2.2.1.

This message has a L2 pseudo length of 18. This message may be sent by the network with either a L2 pseudo length of 18 or some other value. A mobile station that does not ignore this message shall not discard the message due to a received L2 pseudo length different from 18.

Message type: SYSTEM INFORMATION TYPE 2ter

Significance: dual

Direction: network to mobile station

Table 9.31b/3GPP TS 04.18: SYSTEM INFORMATION TYPE 2ter message content

IEI	Information element	Type / Reference	Presence	Format	length
	L2 Pseudo Length	L2 Pseudo Length 10.5.2.19	M	V	1
	RR management Protocol Discriminator	Protocol Discriminator 10.2	M	V	1/2
	Skip Indicator	Skip Indicator 10.3.1	M	V	1/2
	System Information Type 2ter Message Type	Message Type 10.4	M	V	1
	Extended BCCH Frequency List	Neighbour Cell Description 2 10.5.2.22a	M	V	16
	SI 2ter Rest Octets	SI 2ter Rest Octets 10.5.2.33a	M	V	4

9.1.34a System information type 2quater

This message is sent optionally on the BCCH by the network to all mobile stations within the cell giving information on UTRAN neighbour cells. The message may contain more than one instance. Special requirements for the transmission of this message apply on BCCH, see 3GPP TS 05.02.

A mobile station that does not support UTRAN should ignore this message.

This message has a L2 pseudo length of 1

Message type: SYSTEM INFORMATION TYPE 2quater

Significance: dual

Direction: network to mobile station

Table 9.31c/3GPP TS 04.18: SYSTEM INFORMATION TYPE 2 quater message content

IEI	Information element	Type / Reference	Presence	Format	length
	L2 Pseudo Length	L2 Pseudo Length 10.5.2.19	M	V	1
	RR management Protocol Discriminator	Protocol Discriminator 10.2	M	V	1/2
	Skip Indicator	Skip Indicator 10.3.1	M	V	1/2
	System Information Type 2quater Message Type	Message Type 10.4	M	V	1
	SI 2 quater Rest Octets	SI 2quater Rest Octets 10.5.2.33b	M	V	20

9.1.35 System information type 3

This message is sent on the BCCH by the network giving information of control on the RACH, the location area identification, the cell identity and various other information about the cell. See table 9.32/3GPP TS 04.18. Special requirements for the transmission of this message apply, see 3GPP TS 05.02. This message has a L2 Pseudo Length of 18.

Message type: SYSTEM INFORMATION TYPE 3

Significance: dual

Direction: network to mobile station

Table 9.32/3GPP TS 04.18: SYSTEM INFORMATION TYPE 3 message content

IEI	Information element	Type / Reference	Presence	Format	length
	L2 Pseudo Length	L2 Pseudo Length 10.5.2.19	M	V	1
	RR management Protocol Discriminator	Protocol Discriminator 10.2	M	V	1/2
	Skip Indicator	Skip Indicator 10.3.1	M	V	1/2
	System Information Type 3 Message Type	Message Type 10.4	M	V	1
	Cell Identity	Cell Identity 10.5.1.1	M	V	2
	Location Area Identification	Location Area Identification 10.5.1.3	M	V	5
	Control Channel Description	Control Channel description 10.5.2.11	M	V	3
	Cell Options	Cell Options (BCCH) 10.5.2.3	M	V	1
	Cell Selection Parameters	Cell Selection Parameters 10.5.2.4	M	V	2
	RACH Control Parameters	RACH Control Parameters 10.5.2.29	M	V	3
	SI 3 Rest Octets	SI 3 Rest Octets 10.5.2.34	M	V	4

9.1.36 System information type 4

This message is sent on the BCCH by the network giving information on control of the RACH, the location area identification, the cell identity and various other information about the cell. See table 9.33/3GPP TS 04.18. Special requirements for the transmission of this message apply, see 3GPP TS 05.02. The L2 pseudo length of this message is the sum of lengths of all information elements present in the message except the *SI 4 Rest Octets* and *L2 Pseudo Length* information elements.

Message type: SYSTEM INFORMATION TYPE 4

Significance: dual

Direction: network to mobile station

Table 9.33/3GPP TS 04.18: SYSTEM INFORMATION TYPE 4 message content

IEI	Information element	Type / Reference	Presence	Format	length
	L2 Pseudo Length	L2 Pseudo Length 10.5.2.19	M	V	1
	RR management Protocol Discriminator	Protocol Discriminator 10.2	M	V	1/2
	Skip Indicator	Skip Indicator 10.3.1	M	V	1/2
	System Information Type 4 Message Type	Message Type 10.4	M	V	1
	Location Area Identification	Location Area Identification 10.5.1.3	M	V	5
	Cell Selection Parameters	Cell Selection Parameters 10.5.2.4	M	V	2
	RACH Control Parameters	RACH Control Parameters 10.5.2.29	M	V	3
64	CBCH Channel Description	Channel description 10.5.2.5	O	TV	4
72	CBCH Mobile Allocation	Mobile Allocation 10.5.2.21	C	TLV	3-6
	SI 4 Rest Octets	SI 4 Rest Octets 10.5.2.35	M	V	0-10

9.1.36.1 CBCH Channel description

This information element is present if SMSCB is active in the cell and indicates (together with the *CBCH Mobile Allocation IE*) where to find the CBCH.

9.1.36.2 CBCH Mobile Allocation

If the *CBCH Channel Description* Information Element indicates frequency hopping, the *CBCH Mobile Allocation IE* shall be present. If the *CBCH Channel Description* does not indicate frequency hopping, the *CBCH Mobile Allocation IE* shall be considered as an unnecessary IE in the message.

9.1.36.3 SI 4 Rest Octets

The sum of the length of this IE and the L2 pseudo length of the message equals 22.

9.1.37 System information type 5

This message is sent on the SACCH by the network to mobile stations within the cell giving information on the BCCH allocation in the neighbour cells. See table 9.34/3GPP TS 04.18.

When received this information shall be used as the list of BCCH frequencies of the neighbouring cells to be reported on. Any change in the neighbour cells description must overwrite any old data held by the mobile station. The mobile station must analyse all correctly received system information type 5 messages. This message has a L2 Pseudo Length of 18.

Message type: SYSTEM INFORMATION TYPE 5

Significance: dual

Direction: network to mobile station

Table 9.34/3GPP TS 04.18: SYSTEM INFORMATION TYPE 5 message content

IEI	Information element	Type / Reference	Presence	Format	length
	L2 pseudo length	L2 pseudo length 10.5.2.19	M	V	1
	RR management Protocol Discriminator	Protocol Discriminator 10.2	M	V	1/2
	Skip Indicator	Skip Indicator 10.3.1	M	V	1/2
	System Information Type 5 Message Type	Message Type 10.4	M	V	1
	BCCH Frequency List	Neighbour Cell Description 10.5.2.22	M	V	16

9.1.38 System information type 5bis

This message is sent optionally on the SACCH by the network to mobile stations within the cell giving information on the extension of the BCCH allocation in the neighbour cells. See table 9.34a/3GPP TS 04.18.

A GSM 900 mobile station which only supports the primary GSM band P-GSM 900 (cf. 3GPP TS 05.05) may ignore this message, see section 3.2.2.1.

When received (and not ignored) this information must be used as the list of neighbouring cells to be reported on. Any change in the neighbour cells description must overwrite any old data held by the mobile station. The mobile station must, with the exception stated above, analyse all correctly received system information type 5 messages. This message has a L2 Pseudo Length of 18.

Message type: SYSTEM INFORMATION TYPE 5bis

Significance: dual

Direction: network to mobile station

Table 9.34a/3GPP TS 04.18: SYSTEM INFORMATION TYPE 5bis message content

IEI	Information element	Type / Reference	Presence	Format	length
	L2 pseudo length	L2 pseudo length 10.5.2.19	M	V	1
	RR management Protocol Discriminator	Protocol Discriminator 10.2	M	V	1/2
	Skip Indicator	Skip Indicator 10.3.1	M	V	1/2
	System Information Type 5 bis Message Type	Message Type 10.4	M	V	1
	Extension of the BCCH Frequency List Description	Neighbour Cell Description 10.5.2.22	M	V	16

9.1.39 System information type 5ter

This message is sent optionally on the SACCH by the network to mobile stations within the cell giving information on the extension of the BCCH allocation in the neighbour cells. See table 9.34b/3GPP TS 04.18.

A mobile station that supports either:

- only the primary GSM band P-GSM 900 (cf. 3GPP TS 05.05), or
- only the DCS 1800 band (cf. 3GPP TS 05.05)
- may ignore this message, see section 3.2.2.1.

When received (and not ignored) this information must be used as part of the list of neighbouring cells to be reported on. Any change in the neighbour cells description must overwrite this part of any old data held by the mobile station. The mobile station shall, with the exception stated above, analyse all correctly received system information type 5ter messages. This message has a L2 Pseudo Length of 18.

Message type: SYSTEM INFORMATION TYPE 5ter

Significance: dual

Direction: network to mobile station

Table 9.34b/3GPP TS 04.18: SYSTEM INFORMATION TYPE 5ter message content

IEI	Information element	Type / Reference	Presence	Format	length
	L2 pseudo length	L2 pseudo length 10.5.2.19	M	V	1
	RR management Protocol Discriminator	Protocol Discriminator 10.2	M	V	1/2
	Skip Indicator	Skip Indicator 10.3.1	M	V	1/2
	System Information Type 5ter Message Type	Message Type 10.4	M	V	1
	Extended BCCH Frequency List	Neighbour Cell Description 2 10.5.2.22a	M	V	16

9.1.40 System information type 6

This message is sent on the SACCH by the network to mobile stations within the cell giving information of location area identification, of cell identity and various other information. See table 9.35/3GPP TS 04.18. If received correctly by the mobile station this message is treated as in Sections 9.1.40.1 to 9.1.40.4.

This message has a L2 Pseudo Length of 11.

Message type: SYSTEM INFORMATION TYPE 6

Significance: dual

Direction: network to mobile station

Table 9.35/3GPP TS 04.18: SYSTEM INFORMATION TYPE 6 message content

IEI	Information element	Type / Reference	Presence	Format	length
	L2 pseudo length	L2 pseudo length 10.5.2.19	M	V	1
	RR management Protocol Discriminator	Protocol Discriminator 10.2	M	V	1/2
	Skip Indicator	Skip Indicator 10.3.1	M	V	1/2
	System Information Type 6 Message Type	Message Type 10.4	M	V	1
	Cell Identity	Cell Identity 10.5.1.1	M	V	2
	Location Area Identification	Location Area Identification 10.5.1.3	M	V	5
	Cell Options	Cell Options (SACCH) 10.5.2.3	M	V	1
	NCC Permitted	NCC Permitted 10.5.2.27	M	V	1
	SI 6 Rest Octets	SI6 Rest Octets 10.5.2.35a	M	V	7

9.1.40.1 Cell Identity

Only applicable for mobile stations supporting SIM Application Toolkit class 2 or higher :

- if a new Cell Identity is identified, an indication shall be given to the upper layer together with the new identity.

Other mobile stations may ignore this IE.

9.1.40.2 Location Area Identification

Only applicable for mobile stations supporting VGCS listening and VBS listening or SIM Application Toolkit class 2 or higher :

- if a new Location Area Identification is identified, an indication shall be given to the upper layer together with the new identification.

Other mobile stations may ignore this IE.

9.1.40.3 Cell Options

When correctly received, this information shall be used as the current Cell Options information. Any change in the Cell Options shall overwrite any old Cell Options data held by the mobile station.

9.1.40.4 NCC permitted

As for BCCH Frequency List in SYSTEM INFORMATION TYPE 5.

9.1.41 System information type 7

This message is sent on the BCCH by the network giving information about cell reselection parameters to be used in that cell. See table 9.36/3GPP TS 04.18. Special requirements for the transmission of this message apply, see 3GPP TS 05.02. The L2 pseudo length of this message has the value 1.

Message type: SYSTEM INFORMATION TYPE 7

Significance: dual

Direction: network to mobile station

Table 9.36/3GPP TS 04.18: SYSTEM INFORMATION TYPE 7 message content

IEI	Information element	Type / Reference	Presence	Format	length
	L2 pseudo length	L2 pseudo length 10.5.2.19	M	V	1
	RR management Protocol Discriminator	Protocol Discriminator 10.2	M	V	1/2
	Skip Indicator	Skip Indicator 10.3.1	M	V	1/2
	System Information Type 7 Message Type	Message Type 10.4	M	V	1
	SI 7 Rest Octets	SI 7 Rest Octets 10.5.2.36	M	V	20

9.1.42 System information type 8

This message is sent on the BCCH by the network giving information about cell reselection parameters to be used in that cell. See table 9.37/3GPP TS 04.18. Special requirements for the transmission of this message apply, see 3GPP TS 05.02. The L2 Pseudo Length of this message has the value 1.

Message type: SYSTEM INFORMATION TYPE 8

Significance: dual

Direction: network to mobile station

Table 9.37/3GPP TS 04.18: SYSTEM INFORMATION TYPE 8 message content

IEI	Information element	Type / Reference	Presence	Format	length
	L2 Pseudo Length	L2 Pseudo Length 10.5.2.19	M	V	1
	RR management Protocol Discriminator	Protocol Discriminator 10.2	M	V	1/2
	Skip Indicator	Skip Indicator 10.3.1	M	V	1/2
	System Information Type 8 Message Type	Message Type 10.4	M	V	1
	SI 8 Rest Octets	SI 8 Rest Octets 10.5.2.37	M	V	20

9.1.43 System information Type 9

This message is sent on the BCCH by the network to all mobile stations within the cell giving some, but not necessarily all information on the scheduling of information on the BCCH. See table 9.37a/3GPP TS 04.18. Special requirements for the transmission of this message apply, see subclause 3.2.2.1 and 3GPP TS 05.02. This message has a L2 Pseudo Length of 1.

Message type: SYSTEM INFORMATION TYPE 9

Significance: dual

Direction: network to mobile station

Table 9.37a/3GPP TS 04.18: SYSTEM INFORMATION TYPE 9 message content

IEI	Information element	Type / Reference	Presence	Format	length
	L2 pseudo length	L2 pseudo length 10.5.2.19	M	V	1
	RR management Protocol Discriminator	Protocol Discriminator 10.2	M	V	1/2
	Skip Indicator	Skip Indicator 10.3.1	M	V	1/2
	System Information Type 9 Message Type	Message Type 10.4	M	V	1
	RACH Control Parameter	RACH Control Parameters 10.5.2.29	M	V	3
	SI 9 Rest Octets	SI 9 Rest Octets 10.5.2.37a	M	V	17

9.1.43a System information Type 13

This message is sent on the BCCH if indicated in at least one of the SYSTEM INFORMATION TYPE 3, 4, 7 or 8 messages. The message is sent by the network to provide information related to GPRS in the cell. See table 9.37b/GSM04.18. Special requirements for the transmission of this message apply, see 3GPP TS 05.02.

A mobile station not supporting GPRS shall treat this message as an unknown message type.

The L2 Pseudo Length of this message has the value 0.

Message type: SYSTEM INFORMATION TYPE 13

Significance: dual

Direction: network to mobile station

Table 9.37b/3GPP TS 04.18: SYSTEM INFORMATION TYPE 13 message content

IEI	Information element	Type / Reference	Presence	Format	length
	L2 Pseudo Length	L2 Pseudo Length 10.5.2.19	M	V	1
	RR management Protocol Discriminator	Protocol Discriminator 10.2	M	V	1/2
	Skip Indicator	Skip Indicator 10.3.1	M	V	1/2
	System Information Type 13 Message Type	Message Type 10.4	M	V	1
	SI 13 Rest Octets	SI 13 Rest Octets 10.5.2.37b	M	V	20

9.1.43b [Spare]

9.1.43c [Spare]

9.1.43d System information type 16

This message is sent on the BCCH if indicated in the SYSTEM INFORMATION TYPE 3 message. The message is sent by the network giving information about cell selection and reselection parameters to be used in that cell. See table 9.37e/3GPP TS 04.18. Special requirements for the transmission of this message applies, see 3GPP TS 05.02.

The L2 pseudo length of this message has the value 1.

Message type: SYSTEM INFORMATION TYPE 16

Significance: dual

Direction: network to mobile station

Table 9.37e/3GPP TS 04.18: SYSTEM INFORMATION TYPE 16 message content

IEI	Information element	Type / Reference	Presence	Format	length
	L2 pseudo length	L2 pseudo length 10.5.2.19	M	V	1
	RR management Protocol Discriminator	Protocol Discriminator 10.2	M	V	1/2
	Skip Indicator	Skip Indicator 10.3.1	M	V	1/2
	System Information Type 16 Message Type	Message Type 10.4	M	V	1
	SI 16 Rest Octets	SI 16 Rest Octets 10.5.2.37e	M	V	20

9.1.43e System information type 17

This message is sent on the BCCH if indicated in the SYSTEM INFORMATION TYPE 3 message. The message is sent by the network giving information about cell selection and reselection parameters to be used in that cell. See table 9.37f/3GPP TS 04.18. Special requirements for the transmission of this message applies, see 3GPP TS 05.02.

The L2 pseudo length of this message has the value 1.

Message type: SYSTEM INFORMATION TYPE 17

Significance: dual

Direction: network to mobile station

Table 9.37f/3GPP TS 04.18: SYSTEM INFORMATION TYPE 17 message content

IEI	Information element	Type / Reference	Presence	Format	length
	L2 Pseudo Length	L2 Pseudo Length 10.5.2.19	M	V	1
	RR management Protocol Discriminator	Protocol Discriminator 10.2	M	V	1/2
	Skip Indicator	Skip Indicator 10.3.1	M	V	1/2
	System Information Type 17 Message Type	Message Type 10.4	M	V	1
	SI 17 Rest Octets	SI 17 Rest Octets 10.5.2.37f	M	V	20

9.1.43f System information type 19

This message is sent optionally on the BCCH by the network to all mobile stations within the cell giving information on COMPACT neighbour cells. See table 9.37g/3GPP TS 04.18. Special requirements for the transmission of this message apply, see 3GPP TS 05.02.

A mobile station that does not support COMPACT should ignore this message.

This message has a L2 pseudo length of 1.

Message type: SYSTEM INFORMATION TYPE 19

Significance: dual

Direction: network to mobile station

Table 9.37g/3GPP TS 04.18: SYSTEM INFORMATION TYPE 19 message content

IEI	Information element	Type / Reference	Presence	Format	length
	L2 Pseudo Length	L2 Pseudo Length 10.5.2.19	M	V	1
	RR management Protocol Discriminator	Protocol Discriminator 10.2	M	V	1/2
	Skip Indicator	Skip Indicator 10.3.1	M	V	1/2
	System Information Type 19 Message Type	Message Type 10.4	M	V	1
	SI 19 Rest Octets	SI 19 Rest Octets 10.5.2.37g	M	V	20

9.1.43g System information type 18

This message is sent on the BCCH when the operator decides to transmit non-GSM broadcast information.

The L2 pseudo length of this message has the value 1.

Message type: SYSTEM INFORMATION TYPE 18

Significance: dual

Direction: network to mobile station

Table 9.43f/3GPP TS 04.18: SYSTEM INFORMATION TYPE 18 message content

IEI	Information element	Type / Reference	Presence	Format	length
	L2 Pseudo Length	L2 Pseudo Length 10.5.2.19	M	V	1
	RR management Protocol Discriminator	Protocol Discriminator 10.2	M	V	1/2
	Skip Indicator	Skip Indicator 10.3.1	M	V	1/2
	System Information Type 18 Message Type	Message Type 10.4	M	V	1
	SI 18 Rest Octets	SI 18 Rest Octets 10.5.2.37h	M	V	20

9.1.43h System information type 20

This message is sent on the BCCH when the operator decides to transmit non-GSM broadcast information.

The L2 pseudo length of this message has the value 1.

Message type: SYSTEM INFORMATION TYPE 20

Significance: dual

Direction: network to mobile station

Table 9.43h/3GPP TS 04.18: SYSTEM INFORMATION TYPE 20 message content

IEI	Information element	Type / Reference	Presence	Format	length
	L2 Pseudo Length	L2 Pseudo Length 10.5.2.19	M	V	1
	RR management Protocol Discriminator	Protocol Discriminator 10.2	M	V	1/2
	Skip Indicator	Skip Indicator 10.3.1	M	V	1/2
	System Information Type 20 Message Type	Message Type 10.4	M	V	1
	SI 20 Rest Octets	SI 18 Rest Octets 10.5.2.37i	M	V	20

9.1.44 Talker indication

This message is sent on the main DCCH by the mobile station to the network to give the talker information when a new layer 2 connection is established on a VGCS channel after an uplink access. See table 9.44/3GPP TS 04.18.

Message type: TALKER INDICATION

Significance: dual

Direction: mobile station to network

Table 9.44/3GPP TS 04.18 TALKER INDICATION message content

IEI	Information element	Type / Reference	Presence	Format	length
	RR management Protocol Discriminator	Protocol Discriminator 10.2	M	V	1/2
	Skip Indicator	Skip Indicator 10.3.1	M	V	1/2
	Talker Indication Message Type	Message Type 10.4	M	V	1
	Mobile Station Classmark	Mobile Station Classmark 2 10.5.1.6	M	LV	4
	Mobile Identity	Mobile Identity 10.5.1.4	M	LV	2-9

9.1.45 Uplink access

This message is sent in random mode on the voice group call channel uplink. It does not follow the basic format. The possible formats are presented directly below, without reference to information fields. The order of bit transmission is defined in 3GPP TS 04.04.

The message is only one octet long, coded as shown in figure 9.4/3GPP TS 04.18 and table 9.45/3GPP TS 04.18.

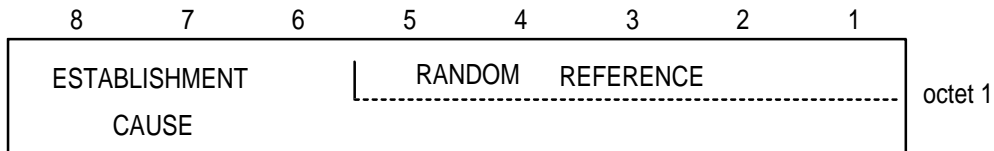

Figure 9.4/3GPP TS 04.18 UPLINK ACCESS message content

ESTABLISHMENT CAUSE (octet 1)

This information field indicates the reason for requesting the establishment of a connection. This field has a variable length (from 3 bits up to 8 bits).

RANDOM REFERENCE (octet 1)

This is an unformatted field with variable length (from 5 bits down to 0 bits).

The Uplink access message is coded as follows:

(Random Reference field is filled with "x").

Table 9.45/3GPP TS 04.18 UPLINK ACCESS message content

Message 8 1	Meaning of Establishment Cause
110xxxxx	Subsequent talker uplink request
00100101	Reply on uplink access request
other values	reserved for future use

9.1.46 Uplink busy

The understanding of this message is only required for mobile stations supporting VGCS talking.

This message is broadcasted on the voice group call channel on the main DCCH, SAPI=0, by the network in unacknowledged mode to inform the mobile station of the uplink status of the voice group call channel. See table 9.46/3GPP TS 04.18.

Message type: UPLINK BUSY

Significance: dual

Direction: network to mobile station

Table 9.46/3GPP TS 04.18 UPLINK BUSY message content

IEI	Information element	Type / Reference	Presence	Format	length
	RR management Protocol Discriminator	Protocol Discriminator 10.2	M	V	1/2
	Skip Indicator	Skip Indicator 10.3.1	M	V	1/2
	Uplink busy Message Type	Message Type 10.4	M	V	1

9.1.47 Uplink free

This message is sent on the main DCCH, in unacknowledged mode using the RR short protocol discriminator by the network to inform the mobile station of the uplink status of the voice group call channel. See table 9.47/3GPP TS 04.18. The message indicates the uplink as free unless the Uplink Access Request field indicates the uplink as not free.

This message may also be used by the network to request the mobile station to perform an uplink reply procedure.

Message type: UPLINK FREE
 Significance: dual
 Direction: network to mobile station

Table 9.47/3GPP TS 04.18 UPLINK FREE message content

<UPLINK FREE> ::= <RR short PD : bit>	See 3GPP TS 24.007
<message type : bit(5)>	See 10.4
<short layer 2 header : bit(2)>	See 3GPP TS 04.06
<Uplink Access Request bit>	
{L H <Uplink Identity Code bit(6)>}	
<implicit spare> ;	
Uplink Access Request :	
L Mobile station shall not perform the uplink reply procedure;	
H Mobile station shall perform the uplink reply procedure.	
When set to H, this element also indicates the uplink as not free for the uplink access procedure	
Uplink Identity Code :	
This field is coded as the binary representation of the UIC.	
If provided by the network, the Uplink Identity Code shall be used by the mobile for the coding of the UPLINK ACCESS message	

9.1.48 Uplink release

Only applicable for mobile stations supporting VGCS talking.

This message is sent on the uplink of the voice group call channel to initiate a deactivation of the group transmit mode and to set the uplink free or on the downlink of the voice group call channel in order to reject an uplink access which was already granted by the network. See table 9.48/3GPP TS 04.18

Message type: UPLINK RELEASE
 Significance: local
 Direction: both

Table 9.48/3GPP TS 04.18 UPLINK RELEASE message content

IEI	Information element	Type / Reference	Presence	Format	length
	RR management Protocol Discriminator	Protocol Discriminator 10.2	M	V	1/2
	Skip Indicator	Skip Indicator 10.3.1	M	V	1/2
	Uplink Release Message Type	Message Type 10.4	M	V	1
	RR Cause	RR Cause 10.5.2.31	M	V	1

9.1.49 VGCS uplink grant

The understanding of this message is only required for mobile stations supporting VGCS talking.

This message is sent in unacknowledged mode on the main signalling channel by the network to the mobile station to stop the sending of access bursts from the mobile station and to change the channel configuration to a dedicated configuration. See table 9.49/3GPP TS 04.18.

Message type: VGCS UPLINK GRANT

Significance: dual

Direction: network to mobile station

Table 9.49/3GPP TS 04.18 VGCS UPLINK GRANT message content

IEI	Information element	Type / Reference	Presence	Format	length
	RR management Protocol Discriminator	Protocol Discriminator 10.2	M	V	1/2
	Skip Indicator	Skip Indicator 10.3.1	M	V	1/2
	VGCS Uplink Grant Message Type	Message Type 10.4	M	V	1
	Request Reference	Request Reference 10.5.2.30	M	V	3
	Timing Advance	Timing Advance 10.5.2.40	M	V	1

9.1.50 System information type 10 \$(ASCII)\$

The understanding of messages of this message type is only required for mobile stations supporting VGCS listening and VBS listening. A mobile station not understanding the message shall treat it as unknown message.

Messages of this message type are optionally sent by the network in unacknowledged mode on the SACCH. SYSTEM INFORMATION TYPE 10 messages contain information about neighbour cells. When sent on the SACCH of a VGCS or VBS downlink, SYSTEM INFORMATION TYPE 10 messages address all mobile stations receiving that downlink within the cell. There may be different SYSTEM INFORMATION TYPE 10 messages sent on the same SACCH.

They are not standard layer 3 messages. They shall be transferred using the short header format for SACCH messages sent in unacknowledged mode specified in 3GPP TS 24.007.

Each SYSTEM INFORMATION TYPE 10 message defines a list of cells and may contain further information for cells of that list, a cell being identified by the pair of ARFCN and BSIC of the BCCH. Newer information about a cell received in SYSTEM INFORMATION TYPE 10 messages shall replace older information.

Message type: SYSTEM INFORMATION TYPE 10

Significance: dual

Direction: network to mobile station

<SYSTEM INFORMATION TYPE 10> ::=	
<RR short PD : bit>	-- See 3G3GPP TS 24.007
<message type : bit(5)>	-- See 10.4
<short layer 2 header : bit(2)>	-- See 3GPP TS 04.06
<S110 Rest Octets : bit(160)>;	-- See 10.5.2.44

9.1.51 EXTENDED MEASUREMENT ORDER

This message is sent on the SACCH by the network to the mobile station, to order the mobile station to send one extended measurement report. See table 9.1.51.1/3GPP TS 04.18.

A mobile station which does not support Extended Measurements shall discard this message.

This message has a L2 Pseudo Length of 18.

Message type: EXTENDED MEASUREMENT ORDER

Significance: dual

Direction: network to mobile station

Table 9.1.51.1/3GPP TS 04.18: EXTENDED MEASUREMENT ORDER message content

IEI	Information element	Type / Reference	Presence	Format	length
	L2 pseudo length	L2 pseudo length 10.5.2.19	M	V	1
	RR management Protocol Discriminator	Protocol Discriminator 10.2	M	V	1/2
	Skip Indicator	Skip Indicator 10.3.1	M	V	1/2
	Extended Measurement Order	Message Type 10.4	M	V	1
	Extended Measurement Frequency List	Extended Measurement Frequency List 10.5.2.46	M	V	16

9.1.52 Extended measurement report

This message is sent on the SACCH by the mobile station to the network to report extended measurement results about the signal strength on specified carriers. See table 9.1.52.1/3GPP TS 04.18.

Message type: EXTENDED MEASUREMENT REPORT

Significance: dual

Direction: mobile station to network

Table 9.1.52.1/3GPP TS 04.18: EXTENDED MEASUREMENT REPORT message content

IEI	Information element	Type / Reference	Presence	Format	length
	RR management Protocol Discriminator	Protocol Discriminator 10.2	M	V	1/2
	Skip Indicator	Skip Indicator 10.3.1	M	V	1/2
	Extended Measurement Report Message Type	Message Type 10.4	M	V	1
	Extended Measurement Results	Extended Measurement Results 10.5.2.45	M	V	16

9.1.53 Application Information

This message is sent on the main DCCH by the network or the mobile station to convey an embedded Application Protocol Data Unit (APDU) or APDU segment between the network and the mobile station. See table 9.1.53.1/3GPP TS 04.18.

Message type: Application

Significance: global

Direction: both

Table 9.1.53.1/3GPP TS 04.18: Application Information message content

IEI	Information Element	Type/Reference	Presence	Format	Length
	RR management Protocol Discriminator	Protocol discriminator 10.2	M	V	1/2
	Skip Indicator	Skip Indicator 10.3.1	M	V	1/2
	Application Information message type	Message type 10.4	M	V	1
	APDU ID	APDU ID 10.5.2.48	M	V	1/2
	APDU Flags	APDU Flags 10.5.2.49	M	V	1/2
	APDU Data	APDU Data 10.5.2.50	M	LV	2 to N

9.1.54 MEASUREMENT INFORMATION

This message is sent on the SACCH by the network to the mobile station. If not all information fits into one message, the remaining information will be sent in other instances of this message. This message can contain a combination of information for e.g. 3G Neighbour Cell Description, Real Time Differences, BSICs, Report priority, Measurement parameters or 3G Measurement parameters.

Message type: MEASUREMENT INFORMATION

Significance: dual

Direction: network to mobile station

```

<Measurement information> ::=
< RR short PD : bit >          -- See 3GPP TS 04.07
< Message type : bit (5) >     -- See 10.4
< Short layer 2 header : bit (2) > -- See 3GPP TS 04.06

< BA_IND : bit >
< 3G_BA_IND : bit >
< MP_CHANGE_MARK : bit >
< MI_INDEX : bit (4) >
< MI_COUNT : bit (4) >
< Report_Type : bit >
< REPORTING_RATE : bit >
< UNKNOWN_BSIC_REPORTING : bit >

{ 0 | 1 < 3G Neighbour Cells Description : < 3G Neighbour Cells Description struct >> }
{ 0 | 1 < Real Time Difference Description : < Real Time Difference Description struct >> }
{ 0 | 1 < BSIC Description : < BSIC Description struct >> }

{ 0 | 1 < REPORT PRIORITY Description : < REPORT PRIORITY Description struct >> }
{ 0 | 1 < MEASUREMENT Parameters Description : < MEASUREMENT Parameters Description struct >> }
{ 0 | 1 < 3G MEASUREMENT Parameters Description : < 3G MEASUREMENT Parameters Description struct >> }

< spare padding > ;

< 3G Neighbour Cells Description struct > ::=
{ 0 | 1 < 3G_Wait : bit (3)> }
{ 0 | 1 < Index_Start_3G : bit (7)> }
{ 0 | 1 < Absolute_Index_Start_EMR : bit (7)> }
{ 0 | 1 < UMTS FDD Description : < UMTS FDD Description struct >> }
{ 0 | 1 < UMTS TDD Description : < UMTS TDD Description struct >> }
{ 0 | 1 < CDMA2000 Description : < CDMA2000 Description struct >> } ;

< UMTS FDD Description struct > ::=
{
{ 0 | 1 < Bandwidth_FDD : bit (3) > }
{ 1 { < Repeated UMTS FDD Neighbour Cells : < Repeated UMTS FDD Neighbour Cells struct >> } ** 0 } ;

< Repeated UMTS FDD Neighbour Cells struct > ::=
{ 0 < FDD-ARFCN : bit (14) > | 1 < FDD-ARFCN-INDEX : bit (3) > }
< Number_of_Scrambling_Codes_and_Diversity : bit (5) >
< Range-1024-Format Scrambling Codes and Diversity Field :
bit(p(Number_of_Scrambling_Codes_and_Diversity)) > ; -- p(x) defined in table 9.1.54.1a/3GPP TS 04.18.

< UMTS TDD Description struct > ::=
{ 0 | 1 < Bandwidth_TDD : bit (3) > }
{ 1 < Repeated UMTS TDD Neighbour Cells : Repeated UMTS TDD Neighbour Cells struct > } ** 0 } ;

< Repeated UMTS TDD Neighbour Cells struct > ::=
{ 0 < TDD-ARFCN : bit (14) > | 1 < TDD-ARFCN-INDEX : bit (3) > }
< Number_of_Cell Parameters_and_sync cases_and_Diversity : bit (5) >
< Range-512-Format Cell Parameters and syncs cases and Diversity : bit(q(Number_of_Cell Parameters_and_sync
cases_and_Diversity)) > ; -- q(x) defined in table 9.1.54.1b/GSM04.18.

```

```

< CDMA 2000 Description struct > ::=
  < cdma2000 frequency band : bit(5)>
  < cdma2000 frequency : bit(11)>
  < number_cdma2000_cells : bit (5) >

  { < Pilot PN offset : bit (9) >
    -- this information is enough for 1X Common Pilot

  {0 | 1 {000 { < TD_MODE : bit (2)> <TD_POWER_LEVEL : bit (3) >}
    -- additional information for 1X Common Pilot with Transmit Diversity

    | 001 { < QOF : bit (2) > < WALSH_LEN_A : bit (3) >
      <AUX_PILOT_WALSH : bit(val(WALSH_LEN_A)+6) >}
    -- additional information for 1X Auxiliary Pilot

    | 010 { < QOF : bit (2) > < WALSH_LEN_B : bit (3) >
      < AUX_TD_WALSH : bit (val(WALSH_LEN_B)+6) >
      < AUX_TD_POWER_LEVEL : bit (2) > <TD_MODE : bit (2) >}
    -- additional information for 1X Auxiliary Pilot with Transmit Diversity

    | 011 { < SR3_PRIM_PILOT : bit (2) > < SR3_PILOT_POWER1 : bit (3) >
      < SR3_PILOT_POWER2 : bit(3)>}
    -- additional information for 3X Common Pilot

    | 110 { < SR3_PRIM_PILOT : bit (2) > < SR3_PILOT_POWER1 : bit (3) >
      < SR3_PILOT_POWER2 : bit (3) > < QOF : bit (2) >
      < WALSH_LEN_C : bit (3) >
      < AUX_WALSH_LEN : bit(val(WALSH_LEN_C)+6) >
      { 0 | 1 < QOF1 : bit (2) > < WALSH_LENGTH1 : bit (3) >
        < AUX_PILOT_WALSH1 : bit(val(WALSH_LENGTH1)+6) > }
      { 0 | 1 < QOF2 : bit (2) > < WALSH_LENGTH2 : bit (3) >
        < AUX_PILOT_WALSH2 : bit(val(WALSH_LENGTH2)+6)> } }
    -- additional information for 3X Auxiliary Pilot
    }
  }
} * val(number_cdma2000_cells);

< Real Time Difference Description struct > ::=
  { 0 | 1 { 0 | 1 < BA_Index_Start_RTD : bit (5) > }          --default value=0
  < RTD Struct : < RTD6 Struct >>
  { 0 < RTD Struct : < RTD6 Struct >> **1 }          -- '0' indicates to increment by 1
    -- the frequency in the BA (list)
  }
  { 0 | 1 { 0 | 1 < BA_Index_Start_RTD : bit (5) > }          --default value=0
  < RTD Struct : < RTD12 Struct >>
  { 0 < RTD Struct : < RTD12 Struct >> **1 }          -- '0' indicates to increment by 1
    -- the frequency in the BA (list)
  };

< RTD6 Struct > ::=
  { 0 < RTD : bit (6) > ** 1 };          -- Repeat until '1'; '1' means last RTD for this frequency

< RTD12 Struct > ::=
  { 0 < RTD : bit (12) > ** 1 };          -- Repeat until '1'; '1' means last RTD for this frequency

< BSIC Description struct > ::=
  { 0 | 1 < BA_Index_Start_BSIC : bit (5) > }          default value=0
  < BSIC : bit (6) >
  < Number_Remaining_BSIC: bit (7) >
  { < Frequency_Scrolling : bit >
    < BSIC : bit (6) > } * (val(Number_Remaining_BSIC));          -- 0 means same frequency

```

```

< REPORT_PRIORITY Description struct > ::=
< Number_Cells : bit(7) >
{ REP_PRIORITY: bit } * (val(Number_Cells)) ;

< MEASUREMENT_PARAMETERS Description struct > ::=
{ 0 | 1 < Multiband_Reporting : bit (2) > }
{ 0 | 1 < Serving_Band_Reporting : bit (2) > }
  < SCALE_ORD : bit(2) >

{ 0 | 1 < 900_REPORTING_OFFSET : bit (3) >
  < 900_REPORTING_THRESHOLD : bit (3) > }

{ 0 | 1 < 1800_REPORTING_OFFSET : bit (3) >
  < 1800_REPORTING_THRESHOLD : bit (3) > }

{ 0 | 1 < 400_REPORTING_OFFSET : bit (3) >
  < 400_REPORTING_THRESHOLD : bit (3) > }

{ 0 | 1 < 1900_REPORTING_OFFSET : bit (3) >
  < 1900_REPORTING_THRESHOLD : bit (3) > }

{ 0 | 1 < 850_REPORTING_OFFSET : bit (3) >
  < 850_REPORTING_THRESHOLD : bit (3) > } ;

< 3G_MEASUREMENT_PARAMETERS Description struct > ::=
{
  < Qsearch_C : bit (4) >
  < 3G_Search_Prio : bit (1) >
  { 0 | 1 < FDD_REP_QUANT ; bit (1) > } -- FDD Parameters
  { 0 | 1 < FDD_MULTIRAT_REPORTING : bit (2) > }
    { 0 | 1 < FDD_REPORTING_OFFSET : bit (3) >
      < FDD_REPORTING_THRESHOLD : bit (3) > }

  { 0 | 1 < TDD_MULTIRAT_REPORTING : bit (2) > } -- TDD Parameters
    { 0 | 1 < TDD_REPORTING_OFFSET : bit (3) >
      < TDD_REPORTING_THRESHOLD : bit (3) > }

  { 0 | 1 < CDMA2000_MULTIRAT_REPORTING : bit (2) > } -- CDMA2000 Parameters
    { 0 | 1 < CDMA2000_REPORTING_OFFSET : bit (3) >
      < CDMA2000_REPORTING_THRESHOLD : bit (3) > }

  < PWRC : bit (1) >
};

```

Figure 9.1.54.1/3GPP TS 04.18: *Measurement Information* message content

Table 9.1.54.1/3GPP TS 04.18: *Measurement Information* information element details.

BA-IND (1 bit), BCCH allocation sequence number indication.

The BA-IND is needed to allow the network to discriminate measurements results related to different GSM neighbour Cell lists sent to the MS, as described in sub-clause 3.4.1.2.1 'The Use of parameters from the Measurement Information/SI2quater messages'. The value of this parameter is reflected in the ENHANCED MEASUREMENT REPORT message and in the MEASUREMENT REPORT message.

3G-BA-IND (1 bit), 3G Sequence Number.

The 3G-BA-IND parameter is needed to allow the network to discriminate measurement results related to different 3G Neighbour Cell lists sent to the MS, as described in sub-clause 3.4.1.2.1, 'The Use of parameters from the Measurement Information/SI2quater messages'. The value of this parameter is reflected in the ENHANCED MEASUREMENT REPORT and MEASUREMENT REPORT messages.

MP-CHANGE-MARK (1 bit), measurement parameters change mark.

This parameter is used to indicate the MS a change of information concerning REPORT PRIORITY, MEASUREMENT INFORMATION and 3G MEASUREMENT INFORMATION, as described in sub-clause 3.4.1.2.1, 'The Use of parameters from the Measurement Information/SI2 quater messages'.

MI_INDEX (4 bits) and **MI_COUNT** (4 bits)

The purpose of the MI_INDEX and MI_COUNT fields is to indicate the number of individual messages within the sequence of MEASUREMENT INFORMATION messages and to assign an index to identify each of them. The MI_INDEX field is binary coded, range 0 to 15, and provides an index to identify the individual MEASUREMENT INFORMATION message. The MI_COUNT field is binary coded, range 0 to 15, and provides the MI_INDEX value for the last (highest indexed) message in the sequence of MEASUREMENT INFORMATION messages.

Report_Type (1bit)

This parameter is used to indicate to the mobile to use the Enhanced Measurement report or Measurement report messages for reporting:

Bit

0 The MS shall use the Enhanced Measurement Report message for reporting if at least one BSIC is allocated to each BA (list) frequency.

1 The MS shall use the Measurement Report message for reporting.

REPORTING_RATE (1 bit)

This parameter is used for measurements, see 3GPP TS 05.08.

bit

0 SACCH rate reporting

1 Reduced reporting rate allowed.

UNKNOWN_BSIC_REPORTING (1 bit)

This field specifies if cells with unknown BSIC and allowed NCC part of BSIC are allowed to be reported or not, see 3GPP TS 05.08.

bit

0 Report on cells with unknown BSIC and allowed NCC part of BSIC is not allowed.

1 Report on cells with unknown BSIC and allowed NCC part of BSIC is allowed.

3G Neighbour Cells Description:

The building of the 3G Neighbour Cell list and the ordering of indices within each Radio Access Technology is described in sub-clause 3.4.1.2.1.1, 'Deriving the 3G Neighbour Cell list from the 3G Neighbour Cell Description'.

3G-WAIT (3 bits)

When 3G-BA-IND is received in a changed state, this parameter indicates the number of instances of MEASUREMENT INFORMATION messages that contain 3G Neighbour Cells Description which shall be received before the MS reports on the new 3G Neighbour Cell list. Two different instances of MEASUREMENT INFORMATION messages are two MEASUREMENT INFORMATION messages with different MI_INDEX. See sub-clause 3.4.1.2.1.

bit

3 2 1

0 0 0 1 instance that contain 3G Neighbour Cell Description shall be received

0 0 1 2 instances that contain Neighbour Cell Description shall be received

...

1 1 1 8 instances that contain Neighbour Cell description shall be received

Index_Start_3G (7 bit)

This optional information element indicates the binary value of the first index to use to build this instance of the 3G Neighbour Cell list. When missing, the value 0 is assumed. See sub-clause 3.4.1.2.1.1.

Absolute_Index_Start_EMR (7 bit)

This parameter indicates in binary the value to be added to the indexes of the 3G Neighbour Cell list for reporting 3G Cells with the ENHANCED MEASUREMENT REPORT message (see sub-clause 3.4.1.2.1.1). If this parameter is absent, the same value as received in a previous instance (with the exception defined in 3.4.1.2.1 on the change of 3G-BA-IND) is assumed.

NOTE: This parameter is not used for reporting 3G Cells with the MEASUREMENT REPORT message, see sub-clause 10.5.2.20, 'Measurement Results'.

UMTS FDD Description:**Bandwidth_FDD** (3bit field)

This optional information element will be used for future releases of the protocol. When missing, this indicates the present FDD bandwidth. When present, this shall not be considered as an error; indices of the 3G Neighbour Cell list shall be incremented accordingly.

FDD_ARFCN (14 bit field)

This optional information element is defined as the UARFCN in 3G3GPP TS 25.101. Any non-supported frequency shall not be considered as an error; indices of the 3G Neighbour Cell list shall be incremented accordingly.

FDD-ARFCN-INDEX (3 bit field)

This field points to the absolute frequency received in the UMTS Freq list information element in the Channel Release message, see sub-clause 10.5.2.1d, UMTS frequency list. If there is no frequency associated to this value of the FDD-ARFCN-INDEX parameter, this shall not be considered as an error; indices of the 3G Neighbour Cell list shall be incremented accordingly.

Number_of_Scrambling_Codes_and_Diversity (5 bit field)

This optional field defines the decimal value of the number of Scrambling Codes/Diversity parameters.

Range-1024-Format Scrambling Codes and Diversity Field (p bit field)

This field allows to compute a set of 10-bit-long Scrambling Codes and Diversity Parameters, re-using the *Range 1024 format* compression algorithm, see Annex J: 'Algorithm to encode frequency list information'. The computation formulas for decoding are given in the 'Range 1024 format' sub-clause, 10.5.2.13.3. The consecutive parameters of this field are concatenated, starting with the bit FDD_Indic0, and then w1, w2...

FDD_Indic0, information 0 indicator (1 bit):

0 information '0000000000' is not a member of the set

1 information '0000000000' is a member of the set

NOTE: This bit FDD_Indic0 is equivalent than the bit F0 bit in the frequency list information element.

For each (10-bit-long) decoded Parameter, bits 1-9 are the Scrambling Codes and bit 10 is the corresponding Diversity Parameter.

The total number of bits p of this field depends on the value of the parameter Number_of_Scrambling_Codes_and_Diversity = n, as follows (with p=0 if n=0):

n	p	n	p	n	p	n	p
1	11	6	53	11	89	16	123
2	20	7	61	12	96	17-31	0
3	29	8	68	13	103		
4	37	9	75	14	110		
5	45	10	82	15	117		

Table 9.1.54.1a.

If n=0, this indicates the 3G Neighbour Cell list index for report on RSSI, see 3GPP TS 05.08.

If n is equal or greater than 17, this shall not be considered as an error; the corresponding index in the 3G Neighbour Cell list shall be incremented by one.

Scrambling Codes (9 bit field)

This parameter is defined in 3GPP TS 25.304.

Diversity (1 bit field)

This parameter indicates if diversity is applied for the cell:

Bit

0 Diversity is not applied for this cell

1 Diversity is applied for this cell.

UMTS TDD Description:**Bandwidth_TDD** (3bit field)

This optional information element refers to 3G3GPP TS 25.331.

Bit

321

000 3.84Mcps

001 1.28Mcps

All other values shall not be interpreted as an error; indexes of the 3G Neighbour Cell list shall be incremented accordingly (and no measurements can be performed).

TDD_ARFCN (14 bit field)

This optional information element is defined as the UARFCN in 3G3GPP TS 25.102. Any non supported frequency shall not be considered as an error; indices of the 3G Neighbour Cell list shall be incremented accordingly.

TDD-ARFCN-INDEX (3 bit field)

This field points to the absolute frequency received in the UMTS Freq list information element in the Channel Release message, see sub-clause 10.5.2.1d, 'UMTS frequency list'. If there is no frequency associated to this value of the TDD-ARFCN-INDEX parameter, this shall not be considered as an error; indices of the 3G Neighbour Cell list shall be incremented accordingly.

Number_of_Cell Parameters_and_Sync Cases_and_Diversity (5 bit field)

This optional field defines the number of Cell Parameters/Sync Case/Time Diversity parameters.

Range-512-Format Cell Parameters and syncs cases and Diversity (q bit field)

This field allows to compute a set of 9-bit-long Scrambling Codes and Diversity Parameters, re-using the *Range 512 format* compression algorithm, see Annex J: 'Algorithm to encode frequency list information'. The computation formulas for decoding are given in the 'Range 512 format' sub-clause, 10.5.2.13.4, with $w_0=0$. The consecutive parameters of this field are concatenated, starting with the bit TDD_Indic0, and then $w_1, w_2...$

TDD_Indic0, information 0 indicator (1 bit):

0 information '000000000' is not a member of the set

1 information '000000000' is a member of the set

NOTE: This bit TDD_Indic0 is equivalent than the bit F0 bit in the frequency list information element.

For each (9-bit-long) decoded Parameter, bits 1-7 are the Cell Parameters, bit 8 is the Sync Case and bit 9 is the Diversity bit

The total number of bits q of this field depends on the value of the parameter **Number_of_Cell Parameters_and_Sync Cases_and_Diversity** = m, as follows (with $q=0$ if $m=0$):

m	q	m	q	m	q	m	q	m	q
1	10	6	47	11	78	16	106	21-31	0
	18	7	54	12	84	17	112		
3	26	8	60	13	90	18	117		
4	33	9	66	14	96	19	122		
5	40	10	72	15	102	20	127		

Table 9.1.54.1b.

If $m=0$ or m is equal or greater than 21, this shall not be considered as an error; the corresponding index in the 3G Neighbour Cell list shall be incremented by one.

Cell Parameter (7 bit field)

This parameter is defined in 3GPP TS 25.304.

Sync Case (1 bit field)

This parameter is defined in 3GPP TS 25.304.

Diversity (1 bit field)

This parameter indicates if diversity is applied for the cell:

Bit

0 Diversity is not applied for this cell

1 Diversity is applied for this cell.

CDMA 2000 Description:**cdma2000 frequency band** (5 bit field)

A binary representation of cdma2000 BAND_CLASS, as defined in TIA/EIA-IS-2000-5-A. The mobile station shall ignore all the information relative to a cdma2000 frequency band that it can not support.

cdma2000 frequency (5 bit field)

A binary representation of cdma2000 CDMA_FREQ, as defined in TIA/EIA-IS-2000-5-A. The mobile station shall ignore all the information relative to a cdma2000 frequency that it can not support.

number_cdma2000_cells (5 bit field)

This field indicates the number of CDMA 2000 neighbour cells.

cdma2000 Pilot PN offset (9 bit field)

A binary representation of the PN offset of the Pilot PN sequence (in units of 64 cdma2000 1x-chips), PILOT_PN, as defined in TIA/EIA-IS-2000-5-A.

TD_MODE (2 bit field)

An indication of transmit diversity mode is specified in TIA/EIA-IS-2000-5-A. The mobile station shall ignore TD_MODE if it does not support 1X Common Pilot with Transmit Diversity.

TD_POWER_LEVEL (3 bit field)

Power level of the Transmit Diversity Pilot relative to that of the Forward Pilot Channel as specified in TIA/EIA/IS-2000-5-A. The mobile station shall ignore TD_POWER_LEVEL if it does not support 1X Common Pilot with Transmit Diversity.

QOF (2 bit field)

Quasi-orthogonal function index is defined in TIA/EIA/IS-2000-5-A. The mobile station shall ignore QOF if it does not support the quasi-orthogonal function.

WALSH_LEN_A, WALSH_LEN_B and WALSH_LEN_C (3 bit field each)

A three bit field to indicate the length of the Walsh code for the pilot that is used in as the Auxiliary Pilot, and specified as WALSH_LEN in TIA/EIA/IS-2000-5-A. The mobile station shall ignore WALSH_LEN if it does not support 1X Auxiliary Pilot.

AUX_PILOT_WALSH (var. length)

Indicates the walsh code corresponding to the Auxiliary Pilot, as specified in TIA/EIA/IS-2000-5-A. The mobile station shall ignore AUX_PILOT_WALSH if it does not support 1X Auxiliary Pilot.

AUX_TD_WALSH (var. length)

Indicates the walsh code corresponding to the Auxiliary Transmit Diversity Pilot, as specified in TIA/EIA/IS-2000-5-A. The mobile station shall ignore AUX_TD_WALSH if it does not support 1X Auxiliary Pilot with Transmit Diversity.

AUX_TD_POWER_LEVEL (2 bit field)

Power level of the Auxiliary Transmit Diversity Pilot relative to that of the Forward Pilot Channel as specified in TIA/EIA/IS-2000-5-A. The mobile station shall ignore AUX_TD_POWER_LEVEL if it does not support 1X Auxiliary Pilot with Transmit Diversity.

SR3_PRIM_PILOT (2 bit field)

Position of the primary SR3 pilot as specified in TIA/EIA/IS-2000-5-A. The mobile station shall ignore SR3_PRIM_PILOT if it does not support 3X Common Pilot.

SR3_PILOT_POWER1 (2 bit field)

Relative power level between the primary SR3 pilot and the pilot on the lower frequency of the two remaining SR3 frequencies, as specified in TIA/EIA/IS-2000-5-A. The mobile station shall ignore SR3_PILOT_POWER1 if it does not support 3X Common Pilot.

SR3_PILOT_POWER2 (2 bit field)

Relative power level between the primary SR3 pilot and the pilot on the higher frequency of the two remaining SR3 frequencies, as specified in TIA/EIA/IS-2000-5-A. The mobile station shall ignore SR3_PILOT_POWER2 if it does not support 3X Common Pilot.

QOF1 (1 bit field), WALSH_LEN1 (3 bit field) and AUX_PILOT_WALSH1 (var. length)

Are the corresponding quantities for pilot on the lower frequency of the two remaining SR3 frequencies, as specified in TIA/EIA/IS-2000-5-A. The mobile station shall ignore QOF1, WALSH_LEN1 and AUX_PILOT_WALSH1 if it does not support 3X Auxiliary Pilot.

QOF2 (2 bit field), WALSH_LENGTH2 (3 bit field) and AUX_PILOT_WALSH2 (var. length)

Are the corresponding quantities for pilot on the higher frequency of the two remaining SR3 frequencies, as specified in TIA/EIA/IS-2000-5-A. The mobile station shall ignore QOF2, WALSH_LEN2 and AUX_PILOT_WALSH2 if it does not support 3X Auxiliary Pilot.

PRIORITY Description**REP_PRIORITY bit:**

- 0** Normal reporting priority
- 1** High reporting priority

The use of these bits is defined in sub-clause 3.4.1.2.1.5 'Report Priority Description'.

BSIC Description

BSIC parameters are used to create the GSM Neighbour Cell list, see sub-clause 3.4.1.2.1.2 'Deriving the GSM Neighbour Cell list from the BSICs and the BA (list)'.

The first **BSIC** parameter received in the structure relates to the index in the BA(list) frequency referenced by the parameter **BA_Index_Start_BSIC** (index 0 if **BA_Index_Start_BSIC** is missing). Then the

FREQUENCY_SCROLLING bit indicates whether the next **BSIC** in the structure relates to the same frequency in the BA(list), with '0', or if the next **BSIC** in the structure relates to the subsequent frequency in the BA (list), with '1'. Each next **BSIC** received within the structure creates a subsequent GSM Cell list index.

When **BSIC** information is received in different instances, the first **BSIC** referring to a BA (list) index in one instance shall be allocated the subsequent GSM Cell list index than the last **BSIC** referring to the previous BA (list) index in another instance.

Real Time Difference Description**BA_Index_Start_RTD** (5 bit field)

This field indicates the BA (list) index for the first **RTD** parameter. When missing, the value '0' is assumed.

RTD (6 or 12 bit field) are defined in 3GPP TS 05.08.

The use of these parameters is defined in sub-clause 3.4.1.2.1.4, 'Real Time Differences'.

MEASUREMENT PARAMETERS Description

The fields of this Description are used for measurements as defined in 3GPP TS 05.08.

PWRC, Power control indicator (1 bit field)

- 0 PWRC is not set
- 1 PWRC is set

Any parameter present overwrites any old data held by the mobile station for this parameter. This means that the value corresponding to a parameter not included is not modified, with the exception defined in 3.4.1.2.1.

3G MEASUREMENT PARAMETERS Description

The fields of this Description are used for measurements as defined in 3GPP TS 05.08.

Any parameter present overwrites any old data held by the mobile station for this parameter. This means that the value corresponding to a parameter not included is not modified, with the exception defined in 3.4.1.2.1.

9.1.55 ENHANCED MEASUREMENT REPORT

This message containing measurement results is sent on the SACCH by the mobile to the network. See figure 9.1.55.1/3GPP TS 04.18.

This message may contain reports on GSM and/or 3G Radio Access Technologies. Measurements are defined in 3GPP TS 05.08.

Message type: ENHANCED MEASUREMENT REPORT

Significance: dual

Direction: mobile station to network

```

<Enhanced Measurement report> ::=
< RR short PD : bit >          -- See 3GPP TS 04.07
< Message type : bit (5) >     -- See 10.4
< Short layer 2 header : bit (2) > -- See 3GPP TS 04.06

< BA_USED : bit >
< 3G_BA_USED : bit >
< BSIC_Seen : bit >

< SCALE : bit >

{ 0 | 1 < Serving cell data : < Serving cell data struct >> }
{ 1 < Repeated Unknown_BSIC_Information : < Repeated Unknown_BSIC_Information struct >> } ** 0

{ 0 | 1 { 0 | 1 < REPORTING_QUANTITY : bit (6) > } ** } - - bitmap type reporting

< spare padding > ;

< Serving cell data struct > ::=
< DTX_USED : bit >
< RXLEV_VAL : bit (6) >
< RX_QUAL_FULL : bit (3) >
< MEAN_BEP : bit (5) >
< CV_BEP : bit (3) >
< NBR_RCVD_BLOCKS : bit (5) > ;

< Repeated Unknown_BSIC_Information struct > ::=
< BCCH-FREQ-NCELL : bit (5) >
< BSIC : bit (6) >
< RXLEV-NCELL : bit (6) > ;

```

Figure 9.1.55.1/3GPP TS 04.18: *Enhanced Measurement Report* message content

Table 9.1.55.1/3GPP TS 04.18: *Enhanced Measurement Report* information element details.

BA_USED (1 bit field),
The value of the BA-IND field of the neighbour cells description information element or elements defining the BCCH allocation used. Range 0 to 1.

3G_BA_USED (1 bit field)
The value of the 3G-BA-IND field of the neighbour cells description information element or elements defining the 3G allocation used. Range 0 to 1.

BSIC_Seen (1 bit field)

This parameters indicates if a GSM RAT cell with unknown BSIC and allowed NCC part BSIC is one of the six strongest, see 3GPP TS 05.08.

Bit

0 Unknown and allowed BSIC not seen

1 Unknown and allowed BSIC seen

SCALE (1 bit field)

The value of this field is defined in 3GPP TS 05.08.

Serving cell reporting

If this structure is missing, this indicates that no valid measurement exist for the serving cell.

Parameters **RXLEV_VAL** (6 bits), **RX_QUAL_FULL** (3 bits), **MEAN_BEP** (5 bits), **CV_BEP** (3 bits), **NBR_RCVD_BLOCKS** (5 bits) are defined in 3GPP TS 05.08.

DTX_USED (1 bit field)

This bit indicates whether or not the mobile station used DTX during the previous measurement period.

0 DTX was not used

1 DTX was used.

Neighbour cell reporting**Repeated Unknown BSIC**

BCCH-FREQ-NCELL (5 bits). This field represents the index of the BA (list), see 10.5.2.20.

BSIC (6 bits). Base station identity code of the corresponding index in the BA (list).

RXLEV (6 bits). GSM RAT reporting quantity, see 3GPP TS 05.08.

Bitmap type reporting:

Each bit of the bitmap points to the corresponding index of the Neighbour Cell list defined in sub-clause 3.4.1.2.1.3 'Deriving the Neighbour Cell list from the GSM Neighbour Cell list and the 3G Neighbour Cell list'.

If this structure is present and more bits than needed are available at the end of the message, the MS shall set the value of the redundant bitmap positions to '0'.

After the last REPORTING_QUANTITY parameter, some remaining bits indicating no report may be missing.

Reporting_Quantity (6 bits):

Measurement quantities are defined in 3GPP TS 05.08.:

9.2 Messages for mobility management

See 3GPP TS 24.008.

9.3 Messages for circuit-switched call control

See 3GPP TS 24.008.

9.4 GPRS Mobility Management Messages

See 3GPP TS 24.008.

9.5 GPRS Session Management Messages

See 3GPP TS 24.008.

9.6 GTTP Messages

Table 9.6.1/3GPP TS 04.18 summarises the GTTP messages.

Table 9.6.1/3GPP TS 04.18: GTTP messages

GPRS Transparent Transport messages	Reference
GPRS Information	9.6.1

9.6.1 GPRS Information

This message is sent in acknowledged mode on the main DCCCH in order to carry GPRS information in a transparent manner between the mobile station and the network. See table 9.6.2/3GPP TS 04.18.

Message type: GPRS Information

Significance: global

Direction: both

Table 9.6.2/3GPP TS 04.18: GPRS Information message content

IEI	Information element	Type / Reference	Presence	Format	length
	GTTP Protocol Discriminator	Protocol Discriminator 10.2	M	V	1/2
	Skip Indicator	Skip Indicator 10.3.1	M	V	1/2
	GPRS Information Message Type	Message Type 10.4	M	V	1
	TLLI	TLLI 10.5.2.41a	M	V	4
	LLC PDU	LCC PDU Container 10.5.8.1	M	LV	2-n

9.6.1.1 TLLI

This information element carries the Temporary Logical Link Identifier.

9.6.1.2 LLC PDU Container

This information element carries an LLC PDU with upper layer information.

10 General message format and information elements coding

The figures and text in this section describe the Information Elements contents.

10.1 Overview

Within the RR protocols defined in 3GPP TS 04.18, every message with the exception of the messages sent on the BCCH, downlink CCCH, SCH, RACH, and the HANDOVER ACCESS message, is a standard L3 message as defined in 3GPP TS 24.007 [20]. This means that the message consists of the following parts:

- a) protocol discriminator;
- b) transaction identifier;
- c) message type;
- d) other information elements, as required.

This organization is illustrated in the example shown in figure 10.1/3GPP TS 04.18.

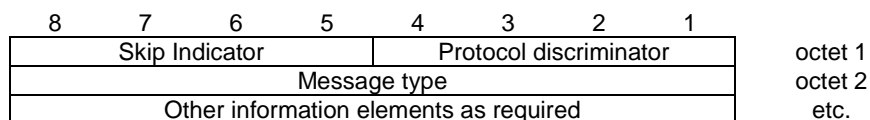

Figure 10.1/3GPP TS 04.18 General message organization example

Unless specified otherwise in the message descriptions of section 9, a particular information element shall not be present more than once in a given message.

The term "default" implies that the value defined shall be used in the absence of any assignment, or that this value allows negotiation of alternative values in between the two peer entities.

When a field extends over more than one octet, the order of bit values progressively decreases as the octet number increases. The least significant bit of the field is represented by the lowest numbered bit of the highest numbered octet of the field.

10.2 Protocol Discriminator

The Protocol Discriminator (PD) and its use are defined in 3GPP TS 24.007 [20].

10.3 Skip indicator

10.3.1 Skip indicator

Bits 5 to 8 of the first octet of every Radio Resource management message contain the skip indicator. A message received with skip indicator different from 0000 shall be ignored. A message received with skip indicator encoded as 0000 shall not be ignored (unless it is ignored for other reasons). A protocol entity sending a Radio Resource management message shall encode the skip indicator as 0000.

10.4 Message Type

The message type IE and its use are defined in 3GPP TS 24.007 [20]. Tables 10.1/3GPP TS 04.18 and 10.1a/3GPP TS 04.18 define the value part of the message type IE used in the Radio Resource management protocol. Table 10.1b/3GPP TS 04.18 defines the value part of the message type IE used in the GPRS Transparent Transport protocol.

Table 10.1/3GPP TS 04.18: Message types for Radio Resource management

8	7	6	5	4	3	2	1	
0	0	1	1	1	-	-	-	Channel establishment messages:
					1	0	0	- RR INITIALISATION REQUEST
					0	1	1	- ADDITIONAL ASSIGNMENT
					1	1	1	- IMMEDIATE ASSIGNMENT
					0	0	1	- IMMEDIATE ASSIGNMENT EXTENDED
					0	1	0	- IMMEDIATE ASSIGNMENT REJECT
0	1	0	0	1	0	0	0	- DTM ASSIGNMENT FAILURE
0	1	0	0	1	0	0	1	- DTM REJECT
0	1	0	0	1	0	1	0	- DTM REQUEST
0	1	0	0	1	0	1	1	- PACKET ASSIGNMENT
0	0	1	1	0	-	-	-	Ciphering messages:
					1	0	1	- CIPHERING MODE COMMAND
					0	1	0	- CIPHERING MODE COMPLETE
0	0	1	1	0	-	-	-	Configuration change messages:
					0	0	0	- CONFIGURATION CHANGE COMMAND
					0	0	1	- CONFIGURATION CHANGE ACK.
					0	1	1	- CONFIGURATION CHANGE REJECT
0	0	1	0	1	-	-	-	Handover messages:
					1	1	0	- ASSIGNMENT COMMAND
					0	0	1	- ASSIGNMENT COMPLETE
					1	1	1	- ASSIGNMENT FAILURE
					0	1	1	- HANDOVER COMMAND
					1	0	0	- HANDOVER COMPLETE
					0	0	0	- HANDOVER FAILURE
					1	0	1	- PHYSICAL INFORMATION
0	1	0	0	1	1	0	1	- DTM ASSIGNMENT COMMAND
0	0	0	0	1	0	0	0	- RR-CELL CHANGE ORDER
0	0	1	0	0	0	1	1	- PDCH ASSIGNMENT COMMAND
0	0	0	0	1	-	-	-	Channel release messages:
					1	0	1	- CHANNEL RELEASE
					0	1	0	- PARTIAL RELEASE
					1	1	1	- PARTIAL RELEASE COMPLETE
0	0	1	0	0	-	-	-	Paging and Notification messages:
					0	0	1	- PAGING REQUEST TYPE 1
					0	1	0	- PAGING REQUEST TYPE 2
					1	0	0	- PAGING REQUEST TYPE 3
					1	1	1	- PAGING RESPONSE
					0	0	0	- NOTIFICATION/NCH
					1	0	1	- Reserved (see NOTE)
					1	1	0	- NOTIFICATION/RESPONSE
0	0	0	0	1	0	1	1	- Reserved (see NOTE)
0	1	1	0	0	-	-	-	3G Specific messages
					0	0	0	- UTRAN Classmark Change
					0	0	1	- UE RAB Preconfiguration
					0	1	0	- cdma 2000 Classmark Change
					0	1	1	- Inter System to UTRAN Handover Command
					1	0	0	- Inter System to cdma2000 Handover Command
0	0	0	1	1	-	-	-	System information messages:
					0	0	0	- SYSTEM INFORMATION TYPE 8
					0	0	1	- SYSTEM INFORMATION TYPE 1
					0	1	0	- SYSTEM INFORMATION TYPE 2
					0	1	1	- SYSTEM INFORMATION TYPE 3
					1	0	0	- SYSTEM INFORMATION TYPE 4
					1	0	1	- SYSTEM INFORMATION TYPE 5
					1	1	0	- SYSTEM INFORMATION TYPE 6
					1	1	1	- SYSTEM INFORMATION TYPE 7
0	0	0	0	0	-	-	-	System information messages:
					0	1	0	- SYSTEM INFORMATION TYPE 2bis
					0	1	1	- SYSTEM INFORMATION TYPE 2ter
					1	1	1	- SYSTEM INFORMATION TYPE 2quater
					1	0	1	- SYSTEM INFORMATION TYPE 5bis
					1	1	0	- SYSTEM INFORMATION TYPE 5ter
					1	0	0	- SYSTEM INFORMATION TYPE 9
					0	0	0	- SYSTEM INFORMATION TYPE 13

8	7	6	5	4	3	2	1	
0	0	1	1	1	-	-	-	System information messages:
					1	0	1	- SYSTEM INFORMATION TYPE 16
					1	1	0	- SYSTEM INFORMATION TYPE 17
0	1	0	0	0	-	-	-	System information messages:
					0	0	0	- SYSTEM INFORMATION TYPE 18
					0	0	1	- SYSTEM INFORMATION TYPE 19
					0	1	0	- SYSTEM INFORMATION TYPE 20
0	0	0	1	0	-	-	-	Miscellaneous messages:
					0	0	0	- CHANNEL MODE MODIFY
					0	1	0	- RR STATUS
					1	1	1	- CHANNEL MODE MODIFY ACKNOWLEDGE
					1	0	0	- FREQUENCY REDEFINITION
					1	0	1	- MEASUREMENT REPORT
					1	1	0	- CLASSMARK CHANGE
					0	1	1	- CLASSMARK ENQUIRY
0	0	1	1	0	1	1	0	- EXTENDED MEASUREMENT REPORT
0	0	1	1	0	1	1	1	- EXTENDED MEASUREMENT ORDER
0	0	1	1	0	1	0	0	- GPRS SUSPENSION REQUEST
0	1	0	0	1	1	0	1	- DTM INFORMATION
VGCS uplink control messages:								
0	0	0	0	1	0	0	1	- VGCS UPLINK GRANT
0	0	0	0	1	1	1	0	- UPLINK RELEASE
0	0	0	0	1	1	0	0	- Reserved (see NOTE)
0	0	1	0	1	0	1	0	- UPLINK BUSY
0	0	0	1	0	0	0	1	- TALKER INDICATION
Application messages:								
0	0	1	1	1	0	0	0	- Application Information

Bit 8 is reserved for possible future use as an extension bit, see 3GPP TS 24.007.

NOTE: This value was allocated but never used in earlier phases of the protocol.

Table 10.1a/3GPP TS 04.18: Message types for Radio Resource management messages using the RR short protocol discriminator

5	4	3	2	1	
0	0	0	0	0	System Information Type 10
0	0	0	0	1	Notification/FACCH
0	0	0	1	0	Uplink Free
0	0	1	0	0	Enhanced Measurement Report (uplink)
0	0	1	0	1	Measurement Information (downlink)

Table 10.1b/3GPP TS 04.18: Message types for GTTP messages

Message type	Message
87654321	
00000000	GPRS Information

10.5 Other information elements

The different formats (V, LV, T, TV, TLV) and the four categories of information elements (type 1, 2, 3, and 4) are defined in 3GPP TS 24.007.

The first octet of an information element in the non-imperative part contains the IEI of the information element. If this octet does not correspond to an IEI known in the message, the receiver shall determine whether this IE is of type 1 or 2 (i.e. it is an information element of one octet length) or an IE of type 4 (i.e. that the next octet is the length indicator indicating the length of the remaining of the information element) (see 3GPP TS 24.007).

This allows the receiver to jump over unknown information elements and to analyse any following information elements.

The information elements which are common for at least two of the three protocols Radio Resources management, Mobility Management and Call Control, are listed in 3GPP TS 04.08, section 10.5.1.

The information elements for the protocols Radio Resources management are listed in section 10.5.2. Default information element identifiers are listed in annex K.

NOTE: Different information elements may have the same default information element identifier if they belong to different protocols.

The descriptions of the information element types in section 10.5.2 are organized in alphabetical order of the IE types. Each IE type is described in one subsection.

The subsection may have an introduction:

- possibly explaining the purpose of the IE;
- possibly describing whether the IE belongs to type 1, 2, 3, 4 or 5;
- possibly indicating the length that the information element has if it is either type 5 or if it is used in format TV (type 1 and 3) or TLV (type 4).

A figure of the subsection defines the structure of the IE indicating:

- possibly the position and length of the IEI. (However it depends on the message in which the IE occurs whether the IE contains an IEI.);
- the fields the IE value part is composed of;
- possibly the position and length of the length indicator. (However it depends on the IE type whether the IE contains a length indicator or not.);
- possibly octet numbers of the octets that compose the IE (see clause a) below).

Finally, the subsection contains tables defining the structure and value range of the fields that compose the IE value part. The order of appearance for information elements in a message is defined in section 9.

The order of the information elements within the imperative part of messages has been chosen so that information elements with 1/2 octet of content (type 1) go together in succession. The first type 1 information element occupies bits 1 to 4 of octet N, the second bits 5 to 8 of octet N, the third bits 1 to 4 of octet N + 1 etc. If the number of type 1 information elements is odd then bits 5 to 8 of the last octet occupied by these information elements contains a spare half octet IE in format V.

Where the description of information elements in this Technical Specification contains bits defined to be "spare bits", these bits shall set to the indicated value (0 or 1) by the sending side, and their value shall be ignored by the receiving side. With few exceptions, spare bits are indicated as being set to "0" in 3GPP TS 04.18.

The following rules apply for the coding of type 4 information elements:

- a) The octet number of an octet (which is defined in the figure of a subsection) consists of a positive integer, possibly of an additional letter, and possibly of an additional asterisk, see clause f). The positive integer identifies one octet or a group of octets.
- b) Each octet group is a self contained entity. The internal structure of an octet group may be defined in alternative ways.
- c) An octet group is formed by using some extension mechanism. The preferred extension mechanism is to extend an octet (N) through the next octet(s) (Na, Nb, etc.) by using bit 8 in each octet as an extension bit.

The bit value "0" indicates that the octet group continues through to the next octet. The bit value "1" indicates that this octet is the last octet of the group. If one octet (Nb) is present, the preceding octets (N and Na) shall also be present.

In the format descriptions appearing in section 10.5.1 to 10.5.4, bit 8 is marked "0/1 ext" if another octet follows. Bit 8 is marked "1 ext" if this is the last octet in the extension domain.

Additional octets may be defined in later versions of the protocols ("1 ext" changed to "0/1 ext") and equipments shall be prepared to receive such additional octets; the contents of these octets shall be ignored. However the length indicated in sections 9 and 10 only takes into account this version of the protocols.

- d) In addition to the extension mechanism defined above, an octet (N) may be extended through the next octet(s) (N+1, N+2 etc.) by indications in bits 7-1 (of octet N).

- e) The mechanisms in c) and d) may be combined.
- f) Optional octets are marked with asterisks (*).

10.5.1 Common information elements.

See 3GPP TS 24.008.

10.5.2 Radio Resource management information elements.

10.5.2.1a BA Range

The purpose of the BA Range information element is to provide the mobile station with ARFCN range information which can be used in the cell selection procedure.

The BA Range information element is coded as shown in figure 10.5.12/3GPP TS 04.18 and table 10.5.12/3GPP TS 04.18.

The BA Range is a type 4 information element with a minimum length of 6 octets. No upper length limit is specified except for that given by the maximum number of octets in a L3 message (see 3GPP TS 04.06).

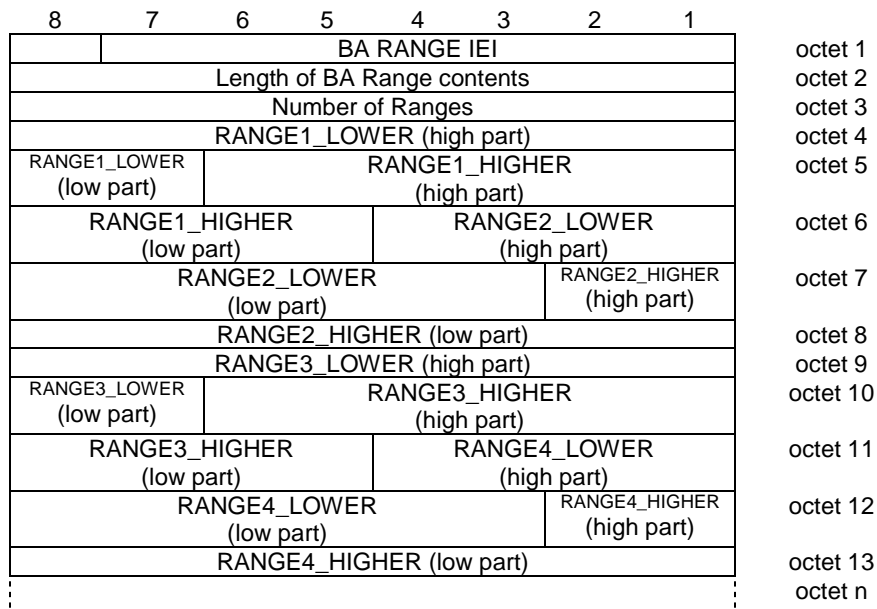

Figure 10.5.12/3GPP TS 04.18 BA RANGE information element

Table 10.5.12/3GPP TS 04.18: BA Range information element

<p>Number of Ranges parameter The number of Ranges parameter indicates in binary the number of ranges to be transmitted in the IE. It shall have a minimum value of 1.</p> <p>RANGEi_LOWER</p> <p>If \$(impr-BA-range-handling)\$ is not supported: \$begin The RANGEi_LOWER is coded as the binary representation of the ARFCN used as the lower limit of a range of frequencies to be used by the mobile station in cell selection (see 3GPP TS 05.08 and 3G3GPP TS 23.022) \$end</p> <p>If \$(impr-BA-range-handling)\$ is supported: \$begin The RANGEi_LOWER is coded as the binary representation of the ARFCN used as the lower limit of a range of frequencies which could be used by the mobile station in cell selection (see 3GPP TS 05.08 and 3G3GPP TS 23.022) \$end</p> <p>RANGEi_HIGHER</p> <p>If \$(impr-BA-range-handling)\$ is not supported: \$begin The RANGEi_HIGHER is coded as the binary representation of the ARFCN used as the higher limit of a range of frequencies to be used by the mobile station in cell selection (see 3GPP TS 05.08 and 3G3GPP TS 23.022) \$end</p> <p>If \$(impr-BA-range-handling)\$ is supported: \$begin The RANGEi_HIGHER is coded as the binary representation of the ARFCN used as the higher limit of a range of frequencies which could be used by the mobile station in cell selection (see 3GPP TS 05.08 and 3G3GPP TS 23.022) \$end</p> <p>If the length of the BA range information element is greater than the number of octets required to carry the Number of Ranges given in octet 3, then any unused octets or parts of octets at the end of the IE shall be considered as spare.</p> <p>If \$(impr-BA-range-handling)\$ is supported: If a mobile station receives range information which has ranges or part of the ranges which are not supported by the mobile station, the mobile station shall take into account those parts of the ranges which it does support.</p>
--

10.5.2.1b Cell Channel Description

The purpose of the *Cell Channel Description* information element is to provide the reference frequency list to be used to decode the mobile allocation information element.

The *Cell Channel Description* is a type 3 information element with 17 octets length.

There are several formats for the *Cell Channel Description* information element, distinguished by the "format indicator" subfield. Some formats are frequency bit maps, the others use a special encoding scheme.

NOTE: No more than 64 RF channels should be encoded in the Cell Allocation since this is the maximum number of RF channels which can be referenced in the Mobile Allocation IE.

10.5.2.1b.1 General description

Figure 10.5.13/04.18 shows only a special bit numbering. The different general format is described in table 10.5.13/04.18.

8	7	6	5	4	3	2	1	
Cell Channel Description IEI								octet 1
Bit 128	Bit 127	0 spare	0 spare	Bit 124	Bit 123	Bit 122	Bit 121	octet 2
Bit 120	Bit 119	Bit 118	Bit 117	Bit 116	Bit 115	Bit 114	Bit 113	octet 3
...								
Bit 008	Bit 007	Bit 006	Bit 005	Bit 004	Bit 003	Bit 002	Bit 001	octet 17

Figure 10.5.13/3GPP TS 04.18 Cell Channel Description information element (general format)

Table 10.5.13/3GPP TS 04.18: Cell Channel Description information element, general format

<p>FORMAT-ID, Format Identifier (Bit 128 and next)</p> <p>The different formats are distinguished by the bits of higher number. The possible values are the following:</p> <table border="0"> <thead> <tr> <th style="text-align: left;">Bit</th> <th style="text-align: left;">Bit</th> <th style="text-align: left;">Bit</th> <th style="text-align: left;">Bit</th> <th style="text-align: left;">Bit</th> <th style="text-align: left;">format notation</th> </tr> <tr> <th style="text-align: left;">128</th> <th style="text-align: left;">127</th> <th style="text-align: left;">124</th> <th style="text-align: left;">123</th> <th style="text-align: left;">122</th> <th></th> </tr> </thead> <tbody> <tr> <td style="text-align: left;">0</td> <td style="text-align: left;">0</td> <td style="text-align: left;">X</td> <td style="text-align: left;">X</td> <td style="text-align: left;">X</td> <td style="text-align: left;">bit map 0</td> </tr> <tr> <td style="text-align: left;">1</td> <td style="text-align: left;">0</td> <td style="text-align: left;">0</td> <td style="text-align: left;">X</td> <td style="text-align: left;">X</td> <td style="text-align: left;">1024 range</td> </tr> <tr> <td style="text-align: left;">1</td> <td style="text-align: left;">0</td> <td style="text-align: left;">1</td> <td style="text-align: left;">0</td> <td style="text-align: left;">0</td> <td style="text-align: left;">512 range</td> </tr> <tr> <td style="text-align: left;">1</td> <td style="text-align: left;">0</td> <td style="text-align: left;">1</td> <td style="text-align: left;">0</td> <td style="text-align: left;">1</td> <td style="text-align: left;">256 range</td> </tr> <tr> <td style="text-align: left;">1</td> <td style="text-align: left;">0</td> <td style="text-align: left;">1</td> <td style="text-align: left;">1</td> <td style="text-align: left;">0</td> <td style="text-align: left;">128 range</td> </tr> <tr> <td style="text-align: left;">1</td> <td style="text-align: left;">0</td> <td style="text-align: left;">1</td> <td style="text-align: left;">1</td> <td style="text-align: left;">1</td> <td style="text-align: left;">variable bit map</td> </tr> </tbody> </table> <p>All other combinations are reserved for future use.</p> <p>A GSM 900 mobile station which only supports the primary GSM band P-GSM 900 (cf. 3GPP TS 05.05) may consider all values except the value for bit map 0 as reserved.</p> <p>The significance of the remaining bits depends on the FORMAT-ID. The different cases are specified in the next sections.</p> <p>Mobile stations shall treat all ARFCNs in the set {0, 1, 2 ... 1023} as valid ARFCN values even if the mobile station is unable to transmit or receive on that ARFCN.</p>						Bit	Bit	Bit	Bit	Bit	format notation	128	127	124	123	122		0	0	X	X	X	bit map 0	1	0	0	X	X	1024 range	1	0	1	0	0	512 range	1	0	1	0	1	256 range	1	0	1	1	0	128 range	1	0	1	1	1	variable bit map
Bit	Bit	Bit	Bit	Bit	format notation																																																
128	127	124	123	122																																																	
0	0	X	X	X	bit map 0																																																
1	0	0	X	X	1024 range																																																
1	0	1	0	0	512 range																																																
1	0	1	0	1	256 range																																																
1	0	1	1	0	128 range																																																
1	0	1	1	1	variable bit map																																																

10.5.2.1b.2 Bit map 0 format

8	7	6	5	4	3	2	1	
Cell Channel Description IE1								octet 1
0	0	0	0	CA	CA	CA	CA	octet 2
FORMAT-ID		spare	spare	ARFCN 124	ARFCN 123	ARFCN 122	ARFCN 121	
CA	CA	CA	CA	CA	CA	CA	CA	octet 3
ARFCN 120	ARFCN 119	ARFCN 118	ARFCN 117	ARFCN 116	ARFCN 115	ARFCN 114	ARFCN 113	
...								
CA	CA	CA	CA	CA	CA	CA	CA	octet 17
ARFCN 008	ARFCN 007	ARFCN 006	ARFCN 005	ARFCN 004	ARFCN 003	ARFCN 002	ARFCN 001	

Figure 10.5.14/3GPP TS 04.18 Cell Channel Description information element, bit map 0 format

Table 10.5.14/3GPP TS 04.18: Cell channel Description information element, bit map 0 format

<p>CA ARFCN N, Cell Allocation Absolute RF Channel Number N (octet 2 etc.)</p> <p>For a RF channel with ARFCN = N belonging to the cell allocation the CA ARFCN N bit is coded with a "1"; N = 1, 2, .. , 124.</p> <p>For a RF channel with ARFCN = N not belonging to the cell allocation the CA ARFCN N bit is coded with a "0"; N = 1, 2 .. , 124.</p>

10.5.2.1b.3 Range 1024 format

8	7	6	5	4	3	2	1	
Cell Channel Description IE1								octet 1
1	0	0	0	0	FORMA	FO	W(1)	octet 2
FORMAT-ID		spare	spare	FORMA	T-ID	F0	(high part)	
W(1) (low part)								octet 3
W(2) (high part)								octet 4
W(2)	W(3)							octet 5
(low)	(high part)							
W(3)	W(4)							octet 6
(low part)	(high part)							
W(4)	W(5)							octet 7
(low part)	(high part)							
W(5)	W(6)							octet 8
(low part)	(high part)							
W(6)	W(7)							octet 9
(low part)	(high part)							
W(7)	W(8)							octet 10
(low part)	(high part)							
W(8)	W(9)							octet 11
(low)	(high part)							
W(10)							W(11)	octet 12
(high part)							high	
W(11)						W(12)		octet 13
(low part)						(high part)		
W(12) (low part)					W(13) (high part)			octet 14
W(13) (low part)				W(14) (high part)				octet 15
W(14) (low part)			W(15) (high part)					octet 16
W(15)		W(16)						octet 17
(low part)		(high part)						

Figure 10.5.15/3GPP TS 04.18 Cell Channel Description information element (1024 range format)

Table 10.5.15/3GPP TS 04.18: Cell Channel Description information element, range 1024 format

F0, frequency 0 indicator (octet 2, bit 3):

0 ARFCN 0 is not a member of the set
 1 ARFCN 0 is a member of the set

W(i), i from 1 to 16 (octet 2 to 17):

Each W(i) encodes a non negative integer in binary format.

If W(k) is null, W(k+1) to W(16) must be null also.

Each non null W(k) allows to compute, together with some previous W(i) the ARFCN F(k) of a frequency in the set. The computation formulas are given in section 10.5.2.13.3.

10.5.2.1b.4 Range 512 format

8	7	6	5	4	3	2	1	
Cell Channel Description IE1								octet 1
1	0	0	0	1	0	0	ORIG-ARFCN high	octet 2
ORIG-ARFCN (middle part)								octet 3
ORIG-ARFCN low	W(1) (high part)							octet 4
W(1) (low part)		W(2) (high part)						octet 5
W(2) (low part)		W(3) (high part)						octet 6
W(3) (low part)		W(4) (high part)						octet 7
W(4) low	W(5)							octet 8
W(6)							W(7) high	octet 9
W(7) (low part)					W(8) (high part)			octet 10
W(8) (low part)				W(9) (high part)				octet 11
W(9) (low part)		W(10)						octet 12
W(11)					W(12) (high part)			octet 13
W(12) (low part)				W(13) (high part)				octet 14
W(13) (low part)		W(14)						octet 15
W(15)					W(16) (high part)			octet 16
W(16) (low part)				W(17)				octet 17

Figure 10.5.16/3GPP TS 04.18 Cell Channel Description information element (512 range format)

Table 10.5.16/3GPP TS 04.18: Cell Channel Description information element, range 512 format

ORIG-ARFCN, origin ARFCN (octet 2, 3 and 4)

This field encodes the ARFCN of one frequency belonging to the set. This value is also used to decode the rest of the element.

W(i), i from 1 to 17 (octet 4 to 17):

Each W(i) encodes a non negative integer in binary format.

If W(k) is null, W(k+1) to W(17) must be null also.

Each non null W(k) allows to compute, together with some previous W(i) the ARFCN F(k) of a frequency in the set. The computation formulas are given in section 10.5.2.13.4.

10.5.2.1b.5 Range 256 format

8	7	6	5	4	3	2	1	
Cell Channel Description IEI								octet 1
1	0	0	0	1	0	1	ORIG-ARFCN high	octet 2
ORIG-ARFCN (middle part)								octet 3
ORIG-ARFCN low	W(1) (high part)							octet 4
W(1) (low)	W(2)							octet 5
W(3)							W(4) high	octet 6
W(4) (low part)					W(5) (high part)			octet 7
W(5) (low part)				W(6) (high part)				octet 8
W(6) low	W(7)						W(8) high	octet 9
W(8) (low part)					W(9) (high part)			octet 10
W(9) low	W(10)					W(11) (high part)		octet 11
W(11) (low part)				W(12)				octet 12
W(13)					W(14) (high part)			octet 13
W(14) low	W(15)						W(16) high	octet 14
W(16) (low part)			W(17)				W(18) high	octet 15
W(18) (low part)			W(19)				W(20) high	octet 16
W(20) (low part)			W(21)				0 spare	octet 17

Figure 10.5.17/3GPP TS 04.18 Cell Channel Description information element, range 256 format

Table 10.5.17/3GPP TS 04.18: Cell Channel Description information element, range 256 format

ORIG-ARFCN, origin ARFCN (octet 2, 3 and 4)

This field encodes the ARFCN of one frequency belonging to the set. This value is also used to decode the rest of the element.

W(i), i from 1 to 21 (octet 4 to 17):

Each W(i) encodes a non negative integer in binary format.

If W(k) is null, W(k+1) to W(21) must be null also.

Each non null W(k) allows to compute, together with some previous W(i) the ARFCN F(k) of a frequency in the set. The computation formulas are given in section 10.5.2.13.5.

10.5.2.1b.6 Range 128 format

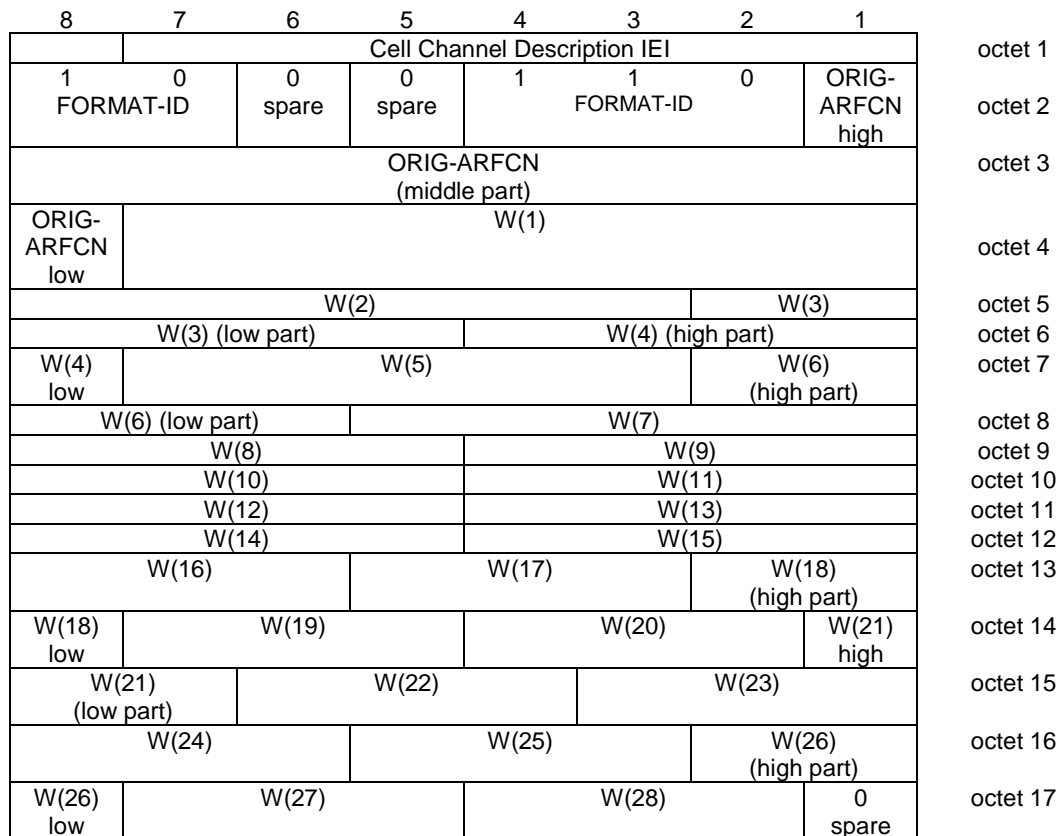

Figure 10.5.18/3GPP TS 04.18 Cell Channel Description information element, range 128 format

Table 10.5.18/3GPP TS 04.18: Cell Channel Description information element, range 128 format

ORIG-ARFCN, origin ARFCN (octet 2, 3 and 4)

This field encodes the ARFCN of one frequency belonging to the set. This value is also used to decode the rest of the element.

W(i), i from 1 to 28 (octet 4 to 17):

Each W(i) encodes a non negative integer in binary format.

If W(k) is null, W(k+1) to W(28) must be null also.

Each non null W(k) allows to compute, together with some previous W(i) the ARFCN F(k) of a frequency in the set. The computation formulas are given in section 10.5.2.13.6.

10.5.2.1b.7 Variable bit map format

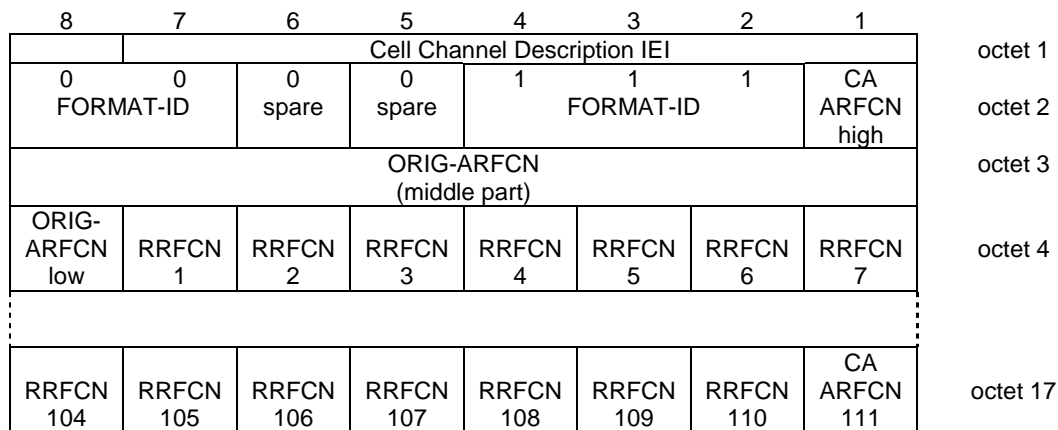

Figure 10.5.19/3GPP TS 04.18 Cell Channel Description information element, variable bit map format

Table 10.5.19/3GPP TS 04.18: Cell Channel Description information element, variable bit map format

ORIG-ARFCN, origin ARFCN (octet 2, 3 and 4)

This field encodes the ARFCN of one frequency belonging to the set. This value is also used as origin of the bit map to generate all other frequencies.

RRFCN N, relative radio frequency channel number N (octet 4 etc.)

For a RF channel with ARFCN = (ORIG-ARFCN + N) mod 1024 belonging to the set, RRFCN N bit is coded with a "1"; N = 1, 2, .. , 111

For a RF channel with ARFCN = (ORIG-ARFCN + N) mod 1024 not belonging to the set, RRFCN N bit is coded with a "0"; N = 1, 2, .. , 111

10.5.2.1c BA List Pref

The purpose of the BA List Pref information element is to provide the mobile station with ARFCN information which can be used in the cell selection/reselection procedure.

The BA List Pref is a type 4 information element with a minimum length of 3 octets. No upper length limit is specified except for that given by the maximum number of octets in a L3 message (see 3GPP TS 04.06).

<BA List Pref>::=

```

    <01110101>
    <LENGTH OF BA LIST PREF : bit (8)>
    { 1 <RANGE LIMITS > } **0
    { 1 <BA FREQ : bit (10)> } **0
    <spare padding>;
  
```

<RANGE LIMITS>::=

```

    <RANGE LOWER : bit (10)>
    <RANGE UPPER : bit (10)>;
  
```

The RANGE LOWER is coded as the binary representation of the ARFCN used as the lower limit of a range of frequencies to be used by the mobile station in cell selection and reselection (see 3GPP TS 05.08 and 3GPP TS 23.022).

The RANGE HIGHER is coded as the binary representation of the ARFCN used as the higher limit of a range of frequencies to be used by the mobile station in cell selection and reselection (see 3GPP TS 05.08 and 3GPP TS 23.022).

BA FREQ is coded as the binary representation of the ARFCN indicating a single frequency to be used by the mobile station in cell selection and reselection (see 3GPP TS 05.08 and 3GPP TS 23.022).

10.5.2.1d UMTS Frequency List

The purpose of the UMTS Frequency List information element is to provide the mobile station with UMTS information which can be used in the cell selection procedure, see 3GPP TS 25.304.

The UMTS Frequency List is a type 4 information element with a minimum length of 3 octets. No upper length limit is specified except for that given by the maximum number of octets in a L3 message (see 3GPP TS 04.06).

In addition, this information element associates absolute explicit FDD frequencies to 3 bit field FDD-ARFCN-INDEX pointers and/or TDD absolute explicit frequencies to 3 bit field TDD-ARFCN-INDEX pointers. The parameters FDD-ARFCN-INDEX and/or TDD-ARFCN-INDEX may then be re-used in the MEASUREMENT INFORMATION message (sub-clause 9.1.54), SI2quarter Rest Octets (sub-clause 10.5.2.33b), and/or SI2ter Rest Octets information element (sub-clause 10.5.2.33a), instead of the explicit frequency. The first FDD frequency shall be assigned to FDD-ARFCN-INDEX 0. Each subsequent FDD frequency in the information element shall increment the value of FDD-ARFCN-INDEX by 1. Then the first TDD frequency shall be assigned to TDD-ARFCN-INDEX 0. Each subsequent TDD frequency in the information element shall increment the value of TDD-ARFCN-INDEX by 1.

If the MS receives some information on some non-supported frequencies, this shall not be considered as an error. The FDD-ARFCN-INDEX and/or TDD-ARFCN-INDEX shall be incremented.

<UMTS Freq List>::=

```

    < 0 1 0 0 1 1 0 0 > --type
    < LENGTH OF UMTS FREQ LIST : bit (8) > -- length following in octets
    { 1 < FDD_ARFCN > : bit (14) } ** 0 -- FDD frequencies
    { 1 < TDD_ARFCN > : bit (14) } ** 0 -- TDD frequencies
    spare bits;
  
```

FDD_ARFCN and TDD_ARFCN are defined as the UARFCN in 3G3GPP TS 25.101 and 3G3GPP TS 25.102.

Spare bits in the end of the field are used to fill the last octet.

10.5.2.2 Cell Description

The purpose of the *Cell Description* information element is to provide a minimum description of a cell, e.g. to allow the mobile station to use its pre-knowledge about synchronization.

The *Cell Description* information element is coded as shown in figure 10.5.20/3GPP TS 04.18 and table 10.5.20/3GPP TS 04.18.

The *Cell Description* is a type 3 information element with 3 octets length.

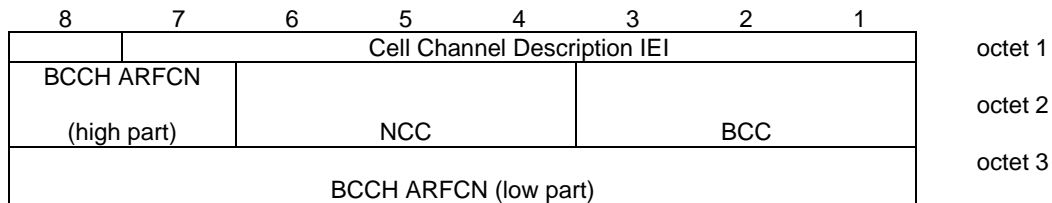

Figure 10.5.20/3GPP TS 04.18 *Cell Description* information element

Table 10.5.20/3GPP TS 04.18: *Cell Description* information element

<p>NCC, PLMN colour code (octet 2) The NCC field is coded as the binary representation of the PLMN colour code (see 3G3GPP TS 23.003).</p> <p>BCC, BS colour code (octet 2) The BCC field is coded as the binary representation of the BS colour code (see 3G3GPP TS 23.003).</p> <p>BCCH ARFCN (octet 2, bits 7 and 8, and octet 3) The BCCH ARFCN number field is coded as the binary representation of the BCCH carriers absolute RF channel number. Range: 0 to 1023</p>
--

10.5.2.3 Cell Options (BCCH)

The purpose of the *Cell Options (BCCH)* information element is to provide a variety of information about a cell.

The *Cell Options (BCCH)* information element is coded as shown in figure 10.5.21/3GPP TS 04.18 and table 10.5.21/3GPP TS 04.18.

The *Cell Options (BCCH)* is a type 3 information element with 2 octets length.

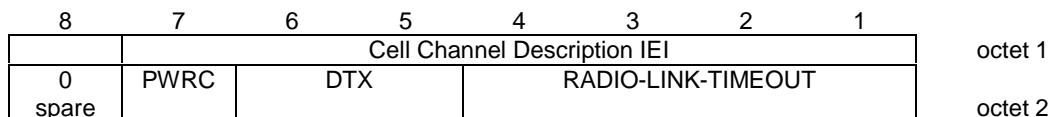

Figure 10.5.21/3GPP TS 04.18 *Cell Options (BCCH)* information element

10.5.2.3a Cell Options (SACCH)

The purpose of the *Cell Options (SACCH)* information element is to provide a variety of information about a cell.

The *Cell Options (SACCH)* information element is coded as shown in figure 10.5.22 /3GPP TS 04.18 and table 10.5.22/3GPP TS 04.18.

The *Cell Options (SACCH)* is a type 3 information element with 2 octets length.

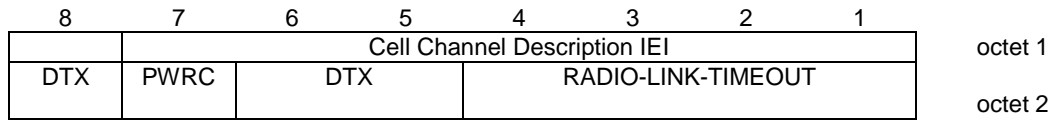

Figure 10.5.22/3GPP TS 04.18 Cell Options (SACCH) information element

Table 10.5.21/3GPP TS 04.18: Cell Options (BCCH) information element

PWRC Power control indicator (octet 2) Note 1	
bit 7	
0	PWRC is not set
1	PWRC is set
DTX, DTX indicator (octet 2) Note 3	
Bit	
6 5	
0 0	The MSs may use uplink discontinuous transmission
0 1	The MSs shall use uplink discontinuous transmission
1 0	The MS shall not use uplink discontinuous transmission
RADIO-LINK_TIMEOUT (octet 2) Note 2	
Bits	
4 3 2 1	
0 0 0 0	4
0 0 0 1	8
0 0 1 0	12
.	
.	
.	
1 1 1 0	60
1 1 1 1	64

NOTE 1: The precise meaning of the PWRC parameter can be found in 3GPP TS 05.08.

NOTE 2: The precise meaning of RADIO-LINK-TIMEOUT parameter can be found in 3GPP TS 05.08.

NOTE 3: The DTX indicator field is not related to the use of downlink discontinuous transmission.

Table 10.5.22/3GPP TS 04.18: Cell Options (SACCH) information element

PWRC Power control indicator (octet 2) Note 1	
bit 7	
0	PWRC is not set
1	PWRC is set
DTX, DTX indicator (octet 2) Note 3	
Bit	
8 6 5	
0 0 0	The MS may use uplink discontinuous transmission on a TCH-F. The MS shall not use uplink discontinuous transmission on TCH-H.
0 0 1	The MS shall use uplink discontinuous transmission on a TCH-F. The MS shall not use uplink discontinuous transmission on TCH-H.
0 1 0	The MS shall not use uplink discontinuous transmission on a TCH-F. The MS shall not use uplink discontinuous transmission on TCH-H.
0 1 1	Note 4: The MS shall use uplink discontinuous transmission on a TCH-F. The MS may use uplink discontinuous transmission on TCH-H.
1 0 0	The MS may use uplink discontinuous transmission on a TCH-F. The MS may use uplink discontinuous transmission on TCH-H.
1 0 1	The MS shall use uplink discontinuous transmission on a TCH-F. The MS shall use uplink discontinuous transmission on TCH-H.
1 1 0	The MS shall not use uplink discontinuous transmission on a TCH-F. The MS shall use uplink discontinuous transmission on TCH-H.
1 1 1	Note 4: The MS may use uplink discontinuous transmission on a TCH-F. The MS shall use uplink discontinuous transmission on TCH-H.
RADIO-LINK_TIMEOUT (octet 2) Note 2	
Bits	
4 3 2 1	
0 0 0 0	4
0 0 0 1	8
0 0 1 0	12
.	
.	
1 1 1 0	60
1 1 1 1	64

NOTE 1: The precise meaning of the PWRC parameter can be found in 3GPP TS 05.08 .

NOTE 2: The precise meaning of RADIO-LINK-TIMEOUT parameter can be found in 3GPP TS 05.08.

NOTE 3: The DTX indicator field is not related to the use of downlink discontinuous transmission.

NOTE 4: These codes shall not be sent to mobile stations that implement an earlier version of this protocol in which these codes were not defined.

10.5.2.4 Cell Selection Parameters

The purpose of the *Cell Selection Parameters* information element is to provide a variety of information about a cell.

The *Cell Selection Parameters* information element is coded as shown in figure 10.5.23/3GPP TS 04.18 and table 10.5.23/3GPP TS 04.18.

The *Cell Selection Parameters* information element is a type 3 information element with 3 octets length.

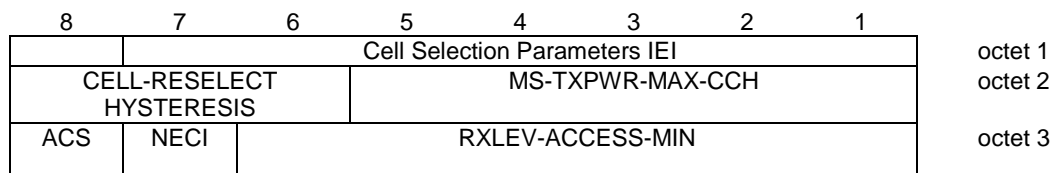

Figure 10.5.23/3GPP TS 04.18 Cell Selection Parameters information element

Table 10.5.23/3GPP TS 04.18: Cell Selection Parameters information element

<p>CELL-RESELECT-HYSTERESIS (octet 2) The usage of this information is defined in 3GPP TS 05.08</p> <p>Bits</p> <table border="0"> <tr> <td style="text-align: right;">8 7 6</td> <td></td> </tr> <tr> <td style="text-align: right;">0 0 0</td> <td>0 dB RXLEV hysteresis for LA re-selection</td> </tr> <tr> <td style="text-align: right;">0 0 1</td> <td>2 dB RXLEV hysteresis for LA re-selection</td> </tr> <tr> <td style="text-align: right;">0 1 0</td> <td>4 dB RXLEV hysteresis for LA re-selection</td> </tr> <tr> <td style="text-align: right;">0 1 1</td> <td>6 dB RXLEV hysteresis for LA re-selection</td> </tr> <tr> <td style="text-align: right;">1 0 0</td> <td>8 dB RXLEV hysteresis for LA re-selection</td> </tr> <tr> <td style="text-align: right;">1 0 1</td> <td>10 dB RXLEV hysteresis for LA re-selection</td> </tr> <tr> <td style="text-align: right;">1 1 0</td> <td>12 dB RXLEV hysteresis for LA re-selection</td> </tr> <tr> <td style="text-align: right;">1 1 1</td> <td>14 dB RXLEV hysteresis for LA re-selection</td> </tr> </table> <p>MS-TXPWR-MAX-CCH (octet 2) The MS-TXPWR-MAX-CCH field is coded as the binary representation of the "power control level" in 3GPP TS 3GPP TS 05.05 corresponding to the maximum TX power level an MS may use when accessing on a Control Channel CCH. This value shall be used by the Mobile Station according to 3GPP TS 05.08.</p> <p>Range: 0 to 31.</p> <p>RXLEV-ACCESS-MIN (octet 3) The RXLEV-ACCESS-MIN field is coded as the binary representation of the minimum received signal level at the MS for which it is permitted to access the system.</p> <p>Range: 0 to 63. (See 3GPP TS 3GPP TS 05.08).</p> <p>ACS, ADDITIONAL RESELECT PARAM IND (octet 3) Bit 8: In System Information type 3 message: 0 System information type 16 and 17 are not broadcast on the BCCH. 1 System information type 16 and 17 are broadcast on the BCCH. A mobile station which does not support System information type 16 and 17 may consider this bit as "0".</p> <p>In System Information type 4 message: 0 The SI 4 rest octets, if present, and SI 7 and SI 8 rest octets, if so indicated in the SI 4 rest octets shall be used to derive the value of PI and possibly C2 parameters and/or other parameters 1 The value of PI and possibly C2 parameters and/or other parameters in a System information type 7 or type 8 message shall be used</p> <p>NECI: HALF RATE SUPPORT (octet 3) Bit 7: 0 New establishment causes are not supported 1 New establishment causes are supported</p>	8 7 6		0 0 0	0 dB RXLEV hysteresis for LA re-selection	0 0 1	2 dB RXLEV hysteresis for LA re-selection	0 1 0	4 dB RXLEV hysteresis for LA re-selection	0 1 1	6 dB RXLEV hysteresis for LA re-selection	1 0 0	8 dB RXLEV hysteresis for LA re-selection	1 0 1	10 dB RXLEV hysteresis for LA re-selection	1 1 0	12 dB RXLEV hysteresis for LA re-selection	1 1 1	14 dB RXLEV hysteresis for LA re-selection
8 7 6																		
0 0 0	0 dB RXLEV hysteresis for LA re-selection																	
0 0 1	2 dB RXLEV hysteresis for LA re-selection																	
0 1 0	4 dB RXLEV hysteresis for LA re-selection																	
0 1 1	6 dB RXLEV hysteresis for LA re-selection																	
1 0 0	8 dB RXLEV hysteresis for LA re-selection																	
1 0 1	10 dB RXLEV hysteresis for LA re-selection																	
1 1 0	12 dB RXLEV hysteresis for LA re-selection																	
1 1 1	14 dB RXLEV hysteresis for LA re-selection																	

10.5.2.4a MAC Mode and Channel Coding Requested

The purpose of the *MAC Mode and Channel Coding Requested* information element is for the mobile station to indicate to the network which channel coding rate the mobile station desires the network to use on the downlink.

The *MAC Mode and Channel Coding Requested* information element is coded as shown in figure 10.5.24/3GPP TS 04.18 and table 10.5.24/3GPP TS 04.18.

The *MAC Mode and Channel Coding Requested* is a type 1 information element.

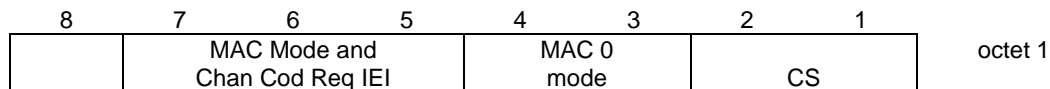

Figure 10.5.24/3GPP TS 04.18 MAC Mode and Channel Coding Requested information element

Table 10.5.24/3GPP TS 04.18: MAC Mode and Channel Coding Requested information element

<p>CS : Coding Scheme This field indicates to network the channel coding scheme (see 3GPP TS 05.03) that the network should use on the downlink. The field is encoded according to the following table:</p> <pre> bits 2 1 0 0 CS 1 0 1 CS 2 1 0 CS 3 1 1 CS 4 </pre> <p>MAC Mode (bits 3-4, octet 1) This field is encoded the same as the MAC_MODE field in the PACKET RESOURCE REQUEST message described in 3GPP TS 04.60.</p>

10.5.2.5 Channel Description

The purpose of the *Channel Description* information element is to provide a description of an allocable channel together with its SACCH.

The *Channel Description* information element is coded as shown in figure 10.5.25/3GPP TS 04.18 and table 10.5.25/3GPP TS 04.18.

The *Channel Description* is a type 3 information element with 4 octets length.

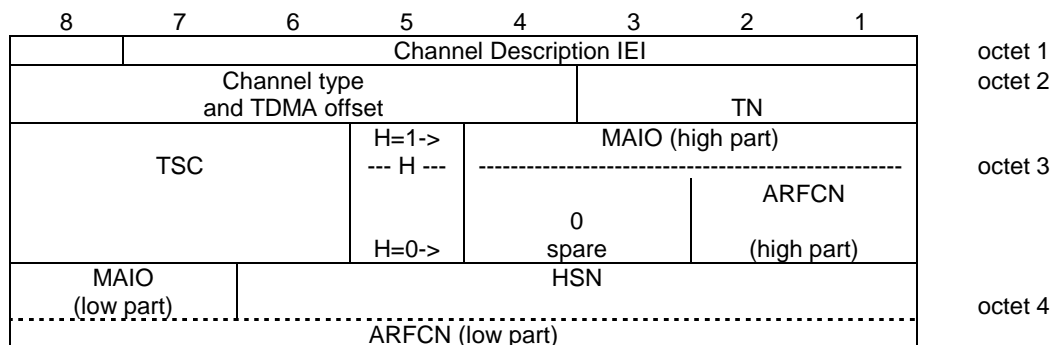

Figure 10.5.25/3GPP TS 04.18 Channel Description information element

Table 10.5.25/3GPP TS 04.18: Channel Description information element

<p>Channel type and TDMA offset (octet 2)</p> <p>Bits</p> <p>8 7 6 5 4</p> <p>0 0 0 0 1 TCH/F + ACCHs</p> <p>0 0 0 1 T TCH/H + ACCHs</p> <p>0 0 1 T T SDCCH/4 + SACCH/C4 or CBCH (SDCCH/4)</p> <p>0 1 T T T SDCCH/8 + SACCH/C8 or CBCH (SDCCH/8)</p> <p>The T bits indicate the subchannel number coded in binary.</p> <p>All other values are reserved.</p> <p>The Channel Type and TDMA offset field shall be ignored and all bits treated as spare when received in a PDCH ASSIGNMENT COMMAND message. The sender set the spare bits to the coding for TCH/F+ACCHs</p> <p>TN, Timeslot number (octet 2)</p> <p>The TN field is coded as the binary representation of the timeslot number as defined in 3GPP TS 05.10.</p> <p>Range: 0 to 7.</p> <p>The Timeslot number field shall be ignored and all bits treated as spare when received in a PDCH ASSIGNMENT COMMAND message. The sender sets the spare bits as '000'</p> <p>TSC, Training Sequence Code (octet 3)</p> <p>The TSC field is coded as the binary representation of the Training Sequence code as defined in 3GPP TS 05.03</p> <p>Range: 0 to 7.</p> <p>H, Hopping channel (octet 3)</p> <p>Bit</p> <p>5</p> <p>0 Single RF channel</p> <p>1 RF hopping channel</p> <p>Note: The value of H affects the semantics of the channel selector field</p> <p>Channel selector (octet 3 and 4)</p> <p>H = "0": The channel selector field consists of the absolute RF channel number</p> <p>Octet 3</p> <p>Bits</p> <p>4 3</p> <p>0 0 Spare</p> <p>ARFCN, (octet 3, bits 2 and 1, and octet 4, bits 8 to 1)</p> <p>The ARFCN is coded as the binary representation of the absolute RF channel number</p> <p>Range: 0 to 1023</p> <p>H = "1": The channel selector field consists of the mobile allocation index offset, MAIO, and the hopping sequence number, HSN.</p> <p>MAIO, (octet 3 bit 4 to 1 high part and octet 4 bit 8 to 7 low part)</p> <p>The MAIO field is coded as the binary representation of the mobile allocation index offset as defined in 3GPP TS 05.02.</p> <p>Range: 0 to 63.</p> <p>HSN, (octet 4 bit 6 to 1)</p> <p>The HSN field is coded as the binary representation of the hopping sequence number as defined in 3GPP TS 05.02</p> <p>Range 0 to 63.</p>

10.5.2.5a Channel Description 2

The purpose of the *Channel Description 2* information element is to provide a description of an allocable channel configuration together with its SACCH.

The *Channel Description 2* information element is coded as shown in figure 10.5.26 /3GPP TS 04.18 and table 10.5.26/3GPP TS 04.18.

The *Channel Description 2* is a type 3 information element with 4 octets length.

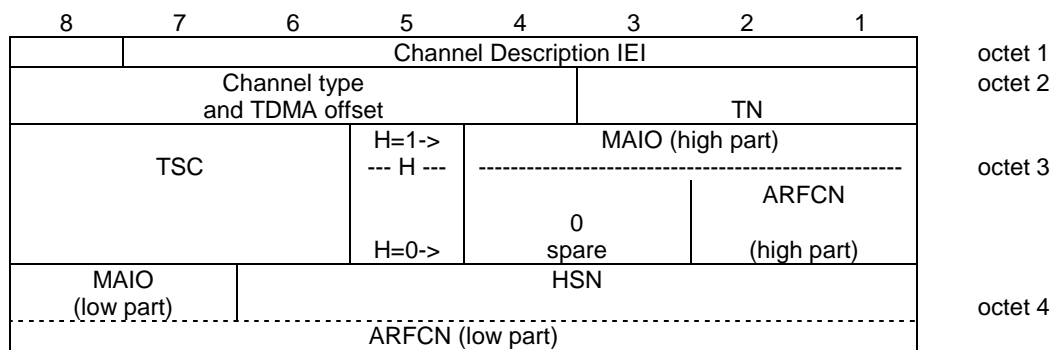

Figure 10.5.26/3GPP TS 04.18 *Channel Description 2* information element

Table 10.5.26/3GPP TS 04.18: *Channel Description 2* information element

Channel type and TDMA offset (octet 2)	
Bits	
8 7 6 5 4	
0 0 0 0 0	TCH/F + FACCH/F and SACCH/M at the timeslot indicated by TN, and additional bidirectional or unidirectional TCH/Fs and SACCH/Ms according to the multislot allocation information element
0 0 0 0 1	TCH/F + FACCH/F and SACCH/F
0 0 0 1 T	TCH/H + ACCHs
0 0 1 T T	SDCCH/4 + SACCH/C4 or CBCH (SDCCH/4)
0 1 T T T	SDCCH/8 + SACCH/C8 or CBCH (SDCCH/8)
The T bits indicate the subchannel number coded in binary.	
In the description below "n" is the timeslot number indicated by TN. The description is valid only if all the indicated timeslot numbers are in the range 0 to 7.	
1 0 X X X	TCH/F + FACCH/F and SACCH/M at the time slot indicated by TN, and additional bidirectional TCH/Fs and SACCH/Ms at other timeslots according to the following:
X X X:	
0 0 0	no additional timeslots
0 0 1	at timeslot n-1
0 1 0	at timeslot n+1, n-1
0 1 1	at timeslot n+1, n-1 and n-2
1 0 0	at timeslot n+1, n-1, n-2, and n-3
1 0 1	at timeslot n+1, n-1, n-2, n-3 and n-4
1 1 0	at timeslot n+1, n-1, n-2, n-3, n-4 and n-5
1 1 1	at timeslot n+1, n-1, n-2, n-3, n-4, n-5 and n-6
1 1 0 0 1	
to	
1 1 0 1 1	TCH/F + FACCH/F and SACCH/M at the time slot indicated by TN and additional unidirectional TCH/FDs and SACCH/MDs at other timeslots according to the following:
1 1 0 0 1	at timeslot n-1
1 1 0 1 0	at timeslot n+1, n-1
1 1 0 1 1	at timeslot n+1, n-1 and n-2
1 1 1 1 0	TCH/F + FACCH/F and SACCH/M at the time slot indicated by TN and additional bidirectional TCH/F and SACCH/M at timeslot n+1 and unidirectional TCH/FD and SACCH/MD at timeslot n-1
All other values are reserved.	
TN, Timeslot number (octet 2)	
The TN field is coded as the binary representation of the timeslot number as defined in 3GPP TS 05.10.	
Range: 0 to 7.	
TSC, Training Sequence Code (octet 3)	
The TSC field is coded as the binary representation of the Training Sequence code as defined in 3GPP TS 05.03	
Range: 0 to 7.	

<p>H, Hopping channel (octet 3)</p> <p>Bit 5</p> <p>0 Single RF channel 1 RF hopping channel</p> <p>Note: The value of H affects the semantics of the channel selector field</p> <p>Channel selector (octet 3 and 4)</p> <p>H = "0": The channel selector field consists of the absolute RF channel number</p> <p>Octet 3</p> <p>Bits 4 3 0 0 Spare</p> <p>ARFCN, (octet 3, bits 2 and 1, and octet 4, bits 8 to 1) The ARFCN is coded as the binary representation of the absolute RF channel number</p> <p>Range: 0 to 1023</p> <p>H = "1": The channel selector field consists of the mobile allocation index offset, MAIO, and the hopping sequence number, HSN.</p> <p>MAIO, (octet 3 bit 4 to 1 high part and octet 4 bit 8 to 7 low part) The MAIO field is coded as the binary representation of the mobile allocation index offset as defined in 3GPP TS 3GPP TS 05.02.</p> <p>Range: 0 to 63.</p> <p>HSN, (octet 4 bit 6 to 1) The HSN field is coded as the binary representation of the hopping sequence number as defined in 3GPP TS 3GPP TS 05.02 Range 0 to 63.</p>
--

10.5.2.6 Channel Mode

The *Channel Mode* information element gives information of the mode on coding/decoding and transcoding. The exact mode is determined by the contents of this IE and the channel type.

The *Channel Mode* information element is coded as shown in figure 10.5.27/3GPP TS 04.18 and table 10.5.27/3GPP TS 04.18.

The *Channel Mode* is a type 3 information element with 2 octets length.

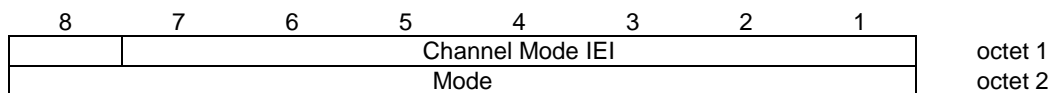

Figure 10.5.27/3GPP TS 04.18 *Channel Mode* information element

Table 10.5.27/3GPP TS 04.18: Channel Mode information element

The mode field is encoded as follows:	
(octet 2)	
Bits	
8 7 6 5 4 3 2 1	
0 0 0 0 0 0 0 0	signalling only
0 0 0 0 0 0 0 1	speech full rate or half rate version 1
0 0 1 0 0 0 0 1	speech full rate or half rate version 2
0 1 0 0 0 0 0 1	speech full rate or half rate version 3
0 1 1 0 0 0 0 1	data, 43.5 kbit/s (downlink)+14.5 kbps (uplink)
0 1 1 0 0 0 1 0	data, 29.0 kbit/s (downlink)+14.5 kbps (uplink)
0 1 1 0 0 1 0 0	data, 43.5 kbit/s (downlink)+29.0 kbps (uplink)
0 1 1 0 0 1 1 1	data, 14.5 kbit/s (downlink)+43.5 kbps (uplink)
0 1 1 0 0 1 0 1	data, 14.5 kbit/s (downlink)+29.0 kbps (uplink)
0 1 1 0 0 1 1 0	data, 29.0 kbit/s (downlink)+43.5 kbps (uplink)
0 0 1 0 0 1 1 1	data, 43.5 kbit/s radio interface rate
0 1 1 0 0 0 1 1	data, 32.0 kbit/s radio interface rate
0 1 0 0 0 0 1 1	data, 29.0 kbit/s radio interface rate
0 0 0 0 1 1 1 1	data, 14.5 kbit/s radio interface rate
0 0 0 0 0 0 1 1	data, 12.0 kbit/s radio interface rate
0 0 0 0 1 0 1 1	data, 6.0 kbit/s radio interface rate
0 0 0 1 0 0 1 1	data, 3.6 kbit/s radio interface rate
Other values are reserved for future use.	
Note 1: The speech full rate or half rate version 3 is also referred as the adaptive multi-rate full rate or half rate speech version 1	

10.5.2.7 Channel Mode 2

The Channel Mode 2 information element gives information of the mode of coding/decoding and transcoding.

The Channel Mode 2 information element is coded as shown in figure 10.5.28/3GPP TS 04.18 and table 10.5.28/3GPP TS 04.18.

The Channel Mode 2 is a type 3 information element with 2 octets length.

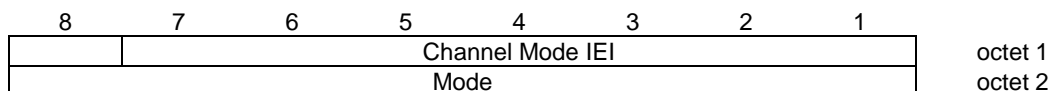

Figure 10.5.28/3GPP TS 04.18 Channel Mode 2 information element

Table 10.5.28/3GPP TS 04.18: Channel Mode 2 information element

The mode field is encoded as follows:	
(octet 2)	
Bits	
8 7 6 5 4 3 2 1	
0 0 0 0 0 0 0 0	signalling only
0 0 0 0 0 1 0 1	speech half rate version 1
0 0 1 0 0 1 0 1	speech half rate version 2
0 1 0 0 0 1 0 1	speech half rate version 3
0 0 0 0 1 1 1 1	data, 6.0 kbit/s radio interface rate
0 0 0 1 0 1 1 1	data, 3.6 kbit/s radio interface rate
Other values are reserved for future use.	
Note 1: The speech half rate version 3 is also referred as the adaptive multi-rate half rate speech version 1	

10.5.2.7a UTRAN pre-defined configuration status information / START-CS / UE Capability information element

Only valid for a multi-RAT UMTS MS. The UTRAN pre-*defined configuration status information / START-CS / UE Capability* information element may give information to the network on:

- The-configuration set stored in the MS; and/or
- Security information to be used after handover to UMTS, with the START-CS parameter that is stored by the MS at handover from UMTS to GSM, see 3G3GPP TS 31.103 ; and/or
- The UMTS Capabilities of the MS.

None, one, two or three of these three information may be present.

The *UTRAN pre-defined configuration status information / START-CS / UE Capability* information element is a type 4 information element with a minimum length of 2 octets. No upper length limit is specified except for that given by the maximum number of octets in a L3 message (see 3GPP TS 04.06).

START-CS is defined in 3G3GPP TS 25.331.

UE Capability is defined in 3G3GPP TS 25.331. If this field is included, it goes up to the end of the information element, as defined by the "LENGTH" field of the information element.

```

<UTRAN pre-defined configuration status information / START-CS / UE Capability>::=
<LENGTH OF UTRAN PRE-DEFINED CONFIGURATION STATUS INFORMATION / START-CS / UE
CAPABILITY : bit (8)>
{ 0 -- Information on pre-defined version numbers is not sent
| 1 -- Information on pre-defined version numbers is sent
{ { 0 -- indicates that the corresponding version number is unknown/deleted
| 1 < Predefined configuration value tag : bit (4) > } **16 } } -- repetition of 16 sequences, see above.

-- first sequence relates to preconfiguration identity 0
-- second sequence relates to preconfiguration identity 1
-- (...) last sequence relates to preconfiguration identity 15

{ 0 -- Information on START-CS is not sent
| 1 -- Information on START-CS is sent
< START-CS : bit (20) > }

{ 0 -- Information on UE Capability is not sent
| 1 -- Information on UE Capability is sent
< UE Capability > -- if this field is present there is no spare padding
}

<spare padding>;

```

10.5.2.7b UTRAN pre-configuration set

The UTRAN pre-configuration set information element defines one or more sets of radio access bearer configuration to be used by the mobile station in UTRAN. At Inter System handover to UTRAN the mobile is configured to one of the pre-defined sets by the target system in the handover signalling.

The UTRAN pre-configuration set is a type 4 information element with 3-202 octets length.

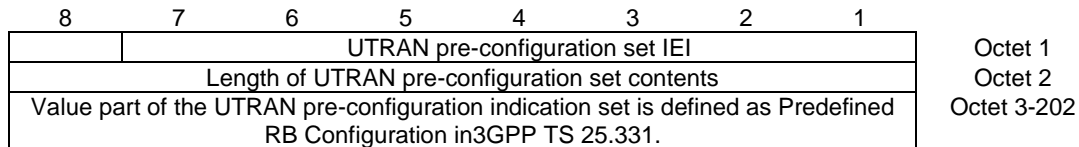

Figure 10.5.27/3GPP TS 04.18: UTRAN pre-configuration set information element

10.5.2.7c Classmark Enquiry Mask

The UE Classmark Request mask defines the capabilities to be returned to network. The bit mask defines the specific information to be returned, such as UE capability and/or information about UMTS RAB pre-configuration versions and/or UMTS security information and/or CDMA2000 capability and/or requests the sending of the CLASSMARK CHANGE message. The classmark change procedure is described in chapter 3.4.10.

The Classmark Enquiry Mask is a type 4 information element with 3 octets length.

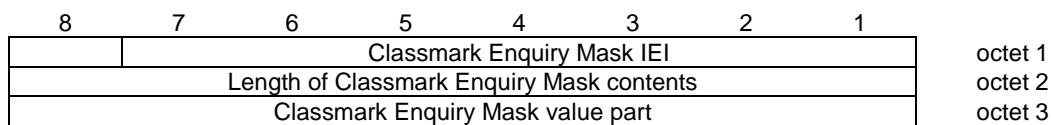

Figure 10.5.2.7c1/3GPP TS 04.18: Classmark Enquiry Mask information element

Table 10.5.2.7.c2/3GPP TS 04.18: Classmark Enquiry Mask value part.

<p>Bit 8: 0 CLASSMARK CHANGE message requested 1 CLASSMARK CHANGE message not requested.</p> <p>Bit 7 0 UTRAN CLASSMARK message including information on pre-defined version numbers requested 1 UTRAN CLASSMARK message not requested</p> <p>Bit 6 0 UTRAN CLASSMARK message including START-CS parameter requested 1 UTRAN CLASSMARK message not requested</p> <p>Bit 5 0 UTRAN CLASSMARK message including UE Capability parameter requested 1 UTRAN CLASSMARK message not requested</p> <p>Bit 4: 0 CDMA2000 CLASSMARK message requested 1 CDMA2000 CLASSMARK message not requested.</p> <p>Bits 3 - 1: spare(0).</p>

10.5.2.8 Channel Needed

The purpose of the *Channel Needed* information element is to indicate to up to two mobile stations which type of channel is needed (for each mobile station) for the transaction linked to the paging procedure.

The *Channel Needed* information element is coded as shown in figure 10.5.29/3GPP TS 04.18 and table 10.5.29/3GPP TS 04.18.

The *Channel Needed* is a type 1 information element.

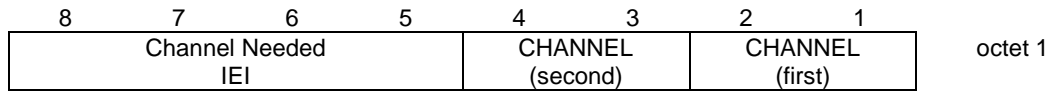

Figure 10.5.29/3GPP TS 04.18 Channel Needed information element

Table 10.5.29/3GPP TS 04.18: Channel Needed information element

CHANNEL (octet 1)		
Bits		
2/4	1/3	
0	0	Any channel.
0	1	SDCCH.
1	0	TCH/F (Full rate).
1	1	TCH/H or TCH/F (Dual rate).
If this information element is used for only one mobile station, then the first CHANNEL field is used and the second CHANNEL field is spare.		

10.5.2.8a Channel Request Description

The purpose of the *Channel Request Description* information element is to indicate to the network the type of requested uplink resources or to indicate the type of paging that is being responded to.

The *Channel Request Description* information element is coded as shown in figure 10.5.30/3GPP TS 04.18 and table 10.5.30/3GPP TS 04.18.

The *Channel Request Description* is a type 3 information element with a length of 6 octets.

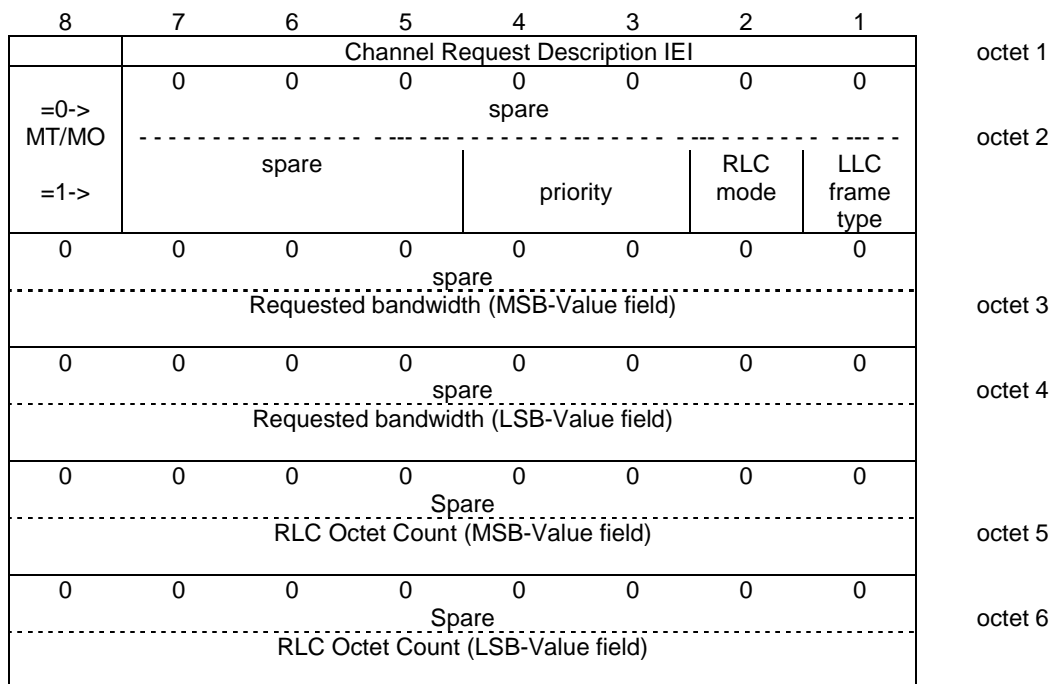

Figure 10.5.30/3GPP TS 04.18 Channel Request Description information element

Table 10.5.30/3GPP TS 04.18: Channel Request Description information element details

<p>MT/MO (bit 8, octet 2)</p> <p>1 Mobile originated (MO)</p> <p>0 Mobile terminated (MT)</p>
--

PRIORITY (bits 3-4, octet 2)

When MT/MO indicates MO, this field indicates the priority of the requested TBF

bit

4 3

0 0 Priority Level 1 (Highest priority)

0 1 Priority Level 2

1 0 Priority Level 3

1 1 Priority Level 4 (Lower priority)

RLC_MODE (bit 2, octet 2)

When MT/MO indic

ates MO, this field indicates the RLC mode of the requested TBF.

0 RLC acknowledged mode

1 RLC unacknowledged mode

LLC_FRAME_TYPE (bit 1, octet 2)

When MT/MO indicates MO, this field indicates the type of the first LLC frame to be transmitted over the requested uplink TBF.

0 LLC frame is SACK or NACK

1 LLC frame is not SACK or NACK

REQUESTED_BANDWIDTH (16 bits field, octets 3 and 4)

When MT/MO indicates MO, this field indicates the useful uplink bandwidth requested in bit rate.

The bit rate field is the binary encoding of the rate information expressed in 100 bits/s, starting from 0 x 100 bits/s until 65535 x 100 bits/s.

The throughput granted by BSS may be higher to cope with protocol overhead and retransmissions.

RLC_OCTET_COUNT (16 bits field, octets 5 and 6)

When MT/MO indicates MO, this field indicates the number of octets of RLC data the mobile station wishes to transfer: see 3GPP TS 04.60.

10.5.2.8b Channel Request Description 2

The purpose of the *Channel Request Description 2* information element is to indicate to the network the reason of the request to enter dual transfer mode.

The *Channel Request Description 2* information element is coded as shown in figure 10.5.30a/3GPP TS 04.18 and table 10.5.30a/3GPP TS 04.18.

The *Channel Request Description 2* information element is a type 4 information element.

Table 10.5.30a/3GPP TS 04.18 Channel Request Description 2 information element

< Channel Request Description 2 IE > ::=	
< LENGTH_IN_OCTETS : bit(8) >	-- Remaining length
< PACKET_ESTABLISHMENT_CAUSE : bit(2) >	
< Channel Request Description : Channel Request Description IE >	-- Defined in 3GPP TS 04.60
< spare padding >;	

Table 10.5.30b/3GPP TS 04.18: Channel Request Description 2 information element details

PACKET_ESTABLISHMENT_CAUSE (2 bit field)	
This field indicates the reason for requesting the access.	
Bit	2 1
	0 0 User Data
	0 1 Page Response
	1 0 Cell Update
	1 1 Mobility Management procedure
Channel Request Description (information element)	
The Channel Request Description information element is defined in 3GPP TS 04.60.	

10.5.2.9 Cipher Mode Setting

The purpose of the *Cipher Mode Setting* information element is to indicate whether stream ciphering shall be started or not and if it is to be started, which algorithm to use.

The *Cipher Mode Setting* information element is coded as shown in figure 10.5.31/3GPP TS 04.18 and table 10.5.31/3GPP TS 04.18.

The *Cipher Mode Setting* is a type 1 information element.

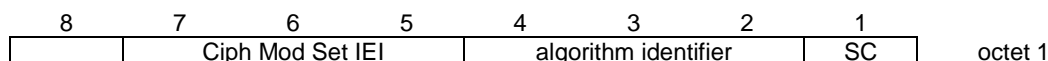
**Figure 10.5.31/3GPP TS 04.18 Cipher Mode Setting information element****Table 10.5.31/3GPP TS 04.18: Cipher Mode Setting information element**

algorithm identifier	
If SC=1 then:	
bits	
4 3 2	
0 0 0	cipher with algorithm A5/1
0 0 1	cipher with algorithm A5/2
0 1 0	cipher with algorithm A5/3
0 1 1	cipher with algorithm A5/4
1 0 0	cipher with algorithm A5/5
1 0 1	cipher with algorithm A5/6
1 1 0	cipher with algorithm A5/7
1 1 1	reserved
If SC=0 then bits 4, 3 and 2 are spare and set to "0"	
SC (octet 1)	
Bit	
1	
0	No ciphering
1	Start ciphering

10.5.2.10 Cipher Response

The *Cipher Response* information element is used by the network to indicate to the mobile station which information the mobile station has to include in the CIPHERING MODE COMPLETE message.

The *Cipher Response* information element is coded as shown in figure 10.5.32/3GPP TS 04.18 and table 10.5.32/3GPP TS 04.18.

The *Cipher Response* is a type 1 information element.

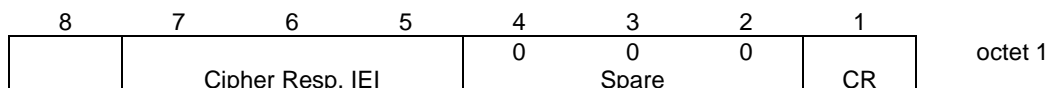

Figure 10.5.32/3GPP TS 04.18 Cipher Response information element

Table 10.5.32/3GPP TS 04.18: Cipher Response information element

CR Cipher Response (octet 1)	
Bit	
1	
0	IMEISV shall not be included
1	IMEISV shall be included

10.5.2.11 Control Channel Description

The purpose of the *Control Channel Description* information element is to provide a variety of information about a cell.

The *Control Channel Description* information element is coded as shown in figure 10.5.33/3GPP TS 04.18 and table 10.5.33/3GPP TS 04.18.

The *Control Channel Description* is a type 3 information element with 4 octets length.

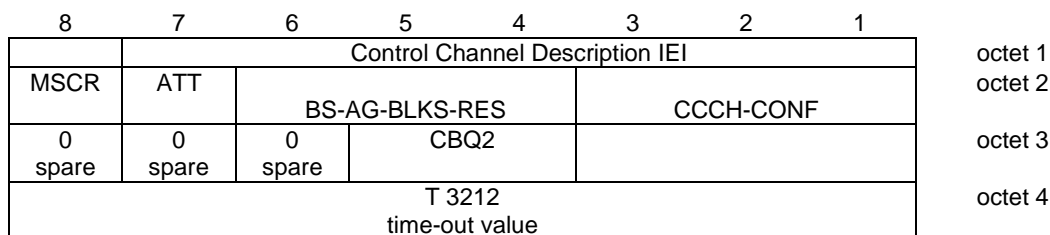

Figure 10.5.33/3GPP TS 04.18 Control Channel Description information element

Table 10.5.33/3GPP TS 04.18: Control Channel Description information element

MSCR, MSC Release (octet 2)	
Bit	
8	
0	MSC is Release '98 or older
1	MSC is Release '99 onwards
ATT, Attach-detach allowed (octet 2)	
Bit	
7	
0	MSs in the cell are not allowed to apply IMSI attach and detach procedure.
1	MSs in the cell shall apply IMSI attach and detach procedure.
BS-AG-BLKS-RES (octet 2)	
The BS-AG-BLKS-RES field is coded as the binary representation of the number of blocks reserved for access grant.	
Range 0 to 2 if CCCH-CONF = "001"	
0 to 7 for other values of CCCH-CONF	
All other values are reserved in the first case	
CBQ2, Cell Bar Qualify 2 (octet 3)	
Bits	
5 4	
0 0	Cell Bar Qualify 2 inactive
0 1	Reserved, shall be interpreted as 11
1 0	Voice not supported, cell not barred, norm. cell selection priority
1 1	Voice not supported, cell not barred, low cell selection priority
Note: See 3GPP TS 05.08 for information on Cell Bar Qualify 2	
CCCH-CONF (octet 2)	
bits	
3 2 1	
0 0 0	1 basic physical channel used for CCCH, not combined with SDCCHs
0 0 1	1 basic physical channel used for CCCH, combined with SDCCHs
0 1 0	2 basic physical channel used for CCCH, not combined with SDCCHs
1 0 0	3 basic physical channel used for CCCH, not combined with SDCCHs
1 1 0	4 basic physical channels used for CCCH, not combined with SDCCHs
all other values are reserved	

BS-PA-MFRMS (octet 3)	
Bits	
3 2 1	
0 0 0	2 multiframe period for transmission of PAGING REQUEST messages to the same paging subgroup
0 0 1	3 multiframe period for transmission of PAGING REQUEST messages to the same paging subgroup
0 1 0	4 multiframe period for transmission of PAGING REQUEST messages to the same paging subgroup
.	.
.	.
1 1 1	9 multiframe period for transmission of PAGING REQUEST messages to the same paging subgroup
Note: The number of different paging subchannels on the CCCH is:	
$\text{MAX}(1, (3 - \text{BS-AG-BLKS-RES})) * \text{BS-PA-MFRMS}$ if CCCH-CONF = "001"	
$(9 - \text{BS-AG-BLKS-RES}) * \text{BS-PA-MFRMS}$ for other values of CCCH-CONF	
T3212 timeout value (octet 4)	
The T3212 timeout value field is coded as the binary representation of the timeout value for periodic updating in decihours.	
Range: 1 to 255	
The value 0 is used for infinite timeout value i.e. periodic updating shall not be used within the cell.	

10.5.2.11a DTM Information Rest Octets

The *DTM Information Rest Octets* Information Element provides the mobile station with relevant GPRS information needed for correct DTM operation. This information element is contained in messages addressed to mobile stations supporting GPRS and DTM.

The *DTM Information Rest Octets* information element is coded as shown in tables 33a/3GPP TS 04.18 and 33b/3GPP TS 04.18.

The *DTM Information Rest Octets* is a type 4 information element.

Table 33a: DTM Information Rest Octets information element

< DTM Information Rest Octets IE > ::= < LENGTH_IN_OCTETS : bit(8) > < MAX_LAPDm : bit (3) > < padding bits >;

Table 33b: DTM Information Rest Octets information element details

<p>LENGTH_IN_OCTETS (8 bit field)</p> <p>This field encodes the number that is equal to one eighth of the number of bits (rounded up to the next integer) in the <i>DTM Information Rest Octets</i> IE that follows the end of this field.</p> <p>MAX_LAPDm (3 bit field)</p> <p>This field indicates the maximum number of LAPDm frames on which a layer 3 can be segmented into and be sent on the main DCCH. It is coded as described in the SI 6 Rest Octets IE.</p>
--

10.5.2.12 Frequency Channel Sequence

The purpose of the *Frequency Channel Sequence* information element is to provide the absolute radio frequency channel numbers used in the mobile hopping sequence. This information element shall only be used for radio frequency channels in the primary GSM band (see 3GPP TS 05.05).

The *Frequency Channel Sequence* information element is coded as shown in figure 10.5.34/3GPP TS 04.18 and table 10.5.34/3GPP TS 04.18.

The *Frequency Channel Sequence* is a type 3 information element with 10 octets length.

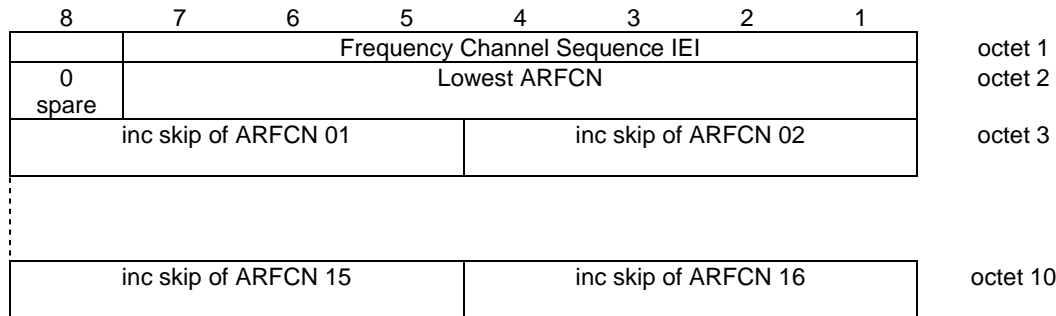

Figure 10.5.34/3GPP TS 04.18 *Frequency Channel Sequence* information element

Table 10.5.34/3GPP TS 04.18: *Frequency Channel Sequence* information element

<p>Lowest ARFCN (octet 2) The lowest ARFCN field is coded as the binary representation of the lowest absolute RF channel number appearing in the sequence of channels used in the frequency hopping.</p> <p>Range: 1 to 124</p> <p>All other values are reserved.</p> <p>Increment skip ARFCN n (octet 3 to 10) The increment skip ARFCN n is coded as the binary representation of the increment of the preceding absolute RF channel number appearing in the sequence of channels used in the frequency hopping: n = 1, ..., 16.</p> <p>Range: 0 to 15</p> <p>The value 0 indicates that the increment value is 15 but the concerned channel is not used and the next field, i.e. Increment skip ARFCN n+1 (if present) must be added to the increment to determine the next absolute RF channel number in the sequence of channels used in the frequency hopping.</p>
--

10.5.2.13 Frequency List

The purpose of the *Frequency List* information element is to provide the list of the absolute radio frequency channel numbers used in a frequency hopping sequence.

The *Frequency List* information element is a type 4 information element.

There are several formats for the *Frequency List* information element, distinguished by the "format indicator" subfield. Some formats are frequency bit maps, the others use a special encoding scheme.

10.5.2.13.1 General description

Table 10.5.35/3GPP TS 04.18: Frequency List information element, general format

FORMAT-ID, Format Identifier (part of octet 3)					
The different formats are distinguished by the FORMAT-ID field. The possible values are the following:					
Bit	Bit	Bit	Bit	Bit	format notation
8	7	4	3	2	
0	0	X	X	X	bit map 0
1	0	0	X	X	1024 range
1	0	1	0	0	512 range
1	0	1	0	1	256 range
1	0	1	1	0	128 range
1	0	1	1	1	variable bit map
All other combinations are reserved for future use. A GSM 900 mobile station which only supports the primary GSM band P-GSM 900 (cf. 3GPP TS 05.05) may consider all values except the value for bit map 0 as reserved.					
The significance of the remaining bits depends on the FORMAT-ID. The different cases are specified in the next sections.					

10.5.2.13.2 Bit map 0 format

8	7	6	5	4	3	2	1	
Frequency List IEI								octet 1
0	0	0	1	0	0	0	0	octet 2
Length of frequency list contents								
0	0	0	0	ARFCN 124	ARFCN 123	ARFCN 122	ARFCN 121	octet 3
FORMAT-ID		spare						
ARFCN 120	ARFCN 119	ARFCN 118	ARFCN 117	ARFCN 116	ARFCN 115	ARFCN 114	ARFCN 113	octet 4
...								
ARFCN 008	ARFCN 007	ARFCN 006	ARFCN 005	ARFCN 004	ARFCN 003	ARFCN 002	ARFCN 001	octet 18

Figure 10.5.35/3GPP TS 04.18 Frequency List information element, bit map 0 format

Table 10.5.36/3GPP TS 04.18: Frequency List information element, bit map 0 format

ARFCN N, Absolute RF Channel Number N (octet 3 etc.)
For a RF channel with ARFCN = N belonging to the frequency list the ARFCN N bit is coded with a "1"; N = 1, 2, .. , 124.
For a RF channel with ARFCN = N not belonging to the frequency list the ARFCN N bit is coded with a "0"; N = 1, 2 .. , 124.

10.5.2.13.3 Range 1024 format

The information element contains a header, and W(1) to W(M) for some M. If, due to octet boundaries, some bits are not used at the end of the last octet, these bits must be set to 0.

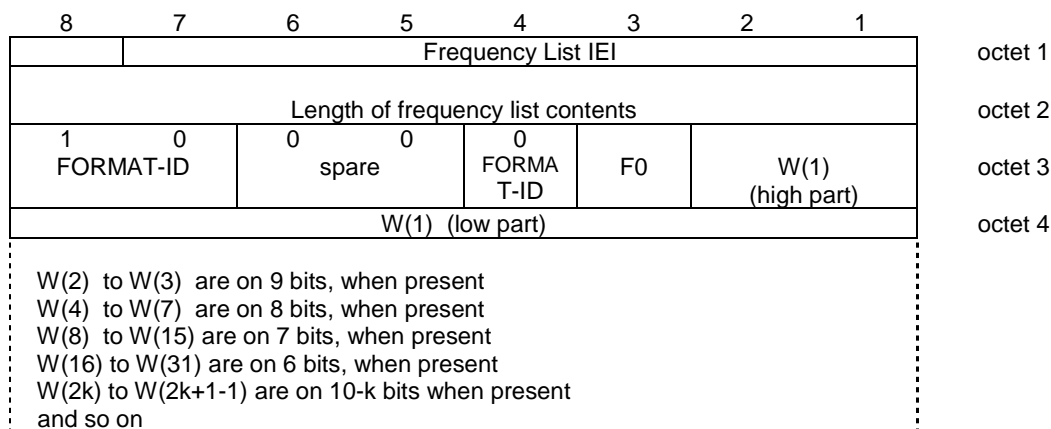

Figure 10.5.36/3GPP TS 04.18 Frequency List information element (Range 1024 format)

Table 10.5.37/3GPP TS 04.18: *Frequency List* information element, range 1024 format

```

F0, frequency 0 indicator (octet 3, bit 3):

0      ARFCN 0 is not a member of the set
1      ARFCN 0 is a member of the set

W(i), i from 1 to M (octet 3 and next):

Each W(i) encodes a non negative integer in binary
format.

If W(k) is null, W(i) for i>k must be null also.

Each non null W(k) allows to compute, together with
some previous W(i) the ARFCN F(k) of a frequency in
the set. The first computation formulas are given
hereafter, with the following conventions:

Wi denotes W(i);
Fi denotes F(i);
+ indicates the natural integer addition;
* indicates the natural integer multiplication;
n mod m indicates the remainder of the euclidian
division of n by m, ie 0 = (n mod m) = m-1 and
there exists k such that n = (k*m) + (n mod m);

n smod m indicates the offset remainder of the
euclidian division of n by m, ie
1 = (n smod m) = m and there exists k such that
n = (k*m) + (n smod m);

F1 = W1
F2 = (W1 - 512 + W2) smod 1023
F3 = (W1 + W3) smod 1023
F4 = (W1 - 512 + (W2 - 256 + W4) smod 511) smod 1023
F5 = (W1 + (W3 - 256 + W5) smod 511) smod 1023
F6 = (W1 - 512 + (W2 + W6) smod 511) smod 1023
F7 = (W1 + (W3 + W7) smod 511) smod 1023
F8 = (W1 - 512 + (W2 - 256 + (W4 - 128 + W8 )
      smod 255) smod 511) smod 1023

F9 = (W1 + (W3 - 256 + (W5 - 128 + W9 )
      smod 255) smod 511) smod 1023
F10 = (W1 - 512 + (W2 + (W6 - 128 + W10)
      smod 255) smod 511) smod 1023
F11 = (W1 + (W3 + (W7 - 128 + W11)
      smod 255) smod 511) smod 1023
F12 = (W1 - 512 + (W2 - 256 + (W4 + W12)
      smod 255) smod 511) smod 1023
F13 = (W1 + (W3 - 256 + (W5 + W13)
      smod 255) smod 511) smod 1023
F14 = (W1 - 512 + (W2 + (W6 + W14)
      smod 255) smod 511) smod 1023
F15 = (W1 + (W3 + (W7 + W15)
      smod 255) smod 511) smod 1023
F16 = (W1 - 512 + (W2 - 256 + (W4 - 128 +
      (W8 - 64 + W16) smod 127)
      smod 255) smod 511) smod 1023

More generally, the computation of F(K) can be done
with the following program, using ADA language
(declarative parts are skipped and should be obvious):

INDEX := K;
J := GREATEST_POWER_OF_2_LESSER_OR_EQUAL_TO(INDEX);
N := W(INDEX);
while INDEX>1 loop
  if 2*INDEX < 3*J then
    INDEX := INDEX - J/2; -- left child
    N := (N + W(PARENT) - 1024/J - 1) mod
        (2048/J - 1) + 1;
  else
    INDEX := INDEX - J; -- right child
    N := (N + W(PARENT) - 1) mod (2048/J - 1) + 1;
  end if;

```

```
J := J/2;  
end loop;  
F(K) := N;
```

10.5.2.13.4 Range 512 format

The information element contains a header, and W(1) to W(M) for some M. If, due to octet boundaries, some bits are not used at the end of the last octet, these bits must be set to 0.

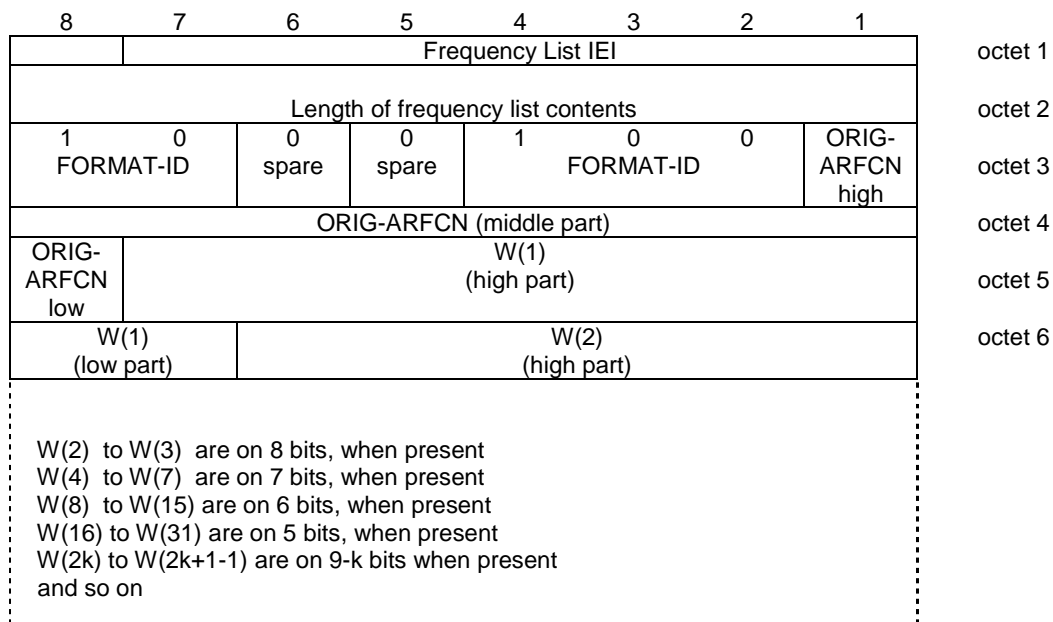

Figure 10.5.37/3GPP TS 04.18 *Frequency List* information element (Range 512 format)

Table 10.5.38/3GPP TS 04.18: *Frequency List* information element, range 512 format

<p>ORIG-ARFCN, origin ARFCN (octet 3, 4 and 5)</p> <p>This field encodes the ARFCN of one frequency belonging to the set. This value is also used to decode the rest of the element.</p> <p>W(i), i from 1 to M (octet 5 and next):</p> <p>Each W(i) encodes a non negative integer in binary format.</p> <p>If W(k) is null, W(i) for i>k must be null also.</p> <p>Each non null W(k) allows to compute, together with some previous W(i) the ARFCN F(k) of a frequency in the set. The first computation formulas are given hereafter, with the following conventions:</p> <p>W_i denotes W(i); W₀ denotes the value of ORIG-ARFCN F_i denotes F(i); + indicates the natural integer addition; * indicates the natural integer multiplication; n mod m indicates the remainder of the euclidian division of n by m, ie 0 ≤ (n mod m) < m and there exists k such that n = (k*m) + (n mod m);</p> <p>n smod m indicates the offset remainder of the euclidian division of n by m, ie 0 ≤ (n smod m) < m and there exists k such that n = (k*m) + (n smod m);</p> <p>F1 = (W0 + W1) mod 1024 F2 = (W0 + (W1 - 256 + W2) smod 511) mod 1024 F3 = (W0 + (W1 + W3) smod 511) mod 1024 F4 = (W0 + (W1 - 256 + (W2 - 128 + W4) smod 255) smod 511) mod 1024 F5 = (W0 + (W1 + (W3 - 128 + W5) smod 255) smod 511) mod 1024 F6 = (W0 + (W1 - 256 + (W2 + W6) smod 255) smod 511) mod 1024 F7 = (W0 + (W1 + (W3 + W7) smod 255) smod 511) mod 1024 F8 = (W0 + (W1 - 256 + (W2 - 128 + (W4 - 64 + W8) smod 127) smod 255) smod 511) mod 1024 F9 = (W0 + (W1 + (W3 - 128 + (W5 - 64 + W9) smod 127) smod 255) smod 511) mod 1024 F10 = (W0 + (W1 - 256 + (W2 + (W6 - 64 + W10) smod 127) smod 255) smod 511) mod 1024 F11 = (W0 + (W1 + (W3 + (W7 - 64 + W11) smod 127) smod 255) smod 511) mod 1024 F12 = (W0 + (W1 - 256 + (W2 - 128 + (W4 + W12) smod 127) smod 255) smod 511) mod 1024 F13 = (W0 + (W1 + (W3 - 128 + (W5 + W13) smod 127) smod 255) smod 511) mod 1024 F14 = (W0 + (W1 - 256 + (W2 + (W6 + W14) smod 127) smod 255) smod 511) mod 1024 F15 = (W0 + (W1 + (W3 + (W7 + W15) smod 127) smod 255) smod 511) mod 1024 F16 = (W0 + (W1 - 256 + (W2 - 128 + (W4 - 64 + (W8 - 32 + W16) smod 63) smod 127) smod 255) smod 511) mod 1024 F17 = (W0 + (W1 + (W3 - 128 + (W5 - 64 + (W9 - 32 + W17) smod 63) smod 127) smod 255) smod 511) mod 1024</p> <p>More generally, the computation of F(K) can be done with the following program, using ADA language (declarative parts are skipped and should be obvious):</p> <pre> INDEX := K; J := GREATEST_POWER_OF_2_LESSER_OR_EQUAL_TO(INDEX); N := W(INDEX); </pre>
--

```

while INDEX>1 loop
  if 2*INDEX < 3*J then          -- left child
    INDEX := INDEX - J/2;
    N := (N + W(PARENT) - 512/J - 1) mod
          (1024/J - 1) + 1;
  else
    INDEX := INDEX - J;          -- right child
    N := (N + W(_INDEX) - 1) mod (1024/J - 1) + 1;
  end if;
  J := J/2;
end loop;
F(K) := (W(0) + N) mod 1024;
    
```

10.5.2.13.5 Range 256 format

The information element contains a header, and W(1) to W(M) for some M. If, due to octet boundaries, some bits are not used at the end of the last octet, these bits must be set to 0.

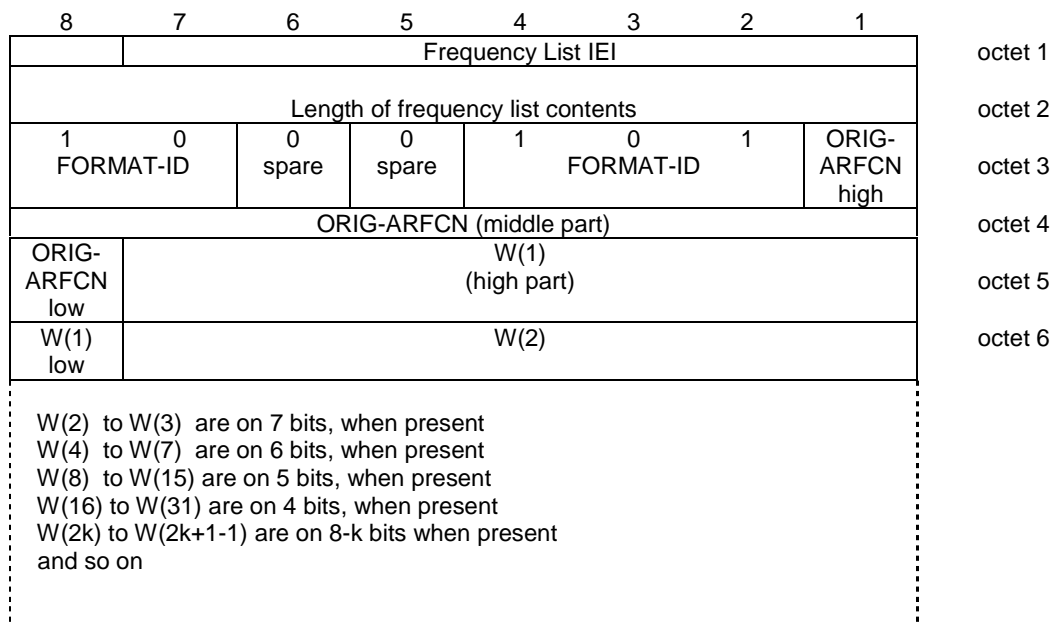

Figure 10.5.38/3GPP TS 04.18 *Frequency List* information element (Range 256 format)

Table 10.5.39/3GPP TS 04.18: *Frequency List* information element, range 256 format

ORIG-ARFCN, origin ARFCN (octet 3, 4 and 5)

This field encodes the ARFCN of one frequency belonging to the set. This value is also used to decode the rest of the element.

$W(i)$, i from 1 to M (octet 5 and next):

Each $W(i)$ encodes a non negative integer in binary format.

If $W(k)$ is null, $W(i)$ for $i > k$ must be null also.

Each non null $W(k)$ allows to compute, together with some previous $W(i)$ the ARFCN $F(k)$ of a frequency in the set. The first computation formulas are given hereafter, with the following conventions:

W_i denotes $W(i)$; W_0 denotes the value of ORIG-ARFCN

F_i denotes $F(i)$;

+ indicates the natural integer addition;

* indicates the natural integer multiplication;

$n \bmod m$ indicates the remainder of the euclidian division of n by m , ie $0 \leq (n \bmod m) < m$ and there exists k such that $n = (k*m) + (n \bmod m)$;

$n \text{ smod } m$ indicates the offset remainder of the euclidian division of n by m , ie $1 \leq (n \text{ smod } m) \leq m$ and there exists k such that $n = (k*m) + (n \text{ smod } m)$;

$$F_1 = (W_0 + W_1) \bmod 1024$$

$$F_2 = (W_0 + (W_1 - 128 + W_2) \text{ smod } 255) \bmod 1024$$

$$F_3 = (W_0 + (W_1 + W_3) \text{ smod } 255) \bmod 1024$$

$$F_4 = (W_0 + (W_1 - 128 + (W_2 - 64 + W_4) \text{ smod } 127) \text{ smod } 255) \bmod 1024$$

$$F_5 = (W_0 + (W_1 + (W_3 - 64 + W_5) \text{ smod } 127) \text{ smod } 255) \bmod 1024$$

$$F_6 = (W_0 + (W_1 - 128 + (W_2 + W_6) \text{ smod } 127) \text{ smod } 255) \bmod 1024$$

$$F_7 = (W_0 + (W_1 + (W_3 + W_7) \text{ smod } 127) \text{ smod } 255) \bmod 1024$$

$$F_8 = (W_0 + (W_1 - 128 + (W_2 - 64 + (W_4 - 32 + W_8) \text{ smod } 63) \text{ smod } 127) \text{ smod } 255) \bmod 1024$$

$$F_9 = (W_0 + (W_1 + (W_3 - 64 + (W_5 - 32 + W_9) \text{ smod } 63) \text{ smod } 127) \text{ smod } 255) \bmod 1024$$

$$F_{10} = (W_0 + (W_1 - 128 + (W_2 + (W_6 - 32 + W_{10}) \text{ smod } 63) \text{ smod } 127) \text{ smod } 255) \bmod 1024$$

$$F_{11} = (W_0 + (W_1 + (W_3 + (W_7 - 32 + W_{11}) \text{ smod } 63) \text{ smod } 127) \text{ smod } 255) \bmod 1024$$

$$F_{12} = (W_0 + (W_1 - 128 + (W_2 - 64 + (W_4 + W_{12}) \text{ smod } 63) \text{ smod } 127) \text{ smod } 255) \bmod 1024$$

$$F_{13} = (W_0 + (W_1 + (W_3 - 64 + (W_5 + W_{13}) \text{ smod } 63) \text{ smod } 127) \text{ smod } 255) \bmod 1024$$

$$F_{14} = (W_0 + (W_1 - 128 + (W_2 + (W_6 + W_{14}) \text{ smod } 63) \text{ smod } 127) \text{ smod } 255) \bmod 1024$$

$$F_{15} = (W_0 + (W_1 + (W_3 + (W_7 + W_{15}) \text{ smod } 63) \text{ smod } 127) \text{ smod } 255) \bmod 1024$$

$$F_{16} = (W_0 + (W_1 - 128 + (W_2 - 64 + (W_4 - 32 + (W_8 - 16 + W_{16}) \text{ smod } 31) \text{ smod } 63) \text{ smod } 127) \text{ smod } 255) \bmod 1024$$

$$F_{17} = (W_0 + (W_1 + (W_3 - 64 + (W_5 - 32 + (W_9 - 16 + W_{17}) \text{ smod } 31) \text{ smod } 63) \text{ smod } 127) \text{ smod } 255) \bmod 1024$$

$$F_{18} = (W_0 + (W_1 - 128 + (W_2 + (W_6 - 32 + (W_{10} - 16 + W_{18}) \text{ smod } 31) \text{ smod } 63) \text{ smod } 127) \text{ smod } 255) \bmod 1024$$

$$F_{19} = (W_0 + (W_1 + (W_3 + (W_7 - 32 + (W_{11} - 16 + W_{19}) \text{ smod } 31) \text{ smod } 63) \text{ smod } 127) \text{ smod } 255) \bmod 1024$$

$$F_{20} = (W_0 + (W_1 - 128 + (W_2 - 64 + (W_4 + (W_{12} - 16 + W_{20}) \text{ smod } 31) \text{ smod } 63) \text{ smod } 127) \text{ smod } 255) \bmod 1024$$

$$F_{21} = (W_0 + (W_1 + (W_3 - 64 + (W_5 + (W_{13} - 16 + W_{21}) \text{ smod } 31) \text{ smod } 63) \text{ smod } 127) \text{ smod } 255) \bmod 1024$$

More generally, the computation of $F(K)$ can be done with the following program, using ADA language (declarative parts are skipped and should be obvious):

```

INDEX := K;
J := GREATEST_POWER_OF_2_LESSER_OR_EQUAL_TO(INDEX);
N := W(INDEX);
while INDEX>1 loop
  if 2*INDEX < 3*J then          -- left child
    INDEX := INDEX - J/2;
    N := (N + W(INDEX) - 256/J - 1) mod
         (512/J - 1) + 1;
  else                             -- right child
    INDEX := INDEX - J;
    N := (N + W(INDEX) - 1) mod (512/J - 1) + 1;
  end if;
  J := J/2;
end loop;
F(K) := (W(0) + N) mod 1024;
    
```

10.5.2.13.6 Range 128 format

The information element contains a header, and W(1) to W(M) for some M. If, due to octet boundaries, some bits are not used at the end of the last octet, these bits must be set to 0.

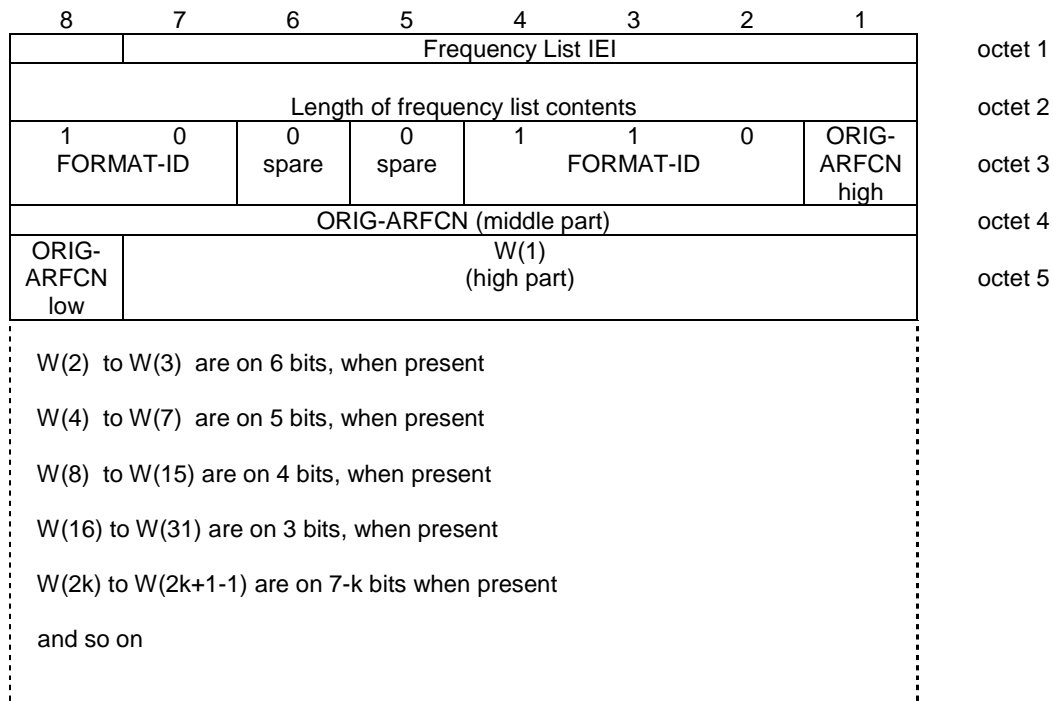

Figure 10.5.39/3GPP TS 04.18 *Frequency List* information element (Range 128 format)

Table 10.5.40/3GPP TS 04.18: *Frequency List* information element, range 128 format

<p>ORIG-ARFCN, origin ARFCN (octet 3, 4 and 5)</p> <p>This field encodes the ARFCN of one frequency belonging to the set. This value is also used to decode the rest of the element.</p> <p>$W(i)$, i from 1 to M (octet 5 and next):</p> <p>Each $W(i)$ encodes a non negative integer in binary format.</p> <p>If $W(k)$ is null, $W(i)$ for $i > k$ must be null also.</p> <p>Each non null $W(k)$ allows to compute, together with some previous $W(i)$ the ARFCN $F(k)$ of a frequency in the set. The first computation formulas are given hereafter, with the following conventions:</p> <p>W_i denotes $W(i)$; W_0 denotes the value of ORIG-ARFCN F_i denotes $F(i)$; $+$ indicates the natural integer addition; $*$ indicates the natural integer multiplication; $n \bmod m$ indicates the remainder of the euclidian division of n by m, ie $0 \leq (n \bmod m) < m$ and there exists k such that $n = (k*m) + (n \bmod m)$;</p> <p>$n \text{ smod } m$ indicates the offset remainder of the euclidian division of n by m, ie $1 \leq (n \text{ smod } m) \leq m$ and there exists k such that $n = (k*m) + (n \text{ smod } m)$;</p> <p>$F_1 = (W_0 + W_1) \bmod 1024$ $F_2 = (W_0 + (W_1 - 64 + W_2) \text{ smod } 127) \bmod 1024$ $F_3 = (W_0 + (W_1 + W_3) \text{ smod } 127) \bmod 1024$ $F_4 = (W_0 + (W_1 - 64 + (W_2 - 32 + W_4) \text{ smod } 63) \text{ smod } 127) \bmod 1024$ $F_5 = (W_0 + (W_1 + (W_3 - 32 + W_5) \text{ smod } 63) \text{ smod } 127) \bmod 1024$ $F_6 = (W_0 + (W_1 - 64 + (W_2 + W_6) \text{ smod } 63) \text{ smod } 127) \bmod 1024$ $F_7 = (W_0 + (W_1 + (W_3 + W_7) \text{ smod } 63) \text{ smod } 127) \bmod 1024$ $F_8 = (W_0 + (W_1 - 64 + (W_2 - 32 + (W_4 - 16 + W_8) \text{ smod } 31) \text{ smod } 63) \text{ smod } 127) \bmod 1024$ $F_9 = (W_0 + (W_1 + (W_3 - 32 + (W_5 - 16 + W_9) \text{ smod } 31) \text{ smod } 63) \text{ smod } 127) \bmod 1024$ $F_{10} = (W_0 + (W_1 - 64 + (W_2 + (W_6 - 16 + W_{10}) \text{ smod } 31) \text{ smod } 63) \text{ smod } 127) \bmod 1024$ $F_{11} = (W_0 + (W_1 + (W_3 + (W_7 - 16 + W_{11}) \text{ smod } 31) \text{ smod } 63) \text{ smod } 127) \bmod 1024$ $F_{12} = (W_0 + (W_1 - 64 + (W_2 - 32 + (W_4 + W_{12}) \text{ smod } 31) \text{ smod } 63) \text{ smod } 127) \bmod 1024$ $F_{13} = (W_0 + (W_1 + (W_3 - 32 + (W_5 + W_{13}) \text{ smod } 31) \text{ smod } 63) \text{ smod } 127) \bmod 1024$ $F_{14} = (W_0 + (W_1 - 64 + (W_2 + (W_6 + W_{14}) \text{ smod } 31) \text{ smod } 63) \text{ smod } 127) \bmod 1024$ $F_{15} = (W_0 + (W_1 + (W_3 + (W_7 + W_{15}) \text{ smod } 31) \text{ smod } 63) \text{ smod } 127) \bmod 1024$ $F_{16} = (W_0 + (W_1 - 64 + (W_2 - 32 + (W_4 - 16 + (W_8 - 8 + W_{16}) \text{ smod } 15) \text{ smod } 31) \text{ smod } 63) \text{ smod } 127) \bmod 1024$ $F_{17} = (W_0 + (W_1 + (W_3 - 32 + (W_5 - 16 + (W_9 - 8 + W_{17}) \text{ smod } 15) \text{ smod } 31) \text{ smod } 63) \text{ smod } 127) \bmod 1024$ $F_{18} = (W_0 + (W_1 - 64 + (W_2 + (W_6 - 16 + (W_{10} - 8 + W_{18}) \text{ smod } 15) \text{ smod } 31) \text{ smod } 63) \text{ smod } 127) \bmod 1024$ $F_{19} = (W_0 + (W_1 + (W_3 + (W_7 - 16 + (W_{11} - 8 + W_{19}) \text{ smod } 15) \text{ smod } 31) \text{ smod } 63) \text{ smod } 127) \bmod 1024$ $F_{20} = (W_0 + (W_1 - 64 + (W_2 - 32 + (W_4 + (W_{12} - 8 + W_{20}) \text{ smod } 15) \text{ smod } 31) \text{ smod } 63) \text{ smod } 127) \bmod 1024$ $F_{21} = (W_0 + (W_1 + (W_3 - 32 + (W_5 + (W_{13} - 8 + W_{21}) \text{ smod } 15) \text{ smod } 31) \text{ smod } 63) \text{ smod } 127) \bmod 1024$ $F_{22} = (W_0 + (W_1 - 64 + (W_2 + (W_6 + (W_{14} - 8 + W_{22}) \text{ smod } 15) \text{ smod } 31) \text{ smod } 63) \text{ smod } 127) \bmod 1024$ $F_{23} = (W_0 + (W_1 + (W_3 + (W_7 + (W_{15} - 8 + W_{23}) \text{ smod } 15) \text{ smod } 31) \text{ smod } 63) \text{ smod } 127) \bmod 1024$ $F_{24} = (W_0 + (W_1 - 64 + (W_2 - 32 + (W_4 - 16 + (W_8 + W_{24})$</p>

```

    smod 15) smod 31) smod 63) smod 127) mod 1024
F25 = (W0 + (W1      + (W3 - 32 + (W5 - 16 + (W9      + W25)
      smod 15) smod 31) smod 63) smod 127) mod 1024
F26 = (W0 + (W1 - 64 + (W2      + (W6 - 16 + (W10     + W26)
      smod 15) smod 31) smod 63) smod 127) mod 1024
F27 = (W0 + (W1      + (W3      + (W7 - 16 + (W11     + W27)
      smod 15) smod 31) smod 63) smod 127) mod 1024
F28 = (W0 + (W1 - 64 + (W2 - 32 + (W4      + (W12     + W28)
      smod 15) smod 31) smod 63) smod 127) mod 1024
F29 = (W0 + (W1      + (W3 - 32 + (W5      + (W13     + W29)
      smod 15) smod 31) smod 63) smod 127) mod 1024

More generally, the computation of F(K) can be done
with the following program, using ADA language
(declarative parts are skipped and should be obvious):

INDEX := K;
J := GREATEST_POWER_OF_2_LESSER_OR_EQUAL_TO(INDEX);
N := W(INDEX);
while INDEX>1 loop
  if 2*INDEX < 3*J then                -- left child
    INDEX := INDEX - J/2;
    N := (N + W(INDEX) - 128/J - 1) mod
         (256/J - 1) + 1;
  else                                   -- right child
    INDEX := INDEX - J;
    N := (N + W(INDEX) - 1) mod (256/J - 1) + 1;
  end if;
  J := J/2;
end loop;
F(K) := (W(0) + N) mod 1024;

```

10.5.2.13.7 Variable bit map format

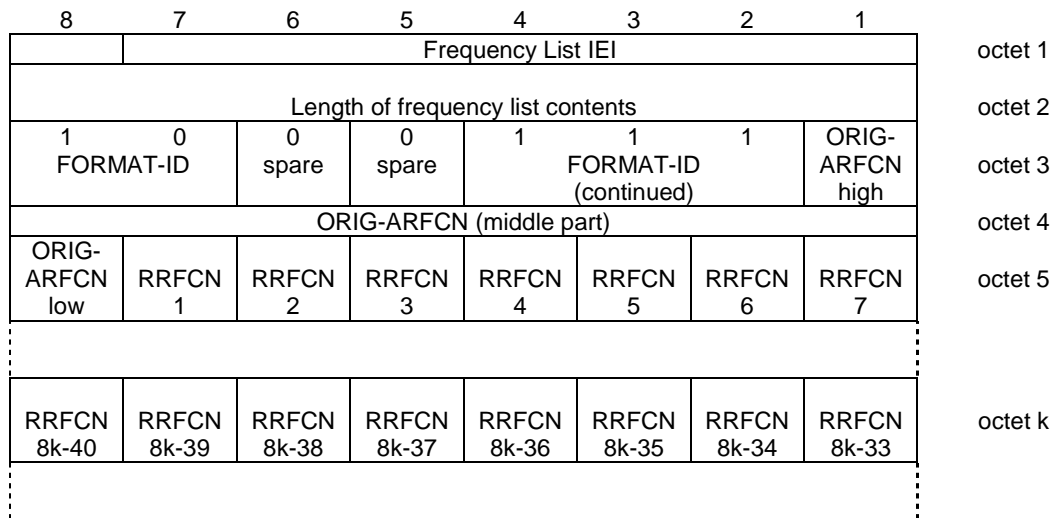

Figure 10.5.40/3GPP TS 04.18 Frequency List information element, variable bit map format

Table 10.5.41/3GPP TS 04.18: *Frequency List* information element, variable bit map format

<p>ORIG-ARFCN, origin ARFCN (octet 3, 4 and 5)</p> <p>This field encodes the ARFCN of one frequency belonging to the set. This value is also used as origin of the bit map to generate all the other frequencies.</p> <p>RRFCN N, relative radio frequency channel number N (octet 5 etc.)</p> <p>For a RF channel with $ARFCN = (ORIG-ARFCN + N) \bmod 1024$ belonging to the set, RRFCN N bit is coded with a "1"; $N = 1, 2, \dots, 8M+7$ with $1 = M = 127$</p> <p>For a RF channel with $ARFCN = (ORIG-ARFCN + N) \bmod 1024$ not belonging to the set, RRFCN N bit is coded with a "0"; $N = 1, 2, \dots, 8M+7$ with $1 = M = 127$</p>
--

10.5.2.14 Frequency Short List

The purpose of the *Frequency Short List* information element is to provide the list of the absolute radio frequency channel numbers used in a frequency hopping sequence, in a small fixed length information element to obtain when possible the HANDOVER COMMAND message in a single block.

The *Frequency Short List* information element is a type 3 information element of 10 octet length.

This element is encoded exactly as the *Frequency List* information element, except that it has a fixed length instead of a variable length and does not contain a length indicator and that it shall not be encoded in bitmap 0 format.

10.5.2.14a Frequency Short List 2

The purpose of the *Frequency Short List 2* information element is to provide the list of the absolute radio frequency channel numbers used in a frequency hopping sequence, in a small fixed length information element to obtain the SYSTEM INFORMATION TYPE 11 and NOTIFICATION FACCH messages in a single block.

The *Frequency Short List* information element is a type 3 information element of 8 octet length.

This element is encoded exactly as the *Frequency List* information element, except that it has a fixed length instead of a variable length and does not contain a length indicator and that it shall not be encoded in bitmap 0 format.

10.5.2.14b Group Channel Description

The purpose of the *Group Channel Description* information element is to provide a description of an allocable voice group call or voice broadcast call channel together with its SACCH and that part of the RF channels belonging to the cell allocation which is used in the mobile hopping sequence if applicable.

The *Group Channel Description* information element is coded as shown in figure 10.5.41/3GPP TS 04.18 and table 10.5.42/3GPP TS 04.18.

The *Group Channel Description* is a type 4 information element with 4 to 13 octets length.

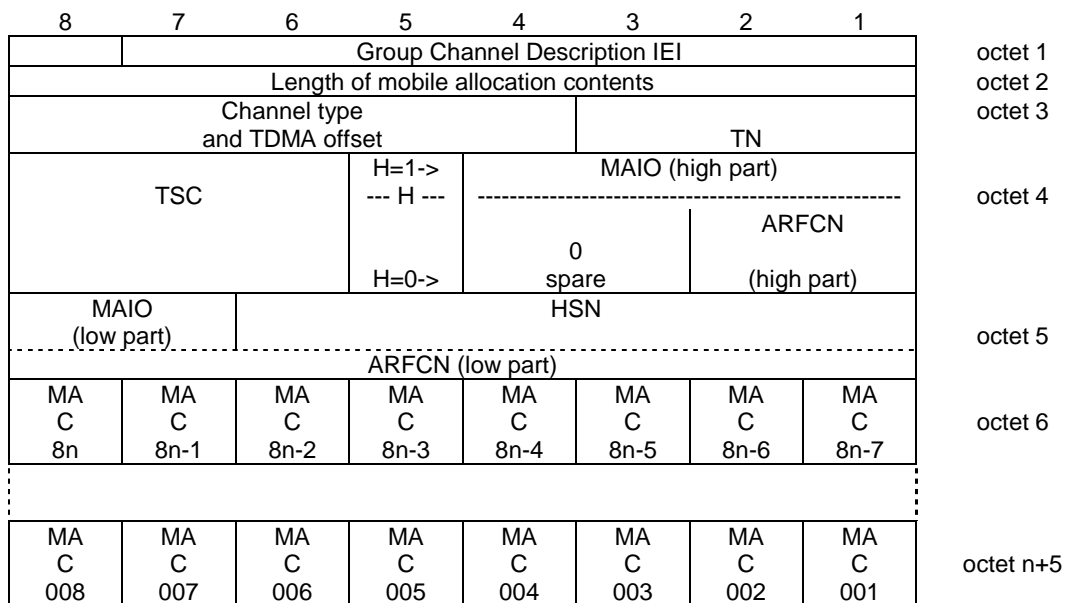

Figure 10.5.41/3GPP TS 04.18 Group Channel Description information element

Table 10.5.42/3GPP TS 04.18 Group Channel Description information element

<p>Channel type and TDMA offset (octet 3)</p> <p>Bits</p> <p>8 7 6 5 4</p> <p>0 0 0 0 1 TCH/FS + ACCHs (speech codec version 1)</p> <p>0 0 0 1 T TCH/HS + ACCHs (speech codec version 1)</p> <p>0 0 1 T T SDCCH/4 + SACCH/C4</p> <p>0 1 T T T SDCCH/8 + SACCH/C8</p> <p>The T bits indicate the subchannel number coded in binary.</p> <p>All other values are reserved for future use.</p>
<p>TN, Timeslot number (octet 3)</p> <p>The TN field is coded as the binary representation of the timeslot number as defined in 3GPP TS 05.10.</p> <p>Range: 0 to 7.</p>
<p>TSC, Training Sequence Code (octet 4)</p> <p>The TSC field is coded as the binary representation of the Training Sequence code as defined in 3GPP TS 05.03</p> <p>Range: 0 to 7.</p>
<p>H, Hopping channel (octet 4)</p> <p>Bit</p> <p>5</p> <p>0 Single RF channel</p> <p>1 RF hopping channel</p> <p>Note 1: The value of H affects the semantics of the channel selector field</p> <p>Note 2: If H=0, the information element terminates with octet 5</p> <p>Channel selector (octet 4 and 5)</p> <p>H = "0": The channel selector field consists of the absolute RF channel number</p> <p>Octet 4</p> <p>Bits</p> <p>4 3</p> <p>0 0 Spare</p> <p>ARFCN, (octet 4, bits 2 and 1, and octet 5, bits 8 to 1)</p> <p>The ARFCN is coded as the binary representation of the absolute RF channel number</p> <p>Range: 0 to 1023</p> <p>H = "1": The channel selector field consists of the mobile allocation index offset, MAIO, and the hopping sequence number, HSN.</p> <p>MAIO, (octet 4 bit 4 to 1 high part and octet 5 bit 8 to 7 low part)</p> <p>The MAIO field is coded as the binary representation of the mobile allocation index offset as defined in 3GPP TS 05.02.</p> <p>Range: 0 to 63.</p> <p>HSN, (octet 5 bit 6 to 1)</p> <p>The HSN field is coded as the binary representation of the hopping sequence number as defined in 3GPP TS 05.02</p> <p>Range 0 to 63.</p>

MA C i, Mobile allocation RF channel i (octet 4 etc.), i = 1, 2, ..., NF
 The MA C i bit indicates whether or not the Mobile allocation frequency list includes the i'th frequency in the cell allocation frequency list. In the cell allocation frequency list the absolute RF channel numbers are placed in increasing order of ARFCN, except that ARFCN 0, if included in the set, is put in the last position in the list,

For a RF channel belonging to the mobile allocation the MA C i bit is coded with a "1"; i = 1, 2, ..., NF.

For a RF channel not belonging to the mobile allocation the MA C i bit is coded with a "0"; i = 1, 2, ..., NF.

If NF mod 8 <> 0 then bits NF to 8n in octet 4 must be coded with a "0" in each.

10.5.2.14c GPRS Resumption

The purpose of the *GPRS Resumption* information element is to indicate whether the network has successfully resumed GPRS services or not.

The *GPRS Resumption* information element is coded as shown in figure 10.5.42/3GPP TS 04.18 and table 10.5.43/3GPP TS 04.18.

The *GPRS Resumption* is a type 1 information element.

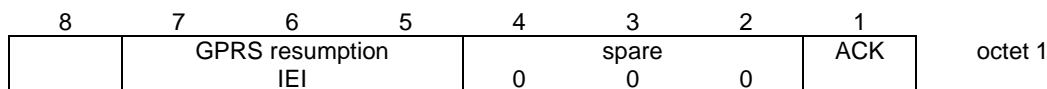

Figure 10.5.42/3GPP TS 04.18 GPRS Resumption information element

Table 10.5.43/3GPP TS 04.18: GPRS Resumption information element

The ACK field (1 bit) is the binary acknowledge of a successful resumption of GPRS services:

- 0 resumption of GPRS services not successfully acknowledged;
- 1 resumption of GPRS services successfully acknowledged.

10.5.2.14d GPRS broadcast information

The *GPRS broadcast information* information element provides the mobile station with relevant GPRS information needed for correct DTM operation. This information element is contained in messages addressed to mobile stations supporting GPRS and DTM.

The *GPRS broadcast information* information element is coded as shown in tables 10.5.43a /3GPP TS 04.18 and 10.5.43b/3GPP TS 04.18.

The *GPRS broadcast information* is a type 4 information element.

Table 10.5.43a: GPRS broadcast information information element

```
< GPRS broadcast information IE > ::=
< LENGTH_IN_OCTETS : bit(8) >
< GPRS Cell Options : < GPRS Cell Options IE > >
< GPRS Power Control Parameters : < GPRS Power Control Parameters struct > >
< padding bits >;
```

Table 10.5.43b: GPRS broadcast information information element details

<p>LENGTH IN OCTETS (8 bit field) This field encodes the number that is equal to one eighth of the number of bits (rounded up to the next integer) in the <i>GPRS broadcast information</i> IE that follows the end of this field.</p> <p>GPRS Cell Options The <i>GPRS Cell Option</i> information element is defined in 3GPP TS 04.60.</p> <p>GPRS Power Control Parameters The GPRS Power Control Parameters struct is defined in 3GPP TS 04.60.</p>

10.5.2.15 Handover Reference

The purpose of the *Handover Reference* information element is to provide a handover reference value used for access identification.

The *Handover Reference* information element is coded as shown in figure 10.5.43/3GPP TS 04.18 and table 10.5.44/3GPP TS 04.18.

The *Handover Reference* is a type 3 information element with 2 octets length.

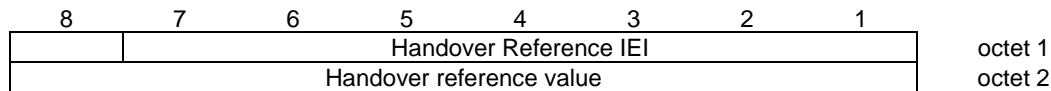

Figure 10.5.43/3GPP TS 04.18 Handover Reference information element

Table 10.5.44/3GPP TS 04.18: Handover Reference information element

<p>Handover reference value (octet 2) The handover reference value field is coded using binary representation. Range: 0 to 255.</p>
--

10.5.2.16 IA Rest Octets

The *IA Rest Octets* information element contains spare bits and possibly either a *packet uplink assignment* construction, a *packet downlink assignment* construction, a *second part packet assignment* construction or a *frequency parameters, before time* construction.

The *frequency parameters, before time* construction combines a mobile allocation (see 10.5.2.21) and a MAIO (see the *channel description* information element).

The *IA Rest Octets* information element is coded according to the syntax specified below and described in table 10.5.45/3GPP TS 04.18.

The *IA Rest Octets* information element is a type 5 information element with 0-11 octets length.

```

<IA Rest Octets> ::=
{
  LL
  | LH
    { 00 < EGPRS Packet Uplink Assignment >
      | 01 < Second Part Packet Assignment >
      | 1   -- reserved for future use (however the value 7C for the first octet shall not be used)
    }
  | HL
    < Length of frequency parameters : bit string (6) >
    < Frequency Parameters, before time >
  | HH
    { 00 < Packet Uplink Assignment >
      | 01 < Packet Downlink Assignment >
      | 1  < Second Part Packet Assignment > }
}
<spare padding>;

< EGPRS Packet Uplink Assignment > ::=
< Extended RA : bit (5) >
{ 0 | 1 < Access Technologies Request : Access Technologies Request struct > }
{ 1
  < TFI_ASSIGNMENT : bit (5) >
  < POLLING : bit >
  { 0 -- Dynamic Allocation
    < USF: bit (3) >
    < USF_GRANULARITY : bit >
    { 0 | 1 < P0 : bit (4) >
      < PR_MODE : bit (1) > }
  | 1 -- Fixed Allocation
    < ALLOCATION_BITMAP_LENGTH : bit (5) >
    < ALLOCATION_BITMAP : bit (val(ALLOCATION_BITMAP_LENGTH)) >
    { 0 | 1 < P0 : bit (4) >
      < BTS_PWR_CTRL_MODE : bit (1) >
      < PR_MODE : bit (1) > }
  }
  < EGPRS CHANNEL_CODING_COMMAND : < EGPRS Modulation and Coding IE>>
  < TLLI_BLOCK_CHANNEL_CODING : bit (1) >
  { 0 | 1 < BEP_PERIOD2 : bit (4) > }
  < Resegment : < Resegment IE>>
  < EGPRS Window Size : < EGPRS Window Size IE>>
  { 0 | 1 < ALPHA : bit (4) > }
  < GAMMA : bit (5) >
  { 0 | 1 < TIMING_ADVANCE_INDEX : bit (4) > }
  { 0 | 1 < TBF_STARTING_TIME : bit (16) > }
| 0 -- Multi Block Allocation
  { 0 | 1 < ALPHA : bit (4) > }
  < GAMMA : bit (5) >
  < TBF_STARTING_TIME : bit (16) >
  < NUMBER OF RADIO BLOCKS ALLOCATED : bit (2) >
  { 0 | 1 < P0 : bit (4) >
    < BTS_PWR_CTRL_MODE : bit (1) >
    < PR_MODE : bit (1) > }
};

<Access Technologies Request struct> ::= -- recursive structure allows any combination of Access technologies
  <Access Technology Type : bit (4)>
  { 0 | 1 <Access Technologies Request struct> };

```

```

< Packet Uplink Assignment > ::=
{
  1
  < TFI_ASSIGNMENT : bit (5) >
  < POLLING : bit >
  { 0
    -- Dynamic Allocation
    < USF : bit (3) >
    < USF_GROANULARITY : bit >
    { 0 | 1 < P0 : bit (4) >
    < PR_MODE : bit (1) > }
  | 1
    -- Fixed Allocation
    < ALLOCATION_BITMAP_LENGTH : bit (5) >
    < ALLOCATION_BITMAP : bit (val(ALLOCATION_BITMAP_LENGTH)) >
    { 0 | 1 < P0 : bit (4) >
    < BTS_PWR_CTRL_MODE : bit (1) >
    < PR_MODE : bit (1) > }
  }
  < CHANNEL_CODING_COMMAND : bit (2) >
  < TLLI_BLOCK_CHANNEL_CODING : bit >
  { 0 | 1 < ALPHA : bit (4) > }
  < GAMMA : bit (5) >
  { 0 | 1 < TIMING_ADVANCE_INDEX : bit (4) > }
  { 0 | 1 < TBF_STARTING_TIME : bit (16) > }
| 0
  -- Single Block Allocation
  { 0 | 1 < ALPHA : bit (4) > }
  < GAMMA : bit (5) >
  0 1
    -- See Note 1
  < TBF_STARTING_TIME : bit (16) >
  { L | H < P0 : bit (4) >
  < BTS_PWR_CTRL_MODE : bit (1) >
  < PR_MODE : bit (1) > }
}
{ L | H -- Additions for R99
  { 0 | 1 < Extended RA : bit (5) > } }
;

< Packet Downlink Assignment > ::=
< TLLI : bit (32) >
{ 0 | 1
  < TFI_ASSIGNMENT : bit (5) >
  < RLC_MODE : bit >
  { 0 | 1 < ALPHA : bit (4) > }
  < GAMMA : bit (5) >
  < POLLING : bit >
  < TA_VALID : bit (1) > }
  { 0 | 1 < TIMING_ADVANCE_INDEX : bit (4) > }
  { 0 | 1 < TBF_STARTING_TIME : bit (16) > }
  { 0 | 1 < P0 : bit (4) >
  < BTS_PWR_CTRL_MODE : bit (1) >
  < PR_MODE : bit (1) > }
{ L | H -- indicates EGPRS TBF mode, see 04.60
  < EGPRS_WINDOW_SIZE : bit(5) >
  < LINK_QUALITY_MEASUREMENT_MODE : bit (2) > ;
  { 0 | 1 < BEP_PERIOD2 : bit (4) > } } ;

< Frequency Parameters, before time > ::=
{ null
  -- Length of frequency parameters = 0
  | 0 0
  < MAIO : bit (6) >
  < Mobile Allocation : octet (val (Length of frequency parameters) – 1)
  };

< Second Part Packet Assignment > ::=
{ L | H -- Additions for R99
  { 0 | 1 < Extended RA : bit (5) > } } ;

```

NOTE 1: A 'Timing Advance index' shall not be allocated at a Single Block allocation. A 'TBF Starting Time' shall be allocated at a Single Block allocation. The control bits set to fixed values to specify these requirements in a way compatible with early GPRS mobile stations in release 97.

Table 10.5.45/3GPP TS 04.18: IA Rest Octet information element

<u>Packet Uplink Assignment</u>	
The Extended RA (5 bits) is the Extended Random Access information. This is an unformatted 5 bit field, whose content is coded as the 5 least significant bits of the the EGPRS PACKET CHANNEL REQUEST message defined in 3GPP TS 04.60.	
The POLLING field (1 bit) indicates if the MS is being polled for a PACKET CONTROL ACKNOWLEDGEMENT.	
0	; no action is required from MS.
1	; MS shall send a PACKET CONTROL ACKNOWLEDGEMENT message in the uplink block specified by TBF Starting Time, on the assigned PDCH.
The TFI_ASSIGNMENT field (5 bit) is the binary representation of the Temporary Flow Identity, see 3GPP TS 04.60. Range: 0 to 31.	
The USF field (3 bit) is the binary representation of the uplink state flag, see 3GPP TS 04.60. Range: 0 to 7.	
The USF_GRANULARITY field (1 bit) indicates the USF granularity to be applied by the mobile station when it is assigned a TBF using Dynamic Allocation, see 3GPP TS 04.60:	
0	the mobile station shall transmit one RLC/MAC block;
1	the mobile station shall transmit four consecutive RLC/MAC blocks.
The ALLOCATION_BITMAP_LENGTH field (5 bit) specifies the number of bits in the ALLOCATION_BITMAP. Range 0 to 31.	
The ALLOCATION_BITMAP field (variable length field) represents uplink radio blocks, each bit representing one radio block. Each bit indicates whether the mobile station is permitted to transmit during the corresponding uplink radio block. The bitmap describes a one dimensional array of block periods, indexed as follows:	
$\text{block period}[z]$ $z = n \quad \text{for } n = 0 \text{ to } L,$	
where:	
L = number of bits in the ALLOCATION_BITMAP - 1;	
z = block period relative to TBF_STARTING_TIME;	
n = bit number index into the ALLOCATION_BITMAP, range 0 to L;	
TBF_STARTING_TIME indicates the first block period of the assigned allocation	
The value of each bit is encoded as:	
0	block period[n] is not part of the assigned allocation
1	block period[n] is part of the assigned allocation
The CHANNEL_CODING_COMMAND field (2 bit) indicates the coding scheme to be used for transmission, see 3GPP TS 05.03:	
0 0	coding scheme 1, CS-1;
0 1	coding scheme 2, CS-2;
1 0	coding scheme 3, CS-3;
1 1	coding scheme 4, CS-4.
The TLLI_BLOCK_CHANNEL_CODING field (1 bit) indicates the channel coding to be used for RLC data block comprising TLLI for contention resolution:	
0	mobile station shall use CS-1 in GPRS TBF mode or MCS-1 in EGPRS TBF mode;
1	mobile station shall use coding scheme as specified by the corresponding CHANNEL CODING COMMAND or EGPRS CHANNEL CODING COMMAND field.

The **ALPHA** field (4 bit) is the binary representation of the parameter α for MS output power control, see 3GPP TS 05.08:

```

0 0 0 0    $\alpha = 0.0$ 
0 0 0 1    $\alpha = 0.1$ 
:         :
1 0 1 0    $\alpha = 1.0$ 

```

All other values are reserved in this version of the protocol and shall be interpreted by the mobile station as $\alpha = 1.0$.

The **GAMMA** field (5 bit) is the binary representation of the parameter Γ_{CH} for MS output power control in units of 2 dB, see 3GPP TS 05.08.

The **TA_INDEX** field (4 bit) is the binary representation of the timing advance index (TAI), see 3GPP TS 05.10 and 3GPP TS 04.04. Range: 0 to 15.

The **TBF_STARTING_TIME** field (16 bit) defines a starting time for the packet uplink assignment. The TBF starting time is coded using the same coding as the V format of the type 3 information element *Starting Time* (10.5.2.38).

P0 (4 bit field)

For description and encoding, see the Packet Uplink Assignment message in 3GPP TS 04.60.

BTS_PWR_CTRL_MODE (1 bit field)

For description and encoding, see the Packet Uplink Assignment message in 3GPP TS 04.60.

PR_MODE (1 bit field)

For description and encoding, see the Packet Uplink Assignment message in 3GPP TS 04.60.

Packet Downlink Assignment

The **TLLI** field (32 bit) is the binary representation of a TLLI. The coding of TLLI is left open for each administration using the structure specified in 3GPP TS 23.003.

The **TFI_ASSIGNMENT** field (5 bit) is the binary representation of the Temporary Flow Identity, see 3GPP TS 04.60. Range: 0 to 31.

The **RLC_MODE** field (1 bit) indicates the RLC mode, see 3GPP TS 04.60:

```

0   RLC acknowledged mode;
1   RLC unacknowledged mode.

```

The **ALPHA** field (4 bit) and the **GAMMA** field (5 bit) are the binary representations of the respective parameters α and Γ_{CH} for MS output power control, see *Packet Uplink Assignment* construction.

The **POLLING** field (1 bit) indicates if the MS is being polled for a PACKET CONTROL ACKNOWLEDGEMENT.

```

0   ; no action is required from MS.
1   : MS shall send a PACKET CONTROL ACKNOWLEDGEMENT message in the uplink block specified by
      TBF Starting Time, on the assigned PDCH.

```

The **TA_VALID** field (1 bit) indicates the validity of the timing advance value given in the *Timing Advance* IE.

```

0   the timing advance value is not valid ;
1   the timing advance value is valid.

```

The **TIMING_ADVANCE_INDEX** field (4 bit) is the binary representation of the timing advance index (TAI), see 3GPP TS 05.10 and 3GPP TS 04.04. Range: 0 to 15.

The **TBF_STARTING_TIME** field (16 bit) defines a starting time for the packet downlink assignment. The TBF starting time is coded using the same coding as the V format of the type 3 information element *Starting Time* (10.5.2.38).

P0 (4 bit field)

For description and encoding, see the Packet Uplink Assignment message in 3GPP TS 04.60.

BTS_PWR_CTRL_MODE (1 bit field)

For description and encoding, see the Packet Uplink Assignment message in 3GPP TS 04.60.

PR_MODE (1 bit field)

For description and encoding, see the Packet Uplink Assignment message in 3GPP TS 04.60.

Second Part Packet Assignment

The presence of the Second Part Packet Assignment is the indication that this message is the second message of two IMMEDIATE ASSIGNMENT messages in an assignment of an uplink or downlink Temporary Block Flow (TBF).

The **Extended RA** (5 bits) is the Extended Random Access information. This is an unformatted 5 bit field, whose content is coded as the 5 least significant bits of the the EGPRS PACKET CHANNEL REQUEST message defined in 3GPP TS 04.60. The field shall be ignored by the mobile station, if present in a message used in an assignment of a downlink TBF.

Frequency parameters, before time**Length of frequency parameters** (6 bit field)

This field is coded as the binary representation of the number of octets occupied by the frequency parameters, before time field. If this length is 0, the frequency parameters, before time is not present.

The **MAIO** field (6 bit field) is coded as the binary representation of the mobile allocation index offset. Range: 0 to 63.

The **Mobile Allocation** field (k octet field (k = Length of frequency parameters – 1) contains a bitmap referring to the *Cell Channel Description* IE in SI 1 message. The length of the bitmap is 8k, where $k = ((NF-1) \div 8 + 1)$ and where NF denotes the number of ARFCNs contained in the cell channel description. The different bit positions in the mobile allocation bitmap are assigned indices $i = 1$ to 8k, starting with $i = 8k$ in the most significant bit position and ending with $i = 1$ in the least significant bit position. The bit position with index i corresponds to the i 'th frequency in the cell channel description arranged in ascending order of ARFCN (except that ARFCN = 0, if included, is put last) and numbered from 1 to NF. Each bit position in the mobile allocation bitmap is coded:

- 0 RF channel not belonging to mobile allocation;
- 1 RF channel belonging to mobile allocation.

If $NF \bmod 8 \neq 0$, then bit positions $i = NF+1$ to 8k shall each be coded with a "0".

EGPRS Window Size IE

This field is encoded as the EGPRS window size IE in the PACKET DOWNLINK ASSIGNMENT message in 3GPP TS 04.60.

LINK_QUALITY_MEASUREMENT_MODE (2 bit field)

This field is encoded as the LINK_QUALITY_MEASUREMENT_MODE in the PACKET DOWNLINK ASSIGNMENT message in 3GPP TS 04.60.

ACCESS TECHNOLOGY TYPE

This field indicates the access technology that is requested from the mobile station. The field is coded according to the definition in 3GPP TS 24.008. The access technology types requested from the MS in the Access Technologies Request structure shall be classified by priority, the most important first. The MS shall reply using the same order.

NUMBER OF RADIO BLOCKS ALLOCATED (2 bit field)

Bits

1 0

- 0 0 1 radio block reserved for uplink transmission
- 0 1 2 radio blocks reserved for uplink transmission
- 1 0 reserved for future use
- 1 1 reserved for future use

EGPRS Modulation and Coding Scheme

The EGPRS Modulation and Coding Scheme information element is defined in 3GPP TS 04.60.

BEP_PERIOD2 (4 bit field)

This field contains a constant which is used for filtering channel quality measurements in EGPRS. BEP_PERIOD2 when present shall be used instead of BEP_PERIOD. For details see 3GPP TS 05.08.

Range: 0 to 15

Resegment

The Resegment information element is defined in 3GPP TS 04.60.

BEP_PERIOD2 (4 bit field)

This field is encoded as the BEP_PERIOD2 in the PACKET DOWNLINK/UPLINK ASSIGNMENT messages in 3GPP TS 04.60

10.5.2.17 IAR Rest Octets

The *IAR Rest Octets* information element contains spare bits or possibly Extended RA informations.

The *IAR Rest Octets* information element is a type 5 information element with 3 octets length.

```
<IAR Rest Octets> ::=
  { 0 | 1 < Extended RA 1 : bit (5) > }
  { 0 | 1 < Extended RA 2 : bit (5) > }
  { 0 | 1 < Extended RA 3 : bit (5) > }
  { 0 | 1 < Extended RA 4 : bit (5) > }
  <spare padding>;
```

Figure 10.5.44/3GPP TS 04.18 IAR Rest Octets information element

The **Extended RA i** (5 bits) is the Extended Random Access information related to the Request Reference i (i within the range 1..4).

These are unformatted 5 bit fields, whose contents are coded as the 5 least significant bits of the EGPRS PACKET CHANNEL REQUEST message defined in 3GPP TS 04.60.

10.5.2.18 IAX Rest Octets

The *IAX Rest Octets* information element contains only spare bits only. Its purpose is to allow the upward compatible introduction of new information on the AGCH in later phases.

The *IAX Rest Octets* information element is a type 5 information element with 0-4 octets length.

```
<IAX Rest Octets> ::=
  <spare padding>;
```

Figure 10.5.45/3GPP TS 04.18 IAX Rest Octets information element

10.5.2.19 L2 Pseudo Length

The *L2 Pseudo Length* information element indicates the number of octets following it in the message which are to be interpreted in the scope of the phase 1 protocol, i.e. the total number of octets (excluding the Rest Octets) for which T, V, TV, LV, or TLV formatting is used (reference Table 11.1/TS 24.007).

The *L2 Pseudo Length* information element is the first part of e.g. SYSTEM INFORMATION messages which are mentioned as exceptions in section 10.1. It occupies the first octet of such messages.

For any of the SYSTEM INFORMATION messages sent on the BCCH, a mobile station should ignore the contents of the L2 Pseudo Length value contained in the *L2 Pseudo Length* information element. For some specific messages, further requirements are specified in section 9.

The *L2 Pseudo Length* Information element is an element with 2 octets length:

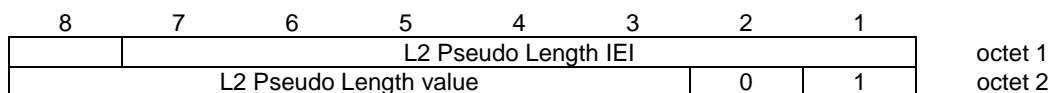

Figure 10.5.46/3GPP TS 04.18 *L2 Pseudo Length* information element

Table 10.5.46/3GPP TS 04.18: *L2 Pseudo Length* information element

<p>L2 pseudo length value (octet 2)</p> <p>The coding of the L2 pseudo length value field is the binary representation of the L2 pseudo length of the message in which the L2 pseudo length information element occurs.</p>

NOTE: Bits 1 and 2 are not spare.

10.5.2.20 Measurement Results

The purpose of the *Measurement Results* information element is to provide the results of the measurements made by the mobile station on the serving cell and the neighbour cells.

The *Measurement Results* information element is coded as shown in figure 10.5.47/3GPP TS 04.18 and table 10.5.47/3GPP TS 04.18.

The *Measurement Results* is a type 3 information element with 17 octets length.

8	7	6	5	4	3	2	1	
Measurement Results IE1								octet 1
BA-USED	DTX-USED	RXLEV-FULL-SERVING-CELL						octet 2
3G-BA-USED	MEAS-VALID	RXLEV-SUB-SERVING-CELL						octet 3
0 spare	RXQUAL-FULL-SERVING-CELL			RXQUAL-SUB-SERVING-CELL			NO-NCELL-M (high part)	octet 4
NO-NCELL-M (low part)		RXLEV-NCELL 1						octet 5
BCCH-FREQ-NCELL 1				BSIC-NCELL 1 (high part)				octet 6
BSIC-NCELL 1 (low part)			RXLEV-NCELL 2 (high part)					octet 7
RXLEV-NCELL 2 (low part)	BCCH-FREQ-NCELL 2					BSIC-NCELL 2 (high part)		octet 8
BSIC-NCELL 2 (low part)			RXLEV-NCELL 3 (high part)					octet 9
RXLEV-NCELL 3 (low part)	BCCH-FREQ-NCELL 3					BSIC-NCELL 3 (high part)		octet 10
BSIC-NCELL 3 (low part)				RXLEV-NCELL 4 (high part)				octet 11
RXLEV-NCELL 4 (low part)			BCCH-FREQ-NCELL 4					octet 12
BSIC-NCELL 4					RXLEV-NCELL 5 (high part)			octet 13
RXLEV-NCELL 5 (low part)				BCCH-FREQ-NCELL 5 (high part)				octet 14
BCCH-FREQ-NCELL 5 (low part)	BSIC-NCELL 5					RXLEV-NCELL 6 (high part)		octet 15
RXLEV-NCELL 6 (low part)				BCCH-FREQ-NCELL 6 (high part)				octet 16
BCCH-FREQ-NCELL 6 (low part)	BSIC-NCELL 6						octet 17	

Figure 10.5.47/3GPP TS 04.18 Measurement Results information element (continued)

Table 10.5.47/3GPP TS 04.18: Measurement Results information element

<p>BA-USED (octet 2), the value of the BA-IND field of the neighbour cells description information element or elements defining the BCCH allocation used for the coding of BCCH-FREQ-NCELL fields. Range 0 to 1.</p> <p>DTX-USED (octet 2) This bit indicates whether or not the mobile station used DTX during the previous measurement period.</p> <p>Bit 7</p> <p>0 DTX was not used</p> <p>1 DTX was used</p>

RXLEV-FULL-SERVING-CELL and RXLEV-SUB-SERVING-CELL, (octets 2 and 3)
Received signal strength on serving cell, measured respectively on all slots and on a subset of slots (see 3GPP TS 05.08)

The RXLEV-FULL-SERVING-CELL and RXLEV-SUB-SERVING-CELL fields are coded as the binary representation of a value N. N corresponds according to the mapping defined in 3GPP TS 05.08 to the received signal strength on the serving cell.

Range: 0 to 63

MEAS-VALID (octet 3)

This bit indicates if the measurement results for the dedicated channel are valid or not

Bit 7

0 The measurement results are valid

1 the measurement results are not valid

3G-BA-USED (octet 3)

The value of the 3G-BA-IND field of the neighbour cells description information element or elements defining the BCCH allocation used for the coding of 3G BCCH-FREQ-NCELL fields. Range 0 to 1.

RXQUAL-FULL-SERVING-CELL and RXQUAL-SUB-SERVING-CELL (octet 4)

Received signal quality on serving cell, measured respectively on all slots and on a subset of the slots (see TS. 3GPP TS 05.08)

CELL fields are coded as the binary representation of the received signal quality on the serving cell.

Range: 0 to 7 (See 3GPP TS 05.08)

NO-NCELL-M, Number of neighbouring cell measurements (octets 4 and 5)

Bits

1 8 7

0 0 0 No neighbour cell measurement result

0 0 1 1 " " " "

0 1 0 2 " " " "

0 1 1 3 " " " "

1 0 0 4 " " " "

1 0 1 5 " " " "

1 1 0 6 " " " "

1 1 1 Neighbour cell information not available for serving cell

RXLEV-NCELL i , Result of measurement on the i 'th neighbouring cell (octet 5, 7, 8, 9, 10, 11, 12, 13, 14, 15 and 16)

If the i 'th neighbouring cell is a GSM RAT cell, the RXLEV-NCELL field is coded as the binary representation of a value N . N corresponds according to the mapping defined in TS. 3GPP TS 05.08 to the received signal strength on the i 'th neighbouring cell. See note 1 & 2.

If the i 'th neighbouring cell is a UMTS FDD cell, the field 'RXLEV-NCELL' in Figure 10.5.47 carries

- the RSSI parameter if no Scrambling Code was indicated for this index ($n=0$ in sub-clause 9.1.54, 'Enhanced Measurement information message').
 - otherwise, the CPICH Ec/No or RSCP parameter, depending on the value of the FDD_REP_QUANT parameter (see 3GPP TS 05.08).
- RSSI, CPICH Ec/No and RSCP are defined in 3G3GPP TS 25.331.

If the i 'th neighbouring cell is a UMTS TDD cell, the field 'RXLEV-NCELL' field in Figure 10.5.47 carries the RSCP parameter, defined in 3G3GPP TS 25.331.

If the i 'th neighbouring cell is a CDMA 2000 cell, the field 'RXLEV-NCELL' in Figure 10.7.47 field carries the PILOT_STRENGTH parameter defined in TIA/EIA-IS-2000-5-A.

Range: 0 to 63.

- Report on GSM Radio Access Technology cells:

BCCH-FREQ-NCELL i , BCCH carrier of the i 'th neighbouring cell (octet 6, 8, 10, 12, 14, 15, 16 and 17)

The BCCH-FREQ-NCELL i field is coded as the binary representation of the position, starting with 0, of the i 'th neighbouring cells BCCH carrier in the BCCH channel list. The BCCH channel list is composed of one or two BCCH channel sub lists, each sub list is derived from the set of frequencies defined by reference neighbour cells description information element or elements. In the latter case the set is the union of the two sets defined by the two neighbour cells description information elements.

In each BCCH channel sub list the absolute RF channel numbers are placed in increasing order of ARFCN, except that ARFCN 0, if included in the set, is put in the last position in the sub list. The BCCH channel list consists either of only the sub list derived from the neighbour cells description information element(s) in System Information 2/5 (and possible 2bis/5bis) or of that sub list immediately followed by the sub list derived from the neighbour cells description information element in System Information 2ter/5ter for the case System Information 2ter/5ter is also received. If the set of ARFCNs defined by the reference neighbour cells description information element or elements includes frequencies that the mobile station does not support then these ARFCNs shall be included in the list.

The notation 2/5 etc. means that the rules above apply to the neighbour cells description information elements received in System Information 2, 2bis and 2ter and to those received in System Information 5, 5bis and 5ter separately.

See note 1 & 2.

Range: 0 to 31/30.

- Report on 3G Radio Access Technology cells:

If no more than 31 (GSM RAT) ARFCN frequencies are included in the BA (list), the index BCCH-FREQ-NCELL 31 indicates report(s) on 3G Radio Access Technology cells.

In this case, the corresponding 'BSIC-NCELL' field in Figure 10.5.47 carries the index of the i 'th 3G neighbouring cell in the 3G Neighbour Cell list defined in sub-clause 3.4.1.2.1.1, Deriving the 3G Neighbour Cell list from the 3G Neighbour Cell Description.

Range: 0 to 63.

BSIC-NCELL *i*, Base station identity code of the *i*'th neighbouring cell (octet 6, 7, 8, 9, 10, 11, 13, 15 and 17)

For the GSM Radio Access Technology, the BSIC-NCELL *i* field is coded as the binary representation of the base station identity code of the *i*'th neighbouring cell. See note 1 & 2.

Range: 0 to 63.

NOTE 1: If the field extends over two octets the highest numbered bit of the lowest numbered octet is the most significant and the lowest numbered bit of the highest numbered octet is the least significant.

NOTE 2: If NO-NCELL-M < 6 the remaining RXLEV-NCELL *i*, BS-FREQ-NCELL *i* and BSIC-NCELL *i* fields (NO-NCELL-M < *i* <= 6) shall be coded with a "0" in each bit.

10.5.2.20a GPRS Measurement Results

The purpose of the *GPRS Measurement Results* information element is to provide the results of the GPRS measurements made by the GPRS mobile station on the serving cell.

The *GPRS Measurement Results* information element is coded as shown in figure 10.5.48/3GPP TS 04.18 and table 10.5.48/3GPP TS 04.18.

The *GPRS Measurement Results* is a type 3 information element with 3 octets length.

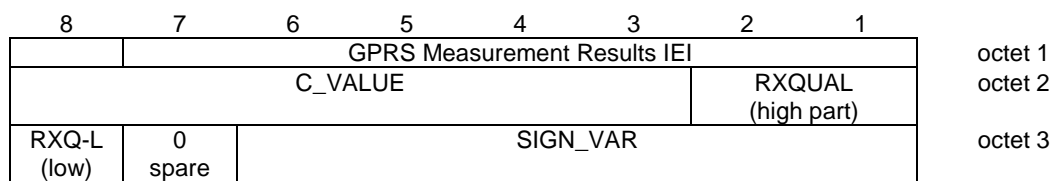

Figure 10.5.48/3GPP TS 04.18 GPRS Measurement Results information element

Table 10.5.48/3GPP TS 04.18: GPRS Measurement Results information element

C_VALUE (octet 1), the value of the C parameter calculated by the GPRS mobile station (see 3GPP TS 05.08). This field is encoded as the binary representation of the C parameter value defined in 3GPP TS 05.08. Range 0 to 63.

RXQUAL (octets 1 and 2), contains the RXQUAL parameter field calculated by the GPRS mobile station (see 3GPP TS 05.08). This field is encoded as defined in 3GPP TS 05.08. Range 0 to 7.

SIGN_VAR (octet 3), contains the signal variance parameter SIGN_VAR calculated by the mobile station (see 3GPP TS 05.08). This field is encoded as defined in 3GPP TS 04.60.

10.5.2.21 Mobile Allocation

The purpose of the *Mobile Allocation* information element is to provide that part of the RF channels belonging to the cell allocation (coded with a "1" in the cell channel description information element) which is used in the mobile hopping sequence.

The *Mobile Allocation* information element is coded as shown in figure 10.5.49/3GPP TS 04.18 and table 10.5.49/3GPP TS 04.18.

The *Mobile Allocation* is a type 4 information element with 3 to 10 octets length except for the cases specified in section 9.1.18.1 and 9.1.19.2.

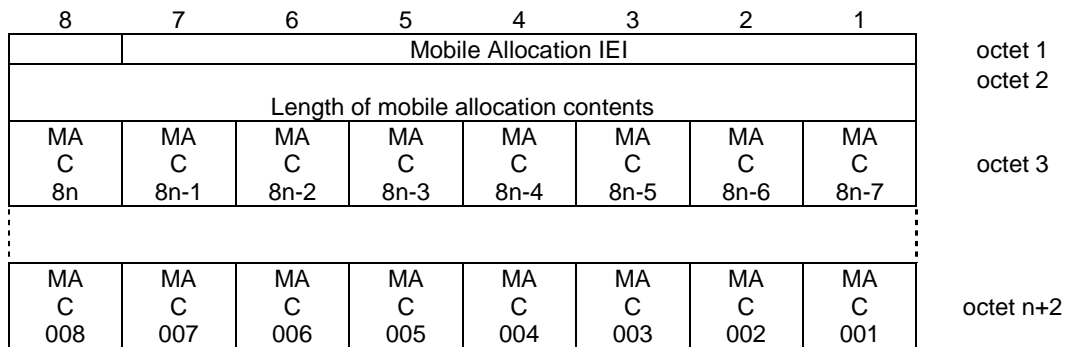

Figure 10.5.49/3GPP TS 04.18 Mobile Allocation information element

Table 10.5.49/3GPP TS 04.18: Mobile Allocation information element

MA C i, Mobile allocation RF channel i (octet 3 etc.), i = 1, 2, ..., NF
 The MA C i bit indicates whether or not the Mobile allocation frequency list includes the i'th frequency in the cell allocation frequency list. The cell allocation frequency list is derived from the set of frequencies defined by the reference cell channel description information element. NF denotes the number of frequencies in the cell allocation frequency list.
 In the cell allocation frequency list the absolute RF channel numbers are placed in increasing order of ARFCN, except that ARFCN 0, if included in the set, is put in the last position in the list,
 For a RF channel belonging to the mobile allocation the MA C i bit is coded with a "1"; i = 1, 2, ..., NF.
 For a RF channel not belonging to the mobile allocation the MA C i bit is coded with a "0"; i = 1, 2, ..., NF.
 If $NF \bmod 8 \neq 0$ then bits NF to 8n in octet 3 must be coded with a "0" in each.

10.5.2.21a Mobile Time Difference

A *Mobile Time Difference* information element encodes a time related to the synchronization difference between the time bases of two base stations. This type of information is used in conjunction with the HANDOVER COMPLETE message.

The *Mobile Time Difference* information element is coded as shown in figure 10.5.50/3GPP TS 04.18 and table 10.5.50/3GPP TS 04.18.

The *Mobile Time Difference* information element is a type 4 information element with 5 octets length.

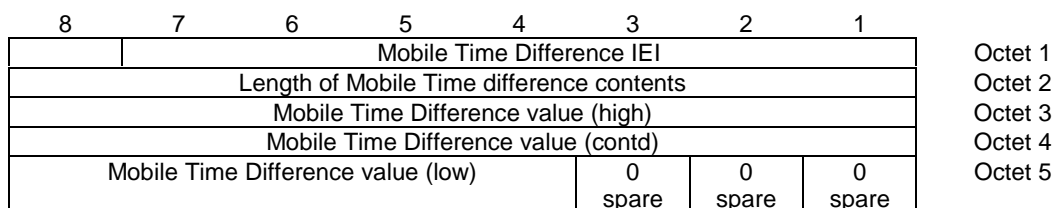

Figure 10.5.50/3GPP TS 04.18 Mobile Time Difference information element

Table 10.5.50/3GPP TS 04.18: Mobile Time Difference information element

Mobile Time Difference value (octet 3, 4 and 5) The coding of the Mobile Time Difference value field is the binary representation of the time difference in half bit periods and modulo 2^{21} half bit periods; 1/2 bit period = 24/13 μ s.

10.5.2.21aa MultiRate configuration

The *MultiRate configuration* information element gives all parameters related to a multi-rate speechcodec.

The *MultiRate configuration* information element is coded as shown in figure 10.5.2.47/3GPP TS 04.18 and table 10.5.2.47/3GPP TS 04.18.

The *MultiRate configuration* is a type 4 information element with a minimum length of 4 octets and a maximum length of 8 octets.

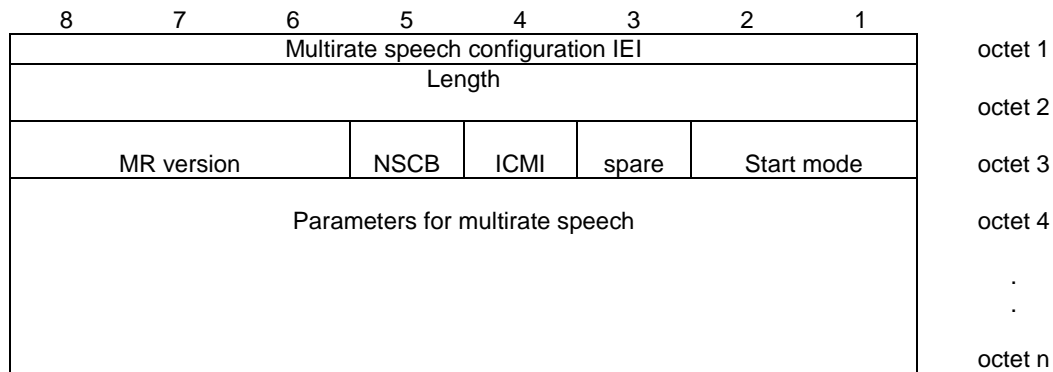

Figure 10.5.2.47/3GPP TS 04.18 MultiRate configuration information element

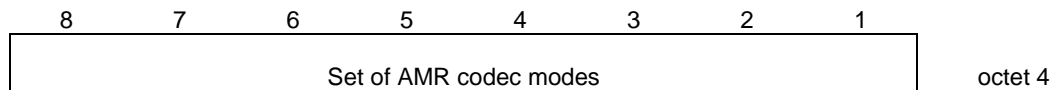

Figure 10.5.2.47a/3GPP TS 04.18 Parameters for multirate speech field for the MR version 1 when a set with one codec mode is chosen

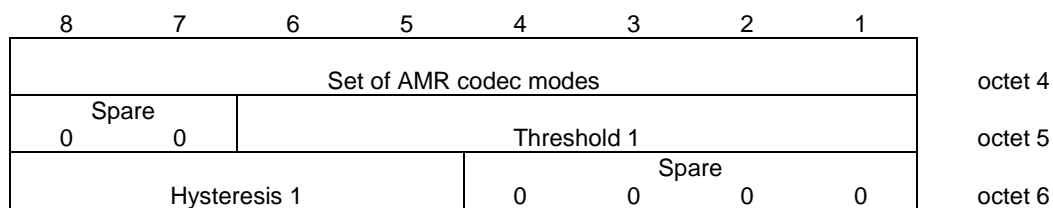

Figure 10.5.2.47b/3GPP TS 04: Parameters for multirate speech field for the MR version 1 when a set with two codec modes is chosen

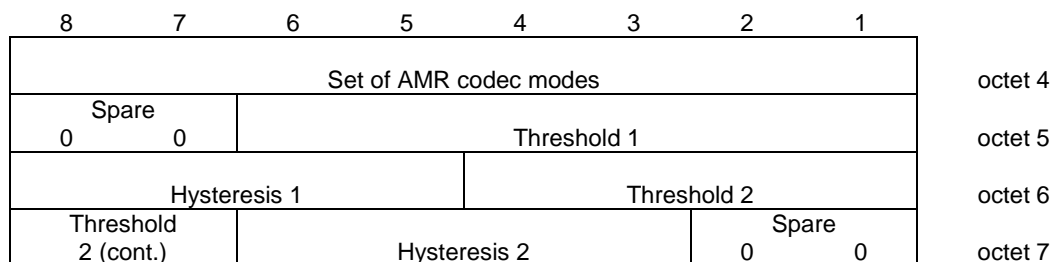

Figure 10.5.2.47c/3GPP TS 04.18: Parameters for multirate speech field for the MR version 1 when a set of three codec modes is chosen

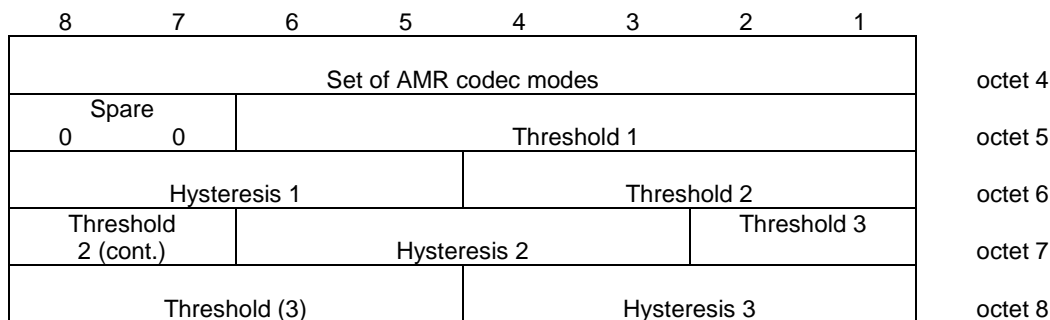

Figure 10.5.2.47d/3GPP TS 04.18: Parameters for multirate speech field for the MR version 1 when a set of four modes is chosen

Table 10.5.2.47/3GPP TS 04.18: MultiRate configuration information element

<p>Octet 3</p> <p>Bits</p> <p>8 7 6 Multirate speech version</p> <p>0 0 1 Adaptive Multirate speech version 1</p> <p>Other values reserved</p> <p>Bit 5 NSCB: Noise Suppression Control Bit</p> <p>0 Noise Suppression can be used (default)</p> <p>1 Noise Suppression shall be turned off</p> <p>Bit 4 Initial Codec Mode Indicator</p> <p>0 The initial codec mode is defined by the implicit rule provided in 3GPP TS 05.09</p> <p>1 The initial codec mode is defined by the Start Mode field</p> <p>Bit 3</p> <p>0 Spare</p> <p>Bits</p> <p>2 1 Start Mode,</p> <p>The initial codec mode is coded as in 3GPP TS 05.09 section 3.4.1</p> <p>When Multirate speech version field indicates Adaptive Multirate speech version 1 then the remaining fields are coded as follows:</p> <p>THR_j (6 bits), is coded as the binary representation of a value N. N corresponds to the threshold of C/I in dB, as defined in 3GPP TS 05.09;</p> <p>HYST_j (4 bits) is coded as the binary representation of the hysteresis value associated to THR_j, as defined in 3GPP TS 05.09.</p> <p>j = 1 corresponds to the lowest value of threshold in dB, j = 2 to the second lowest, j = 3 to the highest value.</p>

Set of adaptive multirate codec modes field (octet 4)	
Bit	
8	
0	12,2 kbit/s codec rate is not part of the subset;
1	12,2 kbit/s codec rate is part of the subset;
Bit	
7	
0	10,2 kbit/s codec rate is not part of the subset;
1	10,2 kbit/s codec rate is part of the subset;
Bit	
6	
0	7,95 kbit/s codec rate is not part of the subset;
1	7,95 kbit/s codec rate is part of the subset;
Bit	
5	
0	7,40 kbit/s codec rate is not part of the subset;
1	7,40 kbit/s codec rate is part of the subset;
Bit	
4	
0	6,70 kbit/s codec rate is not part of the subset;
1	6,70 kbit/s codec rate is part of the subset;
Bit	
3	
0	5,90 kbit/s codec rate is not part of the subset;
1	5,90 kbit/s codec rate is part of the subset;
Bit	
2	
0	5,15 kbit/s codec rate is not part of the subset;
1	5,15 kbit/s codec rate is part of the subset;
Bit	
1	
0	4,75 kbit/s codec rate is not part of the subset;
1	4,75 kbit/s codec rate is part of the subset;

10.5.2.21b Multislot Allocation

The purpose of the *Multislot Allocation* information element is to provide a description of which channels are used in downlink and uplink respectively, in a multislot configuration. It also groups the channels into channel sets, the channel mode for each channel set can be defined by a separate information element.

The *Multislot Allocation* information element is coded as shown in figure 10.5.51/3GPP TS 04.18 and table 10.5.51/3GPP TS 04.18.

The multislot allocation information element is a type 4 information element with a minimum length of 3 octets and a maximum length of 12 octets.

8	7	6	5	4	3	2	1	
Multislot allocation IEI								octet 1
Length of the multislot allocation contents								octet 2
0/1 ext	DA 7	DA 6	DA 5	DA 4	DA 3	DA 2	DA 1	octet 3
1 ext	UA 7	UA 6	UA 5	UA 4	UA 3	UA 2	UA 1	octet 3a
Channel set 1								octet 4*
Channel set 2								octet 5*
.								
.								
Channel set 8								octet 11*

Figure 10.5.51/3GPP TS 04.18 Multislot Allocation information element

Table 10.5.51/3GPP TS 04.18 Multislot allocation information element

<p>DA 1-7, Downlink assignment (octet 3)</p> <p>Indicates additional downlink channel allocation. If bit DA n is set to "1" this indicates that timeslot $TN = (n + TN_m) \bmod 8$ is assigned. If bit DA n is set to "0" the corresponding timeslot is not assigned. TN_m is the timeslot number of the main link.</p> <p>UA 1-7, Uplink assignment (octet 3a)</p> <p>Indicates additional uplink channel allocation. If bit UA n is set to "1" this indicates that timeslot $TN = (n + TN_m) \bmod 8$ is assigned. If bit UA n is set to "0" the corresponding timeslot is not assigned. TN_m is the timeslot number of the main link.</p> <p>If octet 3a is not included the timeslots indicated by octet 3 are allocated in both downlink and uplink direction.</p> <p>Note1: Allocation of timeslots only in uplink is FFS. Note2: In combination with the channel description IE, all types of channels can be indicated. The channel carrying the main signalling link (indicated by the channel description IE is of type 1 (see below)), all other channels allocated both in downlink and uplink are of type 2 and channels with allocation in only one direction are of type 3.</p> <p>Type 1: TCH/F + FACCH/F + SACCH/M bidirectional Type 2: TCH/F + SACCH/M bidirectional Type 3: TCH/F + SACCH/M unidirectional</p> <p>Channel set n (octet 4 to 11 (if included)) If octets 4-11 are omitted, all channels belong to channel set 1.</p> <p>If bit m of Channel set n is set to "1" then timeslot m-1 is included in channel set n. If bit m of Channel set n is set to "0" then timeslot m-1 is not included in channel set n.</p> <p>Each allocated timeslot, including the timeslot carrying the main signalling link, shall be included in one (and only one) channel set.</p>
--

10.5.2.21c NC mode

The purpose of the *NC mode* information element is for the network to inform the mobile station of the NC mode to be implemented on the target cell.

The *NC mode* information element is coded as shown in figure 10.5.52/3GPP TS 04.18 and table 10.5.52/3GPP TS 04.18.

The *NC mode* is a type 1 information element.

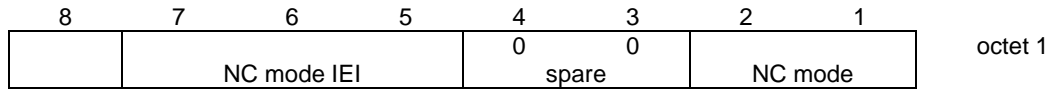

Figure 10.5.52 /3GPP TS 04.18 NC mode information element

Table 10.5.52/3GPP TS 04.18: NC Mode information element

<p>NC mode This field indicates to the mobile the NC mode for the target cell (see 3GPP TS 04.60). The field is encoded according to the following table:</p> <p>bits</p> <table style="margin-left: 20px; border: none;"> <tr><td>2 1</td><td></td></tr> <tr><td>0 0</td><td>NC 0</td></tr> <tr><td>0 1</td><td>NC 1</td></tr> <tr><td>1 0</td><td>NC 2</td></tr> <tr><td>1 1</td><td>information on NC mode to be gathered from the target cell</td></tr> </table>	2 1		0 0	NC 0	0 1	NC 1	1 0	NC 2	1 1	information on NC mode to be gathered from the target cell
2 1										
0 0	NC 0									
0 1	NC 1									
1 0	NC 2									
1 1	information on NC mode to be gathered from the target cell									

10.5.2.22 Neighbour Cells Description

The purpose of the *Neighbour Cells Description* information element is to provide the absolute radio frequency channel numbers of the BCCH carriers to be monitored by the mobile stations in the cell.

The *Neighbour Cells Description* information element is coded as the *Cell Channel Description* information element, as specified in section 10.5.2.1b, with the exception of bits 5 and 6 of octet 2. figure 10.5.53/3GPP TS 04.18 and table 10.5.53/3GPP TS 04.18 contains the difference of specifications.

The *Neighbour Cells Description* information element is a type 3 information element with 17 octets length.

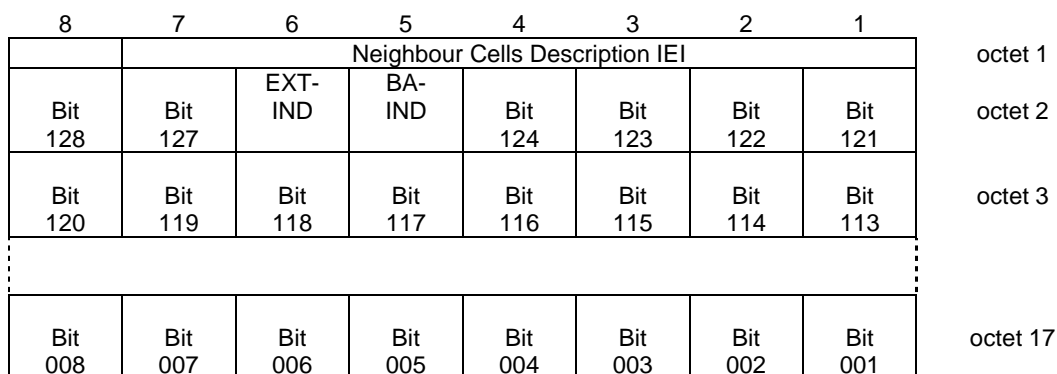

Figure 10.5.53/3GPP TS 04.18 Neighbour Cells Description information element

Table 10.5.53/3GPP TS 04.18: Neighbour Cells Description information element

<p>EXT-IND, Extension indication (octet 2, bit 6)</p> <p>If received in System Information 2, 2bis, 5 or 5bis this bit indicates whether the information element carries the complete information of a BCCH channel sub list or whether a complementary information element is sent in another message. A GSM 900 mobile station which only supports the primary GSM band P-GSM 900 (cf. 3GPP TS 05.05) may consider this bit as a spare bit and assume that the information element carries the complete BA, see section 3.2.2.1.</p> <p>NOTE: This indicator is set to 1 in the neighbour cells description information elements in System Information 2 and 2bis and 5 and 5bis respectively when more than one is needed to describe a BCCH channel sub list.</p> <p>Bit 6</p> <p>0 The information element carries the complete BA</p> <p>1 The information element carries only a part of the BA</p> <p>BA-IND, BCCH allocation sequence number indication (octet 2). Range 0 to 1</p> <p>The BA-IND is needed to allow the network to discriminate measurements results related to different BAs (e.g. BA(BCCH) and BA(SACCH)) sent to the MS.</p>

10.5.2.22a Neighbour Cells Description 2

The purpose of the *Neighbour Cells Description 2* information element is to provide the absolute radio frequency channel numbers of the BCCH carriers to be monitored by the mobile stations in the cell.

The *Neighbour Cells Description 2* information element is coded as the *Cell Channel Description* information element, as specified in section 10.5.2.1b, with the exception of bits 5 to 7 of octet 2. figure 10.5.54/3GPP TS 04.18 and table 10.5.54/3GPP TS 04.18 contains the difference of specifications.

The *Neighbour Cells Description 2* information element is a type 3 information element with 17 octets length.

8	7	6	5	4	3	2	1	
Neighbour Cells Description IEI								octet 1
Bit 128	Multiband reporting		BA-IND	Bit 124	Bit 123	Bit 122	Bit 121	octet 2
Bit 120	Bit 119	Bit 118	Bit 117	Bit 116	Bit 115	Bit 114	Bit 113	octet 3
⋮								
Bit 008	Bit 007	Bit 006	Bit 005	Bit 004	Bit 003	Bit 002	Bit 001	octet 17

Figure 10.5.54/3GPP TS 04.18 Neighbour Cells Description 2 information element

Table 10.5.54/3GPP TS 04.18: Neighbour Cells Description 2 information element

Octet 2 bit 8, 4, 3 and 2
 FORMAT-ID, Format Identifier (Bit 128 and next)
 The different formats are distinguished by the bits of higher number. As an exception to the general format for the neighbour cell description the format ID is coded as follows :

Bit 128	Bit 124	Bit 123	Bit 122	format notation
0	X	X	X	bit map 0
1	0	X	X	1024 range
1	1	0	0	512 range
1	1	0	1	256 range
1	1	1	0	128 range
1	1	1	1	variable bit map

Bits 6 and 7 of Octet 2

Multiband reporting

Binary encoding of multiband reporting parameter as specified in 3GPP TS 05.08.

Range: 0 to 3

Bit 5 of octet 2

BA-IND, BCCH allocation sequence number indication.

The BA-IND is needed to allow the network to discriminate measurements results related to different BAs (e.g. BA(BCCH) and BA(SACCH)) sent to the MS.

Range 0 to 1.

10.5.2.22b Spare

10.5.2.22c NT/N Rest Octets

The *NT/N Rest Octets* information element is a type 5 information element with 20 octets length.

```

NT/N Rest Octets ::=
  {0 | 1 <NLN(PCH) : bit (2)>}
  <list of Group Call NCH information>
  <Spare padding>;
<List of Group Call NCH information> ::=
  0 | 1 <Group Call information> <List of Group Call NCH information> ;
NLN(PCH)
This field gives the NLN value to be used as specified in 3.3.3
<Group Call information>
See clause 9.1.21a
  
```

10.5.2.23 P1 Rest Octets

The *P1 Rest Octets* information element contains information about the status of information on an existing NCH, priority levels and packet page indications applied for mobile station identities and spare bits.

The *P1 Rest Octets* information element is a type 5 information element with 0-17 octets length.

```

{ <P1 Rest Octets> ::=
  {L | H <NLN(PCH) : bit (2)> <NLN status : bit>}
  {L | H <Priority1 ::= Priority>}
  {L | H <Priority2 ::= Priority>}
  {L | H <Group Call information>}
  < Packet Page Indication 1 : {L | H} >
  < Packet Page Indication 2 : {L | H} >
  < spare padding >;
} -- truncation allowed, bits 'L' assumed
<Priority> ::= <bit (3)>;
<Group Call information>
See clause 9.1.21a

```

NOTE 1: The value 17h shall not be used as a value of the first octet when this information element is used in the PAGING REQUEST TYPE 1 message. This will prevent mobile stations misinterpreting this information as the Mobile Identity IEI.

Table 10.5.55/3GPP TS 04.18 P1 Rest Octets information element

NLN(PCH) Notification List Number

The presence of the *NLN(PCH)* field indicates that if an NCH is present, reduced NCH monitoring can be used, and gives the NLN(PCH) value, to be used as specified in 3.3.3.

Priority: Priority *i* relates to *Mobile Station Identity i* (*i* = 1, 2)

0 0 0	no priority applied
0 0 1	call priority level 4
0 1 0	call priority level 3
0 1 1	call priority level 2
1 0 0	call priority level 1
1 0 1	call priority level 0
1 1 0	call priority level B
1 1 1	call priority level A

The **Packet Page Indication *i*** field relates to *Mobile Station Identity i* (*i* = 1, 2) and indicates the kind of paging procedure associated with the mobile station identity. If the identity is not IMSI the Packet Page Indication has no meaning and is ignored.

L	paging procedure for RR connection establishment;
H	packet paging procedure.

10.5.2.24 P2 Rest Octets

The *P2 Rest Octets* information element contains information on the channel needed by the network and information about the status of information on an existing NCH, priority levels and packet page indications applied for mobile station identities and spare bits.

The *P2 Rest Octets* information element is a type 5 information element with 1-11 octets length.

```

{
  <P2 Rest Octets> ::=
  {L | H <CN3: bit (2)>}
  {L | H <NLN : bit (2)> <NLN status : bit>}
  {L | H <Priority1 ::= Priority>}
  {L | H <Priority2 ::= Priority>}
  {L | H <Priority3 ::= Priority>}
  < Packet Page Indication 3 : {L | H} >
  <spare padding>;
}
-- truncation allowed, bits 'L' assumed

<Priority> ::= <bit(3)>;

```

NOTE 1: The value 17h shall not be used as a value of the first octet when this information element is used in the PAGING REQUEST TYPE 2 message. This will prevent mobile stations misinterpreting this information as the Mobile Identity IEI.

Table 10.5.56/3GPP TS 04.18: P2 Rest Octets information element

CN3 Channel Needed for Mobile Identity 3

The values and semantics used in the *CN3* field are those of the CHANNEL field of *Channel Needed* IE (see 10.5.2.8). The *CN3* field is associated with the Mobile Identity 3 IE of the PAGING REQUEST TYPE 2 message.

If the *CN3* field is not present, the default value is 00 (any channel).

NLN Notification List Number

See P1 Rest Octets.

Priority: **Priority i** relates to *Mobile Station Identity i* ($i = 1, 2, 3$)

0 0 0	no priority applied
0 0 1	call priority level 4
0 1 0	call priority level 3
0 1 1	call priority level 2
1 0 0	call priority level 1
1 0 1	call priority level 0
1 1 0	call priority level B
1 1 1	call priority level A

The **Packet Page Indication 3** field relates to *Mobile Station Identity 3* and indicates the kind of paging procedure associated with the mobile station identity. If the identity is not IMSI the Packet Page Indication has no meaning and is ignored.

L	paging procedure for RR connection establishment;
H	packet paging procedure.

10.5.2.25 P3 Rest Octets

The *P3 Rest Octets* information element contains information on the channel needed by the network and information about the status of information on an existing NCH, priority levels applied for mobile station identities and spare bits. The purpose of the spare bits is to allow the upward compatible introduction of new information on the PCH in later phases.

The *P3 Rest Octets* information element is a type 5 information element with 3 octets length.

```

<P3 Rest Octets> ::=
  {L | H <CN3 : bit (2)> <CN4 : bit (2)>}
  {L | H <NLN : bit (2)> <NLN status : bit>}
  {L | H <Priority1 ::= Priority>}
  {L | H <Priority2 ::= Priority>}
  {L | H <Priority3 ::= Priority>}
  {L | H <Priority4 ::= Priority>}
  <spare padding>;

<Priority> ::= <bit(3)>;

```

Table 10.5.57/3GPP TS 04.18: P3 Rest Octets information element

CN3 Channel Needed for Mobile Identity 3
The values and semantics used in the CN3 field are those of the CHANNEL field of Channel Needed IE (see 10.5.2.8). The CN3 field is associated with the Mobile Identity 3 IE of the PAGING REQUEST TYPE 3 message.

If the CN3 field is not present, the default value is 00 (any channel)

CN4 Channel Needed for Mobile Identity 4
The values and semantics used in the CN43 field are those of the CHANNEL field of Channel Needed IE (see 10.5.2.8). The CN4 field is associated with the Mobile Identity 4 IE of the PAGING REQUEST TYPE 3 message.

If the CN4 field is not present, the default value is 00 (any channel)

NLN Notification List Number
See P1 Rest Octets

Priority: Priority i relates to Mobile Station Identity i
i (i = 1,2,3,4)

0 0 0	no priority applied
0 0 1	call priority level 4
0 1 0	call priority level 3
0 1 1	call priority level 2
1 0 0	call priority level 1
1 0 1	call priority level 0
1 1 0	call priority level B
1 1 1	call priority level A

10.5.2.25a Packet Channel Description

The purpose of the *Packet Channel Description* information element is to provide a description of a packet data physical channel (PDCH).

The *Packet Channel Description* information element is coded according to the syntax specified below and described in table 10.58/3GPP TS 04.18.

The *Packet Channel Description* is a type 3 information element with 4 octets length.

```

< Packet Channel Description > ::=
  < Channel type : bit (5) >
  < TN : bit (3) >
  < TSC : bit (3) >
  { 0
    { 0 < spare bit >
      < ARFCN : bit (10) >           -- non-hopping RF channel configuraion
    | 1 < spare bit >
      < MAIO : bit (6) >           -- indirect encoding of hopping RF channel configuration
      < MA_NUMBER_IND : bit >
      { 0 < spare bits : bit (2) >
        | 1 < CHANGE_MARK_1 : bit (2) >
      }
    }
  | 1
    < MAIO : bit (6) >           -- direct encoding of hopping RF channel configuration
    < HSN : bit (6) >
  };

```

Table 10.5.58/3GPP TS 04.18: Packet Channel Description information element

The **Channel type** field (5 bit) shall be ignored by the receiver and all bits treated as spare. For backward compatibility reasons, the sender shall set the spare bits to binary '00001'.

The **TN** field (3 bit) is the binary representation of the timeslot number as defined in 3GPP TS 05.10. Range: 0 to 7

The **TSC** field (3 bit) is the binary representation of the training sequence code as defined in 3GPP TS 05.02. Range: 0 to 7.

Non-hopping RF channel configuration

The **ARFCN** field (10 bit) is the binary representation of the absolute RF channel number, see 3GPP TS 05.05. Range: 0 to 1023.

Indirect encoding of hopping RF channel configuration

The **MAIO** field (6 bit) is the binary representation of the mobile allocation index offset, see 3GPP TS 05.02. Range: 0 to 63.

The **MA_NUMBER_IND** field (1 bit) is the binary representation of the MA_NUMBER to use as reference to a GPRS mobile allocation:

0	MA_NUMBER = 14
1	MA_NUMBER = 15

The **CHANGE_MARK_1** field (2 bit) is the binary representation of the allowed value of the SI *change mark* associated with the GPRS mobile allocation to which the MA_NUMBER refers. Range: 0 to 3.

If the *indirect encoding* is used, this information element may contain the CHANGE_MARK_1 field. If that is present, the mobile station being assigned the TBF shall verify the validity of the SI *change mark* associated with the GPRS mobile allocation to which this information element refers, see 3GPP TS 04.60. The CHANGE_MARK_1 field shall not be included in this information element if MA_NUMBER = 15 is used.

Direct encoding of hopping RF channel configuration

The **MAIO** field (6 bit) is the binary representation of the mobile allocation index offset, see 3GPP TS 05.02. Range: 0 to 63.

The **HSN** field (6 bit) is the binary representation of the hopping sequence number, see 3GPP TS 05.02. Range: 0 to 63.

10.5.2.25b Dedicated mode or TBF

The *Dedicated mode or TBF* information element is used by the network to indicate to the mobile station whether the rest of the message shall be decoded as an IMMEDIATE ASSIGNMENT message allocating a channel in dedicated mode or whether the rest of the message shall be decoded as the allocation of a Temporary Block Flow.

This IE also indicates:

- whether the IMMEDIATE ASSIGNMENT message relates to a downlink TBF for a mobile station in packet idle mode; and
- whether the IMMEDIATE ASSIGNMENT message is the first message of two IMMEDIATE ASSIGNMENT messages in a two-message assignment of an uplink or downlink TBF.

The *Dedicated mode or TBF* information element is coded as shown in figure 10.5.55/3GPP TS 04.18 and table 10.5.59/3GPP TS 04.18.

The *Dedicated mode or TBF* is a type 1 information element.

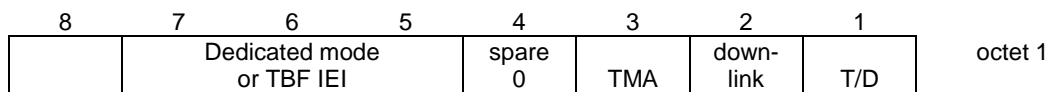

Figure 10.5.55/3GPP TS 04.18 *Dedicated mode or TBF* information element

Table 10.5.59/3GPP TS 04.18: *Dedicated mode or TBF* information element

<p>T/D : TBF or dedicated mode (octet 1)</p> <p>Bit 1 0 this message assigns a dedicated mode resource 1 this message assigns a Temporary Block Flow (TBF).</p> <p>Downlink : Downlink assignment to mobile in packet idle mode</p> <p>Bit 2 0 No meaning 1 this message assigns a resource to the mobile station identified in the IA rest octets. The type of resource (either dedicated mode or TBF) is indicated by bit 1.</p> <p>TMA : Two-message assignment</p> <p>Bit 3 0 No meaning 1 This message is the first message of two in a two-message assignment of an uplink or downlink TBF.</p>

10.5.2.25c RR Packet Uplink Assignment

The *RR Packet Uplink Assignment* information element is sent by the network to the mobile station to indicate the assigned uplink resources.

The *RR Packet Uplink Assignment* information element is coded as shown in tables 10.5.60/3GPP TS 04.18 and 10.5.61/3GPP TS 04.18.

The *RR Packet Uplink Assignment* is a type 4 information element.

Table 10.5.60: RR PACKET UPLINK ASSIGNMENT information element

```

< RR Packet Uplink Assignment IE > ::=
  < LENGTH_IN_OCTETS : bit (8) >
  < CHANNEL_CODING_COMMAND : bit (2) >
  < TLLI_BLOCK_CHANNEL_CODING : bit (1) >
  < Packet Timing Advance : Packet Timing Advance IE >
  {01 <Dynamic Allocation : Dynamic Allocation struct>
   | 10 <Single Block Allocation : Single Block Allocation struct>
   | 11 <Fixed Allocation : Fixed Allocation struct>
   | 00 <Extension>}
  {0 | 1 < EGPRS_MCS_MODE : bit (4) >
   < RESEGMENT : bit (1) >
   < EGPRS Window Size : < EGPRS Window Size IE >>}
  { 0 | 1 < Packet Extended Timing Advance : bit (2) >}
  < SPARE_BITS : bit** >;

  <Extension> : := -- Future extension can be done by modifying this structure
  null;

<Dynamic Allocation struct > ::=
  < Extended Dynamic Allocation : bit(1)>
  {0 | 1 < P0 : bit (4) >
   < PR_MODE : bit (1) >}
  < USF_GRANULARITY : bit (1) >
  { 0 | 1 < UPLINK_TFI_ASSIGNMENT : bit (5) >}
  { 0 | 1 < RLC_DATA_BLOCKS_GRANTED : bit (8) >}
  { 0
   -- Timeslot Allocation
   { 0 | 1 < USF_TN0 : bit (3) >}
   { 0 | 1 < USF_TN1 : bit (3) >}
   { 0 | 1 < USF_TN2 : bit (3) >}
   { 0 | 1 < USF_TN3 : bit (3) >}
   { 0 | 1 < USF_TN4 : bit (3) >}
   { 0 | 1 < USF_TN5 : bit (3) >}
   { 0 | 1 < USF_TN6 : bit (3) >}
   { 0 | 1 < USF_TN7 : bit (3) >}
   | 1
   -- Timeslot Allocation with Power Control Parameters
   < ALPHA : bit (4) >
   { 0 | 1 < USF_TN0 : bit (3) >}
   < GAMMA_TN0 : bit (5) >}
   { 0 | 1 < USF_TN1 : bit (3) >}
   < GAMMA_TN1 : bit (5) >}
   { 0 | 1 < USF_TN2 : bit (3) >}
   < GAMMA_TN2 : bit (5) >}
   { 0 | 1 < USF_TN3 : bit (3) >}
   < GAMMA_TN3 : bit (5) >}
   { 0 | 1 < USF_TN4 : bit (3) >}
   < GAMMA_TN4 : bit (5) >}
   { 0 | 1 < USF_TN5 : bit (3) >}
   < GAMMA_TN5 : bit (5) >}
   { 0 | 1 < USF_TN6 : bit (3) >}
   < GAMMA_TN6 : bit (5) >}
   { 0 | 1 < USF_TN7 : bit (3) >}
   < GAMMA_TN7 : bit (5) >}};

<Single Block Allocation struct > ::=
  < TIMESLOT_NUMBER : bit (3) >
  { 0 | 1 < ALPHA : bit (4) >
   < GAMMA_TN : bit (5) >}
  { 0 | 1 < P0 : bit (4) >
   < BTS_PWR_CTRL_MODE : bit (1) >
   < PR_MODE : bit (1) >};

```

```

<Fixed Allocation struct > ::=
  { 0 | 1 < UPLINK_TFI_ASSIGNMENT : bit (5) > }
  < FINAL_ALLOCATION : bit (1)>
  < DOWNLINK_CONTROL_TIMESLOT: bit(3)>
  { 0 | 1 < P0 : bit (4)
    < BTS_PWR_CTRL_MODE : bit (1) >
    < PR_MODE : bit (1) > }
  { 0 < TIMESLOT_ALLOCATION : bit (8) >
    | 1 < Power Control Parameters : Power Control Parameters IE > }
  < HALF_DUPLEX_MODE : bit (1) >
  { 0 { 0 -- with length of allocation bitmap
    < BLOCKS_OR_BLOCK_PERIODS : bit (1) >
    < ALLOCATION_BITMAP_LENGTH : bit (7) >
    < ALLOCATION_BITMAP : bit (val(ALLOCATION_BITMAP_LENGTH) >
    | 1 -- without length of Allocation Bitmap (fills remainder of this IE)
    < ALLOCATION_BITMAP : bit ** > }
  ! < Message escape : 1 bit (*) = <no string> > } ;

```

Table 10.5.61: RR PACKET UPLINK ASSIGNMENT information element details

LENGTH_IN_OCTETS (8 bit field)

This field encodes (in binary) the number that is equal to one eighth of the number of bits in the *RR Packet Uplink Assignment* information element that follow the end of this field.

TIMESLOT_ALLOCATION (8 bit field)

This field is encoded as the TIMESLOT_ALLOCATION field in the PACKET UPLINK ASSIGNMENT message in 3GPP TS 04.60.

CHANNEL_CODING_COMMAND (2 bit field)

This field is encoded as the CHANNEL_CODING_COMMAND field in the PACKET UPLINK ASSIGNMENT message in 3GPP TS 04.60.

EGPRS_MCS_MODE (4 bit field)

For backward compatibility reasons, the receiver of this message shall consider the case that the EGPRS_MCS_MODE parameter may not be present in the message. EGPRS_MCS_MODE is present for EGPRS only and if present the CHANNEL_CODING_COMMAND which is for GPRS mobiles is not valid. This field is coded as the EGPRS Modulation and Coding Scheme IE in the PACKET UPLINK ASSIGNMENT message in 3GPP TS 04.60.

RESEGMENT (1 bit field)

This field is coded as the RESEGMENT bit in the PACKET UPLINK ASSIGNMENT message in 3GPP TS 04.60.

EGPRS Window Size IE

This field is encoded as the EGPRS window size IE in the PACKET DOWNLINK ASSIGNMENT message in 3GPP TS 04.60.

TLLI_BLOCK_CHANNEL_CODING (1 bit field)

This field is encoded as the TLLI_BLOCK_CHANNEL_CODING field in the PACKET UPLINK ASSIGNMENT message in 3GPP TS 04.60.

Packet Timing Advance IE

This field is encoded as the Packet Timing Advance IE in the PACKET UPLINK ASSIGNMENT message in 3GPP TS 04.60.

Dynamic Allocation struct

This information element contains parameters necessary to define the radio resources of a dynamic allocation or an extended dynamic allocation.

Extended Dynamic Allocation (1 bit field)

This information field indicates the medium access mode to be used during the TBF.

0 Dynamic Allocation

1 Extended Dynamic Allocation

UPLINK_TFI_ASSIGNMENT (5 bit field)

If present, this field is encoded as the UPLINK_TFI_ASSIGNMENT information element in the PACKET UPLINK ASSIGNMENT message in 3GPP TS 04.60.

Power Control Parameters IE

If present, this field is encoded as the Power Control Parameters IE in the PACKET UPLINK ASSIGNMENT message in 3GPP TS 04.60.

RLC_DATA_BLOCKS_GRANTED (8 bit field)

If present, this field is encoded as the RLC_DATA_BLOCKS_GRANTED field in the PACKET UPLINK ASSIGNMENT message in 3GPP TS 04.60.

USF for Timeslot Number 0 (TN0) (3 bit field)**USF for Timeslot Number 1 (TN1)** (3 bit field)**USF for Timeslot Number 2 (TN2)** (3 bit field)**USF for Timeslot Number 3 (TN3)** (3 bit field)**USF for Timeslot Number 4 (TN4)** (3 bit field)**USF for Timeslot Number 5 (TN5)** (3 bit field)**USF for Timeslot Number 6 (TN6)** (3 bit field)**USF for Timeslot Number 7 (TN7)** (3 bit field)

If present, these fields are encoded as the USF for Timeslot Number X field (where $0 \leq X < 8$) in the PACKET UPLINK ASSIGNMENT message in 3GPP TS 04.60.

Single Block Allocation struct

This information element contains parameters necessary to define the radio resources of a Single Block allocation. For example for sending of a PACKET RESOURCE REQUEST message in a two phase access or a Measurement report.

ALPHA (4 bit field)

The ALPHA Power control parameter field is coded according to the following table:

bits				
<u>4</u>	<u>3</u>	<u>2</u>	<u>1</u>	
0	0	0	0	$\alpha = 0.0$
0	0	0	1	$\alpha = 0.1$
:	:	:	:	
1	0	0	1	$\alpha = 0.9$
1	0	1	0	$\alpha = 1.0$

All other values are reserved in this version of the protocol and shall be interpreted by the mobile station as $\alpha = 1.0$.

TIMESLOT_NUMBER (3 bit field)

If present, this field is encoded as the TIMESLOT_NUMBER field in the PACKET UPLINK ASSIGNMENT message in 3GPP TS 04.60.

GAMMA_TN (5 bit field)

The GAMMA_TN field is the binary representation of the parameter Γ_{CH} for MS output power control in units of 2 dB, see 3GPP TS 05.08.

P0, BTS_PWR_CTRL_MODE and PR_MODE fields

These fields are optional downlink power control parameters and are encoded as in the PACKET UPLINK ASSIGNMENT message in 3GPP TS 04.60.

Fixed Allocation struct

This information element contains parameters necessary to define the radio resources of a fixed allocation.

FINAL_ALLOCATION (1 bit field)

This field indicates whether this allocation is the last allocation of the TBF.

- 0 this allocation is not the last allocation of the TBF
- 1 this allocation is the last allocation of the TBF

DOWNLINK_CONTROL_TIMESLOT (3 bit field)

This information field indicates the downlink timeslot that mobile station operating in fixed allocation mode shall monitor for downlink PACCH. This field is coded as the binary representation of the timeslot number as defined in 3GPP TS 05.10.

Range 0 to 7

HALF_DUPLEX_MODE (1 bit field)

This information field indicates, for multislot class 19 to 29, whether the mobile station shall operate in half duplex mode.

Bit

0 the MS shall not operate in half duplex mode

1 the MS shall operate in half duplex mode

BLOCKS_OR_BLOCK_PERIODS (1 bit field)

If present, this field is encoded as the BLOCKS_OR_BLOCK_PERIODS field in the PACKET UPLINK ASSIGNMENT message in 3GPP TS 04.60.

ALLOCATION_BITMAP_LENGTH (7 bit field)

If present, this field is encoded as the ALLOCATION_BITMAP_LENGTH field in the PACKET UPLINK ASSIGNMENT message in 3GPP TS 04.60.

ALLOCATION_BITMAP (variable length field)

If present, this field is encoded as the ALLOCATION_BITMAP field in the PACKET UPLINK ASSIGNMENT message in 3GPP TS 04.60. If the ALLOCATION_BITMAP_LENGTH field is not present, the ALLOCATION_BITMAP fills the remainder of the information element. However the network shall ensure, that in the case of a missing ALLOCATION_BITMAP_LENGTH, the length of the ALLOCATION_BITMAP shall not exceed the maximum length of 256 bits. If the network includes more bits than this maximum length the network has to take into account that there may be two kinds of mobiles: mobiles which are capable of handling the large allocation bitmap, and mobiles which would only use the 256 highest numbered ALLOCATION_BITMAP bit number indexes (as the BLOCKS_OR_BLOCK_PERIOD field is missing) and would ignore the bits with lower indices (i.e. the MS would react after 256 blocks as if the allocation had exhausted (3GPP TS 04.60)).

Packet Extended Timing Advance (2 bit field)

This bit field is used to support Extended Timing Advance.

Bit

1 bit 7 of the Timing Advance IE defined in section 10.5.2.40

2 bit 8 of the Timing Advance IE defined in section 10.5.2.40

Extension and Message escape fields

For mobile stations implemented according to this version of the protocol, those fields shall be considered as reserved values.

10.5.2.25d RR Packet Downlink Assignment

The *RR Packet Downlink Assignment* information element is sent by the network to the mobile station to indicate the assigned downlink resources.

The *RR Packet Downlink Assignment* information element is coded as shown in tables 10.5.62/3GPP TS 04.18 and 10.5.63/3GPP TS 04.18.

The *RR Packet Downlink Assignment* is a type 4 information element.

For a mobile station assigned to operate in the fixed allocation MAC mode, the network may assign regularly repeating intervals during which the mobile station shall measure neighbour cell power levels.

Table 10.5.62: RR PACKET DOWNLINK ASSIGNMENT information element

```

< RR Packet Downlink Assignment IE > ::=
  < LENGTH_IN_OCTETS : bit (8) >
  < MAC_MODE : bit (2) >
  < RLC_MODE : bit (1) >
  < TIMESLOT_ALLOCATION : bit (8) >
    < Packet Timing Advance : Packet Timing Advance IE >
  { 0 | 1 < PO : bit (4) >
    < BTS_PWR_CTRL_MODE : bit(1) >
    < PR_MODE : bit (1) >}
  { 0 | 1 < Power Control Parameters : Power Control Parameters IE > }
  { 0 | 1 < DOWNLINK_TFI_ASSIGNMENT : bit (5) > }
  { 0 | 1 < MEASUREMENT_STARTING_TIME : bit (16) >
    < MEASUREMENT_INTERVAL : bit (5) >
    < MEASUREMENT_BITMAP : bit (8) > }
  { 0 | 1-- indicates EGPRS TBF mode, see 04.60
    < EGPRS Window Size : < EGPRS Window Size IE >>
    < LINK_QUALITY_MEASUREMENT_MODE : bit (2)>}
  { 0 | 1 < Packet Extended timing Advance : bit (2)> }
  < SPARE_BITS : bit **> ;

```

Table 10.5.63: RR PACKET DOWNLINK ASSIGNMENT information element details

LENGTH_IN_OCTETS (8 bit field)

This field encodes (in binary) the number that is equal to one eighth of the number of bits in the *RR Packet Downlink Assignment* information element that follow the end of this field.

MAC_MODE (2 bit field)

This field is encoded as the MAC_MODE information field in the PACKET DOWNLINK ASSIGNMENT message in 3GPP TS 04.60.

RLC_MODE (1 bit field)

This field is encoded as the RLC_MODE field in the PACKET DOWNLINK ASSIGNMENT message in 3GPP TS 04.60.

TIMESLOT_ALLOCATION (8 bit field)

This field is encoded as the TIMESLOT_ALLOCATION field in the PACKET DOWNLINK ASSIGNMENT message in 3GPP TS 04.60.

Packet Timing Advance IE

This field is encoded as the Packet Timing Advance IE in the PACKET DOWNLINK ASSIGNMENT message in 3GPP TS 04.60.

PO, BTS_PWR_CTRL_MODE and PR_MODE fields

These fields are optional downlink power control parameters and are encoded as in the PACKET UPLINK ASSIGNMENT message in 3GPP TS 04.60.

Power Control Parameters IE

This field is encoded as the Power Control Parameters IE in the PACKET DOWNLINK ASSIGNMENT message in 3GPP TS 04.60.

DOWNLINK_TFI_ASSIGNMENT (5 bit field)

If present, this field is encoded as the DOWNLINK_TFI_ASSIGNMENT information element in the PACKET DOWNLINK ASSIGNMENT message in 3GPP TS 04.60.

MEASUREMENT_STARTING_TIME (16 bit field)

If present, this field is encoded as the MEASUREMENT_STARTING_TIME field in the PACKET DOWNLINK ASSIGNMENT message in 3GPP TS 04.60.

MEASUREMENT_BITMAP (8 bit field)

If present, this field is encoded as the MEASUREMENT BITMAP information field in the PACKET DOWNLINK ASSIGNMENT message in 3GPP TS 04.60.

MEASUREMENT_INTERVAL (5 bit field)
 If present, this field is encoded as the MEASUREMENT_INTERVAL field in the PACKET DOWNLINK ASSIGNMENT message in 3GPP TS 04.60.

EGPRS Window Size IE
 This field is encoded as the EGPRS window size IE in the PACKET UPLINK ASSIGNMENT message in 3GPP TS 04.60.

LINK_QUALITY_MEASUREMENT_MODE (2 bit field)
 This field is encoded as the LINK_QUALITY_MEASUREMENT_MODE in the PACKET DOWNLINK ASSIGNMENT message in 3GPP TS 04.60.

Packet Extended Timing Advance (2 bit field)
 This bit field is used for support of Extended Timing Advance.

Bit
 1 bit 7 of the Timing Advance IE defined in section 10.5.2.40
 2 bit 8 of the Timing Advance IE defined in section 10.5.2.40

10.5.2.26 Page Mode

The purpose of the *Page Mode* information element is to control the action of the mobile station belonging to the paging subgroup corresponding to the paging subchannel.

The *Page Mode* information element is coded as shown in figure 10.5.56/3GPP TS 04.18 and table 10.5.64/3GPP TS 04.18.

The *Page Mode* is a type 1 information element.

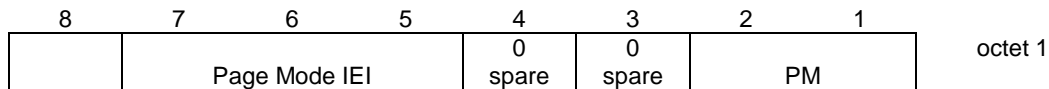

Figure 10.5.56/3GPP TS 04.18 Page Mode information element

Table 10.5.64/3GPP TS 04.18: Page Mode information element

PM (octet 1)	
Bits	
2 1	
0 0	Normal paging.
0 1	Extended paging.
1 0	Paging reorganization.
1 1	Same as before.
Note: The value "same as before" has been defined instead of "reserved" to allow the use of this coding with another meaning in an upwards compatible way in later phases of the GSM system.	

10.5.2.26a Spare

10.5.2.26b Spare

10.5.2.26c Spare

10.5.2.26d Spare

10.5.2.27 NCC Permitted

The purpose of the *NCC Permitted* information element is to provide a definition of the allowed NCCs on the BCCH carriers to be reported in the MEASUREMENT REPORT message by the mobile stations in the cell.

The *NCC Permitted* information element is coded as shown in figure 10.5.57/3GPP TS 04.18 and table 10.5.65/3GPP TS 04.18.

The *NCC Permitted* is a type 3 information element with 2 octets length.

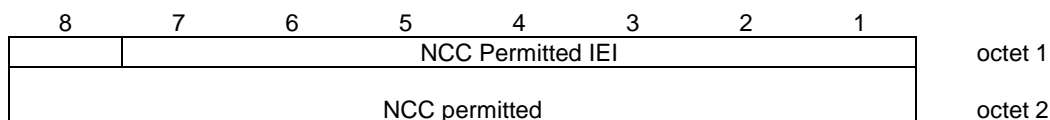

Figure 10.5.57/3GPP TS 04.18 NCC Permitted information element

Table 10.5.65/3GPP TS 04.18: NCC Permitted information element

NCC permitted (octet 2) The NCC permitted field is coded as a bit map, i.e. bit N is coded with a "0" if the BCCH carrier with NCC = N-1 is not permitted for monitoring and with a "1" if the BCCH carrier with NCC = N-1 is permitted for monitoring; N = 1,2,...,8.

10.5.2.28 Power Command

The purpose of the *Power Command* information element is to provide the power level to be used by the mobile station.

The *Power Command* information element is coded as shown in figure 10.5.58/3GPP TS 04.18 and table 10.5.66/3GPP TS 04.18.

The *Power Command* is a type 3 information element with 2 octets length.

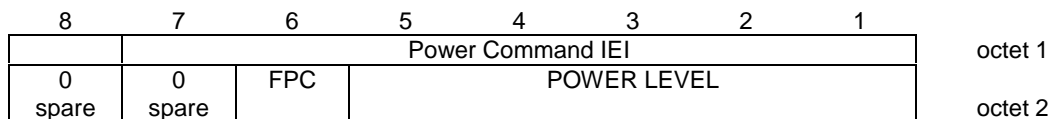

Figure 10.5.58/3GPP TS 04.18 Power Command information element

Table 10.5.66/3GPP TS 04.18: Power Command information element

FPC (octet 2) The FPC field (octet 2) indicates whether Fast Measurement Reporting and Power Control mechanism is used. It is coded as follows: Value 0 FPC not in use 1 FPC in use Power level (octet 2)
--

The power level field is coded as the binary representation of the "power control level", see 3GPP TS 05.05.
 This value shall be used by the mobile station according to 3GPP TS 05.08.

Range: 0 to 31.

10.5.2.28a Power Command and access type

The purpose of the *Power Command and access type* information element is to provide the power level to be used by the mobile station and the indication that the mobile station can avoid the transmission of handover access.

The *Power Command and access type* information element is coded as shown in figure 10.5.59/3GPP TS 04.18 and table 10.5.67/3GPP TS 04.18.

The *Power Command and access type* is a type 3 information element with 2 octets length.

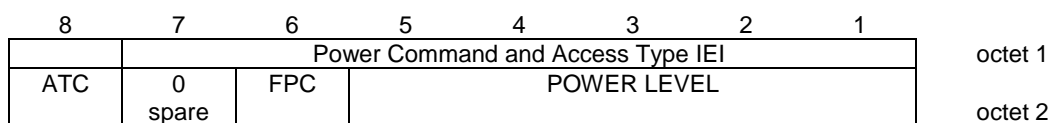

Figure 10.5.59/3GPP TS 04.18 *Power Command and access type* information element

Table 10.5.67/3GPP TS 04.18: *Power Command and access type* information element

ATC (Access Type Control) (octet 2)
 bit 8
 0 Sending of Handover access is mandatory
 1 Sending of Handover access is optional

FPC (octet 2)
 The FPC field (octet 2) indicates whether Fast Measurement Reporting and Power Control mechanism is used. It is coded as follows:

Value

0 FPC not in use
 1 FPC in use

Power level (octet 2)
 The power level field is coded as the binary representation of the "power control level", see 3GPP TS 05.05.
 This value shall be used by the mobile station according to 3GPP TS 05.08.

Range: 0 to 31.

10.5.2.29 RACH Control Parameters

The purpose of the *RACH Control Parameters* information element is to provide parameters used to control the RACH utilization. This information element is broadcast to mobile stations in SYSTEM INFORMATION TYPE 1, 2, 2bis, 3, and 4 messages.

The *RACH Control Parameters* information element is coded as shown in figure 10.5.60/3GPP TS 04.18 and table 10.5.68/3GPP TS 04.18.

The *RACH Control Parameters* is a type 3 information element with 4 octets length.

8	7	6	5	4	3	2	1	
RACH Control Parameters IEI								octet 1
Max retrans		Tx-integer				CELL BARR ACCESS	RE	octet 2
AC C15	AC C14	AC C13	AC C12	AC C11	AC C10	AC C09	AC C08	octet 3
AC C07	AC C06	AC C05	AC C04	AC C03	AC C02	AC C01	AC C00	octet 4

Figure 10.5.60/3GPP TS 04.18 RACH Control Parameters information element

Table 10.5.68/3GPP TS 04.18: RACH Control Parameters information element

<p>Max retrans, Maximum number of retransmissions (octet 2)</p> <p>Bits</p> <p>8 7</p> <p>0 0 Maximum 1 retransmission</p> <p>0 1 Maximum 2 retransmissions</p> <p>1 0 Maximum 4 retransmissions</p> <p>1 1 Maximum 7 retransmissions</p> <p>Tx-integer, Number of slots to spread transmission (octet 2)</p> <p>Bits</p> <p>6 5 4 3</p> <p>0 0 0 0 3 slots used to spread transmission</p> <p>0 0 0 1 4 slots used to spread transmission</p> <p>0 0 1 0 5 slots used to spread transmission</p> <p>0 0 1 1 6 slots used to spread transmission</p> <p>0 1 0 0 7 slots used to spread transmission</p> <p>0 1 0 1 8 slots used to spread transmission</p> <p>0 1 1 0 9 slots used to spread transmission</p> <p>0 1 1 1 10 slots used to spread transmission</p> <p>1 0 0 0 11 slots used to spread transmission</p> <p>1 0 0 1 12 slots used to spread transmission</p> <p>1 0 1 0 14 slots used to spread transmission</p> <p>1 0 1 1 16 slots used to spread transmission</p> <p>1 1 0 0 20 slots used to spread transmission</p> <p>1 1 0 1 25 slots used to spread transmission</p> <p>1 1 1 0 32 slots used to spread transmission</p> <p>1 1 1 1 50 slots used to spread transmission</p> <p>CELL_BAR_ACCESS, Cell Barred for Access (octet 2)</p> <p>Bit</p> <p>2</p> <p>0 The cell is not barred, see 3G3GPP TS 23.022</p> <p>1 The cell is barred, see 3G3GPP TS 23.022</p> <p>RE, Call reestablishment allowed (octet 2)</p> <p>Bit</p> <p>1</p> <p>0 Call Reestablishment allowed in the cell</p> <p>1 Call Reestablishment not allowed in the cell</p> <p>EC Emergency Call allowed (octet 3 bit 3)</p> <p>3</p> <p>0 Emergency call allowed in the cell to all MSs</p> <p>1 Emergency call not allowed in the cell except for the MSs that belong to one of the classes between 11 to 15</p> <p>AC CN, Access Control Class N (octet 3(except bit 3) and octet 4)</p> <p>For a mobile station with AC C = N access is not barred if the AC CN bit is coded with a "0"; N = 0, 1, .. 9,11, .., 15.</p>
--

10.5.2.30 Request Reference

The purpose of the *Request Reference* information element is to provide the random access information used in the channel request and the frame number, FN modulo 42432 in which the channel request was received.

The *Request Reference* information element is coded as shown in figure 10.5.61/3GPP TS 04.18 and table 10.5.69/3GPP TS 04.18.

The *Request Reference* is a type 3 information element with 4 octets length.

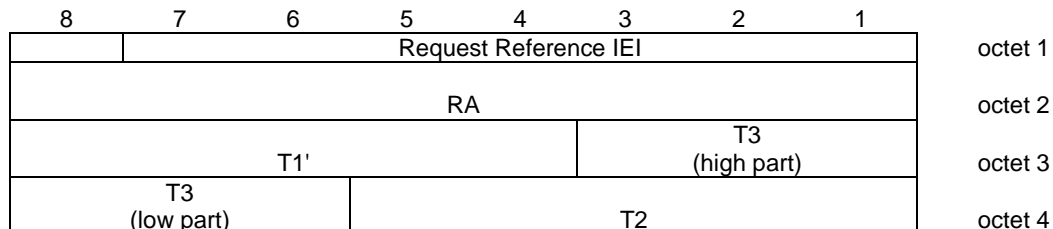

Figure 10.5.61/3GPP TS 04.18 Request Reference information element

Table 10.5.69/3GPP TS 04.18: Request Reference information element

<p>RA, Random Access Information (octet 2) This is an unformatted 8 bit field. Typically the contents of this field are coded the same as the CHANNEL REQUEST message shown in Table 9.9, section 9.1.8</p> <p>T1' (octet 2) The T1' field is coded as the binary representation of $(FN \text{ div } 1326) \text{ mod } 32$.</p> <p>T3 (octet 3 and 4) The T3 field is coded as the binary representation of $FN \text{ mod } 51$. Bit 3 of octet 2 is the most significant bit and bit 6 of octet 3 is the least significant bit.</p> <p>T2 (octet 4) The T2 field is coded as the binary representation of $FN \text{ mod } 26$.</p> <p>NOTE 1: The frame number, FN modulo 42432 can be calculated as $51 \times ((T3 - T2) \text{ mod } 26) + T3 + 51 \times 26 \times T1'$</p>
--

10.5.2.31 RR Cause

The purpose of the *RR Cause* information element is to provide the reason for release or the reason for completion of an assignment or handover.

The *RR Cause* information element is coded as shown in figure 10.5.62/3GPP TS 04.18 and table 10.5.70/3GPP TS 04.18.

The *RR Cause* is a type 3 information element with 2 octets length.

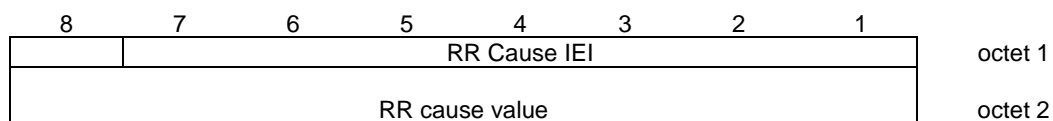

Figure 10.5.62/3GPP TS 04.18 RR Cause information element

Table 10.5.70/3GPP TS 04.18: *RR Cause* information element

RR cause value (octet 2)	
Bits	
8 7 6 5 4 3 2 1	
0 0 0 0 0 0 0 0	Normal event
0 0 0 0 0 0 0 1	Abnormal release, unspecified
0 0 0 0 0 0 1 0	Abnormal release, channel unacceptable
0 0 0 0 0 0 1 1	Abnormal release, timer expired
0 0 0 0 0 1 0 0	Abnormal release, no activity on the radio path
0 0 0 0 0 1 0 1	Preemptive release
0 0 0 0 1 0 0 0	Handover impossible, timing advance out of range
0 0 0 0 1 0 0 1	Channel mode unacceptable
0 0 0 0 1 0 1 0	Frequency not implemented
0 1 0 0 0 0 0 1	Call already cleared
0 1 0 1 1 1 1 1	Semantically incorrect message
0 1 1 0 0 0 0 0	Invalid mandatory information
0 1 1 0 0 0 0 1	Message type non-existent or not implemented
0 1 1 0 0 0 1 0	Message type not compatible with protocol state
0 1 1 0 0 1 0 0	Conditional IE error
0 1 1 0 0 1 0 1	No cell allocation available
0 1 1 0 1 1 1 1	Protocol error unspecified
All other cause values shall be treated as 0000 0000, 'normal event'	
The listed RR cause values are defined in Annex F.	

10.5.2.32 SI 1 Rest Octets

The *SI 1 Rest Octets* information element contains the position about the NCH and spare bits.

The *SI 1 Rest Octets* information element is a type 5 information element with 1 octet length.

```
<SI1 Rest Octets> ::=
  {L |H <NCH Position : bit (5)> };
  <spare padding> ;
```

Table 10.5.71/3GPP TS 04.18 SI 1 Rest Octets information element

NCH Position on the CCCH

The values in the NCH Position field indicates the block number of the CCCH block which is used for the first NCH block and the number of blocks used for the NCH. (The block numbering corresponds to table 5 in section 7 of 3GPP TS 05.02)

The absence of the NCH position field indicates that there is no NCH in the cell/on the carrying CCCH slot

The following coding applies if 1 or more basic physical channels are used for CCCH, not combined with SDCCHs.

Value	No of blocks	Number of first block
0 0 0 0 0	1	0
0 0 0 0 1	1	1
0 0 0 1 0	1	2
0 0 0 1 1	1	3
0 0 1 0 0	1	4
0 0 1 0 1	1	5
0 0 1 1 0	1	6
0 0 1 1 1	2	0
0 1 0 0 0	2	1
0 1 0 0 1	2	2
0 1 0 1 0	2	3
0 1 0 1 1	2	4
0 1 1 0 0	2	5
0 1 1 0 1	3	0
0 1 1 1 0	3	1
0 1 1 1 1	3	2
1 0 0 0 0	3	3
1 0 0 0 1	3	4
1 0 0 1 0	4	0
1 0 0 1 1	4	1
1 0 1 0 0	4	2
1 0 1 0 1	4	3
1 0 1 1 0	5	0
1 0 1 1 1	5	1
1 1 0 0 0	5	2
1 1 0 0 1	6	0
1 1 0 1 0	6	1
1 1 0 1 1	7	0

Other values are reserved for future use. A mobile station receiving a reserved value shall behave as if the NCH position was not present

In the case the CCCH configuration is not compatible with the NCH position (e.g., CCCH with combined SDCCH and the value different from 00000, 00001 or 00111), the mobile station shall behave as if the NCH Position field was not present.

10.5.2.33 SI 2bis Rest Octets

The *SI 2bis Rest Octets* information element contains only spare bits. Its purpose is to allow the upward compatible introduction of new information on the BCCH in later phases.

The *SI 2bis Rest Octets* information element is a type 5 information element with 1 octet length.

Table 10.5.71aa/3G3GPP TS 44.018 SI 2bis Rest Octets information element

```
<SI2bis Rest Octets> ::=
  <spare padding> ;
```

10.5.2.33a SI 2ter Rest Octets

SI2ter Rest Octets information element contains optional information on UMTS cell(s) to be monitored by the mobile in the cell. If some UMTS cell(s) are already included in the SI2quarter message, the union of them shall be monitored. Optionally this information element may in addition include thresholds that the mobile shall use for cell reselection. Information received in this message do not modify the 3G Neighbour Cell list used for reporting and defined in sub-clause 3.4.1.2.1.1.

The *SI 2ter Rest Octets* information element is a type 5 information element with 4 octets length.

Table 10.5.71ab/3G3GPP TS 44.018 SI 2ter Rest Octets information element

<SI2ter Rest Octets> ::=	
< SI2terRO_MP_CHANGE_MARK : bit(1) >	
< SI2terRO_3G_CHANGE_MARK : bit(1) >	
< SI2terRO_INDEX : bit(3) >	
< SI2terRO_COUNT : bit(3) >	
{ 0 1 < UMTS FDD Description : < UMTS FDD Description struct > > }	
{ 0 1 < UMTS TDD Description : < UMTS TDD Description struct > > }	
{ 0 1 < 3G MEASUREMENT Parameters Description : < 3G MEASUREMENT Parameters Description struct > > }	
< spare padding > ;	
< UMTS FDD Description > ::=	-- 20 bits are available if this structure is present on its own
{ 00 { 0 < FDD-ARFCN-INDEX : bit (3) > ** 1 } }	-- requires 2+4n+1 (19 bits for 4 freqs.)
01 < FDD-ARFCN : bit (14) >	-- requires 2+14=16 bits
10 < FDD-ARFCN-INDEX : bit (3) >	
< Scrambling_Code : bit (9) >	
< Diversity : bit >	-- requires 15 bits
11 < FDD-ARFCN-INDEX : bit (3) >	
< SC_P_SCG : bit (8) > ;	-- requires 13 bits
< UMTS TDD Description > ::=	-- 20 bits are available if this structure is present on its own
{ 00 { 0 < TDD-ARFCN-INDEX : bit (3) > ** 1 } }	-- requires 2+4n+1
01 < TDD-ARFCN : bit (14) >	-- requires 2+14=16 bits
10 < TDD-ARFCN-INDEX : bit (3) >	
< Cell Parameter : bit (7) >	
< Sync Case : bit >	
< Diversity : bit >	-- requires 14 bits
11 < TDD-ARFCN-INDEX : bit (3) >	
< TDD-ARFCN-INDEX : bit (3) >	
< TDD-ARFCN-INDEX : bit (3) > ;	-- requires 11 bits
< 3G MEASUREMENT Parameters Description > ::=	
< Qsearch_I : bit (4) >	
{ 0 1 < FDD_REP_QUANT : bit >	-- FDD Parameters
< FDD_Qoffset : bit (4) >	
< FDD_Qmin : bit (3) > }	
{ 0 1 < TDD_Qoffset : bit (4) > } ;	-- TDD Parameters

Table 10.5.71ac/3G3GPP TS 44.018 SI 2ter Rest Octets information element details

SI2terRO_MP_CHANGE_MARK (1 bit field), SI2ter Rest Octet Measurement Parameter Change Mark.
This parameter is used to indicate to the MS a change of information concerning 3G Measurement Parameters, as described in sub-clause 3.2.2.1, 'System information broadcasting'.

SI2terRO_3G_CHANGE_MARK (1 bit field), SI2ter Rest Octet 3G Change Mark.

This parameter is used to indicate to the MS a change of information concerning UMTS FDD Description and UMTS TDD Description, as described in sub-clause 3.2.2.1 'System information broadcasting'.

SI2terRO_INDEX (3 bit field) and **SI2terRO_COUNT** (3 bit field)

The purpose of the SI2terRO_INDEX and SI2terRO_COUNT fields is to indicate the number of individual sequences of SI2ter Rest Octet information elements and to assign an index to identify each of them. The SI2terRO_INDEX field is binary coded, range 0 to 7, and provides an index to identify the individual SI2ter Rest Octet information element. The SI2terRO_COUNT field is binary coded, range 0 to 7, and provides the SI2terRO_INDEX value for the last (highest indexed) information element in the sequence of SI2ter Rest Octet information elements.

UMTS FDD Description**FDD-ARFCN-INDEX** (3 bit field)

This field points to the absolute frequency received in the UMTS Freq list information element in the Channel Release message, see sub-clause 10.5.2.1d, 'UMTS frequency list'. If there is no frequency associated to this value of the FDD-ARFCN-INDEX parameter, this shall not be considered as an error.

FDD_ARFCN (14 bit field)

This optional information element is defined as the UARFCN in 3G3GPP TS 25.101. Any non-supported frequency is ignored.

When a frequency is included with no scrambling code information (no scrambling code and no SC_P_SCG), this indicates all the scrambling codes.

Scrambling Codes (9 bit field)

This parameter is defined in 3GPP TS 25.304.

SC_P_SCG (8 bit field)

Scrambling Codes per Scrambling Code Group. A bitmap indicates which Scrambling Codes per Scrambling Code group are used by the network.

Bits 8-1

Each bit "n" set to "1" indicates scrambling code subset "n-1". More than one scrambling code subset may be indicated. Each Scrambling code subset (n) indicates the 64 scrambling code indices $n+8*i$, with $i=[0..63]$.

Diversity (1 bit field)

This parameter indicates if diversity is applied for the cell:

Bit

0 Diversity is not applied for this cell

1 Diversity is applied for this cell.

UMTS TDD Description**TDD-ARFCN-INDEX** (3 bit field)

This field points to the absolute frequency received in the UMTS Freq list information element in the Channel Release message, see sub-clause 10.5.2.1d, 'UMTS frequency list'. If there is no frequency associated to this value of the TDD-ARFCN-INDEX parameter, this shall not be considered as an error.

TDD_ARFCN (14 bit field)

This optional information element is defined as the UARFCN in 3G3GPP TS 25.102. Any non supported frequency is ignored.

When a frequency is included with no Cell Parameter information, this indicates all the Cell Parameter values.

Cell Parameter (7 bit field)

This parameter is defined in 3GPP TS 25.304.

Sync Case (1 bit field)

This parameter is defined in 3GPP TS 25.304.

Diversity (1 bit field)

This parameter indicates if diversity is applied for the cell:

Bit

0 Diversity is not applied for this cell

1 Diversity is applied for this cell.

3G Measurement Parameters Description:

These parameters are defined in 3GPP TS 05.08.

10.5.2.33b SI 2quater Rest Octets

The *SI 2quater Rest Octets* information element contains neighbour cell lists for UTRAN cells. For cell reselection, if the *SI 2ter Rest Octets* information element also contains information on 3G Cells, cell reselection shall be performed on the union of them.

The *SI 2quater Rest Octets* information element is a type 5 information element with 20 octet length.

Table 10.5.71a: SI2quater message content

```

< SI2quater Rest Octets > ::=
  < 3G-BA_IND : bit (1) >
  < MP_CHANGE_MARK : bit (1) >
  < SI2quater_INDEX : bit (4) >
  < SI2quater_COUNT : bit (4) >

  { 0 | 1 < 3G Neighbour Cells Description : < 3G Neighbour Cells Description struct >> }
  { 0 | 1 < Measurement_Parameters Description : < Measurement Parameters Description struct >> }
  { 0 | 1 < 3G Measurement Parameters Description : < 3G Measurement Parameters Description struct >> }
  { 0 | 1 < GPRS_Real Time Difference Description : < GPRS_Real Time Difference Description struct >> }
  { 0 | 1 < GPRS_BSIC Description : GPRS_BSIC Description struct > }
  { 0 | 1 < GPRS_REPORT PRIORITY Description : < GPRS_REPORT_PRIORITY Description struct >> }
  { 0 | 1 < GPRS_MEASUREMENT_Parameters Description : < GPRS_MEASUREMENT Parameters Description
struct >> }
  { 0 | 1 < GPRS_3G_MEASUREMENT Parameters Description : < GPRS_3G MEASUREMENT Parameters
Description struct >> }
  { 0 | 1 < NC Measurement Parameters : < NC Measurement Parameters struct >> }
  < spare padding > ;
  < 3G Neighbour Cells Description struct > ::=
  { 0 | 1 < Index_Start_3G : bit (7) > }
  { 0 | 1 < Absolute_Index_Start_EMR : bit (7) > }
  { 0 | 1 < UMTS FDD Description : UMTS FDD Description struct >> }
  { 0 | 1 < UMTS TDD Description : UMTS TDD Description struct >> };
  < UMTS FDD Description struct > ::=
  { 0 | 1 < Bandwidth_FDD : bit (3) > }
  { 1 { < Repeated UMTS FDD Neighbour Cells : Repeated UMTS FDD Neighbour Cells struct >> } ** 0 } ;
  < Repeated UMTS FDD Neighbour Cells struct > ::=
  { 0 < FDD-ARFCN : bit (14) > | 1 < FDD-ARFCN-INDEX : bit (3) > }
  < Number_of_Scrambling_Codes_and_Diversity : bit (5) >
  < Range-1024-Format_Scrambling_Codes_and_Diversity Field :
bit(p(Number_of_Scrambling_Codes_and_Diversity)) > ; -- p(x) defined in table 10.5.71.a1/3GPP TS 04.18
  < UMTS TDD Description struct > ::=
  { 0 | 1 < Bandwidth_TDD : bit (3) > }
  { 1 { < Repeated UMTS TDD Neighbour Cells : Repeated UMTS TDD Neighbour Cells struct >> } ** 0 } ;
  < Repeated UMTS TDD Neighbour Cells struct > ::=
  { 0 < TDD-ARFCN : bit (14) > | 1 < TDD-ARFCN-INDEX : bit (3) > }
  < Number_of_Cell_Parameters_and_sync_cases_and_Diversity : bit (5) >
  < Range-512-Format_Cell_Parameters_and_syncs_cases_and_Diversity : bit(q(Number_of_Cell_Parameters_and_sync
cases) > ; -- q(x) defined in table 10.5.71.a2/GSM04.18
  < MEASUREMENT PARAMETERS Description Struct > ::=
  < SERVING_BAND_REPORTING : bit (2) > ;
  < 3G MEASUREMENT PARAMETERS Description struct > ::=
  { < Qsearch_I : bit (4) > }
  < Qsearch_C_Initial : bit (1) >
  { 0 | 1 < FDD_QOffset : bit (4) > -- FDD information
  < FDD_REP_QUANT : bit (1) >
  < FDD_MULTIRAT_REPORTING : bit (2) >
  < FDD_Qmin : bit (3) > }
  { 0 | 1 < TDD_QOffset : bit (4) > -- TDD information
  < TDD_MULTIRAT_REPORTING : bit (2) > } ;
  < GPRS Real Time Difference Description struct > ::=
  { 0 | 1 { 0 | 1 < BA_Index_Start_RTD : bit (5) > } --default value=0
  < RTD : < RTD6 Struct >>
  { 0 < RTD : < RTD6 Struct >> **1 } -- '0' : increment by 1 the index of the BA (list) frequency
  }
  { 0 | 1 { 0 | 1 < BA_Index_Start_RTD : bit (5) > } --default value=0
  < RTD : < RTD12 Struct >>
  { 0 < RTD : < RTD12 Struct >> **1 } -- '0' : increment by 1 the index of the BA (list) frequency
  } ;
  < RTD6 Struct > ::=
  { 0 < RTD : bit (6) > ** 1 } ; -- Repeat until '1'; '1' means last RTD for this frequency
  < RTD12 Struct > ::=
  { 0 < RTD : bit (12) > ** 1 } ; -- Repeat until '1'; '1' means last RTD for this frequency

```

```

< GPRS BSIC Description struct > ::=
  { 0 | 1 < BA_Index_Start_BSIC : bit (5) > }           -- default value=0
  < BSIC : bit (6) >
  < Number_Remaining_BSIC: bit (7) >
  { < Frequency_Scrolling : bit >                     -- 0 means same frequency
    < BSIC : bit (6) > } * (val(Number_Remaining_BSIC));
< GPRS REPORT PRIORITY Description struct > ::=
< Number_Cells : bit (7) >
{ REP_PRIORITY: bit } * (val(Number_Cells));
< GPRS MEASUREMENT PARAMETERS Description struct > ::=

  { 0 | 1 < Multiband_Reporting : bit (2) > }
  { 0 | 1 < Serving_Band_Reporting : bit (2) > }
  < SCALE_ORD : bit(2) >

  { 0 | 1 < 900_REPORTING_OFFSET : bit (3) >
    < 900_REPORTING_THRESHOLD : bit (3) > }

  {0 | 1 < 1800_REPORTING_OFFSET : bit (3) >
    < 1800_REPORTING_THRESHOLD : bit (3) > }

  {0 | 1 < 450_REPORTING_OFFSET : bit (3) >
    < 450_REPORTING_THRESHOLD : bit (3) > }

  {0 | 1 < 1900_REPORTING_OFFSET : bit (3) >
    < 1900_REPORTING_THRESHOLD : bit (3) > }

  {0 | 1 < 850_REPORTING_OFFSET : bit (3) >
    < 850_REPORTING_THRESHOLD : bit (3) > } ;
< GPRS 3G MEASUREMENT PARAMETERS Description struct > ::=
  < Qsearch_P : bit (4) >
  < 3G_Search_PRIO : bit >
  { 0 | 1 < FDD_REP_QUANT : bit >                       -- FDD Parameters
    < FDD_MULTIRAT_REPORTING : bit (2) > }
  { 0 | 1 < FDD_REPORTING_OFFSET : bit (3) >
    < FDD_REPORTING_THRESHOLD : bit (3) > }

  { 0 | 1 < TDD_MULTIRAT_REPORTING : bit (2) > }       -- TDD Parameters
  { 0 | 1 < TDD_REPORTING_OFFSET : bit (3) >
    < TDD_REPORTING_THRESHOLD : bit (3) > } ;
< NC Measurement Parameters struct > ::=
  < NETWORK_CONTROL_ORDER : bit (2) >
  { 0 | 1 < NC_NON_DRX_PERIOD : bit (3) >
    < NC_REPORTING_PERIOD_I : bit (3) >
    < NC_REPORTING_PERIOD_T : bit (3) > } ;

```

Table 10.5.71b: SI2quarter message information

3G-BA-IND (1 bit), 3G BCCH allocation sequence number indication.

The 3G-BA-IND is needed to indicate new sets of 3G Neighbour Cells information, as described in sub-clause 3.4.1.2.1, The Use of parameters from the Measurement Information message/SI2quarter. The value received is reflected in the MEASUREMENT REPORT and ENHANCED MEASUREMENT REPORT message.

MP_CHANGE_MARK (1 bit)

The **MP_CHANGE_MARK** field is changed each time MEASUREMENT INFORMATION or 3G MEASUREMENT INFORMATION has been updated in any instance of the **SI2quarter** messages. A new value indicates that the mobile station shall re-read the MEASUREMENT and 3G MEASUREMENT INFORMATION from all the **SI2quarter** messages, as described in sub-clause 3.4.1.2.1, The Use of parameters from the Measurement Information message/SI2quarter. The coding of this field is network dependent.

SI2quarter_INDEX (4 bit field)

The SI2quarter_INDEX field is used to distinguish individual **SI2quarter** messages. The field can take the binary representation of the values 0 to n, where n is the index of the last SI2quarter message. (**SI2quarter_COUNT**).

SI2quarter_COUNT (4 bit field)

This field is coded as the binary representation of the **SI2quarter_INDEX** for the last (highest indexed) individual **SI2quarter** message.

UMTS FDD DESCRIPTION

Bandwidth_FDD (3 bit field)

This optional information element will be used for future releases of the protocol. When missing, this indicates the present FDD bandwidth. When present, this shall not be considered as an error; indices of the 3G Neighbour Cell list shall be incremented accordingly.

FDD_ARFCN (14 bit field)

This optional information element is defined as the UARFCN 3G3GPP TS 25.101. Any non-supported shall not be considered as an error; indices of the 3G Neighbour Cell list shall be incremented accordingly.

FDD-ARFCN-INDEX (3 bit field)

This field points to the absolute frequency received in the UMTS Freq list information element in the Channel Release message, see sub-clause 10.5.2.1d, 'UMTS frequency list'. If there is no frequency associated to this value of the FDD-ARFCN-INDEX parameter, this shall not be considered as an error; indices of the 3G Neighbour Cell list shall be incremented accordingly.

Number_of_Scrambling_Codes_and_Diversity (5 bit field)

This optional field defines the number of Scrambling Codes/Diversity parameters.

Range-1024-Format Scrambling Codes and Diversity Field (p bit field)

This field allows to compute a set of 10-bit-long Scrambling Codes and Diversity Parameters, re-using the *Range 1024 format* compression algorithm, see Annex J: 'Algorithm to encode frequency list information'. The formulas for decoding are given in the 'Range 1024 format' sub-clause, 10.5.2.13.3. The consecutive parameters of this field are concatenated, starting with the bit FDD_Indic0, and then w1, w2...

FDD_Indic0, information 0 indicator (1 bit):

- 0 information '0000000000' is not a member of the set
- 1 information '0000000000' is a member of the set

NOTE: This bit FDD_Indic0 is equivalent to the bit F0 bit in the frequency list information element.

For each (10-bit-long) decoded Parameter, bits 1-9 are the Scrambling Codes and bit 10 is the corresponding Diversity Parameter.

The total number of bits p of this field depends on the value of the parameter Number_of_Scrambling_Codes_and_Diversity = n, as follows (with p=0 if n=0):

n	p	n	p	n	p	n	p
1	11	6	53	11	89	16	123
2	20	7	61	12	96	17-31	0
3	29	8	68	13	103		
4	37	9	75	14	110		
5	45	10	82	15	117		

Table 10.5.71.a1

If n=0, this indicates the 3G Neighbour Cell list index for subsequent report on RSSI, see 3GPP TS 05.08.

If n is equal or greater than 17, this shall not be considered as an error; the corresponding index in the 3G Neighbour Cell list shall be incremented by one.

UMTS Scrambling code (9 bit field)

This parameter is defined in 3GPP TS 25.304.

Diversity (1 bit field)

This parameter indicates if diversity is applied for the cell:

Bit

0 Diversity is not applied for this cell

1 Diversity is applied for this cell

UMTS TDD DESCRIPTION

Bandwidth_TDD (3 bit field)

This optional information element refers to 3G3GPP TS 25.331.

Bit

321

000 3.84Mcps

001 1.28Mcps

All other values shall not be interpreted as an error; indexes of the 3G Neighbour Cell list shall be incremented accordingly (and no reporting can be performed).

TDD_ARFCN (14 bit field)

This optional information element is defined as the UARFCN in 3G3GPP TS 25.102. Any non-supported frequency not be considered as an error; indices of the 3G Neighbour Cell list shall be incremented accordingly.

TDD-ARFCN-INDEX (3 bit field)

This field points to the absolute frequency received in the UMTS Freq list information element in the Channel Release message, see sub-clause 10.5.2.1d, 'UMTS frequency list'. If there is no frequency associated to this value of the TDD-ARFCN-INDEX parameter, this shall not be considered as an error; indices of the 3G Neighbour Cell list shall be incremented accordingly.

Number_of_Cell Parameters_and_Sync Sases_and_Diversity (5 bit field)

This optional field defines the number of Cell Parameters/Sync Case/Time Diversity parameters.

Range-512-Format Cell Parameters and syncs cases and Diversity (q bit field)

This field allows to compute a set of 9-bit-long Scrambling Codes and Diversity Parameters, re-using the *Range 512 format* compression algorithm, see Annex J: 'Algorithm to encode frequency list information'. The formulas for decoding are given in the 'Range 512 format' sub-clause, 10.5.2.13.4, with w0=0. The consecutive parameters of this field are concatenated, starting with the bit TDD_Indic0, and then w1, w2....

TDD_Indic0, information 0 indicator (1 bit):

0 information '000000000' is not a member of the set

1 information '000000000' is a member of the set

NOTE: This bit TDD_Indic0 is equivalent to the bit F0 bit in the frequency list information element.

For each (9-bit-long) decoded Parameter, bits 1-7 are the Cell Parameters, bit 8 is the Sync Case and bit 9 is the Diversity bit.

The total number of bits q of this field depends on the value of the parameter **Number_of_Cell Parameters_and_Sync Cases_and_Diversity** = m, as follows (with q=0 if m=0):

m	q	m	q	m	q	m	q	m	q
1	10	6	47	11	78	16	106	21-31	0
2	18	7	54	12	84	17	112		
3	26	8	60	13	90	18	117		
4	33	9	66	14	96	19	122		
5	40	10	72	15	102	20	127		

Table 10.5.71.a2.

If m=0 or m is equal or greater than 21, this shall not be considered as an error. The corresponding index in the 3G Neighbour Cell list shall be incremented by one.

Diversity (1 bit field)

This parameter indicates if diversity is applied for the cell:

Bit

- 0 Diversity is not applied for this cell
- 1 Diversity is applied for this cell

Cell Parameter (7 bit field)

This parameter is defined in 3GPP TS 25.304.

Sync Case (1 bit field)

This parameter is defined in 3GPP TS 25.304.

3G MEASUREMENT PARAMETERS Description**Qsearch_I (4 bit field)****Qsearch_C_Initial (1 bit field)**

These parameters are defined in 3GPP TS 05.08.

FDD_Qoffset (3 bit field)**FDD_REP_QUANT (1 bit field)****FDD_MULTIRAT_REPORTING (2 bit field)**

These parameters are defined in 3GPP TS 05.08.

TDD_Qoffset (3 bit field)**TDD_MULTIRAT_REPORTING (2 bit field)**

These parameters are defined in 3GPP TS 05.08.

GPRS PRIORITY Description**REP_PRIORITY bit:**

- 0 Normal reporting priority
- 1 High reporting priority

This information is used for GPRS Enhanced (NC) Reporting when the cell has no PBCCH allocated, see 3GPP TS 04.60 sub-clause 5.6.5 (“Report Priority Description”).

The use of these bits is similar to the PRIORITY description, see sub-clause 3.4.1.2.1.5 (“Report Priority Description”).

GPRS BSIC Description

This information is used for GPRS Enhanced (NC) Measurement reporting when the cell has no PBCCH allocated, see 3GPP TS 04.60 sub-clause 5.6.3.2 (“Deriving the GSM Neighbour Cell list from the BSICs and frequency list”). The use of this information is similar to the BSIC Description, see sub-clause 3.4.1.2.1.2 (“Deriving the GSM Neighbour Cell list from the BSICs and the BA (list)”).

GPRS Real Time Difference Description

This information is used for GPRS neighbour cell measurement when the cell has no PBCCH allocated, see 3GPP TS 04.60 sub-clause 5.6.4 (“Real Time Differences”). The use of this information is similar to the Real Time Difference Description, see sub-clause 3.4.1.2.1.4 (“Real Time Differences”).

GPRS MEASUREMENT PARAMETERS Description

This information is used for GPRS neighbour cell measurement when the cell has no PBCCH allocated, see 3GPP TS 04.60 sub-clause 5.6.6 (“GPRS Measurement Parameters and GPRS 3G Measurement Parameters”).

The fields of this Description are defined in 3GPP TS 05.08.

3G MEASUREMENT PARAMETERS Description

This information is used for GPRS neighbour cell measurement when the cell has no PBCCH allocated, see 3GPP TS 04.60 sub-clause 5.6.6 (“GPRS Measurement Parameters and GPRS 3G Measurement Parameters”).

The fields of this Description are defined in 3GPP TS 05.08.

NC Measurement Parameters struct

Information in this structure is used when the cell has no PBCCH allocated, for (NC) measurement reporting. See 3GPP TS 04.60 sub-clause 5.6.1 ("Network Control (NC) measurement reporting").

Coding of the fields is defined in 3GPP TS 04.60, sub-clause 11.2.23 ("PACKET SYSTEM INFORMATION TYPE5").

10.5.2.34 SI 3 Rest Octets

The *SI 3 Rest Octets* information element is coded according to the syntax specified below and described in tables 10.5.72/3GPP TS 04.18, 10.5.73/3GPP TS 04.18 and 10.5.74/3GPP TS 04.18(See section 10.5.2.35).

The *SI 3 Rest Octets* information element is a type 5 information element with 4 octets length.

Table 10.5.72/3GPP TS 04.18: SI 3 Rest Octets information element

```

<SI3 Rest Octet> ::= <Optional selection parameters>
    <Optional Power offset>
    <System Information 2ter Indicator>
    <Early Classmark Sending Control>
    <Scheduling if and where>
    { L | H <GPRS Indicator> }
    <3G Early Classmark Sending Restriction>
    <spare padding> :
<Optional Selection Parameters> ::=      L | H <Selection Parameters>;
<Selection Parameters> ::=
    <CBQ: bit (1)>
    <CELL_RESELECT_OFFSET: bit (6)>
    <TEMPORARY_OFFSET: bit (3)>
    <PENALTY_TIME: bit (5)>;
<Optional Power Offset> ::=      L | H <Power Offset: bit (2)>; <System Information 2ter Indicator> ::= L | H;
<Early Classmark Sending Control> ::= L | H;
<Scheduling if and where> ::=      L | H <WHERE: bit (3)>;
<GPRS Indicator> ::=              < RA COLOUR : bit (3) >
                                < SI13 POSITION : bit >;
<3G Early Classmark Sending Restriction> ::= L          -- Neither UTRAN nor cdma2000 classmark change message
shall be sent with the Early classmark sending
                                | H ;          -- The sending of UTRAN and CDMA2000 Classmark Sending messages is
controlled by the Early Classmark Sending Control parameter

```

Table 10.5.72a/3GPP TS 04.18: SI 3 Rest Octets information element details

CBQ, CELL_BAR_QUALIFY (1 bit field)
CELL_BAR_QUALIFY is used by the network to control mobile station cell selection and reselection. The use and coding of this parameter is defined in 3GPP TS 05.08.

CELL_RESELECT_OFFSET (6 bit field)
CELL_RESELECT_OFFSET is coded as the binary representation of the "CELL_RESELECT_OFFSET" in 3GPP TS 05.08. It is a value used by the mobile station to apply a positive or negative offset to the value of C2 as defined in 3GPP TS 23.022 and 3GPP TS 05.08.

TEMPORARY_OFFSET (3 bit field)
The TEMPORARY_OFFSET field is coded as the binary representation of the "TEMPORARY_OFFSET" in 3GPP TS 05.08. It is used by the mobile station as part of its calculation of C2 for the cell reselection process as described in 3GPP TS 05.08. It is used to apply a negative offset to C2 for the duration of PENALTY_TIME.

PENALTY_TIME (5 bit field)

The **PENALTY_TIME** is coded as the binary representation of the "PENALTY_TIME" in 3GPP TS 05.08. It defines the length of time for which **TEMPORARY_OFFSET** is active. The usage of **PENALTY_TIME** is described in 3GPP TS 23.022 and 3GPP TS 05.08.

WHERE (3 bit field)

If the **WHERE** field is not contained in the information element, this indicates that BCCH scheduling information is not sent in **SYSTEM INFORMATION TYPE 9** on the BCCH.

If the **WHERE** field is contained in the information element, this indicates that BCCH scheduling information is sent in **SYSTEM INFORMATION TYPE 9** on the BCCH and that **SYSTEM INFORMATION TYPE 9** messages are sent in the blocks of the BCCH norm for which $((FN \text{ DIV } 51) \bmod (8) = 4 \text{ AND } (((FN \text{ DIV } 51) \text{ DIV } 8) \bmod (n+1)) = 0)$, where n is the value encoded in binary in **WHERE**.

GPRS Indicator

The **GPRS Indicator** contains the **RA COLOUR** field and the **SI13_POSITION** field. If the **GPRS Indicator** is contained in the information element, it indicates that GPRS is supported in the cell.

RA COLOUR (3 bit field)

If the mobile station receives different values of the **RA COLOUR** field in different cell, the mobile station shall interpret the cell re-selection information as if the two cells belong to different routing areas.

SI13_POSITION (1 bit field)

The **SI13 POSITION** field indicates the minimum schedule for where the **SYSTEM INFORMATION TYPE 13** message is sent on BCCH, see 3GPP TS 05.02:

- 0 SYSTEM INFORMATION TYPE 13 message is sent on BCCH Norm;
- 1 SYSTEM INFORMATION TYPE 13 message is sent on BCCH Ext.

10.5.2.35 SI 4 Rest Octets

The *SI 4 Rest Octets* information element includes parameters which are used by the mobile station for cell selection and reselection purposes. It may also include the **POWER OFFSET** parameter used by DCS 1800 Class 3 MS.

Its content is described in Table 10.5.73/3GPP TS 04.18.

NOTE: In the future evolution of this standard the values 64h and 72h shall not be used as values of the first octet when this information element is used in the **SYSTEM INFORMATION TYPE 4** message. This will prevent mobile stations misinterpreting this information as the **CBCH IEIs**.

The *SI 4 Rest Octets* information element is a type 5 information element with 0 to 10 octets length.

Table 10.5.72b/3GPP TS 04.18: SI 4 Rest Octets information element content

```

<SI4 Rest Octets> ::=
{
  <SI4 Rest Octets_O>
  {L | H <Break indicator> | H <SI Rest Octets_S>}

  <spare padding>
} -- truncation allowed, bits 'L' assumed;
<SI4 Rest Octets_O> ::=
{
  <Optional selection parameters>
  <Optional Power offset>
  {L | H <GPRS Indicator >}
} -- truncation allowed, bits 'L' assumed
<SI4 Rest Octets_S> ::=
{L | H <LSA Parameters>}
{L | H <Cell Identity : bit(16)>}
{L | H <LSA ID information>} ;
<Break Indicator> ::= L | H ;
<SI7 Rest Octets> ::= <SI4 Rest Octets_O><SI4 Rest Octets_S> | <SI4 Rest Octets_S> ;
<SI8 Rest Octets> ::= <SI4 Rest Octets_O><SI4 Rest Octets_S> | <SI4 Rest Octets_S> ;
<Optional Selection Parameters> ::= L | H <Selection Parameters> ;
<Selection Parameters> ::= <CBQ : bit (1)>
  <CELL_RESELECT_OFFSET : bit (6)>
  <TEMPORARY_OFFSET : bit (3)>
  <PENALTY_TIME : bit (5)> ;
<Optional Power Offset> ::= L | H <Power Offset : bit(2)> ;
<GPRS Indicator> ::= < RA COLOUR : bit (3) >
  < SI13 POSITION : bit > ;
<LSA Parameters> ::= <PRIO_THR : bit (3)>
  <LSA_OFFSET : bit (3)>
  {0 | 1 <MCC : bit (12)>}
  <MNC : bit (12)>} ;
<LSA ID information> ::= <LSA identity>
  {0 | 1 <LSA ID information>} ;
<LSA identity> ::= {0 <LSA_ID : bit (24)>
  | 1 <ShortLSA_ID : bit (10)>} ;

```

If "ACS " in the System information type 4 message is set to "1" then the SI 7 and SI 8 rest octets consists of "SI4 Rest Octets_O" and "SI4 Rest Octets_S", otherwise of only "SI4 Rest Octets_S".

Table 10.5.72c/3GPP TS 04.18: SI 4 Rest Octets information element details

CBQ, CELL_BAR_QUALIFY (1 bit field)

CELL_BAR_QUALIFY is used by the network to control mobile station cell selection and reselection. The use and coding of this parameter is defined in 3GPP TS 05.08.

CELL_RESELECT_OFFSET (6 bit field)

CELL_RESELECT_OFFSET is coded as the binary representation of the "CELL_RESELECT_OFFSET" in 3GPP TS 05.08. It is a value used by the mobile station to apply a positive or negative offset to the value of C2 as defined in 3GPP TS 23.022 and 3GPP TS 05.08.

TEMPORARY_OFFSET (3 bit field)

The TEMPORARY_OFFSET field is coded as the binary representation of the "TEMPORARY_OFFSET" in 3GPP TS 05.08. It is used by the mobile station as part of its calculation of C2 for the cell reselection process as described in 3GPP TS 05.08. It is used to apply a negative offset to C2 for the duration of PENALTY_TIME.

PENALTY_TIME (5 bit field)

The PENALTY_TIME is coded as the binary representation of the "PENALTY_TIME" in 3GPP TS 05.08. It defines the length of time for which TEMPORARY_OFFSET is active. The usage of PENALTY_TIME is described in 3GPP TS 23.022 and 3GPP TS 05.08.

POWER OFFSET (2 bit field)

POWER OFFSET is used only by DCS 1800 Class 3 MSs to add a power offset to the value of MS_TXPWR_MAX_CCH used for its random access attempts. It is also used by the MS in its calculation of C1 and C2 parameters. Its use is defined in 3GPP TS 05.08.

If this parameter is transmitted on a BCCH carrier within the DCS 1800 band, its meaning shall be described below:

Value	Meaning
00	0 dB power offset
01	2 dB power offset
10	4 dB power offset
11	6 dB power offset

If this parameter is transmitted on a BCCH carrier outside the DCS 1800 band, then all bit positions shall be treated as spare.

GPRS Indicator

The **GPRS Indicator** contains the RA COLOUR field and the SI13_POSITION field. If the GPRS Indicator is contained in the information element, it indicates that GPRS is supported in the cell.

RA COLOUR (3 bit field)

If the mobile station receives different values of the RA COLOUR field in different cell, the mobile station shall interpret the cell re-selection information as if the two cells belong to different routing areas.

SI13_POSITION (1 bit field)

The SI13 POSITION field indicates the minimum schedule for where the SYSTEM INFORMATION TYPE 13 message is sent on BCCH, see 3GPP TS 05.02:

- 0 SYSTEM INFORMATION TYPE 13 message is sent on BCCH Norm;
- 1 SYSTEM INFORMATION TYPE 13 message is sent on BCCH Ext.

Break Indicator

The Break Indicator indicates if parameters in addition to those in SI 4 rest octets are sent in SI7 and SI8.

- L Additional parameters are not sent in SYSTEM INFORMATION TYPE 7 and 8.
- H Additional parameters, "SI4 Rest Octets_S", are sent in SYSTEM INFORMATION TYPE 7 and 8.

PRIO_THR (3 bit field)

The **PRIO_THR** field is a signal threshold used by the mobile station to determine whether prioritised cell re-selection shall apply. The use and coding of this parameters is defined in 3GPP TS 05.08.

LSA_OFFSET (3 bit field)

The **LSA_OFFSET** field applies an offset for LSA reselection between cells with same LSA priorities. The use and coding of this parameters is defined in 3GPP TS 05.08.

MCC and MNC (24 bit field)

If the escape PLMN is broadcast in SI3 and SI4 the cell is used for SoLSA exclusive access and the MCC and MNC field shall be included. The MS shall then for all purposes use the MCC and MNC values received in the LSA Parameters instead of the ones received in the Location Area information element in SI3 and 4, eg when deriving the PLMN identity, the Location Area Identity and Cell Global Identity broadcast by the cell. The MCC and MNC value field is coded as specified in Figure 10.5.3/3GPP TS 04.18 and Table 10.5.3/3GPP TS 04.18.

Cell Identity (16 bit field)

The purpose of the Cell Identity is to identify a cell within a location area. The Cell Identity is coded as shown in figure 10.2/3GPP TS 04.18 and table 10.5/3GPP TS 04.18

LSA_ID (24 bit field)

The purpose of the **LSA_ID** field is to identify a LSA. The LSA ID value field is specified in 3GPP TS 23.003.

Short LSA_ID (10 bit field)

The purpose of the Short **LSA_ID** field is to identify a LSA. The LSA ID defined by the Short **LSA_ID** is a **LSA_ID** as specified in 3GPP TS 03.03 with bit 0 set to "0" bit 1 to 10 set to the value of the Short **LSA_ID** field (LSB in bit 1, MSB in bit 10) and bit 11 to 23 set to "0".

10.5.2.35a SI 6 Rest Octets

The *SI 6 Rest Octet* information element may contain information concerning the paging, notification channels, VBS and VGCS services of the cell.

Mobile stations not supporting VGCS listening or VBS listening can ignore the information contained in this information element.

The *SI 6 Rest Octets* information element is a type 5 information element with 7 octets length.

The value part is as shown below:

Table 10.5.73/3GPP TS 04.18: *SI 6 Rest Octets* information element content

```

<SI6 rest octets> ::=
  { L | H <PCH and NCH info> }
  { L | H <VBS/VGCS options : bit(2)> }
  { < DTM_support : bit == L >
  | < DTM_support : bit == H >
  < RAC : bit (8) >
  < MAX_LAPDm : bit (3) > }
  <implicit spare >;
<PCH and NCH info> ::=
  <Paging channel restructuring>
  <NLN(SACCH) : bit(2)>
  { 0 | 1 <Call priority : bit (3)> }
  <NLN status : bit >;
<paging channel restructuring> ::=
  1 | -- paging channel is restructured
  0 -- paging channel is not restructured
<VBS/VGCS options> ::=
  <inband notifications>
  <inband pagings>;
<inband notifications> ::=
  0 | -- the network does not provide notification on FACCH so that the mobile should
      inspect the NCH for notifications
  1 -- the mobile shall be notified on incoming high priority VBS/VGCS calls through NOTIFICATION/FACCH, the
      mobile need not to inspect the NCH
<inband pagings> ::=
  0 | -- the network does not provide paging information on FACCH so that the mobile should inspect the PCH for
      pagings
  1 -- the mobile shall be notified on incoming high priority point-to-point calls
      through NOTIFICATION/FACCH, the mobile need not to inspect the PCH

```

Table 10.5.73a/3GPP TS 04.18: *SI 6 Rest Octets* information element details

Attributes, field contents:

- For <NLN(SACCH): bit(2)>: see 10.5.2.23.
- For <call priority>: see 10.5.2.23. Indication of the highest priority associated with VBS/VGCS calls in a cell.

DTM support (1 bit field)
This field indicates whether DTM is supported in the serving cell (i.e. whether the MS is allowed to initiate the packet request procedure while in dedicated mode). It is coded as follows:

Bit 0

L DTM is not supported in the serving cell
H DTM is supported in the serving cell

RAC (8 bit field)
This field codes the Routing Area Code of the RA to which the serving cell belongs (see 3GPP TS 03.03).

MAX LAPDm (3 bit field)

This field indicates the maximum number of LAPDm frames on which a layer 3 can be segmented into and be sent on the main DCCH. It is coded as follows:

Bit	2	1	0	
0	0	0	0	Any message segmented in up to 5 LAPDm frames.
0	0	1		Any message segmented in up to 6 LAPDm frames.
0	1	0		Any message segmented in up to 7 LAPDm frames.
0	1	1		Any message segmented in up to 8 LAPDm frames.
1	0	0		Any message segmented in up to 9 LAPDm frames.
1	0	1		Any message segmented in up to 10 LAPDm frames.
1	1	0		Any message segmented in up to 11 LAPDm frames.
1	1	1		Any message segmented in up to 12 LAPDm frames.

10.5.2.36 SI 7 Rest Octets

The *SI 7 Rest Octets* information element includes parameters which are used by the mobile station for cell selection and reselection purposes. It may also include the POWER OFFSET parameter used by a DCS 1800 Class 3 MS.

The *SI 7 Rest Octets* information element is a type 5 information element with 20 octets length.

The *SI 7 Rest Octets* information element is coded as the *SI 4 Rest Octets*. Its contents is described in Table 10.5.2.35a-b/3GPP TS 04.18.

10.5.2.37 SI 8 Rest Octets

The *SI 8 Rest Octets* information element includes parameters which are used by the mobile station for cell selection and reselection purposes. It may also include the POWER OFFSET parameter used by a DCS 1800 Class 3 MS.

The *SI 8 Rest Octets* information element is a type 5 information element with 20 octets length.

The *SI 8 Rest Octets* information element is coded as the *SI 4 Rest Octets*. Its contents is described in Table 10.5.73/3GPP TS 04.18 and 10.5.74/3GPP TS 04.18.

10.5.2.37a SI 9 Rest Octets

The *SI 9 Rest Octets* information element contains information about scheduling of some or all of the information on the BCCH.

The *SI 9 Rest Octets* information element is a type 5 information element with 17 octets length.

Table 10.5.74/3GPP TS 04.18: *SI 9 Rest Octets* information element content

<SI9 rest octets>	::=	{L H <Scheduling info>}
		<spare padding>;
<Scheduling info>	::=	<Info type> <Positions>
		{0 1 <Scheduling info>;}
<Info type>	::=	0 <Info_type_4: bit (4)>
		1 0 <Info_type_5: bit (5)>
		1 1 <Info_type_6: bit(6)>;
<Positions>	::=	<Position> {0 1 <Position>}
<Position>	::=	<Modulus: bit(4)>
		<Relative_position: <bit>> --length depends on modulus
		<Bcch_type: bit(1)>;

Table 10.5.75/3GPP TS 04.18 *SI 9 rest octet* information element details

<p>Attributes</p> <p>The <i>scheduling info</i> indicates one or more information types (in <i>info type</i>) together with their <i>positions</i>. Here, a <i>position</i> specifies at which relative position P (specified in relative_position) modulo a position modulus M (specified in modulus) messages of the given information type are sent, on the BCCH norm or BCCH ext (see 3GPP TS 05.02) as indicated in bcch_type. Precisely, messages of the given information type are sent in the multiframes for which</p> $((\text{frame number}) \text{ DIV } 51) \bmod (M) = P.$ <p>If the position modulus M equals 0, the information type is not sent.</p> <p>Field contents</p> <p>The fields of the <i>SI 9 Rest Octets</i> information element are coded as shown in table 10.75/3GPP TS 04.18.</p> <p>Info_type_4_ (4 bits)</p> <p>This field contains a binary encoded non-negative integer number assigned to a type of information sent on the BCCH. All values indicate unknown, unnecessary information and are reserved for future use.</p> <p>Info_type_5 (5 bits)</p> <p>This field contains a binary encoded non-negative integer number assigned to a type of information sent on the BCCH. All values except those defined below indicate unknown, unnecessary information and are reserved for future use.</p> <p>Info_type_5:</p> <ul style="list-style-type: none"> 0 0000 System Information type 1 0 0001 System Information type 2 0 0010 System Information type 2bis 0 0011 System Information type 2ter 0 0100 System Information type 3 0 0101 System Information type 4 0 0110 System Information type 7 0 0111 System Information type 8 0 1000 System Information type 9 0 1001 System Information type 13 0 1011 System Information type 16 0 1100 System Information type 17 0 1101 System Information type 18 0 1110 System Information type 19 0 1111 System Information type 20 <p>Info_type_6_ (6 bits)</p> <p>This field contains a binary encoded non-negative integer number assigned to a type of information sent on the BCCH. All values indicate unknown, unnecessary information and are reserved for future use.</p> <p>modulus (4 bits)</p> <p>This field encodes the position modulus, according to the following encoding method. Let N be the integer encoded in binary in the modulus field; the position modulus is then defined as follows :</p> <ul style="list-style-type: none"> If N=0, the position modulus is 0, if N>0, the position modulus is 2^{N+1}. <p>relative position (0 bits if the non-negative integer n contained in the modulus field is 0; n+1 bits, if the non-negative integer N encoded in the modulus field is > 0.</p> <p>This field contains the N+1 bit binary encoding of a non-negative integer number $< 2^{N+1}$.</p>

bcch_type (1 bit)

- 0 BCCH norm(as defined in 3GPP TS 05.08)
- 1 BCCH ext (as defined in 3GPP TS 05.08)

10.5.2.37b SI 13 Rest Octets

The *SI 13 Rest Octets* information element is coded according to the syntax specified below and described in tables 10.5.76/3GPP TS 04.18.

The *SI 13 Rest Octets* information element is a type 5 information element with 20 octets length.

Table 10.5.76/3GPP TS 04.18: SI 13 Rest Octets information element content

```

< SI 13 Rest Octets > ::=
  { L | H
    < BCCH_CHANGE_MARK : bit (3) >
    < SI_CHANGE_FIELD : bit (4) >

    { 0 | 1 < SI13_CHANGE_MARK : bit (2) >
      < GPRS Mobile Allocation : GPRS Mobile Allocation IE > }      -- Defined in 3GPP TS 04.60

    { 0
      -- PBCCH not present in cell :
      < RAC : bit (8) >
      < SPGC_CCCH_SUP : bit >
      < PRIORITY_ACCESS_THR : bit (3) >
      < NETWORK_CONTROL_ORDER : bit (2) >
      < GPRS Cell Options : GPRS Cell Options IE >                  -- Defined in 3GPP TS 04.60
      < GPRS Power Control Parameters : GPRS Power Control Parameters struct >

    | 1
      -- PBCCH present in cell :
      < PSI1_REPEAT_PERIOD : bit (4) >
      < PBCCH Description : PBCCH Description struct >
    }
    { null | L
      -- Receiver compatible with earlier release
    | H
      -- Additions in release 99 :
      < SGSNR : bit >
    }
  }
  < spare padding > ;
< GPRS Power Control Parameters struct > ::=
  < ALPHA : bit (4) >
  < T_AVG_W : bit (5) >
  < T_AVG_T : bit (5) >
  < PC_MEAS_CHAN : bit >
  < N_AVG_I : bit (4) >;
< PBCCH Description struct > ::=
  < Pb : bit (4) >
  < TSC : bit (3) >
  < TN : bit (3) >
  { 00 -- BCCH carrier
  | 01 < ARFCN : bit (10) >
  | 1 < MAIO : bit (6) >;

```

Table 10.5.76a/3GPP TS 04.18: SI 13 Rest Octets information element

BCCH_CHANGE_MARK (3 bit field)

This field indicates the status of the information on BCCH. The value of this field may be changed when information on BCCH is changed, see 3GPP TS 04.60.

SI_CHANGE_FIELD (4 bit field)

This field is the binary representation of which information was changed at the last indication in BCCH_CHANGE_MARK, see 3GPP TS 04.60. Range 0 to 15:

- 0 Update of *unspecified* SI message or SI messages;
- 1 Update of SI1 message;
- 2 Update of SI2, SI2 bis or SI2 ter message or any instance of SI2quarter messages ;
- 3 Update of SI3, SI4, SI7 or SI8 message;
- 4 Update of SI9 message; 5 Update of SI18 or SI20 message;
- 6 Update of SI19 message;

All other values shall be interpreted as 'update of unknown SI message type'.

SI13_CHANGE_MARK (2 bit field)

This field is the binary representation of the SI change mark identifying the GPRS Mobile Allocation provided in SI13 and PSI13 messages. Range: 0 to 3.

GPRS Mobile Allocation (information element)

This information element is the representation of the GPRS mobile allocation provided in SI13 and PSI13 messages. It is identified by MA_NUMBER = 14 when referenced from a packet assignment message. The *GPRS Mobile Allocation* information element is defined in 3GPP TS 04.60. When used in SI13 or PSI13 message, this information element shall refer to the cell allocation defined for the cell in SI1 or PSI2.

RAC (8 bit field)

This field is the binary representation of the Routing Area Code, see 3GPP TS 23.003.

SPGC_CCCH_SUP (bit field)

This field indicates the support of the parameter SPLIT_PG_CYCLE on CCCH from the network side:

- 0 SPLIT_PG_CYCLE is not supported on CCCH in this cell;
- 1 SPLIT_PG_CYCLE is supported on CCCH in this cell.

The **PRIORITY_ACCESS_THR** field (3 bit) is the binary representation of the parameter PRIORITY_ACCESS_THR:

- 0 0 0 packet access is not allowed in the cell;
- 0 0 1 spare, shall be interpreted as '000' (packet access not allowed);
- 0 1 0 spare, shall be interpreted as '000' (packet access not allowed);
- 0 1 1 packet access is allowed for priority level 1;
- 1 0 0 packet access is allowed for priority level 1 to 2;
- 1 0 1 packet access is allowed for priority level 1 to 3;
- 1 1 0 packet access is allowed for priority level 1 to 4;
- 1 1 1 spare, shall be interpreted as '110' (packet access allowed).

The **NETWORK_CONTROL_ORDER** field (2 bit) is the binary representation of the parameter NETWORK_CONTROL_ORDER, see 3GPP TS 04.60:

- 0 0 NC0: MS controlled cell re-selection, no measurement reporting.
- 0 1 NC1: MS controlled cell re-selection, MS sends measurement reports.
- 1 0 NC2: Network controlled cell re-selection, MS sends measurement reports.
- 1 1 Reserved for future use, interpreted as NC0 by mobile station.

GPRS Cell Options (information element)

The *GPRS Cell Option* information element is defined in 3GPP TS 04.60.

PSI1_REPEAT_PERIOD (4 bit field)

This field is the representation of the PSI1 repeat period. The field is coded according to the following table:

- 0000 PSI1 repeat period = 1 multiframe
- 0001 PSI1 repeat period = 2 multiframe
- :
- 1111 PSI1 repeat period = 16 multiframe

GPRS Power Control Parameters struct

The **ALPHA** field (4 bit) is the binary representation of the parameter α for MS output power control in units of 0.1, see 3GPP TS 05.08: Range: 0 to 10. Values greater than 10 shall be interpreted as 10 by the mobile station.

The **T_AVG_W** field (5 bit) is the binary representation of the parameter T_{AVG_W} for MS output power control, see 3GPP TS 05.08: Range: 0 to 25. Values greater than 25 shall be interpreted as 25 by the mobile station.

The **T_AVG_T** field (5 bit) is the binary representation of the parameter T_{AVG_T} for MS output power control, see 3GPP TS 05.08: Range: 0 to 25. Values greater than 25 shall be interpreted as 25 by the mobile station.

The **PC_MEAS_CHAN** field (bit) indicates the type of channel which shall be used for downlink measurements for power control:

- 0 BCCH;
- 1 PDCH.

The **N_AVG_I** field (4 bit) is the binary representation of the parameter N_{AVG_I} for MS output power control, see 3GPP TS 05.08: Range: 0 to 15.

PBCCH Description struct

The PBCCH description struct provides the channel description for the PBCCH. The frequency description for the PBCCH may be specified by an ARFCN (non-hopping radio frequency channel) or a MAIO (hopping radio frequency channel) field. In case of a hopping radio frequency channel, the PBCCH shall use the GPRS mobile allocation specified in this message. If none of the ARFCN or MAIO fields are present, the PBCCH shall use the BCCH carrier.

Pb (4bit) (for encoding and description see the Global Power Control Parameters IE)

The **TSC** field (3 bit) is the binary representation of the training sequence code used for PBCCH and PCCCHs. Range: 0 to 7.

The **TN** field (3 bit) is the binary representation of the timeslot number for the PBCCH and the corresponding PCCCH. Range: 0 to 7.

The **ARFCN** field (10 bit) is the binary representation of the absolute RF channel number. Range: 0 to 1023.

The **MAIO** field (6 bit) is the binary representation of the mobile allocation index offset. Range: 0 to 63.

SGSNR, SGSN Release (bit field)

- 0 SGSN is Release '98 or older
- 1 SGSN is Release '99 onwards

10.5.2.37c [Spare]

10.5.2.37d [Spare]

10.5.2.37e SI 16 Rest Octets

The *SI 16 Rest Octets* information element includes parameters which are used by the mobile station for cell selection and reselection purposes.

The *SI 16 Rest Octets* information element is coded according to the syntax specified below. Its contents is described in Table 10.52c/3GPP TS 04.18.

The *SI 16 Rest Octets* information element is a type 5 information element with 20 octets length.

Table 10.5.77a/3GPP TS 04.18: SI 16 Rest Octets information element

<SI16 Rest Octets> ::=	{L H <LSA Parameters> <spare padding> ;
<SI17 Rest Octets> ::=	< SI16 Rest Octets> ;
<LSA Parameters> ::=	<PRIO_THR : bit (3)> <LSA_OFFSET : bit (3)> {0 1 <MCC : bit (12)> <MNC : bit (12)>} <LSA ID information>;
<LSA ID information> ::=	<LSA identity> {0 1 <LSA ID information>} ;
<LSA identity> ::=	{0 <LSA_ID : bit (24)> 1 <ShortLSA_ID : bit (10)>} ;

Table 10.5.77b/3GPP TS 04.18: SI 16 Rest Octets information element details

PRIO_THR (3 bit field)
The PRIO_THR field is a signal threshold used by the mobile station to determine whether prioritised cell re-selection shall apply. The use and coding of this parameters is defined in 3GPP TS 05.08.
LSA_OFFSET (3 bit field)
The LSA_OFFSET field applies an offset for LSA reselection between cells with same LSA priorities. The use and coding of this parameters is defined in 3GPP TS 05.08.
MCC and MNC (24 bit field)
If the escape PLMN is broadcast in SI3 and SI4 the cell is used for SoLSA exclusive access and the MCC and MNC field shall be included. The MS shall then for all purposes use the MCC and MNC values received in the LSA Parameters instead of the ones received in the Location Area information element in SI3 and 4, eg when deriving the PLMN identity, the Location Area Identity and Cell Global Identity broadcast by the cell. The MCC and MNC value field is coded as specified in Figure 10.5.3/3GPP TS 04.18 and Table 10.5.3/3GPP TS 04.18.
LSA_ID (24 bit field)
The purpose of the LSA_ID field is to identify a LSA. The LSA ID value field is coded as specified in 3GPP TS 23.003.
Short LSA_ID (10 bit field)
The purpose of the Short LSA_ID field is to identify a LSA. The LSA ID defined by the Short LSA_ID is a LSA_ID as specified in 3GPP TS 03.03 with bit 0 set to "0" bit 1 to 10 set to the value of the Short LSA_ID field (LSB in bit 1, MSB in bit 10) and bit 11 to 23 set to "0".

10.5.2.37f SI 17 Rest Octets

The *SI 17 Rest Octets* information element includes parameters, which are used by the mobile station for cell selection and reselection purposes.

The *SI 17 Rest Octets* information element is a type 5 information element with 20 octets length.

The *SI 17 Rest Octets* information element is coded as the *SI 16 Rest Octets*. Its contents is described in Table 10.5.2c/3GPP TS 04.18.

10.5.2.37g SI 19 Rest Octets

The *SI 19 Rest Octets* information element contains information for cell re-selection to COMPACT channels.

The *SI 19 Rest Octets* information element is a type 5 information element with 20 octets length.

The value part is coded as shown below:

Table 10.5.78a/3GPP TS 04.18: *SI 19 Rest Octets* information element

```

< SI 19 Rest Octets > ::=
  < SI19_CHANGE_MARK : bit (2) >
  < SI19_INDEX : bit (3) >
  < SI19_LAST : bit (1) >
  < COMPACT Neighbour Cell Parameters : COMPACT Neighbour Cell params struct >
  < spare padding >;

< COMPACT Neighbour Cell params struct > ::=
  { 1 < START_FREQUENCY : bit (10) >
    < COMPACT Cell selection params : COMPACT Cell Selection struct >
    < NR_OF_REMAINING_CELLS : bit (4) >
    < FREQ_DIFF_LENGTH : bit (3) >
    { < FREQUENCY_DIFF : bit (n) >
      < COMPACT Cell selection params : COMPACT Cell Selection struct > } * } * 0 ;

< COMPACT Cell Selection struct > ::=
  { 0 < BCC : bit (3)> | 1 < BSIC : bit (6)> }
  < CELL_BARRED : bit (1) >
  { LA Different parameters : LA Different struct }
  { 0 | 1 < MS_TXPWR_MAX_CCH : bit (5) > }
  { 0 | 1 < RXLEV_ACCESS_MIN : bit (6) > }
  { 0 | 1 < CELL_RESELECT_OFFSET : bit (6) > }
  { 0 | 1 < TEMPORARY_OFFSET : bit (3)
    < PENALTY_TIME : bit (5) > }
  { 0 | 1 < TIME_GROUP : bit (2) > }
  { 0 | 1 < GUAR_CONSTANT_PWR_BLKs : bit (2) > };

< LA Different struct > ::=
  { 0 | 1 < CELL_RESELECT_HYSTERISIS : bit (3) > ;

```

Table 10.5.78b/3GPP TS 04.18: *SI 19 Rest Octets* information element details

<p>SI19_CHANGE_MARK (2 bit field)</p> <p>The SI19 change mark field is changed each time information has been updated in any of the SI19 messages. A new value indicates that the mobile station shall re-read the information from all the SI19 messages. The coding of this field is network dependent.</p> <p>Range: 0-3.</p> <p>SI19_INDEX (3 bit field)</p> <p>The SI19_INDEX field is used to distinguish individual SI19 messages containing information about different neighbour cells. The field can take the binary representation of the values 0 to n, where n is the index of the last SI19 message.</p> <p>Range: 0-7.</p> <p>SI19_LAST (1 bit field)</p> <p>This field is coded as binary one if the SI19_INDEX in this message is the last SI19 message (<i>i.e.</i>, it represents the highest SI19_INDEX being broadcast). If the field is coded as binary zero, then this is not the last SI19 message.</p> <p>Range: 0-1.</p> <p>START_FREQUENCY (10 bit field)</p> <p>The Start Frequency defines the ARFCN for the BCCH frequency of the first cell in the list.</p>

FREQ_DIFF_LENGTH (3 bit field)

The Freq Diff length field specifies the number of bits to be used for the Frequency diff field in the current Frequency group. The field is coded according to the following table

3 2 1	
0 0 0	1 bit
0 0 1	2 bits
...	
1 1 1	8 bits

NR_OF_REMAINING_CELLS (4 bit field)

This field specifies the remaining number of cells that are defined in the frequency group. For each of them the parameters 'Frequency diff' and 'Cell selection params' will be repeated.

Range 1-16.

COMPACT Cell Selection params

This struct contains information about COMPACT neighbour cells. The first field of the COMPACT Cell Selection struct, BSIC, defines the BSIC of the cell and then comes the field same RA as serving cell. Then follows none, some, or all of the fields MS_TXPWR_MAX_CCH, RXLEV ACCESS MIN, CELL_RESELECT_OFFSET, TEMPORARY_OFFSET, PENALTY_TIME, TIME_GROUP, GUAR_CONSTANT_PWR_BLKs. If fields are omitted, the values for these parameters are the same as for the preceding cell.

FREQUENCY_DIFF ("Freq Diff length" bit field)

The Frequency Diff field specifies the difference in ARFCN to the BCCH carrier in the next cell to be defined. Note that the difference can be zero if two specified cells use the same frequency.

BSIC (6 bit field)

The BSIC field is coded as the "Base Station Identity Code" defined in 3GPP TS 03.03.

BCC (3 bit field)

The BCC is specified by encoding its binary representation; it specifies the BSIC given by that BCC and the NCC of the BSIC specified by the previous occurrence of <BCC : bit(3)> or <BSIC : bit(6)>.

CELL_BARRED (1 bit field)

- 0 The cell is not barred
- 1 The cell is barred

LA Different parameters

If <LA Different struct> contains a <CELL_RESELECT_HYSTERISIS : bit (3)>, this means that the cell is to be considered by the mobile station to belong to a different location area and that for the cell, the cell reselect hysteresis specified in <CELL_RESELECT_HYSTERISIS : bit (3)> applies.

If <LA Different struct> doesn't contain a <CELL_RESELECT_HYSTERISIS : bit (3)>, this means that the cell is to be considered by the mobile station to belong to the same location area.

For <CELL_RESELECT_HYSTERISIS : bit (3)>: see 10.5.2.4.

For <MS_TXPWR_MAX_CCH : bit (5)>: see 10.5.2.4.

For <RXLEV_ACCESS_MIN : bit (6)> see 10.5.2.4.

For <CELL_RESELECT_OFFSET : bit (6)>: see 10.5.2.35.

For <TEMPORARY_OFFSET : bit (3)>: see 10.5.2.35.

For <PENALTY_TIME : bit (5)>: see 10.5.2.35.

TIME_GROUP (2 bit field)

The TIME_GROUP defines which time group (see 3GPP TS 05.02) the cell belongs to

Bit

2 1

- 0 0 Time Group 0
- 0 1 Time Group 1
- 1 0 Time Group 2
- 1 1 Time Group 3

GUAR_CONSTANT_PWR_BLKs (2 bit field)

This field indicates the guaranteed number of constant power blocks in the neighbour cell. These are the blocks that the MS can use to perform neighbour cell measurements (see 3GPP TS 05.08). Note that there may be more CPBCCCH blocks or allowed paging blocks in the neighbour cell than what is indicated in this field, but never less.

Bit

- 2 1 Blocks at constant power
- 0 0 4
- 0 1 5
- 1 0 6
- 1 1 12 (i.e. BS_PAG_BLKs_RES = 0 in that cell)

10.5.2.37h SI 18 Rest Octets

The *SI 18 Rest Octets* information element includes parameters for non-GSM networks.

The *SI 18 Rest Octets* information element is a type 5 information element and is 20 octets long.

Table 10.5.78c/3GPP TS 04.18: SI 18 Rest Octets information element

```

< SI 18 Rest Octets > ::=
  < NonGSM Message : < NonGSM Message struct > *
    -- may be repeated many times until
    -- A) val(NonGSM Message.NR_OF_CONTAINER_OCTETS)=0 when the
    --   < padding bits > follows immediately or
    -- B) the SI message is fully used
  < padding bits >
  ! < Distribution part error : bit (*) = < no string > > ;

< NonGSM Message struct > ::=
  < NonGSM Protocol Discriminator : bit(3) >
  < NR_OF_CONTAINER_OCTETS : bit(5) >
  { < CONTAINER : bit(8) > } * (val(NR_OF_CONTAINER_OCTETS));

```

Table 10.5.78d: SI 18 information element details

NonGSM Protocol Discriminator (3 bit field)
This information element is used to identify the non-GSM network for which a SI18 message is transmitted and is coded as shown below.

bit	
3 2 1	
0 0 1	TIA/EIA-136

All other values are reserved

NR_OF_CONTAINER_OCTETS (5 bit field)
This field indicates the number of CONTAINER octets that forms a specific non-GSM message and is coded as shown below.

bit	
5 4 3 2 1	
0 0 0 0 0	Zero octets, There are no more NonGSM Messages embedded in this SI message
0 0 0 0 1	1 octet CONTAINER length
0 0 0 1 0	2 octets CONTAINER length
....	through ...
0 1 0 1 1	19 octets CONTAINER length

1 1 1 1 1 The remaining portion of the SI message is used by the associated **CONTAINER**. The Non-GSM message continues with the next **CONTAINER** that has the same **NonGSM Protocol Discriminator** as the current one.

All other values are reserved.

CONTAINER (8 bits)
The concatenation of one or several CONTAINER octets forms the actual contents, specific to the non-GSM network soliciting the transmission of a SI18 message.

NOTE: The format of SI 18 when 2 different non-GSM messages are sent is exemplified below

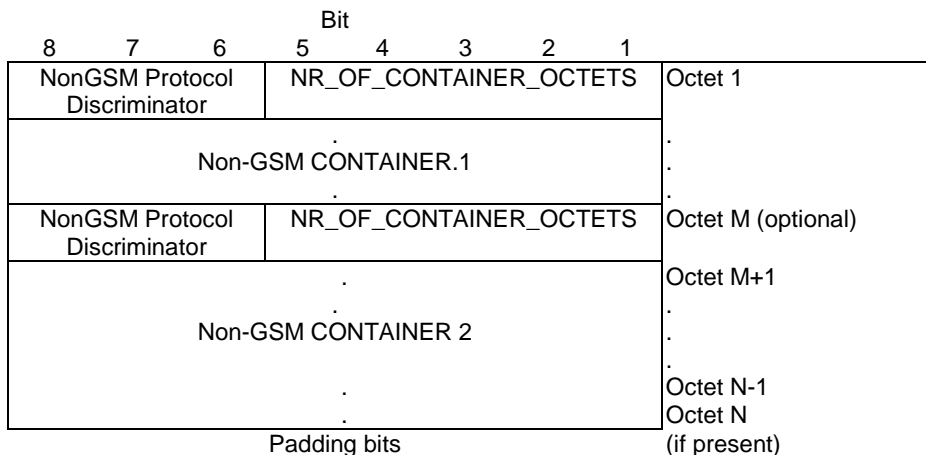

10.5.2.37i SI 20 Rest Octets

The *SI 20 Rest Octets* information element includes parameters for non-GSM networks.

The *SI 20 Rest Octets* information element is a type 5 information element and is 20 octets long.

The *SI 20 Rest Octets* are defined as the *SI 18 Rest Octets*, see also 10.5.2.37h

10.5.2.38 Starting Time

The purpose of the *Starting Time* information element is to provide the start TDMA frame number, FN modulo 42432.

The *Starting Time* information element is coded as shown in figure 10.5.65/3GPP TS 04.18 and table 10.5.79/3GPP TS 04.18.

The *Starting Time* is a type 3 information element with 3 octets length.

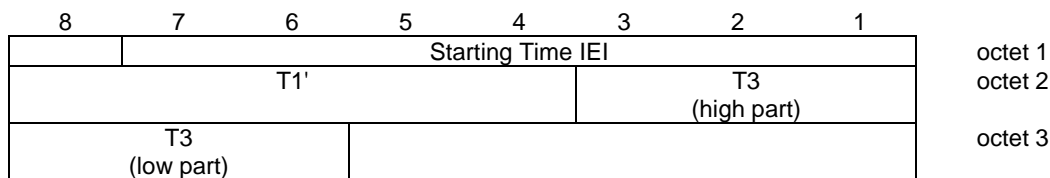

Figure 10.5.65/3GPP TS 04.18 *Starting Time* information element

Table 10.5.79/3GPP TS 04.18: *Starting Time* information element

<p>T1' (octet 2) The T1' field is coded as the binary representation of (FN div 1326) mod 32.</p> <p>T3 (octet 2 and 3) The T3 field is coded as the binary representation of FN mod 51. Bit 3 of octet 2 is the most significant bit and bit 6 of octet 3 is the least significant bit.</p> <p>T2 (octet 3) The T2 field is coded as the binary representation of FN mod 26.</p> <p>NOTE 1: The frame number, FN modulo 42432 can be calculated as $51 \times ((T3 - T2) \bmod 26) + T3 + 51 \times 26 \times T1'$</p>
--

The starting time and the times mentioned above are with reference to the frame numbering in the concerned cell. They are given in units of frames (around 4.615 ms).

The *Starting Time* IE can encode only an interval of time of 42 432 frames, that is to say around 195.8 seconds. To remove any ambiguity, the specification for a reception at time T is that the encoded interval is (T-10808, T+31623). In rigorous terms, if we note ST the starting time:

if $0 \leq (ST-T) \bmod 42432 \leq 31623$, the indicated time is the next time when FN mod 42432 is equal to ST

if $32024 \leq (ST-T) \bmod 42432 \leq 42431$, the indicated time has already elapsed.

The reception time T is not specified here precisely. To allow room for various MS implementations, the limit between the two behaviours above may be anywhere within the interval defined by

$31624 \leq (ST-T) \bmod 42432 \leq 32023$.

10.5.2.39 Synchronization Indication

The purpose of *Synchronization Indication* information element is to indicate which type of handover is to be performed.

The *Synchronization Indication* information element is coded as shown in figure 10.5.66/3GPP TS 04.18 and table 10.5.80/3GPP TS 04.18.

The *Synchronization Indication* is a type 1 information element.

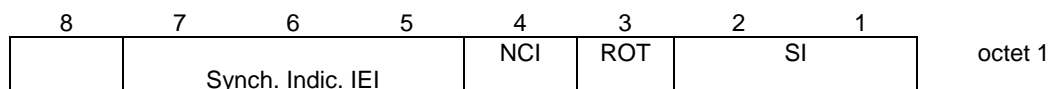

Figure 10.5.66/3GPP TS 04.18 Synchronization Indication information element

Table 10.5.80/3GPP TS 04.18: Synchronization Indication information element

ROT: Report Observed Time Difference (Octet1 bit 3) 0 Mobile Time Difference IE shall not be included in the HANDOVER COMPLETE message 1 Mobile Time Difference IE shall be included in the HANDOVER COMPLETE message SI: Synchronization indication (octet 1) Bit 2 1 0 0 Non-synchronized 0 1 Synchronized 1 0 Pre-synchronised 1 1 Pseudo-synchronised NCI: Normal cell indication (octet 1, bit 4) 0 Out of range timing advance is ignored 1 Out of range timing advance shall trigger a handover failure procedure
--

10.5.2.40 Timing Advance

The purpose of the *Timing Advance* information element is to provide the timing advance value.

The *Timing Advance* information element is coded as shown in figure 10.5.67/3GPP TS 04.18 and table 10.5.81/3GPP TS 04.18

The *Timing Advance* is a type 3 information element with 2 octets length.

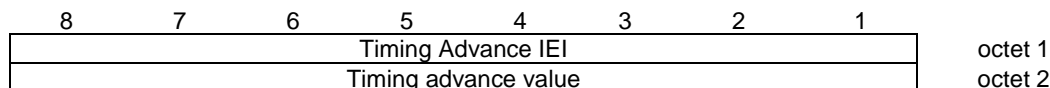

Figure 10.5.67/3GPP TS 04.18 Timing Advance information element

Table 10.5.81/3GPP TS 04.18: *Timing Advance* information element

<p>Timing advance value (octet 2) The coding of the timing advance value field is the binary representation of the timing advance in bit periods; 1 bit period = 48/13 μs.</p> <p>For all the bands except GSM 400, the values 0 - 63 are valid TA values, and bit 7 and bit 8 are set to spare. For GSM 400, the values 0 to 219 are valid TA values. The remaining values 220 to 255 decimal are reserved.</p>
--

10.5.2.41 Time Difference

The purpose of the *Time Difference* information element is to provide information about the synchronization difference between the time bases of two Base Stations. This type of information element is used in relation with the pseudo-synchronization scheme, see 3GPP TS 05.10.

The *Time Difference* information element is coded as shown in figure 10.5.68/3GPP TS 04.18 and table 10.5.82/3GPP TS 04.18.

The *Time Difference* information element is a type 4 information element with 3 octets length.

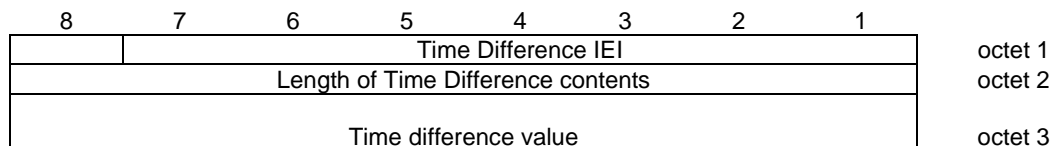

Figure 10.5.68/3GPP TS 04.18 *Time Difference* information element

Table 10.5.82/3GPP TS 04.18: *Time Difference* information element

<p>Time Difference value (octet 3) The coding of the time difference value field is the binary representation of time difference in half bit periods, modulo 256 half bit periods; 1/2 bit period = 24/13 μs.</p>
--

10.5.2.41a TLLI

The purpose of the *TLLI* information element is to provide the Temporary Logical Link Identifier.

The *TLLI* information element is coded as shown in figure 10.5.69/3GPP TS 04.18 and table 10.5.83/3GPP TS 04.18.

The *TLLI* is a type 3 information element with 5 octets length.

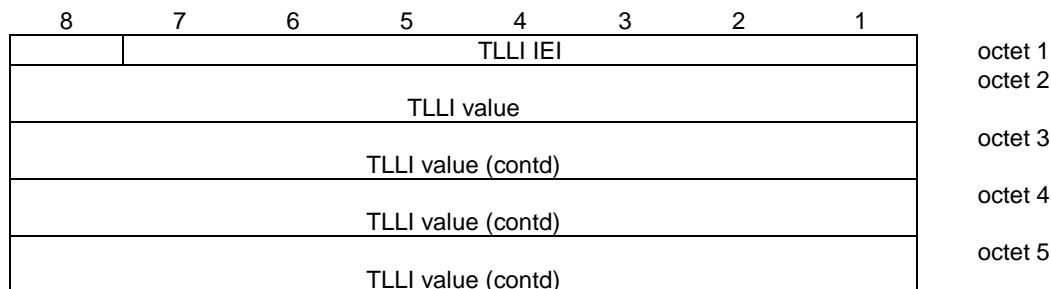

Figure 10.5.69/3GPP TS 04.18 *TLLI* information element

Table 10.5.83/3GPP TS 04.18: TLLI information element

TLLI value (octet 2, 3, 4 and 5)
 Bit 8 of octet 2 is the most significant bit and bit 1 of octet 5 is the least significant bit.

The TLLI is encoded as a binary number with a length of 4 octets. TLLI is defined in 3G3GPP TS 23.003

10.5.2.42 TMSI/P-TMSI

The purpose of the *TMSI/P-TMSI* information element is to provide the Temporary Mobile Subscriber Identity for paging purposes.

The *TMSI/P-TMSI* information element is coded as shown in figure 10.5.70/3GPP TS 04.18 and table 10.5.84/3GPP TS 04.18.

The *TMSI/P-TMSI* is a type 3 information element with 5 octets length.

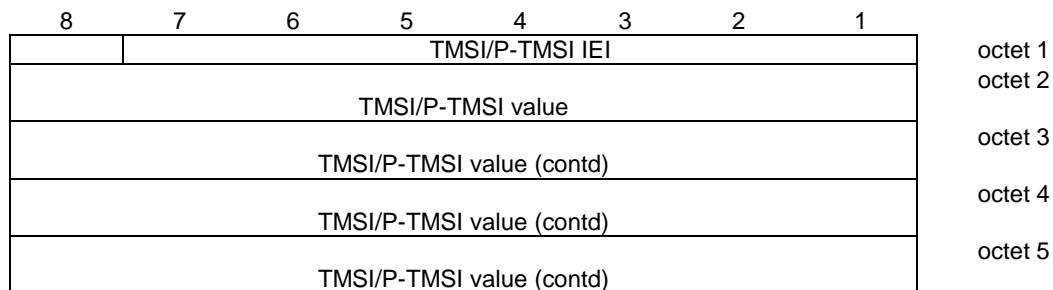

Figure 10.5.70/3GPP TS 04.18 TMSI/P-TMSI information element

Table 10.5.84/3GPP TS 04.18: TMSI/P-TMSI information element

TMSI/P-TMSI value (octet 2, 3, 4 and 5)
 Bit 8 of octet 2 is the most significant bit and bit 1 of octet 5 is the least significant bit.

The coding of the TMSI/P-TMSI is left open for each administration according to 3GPP TS 23.003. The length is 4 octets.

NOTE: For purposes other than paging the TMSI/P-TMSI should be provided using the mobile identity information element.

10.5.2.42a VGCS target mode Indication

The *VGCS target mode Indication* information element is a type 3 information element with 2 octets length.

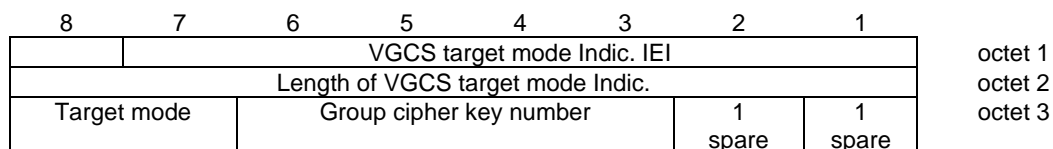

Figure 10.5.71/3GPP TS 04.18 VGCS target mode Indication information element

Table 10.5.85/3GPP TS 04.18 VGCS target mode information element

Target mode (octet 3)	
Bit	
8 7	
0 0	dedicated mode
0 1	group transmit mode
Other values are reserved for future use.	
Group cipher key number (octet 3)	
Bit	
6 5 4 3	
0 0 0 0	no ciphering
0 0 0 1	cipher key number 1
0 0 1 0	cipher key number 2
0 0 1 1	cipher key number 3
0 1 0 0	cipher key number 4
0 1 0 1	cipher key number 5
0 1 1 0	cipher key number 6
0 1 1 1	cipher key number 7
1 0 0 0	cipher key number 8
1 0 0 1	cipher key number 9
1 0 1 0	cipher key number A
1 0 1 1	cipher key number B
1 1 0 0	cipher key number C
1 1 0 1	cipher key number D
1 1 1 0	cipher key number E
1 1 1 1	cipher key number F

10.5.2.43 Wait Indication

The purpose of the *Wait Indication* information element is to provide the time the mobile station shall wait before attempting another channel request.

The *Wait Indication* information element is coded as shown in figure 10.5.72/3GPP TS 04.18 and table 10.5.86/3GPP TS 04.18.

The *Wait Indication* is a type 3 information element with 2 octets length.

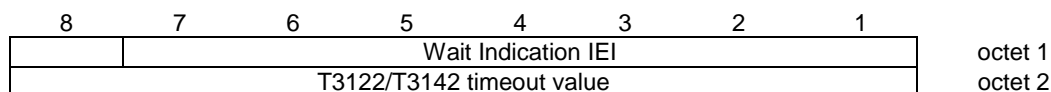

Figure 10.5.72/3GPP TS 04.18 Wait Indication information element

Table 10.5.86/3GPP TS 04.18: Wait Indication information element

T3122/T3142 timeout value (octet 2)
This field is coded as the binary representation of the T3122/T3142 timeout value in seconds.

NOTE 1: The timeout value is used for T3122 when received in IMMEDIATE_ASSIGNMENT REJECT message for RR connection establishment. For GPRS MS the timeout value is used for T3142 when received in IMMEDIATE_ASSIGNMENT REJECT message for TBF establishment.

10.5.2.44 SI10 rest octets \$(ASCII)\$

The *SI 10 rest octets* information element contains information for cell re-selection in group receive mode.

The *SI 10 Rest Octets* information element is a type 5 information element with 20 octets length.

The value part is coded as shown below:

Table 10.5.86a/3GPP TS 04.18: SI 10 Rest Octets information element

<pre> <SI10 rest octets> ::= <BA ind : bitstring(1)> { L <implicit spare> H <neighbour information> }; <neighbour information> ::= <first frequency: bitstring(5)> <cell info> { H <info field> } * L <implicit spare>; <cell info> ::= <bsic : bitstring(6)> { H <cell parameters> L } <cell parameters> ::= <cell barred> L <further cell info> <cell barred> ::= H <further cell info> ::= <la different> <ms txpwr max cch : bitstring(5)> <rxlev access min : bitstring(6)> <cell reselect offset : bitstring(6)> <temporary offset : bitstring(3)> <penalty time : bitstring(5)> <la different> ::= { H <cell reselect hysteresis : bitstring(3)> L } <info field> ::= <next frequency> * L <differential cell info>; <next frequency> ::= H; <differential cell info> ::= { H <BCC : bitstring(3)> L <bsic : bitstring(6)> } { H <diff cell pars> L } <diff cell pars> ::= <cell barred> L <further diff cell info> <further diff cell info> ::= <la different> { H <ms txpwr max cch : bitstring(5)> L } { H <rxlev access min : bitstring(6)> L } { H <cell reselect offset : bitstring(6)> L } { H <temporary offset : bitstring(3)> L } { H <penalty time : bitstring(5)> L } </pre>

Static and dynamic conditions:

- 1) Information from the last received neighbour cells description in SYSTEM INFORMATION TYPE 5/5bis/5ter is necessary for the mobile station to interpret <neighbour information>. If <BA ind> is different from the last received BA IND value indicated in SYSTEM INFORMATION TYPE 5/5bis/5ter, <neighbour information> cannot be interpreted by the mobile station.
- 2) If the correspondence between neighbour cell frequencies and sets of pairs (BSIC, cell information) cannot be established following the rules below, or if more than one set of such pairs corresponds to one neighbour cell frequency, the mobile station shall diagnose an imperative message part error.

Attributes, field contents:

- 1) <cell info> defines a BSIC given by <bsic : bitstring(6)>. It also defines cell information. If <cell parameters> is contained in <cell info>, this cell information is the cell information given by <cell parameters>; if <cell parameters> is not contained in <cell info>, this cell information is empty.
- 2) <differential cell info> defines a BSIC given by <bsic : bitstring(6)> or by <BCC : bitstring(3)>, see below. It also defines cell information. If <diff cell pars> is contained in <differential cell info>, this cell information is the cell information given by <diff cell pars>; if <diff cell pars> is not contained in <differential cell info>, this cell information is empty.
- 3) <cell parameters> either indicates a barred cell (by presence of <cell barred>) or specifies cell information given by <further cell info>.
- 4) Each occurrence of <diff cell pars> either indicates a barred cell (by presence of <cell barred>) or specifies cell information given by <further diff cell info>.
- 5) <further cell info> specifies cell information given by its components
 - <la different>
 - <ms txpwr max cch : bitstring(5)>
 - <rxlev access min : bitstring(6)>
 - <cell reselect offset : bitstring(6)>
 - <temporary offset : bitstring(3)>

- <penalty time : bitstring(5)>,

as defined below.

- 6) For each occurrence of <further diff cell info>, a cell information is defined. This information is given by <la different> and remaining cell information established as follows:

The remaining cell information defined for the first occurrence of <further diff cell info> consists of the cell information given by its actual components plus the cell information specified by <further cell info> corresponding to its missing components.

The remaining cell information defined for a later occurrence of <further diff cell info> consists of the cell information given by its actual components plus the remaining cell information corresponding to its missing components which is defined for the previous occurrence of <further diff cell info>.

Here, the

"actual components" of an occurrence of <further diff cell info> denotes those parameters among

- <ms txpwr max cch : bitstring(5)>
- <rxlev access min : bitstring(6)>
- <cell reselect offset : bitstring(6)>
- <temporary offset : bitstring(3)>
- <penalty time : bitstring(5)>

which are present in that occurrence.

"missing components" of an occurrence of <differential cell info> denote those parameters among

- <ms txpwr max cch : bitstring(5)>
- <rxlev access min : bitstring(6)>
- <cell reselect offset : bitstring(6)>
- <temporary offset : bitstring(3)>
- <penalty time : bitstring(5)>

which are not present in that occurrence.

- 7) Each occurrence of <bsic : bitstring(6)> specifies a BSIC by encoding its binary representation. <BCC : bitstring(3)> specifies a BCC by encoding its binary representation; it specifies the BSIC given by that BCC and the NCC of the BSIC specified by the previous occurrence of <BCC : bitstring(3)> or <bsic : bitstring(6)>. All occurrences of <bsic : bitstring(6)> and <BCC : bitstring(3)> establish a list of BSIC.
- 8) <first frequency : bitstring(5)> is the 5 bit binary coding of an integer n with $0 \leq n \leq 31$. It specifies a first frequency number $n+1$.
- 9) <SI10 rest octets> defines a correspondence between neighbour cell frequencies and sets of pairs (BSIC, cell information) defining the parameters for cell re-selection of any corresponding neighbour cell with BCCH on that frequency and having that BSIC:

Let $a(1), \dots, a(n)$ be the list of neighbour cell frequencies, in the order determined by the mobile station. Let i be the first frequency number specified by <first frequency : bitstring(5)> (see above).

The first BSIC and the cell information specified by <cell info> build a pair belonging to the set corresponding to $a(i)$.

If an m -th occurrence of <info field> is present (where $m \geq 2$), having established the correspondence of the $(m-1)$ -th BSIC to a neighbour frequency $a(k)$, the m -th BSIC and following <differential cell info>

- belong to $a(k)$, if <next frequency> is not present in the m -th occurrence of <info field>,

- belong to $a((\text{smod}(k+t)))$, if $\langle \text{next frequency} \rangle$ is present exactly t times in the m -th occurrence of $\langle \text{info field} \rangle$.

Here, for an integer j , $\text{smod}(j) := ((j-1) \bmod n) + 1$.

10) If $\langle \text{la different} \rangle$ contains a $\langle \text{cell reselect hysteresis : bitstring}(3) \rangle$, this means that the cell is to be considered by the mobile station to belong to a different location area and that for the cell, the cell reselect hysteresis specified in $\langle \text{cell reselect hysteresis : bitstring}(3) \rangle$ applies.

If $\langle \text{la different} \rangle$ doesn't contain a $\langle \text{cell reselect hysteresis : bitstring}(3) \rangle$, this means that the cell is to be considered by the mobile station to belong to the same location area.

11) $\langle \text{same LA indicator : bitstring}(1) \rangle$ defines whether the location area is the same as the location area of the serving cell

12) For $\langle \text{cell reselect hysteresis : bitstring}(3) \rangle$: see 10.5.2.4.

13) For $\langle \text{ms txpwr max cch : bitstring}(5) \rangle$: see 10.5.2.4.

14) For $\langle \text{rxlev access min : bitstring}(6) \rangle$ see 10.5.2.4.

15) For $\langle \text{cell reselect offset : bitstring}(6) \rangle$: see 10.5.2.35.

16) For $\langle \text{temporary offset : bitstring}(3) \rangle$: see 10.5.2.35.

17) For $\langle \text{penalty time : bitstring}(5) \rangle$: see 10.5.2.35.

10.5.2.45 EXTENDED MEASUREMENT RESULTS

The purpose of the *Extended Measurement Results* information element is to provide the results of the measurements made by the mobile station on the carriers specified in the EXTENDED MEASUREMENT ORDER.

The *Extended Measurement Results* information element is coded as shown in figure 10.5.73/3GPP TS 04.18 and table 10.5.87/3GPP TS 04.18.

The *Extended Measurement Results* is a type 3 information element with 17 octets length.

8	7	6	5	4	3	2	1	
Extended Measurement Results IEI								octet 1
SC USED	DTX USED	RXLEV carrier 0						octet 2
RXLEV carrier 1						RXLEV carrier 2 (high part)		octet 3
RXLEV carrier 2 (low part)				RXLEV carrier 3 (high part)				octet 4
RXLEV carrier 3 (low part)		RXLEV carrier 4						octet 5
RXLEV carrier 5						RXLEV carrier 6 (high part)		octet 6
RXLEV carrier 6 (low part)				RXLEV carrier 7 (high part)				octet 7
RXLEV carrier 7 (low part)		RXLEV carrier 8						octet 8
RXLEV carrier 9						RXLEV carrier 10 (high part)		octet 9
RXLEV carrier 10 (low part)				RXLEV carrier 11 (high part)				octet 10
RXLEV carrier 11 (low part)		RXLEV carrier 12						octet 11
RXLEV carrier 13						RXLEV carrier 14 (high part)		octet 12
RXLEV carrier 14 (low part)				RXLEV carrier 15 (high part)				octet 13
RXLEV carrier 15 (low part)		RXLEV carrier 16						octet 14
RXLEV carrier 17						RXLEV carrier 18 (high part)		octet 15
RXLEV carrier 18 (low part)				RXLEV carrier 19 (high part)				octet 16
RXLEV carrier 19 (low part)		RXLEV carrier 20						octet 17

Figure 10.5.73/3GPP TS 04.18 *Extended Measurement Results* information element

Table 10.5.87/3GPP TS 04.18: *Extended Measurement Results* information element details

<p>SC USED (octet 2), indicates the value of the SEQ-CODE in the extended measurement frequency list information element used for defining the list of frequencies reported on.</p> <p>Range: 0 to 1.</p> <p>DTX USED (octet 2) This bit indicates whether or not the mobile station used DTX during the previous measurement period.</p> <p>Bit 7</p> <p>0 DTX was not used</p> <p>1 DTX was used</p> <p>RXLEV carrier 'N' (octets 2 to 17). This field is coded as the binary representation of a value M. M corresponds according to the mapping defined in TS. 3GPP TS 05.08 to the received signal strength on carrier N. N is the index to the frequency in the sorted list of frequencies defined in the EXTENDED MEASUREMENT ORDER message. The list is sorted in increasing order of ARFCN, except that ARFCN 0, if included in the EXTENDED MEASUREMENT ORDER, is put in the last position of the sorted list. If the EXTENDED MEASUREMENT ORDER contains more than 21 carriers, only the signal strength of the carriers 0-20 shall be measured and reported.</p> <p>Range: 0 to 63</p> <p>If the EXTENDED MEASUREMENT ORDER message contains less than 21 carriers, the fields in the EXTENDED MEASUREMENT REPORT not referring to any specified carrier shall have RXLEV values set to zero.</p>

10.5.2.46 Extended Measurement Frequency List

The purpose of *Extended Measurement Frequency List* information element is to provide the absolute radio frequency channel numbers of carriers to measure signal strength on.

The *Extended Measurement Frequency List* information element is coded as the *Cell Channel Description* information element, as specified in section 10.5.2.1b, with the exception of bit 5 of octet 2. figure 10.5.74/3GPP TS 04.18 and table 10.5.88/3GPP TS 04.18 contains the difference of specifications.

The *Extended Measurement Frequency List* information element is a type 3 information element with 17 octets length.

8	7	6	5	4	3	2	1	
Extended Measurement Frequency List IEI								octet 1
Bit 128	Bit 127	0 spare	SEQ- CODE	Bit 124	Bit 123	Bit 122	Bit 121	octet 2
Bit 120	Bit 119	Bit 118	Bit 117	Bit 116	Bit 115	Bit 114	Bit 113	octet 3
...								
Bit 008	Bit 007	Bit 006	Bit 005	Bit 004	Bit 003	Bit 002	Bit 001	octet 17

Figure 10.5.74/3GPP TS 04.18 *Extended Measurement Frequency List* information element

Table 10.5.88/3GPP TS 04.18: *Extended Measurement Frequency List* information element

<p>SEQ-CODE, Sequence code (octet 2, bit 5).</p> <p>Range 0 to 1.</p>

10.5.2.47 Suspension Cause

The purpose of the *Suspension Cause* information element is to provide the reason for the GPRS suspension.

The *Suspension Cause* information element is coded as shown in figure 10.5.2.47/3GPP TS 04.18 and table 10.5.2.47/3GPP TS 04.18.

The *Suspension Cause* is a type 3 information element with 2 octets length.

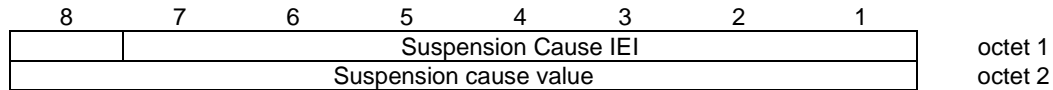

Figure 10.5.2.47/3GPP TS 04.18 *Suspension Cause* information element

Table 10.5.2.47/3GPP TS 04.18: *Suspension Cause* information element

Suspension cause value (octet 2)	
Bits	
8 7 6 5 4 3 2 1	
0 0 0 0 0 0 0 0	Emergency call, mobile originating call or call re-establishment
0 0 0 0 0 0 0 1	Location Area Update
0 0 0 0 0 0 1 0	MO Short message service (note 1)
0 0 0 0 0 0 1 1	Other procedure which can be completed with an SDCCCH
0 0 0 0 0 1 0 0	MO Voice broadcast or group call (note 2)
0 0 0 0 0 1 0 1	Mobile terminating CS connection
0 0 0 0 0 1 1 0	DTM not supported in the cell
Note 1: As an option, cause value 0000 0011 may be used for an MO Short message service	
Note 2: As an option, cause value 0000 0000 may be used for an MO Voice broadcast or group call	
All other cause values shall be treated as 0000 0000	

10.5.2.48 APDU ID

The *APDU ID* information element identifies the particular protocol and associated application for an APDU.

The *APDU ID* information element is coded as shown in figure 10.5.2.48/3GPP TS 04.18 and table 10.5.2.48/3GPP TS 04.18.

The *APDU ID* is a type 1 information element.

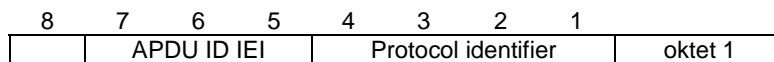

Figure 10.5.2.48/3GPP TS 04.18: *APDU ID* information element

Table 10.5.2.48/3GPP TS 04.18: *APDU ID* information element format

Protocol identifier (octet 1)	
Bits	Protocol / Application
4 3 2 1	
0 0 0 0	RRLP (3GPP TS 04.31)/ LCS
0 0 0 1	to reserved for future use
1 1 1 1	

10.5.2.49 APDU Flags

The *APDU Flags* information element provides segmentation and control information for an associated APDU.

The *APDU Flags* information element is coded as shown in figure 10.5.2.49/3GPP TS 04.18 and table 10.5.2.49/3GPP TS 04.18.

The *APDU Flags* is a type 1 information element.

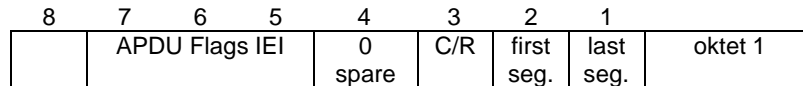

Figure 10.5.2.49/3GPP TS 04.18: *APDU Flags* information element

Table 10.5.2.49/3GPP TS 04.18: *APDU Flags* information element format

Last Segment (oktet 1) bit 1 0 Last or only segment 1 Not last or only segment First Segment (oktet 1) bit 2 0 First or only segment 1 Not first or only segment C/R (oktet 1) If last seg. = 0, then: bit 3 0 Command or Final Response 1 Not Command or Final Response If last seg. = 1, then bit 3 is spare and set to 0
--

10.5.2.50 APDU Data

The purpose of the information element is to provide an APDU or APDU segment.

The *APDU Data* information element is coded as shown in figure 10.5.2.50/3GPP TS 04.18 and table 10.5.2.50/3GPP TS 04.18.

The *APDU Data* is a type 4 information element with minimum length of 2 octets. No upper length limit is specified except for that given by the maximum number of octets in a L3 message (3GPP TS 04.06).

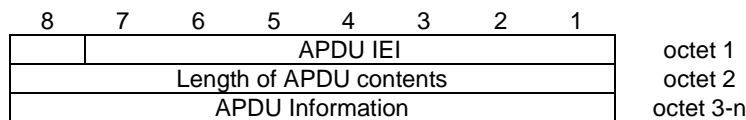

Figure 10.5.2.50/3GPP TS 04.18: *APDU Data* information element

Table 10.5.2.50/3GPP TS 04.18: APDU Data information element format

APDU Information (octets 3-n) Contains an APDU message or APDU segment as follows:	
Protocol ID -----	APDU Message or Segment -----
RRLP	RRLP message in 3GPP TS 04.31 (1)
NOTE 1: Messages are segmented on octet boundaries. Zero bits are used, where necessary, to pad out the last segment to an octet boundary.	

10.5.2.51 Handover To UTRAN Command

The purpose of Handover To UTRAN Command information element is to provide information to the mobile of handover to UTRAN. The Handover to UTRAN Command information element contains all information needed by the mobile for handover to UTRAN.

The Handover To UTRAN Command is a type 4 information element with length 3-n octets.

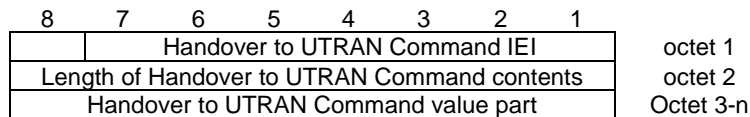

Figure 10.5.2.51/3GPP TS 04.18: Handover to UTRAN Command information element

The value part of the Handover To UTRAN Command IE is coded as defined in 3GPP TS 25.331.

10.5.2.52 Handover To cdma2000 Command

The purpose of Handover To cdma2000 Command information element is to provide information to the mobile of handover to cdma2000. The Handover to cdma2000 Command information element contains all information needed by the mobile for handover to cdma2000.

The Handover To cdma2000 Command IE is coded as follows:

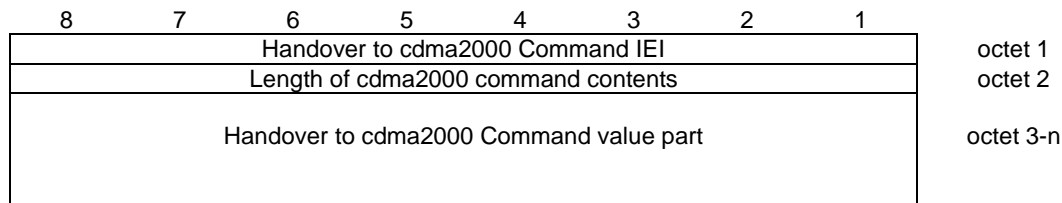
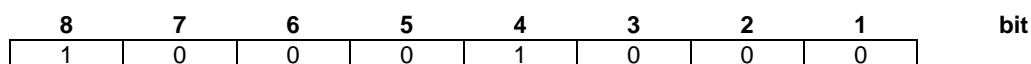

Figure 10.5.2.52/3GPP TS 04.18: Handover to cdma2000 Command information element

The MSG_TYPE of the cdma2000 message used for the intersystem handover shall be included in the first octet of the Handover to cdma2000 value part. It is specified in TIA/EIA/IS-2000-4-A and in TIA/EIA/IS-833. (E.g. MSG_TYPE ::= {00010001} if Extended Handoff Direction Message (EHDM) is used, MSG_TYPE ::= {00011111} if General Handoff Direction Message is used, etc.). The order of the bits in this octet representing is given by the following example. If MSG_TYPE ::= {00010001} (EHDM), the bit number 1 of 'cdma2000 MSG_TYPE IEI' shall be '0', the bit number 2 shall be '0', etc., and the bit number 8 shall be '1', as illustrated below.



The remaining octets in the Handover to cdma2000 value part shall be coded as the payload of the message used for the inter system handover, as specified in TIA/EIA/IS-2000-5-A and in TIA/EIA/IS-833. The bit ordering shall be similar to the case described above. The bit number 1 of 'cdma2000 message payload' shall be coded as the first bit of the first record of the message defined in TIA/EIA/IS-2000-5-A and in TIA/EIA/IS-833, reading the records defined in TIA/EIA/IS-2000-5-A and in TIA/EIA/IS-833 from left to right.

The Handover To cdma2000 Command is a type 4 information element with length 4 to n octets.

10.5.2.53 UTRAN Pre-configuration INDEX/COUNT

This applies only to a UMTS multi-mode MS. The *UTRAN Pre-configuration INDEX/COUNT* information element indicates to the mobile station the number of individual messages relative to a given pre-configuration identity and assigns an index to identify each of them.

The *UTRAN pre-configuration INDEX/COUNT* information element is coded as shown in figure 10.5.2.54/3GPP TS 04.18 and table 10.5.2.54/3GPP TS 04.18.

The *UTRAN pre-configuration INDEX/COUNT* is a type 1 information element.

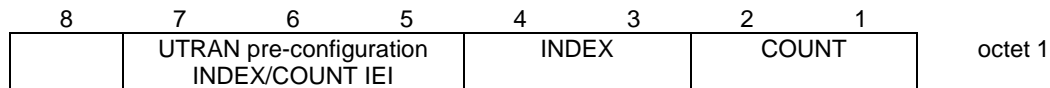

Figure 10.5.2.53/3GPP TS 04.18 UTRAN pre-configuration INDEX/COUNT information element

Table 10.5.2.53/3GPP TS 04.18: UTRAN pre-configuration INDEX/COUNT information element

<p>INDEX (octet 1) The INDEX field is coded in a binary representation and indicates the current index of the pre-configuration. Range: 0 to 3.</p> <p>COUNT (octet 1) The COUNT field indicates the INDEX value for the last pre-configuration. It is coded in a binary representation. Range: 0 to 3.</p>

The value part of each UTRAN pre-configuration set shall be concatenated by increased values of INDEX. In the concatenation, the lower octets are mapped to the lower INDEX values.

When COUNT indicates a value different from 0, all messages with lowest indexed INDEX values shall be received before the MS assumes the pre-configuration is known for this version number and pre-configuration identity.

Any incomplete UTRAN pre-configuration set (mapped to a pre-configuration Identity) shall be deleted at change of cell.

10.5.2.54 UTRAN Pre-configuration identity

This applies only to a UMTS multi-mode MS. The *UTRAN Pre-configuration identity* information element indicates the pre-configuration identity, see 3G3GPP TS 25.922.

The *UTRAN pre-configuration identity* information element is coded as shown in figure 10.5.2.55/3GPP TS 04.18 and table 10.5.2.55/3GPP TS 04.18.

The *UTRAN pre-configuration INDEX/COUNT* is a type 1 information element.

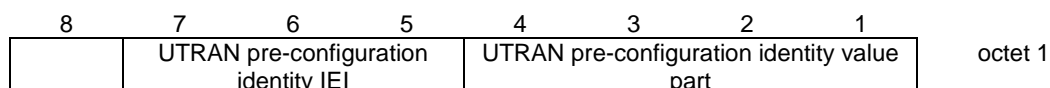

Figure 10.5.2.54/3GPP TS 04.18 UTRAN pre-configuration INDEX/COUNT information element

Table 10.5.2.54/3GPP TS 04.18: UTRAN pre-configuration INDEX/COUNT information element

<p>UTRAN pre-configuration identity value part (octet 1) The UTRAN pre-configuration identity value part field is coded in a binary</p>
--

representation.
Range: 0 to 15.

10.5.2.55 Predefined configuration value tag

This applies only to a UMTS multi-mode MS. The purpose of the *Predefined configuration value tag* information element is to provide to the MS the version number of the pre-configuration.

The *Predefined configuration value tag* information element is coded as shown in figure 10.5.55/3GPP TS 04.18 and table 10.5.55/3GPP TS 04.18.

The *Predefined configuration value tag* is a type 3 information element with 3 octets length.

	8	7	6	5	4	3	2	1	
	Predefined configuration value tag IE1								octet 1
	0	0	0	0	Predefined configuration value tag				octet 2
	spare	spare	spare	spare					

Figure 10.5.2.55/3GPP TS 04.18 Predefined configuration value tag information element

Table 10.5.2.55/3GPP TS 04.18: Predefined configuration value tag information element

Predefined configuration value tag (octet 2)
The predefined configuration value tag is coded as the binary representation of the predefined configuration value tag, see 3G3GPP TS 25.331. It indicates the version number of the pre-configuration.
Range: 0 to 15.

10.5.2.56 3G Target Cell

The purpose of the *3G Target Cell* information element is to indicate to the MS the target 3G Cell.

The *3G Target Cell* is a type 4 information element with a minimum length of 3 octets and a maximum length of 6 octets.

If the *3G Target Cell* information element contains information on both 3G UMTS FDD and 3G UMTS TDD, the information element shall be ignored by the receiver.

Table 10.5.2.56/3GPP TS 04.18: 3G Target Cell information element

```

< 3G Target Cell > ::=
    < 0 0 0 1 0 0 1 1 > --type
    < LENGTH OF 3G TARGET CELL : bit (8) > -- length following in octets
    { 0 | 1 < FDD-ARFCN : bit (14) >                               -- 3G UMTS FDD
      < Diversity : bit >
        { 0 | 1 < Bandwidth_FDD : bit (3) > }
        < SCRAMBLING_CODE : bit (9) > }
    { 0 | 1 < TDD-ARFCN : bit (14) >                               -- 3G UMTS TDD
      < Diversity : bit >
        { 0 | 1 < Bandwidth_TDD : bit (3) > }
      < Cell Parameter : bit (7) >
      < Sync Case : bit > } ;
    spare bits;
    
```

10.5.3 Mobility management information elements.

See 3GPP TS 24.008.

10.5.4 Call control information elements.

See 3GPP TS 24.008.

10.5.5 GPRS mobility management information elements

See 3GPP TS 24.008.

10.5.6 Session management information elements

See 3GPP TS 24.008.

10.5.7 GPRS Common information elements

See 3GPP TS 24.008.

10.5.8 GTTP information elements.

10.5.8.1 LLC PDU Container

The purpose of the *LLC PDU Container* information element is to carry an LLC PDU with upper layer information between the network and the mobile station. Within the scope of 3GPP TS 04.18 the content of the *LLC PDU* field is an array of octets. The usage of the contents of this transportation mechanism is defined in 3GPP TS 04.64.

The *LLC PDU Container* information element is coded as shown in figure 10.5.8.1/3GPP TS 04.18.

The *LLC PDU Container* is a type 4 information element with a minimum length of 3 octets. No upper length limit is specified except for that given by the maximum number of octets in a L3 message (see 3GPP TS 04.06).

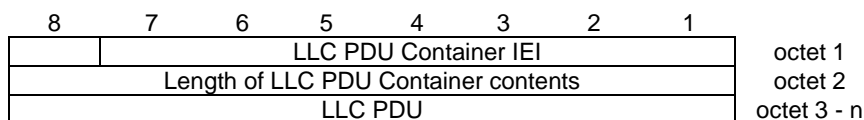

Figure 10.5.8.1/3GPP TS 04.18 LLC PDU Container information element

LLC PDU (variable length field, octets 3 to n)
 This field contains an LLC PDU; see 3GPP TS 04.64.

11 List of system parameters

The description of timers in the following table should be considered a brief summary. The precise details are found in sections 3 to 6, which should be considered the definitive descriptions.

11.1 Timers and counters for radio resource management

11.1.1 Timers on the mobile station side

T3122: This timer is used during random access, after the receipt of an IMMEDIATE ASSIGN REJECT message.

Its value is given by the network in the IMMEDIATE ASSIGN REJECT message.

T3124: This timer is used in the seizure procedure during a hand-over, when the two cells are not synchronized.

Its purpose is to detect the lack of answer from the network to the special signal.

Its value is set to 675 ms if the channel type of the channel allocated in the HANDOVER COMMAND is an SDCCH (+ SACCH); otherwise its value is set to 320 ms.

T3126: This timer is started either
after sending the maximum allowed number of CHANNEL REQUEST messages during an immediate assignment procedure.

or

on receipt of an IMMEDIATE ASSIGNMENT REJECT message,
whichever occurs first.

It is stopped at receipt of an IMMEDIATE ASSIGNMENT message, or an IMMEDIATE ASSIGNMENT EXTENDED message.

At its expiry, the immediate assignment procedure is aborted.

The minimum value of this timer is equal to the time taken by T+2S slots of the mobile station's RACH. S and T are defined in section 3.3.1.2. The maximum value of this timer is 5 seconds.

T3128: This timer is started when the mobile station starts the uplink investigation procedure and the uplink is busy.

It is stopped at receipt of the first UPLINK FREE message.

At its expiry, the uplink investigation procedure is aborted.

The value of this timer is set to 1 second.

T3130: This timer is started after sending the first UPLINK ACCESS message during a VGCS uplink access procedure.

It is stopped at receipt of a VGCS ACCESS GRANT message.

At its expiry, the uplink access procedure is aborted.

The value of this timer is set to 5 seconds.

T3110: This timer is used to delay the channel deactivation after the receipt of a (full) CHANNEL RELEASE. Its purpose is to let some time for disconnection of the main signalling link.

Its value is set to such that the DISC frame is sent twice in case of no answer from the network. (It should be chosen to obtain a good probability of normal termination (i.e. no time out of T3109) of the channel release procedure.)

T3134 This timer is used in the seizure procedure during an RR network commanded cell change order procedure. Its purpose is to detect the lack of answer from the network or the lack of availability of the target cell.

Its value is set to 5 seconds.

T3142: The timer is used during packet access on CCCH and during packet access while in dedicated mode. It is started after the receipt of an IMMEDIATE ASSIGNMENT REJECT or a DTM REJECT message.

Its value is given by the network in the IMMEDIATE ASSIGNMENT REJECT or DTM REJECT message.

- T3148:** This timer is used during DTM establishment in dedicated mode.
- It is started after sending a DTM REQUEST message during a packet access procedure while in dedicated mode.
- It is stopped at the receipt of one of the following messages:
- DTM ASSIGNMENT COMMAND
 - PACKET ASSIGNMENT
 - DTM REJECT
 - ASSIGNMENT COMMAND
 - HANDOVER COMMAND
- At its expiry, the packet access procedure is aborted.
- Its value is 4 seconds.
- T3146:** This timer is started either
- after sending the maximum allowed number of CHANNEL REQUEST or EGPRS PACKET CHANNEL REQUEST messages during a packet access procedure.
- or
- on receipt of an IMMEDIATE ASSIGNMENT REJECT message during a packet access procedure,
- whichever occurs first.
- It is stopped at receipt of an IMMEDIATE ASSIGNMENT message, or an IMMEDIATE ASSIGNMENT EXTENDED message.
- At its expiry, the packet access procedure is aborted.
- The minimum value of this timer is equal to the time taken by T+2S slots of the mobile station's RACH. S and T are defined in section 3.3.1.2. The maximum value of this timer is 5 seconds.
- T3164:** This timer is used during packet access using CCCH. It is started at the receipt of an IMMEDIATE ASSIGNMENT message.
- It is stopped at the transmission of a RLC/MAC block on the assigned temporary block flow, see 3GPP TS 04.60.
- At expiry, the mobile station returns to the packet idle mode.
- The value of the timer is 5 seconds.
- T3190:** The timer is used during packet downlink assignment on CCCH. It is started at the receipt of an IMMEDIATE ASSIGNMENT message or of a PDCH ASSIGNMENT COMMAND message when in dedicated mode.
- It is stopped at the receipt of a RLC/MAC block on the assigned temporary block flow, see 3GPP TS 04.60.
- At expiry, the mobile station returns to the packet idle mode.
- The value of the timer is 5 seconds.
- T3204:** This timer is used by a mobile station with non-GSM capabilities. The timer is started after sending the first CHANNEL REQUEST during a packet access procedure. The CHANNEL REQUEST was sent requesting a single block packet access and the purpose of the packet access procedure is to send a PACKET PAUSE message.

It is stopped at the receipt of an IMMEDIATE ASSIGNMENT message granting a single block period on an assigned packet uplink resource.

At expiry, the packet access procedure is aborted.

The value of the timer is 1 second.

11.1.2 Timers on the network side

T3101: This timer is started when a channel is allocated with an IMMEDIATE ASSIGNMENT message. It is stopped when the MS has correctly seized the channels.

Its value is network dependent.

NOTE: It could be higher than the maximum time for a L2 establishment attempt.

T3103: This timer is started by the sending of a HANDOVER message and is normally stopped when the MS has correctly seized the new channel. Its purpose is to keep the old channels sufficiently long for the MS to be able to return to the old channels, and to release the channels if the MS is lost.

Its value is network dependent.

NOTE: It could be higher than the maximum transmission time of the HANDOVER COMMAND, plus the value of T3124, plus the maximum duration of an attempt to establish a data link in multiframe mode.)

T3105: This timer is used for the repetition of the PHYSICAL INFORMATION message during the hand-over procedure.

Its value is network dependent.

NOTE: This timer may be set to such a low value that the message is in fact continuously transmitted.

T3107: This timer is started by the sending of an ASSIGNMENT COMMAND or a DTM ASSIGNMENT COMMAND message and is normally stopped when the MS has correctly seized the new RR channels.

Its purpose is to keep the old channel sufficiently long for the MS to be able to return to the old channels, and to release the channels if the MS is lost.

Its value is network dependent.

NOTE: It could be higher than the maximum transmission time of the ASSIGNMENT COMMAND message plus twice the maximum duration of an attempt to establish a data link multiframe mode.

T3109: This timer is started when a lower layer failure is detected by the network, when it is not engaged in a RF procedure. It is also used in the channel release procedure.

Its purpose is to release the channels in case of loss of communication.

Its value is network dependent.

NOTE: Its value should be large enough to ensure that the MS detects a radio link failure.

T3111: This timer is used to delay the channel deactivation after disconnection of the main signalling link. Its purpose is to let some time for possible repetition of the disconnection.

Its value is equal to the value of T3110.

T3113: This timer is started when the network has sent a PAGING REQUEST message and is stopped when the network has received the PAGING RESPONSE message.

Its value is network dependent.

NOTE: The value could allow for repetitions of the Channel Request message and the requirements associated with T3101.

T3115: This timer is used for the repetition of the VGCS UPLINK GRANT message during the uplink access procedure.

Its value is network dependent.

NOTE: This timer may be set to such a low value that the message is in fact continuously transmitted.

T3117: This timer is started by the sending of a PDCH ASSIGNMENT COMMAND message and is normally stopped when the MS has correctly accessed the target TBF.

Its purpose is to keep the old channel sufficiently long for the MS to be able to return to the old channels, and to release the channels if the MS is lost.

Its value is network dependent.

NOTE: It could be higher than the maximum transmission time of the PDCH ASSIGNMENT COMMAND message plus T3132 plus the maximum duration of an attempt to establish a data link in multiframe mode.

T3119: This timer is started by the sending of a RR-CELL CHANGE ORDER message and is normally stopped when the MS has correctly accessed the new cell. Its purpose is to keep the old channels sufficiently long for the MS to be able to return to the old channels, and to release the channels if the MS is lost.

Its value is network dependent.

NOTE: It could be higher than the maximum transmission time of the RR_CELL CHANGE ORDER, plus T3134, plus the maximum duration of an attempt to establish a data link in multiframe mode.

T3121: This timer is started by the sending of an INTER SYSTEM TO UTRAN HANDOVER message and is normally stopped when the MS has correctly seized the UMTS channel(s). Its purpose is to keep the old channels sufficiently long for the MS to be able to return to the old channels, and to release the channels if the MS is lost.

Its value is network dependent.

T3141: This timer is started when a temporary block flow is allocated with an IMMEDIATE ASSIGNMENT message during a packet access procedure. It is stopped when the mobile station has correctly seized the temporary block flow.

Its value is network dependent.

11.1.3 Other parameters

Ny1: The maximum number of repetitions for the PHYSICAL INFORMATION message during a handover (see section 3.4.4.2.2). The value is network dependent.

Ny2: The maximum number of repetitions for the VGCS UPLINK GRANT message during an uplink access procedure (see section 3.3.1.2.2). The value is network dependent.

11.2 Timers of mobility management

See 3GPP TS 24.008.

11.3 Timers of circuit-switched call control

See 3GPP TS 24.008.

Annex A (informative): Example of subaddress information element coding

See 3GPP TS 24.008.

Annex B (normative): Compatibility checking

See 3GPP TS 24.008.

Annex C (normative): Low layer information coding principles

See 3GPP TS 24.008.

Annex D (informative): Examples of bearer capability information element coding

See 3GPP TS 24.008.

Annex E (informative):
Comparison between call control procedures specified in
3GPP TS 24.008 and CCITT Recommendation Q.931

See 3GPP TS 24.008.

Annex F (informative): GSM specific cause values for radio resource management

This annex is informative.

Cause value = 0 Normal event;

indicates that the channel is released because of a normal event or that an assignment or handover is successfully, and normally, completed.

Cause value = 1 Abnormal release, unspecified;

indicates that the channel is released because of an abnormal event without specifying further reasons.

Cause value = 2 Abnormal release, channel unacceptable;

indicates that the channel type or channel characteristics are not acceptable.

Cause value = 3 Abnormal release, timer expired;

indicates that the release is caused by a timer expiry.

Cause value = 4 Abnormal release, no activity on the radio path;

indicates that some supervisory function has detected that the channel is not active.

Cause value = 5 Pre-emptive release;

indicates that the channel is released in order to be allocated to a call with priority (e.g. an emergency call).

Cause value = 8 Handover impossible, timing advance out of range;

indicates that a handover is unsuccessful because the target BTS is beyond the normal range and the target BTS would not accept an out of range timing advance.

Cause value = 9 Channel mode unacceptable

indicates that the MS does not have the capability to handle the requested mode or type of channel.

Cause value = 10 Frequency not implemented

indicates that the MS does not have the capability to operate on (at least one of) the requested frequency(ies).

Cause value = 65 Call already cleared;

indicates that a handover is unsuccessful because the connection has been released by the network or the remote user.

Cause value = 95 Semantically incorrect message;

See annex H, section H5.10.

Cause value = 96 Invalid mandatory information;

See annex H, section H6.1.

Cause value = 97 Message type non-existent or not implemented;

See annex H, section H6.2.

Cause value = 98 Message type not compatible with protocol state;

See annex H, section H6.3

Cause value = 100 Conditional IE error;

See annex H, section H6.5

Cause value = 101 No cell allocation available;

indicates that an assignment or handover is unsuccessful because the MS has no current CA.

Cause value = 111 Protocol error unspecified;

See annex H, section H6.8.

Annex G (informative): GSM specific cause values for mobility management

See 3GPP TS 24.008.

Annex H (informative): GSM specific cause values for call control

See 3GPP TS 24.008.

Annex I (informative): GSM specific cause values for session management

See 3GPP TS 24.008.

Annex J (informative): Algorithm to encode frequency list information elements

This annex is informative.

J.1 Introduction

Some information elements encode frequency lists with a special method. The main specification specifies the meaning of the fields and hence the way to decode them, but the corresponding encoding algorithm is difficult to infer from the decoding algorithm. This annex is intended as an aid for implementers of the encoding algorithm.

It could be shown that any set of frequency with less or the same number of frequencies as the number of words can be encoded with a careful choice of F_1 , F_2 , and so on, i.e. that a set of W_i can be found so that the decoding algorithm given in the main section will give back the frequency set. The right order is not the order of the frequency values.

J.2 General principle

The encoding algorithm is based on a recursive dichotomy of both the range (i.e. the set of values that are possible) and the subset (the values to encode).

The dichotomy is best understood if the range is seen as a circle. For instance, for the 1023 range:

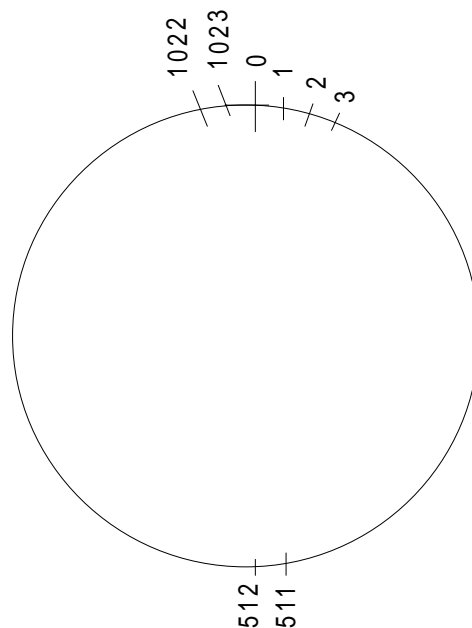

Figure J.1: Circular arrangement of 0..1023

The dichotomy consists in finding a value in the subset such that the diameter determined by this value splits the subset in two equal or nearly equal sub-subsets. In the following case, we see that value 290 is acceptable (the two sub-subsets have 3 elements), when value 250 is not acceptable (the two sub-subsets have 4 and 2 elements):

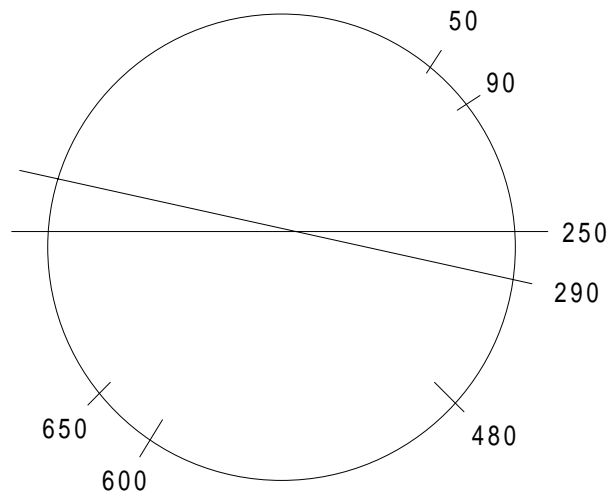

Figure J.2: Example of dichotomy

The pivot value is part of the information field, then the two sub-subsets are renumbered and the same algorithm is applied again on each of them. Because the range is halved at each step, the number of bits needed to encode a pivot value is 1 bit less than the number of bits needed to encode the parent pivot value.

The convention is that if the number of values is even, the left sub-subset (that is to say the values that can be expressed as the pivot value minus some integer between 1 and half the range) will have 1 element more than the right subset.

At each step the subset is numbered from 0 to the range minus 1. The coding in the information field of the pivot value is its value as renumbered, plus 1. Value 0 is reserved to indicate no element.

The order of appearance in the information field of the successive pivot values is particular. If we present the values as organized as a tree, with the left child being the pivot of the left sub-subset and the right child the pivot of the right sub-subset, the order of appearance is given by the following tree:

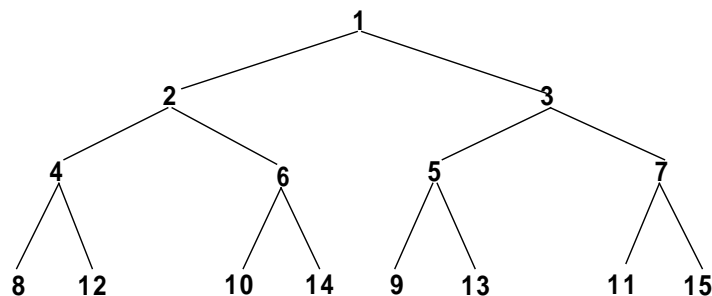

(and so on)

This order has been chosen so that

- a) whatever the number N of elements in the set, the meaningful nodes are the first N and the value for all nodes from N+1 on are null (if sent),
- b) the tree and all subtrees are balanced.

Important properties of these trees are used in the algorithms (with generation 1 corresponding to the root):

Generation g contains 2^{g-1} nodes, and their indices are 2^{g-1} to 2^g-1 ;

For generation g, nodes 2^{g-1} to $2^{g-1}+2^{g-2}-1$ are left children, the others are right children;

If node k belongs to generation g, its left child is node $k + 2^{g-1}$, and its right child is $k + 2^g$;

Reciprocally, if k is a left child from generation g , its parent node is node $k - 2^{g-2}$, and if k is a right child of generation g , its parent is node $k - 2^{g-1}$.

J.3 Performances

The number of bits needed to encode a given set of values depends on the number of values and on the range they can span.

For the application on the BCCH and the SACCH (CA and BA information) 16 octets are available, and the number of frequencies that can be encoded in one information element is the following:

Range	Number of frequencies
513 to 1024	2 to 16 (17 if frequency 0 is in)
257 to 512	2 to 18
129 to 256	2 to 22
113 to 128	2 to 29
up to 112	any

With two messages (for the BA) the number of frequencies that can be encoded is the following:

Range	Number of frequencies
513 to 1024	2 to 36 (NOTE 1)
257 to 512	2 to 40 (NOTE 2)
225 to 256	2 to 51 (NOTE 3)
up to 224	any

NOTE 1: A 1024 range can be split cyclically in to two 512 ranges each with less than 18 frequencies; each subset is coded in one message with 512 range format.

NOTE 2: A 512 range can be split in to two consecutive 256 ranges. If both sub-ranges contain 22 frequencies or less, it is possible to code each of these in a messages using the 256 range format. Otherwise one of the two ranges contains 23 frequencies or more: 22 of them can be coded in one message using the 256 range format and the remaining frequencies (numbering less than or equal to 18) can be coded in the other message using the 512 range format.

NOTE 3: The principles described in notes 1 and 2, above apply in this case.

The frequency short list information element allows the following:

Range	Number of frequencies
513 to 1024	2 to 7 (8 if frequency 0 is in)
257 to 512	2 to 8
129 to 256	2 to 9
57 to 128	2 to 12
up to 56	any

The number of frequencies as a function of the range and the length in octets of the variable length frequency list information element (including the message type and length fields) is given by the following table:

Table J.1/3GPP TS 04.18: Performance of the variable length frequency list information element

Range	513 to 1024	257 to 512	129 to 256	up to 128	variable bit map
octets					
5	1	1	1	1	8
6	2	2	3	3	16
7	3	3	4	4	24
8	4	4	5	6	32
9	5	6	6	8	40
10	6	7	8	10	48
11	7	8	9	12	56
12	9	9	11	14	64
13	10	11	13	16	72
14	11	12	14	18	80
15	12	13	16	21	88
16	13	15	18	24	96
17	14	16	20	26	104
18	16	18	22	29	112
19	17	19	24	32	120
20	18	21	26	--	128
21	20	22	28		136
22	21	24	30		144
23	22	26	32		152
24	24	27	34		160
25	25	29	37		168
26	26	30	40		176
27	28	32	42		184
28	29	34	45		192
29	30	36	48		200
30	32	38	50		208
31	33	40	53		216
32	35	42	56		224

J.4 Encoding algorithm

The choice is done recursively as given by the following programs, written in ADA:

Let us define the recursive procedure:

```

procedure ENCODE_SUBTREE(in INDEX : INTEGER;
                        in SET : SET_OF_VALUE;
                        in RANGE : INTEGER);

```

This procedure is given a set of integer values and an index. It chooses one of those values and computes the corresponding $W(\text{INDEX})$ (considered as a global variable), it splits the set less the value in two equal or nearly equal subsets, and calls itself recursively for each of those subsets, with suitable INDEX.

Assumption: all values in SET lie (inclusively) between 0 and RANGE-1, and they are all distinct.

As written, the program does not assume special values for the range. With a range such as 2^k-1 , some expressions can be simplified.

```

Declarative part:
  INDEX_IN_SET : INTEGER;
begin

```

First the program tests the leaf conditions :

```

  if SET'SIZE=0 then
    W(INDEX) := 0;
    return;
  elsif SET'SIZE=1 then
    W(INDEX) := 1 + SET(1);

```

```

    return;
end if;

```

The following program finds a value in the set such that exactly $(\text{SET}'\text{SIZE}-1)/2$ values from the set are between this value plus 1 and this value plus half the range :

```

declare
  N : INTEGER;
  J : INTEGER;
begin
  for I in 1..SET'SIZE loop
    N:=0;
    for J in 1..SET'SIZE loop
      if (SET(J)-SET(I)) mod RANGE <= (RANGE-1)/2 then
        N := N+1;
      end if;
    end loop;
  end loop;

```

The test compares N-1 because the possible pivot value is counted.

```

    if N-1 = (SET'SIZE-1)/2 then
      INDEX_IN_SET := I;
      exit;
    end if;
  end loop;
end;

```

INDEX_IN_SET is then the index in the list of the pivot value.

The following sets W(INDEX)

```

W(INDEX) := SET(INDEX_IN_SET) + 1;

```

Then the program does the same thing for the two halves of the range delimited by W(INDEX) and W(INDEX)+RANGE/2. First the left subset:

```

declare
  SUBSET : SET_OF_VALUE(1..SET'SIZE/2);
  SUBSET_INDEX : INTEGER;
  ORIGIN_VALUE : INTEGER;
begin
  ORIGIN_VALUE := (SET(INDEX_IN_SET] + (RANGE-1)/2
    + 1) mod RANGE;
  SUBSET_INDEX:=1;
  for I in 1..SET'SIZE loop
    if (SET(I)-ORIGIN_VALUE) mod RANGE) < RANGE/2 then
      SUBSET(SUBSET_INDEX) :=
        (SET(I) - ORIGIN_VALUE) mod RANGE;
      SUBSET_INDEX := SUBSET_INDEX + 1;
    end if;
  end loop;

  ENCODE_SUBTREE(
    INDEX := INDEX +
      GREATEST_POWER_OF_2_LESSER_OR_EQUAL_TO(INDEX) ,
    SET := SUBSET,
    RANGE := RANGE/2);
end;

```

Then the right subset:

```

declare
  SUBSET : SET_OF_VALUE(1..(SET'SIZE-1)/2);
  SUBSET_INDEX : INTEGER;
  ORIGIN_VALUE : INTEGER;
begin
  ORIGIN_VALUE := (SET(INDEX_IN_SET] + 1) mod RANGE;
  SUBSET_INDEX:=1;
  for I in 1..SET'SIZE loop
    if (SET(I)-ORIGIN_VALUE) mod RANGE) < RANGE/2 then
      SUBSET(SUBSET_INDEX) :=
        (SET(I) - ORIGIN_VALUE) mod RANGE;
      SUBSET_INDEX := SUBSET_INDEX + 1;
    end if;
  end loop;
  ENCODE_SUBTREE(

```

```

INDEX := INDEX +
      2 * GREATEST_POWER_OF_2_LESSER_OR_EQUAL_TO(INDEX),
SET := SUBSET,
RANGE := (RANGE - 1) / 2;
end;

end ENCODE_SUBTREE;

```

The initial call of the procedure depends on the format. Given some set to encode, the first problem is to verify that it can be encoded, and by so doing to choose the format.

First the encoding process must find the minimum range of the set, that is to say the minimum value R such that there exists one frequency F_0 in the set such that all frequencies in the set can be written $(F_0 + N) \bmod 1024$, with some N , $0 = N = R - 1$. The choice of the format depends on R and the number of frequencies : the 512 range format can be chosen only if $R \leq 512$, the 256 range format can be chosen only if $R = 256$, the 128 range format can be chosen only if $R \leq 128$.

If the chosen format is "1024 range", then the program must first check if frequency 0 is in the set. If so the F_0 subfield is set to 1, and frequency 0 is removed from the set. Otherwise, the F_0 subfield is set to 0. Then ENCODE_SUBTREE is called with INDEX := 1, SET set to the set of values equal to the ARFCN of all frequencies minus 1, and RANGE := 1023.

If the chosen format is "512 range", "256 range" or "128 range", F_0 is chosen as ORIG-ARFCN and ENCODE_SUBTREE is called with INDEX := 1, SET set to the set of values equal to the ARFCN of all frequencies except F_0 , minus $F_0 + 1$, and RANGE set respectively to 511, 255 or 127.

J.5 Decoding

The decoding algorithm, as given below, is the inverse transform of the program given in the previous section, for the specific case where the original range is a power of 2 minus 1. It is given a set of integer values $W(i)$, and an original range R , and it builds a set of values from $0..R-1$.

The program is here written so that the fact that it is the inverse of the encoding program needs no more proof.

```

procedure DECODE(in W : array <> of INTEGER;
                 out SET : SET_OF_VALUE;
                 in ORIGINAL_RANGE : INTEGER);

  -- local variables
  INDEX : 1..W'SIZE;      RANGE : INTEGER;
  N : INTEGER;

begin
  for K in 1..W'SIZE loop

```

The next loop follows the tree from child to parent, from the node of index K to the root (index 1). For each iteration the node of index INDEX is tackled. The corresponding range is RANGE, and N is the value of the element in the range defined by the node.

The data are set to their initial values :

```

INDEX := K;
RANGE := ORIGINAL_RANGE / GREATEST_POWER_OF_2_LESSER_OR_EQUAL_TO(INDEX);
N := W(INDEX) - 1;

while INDEX > 1 loop

```

Due to the assumption that the original range is a power of two minus one, the range for the parent node can be easily computed, and does not depend upon whether the current node is a left or right child :

```

RANGE := 2 * RANGE + 1;

```

Let us note $J := 2^{g-1}$, g being the generation of node INDEX. We have $J = \text{GREATEST_POWER_OF_2_LESSER_OR_EQUAL_TO}(\text{INDEX})$.

The numbering used in the tree is such that the nodes of index J to $J + J/2 - 1$ are left children, and the nodes of index $J/2$ to $J+J-1$ are right children. Hence an easy test to distinguish left and right children:

```
if 2*INDEX <
    3*GREATEST_POWER_OF_2_LESSER_OR_EQUAL_TO(INDEX)
then
    -- left child
```

The next computation gives the index of the parent node of the node of index INDEX, for a left child :

```
INDEX := INDEX -
    GREATEST_POWER_OF_2_LESSER_OR_EQUAL_TO(INDEX) / 2;
```

The next formula is the inverse of the renumbering appearing in the encoding for a left child. It gives the value of the parent node in the range defined by the grand-parent node:

```
N := (N + W(INDEX) - 1 + (RANGE-1)/2 + 1)
    mod RANGE;
else
    -- right child
```

The next computation gives the index of the parent node of the node of index INDEX, for a right child :

```
INDEX := INDEX - GREATEST_POWER_OF_2_LESSER_OR_EQUAL_TO(INDEX);
```

The next formula is the inverse of the renumbering appearing in the encoding for a right child:

```
N := (N + W(INDEX) - 1 + 1) mod RANGE;
end if;
end loop;
F(K) := N;
end loop;
end;
```

A careful study will show that the programs given in the main part of the Technical Specification are equivalent to the one presented here. The main difference is the use of different remnant variables to remove most of the calls to the function giving the greatest power of 2 less than or equal to some integer.

The decoding must be terminated by the correction specific to the format.

J.6 A detailed example

Let us take the following subset of 16 elements of the set $[0..1023]$: [13, 71, 122, 191, 251, 321, 402, 476, 521, 575, 635, 701, 765, 831, 906, 981]

Range 1024 format will be used. Frequency 0 is not in the set, thus field F0 is set to 0. The set is renumbered, so as to give a subset of $0..1022$: [12, 70, 121, 190, 250, 320, 401, 475, 520, 574, 634, 700, 764, 830, 905, 980].

For the first node (corresponding to $W(1)$), the value 121 satisfies the requirements. The opposite value is $121 + 511 = 632$. There are 8 values between 633 and 120 (namely the left-hand subset 634, 700, 764, 830, 905, 980, 12 and 70), and 7 values between 122 and 632 (namely the right-hand subset 190, 250, 320, 401, 475, 520 and 574).

The encoded value $W(1)$ is $121 + 1$, i.e. 122.

The second node (corresponding to $W(2)$) is the left-hand child of the first node. The corresponding subtree has to encode for the left-hand subset, renumbered beginning at 633. This gives the following 8 element subset of $0..510$, ordered as resulting from the example of algorithm : [402, 460, 1, 67, 131, 197, 272, 347]. Out of these values, 1 splits the set in 4 and 3, and the encoded value $W(2)$ is 2.

Similarly, the third node ($W(3)$) is the right-hand child of the first node and then the corresponding subtree encodes for the right-hand subset, renumbered starting at 122. This gives the following set of $0..510$: [68, 128, 198, 279, 353, 398, 452]. Out of these values, 68 splits the set into 3 and 3, and the encoded value $W(3)$ is 69.

The same method is applied for all nodes, giving the following encoded values per node:

Node	Value
1	122
2	2
3	69
4	204
5	75
6	66
7	60
8	70
9	83
10	3
11	24
12	67
13	54
14	64
15	70
16	9

The encoding then consists in formatting, in that order :

122 on 10 bits, then 2 and 69 on 9 bits each, then 204, 75, 66 and 60 on 8 bits each, then 70, 83, 3, 24, 67, 54, 64 and 70 on 7 bits each, and finally 9 on 6 bits.

Conversely the decoding can be done easily. For instance for node 2, the original value is:

$$(122 - 512 + 2) \text{ smod } 1023 = 635$$

For node 14, we have as original value:

$$(122 - 512 + (2 + (66 + 64) \text{ smod } 255) \text{ smod } 511) \text{ smod } 1023 = 765$$

Annex K (informative): Default Codings of Information Elements

This annex is informative.

The information in this annex does NOT define the value of any IEI for any particular message. This annex exists to aid the design of new messages, in particular with regard to backward compatibility with phase 1 mobile stations.

K.1 Common information elements

For the common information elements see 3GPP TS 24.008 Annex K.

K.2 Radio Resource management information elements

For the Radio Resource management information elements listed below, the default coding of the information element identifier bits is summarized in table K.2/3GPP TS 04.18.

Table K.2/3GPP TS 04.18 (page 1 of 2): Default information element identifier coding for Radio Resource management information elements

8	7	6	5	4	3	2	1	Reference	section
1	:	:	:	-	-	-	-	Type 1 info elements	
1	0	0	1	-	-	-	-	Cipher Mode Setting	10.5.2.9
1	0	1	0	-	-	-	-	Cipher Response	10.5.2.10
1	0	1	1	-	-	-	-	Note	
1	1	0	1	-	-	-	-	Synchronization Indication	10.5.2.39
1	1	1	0	-	-	-	-	Channel Needed	10.5.2.8
0	:	:	:	:	:	:	:	Type 3 & 4 info elements	
0	0	0	0	0	0	1	0	Frequency Short List	10.5.2.14
0	0	0	0	0	1	0	1	Frequency List	10.5.2.13
0	1	1	0	0	0	0	1	Note	
0	1	1	0	0	0	1	0	Cell Channel Description	10.5.2.1b
0	1	1	0	0	0	1	1	Channel Mode	10.5.2.6
0	1	1	0	0	1	0	0	Channel Description	10.5.2.5
0	1	1	0	0	1	1	0	Channel Mode 2	10.5.2.7
0	1	1	0	1	0	0	0	Note	
0	1	1	0	1	0	0	1	Frequency Channel Sequence	10.5.2.12
0	1	1	0	1	0	1	0	Note	
0	1	1	0	1	0	1	1	Note	
0	1	1	0	1	1	0	0	Note	
0	1	1	1	0	0	0	1	Note	
0	1	1	1	0	0	1	0	Mobile Allocation	10.5.2.21
0	1	1	1	0	0	1	1	BA range	10.5.2.1
0	1	1	1	0	1	0	0	Note	
0	1	1	1	0	1	0	1	Note	
0	1	1	1	0	1	1	0	Note	
0	1	1	1	0	1	1	1	Mobile Time difference	10.5.2.21a
0	1	1	1	1	0	0	0	Note	
0	1	1	1	1	0	0	1	Note	
0	1	1	1	1	0	1	0	Note	
0	1	1	1	1	0	1	1	Time Difference	10.5.2.41
0	1	1	1	1	1	0	0	Starting Time	10.5.2.38
0	1	1	1	1	1	0	1	Timing Advance	10.5.2.40
0	1	1	1	1	1	1	0	TMSI	10.5.2.42
0	1	1	1	1	1	1	1	Note	

NOTE: These values were allocated but never used in earlier phases of the protocol.

Annex L (normative):
Additional Requirements for backward compatibility with
PCS 1900 for NA revision 0 ME

See 3GPP TS 24.008.

Annex M (informative): Change history

Meeting	TDoc	CR	REV	SUBJECT	NEW_VERS
SMG#29	P-99-510	A371	2	BCIE modifications due to EDGE	8.0.0
SMG#29	P-99-523	A515	1	Split of 04.08 in RR and CN parts (Section 7, "L3 stage2")	8.0.0
SMG#29	P-99-388	A562		CR to 04.08 due to EDGE SMG2 EDGE WS	8.0.0
SMG#29	P-99-523	A567	1	Split of 04.08 in RR and CN parts	8.0.0
SMG#29	P-99-390	A592	1	GSM 400 and Mobile Station Classmark	8.0.0
SMG#29	P-99-523	A611	1	Split of 04.08 in RR and CN parts	8.0.0
SMG#29	P-99-523	A613	1	Split of 04.08 in RR and CN parts	8.0.0
SMG#29	P-99-512	A621	2	IE Daylight saving time	8.0.0
SMG#29	P-99-461	A687		Transfer of the LSA Information to the MS	8.0.0
SMG#30	896/99	A002		Correction of Mobile Station Classmark 2 in the Talker Indication message	8.1.0
SMG#30	1000/99	A004		Modification due to ECSD Asymmetry	8.1.0
SMG#30	1006/99	A005		Fast power control	8.1.0
SMG#30	1419/99	A006	1	Compact Cell Reselection	8.1.0
SMG#30	1403/99	A008	1	EGPRS support on 04.18 Immediate Assignment & PDCH assignment.	8.1.0
SMG#30	1322/99	A009	1	Alignment on 04.60 of information elements RR Packet Uplink and Downlink Assignment	8.1.0
SMG#30	1415/99	A010	1	Clarification of MCC and MNC in SI 4/16/17 rest octets	8.1.0
SMG#30	1082/99	A011		Length of BA List Pref IE in the Channel Release message	8.1.0
SMG#30	1327/99	A013	1	Alignment of RLC_OCTET_COUNT in 04.08 with 04.60	8.1.0
SMG#30	1139/99	A014		System information type 14 and 15	8.1.0
SMG#30	1133/99	A015		EDGE Compact and support for EGPRS in ANSI-136 networks	8.1.0
SMG#30	1348/99	A016	1	Introduction of short LSA ID.	8.1.0
SMG#30	1330/99	A018	1	New coding of SI 4/7/8 Rest Octets.	8.1.0
SMG#30	1252/99	A019		Correction to handling of GPRS suspension cause	8.1.0
SMG#30	1353/99	A022	2	Alignment between 04.08 & 04.60 on the packet access procedure attempt following T3142 or T3172 attempt	8.1.0
SMG#30	1452/99	A023		Addition of 3rd MNC digit in Routing Area Identification and correction of LAI	8.1.0
SMG#30	1358/99	A024		Addition of new SI type in SI 9 Rest Octets.	8.1.0
SMG#30	1458/99	A025		Addition of PR mode in ASSIGNMENT message in 04.08	8.1.0
SMG#30bis	1908/99	A007	2	Definition of extended TA layer 3 information	8.2.0
SMG#30bis	1510/99	A028		Applicability of "Uplink Reply"	8.2.0
SMG#30bis	1511/99	A029		Removal of old message types	8.2.0
SMG#30bis	1512/99	A030		Corrections in Uplink management procedures	8.2.0
SMG#30bis	1513/99	A031		NCH parameters & combined CCCH	8.2.0
SMG#30bis	1628/99	A037		Editorial (misleading reference) (R99)	8.2.0
SMG#30bis	1646/99	A041		Handover execution in cells that support extended TA IE	8.2.0
SMG#30bis	1733/99	A042		Introduction of two 'Release Indication' bits in the BCCH	8.2.0
SMG#30bis	1839/99	A051		Multiband on early classmark sending	8.2.0
SMG#30bis	1957/99	A052	1	Packet extended timing advance	8.2.0
SMG#30bis	1918/99	A053		Correction to Packet Access Reject procedure	8.2.0
SMG#31		A003	3	Non-GSM Broadcast Information	8.3.0
SMG#31		A038	2	EGPRS COMPACT Cell Selection, Cell Bar Qualify 2	8.2.0
SMG#31		A063	1	Alignment of 04.18 with 04.60 for EGPRS Downlink Assignments	8.3.0
SMG#31		A064		Support for packet pause procedure for mobile stations capable of non-GSM circuit operation	8.3.0
SMG#31		A065		COMPACT Cell Selection, Cell Bar Qualify 2 removal	8.3.0
SMG#31		A068		Emergency Call Handling in COMPACT	8.3.0
SMG#31		A001	3	Immediate assignment	8.3.0
SMG#31		A033	5	PR_MODE field in assignment message	8.3.0
SMG#31		A040	2	Channel Request Description IE length and Packet	8.3.0

				Channel Description IE coding	
SMG#31		A054		Clarification of the RLC/MAC segmentation in single block allocation	8.3.0
SMG#31		A073		Suspension Cause IE	8.3.0
SMG#31		A075		Clarification of starting timer T3134	8.3.0
SMG#31		A043	1	Uplink L3 Message Sequencing	8.3.0
SMG#31		A035	2	Intorduction of LCS into 3GPP TS 04.08	7.2.0
SMG#31bis		none		First some purely editorial changes have been made implementing ETSIs stylesheet in a noticeably better way, and figures in LD (linedraw) format have been corrected to table format which is also readable in Windows 2000. Corroded bullit styles in subclause 3.4.17 which consistently crashed the PCs have been corrected. All those framed CSN.1 parts have been corrected to 'real' tables, which is much more stable and easier to maintain.	8.4.0
SMG#31bis		A082		Addition of CSCH description	8.4.0
SMG#31bis		A084		Inconsistent Rest Octet length indication	8.4.0
SMG#31bis		A091		Inter System Handover Command (scls 10.5.2.48 in CR is added as scls 10.5.2.51	8.4.0
SMG#31bis		A094		Correction of SI 4 Rest Octets	8.4.0
SMG#31bis		A080		Moving NOTIFICATION RESPONSE from MM to GSM RR	8.4.0
SMG#31bis		A101	1	Downlink and Uplink information for Measurement Reporting and Enhanced Measurement Reporting on 3G Cells. Note that scls 9.1.53 and 54 in the CR has been added as 9.1.54 and 9.1.55.	8.4.0
SMG#31bis		A081	1	COMPACT : impact of new block ordering on SI19	8.4.0
SMG#31bis		A097	1	EGPRS and IA Rest Octets IE	8.4.0
SMG#31bis		A098	2	DTM: definition of new procedures while in dedicated mode	8.4.0
SMG#31bis		A092	2	Support of Handover from GSM to cdma2000	8.4.0
SMG#31bis		A056	4	EGPRS mode TBF establishment on CCCH	8.4.0
SMG#31bis		A086	2	Clarification of power control requirements during TBF establishment	8.4.0
SMG#31bis		A085	2	Incomplete Rest Octet information	8.4.0
SMG#31bis		A090	2	New measurement order - Idle mode	8.4.0
SMG#31bis		A099	2	DTM: definition of new messages	8.4.0
SMG#31bis		A057	5	Blind search Idle Mode – SI2ter	8.4.0
SMG#31bis		A062	3	RR UTRAN Classmark Change	8.4.0
SMG#31bis		A089	1	RR Pre-configuration Command	8.4.0
SMG#31bis		A095	3	Distributing UMTS frequencies to the mobiles	8.4.0
SMG#31bis		A104	2	UE Classmark Enquiry	8.4.0
SMG#32	P-00-247	A105	2	DTM: Replacement of Channel Request Description 2 IE	8.5.0
SMG#32	P-00-247	A106		DTM: Removal of DTM Reject Information	8.5.0
SMG#32	P-00-247	A107		DTM: Editorial Corrections	8.5.0
SMG#32	P-00-247	A108	1	Maximum size of fixed ALLOCATION_BITMAP	8.5.0
SMG#32	P-00-247	A110	2	DTM: Alignment of normal release procedure	8.5.0
SMG#32	P-00-247	A113		DTM: Alignment of the assignment procedure	8.5.0
SMG#32	P-00-247	A117	2	GSM to 3G Handovers: Various Corrections and Clarifications	8.5.0
SMG#32	P-00-247	A119		Clarification of Channel Mode Modify and Configuration Change procedures (RSB)	8.5.0
SMG#32	P-00-247	A124		Definition of the SCALE parameter	8.5.0
GP-01	GP-000179	A137		DTM: GPRS information for DTM operation – TBF re-establishment	8.6.0
GP-01	GP-000191	A139		Interpretation addition of CELL_BAR_QUALIFY_2 value	8.6.0
GP-01	GP-000095	A140		DTM and EGPRS	8.6.0
GP-01	GP-000266	A141		Correction on Measurement Info message	8.6.0
GP-01	GP-000206	A143		SI2quarter updates to allow GPRS -> UMTS Cell Reselection.	8.6.0
GP-01	Gp-000356	A146	1	Handover to UMTS description procedure including "blind handover" to UMTS.	8.6.0
GP-01	GP-000353	A147	1	Correction on UTRAN classmark change procedure	8.6.0
GP-01	GP-000389	A136	1	Support of 11 bits request reference in IA and IAR messages	8.6.0

GP-01	GP-000358	A152		AMR Noise Suppressor Control	8.6.0
GP-01	GP-000385	A142	1	SI2ter bit map correction.	8.6.0
GP-01	GP-000306	A150	1	Editorial correction on RR Packet Uplink/Downlink Assignment	8.6.0
GP-01	GP-000121	A127		DTM: Removal of polling from DTM assignment	8.6.0
GP-01	GP-000411	A144	2	Detailed coding modifications for the Pre-configurations.	8.6.0
GP-01	GP-000150	A135		DTM: definition	8.6.0
GP-01	GP-000380	A126	1	Extended measurement report (MAFA)	8.6.0
GP-01	GP-000342	A128	1	DTM: Correction of timers T3148 and T3107	8.6.0
GP-01	GP-000127	A129		DTM: tunnelling of GPRS information on the main DCCH	8.6.0
GP-01	GP-000314	A130	1	DTM: provision of GPRS information for correct DTM behaviour	8.6.0
GP-01	GP-000317	A131	1	DTM: reuse of the GPRS Suspension procedure in cells with no DTM capabilities	8.6.0
GP-01	GP-000142	A132		DTM: alignment of the handover procedure	8.6.0
GP-01	GP-000144	A133		DTM: clarification of Radio Link Failure and RR connection abortion while in DTM	8.6.0
GP-01	GP-000337	A134	1	DTM: removal of the Main DCCH Assignment message	8.6.0
GP-01	GP-000027	A125		Handling of Power-Control-Parameter alpha	8.6.0
GP-01		none		Implementation comments (in addition to the CRs): Tables formatting improved. Strange pagebreaks removed. Change History table tightened up. Defect and unused textstyle crashing PCs and persistent to earlier removal attempts now removed. Format updated to 3GPP style.	8.6.0

History

Document history			
V8.3.0	May 2000	One-step Approval Procedure	OAP 20000901: 2000-05-03 to 2000-09-01
V8.4.0	June 2000	One-step Approval Procedure	OAP 20001013: 2000-06-14 to 2000-10-13
V8.5.0	August 2000	Publication	
V8.3.1	October 2000	Publication as EN 301 503	
V8.4.1	October 2000	Publication as EN 301 503	
V8.6.0	October 2000	Publication	