

# ETSI TS 123 079 V5.3.0 (2003-09)

*Technical Specification*

**Digital cellular telecommunications system (Phase 2+);  
Universal Mobile Telecommunications System (UMTS);  
Support of Optimal Routing (SOR);  
Technical realization;  
Stage 2  
(3GPP TS 23.079 version 5.3.0 Release 5)**



---

Reference

RTS/TSGN-0423079v530

---

Keywords

GSM, UMTS

**ETSI**

650 Route des Lucioles  
F-06921 Sophia Antipolis Cedex - FRANCE

Tel.: +33 4 92 94 42 00 Fax: +33 4 93 65 47 16

Siret N° 348 623 562 00017 - NAF 742 C  
Association à but non lucratif enregistrée à la  
Sous-Préfecture de Grasse (06) N° 7803/88

---

**Important notice**

Individual copies of the present document can be downloaded from:

<http://www.etsi.org>

The present document may be made available in more than one electronic version or in print. In any case of existing or perceived difference in contents between such versions, the reference version is the Portable Document Format (PDF). In case of dispute, the reference shall be the printing on ETSI printers of the PDF version kept on a specific network drive within ETSI Secretariat.

Users of the present document should be aware that the document may be subject to revision or change of status. Information on the current status of this and other ETSI documents is available at

<http://portal.etsi.org/tb/status/status.asp>

If you find errors in the present document, send your comment to:

[editor@etsi.org](mailto:editor@etsi.org)

---

**Copyright Notification**

No part may be reproduced except as authorized by written permission.  
The copyright and the foregoing restriction extend to reproduction in all media.

© European Telecommunications Standards Institute 2003.  
All rights reserved.

**DECT**<sup>TM</sup>, **PLUGTESTS**<sup>TM</sup> and **UMTS**<sup>TM</sup> are Trade Marks of ETSI registered for the benefit of its Members.  
**TIPHON**<sup>TM</sup> and the **TIPHON logo** are Trade Marks currently being registered by ETSI for the benefit of its Members.  
**3GPP**<sup>TM</sup> is a Trade Mark of ETSI registered for the benefit of its Members and of the 3GPP Organizational Partners.

---

## Intellectual Property Rights

IPRs essential or potentially essential to the present document may have been declared to ETSI. The information pertaining to these essential IPRs, if any, is publicly available for **ETSI members and non-members**, and can be found in ETSI SR 000 314: "*Intellectual Property Rights (IPRs); Essential, or potentially Essential, IPRs notified to ETSI in respect of ETSI standards*", which is available from the ETSI Secretariat. Latest updates are available on the ETSI Web server (<http://webapp.etsi.org/IPR/home.asp>).

Pursuant to the ETSI IPR Policy, no investigation, including IPR searches, has been carried out by ETSI. No guarantee can be given as to the existence of other IPRs not referenced in ETSI SR 000 314 (or the updates on the ETSI Web server) which are, or may be, or may become, essential to the present document.

---

## Foreword

This Technical Specification (TS) has been produced by ETSI 3rd Generation Partnership Project (3GPP).

The present document may refer to technical specifications or reports using their 3GPP identities, UMTS identities or GSM identities. These should be interpreted as being references to the corresponding ETSI deliverables.

The cross reference between GSM, UMTS, 3GPP and ETSI identities can be found under <http://webapp.etsi.org/key/queryform.asp>.

# Contents

Intellectual Property Rights .....	2
Foreword.....	2
Foreword.....	5
1 Scope .....	6
2 References .....	6
3 Definitions and abbreviations.....	7
3.1 Definitions .....	7
3.2 Abbreviations .....	8
4 Architecture.....	8
4.1 Optimal routeing for basic mobile-to-mobile calls.....	8
4.2 Optimal routeing for conditional call forwarding.....	10
5 Optimal routeing for basic mobile-to-mobile calls: message flows .....	11
5.1 Successful outcome .....	12
5.2 Unsuccessful outcome .....	13
5.2.1 B subscriber address not recognised as belonging to a UMTS or GSM PLMN .....	13
5.2.2 HLRB or VLRB does not support optimal routeing .....	13
5.2.3 OR charging requirements contravened.....	13
6 Optimal routeing for conditional call forwarding: message flows .....	14
6.1 Early call forwarding.....	14
6.1.1 Forwarding without interrogation of VLRB .....	14
6.1.1.1 Successful outcome.....	14
6.1.1.2 Unsuccessful outcome.....	15
6.1.2 Forwarding after interrogation of VLRB .....	15
6.1.2.1 Successful outcome .....	15
6.1.2.2 Unsuccessful outcome.....	16
6.2 Late call forwarding .....	17
6.2.1 Successful outcome.....	18
6.2.2 Unsuccessful outcome .....	18
6.2.2.1 GMSC does not support OR .....	18
6.2.2.2 HLRB does not support OR .....	18
6.2.2.3 VMSCB/VLRB does not support OR .....	18
6.2.2.4 OR charging requirements contravened.....	18
7 Interactions between optimal routeing and supplementary services .....	19
7.1 Call forwarding .....	19
7.2 Closed User Group (CUG) .....	19
7.3 Advice of Charge.....	19
7.4 Call barring.....	19
7.5 Other supplementary services.....	20
8 Interactions between optimal routeing and other network features.....	20
8.1 Operator determined barring .....	20
8.2 CAMEL.....	20
9 Functional requirements of entities performing optimal routeing.....	21
9.1 Charging requirements for optimal routeing .....	21
9.2 Functional behaviour of VMSCA .....	22
9.3 Functional behaviour of VLRA.....	22
9.4 Functional behaviour of GMSC .....	22
9.4.1 Procedure OR_Set_OR_Parameters.....	22
9.4.2 Procedure OR_Handle_RCH.....	22
9.4.3 Procedure Route_Permitted .....	23
9.4.4 Procedure OR_Handle_SRI_Negative_Response .....	23

9.5	Functional behaviour of HLR.....	29
9.5.1	Procedure OR_HLR_CF.....	30
9.5.2	Procedure OR_HLR_Interrogate_VLR .....	30
9.6	Functional behaviour of VLRB .....	34
9.6.1	Functional behaviour of VLRB for provision of subscriber information.....	34
9.6.2	Functional behaviour of VLRB for roaming number allocation.....	34
9.6.3	Functional behaviour of VLRB when handling an incoming call.....	34
9.7	Functional behaviour of VMSCB.....	34
9.7.1	Procedure Handle_ORLCF_VMSC.....	34
10	Contents of messages .....	36
10.1	Messages on the B interface (MSC-VLR).....	36
10.1.1	Send Info For Outgoing Call.....	36
10.1.2	Send Info For Outgoing Call negative response .....	36
10.1.3	Send Info For Incoming Call .....	36
10.1.4	Send Info For Incoming Call ack.....	36
10.1.5	Send Info For Incoming Call negative response .....	36
10.1.6	Complete Call .....	37
10.1.7	Process Call Waiting.....	37
10.2	Messages on the C interface (MSC-HLR).....	37
10.2.1	Send Routeing Info .....	37
10.2.2	Send Routeing Info ack.....	38
10.2.3	Send Routeing Info negative response.....	38
10.3	Messages on the D interface (VLR-HLR).....	38
10.3.1	Provide Roaming Number .....	38
10.3.2	Provide Roaming Number ack.....	38
10.3.3	Provide Roaming Number negative response .....	39
10.3.4	Provide Subscriber Information.....	39
10.3.5	Provide Subscriber Information ack .....	39
10.4	Messages on the E interface (MSC-MSC) .....	39
10.4.1	Resume Call Handling .....	39
10.4.2	Resume Call Handling ack .....	39
10.4.3	Resume Call Handling negative response.....	39
<b>Annex A (informative):</b>	<b>Handling of an IAM at an MSC .....</b>	<b>41</b>
<b>Annex B (informative):</b>	<b>Change history .....</b>	<b>42</b>
History .....		43

---

# Foreword

This Technical Specification (TS) has been produced by the 3<sup>rd</sup> Generation Partnership Project (3GPP).

The present document specifies the technical realisation of the first phase of the network feature Support of Optimal Routeing (SOR) within the 3GPP system.

The contents of the present document are subject to continuing work within the TSG and may change following formal TSG approval. Should the TSG modify the contents of the present document, it will be re-released by the TSG with an identifying change of release date and an increase in version number as follows:

Version x.y.z

where:

- x the first digit:
  - 1 presented to TSG for information;
  - 2 presented to TSG for approval;
  - 3 or greater indicates TSG approved document under change control.
- y the second digit is incremented for all changes of substance, i.e. technical enhancements, corrections, updates, etc.
- z the third digit is incremented when editorial only changes have been incorporated in the document.

---

# 1 Scope

The present document specifies the technical realisation of the first phase of the network feature Support of Optimal Routeing (SOR). The first phase of SOR provides:

- as a network operator option, a method to route a call from one mobile subscriber directly to another mobile subscriber who is in the same country as the calling mobile subscriber or in the called mobile subscriber's home country, without needing to connect the call via the HPLMN of the called subscriber, even though the called mobile subscriber has roamed outside his HPLMN;
- a method to forward calls when a called mobile subscriber who has roamed outside his home country is busy, or is not reachable, or does not reply, to a forwarded-to destination in the HPLMN country of the called subscriber or the VPLMN country of the called subscriber, without needing to connect the forwarded call via the VPLMN of the called subscriber;
- a method to combine the optimal routeing described in the first bullet point above with the optimal routeing described in the second bullet point above.

OR of a call is permitted only if all entities involved in handling the call support OR.

Other cases of optimal routeing (e.g. calls where the calling and called subscribers are in different countries, forwarding to a mobile subscriber or multiple forwarding) will be considered for inclusion in later phases.

---

# 2 References

The following documents contain provisions which, through reference in this text, constitute provisions of the present document.

- References are either specific (identified by date of publication, edition number, version number, etc.) or non-specific.
- For a specific reference, subsequent revisions do not apply.
- For a non-specific reference, the latest version applies. In the case of a reference to a 3GPP document (including a GSM document), a non-specific reference implicitly refers to the latest version of that document *in the same Release as the present document*.

- [1] GSM 03.04: "Digital cellular telecommunications system (Phase 2+); Signalling requirements relating to routeing of calls to mobile subscribers".
- [2] 3GPP TR 21.905: "Vocabulary for 3GPP Specifications".
- [3] 3GPP TS 22.079: "Support of Optimal Routeing (SOR); Service definition - Stage 1".
- [4] 3GPP TS 22.082: "Call Forwarding (CF) supplementary services - Stage 1".
- [5] 3GPP TS 23.003: "Numbering, addressing & identification".
- [6] 3GPP TS 23.018: "Basic call handling; Technical realization".
- [7] 3GPP TS 23.078: "Customized Applications for Mobile network Enhanced Logic (CAMEL) - Phase 3; Stage 2".
- [8] 3GPP TS 23.085: "Closed User Group (CUG) Supplementary Service - Stage 2".
- [9] 3GPP TS 23.087: "User –to-User Signalling (UUS) - Stage 2".
- [10] 3GPP TS 23.172: "Technical realization of Circuit Switched (CS) multimedia service; UDI/RDI fallback and service modification"

---

## 3 Definitions and abbreviations

### 3.1 Definitions

For the purposes of the present document, the following terms and definitions apply.

**A subscriber:** calling subscriber, who may be fixed or mobile

**B subscriber:** mobile subscriber originally called by the A subscriber

**C subscriber:** subscriber to whom the B subscriber has requested that calls be forwarded. The C subscriber may be fixed or mobile

**Direct route:** call takes the direct route if the route from the serving PLMN of the A subscriber to the serving PLMN of the B subscriber is defined by the MSRN of the B subscriber rather than by the MSISDN of the B subscriber

**Early call forwarding:** call forwarding from the IPLMN before the call has been extended to the VPLMN of the forwarding subscriber

**HPLMN leg:** portion of the HPLMN route from the serving MSC of the A subscriber to an MSC in the HPLMN of the B subscriber

**HPLMN route:** call takes the HPLMN route if the route from the serving MSC of the A subscriber to the serving MSC of the B subscriber is defined by the MSISDN of the called subscriber. This forces the call to be routed via the HPLMN of the B subscriber

**Interrogating PLMN (IPLMN):** PLMN which interrogates the HPLMN of the B subscriber to obtain information to route the call to that subscriber or to the forwarded-to destination defined by the called mobile subscriber. The IPLMN is also the VPLMN of the A subscriber

**Late call forwarding:** call forwarding after the call has been extended to the VPLMN of the forwarding subscriber. Late call forwarding may be invoked in the IPLMN or the VPLMN of the forwarding subscriber

**Reference address:** address which defines the maximum charge which the A party is prepared to pay for the call leg which he originates

**Routeing address:** address which the GMSC uses to route a call towards the B subscriber or the C subscriber



## 3.2 Abbreviations

Abbreviations used in the present document are listed in TS 21.905 [2].

For the purposes of the present document, the following abbreviations apply:

BOIZC	Barring of Outgoing InterZonal Calls
BOIZC-exHC	Barring of Outgoing InterZonal Calls except those directed to the HPLMN Country
CMN	CAMEL Modified Number
FTN	Forwarded-To Number
FTNW	Forwarded-To NetWork
GMSCA	The GMSC in the IPLMN, which may also be VMSCA
GMSCB	The GMSC in HPLMNB
GMSCC	The GMSC in HPLMNC
HLRB	The HLR of the B subscriber
HLRC	The HLR of the C subscriber
HPLMNB	The HPLMN of the B subscriber
HPLMNC	The HPLMN of the C subscriber
IAM	Initial Address Message
IPLMN	Interrogating PLMN
ORLCF	Optimal Routeing for Late Call Forwarding
PRN	Provide Roaming Number
PSI	Provide Subscriber Information
RCH	Resume Call Handling
SIFIC	Send Information For Incoming Call
SIFOC	Send Information For Outgoing Call
SRI(B)	Send Routeing Information (Basic call)
SRI(F)	Send Routeing Information (Forwarding information)
VLRA	The VLR of the A subscriber
VLRB	The VLR of the B subscriber
VMSCA	The VMSC of the A subscriber
VMSCB	The VMSC of the B subscriber

---

## 4 Architecture

### 4.1 Optimal routeing for basic mobile-to-mobile calls

It is a network operator option whether to implement optimal routeing for basic mobile-to-mobile calls.

The existing UMTS and GSM architectures support the primary technical requirement of optimal routeing for mobile-to-mobile calls (basic OR): that a GMSC can interrogate an HLR in a different PLMN to obtain routeing information for a mobile terminated call (see GSM 03.04 [1]). Three logically distinct PLMNs are involved in the handling of an optimally routed mobile-to-mobile call:

- the IPLMN, which is also the VPLMN of the calling mobile subscriber;
- the HPLMN of the called mobile subscriber (HPLMNB);
- the VPLMN of the called mobile subscriber (VPLMNB).

Any two or all three of these PLMNs may be identical; in figure 1 they are shown as distinct.

Figure 1 shows the communication between the IPLMN, HPLMNB and VPLMNB for an optimally routed mobile-to-mobile call.

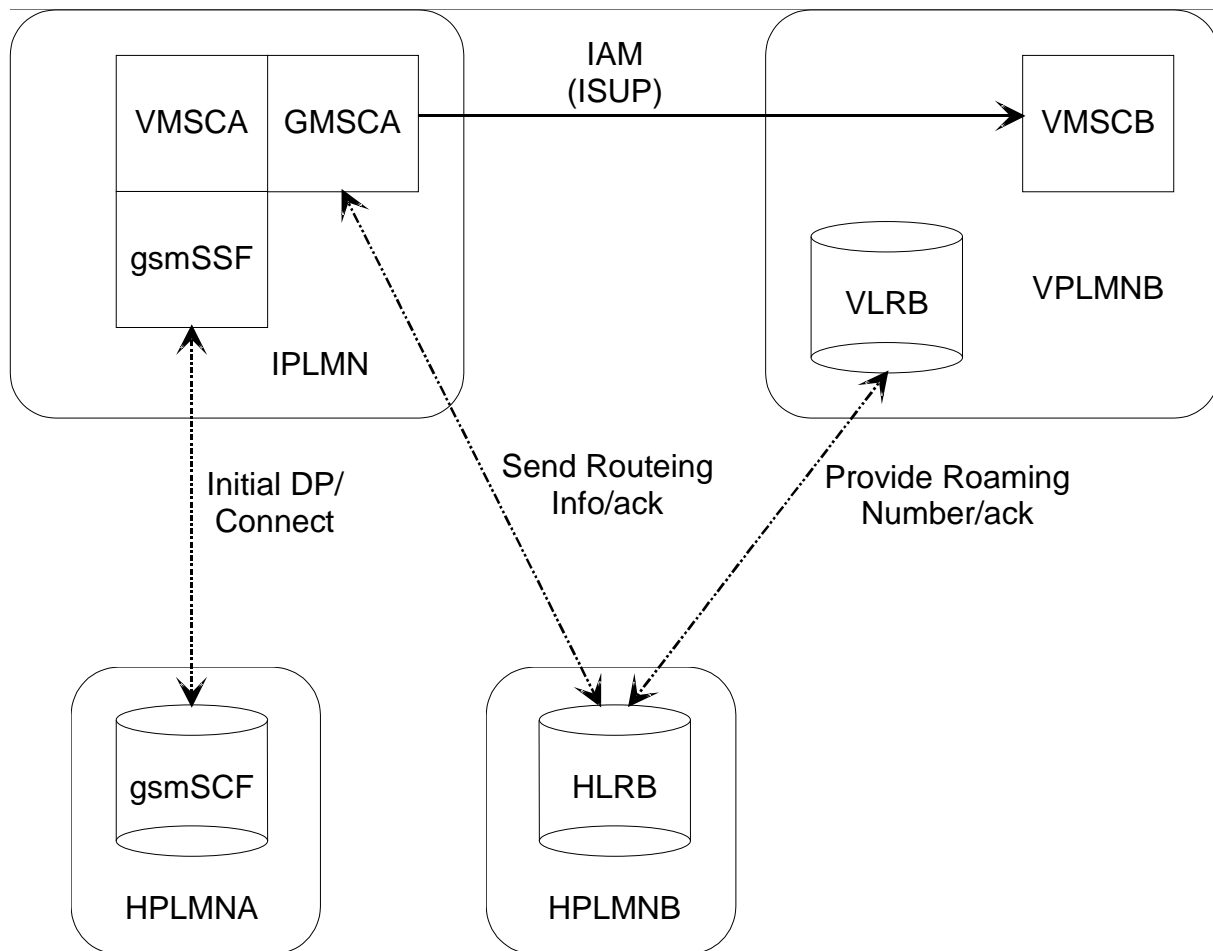

**Figure 1: Architecture for optimal routing of basic mobile-to-mobile call**

In figure 1 and throughout the present document, the term ISUP is used to denote the telephony signalling system used between exchanges. In this architecture the VMSC of the calling mobile subscriber (VMSCA) is integrated with the GMSC; communication between them is over an internal interface. A gsmSSF is also associated with VMSCA, to support CAMEL functionality; this is required for the support of optimal routing of mobile-to-mobile calls.

If the originating subscriber has a CAMEL subscription, then when VMSCA receives the setup message it sends an Initial DP message, containing the address digits received in the setup message, via the gsmSSF to the gsmSCF. If the gsmSCF determines that the destination defined by the address digits belongs to a GSM or UMTS PLMN, it responds to the Initial DP with a Connect or Continue With Argument message to VMSCA containing an indication that the call is eligible for optimal routing. This causes VMSCA to route the call to the associated GMSC (GMSCA).

If the GMSC is in the VPLMN of the calling mobile subscriber, is in a different PLMN from HLRB, it requests routing information from HLRB using the MAP protocol. If HLRB determines that the call can be routed directly from the GMSC to VMSCB without contravening the charging requirements for optimal routing given in subclause 9.1, it requests a roaming number from VLRB using the MAP protocol, and VLRB returns a roaming number in the Provide Roaming Number ack. HLRB returns the roaming number to the GMSC in the Send Routeing Info ack. The GMSC uses the roaming number to construct an ISUP IAM, which it sends to VMSCB. The call is then handled according to the procedures defined in 3GPP TS 23.018 [6], except that if the call is answered GMSCA relays the answer event to VMSCA and includes the destination address which it used to route the call, to allow VMSCA to generate the correct charging record.

**NOTE:** If the GMSC relays an answer event to VMSCA before it has received an Answer message from the final destination (e.g. because of an interaction with a Specialised Resource Function) an incorrect destination address (or no destination address) can be sent to VMSCA, even though the call is eventually optimally routed.

## 4.2 Optimal routing for conditional call forwarding

Some cases of call forwarding on mobile subscriber not reachable (CFNRC) are handled in the IPLMN, without the call being extended to the VPLMN of the forwarding subscriber. For these cases, referred to in the present document as early call forwarding, the forwarding is already optimally routed.

When a call has been extended from the GMSC to VMSCB, the procedures defined in 3GPP TS 23.018 [6] lead to any conditional call forwarding being routed from VMSCB to the forwarded-to destination; this is referred to in this specification as late call forwarding. Optimal routing for late call forwarding (ORLCF) allows VMSCB to return control of the call to the GMSC, which can then route the call to the forwarded-to destination.

Figure 2 shows the architecture for ORLCF. Phase 1 of SOR does not include optimal routing of forwarding to a mobile subscriber, so optimal routing of the forwarding leg is not considered.

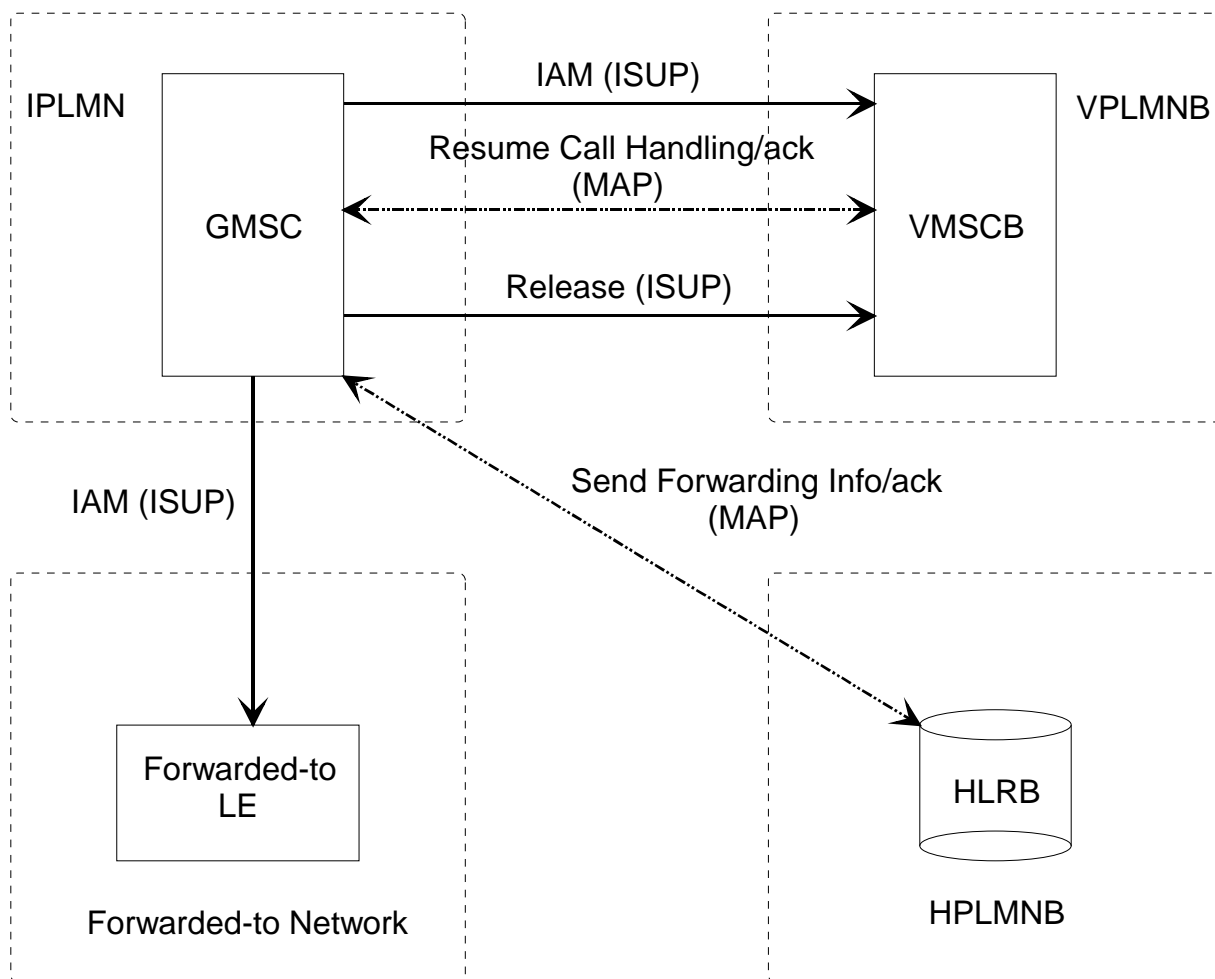

**Figure 2: Architecture for optimal routing of late call forwarding**

After the call has been extended from the GMSC to VMSCB, if the VMSC/VLR determines that the call should be forwarded it requests the GMSC to resume call handling. The GMSC uses the forwarding information received in the request to resume call handling, or interrogates HLRB for forwarding information, depending on the indication received from the HLR with the roaming number. If the GMSC determines that the call can be routed directly to the forwarded-to destination without contravening the charging requirements for optimal routing given in subclause 9.1 it acknowledges the request, clears the traffic connection to VMSCB and sends an ISUP IAM to the forwarded-to local exchange.

---

## 5 Optimal routeing for basic mobile-to-mobile calls: message flows

It is a network operator option whether to implement optimal routeing for basic mobile-to-mobile calls.

This clause does not consider the handling of calls to a fixed network B subscriber.

The description in this clause of the handling of optimal routeing for basic mobile-to-mobile calls is informative, not normative. Further, the description does not consider the effects of other services or features, except where these are specifically mentioned.

The message flow for an optimally routed call from one mobile subscriber to another mobile subscriber is shown in figure 3. For simplicity of description, it is assumed that forwarding of calls from the B subscriber is not required. Solid lines indicate circuit-associated signalling; dashed lines indicate connectionless signalling.

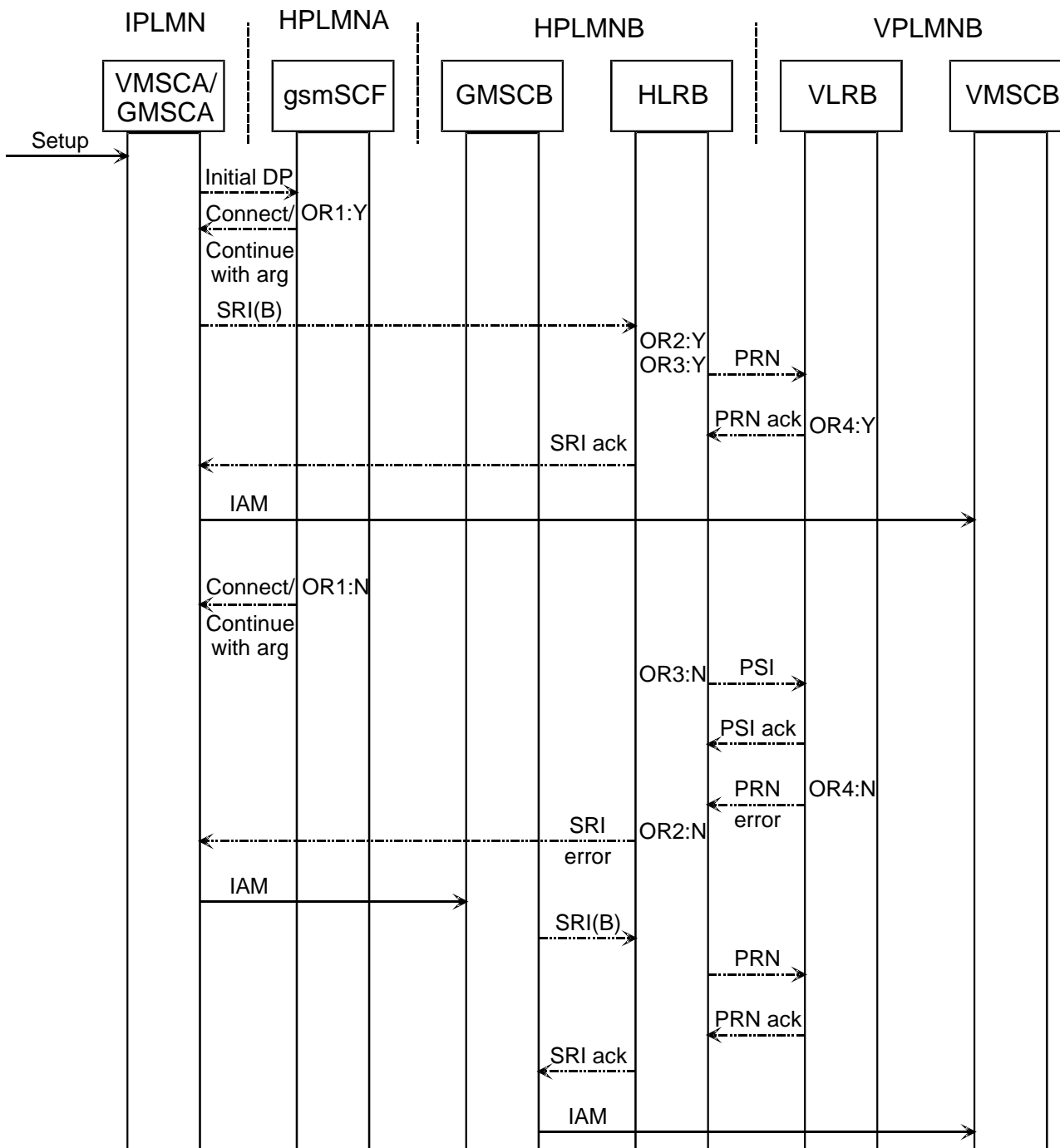

Figure 3: Message flow for optimal routing of basic mobile-to-mobile call

### 5.1 Successful outcome

When VMSCA receives a Setup message from the MS, it sends a request for information to handle the outgoing call to VLRA, according to the procedures described in 3GPP TS 23.018 [6]. If VLRA determines that the MS is allowed service, it returns a positive acknowledgement, including an indication that the subscriber has a CAMEL subscription, so that VMSCA will request instructions via the gsmSSF (not shown in this diagram) from the gsmSCF.

If the gsmSCF recognises the B subscriber address as belonging to a UMTS or GSM PLMN (decision OR1:Y), it sends a Connect message or a Continue With Argument message, containing an indication that the call is eligible for optimal routing, to VMSCA. This causes VMSCA to route the call to the associated GMSC function (GMSCA). GMSCA checks the identity of HPLMNB. If GMSCA is in a different PLMN from HLRB, it then sends a request for routing information (SRI(B)) to HLRB; this request contains an indication that it is an optimal routing enquiry for information

to route a basic call. If HLRB is prepared to accept an optimal routing enquiry from GMSCA (decision OR2:Y), it checks whether at least one of the three conditions:

- the GMSC is in the same country as VMSCB;
- the HLR is in the same country as VMSCB;
- the GMSC is in the same PLMN as the HLR;

is met. If it is (decision OR3:Y), HLRB sends a request for a roaming number (PRN) to VLRB; the request contains an indication that it is for an optimally routed call. If VLRB supports optimal routing (decision OR4:Y), it returns the roaming number in the PRN ack, and HLRB relays the roaming number in the SRI ack to GMSCA. GMSCA constructs an ISUP IAM using the roaming number, and sends it to VMSCB, which processes the incoming IAM according to the procedures described in 3GPP TS 23.018 [6].

## 5.2 Unsuccessful outcome

Error situations which lead to failure of the call, rather than non-optimal routing, are not described in this subclause.

### 5.2.1 B subscriber address not recognised as belonging to a UMTS or GSM PLMN

If the gsmSCF does not recognise the B subscriber address as belonging to a UMTS or GSM PLMN (decision OR1:N), it sends a Connect or Continue With Argument message, omitting the indication that the call is eligible for optimal routing. VMSCA constructs an IAM using the B subscriber address and sends it to GMSCB in HPLMNB. GMSCB analyses the address received in the IAM, and sends a request for routing information (SRI(B)) to HLRB; this request contains an indication that it is not an optimal routing enquiry. Because GMSCB is in the same PLMN as HLRB, it will always be able to derive an HLR address. HLRB sends a request for a roaming number (PRN) to VLRB. VLRB returns the roaming number in the PRN ack, and HLRB relays the roaming number in the SRI ack to GMSCB. GMSCB constructs an ISUP IAM using the roaming number, and sends it to VMSCB, which processes the incoming IAM according to the procedures described in 3GPP TS 23.018 [6].

### 5.2.2 HLRB or VLRB does not support optimal routing

If HLRB is not prepared to accept an optimal routing enquiry from GMSCA, because:

- it does not support optimal routing for basic mobile-to-mobile calls, or
- because there is no agreement for optimal routing for basic mobile-to-mobile calls between the operators of GMSCA and HLRB, or
- because optimal routing of basic mobile-to-mobile calls to the specific B subscriber is not allowed,

(decision OR2:N), it returns an SRI negative response (shown in figure 3 as 'SRI error'). This causes GMSCA to construct an IAM using the B subscriber address and send it to GMSCB, as described in subclause 5.2.1.

If VLRB does not support optimal routing (decision OR4:N), it returns a PRN negative response (shown in figure 3 as 'PRN error'). This causes HLRB to return an SRI negative response (shown in figure 3 as 'SRI error'), which in turn causes GMSCA to construct an IAM using the B subscriber address and send it to GMSCB, as described in subclause 5.2.1.

### 5.2.3 OR charging requirements contravened

If HLRB determines that the call cannot be routed directly from GMSCA to VMSCB without contravening the charging requirements for optimal routing given in subclause 9.1 (decision OR3:N) it sends a request for subscriber information (PSI) to VLRB. VLRB sends a response indicating whether the B subscriber is detached or in some other state. If the B subscriber is not detached, HLRB sends an SRI negative response (shown in figure 3 as 'SRI error') to GMSCA, which constructs an IAM using the B subscriber address and sends it to GMSCB, as described in subclause 5.2.1.

---

## 6 Optimal routeing for conditional call forwarding: message flows

The description in this clause of the handling of optimal routeing for conditional call forwarding is informative, not normative. Further, the description does not consider the effects of other services or features, except where these are specifically mentioned.

Two cases of conditional call forwarding are described in this clause:

- early call forwarding to a fixed destination;
- late call forwarding to a fixed destination.

For phase 1 of SOR, no attempt is made to route a call directly from the GMSC to a forwarded-to mobile subscriber; if the forwarded-to subscriber is mobile, the call is routed from the GMSC to a GMSC in the HPLMN of the forwarded-to subscriber.

### 6.1 Early call forwarding

Early call forwarding is defined as call forwarding from the IPLMN **before** the call has been extended to the VPLMN of the forwarding subscriber. CFU and CFNRc when the forwarding mobile subscriber is IMSI detached are examples of early call forwarding. Early call forwarding is effectively optimally routed, because the call takes the most direct route possible from the IPLMN to the forwarded-to destination.

The message flows for early call forwarding to a fixed destination are shown in figure 4a (forwarding without VLR interrogation) and figure 4b (forwarding after VLR interrogation). The IPLMN is shown as distinct from HPLMNB, on the assumption that the original call towards the B subscriber was optimally routed; however if optimal routeing of basic mobile-to-mobile calls is not implemented, the IPLMN will be the same as HPLMNB. Solid lines indicate circuit-associated signalling; dashed lines indicate connectionless signalling.

#### 6.1.1 Forwarding without interrogation of VLRB

##### 6.1.1.1 Successful outcome

GMSCA sends a request for routeing information (SRI(B)) to HLRB. If HLRB determines that the call is to be forwarded without needing to signal to VLRB then HLRB returns the forwarded-to number (FTN) in the SRI ack.

If GMSCA determines that the call can be forwarded to LEC without contravening the charging requirements for Support of Optimal Routeing given in subclause 9.1 (decision OR:Y) it constructs an ISUP IAM using the FTN and sends it to LEC.

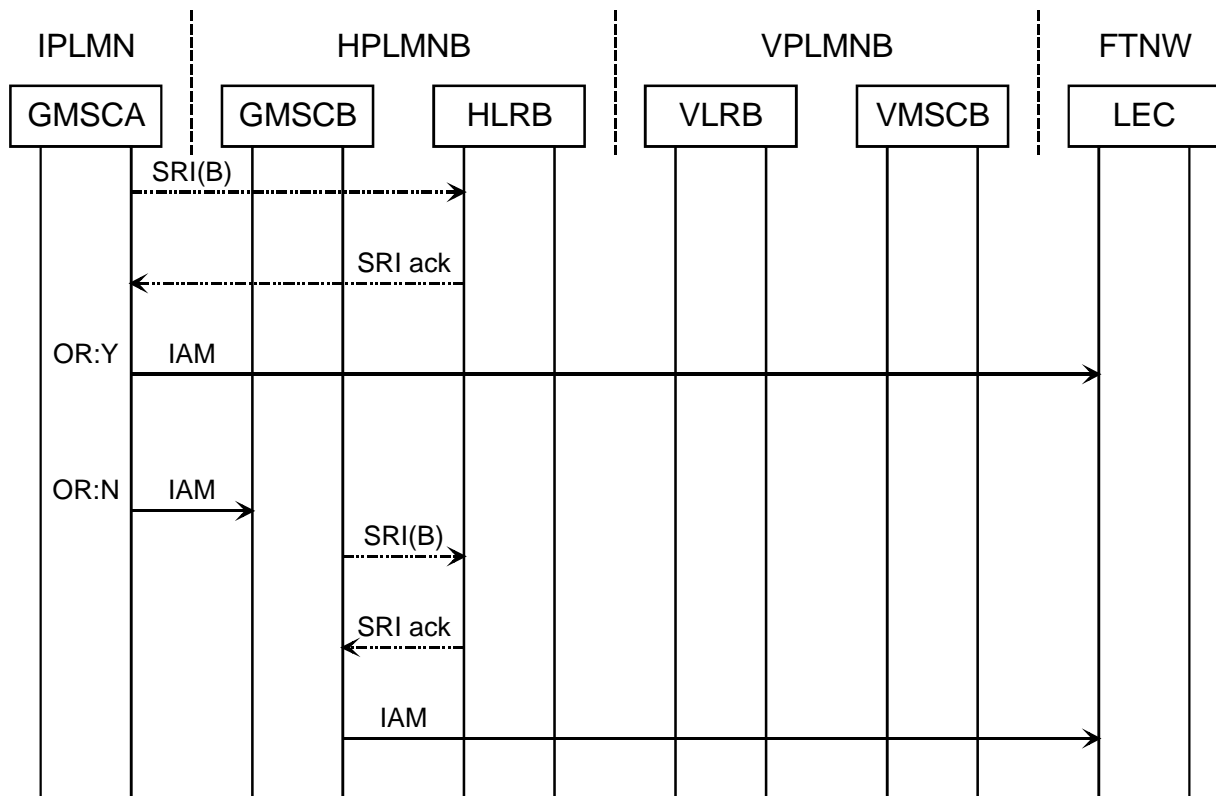

**Figure 4a: Message flow for early call forwarding to a fixed destination - forwarding without interrogation of VLRB**

### 6.1.1.2 Unsuccessful outcome

Error situations which lead to failure of the call, rather than non-optimal routing, are not described in this subclause.

If GMSCA determines that the call cannot be forwarded to LEC without contravening the charging requirements for Support of Optimal Routing given in subclause 9.1 (decision OR:N) it constructs an IAM using the B subscriber address and sends it to GMSCB.

GMSCB sends a request for routing information (SRI(B)) to HLRB. If HLRB determines that the call is to be forwarded, as described in subclause 6.1.1.1, it returns the FTN in the SRI ack.

GMSCB constructs an IAM using the FTN and sends it to LEC.

## 6.1.2 Forwarding after interrogation of VLRB

### 6.1.2.1 Successful outcome

GMSCA sends a request for routing information (SRI(B)) to HLRB. HLRB sends a request for the subscriber status (PSI) to VLRB. If the record in VLRB for the B subscriber shows that the B subscriber is IMSI detached, VLRB indicates this in the PSI ack. Alternatively, if HLRB determines that at least one of the three conditions:

- the GMSC is in the same country as VMSCB;
- the HLR is in the same country as VMSCB;
- the GMSC is in the same PLMN as the HL;

is met, it sends a request for a roaming number (PRN) to VLRB. If the record in VLRB for the B subscriber shows that the B subscriber is IMSI detached, VLRB indicates this in a PRN negative response. If HLRB determines that CFNRC should be invoked, it returns the forwarded-to number (FTN) in the SRI ack.



If GMSCA determines that the call can be forwarded to LEC without contravening the charging requirements for Support of Optimal Routeing given in subclause 9.1 (decision OR:Y) it constructs an ISUP IAM using the FTN and sends it to LEC.

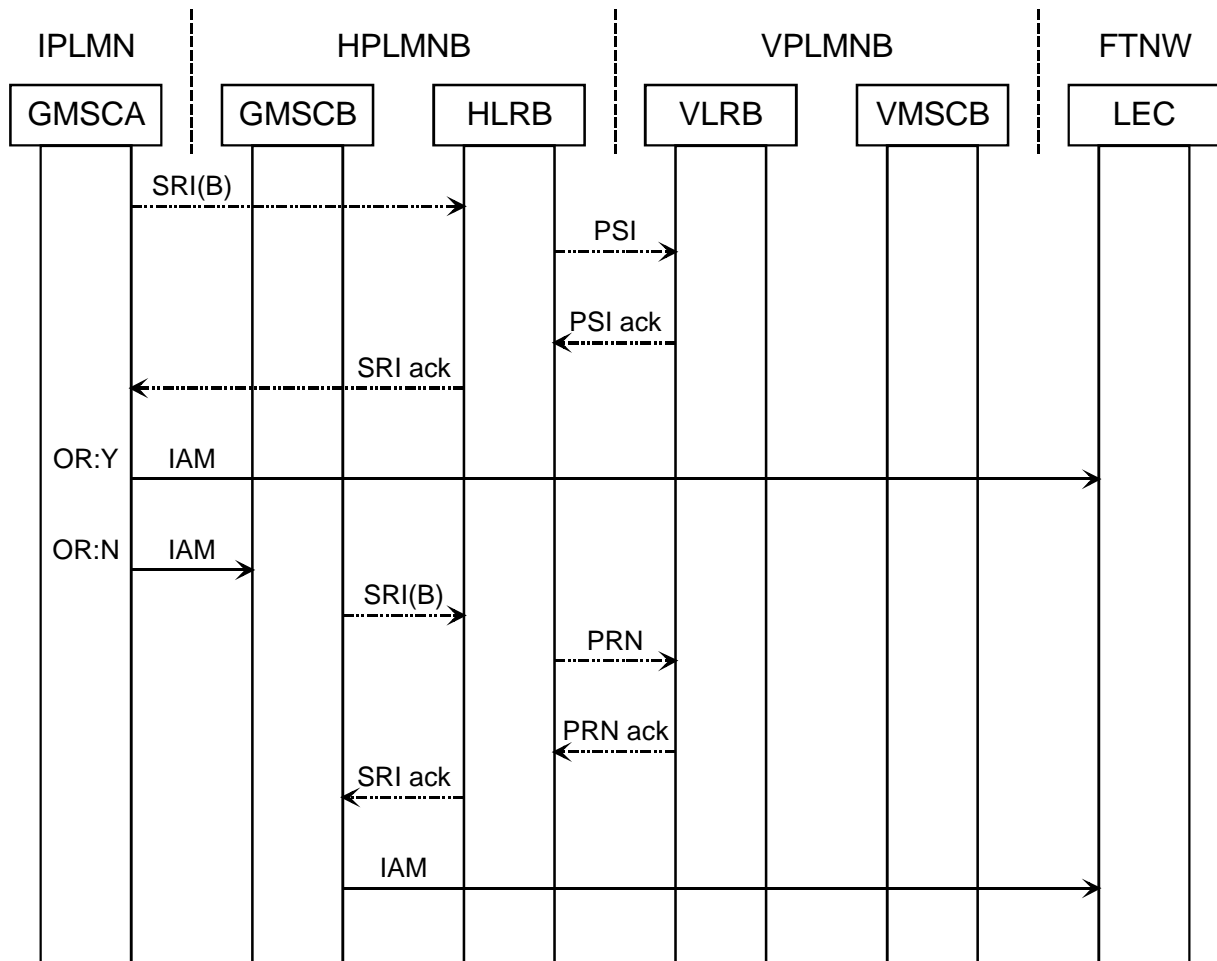

NOTE: HLRB may send a PRN to VLRB, and receive a PRN negative response indicating absent subscriber, to determine that CFNRc should be invoked.

**Figure 4b: Message flow for early call forwarding to a fixed destination - forwarding after interrogation of VLRB**

### 6.1.2.2 Unsuccessful outcome

Error situations which lead to failure of the call, rather than non-optimal routeing, are not described in this subclause.

If GMSCA determines that the call cannot be forwarded to LEC without contravening the charging requirements for Support of Optimal Routeing given in subclause 9.1 (decision OR:N), it constructs an ISUP IAM using the B subscriber address and sends it to GMSCB.

GMSCB sends a request for routeing information (SRI(B)) to HLRB. HLRB sends a request for a roaming number (PRN) to VLRB. If the record in VLRB for the B subscriber shows that the B subscriber is IMSI detached, VLRB indicates this in the PRN ack. If HLRB determines that CFNRc should be invoked, it returns the forwarded-to number (FTN) in the SRI ack.

GMSCB constructs an IAM using the FTN and sends it to LEC.

## 6.2 Late call forwarding

Late call forwarding is defined as call forwarding **after** the call has been extended to the VPLMN of the forwarding subscriber. CFB, CFNRc on no response to paging and CFNRy are examples of late call forwarding. In the absence of OR, late call forwarding occurs in the VPLMN of the forwarding party; if OR applies, late call forwarding occurs in the IPLMN.

The message flow for optimal routing of late call forwarding to a fixed destination is shown in figure 5. The IPLMN may be distinct from HPLMNB or the same as HPLMNB, depending on whether or not the original call to VPLMNB was optimally routed, but this description assumes that the original call to VPLMNB was optimally routed. For simplicity of description, the separation of VMSCA and GMSCA (described in clause 5 & subclause 6.1) is omitted. Solid lines indicate circuit-associated signalling; dashed lines indicate connectionless signalling.

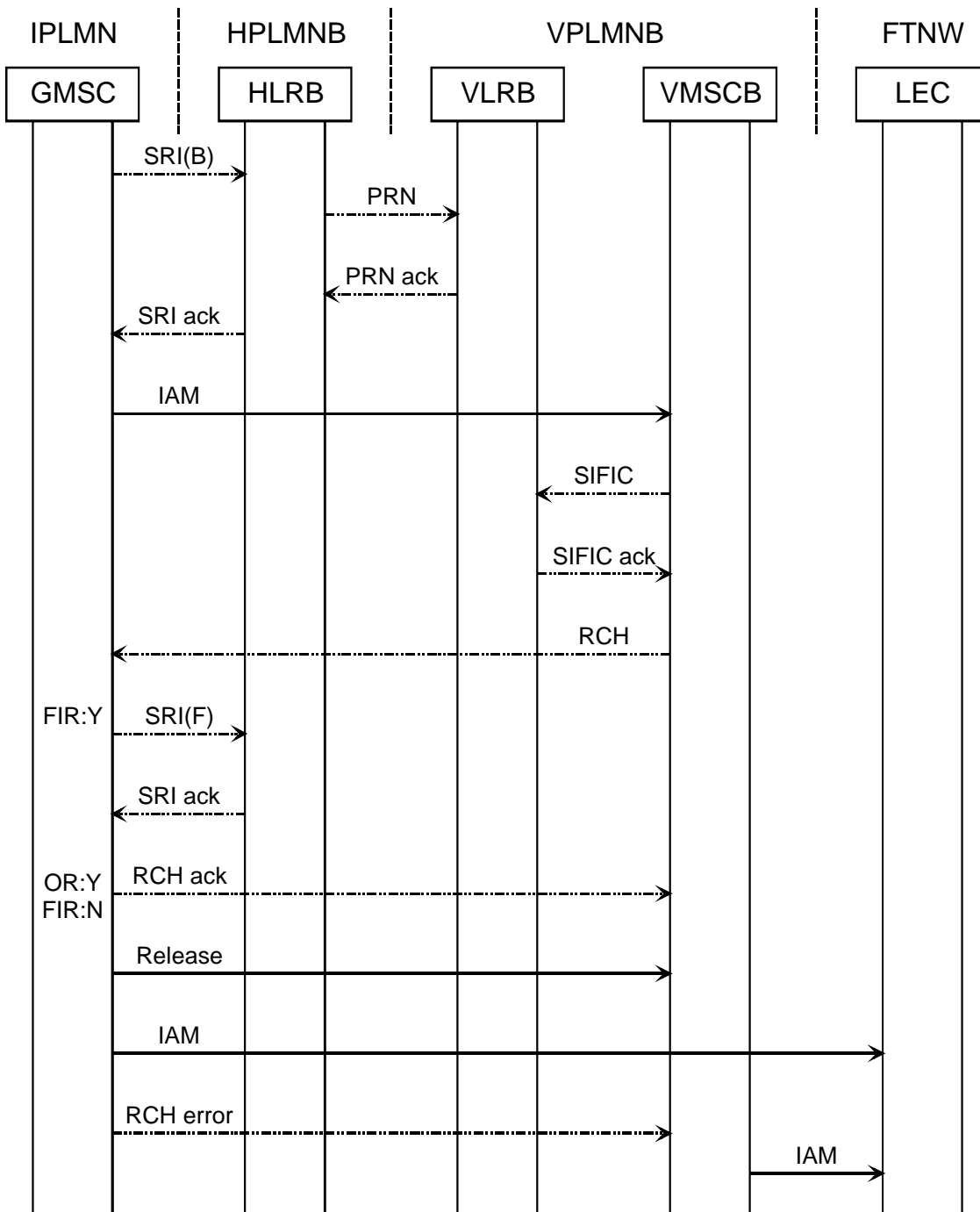

Figure 5: Message flow for optimal routing of late call forwarding to a fixed destination

## 6.2.1 Successful outcome

The GMSC obtains a roaming number from HLRB to route the call to VMSCB, as described in subclause 5.1. The SRI ack also includes an indication of whether the GMSC should interrogate the HLR for routing information for late call forwarding. The GMSC constructs an IAM using the roaming number, and sends it to VMSCB. When VMSCB receives the IAM, it requests subscriber information for the incoming call (SIFIC) from VLRB. If VLRB determines that the call should be forwarded, because the called mobile subscriber is busy, or is not reachable, or has not replied to the call before the no-reply call timer has expired, it returns a SIFIC ack containing the forwarded-to number, the forwarding reason, the GMSC address and the call reference number to VMSCB. VMSCB sends a request to resume call handling (RCH) to the GMSC; the RCH includes the forwarded-to number, the forwarding reason and the basic service information received in the SIFIC ack.

If the HLR indicated in the SRI ack which contained the MSRN that the GMSC should interrogate the HLR for forwarding information (FIR:Y), the GMSC then sends a request for forwarding information (SRI(F)), containing the forwarding reason and the basic service group which applies for this call, to HLRB. HLRB responds with the appropriate forwarded-to number.

If the HLR indicated in the SRI ack which contained the MSRN that the GMSC should not interrogate the HLR for forwarding information (FIR:N), the GMSC checks the forwarded-to number received in the RCH.

If the GMSC determines that the call can be forwarded to the forwarded-to destination without contravening the charging requirements for Support of Optimal Routing given in subclause 9.1 (decision OR:Y) it:

- sends an RCH ack to VMSCB to indicate that control of the call has been accepted;
- sends an ISUP Release message indicating normal clearing to VMSCB to release the traffic circuit;
- constructs an IAM using the forwarded-to number, and sends it to LEC.

## 6.2.2 Unsuccessful outcome

Error situations which lead to failure of the call, rather than non-optimal routing, are not described in this subclause.

### 6.2.2.1 GMSC does not support OR

If the GMSC does not support OR, it omits the 'or-capability' information element from the SRI(B) request. The HLR then sends the 'OR not supported in GMSC' indicator in the PRN to VLRB. VMSCB will not send the RCH to the GMSC if the 'OR not supported in GMSC' indicator was received in the PRN. Instead, the call will be forwarded at VMSCB.

### 6.2.2.2 HLRB does not support OR

If HLRB does not support OR, it does not relay the GMSC address and the call reference number which it received in the SRI(B), so VMSCB cannot send the RCH to the GMSC. Instead, the call will be forwarded at VMSCB.

### 6.2.2.3 VMSCB/VLRB does not support OR

If VMSCB/VLRB does not support OR, VMSCB cannot send the RCH to the GMSC. Instead, the call will be forwarded at VMSCB.

### 6.2.2.4 OR charging requirements contravened

If the original call to VMSCB was optimally routed, the GMSC can route the call to the forwarded-to destination only if the charge to do so is no more than the charge to route the call to HPLMN. If this requirement, determined as described in subclause 9.1, is not met (decision OR:N) the GMSC returns an RCH negative response (shown in figure 5 as 'RCH error') to VMSCB, which then forwards the call.

If the original call to VMSCB was not optimally routed, the GMSC can route the call directly to the forwarded-to destination only if the charge to do so is no more than the charge for the routing to VMSCB. If this requirement, determined as described in subclause 9.1, is not met (decision OR:N) the GMSC returns an RCH negative response (shown in figure 5 as 'RCH error') to VMSCB, which then forwards the call.

---

## 7 Interactions between optimal routing and supplementary services

### 7.1 Call forwarding

If an optimally routed call encounters early call forwarding, GMSCA attempts to route the call to the forwarded-to destination. The forwarded-to destination is the C subscriber if the C subscriber is not a mobile subscriber, or the HPLMN of the C subscriber if the C subscriber is a mobile subscriber. If GMSCA cannot route the call to the forwarded-to destination without contravening the charging requirements for Support of Optimal Routing given in subclause 9.1, the call is routed to a GMSC in the HPLMN of the B subscriber.

If an optimally routed call encounters late call forwarding, GMSCA attempts to route the call to the forwarded-to destination. The forwarded-to destination is the C subscriber if the C subscriber is not a mobile subscriber, or the HPLMN of the C subscriber if the C subscriber is a mobile subscriber. If GMSCA cannot route the call to the forwarded-to destination without contravening the charging requirements for Support of Optimal Routing given in subclause 9.1, the call is routed from VMSCB to the forwarded-to destination.

The handling of call forwarding at HLRB for optimally routed calls is encapsulated in the procedures First\_Forwarding\_HLR, PRN\_Error\_HLR, Handle\_CFB, Handle\_CFNRC and Handle\_CFNRY, which are specified in 3GPP TS 23.018 [6].

### 7.2 Closed User Group (CUG)

The handling of CUG checking for outgoing calls at VLRA is encapsulated in the process OCH\_VLR, which is specified in 3GPP TS 23.018 [6].

The handling of CUG checking at HLRB is encapsulated in the procedures Subscription\_Check\_HLR and Forward\_CUG\_Check, which are specified in 3GPP TS 23.018 [6].

### 7.3 Advice of Charge

Advice of Charge (Information) and Advice of Charge (Charging) do not take account of whether a call has been optimally routed.

### 7.4 Call barring

It has been accepted in principle that all supplementary service call barring programmes except for BAIC are applied for cost control reasons, and that therefore barring should be applied on the basis of the cost of the actual route taken by the call. For phase 1 of Support of Optimal Routing, this principle does not apply. Barring of outgoing calls is applied on the basis of the B subscriber number. Barring of all incoming calls will prevent a call to the served mobile subscriber, whether or not the call is optimally routed. If Barring of Incoming Calls when roaming outside the home PLMN country is active and operative it will prevent a call to the B subscriber even if the A subscriber pays to route the call to the VMSC of the B subscriber.

The handling of barring of outgoing calls at VLRA is encapsulated in the process OCH\_VLR, which is specified in 3GPP TS 23.018 [6].

The handling of barring of incoming calls at HLRB is encapsulated in the procedure Subscription\_Check\_HLR, which is specified in 3GPP TS 23.018 [6].

The interactions between barring of outgoing calls and call forwarding for phase 1 of Support of Optimal Routeing are defined in 3GPP TS 22.082 [4].

The interactions between BIC-Roam and call forwarding for phase 1 of Support of Optimal Routeing are defined in 3GPP TS 22.082 [4].

## 7.5 Other supplementary services

The effects of the following supplementary services on optimally routed calls are identical to their effects on non-optimally routed calls, so they are omitted from the present document:

- CLIP, CLIR, COLP, COLR (3GPP TS 23.081);
- CW, HOLD (3GPP TS 23.083);
- MPTY (3GPP TS 23.084);
- ECT (3GPP TS 23.091).

---

# 8 Interactions between optimal routeing and other network features

## 8.1 Operator determined barring

The principles for the interactions between operator determined barring and optimal routeing are the same as those for interactions between supplementary service barring and optimal routeing.

## 8.2 CAMEL

The principles for interactions between CAMEL services and optimal routeing are specified in this subclause. The interworking between CAMEL processing and optimal routeing in the GMSC and the terminating VMSC is specified in subclause 9.4 and 3GPP TS 23.018 [6].

If a mobile-originating CAMEL service modifies the number entered by the A subscriber, VMSCA treats the number returned by the gsmSCF in the same way as a number received in the SETUP message, i.e.:

:

- If the gsmSCF indicated that the call is eligible for optimal routeing, VMSCA sends a signal containing the modified number to the associated GMSC, which sends a request for routeing information to the appropriate HLR;
- If the gsmSCF did not indicate that the call is eligible for optimal routeing, VMSCA sends an IAM containing the modified number to a GMSC in HPLMNB, which sends a request for routeing information to the appropriate HLR.

If a mobile-terminating CAMEL service modifies the number received by the GMSC, the GMSC treats the number returned by the CAMEL server in the same way as a forwarded-to number, i.e. it checks it against the optimal routeing criteria in subclause 9.1 but does not analyse it to find if it can derive an HLR address. If the number returned by the CAMEL server does not satisfy the optimal routeing criteria in subclause 9.1 and the GMSC is not in the same PLMN as HLRB, the GMSC will route the call to a GMSC in the same PLMN as HLRB. This will lead to a repetition of the mobile terminating CAMEL interaction.

If the call is to be forwarded early at the GMSC (whether by a UMTS-standardised call forwarding service or by a CAMEL-based call forwarding service) and a mobile originating CAMEL service applies to the forwarding subscriber, the GMSC checks the number which results from the CAMEL service against the optimal routeing criteria in subclause 9.1. If the number returned by the CAMEL server does not satisfy the optimal routeing criteria in subclause 9.1, the

GMSC will not route the call to the forwarded-to destination. The GMSC will route the call to a GMSC in the same PLMN as HLRB. This will lead to a repetition of the mobile originating CAMEL interaction.

If the call is optimally routed back to the GMSC (optimal routeing of late call forwarding) and a mobile originating CAMEL service applies to the forwarding subscriber, then the GMSC does not check the number which results from the CAMEL service against the optimal routeing criteria in subclause 9.1.

**NOTE:** Service Logic designers should be aware that Optimal Routeing of Late Call Forwarding (ORLCF) may be combined with Optimal Routeing of basic mobile to mobile calls (Basic Optimal Routeing - BOR) in a single call. The ORLCF handling in the GMSC may be subject to Mobile Terminating (MT) CAMEL handling and Mobile Forwarding (MF) CAMEL handling, as depicted in Procedure OR\_Handle\_RCH. Both the MT CAMEL Service and the MF CAMEL Service may provide a new destination for the forwarded leg.

When BOR and ORLCF are combined within one call, and the MT CAMEL Service or the MF CAMEL Service provides a new destination for the forwarded leg, then these CAMEL Services should take particular care, if they need to ascertain whether this new destination complies with the optimal routeing criteria as specified in subclause 9.1.

---

## 9 Functional requirements of entities performing optimal routeing

### 9.1 Charging requirements for optimal routeing

MoU have imposed two constraints for the charging of optimally routed calls:

- No subscriber shall pay more for a call which has been optimally routed than he would do under the present routeing scheme described in GSM 03.04 [1] in the subclauses describing the call cases where the GMSC is in the same PLMN as the HLR.
- At least for the first phase of Support of Optimal Routeing, the charge for one leg of a call shall be paid for entirely by one subscriber.

These constraints mean that the direct route for a call cannot always be used. For example, if the calling mobile subscriber (the A subscriber) is in Germany, and the B subscriber's HPLMN is in Switzerland but he has roamed to Finland, the charge payable by the A subscriber to route the call by the direct route to Finland would be greater than the charge payable to route the call to HPLMNB, so the HPLMN route must be used.

In the first phase of Support of Optimal Routeing, it cannot be assumed that a GMSC is able to calculate the charge payable for the direct route and the charge payable for the HPLMN leg. The MoU requirements can be met by applying more stringent (but simpler) criteria for deciding whether the direct route may be used:

- If the country code of the destination exchange and the country code of the GMSC are the same, then the direct route may be used.
- Otherwise, for a call leg which is chargeable to the A subscriber, if the country code of the destination exchange and the country code of HPLMNB are the same, then the direct route may be used.
- Otherwise, the HPLMN route shall be used.

In certain cases, the second criterion above (equality of country codes for the HPLMN and the destination exchange) may not be enough to determine equality of the charges payable for the direct route and the HPLMN route. In these cases, analysis of the national destination code as well as the country code is required; however the principle is still that if the two numbers are the same to the depth of analysis required then the direct route may be used.

For optimal routeing of late call forwarding, the constraints are satisfied if the following criteria are applied:

- if the country code of the forwarded-to-exchange and the country code of the GMSC are the same, then the forwarded call may be routed directly from the GMSC to the forwarded-to-exchange;

- otherwise, if the country code of the forwarded-to exchange and the country code of HPLMNB are the same, then the forwarded call may be routed directly from the GMSC to the forwarded-to exchange;
- otherwise, if the country code of the forwarded-to exchange and the country code of VPLMNB are the same, then the forwarded call may be routed directly from the GMSC to the forwarded-to exchange;
- otherwise the forwarded call shall be routed through VPLMNB.

## 9.2 Functional behaviour of VMSCA

The functional behaviour of VMSCA is specified in 3GPP TS 23.018 [6]. The only functions specific to optimal routing are:

- Routing the call to the associated GMSC function if the gsmSCF indicates that the call is eligible for optimal routing;
- The transfer of the destination address, if it is received in the indication of the answer event, to the call data record, to allow the correct charge for the call to be made. This function is required only if VMSCA supports optimal routing of mobile-to-mobile calls.

## 9.3 Functional behaviour of VLRA

The functional behaviour of VLRA is specified in 3GPP TS 23.018 [6].

## 9.4 Functional behaviour of GMSC

When a call is being forwarded the forwarding leg is controlled by a process MT\_CF\_MSC which runs in the forwarding MSC (VMSC or GMSC). If CAMEL processing of the forwarding leg indicates that Basic Optimal Routing of the forwarding leg should be attempted, the forwarding MSC may use the services of an associated GMSC for the forwarding leg, i.e. the associated GMSC requests routing information from HLRC. In this case, the forwarding leg is processed in the same way as a mobile-originated call from mobile subscriber B.

The functional behaviour of a GMSC is specified in 3GPP TS 23.018 [6]. The procedures specific to Support of Optimal Routing are specified in this subclause.

### 9.4.1 Procedure OR\_Set\_ORA\_Parameters

### 9.4.2 Procedure OR\_Handle\_RCH

Sheet 1: if the GMSC interrogates the HLR for a Forwarded-to number, the Routing address is the Forwarded-to number received in the Send Routing Info ack; otherwise the Routing address is the Forwarded-to number received in the Resume Call Handling.

Sheet 1: the task "Destination address := FTN" is executed only if the GMSC supports optimal routing of basic mobile-to-mobile calls.

Sheet 1: the procedure Route\_permitted is called to verify the number received in Resume Call Handling or the number received from HLR. If the result is "False", then the GMSC disallows the Optimal Routing. The call forwarding will now be done by the VMSC.

Note When the procedure Route\_permitted returns result "False", then the gsmSCF is not informed about the forwarding and can therefore not provide an alternative destination address. Reason is that once the gsmSCF is informed about forwarding, the call forwarding can not be returned to the VMSC.

Sheet 2: the procedure CAMEL\_MT\_GMSC\_Notify\_CF is specific to CAMEL phase 2 or higher; it is specified in 3GPP TS 23.078 [7]. If the GMSC does not support CAMEL phase 2 or higher, processing continues from the "Continue" exit of the test "Result".

If the result of the procedure CAMEL\_MT\_GMSC\_Notify\_CF is "Fail" or "Release", then the call will be released.

If the result of the procedure CAMEL\_MT\_GMSC\_Notify\_CF is "Reconnect", then the GMSC allows the Optimal Routing. The GMSC will then start a call forwarding process.

Sheet 2: when the procedure Route\_permitted on sheet 1 returns result "False", then the GMSC returns "OR not allowed" to the VMSC. The call forwarding will now be done by the VMSC.

Sheet 3: the procedure Activate\_CF\_Process is specified in 3GPP TS 23.018 [6]. When procedure Activate\_CF\_Process returns result "Release" or "Fail", the call is released.

If the result is "Pass", then the GMSC allows the Optimal Routing.

Sheet 3: the procedure UUS\_GMSC\_Check\_Forwarding is specific to UUS; it is specified in 3GPP TS 23.087 [9].

Sheet 3: the procedure CAMEL\_Store\_Destination\_Address is specific to CAMEL phase 3 or higher; it is specified in 3GPP TS 23.078 [7].

Sheet 3: the called party address sent in the IAM to the process MT\_CF\_MSC is the Forwarded-to number received in the Perform Call Forwarding ack.

Sheet 3: the process MT\_CF\_MSC is specified in 3GPP TS 23.018 [6].

### 9.4.3 Procedure Route\_Permitted

### 9.4.4 Procedure OR\_Handle\_SRI\_Negative\_Response

'Non-fatal' error situations, which cause the call to be routed through a GMSC in the same PLMN as the HLR, are:

- Send Routing Info request rejected because the HLR does not support OR.
- Protocol error.
- System failure.
- Unexpected data value.
- Data missing.
- OR not allowed.

'Fatal' negative responses, which cause the GMSC to return a 'fail' result, are:

- Unknown subscriber.
- Number changed.
- Bearer service not provisioned.
- Teleservice not provisioned.
- Call barred.
- CUG reject.
- Forwarding violation.
- Facility not supported.
- Absent subscriber.



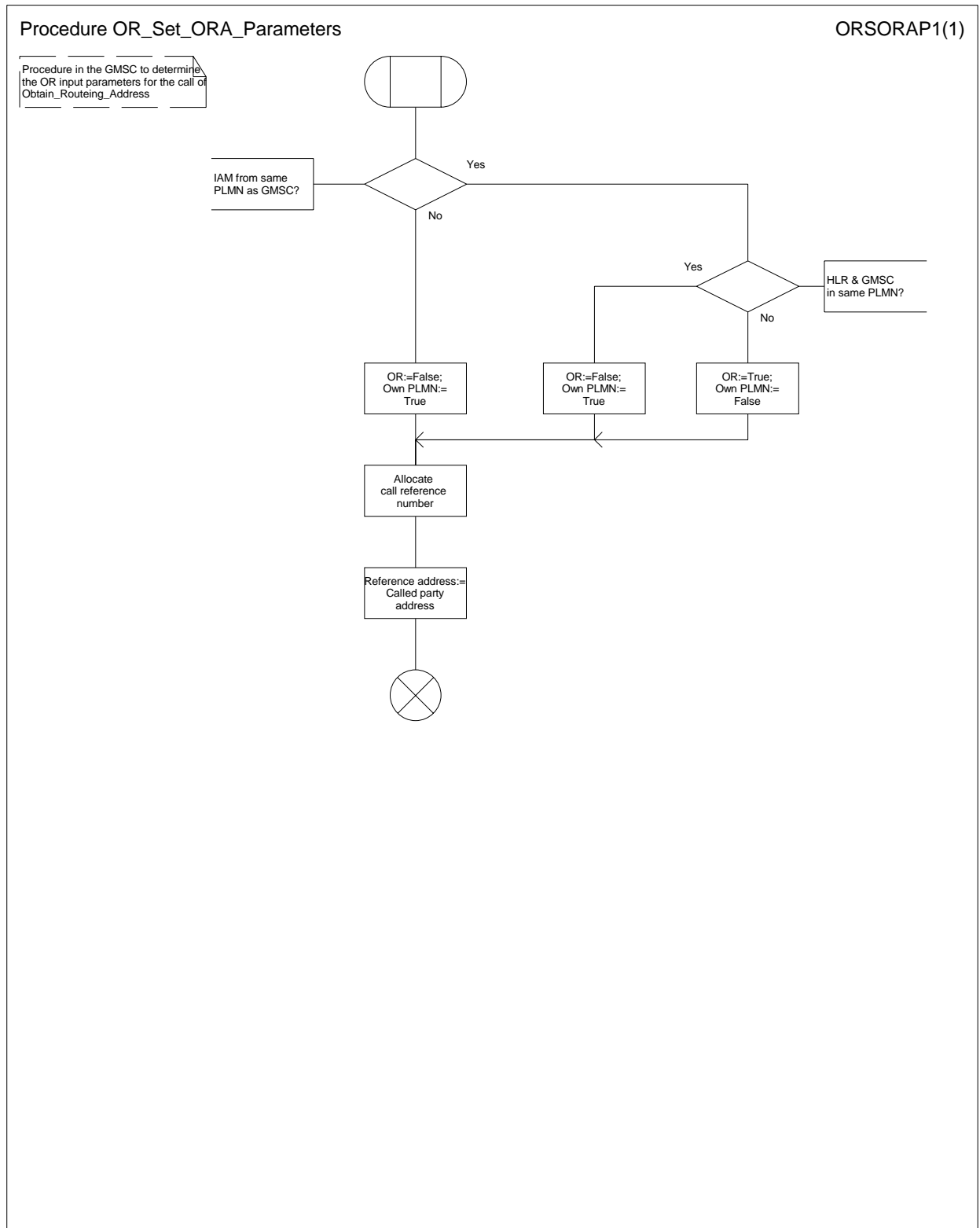

Figure 6: Procedure OR\_Set\_OR\_A\_Parameters

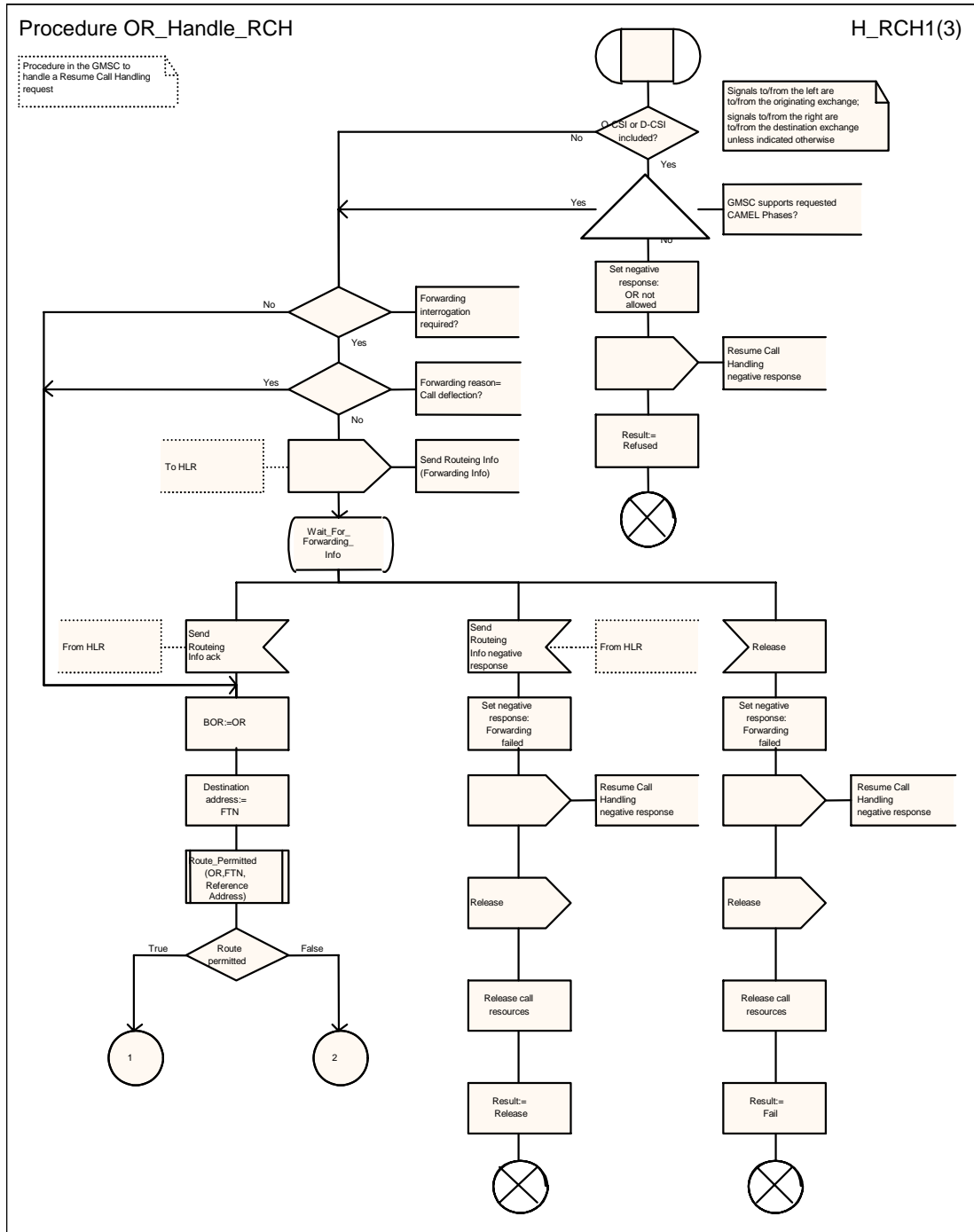

Figure 7a: Procedure OR\_Handle\_RCH (sheet 1)

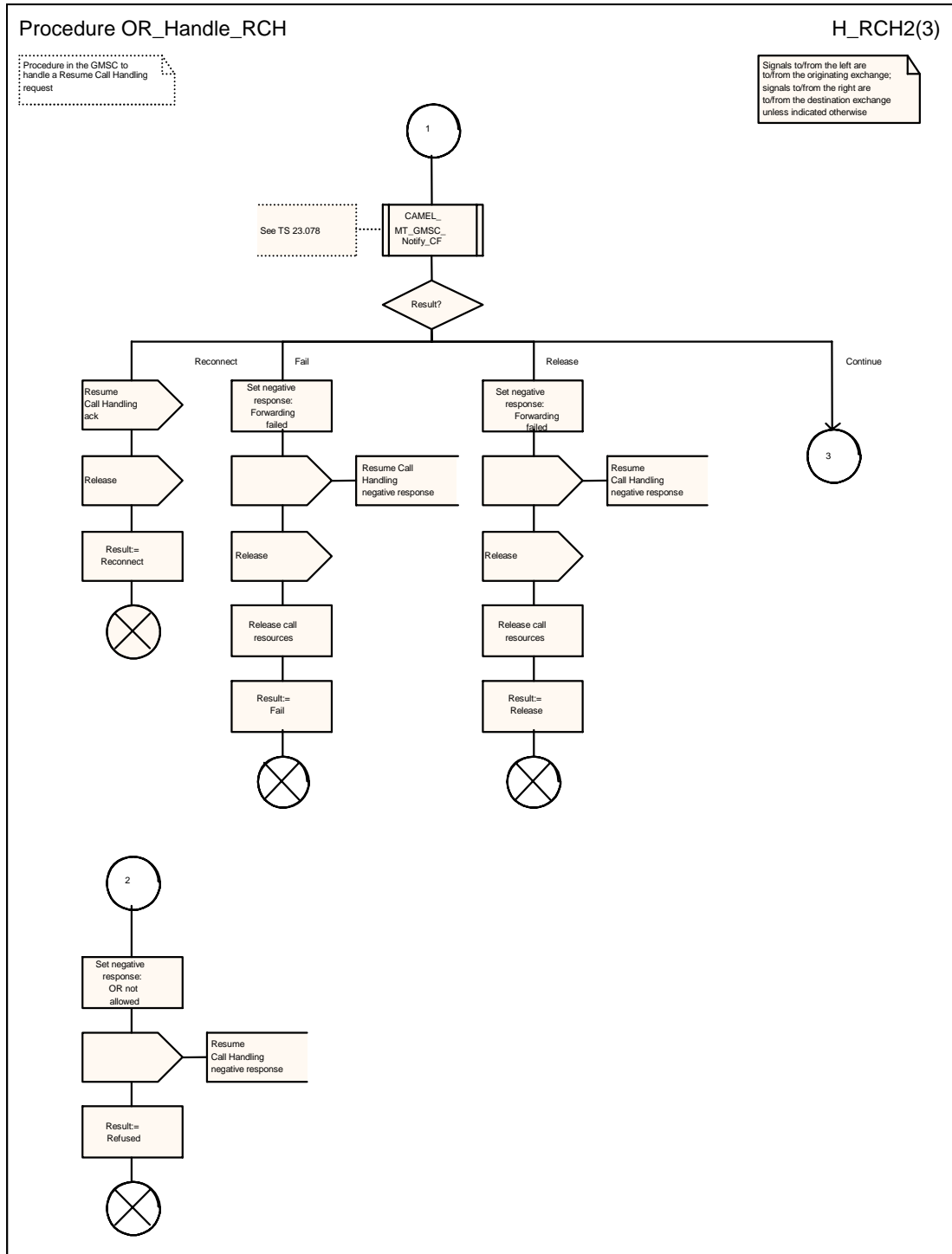

Figure 7b: Procedure OR\_Handle\_RCH (sheet 2)

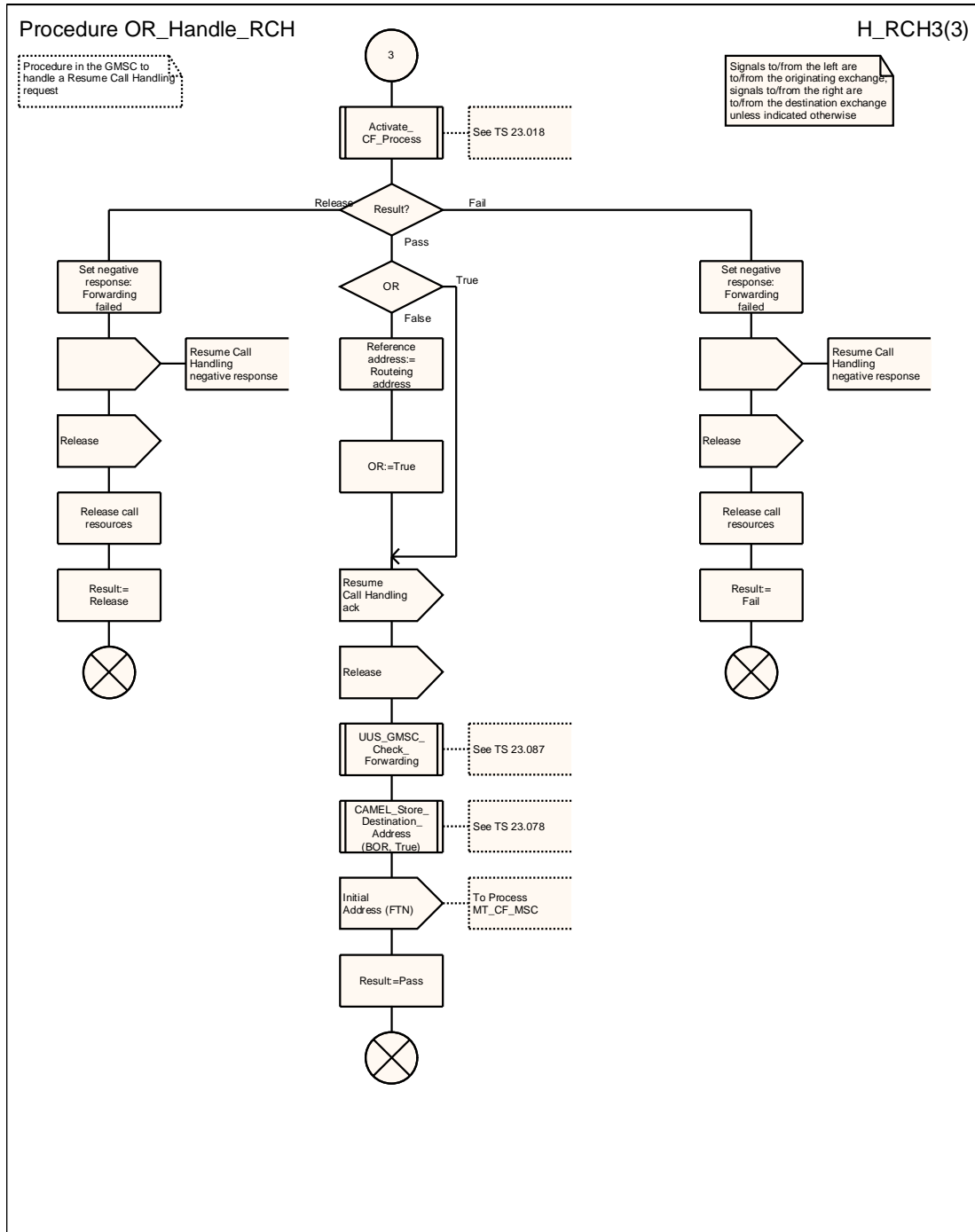

Figure 7c: Procedure OR\_Handle\_RCH (sheet 3)

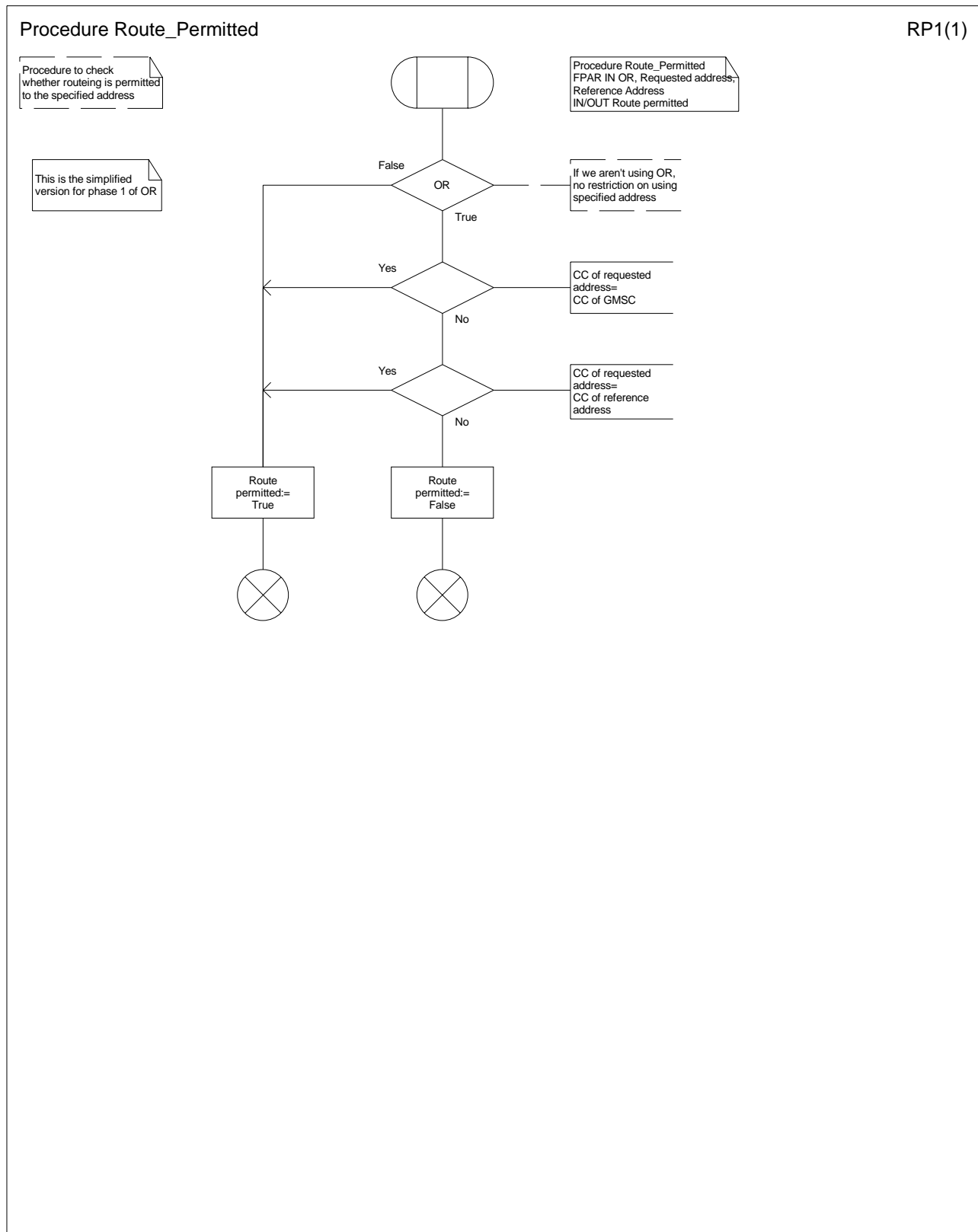

Figure 8: Procedure Route\_Permitted

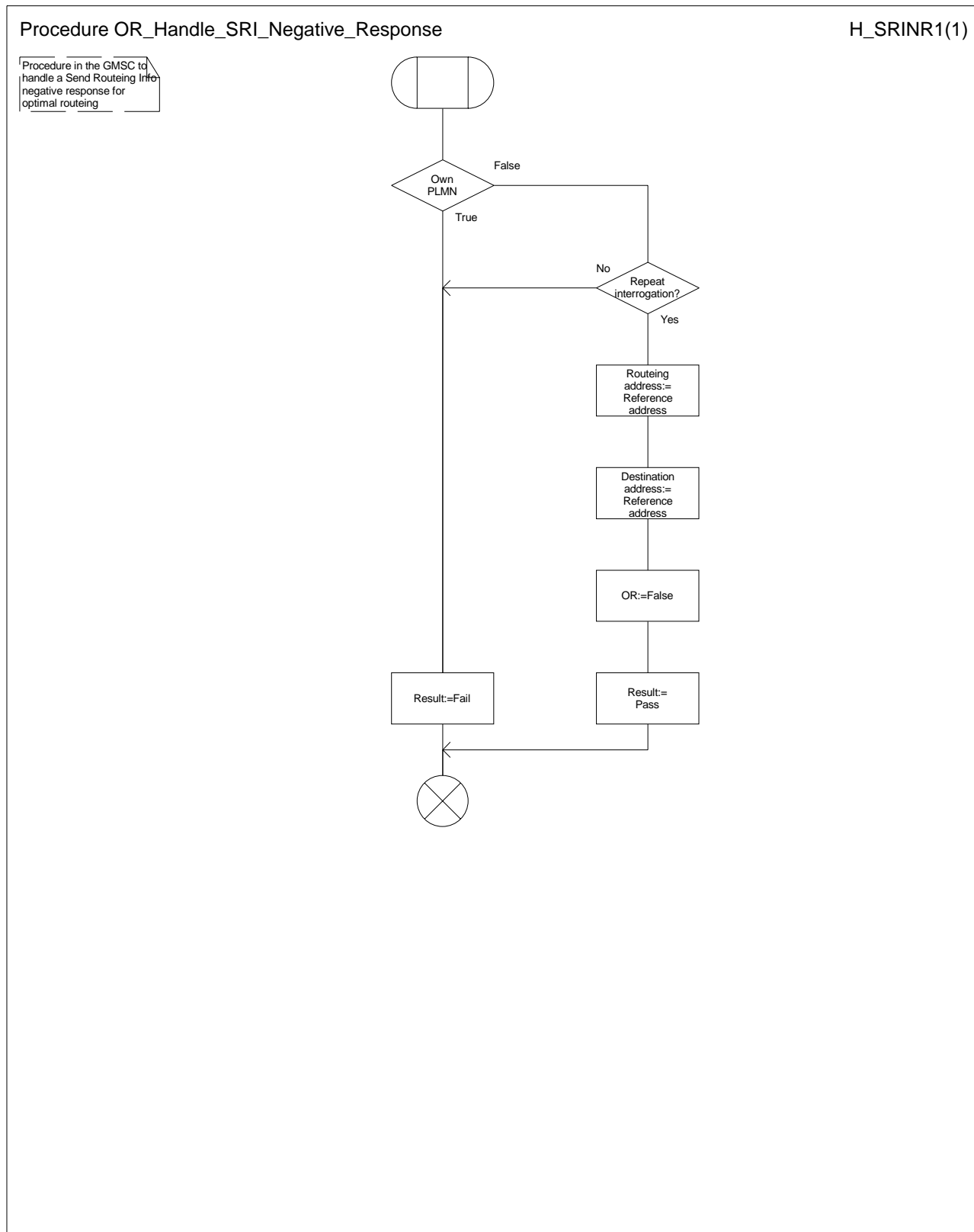

Figure 9: Procedure OR\_Handle\_SRI\_Negative\_Response

## 9.5 Functional behaviour of HLR

The functional behaviour of an HLR is specified in 3GPP TS 23.018 [6]. The procedures specific to Support of Optimal Routing are specified in this subclause.

### 9.5.1 Procedure OR\_HLR\_CF

Sheet 1: if the HLR does not support optimal routing of basic mobile-to-mobile calls, the test "Optimal routing allowed" takes the "No" exit.

Sheet 2: the procedures Handle\_CFB, Handle\_CFNRC and Handle\_CFNRY are specified in 3GPP TS 23.018 [6].

### 9.5.2 Procedure OR\_HLR\_Interrogate\_VLR

If the HLR does not support optimal routing of basic mobile-to-mobile calls, this procedure will be executed only if the Send Routing Info was from a GMSC in the same PLMN as the HLR, i.e. this was not an Optimal Routing enquiry.

The procedure Handle\_CFNRC is specified in 3GPP TS 23.018 [6].

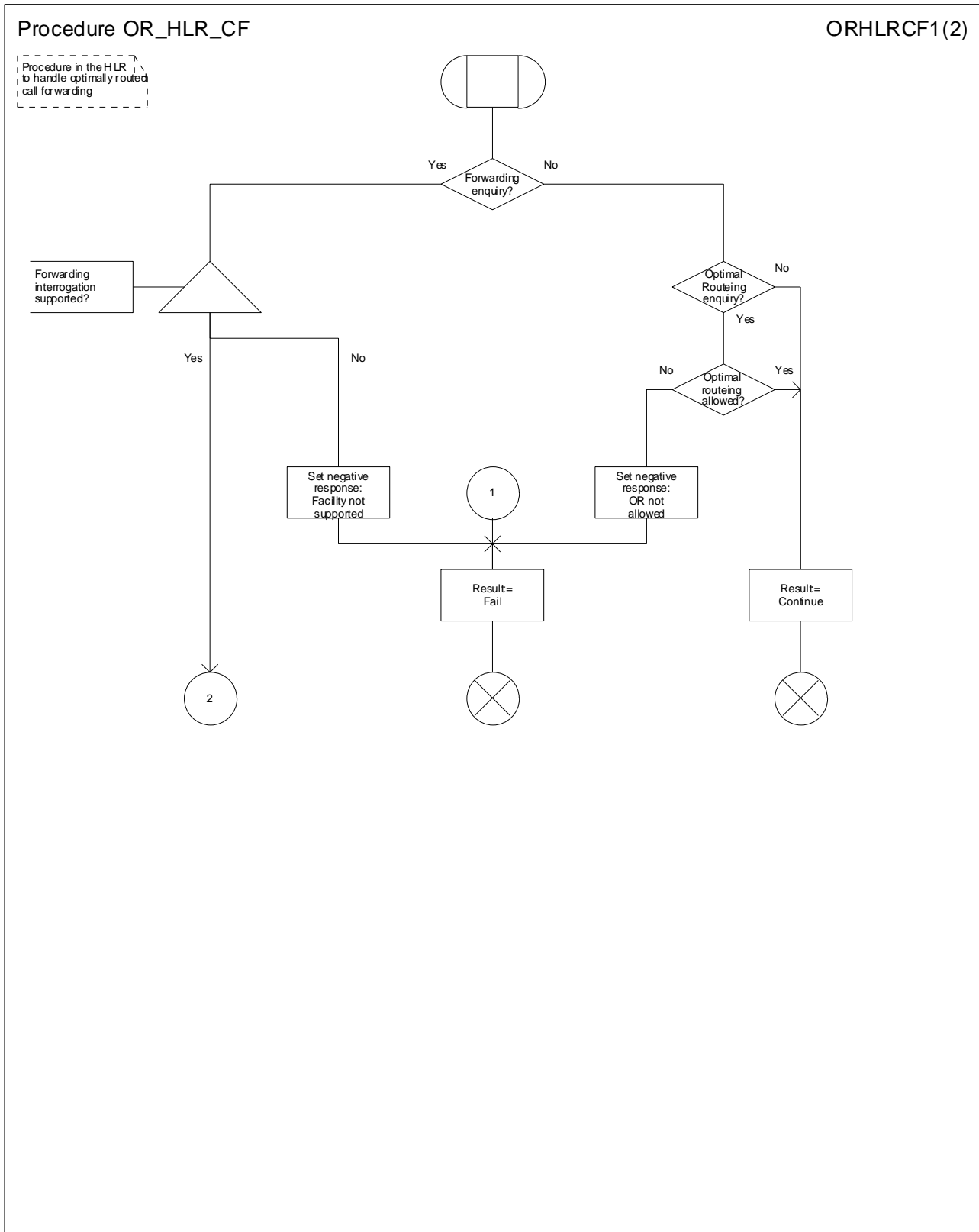

Figure 10a: Procedure OR\_HLR\_CF (sheet 1)



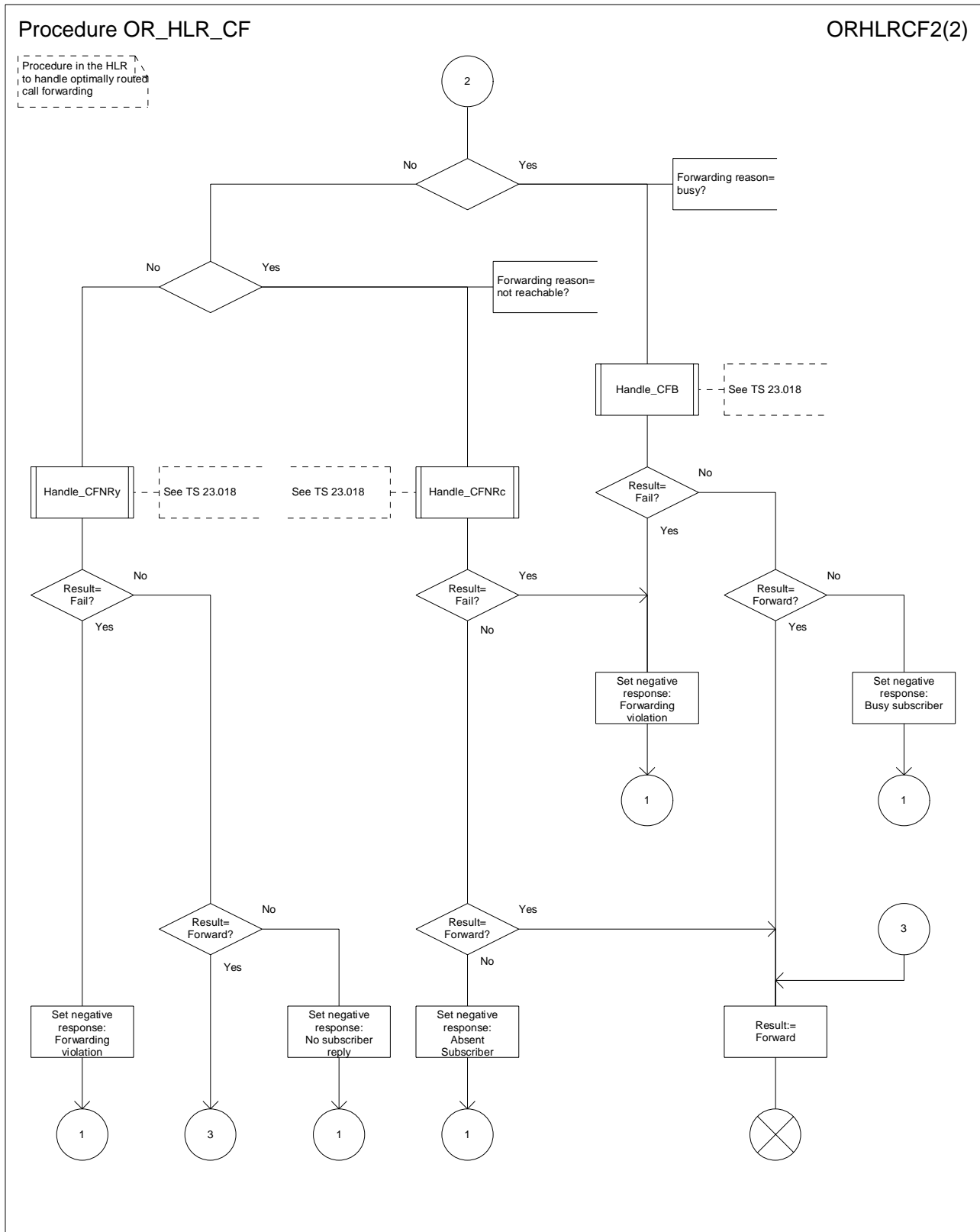

Figure 10b: Procedure OR\_HLR\_CF (sheet 2)

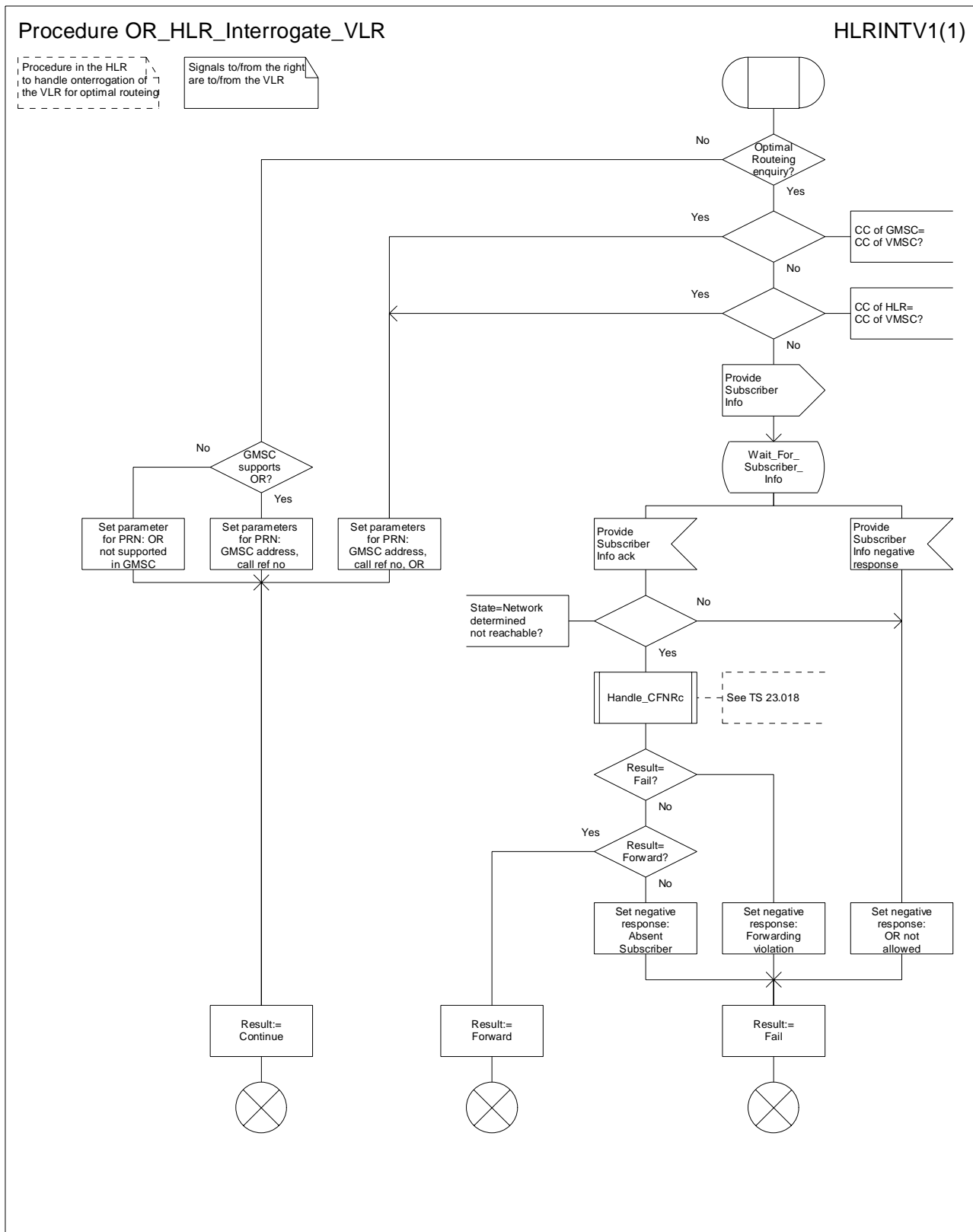

Figure 11: Procedure OR\_HLR\_Interrogate\_VLR

## 9.6 Functional behaviour of VLRB

### 9.6.1 Functional behaviour of VLRB for provision of subscriber information

The functional behaviour of VLRB for provision of subscriber information is specified in 3GPP TS 23.018 [6].

### 9.6.2 Functional behaviour of VLRB for roaming number allocation

The functional behaviour of VLRB for roaming number allocation is specified in 3GPP TS 23.018 [6]. The only function specific to Support of Optimal Routeing is the storage of the OR indicator, the 'OR not supported in GMSC' indicator, the GMSC address and the call reference number if VLRB receives them in the Provide Roaming Number request.

### 9.6.3 Functional behaviour of VLRB when handling an incoming call

The functional behaviour of VLRB when handling a request for information to handle an incoming call is specified in 3GPP TS 23.018 [6]. The only functions specific to Support of Optimal Routeing are:

- the inclusion in the Complete Call or Process Call Waiting, if the call is to be offered to the B subscriber, of the OR indicator and the GMSC address if VLRB received them in the Provide Roaming Number request;
- the inclusion in the Send Info For Incoming Call response, if the call is to be forwarded, of:
  - the OR indicator, the 'OR not supported in GMSC' indicator, the GMSC address and the call reference number if VLRB received them in the Provide Roaming Number request;
  - the basic service which applies for this call.

## 9.7 Functional behaviour of VMSCB

The functional behaviour of VMSCB when it handles an incoming call is described in 3GPP TS 23.018 [6]. The procedure specific to Support of Optimal Routeing is specified in this subclause.

### 9.7.1 Procedure Handle\_ORLCF\_VMSC

The procedure UUS\_ICH\_Handle\_LCF is specific to UUS; it is specified in 3GPP TS 23.087 [9].

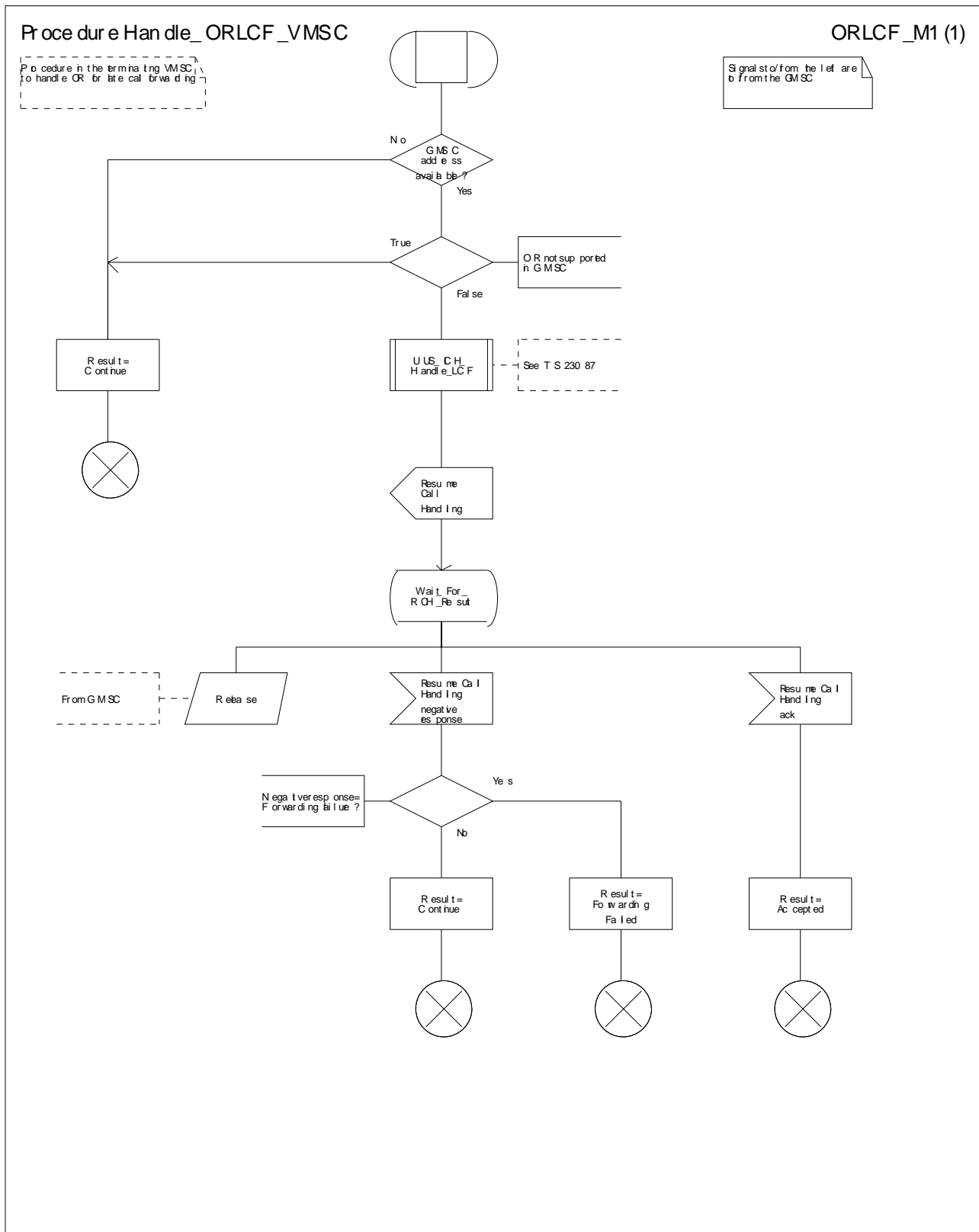

Figure 12: Procedure Handle\_ORLCF\_VMSC

## 10 Contents of messages

This clause specifies the changes to the content of each message shown in clauses 5, 6 and 9, including those messages which are already specified for UMTS but which require changes for Optimal Routeing. It should be read as a 'delta' on the corresponding clause of 3GPP TS 23.018 [6]; those information elements which are the same for SOR as for the basic call without OR are not specified in this clause.

In the tables which follow, information elements are shown as mandatory (M) or conditional (C). A mandatory information element shall always be present. A conditional information element shall be present if certain conditions are fulfilled; if those conditions are not fulfilled it shall be absent.

### 10.1 Messages on the B interface (MSC-VLR)

#### 10.1.1 Send Info For Outgoing Call

This message is specified in 3GPP TS 23.018 [6].

#### 10.1.2 Send Info For Outgoing Call negative response

This message is specified in 3GPP TS 23.018 [6].

#### 10.1.3 Send Info For Incoming Call

This message is specified in 3GPP TS 23.018 [6].

#### 10.1.4 Send Info For Incoming Call ack

**This message is specified in 3GPP TS 23.018 [6]. The following additional information elements are required:**

Information element name	Required	Description
OR indicator	C	Indicates whether the call has been routed directly from a GMSC not in the same PLMN as the HLR. Shall be present if it was received in the Provide Roaming Number, otherwise shall be absent.
GMSC address	C	E.164 address of the GMSC. Shall be present if it was received in the Provide Roaming Number, otherwise shall be absent.
Call reference number	C	Call reference number used by the GMSC for this call. Shall be present if it was received in the Provide Roaming Number, otherwise shall be absent.
OR not supported in GMSC	C	Indicates that the GMSC does not support Optimal Routeing. Shall be present if it was received in the Provide Roaming Number, otherwise shall be absent.

#### 10.1.5 Send Info For Incoming Call negative response

This message is specified in 3GPP TS 23.018 [6].

## 10.1.6 Complete Call

This message is specified in 3GPP TS 23.018 [6]. The following additional information elements are required:

Information element name	Required	Description
OR indicator	C	Indicates whether the call has been routed directly from a GMSC not in the same PLMN as the HLR. Shall be present if it was received in the Provide Roaming Number, otherwise shall be absent.
GMSC address	C	E.164 address of the GMSC. Shall be present if it was received in the Provide Roaming Number, otherwise shall be absent.

## 10.1.7 Process Call Waiting

This message is specified in 3GPP TS 23.018 [6]. The following additional information elements are required:

Information element name	Required	Description
OR indicator	C	Indicates whether the call has been routed directly from a GMSC not in the same PLMN as the HLR. Shall be present if it was received in the Provide Roaming Number, otherwise shall be absent.
GMSC address	C	E.164 address of the GMSC. Shall be present if it was received in the Provide Roaming Number, otherwise shall be absent.

## 10.2 Messages on the C interface (MSC-HLR)

### 10.2.1 Send Routeing Info

This message is specified in 3GPP TS 23.018 [6]. The following additional information elements are required:

Information element name	Required	Description
Interrogation type	M	Indicates the type of interrogation: basic(for routeing information for an MT call) or forwarding (when the GMSC has been asked to resume call handling for OR of late call forwarding).
OR interrogation indicator	C	Indicates that the interrogation is from a GMSC not in the same PLMN as the HLR. Shall be present if the interrogation is from a GMSC not in the same PLMN as the HLR, otherwise shall be absent.
OR capability	C	Indicates the phase of OR which the GMSC supports. Shall be present if the GMSC supports OR, otherwise shall be absent.
GMSC or gsmSCF address	M	E.164 address of the GMSC.
Call reference number	C	Call reference number used by the GMSC for this call. Shall be present if the interrogation type=basic call, otherwise shall be absent.
Forwarding reason	C	Indicates the reason for forwarding (on busy, on no subscriber reply, or on mobile subscriber not reachable). Shall be present if the Interrogation type=forwarding, otherwise shall be absent.
Basic service group	C	Basic service group which applies for this call. Shall be present if the Interrogation type=forwarding, otherwise shall be absent.
Basic service group 2	C	Basic service group which applies for this call. Shall be present if the Interrogation type=forwarding and if the VMSC has determined that the forwarded call is to be treated as a SCUDIF call in accordance with the rules in 3GPP TS 23.172[10], otherwise shall be absent.

## 10.2.2 Send Routeing Info ack

This message is specified in 3GPP TS 23.018 [6]. Two new information elements are required, and the condition for the presence of one existing information element is changed, as shown in the following table.

Information element name	Required	Description
Forwarding interrogation required	C	Indicates that the GMSC shall interrogate the HLR for routeing information for late call forwarding. Shall be present if the SRI ack contains an MSRN and GMSC has to interrogate the HLR for routeing information for late call forwarding, otherwise shall be absent.
VMSC address	C	E.164 address of the VMSC in whose area the B subscriber is currently registered. Shall be present in the Send Routeing Info ack if the OR interrogation indicator in the Send Routeing Info was present and the HLR supports optimal routeing of basic mobile-to-mobile calls and the HLR has not determined that the call is to be forwarded, otherwise shall be absent.
Roaming number	C	E.164 address required to route the call to the VMSC of the B party. Shall be present in the Send Routeing Info ack which is sent in response to a Send Routeing Info with Interrogation type=basic if the HLR has determined that the charging requirements for optimal routeing are not contravened and that the call is not to be forwarded, otherwise shall be absent.

## 10.2.3 Send Routeing Info negative response

This message is specified in 3GPP TS 23.018 [6]. The negative response information element can take the following values in addition to those specified in 3GPP TS 23.018 [6]:

- OR not allowed.
- Busy subscriber.
- No subscriber reply.

## 10.3 Messages on the D interface (VLR-HLR)

### 10.3.1 Provide Roaming Number

This message is specified in 3GPP TS 23.018 [6]. The following additional information elements are required:

Information element name	Required	Description
GMSC address	C	E.164 address of the GMSC. Shall be present if it was received by the HLR in the Send Routeing Info, otherwise shall be absent.
Call reference number	C	Call reference number used by the GMSC for this call. Shall be present if it was received by the HLR in the Send Routeing Info, otherwise shall be absent.
OR interrogation indicator	C	Indicates that the HLR received the corresponding Send Routeing Info from a GMSC not in the same PLMN as the HLR. Shall be present if the HLR received the Send Routeing Info from a GMSC not in the same PLMN as the HLR, otherwise shall be absent.
OR not supported in GMSC	C	Indicates that the GMSC does not support OR, and that RCH shall not be sent. Shall be present if the HLR received the Send Routeing Info from the GMSC without the OR-capability information Element, otherwise shall be absent.

### 10.3.2 Provide Roaming Number ack

This message is specified in 3GPP TS 23.018 [6].

### 10.3.3 Provide Roaming Number negative response

This message is specified in 3GPP TS 23.018 [6].

### 10.3.4 Provide Subscriber Information

This message is specified in 3GPP TS 23.018 [6].

### 10.3.5 Provide Subscriber Information ack

This message is specified in 3GPP TS 23.018 [6].

## 10.4 Messages on the E interface (MSC-MSC)

### 10.4.1 Resume Call Handling

The following information elements are required:

Information element name	Required	Description
Call reference number	M	Call reference number used by the GMSC for this call.
Forwarding reason	M	Indicates the reason for forwarding (on call deflection, on busy, on no subscriber reply, or on mobile subscriber not reachable).
Basic service group	M	Basic service group which applies for this call. For SCUDIF calls, see 3GPP TS 23.172 [10] for the use of this information element.
IMSI	M	IMSI of the B subscriber.
Forwarded-to number	M	E.164 number of the C subscriber.
Notification to calling party	M	Indication of whether the calling party is to be notified that the call has been forwarded.
Forwarded-to subaddress	C	Subaddress of the C subscriber (see 3GPP TS 23.003 [5]). Shall be present if a forwarded-to subaddress is stored in the VLR in association with the forwarded-to number; otherwise shall be absent.
Redirecting presentation	C	Indication of whether the MSISDN of the B subscriber shall be presented to the C subscriber. Shall be present if VMSCB supports the handling of the redirecting number, otherwise shall be absent.
MSISDN	C	E.164 number which identifies the B subscriber. It will be used to create the redirecting number presented to the C subscriber. Shall be present if VMSCB supports the handling of the redirecting number, otherwise shall be absent.
CUG interlock	C	For the definition of this IE, see 3GPP TS 23.085 [8]. Shall be present if the VLR has determined that the forwarded call is to be treated as a CUG call in accordance with the rules in 3GPP TS 23.085 [8], otherwise shall be absent.
CUG outgoing access	C	For the definition of this IE, see 3GPP TS 23.085 [8]. Shall be present if the VLR has determined that the forwarded call is to be treated as a CUG call with outgoing access in accordance with the rules in 3GPP TS 23.085 [8], otherwise shall be absent.
Basic service group 2	C	For the definition of this IE, see 3GPP TS 23.172 [10]. Shall be present if the VMSC has determined that the forwarded call is to be treated as a SCUDIF call in accordance with the rules in 3GPP TS 23.172[10], otherwise shall be absent.

### 10.4.2 Resume Call Handling ack

This message contains no information elements.

### 10.4.3 Resume Call Handling negative response

The negative response information element can take the following values:

- OR not allowed.



- Forwarding failed.

---

## Annex A (informative): Handling of an IAM at an MSC

An MSC which receives an IAM from an originating exchange may react in three different ways:

- It acts as a transit exchange, i.e. it relays the IAM to a destination exchange determined by analysis of the called party address, and thereafter relays other ISUP signalling between the originating and destination exchange until the connection is released. This behaviour is not specific to UMTS or GSM.
- It acts as a terminating exchange, i.e. it attempts to connect the call to an MS currently registered in the service area of the MSC.
- It acts as a GMSC, i.e. it interrogates an HLR for information to route the call. If the HLR returns routing information, the MSC uses the routing information from the HLR to construct an IAM, which it sends to a destination exchange determined by analysis of the routing information from the HLR.

The method which the MSC uses to determine how to handle the IAM is described in 3GPP TS 23.018 [6]. However, the number analysis required to derive the address of an HLR in a different PLMN from the MSC is much more extensive than that required to derive the address of an HLR in the same PLMN as the MSC - the MSC needs to be able to recognise the combination of country code and national destination code for every subscriber of every PLMN to which calls are to be optimally routed. In order to avoid the need to maintain the tables required to support this extensive number analysis, and the run-time processing load of performing the number analysis, optimal routing of mobile-to-mobile calls is handled as a mobile originating CAMEL service; the gsmSCF analyses the destination address (after possible modification of the number by other MO CAMEL services) to determine whether the call is eligible for optimal routing. If the call is eligible for optimal routing, the gsmSCF indicates this to VMSCA, which routes the call to an associated GMSC function, which in turn sends a request for routing information to the appropriate HLR.

When a GMSC has interrogated an HLR and received an MSRN, the GMSC may need to route the call to the HPLMN of the called subscriber. If the call is routed through an MSC which has the capability to analyse an address to derive an HLR address, a method must be provided to prevent the transit MSC from performing a further interrogation of the HLR, using the MSRN as an MSISDN. The method used to prevent this further interrogation is a matter for the PLMN operator.

## Annex B (informative): Change history

Change history						
TSG CN#	Spec	Version	CR	<Phase>	New Version	Subject/Comment
Apr 1999	GSM 03.79	7.0.0				Transferred to 3GPP CN1
CN#03	23.079			R99	3.0.0	Approved at CN#03
CN#04	23.079	3.0.0		R99	3.1.0	Notification of Call Forwarding to the gsmSCF
CN#05	23.079	3.1.0	001	R99	3.2.0	OR capability IE in PRN
	23.079	3.1.0	003	R99	3.2.0	Removal of TDP Criteria from Resume Call Handling
	23.079	3.1.0	005r1	R99	3.2.0	Separation of success & failure cases for OR of late call forwarding
	23.079	3.1.0	006	R99	3.2.0	Notification of Call Forwarding to the gsmSCF before activating call forwarding process
	23.079	3.1.0	007	R99	3.2.0	Handling of Release during forwarding interrogation
CN#06	23.079	3.2.0	008	R99	3.3.0	Introduction of CAMEL Phase 3
CN#07	23.079	3.3.0	009	R99	3.4.0	Correction of CF Notification
	23.079	3.3.0	010r1	R99	3.4.0	Replacement of references to GSM with references to UMTS
	23.079	3.3.0	011	R99	3.4.0	Indication of OR capability of the GMSC to the destination MSC/VLR
CN#08	23.079	3.4.0	014	R99	3.5.0	Indication in PRN of support of Long FTNs
CN#09	23.079	3.5.0	015	R99	3.6.0	Sheet 1 of Procedure OR_HLR_CF
CN#11	23.079	3.6.0		Rel-4	4.0.0	Release 4 after CN#11
CN#15	23.079	4.0.0	016	Rel-5	5.0.0	Introduction of CAMEL Phase 4
CN#16	23.079	5.0.0	019	Rel-5	5.1.0	Removal of unnecessary references to O-CSI
CN#18	23.079	5.1.0	020r1	Rel-5	5.2.0	Optimal routing and CAMEL discrepancy
CN#18	23.079	5.1.0	024	Rel-5	5.2.0	Correction to figure 7a (handling of RCH in GMSC)
CN#21	23.079	5.2.0	025r4	Rel-5	5.3.0	Correction to interaction between ORLCF and forwarding notification
CN#21	23.079	5.2.0	026r1	Rel-5	5.3.0	Notification of the 2nd BSG in case of Late CF with OR

---

## History

<b>Document history</b>		
V5.0.0	March 2002	Publication
V5.1.0	June 2002	Publication
V5.2.0	December 2002	Publication
V5.3.0	September 2003	Publication