

# ETSI TS 123 116 V6.0.0 (2004-12)

---

*Technical Specification*

**Digital cellular telecommunications system (Phase 2+);  
Universal Mobile Telecommunications System (UMTS);  
Super-Charger technical realization;  
Stage 2  
(3GPP TS 23.116 version 6.0.0 Release 6)**

---



---

Reference

RTS/TSGN-0423116v600

---

Keywords

GSM, UMTS

**ETSI**

650 Route des Lucioles  
F-06921 Sophia Antipolis Cedex - FRANCE

Tel.: +33 4 92 94 42 00 Fax: +33 4 93 65 47 16

Siret N° 348 623 562 00017 - NAF 742 C  
Association à but non lucratif enregistrée à la  
Sous-Préfecture de Grasse (06) N° 7803/88

---

**Important notice**

Individual copies of the present document can be downloaded from:

<http://www.etsi.org>

The present document may be made available in more than one electronic version or in print. In any case of existing or perceived difference in contents between such versions, the reference version is the Portable Document Format (PDF). In case of dispute, the reference shall be the printing on ETSI printers of the PDF version kept on a specific network drive within ETSI Secretariat.

Users of the present document should be aware that the document may be subject to revision or change of status. Information on the current status of this and other ETSI documents is available at

<http://portal.etsi.org/tb/status/status.asp>

If you find errors in the present document, please send your comment to one of the following services:

[http://portal.etsi.org/chaicor/ETSI\\_support.asp](http://portal.etsi.org/chaicor/ETSI_support.asp)

---

**Copyright Notification**

No part may be reproduced except as authorized by written permission.  
The copyright and the foregoing restriction extend to reproduction in all media.

© European Telecommunications Standards Institute 2004.  
All rights reserved.

**DECT**<sup>TM</sup>, **PLUGTESTS**<sup>TM</sup> and **UMTS**<sup>TM</sup> are Trade Marks of ETSI registered for the benefit of its Members.  
**TIPHON**<sup>TM</sup> and the **TIPHON logo** are Trade Marks currently being registered by ETSI for the benefit of its Members.  
**3GPP**<sup>TM</sup> is a Trade Mark of ETSI registered for the benefit of its Members and of the 3GPP Organizational Partners.

---

## Intellectual Property Rights

IPRs essential or potentially essential to the present document may have been declared to ETSI. The information pertaining to these essential IPRs, if any, is publicly available for **ETSI members and non-members**, and can be found in ETSI SR 000 314: "*Intellectual Property Rights (IPRs); Essential, or potentially Essential, IPRs notified to ETSI in respect of ETSI standards*", which is available from the ETSI Secretariat. Latest updates are available on the ETSI Web server (<http://webapp.etsi.org/IPR/home.asp>).

Pursuant to the ETSI IPR Policy, no investigation, including IPR searches, has been carried out by ETSI. No guarantee can be given as to the existence of other IPRs not referenced in ETSI SR 000 314 (or the updates on the ETSI Web server) which are, or may be, or may become, essential to the present document.

---

## Foreword

This Technical Specification (TS) has been produced by ETSI 3rd Generation Partnership Project (3GPP).

The present document may refer to technical specifications or reports using their 3GPP identities, UMTS identities or GSM identities. These should be interpreted as being references to the corresponding ETSI deliverables.

The cross reference between GSM, UMTS, 3GPP and ETSI identities can be found under <http://webapp.etsi.org/key/queryform.asp>.

# Contents

Intellectual Property Rights .....	2
Foreword.....	2
Foreword.....	4
1 Scope .....	5
2 References .....	5
3 Definitions and abbreviations.....	5
3.1 Definitions .....	5
3.2 Abbreviations .....	6
4 Information flows .....	6
4.1 Location Updating in a Super-Charged Network .....	6
4.1.1 CS-domain Location Updating in a serving network entity that does not have subscription data .....	6
4.1.2 CS-domain Location Updating in a network entity that has retained subscription data .....	7
4.1.3 PS-domain Location Updating in a network entity that does not have subscription data .....	8
4.1.4 PS-domain Location Updating in a network entity that has retained subscription data .....	9
5 Functional behaviour.....	11
5.1 Subscriber Settings .....	11
5.2 Data Consistency.....	11
5.2.1 Modification of subscription data .....	11
5.2.2 Location Updating .....	11
5.2.2.1 Detailed Procedure in the serving network entity .....	11
5.2.2.2 Detailed Procedure in the HLR .....	13
5.2.3 Cancel Location .....	15
5.2.3.1 Detailed procedures in the serving network entity .....	15
5.2.3.2 Detailed procedures in the HLR.....	15
5.2.4 Purge MS .....	15
5.2.4.1 CS-domain restoration procedures .....	17
5.2.4.2 Mobile Terminating Short Message Service .....	20
5.3 Subscriber Deactivation .....	21
5.4 TMSI Management.....	21
5.5 Database Management .....	21
5.5.1 Utilisation of a larger database .....	21
5.5.2 Periodic Audit.....	21
5.5.3 Dynamic Subscription Data Deletion .....	22
5.6 Enhanced User Identity Confidentiality .....	22
5.7 Exception procedure.....	22
6 Contents of the messages .....	23
6.1 Update Location .....	23
6.2 Update Location ack.....	23
6.3 Update GPRS Location .....	23
6.4 Update GPRS Location ack.....	24
6.5 Insert Subscriber Data .....	24
6.6 Insert Subscriber Data ack.....	24
<b>Annex A (informative): Change History .....</b>	<b>25</b>
History .....	26

---

# Foreword

This Technical Specification (TS) has been produced by the 3<sup>rd</sup> Generation Partnership Project (3GPP).

The contents of the present document are subject to continuing work within the TSG and may change following formal TSG approval. Should the TSG modify the contents of the present document, it will be re-released by the TSG with an identifying change of release date and an increase in version number as follows:

Version x.y.z

where:

- x the first digit:
  - 1 presented to TSG for information;
  - 2 presented to TSG for approval;
  - 3 or greater indicates TSG approved document under change control.
- y the second digit is incremented for all changes of substance, i.e. technical enhancements, corrections, updates, etc.
- z the third digit is incremented when editorial only changes have been incorporated in the document.

---

# 1 Scope

The present document specifies the stage 2 description of the Super-Charger that provides a mechanism to reduce the signalling traffic associated with mobility.

---

# 2 References

The following documents contain provisions which, through reference in this text, constitute provisions of the present document.

- References are either specific (identified by date of publication, edition number, version number, etc.) or non-specific.
- For a specific reference, subsequent revisions do not apply.
- For a non-specific reference, the latest version applies. In the case of a reference to a 3GPP document (including a GSM document), a non-specific reference implicitly refers to the latest version of that document *in the same Release as the present document*.

- [1] 3GPP TS 21.905: "3G Vocabulary".
- [2] 3GPP TR 23.912: "Technical Report on Super-Charger".
- [3] 3GPP TS 23.007: "Restoration Procedures".
- [4] 3GPP TS 23.008: "Organisation of Subscriber Data".
- [5] 3GPP TS 23.012: "Location Management Procedures".
- [6] 3GPP TS 23.016: "Subscriber Data Management: Stage 2".
- [7] 3GPP TS 23.040: "Technical Realisation of the Short Message Service (SMS); Point-To-Point (PP)".
- [8] 3GPP TS 23.060: "General Packet Radio Service; Stage 2".
- [9] 3GPP TS 29.002: "Mobile Application Part (MAP)".

---

# 3 Definitions and abbreviations

## 3.1 Definitions

For the purposes of the present document the following terms and definitions apply.

Procedure Calls to stage 2.

<b>Super-Charged Network:</b>	UMTS network in which the Super-Charger mechanism is being used to optimise mobility management signalling
<b>Network Entity:</b>	either an MSC/VLR, SGSN or UMSC
<b>Serving Network Entity:</b>	network entity to which the mobile station is attached
<b>Previous Network Entity:</b>	network entity to which the mobile station was attached prior to the serving network entity

## 3.2 Abbreviations

Abbreviations used in the present document are listed in GSM 01.04.

---

# 4 Information flows

In a Super-Charged network subscription data is retained by the previous network entity when the subscriber roams to a new network entity.

When a subscriber performs location updating in a Super-Charged network the HLR shall only cancel the subscription information at the previous network entity if it does not support the Super-Charger functionality. If the network entity to which the subscriber has roamed has retained subscription data from a previous visit then the HLR shall only send subscription data to the network entity if the retained subscription data is not consistent with the data stored by the HLR. If the HLR does not send subscription data to the serving network entity it shall treat the retained subscription data as valid.

## 4.1 Location Updating in a Super-Charged Network

### 4.1.1 CS-domain Location Updating in a serving network entity that does not have subscription data

When a Super-Charged network entity receives a request to perform a location update for a subscriber for whom there is no record, the network entity shall initiate the location updating procedures as described in 3GPP TS 23.012.

The Super-Charged HLR shall determine whether the previous network entity supports the Super-Charger functionality:

- if the previous network entity does not support the Super-Charger functionality then the HLR shall respond to the location updating request as described in 3GPP TS 23.012;
- if the previous network entity supports the Super-Charger functionality then the HLR shall respond to the location updating request as described in 3GPP TS 23.012 but shall not cancel the location information at the previous network entity.

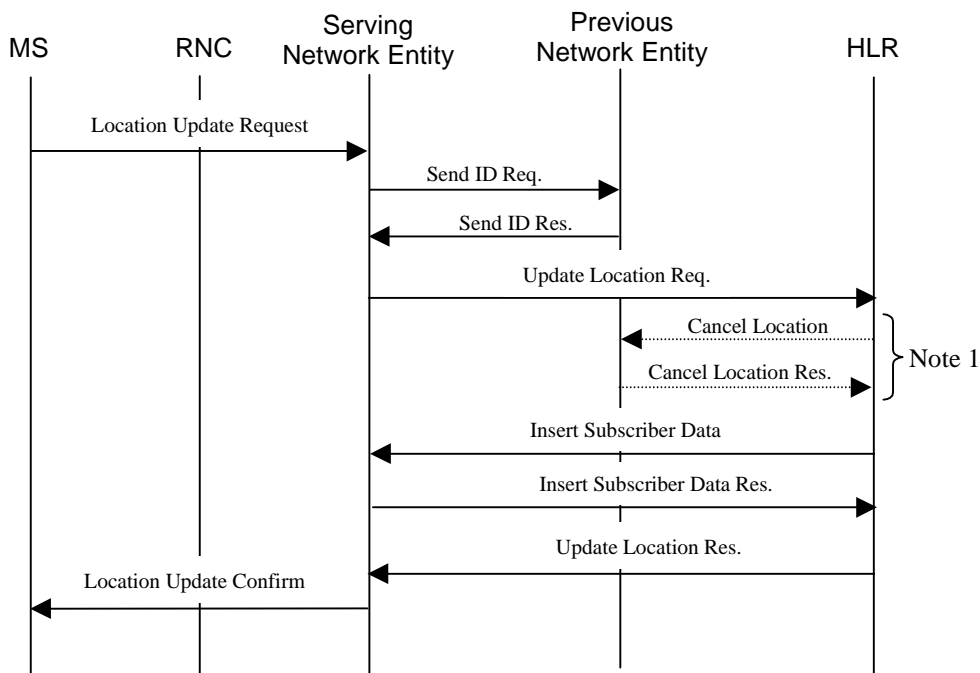

**Figure 1: Information flow for an inter-node location update in a Super-Charged network for the case when the serving network entity does not have subscription data for the requesting mobile station**

Note 1: If the previous network entity supports the Super-Charger features the HLR shall not send the cancel location message to the previous network entity.

#### 4.1.2 CS-domain Location Updating in a network entity that has retained subscription data

When a Super-Charged network entity receives a request to perform a location update for a subscriber for whom subscription data has been retained, the network entity shall initiate the location updating procedures as described in 3GPP TS 23.012.

The Super-Charged HLR shall determine whether the previous network entity supports the Super-Charger functionality:

- if the previous network entity does not support the Super-Charger functionality then the HLR shall cancel the location information at the previous network entity as described in 3GPP TS 23.012.
- if the previous network entity supports the Super-Charger functionality then the HLR shall not cancel the location information at the previous network entity.

The Super-Charged HLR shall determine whether the subscription data retained by the serving network entity is consistent with the subscription data stored in the HLR:

- if the subscription data is consistent then the HLR shall not send subscription data to the serving network entity as part of the location updating;
- if the subscription data is not consistent then the HLR shall respond to the location updating request as described in 3GPP TS 23.012.



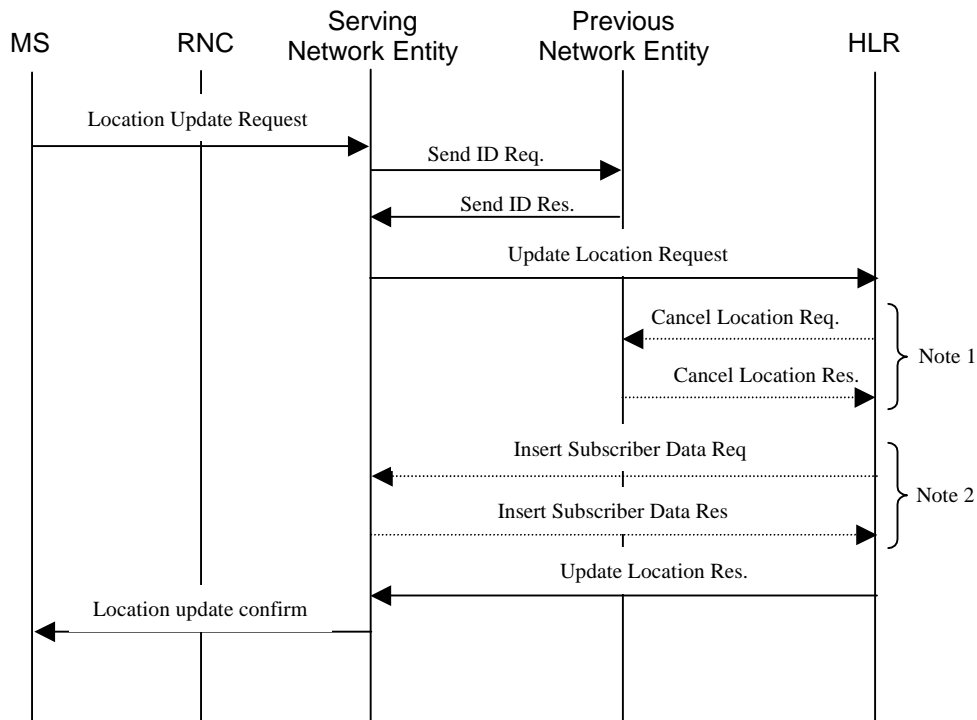

**Figure 2: Information flow for an inter-node location update in a Super-Charged network for the case when the serving network entity has retained subscription data for the requesting mobile station**

Note 1: If the previous network entity supports the Super-Charger features the HLR shall not send the cancel location message to the previous network entity.

Note 2: If the subscription data retained by serving network entity is consistent with the subscription data stored by the HLR, the HLR shall not send subscription data.

### 4.1.3 PS-domain Location Updating in a network entity that does not have subscription data

When a Super-Charged network entity receives a request to perform a routing area update or attach for a subscriber for whom there is no record, the network entity shall initiate the location updating procedures as described in 3GPP TS 23.012.

The Super-Charged HLR shall determine whether the previous network entity supports the Super-Charger functionality:

- if the previous network entity does not support the Super-Charger functionality then the HLR shall respond to the location updating request as described in 3GPP TS 23.012;
- if the previous network entity supports the Super-Charger functionality then the HLR shall respond to the location updating request as described in 3GPP TS 23.012 but shall not cancel the location information at the previous network entity.

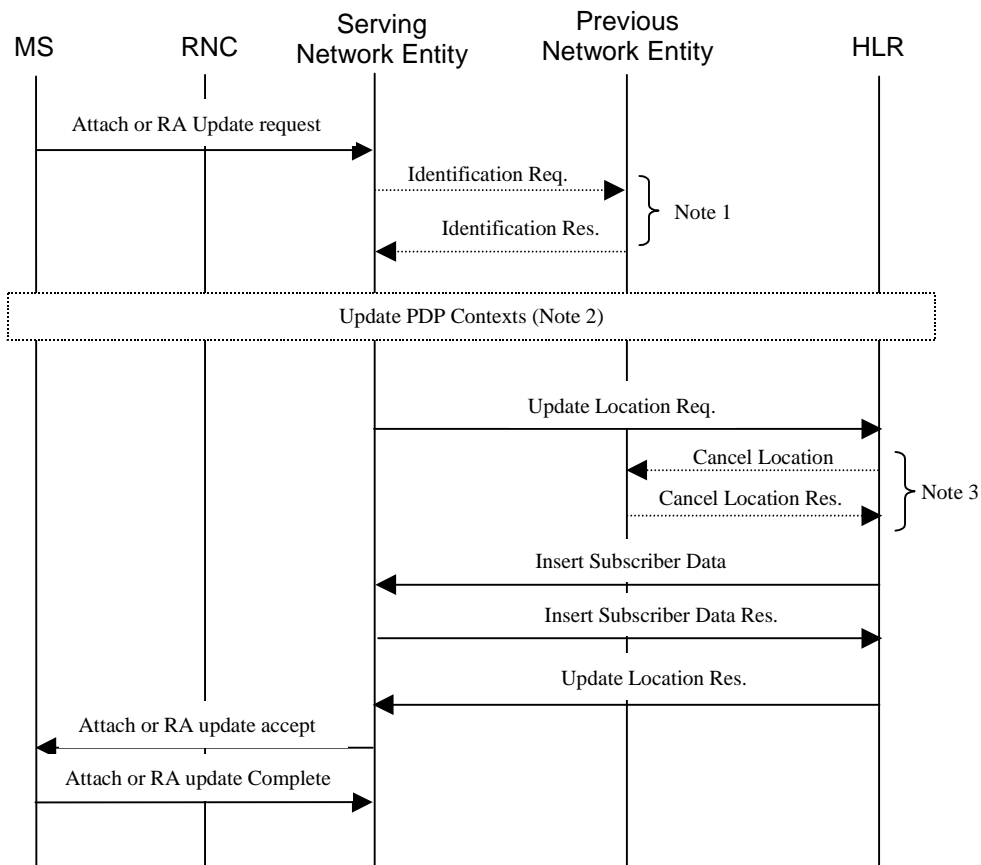

**Figure 3: Information flow for an inter-node routing area update or attach in a Super-Charged network for the case when the serving network entity does not have subscription data for the requesting mobile station**

Note 1: This procedure is optionally performed as part of the Attach procedures, see 3GPP TS 23.060.

Note 2: This procedure is used to update PDP contexts during a routing area update when there is a one or more PDP Contexts established, see 3GPP TS 23.060.

Note 3: If the previous network entity supports the Super-Charger features the HLR shall not send the cancel location message.

#### 4.1.4 PS-domain Location Updating in a network entity that has retained subscription data

When a Super-Charged network entity receives a request to perform a routing area update or attach for a subscriber for whom subscription data has been retained, the network entity shall initiate the location updating procedures as described in 3GPP TS 23.012.

The Super-Charged HLR shall determine whether the previous network entity supports the Super-Charger functionality:

- if the previous network entity does not support the Super-Charger functionality then the HLR shall cancel the location information as described in 3GPP TS 23.012;
- if the previous network entity supports the Super-Charger functionality then the HLR shall not cancel the location information.

The Super-Charged HLR shall determine whether the subscription data retained by the serving network entity is consistent with the subscription data stored in the HLR:

- if the subscription data is consistent then the HLR shall not send subscription data to the serving network entity as part of the location updating procedures;

- if the subscription data is not consistent then the HLR shall respond to the location updating request as described in 3GPP TS 23.012.

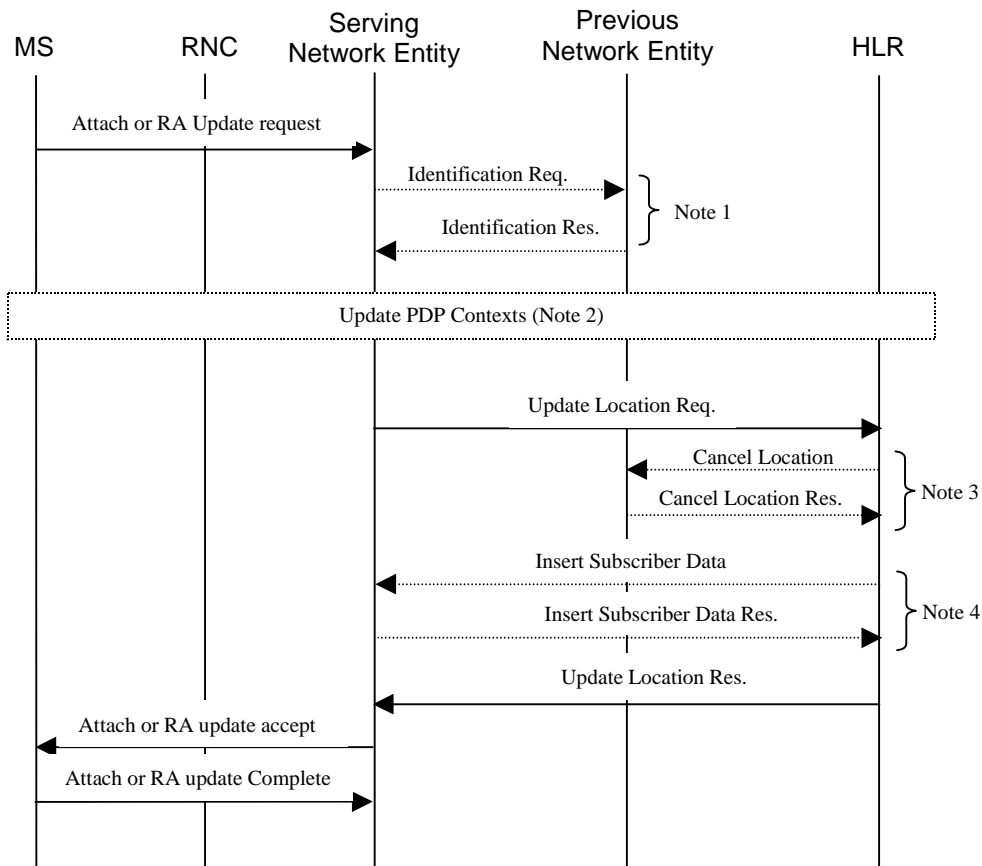

**Figure 4: Information flow for an inter-node routing area update or attach in a Super-Charged network for the case when the serving network entity has retained subscription data for the requesting mobile station**

Note 1: This procedure is optionally performed as part of the Attach procedures, see 3GPP TS 23.060.

Note 2: This procedure is used to update PDP contexts during a routing area update when there is a one or more PDP Contexts established, see 3GPP TS 23.060.

Note 3: If the previous network entity supports the Super-Charger features the HLR shall not send the cancel location message.

Note 4: If the subscription data retained by serving network entity is consistent with the subscription data stored by the HLR, the HLR shall not send subscription data.

---

## 5 Functional behaviour

This clause describes the implementation of Super-Charger feature. This mechanism can reduce the signalling traffic associated with mobility, provided the HLR and serving network entity (i.e. MSC/VLR, SGSN, and UMSC) support the Super-Charger functionality.

### 5.1 Subscriber Settings

The Super-Charger feature requires a mechanism using which the HLR can determine whether the subscription data retained by the serving network entity is valid. In this specification this parameter shall be referred to as the age indicator. The format of the age indicator is implementation specific since it shall be defined and used by the HPLMN. The HLR shall store the age indicator and an indication as to whether the previous network entity supported the Super-Charger functionality on a per subscriber basis.

The serving network entity shall store the age indicator provided by the HLR and an indication as to whether the HLR supports the Super-Charger functionality on a per subscriber basis.

### 5.2 Data Consistency

In a Super-Charged Network, subscription data may be retained by a number of network entities. Each Super-Charged network entity provided with subscription data will retain this information when the subscriber roams to a different network entity.

#### 5.2.1 Modification of subscription data

If the subscription data is changed in the HLR the copy of the data in each of the network entities will become outdated. To ensure data consistency:

- the HLR shall update the age indicator to reflect the change in the subscription data;
- the subscription data in the serving network entity shall be updated as described in 3GPP TS 23.012. The subscription data provided to the serving network entity shall include the new age indicator.

#### 5.2.2 Location Updating

The location updating procedures shall be initiated according to 3GPP TS 23.012.

##### 5.2.2.1 Detailed Procedure in the serving network entity

If the serving network entity has retained subscription data, it shall provide the age indicator as part of the location updating procedure.

If the serving entity has retained subscription data and does not receive subscription data as part of a successful location updating procedure, the serving entity shall treat the retained subscription data as valid and indicate successful completion of the location updating procedure towards the mobile station.

If the serving entity has retained subscription data then subscription data received as part of a successful location updating procedure shall be treated as described in 3GPP TS 23.012.

The procedure `Check_User_Error_In_Serving_Network_Entity` is defined for the case when the serving entity has retained subscription data but receives a negative response to the location update procedure. In this case, the serving entity shall not treat the retained subscription data as valid. If the negative response indicates "Unknown Subscriber" or "Roaming Not Allowed" the serving network entity shall delete the retained subscription data.

Procedure Check\_User\_Error\_In\_Serving\_Network\_Entity

1(1)

Figure 5: Procedure in a Super-Charged serving network entity to determine whether retained subscription data shall be deleted following the receipt of a negative response to the location updating procedure.

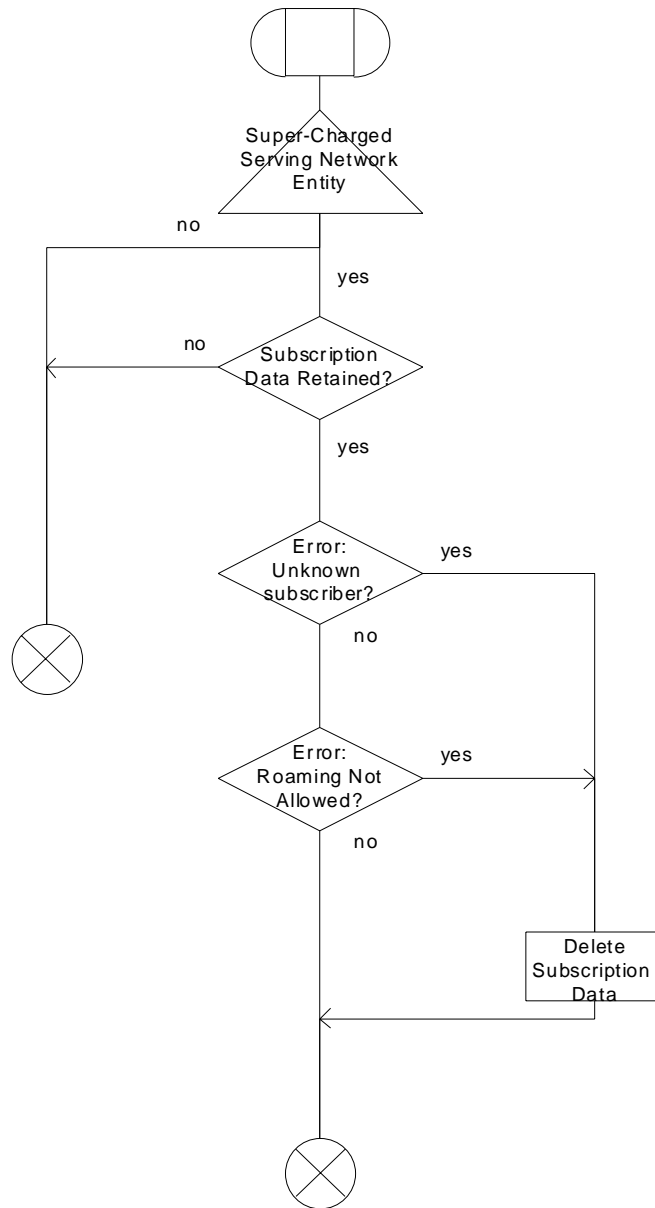

Figure 5: Procedure Check\_User\_Error\_In\_Serving\_Network\_Entity

### 5.2.2.2 Detailed Procedure in the HLR

The procedure `Super_Charged_Location_Updating_HLR` determines when a Super-Charged HLR shall send subscription data to the requesting network entity.

If the serving network entity indicates support for Super-Charger and includes the age indicator, the HLR shall use the age indicator to determine whether the subscription data retained by the serving network entity is valid i.e. the same as the subscription data stored in the HLR:

- If the subscription data retained by serving network entity is invalid, then the HLR shall send subscriber data to the requesting entity including an indication of support for the Super-Charger functionality and the age indicator.
- If the subscription data retained by the serving network entity is valid, then the HLR shall not send subscription data to the requesting entity.

If the serving network entity indicates support for Super-Charger but includes a request for subscription data, the HLR shall send subscriber data to the requesting entity including an indication of support for the Super-Charger functionality and the age indicator.

If the serving network entity does not indicate support for Super-Charger the HLR shall send subscriber data to the requesting entity.

Procedure Super\_Charged\_Location\_Updating\_HLR

1(1)

Figure 6: The procedure Super\_Charged\_Location\_Updating\_HLR determines when a Super-Charged HLR shall send subscription data to the requesting network entity.

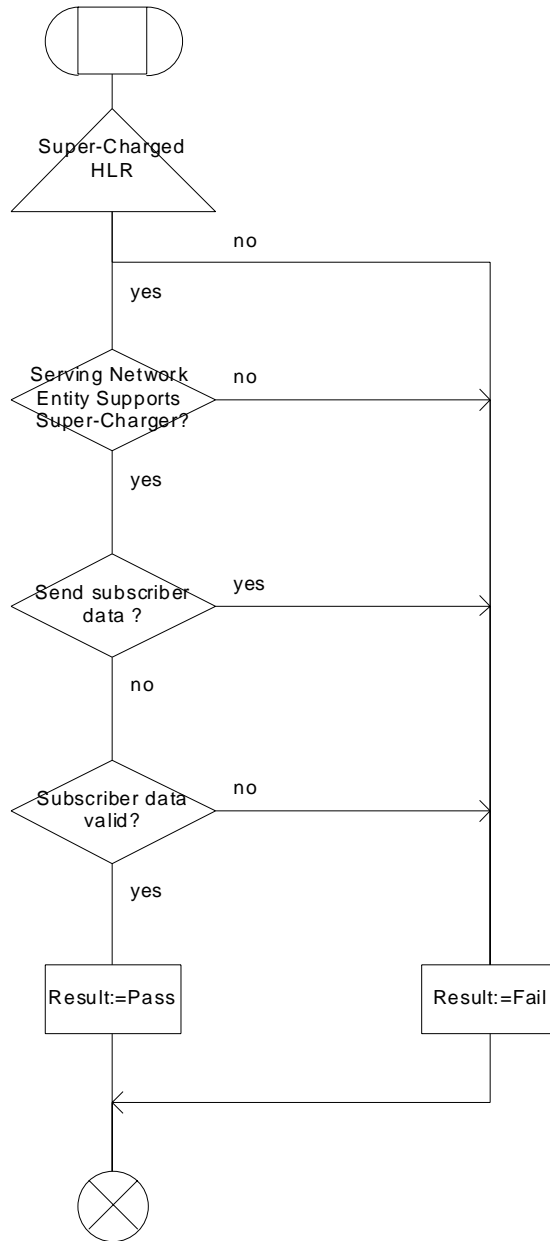

Figure 6: Procedure Super\_Charger\_Location\_Updating\_HLR

### 5.2.3 Cancel Location

The cancel location procedures are normally not used within and between Super-Charged networks as part of the location update procedure, as described 3GPP TS 23.012. However, Super-Charged networks shall support the cancel location procedure to provide interworking for location update procedures with GSM & UMTS networks that do not support the Super-Charger functionality. The cancel location procedure shall also be used within a Super-Charged network as a notification when there is a need to inform the previous network entity that the connections for the subscriber can be released, due to the fact that the MS has moved to another network entity. Subscription data may still be kept in the previous network entities that support Super-Charger.

The mechanisms used to determine which network entities the cancel location message shall be sent to are outside the scope of this specification. However, it is recommended that the HLR store an indication if the serving network entity supports the Super-Charger functionality. It is also recommended that an HLR supporting the Super-Charger functionality have mechanisms to decide when a notification as described above needs to be sent against previous network entity or not. Without such mechanisms, Cancel Location shall always be sent. The mechanisms are triggered by the indication received from serving network entity during location update procedure saying that previous network entity must be notified. These mechanisms are triggered when there is a risk data inconsistency between nodes in the network, and are detailed in 3GPP TS 23.912.

#### 5.2.3.1 Detailed procedures in the serving network entity

A Super-Charged serving network entity shall be capable of receiving a cancel location message as described in 3GPP TS 23.012.

#### 5.2.3.2 Detailed procedures in the HLR

The procedure `Super_Charged_Cancel_Location_HLR` determines to whether a Super-Charged HLR shall send the cancel location message to the previous network entity during location updating as described in 3GPP TS 23.012.

If the previous network entity does support the Super-Charger functionality, the HLR shall not send the cancel location message during location updating except in the conditions described in section 5.2.3.. This is indicated by the "Result:= Pass" exit in figure 7.

### 5.2.4 Purge MS

In a Super-Charged network, the subscriber record for an MS may be deleted by database management procedure to free up capacity in the network entity to accept new subscribers as described in subclause 5.5.

The procedure `Purge_MS_in_Serving_Network_Entity` determines whether a Super-Charged Serving Network Entity shall send the purge MS message to the HLR when deleting inactive subscription data.

If the HLR does not support the Super-Charger functionality, the deletion of inactive subscription data shall initiate the purge MS procedure as described in 3GPP TS 23.012. This is indicated by the "Result:= Fail" exit in Figure 8.

For the CS-domain, the restoration procedures for Super-Charged network entities shall be modified to minimize the number of unnecessary mobile terminated call and short message attempts.

For the PS-domain, any attempt to establish a network-requested PDP context to a network entity that has no record for the subscriber shall proceed as described in 3GPP TS 23.060.

In addition, the Mobile Terminating Short Message Service is modified to minimize the number of unnecessary mobile terminated calls and short message attempts.



Procedure Purge\_MS\_In\_Serving\_Network\_Entity

1(1)

Figure 8: The procedure Purge\_MS\_in\_Serving\_Network\_Entity determines whether a Super-Charged Serving Network Entity shall send the purge MS message to the HLR when deleting inactive subscription data.

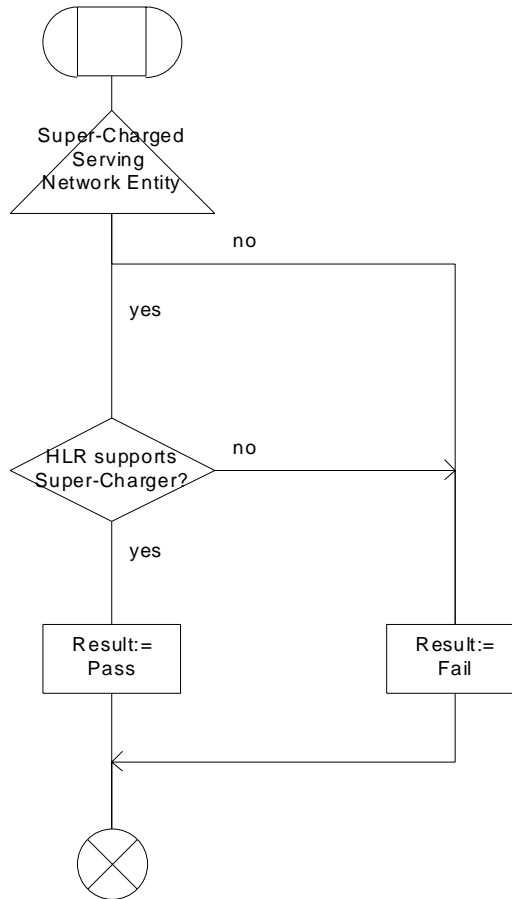

Figure 8: Procedure Purge\_MS\_In\_Serving\_Network\_Entity

### 5.2.4.1 CS-domain restoration procedures

Upon receipt of a request for a roaming number, if there is no subscriber data record in the recipient network entity the network entity shall distinguish two cases:

- the subscriber data record was lost due to network entity restart;
- the subscriber data record was removed by the Super-Charger database management function described in subclause 5.5.

If the subscriber data record was lost due to a network entity restart the restoration procedure as described in 3GPP TS 29.002 shall be initiated.

The procedure `Check_Reason_In_Serving_Network_Entity` determines whether the subscriber data was removed by the Super-Charger database management function and whether the network entity shall return the Purged MS diagnostic information to the HLR.

The procedure `Super_Charged_SRI_Error_HLR` determines whether the HLR shall mark its data for the MS as purged and maps the Purged\_MS diagnostic information to indicate that the IMSI is detached, in the send routing information response. Consequently any request for routing information for a mobile terminated call or a mobile terminated short message shall be treated as if the MS is not reachable.

The means by which the network entity distinguishes the two cases is implementation dependent and therefore outside the scope of this specification.

Procedure Check\_Reason\_In\_Serving\_Network\_Entity

1(1)

Figure 9: The procedure Check\_Reason\_In\_Serving\_Network\_Entity determines whether the subscriber data was removed by the Super-Charger database management function and sets the Purged MS diagnostic information, if required.

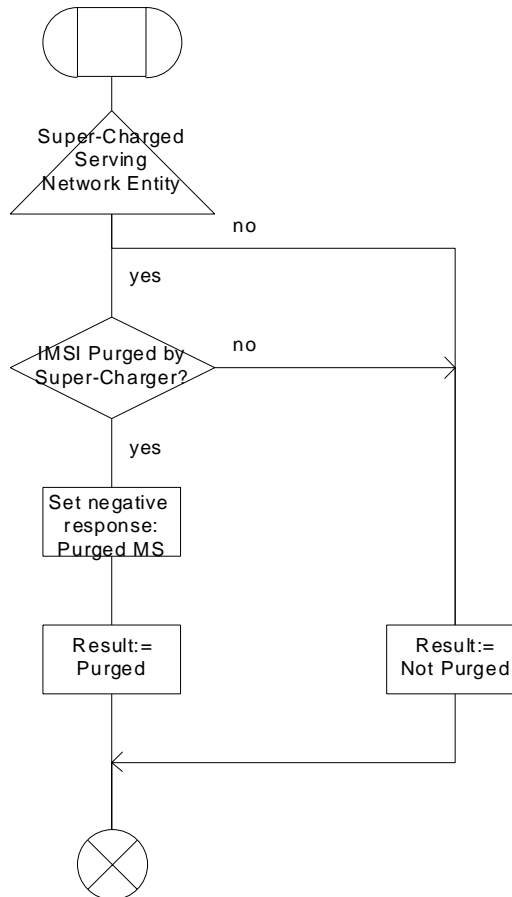

Figure 9: Procedure Check\_Reason\_In\_Serving\_Network\_Entity

Procedure Super\_Charged\_SRI\_Error\_HLR

1(1)

Figure 10: The procedure Super\_Charged\_SRI\_Error\_HLR determines whether the HLR shall mark its data for the MS as purged and maps the Purged\_MS diagnostic information to indicate that the IMSI is detached, in the send routing information response.

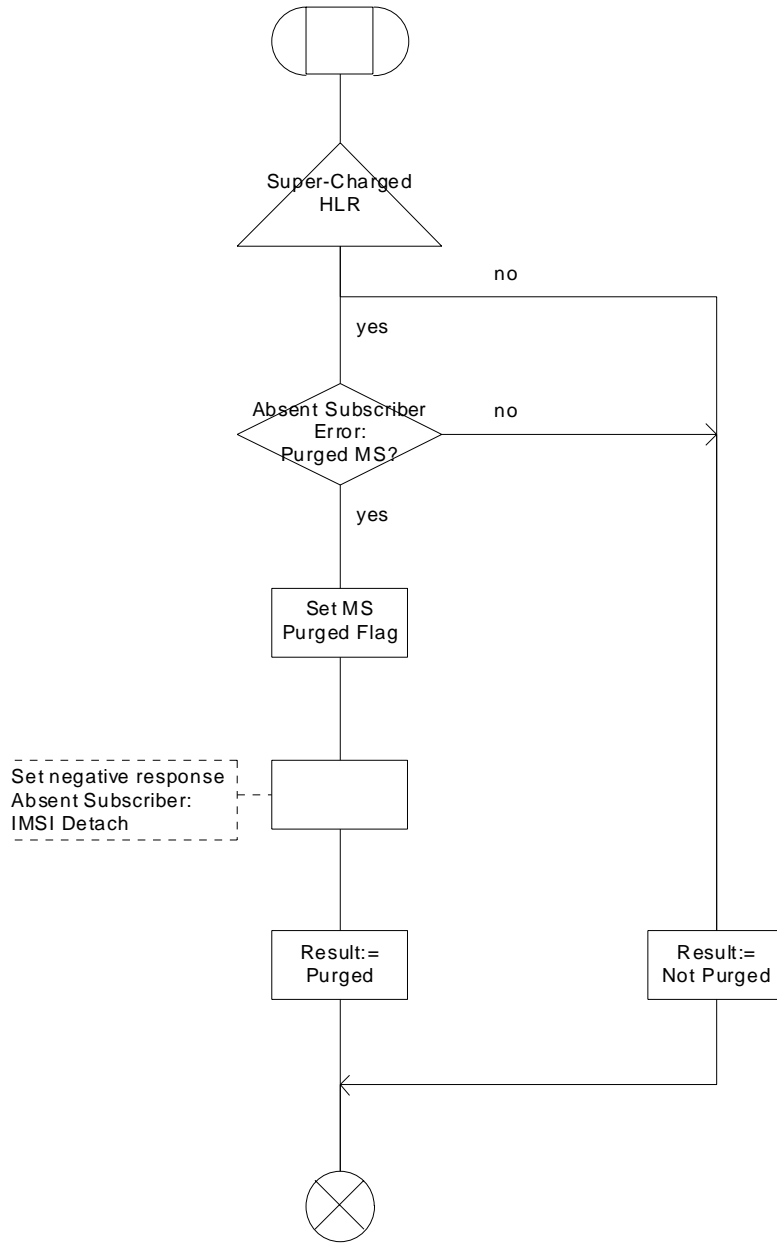

Figure 10: Procedure Super\_Charged\_SRI\_Error\_HLR

### 5.2.4.2 Mobile Terminating Short Message Service

The procedure Check\_Absent\_SubscriberSM\_In\_HLR determines whether the HLR shall mark its data for the MS as purged based on the content of the absent subscriber SM diagnostic information (See 3GPP TS 23.040), if received from the SMS-GMSC, following a Mobile Terminating Short Message delivery attempt.

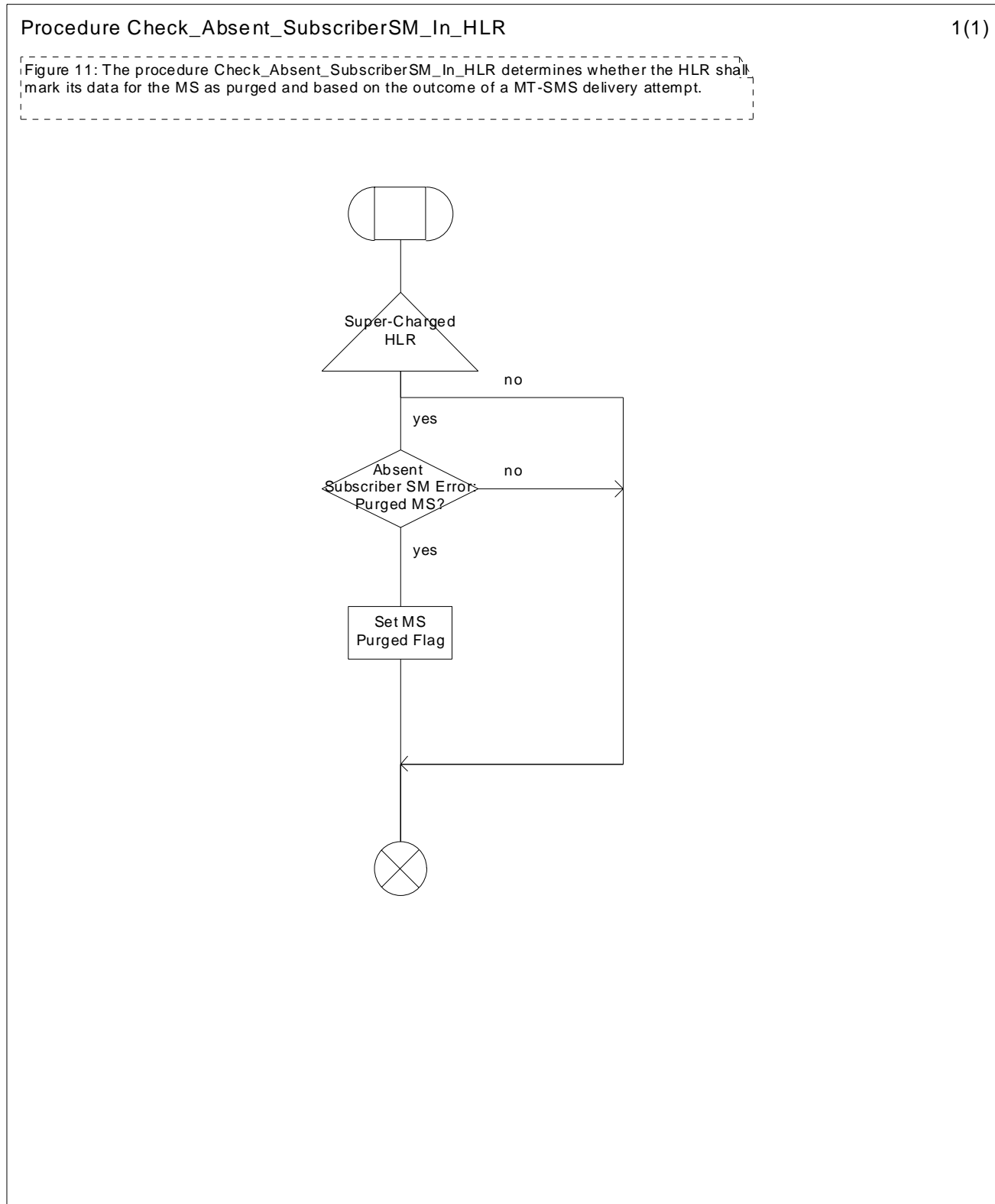

Figure 11: Procedure Check\_Absent\_SubscriberSM\_In\_HLR

## 5.3 Subscriber Deactivation

When a subscriber is deactivated, the cancel location message is sent to the serving network entity and the subscription data shall be deleted in the HLR.

Subsequently, when the subscriber attempts to register in a network entity that has data for the subscriber, the HLR will return an error of "Unknown Subscriber" and the subscription data in the network entity shall be deleted as described in subclause 5.2.2.1.

## 5.4 TMSI Management

In a Super-Charged network, if the cancel location or purge MS procedures are not performed the TMSI and P-TMSI values shall be de-allocated by another mechanism to avoid double allocation of temporary identifiers.

If the send identification procedure as described in 3GPP TS 29.002 is used, the previous network entity may use this to explicitly de-allocate the temporary identifier assigned to that subscriber.

In the event that the send identification procedure is not performed or not used as an explicit de-allocation trigger, it is recommended that an alternative mechanism is available to de-allocate temporary identifiers. The chosen mechanism is an implementation detail. De-allocation of TMSI and P-TMSI values may be achieved by a system of supervision timers or as part of the database management function, see subclause 5.5. However, other mechanisms may be used to avoid double allocation.

## 5.5 Database Management

In a Super-Charged network subscription data shall not be deleted in the previous network entity. The subscription data shall be retained using spare capacity available in the network entity. This results in a continuous growth of the database size. If not managed properly, the network entity will eventually become full and unable to handle newly arrived MSs. A strategy to manage the capacity of Super-Charged network entities is required.

The database management scheme shall be an implementation option and so outside the scope of this specification. Example mechanisms are:

- Utilisation of a larger database.
- Periodic audit scheme.
- Implementation of a strategy to make room for new users by removing old subscriber information from the associated database.

### 5.5.1 Utilisation of a larger database

The implementation of larger databases may be used to limit the need for other mechanisms to ensure that sufficient database capacity is available to service new subscribers. However, the need for an alternative mechanism such as Periodic Audits and Dynamic Subscription Data Deletion is not removed.

Implementing larger databases such that subscription data is retained for an increased number of subscribers can increase the benefit from a Super-Charged network. However, the optimal database capacity will be network specific.

The implementation of a larger database is not a requirement for this feature.

### 5.5.2 Periodic Audit

This scheme periodically removes inactive subscription data from the VLR and SGSN databases. The volume of subscription data deleted should be based on an estimation of the growth of the database size during the audit cycle.

The criterion for removal of the subscriber is outside the scope of this specification. Circuit Switched and Packet Service activity of the subscriber should be checked before any deletion.

### 5.5.3 Dynamic Subscription Data Deletion

This scheme allows the run-time removal of subscription if the associated database is full. In this case, the oldest subscription data is deleted to make room for the newly arrived subscriber. This mechanism may be used in conjunction with the other scheme detailed above or as the only method by which to create available capacity within a database.

The criterion for removal of the subscriber is outside the scope of this specification. Circuit Switched and Packet Service activity of the subscriber should be checked before any deletion.

## 5.6 Enhanced User Identity Confidentiality

If an MS configured to support Enhanced User Identity Confidentiality updates location at a serving network entity which has retained subscriber data from a previous visit, the normal procedure of Enhanced User Identity Confidentiality as defined in 3GPP TS 23.018 shall apply.

The serving network entity shall replace the TEMSI stored in the subscriber data by the TEMSI received from the UIDN as a result of the Send IMSI operation.

## 5.7 Exception procedure

A Super-Charged network entity shall inform the HLR about the support of the Super-Charger functionality whenever a subscriber roams on to that network entity. This information shall be included in the update location message sent to the HLR. The HLR shall use this information to determine the most appropriate action.

If the HLR does not support the Super-Charger functionality the HLR shall ignore this information and proceed according to 3GPP TS 29.002.

If the serving network entity does not support the Super-Charger functionality the serving network entity shall ignore information relating to the Super-Charger feature and proceed according to 3GPP TS 29.002.

## 6 Contents of the messages

This clause contains detailed description of the messages shown in Section 5 of the specification.

### 6.1 Update Location

The contents of this message are specified in 3GPP TS 29.002. In the case when the originating entity supports the Super-Charger functionality, the following Super-Charger specific information is defined:

Information element name	Required	Description
Super-Charger Supported In Serving Network Entity	C	When included, this parameter indicates that the originating entity supports the Super-Charger functionality. In addition, this parameter shall indicate either that subscription data is required or the date and time of the last known subscriber data modification.
Inform Previous Network Entity	C	When included, this parameter indicates that the previous network entity needs to be informed about the update location. The parameter shall be included only if Send Identification has not been sent to the previous network entity.

### 6.2 Update Location ack

The contents of this message are specified in 3GPP TS 29.002.

### 6.3 Update GPRS Location

The contents of this message are specified in 3GPP TS 29.002. In the case when the originating entity supports the Super-Charger functionality, the following Super-Charger specific information is defined:

Information element name	Required	Description
Super-Charger Supported In Serving Network Entity	C	When included, this parameter indicates that the originating entity supports the Super-Charger functionality. In addition, this parameter shall indicate either that subscription data is required or the date and time of the last known subscriber data modification.
Inform Previous Network Entity	C	When included, this parameter indicates that the previous network entity needs to be informed about the update location. The parameter shall be included only if SGSN Context Request has not been sent to the previous network entity.



## 6.4 Update GPRS Location ack

The contents of this message are specified in 3GPP TS 29.002.

## 6.5 Insert Subscriber Data

The contents of this message are specified in 3GPP TS 29.002. In the case when the originating entity supports the Super-Charger functionality, the following Super-Charger specific information is defined:

Information element name	Required	Description
Super-Charger Supported In HLR	C	When included, this parameter indicates that the originating entity supports the Super-Charger functionality. In addition, this parameter is used by the HLR to indicate the age of the subscription data stored in the HLR.

## 6.6 Insert Subscriber Data ack

The contents of this message are specified in 3GPP TS 29.002.

---

## Annex A (informative): Change History

Change history							
Date	TSG #	TSG Doc.	CR	Rev	Subject/Comment	Old	New
Mar 2000	CN#07				Approved by TSG CN#07		3.0.0
Mar 2001	CN#11				Release 4 after CN#11	3.0.0	4.0.0
Jun 2001	CN#12	NP-010299	002	3	Essential drawbacks on services due to introduction of Super-Charger function	4.0.0	4.1.0
Dec. 2001	CN#14	NP-010617	004	1	Clarification of methodology for maintaining data consistency in Supercharger	4.1.0	4.2.0
Jun 2002	CN#16				Release 5 after CN#16	4.2.0	5.0.0
Dec 2004	CN#26				Release 6 after CN#26	5.0.0	6.0.0

---

## History

<b>Document history</b>		
V6.0.0	December 2004	Publication