

ETSI TS 123 167 V7.5.0 (2007-06)

Technical Specification

**Universal Mobile Telecommunications System (UMTS);
IP Multimedia Subsystem (IMS)
emergency sessions
(3GPP TS 23.167 version 7.5.0 Release 7)**



Reference

RTS/TSGS-0223167v750

Keywords

UMTS

ETSI

650 Route des Lucioles
F-06921 Sophia Antipolis Cedex - FRANCE

Tel.: +33 4 92 94 42 00 Fax: +33 4 93 65 47 16

Siret N° 348 623 562 00017 - NAF 742 C
Association à but non lucratif enregistrée à la
Sous-Préfecture de Grasse (06) N° 7803/88

Important notice

Individual copies of the present document can be downloaded from:

<http://www.etsi.org>

The present document may be made available in more than one electronic version or in print. In any case of existing or perceived difference in contents between such versions, the reference version is the Portable Document Format (PDF). In case of dispute, the reference shall be the printing on ETSI printers of the PDF version kept on a specific network drive within ETSI Secretariat.

Users of the present document should be aware that the document may be subject to revision or change of status. Information on the current status of this and other ETSI documents is available at

<http://portal.etsi.org/tb/status/status.asp>

If you find errors in the present document, please send your comment to one of the following services:

http://portal.etsi.org/chaicor/ETSI_support.asp

Copyright Notification

No part may be reproduced except as authorized by written permission.
The copyright and the foregoing restriction extend to reproduction in all media.

© European Telecommunications Standards Institute 2007.
All rights reserved.

DECTTM, **PLUGTESTS**TM and **UMTS**TM are Trade Marks of ETSI registered for the benefit of its Members.
TIPHONTM and the **TIPHON logo** are Trade Marks currently being registered by ETSI for the benefit of its Members.
3GPPTM is a Trade Mark of ETSI registered for the benefit of its Members and of the 3GPP Organizational Partners.

Intellectual Property Rights

IPRs essential or potentially essential to the present document may have been declared to ETSI. The information pertaining to these essential IPRs, if any, is publicly available for **ETSI members and non-members**, and can be found in ETSI SR 000 314: "*Intellectual Property Rights (IPRs); Essential, or potentially Essential, IPRs notified to ETSI in respect of ETSI standards*", which is available from the ETSI Secretariat. Latest updates are available on the ETSI Web server (<http://webapp.etsi.org/IPR/home.asp>).

Pursuant to the ETSI IPR Policy, no investigation, including IPR searches, has been carried out by ETSI. No guarantee can be given as to the existence of other IPRs not referenced in ETSI SR 000 314 (or the updates on the ETSI Web server) which are, or may be, or may become, essential to the present document.

Foreword

This Technical Specification (TS) has been produced by ETSI 3rd Generation Partnership Project (3GPP).

The present document may refer to technical specifications or reports using their 3GPP identities, UMTS identities or GSM identities. These should be interpreted as being references to the corresponding ETSI deliverables.

The cross reference between GSM, UMTS, 3GPP and ETSI identities can be found under <http://webapp.etsi.org/key/queryform.asp>.

Contents

Intellectual Property Rights	2
Foreword.....	2
Foreword.....	5
1 Scope	6
2 References	6
3 Definitions, symbols and abbreviations	7
3.1 Definitions	7
3.2 Abbreviations	8
4 High level Principles	8
4.1 Architectural Principles	8
4.2 Naming and Addressing	10
4.3 Location information for Emergency Sessions.....	10
4.3.1 General Location Information Principles.....	10
4.3.2 Void	11
4.4 IP-CAN	11
5 Architecture model and reference points.....	11
5.1 Reference architecture	11
5.2 Reference points	12
6 Functional description	12
6.1 UE	12
6.2 IMS Functional entities	13
6.2.1 Proxy-CSCF.....	13
6.2.2 Emergency-CSCF	14
6.2.3 Location Retrieval Function	14
7 Procedures related to establishment of IMS emergency session.....	15
7.1 High Level Procedures for IMS Emergency Services	15
7.1.1 UE Detectable Emergency Session.....	15
7.1.2 Non UE detectable Emergency Session.....	16
7.1.3 Emergency Session Establishment using LRF/RDF.....	17
7.2 IMS Registration for Emergency Session	17
7.3 Emergency Session Establishment in the Serving IMS network.....	18
7.4 IMS Emergency Session Establishment without Registration	19
7.5 Interworking with PSAP	19
7.5.1 PSAP/Emergency centre located at the GSTN	19
7.5.2 PSAP/Emergency centre connected via IP using SIP	19
7.5.3 PSAP/Emergency centre connected via ECS.....	20
7.6 Retrieving Location information for Emergency Session	20
7.6.1 Acquiring location information from the UE or the network.....	20
7.6.2 Void	22
7.6.3 Void	22
Annex A (informative): IMS emergency services using GPRS Network.....	23
A.1 Requirements on the GPRS network as an IP-CAN.....	23
A.2 UE specific behaviour for emergency calls over the GPRS	23
A.3 GPRS specific aspects of High Level Procedures for IMS emergency calls.....	23
A.4 Location handling for GPRS	24
A.5 Open Issues on GPRS specific aspects.....	24
A.6 Selection of method for UICC-less emergency calls.....	27
A.6.1 GPRS considerations for IMS Emergency sessions.....	27
A.6.2 Emergency Calls in absence of UICC for GPRS Access.....	27
Annex B (informative): IMS emergency sessions over 3GPP/WLAN Interworking (I-WLAN)	29

B.1	Void.....	29
B.2	Void.....	29
B.3	Location handling for I-WLAN	29
Annex C (normative):	IMS emergency services using Fixed Broadband Access.....	30
C.1	Location Retrieval for emergency services over fixed broadband access	30
C.1.1	High Level Principles for Emergency location information for fixed broadband access	30
C.1.2	Retrieval of location information for emergency services over fixed broadband access	31
Annex D (informative):	Examples of call flows according to NENA I2 recommendations	32
D.1	ECS redirecting IMS emergency call.....	32
D.2	ECS routes the emergency call to the gateway with record route	34
Annex E (informative):	Change history	36
History		37

Foreword

This Technical Specification has been produced by the 3rd Generation Partnership Project (3GPP).

The contents of the present document are subject to continuing work within the TSG and may change following formal TSG approval. Should the TSG modify the contents of the present document, it will be re-released by the TSG with an identifying change of release date and an increase in version number as follows:

Version x.y.z

where:

- x the first digit:
 - 1 presented to TSG for information;
 - 2 presented to TSG for approval;
 - 3 or greater indicates TSG approved document under change control.
- y the second digit is incremented for all changes of substance, i.e. technical enhancements, corrections, updates, etc.
- z the third digit is incremented when editorial only changes have been incorporated in the document.

1 Scope

This document defines the stage-2 service description for emergency services in the IP Multimedia Core Network Subsystem (IMS), including the elements necessary to support IP Multimedia (IM) emergency services. ITU-T Recommendation I.130 [4] describes a three-stage method for characterisation of telecommunication services, and ITU-T Recommendation Q.65 [3] defines stage 2 of the method.

This document covers also the Access Network aspects that are crucial for the provisioning of IMS emergency services. Other 3GPP specifications that are related to the IMS emergency services are TS 23.228 [1] on IMS in general, including fixed broadband access aspects, TS 23.060 [2] and TS 23.234 [7] describing GPRS and 3GPP/WLAN Interworking respectively and TS 23.271 [5] that covers location services. TS 25.301 [6] contains an overall description of the UMTS Terrestrial Radio Access Network.

2 References

The following documents contain provisions which, through reference in this text, constitute provisions of the present document.

- References are either specific (identified by date of publication, edition number, version number, etc.) or non-specific.
- For a specific reference, subsequent revisions do not apply.
- For a non-specific reference, the latest version applies. In the case of a reference to a 3GPP document (including a GSM document), a non-specific reference implicitly refers to the latest version of that document *in the same Release as the present document*.

- [1] 3GPP TS 23.228: "3rd Generation Partnership Project; Technical Specification Group Services and Systems Aspects; IP Multimedia Subsystem (IMS); Stage 2".
- [2] 3GPP TS 23.060: "3rd Generation Partnership Project; Technical Specification Group Services and Systems Aspects; General Packet Radio Service (GPRS); Service description; Stage 2".
- [3] CCITT Recommendation Q.65: "Methodology – Stage 2 of the method for the characterisation of services supported by an ISDN".
- [4] ITU Recommendation I.130: "Method for the characterization of telecommunication services supported by an ISDN and network capabilities of an ISDN".
- [5] 3GPP TS 23.271: "3rd Generation Partnership Project; Technical Specification Group Services and Systems Aspects; Functional stage 2 description of LCS".
- [6] 3GPP TS 25.301: "3rd Generation Partnership Project; Technical Specification Group Radio Access Network; Radio Interface Protocol Architecture".
- [7] 3GPP TS 23.234: "3rd Generation Partnership Project; Technical Specification Group Services and Systems Aspects; 3GPP system to Wireless Local Area Network (WLAN) interworking; System description".
- [8] 3GPP TS 22.101: "3rd Generation Partnership Project; Technical Specification Group Services and Systems Aspects; Service aspects; Service principles".
- [9] IETF RFC 3825: "Dynamic Host Configuration Protocol Option for Coordinate-based Location Configuration Information".
- [10] IETF Internet-Draft: "Dynamic Host Configuration Protocol (DHCPv4 and DHCPv6) Option for Civic Addresses Configuration Information ", draft-ietf-geopriv-dhcp-civil-06 (May 30, 2005).
- [11] 3GPP TR 21.905: "3rd Generation Partnership Project; Technical Specification Group Services and System Aspects; Vocabulary for 3GPP Specifications".

- [12] 3GPP TS 23.002: "3rd Generation Partnership Project; Technical Specification Group Services and Systems Aspects; Network architecture".
- [13] 3GPP TS 24.008: "3rd Generation Partnership Project; Technical Specification Group Core Network and Terminals; Mobile radio interface Layer 3 specification; Core network protocols; Stage 3".
- [14] IETF RFC 4119: "A Presence-based GEOPRIV Location Object Format".
- [15] OMA AD SUPL: "Secure User Plane Location Architecture", <http://www.openmobilealliance.org>.
- [16] OMA TS ULP: "User Plane Location Protocol", <http://www.openmobilealliance.org>.
- [17] NENA I2 architecture: "Interim VoIP Architecture for Enhanced 9-1-1 Services (i2)".
- [18] ETSI ES 282 004: "Protocols for Advanced Networking (TISPAN); NGN Functional Architecture; Network Attachment Sub-System (NASS)".
- [19] 3GPP TS 24.229: "IP multimedia call control protocol based on SIP and SDP; stage 3".
- [20] 3GPP TS 23.203: "Policy and Charging Control architecture".

3 Definitions, symbols and abbreviations

3.1 Definitions

For the purposes of the present document, the terms and definitions given in TR 21.905 [11] and the following apply. A term defined in the present document takes precedence over the definition of the same term, if any, in TR 21.905 [11].

Connectivity Session Location and Repository Function (CLF): As per ETSI ES 282 004 [18], the Connectivity Session Location and Repository Function (CLF) registers the association between the IP address allocated to the UE and related network location information, i.e.: access transport equipment characteristics, line identifier (Logical Access ID), IP Edge identity.

Emergency Call Server (ECS): The functional entity consists of a Location Retrieval Function (LRF) and either a routing proxy or a redirect server, e.g. an ECS contains a VPC and a Routing Proxy or Redirect Server in NENA I2 architecture [17].

Emergency-CSCF: The Emergency-CSCF handles certain aspects of emergency sessions, e.g. routing of emergency requests to the correct emergency centre or PSAP.

Emergency Service Query Key (ESQK): A 10-digit North American Numbering Plan number used to identify a particular emergency call instance. It is used by the LRF as a key to look up for the location information and callback information associated with the emergency call instance and is also used by the PSAP to query location information from the LRF.

Emergency Service Routing Key (ESRK): see TS 23.271 [5].

Emergency Service Routing Number (ESRN): North American Numbering Plan number used for routing of an emergency call to the appropriate gateway for an eventual delivery towards a CS-based PSAP.

Geographical Location Information: Location indicated in geographical terms, for example geographical coordinates or street address (e.g. as supported by IETF RFC 4119 [14]).

IP-Connectivity Access Network (IP-CAN): The collection of network entities and interfaces that provides the underlying IP transport connectivity between the UE and the IMS entities. An example of an "IP-Connectivity Access Network" is GPRS.

Location Identifier: Information about the current location of the UE in the network. Location is indicated in network terms, for example using the global cell id in cellular networks, line-id in fixed broadband networks, (OMA-Location also uses this term, but OMA so far defines the Location Identifier only for cellular access.)

Location Information: The location information may consist of the Location Identifier, and/or the Geographical location information.

Location Retrieval Function (LRF): This functional entity handles the retrieval of location information for the UE including, where required, interim location information, initial location information and updated location information. The LRF may interact with a separate RDF or contain an integrated RDF in order to obtain routing information. The LRF may interact with a separate GMLC or contain an integrated GMLC in order to obtain location information. The LRF may interact with or contain other types of location server functions in order to obtain location information.

Last Routing Option (LRO): A number, which may be used in the event of network failure towards a specific location based PSAP or a number that can be associated to a national or default PSAP/Emergency centre.

Public Safety Answering Point (PSAP): A physical location, where emergency calls from the public are received.

Routing Determination Function (RDF): The functional entity, which may be integrated in a Location Server (e.g. GMLC) or in an LRF, provides the proper PSAP destination address to the E-CSCF for routing the emergency request. It can interact with a location functional entity (e.g. GMLC) to manage ESQK allocation and management, and deliver location information to the PSAP.

3.2 Abbreviations

For the purposes of the present document, the following abbreviations apply:

CLF	Connectivity session Location and repository Function
E-CSCF	Emergency-CSCF
ECS	Emergency Call Server
ESQK	Emergency Service Query Key
ESRK	Emergency Service Routing Key
ESRN	Emergency Service Routing Number
LRF	Location Retrieval Function
LRO	Last Routing Option
PSAP	Public Safety Answering Point
RDF	Routing Determination Function

4 High level Principles

4.1 Architectural Principles

The solution for emergency sessions in the IMS fulfils the emergency principles and requirements of TS 22.101 [8] and the following architectural requirements:

1. Void.
2. Emergency services are independent from the IP-CAN with respect to the detection and routing of emergency sessions. The emergency services shall be possible over at least a cellular access network, a fixed broadband access, I-WLAN access and a nomadic access.
3. Any kind of emergency numbers, and emergency SIP and TEL URIs as specified in TS 22.101 [8], and special indications for emergency sessions within the SIP signalling shall be supported.
4. Emergency sessions should be prioritized over non-emergency sessions by the system.
5. The establishment of IMS emergency sessions shall be possible for users with a barred public user identity.
6. The primary solution shall be that the UE can detect an emergency session (e.g. by evaluating the SIP-URI or the dialled number) by itself and indicates the emergency session to the network. The cases where the UE can't detect an emergency session shall also be supported.

7. The solution shall work in case the UE has sufficient credentials to authenticate with the IMS and is registered to the IMS or is not registered with the IMS. The case where the UE does not have sufficient credentials to authenticate with the IMS shall also be supported where regulations allow.

In the case that UE is not already IMS registered, it shall perform a registration for the support of emergency services (emergency registration).

In the case a UE is already IMS registered, the UE may skip the additional emergency registration if the UE is aware that it is in its home network (e.g. including IP-CANs where roaming outside the home network is not supported).

Editor's Note: The usage of local routing numbers in North America to call back the roaming user without involving the home network is FFS.

If the UE does not have sufficient credentials to authenticate with the IMS it shall be possible to perform session establishment without an existing security association between UE and P-CSCF, and the UE shall include an equipment identifier (the specific details of the equipment identifier to use may depend upon the IP-CAN) in the request to establish an emergency session.

8. It shall be possible to reject emergency service requests from an UE, without sufficient credentials to authenticate with the IMS in networks where emergency services from UEs with sufficient credentials to authenticate with the IMS are required.
9. Emergency Service is not a subscription service and therefore will mainly be supported in the roamed-to network. In the case that a UE has sufficient credentials, it shall initiate an emergency registration with the network (requiring the involvement of the home network). The CSCFs providing service for emergency sessions may be different from the CSCFs involved in the other IMS services. In the case that the registration fails, the UE may attempt an anonymous emergency call.
10. If an emergency session establishment request is routed to a P-CSCF located in the home network, the home network should be able to detect that the session is for emergency service (whether indicated as such or not) and respond to the UE indicating that the UE should initiate an emergency session in the visited network (e.g. via the CS domain of the visited network).
11. Emergency centers and PSAPs may be connected to the PSTN, CS domain, PS domain or any other packet network.
12. Emergency centres and PSAPs shall be able to call back the user for an emergency session from a UE that has registered (i.e. containing valid credentials).
13. The IMS core network shall be able to transport information on the location of the subscriber.
14. Void.
15. The network shall be able to retrieve the caller's location;
16. As a regional option, the network shall be capable of assigning a routable location key (i.e. Emergency Services Query Key, a.k.a. ESQK, which has the same properties as the existing ESRK in wireless 911 services) to an IMS emergency session, and releasing the ESQK when the emergency session is terminated.
17. The network shall provide the caller's location information to the PSAP upon query from the PSAP.
18. The network shall provide the possibility to route to a default answering point given the scenario where the local PSAP can not be determined.
19. The network may provide a capability to enable a UE to obtain local emergency numbers.
20. A UE should support a capability to obtain local emergency numbers from the network once such a capability has been defined and agreed.
21. It shall be possible to prevent the sending of the information of the users, such as public user identifiers and the location information to the PSAP when explicitly requested by the user, i.e. request on session by session basis.
22. The Emergency Public User Identifier shall only be used for emergency services and not for other services.

NOTE: TS 24.008 [13] contains a procedure to provide local emergency numbers for UMTS and GPRS access but the procedure is not applicable to I-WLAN and contains a limited number of emergency service categories. Therefore, an improved capability may need to be developed for IMS Emergency calls.

In addition to the architectural requirements, the following architectural principles apply to IMS emergency sessions:

- The IMS network shall be able to discriminate between emergency sessions and other sessions. This shall allow special treatment (e.g. with respect to filtering, higher priority, routing, QoS) of emergency sessions.
- If a visited network can support PS emergency service, the emergency session shall be established in the visited network whether or not UE is registered in IMS in the home network.
- The P-CSCF is the IMS network entity, which is responsible to detect the request for emergency session and forwards the request to E-CSCF in the same network.
- The P-CSCF serving the emergency call is the IMS network entity which may retrieve the location identifier from the IP-CAN.
- The E-CSCF is the IMS network entity, which shall be able to retrieve geographical location information from the LRF in the case that the geographical location information is not available and is required.
- If required, the E-CSCF shall be able to forward the location information to the LRF for validation of geographical location information in the case that the geographical location information is included by the UE over any access network type.
- The E-CSCF is the IMS network entity, which is responsible to route the request to an emergency centre/PSAP or BGCF based on location information and additionally other information such as type of emergency service in the request.

4.2 Naming and Addressing

The UE shall use a special emergency Public User Identifier in the emergency registration request. The implicit registration set of the emergency Public User Identifier shall contain an associated Tel URI.

4.3 Location information for Emergency Sessions

Location information is needed for 2 main reasons in emergency services. The initial purpose of the location information is to enable the IMS network to determine which PSAP serves the area where the UE is currently located, so that the IMS network can route the emergency session to the correct PSAP. The second purpose is for the PSAP to get more accurate or updated location information for the terminal during or after the emergency session.

4.3.1 General Location Information Principles

The following general principles shall apply regarding the handling of location information:

- If the UE has location information available, the UE shall include the location information in the request to establish an emergency session. The location information may consist of network location information, that is the Location Identifier, and/or the Geographical location information.
- The P-CSCF may query the IP-CAN to obtain location identifier. The E-CSCF, if required, may query the LRF for additional location information. If the E-CSCF does not receive location information in the emergency service request, it may query the LRF for location information.
- The E-CSCF shall be able to query the LRF to validate the location information if provided initially by the UE.
- The E-CSCF routes the emergency request to the PSAP/Emergency Centre that corresponds to the current location of the UE or to a default PSAP/Emergency Centre. The access dependent variations of this approach are described below, for the cases where the UE is using GPRS, I-WLAN or fixed broadband access for the emergency service.

- The E-CSCF forwards the SIP request containing the UE's location information to the PSAP/Emergency Centre or BGCF/MGCF. The location information can contain explicit location information and/or a reference key to allow the PSAP to retrieve location at a later stage.

4.3.2 Void

4.4 IP-CAN

The following are the expectations on the IP-CAN for IMS emergency services:

- It shall be possible to access the IP-CAN without sufficient security credentials.
- It shall be possible to reject requests from UE without sufficient security credentials to establish bearer resources:
 - In the case that the IP-CAN receives a request to establish bearer resources for emergency services, it shall be possible for the IP-CAN to prioritise emergency services traffic. PCC (Policy and Charging Control) methods may be used to inform the IP-CAN and request appropriate handling of the emergency service. The QoS information for emergency traffic is specified in TS 23.203 [20].
- In the case that the IP-CAN receives a request to establish bearer resources for emergency services, the IP-CAN shall ensure that the IP flows using the requested resources are only for communication with the network entities involved in the support of the emergency services. Applicable service data flow filters for emergency traffic need to be defined by the operator according to the details described in TS 23.203 [20].
- The IP-CAN may support emergency services free of charge. Applicable PCC rules need to be defined by the operator according to the details described in TS 23.203 [20].
- The IP-CAN may provide emergency numbers to the UE in order to ensure that local emergency numbers are known to the UE (see TS 22.101 [8]).

In case the IP-CAN is a GPRS network, the detailed procedures are described in the TS 23.060 [2].

5 Architecture model and reference points

5.1 Reference architecture

This specification introduces an additional CSCF role to those defined in the IMS architecture TS 23.002 [12], called Emergency CSCF (E-CSCF), see figure 5.1.

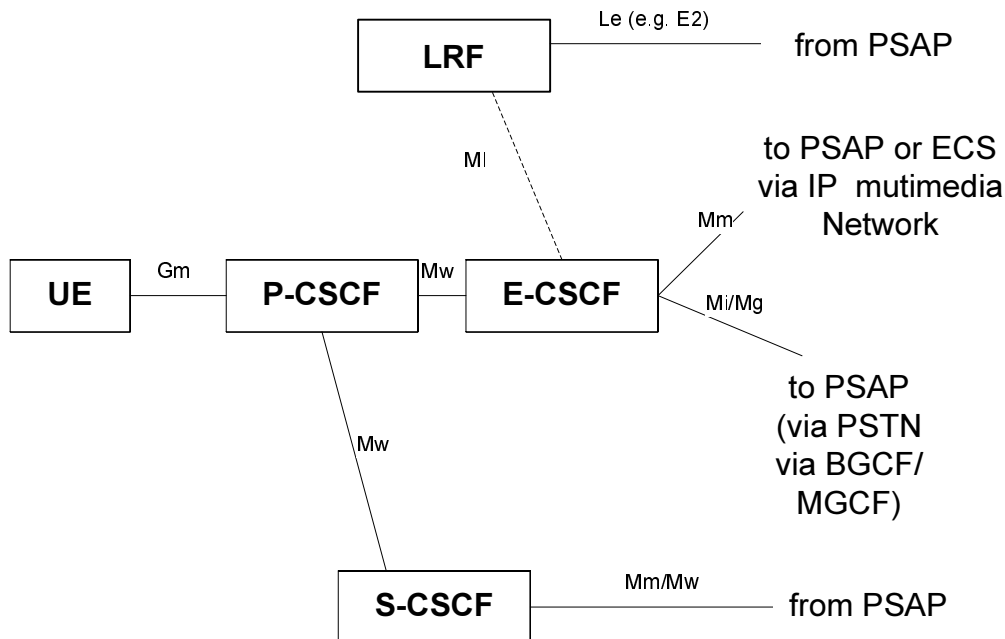

Figure 5.1: E-CSCF in reference architecture

NOTE 1: P-CSCF and E-CSCF are always located in the same network; this is the visited network when the UE is roaming.

NOTE 2: For simplicity, not all functional components, e.g. IBCF, I-CSCF, MGCF and BGCF, are shown in this figure.

NOTE 3: It shall be possible, for example in the North America regions, to support configurations where the Location Retrieval Function (LRF) may consist of a Routing Determination Function (RDF) and a Location Server (e.g. GMLC), the interface between Location Server and RDF is out of scope of this specification. The RDF may be integrated in the Location Server (e.g. in the LRF).

NOTE 4: Based on local policy, the E-CSCF may route the emergency IMS session to the PSAP via an ECS. See the details in Annex D.

5.2 Reference points

The E-CSCF uses Mw, Mr, Mg, Mi, MI, and Mm reference points to connect to other IMS entities.

6 Functional description

6.1 UE

- Should be able to detect an emergency session establishment request.
- Use a special emergency Public User Identifier in the IMS emergency registration request.
- The UE may perform an IMS emergency session establishment without prior emergency registration when already IMS registered and it is in home network (e.g. including IP-CANs where roaming outside the home network is not supported).
- Otherwise, the UE shall perform an IMS emergency registration.

- Include an emergency service indication in the emergency session request.
- Include an equipment identifier in the request to establish an emergency session for "anonymous user".

NOTE: "Anonymous user" in this context is the person who does not have sufficient credential for IMS registration. No Stage 3 work is expected as the anonymous user detection already existed today.

- Attempt the emergency call in CS domain, if capable.
- Handle a 380 (Alternative Service) response with the type set to "emergency" as a result of emergency attempt.
- Handle a response with an indication, IMS emergency registration required as a result of emergency session establishment attempt.
- Other general requirements of UE shall be referred to the general requirements of emergency calls in TS 22.101 [8].

The UE initiates the emergency session establishment request, and for the purpose of processing the request properly in the network the following specific information is supplied in the request message.

- Emergency session indication.
- Emergency Public User Identifier if an IMS emergency registration is performed. If not, any registered Public User Identifier is used.
- Optionally, type of emergency service. It could be implied in the above emergency session indication.
- UE's location information, if available.
- The Tel URI associated to the emergency Public User Identifier, if available.

6.2 IMS Functional entities

6.2.1 Proxy-CSCF

- Handle registration requests with an emergency Public User Identifier like any other registration requests except that the registration expiration. P-CSCF may set the proposed registration expiration time according to the local policy and change the expiration value in the REGISTER requests, and then forward the request to the IBCF or I-CSCF in the user's home network.

NOTE: If the registration expiration time is changed by the P-CSCF in the visited network, the S-CSCF in the home network should obtain the proposed registration expiration value from the REGISTER request and use the same registration expiration time.

- Detect an emergency session establishment request.
- Reject/allow unmarked emergency requests.
- Reject/allow anonymous emergency requests.
- Prevent the assertion of an emergency Public User Identifier in non-emergency requests
- May query IP-CAN for location identifier.
- Select an Emergency CSCF in the same network to handle the emergency session request. The selection method is not standardized in the present document.
- Prioritize the emergency session.
- Check the validity of the caller Tel URI if provided by the UE and shall provide the Tel URI in the session establishment request if it is aware about the Tel URI associated with the emergency Public User Identifier.
- May response to the UE with an indication, IMS emergency registration required as a result of processing the emergency session establishment attempt.

- Should be able to identify the service data flow associated with emergency service and inform PCRF accordingly.

6.2.2 Emergency-CSCF

- Receive an emergency session establishment request from a P-CSCF.
- If location information is not included in the emergency request or additional location information is required, the E-CSCF may request the LRF to retrieve location information as described in subclause 7.6 Retrieving Location information for Emergency Session.
- If required, the E-CSCF requests the LRF to validate the location information if included by the UE.
- Determines or queries the LRF for the proper routing information/PSAP destination.
- Route emergency session establishment requests to an appropriate destination including anonymous session establishment requests.
- Subject to national requirements, the E-CSCF may send the contents of the P-asserted ID or UE identification to the LRF.
- Based on local policy, the E-CSCF may route the emergency IMS call to ECS for further call process.

6.2.3 Location Retrieval Function

The Location Retrieval Function (LRF) is responsible for retrieving the location information of the UE that has initiated an IMS emergency session. It shall be possible to support configurations where the Location Retrieval Function (LRF) may consist of a Routing Determination Function (RDF) and a Location Server (e.g. GMLC), the interface between Location Server and RDF is out of scope of this specification.

The LRF utilizes the RDF to provide the routing information to the E-CSCF for routing the emergency request. The RDF can interact with a location functional entity (e.g., GMLC) and manage ESQK allocation and management. The ESQK is used by the PSAP to query the LRF for location information and optionally a callback number. The LRF-PSAP interactions are outside the scope of this specification.

Information provided by the LRF to the E-CSCF includes the routing information and other parameters necessary for emergency services, which are subject to local regulation. For example, this information may include the ESQK, ESRN, LRO in North America, location number in EU, PSAP SIP URI or Tel URI.

In order to provide the correct PSAP destination address to the E-CSCF, the LRF may require interim location information for the UE.

In some regions, for example in the North American region, it may be a requirement to provide the PSAP with an accurate initial location estimate for the UE and possibly to provide an accurate updated location estimate for the UE if requested by the PSAP. When this requirement exists, the LRF may store a record of the emergency session including all information provided by the E-CSCF and shall only release this record when informed by the E-CSCF that the emergency session has terminated. The information provided by the LRF to the E-CSCF (e.g. ESQK) shall then include correlation information identifying both the LRF and the emergency session record in the LRF. This correlation information shall be transferred to the PSAP during session establishment (e.g. in a SIP INVITE or via SS7 ISUP signalling from the MGCF). The PSAP may use this information to request an initial location estimate from the LRF and/or to request an updated location estimate.

7 Procedures related to establishment of IMS emergency session

7.1 High Level Procedures for IMS Emergency Services

7.1.1 UE Detectable Emergency Session

The following flow contains a high level description of the emergency service procedures performed when the UE can detect the emergency session is being requested.

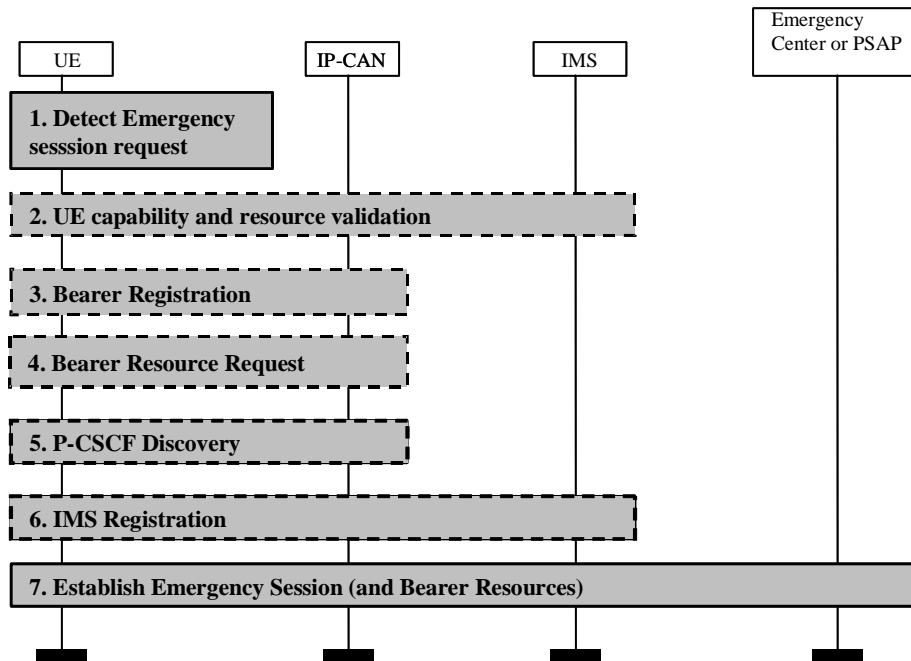

Figure 7.1: Terminal Detected Emergency Calls

The following steps are performed:

1. The UE detects the request for the establishment of an emergency session. Step 2 to 6 may be skipped based on the conditions specified in clause 6.1.
2. In the case that the UE has insufficient resources or capabilities to establish an emergency call due to other ongoing sessions then the UE should terminate the ongoing communication and release reserved bearer resources
3. In the case that bearer registration is required and has not been performed, the UE shall perform bearer registration to the IP-CAN. If the UE is already bearer registered, then the bearer registration procedures are not required to be performed.

NOTE 1: Depending on the IP-CAN, the UE may be assigned an IP address at this stage.

4. In the case that bearer resources for the transport of the IMS related signalling are required to be reserved in the IP-CAN, the UE shall reserve the resources in the IP-CAN. The UE shall provide an indication that this is for an emergency service.
If the IP-CAN does not provide an IP address to the UE in step 3, then the IP-CAN shall allocate an IP address to the UE during the bearer resource request procedures.
5. UE performs a P-CSCF discovery procedure, where the UE discovers a P-CSCF in the local network suitable for use in emergency sessions.

NOTE 2: The exact means for the P-CSCF discovery is dependant upon the IP-CAN.

6. If the UE has sufficient credentials to authenticate with the IMS network, it shall initiate an IMS emergency registration by providing the IP address obtained at step 3 or step 4 to the P-CSCF selected at step 5. The IP address used for signalling purposes is allocated in association with step 3 or step 4. The IMS registration request shall include an Emergency Public User Identity. The implicit registration set of the emergency Public User Identifier shall contain an associated Tel URI that is used to call back the user from the PSTN.

The P-CSCF may set the proposed registration expiration according to the local policy and change the registration expiration in the REGISTER request. An indication may be added to explicitly indicate that the expiration has been set by the visited network. When the S-CSCF in the home network receives the REGISTER request, the S-CSCF should obtain the proposed registration expiration value from the request and use the same registration time. The S-CSCF should return the response containing the same registration expiration to the UE. The sequent registration flows are like any other registration.

If the UE does not have sufficient credentials to authenticate with the IMS network, it shall not initiate an IMS emergency registration request, but instead immediately establish an emergency session towards the P-CSCF as described in step 7.

7. If IMS emergency registration is performed, the UE shall initiate the IMS emergency session establishment using the IMS session establishment procedures containing an emergency session indication and emergency Public User Identifiers. Otherwise, the UE shall initiate the IMS emergency session establishment using the IMS session establishment procedures containing an emergency session indication and any registered Public User Identifier.

Whether the procedures are activated individually by the UE or some of them are performed automatically depends on the implementation of the terminal and on the UE's configuration. For instance, the multimedia application in the UE could start the application level registration and steps 2-4 would have to be executed in response to support the operation initiated by the application. Interaction with the UE may happen during these steps.

7.1.2 Non UE detectable Emergency Session

As the UE could not detect the emergency session, the session establishment request will be sent to a P-CSCF in the visited PLMN or a P-CSCF in the home PLMN as per a normal session establishment procedure. The former is only applicable to a roaming situation whereas the latter can apply to both a roaming and non-roaming situation. Prior to sending the session establishment request the UE must be registered in the IMS as per the normal registration procedure.

In the case that the P-CSCF detects that this is a request to establish an emergency session, based upon local policy (e.g., checking access type):

- the P-CSCF may reject the session initiation request with an indication that this is for an emergency session. When the UE receives the session rejection then the UE shall either attempt to initiate an emergency call in the CS domain or follow the procedure in 7.1.1.
- Alternatively, the P-CSCF in the visited PLMN or the P-CSCF in the home PLMN for a non-roaming UE may allow the session initiation request to continue by inserting the explicit emergency indication in the session request and forward that request to an Emergency CSCF in the same network. There is no requirement to inform the UE that the session has been marked as an emergency session, i.e. the UE can treat the session as a normal session establishment.

7.1.3 Emergency Session Establishment using LRF/RDF

Figure 7.2 illustrates a high level call flow for the IMS emergency session establishment procedure using LRF/RDF to retrieve location and routing information.

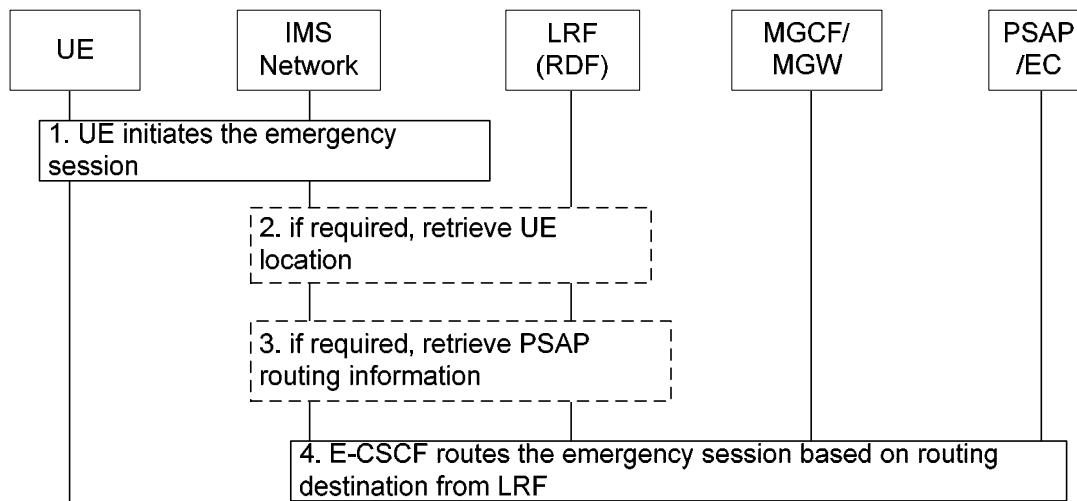

Figure 7.2: Emergency Session Establishment procedure with using LRF/RDF

1. UE initiates an emergency session request by sending a SIP INVITE message with including emergency URI.
2. If required, the IMS network may access the LRF to retrieve the UE's location.
3. If required, LRF invokes the RDF to determine the proper PSAP destination. LRF returns the necessary location/routing information (e.g., ESQK for North America or location number for EU) to the IMS network.
4. The IMS network uses the routing information returned by the LRF to route the emergency session request towards the appropriate PSAP.

NOTE: If the LRF provides an ESQK to the IMS network in step 3 or assigns any other dedicated resource to the emergency session, the IMS network shall inform the LRF when the session is released in order to allow the LRF to release this resource.

7.2 IMS Registration for Emergency Session

The IMS emergency registration procedure shall follow the procedures as described in subclause 5.2.2.3 of TS 23.228 [1] with the following modifications:

- The UE shall initiate an IMS emergency registration when all of the following conditions are met:
 - either the UE is not already IMS registered or the UE is IMS registered but is roaming outside its home network;
 - the UE has sufficient credentials to authenticate with the IMS network;
 - the UE is able to detect emergency session.

The UE shall also initiate an IMS emergency registration when it receives an "IMS emergency registration required" response as a result of the emergency session request.

- The UE shall use an emergency Public User Identifier in the emergency registration request. This indication may be used to route calls coming from the PSAP to the contact address registered during the emergency registration procedure and to inform the home network that roaming restrictions may not be applied. The format of this public user identity has to be defined by stage 3.
- The user's home network should ignore roaming restrictions for emergency registration requests.

- No originating and terminating services should be applied to emergency Public User Identifiers.

NOTE: The special emergency public user identifier is different from emergency indication in the IMS emergency session establishment request.

P-CSCF handles the registration requests with an emergency Public User Identifier like any other registration requests except that the registration expiration. P-CSCF may set the proposed registration expiration time according to the local policy and change the expiration value in the REGISTER requests, and then forward the request to the IBCF or I-CSCF in the user's home network.

If the registration expiration time in the REGISTER request is changed by the P-CSCF, the S-CSCF in the home network should obtain the proposed registration expiration value from the request and use the same registration expiration time. The S-CSCF should return the response containing the same registration expiration to the UE. The sequent registration flows are like any other registration.

7.3 Emergency Session Establishment in the Serving IMS network

If the UE is able to detect that the user is requesting an emergency session then it shall include an emergency service indication in the emergency session establishment request.

If the UE is CS capable and not attached to the PS domain, the UE shall attempt an emergency call in the CS domain. If the UE is only PS attached, and the network has indicated that IMS emergency services are supported, it should attempt the emergency call in the PS Domain. If the UE is attached to both domains, it should follow the requirement as stated in TS 22.101 [8] that specifies "A CS and IMS capable UE attempting an emergency call should give priority to the CS Domain. In case the call attempt fails, the UE should automatically make a second attempt on the other domain". For an attempt in the IM CN Subsystem of the PS domain, the attempt should be in the serving (visited if roaming) IM CN Subsystem of the PS domain.

If the initial attempt is in the CS domain and it fails, the serving (visited if roaming) IM CN Subsystem of the PS domain shall be attempted if the UE is capable. If the initial attempt is in the IM CN Subsystem of the PS domain and it fails, the UE shall make the attempt in the CS domain (if the UE is capable and if for an appropriate service e.g., voice).

If a UE attempts to initiate a session and receives a 380 (Alternative Service) response with the type set to "emergency", the UE shall then re-attempt the session as described above with first attempt being towards the CS domain (if the UE is capable and if for an appropriate service e.g., voice), and with an indication that emergency service is requested.

If the UE is aware that it does not have sufficient credentials to authenticate with the IMS network, it shall not initiate an IMS registration but immediately establish an emergency session towards the P-CSCF, see subclause 7.4.

Upon receiving an initial request for an emergency session, the P-CSCF shall follow the rules and procedures described in TS 23.228 [1] with the following additions and clarifications:

- The P-CSCF is the IMS network entity, which detects an emergency session.
- A P-CSCF in the home network should, when it can recognise the emergency number or emergency indication, respond to the UE indicating that the UE should initiate an emergency session in the visited network (e.g. via the CS domain of the visited network).
- For the case that the initial request carries an indication that the request is for emergency services, and the UE is not registered in the IMS network, see subclause 7.4 for details.
- For the case that UE is IMS registered and the initial request does not carry an indication that the request is for emergency services, and the P-CSCF is able to detect that the request is for emergency services, the P-CSCF shall perform the " Non UE detectable Emergency Session " described in subclause 7.1.2 above.
- On receipt of a session establishment request, which is recognized to be for an emergency service, the P-CSCF shall check whether the UE provided a Tel URI as its identity in the request. If a Tel URI is present in the request, the P-CSCF shall check the validity of this Tel URI. If no Tel URI is present in the request and the P-CSCF is aware about the Tel URI associated with the emergency Public User Identifier, it shall provide the Tel URI to the E-CSCF in the session establishment request.
- The P-CSCF may query the IP-CAN for the location identifier.

- P-CSCF shall prioritize emergency sessions over other non-emergency sessions.
- Emergency IP flows need to be identified by P-CSCF in the Rx interface signalling to allow the PCRF to prioritize emergency service data flows over non-emergency service data flows within IP-CAN. The detailed procedures are specified in TS 23.203 [20].

Upon receiving an initial request for an emergency session from P-CSCF, the E-CSCF shall perform the following:

- if location information is not included in the emergency service request or if additional location information is required, the E-CSCF, if required, retrieves the UE's location information as described in subclause 7.6 Retrieving Location information for Emergency Session.
- If location information is included by the UE, the E-CSCF, if required requests the LRF to validate the location information.
- May determine or may request the LRF to determine the appropriate routing information which could be based on the type of emergency service requested and UE's location.

Editor's Note: This "routing" interface and RDF interaction is FFS! It is expected that the input parameter to the RDF to determine the proper PSAP routing is location information, user's identity, and type of emergency service requested.

Editor's Note: Location interface and E-CSCF interaction is FFS!

Editor's Note: How the IMS network routes the emergency session based on location information is FFS.

- determine the default PSAP destination if routing based on UE's location is required but the location is unknown.
- If the PSAP/emergency centre contains a point of presence within the IMS connectivity network, the E-CSCF shall forward the emergency session initiation request directly to the PSAP/emergency centre.
- If the PSAP/emergency centre has its point of presence in the PSTN/ISDN network or the CS domain, the E-CSCF uses the Tel-URI obtained from the LRF and forwards the request to an appropriate BGCF/MGCF for routing in the GSTN. This number shall have the same format as used for CS emergency calls. The MGCF may insert any available location information in the PSTN/CS signalling.

NOTE: In case an ESRN is received from the LRF, the E-CSCF maps the received ESRN from the LRF to a TEL-URI before forwarding the request to MGCF.

7.4 IMS Emergency Session Establishment without Registration

When the UE initiates an emergency session establishment without prior IMS registration, it shall include both the "anonymous user" and "emergency service" indications in the emergency session establishment request to the P-CSCF.

Based on local policy, the P-CSCF may reject "anonymous user" emergency session establishment with appropriate error code. UE shall not reattempt the "anonymous user" emergency session again via the same network.

When P-CSCF accepts the "anonymous user" emergency session establishment, it forwards this request to an appropriate E-CSCF although no security association between UE and P-CSCF is established.

The E-CSCF shall follow the same rules and procedure as defined for the Emergency Session Establishment in the Serving IMS network in subclause 7.3 to route the anonymous emergency session.

Editor's Note: Location aspect with anonymous user is FFS!

7.5 Interworking with PSAP

7.5.1 PSAP/Emergency centre located at the GSTN

No special procedure is defined. PSAP uses the MSISDN (E.164) of the user for call back.

7.5.2 PSAP/Emergency centre connected via IP using SIP

No special procedure is defined. PSAP uses any public user identity that it has received from the user for call back.

7.5.3 PSAP/Emergency centre connected via ECS

No special procedures are identified in IMS Core, the routing determination will be performed by the ECS.

7.6 Retrieving Location information for Emergency Session

7.6.1 Acquiring location information from the UE or the network

When performing an emergency service, four scenarios for retrieving location information for routing purposes are considered:

- the UE knows its own location;
- the UE retrieves its location information from the network;
- the IMS core retrieves the location information. The related high level procedures are described below;
- location information is not needed to route the emergency call by the IMS core, optionally the emergency routing determination and location information retrieval may be performed by the Emergency Call Server (ECS) as part of the emergency session establishment procedure. In this case, the IMS core does not need to obtain the location information. See the details in Annex D.

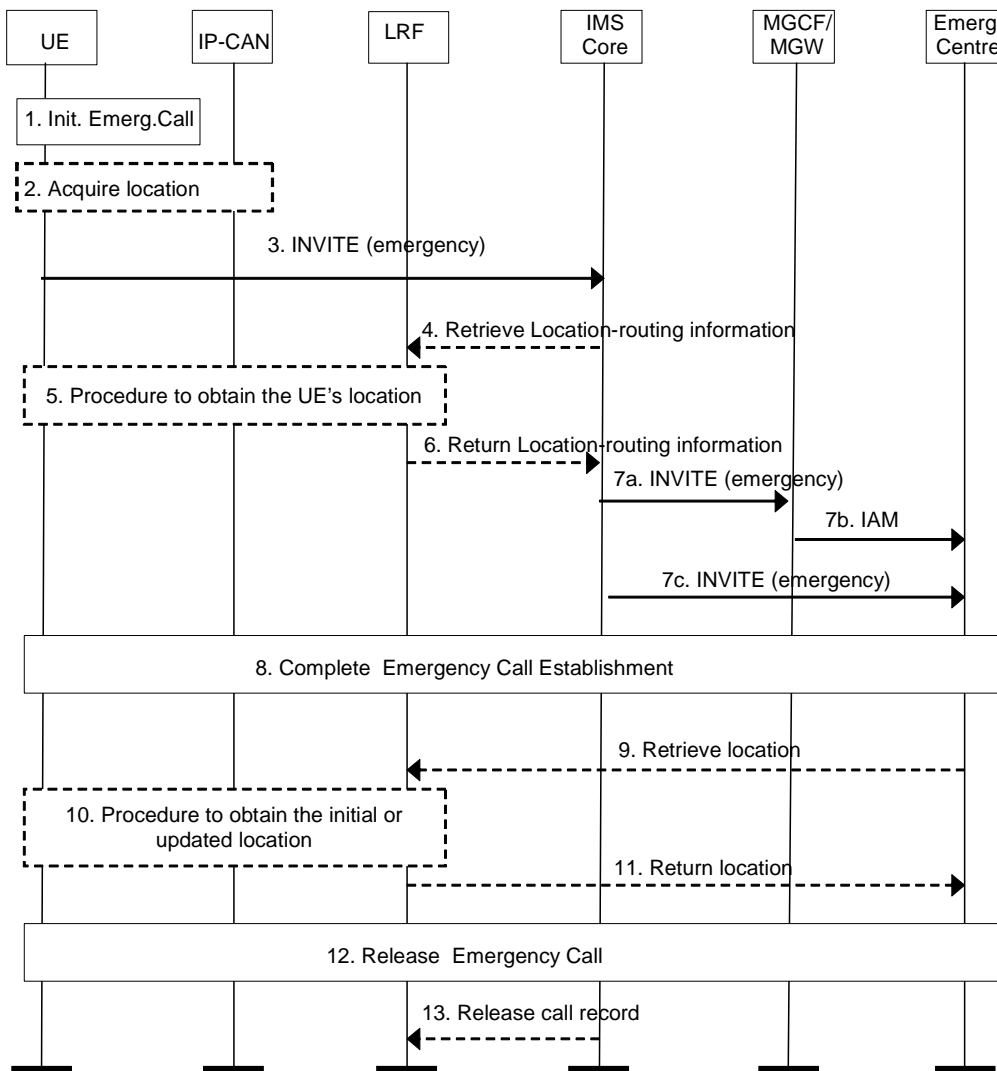

Figure 7.6-1: Handling of location information in IMS emergency calls

1. The user initiates an emergency call.

2. The UE determines its own location or location identifier if possible. If the UE is not able to determine its own location, the UE may, if capable, request its location information from the IP-CAN, if that is supported for the used IP-CAN. If applicable, the IP-CAN delivers to the UE the UE's geographical location information and/or the location identifier.
3. The UE sends an INVITE with an emergency indication to the IMS core. The INVITE should contain any location information that the terminal has. The location information may be geographical location information or a location identifier, which is dependant upon the access network technology. In case the UE is not able to provide any location information, the IMS core may seek to determine the UE's location from the LRF as described below. The INVITE may optionally contain information concerning the location solutions and position methods supported by the UE.

NOTE: the location solutions and position methods conveyed in the INVITE and the means of inclusion in the INVITE are outside the scope of this specification.

4. If the location information provided in step 3 is trusted and sufficient to determine the correct PSAP, the procedure continues from step 7 onwards. If the location information is insufficient or if the IMS core requires emergency routing information, or if the IMS core is required to validate the location information, or if the IMS core is required to map the location identifier received from the UE into the corresponding geographical location information, the IMS core sends a location request to the LRF. The request shall include information identifying the IP-CAN and the UE and may include means to access the UE (e.g. UE's IP address). The request shall also include any location information provided by the UE in step 2. The request may optionally include any information concerning the location solutions and position methods supported by the UE.
4. The LRF may already have the information requested by IMS core or LRF may request the UE's location information. The means to obtain the location information may differ depending on the access technology the UE is using to access the IMS. With GPRS access the PS-NI-LR or PS-MT-LR procedures defined in TS 23.271 [5] may be used. The SUPL procedures defined in OMA AD SUPL: "Secure User Plane Location Architecture" [15], OMA TS ULP: "User Plane Location Protocol" [16], may be used if supported by the terminal and if it is possible to establish a user plane connection between the UE and the SUPL server. Information provided in step 4 concerning the location solutions and position methods supported by the UE may optionally be used by the LRF to help determine the means to obtain the location information.

The LRF may invoke an RDF to convert the location information received in step 4 or obtained in step 5 into PSAP routing information, but LRF's interactions with RDF are out of scope of the present specification. The LRF may store the location information, but only for a defined limited time in certain regions, according to regional requirements.

6. The LRF sends the location information and/or the routing information to the IMS core. The LRF may also return correlation information (e.g. ESQK) identifying itself and any record stored in step 5.
7. The IMS core uses the routing information provided in step 6 or selects an emergency centre or PSAP based on location information provided in step 3 or 6 and sends the request including the location information and any correlation information and possibly location information source, e.g., positioning method that was used to obtain the location information to the emergency centre or PSAP.
 - 7a. The INVITE is sent to an MGCF/MGW,
 - 7b. The IAM is continued towards the emergency centre or PSAP, or
 - 7c. The INVITE is sent directly to the emergency centre or PSAP.
8. The emergency call establishment is completed.
9. The PSAP may send a location request to the LRF to get the initial location information for the target UE, or to request LRF to get updated, i.e. current, location information for the target UE. The PSAP may determine the LRF based on the location and/or correlation information received in step 7. The PSAP may also include the correlation information in the request to the LRF.
10. The LRF determines the target UE's location using one of the means listed in step 5 above. The LRF may use the correlation information received in step 9 to retrieve information about the UE that was stored in step 5.
11. The LRF returns the initial or updated location information to the emergency centre or PSAP. As an option for initial location, the LRF may instigate the location step 10 before the request in step 9 is received and may send the initial location to the emergency centre or PSAP either after the request in step 9 is received or before it is received.

12. The emergency call is released.

13. The IMS core may indicate to the LRF that the call is released. The LRF deletes any record stored in step 5.

7.6.2 Void

7.6.3 Void

Annex A (informative): IMS emergency services using GPRS Network

Editor's Note: The content of this Annex is a place holder until such stage that they are moved to appropriate TS (i.e. TS 23.060 [2]). After these contents are moved, this annex will be removed from this specification..

A.1 Requirements on the GPRS network as an IP-CAN

For an emergency call over the GPRS, the requirements on the IP-CAN, as described in subclause 4.3, are covered by the following GPRS specific requirements:

- It shall be possible to access the PS domain without a UICC
- It shall be possible to reject requests from a UE without a UICC to establish bearer resources
- A globally dedicated emergency APN shall be used to support PDP contexts for emergency services for roaming UEs in VPLMN and for anonymous emergency calls by a UICC-less terminal. The globally dedicated APN may be configured in the SGSN and GGSN. The GGSN may use filter rules applicable to the globally dedicated emergency APN to ensure that only certain allowed IP addresses (e.g. IP addresses of the emergency P-CSCF) can be reached. When a mobile terminal sends packets to IP addresses other than the allowed IP addresses over the PDP context for emergency services, the GGSN drops these data packets. The GGSN may also drop data packets addressed to the mobile terminal over a PDP context for emergency services, which are not coming from an allowed IP address.
- PCC rules may be used for the emergency service data flow filtering as well as associated policy and charging. The emergency service related PCC rules may be pre-defined in the GGSN or dynamically provided by the PCRF over Gx interface. Pre-defined PCC rules may be automatically activated by the GGSN for a dedicated emergency APN. For non-emergency APN pre-defined emergency PCC rules may be activated dynamically by the PCRF. The details of the PCC rules and PCC procedures are specified in TS 23.203 [20].
- The PS domain may support the download of emergency numbers to the UE via the procedures defined in TS 24.008 [13].

A.2 UE specific behaviour for emergency calls over the GPRS

For the specific case of an emergency call over GPRS the UE shall follow the following procedures:

- If not already PS attached, the UE shall perform a PS attach with an indication that this is for emergency use.
- UEs that need to do IMS emergency registration or UICC-less terminals that are used for an anonymous emergency call shall request PDP context activation to a globally dedicated emergency APN.
- The UE shall include the Cell Global Identification (CGI) in the INVITE request establishing the emergency call.

A.3 GPRS specific aspects of High Level Procedures for IMS emergency calls

For the high level procedures (as described in subclause 7.1.1.) the following statements apply for emergency calls when GPRS access is used:

- the bearer resource request is the PDP context activation procedure, and the globally dedicated emergency APN is used to indicate the emergency request.
- the release of reserved bearer resources is the release of a PDP context.
- the bearer registration to the IP-CAN is the PS attach procedure

A.4 Location handling for GPRS

For access in the PS domain, the UE shall include the access type and cell identity as specified in TS 24.229 [19], clause 7.2A in the SIP INVITE request, when it initiates an emergency session using GPRS bearer. It is noted that the UE normally is not aware of SAI and therefore SAI cannot be used as location information in SIP signalling.

For regions (e.g. North America) in which an interim location may be required to assist routing to the correct PSAP and/or where accurate initial and updated location information may be required, the PS-NI-LR and PS-MT-LR procedures defined in TS 23.271 [5] are applicable as well as use of SUPL defined in OMA AD SUPL: "Secure User Plane Location Architecture" [15], or OMA TS ULP: "User Plane Location Protocol" [16].

NOTE: The use of SUPL procedure is depended on the UE capabilities.

A.5 Open Issues on GPRS specific aspects

Editor's Note: This section will be used to capture and develop open issues that need to be resolved for GPRS access in relation of Emergency calls before the contents are moved to TS 23.060 [2].

1) How to support an MS in Limited Service state?

It is assumed that a blocked MS, e.g. an MS camping in a Forbidden Location Area or Forbidden PLMN, see TS 23.122, should be able to initiate the IMS emergency service request. Such an MS may be in the so-called limited service state. When the UE is in GMM-DEREGISTERED state, it shall execute the Attach procedure and when the UE is in GMM-REGISTERED state, it shall perform the RAU procedure. Note that main states have several sub-states as defined in TS 24.008 [13] e.g. GMM-REGISTERED.LIMITED-SERVICE (the UE shall do RAU) and GMM-DEREGISTERED.LIMITED-SERVICE (the UE shall do Attach).

Conclusion: when the UE is DEREGISTERED it shall do Attach with the emergency indication included and when the UE is REGISTERED it shall do RAU with the emergency indication included.

2) When shall the MS request Emergency APN?

The MS requests the Emergency APN in order to ensure that the access point is in the same network as the UE itself. From GGSN the MS gets the address of the P-CSCF within the same network and this P-CSCF knows which E-CSCF serves the location of the MS. In this way it is possible for IMS and E-CSCF to determine the correct PSAP to which IMS shall route the emergency call.

An MS without a valid UICC needs to request an anonymous IMS emergency call and the only way for such an MS to get access is to request the Emergency APN. An MS in limited service state shall always do IMS emergency registration first and therefore starts by requesting the Emergency APN.

Conclusion: The MS shall request Emergency APN whenever it needs to perform IMS emergency registration. UICC-less terminals that are used for an anonymous emergency call shall also request Emergency APN.

A) How to convey emergency indication in RAU procedures (Intra and Inter)?

The MS may have done the emergency attach earlier and already included the emergency indication in that procedure. There are 2 alternative solutions how to carry on the emergency information in the following RAU procedures;

1. the MS includes the emergency indication also in RAU signalling or
2. the SGSNs use the Emergency APN information.

For intra SGSN RAU the SGSN is already aware of the Emergency APN and possibly also emergency indication in case the mobile performed emergency attach. In the inter SGSN case the Emergency APN information and the emergency indication is delivered inside the MM and PDP context information across the Gn/Gp interface (TS 29.060 [2]). According to question 1), however, the MS in Limited Service state shall include the emergency indication in RAU.

Conclusion: The MS shall include the emergency indication in RAU signalling (Intra and Inter).

- B) In TR 23.867 for a few procedures e.g. RAU and Serving RNS relocation, there is an editor's note stating that "It is FFS whether CAMEL procedures are performed if the MS is emergency attached or if the MS has active PDP context(s) for an emergency use".**

The CAMEL TDPs seems to be applicable, but most probably there is no real need for any CAMEL functionality in those cases.

Working Assumption: Keep the CAMEL TDPs as is and let operator configuration decide whether the TDPs are invoked or not.

- C) What level Emergency calls will work with pre-REL-7 SGSNs?**

The Rel-7 MS that supports IMS emergency services shall be able to insert the emergency indication (new Rel-7 information) in the PS attach, RAU and combined procedures and to request Emergency APN (new in Rel-7). The Rel-7 GPRS network that supports IMS emergency services shall be able to interpret and handle these new emergency indications from the UE.

Conclusion: Pre-Rel-7 SGSNs do not support IMS emergency services.

- D) Are combined procedures applicable if IMS emergency services are in use (Attach and RA/LA Updating)?**

Clause 7.3 of the present document refers to TS 22.101 [8], clause 10.1.2 that specifies that "A CS and IMS capable UE attempting an emergency call should give priority to the CS Domain. In case the call attempt fails, the UE should automatically make a second attempt on the other domain".

The GPRS network may send an indication that the combined PS+CS procedures are to be used by all MS in that network.

Conclusion: The combined procedures (Attach and RA/LA Updating) shall support IMS emergency services.

NOTE 1: It is FFS if a new message type for combined emergency Attach is needed.

NOTE 2: It is FFS if a new message type for Routing Area Update is needed.

NOTE 3: A UICC less UE that initiates an emergency access does not use combined procedures.

- E) Procedures for UICC-less IMS emergency Attach**

Principles to be followed during Attach are described in subclause A.6 Selection of method for UICC-less emergency calls.

Conclusion: The UICC-less UE is always DEREGISTERED by default. Thus, when the UICC-less UE initiates an emergency access, it shall do Attach with the emergency indication included.

NOTE 4: It is FFS: whether a new message type for emergency Attach is needed.

- F) Selection rules for Emergency APN**

In order to handle the Emergency APN it is necessary to modify the decision logic of Annex A in TS 23.060 [2] in Rel-7, such that the SGSN supports the special Emergency APN for all users explicitly, without any need for the user to subscribe to the Emergency APN. This is useful in cases where e.g. the user tries to make the emergency call even though his or her MS is barred from all PS services. Further, this removes the necessity to store the Emergency APN in every single subscriber's subscription in the HLR, thus saving a great deal of memory in the HLR.

Conclusion: The APN decision logic specification in TS 23.060 [2], Annex A, has to be modified for Rel-7.

- G) Impacts on Intra and Inter System change in case not all access systems support IMS emergency services (A/Gb mode, Iu-mode)**

Changes in the specifications are needed in order to handle Intra and Inter system GPRS changes for IMS emergency services in Rel-7. It is not seen possible to have any IMS emergency interworking with access networks that do not support IMS emergency services.

Conclusion: IMS emergency services needs to be supported during Intra and Inter System changes in Rel-7 access networks that support IMS emergency services. The IMS emergency service has to be released during an Intra or Inter system change to an access network that do not support IMS emergency services.

H) In TR 23.867 the statement that the security functions are optional is repeated for a number of procedures, even though the function already is optional.

It is seen that the existing security functions should be applied as specified in TS 23.060 [2] when a "normal" UE (not in limited-service-state) equipped with a valid UICC is used for making the IMS emergency call. It is noted that the SGSN handling of the emergency APN in VPLMN allows emergency calls to be supported in VPLMN even in case the UE would not get any normal PDP context in that VPLMN. The security related functional requirements for UICC-less terminals are specified in clause A.6.2 below.

- Using the GGSN static filters or PCC methods it is possible for the PS core to ensure that the UE or terminal does not use the PDP context established for the emergency call for any other purposes.

Conclusion: This issue will be resolved when the TS 23.060 [2] CRs are prepared based on the security related functional requirements and with guidance from 3GPP SA WG3.

I) Treatment of a UE that is not registered and GPRS network selection

The assumed scenario where this question applies is for example when the UE is powered on for the first time in a country and the user simultaneously initiates an IMS emergency call. In this case the UE could try to request an anonymous IMS emergency call immediately in any detected PLMN, but that would probably not be the best solution since the network may reject anonymous IMS emergency calls.

Conclusion: When the UE with a valid UICC is powered on and the user simultaneously requests an IMS emergency call, the UE shall perform PLMN selection according to TS 22.011 and TS 23.122 and request GPRS emergency attach in the selected network based on network mode of operation. The user may do a manual network selection anytime and in such a case the UE shall follow the manual PLMN selection requirements of TS 22.011 and TS 23.122. If an emergency call is made prior to attach to that network, the UE shall request emergency attach.

TS 23.122 seems to apply as such for UEs with valid UICC requesting IMS emergency services. However, TS 23.122 needs to be revised to allow IMS emergency services for UEs without a valid UICC and for UEs in "forbidden Location Areas", "forbidden PLMN", etc. The following clauses of TS 23.122, version 7.5.0, seem to be affected: 3.4.2, 3.5, 4.4, 5, table 2, and so on.

J) Continued support of location (where required) following handover to a new SGSN

If the emergency session is handed over to a new SGSN – e.g. according to the A/Gb PS mode handover procedure defined in TS 43.129 or the UMTS procedure defined in TS 25.936 and TS 23.060 [2], then some further refinements to support the PS-NI-LR procedure may be needed when this procedure is used. For example, if the initial location of the UE was already sent to a GMLC by a previous SGSN using a PS-NI-LR, the new SGSN should not re-invoke another PS-NI-LR. On the other hand, the GMLC needs to know the address of the new SGSN in case an updated position estimate is required using a PS-MT-LR. This might be solved by adding both the GMLC address and an indication of whether an initial location estimate was already sent to the GMLC to the emergency PDP Context Information included in the Forward Relocation Request (defined in 3GPP TS 29.060) which is sent from the old SGSN to the new SGSN when a handover is started. The inclusion of the GMLC address avoids the possibility that based on different location information (e.g. new cell ID), the new SGSN selects the wrong GMLC for a PS-NI-LR. The indication of initial location performance tells the new SGSN whether besides sending its address to the GMLC (e.g. using a PS-NI-LR), it should also obtain and send a location estimate. During the handover itself, the old SGSN can refrain from performing location to ensure that the information sent in the Forward Relocation Request remains correct. These impacts affect core GPRS specifications.

Answer: Enable transfer of an indication as to whether a PS-NI-LR procedure was already performed or not together with the GMLC address from an old to new SGSN during handover of an emergency session.

Exact mechanism for information transfer to the new SGSN is FFS.

A.6 Selection of method for UICC-less emergency calls

A.6.1 GPRS considerations for IMS Emergency sessions

In GPRS, before IMS emergency session establishment, the UE performs an emergency attach if the UE is not attached to the network. The UE indicates the emergency attach by including an emergency indication to the Attach Request message. The network applies special treatment in case of the emergency attach procedure. After a successful emergency attach, only PDP context requests for emergency use shall be accepted by the SGSN. It is assumed that an already GPRS attached UE does not detach and re-attach for emergency services. If the UE is not equipped with an UICC, the UE performs the Emergency Attach using the IMEI. In this case the SGSN checks whether such an anonymous Emergency Attach is allowed. If this is not allowed, the Emergency Attach is rejected.

At GPRS level the mechanisms for establishing a bearer for emergency use should not differ much from the normal GPRS bearer establishment currently specified by 3GPP. In fact there is only a need for the network to be able to detect the emergency use and to be able to give special treatment to these bearers.

As a minimum emergency sessions and bearers for them should not be dropped, so emergency bearers may require enhanced QoS, e.g. higher priority than subscription based priority.

The UE establishes a bearer for emergency use by including the globally dedicated emergency APN during PDP context activation. PDP context modification and PDP context deactivation procedures are not affected.

A.6.2 Emergency Calls in absence of UICC for GPRS Access

The UE shall follow the procedures described below using the IMEI as the identity to access GPRS in the absence of an UICC.

The UICC-less MS is DEREGISTERED by default and shall therefore do Attach including the emergency indication when requesting access for the IMS emergency service. When the UICC is not present or the UICC is not valid, the ME shall identify itself in the Attach signalling by the IMEI in the same way as in the CS domain (the CM Service Request), see TS 24.008 [13] for more details.

NOTE 1: A UICC that is not valid is a UICC that in spite of being inserted is blocked for use, e.g. due to attempted access by a wrong pin-code or lack of roaming agreements.

NOTE 2: It is FFS how to use the EIR to blacklist certain IMEIs with frequent junk emergency calls.

NOTE 3: TS 23.122 needs to be revised to allow IMS emergency services for UICC-less MS.

NOTE 4: It is FFS: whether a new message type for emergency Attach is needed.

As neither authentication nor ciphering functionality can be performed there is no need to communicate with any HSS. After successful attach, the mobile shall continue with emergency session establishment. The above ensures that the existing GPRS procedures can be used without any major system impacts both in the network and the UE.

The UE shall not accept other numbers than the numbers stored in the ME as valid number for an emergency calls.

The emergency call application determines whether the CS emergency call or the IMS emergency call shall be used in the same way regardless whether the UICC is valid or not.

In order to support emergency calls from UICC-less terminals and UEs in limited-service-state (see TS 23.122) there is a need to specify a method for the UE to get emergency access to GPRS, otherwise such terminals will not be accepted in the network. There are also benefits if the emergency access method is used by "normal" UEs in PMM-idle mode. The requirements related to the emergency access method are specified below with additional comments.

Functional requirements for the emergency access method:

1. The emergency access method should be the same for UICC-less terminals, UEs in limited-service-state and for UEs in PMM-idle mode.
2. Existing security functions should apply when possible:
UEs with valid UICC are able to support standard security functions even when roaming in a forbidden PLMN or forbidden area. But in some scenarios the network will not be able to initiate the security functions. e.g. a non-roaming partner VPLMN is probably not able to get the authentication credentials and keys from the HSS of the UE in a forbidden area (i.e. in limited-service-state).
3. The level of security for UICC-less terminals and UEs in limited-service-state making a IMS emergency call shall not be any different from that of a UICC-less terminal or UE in limited service state making a CS emergency call.
4. Pre-Rel-7 SGSNs cannot support the emergency access method and the attempted emergency call from terminal should be rejected as soon as possible.
5. After the emergency call is cleared, the terminal should resume normal idle mode behaviour.

Annex B (informative): IMS emergency sessions over 3GPP/WLAN Interworking (I-WLAN)

B.1 Void

B.2 Void

B.3 Location handling for I-WLAN

If the UE has location information available, the UE should include the location information in the SIP INVITE request to establish an emergency session. The UE using WLAN access may use the identifier of the access node (e.g. the MAC address of the WLAN Access Point) as the Location Identifier. WLAN UE Originated Procedure in I-WLAN procedure defined in TS 23.271 [5] is applicable to obtain location information.

For regions (e.g. North America) in which an interim location may be required to assist routing to the correct PSAP and/or where accurate initial and updated location information may be required, the IW-MT-LR without HLR/HSS or AAA Query procedure defined in TS 23.271 [5] is applicable.

Annex C (normative): IMS emergency services using Fixed Broadband Access

C.1 Location Retrieval for emergency services over fixed broadband access

These procedures described in this annex apply when the IP-CAN contains a Network Attachment Subsystem with a CLF as specified in ETSI ES 282 004 [18].

C.1.1 High Level Principles for Emergency location information for fixed broadband access

In addition to the architecture described in clause 5.1 above, the P-CSCF has an interface to an LRF which may contain a CLF as described below in figure C.1. For more information on the CLF refer to ETSI ES 282 004 [18].

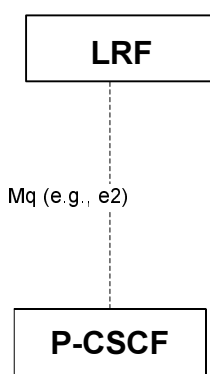

Figure C.1: Additional P-CSCF interface for fixed broadband access

For fixed broadband access, the UE may know its own network location or geographical location. If the UE knows its location, it shall insert the location information in the SIP INVITE request when establishing the emergency IMS session.

As an alternative, if the UE is not able to determine its own location, the UE should try to request its location from the access network. The access network may know the location of the access point where the UE is connected to. The UE should request the location information from the access network according to clause 7.6. The UE shall insert the location information received as a response to the location query in the emergency SIP INVITE request. This location information may be network based, e.g. line identification, or geographical location information.

If the UE does not know its location and is unable to obtain its location from the access network, the UE should have a means to indicate in the emergency SIP INVITE that its location is unknown.

If the UE does not provide location information, the P-CSCF may request location information from the LRF as described in clause 7.6 and insert the location information in the received INVITE request. The IMS network may also request location information from the LRF in the case that verification of the location information provided by the UE is required. After such verification, the IMS network may insert the location information received from the LRF or override the location information received from the UE before routing the request to the PSAP.

Editor's Note: How the IMS network routes the emergency session based on location information is FFS.

Editor's Note: Emergency location information for I-WLAN will be placed in a separate subclause.

C.1.2 Retrieval of location information for emergency services over fixed broadband access

In addition to subclause 7.6, the following applies for a fixed broadband access:

- When the UE is requesting to retrieve the location information from IP-CAN, the UE may use the DHCP option for coordinate-based geographic location of the client as specified by IETF in RFC 3825 [9] and the DHCP option that allows hosts to learn their civic location via DHCP, as specified in the draft-ietf-geopriv-dhcp-civil-06 [10]. This DHCP option shall not be used by an UE on an IP-CAN using 3GPP RAT.

Editor's Note: The implications when there is a NAT between the UE and the DHCP server is FFS.

- The line identifier used by the UE with fixed broadband access may be authenticated by the IMS core.

Annex D (informative): Examples of call flows according to NENA I2 recommendations

This section provides the examples of call flows according to NENA I2 recommendations [17].

D.1 ECS redirecting IMS emergency call

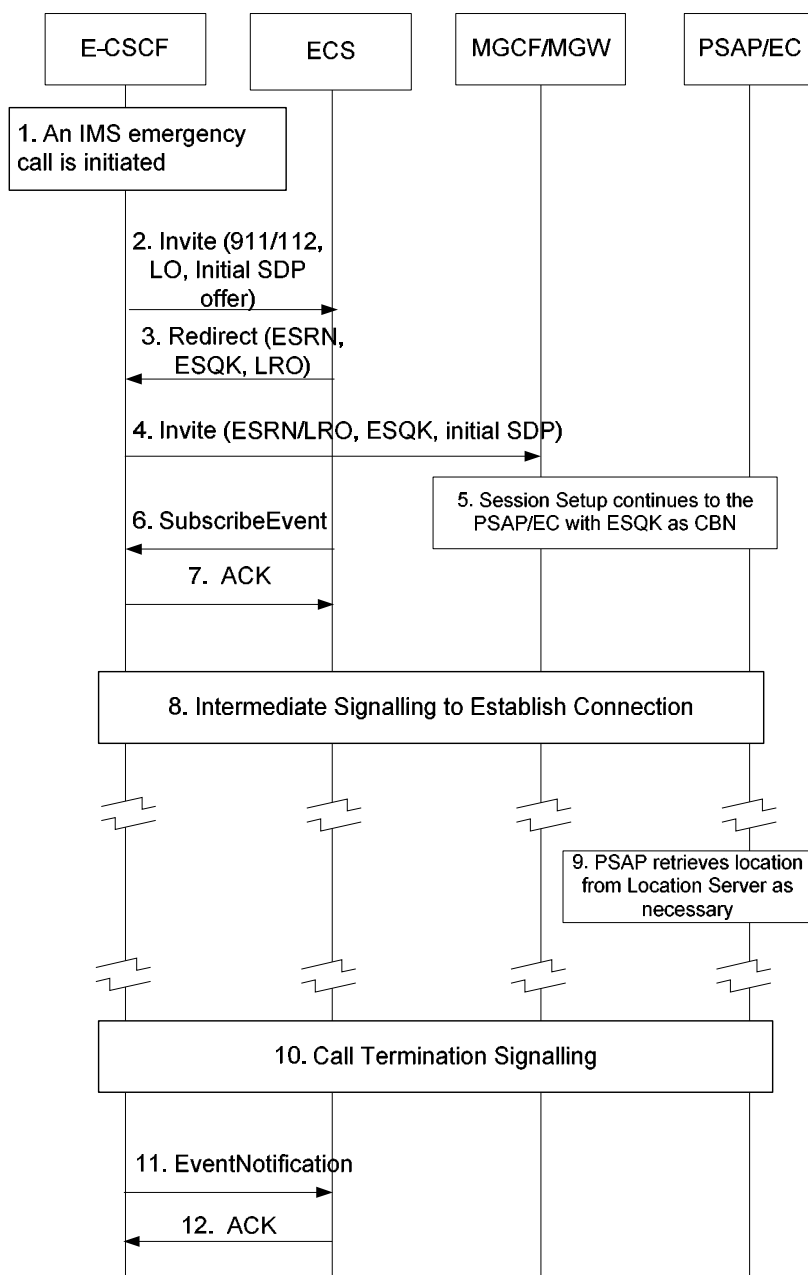

Figure D.1

This flow is supported by the procedures in clause 7.3, where the E-CSCF need not enquire the LRF for location information. Additional steps defined here are standard SIP methods, but not defined in this specification.

Detailed description of the procedure:

- 1) An IMS emergency call is initiated.
- 2) The E-CSCF sends an Invite message with 911 or other well known emergency number as the dialed number, the UE's location information in a Location Object (LO) if available, and the UE's media capabilities encapsulated in a SDP payload, to the ECS.
- 3) Based on the received Location Object (LO), the ECS will determine to which PSAP/EC the call should be routed and allocate an ESQK from the ESQK pool associated with that particular PSAP/EC. The ECS then will format a SIP response with the retrieved ESRN/ESQK in the Contact fields to redirect the emergency call.
- 4) The IMS Core uses the ESRN/ESQK received in the call redirect message to format an INVITE message properly, and sends it to the MGCF/MGW. A P-Asserted-Identity field may be inserted in the INVITE message, it contains either an ESQK or the CBN.
- 5) The emergency call setup continues with the PSAP/EC.
- 6) The ECS initiates a subscription at the IMS Core to request a notification of call termination of the emergency call.
- 7) An acknowledgement is returned.
- 8) The emergency session establishment signalling continues.
- 9) The PSAP retrieves location from the ECS.
- 10) The emergency session is released.
- 11) The IMS Core sends an EventNotification message to the ECS with an Event indicating that the 911 call has been terminated. At this time, the ESQK allocated to the emergency session can be released.
- 12) An acknowledgement is returned to the IMS Core.

D.2 ECS routes the emergency call to the gateway with record route

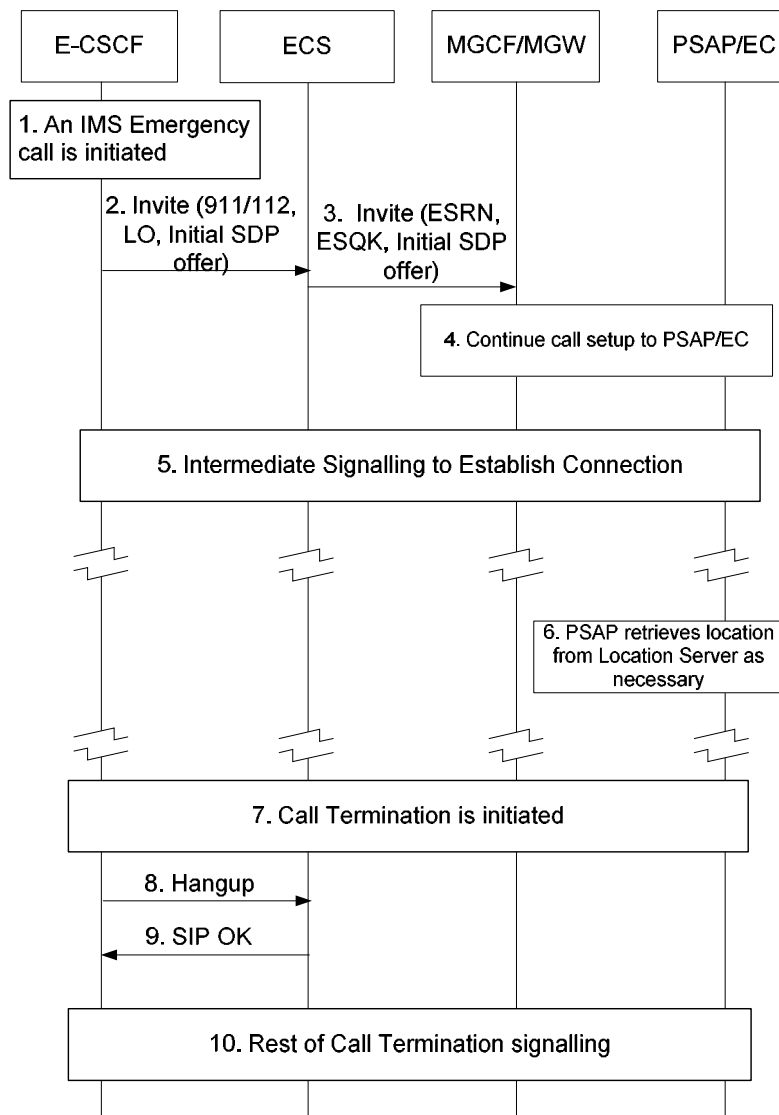

Figure D.2

This flow is supported by the procedures in clause 7.3, where the E-CSCF need not enquire the LRF for location information.

Detailed description of the procedure:

- 1) An IMS emergency call is initiated.
- 2) The E-CSCF sends an Invite message with 911 or other well known emergency number as the dialled number, the UE's location information in a Location Object (LO) if available, and the UE's media capabilities encapsulated in a SDP payload, to the ECS.
- 3) Based on the received Location Object (LO), the ECS will determine to which PSAP/EC the call should be routed and allocate an ESQK from the ESQK pool associated with that particular PSAP/EC. The ECS then re-issues an Invite to an appropriate MGCF/MGW with the ESRN/LRO, ESQK and a record route indication. or the call to be routed to PSAP the P-Asserted-Identity contains ESQK, A P-Asserted-Identity field may be inserted in the INVITE message, f for the call to be routed to other emergency answering centre the P-Asserted-Identity contains the CBN.

- 4) The emergency call setup continues with the PSAP/EC.
- 5) The emergency session establishment signalling continues.
- 6) The PSAP retrieves location from the ECS.
- 7) Either the caller or PSAP initiates the call termination signalling.
- 8) The E-CSCF or MGCF/MGW forwards the hangup message to the ECS. At this time, the ESQK allocated to the emergency session can be released.
- 9) The ECS sends an OK to the E-CSCF or MGCF/MGW.
- 10) The call termination signalling continues.

Annex E (informative): Change history

Change history								
Date	TSG #	TSG Doc.	CR	Rev	Cat	Subject/Comment	Old	New
2005-11	SA#30	SP-050676	-	-		Editorial update by MCC for presentation to TSG SA for information	0.2.0	1.0.0
2006-03	SA#31	SP-060151	-	-		Editorial update by MCC for presentation to TSG SA for approval	1.3.1	2.0.0
2006-03	SA#31	-	-	-		Publication after TSG SA Approval	2.0.0	7.0.0
2006-06	SA#32	SP-060283	0001	3		Basic Call Flows of North America IMS Emergency Session Establishment	7.0.0	7.1.0
2006-06	SA#32	SP-060395	0004	4		Corrections in emergency registration and session request	7.0.0	7.1.0
2006-06	SA#32	SP-060283	0008	1		23.167 Cleanup	7.0.0	7.1.0
2006-06	SA#32	SP-060283	0009	2		Additional Emergency text clarification with regards to NA regional requirements	7.0.0	7.1.0
2006-06	SA#32	SP-060394	0010	3		Location retrieval interface clarification	7.0.0	7.1.0
2006-06	SA#32	SP-060283	0011	2		Addition of missing definitions and abbreviations	7.0.0	7.1.0
2006-06	SA#32	SP-060283	0012	-		Removal of editor's notes on emergency Public User Identifier	7.0.0	7.1.0
2006-06	SA#32	SP-060282	0018	3		Requirement of emergency session establishment without emergency registration	7.0.0	7.1.0
2006-06	SA#32	SP-060283	0021	1		Correction of reference in subclause A-4	7.0.0	7.1.0
2006-09	SA#33	SP-060578	0005	2	F	Support of Local Emergency Numbers for IMS Emergency Calls	7.1.0	7.2.0
2006-09	SA#33	SP-060578	0024	1	F	Miscellaneous corrections for IMS Emergency Calls	7.1.0	7.2.0
2006-09	SA#33	SP-060578	0030	3	F	Answers to the GPRS questions in Annex A	7.1.0	7.2.0
2006-12	SA#34	SP-060824	0025	4	C	Blocking of caller's information for emergency communications	7.2.0	7.3.0
2006-12	SA#34	SP-060823	0032	2	F	Clarification to emergency service requirement	7.2.0	7.3.0
2006-12	SA#34	SP-060823	0034	2	F	Change of Annex C title following LS from TISPAN WG2 and approved by SA WG2	7.2.0	7.3.0
2006-12	SA#34	SP-060824	0036	4	C	Addition of source of location information	7.2.0	7.3.0
2006-12	SA#34	SP-060823	0043	1	F	Emergency IMS registration	7.2.0	7.3.0
2006-12	SA#34	SP-060824	0044	2	C	Emergency location information for I-WLAN	7.2.0	7.3.0
2006-12	SA#34	SP-060824	0045	2	B	Restriction to Emergency IMPU	7.2.0	7.3.0
2006-12	SA#34	SP-060823	0049	-	F	Conveying UE Location Capabilities and Clarifying Location Procedures for IMS Emergency Calls	7.2.0	7.3.0
2007-03	SA#35	SP-070086	0038	3	F	GGSN filtering rules	7.3.0	7.4.0
2007-03	SA#35	SP-070086	0050	1	F	Correction to the criteria of IMS emergency registration	7.3.0	7.4.0
2007-03	SA#35	SP-070086	0051	1	F	Correction to XML element and value of 380 response for emergency call with non-emergency registration	7.3.0	7.4.0
2007-03	SA#35	SP-070086	0053	2	F	Rejection of non emergency request with EIMPU	7.3.0	7.4.0
2007-03	SA#35	SP-070086	0054	-	F	Annex B (I-WLAN) cleanup	7.3.0	7.4.0
2007-03	SA#35	SP-070086	0059	1	B	PCC in emergency sessions	7.3.0	7.4.0
2007-03	SA#35	SP-070086	0060	1	F	Correction to Location Information Principle of P-CSCF	7.3.0	7.4.0
2007-03	SA#35	SP-070086	0061	1	C	Setting Emergency Registration Expiration by the Visited Network	7.3.0	7.4.0
2007-03	SA#35	SP-070086	0062	-	F	Functional requirements for GPRS emergency access	7.3.0	7.4.0
2007-03	SA#35	SP-070086	0063	1	B	Use of PCC rules to enforce emergency bearer's usage	7.3.0	7.4.0
2007-06	SA#36	SP-070385	0065	1	F	Align Stage 2 with stage 1 on domain selection for emergency call	7.4.0	7.5.0
2007-06	SA#36	SP-070385	0066	-	F	Editor's note clean up - anonymous rejection by access network	7.4.0	7.5.0

History

Document history		
V7.4.0	March 2007	Publication
V7.5.0	June 2007	Publication