

ETSI TS 123 204 V11.2.0 (2012-11)



**Universal Mobile Telecommunications System (UMTS);
LTE;
Support of Short Message Service (SMS)
over generic 3GPP Internet Protocol (IP) access;
Stage 2
(3GPP TS 23.204 version 11.2.0 Release 11)**



Reference

RTS/TSGS-0223204vb20

Keywords

LTE,UMTS

ETSI

650 Route des Lucioles
F-06921 Sophia Antipolis Cedex - FRANCE

Tel.: +33 4 92 94 42 00 Fax: +33 4 93 65 47 16

Siret N° 348 623 562 00017 - NAF 742 C
Association à but non lucratif enregistrée à la
Sous-Préfecture de Grasse (06) N° 7803/88

Important notice

Individual copies of the present document can be downloaded from:

<http://www.etsi.org>

The present document may be made available in more than one electronic version or in print. In any case of existing or perceived difference in contents between such versions, the reference version is the Portable Document Format (PDF). In case of dispute, the reference shall be the printing on ETSI printers of the PDF version kept on a specific network drive within ETSI Secretariat.

Users of the present document should be aware that the document may be subject to revision or change of status. Information on the current status of this and other ETSI documents is available at

<http://portal.etsi.org/tb/status/status.asp>

If you find errors in the present document, please send your comment to one of the following services:

http://portal.etsi.org/chaicor/ETSI_support.asp

Copyright Notification

No part may be reproduced except as authorized by written permission.
The copyright and the foregoing restriction extend to reproduction in all media.

© European Telecommunications Standards Institute 2012.
All rights reserved.

DECT™, **PLUGTESTS™**, **UMTS™** and the ETSI logo are Trade Marks of ETSI registered for the benefit of its Members.
3GPP™ and **LTE™** are Trade Marks of ETSI registered for the benefit of its Members and
of the 3GPP Organizational Partners.
GSM® and the GSM logo are Trade Marks registered and owned by the GSM Association.

Intellectual Property Rights

IPRs essential or potentially essential to the present document may have been declared to ETSI. The information pertaining to these essential IPRs, if any, is publicly available for **ETSI members and non-members**, and can be found in ETSI SR 000 314: *"Intellectual Property Rights (IPRs); Essential, or potentially Essential, IPRs notified to ETSI in respect of ETSI standards"*, which is available from the ETSI Secretariat. Latest updates are available on the ETSI Web server (<http://ipr.etsi.org>).

Pursuant to the ETSI IPR Policy, no investigation, including IPR searches, has been carried out by ETSI. No guarantee can be given as to the existence of other IPRs not referenced in ETSI SR 000 314 (or the updates on the ETSI Web server) which are, or may be, or may become, essential to the present document.

Foreword

This Technical Specification (TS) has been produced by ETSI 3rd Generation Partnership Project (3GPP).

The present document may refer to technical specifications or reports using their 3GPP identities, UMTS identities or GSM identities. These should be interpreted as being references to the corresponding ETSI deliverables.

The cross reference between GSM, UMTS, 3GPP and ETSI identities can be found under <http://webapp.etsi.org/key/queryform.asp>.

Contents

Intellectual Property Rights	2
Foreword.....	2
Foreword.....	5
Introduction	5
1 Scope	6
2 References	6
3 Definitions and abbreviations.....	7
3.1 Definitions	7
3.2 Abbreviations	8
4 Void.....	8
4a Architecture Requirements.....	8
4a.1 General	8
4a.2 Transport-level interworking.....	8
4a.3 Service-level interworking	8
4a.4 MT-SMS without MSISDN interworking.....	10
5 Architecture model and reference points.....	10
5.1 Reference architecture	10
5.2 Reference points	11
5.2.1 General.....	11
5.2.2 C interface.....	11
5.2.3 Interface between the IP-SM-GW and the HLR/HSS.....	11
5.2.4 E/Gd interface	11
5.2.5 ISC interface	11
5.2.6 Void	11
5.3 Functional entities	11
5.3.1 IP-Short-Message-Gateway (IP-SM-GW)	11
5.3.1.1 General	11
5.3.1.2 Transport-level interworking.....	12
5.3.1.3 Service-level interworking	13
5.3.2 HSS	13
6 Procedures	14
6.0 General	14
6.0a MT-SMS without MSISDN in IMS	14
6.1 Registration procedure	14
6.2 De-registration procedure.....	15
6.2.1 UE initiated.....	15
6.2.2 Network initiated	16
6.3 Transport-level interworking: Successful encapsulated Short Message origination procedure	16
6.4 Transport-level interworking: Successful encapsulated Short Message termination procedure.....	17
6.5 Transport-level interworking: Delivery Report procedure	19
6.5a Unsuccessful SM termination procedure.....	19
6.5b Alert Service Centre procedure when UE is available	21
6.6 Transport-level interworking: Alert service centre procedure when memory capacity is available.....	22
6.7 Service-level Interworking: IM or CPM capable UE sends an Instant Message to an SMS user	24
6.8 Interaction between transport-level and service-level Interworking	25
6.8.1 General.....	25
6.8.2 IMS Originating.....	25
6.8.3 IMS Terminating	27
6.9 Service-level Interworking: Concatenated Short Messages delivered as a large Instant Message	27
6.10 Service-level interworking: Status Report procedure for Instant Message to Short Message interworking.....	30
6.11 IM or CPM user sends an Instant Message to an SMSIP UE.....	31

6.12	Delivery report for an Instant Message delivered as encapsulated Short Message	32
6.13	Service-level interworking: IM or CPM capable UE sends an Instant Message to an SMS user with Interworking in the terminating side	33
6.14	Service-level interworking: IM or CPM user receives Short Message from an SMS user.....	34
6.15	Service-level Interworking: CPM capable UE sends a Chat session invitation to an SMS user	36
6.15.1	IP-SM-GW in the originating network	36
6.15.2	IP-SM-GW in the terminating network	38
6.16	Service-level Interworking: CPM capable UE tearing down a Chat session between a CPM user and an SMS user	40
6.16.1	IP-SM-GW in the originating network	40
6.16.2	IP-SM-GW in the terminating network	40
6.17	Service-level Interworking: SMS user requesting the IP-SM-GW to tear down the Chat session between a CPM user and an SMS user	42
6.17.1	IP-SM-GW in the originating network	42
6.17.2	IP-SM-GW in the terminating network	42
6.18	Service-level interworking: Status Report procedure for chat session message to Short Message interworking	44
Annex A (informative):	Service-level interworking: IM or CPM user sends an Instant Message to a group list including SMS users	46
Annex B (informative):	Group chat sessions	48
B.1	Service-level interworking: IM or CPM user initiates a group chat and sends an Instant Message to a group list including SMS users.....	48
B.2	Service-level interworking: CPM user extends a one-to-one chat session into a group chat session	51
B.3	Service-level interworking: IP-SM-GW informs SMS users about group chat participant changes	52
Annex C (informative):	Change History	54
History		55

Foreword

This Technical Specification has been produced by the 3rd Generation Partnership Project (3GPP).

The contents of the present document are subject to continuing work within the TSG and may change following formal TSG approval. Should the TSG modify the contents of the present document, it will be re-released by the TSG with an identifying change of release date and an increase in version number as follows:

Version x.y.z

where:

- x the first digit:
 - 1 presented to TSG for information;
 - 2 presented to TSG for approval;
 - 3 or greater indicates TSG approved document under change control.
- y the second digit is incremented for all changes of substance, i.e. technical enhancements, corrections, updates, etc.
- z the third digit is incremented when editorial only changes have been incorporated in the document.

Introduction

The Short Message Service (SMS) has have enjoyed great success in cellular networks. At the same time, specifications have been and are being developed for extending 3GPP services to non-cellular IP Connectivity Access Networks (IP-CANs). In this same spirit, this specification describes the capabilities needed to support SMS for generic IP-CANs.

SMS over generic IP access can be used to support applications and services that use SMS when a generic IP access is used.

1 Scope

The present document specifies the new capabilities and enhancements needed to support SMS over a generic IP Connectivity Access Network (IP-CAN) using IMS capabilities (TS 23.228 [9]). These include (but are not limited) to:

- 1 Enhancements to the HSS;
- 2 Communication between the SMS-GMSC/SMS-IW MSC and the HSS;
- 3 Authentication of service usage and registration;
- 4 Transfer of UE Terminated SMS, UE Originated SMS, and Delivery reports;
- 5 Mechanisms to handle SMS when there is more than one IP connection active with the UE, etc.
- 6 Mechanisms to handle MT-SMS without MSISDN.

The document also specifies the capabilities and enhancements needed to support the service level interworking for the Short Message service as defined in the TS 23.040 [2] and in this specification and the Instant Messaging service as defined in OMA-TS-SIMPLE-IM-V1_0 [12]. The features supported from the IM specification are limited to the exchange of short or large immediate messages in pager mode.

NOTE: The page-mode immediate message as defined in TS 24.247[14] is considered as a subset of OMA-TS-SIMPLE-IM-V1_0 [12].

The document also specifies the capabilities and enhancements needed to support service level interworking for the Short Message service, as defined in the TS 23.040 [2] and in this specification and the OMA CPM service as defined in OMA-TS-CPM_Conv_Funct-V1_0 [17]. The features supported from the CPM specification are the exchange of short or large immediate messages in pager mode, as well as session-based messaging.

The service requirements are described in TS 22.340 [18].

2 References

The following documents contain provisions which, through reference in this text, constitute provisions of the present document.

- References are either specific (identified by date of publication, edition number, version number, etc.) or non-specific.
- For a specific reference, subsequent revisions do not apply.
- For a non-specific reference, the latest version applies. In the case of a reference to a 3GPP document (including a GSM document), a non-specific reference implicitly refers to the latest version of that document *in the same Release as the present document*.

- | | |
|-----|---|
| [1] | 3GPP TR 21.905: "Vocabulary for 3GPP Specifications". |
| [2] | 3GPP TS 23.040: "Technical realization of the Short Message Service (SMS) Point to Point (PP)". |
| [3] | Void. |
| [4] | Void. |
| [5] | Void. |
| [6] | 3GPP TS 29.002: "Mobile Application Part (MAP) specification". |
| [7] | Void. |
| [8] | Void. |

- [9] 3GPP TS 23.228: "IP Multimedia Subsystem (IMS); Stage 2".
- [10] Void.
- [11] Void.
- [12] OMA: "Instant Messaging using SIMPLE", OMA-TS-SIMPLE_IM-V1_0, <http://www.openmobilealliance.org/>
- [13] IETF RFC 5438: "Instant Message Disposition Notification", February, 2009.
- [14] 3GPP TS 24.247: "Messaging service using the IP Multimedia (IM) Core Network (CN) subsystem; Stage 3".
- [15] OMA: "CPM Requirements", OMA-RD-CPM-V1_0, <http://www.openmobilealliance.org/>
- [16] OMA: "CPM Architecture", OMA-AD-CPM-V1_0, <http://www.openmobilealliance.org/>
- [17] OMA: "CPM Conversation Functions", OMA-TS-CPM_Conv_Funct-V1_0, <http://www.openmobilealliance.org/>
- [18] 3GPP TS 22.340: "IP Multimedia System (IMS) messaging; Stage 1".
- [19] IETF RFC 4975: "The Message Session Relay Protocol (MSRP)", September 2007.
- [18] 3GPP TS 23.682: "Architecture enhancements to facilitate communications with packet data networks and applications".

3 Definitions and abbreviations

3.1 Definitions

For the purposes of the present document, the terms and definitions given in TR 21.905 [1] and the following definitions apply. A term defined in the present document takes precedence over the definition of the same term, if any, in TR 21.905 [1]:

Converged IP Messaging: as defined in OMA-RD-CPM-V1_0 [15]. Converged IP Messaging supports one-to-one, one-to-many personal communications, and also communication with Applications.

CPM Message: as defined in OMA-RD-CPM-V1_0 [15]: Information that is sent to one or more recipients. A CPM Message can contain several discrete Media (e.g. text, images, audio-clips, video-clips).

CPM AS: An application server supporting the functionality of a CPM Participating Function and/or a CPM Controlling Function as defined in OMA-RD-CPM-V1_0 [15].

IM origination: origination of an Instant Message by an IMS UE.

IM termination: termination of an Instant Message by an IMS UE.

IMS core: refers to the core session control elements of the IM CN Subsystem, i.e. the CSCFs, and the IBCF.

Instant Message: an Instant Message as defined in the OMA-TS-SIMPLE_IM-V1_0 [12] and TS 24.247 [14]. The term Instant Message is also used to designate a CPM Message.

Interworking Selection Function: as defined in OMA-AD-CPM-V1_0 [16]. The Interworking Selection Function selects an Interworking Function that should perform the actual interworking between CPM and SMS.

SIMPLE IM service: the Instant Messaging Service as defined in the OMA-TS-SIMPLE_IM-V1_0 [12].

SM origination: origination of a Short Message (including SMS over IP) by an SMS capable UE, as defined in TS 23.040 [2] and this specification.

SM termination: termination of a Short Message (including SMS over IP) by an SMS capable UE, as defined in TS 23.040 [2] and this specification.

SMS: the Short Message Service as defined in the TS 23.040 [2].

SMSIP MESSAGE: an immediate message as defined in TS 23.228 [9], which encapsulates a SM in its text body.

SMSIP UE: a UE which supports SMSIP MESSAGE.

3.2 Abbreviations

For the purposes of the present document, the abbreviations given in TR 21.905 [1] and the following apply:

CPM	Converged IP Messaging
IM	Instant Message
IMDN	Instant Message Disposition Notification
IP-SM-GW	IP-Short-Message-Gateway
ISF	Interworking Selection Function
SM	Short Message

4 Void

4a Architecture Requirements

4a.1 General

The SMS-IP architecture supports the following:

- Notification shall be sent to the HSS that a previously unreachable UE is now reachable.
- Functionality is required to be able to select the domain for message delivery between IMS and CS/PS, and to have the message delivered to the selected domain.
- Functionality is required to determine whether to transform the message format or not, and to perform the transformation of the message format when determined.
- The interworking function shall generate the appropriate charging-related information and provide the appropriate online charging mechanism (if it is applied for the Short Message Service and/or SIMPLE IM services and/or CPM based services) for the interworking services.

4a.2 Transport-level interworking

For transport-level interworking, the architecture allows for the following:

- A registration and de-registration mechanism shall be supported where UEs are required to explicitly indicate their ability to send and receive encapsulated Short Messages.
- It shall provide for the transport of Short Message Service TP layer PDUs (TS 23.040 [2]) and associated RP layer information.

4a.3 Service-level interworking

For service-level interworking, the architecture allows for the following:

- The service-level interworking is a value added service which requires service subscription. In addition, it shall also take the operator's policy, if available, into account, e.g. checking on the barring setting of the subscriber to determine whether to provide this interworking or not, so the service authorisation shall be supported before the interworking is executed.
- The service-level interworking applies as a fallback only if the users cannot communicate with each other using their chosen messaging service according to the user preference and operator policy. The location of the interworking service can be in the originating network and in the terminating network.
- The service-level interworking shall support interworking between OMA SIMPLE IM service as defined in OMA-TS-SIMPLE_IM-V1_0 [12] and Short Message Service, as defined in the TS 23.040 [2] and in the current specification.
- The service-level interworking shall support interworking between OMA CPM service as defined in OMA-TS-CPM_Conv_Funct-V1_0 [17] and Short Message Service, as defined in the TS 23.040 [2] and in the current specification.
- The service-level interworking shall take the capability of the terminating UE into account when possible.
- The service level interworking shall be transparent to the end user.
- The service-level interworking shall minimize the impact on the IMS architecture.
- The service-level interworking shall not impact existing functionality of the Short Message Service as described in TS 23.040 [2] or of the SIMPLE IM service enabler as described in OMA-TS-SIMPLE_IM-V1_0 [12] or of the CPM service enabler as described in OMA TS CPM_Conv_Funct-V1_0 [17]. Existing security mechanisms for the SIMPLE IM service, the Converged IP Messaging service and the Short Message Service shall be reused.
- The interworking function shall be aware if the message should be interworked or not, e.g. specific types of Short Messages such as an over the air configuration message, shall not be interworked at service-level, but shall be instead transported as a Short Message via IMS, CS or PS.
- If an SMS user requests an SMS status report that the message was delivered to the recipient, then an SMS status report shall be generated when the message is delivered using Instant Message.
- If an IMS user requests a notification that the message was delivered to the recipient and the Instant Message is interworked to Short Message on the originating side, an SMS status report shall be interworked to a delivery notification when the message is delivered.
- The interworking functionality shall be executed in the following cases:
 - Originating network:
 - The sender is an IM user or a CPM user who has subscribed to the interworking function and the recipient is not routable in IMS;
 - The operator policy on the originating side has been set to send the Instant Messages via Short Message Service.
 - Terminating network:
 - The user preferences and/or the operator policy of the recipient have been set to receive the incoming Instant Messages via Short Message Service;
 - The received message is a Short Message and the recipient is an IM user or a CPM user and has subscribed to the interworking service.

NOTE: For ensuring the integrity of the response messages from the IM UE or the CPM UE, it is strongly recommended that in networks where the IP-SM-GW is deployed, no intermediate nodes modify or terminate the message between the IP-SM-GW and the terminating IM UE or CPM UE. If intermediate nodes are deployed, they can send response messages that do not reflect the final response from the IM UE or CPM UE. Final responses from the IM UE or CPM UE are necessary to ensure correct charging and delivery reports on the Short Message Service side.

4a.4 MT-SMS without MSISDN interworking

For MT-SMS without MSISDN interworking, the architecture allows for the following in addition to clause 4a.2:

- It shall provide for the transport of Mobile Terminating Short Message Service to UE without the need of MSISDN in the UE's IMS subscription profile.

5 Architecture model and reference points

5.1 Reference architecture

Figure 5.1 below shows the overall architecture for providing SMS over a generic IP CAN.

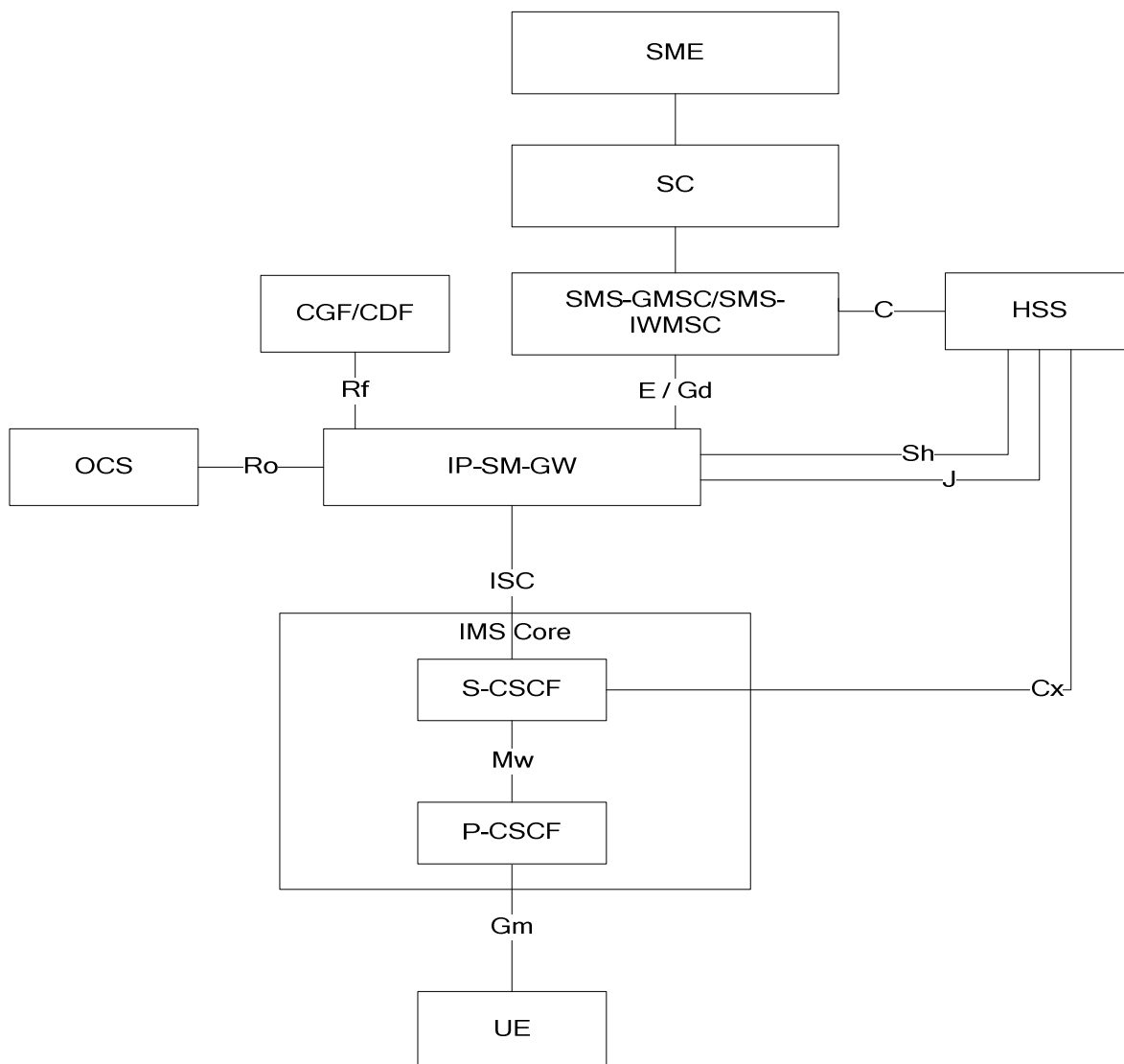

Figure 5.1: Architecture for providing SMS over a generic IP-CAN

NOTE: Nodes specific to the CPM functions such as ISF are either collocated with the IP-SM-GW or else are not shown.

5.2 Reference points

5.2.1 General

The sub-sections below describe the needed enhancements and specific considerations to existing interfaces in order to support SMS over a generic IP-CAN.

5.2.2 C interface

The C interface allows the SMS-GMSC, using MAP, to obtain the address of the IP-Message-GW via mechanisms described in clause 5.3.

5.2.3 Interface between the IP-SM-GW and the HLR/HSS

The interface(s) between the IP-SM-GW and the HLR/HSS is used for:

- Supporting the registration and de-registration from the IP-SM-GW to the HLR/HSS for SMS delivery.
- Forwarding of the Send Routeing Information for Short Message requests from HLR/HSS to IP-SM-GW in order to return the address where the SM should be forwarded.
- Interrogating the HLR/HSS using Send Routeing Information for Short Message to retrieve the IMSI and the current MSC and/or SGSN addresses.
- Informing the HLR/HSS when a memory capacity exceeded condition ceases.
- Retrieving SMS related data from the HLR/HSS: subscriber data of the short message service similar to the data for the current CS/PS domain and additional service data on the service authorisation of the encapsulated short message delivery via IMS, SC address for service-level interworking from Instant Message to Short Message if the SC address is stored in the HLR/HSS.

Both the J and a Sh interface can be deployed between the IP-SM-GW and the HLR/HSS. During the functional allocation the change on existing MAP functions should be minimized. The deployment of the J interface is mandatory, since it is used for forwarding the SRI for SM MAP message.

5.2.4 E/Gd interface

The E/Gd interface allows the IP-SM-GW to connect to the SMS-GMSC using MAP, appearing to the SMS-GMSC as an MSC or SGSN.

5.2.5 ISC interface

The ISC interface allows the IP-SM-GW to forward the receiving message to the SIP based UE via IMS core.

5.2.6 Void

5.3 Functional entities

5.3.1 IP-Short-Message-Gateway (IP-SM-GW)

5.3.1.1 General

The IP-SM-GW shall provide the protocol interworking for delivery of the short message between the IP-based UE and the SMS-SC. The message is routed to the SMS-SC for delivery to the SMS-based user or the message is received from the SMS-SC of an SMS-based UE for delivery to an IP-based UE.

The general functions of the IP-SM-GW are:

- to determine the domain (CS/PS or IMS) for delivery of a Short Message;
- to connect to the SMS-GMSC using established MAP protocols, appearing to the SMS-GMSC as an MSC or SGSN using the E or Gd interfaces;
- to respond to Send Routing Information for Short Message requests made by the SMS-GMSC, and forwarded from the HSS, with its own address;
- to connect to the SMS-IW MSC using established MAP protocols, appearing to the SMS-IW MSC as an MSC or SGSN using the E or Gd interfaces;
- to connect to the HSS using established MAP protocols, to obtain the address of MSC/SGSN address(es) for SM termination in CS/PS;

NOTE: The IP-SM-GW need not support all of the functionality defined in MAP in TS 29.002 [6].

- to acquire and maintain knowledge of the association between the MSISDN, IMSI and the address of the S-CSCF serving of the user;
- to check that it has a valid address in SMS for the sender as well as the recipient when receiving an IMS message for an SMS user. The IP-SM-GW shall obtain a valid address for both from the SIP headers of the IMS message (e.g. the sender would be identified in the asserted id in form of TEL URI);
- for terminating procedures:
 - if TEL URI is available, it maps the recipient's address from an MSISDN/IMSI to TEL URI format when receiving an SMS for an IP-based UE, and then it is the responsibility of the IMS core to perform any further mapping towards a SIP URI as required;
 - if TEL URI is not available, it maps the recipient's address from an IMSI to SIP URI format when receiving an SMS for an IP-based UE.
- to act as an Application Server towards the IMS core;
- to perform domain selection to choose the appropriate domain to deliver a message to a recipient and to obtain the MSC and/or SGSN addresses from the HSS; and
- to manage flags indicating user availability for SMS termination in the HSS.

5.3.1.2 Transport-level interworking

The additional functions of the IP-SM-GW when interworking is done by carrying encapsulated Short Messages in IMS messages are:

- to communicate with the UE using IMS messaging as transport while maintaining the format and functionality of the Short Message;
- to carry the SMS status messages as encapsulated bodies of IMS messages;
- to store the subscriber data of the short message service similar to the data for the current CS/PS domain and to perform the short message authorization as performed by the MSC/SGSN, as well as to store additional service data on the service authorisation of the encapsulated Short Message delivery via IMS and to perform the service authorization.

NOTE 1: The short message subscriber data of the CS/PS domain and additional service data on the authorisation of encapsulated Short Message delivery via IMS are retrieved from the HLR/HSS via third party registration procedure as specified in the clause 6.1. The IP-SM-GW can request the HSS to send a notification whenever the subscriber data and/or additional service data is updated, which the IP-SM-GW can then retrieve.

NOTE 2: The mechanism for prioritizing whether the short message is delivered via a GSM/UMTS or other IP-CAN connection when the terminal is simultaneously connected to both access networks is outside the scope of this specification.

5.3.1.3 Service-level interworking

The additional functions of the IP-SM-GW when service-level interworking is done between Short Messages and Instant Messages in IMS are:

- to determine whether to transform the message format or not, and to perform the transformation of the message format when determined.
- to use the SC address retrieved either as part of the subscriber data from the HSS at registration or as provisioned by configuration, when transforming the Instant Message into Short Message.
- to perform the authorization for service-level interworking.

The additional functions of the IP-SM-GW when service-level interworking is done between Short Messages and CPM Messages in IMS are the same as functions performed for Instant Messages in IMS and additionally:

- to translate a chat session invitation to a short message including instructions for the SMS user how to react (accept/reject) the chat session invitation, if operator policy mandates the consent of the SMS user. Otherwise the IP-SM-GW shall respond a chat session invitation on behalf of the SMS user (accept/reject), according to operator policy;
- to translate the SMS user's answer to a chat session invitation to a proper response for the chat session invitation request;
- to inform SMS user about the changes of group chat session parameters;
- to translate a chat session teardown request to a short message, if operator policy mandates it; and
- to translate the SMS user's request to leave a chat session to a proper CPM request.

5.3.2 HSS

In order to support SMS over generic IP access, the HSS shall support the following functions:

- storing the pre-configured address of the IP-SM-GW on a subscriber basis;

NOTE: If all subscribers are assigned to a single IP-SM-GW address, the IP-SM-GW address does not need to be pre-configured in the HSS.

- handling an indication that the terminal is registered with an IP-SM-GW for delivery of SMS;
- responding to the "send routing information for short message" query from IP-SM-GW with the address of the MSC/SGSN;
- forwarding the Send Routeing Information for Short Message, from an SMS-GMSC, towards the IP-SM-GW and forwarding any responses to the originator of the Send Routeing Information for Short Message;
- returning the IMSI and the MSC and/or SGSN addresses as a response to Send Routeing Information for Short Message required from IP-SM-GW;
- alerting the SCs stored in the message waiting data when the terminal is registered with an IP-SM-GW for delivery of short message;
- reporting notification to the IP-SM-GW of the reachability of a UE at the transport layer after a delivery failure ; and
- accepting delivery status reports from IP-SM-GWs instead of SMS-GMSC.

6 Procedures

6.0 General

The clause describes the procedures for the support of transport-level interworking between Short Message service and encapsulated Short Message via IP service, for the support of the service-level interworking for the Short Message service and Instant Messaging service as defined in OMA-TS-SIMPLE_IM-V1_0 [12], for the support of the service-level interworking for the Short Message service and Converged IP Messaging service as defined in OMA-TS-CPM_Conv_Funct-V1_0 [17] and for the support of receiving MT-SMS to a UE without MSISDN. Clauses only applying to either transport-level interworking or service-level interworking are indicated as such.

NOTE: In the procedures in the following clauses, the I-CSCF, P-CSCF and ASs such as IM AS, as well as nodes specific to CPM functions such as ISF, are not shown in the figures.

6.0a MT-SMS without MSISDN in IMS

The selection of IMS to deliver MT-SMS without MSISDN for device triggering is defined in TS 23.682 [20]. This clause describes the additional functionality required for the delivery of MT-SMS toward a UE in IMS without MSISDN.

During UE IMS registration procedure, the serving IP-SM-GW obtains IMSI of the UE from the S-CSCF and the serving IP-SM-GW address is indicated to HSS as defined in clause 6.1 and HSS stores this IP-SM-GW address. IP-SM-GW subscribes to event registration package to receive UE's IMPU (i.e. SIP URI). UE which does not have MSISDN will have at least one SIP-URI as IMPU. IP-SM-GW shall try to deliver the MT-SMS via IMS without retrying to other domain.

6.1 Registration procedure

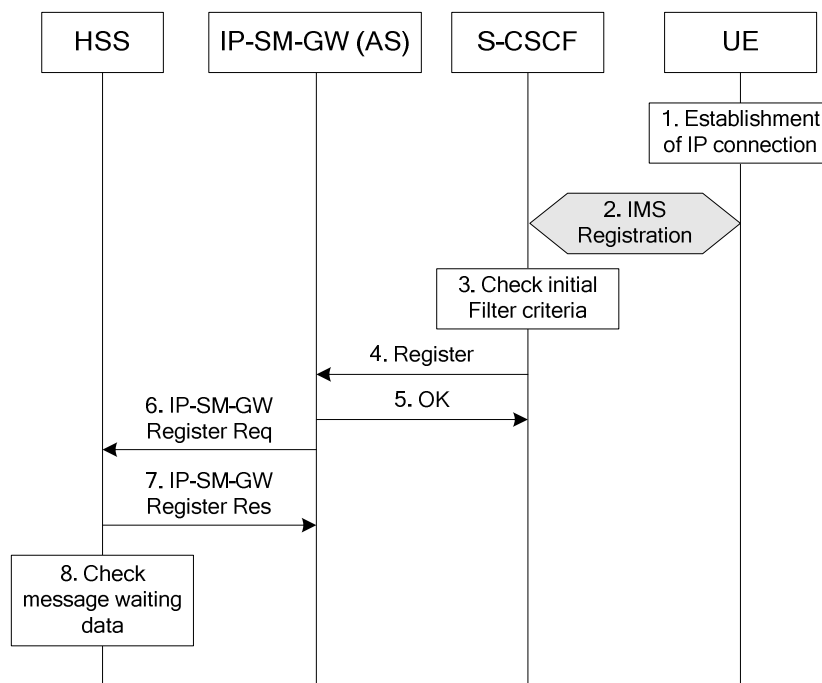

Figure 6.1: Registration procedure

- 1) The UE establishes IP connection.
- 2) At any time after the establishment of the IP connection, the UE registers at the S-CSCF according to the IMS registration procedures.

NOTE 1: For simplicity, not all messages between UE and S-CSCF and between S-CSCF and HSS are shown in detail.

- 3) S-CSCF checks the initial filter criteria retrieved from the HSS during the IMS registration procedure.
- 4) After successful IMS registration and based on the retrieved initial filter criteria, the S-CSCF informs the IP-SM-GW (AS) about the registration of the user. IMSI is informed to the IP-SM-GW (AS) when there is no MSISDN in the UE's IMS subscription profile.
- 5) The IP-SM-GW (AS) returns OK to the S-CSCF.
- 6) The IP-SM-GW (AS) sends IP-SM-GW Register Req to the HSS.
- 7) The HSS stores the received IP-SM-GW address if necessary or for MT-SMS without MSISDN (see clause 6.0a), uses it as an indication that the UE is available to be accessed via the IMS to trigger an Alert service centre message if the message waiting flag is set, and responses to the IP-SM-GW (AS) with IP-SM-GW Register Res. IP-SM-GW gets the IMPU (SIP URI) for SMS delivery without TEL-URI from registration event package.

NOTE 2: IP-SM-GW Register Res can include the SC address to be used for this user in the subscriber data (see also clause 6.7).

NOTE 3: If the IP-SM-GW address stored in the HSS via registration procedure is not the same as the preconfigured IP-SM-GW address (if any), then the short message delivery attempted during registration can be unnecessarily delayed.

- 8) After successful registration of the IP-SM-GW address at the HSS the HSS checks whether message waiting data are stored and alerts all SCs using procedures described in TS 23.040 [2] (see also clause 6.5b).

6.2 De-registration procedure

6.2.1 UE initiated

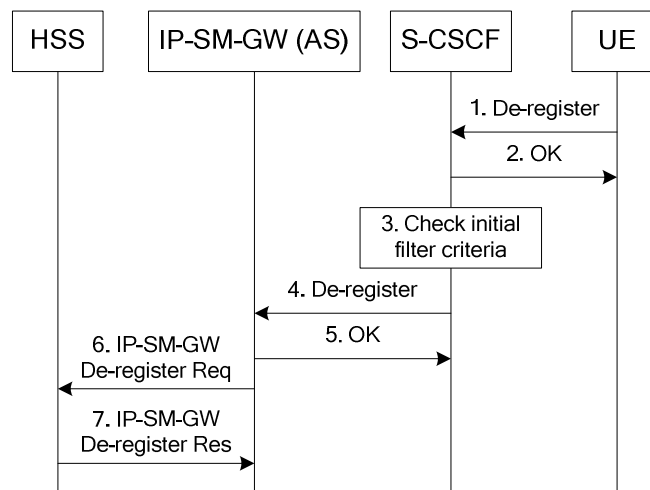

Figure 6.2: UE initiated de-registration procedure

- 1) At any time after the registration procedure, the UE may initiate a de-registration procedure. The UE sends a De-Register request (Register request with Expires header having value 0) to the S-CSCF.
- 2) S-CSCF responds to the UE with OK.
- 3) S-CSCF checks the initial filter criteria retrieved from the HSS during the IMS registration procedure.
- 4) Based on initial filter criteria the S-CSCF informs the IP-SM-GW (AS) about the de-registration of the user.
- 5) The IP-SM-GW (AS) returns OK to the S-CSCF.

- 6) The IP-SM-GW (AS) de-registers the UE at the HSS sending a De-register Req.
- 7) The HSS de-registers the UE and responds to the IP-SM-GW (AS) with De-register Res.

NOTE: The pre-configured IP-SM-GW address in the HSS, if any, is not removed, as it is used for subsequent SM termination.

6.2.2 Network initiated

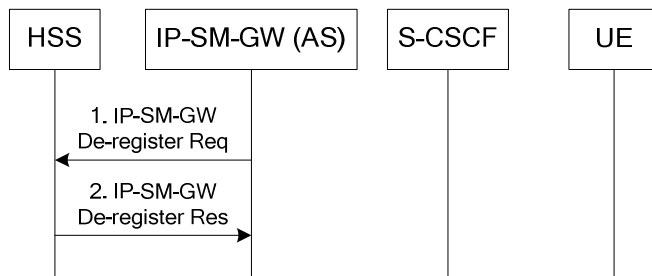

Figure 6.2a: Network initiated de-registration procedure

- 1) After receiving a trigger (e.g. De-Register message from the S-CSCF), the IP-SM-GW shall de-register the IP-SM-GW of a subscriber from the HSS sending a De-Register Req.
- 2) The HSS de-registers the UE and responds to the IP-SM-GW (AS) with De-register Res.

6.3 Transport-level interworking: Successful encapsulated Short Message origination procedure

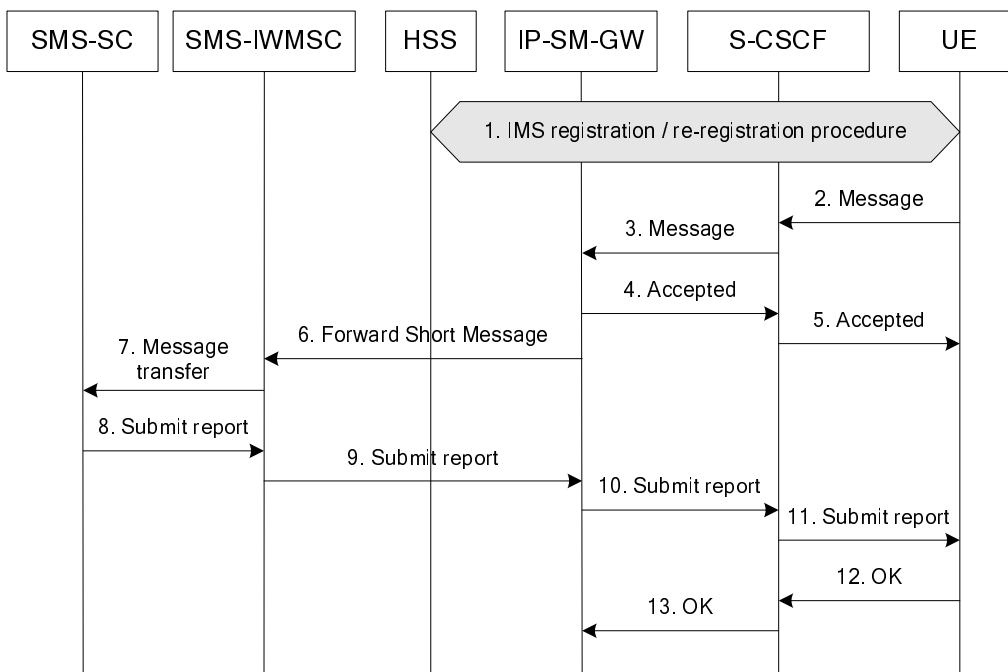

Figure 6.3: Successful encapsulated Short Message origination procedure

- 1) The UE registers to S-CSCF according to the IMS registration procedure. Note that I-CSCF and P-CSCF are not shown in this figure.
- 2) UE submits the encapsulated Short Message (SMS-SUBMIT, SC Address) to the S-CSCF using an appropriate SIP method.

- 3) S-CSCF forwards the encapsulated Short Message (SMS- SUBMIT, SC Address) to IP-SM-GW (AS) based on stored iFC.
- 4) IP-SM-GW (AS) acknowledges the SIP message.
- 5) SIP message acknowledge is forwarded by S-CSCF to UE.
- 6) The IP-SM-GW performs service authorization based on the stored subscriber data as described in the clause 6.1. The IP-SM-GW shall check whether the subscriber is authorised to use the short message service (e.g. Operator Determined Barring settings), similar to the authorization performed by MSC/SGSN in case the Short Message is delivered via CS or PS domain. In addition, the IP-SM-GW shall also check whether the user is authorised to use the encapsulated Short Message delivery via IMS. If the result of service authorization is negative, the IP-SM-GW shall not forward the message, and shall return the appropriate error information to the UE in a failure report. Otherwise, the IP-SM-GW (AS) extracts the Short Message (SMS- SUBMIT) and forwards it towards the SMS-SC (SC Address) via the SMS-IWMSC using standard MAP signalling (as described in TS 23.040 [2]).
- 7) The SMS-IWMSC forwards the Short Message (SMS-SUBMIT) to the SMS-SC (see TS 23.040 [2]).
- 8) SMS-SC sends a Submit report (SMS-SUBMIT-REPORT) to SMS-IWMSC (see TS 23.040 [2]).
- 9) SMS-IWMSC sends the Submit report to IP-SM-GW (AS) (see TS 23.040 [2]).
- 10) IP-SM-GW (AS) sends the Submit report to S-CSCF, encapsulated in an appropriate SIP request.
- 11) The S-CSCF sends the Submit report to the UE.
- 12) The UE acknowledges the SIP request.
- 13) The S-CSCF forwards the acknowledgement of the SIP request to IP-SM-GW (AS).

6.4 Transport-level interworking: Successful encapsulated Short Message termination procedure

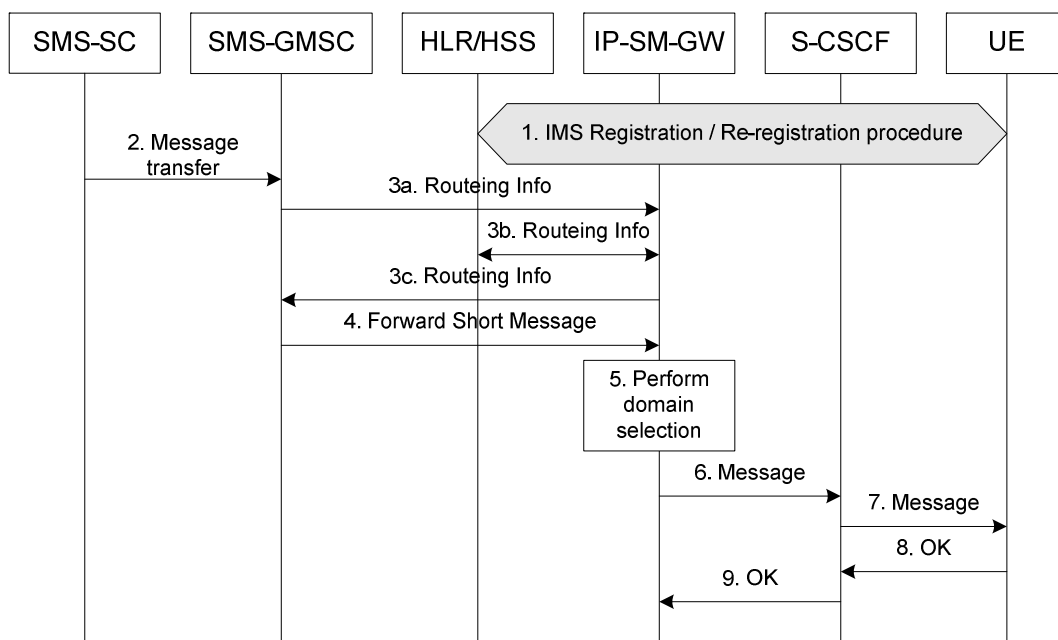

Figure 6.4: Successful encapsulated Short Message termination procedure

- 1) The UE registers to the S-CSCF according to the IMS registration procedure.
- 2) The SMS-SC forwards the Short Message (SMS-DELIVER) to the SMS-GMSC.

The following steps 3a to 3c are skipped if this procedure is performed due to MT-SMS without MSISDN as defined in clause 6.0a.

3a) The SMS-GMSC interrogates the HSS to retrieve routing information. Based on the pre-configured IP-SM-GW address for the user, the HSS forwards the request to the corresponding IP-SM-GW.

NOTE 1: The Send Routing Info for SM request is not forwarded if it has been sent originally from the IP-SM-GW.

NOTE 2: If there is only a single IP-SM-GW address, the IP-SM-GW address does not need to be pre-configured in the HSS, the Send Routing Info for SM request can be forwarded on the STP level.

3b) The HLR/HSS returns the addresses of the current MSC, SGSN to the IP-SM-GW for delivery of the Short Message in CS/PS domain. The HLR/HSS also returns the IMSI, for the IP-SM-GW to correlate the receipt of Short Message from the MT Correlation ID within the IMSI field of the Forward Short Message.

3c) The IP SM GW creates a MT Correlation ID as per TS 23.040 [2] which associates the Send Routing Info for SM with the subsequent Forward Short Message message(s), and stores this along with the IMSI of the receiving subscriber. The IP-SM-GW returns only one address, which is of itself, along with the MT Correlation ID as routing information to the SMS-GMSC.

NOTE 3: For the case where the IP-SM-GW address is not pre-configured in the HSS, the Send Routing Info for SM request will be forwarded on the STP level, the IP-SM-GW returns the address of itself as routing information to SMS-GMSC upon receipt of the forwarded Send Routing info for SM request.

4) SMS-GMSC delivers the Short Message (SMS-DELIVER) to IP-SM-GW (AS) including the MT Correlation ID received from the IP-SM-GW, in the same manner that it delivers the Short Message to an MSC or SGSN.

5) The IP-SM-GW performs service authorization based on the stored subscriber data described in the clause 6.1. The IP-SM-GW shall check whether the subscriber is authorised to use the short message service (e.g. Operator Determined Barring settings), similar to the authorization performed by MSC/SGSN in case the Short Message is delivered via CS or PS domain. In addition, the IP-SM-GW shall also check whether the subscriber is authorised to use the encapsulated Short Message delivery via IMS. If the result of service authorization is negative, the IP-SM-GW shall not forward the message, and shall return the appropriate error information to the SMS-SC in a failure report. Domain selection function is not performed for MT-SMS without MSISDN and IMS is used for delivery. Otherwise, the IP-SM-GW performs domain selection function to determine the preferred domain for delivering the message according to operator policy and user preferences. The logic for selecting preferred route for message delivery is a matter of implementation.

6) If the preferred domain is IMS, the IP-SM-GW (AS) uses the TEL-URI associated with the IMSI of the message received for the target UE to send the Short Message (SMS-DELIVER, SC Address) encapsulated in the appropriate SIP method towards the S-CSCF. If TEL URI is not available, SIP URI is used.

7) S-CSCF forwards the encapsulated Short Message (SMS-DELIVER, SC Address) to the UE.

8) The UE acknowledges the SIP request.

NOTE 4: This is not yet the Delivery report.

9) The S-CSCF forwards the acknowledgement of the SIP request to the IP-SM-GW (AS).

6.5 Transport-level interworking: Delivery Report procedure

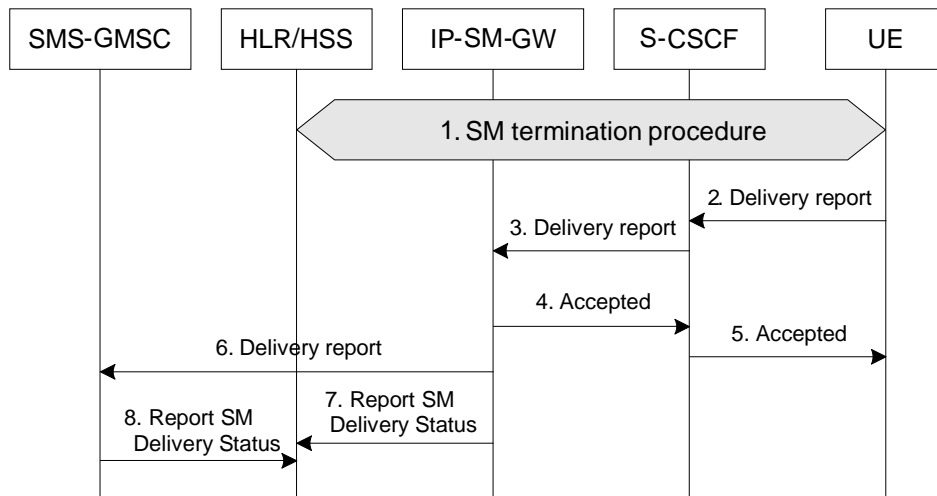

Figure 6.5: Delivery report procedure

- 1) The UE has received the Short Message as described in clause 6.4.
 - 2) The UE sends a Delivery report (SMS-DELIVER-REPORT) to the S-CSCF, including either a positive or a negative acknowledgement to the Short Message received in step 1.
 - 3) The S-CSCF forwards the Delivery report to the IP-SM-GW (AS). It shall be ensured that the Delivery report reaches the same IP-SM-GW that forwarded the Short Message in step 1.
 - 4) IP-SM-GW (AS) acknowledges, at the SIP level, the Delivery report to S-CSCF.
- NOTE: This is the acknowledgement to the Forward Short Message in the SM termination procedure.
- 5) S-CSCF forwards the SIP acknowledgement to the Delivery report to the UE.
 - 6) The IP-SM-GW (AS) sends a Delivery report to the SMS-GMSC.
 - 7) The IP-SM-GW may send a Report SM Delivery Status to the HSS. This may trigger the Alert service centre procedure or an update of the message waiting data in the HSS as described in TS 23.040 [2], if necessary.
 - 8) The SMS-GMSC may send a Report SM Delivery Status to the HSS. The HSS shall ignore the information provided in this report.

6.5a Unsuccessful SM termination procedure

When a Short Message fails to reach the UE via the selected domain, a failure delivery report is returned to the IP-SM-GW. The IP-SM-GW takes responsibility to re-attempt the delivery of the message in another domain which is listed in the sequence of the priority in the IP-SM-GW while the domain selection is performed during the SM termination procedure. If the message successfully reaches the UE after re-delivery, the IP-SM-GW forwards the received successful Delivery report to the SMS-GMSC. Otherwise, if the message still fails after the IP-SM-GW has tried all selectable domains, the IP-SM-GW forwards the received unsuccessful Delivery report to the SMS-GMSC and sends Report SM Delivery Status message to the HLR/HSS. The HLR/HSS then records the corresponding Messages Waiting Data (MWD), and an Alert service centre procedure may be initiated as described in clause 6.5b or 6.6.

The order in which domains are selected for message delivery by the IP-SM-GW is subject to operator policy and/or user preferences and any known or assumed timer values in the SMS-GMSC for the Forward Short Message message (see NOTE 1).

The following flow shows only an example order of selected domains, i.e. the IMS is the preferred domain, followed by the PS domain, and finally the CS domain.

NOTE 1: If the timer at the SMS-GMSC has been configured to a short value (near to the minimum value), the IP-SM-GW may not have sufficient time to try the message delivery in all three domains. This problem can be resolved by several implementation solutions, e.g. re-configuring the SMS-GMSC timer to be longer, enhancing the IP-SM-GW to try the delivery only in two or one domain(s).

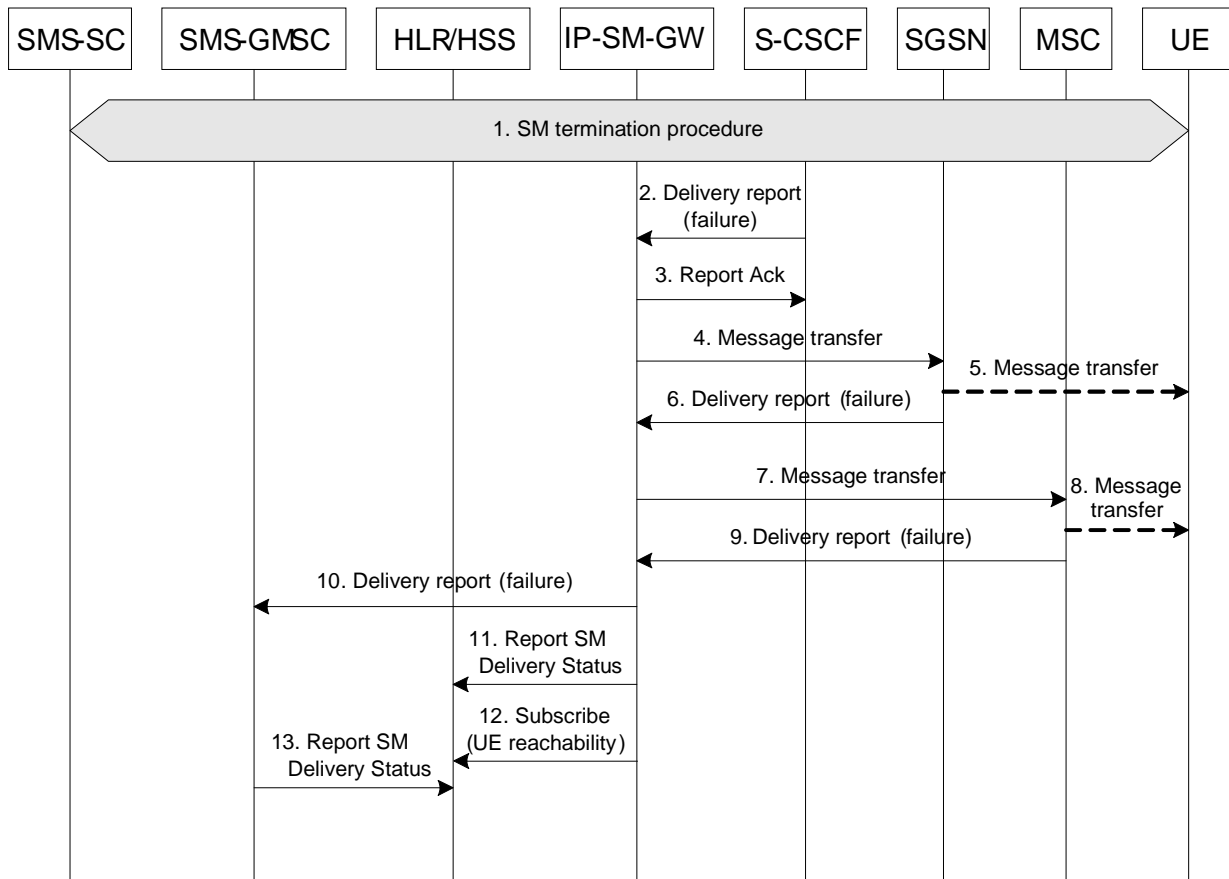

Figure 6.5a: Unsuccessful SM termination procedure

- 1) As described in clause 6.4, the Short Message is routed to the UE via S-CSCF after the domain selection is performed in the IP-SM-GW and all the available domains have been listed in the sequence of the priority in the IP-SM-GW. The message fails to reach the UE, e.g. due to the UE not being reachable in IMS, or exceeded memory capacity of the UE.
- 2) The S-CSCF sends an appropriate failure message according to normal IMS procedure as defined in TS 23.228 [9], and sends it to the IP-SM-GW (AS) including an appropriate error value. This Delivery report is an acknowledgement to the Short Message received by the S-SCSF in step 1.

NOTE 2: When the failure message is sent from the UE, e.g. the UE notifies the network that the UE has been unable to accept a Short Message because its memory capacity has been exceeded, the S-CSCF forwards the failure message to the IP-SM-GW (AS).

- 3) IP-SM-GW (AS) acknowledges the failure message to S-CSCF.
- 4) The IP-SM-GW verifies the error cause of the failure delivery report. If the error is due to exceeded memory capacity of the UE, the IP-SM-GW forwards the Delivery report (SMS-DELIVER-REPORT) back to the SMS-GMSC and the procedure continues as described in step 10. Otherwise, the IP-SM-GW forwards the Short Message to the domain which is listed in the second place in its priority list. It is supposed that the SGSN is selected.
- 5) The SGSN delivers the message to the UE but the message fails to reach the UE, e.g. the UE is not reachable in PS domain.

NOTE 3: If the delivery succeeds in the PS domain at this point, the procedure for successful message delivery over PS domain is described in clause 6.4.

- 6) The SGSN generates a Delivery report (SMS-DELIVER-REPORT) and sends it to the IP-SM-GW, including an appropriate error value. This Delivery report is an acknowledgement to the Short Message received by the SGSN in step 5.
- 7) The IP-SM-GW forwards the Short Message to the domain which is listed in the third place in its priority list. It is supposed that the MSC is selected.
- 8) The MSC delivers the message to the UE but the message fails to reach the UE, e.g. the UE is not reachable in CS domain.

NOTE 4: If the delivery succeeds in the CS domain at this point, the procedure for successful message delivery over CS domain is described in clause 6.4.

- 9) The MSC generates a Delivery report (SMS-DELIVER-REPORT) and sends it to the IP-SM-GW, including an appropriate error value. This Delivery report is an acknowledgement to the Short Message received by the MSC in step 9.
- 10) The IP-SM-GW sends a Delivery report to the SMS-GMSC.

NOTE 5: The SMS-GMSC is aware of the availability of the UE on only one domain (see clause 6.4), and so will not attempt redelivery to another domain after receiving a failure report.

- 11) The IP-SM-GW sends a Report SM Delivery Status to the HSS with accurate results from different domains. The HSS records the corresponding MWD, i.e. the SMS-SC address which stores the un-delivered message and the failure reason which indicates that the message failed to be sent by IP-SM-GW due to the UE not being available or the memory capacity of the UE being exceeded.
- 12) The IP-SM-GW subscribes to the HSS for a one-time notification of the UE being reachable again. The HSS records the subscription and instructs the transport layer to report when the UE is reachable.
- 13) The SMS-GMSC sends a Report SM Delivery Status to the HSS. The HSS shall ignore the information provided in this report.

6.5b Alert Service Centre procedure when UE is available

When a Short Message is received in the IP-SM-GW for delivery to an IMS subscriber, the IP-SM-GW shall verify the registration status of the UE. If the UE is not registered in IMS, or is registered in IMS but does not advertise the Converged IP Messaging, SIMPLE IM or SMSIP capability, the Short Message shall not be interworked; neither at service level nor at transport level. Based on operator policy and user preferences, either the message is sent over CS/PS or an error indication is sent back to the SMS-SC. In the latter case, when the UE registers in IMS advertising the Converged IP Messaging, SIMPLE IM and/or the SMSIP capability at a later time, this information is sent to the SMS-SC and the delivery is attempted at that time, as an Instant Message or an encapsulated Short Message as appropriate.

NOTE: The service level or transport level interworking of a message is prohibited as identified in the above scenario in order to prevent the possibility of the message being deferred in the terminating network.

If the HLR/HSS has recorded the MWD with a failure reason that the message failed to be sent by IP-SM-GW due to the UE not being available, once the HLR/HSS receives a message from any of the domains indicating that the UE is available again, e.g. IMSI attached, or IMS registered, the HLR/HSS initiates an Alert service centre procedure to request the SMS-SC to re-send the stored message.

The following figure shows an example of how a deferred message is re-transmitted to an IMS UE upon the UE availability.

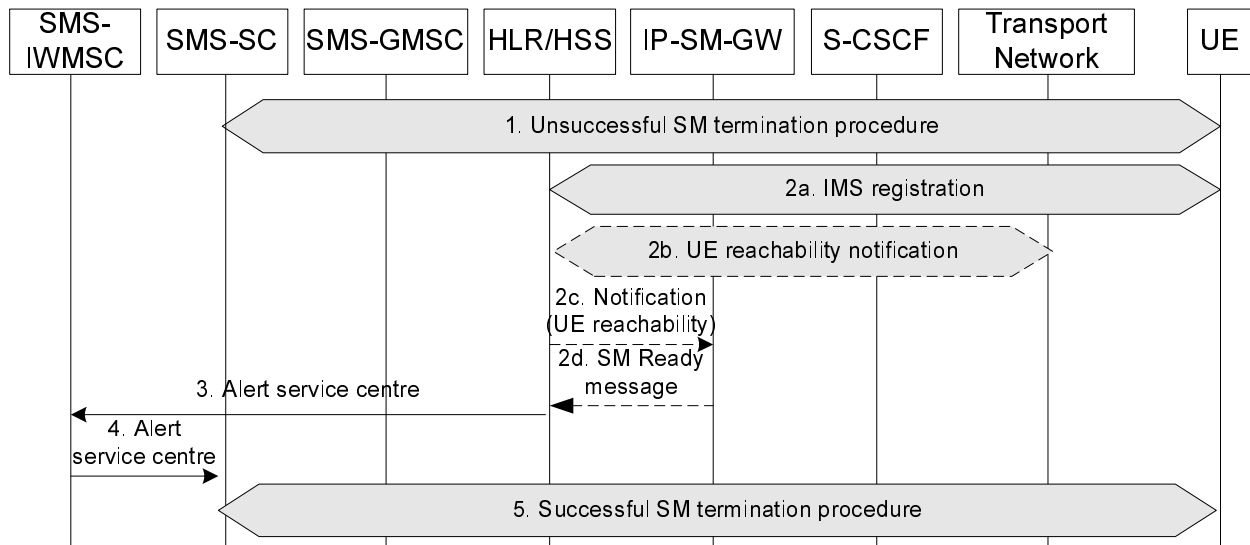

Figure 6.5b: Alert service centre procedure when UE is available

- 1) The message is transmitted from SMS-SC to IP-SM-GW for delivery to the subscriber, possibly after transport-level and/or service-level interworking. Prior to this interworking, the IP-SM-GW shall check for UE availability. If the UE is not registered in IMS, and delivery over CS/PS is unsuccessful (see clause 6.5a), the IP-SM-GW returns an appropriate error response to SMS-SC. The SMS-SC then informs the HSS/HLR about the unavailability of the UE. After an unsuccessful SM termination procedure due to the UE being unavailable, the HSS records the MWD i.e. the SMS-SC address which stores the un-delivered message and the failure reason which indicates that the message failed to be sent by IP-SM-GW due to the UE not being available, for a subsequent Alert service centre procedure.

At any time after the unsuccessful SM termination procedure, the UE may attach in the PS and or CS domain again, in which case a Ready for SM message from the SGSN or MSC is sent to the HLR/HSS as described in TS 23.040 [2]. The HLR/HSS initiates an Alert service centre procedure to the SM-IWMSC when the user's MWD is not NULL, and the procedure continues as described in step 3.

- 2) At any time after the unsuccessful SM termination procedure, the status of the UE may indicate that the UE is available due to, e.g. registration in IMS (step 2a). At that point UE-Not-Reachable-for-IP (UNRI) is updated in HLR/HSS, as described in TS 23.040 [2]. After the IMS registration is finished, the procedure continues as described in step 3.

At any time after the unsuccessful SM termination procedure, the HSS can receive a notification from the transport layer e.g. MME that the UE is reachable again (step 2b). As the IP-SM-GW has subscribed to the event as described in clause 6.5a, the HSS shall notify the IP-SM-GW of the UE being reachable again (step 2c). If the UE is already registered in IMS, the IP-SM-GW shall then send a Ready for SM message to the HLR/HSS (step 2d) and the procedure continues as described in step 3. Otherwise, the IP-SM-GW discards the notification message. The procedure will resume when one of the conditions described in steps 1 and 2 is fulfilled.

- 3) The HLR/HSS checks the user's MWD. If MWD is not Null, the HLR/HSS initiates an Alert service centre message to the SMS-IWMSC.
- 4) The SMS-IWMSC forwards the Alert service centre procedure to the responding SMS-SC.
- 5) Upon receipt of the Alert service centre message, the SMS-SC re-attempts to send the stored Short Message. The message is transmitted to IP-SM-GW and thereafter to the UE after appropriate interworking (transport-level and/or service-level interworking) is performed. The UE acknowledges the reception of the message.

6.6 Transport-level interworking: Alert service centre procedure when memory capacity is available

If the HLR/HSS has recorded the MWD with a failure reason that the message failed to be sent by IP-SM-GW due to the memory capacity of the UE is exceeded, once the HLR/HSS receives a message from any of the domain indicating

that the memory capacity of the UE is available again, e.g. from the IMS, PS or CS domain, the HLR/HSS initiates a Alert service centre procedure to request the SMSC to re-send the stored message.

The following figure only shows an example where the HLR/HSS invokes the Alert service centre procedure when the memory capacity available message is received from IMS.

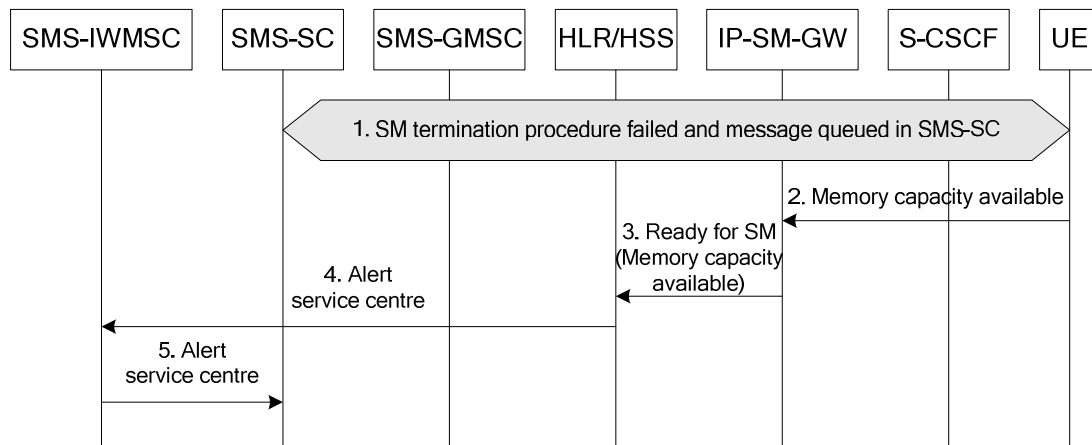

Figure 6.6: Alert service centre procedure when memory capacity is available

- 1) If SM termination attempts (via IP-SM-GW) failed because the UE's Memory Capacity Exceeded, the message to be transferred to IP Based UE is queued in the SMS-SC.
- 2) UE sends a message to IP-SM-GW indicating that the UE has memory available to receive one or more Short Messages.
- 3) IP-SM-GW notifies the HLR/HSS of memory being available in the UE.
- 4) If the HLR/HSS receives the indication that the UE has memory available to receive one or more Short Messages, it initiates a Alert service centre procedure with the SC address and the MSISdn-Alert to SMS-IWMSC as described in TS 23.040 [2].
- 5) The SMS-IWMSC forwards the Alert service centre message to the SMS-SC whose address was provided by the HLR/HSS in step 4.

6.7 Service-level Interworking: IM or CPM capable UE sends an Instant Message to an SMS user

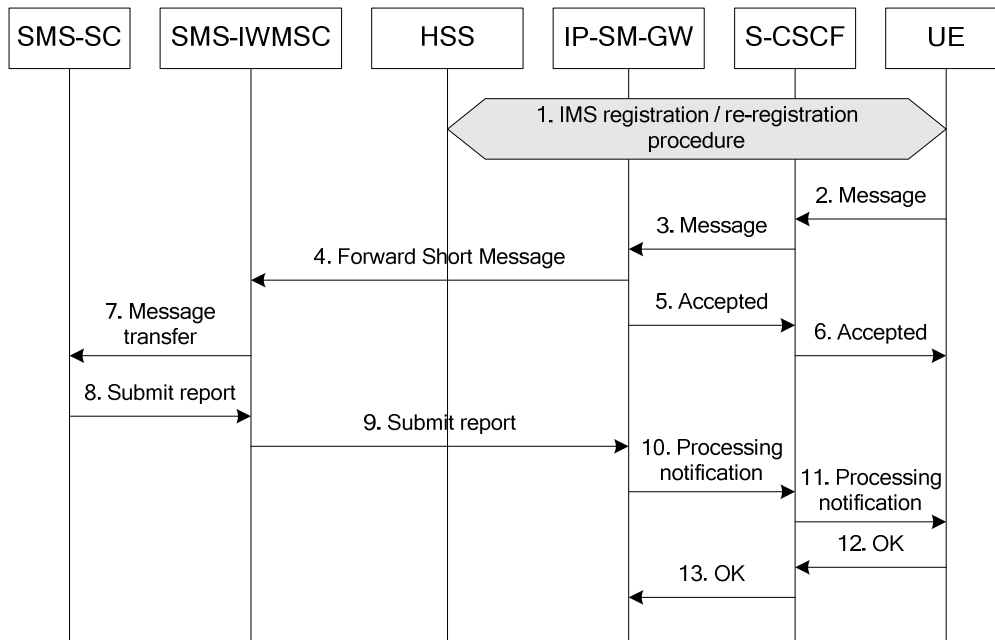

Figure 6.7: Successful IM origination to SMS procedure

- 1) The UE registers to S-CSCF according the IMS registration procedure.
- 2) UE submits the Instant Message to the S-CSCF using an appropriate SIP method. The UE may request to hide its Public User Identity from the recipient within the Instant Message, as described in OMA-TS-SIMPLE_IM-V1_0 [12] or in OMA-TS-CPM_Conv_Funct-V1_0 [17].
- 3) S-CSCF forwards the Instant Message to IP-SM-GW based on stored iFC.

NOTE 1: Subscribers with no subscription for service level interworking will not be provided with the relevant iFCs.

- 4) The IP-SM-GW shall decide whether to perform service-level interworking depending on SIP request header (e.g. Request-URI), operator policy, when the Instant Message is not routable in the IMS. If an ISF is deployed in the network, the ISF may take the decision to interwork using SMS and sends the message to the IP-SM-GW to perform the interworking. If IP-SM-GW decided to perform service-level interworking, the IP-SM-GW performs service authorization based on the stored subscriber data retrieved from the HLR/HSS at the time of the registration procedure as specified in clause 6.1. The IP-SM-GW shall check whether the originating subscriber is authorised to use the interworking service. If the result of service authorization is negative, the IP-SM-GW shall not forward the message, and shall return the appropriate error information to the UE in a failure report. Otherwise, the IP-SM-GW shall use the SC Address in the subscriber data retrieved from the HSS at registration or provisioned by configuration and translates the Instant Message to a Short Message (SMS- SUBMIT) carrying SC Address, then forwards it towards SMS-SC (SC Address) via the SMS-IWMSC (as described in TS 23.040 [2]). If the size of the content of the Instant Message is larger than the size of the content that one Short Message could transfer, the IP-SM-GW shall split the content of the Instant Message into several parts, translate them to concatenated Short Messages, and forward the concatenated Short Messages to the SMS-SC as described in TS 23.040 [2]. If the sender of the Instant Message requests to hide its Public User Identity from the recipient and operator policy allows for this, the IP-SM-GW shall anonymize the identity of the user to the recipient. Otherwise, if operator policy prohibits this, the IP SM GW shall return an appropriate error to the user.
- 5) If service authorization is successful, the IP-SM-GW acknowledges the Instant Message.
- 6) Instant Message acknowledgement is forwarded by S-CSCF to UE.

NOTE 2: Steps 5 and 6 can occur anytime after the subscriber authorization check has been performed by the IP-SM-GW.

- 7) The SMS-IWMSC forwards the Short Message (SMS- SUBMIT) to the SMS-SC (see TS 23.040 [2]).
- 8) The SMS-SC sends a Submit report (SMS-SUBMIT REPORT) to the SMS-IWMSC (see TS 23.040 [2]).
- 9) SMS-IWMSC sends a Submit report to IP-SM-GW (see TS 23.040 [2]).

NOTE 3: The procedure can end in step 9. Steps 10 to 13 occur only if the IM user requested a processing notification in the Instant Message sent in step 2, as described in IETF IMDN RFC 5438 [13].

- 10) IP-SM-GW translates the received Submit report to an appropriate Instant Message, and forwards it to the S-CSCF. If the IP-SM-GW sent concatenated Short Messages to SMS-SC in step 4, the IP-SM-GW should wait for the last Submit report, and translate the last Submit report to an appropriate Instant Message, and forward it to the S-CSCF.
- 11) S-CSCF sends the translated Instant Message to the UE.
- 12) UE acknowledges the translated Instant Message.
- 13) Acknowledgement of the translated Instant Message is forwarded by S-CSCF to IP-SM-GW.

6.8 Interaction between transport-level and service-level Interworking

6.8.1 General

The interaction between transport-level interworking (between SMS over CS/PS and SMS over IMS) and service-level interworking (between Instant Messaging and SMS) depends on the user subscription and authorisation, on the UE capabilities, and on operator policy.

If a user is only subscribed to either transport-level interworking or service-level interworking, only procedures defined for the subscribed interworking may be performed.

If a user is subscribed to both transport-level interworking and service-level interworking, but the user is only authorised for one of the interworking when the message is processed, only the authorised interworking may be performed.

If a user is subscribed to both transport-level interworking and service-level interworking, and is authorised for both, the behaviour of the IP-SM-GW depends on the specific scenario, on the registered capabilities of the UE, and finally is defined by operator policy and user preferences.

For a user subscribed to service-level interworking, two Application Servers in the network are normally called upon to handle an Instant Message:

- the IM AS, defined in OMA-TS-SIMPLE_IM-V1_0 [12] or the CPM AS, defined in OMA-TS-CPM_Conv_Funct-V1_0 [17].
- the IP-SM-GW.

The following clauses describe the different interaction scenarios.

6.8.2 IMS Originating

In the originating network, a UE sends a SIP MESSAGE (Encapsulated Short Message or Instant Message). The originating S-CSCF forwards the SIP MESSAGE to the IP-SM-GW based on the iFC. The subscription of the transport level interworking and the service level interworking applies for different iFC. However, the SIP MESSAGE is forwarded to the IP-SM-GW if the user subscribes to one of the interworking services. If there is no subscription for the interworking service, the S-CSCF continues with the subsequent iFC check. After all the originating iFC triggers have been handled, the S-CSCF attempts to route the message to the terminating IMS network. If it fails, an error is returned to the sender.

NOTE 1: if an IM AS or a CPM AS is present in the network, Instant Messages are routed to it before going to the IP-SM-GW.

NOTE 2: An encapsulated Short Message uses the PSI of the SC as the Request-URI. If the user is not subscribed to transport-level interworking and the IP-SM-GW is not invoked, the ENUM query fails, and an error is returned to the sender.

When the IP-SM-GW receives the SIP MESSAGE, it shall decide which interworking should be performed based on the content of the received SIP MESSAGE, as the IP-SM-GW can distinguish between an encapsulated Short Message and an Instant Message. If an encapsulated Short Message is received and if the subscriber is authorised for the service, the IP-SM-GW maps the encapsulated Short Message to a Short Message. Similarly, when an Instant Message is received, the IP-SM-GW considers performing the service-level interworking if the service is authorized: the IP-SM-GW shall decide whether to send the SIP MESSAGE via interworking service based on SIP request header (e.g., R-URI), operator policy, when the Instant Message is not routeable in the IMS or when the IP-SM-GW is selected to handle the message.

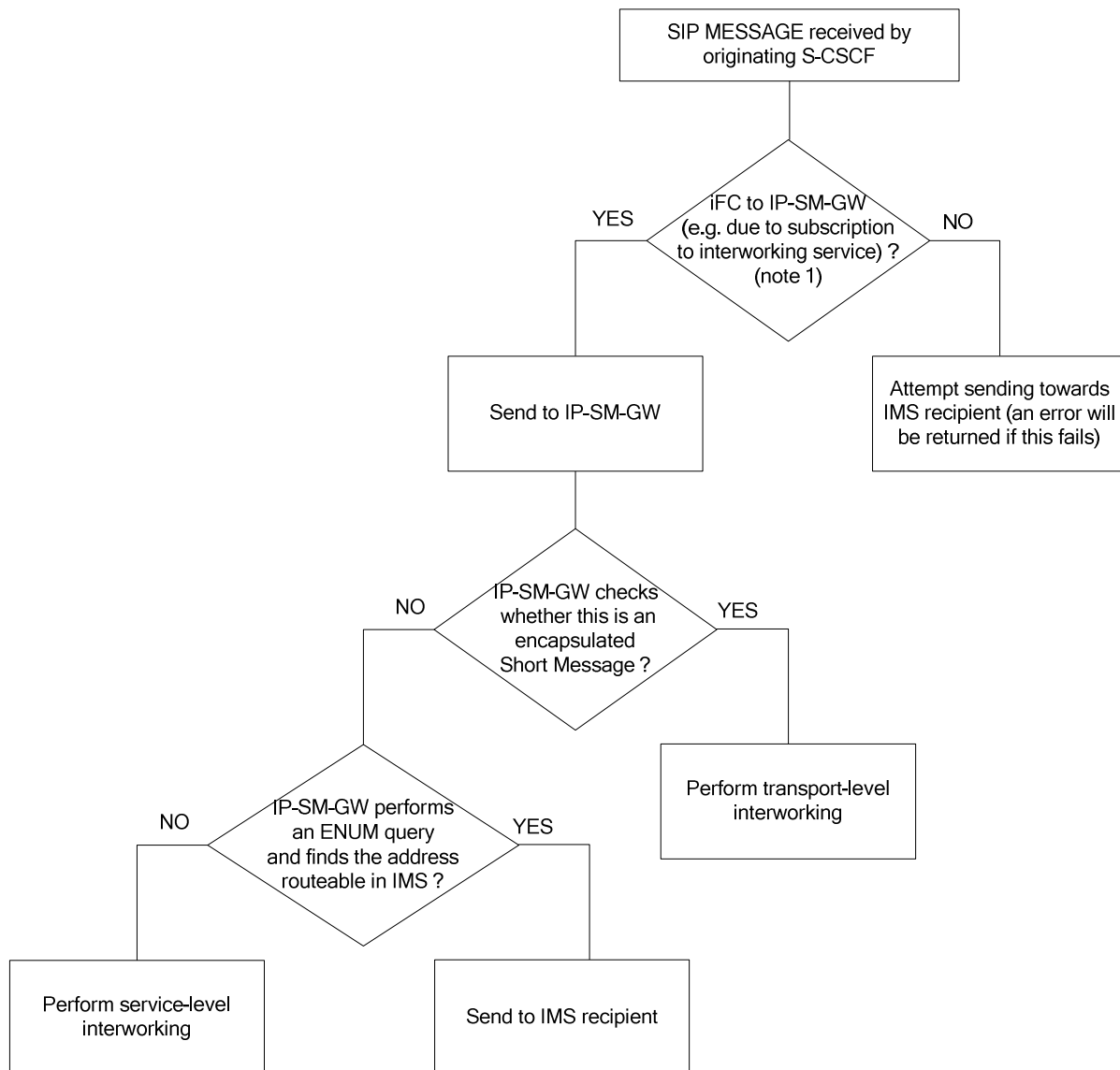

Figure 6.8.2.1: Performing interworking service on originating side

6.8.3 IMS Terminating

When the IP-SM-GW receives a Short Message from the legacy network on the terminating side, it performs the domain selection to determine the preferred domain to transfer the short message. If the selected network is IMS, the IP-SM-GW will determine whether the transport level interworking or the service level interworking is to be performed based on the users' subscription and authorisation, and on the UE capability as indicated during IMS registration. If the user has subscribed to both services, is authorised for both and the UE has indicated its capability to receive both encapsulated Short Messages and Instant messages, the priority between the transport-level interworking and the service-level interworking is based on operator policy and user preferences.

NOTE 1: If the incoming Short Message is interworked to an Instant Message, the resulting Instant Message could be routed to the IM AS or CPM AS before being sent to the UE.

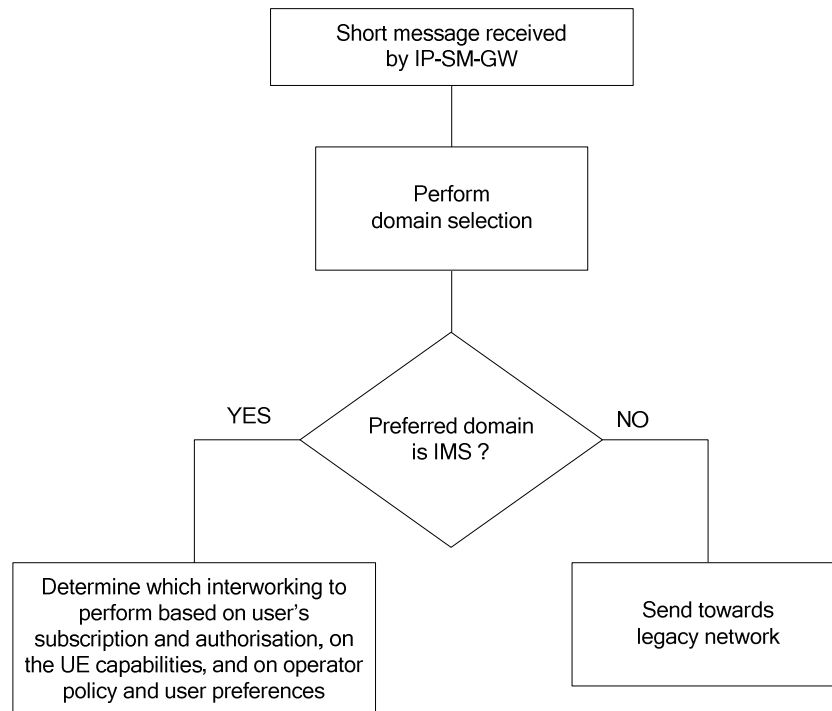

Figure 6.8.3.1: Performing interworking service on terminating side for an incoming Short Message

When the IP-SM-GW receives an Instant Message, based on user subscription and authorisation for service-level interworking, on operator policy and user preferences, and on UE capability indicated during IMS registration, the IP-SM-GW may perform service-level interworking to transform the message format to SMS and deliver the message to the UE. If the user is subscribed and authorised for transport-level interworking, and based on UE capability indicated during IMS registration, and on operator policy and user preferences, the message may be delivered as an encapsulated Short Message to the UE over IMS. Otherwise, the Short Message is delivered over CS/PS.

6.9 Service-level Interworking: Concatenated Short Messages delivered as a large Instant Message

An IMS registered user with IM service or CPM service receives a concatenated short message delivered as two or more short messages. The information below describes the behaviour when the received concatenated Short Message exceeds the maximum payload size of an Instant Message.

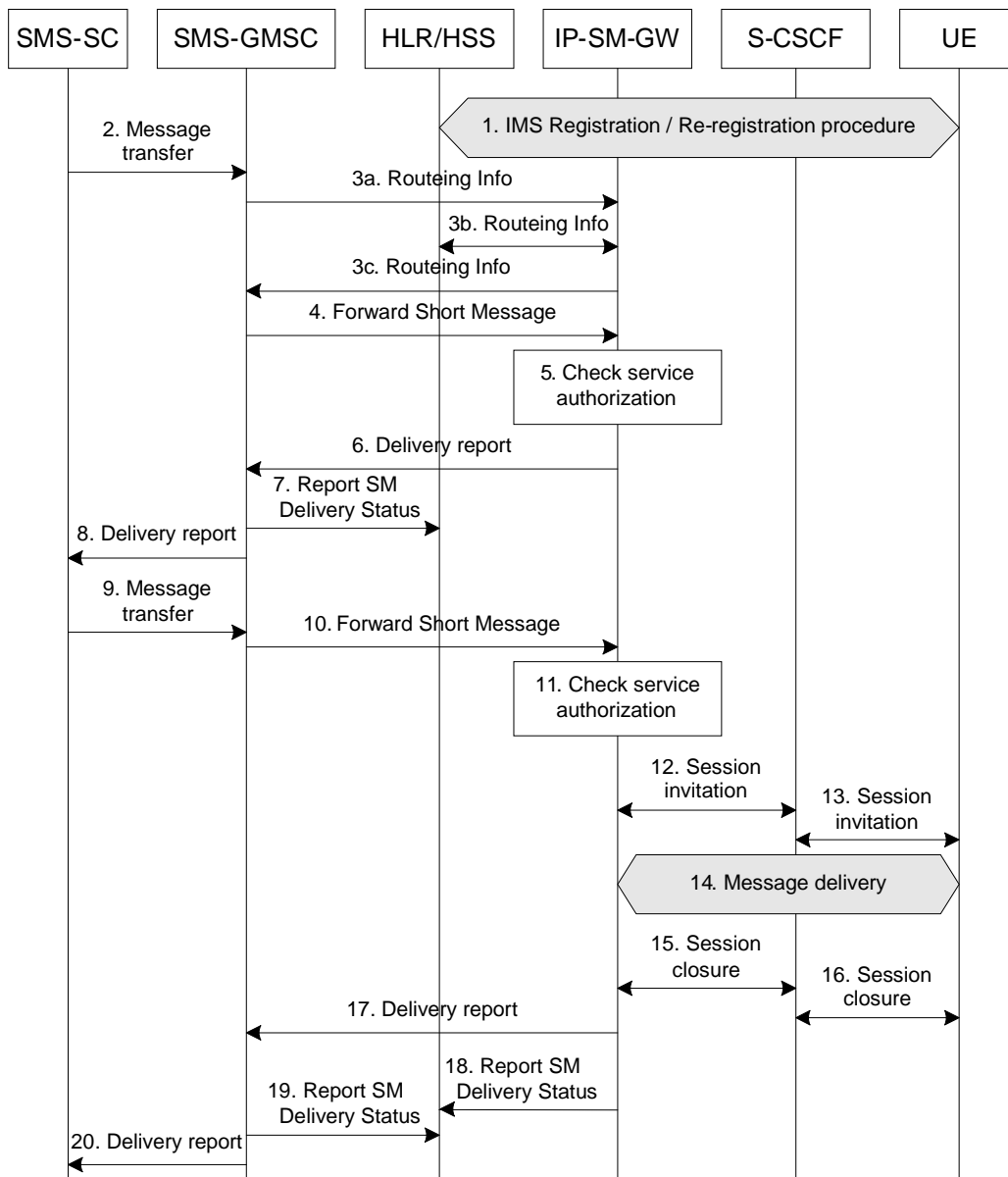

Figure 6.9: Concatenated Short Messages delivered as an IM large message

- 1) The UE registers to the S-CSCF according to the IMS registration procedure.
- 2) The SMS-SC forwards a Short Message that is part of a concatenation of two or more Short Messages to the SMS-GMSC.
- 3a) The SMS GMSC interrogates the HSS to retrieve routing information. Based on the pre-configured IP-SM-GW address for the user, the HSS forwards the request to the corresponding IP-SM-GW.
- 3b) The HLR/HSS returns the IMSI and the address(es) of the current MSC and/or SGSN to the IP-SM-GW for delivery of the SMS SM in CS/PS domain.
- 3c) The IP-SM-GW creates a MT Correlation ID as per TS 23.040 [2], which associates the Routing Info retrieval with the subsequent Forward Short Message message(s), and stores this along with the IMSI of the receiving subscriber. The IP-SM-GW returns to the SMS-GMSC the address of itself, along with the MT Correlation ID in the IMSI field, as routing information. Alternatively, the IP-SM-GW may return the address(es) of the current MSC and/or SGSN, in which case, the subsequent procedure to forward the message is the same as defined in TS 23.040 [2].
- 4) The SMS-GMSC delivers the Short Message to the IP-SM-GW in the same manner that it delivers the Short Message to an MSC or SGSN, including the MT Correlation ID received from the IP-SM-GW, in place of the IMSI.

- 5) The IP-SM-GW checks whether the recipient is authorized for the interworking service. If the user is authorized, the IP-SM-GW recognizes that the received message is part of a concatenated Short Message and stores the received message.

NOTE 1: The IP-SM-GW needs to have access to a persistent storage in order to aggregate all the Short Message parts.

- 6) The IP-SM-GW acknowledges the Forward Short Message to the SMS-GMSC.
- 7) The SMS-GMSC may send a Report SM Delivery Status to the HSS. The HSS shall ignore the information provided in this report.
- 8) The SMS-GMSC sends a Delivery report (SMS-DELIVER-REPORT) to the SMS-SC.
- 9) The SMS-SC forwards the next Short Message that is part of a concatenation of two or more Short Messages to the SMS-GMSC.

NOTE 2: If this is not the last Short Message of the concatenation, then processing continues at step 4.

- 10) If this is the last Short Message of the concatenation, then the SMS GMSC delivers the Short Message to the IP-SM-GW in the same manner that it delivers the Short Message to an MSC or SGSN, including the MT Correlation ID received from the IP-SM-GW, in place of the IMSI.
- 11) The IP-SM-GW checks whether the recipient is authorized for the interworking service. If the user is authorized, the IP-SM-GW recognizes that the received message is part of a concatenated Short Message and stores it.
- 12-13) Once all the segments have been received, the IP-SM-GW establishes an MSRP session with the recipient's UE to deliver the message. The session invitation is sent to the recipient UE.

NOTE 3: As a matter of implementation efficiency, the IP-SM-GW may initiate the connection towards the recipient after receiving the first Forward Short Message and passing a service authorization check. This may help prevent timeouts at the SMS GMSC (while it waits for the final Delivery report) but may also result in unnecessary session initiation signalling if there is a failure in a service check for subsequently received Short Messages.

- 14) The IP-SM-GW delivers the message in one or more MSRP SEND requests to the recipient UE.
- 15) -16) The IP-SM-GW closes the session after message delivery is complete.
- 17) The IP-SM-GW acknowledges the Forward Short Message to the SMS-GMSC.
- 18) The IP-SM-GW may send a Report SM Delivery Status to the HLR/HSS for either of the following cases:
- setting of the Message Waiting flags when the Forward Short Message was unsuccessful;
 - clearing of the Message Waiting flags in HLR/HSS when the Forward Short Message was successful, but had previously failed.

NOTE 4: See TS 23.040 [2] for a full explanation of when the Message Waiting flags are set and unset.

- 19) The SMS-GMSC may send a Report SM Delivery Status to the HSS. The HSS shall ignore the information provided in this report.
- 20) The SMS-GMSC sends a Delivery report (SMS-DELIVER-REPORT) to the SMS-SC.

6.10 Service-level interworking: Status Report procedure for Instant Message to Short Message interworking

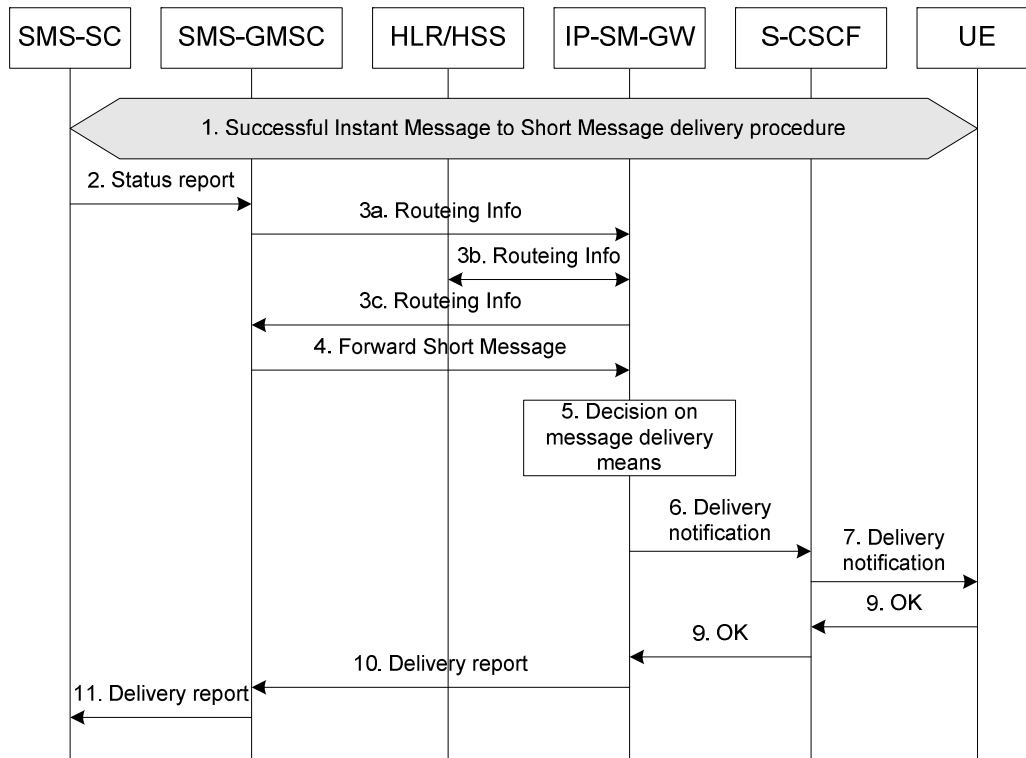

Figure 6.10: Status report procedure for Instant Message to Short Message interworking

- 1) An Instant Message from the UE is successfully delivered to the SMS user after service-level interworking. The original Instant Message requested a Disposition Notification.

NOTE 1: A Disposition Notification can be requested in the message sent by the UE in step 1 as described in IETF IMDN draft-ietf-simple-imdn [13]. If the requested Disposition Notification by the IM user is a request for a read notification, the IP-SM-GW ignores the request.

- 2) The SMS-SC sends a Status report to the SMS-GMSC.

NOTE 2: The Status report will, from the SMS-GMSC's point of view be treated as any SM termination.

NOTE 3: The Status report is an optional message.

- 3a) The SMS GMSC interrogates the HLR/HSS to retrieve routing information. Based on the pre-configured IP-SM-GW address for the user, the HLR/HSS forwards the request to the corresponding IP-SM-GW.

- 3b) The HLR/HSS returns the IMSI and the address(es) of the current MSC and/or SGSN to the IP-SM-GW for delivery of the Short Message in CS/PS domain.

- 3c) The IP-SM-GW creates a MT Correlation ID as per TS 23.040 [2], which associates the Routing Info retrieval with the subsequent Forward Short Message message(s), and stores this along with the IMSI of the receiving subscriber. The IP-SM-GW returns to the SMS-GMSC the address of itself, along with the MT Correlation ID in the IMSI field, as routing information. Alternatively, the IP-SM-GW may return the address(es) of the current MSC and/or SGSN, in which case, the subsequent procedure to forward the message is the same as defined in TS 23.040 [2].

- 4) The SMS-GMSC sends the status report in the Forward Short Message to the IP-SM-GW.

NOTE 4: Steps 5 to 11 only occur if the original IM requested a delivery notification in the Disposition Notification.

- 5) The IP-SM-GW translates and maps the Status report in the Forward Short Message into an Instant Message carrying a Delivery Notification as described in the IETF IMDN draft-ietf-simple-imdn [13]. The IP-SM-GW should keep the message id for a message for which IMDN was requested so it can send the message id to the UE in the IMDN.
- 6-7) The IP-SM-GW sends a Delivery Notification within an Instant Message to the S-CSCF, which sends the Instant Message to the UE.
- 8-9) The UE acknowledges receipt of the Instant Message containing the Delivery Notification to the S-CSCF. The S-CSCF sends the acknowledgment to the IP-SM-GW.
- 10) The IP-SM-GW sends a Delivery report (SMS-DELIVER-REPORT) to the SMS-GMSC.
- 11) The SMS-GMSC sends an acknowledgement back to the SMS-SC.

6.11 IM or CPM user sends an Instant Message to an SMSIP UE

An IMS registered user with SIMPLE IM service or CPM service sends an Instant Message via service-level interworking as an encapsulated Short Message to an SMSIP UE, which did not indicate support for SIMPLE IM or CPM when registering to IMS.

NOTE 1: Based upon user subscription and depending on network deployment, other Application Servers could be processing the incoming Instant Message before the IP-SM-GW. The behaviour of the IM AS is described in OMA-TS-SIMPLE_IM-V1_0 [12]. The behaviour of the CPM AS is described in OMA-TS-CPM_Conv_Funct-V1_0 [17].

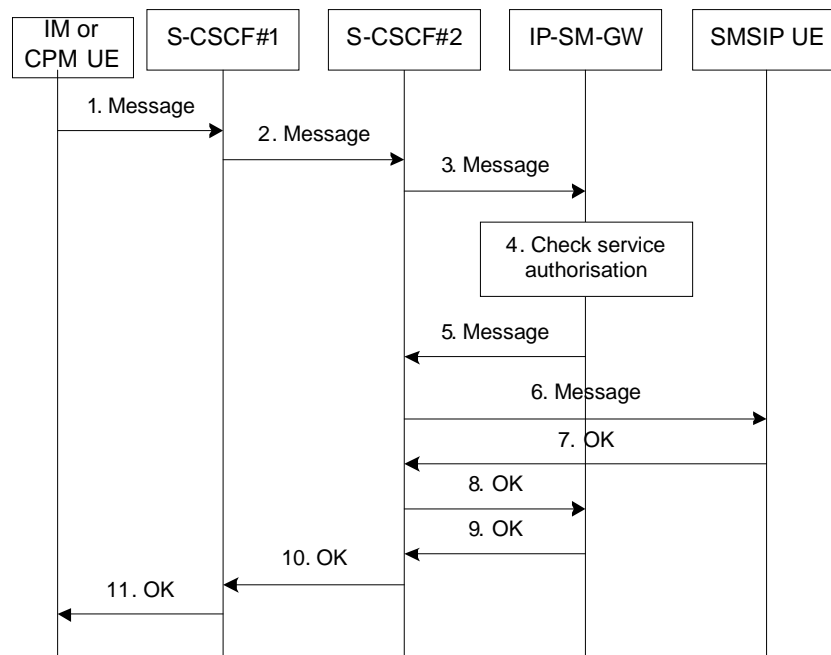

Figure 6.11: Successful UE termination Instant Message to encapsulated Short Message procedure

- 1) IM or CPM UE sends an Instant Message to the S-CSCF#1. The UE may request to hide its Public User Identity from the recipient within the Instant Message, as described in OMA-TS-SIMPLE_IM-V1_0 [12] and in OMA-TS-CPM_Conv_Funct-V1_0 [17].
- 2) The S-CSCF#1 forwards the Instant Message to the S-CSCF#2.
- 3) The S-CSCF#2 forwards the Instant Message to the IP-SM-GW based on iFC.
- 4) Based on user subscription and authorisation for service-level interworking, on operator policy and user preferences, and on UE capability indicated during IMS registration, the IP-SM-GW shall decide whether to perform service-level interworking. If the user is subscribed and authorised for transport-level interworking, and based on UE capability indicated during IMS registration, and on operator policy and user preferences, the

message may be delivered as an encapsulated Short Message to the UE over IMS. Otherwise, the Short Message is delivered over CS/PS, as described in clause 6.13. If the sender of the Instant Message requests to hide its Public User Identity from the recipient and operator policy allows for this, the IP-SM-GW shall anonymise the identity of the user to the recipient. Otherwise, if operator policy prohibits this, the IP-SM-GW shall return an appropriate error to the user.

NOTE 2: If a delivery notification was requested in the message sent by the UE in step 1 as described in IETF IMDN RFC 5438 [13], the procedure for delivery report described in clause 6.12 applies. Otherwise IP-SM-GW will just acknowledge, at the SIP level, the Delivery report received from the SMSIP UE.

- 5) The IP-SM-GW forwards the encapsulated Short Message to the S-CSCF#2.
- 6) The S-CSCF#2 forwards the encapsulated Short Message to the SMSIP UE.
- 7) The SMSIP UE acknowledges the translated encapsulated Short Message.
- 8) The S-CSCF forwards the acknowledgement of the translated encapsulated Short Message to the IP-SM-GW.
- 9-11) The IP-SM-GW forwards the acknowledgement of the translated encapsulated Short Message to the originating IM UE or CPM UE.

6.12 Delivery report for an Instant Message delivered as encapsulated Short Message

This procedure follows the procedure described in clause 6.11, when the original Instant Message included a delivery notification request.

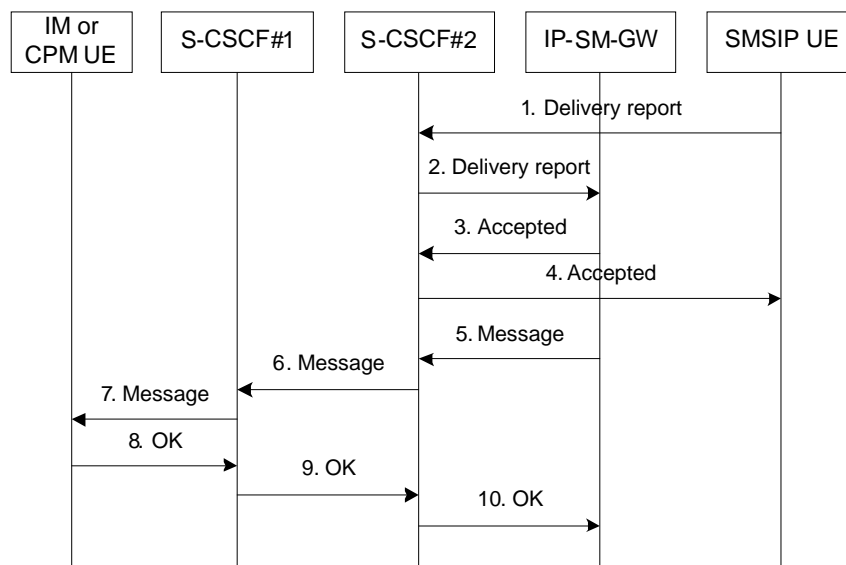

Figure 6.12: Delivery report after a successful Instant Message to encapsulated Short Message procedure

NOTE: An encapsulated Short Message has been sent successfully according to the procedure described in clause 6.11 before the procedure below can be performed.

- 1-2) The SMSIP UE has received the Short Message as described in clause 6.11 and sends a Delivery report (SMS-DELIVER-REPORT) to the IP-SM-GW via the S-CSCF.
- 3-4) The IP-SM-GW acknowledges, at the SIP level, the Delivery report to the SMSIP UE via the S-CSCF.
- 5-7) The IP-SM-GW sends a Delivery Notification to the IM UE or CPM UE.
- 8-10) The IM UE or CPM UE acknowledges the reception of the Delivery Notification.

6.13 Service-level interworking: IM or CPM capable UE sends an Instant Message to an SMS user with Interworking in the terminating side

This procedure describes the delivery of an Instant Message to a registered or an un-registered IMS subscriber. For the unregistered case, the S-CSCF forwards the Instant Message to the IP-SM-GW based on the unregistered iFC of the subscriber.

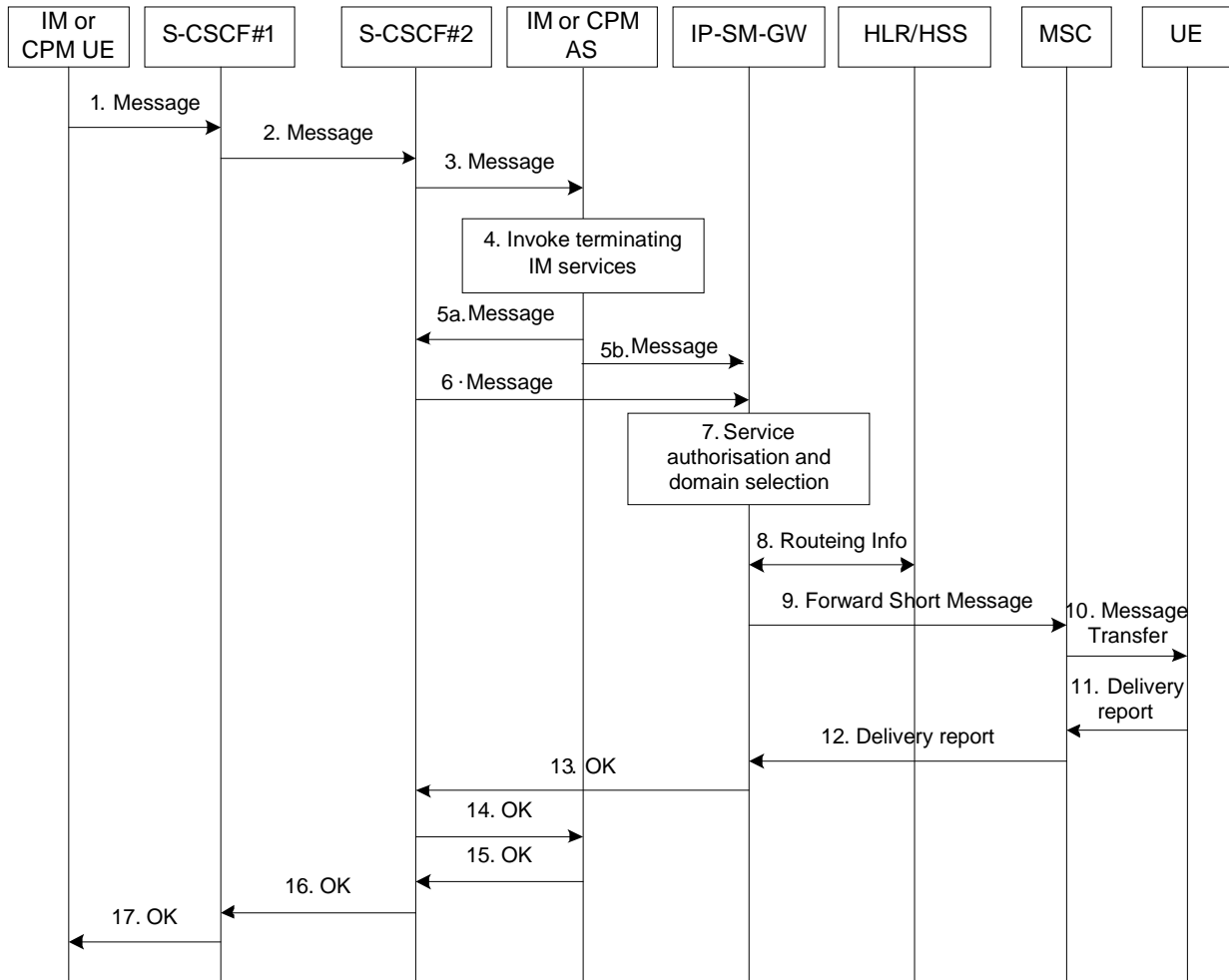

Figure 6.13: Successful IM terminating to SMS procedure with Interworking in the Terminating Side

- 1) UE submits an Instant Message, destined to another IM user or CPM user in another IMS domain, using an appropriate SIP method. The UE may request to hide its Public User Identity from the recipient within the Instant Message, as described in OMA-TS-SIMPLE_IM-V1_0 [12] and in OMA-TS-CPM_Conv_Funct-V1_0 [17].
- 2) The S-CSCF resolves the destination domain and routes the message towards the S-CSCF in the terminating network ("Terminating S-CSCF").
- 3) The terminating S-CSCF forwards the Instant Message to the IM AS ("Terminating IM AS") or to the CPM AS ("Terminating CPM AS") based on stored iFC.

NOTE: Depending on iFC configuration, it is possible that the IM AS or CPM AS is not triggered for the unregistered subscribers.

- 4) The terminating IM AS or CPM AS invokes terminating IM or CPM services as applicable for the destination IM or CPM user.

- 5a) The IM AS or CPM AS can forward the Instant Message back to the terminating S-CSCF, e.g. the terminating IM user is offline or the CPM user has no terminating interworking user preferences.
- 5b) In the case of the CPM AS, if terminating interworking user preferences are set, the Instant Message is routed directly to the IP-SM-GW in which case the procedure continues with step 7.
- 6) The terminating S-CSCF forwards the Instant Message to the IP-SM-GW, e.g. based on stored iFC.
- 7) If the user is authorized, the IP-SM-GW performs service-level interworking by converting the Instant Message to Short Message. The IP-SM-GW shall obtain the routing information for the UE from the HLR/HSS and deliver the message to the UE. If the sender of the Instant Message requests to hide its Public User Identity from the recipient and operator policy allows for this, the IP-SM-GW shall anonymise the identity of the user to the recipient. Otherwise, if operator policy prohibits this, the IP-SM-GW shall return an appropriate error to the user.
- 8) The IP-SM-GW obtains the routing information for the destination UE from the HLR/HSS.
- 9) The IP-SM-GW sends the Forward Short Message message to the target MSC.
- 10) The MSC sends the Short Message to the UE.
- 11) The UE acknowledges the receipt of the Short Message.
- 12) The MSC sends a Delivery report (SMS-DELIVER-REPORT) to the IP-SM-GW.
- 13) The IP-SM-GW sends OK response to the terminating S-CSCF.
- 14) The S-CSCF forwards the OK to the terminating IM AS or CPM AS.
- 15) The terminating IM AS or CPM AS forwards the OK response back to the terminating S-CSCF.
- 16) The terminating S-CSCF forwards the OK back towards the originating S-CSCF.
- 17) The originating S-CSCF forwards the OK to the originating UE.

6.14 Service-level interworking: IM or CPM user receives Short Message from an SMS user

An IMS registered user with SIMPLE IM or CPM service receives a Short Message formatted via service-level interworking to an Instant Message.

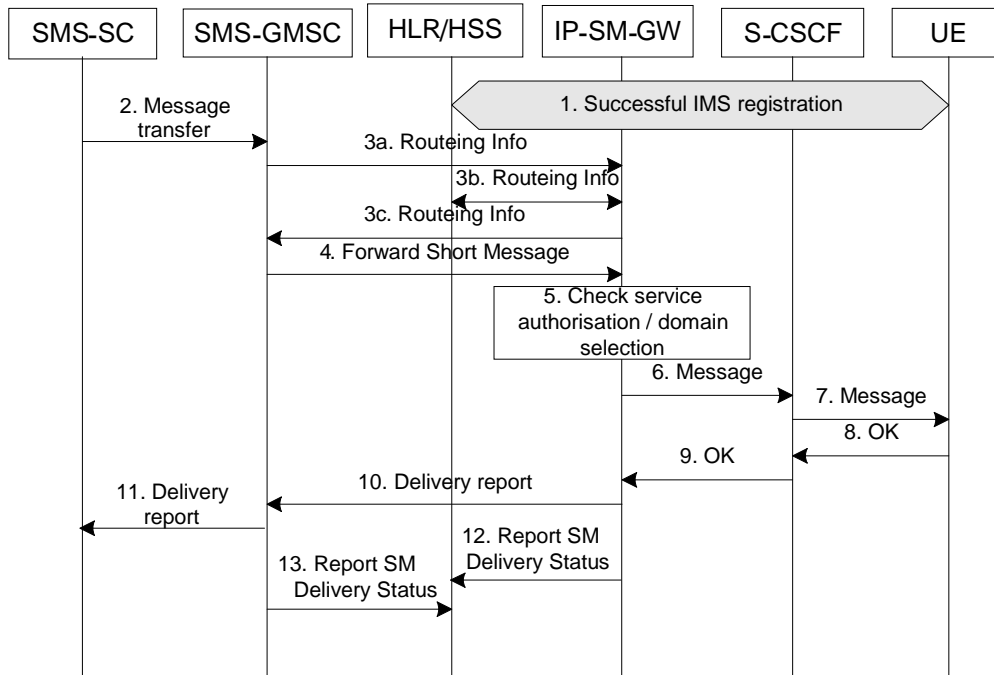

Figure 6.14: Successful IM termination after service-level interworking

- 1) The UE registers to the S-CSCF according to the IMS registration procedure.
- 2) The SMS-SC forwards a Short Message to the SMS-GMSC.
- 3a) The SMS GMSC interrogates the HSS to retrieve routing information. Based on the pre-configured IP-SM-GW address for the user, the HSS forwards the request to the corresponding IP-SM-GW.
- 3b) The HLR/HSS returns the IMSI and the address(es) of the current MSC and/or SGSN to the IP-SM-GW for delivery of the SM in CS/PS domain.
- 3c) The IP-SM-GW creates a MT Correlation ID as per TS 23.040 [2], which associates the Routing Info retrieval with the subsequent Forward Short Message message(s), and stores this along with the IMSI of the receiving subscriber. The IP-SM-GW returns to the SMS-GMSC the address of itself, along with the MT Correlation ID in the IMSI field, as routing information.
- 4) The SMS-GMSC delivers the Short Message to the IP-SM-GW in the same manner that it delivers the Short Message to an MSC or SGSN, including the MT Correlation ID received from the IP-SM-GW, in place of the IMSI.

5) The IP-SM-GW checks whether the recipient is authorized for the interworking service.

NOTE 1: The IP-SM-GW will determine whether the transport-level interworking or the service-level interworking is to be performed according to clause 6.8.3.

- 6) If the user is authorized for service-level interworking, the IP-SM-GW converts the Short Message to an Instant Message. It sends the Instant Message using the appropriate SIP method towards the S-CSCF.
- 7) The S-CSCF forwards the Instant Message to the UE.
- 8) The UE acknowledges the SIP request to the S-CSCF.
- 9) The S-CSCF forwards the acknowledgement of the SIP request to the IP-SM-GW.
- 10) The IP-SM-GW acknowledges the Forward Short Message to the SMS-GMSC.
- 11) The SMS-GMSC sends a Delivery report (SMS-DELIVER-REPORT) to the SMS-SC.
- 12) The IP-SM-GW may send a Report SM Delivery Status to the HLR/HSS.

13) The SMS-GMSC may send a Report SM Delivery Status to the HSS. The HSS shall ignore the information provided in this report.

6.15 Service-level Interworking: CPM capable UE sends a Chat session invitation to an SMS user

6.15.1 IP-SM-GW in the originating network

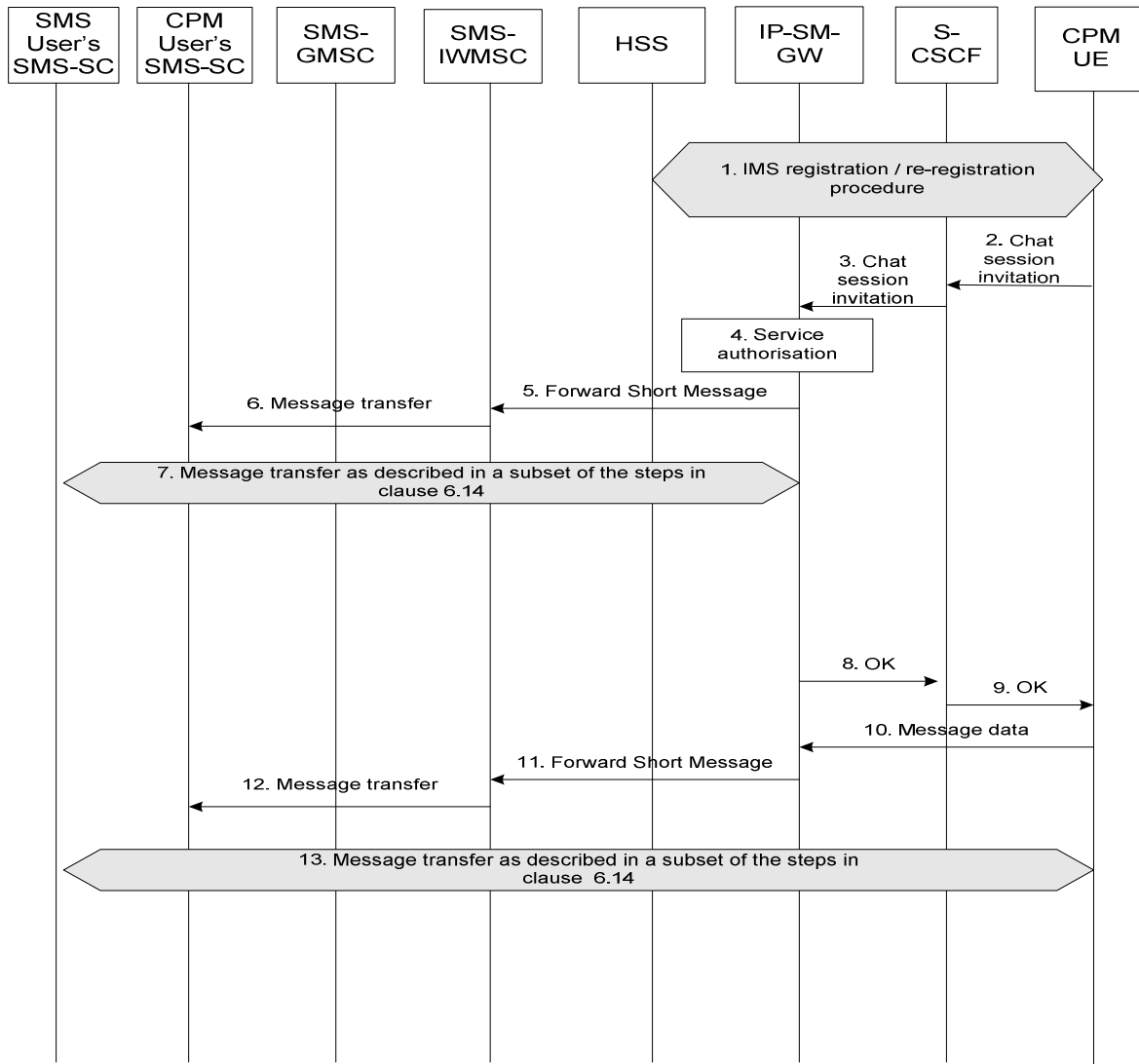

Figure 6.15.1: Chat session invitation to SMS user and Message data exchange (IP-SM-GW in originating network)

- 1) The UE registers to S-CSCF according to the IMS registration procedure.
- 2) The UE sends a session invitation request for a chat session to the S-CSCF, using the appropriate SIP method. The UE may request to hide its Public User Identity from the recipient within the session invitation.
- 3) S-CSCF forwards the session invitation to the IP-SM-GW based on stored iFC.

NOTE 1: Subscribers with no subscription for service level interworking will not be provided with the relevant iFCs.

- 4) The IP-SM-GW performs service authorization based on the stored subscriber data retrieved from the HLR/HSS at the time of the registration procedure as specified in clause 6.1. The IP-SM-GW shall check whether the originating subscriber is authorised to use the interworking service. If the result of service authorization is negative, the IP-SM-GW shall not forward the message, and shall return the appropriate error information to the UE in a failure report. If the sender of the session invitation asks to hide its Public User Identity from the recipient and operator policy allows for this, the IP-SM-GW shall anonymize the identity of the user in all messages it sends to the recipient. If operator policy prohibits anonymity, the IP-SM-GW shall not perform interworking and shall send back an appropriate response.

NOTE 2: Steps 5 to 7 are only executed if the operator policy is to check back with the SMS user before accepting the invitation on behalf of the SMS user. Otherwise, the process continues with step 8, as if the SMS user has responded with an acceptance of the chat session invitation.

- 5) Otherwise, the IP-SM-GW correlates an MSISDN to this chat session. Any SMS sent from the SMS user to this MSISDN should be interworked into the chat session with which this MSISDN is correlated. The IP-SM-GW shall use the SC Address in the subscriber data retrieved from the HSS at registration or provisioned by configuration and translates the chat session invitation request to a Short Message (SMS- SUBMIT) carrying an SC Address, then forwards it towards the SMS-SC (SC Address) via the SMS-IWMSC (as described in TS 23.040 [2]). The text in the Short Message is defined by the operator and should convey information to the SMS user that he is invited to send and receive messages in the context of a chat session, and include instructions on how to accept, reject and end the session. If no response is received in time, the IP-SM-GW will consider the session rejected and send an appropriate response to the session invitation.

NOTE 3: The MSISDN used as the sender of the Short Message is either the MSISDN of the CPM user or one that is assigned by the IP-SM-GW, depending on operator configuration.

- 6) The SMS-IWMSC forwards the Short Message (SMS- SUBMIT) to the SMS-SC and the SMS is delivered to the SMS user using standard SMS procedures (see TS 23.040 [2]).
- 7) A Short Message is sent by the SMS user via the SMS-GMSC to the IP-SM-GW in accordance to steps 2 to 4 and steps 10 to 13 from clause 6.14.
- 8) If the answer is positive, the IP-SM-GW acknowledges the session invitation. Otherwise the IP-SM-GW will consider the session rejected and send back an appropriate response.
- 9) Session invitation acknowledgement is forwarded by S-CSCF to the CPM UE.

NOTE 4: The following steps are executed only if an SMS with a positive answer is received from the SMS user or if the operator policy indicated that the session is accepted without SMS user interaction. If a negative response to the invitation is received or if no response from the SMS user is received within an operator defined time, the IP-SM-GW will send a negative response to the chat invitation.

NOTE 5: Steps 10 to 12 are repeated for each message sent from the CPM user towards the SMS user, and steps 13 to 14 are repeated for each message sent from the SMS user towards the CPM user.

- 10) The CPM user sends a message within the chat session containing data to the recipient SMS user.
- 11) The IP-SM-GW transforms the received message into a Short Message and sends a Short Message (SMS- SUBMIT) carrying the SC Address, then forwards it towards the SMS-SC (SC Address) via the SMS-IWMSC (as described in TS 23.040 [2]). According to operator policy, each SMS generated for the SMS user may include text instructions on how to leave the chat session.
- 12) The SMS-IWMSC forwards the Short Message (SMS- SUBMIT) to the SMS-SC and the SMS is delivered to the SMS user using standard SMS procedures (see TS 23.040 [2]).
- 13) A Short Message is sent by the SMS user via the SMS-GMSC to the IP-SM-GW in accordance to steps 2 to 13 from clause 6.14.

NOTE 6: Step 5 of the flow in clause 6.14 becomes this: The IP-SM-GW identifies that a session exists between the SMS user and the CPM user.

6.15.2 IP-SM-GW in the terminating network

The SMS user (SMS UE B) in this flow is a CPM user (CPM user B) whose preferences are set in his home network to receive his incoming chat sessions as Short Messages.

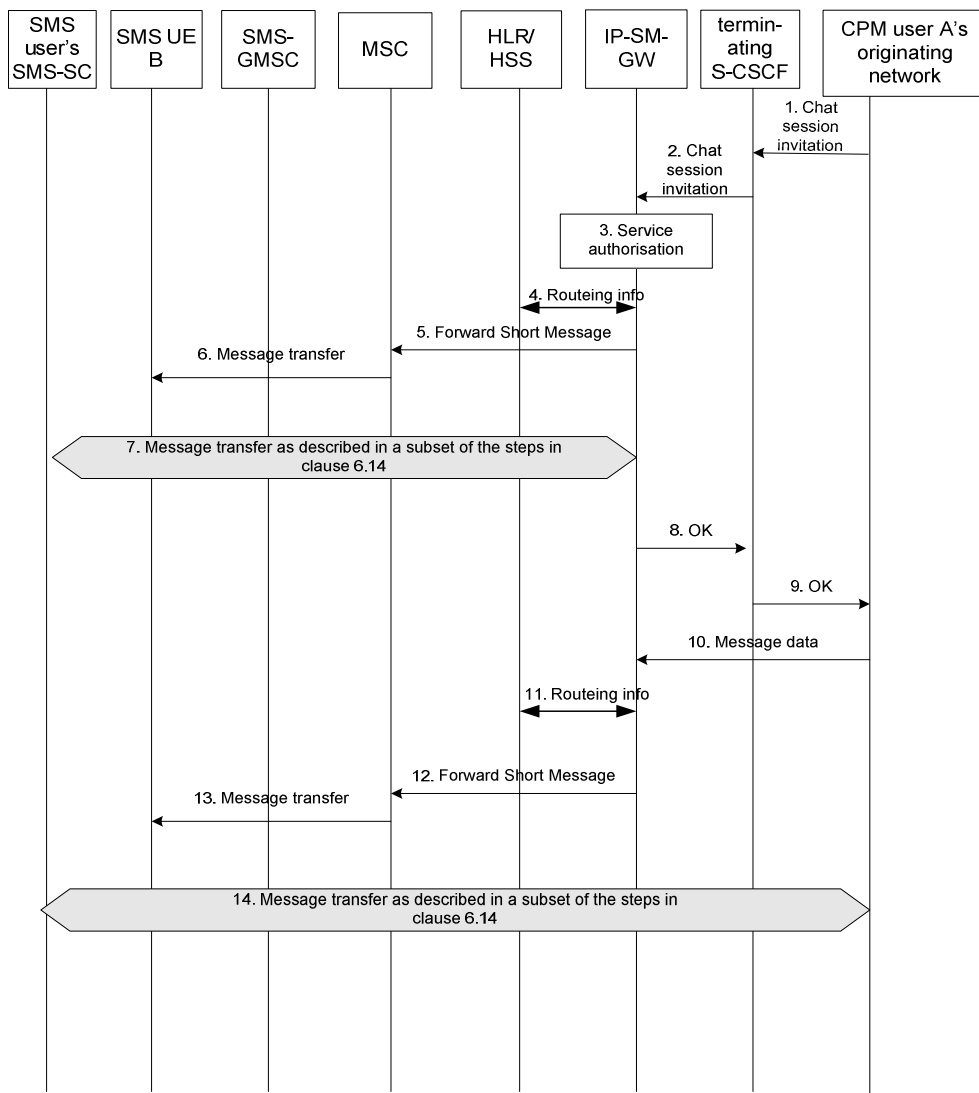

Figure 6.15.2: Chat session invitation to SMS user and message data exchange (IP-SM-GW in terminating network)

1) The originating network for CPM user A sends a session invitation request for a chat session to a CPM user (CPM user B) in another IMS domain, using the appropriate SIP method. The UE may request to hide its Public User Identity from the recipient within the session invitation. The originating S-CSCF (not shown) resolves the destination domain and routes the session invitation towards the S-CSCF in the terminating network ("terminating S-CSCF").

2) The terminating S-CSCF forwards the session invitation to the IP-SM-GW based on stored iFC.

NOTE 1: Subscribers with no subscription for service level interworking will not be provided with the relevant iFCs.

3) Authorization to continue is checked. If the sender of the session invitation asks to hide its Public User Identity from the recipient and operator policy allows for this, the IP SM GW shall anonymize the identity of the user in all messages it sends to the recipient. If operator policy prohibits anonymity, or if the IP-SM-GW cannot identify the sending party and the operator prohibits session invitations from unidentified users, the IP SM GW shall not perform interworking and send back an appropriate response.

NOTE 2: Steps 5 to 7 are only executed if the operator policy is to check back with the SMS user before accepting the invitation on behalf of the SMS user. Otherwise, the process continues with step 8, as if the SMS user has responded with an acceptance of the chat session invitation.

- 4) The IP-SM-GW performs service-level interworking by converting the chat session invitation request to a Short Message. The IP-SM-GW obtains the routing information for the destination UE from the HLR/HSS.
- 5) The IP-SM-GW sends the Forward Short Message message to the target MSC. The IP-SM-GW assigns an MSISDN representing the chat session to ensure that the reply to this SMS is sent back to this particular IP-SM-GW. Any SMS sent from the SMS user to this MSISDN should be interworked into the chat session with which this MSISDN is correlated. The text in the Short Message is defined by the operator and should convey information to the SMS user that he is invited to send and receive messages in the context of a chat session, and include instructions on how to accept, reject and end the session. The identity of the original sender (CPM user or group) is included as part of the operator provided invitation text. If no response is received in time, the IP-SM-GW will consider the session rejected and send an appropriate response to the session invitation.
- 6) The MSC sends the Short Message to the SMS user.
- 7) A Short Message is received via the SMS-GMSC from the SMS user by the IP-SM-GW, in accordance to steps 2 to 4 and steps 10 to 13 of clause 6.14, indicating the response to the chat session invitation. The message is targeted to the MSISDN representing the chat session which was assigned in step 5.
- 8) If the answer is positive, the IP-SM-GW acknowledges the session invitation. Otherwise the IP-SM-GW will consider the session rejected and send back an appropriate response.
- 9) The session invitation acknowledgement is forwarded by S-CSCF to the CPM UE.

NOTE 3: The following steps are executed only if an SMS with a positive answer is received from the SMS user or if the operator policy indicated that the session is accepted without SMS user interaction. In case a negative response to the invitation is received or if no response from the SMS user is received within an operator defined time, the IP-SM-GW will send a negative response to the chat invitation.

NOTE 4: Steps 10 to 13 are repeated for each message sent from the CPM user towards the SMS user, and step 14 is repeated for each message sent from the SMS user towards the CPM user.

- 10) The CPM user sends a message within the chat session containing data to the recipient SMS user.
- 11) The IP-SM-GW transforms the received message into a Short Message and obtains the routing information for the destination UE from the HLR/HSS.
- 12) The IP-SM-GW sends a Short Message (SMS- DELIVER) towards the MSC, as described in TS 23.040 [2]. The IP-SM-GW inserts the MSISDN representing the chat session as the sender of the message, to ensure that the reply to this SMS is sent back to it.
- 13) The MSC forwards the Short Message (SMS- DELIVER) to the SMS user, and the SMS is delivered to the SMS user using standard SMS procedures as described in TS 23.040 [2]).
- 14) A Short Message is received via the SMS-GMSC from the SMS user by the IP-SM-GW, in accordance to steps 2 to 13 from clause 6.14. The message is targeted to the MSISDN representing the chat session which was assigned in step 5.

NOTE 5: Step 5 of the flow in clause 6.14 becomes this: "The IP-SM-GW identifies that a session exists between the SMS user and the CPM user".

6.16 Service-level Interworking: CPM capable UE tearing down a Chat session between a CPM user and an SMS user

6.16.1 IP-SM-GW in the originating network

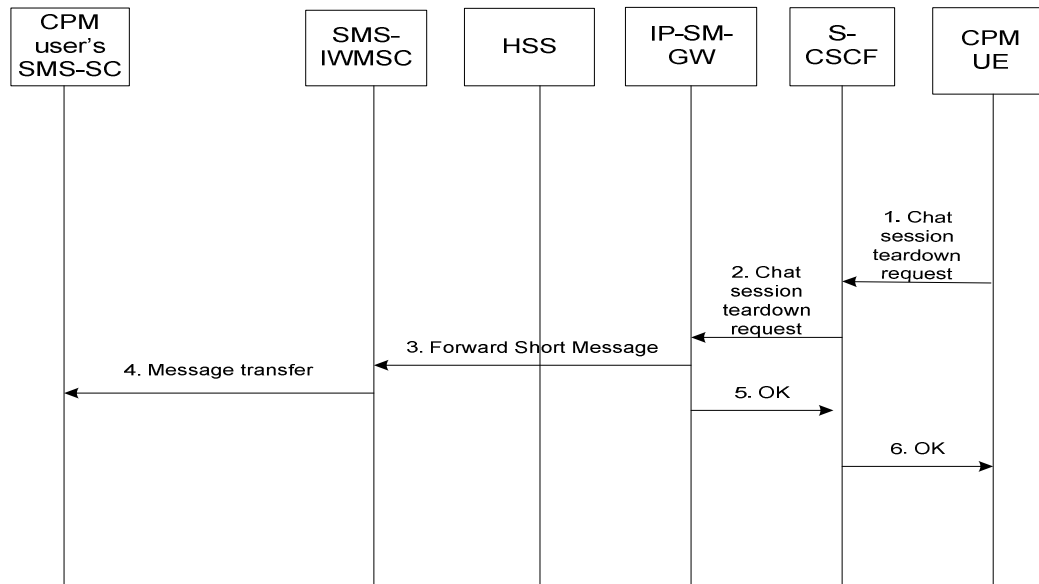

Figure 6.16.1: Chat session teardown request to SMS (IP-SM-GW in originating network)

- 1) The CPM UE sends a SIP BYE for an ongoing session to the S-CSCF.
- 2) S-CSCF forwards the session teardown request to the IP-SM-GW. The IP-SM-GW performs service-level interworking by converting the session teardown request to a Short Message (SMS-SUBMIT) carrying the SC Address and including operator provided teardown text. The IP-SM-GW uses the SC Address in the subscriber data retrieved from the HSS at registration or provisioned by configuration.
- 3) The IP-SM-GW forwards the Short Message towards the SMS-SC (SC Address) via the SMS-IWMSC (as described in TS 23.040 [2]). The text in the Short Message is defined by the operator and should convey information to the SMS user that the chat session is ending.

NOTE 1: The MSISDN used as the sender of the Short Message is either the MSISDN of the CPM user or one that was assigned by the IP-SM-GW at session establishment, depending on operator configuration.

- 4) The SMS-IWMSC forwards the Short Message (SMS- SUBMIT) to the SMS-SC (see TS 23.040 [2]).

NOTE 2: Steps 3 to 4 are only executed if the operator policy requires that the SMS user be told the session is being torn down. Otherwise, the process continues with step 5.

- 5) The IP-SM-GW acknowledges the session teardown request and tears down the associated resources.
- 6) The session teardown acknowledgement is forwarded by the S-CSCF to the CPM UE.

6.16.2 IP-SM-GW in the terminating network

The SMS user (SMS user B) in this flow is a CPM user (CPM user B) who has set his preferences in his home network to receive his incoming chat sessions as Short Messages.

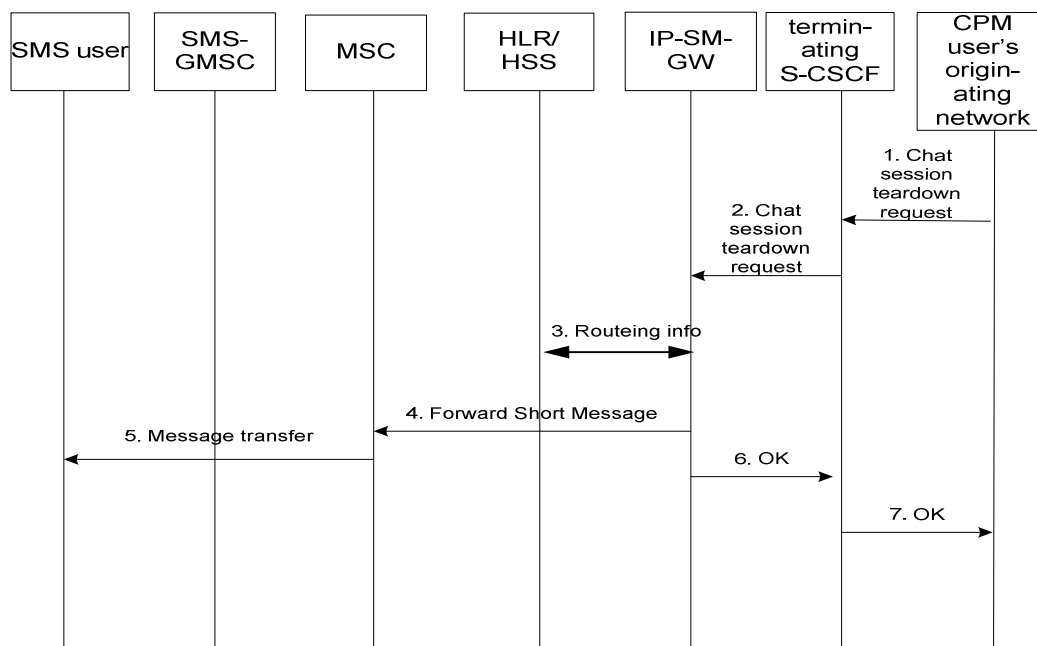

Figure 6.16.2: Chat session teardown request to SMS (IP-SM-GW in terminating network)

- 1) The CPM user's originating network sends a session teardown request for an ongoing chat session to the terminating S-CSCF.
- 2) The terminating S-CSCF forwards the session teardown request to the IP-SM-GW serving the SMS user. The IP-SM-GW performs service-level interworking by converting the session teardown request to a Short Message including operator provided teardown text.
- 3) The IP-SM-GW obtains the routing information for the destination UE from the HLR/HSS.
- 4) The IP-SM-GW sends the Forward Short Message to the target MSC. The IP-SM-GW inserts the MSISDN it had previously assigned to represent this chat session as the sender of the message.

NOTE: Steps 3 to 5 are only executed if the operator policy requires that the SMS user be told the session is being torn down. Otherwise, the process continues with step 6.

- 5) The MSC sends the Short Message to the SMS user.
- 6) The IP-SM-GW acknowledges the session teardown request and tears down the associated resources.
- 7) The session teardown acknowledgement is forwarded by S-CSCF towards the CPM user's originating network.

6.17 Service-level Interworking: SMS user requesting the IP-SM-GW to tear down the Chat session between a CPM user and an SMS user

6.17.1 IP-SM-GW in the originating network

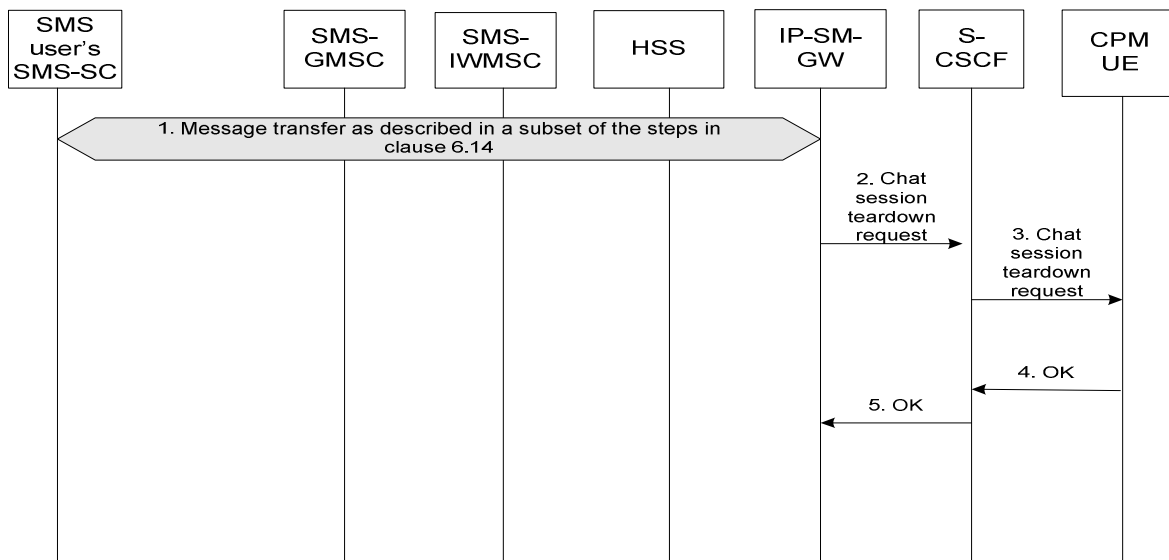

Figure 6.17.1: Chat session teardown request to CPM UE (IP-SM-GW in originating network)

- 1) A message is received from the SMS user via the SMS-GMSC by the IP-SM-GW, in accordance to steps 2 to 4 and steps 10 to 13 of clause 6.14, with the operator defined Short Message indicating the SMS user wants to leave the chat session.
- 2) The IP-SM-GW performs service-level interworking by recognizing that the Short Message corresponds to the operator defined teardown text indicating the SMS user wants to leave the chat session, so the IP-SM-GW sends a chat session teardown request.
- 3) The session teardown request is forwarded by S-CSCF to the CPM UE.
- 4) The CPM UE acknowledges the session teardown request.
- 5) The acknowledgement is forwarded by the S-CSCF to the IP-SM-GW.

6.17.2 IP-SM-GW in the terminating network

The SMS user in this flow is a CPM user who has set his preferences in his home network to receive his incoming chat sessions as Short Messages.

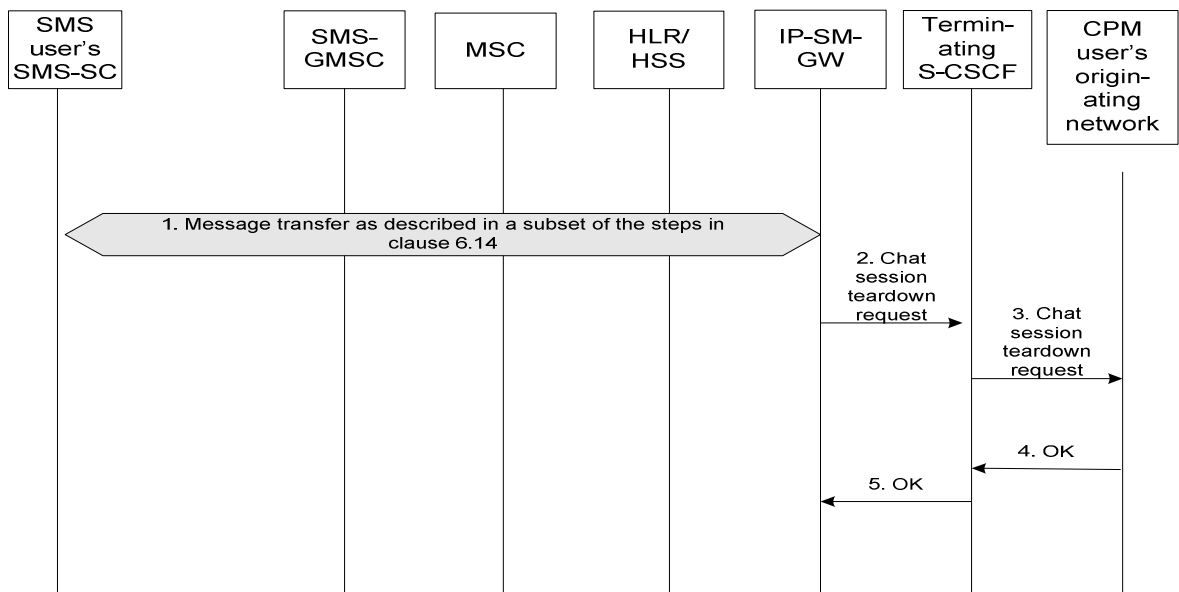

Figure 6.17.2: Chat session teardown request to CPM UE (IP-SM-GW in terminating network)

- 1) A message is received from the SMS user via the SMS-GMSC by the IP-SM-GW, in accordance to steps 2 to 4 and steps 10 to 13 of clause 6.14, with the operator provided teardown text indicating the SMS user wants to leave the chat session.
- 2) The IP-SM-GW performs service-level interworking by recognizing that the Short Message corresponds to the operator provided teardown text indicating the SMS user wants to leave the chat session, so the IP-SM-GW sends a chat session teardown request.
- 3) The session teardown request is forwarded by the S-CSCF towards the CPM user's originating network.
- 4) The CPM user's originating network acknowledges the session teardown request and tears down the associated resources.
- 5) The acknowledgement is forwarded by the S-CSCF to the IP-SM-GW.

6.18 Service-level interworking: Status Report procedure for chat session message to Short Message interworking

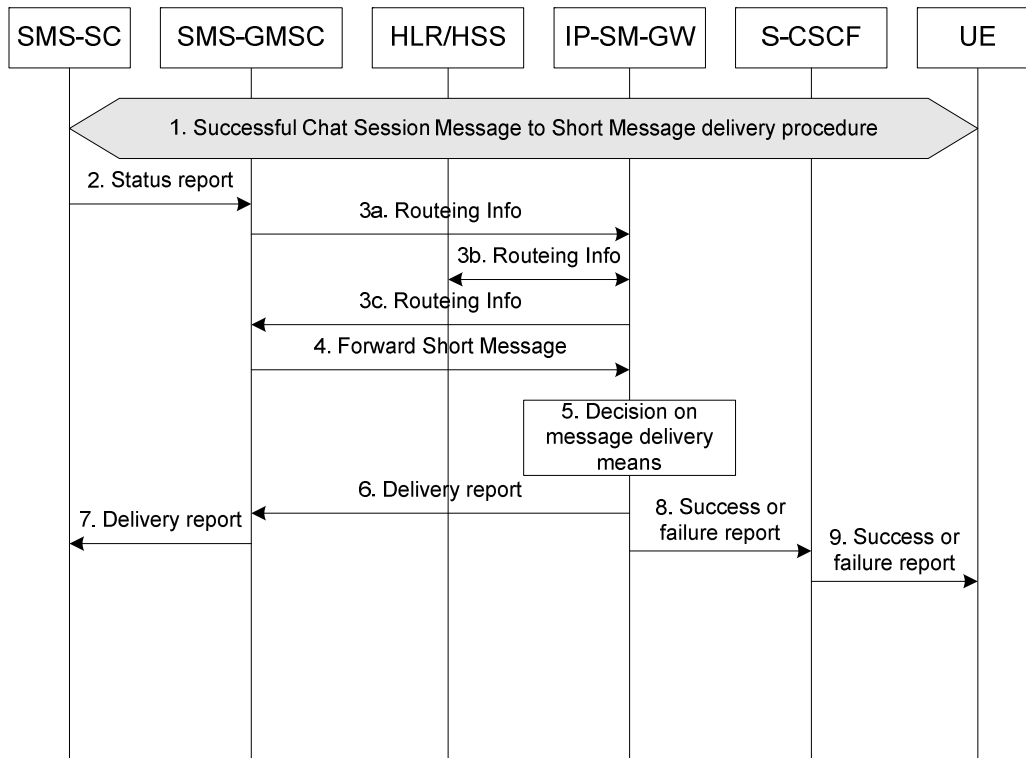

Figure 6.18: Status report procedure for chat session message to Short Message interworking

- 1) A chat session message from the UE is successfully delivered to the SMS user after service-level interworking according to clause 6.15. The chat session message requested a success or failure delivery report.

NOTE 1: A Request for success or failure delivery report can be requested in a chat session message sent by the UE as described in IETF RFC 4975 [19].

- 2) The SMS-SC sends a Status report to the SMS-GMSC.

NOTE 2: The Status report, from the SMS-GMSC's point of view, will be treated as any SM termination.

NOTE 3: The Status report is an optional message.

- 3a) The SMS GMSC interrogates the HLR/HSS to retrieve routing information. Based on the pre-configured IP-SM-GW address for the user, the HLR/HSS forwards the request to the corresponding IP-SM-GW.

- 3b) The HLR/HSS returns the IMSI and the address(es) of the current MSC and/or SGSN to the IP-SM-GW for delivery of the Short Message in CS/PS domain.

- 3c) The IP-SM-GW creates a MT Correlation ID as per TS 23.040 [2], which associates the Routing Info retrieval with the subsequent Forward Short Message messages(s), and stores this along with the IMSI of the receiving subscriber. The IP-SM-GW returns to the SMS-GMSC the address of itself, along with the MT Correlation ID in the IMSI field, as routing information. Alternatively, the IP-SM-GW may return the address(es) of the current MSC and/or SGSN, in which case, the subsequent procedure to forward the message is the same as defined in TS 23.040 [2].

- 4) The SMS-GMSC sends the status report in the Forward Short Message to the IP-SM-GW.

- 5) The IP-SM-GW translates and maps the Status report in the Forward Short Message into a report request as described in MSRP IETF RFC 4975 [19].

- 6) The IP-SM-GW sends a Delivery report (SMS-DELIVER-REPORT) to the SMS-GMSC.

7) The SMS-GMSC sends an acknowledgement back to the SMS-SC.

8-9) The IP-SM-GW sends a success or failure report based on the value in the status report.

NOTE 4: Step 6 and 8 can happen independently of each other.

Annex A (informative): Service-level interworking: IM or CPM user sends an Instant Message to a group list including SMS users

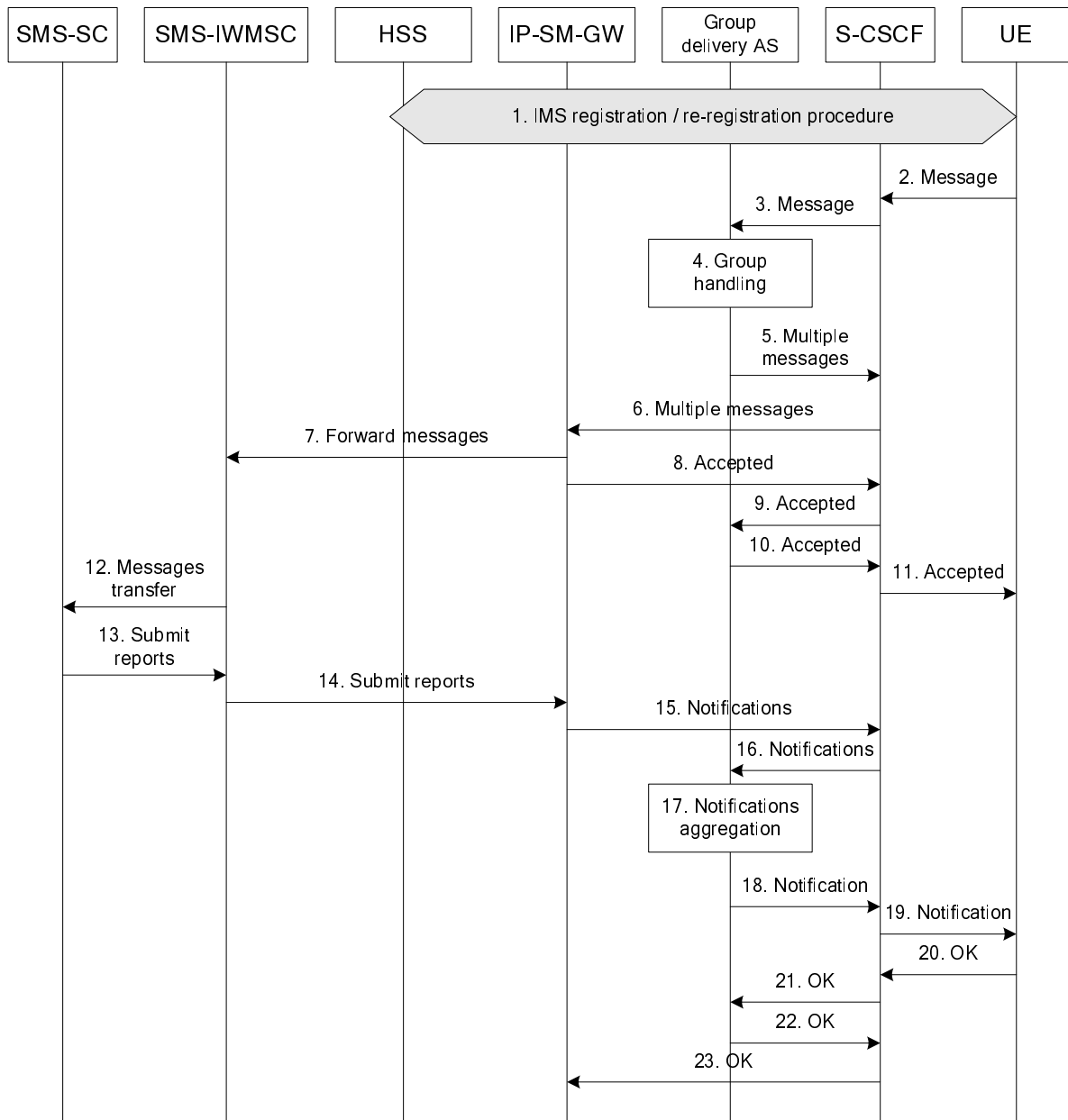

Figure A.1: IM user sends an Instant Message to a group list via service-level interworking

- 1) The UE registers to S-CSCF according to the IMS registration procedure.
- 2) UE generates Instant Message which includes group information, e.g. Group identifier in the Request-URI and/or recipient list in the body of the Instant Message. UE submits the Instant Message to the S-CSCF using an appropriate SIP method.
- 3) Based on the stored iFC, S-CSCF forwards the Instant Message to an AS in charge of the group delivery, e.g., the controlling function server defined in OMA-TS-SIMPLE_IM-V1_0 [12] or the controlling function server defined in OMA-TS-CPM_Conv_Funct-V1_0 [17].

- 4) The group delivery AS replicates per Instant Message for per recipient according to the group information it obtains acting as a B2BUA. See detail in OMA-TS-SIMPLE_IM-V1_0 [12] or in OMA-TS-CPM_Conv_Funct-V1_0 [17].
- 5) The group delivery AS sends the generated multiple Instant Messages to S-CSCF (e.g., the Instant Messages can be delivered as what the list server does defined in the TS 24.247 [14]).
- 6) The S-CSCF forwards the Instant Messages to the IP-SM-GW based on the stored iFC.
- 7) The IP-SM-GW shall decide whether to perform service-level interworking depending on SIP request header (e.g. Request-URI), operator policy, when the Instant Message is not routeable in the IMS. If IP-SM-GW decided to perform service-level interworking, the IP-SM-GW performs service authorization based on the stored subscriber data retrieved from the HLR/HSS at the time of the third party registration procedure as described in the clause 6.1. The IP-SM-GW shall check whether the originating subscriber is authorised to use the interworking service. If the result of service authorization is negative, the IP-SM-GW shall not forward the message, and shall return the appropriate error information to the UE in a failure report. Otherwise, the IP-SM-GW shall translate the IMS message to a Short Message (SMS- SUBMIT) and forwards it towards the SMS-SC (SC Address) via the SMS-IW MSC (as described in TS 23.040 [2]).
- 8) If service authorization is successful, the IP-SM-GW acknowledges the Instant Messages.
- 9-11) Instant Message acknowledgement is forwarded by S-CSCF to UE.
- 12) The SMS-IW MSC forwards the Short Messages (SMS- SUBMIT) to the SMS-SC (see TS 23.040 [2]).
- 13) The SMS-SC sends multiple Submit reports (SMS-SUBMIT REPORT) to SMS-IW MSC (see TS 23.040 [2]).
- 14) SMS-IW MSC sends the Submit reports to IP-SM-GW (see TS 23.040 [2]).
- 15) IP-SM-GW translates the received Submit reports to appropriate IMS delivery notifications defined in RFC 5438 [13], and forwards the IMS delivery notifications to the S-CSCF.
- 16) The S-CSCF forwards the IMS delivery notifications to the group delivery AS.
- 17) The group delivery AS aggregates the delivery notifications of the same type from different recipients into a single delivery notification.
- 18) The group delivery AS sends the delivery notification to the S-CSCF.
- 19) The S-CSCF forwards the delivery notification to the UE.
- 20-23) Acknowledgement of the delivery notification is forwarded by S-CSCF to IP-SM-GW.

Annex B (informative): Group chat sessions

B.1 Service-level interworking: IM or CPM user initiates a group chat and sends an Instant Message to a group list including SMS users

The flow in this clause is the same as that described in clause 6.15.1 with the difference that it is required that the IP-SM-GW assign an MSISDN for this group chat session so that it is clear for the SMS user that any message sent to the assigned MSISDN will be delivered to the group chat session participants, not just to the CPM UE that invited the SMS user.

In this flow, the IP-SM-GW is in the PLMN of the CPM UE, but it could also be in the PLMN of the SMS user if that user was also a CPM user and had terminating user preferences to deliver the session invitation via SMS.

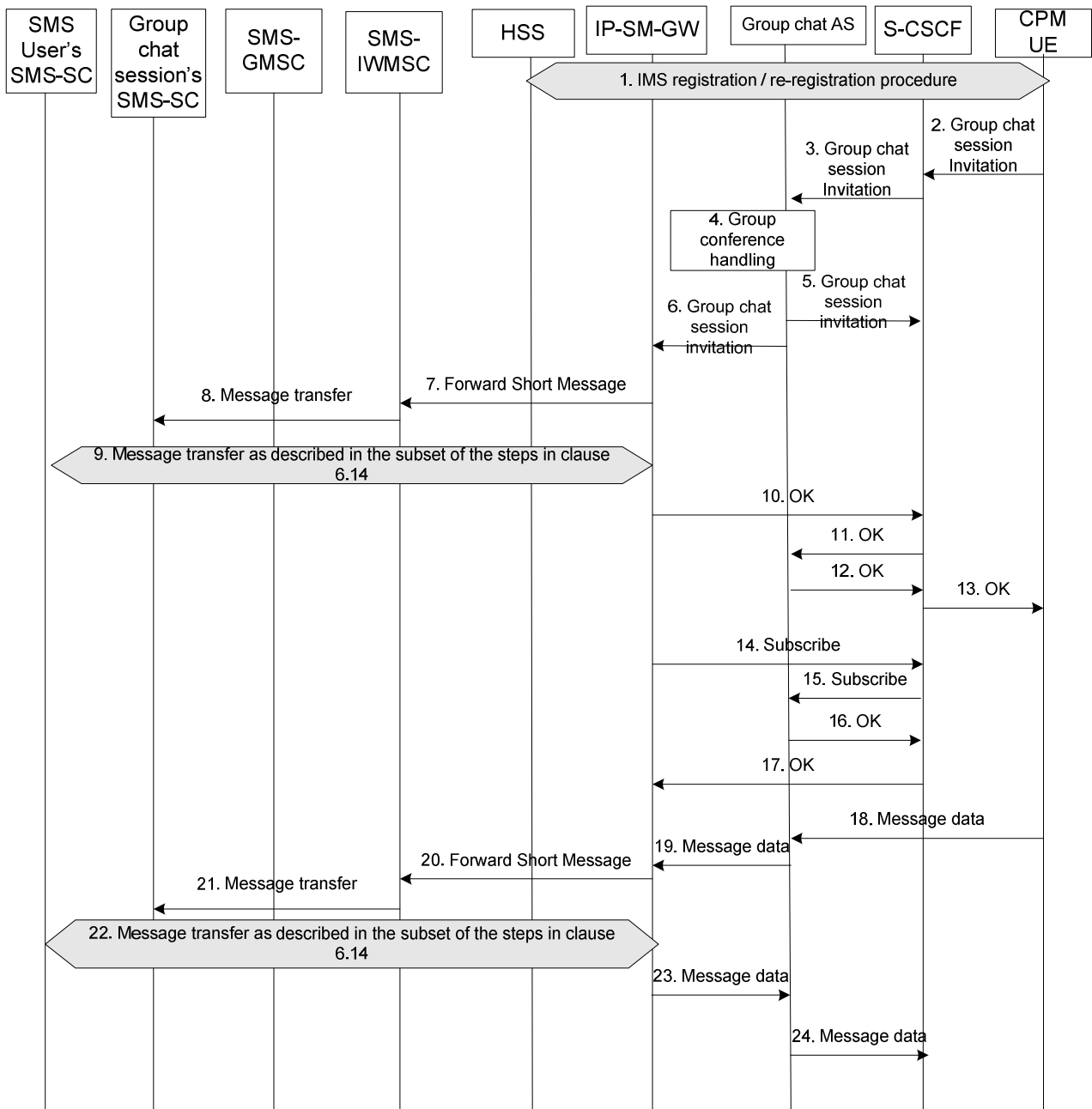

Figure B.1: CPM user initiates a group chat and messages are exchanged within the group chat via service-level interworking

- 1) The UE registers to S-CSCF according the IMS registration procedure.
- 2) The UE generates a chat session invitation which includes group information, e.g. Group identifier in the Request-URI and/or recipient list in the body of the chat session invitation. UE submits the Instant Message to the S-CSCF using an appropriate SIP method.
- 3) Based on the stored iFC, S-CSCF forwards the session invitation to an AS in charge of handling group chat requests, e.g., the controlling function server defined in OMA-TS-SIMPLE_IM-V1_0 [12] or the controlling function server defined in OMA-TS-CPM_Conv_Funct-V1_0 [17].
- 4) The group chat AS replicates a session invitation per recipient according to the group information it obtains acting as a B2BUA. See details in OMA-TS-SIMPLE_IM-V1_0 [12] or in OMA-TS-CPM_Conv_Funct-V1_0 [17].
- 5) The group chat AS sends the generated multiple session invitations to the S-CSCF.

- 6) The group chat AS forwards one of the chat session invitations to the IP-SM-GW according to normal routing procedures (e.g., via S-CSCF).

NOTE 1: Nodes specific to the CPM functions such as ISF are either collocated with the IP-SM-GW or else are not shown.

- 7) The IP-SM-GW translates the chat session invitation request to a Short Message (SMS- SUBMIT) and forwards it towards the group chat SMS-SC (SC Address) via the SMS-IW MSC (as described in TS 23.040 [2]). The IP-SM-GW assigns an MSISDN representing the group chat session to ensure that the reply to this SMS is sent back to this particular IP-SM-GW. Any SMS sent from the SMS user to this MSISDN will be interworked into the group chat session with which this MSISDN is correlated. The text in the Short Message is defined by the operator and conveys information to the SMS user that he is invited to send and receive messages in the context of a group chat session, and includes instructions on how to accept, reject and end the session. The identity of the original sender (CPM user or group) is included as part of the operator provided invitation text.
- 8) The SMS-IW MSC forwards the Short Messages (SMS- SUBMIT) to the group chat SMS-SC and the SMS is delivered to the SMS user using standard SMS procedures (see TS 23.040 [2]).
- 9) A Short Message is received from the SMS user via the SMS-GMSC by the IP-SM-GW, in accordance to steps 2 to 4 and steps 10 to 13 from clause 6.14, indicating the response to the group chat session invitation. The message is targeted to the MSISDN representing the group chat session which was assigned in step 7.
- 10) If the answer is positive or if operator policy is to accept the session invitation on behalf of the SMS user, the IP-SM-GW acknowledges the session invitation. Otherwise the IP-SM-GW will consider the session rejected and send back an appropriate response.
- 11) The session invitation acknowledgement is forwarded by S-CSCF to the group chat AS.
- 12-13) The group chat AS responds back to the group chat session initiator once the first user joins the group chat session.

NOTE 2: The following steps are executed only if an SMS with a positive answer is received from the SMS user or if the operator policy indicated that the session is accepted without SMS user interaction. In case a negative response to the invitation is received or if no response from the SMS user is received within an operator defined time, the IP-SM-GW shall send a negative response to the chat invitation.

- 14-17) The IP-SM-GW subscribes to the participant information changes.

NOTE 3: Steps 18 to 21 are repeated for each message sent from any group chat session participant towards the SMS user, and steps 22 to 24 are repeated for each message sent from the SMS user towards the group chat session participants.

- 18) The CPM UE (or any group chat session participant) sends a message containing data to the group chat AS.
- 19) For the group chat session participant who is an SMS user, the message is routed towards the IP-SM-GW.
- 20) The IP-SM-GW identifies that a session exists between the SMS user and group chat AS and transforms the received message into a Short Message and sends a Short Message (SMS- SUBMIT) carrying the SC Address, then forwards it towards the group chat SMS-SC (SC Address) via the SMS-IW MSC (as described in TS 23.040 [2]). The IP-SM-GW inserts the address representing the group chat session as the sender of the message to ensure that the reply to this SMS is sent back to this particular IP-SM-GW.
- 21) The SMS-IW MSC forwards the Short Message (SMS- SUBMIT) to the group chat SMS-SC and the SMS is delivered to the SMS user using standard SMS procedures (see TS 23.040 [2]).
- 22) A Short Message is received from the SMS user via the SMS-GMSC by the IP-SM-GW, in accordance to steps 2 to 13 from clause 6.14. The message is targeted to the MSISDN representing the group chat session which was assigned in step 7.

NOTE 4: Step 5 of the flow in clause 6.14 becomes this: The IP-SM-GW identifies that a session exists between the SMS user and the CPM user. Steps 6 and 7 of the flow in clause 6.14 are replaced by steps 23 and 24 in this flow.

- 23) The IP-SM-GW identifies that a session exists between the SMS user and the group chat AS and transforms the received message into message data and sends it within the session towards the group chat AS.

24) The group chat AS forwards the message to all group chat participants.

B.2 Service-level interworking: CPM user extends a one-to-one chat session into a group chat session

This flow is the same as that described in clause 6.15.1 with the difference that it is required that the IP-SM-GW assign an MSISDN when this group chat session starts if one was not assigned before, so that it is clear for the SMS user that any message sent to the assigned MSISDN will be delivered to the group chat session participants, not just to the CPM UE that invited the SMS user.

In this flow, the IP-SM-GW is in the PLMN of the CPM UE, but it could also be in the PLMN of the SMS user if that user was also a CPM user and had terminating user preferences to deliver the session invitation via SMS.

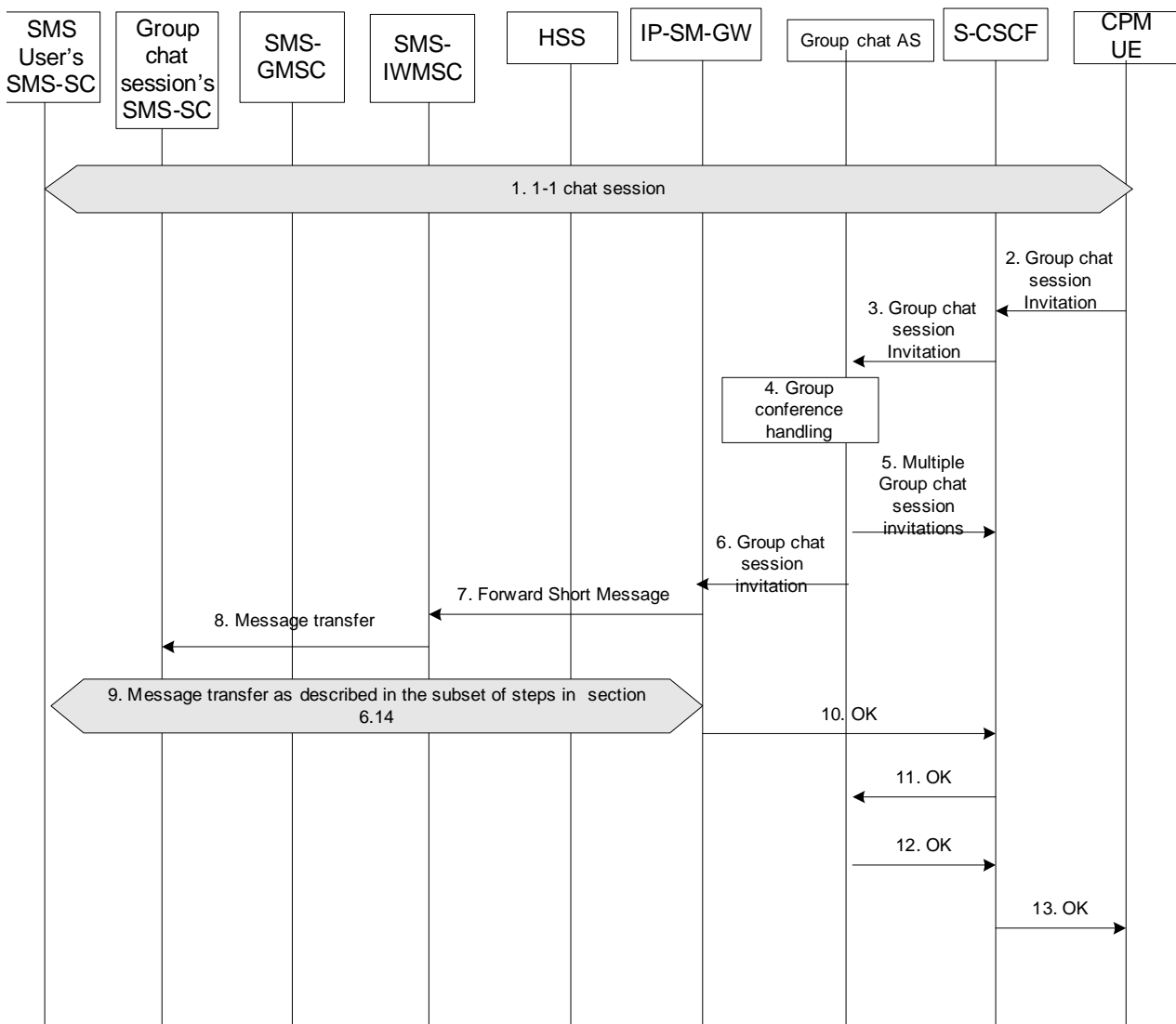

Figure B.2: CPM user modifies a one-to-one chat session into a group chat session

- 1) A one-to-one chat session is established between the CPM user and the SMS user.
- 2) The UE generates a chat session invitation which includes a recipient list in the body of the chat session invitation. The original SMS user who is part of the one-to-one chat session is included in that list An indication

is added for the original SMS user in the list that the existing one-to-one session is to be replaced by the new session. The UE submits the chat session invitation to the S-CSCF.

- 3) Based on the stored iFC, S-CSCF forwards the session invitation to an AS in charge of handling group chat requests, e.g., the controlling function server defined in OMA-TS-SIMPLE_IM-V1_0 [12] or the controlling function server defined in OMA-TS-CPM_Conv_Funct-V1_0 [17].
- 4) The group chat AS replicates a session invitation per recipient according to the group information it obtains acting as a B2BUA. See details in OMA-TS-SIMPLE_IM-V1_0 [12] or in OMA-TS-CPM_Conv_Funct-V1_0 [17].
- 5) The group chat AS sends the generated multiple session invitations to the S-CSCF.
- 6) The group chat AS sends one of the chat session invitations to the IP-SM-GW according to normal routing procedures (e.g., via S-CSCF). The chat session invitation will indicate that the existing session is to be replaced with a new session.
- 7) The IP-SM-GW translates the chat session invitation request to a Short Message (SMS- SUBMIT) and forwards it towards the group chat SMS-SC (SC Address) via the SMS-IWMSC (as described in TS 23.040 [2]). The IP-SM-GW assigns an MSISDN representing the group chat session, if one was not assigned for the one-to-one chat session, to ensure that the reply to this SMS is sent back to this particular IP-SM-GW. Any SMS sent from the SMS user to this MSISDN will be interworked into the group chat session with which this MSISDN is correlated. The text in the Short Message is defined by the operator and conveys information to the SMS user that the one-to-one session has been transformed into a group session and that he is invited to send and receive messages in the context of a group chat session, and includes instructions on how to accept, reject and end the session. The identity of the original sender (CPM user or group) is included as part of the operator provided invitation text.
- 8) The SMS-IWMSC forwards the Short Messages (SMS- SUBMIT) to the group chat SMS-SC and the SMS is delivered to the SMS user using standard SMS procedures (see TS 23.040 [2]).
- 9) A Short Message is received from the SMS user via the SMS-GMSC by the IP-SM-GW, in accordance to steps 2 to 4 and steps 10 to 13 from clause 6.14, indicating the response to the group chat session invitation. The message is targeted to the MSISDN representing the group chat session which was assigned in step 7.
- 10) If the answer is positive or if operator policy is to accept the session invitation on behalf of the SMS user, the IP-SM-GW acknowledges the session invitation. Otherwise the IP-SM-GW will consider the session rejected and sends back an appropriate response.
- 11) The session invitation acknowledgement is forwarded by S-CSCF to the group chat AS.
- 12-13) The group chat AS responds back to the group chat session initiator once the first user joins the group chat session.

B.3 Service-level interworking: IP-SM-GW informs SMS users about group chat participant changes

In this flow, the IP-SM-GW is in the PLMN of the CPM UE, but it could also be in the PLMN of the SMS user if that user was also a CPM user and had terminating user preferences to deliver the session invitation via SMS.

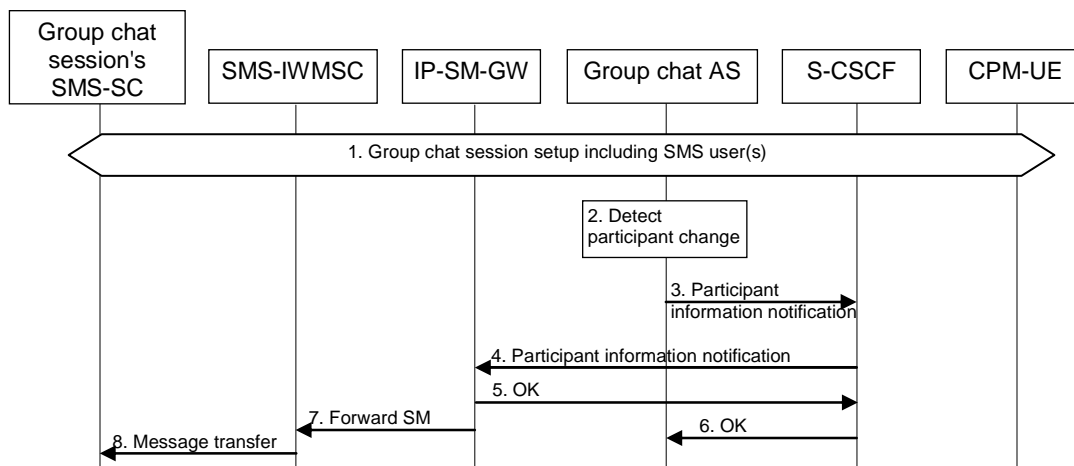

Figure B.3: Sending participant information changes to an SMS user in a group chat session

- 1) A group chat session including SMS user(s) set up by an IM or CPM user as described in clause B.1 steps 1-17.
- 2) The group chat AS detects change in participants of the group chat session (e.g. participant added or left the group chat session, that event is not shown in the flow).
- 3-4) As the IP-SM-GW has subscribed to participant information changes, the group chat AS notifies the IP-SM-GW about the participant change through the S-CSCF using an appropriate SIP method.
- 5-6) The IP-SM-GW acknowledges the notification.
- 7) According to operator policy, the IP-SM-GW translates the participant change notification to a Short Message (SMS- SUBMIT) and forwards it towards the group chat SMS-SC (SC Address) via the SMS-IWMSC (as described in TS 23.040 [2]). The text in the Short Message is defined by the operator and conveys appropriate information to the SMS user.
- 8) The SMS-IWMSC forwards the Short Messages (SMS- SUBMIT) to the group chat SMS-SC and the SMS is delivered to the SMS user using standard SMS procedures (see TS 23.040 [2]).

Annex C (informative): Change History

Change history								
Date	TSG #	TSG Doc.	CR	Rev	Cat	Subject/Comment	Old	New
2007-12	SP-38	SP-070898	0036	1	B	New Annex: IM user sends an Instant Message to a group list including SMS users	7.4.0	8.0.0
2007-12	SP-38	SP-070898	0037	3	B	IM capable UE sends an Instant Message to an SMS user	7.4.0	8.0.0
2007-12	SP-38	SP-070898	0038	4	B	Relationship between SMSIP and Service level interworking	7.4.0	8.0.0
2007-12	SP-38	SP-070898	0039	4	B	Definition, Symbol, Abbreviation Clauses	7.4.0	8.0.0
2007-12	SP-38	SP-070898	0041	5	B	Status Report for IM to SMS IW	7.4.0	8.0.0
2007-12	SP-38	SP-070898	0043	2	B	Updating the scope for TS 23.204	7.4.0	8.0.0
2007-12	SP-38	SP-070898	0044	2	B	Concatenated Short Messages delivered as an large Instant Message	7.4.0	8.0.0
2007-12	SP-38	SP-070898	0045	2	B	IP-SM-GW Additional Features	7.4.0	8.0.0
2008-03	SP-39	SP-080109	0047	2	C	SC address retrieval for IM MO	8.0.0	8.1.0
2008-03	SP-39	SP-080108	0050	2	A	Correction to Reference	8.0.0	8.1.0
2008-03	SP-39	SP-080109	0053	-	D	Implementing the documentation guidance from SA#38	8.0.0	8.1.0
2008-03	SP-39	SP-080109	0056	-	F	IM to SM interworking procedure corrections	8.0.0	8.1.0
2008-03	SP-39	SP-080109	0058	2	B	Procedures when disposition notification is requested by IMS UE	8.0.0	8.1.0
2008-03	SP-39	SP-080109	0059	3	C	Adding architecture requirement for service level interworking	8.0.0	8.1.0
2008-03	SP-39	SP-080109	0060	2	C	Implementing the functionality for SC address retrieval	8.0.0	8.1.0
2008-03	SP-39	SP-080109	0061	1	F	General cleanup of the specification	8.0.0	8.1.0
2008-03	SP-39	SP-080109	0062	3	C	General cleanup of new sections agreed in SA2#62	8.0.0	8.1.0
2008-03	SP-39	SP-080109	0063	3	C	Correctly adding SMS to IM interworking procedures and clean up	8.0.0	8.1.0
2008-06	SP-40	SP-080368	0064	1	C	Adding privacy functionality to the service level interworking	8.1.0	8.2.0
2008-06	SP-40	SP-080368	0065	2	C	IM delivery to unregistered IMS subscriber	8.1.0	8.2.0
2008-06	SP-40	SP-080368	0066	1	F	General Cleanup (cont'd)	8.1.0	8.2.0
2008-06	SP-40	SP-080368	0067	4	F	Deferred message when SMS is transport or service level interworked	8.1.0	8.2.0
2008-06	SP-40	SP-080368	0068	1	F	Corrections for IM termination call flow	8.1.0	8.2.0
2008-06	SP-40	SP-080368	0070	1	F	Architectural requirement corrections	8.1.0	8.2.0
2008-06	SP-40	SP-080368	0072	-	F	SMS delivery correction	8.1.0	8.2.0
2008-09	SP-41	SP-080585	0074	3	B	Update of 23.204 for SMS over IP procedures for E-UTRAN	8.2.0	8.3.0
2009-03	SP-43	SP-090111	0077	4	A	Correction of procedure for SM termination through the home network	8.3.0	8.4.0
2009-03	SP-43	SP-090106	0078	1	F	Reduction of unnecessary signalling	8.3.0	8.4.0
2009-12	SP-46	-	-	-	-	Update to Rel-9 version (MCC)	8.4.0	9.0.0
2010-03	SP-47	SP-100157	0085	-	B	IP-SM-GW enhancements for interworking with OMA CPM (Rel-9 CR0087 not included as instructed on the Rel-9 CR)	9.0.0	10.0.0
2010-06	SP-48	SP-100336	0088	-	F	Scope and References Corrections of CPM-SMS IW	10.0.0	10.1.0
2010-06	SP-48	SP-100336	0089	-	F	Clarify routing of messages for processing in the IP-SM-GW	10.0.0	10.1.0
2010-09	SP-49	SP-100557	0090	1	F	NOTE corrections	10.1.0	10.2.0
2011-06	SP-52	SP-110343	0091	-	F	IP-SM-GW address handling clarification	10.2.0	11.0.0
2011-09	SP-53	SP-110469	0092	-	F	MCC Implementation correction to CR0091	11.0.0	11.1.0
2012-06	SP-56	SP-120240	0093	5	B	Server to MSISDN-less IMS UE direction in IMS	11.1.0	11.2.0

History

Document history		
V11.2.0	November 2012	Publication