

ETSI TS 123 218 V7.0.0 (2005-12)

Technical Specification

**Digital cellular telecommunications system (Phase 2+);
Universal Mobile Telecommunications System (UMTS);
IP Multimedia (IM) session handling;
IM call model;
Stage 2
(3GPP TS 23.218 version 7.0.0 Release 7)**



Reference

RTS/TSGC-0123218v700

Keywords

GSM, UMTS

ETSI

650 Route des Lucioles
F-06921 Sophia Antipolis Cedex - FRANCE

Tel.: +33 4 92 94 42 00 Fax: +33 4 93 65 47 16

Siret N° 348 623 562 00017 - NAF 742 C
Association à but non lucratif enregistrée à la
Sous-Préfecture de Grasse (06) N° 7803/88

Important notice

Individual copies of the present document can be downloaded from:

<http://www.etsi.org>

The present document may be made available in more than one electronic version or in print. In any case of existing or perceived difference in contents between such versions, the reference version is the Portable Document Format (PDF). In case of dispute, the reference shall be the printing on ETSI printers of the PDF version kept on a specific network drive within ETSI Secretariat.

Users of the present document should be aware that the document may be subject to revision or change of status. Information on the current status of this and other ETSI documents is available at

<http://portal.etsi.org/tb/status/status.asp>

If you find errors in the present document, please send your comment to one of the following services:

http://portal.etsi.org/chaicor/ETSI_support.asp

Copyright Notification

No part may be reproduced except as authorized by written permission.
The copyright and the foregoing restriction extend to reproduction in all media.

© European Telecommunications Standards Institute 2005.
All rights reserved.

DECTTM, **PLUGTESTS**TM and **UMTS**TM are Trade Marks of ETSI registered for the benefit of its Members.
TIPHONTM and the **TIPHON logo** are Trade Marks currently being registered by ETSI for the benefit of its Members.
3GPPTM is a Trade Mark of ETSI registered for the benefit of its Members and of the 3GPP Organizational Partners.

Intellectual Property Rights

IPRs essential or potentially essential to the present document may have been declared to ETSI. The information pertaining to these essential IPRs, if any, is publicly available for **ETSI members and non-members**, and can be found in ETSI SR 000 314: "*Intellectual Property Rights (IPRs); Essential, or potentially Essential, IPRs notified to ETSI in respect of ETSI standards*", which is available from the ETSI Secretariat. Latest updates are available on the ETSI Web server (<http://webapp.etsi.org/IPR/home.asp>).

Pursuant to the ETSI IPR Policy, no investigation, including IPR searches, has been carried out by ETSI. No guarantee can be given as to the existence of other IPRs not referenced in ETSI SR 000 314 (or the updates on the ETSI Web server) which are, or may be, or may become, essential to the present document.

Foreword

This Technical Specification (TS) has been produced by ETSI 3rd Generation Partnership Project (3GPP).

The present document may refer to technical specifications or reports using their 3GPP identities, UMTS identities or GSM identities. These should be interpreted as being references to the corresponding ETSI deliverables.

The cross reference between GSM, UMTS, 3GPP and ETSI identities can be found under <http://webapp.etsi.org/key/queryform.asp>.

Contents

Intellectual Property Rights	2
Foreword.....	2
Foreword.....	6
1 Scope	7
2 References	7
3 Definitions and abbreviations.....	8
3.1 Definitions	8
3.2 Abbreviations	9
4 Architecture and information flows for IM multimedia session	10
4.1 Architecture for a mobile originated IP multimedia session	10
4.2 Architecture for a mobile terminated IP multimedia session	10
4.3 Void.....	11
4.4 Void.....	11
4.5 Void.....	11
5 Functional requirements of network entities	11
5.1 Architecture for service provision for IP multimedia subsystem	11
5.2 Service interaction with IP multimedia subsystem.....	12
6 Functional requirements of serving CSCF	15
6.1 Modes of operation of the S-CSCF	15
6.1.1 General overview of functional models and modes of operation of the S-CSCF	15
6.2 Interfaces defined for S-CSCF	16
6.2.1 S-CSCF – CSCF (Mw) interface	16
6.2.2 S-CSCF – Application Server (ISC) interface	16
6.2.3 S-CSCF – HSS (Cx) interface.....	16
6.3 Handling of SIP registration.....	16
6.4 Handling of mobile originating requests	17
6.4.1 Handling of mobile originating requests, registered user	17
6.4.2 Handling of mobile originating requests, unregistered user	18
6.5 Handling of mobile terminating requests	18
6.5.1 Handling of mobile terminating requests, registered user.....	18
6.5.2 Handling of mobile terminating requests, unregistered user.....	19
6.6 Handling of IP multimedia session release requests.....	19
6.6.1 S-CSCF proxying release request	19
6.6.2 S-CSCF initiating release request	19
6.7 Handling of subscription and notification	20
6.8 S-CSCF handling IMS charging.....	20
6.9 Description of subscriber data.....	21
6.9.1 Application Server subscription information	21
6.9.2 Filter Criteria	21
6.9.2.1 Application Server address	21
6.9.2.2 Default handling.....	21
6.9.2.3 Trigger point	21
6.9.2.4 iFC Priority	22
6.9.2.5 Service Information.....	22
6.9.3 Authentication data	22
7 Functional requirements of HSS	22
7.1 Subscriber data related storage requirements for HSS	22
7.2 Interfaces defined for HSS	22
7.2.1 HSS – CSCF (Cx) interface	22
7.2.2 HSS - Application Server (Sh) interface.....	22
7.2.3 HSS – CSE interface.....	23

7.2.4	HSS – IM-SSF Application Server (Si) interface	23
7.3	Procedures during IP multimedia registration	23
7.4	Procedures during IP multimedia sessions	23
8	Functional requirements of the MRFC.....	23
8.1	Functionality of the MRFC	23
8.1.1	Overview of MRFC Functionality	23
8.1.2	Tones and announcements	24
8.1.3	Ad hoc conferences (multiparty calls)	24
8.1.4	Transcoding	25
8.2	Interfaces defined for MRFC.....	25
8.2.1	MRFC – S-CSCF (Mr) interface.....	25
9	Generic IP multimedia session handling for SIP Application Servers.....	26
9.1	Architecture	26
9.1.1	Modes of operation between Application Server and S-CSCF.....	27
9.1.1.1	Application Server acting as terminating UA, or redirect server	27
9.1.1.2	Application Server acting as originating UA	27
9.1.1.3	Application Server acting as a SIP proxy.....	28
9.1.1.4	Application Server performing third party call control/ B2BUA mode	28
9.1.1.5	Application Server not involved or no longer involved	29
9.2	Interfaces defined for a SIP Application Server.....	29
9.2.1	S-CSCF – Application Server (ISC) interface	29
9.2.2	Application Server – HSS (Sh) interface	29
9.2.3	Application Server – SLF (Dh) interface	30
9.3	Description of Application Server related subscriber data	30
9.3.1	Application server subscription information.....	30
9.3.1.1	Service key	30
9.3.1.2	Service platform trigger points (STP)	30
9.3.1.3	Service scripts	30
9.4	Procedures for multimedia session handling with a SIP based Application Server	30
9.4.1	Application Server handling of mobile originating requests	30
9.4.2	Application Server handling of mobile terminating requests.....	30
9.4.3	Application Server handling of SIP registration	31
9.4.4	Application Server handling of IP multimedia session release requests	31
9.4.4.1	Session release request terminated at the Application Server	31
9.4.4.2	Session release request proxied by the Application Server	32
9.4.4.3	Session release request initiated by the Application Server	32
9.4.5	Application server handling of IP multimedia charging	32
10	IP multimedia session handling with IM-SSF Application Server.....	33
11	IP multimedia session handling with an OSA-Service Capability Server.....	33
12.	IP multimedia session handling with an Charging Server.....	33
Annex A (informative):	Scalability and deployment considerations for IP multimedia service provision	34
Annex B (informative):	Information flows for example services	36
B.1	Call forwarding example	36
B.1.1	Call forwarding through Application Servers.....	36
B.1.1.1	Service activation and programming	37
B.1.1.2	Service invocation and control.....	37
B.1.2	Assumptions	38
B.1.3	UE redirect based call flows.....	38
B.1.4	S-CSCF based redirect call flows.....	39
B.2	Announcement, conferencing and transcoding examples using MRFC.....	41
B.2.1	Example information flow for a mobile originated IP multimedia session that results in playing an announcement.....	41
B.2.2	Example information flow for a mobile originated IP multimedia ad hoc conferencing session (multiparty call).....	43

B.2.3	Example information flows for a mobile originated IP multimedia session that requires transcoding	45
B.3	Example information flows for a voicemail service.....	49
B.3.1	User out of coverage message recording	49
B.3.2	User IMS registers voice mail service plays back messages	51
Annex C (informative):	Example for Initial filter criteria triggering.....	54
Annex D (informative):	Change history	56
History		59

Foreword

This Technical Specification has been produced by the 3rd Generation Partnership Project (3GPP).

The contents of the present document are subject to continuing work within the TSG and may change following formal TSG approval. Should the TSG modify the contents of the present document, it will be re-released by the TSG with an identifying change of release date and an increase in version number as follows:

Version x.y.z

where:

- x the first digit:
 - 1 presented to TSG for information;
 - 2 presented to TSG for approval;
 - 3 or greater indicates TSG approved document under change control.
- y the second digit is incremented for all changes of substance, i.e. technical enhancements, corrections, updates, etc.
- z the third digit is incremented when editorial only changes have been incorporated in the document.

1 Scope

The present document specifies the IP Multimedia (IM) Call Model for handling of an IP multimedia session origination and termination for an IP Multimedia subscriber.

The present document includes interactions between an Application Server and IP multimedia sessions.

The IP Multimedia (IM) Subsystem stage 2 is specified in 3GPP TS 23.228 [3].

2 References

The following documents contain provisions which, through reference in this text, constitute provisions of the present document.

- References are either specific (identified by date of publication, edition number, version number, etc.) or non-specific.
- For a specific reference, subsequent revisions do not apply.
- For a non-specific reference, the latest version applies. In the case of a reference to a 3GPP document (including a GSM document), a non-specific reference implicitly refers to the latest version of that document *in the same Release as the present document*.

- [1] Void.
- [2] 3GPP TR 21.905: "Vocabulary for 3GPP Specifications".
- [3] 3GPP TS 23.228: " IP multimedia subsystem; Stage 2".
- [4] Void.
- [5] 3GPP TS 24.229: "IP multimedia call control protocol based on SIP and SDP; stage 3".
- [6] IETF RFC 3261: "SIP: Session Initiation Protocol".
- [7] 3GPP TR 29.998-4-4: "Open Service Access (OSA); Application Programming Interface (API) Mapping for Open Service Access (OSA); Part 4: Call Control Service Mapping; Subpart 4: Multiparty Call Control SIP".
- [8] 3GPP TS 29.228: "IP Multimedia (IM) Subsystem Cx Interface; Signalling flows and message contents".
- [9] 3GPP TS 23.278: "Customised Applications for Mobile network Enhanced Logic (CAMEL); IP Multimedia System (IMS) interworking; Stage 2".
- [10] 3GPP TS 23.008: "Organisation of subscriber data".
- [11] 3GPP TS 33.203: "Access security for IP based services".
- [12] 3GPP TS 29.198: "Open Service Access (OSA); Application programming Interface (API)".
- [13] IETF RFC 3265: "Session Initiation Protocol (SIP) Event Notification".
- [14] 3GPP TS 29.078: "Customised Applications for Mobile network Enhanced Logic (CAMEL) Phase 3; CAMEL Application Part (CAP) specification".
- [15] IETF RFC 3264: "An Offer/Answer Model with Session Description Protocol".
- [16] 3GPP TS 29.002: "Mobile Application Part (MAP) specification".
- [17] 3GPP TS 29.229: "Cx Interface based on the Diameter protocol".

- [18] 3GPP TS 29.328: "IP Multimedia Subsystem (IMS) Sh Interface; Signalling flows and message contents".
- [19] 3GPP TS 29.329: "Sh Interface based on the Diameter protocol".
- [20] 3GPP TS 32. 240: "Telecommunication management; Charging management; Charging architecture and principles".
- [21] 3GPP TS 32. 260: "Telecommunication management; Charging management; IP Multimedia Subsystem (IMS) charging".

3 Definitions and abbreviations

3.1 Definitions

For the purposes of the present document, the terms and definitions given in 3GPP TR 21.905 [2] and the following apply:

Application Server Incoming Leg Control Model (AS-ILCM): models AS behaviour for handling SIP information for an incoming leg.

Application Server information (AS-info): AS-info contains individualized information concerning one particular Application Server entry.

This information contains e.g. Application Server Address (6.9.1.1) and it's corresponding Default IP Multimedia Handling information (6.9.1.2).

Application Server Outgoing Leg Control Model (AS-OLCM): models AS behaviour for handling SIP information for an outgoing leg.

Combined ILSM OLSM – Incoming/outgoing Leg State Model: models the behaviour of an S-CSCF for handling SIP messages on an incoming and outgoing session leg.

Filter Criteria (FC): the information which the S-CSCF receives from the HSS or the AS that defines the relevant SPTs for a particular application.

They define the subset of SIP requests received by the S-CSCF that should be sent or proxied to a particular application.

Incoming Leg Control Model (ILCM): models the behaviour of an S-CSCF for handling SIP information sent to and received from an AS for an incoming session leg.

Initial Filter Criteria (iFC): filter criteria that are stored in the HSS as part of the user profile and are downloaded to the S-CSCF upon user registration.

They represent a provisioned subscription of a user to an application.

Initial Request: a SIP request that either initiates the creation of a new dialog or is part of a standalone transaction.

IP Multimedia Service Switching Function (IM-SSF): functional entity that interfaces SIP to CAP.

IP Multimedia CAMEL Subscription Information (IM-CSI): identifies the subscriber as having IP Multimedia CAMEL services.

IP Multimedia session: IP Multimedia session and IP Multimedia call are treated as equivalent in the present document.

Originating IP Multimedia CAMEL Subscription Information (O-IM-CSI): identifies the subscriber as having originating IP Multimedia CAMEL services.

Outgoing Leg Control Model (OLCM): models the behaviour of an S-CSCF for handling SIP information received from and sent to an AS for an outgoing session leg.

Private User Identity: a unique global identity defined by the Home Network Operator, as defined in 3GPP TS 23.228 [3].

Public User Identity: the public user identity/identities are used by any user for requesting communications to other users and are in the form of a SIP URL or TEL URL as defined in 3GPP TS 23.228[3].

Service Key: the Service Key identifies to the Application Server the service logic that shall apply. The Service Key is administered by the HPLMN. For CAMEL services, the Service Key is an element of the CAMEL Subscription Information (CSI).

Service Point Trigger (SPT): the points in the SIP signalling that may cause the S-CSCF to send/proxy the SIP message to an SIP AS/OSA SCS/IM-SSF.
The subset of all possible SPTs which are relevant to a particular application are defined by means of Filter Criteria.

Service Platform Trigger Points (STP): the points in the SIP signalling that instruct the SIP AS, OSA SCS and IM-SSF to trigger the service logic.
For the IM-SSF the IP Multimedia Camel Subscriber Information (IM-CSI) defines them.

Subsequent Filter Criteria (sFC): filter criteria that are signalled from the SIP AS/OSA SCS/IM-SSF to the S-CSCF. They allow for dynamic definition of the relevant SPTs at application execution time.

Subsequent Request: a SIP request which is part of an existing dialog. This also includes target refresh requests as defined in RFC 3261 [6].

Standalone Transaction: a SIP transaction that is not part of an existing dialog and does not initiate the creation of a new dialog.

Terminating IP Multimedia CAMEL Subscription Information (T-IM-CSI): identifies the subscriber as having terminating IP Multimedia CAMEL services.

3.2 Abbreviations

For the purposes of the present document, the following abbreviations apply:

API	Application Programming Interface
AS	Application Server
AS-ILCM	Application Server Incoming Leg Control Model
AS-OLCM	Application Server Outgoing Leg Control Model
B2BUA	Back-to-Back User Agent
CAMEL	Customized Applications for Mobile network Enhanced Logic
CAP	CAMEL Application Part
CCF	Charging Collection Function
CDR	Charging Data Records
CF	Call Forwarding
CFonCLI	Call Forwarding on Calling Line Identification
CGI	Common Gateway Interface
CPL	Call Processing Language
CLI	Calling Line Identification
CSCF	Call Session Control Function
CSE	CAMEL Service Environment
ECF	Event Charging Function
FC	Filter Criteria
GPRS	General Packet Radio Service
GPRS CID	GPRS Charging Identifiers
gsmSCF	gsm Service Control Function
HPLMN	Home PLMN
HSS	Home Subscriber Server
IETF	Internet Engineering Task Force
I-CSCF	Interrogating CSCF
ICID	IMS Charging ID
iFC	Initial Filter Criteria
ILCM	Incoming Leg Control Model
IM	IP Multimedia
IM-CSI	IP Multimedia CAMEL Subscription Information
IMS	IP Multimedia Subsystem

IMSI	International Mobile Subscriber Identity
IM-SSF	IP Multimedia Service Switching Function
IOI	Inter Operator Identifier
IP	Internet Protocol
ISC	IP multimedia Service Control
MAP	Mobile Application Part
MGCF	Media Gateway Control Function
MO	Mobile Originating
MRFC	Multimedia Resource Function Controller
MRFP	Multimedia Resource Function Processor
MT	Mobile Terminating
O-IM-CSI	Originating IP Multimedia CAMEL Subscription Information
OLCM	Outgoing Leg Control Model
OSA	Open Service Access
PLMN	Public Land Mobile Network
P-CSCF	Proxy CSCF
RFC	Request For Comments
SCF	Session Charging Function
SCIM	Service Capability Interaction Manager
SCS	Service Capability Server
SDP	Session Description Protocol
sFC	Subsequent Filter Criteria
SIP	Session Initiation Protocol
S-CSCF	Serving CSCF
SPT	Service Point Trigger
STP	Service platform Trigger Points
T-IM-CSI	Terminating IP Multimedia CAMEL Subscription Information
UA	User Agent
UE	User Equipment
URL	Uniform Resource Locator

4 Architecture and information flows for IM multimedia session

Clauses 4.1 and 4.2 show the architecture for handling a basic MO multimedia session and a basic MT multimedia session. A basic mobile-to-mobile multimedia session is treated as the concatenation of a MO multimedia session and a MT multimedia session.

Clauses 4.3, 4.4 and 4.5 show the information flows for handling a basic MO multimedia session and a basic MT multimedia session.

4.1 Architecture for a mobile originated IP multimedia session

This is specified in 3GPP TS 23.228 [3].

4.2 Architecture for a mobile terminated IP multimedia session

This is specified in 3GPP TS 23.228 [3].

4.3 Void

4.4 Void

4.5 Void

5 Functional requirements of network entities

5.1 Architecture for service provision for IP multimedia subsystem

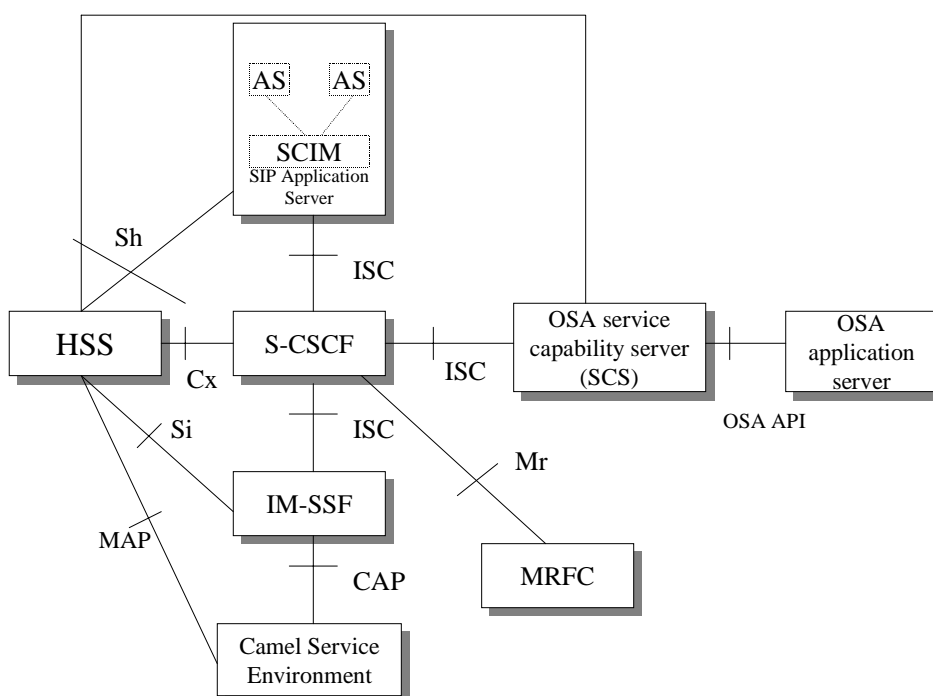

NOTE: Not all interfaces shown are within the scope of this document.

Figure 5.1.1: Functional architecture for support of service provision for IP multimedia subsystem

Figure 5.1.1 illustrates the architecture with the S-CSCF communicating to Application Servers via the IP multimedia service control (ISC) interface. The Application Servers can be:

- SIP Application Servers - which may host and execute services. It is intended to allow the SIP Application Server to influence and impact the SIP session on behalf of the services;
- the IM-SSF - which is a particular type of application server the purpose of which is to host the CAMEL network features (i.e. trigger detection points, CAMEL Service Switching Finite State Machine, etc) and to interface to CAP as specified in 3GPP TS 29.078 [14];
- the OSA service capability server (OSA SCS) which interfaces to the OSA framework Application Server and which provides a standardized way for third party secure access to the IM subsystem. The OSA reference architecture defines an OSA Application Server as an entity that provides the service logic execution environment for client applications using the OSA API as specified in 3GPP TS 29.198 [12]. This definition of Application Server differs from the definition of Application Server in the context of service provisioning for the IM subsystem, i.e. the entity communicating to the S-CSCF via the ISC interface;

- in addition a specialized type of SIP Application Server, the service capability interaction manager (SCIM) which performs the role of interaction management between other application servers.

All the Application Servers, (including the IM-SSF and the OSA SCS) behave as SIP application servers on the ISC interface.

In addition the Application Servers can also interact with the MRFC via the S-CSCF (ISC and Mr interfaces) in order to control Multimedia Resource Function processing.

5.2 Service interaction with IP multimedia subsystem

Service Point Triggers (SPTs) are those points in the SIP signalling on which Filter Criteria can be set. The following SPTs are defined:

- any initial known or unknown SIP method (e.g. REGISTER, INVITE, SUBSCRIBE, MESSAGE);
- registration type – indicates if the REGISTER request is initial registration, re-registration, or de-registration;
- presence or absence of any known or unknown header field;
- content of any known or unknown header field or Request-URI;
- direction of the request with respect to the served user – either mobile originated (MO) or mobile terminated (MT) to registered user; mobile terminated to unregistered user or mobile originated for unregistered user; see 3GPP TS 29.228 [8] for the details of the direction information in service point trigger;

NOTE 1: REGISTER is considered part of the Mobile Origination. See 3GPP TS 24.229[5] for further information about how to determine MO or MT.

NOTE 2: The S-CSCF shall verify if the end user is barred before checking if any trigger applies for that end user.

- session description information.

A Filter Criteria triggers one or more SPTs in order to send the related request to one specific application server. The set of Filter Criteria that is stored for a service profile of a specific user is called "Application Server Subscription Information". In order to allow the S-CSCF to handle the different Filter Criteria in the right sequence, a priority shall be assigned to each of them. If the S-CSCF can not reach the Application Server, the S-CSCF shall apply the default handling associated with the trigger. This default handling shall be :

- to continue verifying if the triggers of lower priority in the list match; or
- to abandon verification of matching of the triggers of lower priority in the list; and to release the dialogue.

Therefore a Filter Criteria shall contain the following information:

- address of the Application Server to be contacted;
- priority of the Filter Criteria providing the sequence in which the criteria shall be applied;
- Trigger Point composed by 1 to n instances of the Service Point Triggers (SPTs). The SPTs may be linked by means of logical expressions (AND, OR, NOT, etc.);
- default handling (as described above);
- optional Service Information that shall be added to the message body before it is sent to the Application Server (as an example this may include the IMSI for the IM-SSF).

The same priority shall not be assigned to more than one initial Filter Criteria for a given end user.

The S-CSCF shall request from the HSS the relevant set of iFCs that applies to the end user (i.e., registered, unregistered, or both). If the S-CSCF has a set of iFCs that is deemed valid (e.g., from a previous request), the S-CSCF need not request a new set.

In the case that multiple Filter Criteria are sent from the HSS to the S-CSCF, the S-CSCF shall check the filter criteria one by one according to their indicated priority when the S-CSCF receives a message via the Mw interface.

On reception of a REGISTER request, the S-CSCF shall send a third-party REGISTER request to each Application Server that matches the Filter Criteria sent from the HSS for the REGISTER event.

On an event that causes network-initiated deregistration, the S-CSCF shall send a third-party REGISTER request to each Application Server that matches the Filter Criteria sent from the HSS as if a equivalent REGISTER request had been received from the user deregistering that public user identity, or combination of public user identities.

On reception of any other request the S-CSCF shall:

1. set up the list of filter criteria for that request according to their priority – the sequence of the filter criteria shall not be changed until the request finally leaves the S-CSCF via the Mw interface again;
2. parse the received request in order to find out the Service Point Triggers (SPTs) that are included in it;
3. check whether the trigger points of the filter criteria with the next highest priority are matched by the SPTs of the request and
 - a) if it does not match the S-CSCF shall immediately proceed with step 4;
 - b) if it matches the S-CSCF shall:
 - i) add an indication to the request which will allow the S-CSCF to identify the message on the incoming side, even if its dialog identification has been changed e.g. due to the Application Server performing third party call control;
 - ii) forward the request via the ISC interface to the Application Server indicated in the current filter criteria. The Application Server then performs the service logic, may modify the request and may send the request back to the S-CSCF via the ISC interface;
 - iii) proceed with step 4 if the request was received again from the Application Server via the ISC interface;
4. repeat the above steps 2 and 3 for every filter criteria which was initially set up (in step 1) until the last filter criteria has been checked;
5. route the request based on normal SIP routing behaviour.

If an Application Server decides to locally terminate a request and sends back a final response for that request via the ISC interface to the S-CSCF, the S-CSCF shall abandon verification of the matching of the triggers of lower priority in the list. The final response shall include the indicator defined in step 3 b) i) above, so that the S-CSCF can correlate the messages.

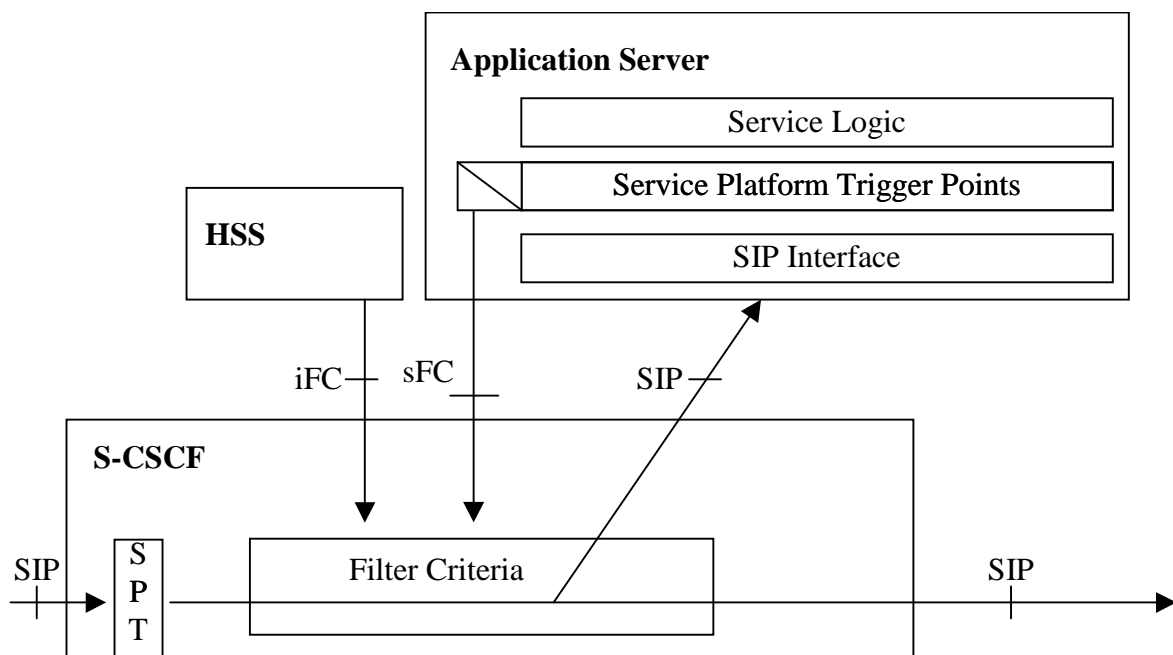

Figure 5.2.1: Application triggering architecture

Each invoked Application Server/service logic may decide not to be engaged with the invoked session by indicating that during the very first SIP transaction when the Record-Route/Route is generated for subsequent SIP requests. The denial shall mean that subsequent requests shall not be routed to such Application Servers/service logic any more during the lifetime of that session. Any Application Server, which has determined that it will not receive subsequent requests for a session cannot revoke this determination by means of Initial Filter Criteria (iFC).

NOTE: Care should be taken in design of the Initial Filter Criteria when designing services to avoid unintended loops being setup, where requests from an Application Server may be sent back to the same Application Server. This does not imply that it is not allowed for requests to be sent back to the same Application Server when that is intended behaviour as part of the design of the service and the Application Server is able to handle this correctly. Special care should be taken for the case when an Application Server may act as an originating UA or B2BUA and may originate an initial request causing evaluation of Initial Filter Criteria.

6 Functional requirements of serving CSCF

6.1 Modes of operation of the S-CSCF

6.1.1 General overview of functional models and modes of operation of the S-CSCF

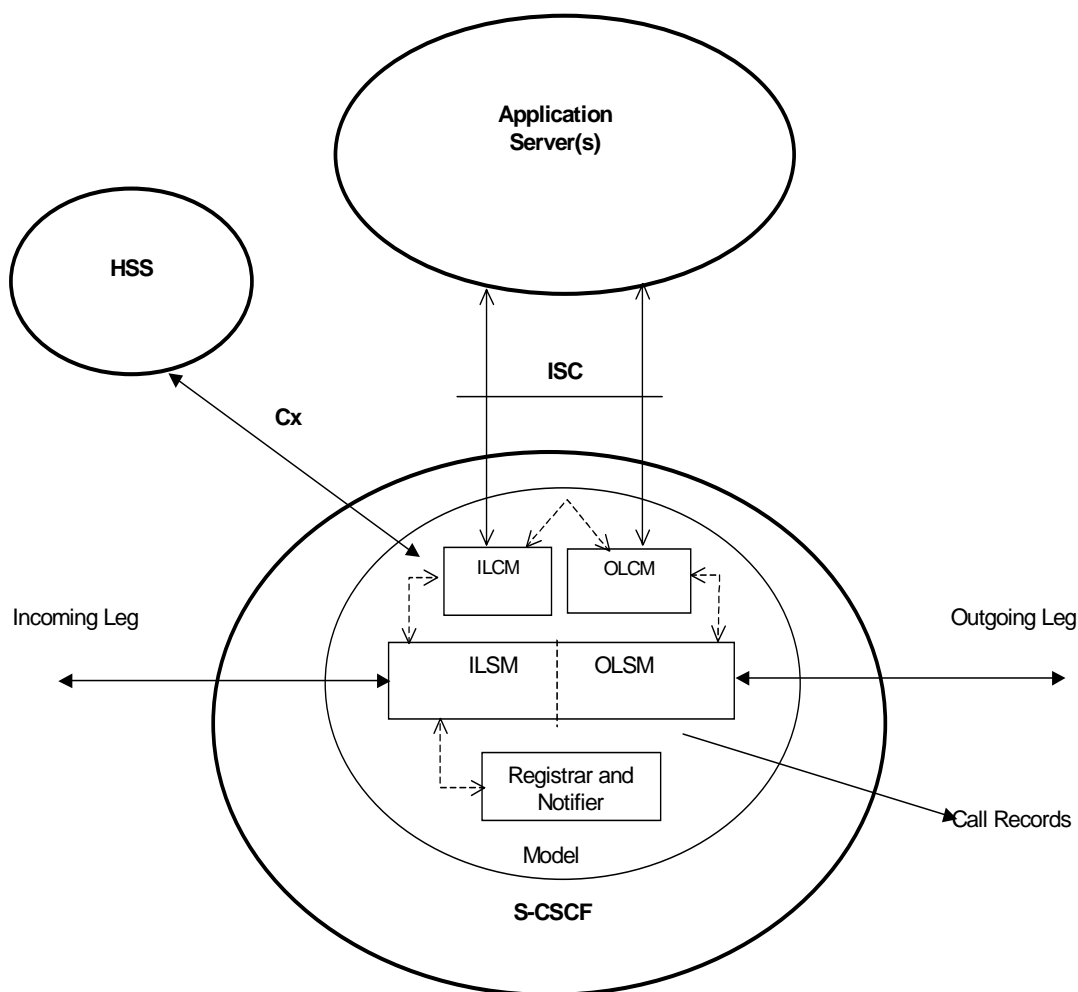

Figure 6.1.1.1: S-CSCF functional model with incoming leg control and outgoing leg control

Figure 6.1.1.1 identifies the components of a functional model of the S-CSCF.

NOTE: These components are defined only as a model of the expected behaviour of the S-CSCF and are not intended to define or constrain the actual implementation.

The components include the Combined I/OLSM, the ILCM and OLCM and the Registrar and Notifier. There is a single Combined I/OLSM, which shall be able to store session state information. It may act on each leg independently, acting as a SIP Proxy, Redirect Server or User Agent dependant on the information received in the SIP request, the filter conditions specified or the state of the session.

It shall be possible to split the application handling on each leg and treat each endpoint differently.

There is a single ILCM, which shall store transaction state information.

There is a single OLCM, which shall store transaction state information.

The Registrar and Notifier component handles registration and subscription to and notification of registration events.

6.2 Interfaces defined for S-CSCF

6.2.1 S-CSCF – CSCF (Mw) interface

The protocol used between two CSCFs is also based on Session Initiation Protocol, which is specified in 3GPP TS 24.229 [5].

6.2.2 S-CSCF – Application Server (ISC) interface

The protocol used between the S-CSCF and the Application Servers (ISC interface) is also based on Session Initiation Protocol, which is specified in 3GPP TS 24.229 [5].

6.2.3 S-CSCF – HSS (Cx) interface

This interface is used to send subscriber data to the S-CSCF; including Filter criteria, which indicates which SIP requests should be proxied to which Application Servers.

The protocol used between the S-CSCF and HSS (Cx Interface) is specified in 3GPP TS 29.228 [8].

6.3 Handling of SIP registration

Upon receiving the initial registration request from the user, the S-CSCF shall authenticate the user and upon receiving a subsequent registration request containing valid authentication credentials, request the HSS to send the relevant service profile(s) for the user's subscription. More than one service profile may be sent, depending on configuration options for identifying implicitly registered public user identities. For further detailed information on registration, profile download and authentication procedures see 3GPP TS 24.229 [5] and 3GPP TS 33.203 [11].

The initial filter criteria (subset of the profile) is stored locally at the S-CSCF, as specified in 3GPP TS 24.229 [5].

The S-CSCF shall verify if the triggers match, from the highest to the lowest priority (see subclause 5.2).

After a successfully authenticated registration, the S-CSCF shall download from the HSS all the implicitly registered public user identities associated with the registered public user identity. The S-CSCF shall then verify, in their order of priority, if the triggers downloaded from the HSS match. If the registration request from the user matches a trigger, the S-CSCF performs a third party registration to the application servers which are interested to be informed about the user registration event of these public user identities. This may trigger services to be executed by an Application Server.

The important information carried in the third party REGISTER request is the public user identity, the S-CSCF address and the expiration time. It shall be possible based on operator configuration to use one of the implicitly registered public user identities as the public user identity in the To header of the third party REGISTER request sent to the Application Server. Additional application server specific data, which is associated with the Filter Criteria and obtained from the HSS, is added to the REGISTER request body. This data should include the IMSI for an Application Server that supports CAMEL services or the private user identity for other Application Servers as received from the HSS.

This third party registration will include an expiration time that is equal to the expiration time sent to the UE by the S-CSCF in the 200 OK response to the incoming REGISTER request

On receiving a failure response to one of the REGISTER requests, the S-CSCF shall apply the "default handling" related with the initial Filter Criteria's trigger used (see subclauses 5.2, 6.9.2.2).

See figure 6.3.1:

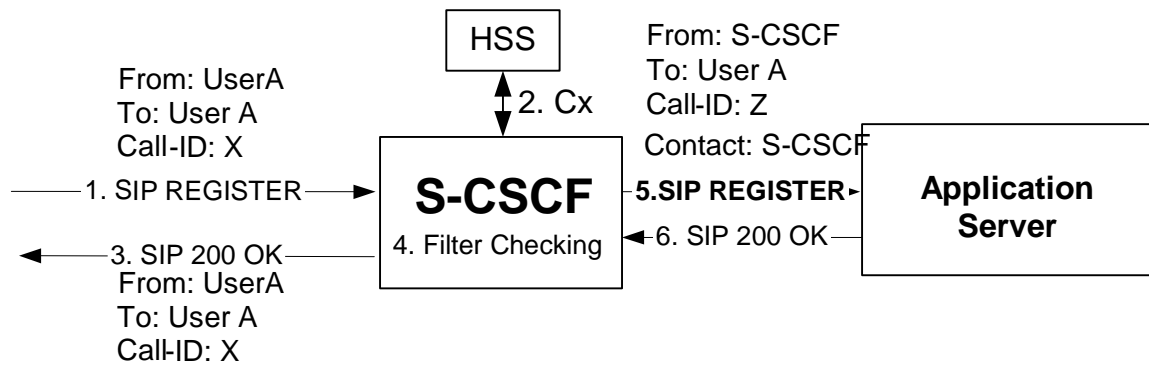

Figure 6.3.1: S-CSCF handling registration

Application Servers can in addition subscribe to the S-CSCF Registration Event Package. This provides a mechanism for the Application Server to discover all the implicitly registered public user identities without requiring multiple Register requests to be sent to the Application Server and to obtain the current capabilities of the UE as well as be notified about refresh registrations and de-registrations. The S-CSCF will send NOTIFY requests to the Application Server that has subscribed to the registration event package for the registered public user identity.

NOTE: When the Application Server maintains a persistent subscription to the reg-event package it is not necessary for the Application Server to receive third party registration requests from the S-CSCF in response to refresh and de-registration events as these are communicated to the Application Server in the Registration event notifications.

More information on these procedures is contained in 3GPP TS 24.229 [5].

6.4 Handling of mobile originating requests

6.4.1 Handling of mobile originating requests, registered user

The S-CSCF shall verify if the public user identity is barred. If so, it shall respond with a 4xx error code and stop further session processing.

The S-CSCF only looks for initial filter criteria when receiving an initial request.

The initial filter criteria (subset of the profile) has already been downloaded from the HSS and is stored locally at the S-CSCF, and 3GPP TS 24.229 [5].

When such a session request comes in, the S-CSCF shall first check whether this is an originating request or a terminating request in order to perform the matching procedure with SPTs within initial filter criteria. This clause describes the requirements for the S-CSCF when this request is a mobile originating request. So, if this request is a mobile originating request, the S-CSCF shall:

- use the initial Filter Criteria for the Mobile Originating case;
- check whether this request matches the initial filter criteria with the highest priority for that user by checking the service profile against the public user identity, which was used to place this request;
- if this request matches the initial filter criteria, the S-CSCF shall forward this request to that application server, then check for matching of the next following filter criteria of lower priority, and apply the filter criteria on the SIP method received from the previously contacted application server;
- if this request does not match the highest priority initial filter criteria, check for matching of the following filter criteria priorities until one applies;
- if no more (or none) of the initial filter criteria apply, the S-CSCF shall forward this request downstream based on the route decision;
- in any instance, if the contact of the application server fails, the S-CSCF shall use the "default handling" associated with the initial Filter Criteria to determine if it shall either terminate the call or let the call continue

based on the information in the filter criteria; if the filter criteria does not contain instruction to the S-CSCF regarding the failure of the contact to the application server, the S-CSCF shall let the call continue as the default behaviour.

6.4.2 Handling of mobile originating requests, unregistered user

The S-CSCF shall verify if the public user identity is barred. If so, it shall respond with a 4xx error code and stop further session processing.

The S-CSCF only looks for initial filter criteria when receiving an initial request. A originating initial request may originate from an Application Server via the ISC interface. Originating initial requests from an Application Server via the ISC interface also cause the S-CSCF to look for initial filter criteria.

When such a request comes in, the S-CSCF shall first check this is an originating request or a terminating request. This clause describes the requirements for the S-CSCF when this request is a originating request. So, if this request is a originating request, the S-CSCF shall:

- if unavailable, download the relevant subscriber profile including the initial filter criteria from the HSS;
- use the initial Filter Criteria for the Mobile Originating request for unregistered user;
- check whether this request matches the initial filter criteria with the highest priority for that user by checking the service profile against the public user identity, which was used to place this request;
- if this request matches the initial filter criteria, the S-CSCF shall forward this request to that application server, then check for matching of the next following filter criteria of lower priority, and apply the filter criteria on the SIP method received from the previously contacted application server;
- if this request does not match the highest priority initial filter criteria, check for matching of the following filter criteria priorities until one applies;
- if no more (or none) of the initial filter criteria apply, the S-CSCF shall forward this request downstream based on the route decision;
- in any instance, if the contact of the application server fails, the S-CSCF shall use the "default handling" associated with the initial Filter Criteria to determine if it shall either terminate the call or let the call continue based on the information in the filter criteria; if the filter criteria does not contain instruction to the S-CSCF regarding the failure of the contact to the application server, the S-CSCF shall let the call continue as the default behaviour.

6.5 Handling of mobile terminating requests

6.5.1 Handling of mobile terminating requests, registered user

The S-CSCF shall verify if the public user identity is barred. If so, it shall respond with a 4xx error code and stop further session processing.

The S-CSCF only looks for initial filter criteria when receiving an initial request. A terminating initial request may also originate from an Application Server via the ISC interface. Terminating Initial requests from an Application Server via the ISC interface also cause the S-CSCF to look for initial filter criteria.

When such a request comes in, the S-CSCF shall first check whether this is an originating request or a terminating request. For terminating initial requests the S-CSCF shall first perform any routing of the request to Application Server based on matching of initial Filter Criteria before performing other routing procedures towards the terminating UE, (e.g. forking, caller preferences etc). This clause describes the requirements for the S-CSCF when this request is a terminating request. So, if this request is a terminating request, the S-CSCF shall:

- if unavailable, download the relevant subscriber profile including the initial filter criteria from the HSS;
- use the initial Filter Criteria for the Mobile Terminating request to registered user;
- in case the Request-URI changes when visiting an Application Server, terminate the checking of filter criterias, route the request based on the changed value of the Request-URI and do not execute the subsequent steps;

- the subsequent requirements for the S-CSCF are the same as those for handling originating requests.

It may be possible that originating UE and terminating UE shares the same S-CSCF and Application Server, therefore the shared application server may interact with the S-CSCF twice in one transaction but in originating and terminating procedures respectively.

6.5.2 Handling of mobile terminating requests, unregistered user

The S-CSCF shall verify if the public user identity is barred. If so, it shall respond with a 4xx error code and stop further session processing.

The S-CSCF only looks for initial filter criteria when receiving an initial request. A terminating initial request may also originate from an Application Server via the ISC interface. Terminating Initial requests from an Application Server via the ISC interface also cause the S-CSCF to look for initial filter criteria.

When such a request comes in, the S-CSCF shall first check this is an originating request or a terminating request. This clause describes the requirements for the S-CSCF when this request is a terminating request. So, if this request is a terminating request, the S-CSCF shall:

- if unavailable, download the relevant subscriber profile including the initial filter criteria from the HSS;
- use the initial Filter Criteria for the Mobile Terminating request to unregistered user;
- in case the Request-URI changes when visiting an Application Server, terminate the checking of filter criterias, route the request based on the changed value of the Request-URI and do not execute the subsequent steps;
- the subsequent requirements for the S-CSCF are the same as those for handling originating requests.

It may be possible that originating UE and terminating UE shares the same S-CSCF and Application Server, therefore the shared application server may interact with the S-CSCF twice in one transaction but in originating and terminating procedures respectively.

6.6 Handling of IP multimedia session release requests

In handling session release, the S-CSCF may either proxy the release request or initiates a release request.

6.6.1 S-CSCF proxying release request

When the S-CSCF receives a release request from some entities (etc, application server, user agent) for a dialog, it proxies the release request to the destination according to route information in that release request.

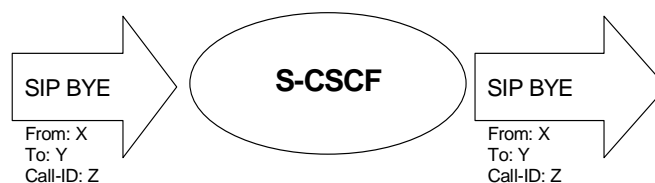

Figure 6.6.1.1: S-CSCF proxying release request

6.6.2 S-CSCF initiating release request

For some reason (etc. administration decision of the network), the S-CSCF may be required to release an ongoing dialog. In this case, the S-CSCF shall send a release request to all the entities that are involved in this dialog. In a typical AS involved dialog, the S-CSCF should send the release request to the AS and the UE it is serving as shown in figure 6.6.2.1.

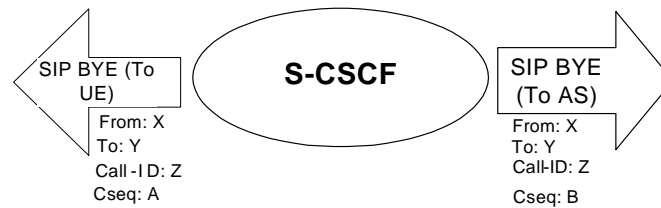

Figure 6.6.2.1: S-CSCF initiating release request

6.7 Handling of subscription and notification

The S-CSCF supports subscription to and notification of user registration events by the UE, P-CSCFs and Application Servers using the mechanisms specified in IETF RFC 3265 [13]. The subscribing entity may subscribe to the registration state of individual public user identities for the purpose of discovering the implicitly registered public user identities. When notifying a subscribing entity of a change in the registration state of a subscribed to public user identity the S-CSCF shall include in the notification all the implicitly registered public user identities associated with the registered public user identity in addition to the registered public user identity.

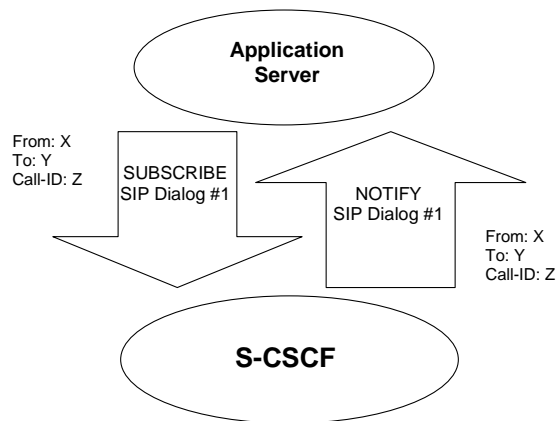

Figure 6.7.1: Application Server – S-CSCF subscribe notify dialog

6.8 S-CSCF handling IMS charging

In registration processing, a S-CSCF may send a third party REGISTER to an application server, where the ICID, IOI and charging function addresses are included in the message.

During a session, the S-CSCF shall generate the CDR for charging purposes.

In a session originating case, when receiving an incoming initial request, this request will carry the ICID generated by the upstream P-CSCF, which is serving the originating user; the S-CSCF shall store the ICID for this session and handle this request based on filter criteria. After processing this request the S-CSCF shall include the ICID and the charging function addresses received from the HSS in the outgoing message. The charging function addresses identify on-line, and off-line charging entities in the home network. It is implementation dependent how IMS related entities such as P-CSCF in the visited network get the local CCF addresses in the case that the P-CSCF is located in the visited network. Charging function addresses may be allocated as locally preconfigured addresses. If this message is sent outside the mobile network, S-CSCF shall include Inter Operator Identifier (IOI) that identifies the home network into the message. IOI is globally unique identifier for using inter operator accounting purposes. The response to the outgoing message may contain a separate IOI that identifies the home network of the called party. The S-CSCF shall retain either IOI in the message when contacting the Application Servers. The S-CSCF will receive GPRS charging information from subsequent requests and responses, the S-CSCF shall store these parameters and shall remove them from the outgoing message if this message is sent to the terminating UE's home network or the originating UE's visited network. The GPRS charging information may be sent to application servers.

In a session terminating case, when receiving an incoming initial request, this request will carry the ICID generated by the originating UE's P-CSCF; the S-CSCF shall store the ICID for this session and handle this request based on filter criteria. After processing this request the S-CSCF shall include the ICID and the charging function addresses received from the HSS in the outgoing message. The charging function addresses identify on-line and off-line charging entities in the home network. IOI may be received from another network or is inserted by the MGCF to identify the originating PSTN/PLMN. If IOI is received at the S-CSCF, the S-CSCF shall store the IOI value for the network that sent the request. The response to the incoming message may contain a separate IOI that identifies the home network of the S-CSCF. The S-CSCF shall retain either IOI in the message when contacting the Application Servers. Afterwards, the S-CSCF shall remove the IOI of the requesting network from the message before sending the message further within the network. The S-CSCF will receive GPRS charging information from subsequent requests and responses, the S-CSCF shall store these parameters and removes them from the outgoing message if this message is sent to the terminating UE's visited network or the originating UE's home network. The GPRS charging information may be sent to application servers.

For detailed information on transporting charging parameters between IMS entities using SIP, see 3GPP TS 24.229 [5].

6.9 Description of subscriber data

6.9.1 Application Server subscription information

The Application Server Subscription Information is the set of all Filter Criteria that are stored within the HSS for service profile for a specific user. This information shall be sent by the HSS to the S-CSCF via the Cx Interface during registration. More than one set of Filter Criteria may be sent during registration if implicitly registered public user identities belong to different service profiles. Filter Criteria shall also be sent after registration via the Cx interface when requested, as specified in 3GPP TS 29.228 [8].

6.9.2 Filter Criteria

This clause defines the contents of the Filter Criteria. This information is part of the Application Server Subscription Information. For further information about the XML modelling see 3GPP TS 29.228 [8].

Filtering is done for initial SIP request messages only.

The S-CSCF shall apply filter criteria to determine the need to forward SIP requests to Application Servers. These filter criteria will be downloaded from the HSS.

Initial Filter Criteria (iFC) are stored in the HSS as part of the user profile and are downloaded to the S-CSCF upon user registration, or upon a terminating initial request for an unregistered user if unavailable. They represent a provisioned subscription of a user to an application. After downloading the User Profile from the HSS, the S-CSCF assesses the filter criteria. Initial Filter Criteria are valid throughout the registration lifetime of a user or until the User Profile is changed.

Subsequent Filter Criteria (sFC) are not used in this version of this specification.

6.9.2.1 Application Server address

Address to be used to access the Application Server for a particular subscriber.

6.9.2.2 Default handling

The default handling procedure indicates whether to abandon matching of lower priority triggers and to release the dialogue, or to continue the dialogue and trigger matching.

6.9.2.3 Trigger point

Trigger Points are the information the S-CSCF receives from the HSS that defines the relevant SPTs for a particular application. They define the subset of initial SIP requests received by the S-CSCF that should be sent or proxied to a particular application server. When the S-CSCF receives an initial SIP request, it evaluates the filter criteria one by one. If the initial SIP request matches the filter criteria, the S-CSCF proxies the SIP request to the corresponding SIP AS/IM-SSF/OSA SCS.

6.9.2.4 iFC Priority

If there are multiple initial Filter Criteria assigned for one subscriber, the priority shall describe the order in which the S-CSCF shall assess them, and then contact the Application Servers when the SIP request matches the initial filter criteria. In this case, the S-CSCF shall interact with the application server associated with the initial matching filter criteria, starting from the filter criteria which has the highest priority.

6.9.2.5 Service Information

Service Information is transparent information, and is not processed by the HSS or the S-CSCF. Service Information is optionally part of an initial Filter Criteria. If it is available from the initial Filter Criteria the S-CSCF shall include it into the body of the SIP request which is sent from the S-CSCF to the AS to which the initial Filter Criteria is pointing to. Service Information is only included by the S-CSCF in REGISTER requests where the S-CSCF acts as a UAC.

6.9.3 Authentication data

This clause defines the Authentication Data. This data shall be sent by the HSS to the S-CSCF via the Cx Interface during registration.

For definition of authentication data see specification 3GPP TS 23.008 [10]. For the handling of authentication data, see 3GPP TS 33.203 [11].

7 Functional requirements of HSS

7.1 Subscriber data related storage requirements for HSS

HSS stores information required by:

- S-CSCFs (downloaded via Cx interface). Data model and abstract syntax notation are described in TS 29.228 [8];
- IM-SSF Application Servers (downloaded via Si interface);
- Application Servers (downloaded via Sh interface).

The service related data shall be transparent to HSS, this requires the HSS has some means to differentiate the source of the request for the data, therefore, the HSS can respond with the data the request asks for.

7.2 Interfaces defined for HSS

7.2.1 HSS – CSCF (Cx) interface

This interface is used to send subscriber data to the S-CSCF, including Filter Criteria (and their priority); which indicates which SIP requests should be proxied to which Application Servers.

The protocol used between the HSS and CSCF (Cx Interface) is specified in 3GPP TS 29.228 [8] and 3GPP TS 29.229 [17].

7.2.2 HSS - Application Server (Sh) interface

The Sh interface is between the HSS and the SIP Application Servers and the OSA SCS and may be used for transferring User Profile information such as user service related information or user location information or charging function addresses. Requirements for the Sh interface are specified in 3GPP TS 23.228 [3].

The protocol used between the HSS and AS (Sh Interface) is specified in 3GPP TS 29.328 [18] and 3GPP TS 29.329 [19].

7.2.3 HSS – CSE interface

The protocol used on the interface between the HSS and the CAMEL Service Environment (CSE) is the MAP protocol [16].

7.2.4 HSS – IM-SSF Application Server (Si) interface

The Si interface is between the HSS and the IM-SSF Application Server and is used for transferring IMS CAMEL specific information.

The protocol used between the HSS and IM-SSF (Si Interface) is specified in 3GPP TS 23.278 [9] and 3GPP TS 29.002 [16].

7.3 Procedures during IP multimedia registration

These procedures are described in TS 29.228 [8].

7.4 Procedures during IP multimedia sessions

These procedures are described in TS 29.228 [8].

8 Functional requirements of the MRFC

8.1 Functionality of the MRFC

8.1.1 Overview of MRFC Functionality

The functionality of the MRFC is defined in 3GPP TS 23.228 [3]. These clauses describe how an Application Server may interact with a MRFC. In some cases a UE may interact directly with the MRFC, however these cases are outside the scope of this specification and only the cases of Application Server control for service provision are considered here. In all cases of Application Server control, all session control requests that are passed between the Application Server and the MRFC are sent via the S-CSCF using the ISC interface and the interface of the Mr reference point.

MRFC addresses are made known via peer-to-peer arrangements within the IM CN subsystem.

Figure 8.1.1.1 describes the relationship of the Application Server with the S-CSCF and MRFC.

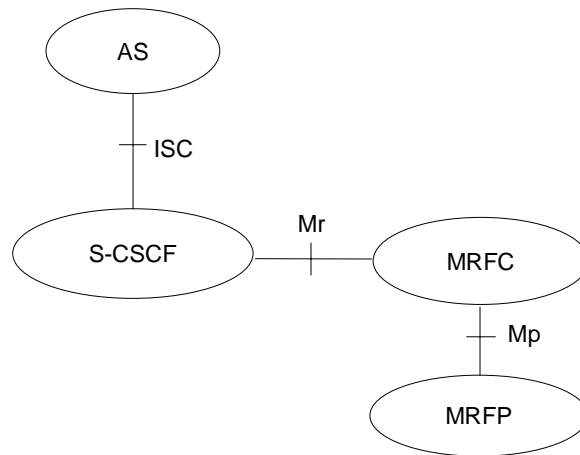

Figure 8.1.1.1: Relationship of MRFC and MRFP with S-CSCF, and Application Servers

8.1.2 Tones and announcements

An Application Server is in control of the tone/announcement selection and is aware of MRFC capabilities.

The MRFC accepts INVITE requests sent from an Application Server, via the S-CSCF, for the purpose of applying tones and announcements. The INVITE sent to the MRFC will contain sufficient information to play the appropriate tone or announcement.

The MRFC shall support both the offer/answer as defined in IETF RFC 3264 [15] and the offer/answer with preconditions models for SDP negotiation with the AS. However, the offer/answer model for SDP negotiation between the AS/S-CSCF and the MRFC is sufficient for applying tones and announcements. The MRFC should always grant the requests from the AS (unless there is a resource problem). The receipt of the ACK at the MRFC triggers the playing of the tone or announcement.

The tone or announcement should end when a BYE is received. Alternatively, an expiration time may have been specified from the AS within the SDP of the INVITE request. In this case, the MRFC may terminate the media on its own and generate a BYE request towards the AS. A tone or announcement may also have a pre-determined play time (e.g., confirmation tone), and so there may not be a need for the AS to send a request to stop it or to include the play time in the request.

See annex B for a call flow example of playing an announcement for a mobile originated call.

8.1.3 Ad hoc conferences (multiparty calls)

An Application Server can control an Ad Hoc conference (multiparty call) and is aware of MRFC capabilities.

The MRFC accepts INVITE requests sent from an Application Server, via the S-CSCF, for the purpose of managing ad hoc conferences. The INVITE sent to the MRFC shall contain sufficient information to initiate, add and remove parties from the conference. Re-INVITE requests can also be sent for managing floor control and for parties to leave and rejoin the media path.

The MRFC shall support both the offer/answer as defined in IETF RFC 3264 [15] and the offer/answer with preconditions models for SDP negotiation with the AS. However, the offer/answer model for SDP negotiation between the AS/S-CSCF and the MRFC is sufficient for managing ad hoc conferences. The MRFC should always grant the requests from the AS (unless there is a resource problem). The MRFC will reserve the requested local resources and return the appropriate resource identifiers in the 200 response.

See annex B for a call flow example of an Ad Hoc Conference (Multiparty Call).

8.1.4 Transcoding

An Application Server can control a transcoding session and is aware of MRFC capabilities.

The MRFC accepts INVITE requests sent from an Application Server, via the S-CSCF, for the purpose of transcoding. The INVITE sent to the MRFC shall contain sufficient information to associate the two sessions that require transcoding.

The MRFC shall support both the offer/answer as defined in IETF RFC 3264 [15] and the offer/answer with preconditions models for SDP negotiation with the AS. Either may be necessary for SDP negotiation between the AS/S-CSCF and the MRFC. The MRFC should always grant the requests from the AS (unless there is a resource problem).

For the offer/answer model, the MRFC responds to the INVITE request with a 200 response indicating the selected media in the SDP. The MRFC will also reserve the requested local resources at that time and return the appropriate resource identifiers in the 200 response.

For the offer/answer with preconditions model, the MRFC responds to the INVITE request with a 183 response indicating the list of codecs supported by the MRFC. When the PRACK is received indicating the selected media in the SDP, the MRFC will reserve the requested local resources at that time and return the appropriate resource identifiers in the 200 response.

See annex B for call flow examples of providing transcoding.

8.2 Interfaces defined for MRFC

8.2.1 MRFC – S-CSCF (Mr) interface

The protocol used between MRFC and S-CSCF is based on Session Initiation Protocol, which is specified in 3GPP TS 24.229 [5].

9 Generic IP multimedia session handling for SIP Application Servers

9.1 Architecture

This clause describes the functional architecture needed to support interactions between the S-CSCF in the IP Multimedia Subsystem and the Application Server(s). This clause relates to the generic behaviour of SIP Application Servers, which since SIP is the ISC interface protocol shall be considered to apply to all application servers, (which also includes the SIP behaviour of the OSA SCS and IM-SSF). The detailed models for service provision are described in the clauses below. These models shall apply to the SIP behaviour of the OSA SCS and IM-SSF and all the Application Servers.

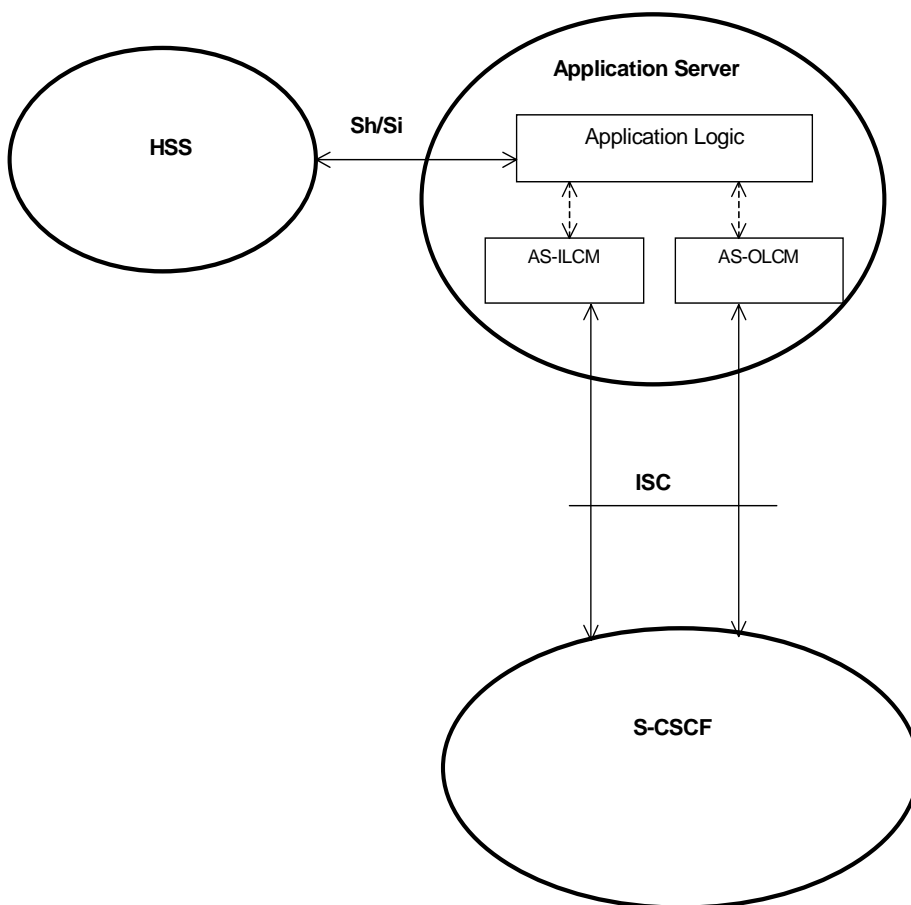

Figure 9.1.1: Application Server functional model

Figure 9.1.1 identifies the components of a functional model of the AS.

NOTE: These components are defined only as a model of the expected behaviour of the AS on the ISC interface and are not intended to define or constrain the actual implementation.

The components include the AS-ILCM, the AS-OLCM and the Application Logic. The AS-ILCM shall store transaction state, and may optionally store session state depending on the specific service being executed. The AS-ILCM interfaces to the S-CSCF (ILCM) for an incoming leg.

The AS-OLCM shall store transaction state, and may optionally store session state depending on the specific service being executed. The AS-OLCM interfaces to the S-CSCF (OLCM) for an outgoing leg.

The Application Logic provides the service(s) and interacts between the AS-ILCM and AS-OLCM.

The Application Server can access the HSS via the Sh or Si interface to access subscriber related data specific to the service or application including the address of the S-CSCF.

9.1.1 Modes of operation between Application Server and S-CSCF

An Application Server can utilize five basic modes of operation for processing SIP Requests. Services can be built using combinations of these five modes of operation between the Application Server and the S-CSCF. An application Server can transition from one mode of operation to another during the lifetime of a multimedia session it is managing.

9.1.1.1 Application Server acting as terminating UA, or redirect server

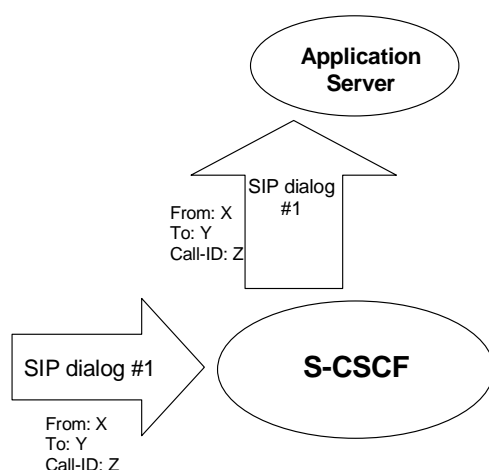

Figure 9.1.1.1.1: Application Server acting as terminating UA, or redirect server

In this mode of operation the incoming SIP Request is proxied by the S-CSCF to the Application Server, which then acts as either a UA or Redirect Server as specified in IETF RFC 3261 [6].

9.1.1.2 Application Server acting as originating UA

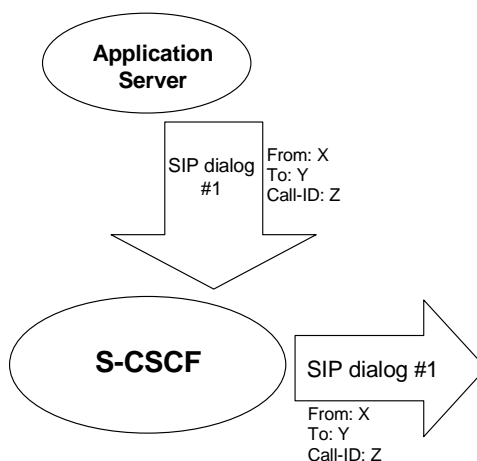

Figure 9.1.1.2.1: Application Server acting as originating UA

In this mode of operation the Application Server acts as a UA as specified in IETF RFC 3261 [6] and generates a SIP Request which it sends to the S-CSCF which then proxies it towards the destination.

9.1.1.3 Application Server acting as a SIP proxy

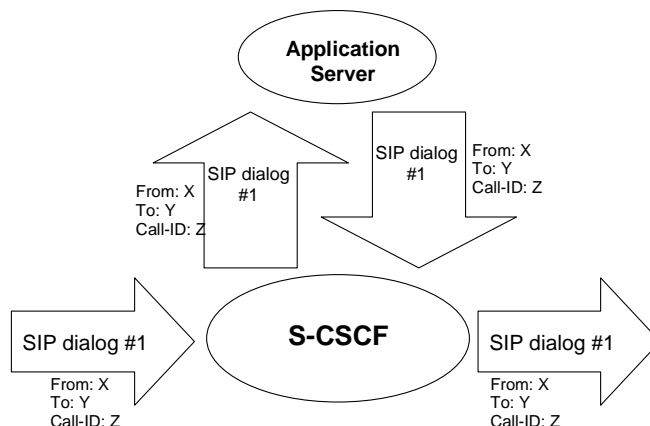

Figure 9.1.1.3.1: Application Server acting as a SIP proxy

In this mode of operation the incoming SIP Request is proxied by the S-CSCF to the Application Server which then acts as a proxy as specified in IETF RFC 3261 [6] proxying the request back to the S-CSCF which then proxies it towards the destination. During the proxy operation the Application Server can add, remove or modify the header contents contained in the SIP request according to the Proxy rules specified in IETF RFC 3261 [6].

9.1.1.4 Application Server performing third party call control/ B2BUA mode

The AS performing 3rd party call control acts as a B2BUA. There are several kinds of 3rd party call control, for example:

- Routing B2BUA: an AS receives a request from the S-CSCF, terminates it and generates a new request, which is based on the received request.

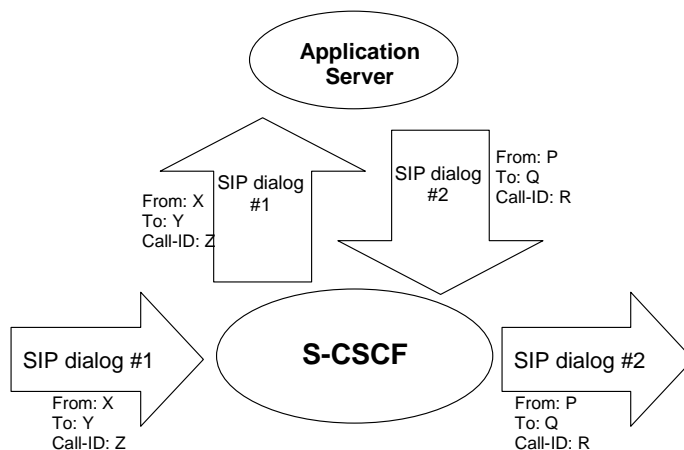

Figure 9.1.1.4.1: Application Server performing third party call control acting as a routing B2BUA

In this mode of operation the incoming SIP Request is proxied by the S-CSCF to the Application Server which then generates a new SIP request for a different SIP dialog which it sends to the S-CSCF which then proxies it towards the destination. In this mode the Application Server behaves as a B2BUA for the multiple SIP dialogs as specified in IETF RFC 3261 [6].

- Initiating B2BUA: an AS initiates two requests, which are logically connected together at the AS.

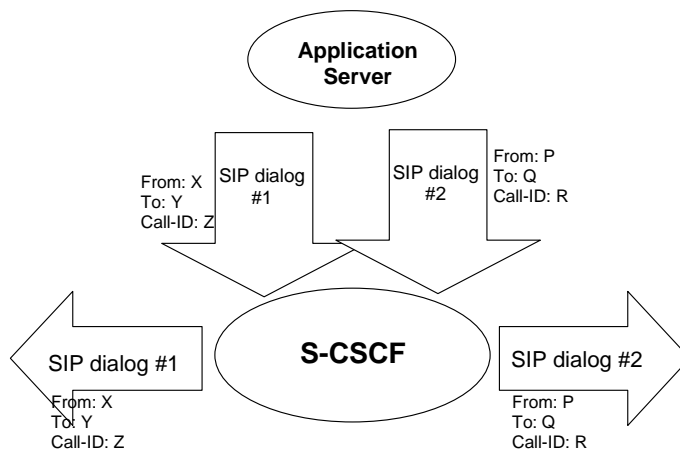

Figure 9.1.1.4.2: Application Server performing third party call control acting as an initiating B2BUA

In this mode of operation the Application Server initiates two requests with different SIP dialogs. The Application Server is responsible for correlating the two dialogs. These requests are proxied through the S-CSCF which then proxies them towards the destination. In this mode the Application Server behaves as a B2BUA for the multiple SIP dialogs as specified in IETF RFC 3261 [6].

9.1.1.5 Application Server not involved or no longer involved

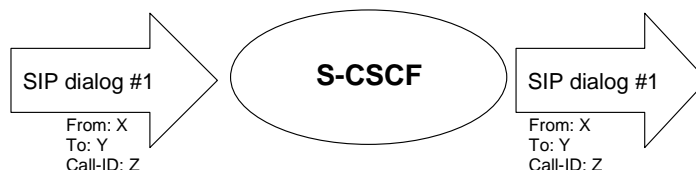

Figure 9.1.1.5.1: A SIP leg is passed through the S-CSCF without Application Server involvement

In this mode of operation the Application Server was either never involved in the SIP session signalling or has determined to be no longer involved. The incoming SIP Request is proxied by the S-CSCF towards the destination. The Application Server can maintain itself in the SIP session signalling path by inserting itself in a Record-Route Header as specified in IETF RFC 3261 [6]. If the Application Server does not insert itself in a Record Route header then this mode of operation shall be used for all subsequent requests related to this SIP dialog.

9.2 Interfaces defined for a SIP Application Server

9.2.1 S-CSCF – Application Server (ISC) interface

This interface can be used by the Application Server to control an IP Multimedia session via a S-CSCF. Transactions between the S-CSCF and the Application Server on this interface are initiated either as a result of the S-CSCF proxying a SIP request to the Application Server or by the Application Server initiating by generating and sending a SIP request to the S-CSCF. This interface is based on SIP.

9.2.2 Application Server – HSS (Sh) interface

The Sh interface is between the HSS and the SIP Application Servers and the OSA SCS and may be used for transferring User Profile information.

9.2.3 Application Server – SLF (Dh) interface

The Dh interface is between the SLF and the SIP Application Servers, the OSA SCS, and the IM-SSF and may be used for retrieving the address of the HSS which holds the User Profile information for a given user.

9.3 Description of Application Server related subscriber data

9.3.1 Application server subscription information

This clause defines the general contents of the Subscription Information that may be required by the Application Server. The AS shall obtain this information from the HSS via the Sh interface or by other operator defined methods. The subscription information may be retrieved during registration or at any other time dependent on AS and service requirements.

9.3.1.1 Service key

The Service Key identifies to the Application Server the service logic that shall apply.

9.3.1.2 Service platform trigger points (STP)

Service Platform Trigger Points (STP) are the points in the SIP signalling that instruct the Application Server to trigger the service logic.

9.3.1.3 Service scripts

The Application Server can utilize a call processing script (e.g. in CGI, CPL, Java® Servlets, or another proprietary language), which may be obtained from the HSS via the Sh interface or by other operator defined methods.

NOTE: Java® is the trade name of a product supplied by Sun Microsystems. This information is given for the convenience of users of the present document and does not constitute an endorsement by 3GPP of the product named. Equivalent products may be used if they can be shown to lead to the same results.

9.4 Procedures for multimedia session handling with a SIP based Application Server

9.4.1 Application Server handling of mobile originating requests

The functional mode of application server is shown in figure 9.1.1.

For an originating request, the AS-ILCM may interact with the application logic reporting call state information. Depending on the service that is being provided, the application logic may instruct the AS-OLCM to modify the request if needed (e.g. by inserting itself in the Record-Route etc). After processing the request the AS-OLCM may send this request back to the S-CSCF.

When the AS acts as a B2BUA, the application server shall maintain and correlate the multiple dialogues that it creates. It shall be responsible for correlating the dialogue identifiers and shall decide when to translate a message from one dialog to the other, or when to perform other functions based on the instruction from the application logic.

9.4.2 Application Server handling of mobile terminating requests

The handling of mobile terminating requests is similar with the handling of mobile originating requests as defined in clause 9.4.1.

9.4.3 Application Server handling of SIP registration

When the user is registered with the network and has been assigned a S-CSCF, the application servers, which are interested to know about the user registration events, should get a third party registration request generated by the S-CSCF. When the application server receives the request, the Application Server may perform a service triggered by a REGISTER. If the application server doesn't support this mechanism, it shall send back an error response to the S-CSCF. If the application server supports this mechanism, it shall treat this request as a notification from the network about the user's registration event and extract the important information from this request.

The application server may, depending on the Filter Criteria receive REGISTER requests indicating reregistration or deregistration events from the S-CSCF, so that the application server can update or release user's registration information.

The important information carried in the third party registration request are, the public user identity, the S-CSCF address, and the expiration time.

The application server can also extract user specific data from the REGISTER request, e.g. the IMSI for an Application Server that supports CAMEL services.

Application Servers can also subscribe to the S-CSCF Registration Event Package after receiving the third party registration request. After subscribing to the event package with the S-CSCF, the application will expect to receive the notifications from the S-CSCF, which may carry the user's implicitly registered public user identities, the user's terminal current capabilities and the user's registration event information.

The application server can also obtain the user's implicitly registered public identities by accessing the HSS via Sh or Si interface.

An application server will require knowledge of a user's IMS subscription information if they are to correctly apply services. This information can be provided to the application server in two ways, either:

- a) Manually by provisioning. This is outside of the scope of this specification.
- b) Automatically from the HSS via the Sh and Si interfaces.

More information on these procedures is contained in 3GPP TS 24.229 [5].

9.4.4 Application Server handling of IP multimedia session release requests

9.4.4.1 Session release request terminated at the Application Server

When the application server receives a session release request, if the application server is acting as a user agent or a B2BUA, it shall send 200 OK to the entity that initiated the session release request.

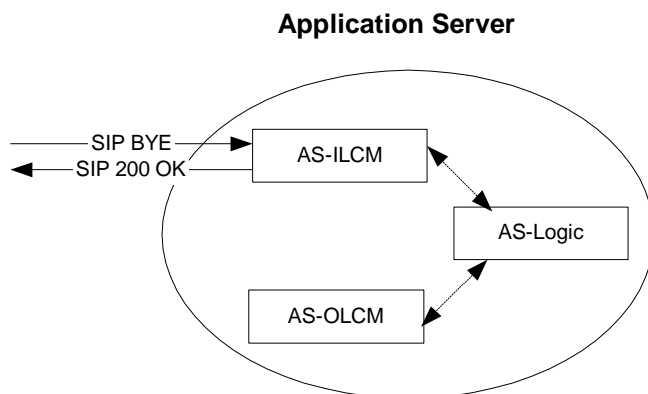

Figure 9.4.4.1.1: Release request terminated at the Application Server

9.4.4.2 Session release request proxied by the Application Server

When receiving a session release request, the application server may proxy the release request based on the route information in that request. This handling is typically used when the application server is in proxy mode.

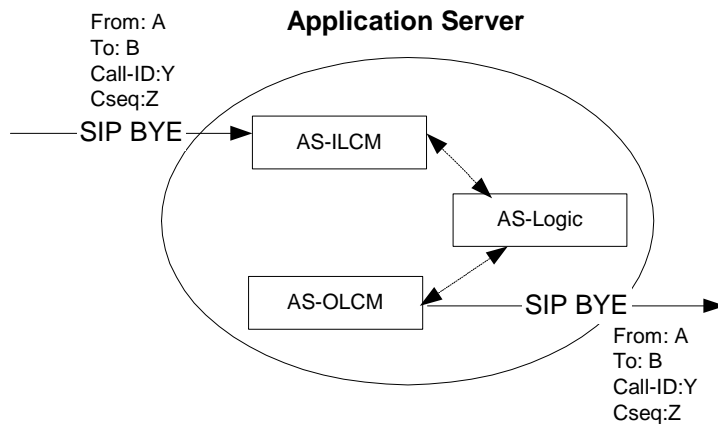

Figure 9.4.4.2.1: Release request proxied by the Application Server

9.4.4.3 Session release request initiated by the Application Server

If needed, the application server may initiate release requests to the entities involved in the dialogs the application server manages. Application servers may initiate release requests in either user agent or B2BUA mode.

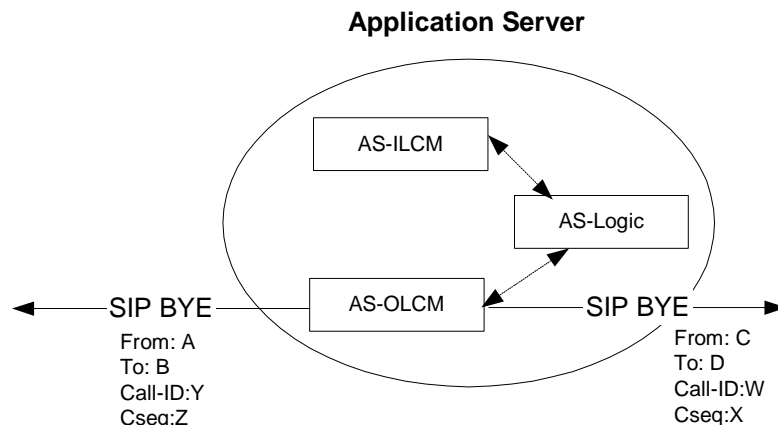

Figure 9.4.4.3.1: Release request initiated by the Application Server

9.4.5 Application server handling of IP multimedia charging

If an application server receives a third party REGISTER from the S-CSCF carrying the ICID, IOI and charging function addresses, the application server may store these parameters for charging purposes.

In an originating case, when processing an incoming initial request carrying the ICID, IOI, GPRS charging information and charging function addresses for this session, the application server shall pass these parameters in the outgoing message and may store the parameters for charging purposes.

In a terminating case, when processing an incoming initial request carrying the ICID, IOI, GPRS charging information and charging function addresses for this session, the application server shall pass these parameters in the outgoing message and may store the parameters for charging purposes.

When the application server is acting as an originating user agent as described in clause 9.1.1.2 and initiates a session or a standalone transaction, it shall generate ICID itself. Charging function addresses may be allocated as locally preconfigured addresses. The application server may retrieve the charging addresses on Sh interface.

When the conflict occurs between the charging function address(es) received over the ISC interface and those received over the Sh interface, the address(es) received over the ISC interface should take precedence.

NOTE: The use of the Sh interface to retrieve charging function addresses is not intended as a general-purpose alternative to receiving charging function addresses from the ISC interfaces. Rather, it is meant to address a special case where the AS needs to interact with the charging system before initiating a request to a user when the AS has not received the third party REGISTER for that user.

For detailed information on transporting charging parameters between IMS entities using SIP, see 3GPP TS 24.229 [5].

10 IP multimedia session handling with IM-SSF Application Server

This clause describes the functional architecture needed to support CAMEL interactions with the S-CSCF in the IP Multimedia Subsystem. The IM-SSF is a SIP Application Server that interfaces SIP to CAP. The generic SIP Application Server behaviour of the IM-SSF is specified in clause 9 of the present document.

The detailed CAMEL procedures for IM-SSF Application Server are specified in 3GPP TS 23.278 [9].

11 IP multimedia session handling with an OSA-Service Capability Server

This clause describes the functional architecture needed to support interactions with the S-CSCF in the IP Multimedia Subsystem and the OSA-SCS. The OSA-Service Capability Server is a SIP Application Server which interfaces SIP to the OSA framework. The generic SIP Application Server behaviour of the OSC-SCS is specified in clause 9 of the present document.

The detailed OSA-SCS procedures for IMS Application Server are specified in 3GPP TR 29.998 [7].

12. IP multimedia session handling with an Charging Server

This clause describes the functional architecture needed to support interactions with the S-CSCF in the IP Multimedia Subsystem and Charging Server. The Charging Server is a specific SIP Application Server that performs the role of online charging mechanism for the Event Charging Function (ECF) and Session Charging Function (SCF).

The detailed procedures for Charging Server are specified in 3GPP TS 32.240 [20] and 3GPP TS 32.260 [21].

Annex A (informative): Scalability and deployment considerations for IP multimedia service provision

This Annex is intended to guide the reader in deployment and real life issues.

This specification has provided a set of tools for the application developer and the application integrator to utilize in order to develop and deploy applications and provide services for the IP multimedia core network subsystem. However, practical deployments will need to consider certain scalability issues with the use or misuse of some of the tools specified in this specification.

The architecture allows for any number of Application Servers to be connected to any number of S-CSCFs and any number of Application Servers to be involved in the initiation of a multimedia session. A scalability issue may arise if there are a large number of S-CSCF and AS in a network.

Consideration should be given to the signalling propagation delays introduced when many Application Servers add themselves to the route to provide originating and terminating services for the calling and called parties.

A SIP Application Server may act as gateway function by forwarding an incoming request to external ASs beyond the IM CN subsystem. An external ASs will also send responses to IM CN subsystem via a SIP AS gateway. These other Application Servers can be located externally to the home network, and use the SIP Application Server as a gateway to the ISC interface. The interface between the SIP Application Server acting as a gateway, and other Application Servers is outside the scope of the present document.

There is another case where the external AS is connected with S-CSCF (or I-CSCF) via public ISP networks depending on the operators desire for network configuration hiding. S-CSCF or entities outside the S-CSCF may perform the interworking function.

Care must also be taken to the priority and order of contact of multiple Application Servers during a session in order to account for feature interaction issues.

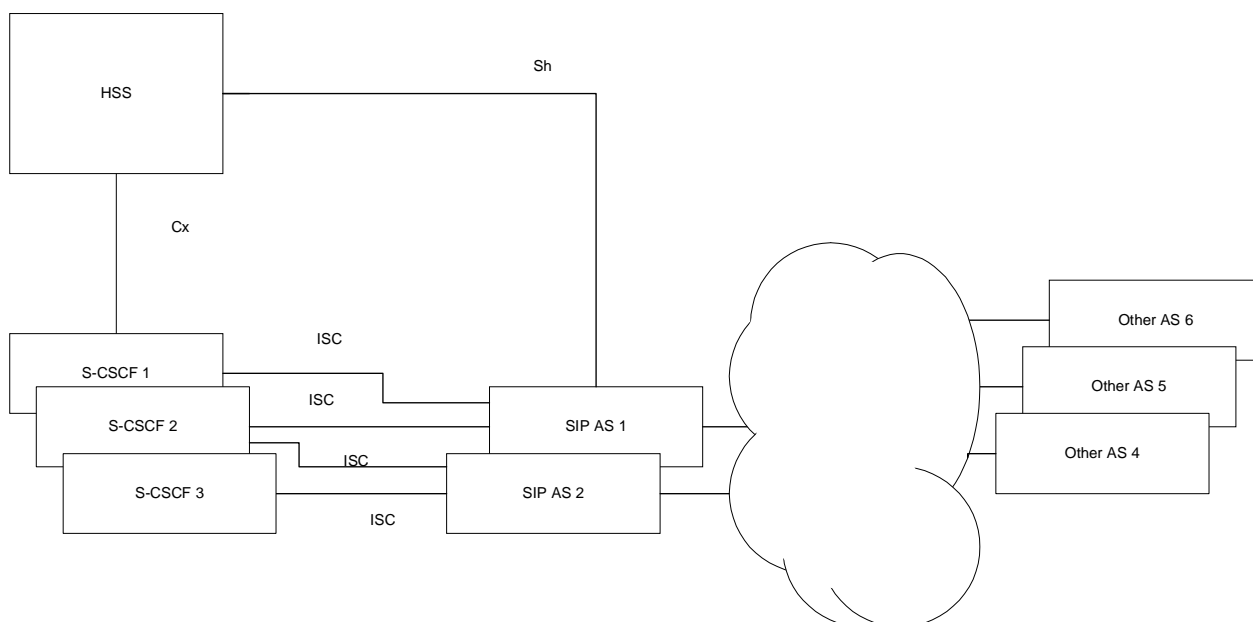

Figure A.1: Example hierarchical architecture for Application Servers

Figure A.1 depicts a possible solution that shows how a S-CSCF (S-CSCF1 S-CSCF3) could be connected to a single AS (SIP AS1), while another (S-CSCF2) could be connected to more than one, in this case it is two (SIP AS1, SIP AS2). All S-CSCF will be connected to the HSS via Cx. A SIP AS may be connected to the HSS via Sh. SIP ASs may be connected to the IP network, which could allow them to contact Application Servers (e.g., either SIP ASs, or Other ASs).

Care should be taken to the transaction delays resulting of a high number of S-CSCF and ASs on the session signalling path.

A possible application of this architecture is described below (see figure A.2).

While some applications need to discover the registration of a user on an event driven basis, many applications do not. For many applications an access to the HSS or other database to obtain the address of the S-CSCF that serves a user is sufficient to contact and initiate a session to that user, and others (such as basic call feature servers) do not require to be informed of the registration state or necessarily even need to know the identity of the user. It is therefore possible that the filter criteria are set in such a way that S-CSCF3 does not forward or notify SIP AS 3 of REGISTER requests. SIP AS3 would then need to determine registration status via other means (i.e. via IP network) not specified.

The number of Application Servers receiving REGISTER requests (i.e., SIP AS3) from an individual S-CSCF should be minimized.

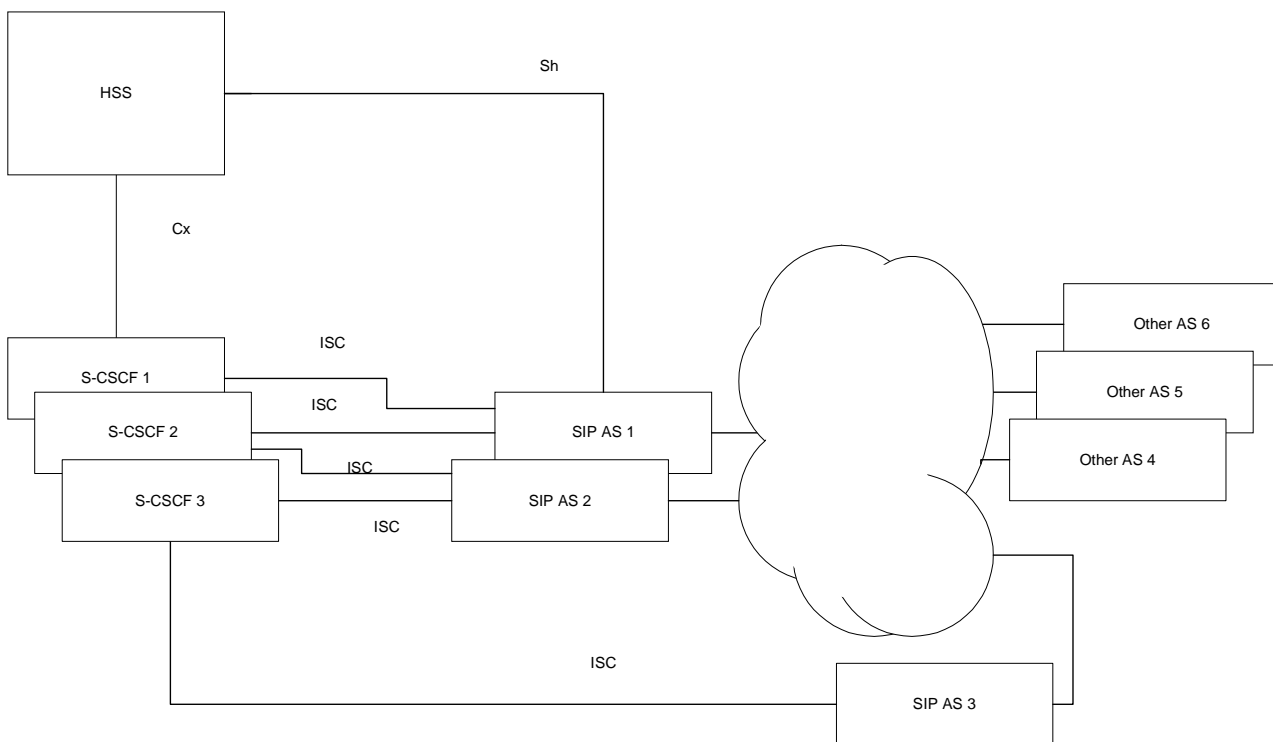

Figure A.2: Use of a hierarchy in a practical architecture for Application Servers

Annex B (informative):

Information flows for example services

This annex contains some informative example information flows that show the possible flow of information for some example services. These examples are intended only to help aid the understanding of the behaviour of the S-CSCF, MRFC and Application Servers for service provision for the IM CN subsystem and are not intended to recommend or specify how to create such services, (indeed the examples given may not even be a good idea for a practical implementation).

The following modes of operation are shown in these examples:

- | | |
|-------------------------------------------------------------|----------------------------------|
| - Third Party Registration to Application Server | Clause B.3.2; |
| - Application Server in Originating UA mode | Clause B.3.2; |
| - Application Server in Redirect mode | Clause B.1.3; |
| - Application Server in Terminating UA mode | Clause B.3.1; |
| - Application Server in Proxy mode | Clause B.1.4; |
| - Application Server in Third Party Call Control/B2BUA mode | Clauses B.2.1, B.2.2, and B.2.3; |
| - Application Server with no involvement | Clause B.1.4. |

B.1 Call forwarding example

B.1.1 Call forwarding through Application Servers

Figure B.1.1.1 presents the network configuration for a call-forwarding scenario. Some interfaces between nodes have been omitted purely for clarity. In this configuration, the UE1 originates a call to the UE2. The UE2 is subscribed to a Call Forwarding (CF) service based on the Calling Line Identification (CLI). The CF service logic resides in an Application Server interfacing to the IM CN subsystem via the ISC interface. The Application Server is programmed to detect all incoming calls or terminating sessions with UE1's CLI and to instruct the S-CSCF to forward the calls/sessions to another destination, UE3, either directly or via the UE1. These two session forwarding scenarios are shown by the red and blue coloured flows. When the session redirection is carried out directly by the S-CSCF of the UE2, the network may notify the UE1 of its call/session redirection.

As shown in figure B.1.1.1, the Application Server may be a SIP AS, or an OSA AS or a CAMEL CSE. The latter two Application Servers interface the S-CSCF via the OSA SCS and IM SSF gateways, respectively.

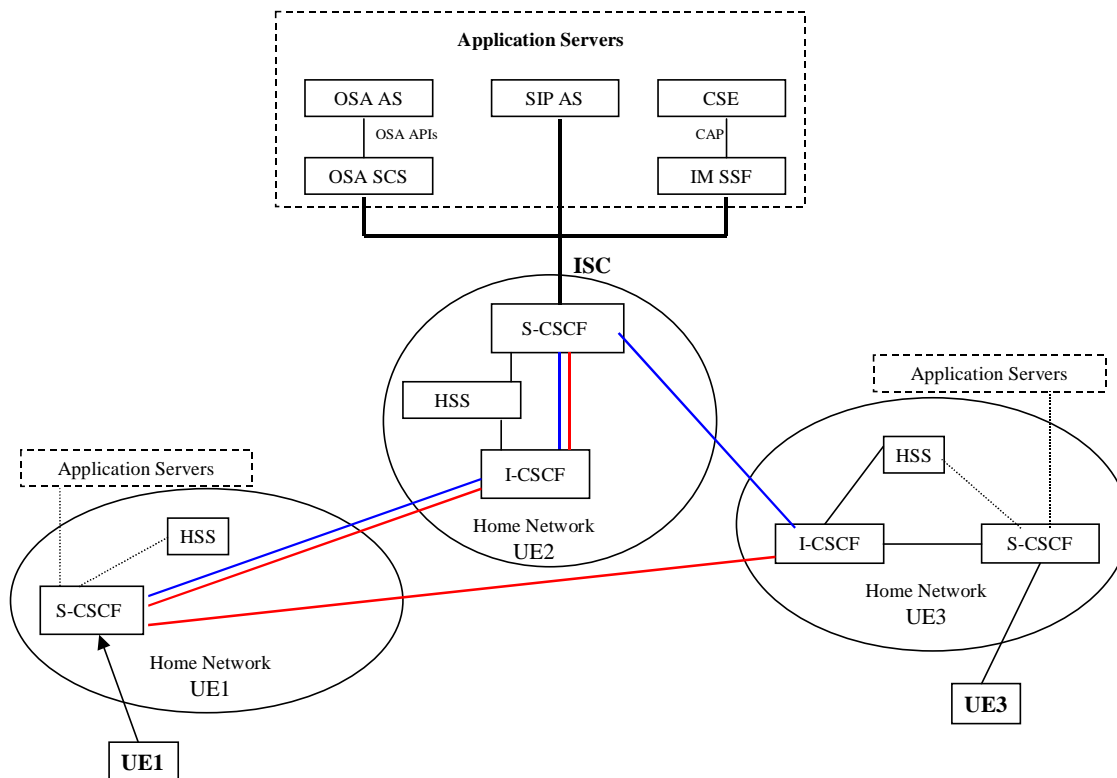

Figure B.1.1.1: Network configuration for the call forwarding examples

In this configuration, the originating UE1 and the terminating UE3 are assumed to be in their respective home network. The UE2, not shown in figure B.1.1.1, may be either at its home network or roaming in a visited network.

The CF feature is invoked based on the detection of the originating party's CLI "pre-activated" for call forwarding. Upon invocation of the CFonCLI feature, the call will be forwarded to a pre-specified destination. These two steps and a few underlying assumptions are briefly described below:

B.1.1.1 Service activation and programming

The UE2 activates its CFonCLI service and programs it with a Forward-to Number which is UE3's number, conditioning it to the originating party's line identity, CLI.

B.1.1.2 Service invocation and control

The UE1 makes a call to the UE2. The CFonCLI is invoked and the call is forwarded to the UE3 following a "Session Redirection" that is initiated by either the S-CSCF or the UE1.

NOTE: 3GPP TS 23.228 [3] lists six redirection procedures as follows:

NOTE 1: Session Redirection initiated by S-CSCF to IMS;

NOTE 2: Session Redirection initiated by S-CSCF to CS-domain;

NOTE 3: Session Redirection initiated by S-CSCF to general endpoint;

NOTE 4: Session Redirection initiated by P-CSCF;

NOTE 5: Session Redirection initiated by UE;

NOTE 6: Session Redirection initiated after Bearer Establishment.

B.1.2 Assumptions

For the CFonCLI service invocation and service control procedure, the following are assumed to hold:

- Normal case scenario, showing successful cases only;
- Subscriber data of all three UE1, UE2 and UE3 are stored in their respective HSS;
- All call/session control for the UE1, UE2, and UE3 is done in their respective home network S-CSCF;
- The UE2 has already subscribed to the CFonCLI service with a service provider operating an Application Server where the service control logic resides;
- The pre-selected numbers (e.g., UE3) to which the originated calls are forwarded, are stored by the CFonCLI service control logic upon activation of the feature by the UE2.

B.1.3 UE redirect based call flows

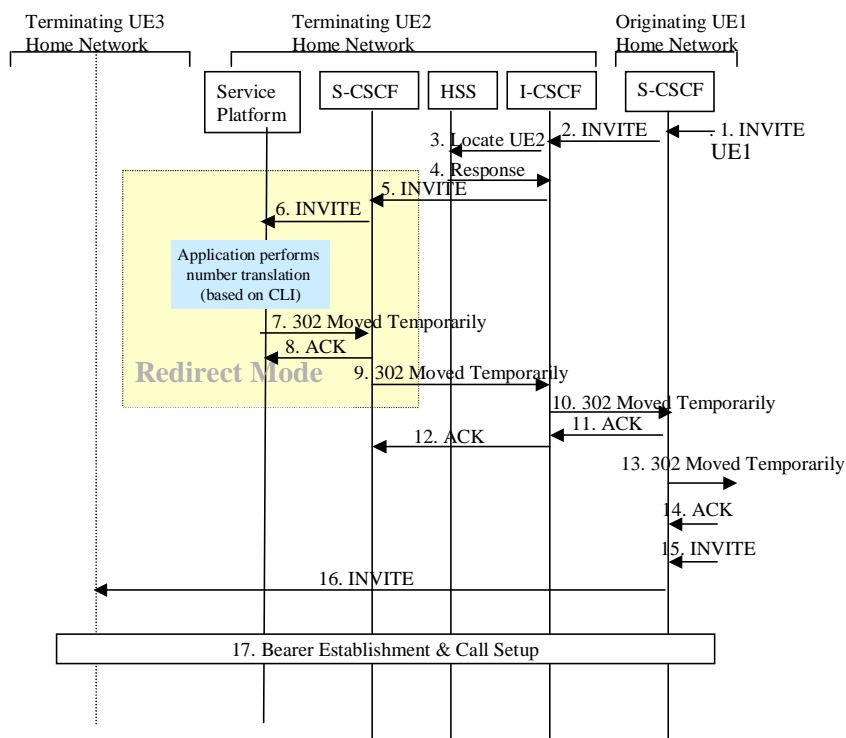

Figure B.1.3.1: CFonCLI information flows with UE re-direct

Figure B.1.3.1 presents the information flow diagram for the invocation and control of the CFonCLI service based on the configuration of figure B.1.1.1.

The UE1 initiates a call to UE2. The CFonCLI service logic is invoked in the Application Server when the S-CSCF for UE2 detects that service invocation is required. The call is forwarded to the UE3 by the UE1 according to the "Session Redirection initiated by UE" procedure. The UE3 accepts the (forwarded) call. A detailed description for each flow is given below:

- 1) The S-CSCF of UE1 receives a SIP invite request form UE1.

- 2) The I-CSCF of the UE2 receives a SIP INVITE request from the S-CSCF of the originating user, UE1. UE1's CLI is included in this INVITE request.
- 3) The I-CSCF of the UE2 queries the HSS to obtain the S-CSCF of the UE2.
- 4) The HSS returns the S-CSCF location.
- 5) The I-CSCF forwards the INVITE to the S-CSCF of UE2.
- 6) Based on the information obtained from the UE2 Service Profile (during registration), the S-CSCF of the UE2 detects that the criteria for certain pre-defined triggers are met. The INVITE request is forwarded to the Application Server. The service logic is invoked in the Application Server.
- 7) Based on the outcome of the execution of the service logic, the Application Server instructs the S-CSCF to REDIRECT the session to UE3. The behaviour of the Application Server follows the description of a 'redirect server'. It sends the 302 Move Temporary response with UE3 as the redirect address to UE1. The Application Server plays no further part in the session establishment.
- 8) S-CSCF of UE2 sends ACK back to the Application Server to acknowledge the receiving of the 302 response.
- 9) S-CSCF of UE2 forwards the 302 Move Temporary to the I-CSCF of UE2.
- 10) The I-CSCF of UE2 forwards the 302 Move Temporary to the S-CSCF of UE1.
- 11) The S-CSCF of UE1 sends ACK to acknowledge the receiving of the 302 Move Temporary.
- 12) The I-CSCF of UE2 forwards the ACK to the S-CSCF of UE2.
- 13) The S-CSCF of UE1 forwards the 302 Move Temporary response to the next downstream hop.
- 14) The S-CSCF of UE1 receives the ACK for that 302 response from the downstream hop.
- 15) The UE1 re-issues an INVITE with UE3 as the destination.
- 16) The originating S-CSCF redirects the SIP INVITE request to the UE3's home network.
- 17) Bearer establishment & call setup between from the UE1 to the UE3 is performed following the procedure described in the basic call flow sections for originating, inter-network and terminating segments.

B.1.4 S-CSCF based redirect call flows

Figure B.1.4.1 presents the information flow diagram for the invocation and control of the CFonCLI service based on the configuration of figure B.1.1.1, where redirection is made by the S-CSCF after instructions from the service logic in the Application Servers.

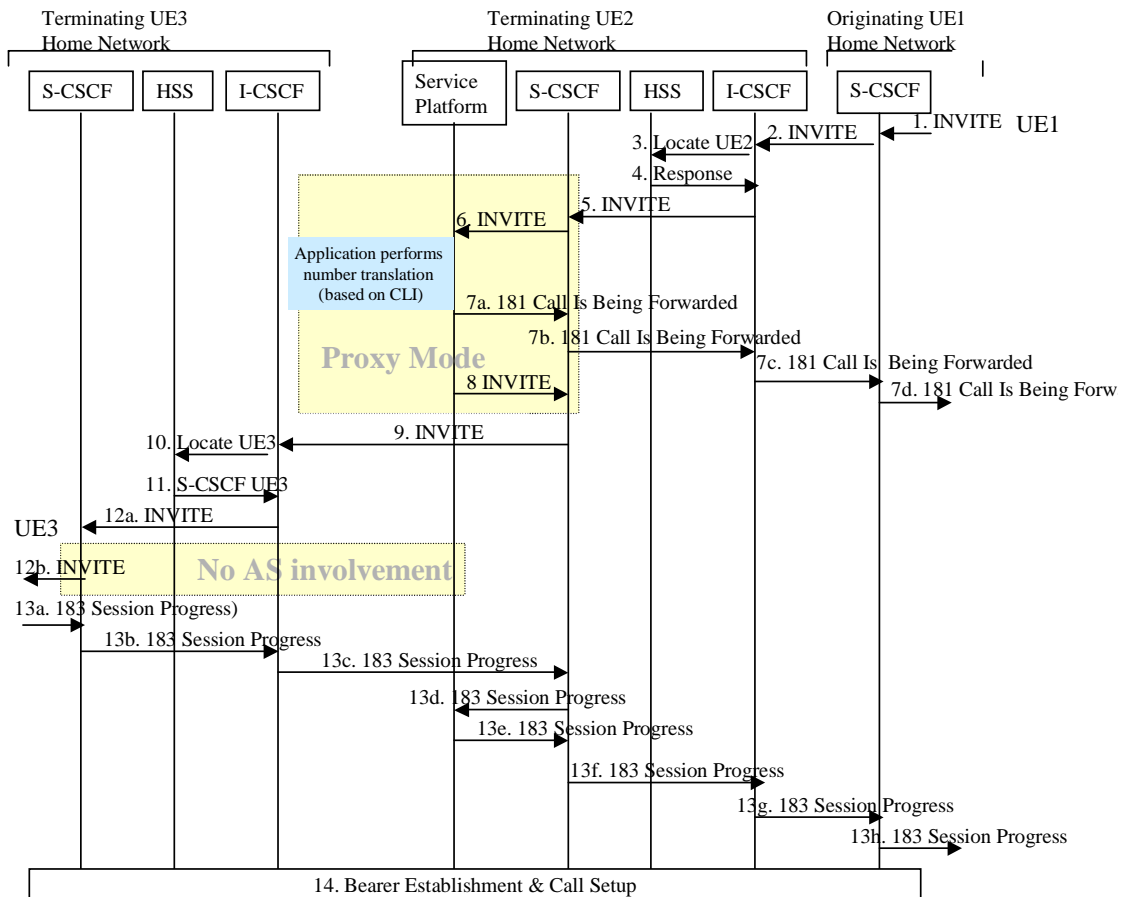

Figure B.1. 4.1: CFonCLI information flow with S-CSCF redirect

The UE1 (located in the originating visited network) makes a call to UE2. The CFonCLI is invoked and the CFonCLI service logic is executed by an application residing in the Application Server.

The call is forwarded to the UE3 by the S-CSCF of UE2 according to the "Session Redirection" instructed by the Application Server. The S-CSCF sends a SIP 181Call Is Being Forwarded to UE1 and a SIP Invite request to UE3. The UE3 accepts the (forwarded) call. A detailed description for each flow is given below:

- 1) - 6) are identical to flows by the same number in the UE Redirect example provided in B.1.3.
- (7a, 7b, 7c and 7d) The Application Server notifies the UE1 that the call is being forwarded, by sending a 181 Call Is Being Forwarded response.
- 8) The service logic forwards the INVITE request back to S-CSCF modifies the destination address by inserting the identity of the UE3. The Application Server is in SIP proxy mode.
- 9) The S-CSCF of UE2 forwards the modified INVITE request it received from the Application Server to the I-CSCF of UE3.
- 10) The I-CSCF of the UE3 queries the HSS to obtain the S-CSCF of the UE3.
- 11) The HSS returns UE3's S-CSCF location.
- (12a and 12b) The I-CSCF forwards the SIP INVITE request the UE3 via its S-CSCF.
- (13a, 13b, 13c, 13d, 13e, 13f, 13g, 13h and 13g) The UE3 accepts the incoming call and sends an 183 Session Progress back to UE1.
- 14) Bearer establishment & call setup between from the UE1 to the UE3 is performed following the procedure described in the basic call flow clauses for originating, inter-network and terminating segments.

B.2 Announcement, conferencing and transcoding examples using MRFC

B.2.1 Example information flow for a mobile originated IP multimedia session that results in playing an announcement

The following diagram shows an example of playing an announcement for a mobile originated IP multimedia session. An AS (acting as B2BUA) performs third party call control with the MRFC, where the S-CSCF is in the signalling path.

The "[x]" notation in the diagram is an indicator of a unique SIP dialog. The "dot" notation on the AS line indicates B2BUA actions are taking place along with AS service logic. The 100 Trying responses are not shown in the diagram, but it is assumed that 100 Trying is sent in response to each INVITE request.

The B2BUA AS interacts with the UE as usual to establish the dialog. The B2BUA AS interacts with the MRFC using a third party control model to establish the dialog. The B2BUA AS manages the interactions between the two dialogs.

The offer/answer model as defined in IETF RFC 3264 [15] is used for SDP negotiation between the AS/S-CSCF and the MRFC. The MRFC should always grant the requests from the AS (unless there is a resource problem). The MRFC responds to the INVITE request with a 200 response indicating the selected codec in the SDP. The MRFC will also reserve the requested local resources at that time. The selected codec is included by the B2BUA AS in the 183 response to the UE. The receipt of the ACK at the MRFC triggers the playing of the tone or announcement.

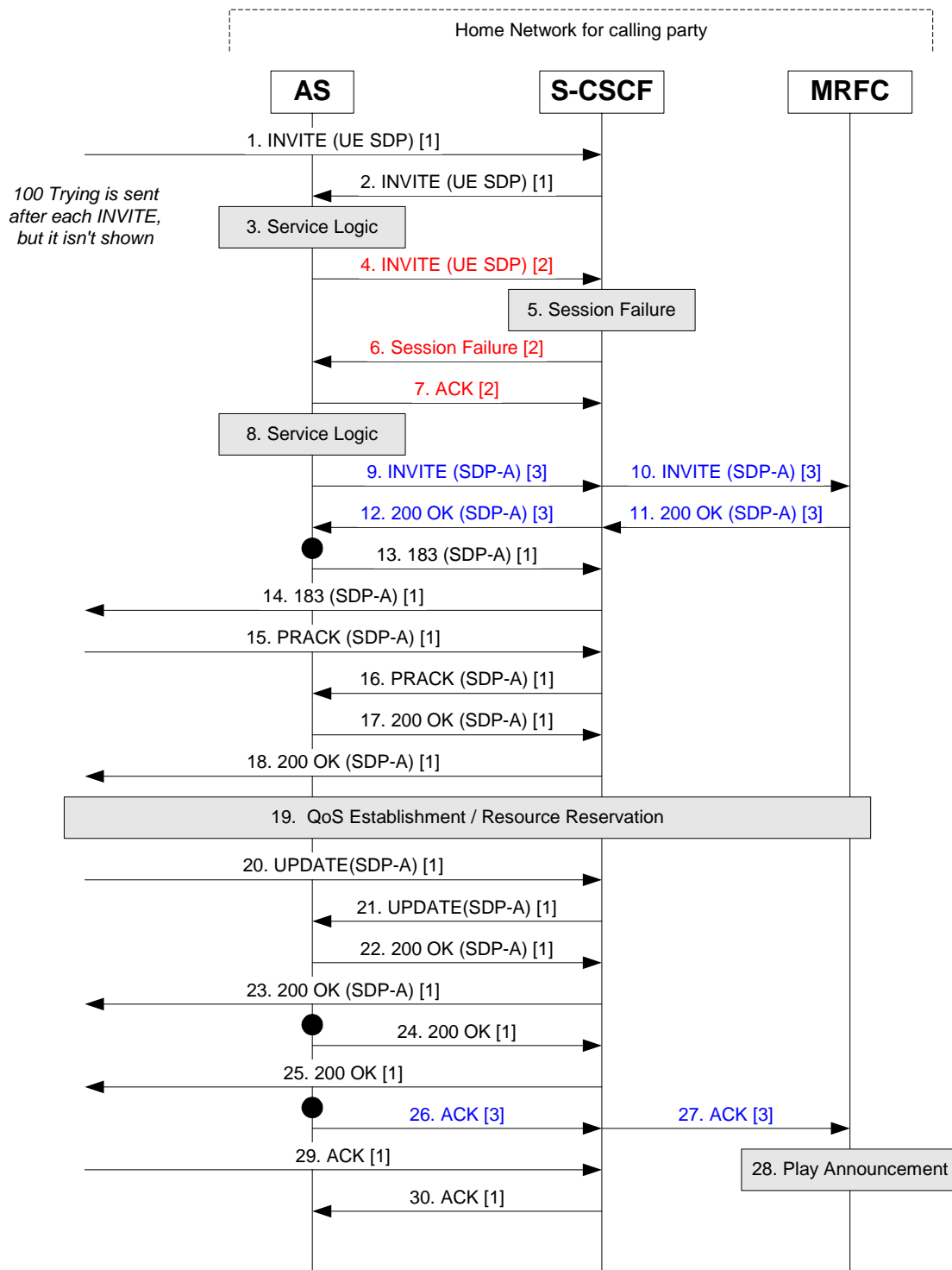

Figure B.2.1.1: Tones and announcements call flow

Notes for figure B.2.1.1:

- 1) INVITE request is received at the S-CSCF [Call-ID 1].
- 2) INVITE request is forwarded to an AS, based on the filter criteria.
- 3) The AS service logic determines to proceed with the call.
- 4) New INVITE request is sent towards destination, via the S-CSCF, to establish a new dialog [Call-ID 2].
- 5) S-CSCF experiences a failure, such as not being able to determine the next hop for the SIP URL.

- 6) Session failure returned to the AS.
- 7) ACK returned to complete this dialog [Call-ID 2].
- 8) The AS service logic determines to play an announcement to the calling party.
- 9) New INVITE request is sent to the MRFC, via the S-CSCF, to establish a new dialog for playing an announcement [Call-ID 3]. Sufficient information is included to specify the details for the announcement.
- 10) S-CSCF relays INVITE to the MRFC.
- 11) The MRFC allocates the requested resource and returns 200 OK, with SDP-A indicating selected media.
- 12) S-CSCF relays 200 OK to the AS.
- 13 - 30) The B2BUA AS manages the dialog for Call-ID 1 as normal, with the SDP-A supplied from the MRFC. The MRFC is instructed to play the announcement using the ACK request at flow 26 for Call-ID 3.

B.2.2 Example information flow for a mobile originated IP multimedia ad hoc conferencing session (multiparty call)

The following diagram shows an example of an ad hoc conference (multiparty call). An AS (acting as B2BUA) performs third party call control with the MRFC, where the S-CSCF is in the signalling path.

The "[x]" notation in the diagram is an indicator of a unique SIP dialog. The "dot" notation on the AS line indicates B2BUA actions are taking place along with AS service logic. The 100 Trying responses are not shown in the diagram, but it is assumed that 100 Trying is sent in response to each INVITE request.

The Application Server is in control of the ad hoc conference, is aware of the MRFC capabilities and is also operating as a B2BUA performing third party call control.

An INVITE request is generated from UE-1 indicating a desire to start a multiparty call (ad hoc conference) by taking the existing sessions, between UE-1 to UE-2 and UE-1 to UE-3, and bringing them together. The AS uses third party call control to request the conference facilities from the MRFC. A separate dialog is established from the AS to the MRFC for each of the three parties (UE-1, UE-2, UE-3). New dialogs are also established between the AS and each of the UE endpoints. The media from each UE is connected at the conferencing resource at the MRFP. The first INVITE request to the MRFC should receive a response that includes the conference identifier. The same conference identifier will be used for subsequent INVITE requests to add or drop parties to the conference.

The offer/answer model as defined in IETF RFC 3264 [15] is used for SDP negotiation between the AS/S-CSCF and the MRFC. The MRFC should always grant the requests from the AS (unless there is a resource problem). The MRFC responds to the INVITE request with a 200 response indicating the selected media in the SDP. The MRFC will also reserve the requested local resources at that time and return the appropriate resource identifiers in the 200 response.

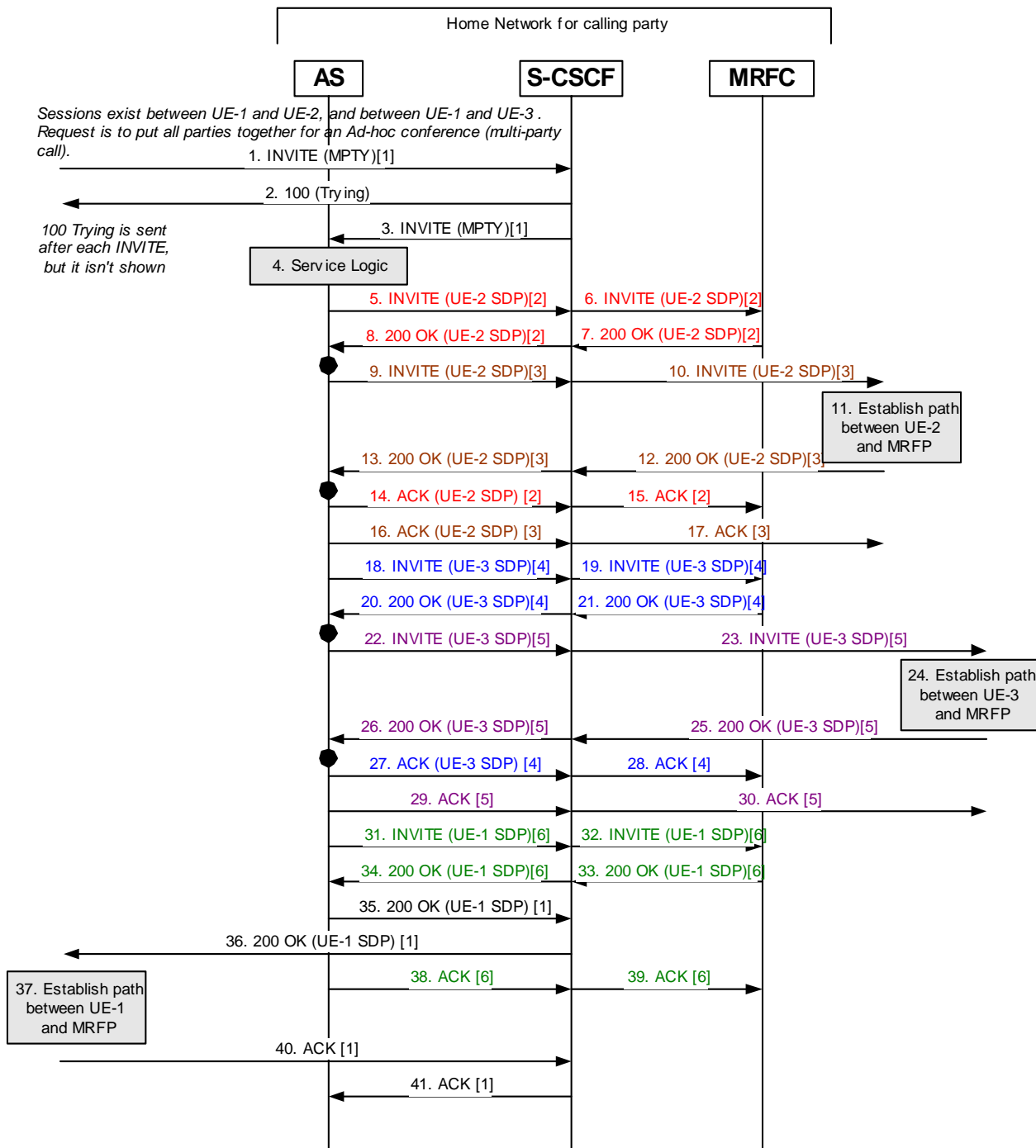

Figure B.2.2.1: Ad hoc conference call flow

Notes for figure B.2.2.1:

- 1) INVITE request received at S-CSCF from UE-1 indicating desire to start ad hoc conference (multiparty call) for the existing sessions between UE-1 to UE-2 and UE-1 to UE-3.
- 2) 100 Trying returned.
- 3) INVITE forwarded to AS.
- 4) AS performs service logic and allows attempt to start ad hoc conference.
- 5 - 8) New INVITE request sent to MRFC to initiate multiparty call, get conference identifier and prepare dialog for UE-2 [Call-ID 2].
- 9 - 13) Re-INVITE sent to UE-2 to establish dialog between AS and UE-2 [Call-ID 3].

- 14 - 17) ACK sent for Call-ID 2 and Call-ID 3.
- 18 - 21) New INVITE request sent to MRFC using the same conference identifier and prepare dialog for UE-3 [Call-ID 4].
- 22 - 26) Re-INVITE sent to UE-3 to establish dialog between AS and UE-3 [Call-ID 5].
- 27 - 30) ACK sent for Call-ID 4 and Call-ID 5.
- 31 - 34) New INVITE request sent to MRFC using the same conference identifier and prepare dialog for UE-1 [Call-ID 6].
- 35 - 36) 200 OK returned to UE-1 with SDP.
- 37) The session is established.
- 38 - 41) ACK sent for Call-ID 1 and Call-ID 6.

B.2.3 Example information flows for a mobile originated IP multimedia session that requires transcoding

The two figures B.2.3.1 and B.2.3.2 that follow illustrate the MRFC providing transcoding for a mobile originated session, where the MRFC is receiving directions from the AS operating as a B2BUA.

The "[x]" notation in the diagram is an indicator of a unique SIP dialog. The "dot" notation on the AS line indicates B2BUA actions are taking place along with AS service logic. The 100 Trying responses are not shown in the diagram, but it is assumed that 100 Trying is sent in response to each INVITE request.

The B2BUA AS interacts with the originating UE as usual to establish the dialog. The B2BUA AS interacts with the MRFC using a third party control model to establish the dialog with the called party after receiving the initial failure indication. The B2BUA AS manages the interactions between the two dialogs.

An INVITE request is generated from a UE. A 606 "Not Acceptable" response is received from the called party. The AS uses third party call control to request transcoding facilities from the MRFC. A separate dialog is established from the AS to the MRFC for each of the two parties. New dialogs are also established between the AS and each of the UE endpoints. The media from each UE is connected at the transcoding resource at the MRFP.

In the first figure B.2.3.1 below, the called party returns an indication of an acceptable codec. For this case, the request to the MRFC will include the appropriate codec for the called party and the offer/answer model as defined in IETF RFC 3264 [15] with the MRFC is used. In figure B.2.3.2 below, the called party does not indicate any SDP, which means that more steps will be required on the subsequent INVITE request to set up transcoding with the MRFC. An INVITE without SDP is sent to the MRFC to get the list of codecs it supports. The AS then sends that list of codecs in the new INVITE that it sends to the called party. The B2BUA function of the AS matches up the responses.

The offer/answer model is used for SDP negotiation between the AS/S-CSCF and the MRFC. The MRFC should always grant the requests from the AS (unless there is a resource problem). The MRFC responds to the INVITE request with a 200 response indicating the selected codec in the SDP. The MRFC will also reserve the requested local resources at that time. The selected codec is included by the B2BUA AS in the 183 response to the UE. The receipt of the ACK at the MRFC triggers the playing of the tone or announcement.

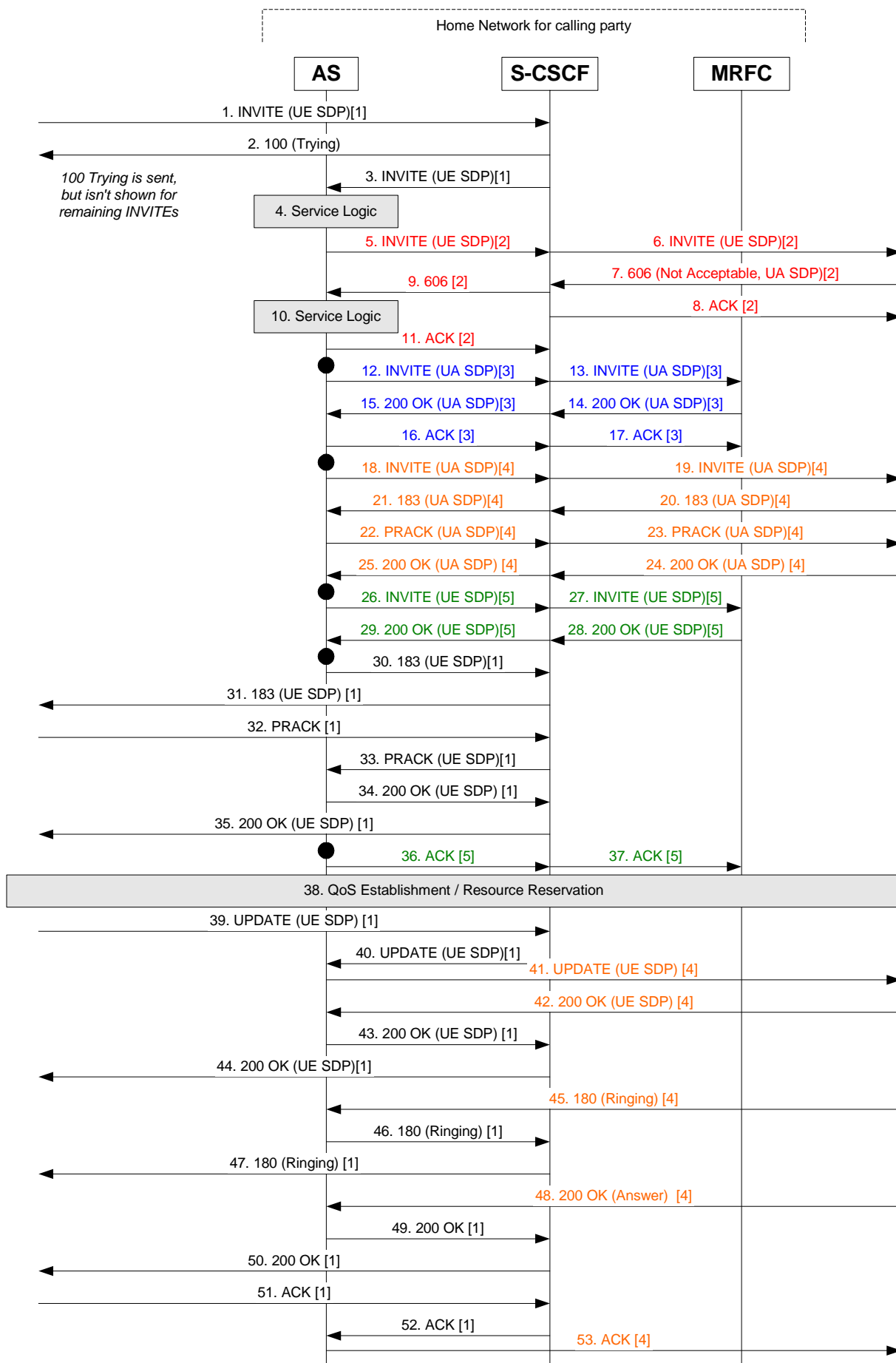

Figure B.2.3.1: Transcoding call flow (called party indicates codec)

Notes for figure B.2.3.1:

- 1) INVITE request received at S-CSCF from UE [Call-ID 1].
- 2) 100 Trying returned.
- 3) INVITE forwarded to an AS, based on filter criteria.
- 4) AS service logic determines to proceed with the call.
- 5) New INVITE request is sent towards destination, via the S-CSCF, to establish a new dialog [Call-ID 2].
- 6) S-CSCF forwards the INVITE.
- 7) Called UA returns 606 Not Acceptable in response to the INVITE request. Included in the response is an indicator that the offered codec is not acceptable plus information on what codec would be acceptable.
- 8) An ACK is sent to the called UA to complete the dialog for Call-ID 2.
- 9) 606 response is forwarded to the AS.
- 10) AS service logic determines that there is an MRFC that can perform the transcoding.
- 11) ACK sent to S-CSCF to complete the dialog for Call-ID 2.
- 12 - 17) New INVITE request sent to MRFC to establish transcoding for called UA [Call-ID 3].
- 18 - 25) New INVITE request sent to called UA to establish session between UA and MRF [Call-ID 4].
- 26 - 29) New INVITE request sent to MRFC to establish transcoding for calling UE [Call-ID 5].
- 30 - 53) Normal call establishment procedures from here on, with B2BUA AS performing the appropriate signalling translations between the associated dialogs.

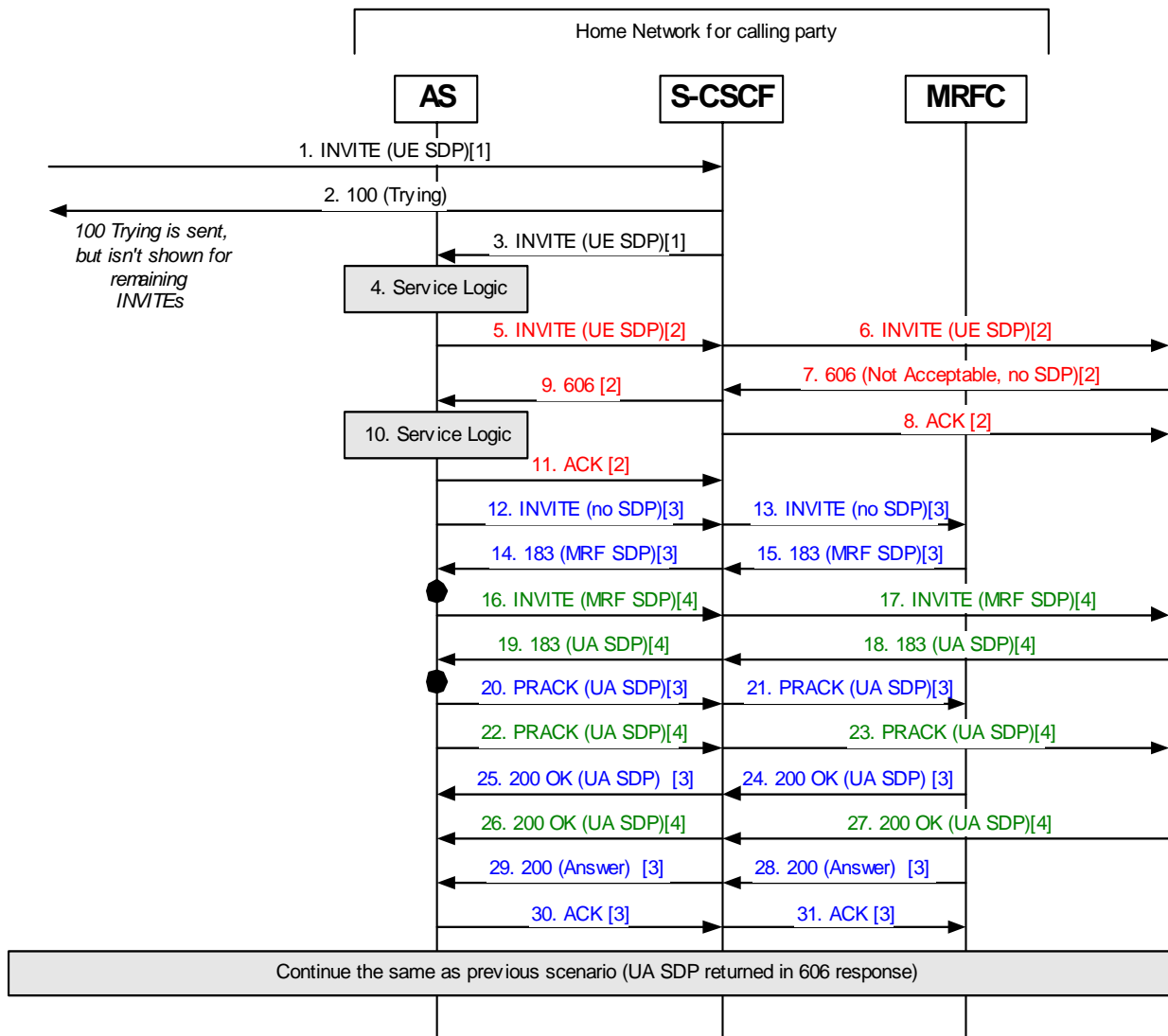

Figure B.2.3.2: Transcoding call flow (called party codec negotiated)

Notes for figure B.2.3.2:

- 1) INVITE request received at S-CSCF from UE [Call-ID 1].
- 2) 100 Trying returned.
- 3) INVITE forwarded to an AS, based on filter criteria.
- 4) AS service logic determines to proceed with the call.
- 5) New INVITE request is sent towards destination, via the S-CSCF, to establish a new dialog [Call-ID 2].
- 6) S-CSCF forwards the INVITE.
- 7) Called UA returns 606 Not Acceptable in response to the INVITE request. Included in the response is an indicator that the offered codec is not acceptable but there is no information on what codec would be acceptable (no SDP).
- 8) ACK sent to called UA to complete the dialog for Call-ID 2.
- 9) 606 response is forwarded to the AS.
- 10) AS service logic determines that there is an MRFC that can perform the transcoding.
- 11) ACK sent to S-CSCF to complete the dialog for Call-ID 2.

- 12 - 15) New INVITE request sent to MRFC to establish transcoding for called UA and to get the list codecs supported by the MRF [Call-ID 3].
- 16 - 19) New INVITE request sent to called UA with SDP for all codecs supported by the MRF to establish session between UA and MRF [Call-ID 4]. UA returns SDP with acceptable codecs.
- 20 - 23) A new offer with the codecs provided by the UA is sent in PRACK and the 200 OK response indicates the selected codec.
- 24 - 31) Acknowledgements sent to complete Call-ID 3.

Call establishment procedures from here on are common with the previous transcoding call flow.

B.3 Example information flows for a voicemail service

B.3.1 User out of coverage message recording

Figure B.3.1.1 shows a possible scenario of an Application Server, which acting as a terminating UA performs the function of a Voicemail Server in order to terminate a call and record a message on behalf of a UE that is out of coverage or powered off.

A S-CSCF is forwarded the initial INVITE destined for a UE that is not currently IMS registered. The Default Filter Criteria in the S-CSCF indicates that for the case of an unregistered user the INVITE should be forwarded to the Voicemail and Announcement Server.

Upon receiving the INVITE request the Voicemail and Announcement Server determines that the destination UE has subscribed to the Voicemail Service (possibly by downloading some subscriber profile information via the Sh interface). The Voicemail and Announcement Server therefore in addition to playing an announcement to inform the caller that the called party is either powered off or out of coverage also informs the caller that he may leave a message for the called party.

The calling party leaves a message for the called party and then hangs up the call by sending a BYE.

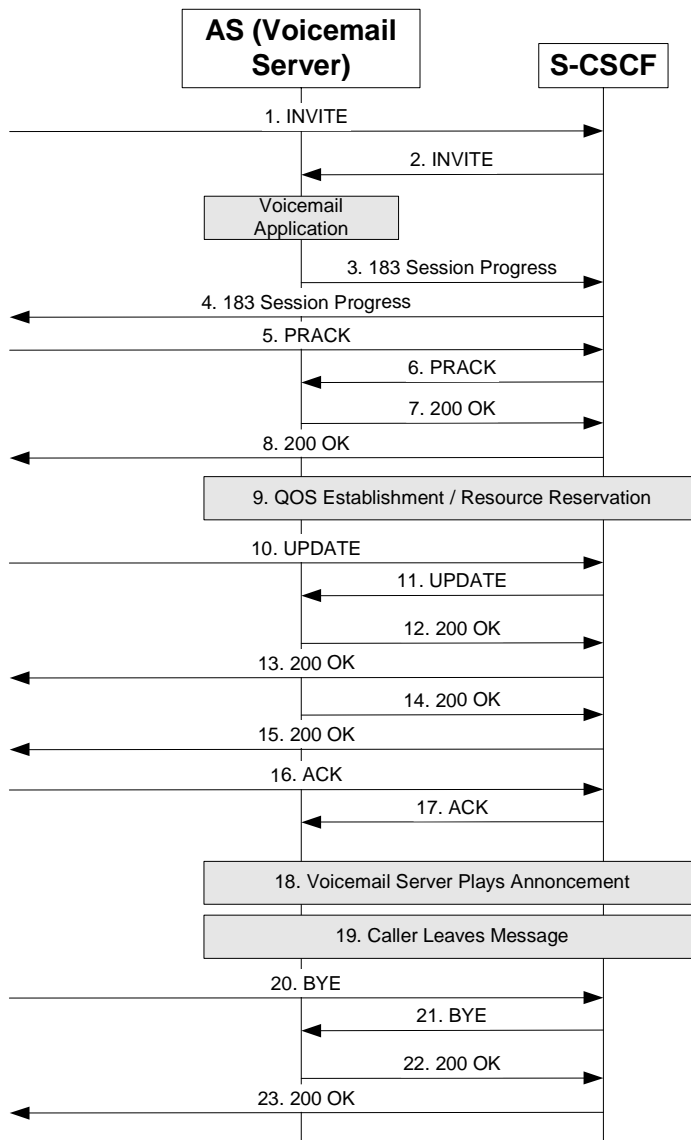

Figure B.3.1.1: Voicemail server records messages

Notes for figure B.3.1.1:

NOTE: For simplicity the 100 Trying response returned or received by the S-CSCF in response to requests is omitted from figure B.3.1.1.

- 1) INVITE request destined for an unregistered user is received at the S-CSCF.
- 2) Based on trigger point of the initial Filter Criteria S-CSCF proxies the INVITE request to the AS (Voicemail Server).
- 3 - 4) The AS starts the voicemail application and responds with a 183 Session Progress containing SDP which is proxied back to the caller by the S-CSCF.
- 5 - 8) The caller responds with a PRACK containing SDP, which the S-CSCF proxies to the AS and the AS responds with a 200 OK containing SDP which the S-CSCF proxies back to the caller.
- 9) QOS establishment and resource reservation takes place.
- 10 - 13) After completing resource reservation the caller sends a UPDATE containing SDP which is proxied by the S-CSCF to the AS which responds with a 200 OK containing SDP which is proxied back to the caller by the S-CSCF.

- 14 - 15) The AS then sends a 200 OK to the initial INVITE which the S-CSCF proxies to the caller.
- 16 - 17) The caller returns an ACK to the 200 OK.
- 18) The AS plays an announcement using the session established indicating that the caller is powered off but that the caller may leave a message.
- 19) The caller leaves a message using the session established.
- 20 - 21) The caller hangs up by sending a BYE which the S-CSCF proxies to the AS.
- 22 - 23) The AS responds with a 200 OK, which the S-CSCF proxies back to the caller.

B.3.2 User IMS registers voice mail service plays back messages

Figure B.3.2.1 shows the scenario when the UE that has subscribed to a voicemail service with a feature enabled that contacts the user upon registration informing him of any recorded messages.

The Filter Criteria downloaded by the S-CSCF indicates that a third party REGISTER request should be sent to the Voicemail Server. Upon receiving the third party registration of the UE, the Voicemail Server acting as an originating UA contacts the UE by sending an INVITE request to inform him that he has voicemail messages recorded while he was not registered.

The user listens to the messages played back by the voicemail server, (only streaming class QOS is required for this session) and then terminates the session with a BYE.

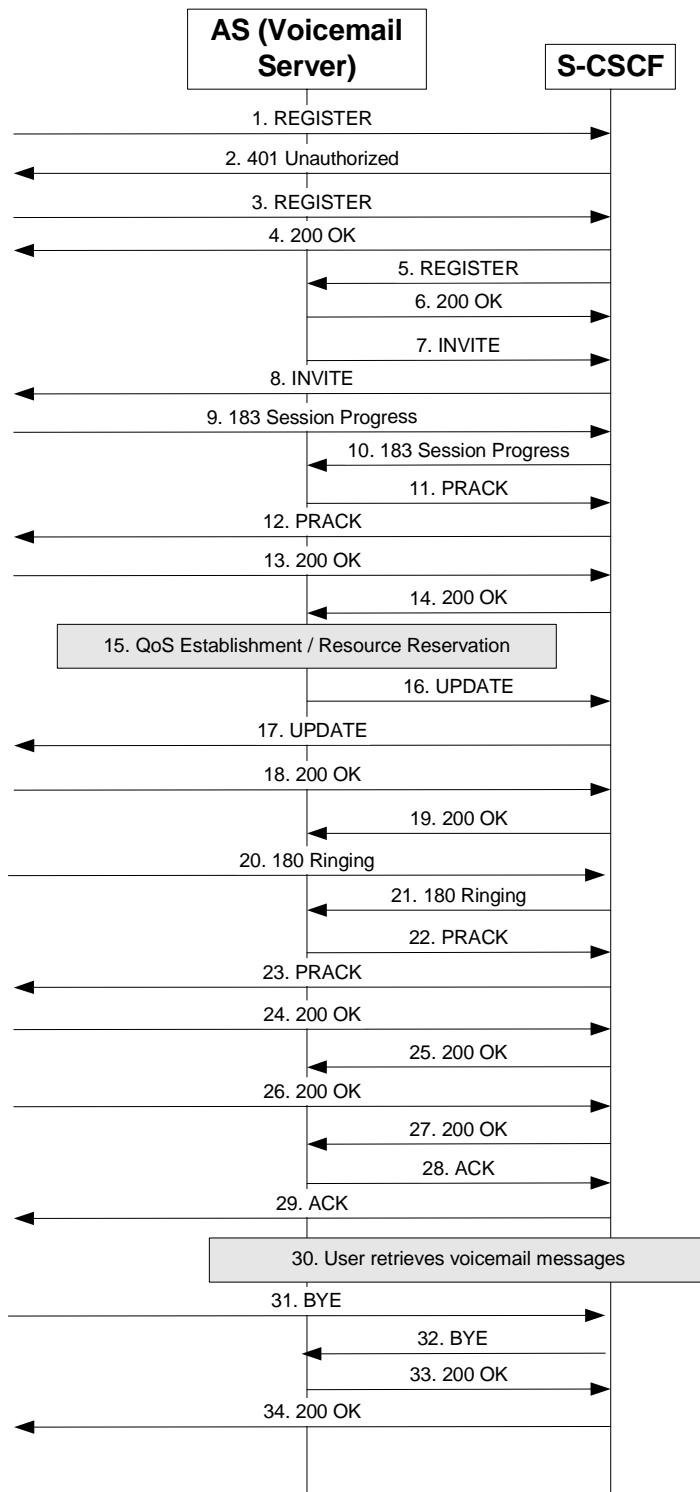

Figure B.3.2.1: Upon registration voicemail server replays messages

Notes for figure B.3.2.1:

NOTE: For simplicity the 100 Trying response returned or received by the S-CSCF in response to requests is omitted from figure B.3.2.1.

- 1 - 4) The UE sends a REGISTER request to the S-CSCF which authenticates with a 401 Unauthorized response challenge with the authentication response being supplied in a second REGISTER request. The registration completes with a 200 OK from the S-CSCF to the UE.
- 5 - 6) The S-CSCF downloads Filter Criteria for the UE from the HSS which indicates the S-CSCF should send a third party REGISTER request on behalf of the UE to an AS that performs a voicemail service. The AS responds to the REGISTER request with a 200 OK.
- 7 - 8) The AS downloads subscriber data for the subscriber (possibly from the HSS via the Sh interface) that indicates that the subscriber has enabled a feature that has the voicemail application contact the subscriber upon registration to deliver recorded messages. The AS sends an INVITE request containing SDP for the UE to the S-CSCF which proxies it to the UE.
- 9 - 10) The UE responds with 183 Session Progress containing SDP which the S-CSCF proxies to the AS.
- 11 - 14) The AS sends a PRACK, which the S-CSCF proxies to the UE and the UE respond with a 200 OK which the S-CSCF proxies to the AS.
- 15) QOS establishment and resource reservation takes place.
- 16 - 19) The AS sends an UPDATE, which the S-CSCF proxies to the UE and the UE responds with a 200 OK which the S-CSCF proxies to the AS.
- 20 - 21) The UE sends a 180 Ringing indicating that it is alerting the user which the S-CSCF proxies to the AS.
- 22 - 25) The AS to indicate receipt of the 180 response sends a PRACK which the S-CSCF proxies to the UE and the UE responds with a 200 OK which the S-CSCF proxies to the AS.
- 26 - 27) When the subscriber answers the UE sends a 200 OK to the initial INVITE which the S-CSCF proxies to the AS.
- 28 - 29) The AS acknowledges the 200 OK with an ACK which the S-CSCF proxies to the UE.
- 30) The AS plays an announcement indicating the number of messages stored and then plays back the messages to the UE using the session established.
- 31 - 32) The UE hangs up by sending a BYE, which the S-CSCF proxies to the AS.
- 33 - 34) The AS responds with a 200 OK, which the S-CSCF proxies back to the UE.

Annex C (informative): Example for Initial filter criteria triggering

This example applies both for call originating and terminating procedure. But we assume this is a call originating procedure. User has registered with the network. Its filter criteria and addresses of the assigned application servers have been downloaded to its S-CSCF during registration via Cx interface. Also, the application server specific data may have been downloaded via the Sh interface to the application server during registration.

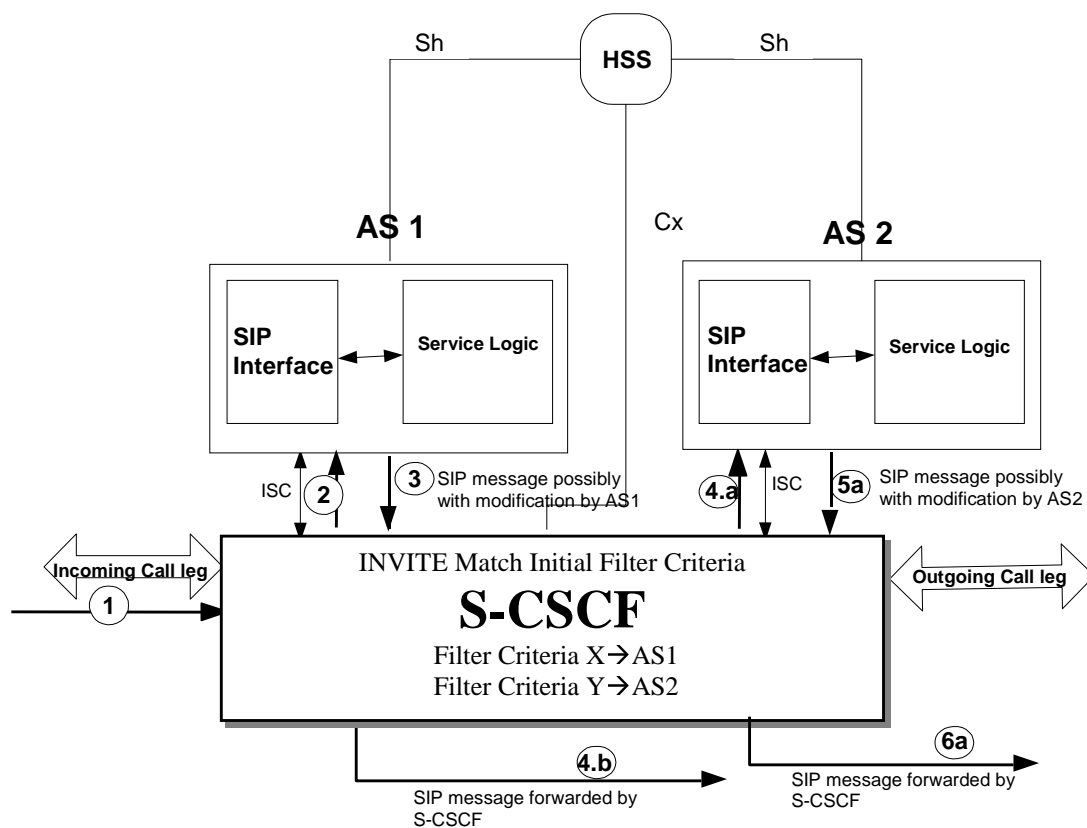

Figure C.1: Initial Filter Criteria Triggering Example

There is a flow example in figure C.1:

In this example, two application servers are assigned to provide additional services to a subscriber and they are shown as AS1 and AS2 in this example.

1. User initiates a SIP session by sending a SIP initial request to its S-CSCF.
2. On receiving this request, the S-CSCF evaluates the SPTs and checks if they match the initial filter criteria X for AS1. If they match, the S-CSCF forwards this request to AS1.
3. The AS1 performs any needed service logic based on the Service Key and sends the SIP request possibly with service related modification back to the S-CSCF.
- 4.a On receiving the request from the AS, the S-CSCF evaluates the SPTs and checks if they match the initial filter criteria Y for AS2. If they match the S-CSCF forwards the request to the associated Application Server AS2.
- 4.b If the request doesn't match any further filter criteria, the S-CSCF forwards this request to the next hop based on the route decision.
- 5.a The AS2 performs any needed service logic based on the Service Key and sends the SIP request possibly with service related modification back to the S-CSCF.

6.a The S-CSCF checks the request sent by AS2 and finds that no initial criteria is matched, then the S-CSCF forwards this request to next hop based on the route decision.

Annex D (informative): Change history

Change history								
Date	TSG #	TSG Doc.	CR	Rev	Subject/Comment	Old	New	WG doc
Nov 2000		N1-001300			First draft created. Presented to CN1meeting #14.			
21/11/00		N1-001352			V 0.1.0 created based on discussion in CN1#14. Additional clause on OSA API added.			
22/11/00		N1-001386			V 0.2.0 created based on discussion in CN1#14. The clause on scope modified.			
28/11/00		N1-001448			V 0.3.0 created based on discussion in CN1/SA2 joint meeting. The title modified.			
Jan 2001		N1-010069 NJ-010102			V0.3.1 created. Specification number TS 23.218 allocated to TS 23.cde.			
16/1/01		NJ-010106			V0.4.0 created. Clause 8 on OSA API updated to include the proposal in NJ-010104 agreed at joint CN1/2/4 meeting on 23.218.			
March 2001		N1-010762			V0.5.0 created. Clause 6.5 updated to include the proposal in NJ-010117 agreed at the joint CN1/2/3/4 Feb meeting in Sophia. Reference to Visited Network updated.			
June 2001		N1-010981			V0.5.1 created. Informative Annex B created containing N1-010749 agreed at Joint CN1/2/3/4 meeting in Puerto Rico.			
August 2001		N1-011090			V0.5.2 created. Section 5 updated to include the proposals in N1-010982, N1-011013 and N1-011043; Section 6 updated to include the proposals in N1-011044 and N1-011045, agreed at CN1#18 and joint CN1/2/3/4 meetings in Dresden.			
September 2001		N1-011365			V0.6.0 created. Document layout reorganized and content updated to conform to proposal in N1-011277; Section 6 and Section 9 updated to include the proposals in N1-011342, agreed at CN1#19 meeting in Helsinki.			
October 2001		N1-011522			V.0.7.0 created. Appendix B.1 added based on N1-011423 agreed at CN1#19bis meeting in Sophia Antipolis			
October 2001		N1-011707			V.0.8.0 created using Tdocs: N1-011596, N1-011597, N1-011599, N1-011600	0.7.0	0.8.0	
Nov 2001		N1-011867			V.0.9.0 created using Tdocs: N1-011751, N1-011778	0.8.0	0.9.0	
Dec 2001		NP-010640 N1-020033			V.1.0.0 created using Tdocs: N1-011999, N1-012051 agreed at CN#21 in Cancun. To be presented for information at CN#14	0.9.0	1.0.0	
Jan 2002		N1-020343			V.1.1.0 created using Tdocs: N1-020035, N1-020036, N1-020069, N1-020071, N1-020072, N1-020107, N1-020109, N1-020110, N1-020114, N1-020115, N1-020116, N1-020119, N1-020137, N1-020153, N1-020156, N1-020164 agreed at CN1 SIP Adhoc 0102 in Phoenix.	1.0.0	1.1.0	
February 2002		N1-020552			V.1.2.0 created using Tdocs: N1-020231, N1-020385, N1-020387, N1-020392, N1-020393, N1-020448, N1-020450, N1-020451, N1-020452, N1-020453 agreed at CN1#22 in Sophia Antipolis, and corrected implementation error of N1-020156.	1.1.0	1.2.0	
February 2002					V.2.0.0 created using Tdocs: N1-020607, N1-020620, N1-020633, N1-020634, N1-020637, N1-020653, N1-020661, N1-020662, N1-020667 agreed at CN1#22 bis in Oulu.	1.2.0	2.0.0	

March 2002					Editorial clean-up by ETSI/MCC.	2.0.0	2.0.1	
11. March 2002	TSG CN#15	NP-020047			The draft was approved and decided to be "frozen", and 3GPP TS 23.218 was then to be issued in Rel-5 with the needed new RFC numbers allocated in NP-020134 incorporated.	2.0.1	5.0.0	
June 2002	NP-16	NP-020226	002	3	HSS providing to the S-CSCF the subset of the relevant end user profile	5.0.0	5.1.0	N1-020972
June 2002	NP-16	NP-020226	003	10	Clarification on SPI related text	5.0.0	5.1.0	N1-021405
June 2002	NP-16	NP-020226	004	4	Passing charging correlation information	5.0.0	5.1.0	N1-021423
June 2002	NP-16	NP-020226	006	1	Correction of terminology in 23.218 regarding Offer-counter offer answer	5.0.0	5.1.0	N1-020951
June 2002	NP-16	NP-020226	012	5	Update of the S-CSCF AS relationship, for REGISTER	5.0.0	5.1.0	N1-021425
June 2002	NP-16	NP-020226	014	1	User profile filter criteria updates	5.0.0	5.1.0	N1-021384
June 2002	NP-16	NP-020226	015	1	Add references for Sh and Si interfaces	5.0.0	5.1.0	N1-021385
June 2002	NP-16	NP-020226	016	1	SIP Application Server acting as a Gatewas to an external Application Server; and OSA API usage.	5.0.0	5.1.0	N1-021404
June 2002	NP-16	NP-020226	017	1	Clarification to Handling of IP multimedia registration for barred public user identities	5.0.0	5.1.0	N1-021424
June 2002	NP-16	NP-020226	019		Correction of COMET to UPDATE in 23.218	5.0.0	5.1.0	N1-021252
Sept. 2002	NP-17	NP-020373	021	1	Service profiles and implicitly registered public user identities	5.1.0	5.2.0	N1-021828
Sept. 2002	NP-17	NP-020373	022	2	Clarification on specialized charging server	5.1.0	5.2.0	N1-021859
Sept. 2002	NP-17	NP-020373	025	1	Clarification on location information for IMS	5.1.0	5.2.0	N1-021829
Sept. 2002	NP-17	NP-020373	026	1	Proposed change of term SPI to SPT	5.1.0	5.2.0	N1-021830
Sept. 2002	NP-17	NP-020373	027	1	Support of originating requests from Application Servers	5.1.0	5.2.0	N1-021831
Dec. 2002	NP-18	NP-020552	029	1	Clarification on CCF/ECF addresses	5.2.0	5.3.0	N1-022142
Dec. 2002	NP-18	NP-020553	030	3	Clarification on MRFP reference point	5.2.0	5.3.0	N1-022468
Dec. 2002	NP-18	NP-020552	031	1	Support of originating requests from Application Servers	5.2.0	5.3.0	N1-022144
Dec. 2002	NP-18	NP-020552	033		Addition of Request-URI as SPT	5.2.0	5.3.0	N1-022297
Dec. 2002	NP-18	NP-020552	034	1	Clarifications on Annex C (Informative)	5.2.0	5.3.0	N1-022469
Dec. 2002	NP-18	NP-020552	038	1	Clarification to use of Service Information	5.2.0	5.3.0	N1-022475
March 2003	NP-19	NP-030045	040	2	Clarification on Sh interface for charging purposes	5.3.0	5.4.0	N1-030309
March 2003	NP-19	NP-030046	042		Correction related to implicit public user identities in third party REGISTER	5.3.0	5.4.0	N1-030197
June 2003	NP-20	NP-030272	043	5	Correction on Handling of MO request	5.4.0	5.5.0	N1-030943
June 2003	NP-20	NP-030272	044	1	Corrections regarding SPTs and Filter Criteria handling on REGISTER request	5.4.0	5.5.0	N1-030516
June 2003	NP-20	NP-030272	046	1	Clarifications on SPT.	5.4.0	5.5.0	N1-030517
June 2003	NP-20	NP-030272	048		Service Key Clarification	5.4.0	5.5.0	N1-030663
June 2003	NP-20	NP-030272	051	1	S-CSCF behavior correction to enable call forwarding	5.4.0	5.5.0	N1-030855
June 2003	NP-20	NP-030272	055	1	Filtering of unknown header fields and header parameters	5.4.0	5.5.0	N1-030924
Sept 2003	NP-21	NP-030411	057		Removal of Incorrect Information	5.5.0	5.6.0	N1-031070

Dec 2003	NP-22	NP-030475	053	3	Flow number corrections in Annex B	5.6.0	5.7.0	N1-031630
Dec 2003	NP-22	NP-030482	059		Corrections on charging specification number	5.7.0	6.0.0	N1-031468
March 2004	NP-23	NP-040032	064	1	Dh interface	6.0.0	6.1.0	N1-040158
March 2004	NP-23	NP-040032	066	2	Initiating Back to Back User Agent	6.0.0	6.1.0	N1-040472
Sep 2004	NP-25	NP-040384	69		IFC process termination at R-URI change	6.1.0	6.2.0	N1-041440
Sep 2004	NP-25	NP-040384	70	1	Third party registration optimization	6.1.0	6.2.0	N1-041562
March 2005	NP-27	NP-050069	76		Filter criteria matching and generation of third-party REGISTER request for network-initiated deregistration	6.2.0	6.3.0	N1-050223
March 2005	NP-27	NP-050073	072		Resolution of references to 24.228	6.2.0	6.3.0	N1-050061
March 2005	NP-27	NP-050073	074	1	Default handling	6.2.0	6.3.0	N1-050288
Dec 2005	CT-30	CP-050550	079		Mobile originated request unregistered	6.3.0	7.0.0	C1-051428

History

Document history		
V7.0.0	December 2005	Publication