

# ETSI TS 123 237 V11.9.0 (2013-09)



Technical Specification

**Digital cellular telecommunications system (Phase 2+);  
Universal Mobile Telecommunications System (UMTS);  
LTE;  
IP Multimedia Subsystem (IMS) Service Continuity;  
Stage 2  
(3GPP TS 23.237 version 11.9.0 Release 11)**



---

Reference

RTS/TSGS-0223237vb90

---

Keywords

GSM,LTE,UMTS

**ETSI**

650 Route des Lucioles  
F-06921 Sophia Antipolis Cedex - FRANCE

Tel.: +33 4 92 94 42 00 Fax: +33 4 93 65 47 16

Siret N° 348 623 562 00017 - NAF 742 C  
Association à but non lucratif enregistrée à la  
Sous-Préfecture de Grasse (06) N° 7803/88

---

**Important notice**

Individual copies of the present document can be downloaded from:

<http://www.etsi.org>

The present document may be made available in more than one electronic version or in print. In any case of existing or perceived difference in contents between such versions, the reference version is the Portable Document Format (PDF). In case of dispute, the reference shall be the printing on ETSI printers of the PDF version kept on a specific network drive within ETSI Secretariat.

Users of the present document should be aware that the document may be subject to revision or change of status. Information on the current status of this and other ETSI documents is available at

<http://portal.etsi.org/tb/status/status.asp>

If you find errors in the present document, please send your comment to one of the following services:

[http://portal.etsi.org/chaicor/ETSI\\_support.asp](http://portal.etsi.org/chaicor/ETSI_support.asp)

---

**Copyright Notification**

No part may be reproduced except as authorized by written permission.  
The copyright and the foregoing restriction extend to reproduction in all media.

© European Telecommunications Standards Institute 2013.  
All rights reserved.

DECT™, PLUGTESTS™, UMTS™ and the ETSI logo are Trade Marks of ETSI registered for the benefit of its Members.  
3GPP™ and LTE™ are Trade Marks of ETSI registered for the benefit of its Members and  
of the 3GPP Organizational Partners.  
GSM® and the GSM logo are Trade Marks registered and owned by the GSM Association.

---

## Intellectual Property Rights

IPRs essential or potentially essential to the present document may have been declared to ETSI. The information pertaining to these essential IPRs, if any, is publicly available for **ETSI members and non-members**, and can be found in ETSI SR 000 314: *"Intellectual Property Rights (IPRs); Essential, or potentially Essential, IPRs notified to ETSI in respect of ETSI standards"*, which is available from the ETSI Secretariat. Latest updates are available on the ETSI Web server (<http://ipr.etsi.org>).

Pursuant to the ETSI IPR Policy, no investigation, including IPR searches, has been carried out by ETSI. No guarantee can be given as to the existence of other IPRs not referenced in ETSI SR 000 314 (or the updates on the ETSI Web server) which are, or may be, or may become, essential to the present document.

---

## Foreword

This Technical Specification (TS) has been produced by ETSI 3rd Generation Partnership Project (3GPP).

The present document may refer to technical specifications or reports using their 3GPP identities, UMTS identities or GSM identities. These should be interpreted as being references to the corresponding ETSI deliverables.

The cross reference between GSM, UMTS, 3GPP and ETSI identities can be found under <http://webapp.etsi.org/key/queryform.asp>.

# Contents

Intellectual Property Rights .....	2
Foreword.....	2
Foreword.....	9
Introduction .....	9
1 Scope .....	10
2 References .....	10
3 Definitions, symbols and abbreviations .....	12
3.1 Definitions .....	12
3.2 Abbreviations .....	13
4 High level principles and architectural requirements .....	14
4.1 Basic Assumptions .....	14
4.1.0 General.....	14
4.1.1 PS-CS Access Transfer .....	14
4.1.2 PS-PS Access Transfer .....	15
4.1.3 Inter-UE Transfer.....	15
4.2 Architectural Requirements .....	15
4.2.1 General Requirements.....	15
4.2.2 Access Transfer Requirements .....	16
4.2.3 IUT Requirements .....	16
4.3 Service Continuity .....	18
4.3.1 Session Transfer concepts.....	18
4.3.1.1 General .....	18
4.3.1.2 Access Transfer concepts.....	18
4.3.1.2.1 General Access Transfer concepts.....	18
4.3.1.2.2 Access Transfer (PS – CS) concepts .....	18
4.3.1.2.2A MSC Server assisted mid-call feature.....	19
4.3.1.2.3 Co-existence of ICS UE and MSC Server assisted mid-call feature .....	19
4.3.1.3 Inter-UE Transfer concepts .....	20
4.3.1.3.1 General .....	20
4.3.1.3.2 Controller UE and Controllee UE operations .....	21
4.3.1.3.2.1 Overview .....	21
4.3.2 Void .....	21
4.3.3 Information used for IMS Service Continuity .....	21
5 Architecture model and reference points.....	22
5.1 Overview .....	22
5.2 Reference Architecture for non emergency session .....	22
5.2.1 General.....	22
5.2.2 Architecture when using ATCF enhancements.....	22
5.3 Functional Entities.....	23
5.3.1 SCC AS.....	23
5.3.2 IMS Service Continuity UE.....	25
5.3.2.1 Access Transfer Functions .....	25
5.3.2.2 IUT Functions and Roles .....	25
5.3.2.2.1 Functions .....	25
5.3.2.2.2 Controller UE Role.....	25
5.3.2.2.3 Controllee UE Role .....	26
5.3.3 Emergency Access Transfer Function (EATF).....	26
5.3.4 Access Transfer Control Function (ATCF) .....	26
5.3.4.1 General .....	26
5.3.4.2 ATCF inclusion.....	27
5.3.5 Access Transfer Gateway (ATGW).....	28
5.3.6 HSS .....	28

5.3.7	MSC Server .....	28
5.4	Signalling and bearer paths for IMS Service Continuity .....	28
5.4.1	General.....	28
5.4.2	Sessions with PS media flow(s).....	28
5.4.2a	Sessions with PS media flow(s) using ATCF .....	29
5.4.3	Sessions with CS media.....	29
5.4.3a	Sessions with CS media flow(s) using ATCF.....	29
5.5	IUT Collaborative Sessions.....	30
5.6	Reference Architecture for SRVCC emergency session .....	31
6	Procedures and flows for Access Transfer .....	31
6.0	Introduction .....	31
6.1	Registration .....	31
6.1.1	General.....	31
6.1.2	Registration using ATCF enhancements.....	31
6.1.3	Registration: CS to PS - Single Radio .....	33
6.1.3.1	IMS Registration by UE.....	33
6.1.3.2	UE IMS Registration change update .....	33
6.2	Origination and Termination .....	34
6.2.1	Origination.....	34
6.2.1.1	Origination Procedures.....	34
6.2.1.2	Originating sessions that use CS media .....	34
6.2.1.3	Originating sessions that use only PS media flow(s) .....	35
6.2.1.4	Originating sessions for (v)SRVCC that use ATCF enhancements .....	36
6.2.1.5	Originating sessions for CS to PS - Single Radio .....	36
6.2.2	Termination.....	37
6.2.2.1	Termination Procedures .....	37
6.2.2.2	Terminating sessions that use CS media .....	37
6.2.2.3	Terminating sessions that use only PS media flow(s).....	38
6.2.2.4	Terminating sessions over Gm where speech media is not accepted by the UE .....	39
6.2.2.5	Terminating sessions for (v)SRVCC that use ATCF enhancements.....	39
6.2.2.6	Terminating sessions for CS to PS - Single Radio .....	40
6.3	Access Transfer .....	41
6.3.1	Access Transfer Procedure .....	41
6.3.1.1	Introduction.....	41
6.3.1.2	Access Transfer Procedures .....	41
6.3.1.2a	Access Transfer Procedures using ATCF enhancements .....	42
6.3.1.3	Enablement of Access Transfer procedures .....	42
6.3.1.3a	Enablement of Access Transfer procedures using ATCF enhancements .....	43
6.3.1.4	Execution of Access Transfer procedures .....	43
6.3.1.4a	Execution of Access Transfer procedures using ATCF enhancements.....	43
6.3.1.5	Remote Leg Update.....	43
6.3.1.6	Source Access Leg Release.....	44
6.3.1.7	Access Transfer Information for ATCF.....	44
6.3.2	Access Transfer Information flows.....	45
6.3.2.0	General.....	45
6.3.2.1	PS – CS Access Transfer.....	45
6.3.2.1.1	PS – CS Access Transfer: PS to CS - Dual Radio .....	45
6.3.2.1.1a	PS – CS Access Transfer: PS to CS – Dual Radio with Session State Information .....	46
6.3.2.1.2	PS – CS Access Transfer: CS to PS - Dual Radio .....	47
6.3.2.1.2a	PS – CS Access Transfer: CS to PS – Dual Radio with Session State Information .....	48
6.3.2.1.3	Subsequent Access Transfers .....	49
6.3.2.1.4	PS – CS Access Transfer: PS to CS – Single Radio .....	49
6.3.2.1.4a	PS – CS Access Transfer: PS to CS – Single Radio with Session State Information.....	51
6.3.2.1.4b	PS to CS Access Transfer: PS to CS – Single Radio; using I1 reference point.....	53
6.3.2.1.4c	PS - CS Access Transfer: PS to CS - Single Radio, incoming voice or video call in alerting phase.....	54
6.3.2.1.4d	PS - CS Access Transfer: PS to CS - Single Radio, outgoing voice or video call in alerting phase.....	56
6.3.2.1.4e	PS - CS Access Transfer: PS to CS - Single Radio, voice and video .....	58
6.3.2.1.5	PS – CS Access Transfer for voice and video, Dual Radio .....	60

6.3.2.1.6	PS – CS Access Transfer: PS to CS – Dual Radio, mid-call service with an active speech and video session.....	61
6.3.2.1.7	PS – CS Access Transfer: PS to CS – Dual Radio, mid-call service with one inactive speech and video session.....	61
6.3.2.1.7a	PS - CS Access Transfer: PS to CS - Single Radio, mid-call service with an incoming waiting call in alerting phase.....	62
6.3.2.1.7b	PS - CS Access Transfer: PS to CS - Single Radio, mid-call service with an outgoing call in alerting phase.....	64
6.3.2.1.7c	PS - CS Access Transfer: PS to CS - Single Radio, mid-call service with an incoming call in alerting phase and a held session.....	66
6.3.2.1.8	PS - CS Access Transfer: Conferencing - for UEs not using ICS capabilities.....	68
6.3.2.1.9	PS – CS Access Transfer: PS to CS – Single Radio using ATCF enhancements.....	69
6.3.2.1.10	PS - CS Access Transfer: CS to PS - Single Radio.....	72
6.3.2.2	PS - PS Access Transfer.....	75
6.3.2.2.1	PS-PS Access Transfer with full media transfer.....	75
6.3.2.2.2	PS-PS Access Transfer with partial media transfer.....	76
6.3.2.2.3	PS-PS Access Transfer with full media transfer for an incoming call in early dialog phase.....	76
6.3.2.2.4	PS-PS Access Transfer with full media transfer for an outgoing call in early dialog phase.....	78
6.3.2.3	PS - PS in conjunction with PS - CS Access Transfer.....	79
6.3.2.3.1	PS - PS in conjunction with PS - CS Access Transfer: PS to CS for UEs not using ICS capabilities.....	79
6.3.2.3.2	PS - PS in conjunction with PS - CS Access Transfer: CS to PS for UEs not using ICS capabilities.....	81
6.3.2.3.3	PS – PS in conjunction with PS - CS Access Transfer: PS to CS for UEs with ICS capabilities - Using Gm reference point.....	81
6.3.2.3.4	PS - PS in conjunction with PS - CS Access Transfer: CS to PS for UEs with ICS capabilities - Using Gm reference point.....	83
6.3.2.3.5	PS – PS in conjunction with PS – CS Access Transfer: Active/Held sessions - Using Gm reference point.....	83
6.3.2.3.6	PS – PS in conjunction with PS – CS Access Transfer: Explicit Communication Transfer - Using Gm reference point.....	84
6.3.2.3.7	PS – PS in conjunction with PS – CS Access Transfer: Conferencing - Using Gm reference point.....	84
6.3.2.3.8	PS – PS in conjunction with PS – CS Access Transfer: PS to CS – using I1 reference point.....	84
6.3.2.3.9	PS - PS in conjunction with PS - CS Access Transfer: CS to PS - using I1 reference point.....	86
6.3.2.3.10	PS - PS in conjunction with PS - CS Access Transfer: PS to CS for Active/Held sessions - using I1 reference point.....	86
6.3.2.3.11	PS - PS in conjunction with PS - CS Access Transfer: CS to PS for Active/Held sessions - using I1 reference point.....	87
6.3.3	Media Adding/Deleting.....	87
6.3.3.1	Local End Initiation case: Adding new PS media to existing CS session.....	87
6.3.3.2	Local End Initiation case: Incorporating existing CS media in new IMS Session and Gm Service Control.....	88
6.3.3.3	Local End Initiation case: Adding PS media to IMS session with CS media.....	89
6.3.3.4	Remote End Initiation case: Adding new PS media to existing CS session.....	90
6.3.3.5	Remote End Initiation case: Incorporating existing CS media in new IMS Session and Gm Service Control.....	91
6.3.3.6	Remote End Initiation case: Adding PS media to IMS session with CS media.....	92
6.3.3.7	Local End Initiation case – Removing media from split CS and PS sessions.....	93
6.3.3.8	Remote End Initiation case – Removing media from split CS and PS sessions.....	94
6.3.3.9	Local End Initiation case: Adding new PS media to existing PS session.....	95
6.3.3.10	Remote End Initiation case: Adding new PS media to existing PS session.....	95
6.3.3.11	Local End Initiation case: Removing media from split PS sessions.....	95
6.3.3.12	Remote End Initiation case: Removing media from split PS sessions.....	95
6.3.4	Void.....	95
6.3.5	Service continuity for ICS UE using MSC Server assisted mid-call feature while maintaining CS media.....	95
6.4	Operator Policy and User Preferences.....	95
6.5	Execution of supplementary services.....	96
6.5.1	General.....	96
6.5.2	Originating Identification Presentation (OIP).....	96
6.5.3	Originating Identification Restriction (OIR).....	97

6.5.4	Terminating Identification Presentation (TIP).....	97
6.5.5	Terminating Identification Restriction (TIR).....	97
6.5.6	Communication Diversion (CDIV).....	97
6.5.7	Communication Hold (HOLD).....	97
6.5.8	Communication Barring (CB).....	97
6.5.9	Message Waiting Indication (MWI).....	97
6.5.10	Conference (CONF).....	97
6.5.11	Explicit Communication Transfer (ECT).....	98
6.5.12	Advice of Charge (AOC).....	98
6.5.13	Closed User Groups (CUG).....	98
6.5.14	Three-Party (3PTY).....	98
6.5.15	Flexible Alerting (FA).....	98
6.5.16	Communication Waiting (CW).....	98
6.5.17	Completion of Communications to Busy Subscriber (CCBS)/Completion of Communications by No Reply (CCNR).....	98
6.5.18	Customized Alerting Tones (CAT).....	98
6.5.19	Malicious Communication IDentification (MCID).....	98
6.5.20	Reverse Charging.....	98
6.5.21	Personal Network Management (PNM).....	99
6.5.22	Customized Ringing Signal (CRS).....	99
6a	Procedures and flows for Inter-UE Transfer.....	99
6a.0	Introduction.....	99
6a.0.1	Void.....	99
6a.1	IUT general procedures.....	99
6a.1.1	General.....	99
6a.1.2	Remote Leg Update.....	99
6a.2	Information flows for Collaborative Session establishment.....	99
6a.2.1	Establish Collaborative Session by transferring media.....	99
6a.2.2	Establish Collaborative Session with new media.....	100
6a.2.3	Establish Collaborative Session at originating IMS session setup.....	101
6a.2.4	Establish Collaborative Session at terminating IMS session setup.....	103
6a.3	Media Transfer within Collaborative Session.....	104
6a.3.1	Controller UE initiated media transfer from Controller UE to Controllee UE.....	104
6a.3.1.1	Controller UE and Controllee UE belong to the same subscription.....	104
6a.3.1.2	Controller UE and Controllee UE belong to different subscriptions.....	105
6a.3.2	Controller UE initiated media transfer from Controllee UE to Controller UE.....	106
6a.3.3	Controller UE initiated media transfer from Controllee UE to another Controllee UE.....	107
6a.3.3.1	Controller UE and Controllee UEs belong to the same subscription.....	107
6a.3.3.2	Controller UE and Controllee UEs belong to different subscriptions.....	108
6a.3.3a	Controllee UE Initiated Transfer Media from one Controllee UE to another Controllee UE.....	110
6a.3.4	Void.....	111
6a.3.4.1	Void.....	111
6a.3.4.2	Void.....	111
6a.4	Media adding/deleting/modifying within Collaborative Session.....	112
6a.4.1	Controller UE initiated add new media on Controller UE.....	112
6a.4.2	Controller UE initiated add new media on Controllee UE.....	112
6a.4.2.1	Controller UE and Controllee UE belong to the same subscription.....	112
6a.4.2.2	Controller UE and Controllee UE belong to different subscriptions.....	113
6a.4.3	Controller UE Initiated Release Media (media flow on the Controller UE).....	115
6a.4.4	Controller UE Initiated Release Media (media flow on the Controllee UE).....	116
6a.4.4.1	Controller UE and Controllee UE belong to the same subscription.....	116
6a.4.4.2	Controller UE and Controllee UE belong to different subscriptions.....	117
6a.4.4a	Controller UE initiated modify media (media flow on the Controllee UE).....	118
6a.4.4a.1	Controller UE and Controllee UE belong to the same IMS subscription.....	118
6a.4.4a.2	Controller UE and Controllee UE belong to different IMS subscriptions under the same operator.....	119
6a.4.5	Controllee UE initiated release media on itself.....	120
6a.4.6	Controllee UE initiated modify media on itself.....	121
6a.4.6.0	General.....	121
6a.4.6.1	Controller UE and Controllee UE belong to the same IMS subscription.....	121
6a.4.6.2	Controller UE and Controllee UE belong different IMS subscriptions under the same operator.....	122
6a.4.6a	Controllee UE initiated add new media on another Controllee UE.....	123

6a.4.7	Remote party initiated add new media.....	124
6a.4.8	Remote party initiated release media .....	126
6a.4.9	Remote party initiated media modification.....	127
6a.4a	Transfer of Collaborative Session Control .....	127
6a.4a.1	Controller UE transfers Collaborative Session Control to a Controllee UE without Media Transfer.....	127
6a.4a.2	Controller UE transfers Collaborative Session Control to another UE with Media Transfer .....	129
6a.4a.3	Transfer of Collaborative Session Control upon loss of Controller UE.....	130
6a.4a.4	Transfer of Collaborative Session Control with media flows upon loss of Controller UE.....	131
6a.4a.5	Transfer of Collaborative Session Control initiated by the target UE .....	133
6a.5	Collaborative Session release .....	134
6a.5.1	Controller UE Initiated Release Collaborative Session .....	134
6a.5.2	Remote Party Initiated Release Collaborative Session .....	135
6a.6	Inter-UE Transfer without establishing a Collaborative Session.....	135
6a.6.1	Inter-UE Transfer initiated by the source UE .....	135
6a.6.2	Inter-UE Transfer initiated by the target UE.....	137
6a.7	Execution of supplementary services .....	138
6a.7.1	General.....	138
6a.7.2	Originating Identification Presentation (OIP).....	138
6a.7.3	Originating Identification Restriction (OIR).....	138
6a.7.4	Terminating Identification Presentation (TIP).....	138
6a.7.5	Terminating Identification Restriction (TIR).....	138
6a.7.6	Communication Diversion (CDIV).....	138
6a.7.7	Communication Hold (HOLD).....	138
6a.7.7.1	Controller UE invoking the HOLD service on the media flow on a Controllee UE .....	139
6a.7.8	Communication Barring (CB).....	139
6a.7.9	Message Waiting Indication (MWI) .....	139
6a.7.10	Conference (CONF).....	140
6a.7.11	Explicit Communication Transfer (ECT) .....	140
6a.7.12	Advice of Charge (AOC) .....	140
6a.7.13	Closed User Groups (CUG) .....	140
6a.7.14	Three-Party (3PTY) .....	140
6a.7.15	Flexible Alerting (FA) .....	140
6a.7.16	Communication Waiting (CW).....	140
6a.7.17	Completion of Communications to Busy Subscriber (CCBS)/Completion of Communications by No Reply (CCNR) .....	141
6a.7.18	Customized Alerting Tones (CAT).....	141
6a.7.19	Malicious Communication IDentification (MCID) .....	141
6a.7.20	Reverse Charging.....	141
6a.7.21	Personal Network Management (PNM).....	141
6a.7.22	Customized Ringing Signal (CRS) .....	141
6a.8	IUT target discovery.....	141
6a.8.1	General.....	141
6a.8.2	Information flow for IUT target availability and capabilities discovery.....	142
6a.8.3	Session Discovery.....	143
6a.8.3.1	General .....	143
6a.8.3.2	Discovery of ongoing session information on other UE(s) belonging to same IMS subscription.....	143
6a.8.3.3	Discovery of ongoing session information on other UE(s) belonging to different IMS subscription .....	144
6a.9	Inter-UE Transfer Initiated by Target UE .....	144
6a.9.1	Controller UE and Controllee UE belong to same IMS subscription .....	144
6a.9.1.1	Initiated by UE not participating in ongoing Collaborative Session .....	144
6a.9.1.2	Initiated by Controllee UE in ongoing Collaborative Session .....	145
6a.9.1.3	IUT solicited by a target UE without prior information about the existing sessions.....	146
6a.9.2	Controller UE and Controllee UE belong to different IMS subscriptions .....	148
6a.9.2.1	Initiated by UE not participating in the session - Collaborative Session established.....	148
6a.9.2.2	Initiated by UE not participating in ongoing Collaborative Session - media on Controllee UE .....	149
6a.10	Media Flow Replication by network .....	151
6a.10.1	Replicating media in network from Controller UE to another UE belonging to same IMS subscription.....	151
6a.10.2	Replicating media in network from Controller UE to another UE belonging to different IMS subscription.....	152



6a.10.3	Replicating media in network from Controller UE to another UE belonging to same IMS subscription - pull mode .....	154
6a.10.4	Replicating media in network from Controller UE to another UE belonging to different IMS subscription - pull mode .....	156
6a.11	Session Replication by remote party .....	157
6a.11.1	Session replication initiated by target UE .....	157
6a.11.2	Session replication initiated by source UE .....	158
6a.11.3	Session replication initiated by source UE (different subscription) .....	159
6a.11.4	Session replication initiated by target UE (different subscription) .....	160
6a.12	User authorisation and preferences .....	161
6b	Void .....	161
6c	Procedures and flows for SRVCC Emergency Session .....	162
6c.1	IMS Emergency origination flow for PS to CS SRVCC .....	162
6c.2	SRVCC session transfer of IMS emergency session for PS to CS .....	162
6c.3	SRVCC Support for UEs in Normal Mode .....	163
6c.4	SRVCC Support for UEs in Limited Service Mode .....	164
7	Security .....	164
7.1	General .....	164
7.2	Access security for CS Domain .....	164
7.3	Access security for IMS .....	164
8	Charging .....	164
8.1	Charging strategy .....	164
8.2	Accounting strategy .....	165
<b>Annex A (informative): Controller UE and Controllee UE operations .....</b>		<b>166</b>
A.1	General .....	166
<b>Annex B (informative): Change history .....</b>		<b>168</b>
History .....		170

---

## Foreword

This Technical Report has been produced by the 3rd Generation Partnership Project (3GPP).

The contents of the present document are subject to continuing work within the TSG and may change following formal TSG approval. Should the TSG modify the contents of the present document, it will be re-released by the TSG with an identifying change of release date and an increase in version number as follows:

Version x.y.z

where:

- x the first digit:
  - 1 presented to TSG for information;
  - 2 presented to TSG for approval;
  - 3 or greater indicates TSG approved document under change control.
- y the second digit is incremented for all changes of substance, i.e. technical enhancements, corrections, updates, etc.
- z the third digit is incremented when editorial only changes have been incorporated in the document.

---

## Introduction

IMS based services can be provided with use of PS bearers and CS bearers for the media. When using CS bearer for media transport of IMS sessions, interworking solutions for IMS Centralized Services as specified in TS 23.292 [5] are used. ICS allows IMS sessions using CS bearers to be treated as standard IMS sessions for the purpose of IMS Service Continuity. ICS defines signalling mechanisms between the UE and IMS for transport of information as needed for service continuity when using CS access for media transport.

Both IMS Centralized Services and IMS Service Continuity specify functions which are provided by a SIP application server.

---

# 1 Scope

The present document specifies the architectural requirements and procedures for delivery of IMS Service Continuity. TS 23.206 [3] is migrated to this specification.

The scope of the specification includes:

- Access Transfer related functionality:
  - PS-CS Access Transfer;
  - PS-PS Access Transfer;
  - PS-PS Access Transfer in conjunction with PS-CS Access Transfer;
  - Adding and/or removing media flows to support service;
  - MSC Server assisted mid-call feature;
  - SRVCC session transfer of IMS emergency session.
- Inter-UE Transfer related functionality:
  - Establishment and release of a Collaborative Session;
  - Addition of media flows to, modification of media flows in, and release of media flows from a Collaborative Session;
  - Transfer of media flows from one UE to another;
  - Transfer of the Collaborative Session Control with or without transfer of media flows;
  - Transfer of all media flows to a target UE without establishing a Collaborative Session;
  - Session discovery;
  - Inter-UE Transfer initiated by the target UE or by the SCC AS;
  - Replication of media flows by means of Inter-UE Transfer procedures;
  - Authorization and other aspects to support Inter-UE Transfer across multiple IMS subscriptions.

The solution is restricted to service continuity using IMS procedures, i.e. mobility mechanisms on the IP-CAN level are not within the scope of this specification.

---

# 2 References

The following documents contain provisions which, through reference in this text, constitute provisions of the present document.

- References are either specific (identified by date of publication, edition number, version number, etc.) or non-specific.
- For a specific reference, subsequent revisions do not apply.
- For a non-specific reference, the latest version applies. In the case of a reference to a 3GPP document (including a GSM document), a non-specific reference implicitly refers to the latest version of that document *in the same Release as the present document*.

- [1] 3GPP TR 21.905: "Vocabulary for 3GPP Specifications".
- [2] 3GPP TS 22.258: "Service requirements for the AIPN".

- [3] 3GPP TS 23.206: "Voice Call Continuity between CS and IMS".
- [4] 3GPP TS 23.228: "IP Multimedia Subsystem (IMS); Stage 2".
- [5] 3GPP TS 23.292: "IP Multimedia Subsystem (IMS) centralized services; Stage 2".
- [6] Void.
- [7] OMA-ERELED-DM-V1\_2-20060602-C: "Enabler Release Definition for OMA Device Management, Candidate Version 1.2".
- [8] IETF RFC 3261 (June 2002): "SIP: Session Initiation Protocol".
- [9] 3GPP TS 22.101: "Service aspects; Service principles".
- [10] 3GPP TS 23.216: "Single Radio Voice Call Continuity (SRVCC); Stage 2".
- [11] 3GPP TS 33.102: "3G security; Security architecture".
- [12] 3GPP TS 33.203: "Access security for IP-based services".
- [13] 3GPP TS 23.218: "IP Multimedia (IM) session handling; IM call model; Stage 2".
- [14] 3GPP TS 23.003: "Numbering, addressing and identification".
- [15] 3GPP TS 22.173: "IP Multimedia Core Network Subsystem (IMS) Multimedia Telephony Service and supplementary services; Stage 1".
- [16] 3GPP TS 24.610: "Communication HOLD (HOLD) using IP Multimedia (IM) Core Network (CN) subsystem; Protocol specification".
- [17] 3GPP TS 24.605: "Conference (CONF) using IP Multimedia (IM) Core Network (CN) subsystem; Protocol specification".
- [18] 3GPP TS 24.629: "Explicit Communication Transfer (ECT) using IP Multimedia (IM) Core Network (CN) subsystem; Protocol specification".
- [19] 3GPP TS 24.647: "Advice Of Charge (AOC) using IP Multimedia (IM)Core Network (CN) subsystem; Protocol Specification".
- [20] 3GPP TS 24.616: "Malicious Communication Identification (MCDI) using IP Multimedia (IM)Core Network (CN) subsystem; Protocol Specification".
- [21] 3GPP TS 24.604: "Communication Diversion (CDIV) using IP Multimedia (IM)Core Network (CN) subsystem; Protocol specification".
- [22] 3GPP TS 24.615: "Communication Waiting (CW) using IP Multimedia (IM) Core Network (CN) subsystem; Protocol Specification".
- [23] 3GPP TS 23.167: "IP Multimedia Subsystem (IMS) emergency sessions".
- [24] 3GPP TS 24.008: "Mobile radio interface Layer 3 specification; Core network protocols; Stage 3".
- [25] 3GPP TS 24.147: "Conferencing using the IP Multimedia (IM) Core Network (CN) subsystem; Stage 3".
- [26] 3GPP TS 24.229: "IP multimedia call control protocol based on Session Initiation Protocol (SIP) and Session Description Protocol (SDP); Stage 3".
- [27] 3GPP TS 23.060: "General Packet Radio Service (GPRS); Service description; Stage 2".
- [28] 3GPP TS 23.401: "General Packet Radio Service (GPRS) enhancements for Evolved Universal Terrestrial Radio Access Network (E-UTRAN) access".
- [29] 3GPP TR 26.911: "Codec(s) for Circuit-Switched (CS) multimedia telephony service; Terminal implementor's guide".

- [30] 3GPP TS 23.334: "IP Multimedia Subsystem (IMS) Application Level Gateway (IMS-ALG) - IMS Access Gateway (IMS-AGW) interface".
- [31] 3GPP TS 29.162: "Interworking between the IM CN subsystem and IP networks".
- [32] 3GPP TS 26.111: "Codec for circuit switched multimedia telephony service; Modifications to H.324".

---

## 3 Definitions, symbols and abbreviations

### 3.1 Definitions

For the purposes of the present document, the terms and definitions in TR 21.905 [1] and the following apply.

**Access Leg:** This is the call control leg between the UE and the SCC AS; also see TS 23.292 [5] for the definition of Access Leg for IMS sessions which use the CS media.

**Access Transfer:** Transfer at the IMS-level of one or more media paths of an ongoing IMS session on one UE between PS to CS access; or transfer at the IMS-level of both the signalling and the media path of an ongoing IMS session on a UE between different IP-CANs.

**Collaborative Session:** A set of two or more Access Legs and related media on two or more UEs having IMS subscriptions under the same operator that are presented as one Remote Leg by the SCC AS.

**Collaborative Session Control:** The control operations on the Collaborative Session which can only be performed by the Controller UE, e.g. ability to release the Collaborative Session, to invoke supplementary services, and to authorize requests for IUT Media Control Related Procedures from other UEs.

**Controllee UE:** A UE that supports media flows for a Collaborative Session and may request IUT Media Control Related Procedures but is subordinate to the Controller UE for authorization of these procedures.

**Controller UE:** The UE that controls a Collaborative Session and whose service profile determines the services on the remote leg. The Controller UE may also support media flows for a Collaborative Session and may request IUT Media Control Related Procedures.

**Correlation MSISDN:** An MSISDN used for correlation of sessions. See TS 23.003 [14] for more information.

**Dual Radio:** This refers to the situation where the UE is capable to transmit/receive on two different radio access technologies simultaneously.

**Emergency Session Transfer Number for SRVCC:** A number used in the session transfer procedure for emergency calls, pointing toward the serving (visited if roaming) IMS EATF which handles the IMS emergency session transfer from PS to CS access.

**Hosting SCC AS:** The SCC AS that manages the dialog with the remote party for a Collaborative Session.

**IMS Service Continuity:** A service of the IMS which supports the use of Session Transfer mechanisms to maintain service continuity in the event of terminal mobility and/or mobility between terminals for the case when such events are not hidden from the IMS session layer and thus service continuity could not otherwise be maintained.

**Inter-UE Transfer:** Transfer at the IMS-level of some or all of the media flows and/or service control across a set of having IMS subscriptions under the same operator.

NOTE 1: The transfer of all media flows and the control signalling from one UE to another is also known as Session Mobility as defined in TS 22.258 [2].

**IP Multimedia Routing Number (IMRN):** An IP Multimedia Routing Number (IMRN) is a routable number that points to an SCC AS in the IM CN subsystem. See TS 23.003 [14] for more information.

**IUT Media Control Related Procedures:** The control operations on the media flows of the Collaborative Session which involve multiple UEs or need Controller UE's authorization within the Collaborative Session, e.g. ability to transfer/add/replicate media flows, to remove/modify media flows on a different UE.

**Local Operating Environment Information:** This is a set of parameters, which can include access network(s) conditions and other parameters implementation specific, which describe the local environment in which the UE is operating.

**MSC Server assisted mid-call feature:** Functionality of the MSC Server, the SCC AS and the UE, enabling PS - CS Access Transfer for UEs not using ICS capabilities, while preserving the provision of mid-call services (inactive sessions or sessions using the Conference service).

NOTE 2: This terminology is often abbreviated as "mid-call feature" or even "mid-call" throughout this specification.

**Remote Leg:** This is the call control leg between the SCC AS and the remote party from the subscriber's perspective; also see TS 23.292 [5] for the definition of Remote Leg for IMS sessions which use the CS media.

**Service Control Signalling Path:** As defined in TS 23.292 [5].

**Session Replication:** Replication, at the IMS-level, of a session ongoing in a source UE at a target UE. When the new, independent, session is established at the target UE, the state of the original media is replicated e.g. same playback state; same used media etc. is replicated.

**Session State Information:** Information of IMS session state sent by the SCC AS for enablement of PS-CS and CS-PS Access Transfer of IMS multimedia-sessions when ICS UE capabilities can not be used.

**Session Transfer:** Transfer at the IMS-level of one or more of the session signalling paths and/or associated media flow paths of an ongoing IMS session while maintaining service continuity. Session Transfer incorporates Access Transfer and / or Inter-UE Transfer.

**Session Transfer Identifier (STI):** An identifier used by the UE to request the SCC AS to perform Session Transfer. The STI is either statically configured on the UE or dynamically assigned. See TS 23.003 [14] for more information.

**Session Transfer Identifier for reverse SRVCC (STI-rSR):** A dynamic identifier used by the UE to request the IMS network to perform Session Transfer for CS to PS SRVCC (reverse SRVCC). The STI-rSR is used by the network to correlate two access legs, and is unique for each access transfer control function within an ATCF.

**Session Transfer Number (STN):** A number used by the UE to request the SCC AS to perform Session Transfer from PS to CS access. The STN is statically configured on the UE. See TS 23.003 [14] for more information.

**Session Transfer Number for SRVCC (STN-SR):** A STN used for SRVCC procedures as specified in TS 23.216 [10]. STN-SR is a subscription information provided to HSS for each subscriber if SRVCC service is allowed by hPLMN. STN-SR is a routing number indicating the SCC-AS or the ATCF if SRVCC enhanced with ATCF is used. See TS 23.003 [14] for more information.

**Single Radio:** This refers to the situation where the UE is only capable of transmitting/receiving on one radio access technology at a time.

**Source Access Leg:** The Access Leg that exists in the transferred-out access before executing Access Transfer procedures.

**Target Access Leg:** The Access Leg that is established in the transferred-in access during Access Transfer procedures.

## 3.2 Abbreviations

For the purposes of the present document, the abbreviations given in TR 21.905 [1] and the following apply. An abbreviation defined in the present document takes precedence over the definition of the same abbreviation, if any, in TR 21.905 [1].

3pcc	3rd party call control
ATCF	Access Transfer Control Function
ATGW	Access Transfer Gateway
ATU-STI	Access Transfer Update - Session Transfer Identifier
C-MSISDN	Correlation MSISDN
EATF	Emergency Access Transfer Function
iFC	Initial Filter Criteria
IMRN	IP Multimedia Routing Number.

IUT	Inter-UE Transfer
OCS	Online Charging System
SC	Service Continuity
SCC AS	Service Centralization and Continuity Application Server
SRVCC	Single Radio Voice Call Continuity
STI	Session Transfer Identifier
STI-rSR	Session Transfer Identifier for CS to PS SRVCC
STN	Session Transfer Number
STN-SR	Session Transfer Number - Single Radio
E-STN-SR	Emergency Session Transfer Number for SRVCC

---

## 4 High level principles and architectural requirements

### 4.1 Basic Assumptions

#### 4.1.0 General

It is assumed that the UE may be capable of transmitting and receiving simultaneously in multiple Access Networks or it may be capable of transmitting and receiving in only one Access Network at a time.

#### 4.1.1 PS-CS Access Transfer

The following assumptions apply for PS-CS Access Transfer:

- Functions of IMS Centralized Services and IMS Service Continuity are collocated in a single SCC AS. Not all functions are always required.
- When (v)SRVCC enhanced with ATCF is used, additional functions of IMS Service Continuity are provided by the ATCF/ATGW in the serving (visited if roaming) network.
- IMS Centralized Services specifies functions and procedures for use of CS bearer for the media of the IMS sessions.
- If both UE and network supports the ICS UE capabilities described in TS 23.292 [5], these capabilities are used for communication of required information if needed for enablement of PS-CS Access Transfer of IMS multimedia sessions. During Access Transfer, the UE may decide to retain the use of the Gm reference point for service control of the real time media flow(s) in the old PS access (if available) or may decide to transfer the Gm service control for the real time media flow(s) to a new PS access. Support and use of the I1 interface in both the UE and SCC AS are subject to the requirements specified in clauses 5.3.2 and 5.3.1, respectively, of TS 23.292 [5].
- When using the CS bearer for the media of the IMS session(s), multiple sessions can exist, but only one active session can be transferred over the CS bearer; one or more inactive sessions can be transferred.
- When using the CS bearer for the voice + video media of the IMS session(s) as a result of performing vSRVCC, only one session with voice+video media can be transferred to the CS access. All remaining bi-directional voice and voice + video sessions but the transferred one are released, if the UE and network do not support ICS capabilities.
- PS-CS Access Transfer with UE-based conferencing is not specified in this release.
- The SCC AS shall provide the Session State Information to the MSC Server if:
  - the Access Transfer request is sent by or via the MSC Server;
  - the MSC Server has indicated its capability to support mid-call services in the registration or indicates its capability in the Access Transfer request sent to the SCC AS;
  - and ICS UE capabilities cannot be used upon transfer.

- If supported, the SCC AS and ATCF have additional functions in handling of PS-CS Access Transfer procedure with priority indication for Single Radio.

## 4.1.2 PS-PS Access Transfer

If a UE has an ongoing multimedia session over an access system and moves to a different access system but its IMS contact address and its serving P-CSCF remains the same, then there is no need to activate any IMS Service Continuity mechanisms to transfer its multimedia session. The UE may update the session (e.g. remove media type(s) not supported by the target access system) based on the normal IMS procedures specified in TS 23.228 [4].

When the Evolved Packet System mobility with IP address preservation is used, the assumption above also applies.

**NOTE:** If an ICS UE has an ongoing session using CS bearer and Gm reference point over an IP-CAN and performs an Access Transfer to a different IP-CAN, the Service Control Signalling Path can be transferred from the old IP-CAN to the new IP-CAN while retaining the media flow(s) in the CS access network, so that service continuity of the session is maintained.

## 4.1.3 Inter-UE Transfer

The following assumptions apply for Inter-UE Transfer:

- The UEs involved in IUT Media Control Related Procedures can belong to different IMS subscriptions under the same operator.
- The Collaborative Session Control can be transferred between UEs registering Public User identities that share the same service profile (and thus belong to the same IMS subscription).
- There is only one Controller UE within a Collaborative Session.
- A Controllee UE is not aware of its role within a Collaborative session and it is not aware of the Controller UE. In that respect any UE can undertake the role of Controllee UE.
- The Collaborative Session is transparent to the remote end, to which it appears that the session is with the Controller UE.
- Any IUT capable UE can request IUT Media Control Related Procedures. Such requests are subject to authorization by the SCC AS and/or the Controller UE.
- The UEs involved in Inter-UE Transfer without establishing a Collaborative Session use Public User identities that share the same service profile.

## 4.2 Architectural Requirements

### 4.2.1 General Requirements

- It shall be possible to perform multimedia session transfer between access systems regardless of whether network layer mobility is deployed or not.

**NOTE 1:** The mechanism to avoid potential conflict between PS-PS Access Transfer and underlying network layer mobility (e.g. Evolved Packet System mobility, etc.) is not specified within this Release of the specification.

- The service disruption when session transfer occurs shall be minimized.
- There shall be no impact on the radio and transport layers and on the PS core network.
- UEs that do not support the functionality described in this specification shall not be impacted.
- All media flow(s) within a multimedia session or a subset of media flow(s) within a multimedia session could be subject to session transfer procedures.



- It shall be possible to register a Public User Identity with multiple contact addresses (at the same or via separate UEs) via IMS registration procedures as defined in TS 23.228 [4], clause 5.2.1. The number of allowed simultaneous registrations is defined by home operator policy.
- It shall be possible to perform correlation of charging data from different access networks when service continuity between these networks is performed.
- The UE shall be IMS registered before invoking any Session Transfer procedures.
- The filter criteria shall contain a condition that a 3rd-party registration is performed via the ISC interface for the SCC AS.
- It shall be possible to provide SR-VCC support for IMS emergency call from PS to CS Access Transfer.

NOTE 2: The CS to PS Access transfer for IMS emergency call SRVCC is not supported in this Release of the specification.

## 4.2.2 Access Transfer Requirements

- It shall be possible to provide Access Transfer in the home network or in the visited network (if roaming) when the user is moving between 3GPP access systems.
- It shall be possible to provide Access Transfer when the user is moving between 3GPP and non-3GPP access systems.
- It shall be possible to provide Access Transfer when the user is moving between non-3GPP access systems.
- It shall be possible to provide Access Transfer between an Access Network that supports real-time media on the CS domain and non-real-time media on the PS domain, and an IP-CAN that supports transport of all media types.
- If it is not possible or not desired (e.g. due to user preferences and/or operator policies) to transfer all the media flow(s), then a subset of the media flow(s) shall be transferred (if possible) and the remaining flow(s) will be released or kept in the transferred out access.
- It shall be possible for the UE to add or remove one or more media flow(s) to/from an ongoing multimedia session that it controls during Access Transfer.
- It shall be possible to provide Access Transfer when the P-CSCF changes.
- It shall be possible for the UE to use IMS mechanisms to transfer its ongoing multimedia sessions to a target Access Network without requiring any new functionality on the remote party.
- It shall be possible for the UE to initiate an Access Transfer procedure based on operator policy provided by the network which may include restrictions of Access Transfer.
- It shall be possible for the SCC AS to update the operator policy in the UE.

## 4.2.3 IUT Requirements

- It shall be possible for the Controller UE to apply IUT when a remote end adds media to an existing session.
- IUT shall be able to coexist with Access Transfer as specified in this specification and TS 23.292 [5].
- If the Collaborative Session Control is lost for an active Collaborative Session, the SCC AS shall release all the Access Legs participating in that Collaborative Session.
- It shall be possible for the Controller UE to determine all other UEs that are currently available and authorised for IUT procedures.
- It shall be possible for the Controller UE to determine the media and service capabilities of each available UE.
- The network shall reject IUT between UEs that are not authorised.
- The Hosting SCC AS shall maintain the end-to-end session service state of a UE engaged in IUT.

- It shall be possible to execute IUT Media Control Related Procedures in any order, and any number of times, for a given session.
- The Controller UE shall maintain the Collaborative Session Control for the session until the Collaborative Session is released or until the Collaborative Session Control is transferred to another Controller capable UE.
- It shall be possible for a Controller UE to initiate transfer of Collaborative Session Control to another Controller capable UE that has registered a Public User identity that shares the service profile with the Public User identity used in the Collaborative Session.
- It shall be possible for a Controller capable UE to request and, when authorized, to pull Collaborative Session Control from a source UE.
- The media flow(s) on the target UE shall be established using IMS session setup procedures as specified in TS 23.228 [4].
- The Controller UE may transfer one or more media flow(s) to one or more target UEs (including itself).
- The selection of the media flows to be transferred may be based on the target UE(s) capabilities.
- The Controller UE shall have information about a Collaborative Session, which describes all media components currently existing in this session and the UEs associated with these media components.
- The Collaborative Session procedures for a Controllee UE without IUT capabilities shall not have any impact to the UE. Therefore any IMS UE shall be able to act a Controllee UE within a Collaborative Session.
- UEs using CS access interworked with IMS by an interworking node shall be provided with limited Controllee UE functionality based on the constraints of the interworking node.
- After the local end changes due to an IUT procedure without establishing a Collaborative Session, the SCC AS shall update the remote end that the session is continuing with a new local end.
- It shall be possible to apply IUT Media Control Related Procedures between UEs belonging to different IMS subscriptions.
- When UEs from different subscriptions are involved in a Collaborative Session, the SCC ASs shall assure that UEs do not create subsequent Collaborative Sessions for media belonging to Access Legs of the original Collaborative Session, and thus only a single Collaborative Session with a single hosting SCC AS shall be allowed.
- When an SCC AS creates an access leg towards a UE that is not part of the same subscription that is currently associated with the Collaborative Session, it shall include sufficient information indicating that there already exists a hosting SCC AS.
- It shall be possible for a UE to indicate that it is capable to become a Controller UE.
- It shall be possible for the Controller UE to apply IUT Media Control Related Procedures when setting up either an originating or terminating session.
- It shall be possible, based on the terminating user's preferences, to route incoming IMS session requests to a UE that is capable of becoming a Controller UE.
- It shall be possible for a UE to request to replicate one or more media flow(s) from the remote end.
- It shall be possible for the network to replicate media in order to support the media replication scenarios described in this document.
- It shall be possible for a UE to determine the information of ongoing multimedia session(s) in other UEs before or during IUT Media Control Related Procedures.
- It shall be possible for the network to mask information on some or all of the sessions or media flows composing the session from session discovery based on user service configuration or operator policy.
- The selection of the media flows to be transferred may be based on the ongoing multimedia session(s) on the source UE(s) discovered by the target UE(s) in pull mode.

- It shall be possible for a UE to request and, when authorized, to pull one or more media flow(s) from a source UE.
- It shall be possible for the Controller UE to authorize requests for IUT Media Control Related Procedures.
- It shall be possible for the network to authorize requests for IUT Media Control Related Procedures on behalf of the Controller UE.
- The network shall resolve conflicting IUT Media Control Related Procedures within a Collaborative Session.
- When the Collaborative Session Control on the Controller UE is lost, the SCC AS may transfer the Collaborative Session Control to another Controller capable UE (with a Public User Identity belonging to the same service profile) involved in the Collaborative Session based on the user preferences associated with the Controller UE.
- It shall be possible for the SCC AS to initiate Inter-UE Transfer on behalf of the UE/user as a result of a UE requesting IUT, or due to other stimulus such as, but not restricted to, IMS signalling received by the SCC AS from other IMS entities, user preferences, or other service layer triggers.
- Replication / transfer of some or all media components to target IMS UE(s), belonging to the same or to different user(s) that are subscribed to the same operator, shall not be performed when the remote end (e.g. the source of the media) of the session restricts such operation.

## 4.3 Service Continuity

### 4.3.1 Session Transfer concepts

#### 4.3.1.1 General

When an UE is active in an IMS session, the Session Transfer procedures provide service continuity between Access Networks and between UEs having IMS subscriptions under the same operator.

The initial and all subsequent Session Transfer procedures are initiated by the UE and are executed and controlled by the same SCC AS.

The SCC AS generates charging information for all Session Transfers for an IMS session for the purpose of billing and charging.

The UE sends information required by the SCC AS in order to execute Session Transfer procedures.

#### 4.3.1.2 Access Transfer concepts

##### 4.3.1.2.1 General Access Transfer concepts

IMS sessions from and to a UE are anchored at the SCC AS in the home IMS and may also be anchored at the ATCF in the serving (visited if roaming) network to provide Service Continuity for the user during transition between two Access Networks. Sessions are anchored at the SCC AS in the home IMS, based on iFC. A 3pcc (3rd party call control) function is employed at the SCC AS to facilitate inter-Access Network mobility through the use of Access Transfers between the two Access Networks. IMS media sessions may be anchored by the ATCF during session establishment depending on operator policy. Access Transfers may be enabled in one or both directions as per network configuration requirements. The SCC AS has the capability to perform Access Transfers for a UE's sessions multiple times.

Initiation of Access Transfer procedures for ongoing multimedia session may be based on the operator policy received from the SCC AS.

##### 4.3.1.2.2 Access Transfer (PS – CS) concepts

IMS sessions established in CS or PS Access Networks are anchored at the SCC AS. Additionally, IMS media sessions subject to CS to PS or PS to CS SRVCC can be anchored by the ATCF. IMS sessions using CS bearer are established at session setup or upon Access Transfer using procedures specified in TS 23.292 [5].

PS-CS Access Transfer shall be provided according to the requirements specified in clause 22.3, Service Continuity, of TS 22.101 [9].

When using a UE that does not have, or that is unable to use, ICS UE capabilities as specified in TS 23.292 [5], Access Transfer of one active bi-directional speech or speech and video session and zero or one inactive bi-directional speech session shall be provided when transferring speech and/or video media flow between CS and PS access. For PS to CS (not CS to PS) Access Transfer, if the UE has more than one anchored active bi-directional session, the session that was most recently made active shall be transferred.

NOTE: PS to CS transfer - Single Radio of a bi-directional session in pre-alerting state (the state before alerting state in early dialog) is not supported.

When using a UE that is able to use ICS capabilities as specified in TS 23.292 [5], Access Transfer of one active bi-directional speech or speech and video session and zero or more inactive bi-directional speech sessions shall be provided using the Gm reference point, or optionally the I1 reference point, of ICS to transport required information, as specified in TS 23.292 [5], when transferring speech and/or video media flow between CS and PS access.

For PS to CS Dual Radio Access Transfer, if the UE has more than one anchored active bi-directional speech session, then the UE shall first request transfer of one of the active bi-directional sessions, put the remaining active sessions on hold and then request the transfer of one of the remaining inactive bi-directional sessions. Access Transfer shall also be provided for one or more inactive bi-directional speech sessions if the UE has no active bi-directional speech sessions.

When Single Radio PS-to-CS Access Transfer is performed for an active bi-directional speech and video session, if the UE and network do not support ICS capabilities, all the remaining bi-directional speech and speech + video sessions, if any, are released by the UE and SCC AS.

The SCC AS maintains, for all active and inactive sessions, Session State Information as defined in clause 4.3.3.

For PS to CS Access Transfer, if the Access Transfer request has been sent by MSC Server or by the UE through the MSC Server and if the MSC Server has indicated its capability and ICS UE capability cannot be used upon transfer, then the SCC AS shall provide Session State Information to the MSC Server enhanced for ICS or (v)SRVCC as specified in TS 23.292 [5] and TS 23.216 [10], respectively. The SCC AS shall not provide Session State Information if either the UE or operator policy on the SCC AS indicates that network capabilities shall not be used to support mid-call services during Access Transfer. When receiving information about an additional session, the MSC Server enhanced for ICS or (v)SRVCC shall initiate Access Transfer towards the SCC AS for the additional session. When receiving information for a session, the MSC Server shall create a service context for this session using this information and perform service control on behalf of the UE as specified in TS 23.292 [5].

For CS to PS Access Transfer initiated by a UE not able to use ICS capability, the SCC AS shall provide Session State Information to the UE on the transferring-in leg.

#### 4.3.1.2.2A MSC Server assisted mid-call feature

The MSC Server assisted mid-call feature provides the preservation of mid-call services (inactive sessions or sessions using the Conference service) upon PS - CS Access Transfer without requiring the UE to use ICS capabilities.

When the MSC Server assisted mid-call feature is enabled, the MSC Server, the SCC AS and the UE shall support one or more of the procedures specified in clauses 6.3.2.1.1a, 6.3.2.1.2a, 6.3.2.1.4a, 6.3.2.1.6, 6.3.2.1.7, 6.3.2.1.7a, 6.3.2.1.7b and 6.3.2.1.8.

The MSC Server assisted mid-call feature shall only be triggered if UE, MSC Server, and SCC AS all support the MSC Server assisted mid-call feature.

#### 4.3.1.2.3 Co-existence of ICS UE and MSC Server assisted mid-call feature

A UE may implement both ICS UE capability and the MSC Server assisted mid-call feature for situations when the ICS UE capabilities cannot be used or be maintained after the transfer. For such a scenario, if ICS UE indicates both capabilities then the SCC AS needs to determine which capabilities are used to transfer the additional active or inactive sessions. The following logic is applied in the SCC AS to achieve this:

- If the Access Transfer request is made using ICS UE capabilities, the SCC AS detects that ICS UE capabilities are used and executes the transfer according to procedures defined in clause 6.3.2 of the present document.

- If the Access Transfer request is made via the MSC Server, the SCC AS needs to determine whether ICS capabilities are used:
  - If the ICS UE is able to use ICS capabilities, then clause 6.3.2 of the present document applies.
  - If the ICS UE is not able to use ICS capabilities, then MSC Server assisted mid-call feature is used.

The SCC AS can determine whether ICS capabilities are used based on the local configuration, or alternatively delay for an adequate time sending the session state information to the MSC Server in order to trigger the MSC Server assisted mid-call feature such that the potential re-establishment of Service Control Signalling Path by the ICS UE can be excluded.

- If no Access Transfer request is received, and the SCC AS detects that the ICS UE capabilities can not be used for the ICS UE due to loss of the Service Control Signalling Path over Gm reference point and unavailability of I1 reference point, the MSC Server assisted mid-call feature is used, with the following differences from the PS-CS Access Transfer:
  - the CS Bearer Control Signalling Path(s) is/are used for control of the session(s), with the existing CS bearer Control Signalling Path reused for control of the most recently active session.
  - upon detecting that the Service Control Signalling Path is unavailable then clause 6.3.5 of the present document applies.

### 4.3.1.3 Inter-UE Transfer concepts

#### 4.3.1.3.1 General

IMS sessions from and to a UE are anchored at the SCC AS in the home IMS to provide service continuity for the user when one or more media flows of an ongoing IMS multimedia session are transferred, added or deleted among different UEs.

A Collaborative Session, which is split on the local end across two or more UEs and anchored in the SCC AS, is established due to the Inter-UE Transfer procedures; such procedures may be executed by the UE either at the time of IMS session setup or subsequent to IMS session setup. The UE which initiates the Inter-UE Transfer procedures to establish the Collaborative Session becomes the Controller UE of the Collaborative Session and the other UE(s) involved in the Collaborative Session become the Controllee UE(s). Subsequent Inter-UE Transfer procedures, initiated by the Controller UE, can also be performed within the Collaborative Session. The SCC AS provides the coordination of the Collaborative Session procedures which may involve both the Controller UE and the Controllee UE(s).

Any IUT capable UE can request IUT Media Control Related Procedures. Such requests are subject to authorization by the SCC AS and/or the Controller UE. Authorization is based on user and/or operator provided application specific settings in the SCC AS and/or the Controller UE. These application specific settings may be associated with the service profile of the Controller UE in service specific data in the HSS.

Although any IUT capable UE can request IUT Media Control Related Procedures, there can be only one Controller UE at a time in a Collaborative Session. The UE that establishes the Collaborative Session and whose service profile is active for the session with the remote end is the initial Controller UE. The Controller UE role (Collaborative Session Control) may be transferred to a different UE during the life of the Collaborative Session. Collaborative Session Control may be transferred only to another Controller capable UE that has registered a Public User Identity that shares the same service profile (and thus belongs to the same IMS subscription) as the Controller UE. The Hosting SCC AS does not change during the life of the Collaborative Session.

Inter-UE Transfer procedures can also be executed without establishing a Collaborative Session. In this case, the whole IMS multi-media session is transferred from one UE to the other UE, and the roles of the Controller and Controllee UEs are not applicable.

Inter-UE Transfer procedures may be initiated by the UE based on the information it gets from Target UE discovery.

The UEs that participate in IUT Media Control Related Procedures may belong to different IMS subscriptions under the same operator. When this is the case, the IUT service request must be authorized by the Controller UE (or by its associated SCC AS on behalf of the Controller UE) of a Collaborative Session, and may also be authorized by the SCC AS associated with a Controllee UE or associated with another UE not participating in the Collaborative Session that has issued an IUT service request. In order to perform "network-based" (SCC AS-based) authorization of such requests, the SCC AS can use participant (user)-related information in the request; that is, the SCC AS may authorize a given

IUT service request if it is associated with a particular user, but not authorize the same request if it is associated with a different user.

#### 4.3.1.3.2 Controller UE and Controllee UE operations

##### 4.3.1.3.2.1 Overview

The operations of Controller UE and Controllee UE are described respectively in clauses 5.3.2.2.2 and 5.3.2.2.3.

#### 4.3.2 Void

### 4.3.3 Information used for IMS Service Continuity

The following information may be provided between SCC AS and the UE.

Depending on the IMS Service Continuity scenario, the Access Transfer request may contain the following:

- session transfer indicator;
- details about the access and the media flow(s) being transferred / kept / released;
- optionally, an IMS Communication Service Identifier defined in TS 23.228 [4];
- which session is required to be replaced or updated;
- whether to merge the session(s).

The above addressed information are carried in various SIP/SDP and CS call control messages (specified in the applicable information flows), which provides the necessary details to enable IMS Service Continuity. The SCC AS and the UE analyze the included information and determine if and how a Session Transfer operation needs to be performed.

The ATCF may include into the Registration request the following:

- allocated STN-SR pointing to the ATCF.

The above information is carried in SIP messages (specified in the information flows) providing the necessary details.

When an ATCF is used, the SCC AS provides the following information to the ATCF:

- ATU-STI; and
- C-MSISDN.

The above information is carried in SIP messages (specified in the information flows) providing the necessary details.

The Access Transfer Update request from the ATCF to the SCC AS may contain the following:

- indication that Access Transfer has taken place for a particular session.

The above information is carried in SIP messages (specified in the information flows) providing the necessary details.

For support of CS to PS SRVCC, a dynamic STI-rSR is provided to the UE from the ATCF.

The Session State Information sent by the SCC AS may contain the following about one active and zero or one inactive bi-directional speech session(s) for enablement of PS-CS service continuity of IMS multimedia-sessions:

- calling party;
- called party;
- needed STI;

- further session information (e.g. active, inactive, conference call initiator, conference URI, identifier of all participants) as required.

The above information is carried in SIP messages (specified in the information flows) providing the necessary details to enable MSC Server assisted mid-call feature.

---

## 5 Architecture model and reference points

### 5.1 Overview

IMS Service Continuity provides intra-UE transfers of one or more components of IMS multi media sessions across different Access Networks. When SRVCC enhanced with ATCF is used, IMS Service Continuity may be executed in the serving network (visited if roaming) or in the home network. In addition, Service Continuity enables adding, deleting, and transferring media flows of IMS multi-media sessions or transferring whole IMS multi-media sessions across multiple UEs having IMS subscriptions under the same operator.

NOTE: For IMS emergency service, IMS Service Continuity is a serving network (visited if roaming) based IMS application.

The UE shall not invoke Inter-UE Transfer procedures while engaged in an emergency call.

### 5.2 Reference Architecture for non emergency session

#### 5.2.1 General

IMS Service Continuity requires a Service Centralization and Continuity (SCC) AS, which is an Application Server as described in TS 23.228 [4], and a UE with SC capabilities. When SRVCC enhanced with ATCF is used, an Access Transfer Control Function (ATCF) and an Access Transfer Gateway (ATGW) may be used in the serving network (visited if roaming). For the support of IMS sessions with CS media, refer to the reference architecture in TS 23.292 [5], clause 5.2; the functions of ICS and SC are specified as optional functions co-located in the SCC AS in this release.

OMA Device Management [7] is used between the SCC AS and the UE for provisioning of operator policy for Access Transfer.

#### 5.2.2 Architecture when using ATCF enhancements

Figure 5.2.2-1 provides the reference architecture for SRVCC using the ATCF enhancements (non-emergency session). The figure only depicts the specific reference points for the ATCF. For other reference points of the general architecture, refer to the reference architecture in TS 23.292 [5], clause 5.2.

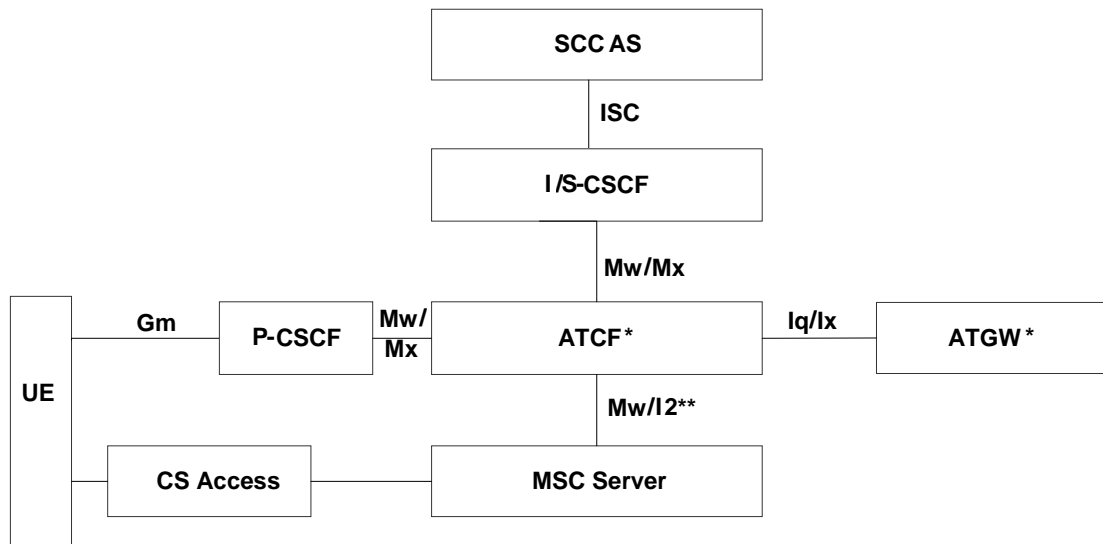

\*: Location of functionality depends on deployment and collocation scenario

\*\* : Reference point dependent on MSC Server capability

**Figure 5.2.2-1: IMS Service Centralization and Continuity Reference Architecture when using ATCF enhancements**

If the MSC Server is not enhanced for ICS, the interface between MSC Server and ATCF is Mw.

If the MSC Server is enhanced for ICS, the interface between MSC Server and ATCF is I2.

If the ATCF is co-located with P-CSCF, the interface between ATCF and ATGW is Iq, according to TS 23.334 [30].

If the ATCF is co-located with IBCF, the interface between ATCF and ATGW is Ix, according to TS 29.162 [31].

For CS to PS SRVCC scenarios, the interface between MSC Server and ATCF is I2.

## 5.3 Functional Entities

### 5.3.1 SCC AS

The SCC AS provides IMS-based mechanisms for enabling service continuity of multimedia sessions.

For IMS Service Continuity, the SCC AS implements the following functionalities:

- **Access Transfer:** The SCC AS uses the ISC reference point towards the S-CSCF for execution of the Access Transfer. The SCC AS performs the following for enablement and execution of Access Transfers:
  - analyzes the information required for Access Transfer as described in the procedure section and decides which Access Transfer scenario should be executed; it rejects the Access Transfer request if it is not aligned with the operator policy;
  - retrieves from the HSS after third party registration the C-MSISDN bound to the IMS Private User Identity stored in the user profile in the HSS;
  - correlates the Access Transfer request with the anchored session, using information provided in the incoming SIP INVITE;
  - correlates the Access Leg created by Access Transfer Update message from the ATCF with the Remote Leg;



- when third-party register is received (as a result of a UE is registering) and this third-party register is related to a contact address for which SRVCC is provided, clears any existing STN-SR that has been set and provides to the HSS:
  - home-network configured STN-SR if a third-party register without a STN-SR is received; or
  - STN-SR received in a third-party register different from the existing STN-SR that has been set into HSS;
- when an ATCF is used, provides after successful IMS registration procedure the C-MSISDN and a routable Access Transfer Update - Session Transfer Identifier (ATU-STI) to the ATCF;
- executes the transfer of the IMS session between different access networks;
- implements 3rd party call control (3pcc) upon session establishment;
- provides Access Transfer specific charging data;
- decides based on analysis of the various service continuity related input factors, whether to update provisioned operator policy for Access Transfer;
- generates and updates operator policy by sending operator policy to the UE via OMA DM [7] including the priority between the operator policy and user preferences that could be used also to initiate Access Transfer procedure for ongoing sessions.
- in case it supports vSRVCC it provides information to the MSC related whether the most recently active bi-directional sessions is voice or voice + video to determine if it should perform vSRVCC or SRVCC procedure.
- if CS to PS SRVCC is supported and indicated by the MSC Server, the SCC AS provides to MSC Server:
  - updated ATCF management URI for the UE's IMS registration when available.
  - updated registration status of the UE's IMS registration.
- **Inter-UE Transfer:** The SCC AS performs the functions for enablement and execution of Inter-UE Transfer procedures:
  - executes the IMS Inter-UE Transfer related procedures between different UEs having IMS subscriptions under the same operator connected via the same or different access networks;
  - authorizes requests for IUT procedures;
  - when UEs from different subscriptions are involved in a Collaborative Session, assures that UEs do not create subsequent Collaborative Sessions for media belonging to Access Legs of the original Collaborative Session, by adding an indication to the IUT request;
  - when aware that a Hosting SCC AS already exists for a Collaborative Session, forwards received IUT requests to that SCC AS;
  - provides Inter-UE Transfer specific charging data.
- **Terminating Access Domain Selection (T-ADS):** In addition to T-ADS specified in TS 23.292 [5].

For a terminating session, the SCC AS may select more than one contact amongst multiple registered contacts for each selected UE of the SC User and may split the session into sessions directed to the selected contacts.

For multiple contacts in the PS domain, the SCC AS shall be able to select one or more types of access networks through which the session shall be terminated. In this case, the SCC AS includes additional information within the session request(s) to ensure that the corresponding session is terminated via the selected access network type(s).

For Inter-UE Transfer procedures to a target UE, the SCC AS shall execute T-ADS to select one or more contacts to establish one or more access legs or to reuse one or more access legs belonging to the same Collaborative Session towards the target UE for the transferred media flow(s).

T-ADS in SCC AS may be used in order to enforce user preferences between 3GPP and non-3GPP access networks.

UE assisted T-ADS (UE T-ADS) may be used in order to enforce user preferences for CS bearer or PS bearer for voice/video on 3GPP accesses.

- **Handling of multiple media flows:** The SCC AS provides functionality to combine and/or split media flows over one or more Access Networks as needed for Session Transfers, session termination, or upon request by the UE to add media flows over an additional Access Network during the setup of a session, or upon request by the UE to add and/or delete media flows over one or more Access Networks to existing sessions.

When handling media flows of an IMS session, the SCC AS takes into account the services associated with the session.

## 5.3.2 IMS Service Continuity UE

### 5.3.2.1 Access Transfer Functions

For supporting Access Transfer, the UE provides the following functions:

- Stores and applies operator policy for Access Transfer.
- Initiates Access Transfer procedure based on trigger criteria including the current operator policy, user preferences and the Local Operating Environment Information, providing the necessary details for conducting an Access Transfer operation to the SCC AS.

When supporting CS to PS SRVCC, the UE provides the following functions:

- Retrieves and stores STI-rSR in conjunction with the IMS registration.
- Provide the network with information of pre-allocated ports and codec information to be used during CS to PS access transfer.

### 5.3.2.2 IUT Functions and Roles

#### 5.3.2.2.1 Functions

For supporting Inter-UE Transfer, the UE may provide the following functions:

- Discovers the target UE(s) for Inter-UE Transfer;
- Initiates Inter-UE Transfer procedures based on user input.
- Takes the role of a Controller UE within a Collaborative Session.

Any IMS UE can take the role of a Controllee UE.

#### 5.3.2.2.2 Controller UE Role

- The Controller UE can initiate the addition of a media flow to a Collaborative Session, on any of the Controllee UEs already involved in the Collaborative Session.
- The Controller UE can initiate the modification of a media flow that is part of a Collaborative Session it controls.
- The Controller UE can initiate the release of a media flow that is part of a Collaborative Session it controls.
- The Controller UE keeps track of all the UEs and about the state of the media flows which are part of a Collaborative Session it controls. That means it remains aware about the media flows that are established, as well as about the media used for those.
- The Controller UE is the one to accept or refuse requests for media additions initiated by the remote party for a Collaborative Session it controls. In case it accepts a remote party initiated media addition, the controller decides on which terminal the media shall be added.
- The Controller UE for a Collaborative Session can initiate Inter-UE Transfer of one or more of the media flows of the Collaborative Session.

- The Controller UE can initiate the release of a Collaborative Session.
- The Controller UE can add into a Collaborative Session it controls a UE not yet involved in this Collaborative Session.
- The Controller UE can initiate the transfer of Collaborative Session Control.

#### 5.3.2.2.3 Controllee UE Role

Any IMS UE can take the role of a Controllee UE. In this role the Controllee UE can:

- initiate the modification of a media flow which terminates on it.
- initiate the release of a media flow which terminates on it.
- accept or refuse:
  - media modifications initiated by the remote party or by the Controller UE or other Controllee UEs of the same Collaborative Session, for media flow(s) it terminates;
  - media additions initiated by the Controller UE or other Controllee UEs of the same Collaborative Session or by a remote party (in the last case, this assumes that the Controller UE has accepted the addition and selected the Controllee UE);
  - media transfers initiated by the Controller UE or other Controllee UEs of the same Collaborative Session, for which the Controllee UE is the target.
- initiate IUT Media Control Related Procedures if the Controllee UE is capable of IUT.

### 5.3.3 Emergency Access Transfer Function (EATF)

The Emergency Access Transfer Function (EATF) provides IMS-based mechanisms for enabling service continuity of IMS emergency sessions. It is a function in the serving (visited if roaming) IMS network, providing the procedures for IMS emergency session anchoring and PS to CS Access Transfer. The EATF acts as a routing B2BUA which invokes third party call control (3pcc) for enablement of Access Transfer.

The EATF performs the session continuity when the Access Transfer request indicated by the E-STN-SR is received.

### 5.3.4 Access Transfer Control Function (ATCF)

#### 5.3.4.1 General

The Access Transfer Control Function (ATCF) is a function in the serving (visited if roaming) network. When (v)SRVCC enhanced with ATCF is used, the ATCF is included in the session control plane for the duration of the call before and after Access Transfer.

The ATCF may be co-located with one of the existing functional entities within the serving network (i.e. P-CSCF or IBCF).

NOTE 1: Anchoring in the ATCF for sessions that include audio and video media may not provide delay benefits for the video part given the additional delay required for video codec negotiation when the UE moves to the CS domain.

NOTE 2: Anchoring Support of CS to PS SRVCC in the serving network requires that there is no other media gateway on the media path between UE and ATGW.

The ATCF shall:

- based on operator policy, decide to:
  - allocate a STN-SR;
  - include itself for the SIP sessions; and

- instruct the ATGW to anchor the media path for originating and terminating sessions;
- keep track of sessions (either in alerting state, active or held) to be able to perform Access Transfer of the selected session;
- perform the Access Transfer and update the ATGW with the new media path for the (CS) access leg, without requiring updating the remote leg;
- after Access Transfer, update the SCC AS that Access Transfer has taken place to ensure that T-ADS has the information on the currently used access;
- handle failure cases during the Access Transfer.

After access transfer, and based on local policy, the ATCF may remove the ATGW from the media path. This step requires remote end update.

If MSC Server assisted mid-call feature is used, then the SCC AS provides required session state information on alerting, held and/or conference state for any transferred session.

The ATCF shall not modify the dynamic STI that is exchanged between the UE and SCC AS.

When CS to PS SRVCC is supported, the ATCF shall:

- Provide a STI-rSR (unique to the ATCF) to the UE.
- Handle CS to PS Access Transfer notification and preparation requests from the MSC Server.

#### 5.3.4.2 ATCF inclusion

The following implementation methods could be used to determine if the ATCF should be including itself during registration:

- If UE is roaming, based on the roaming agreement (e.g., home operator also support SRVCC enhanced with ATCF in SCC AS and HSS).
- Based on local configuration (e.g. if operator always deploys IBCF, MGCF etc. with media anchor for inter-operator calls).
- Based on registered communication service and media capabilities of the UE.
- Based on the access type over which the registration request is sent.

NOTE: If the ATCF decides not to include itself during registration, it will not be possible to use the ATCF enhancements during and after the registration period.

The following implementation methods could be used to determine if the ATCF should anchor the media in the ATGW for an originating or terminating call:

- Based on whether the UE is roaming or not.
- Based on local configuration (e.g., if operator always deploys IBCF, MGCF etc. with media anchor for inter-operator calls).
- Based on the communication service and media capabilities used for the session.
- Based on knowledge of which network the remote party is in.
- Based on the access type over which the request or response is sent.
- Based on the SRVCC capability of the UE.

The decision to anchor media at the ATGW, during the session origination or termination, can occur either at receipt of SDP offer or after a round trip of SIP signalling with the remote party depending on the method(s) used for determining whether to anchor media or not.

### 5.3.5 Access Transfer Gateway (ATGW)

The Access Transfer Gateway (ATGW) is controlled by the ATCF and, if SRVCC enhanced with ATCF is used, stays in the session media path for the duration of the call and after Access Transfer, based on the local policy of the serving network.

It supports transcoding after SRVCC handover in case the media that was used prior to the handover is not supported by the MSC server.

Depending on placement of the ATCF, different physical nodes may be considered for the ATGW, i.e. IMS-AGW or TrGW.

### 5.3.6 HSS

The HSS shall allow the SCC AS to update the user profile with a new STN-SR. In the case the ATCF is involved, the STN-SR will address the ATCF, otherwise, it will address the SCC AS.

### 5.3.7 MSC Server

The MSC Server enhanced for SRVCC shall not provide announcement or other in-band media for any calls that have been transferred or are in the process of being transferred (being in active, held or alerting state).

## 5.4 Signalling and bearer paths for IMS Service Continuity

### 5.4.1 General

The SCC AS is inserted in the signalling path of all the IMS user's sessions; the SCC AS behaves as a SIP-AS as described in TS 23.228 [4] to set up a 3pcc to control the bearer path of the session for enablement and execution of Session Transfer.

### 5.4.2 Sessions with PS media flow(s)

Figure 5.4.2-1 shows 3pcc at the SCC AS, for enablement and execution of Session Transfers, when the media flow(s) for the Access Leg is established via IP-CAN.

The figure is for illustration of the 3pcc at the SCC AS and its use for Session Transfer; hence it only shows the signalling and bearer components relevant to the enablement and execution of Session Transfers.

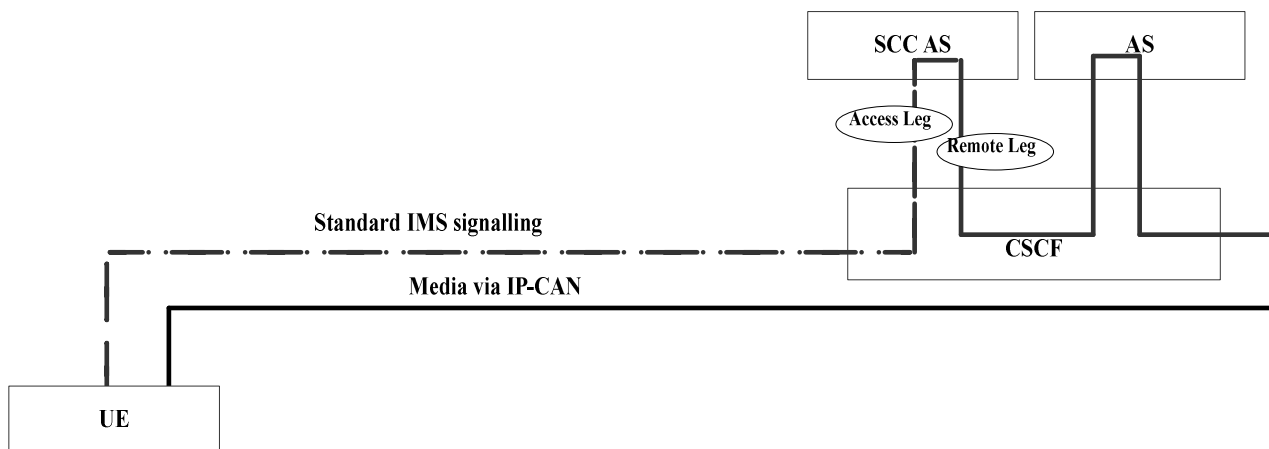

Figure 5.4.2-1: Signalling and bearer paths for sessions with PS media

### 5.4.2a Sessions with PS media flow(s) using ATCF

Figure 5.4.2a-1 shows 3pcc at the ATCF and SCC AS, for enablement and execution of Access Transfers, when the media flow(s) for the Access Leg is established via IP-CAN.

The figure is for illustration of the 3pcc at the ATCF and SCC AS and its use for Access Transfer; hence it only shows the signalling and bearer components relevant to the enablement and execution of Access Transfers.

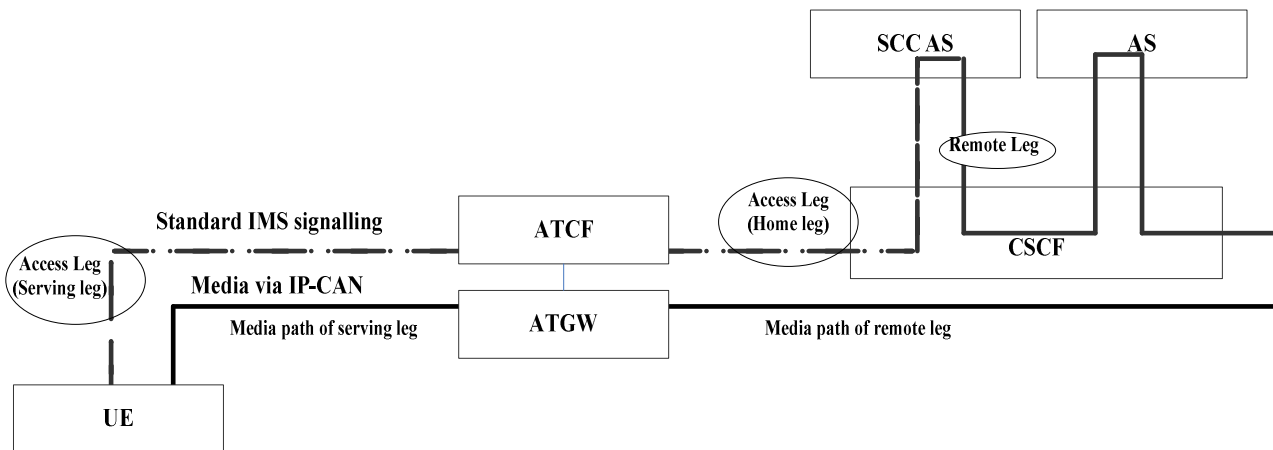

Figure 5.4.2a-1: Signalling and bearer paths for sessions with PS media using ATCF

### 5.4.3 Sessions with CS media

For details of signalling and bearer paths when the media for the Access Leg is established via the CS access, see TS 23.292 [5], clause 7.1.1. For illustration of 3pcc at the SCC AS, for enablement and execution of Session Transfers, with use of the Gm reference point, the I1 reference point and when not using Gm or I1 for service control signalling respectively, refer to figures 7.1.1-1, 7.1.1-2 and 7.1.2-1, in TS 23.292 [5], clause 7.1.

#### 5.4.3a Sessions with CS media flow(s) using ATCF

Figure 5.4.3a-1 shows 3pcc at the ATCF and SCC AS, for enablement and execution of CS to PS Access Transfers, when the media flow(s) for the Access Leg is established via CS.

The figure is for illustration of the 3pcc at the ATCF and SCC AS and its use for Access Transfer; hence it only shows the signalling and bearer components relevant to the enablement and execution of Access Transfers.

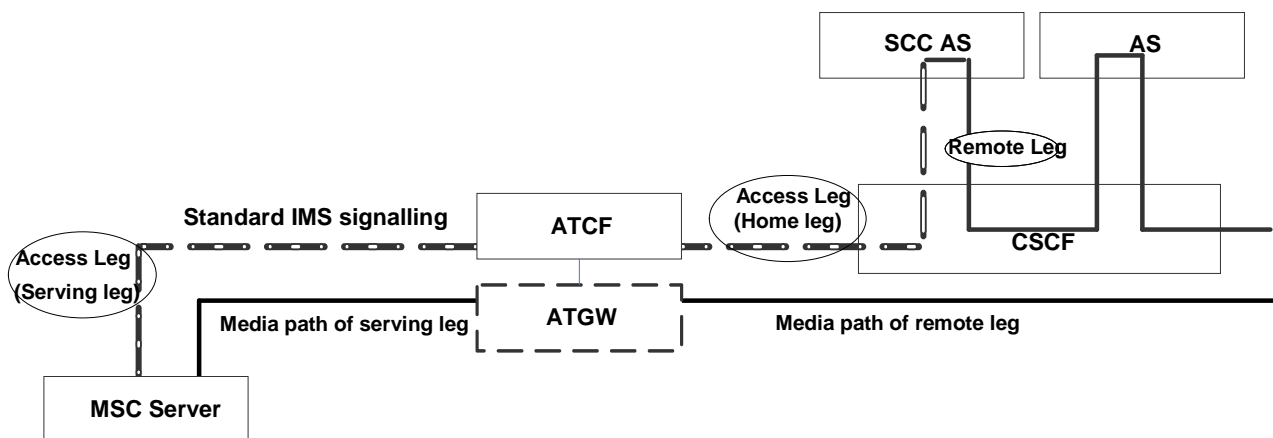
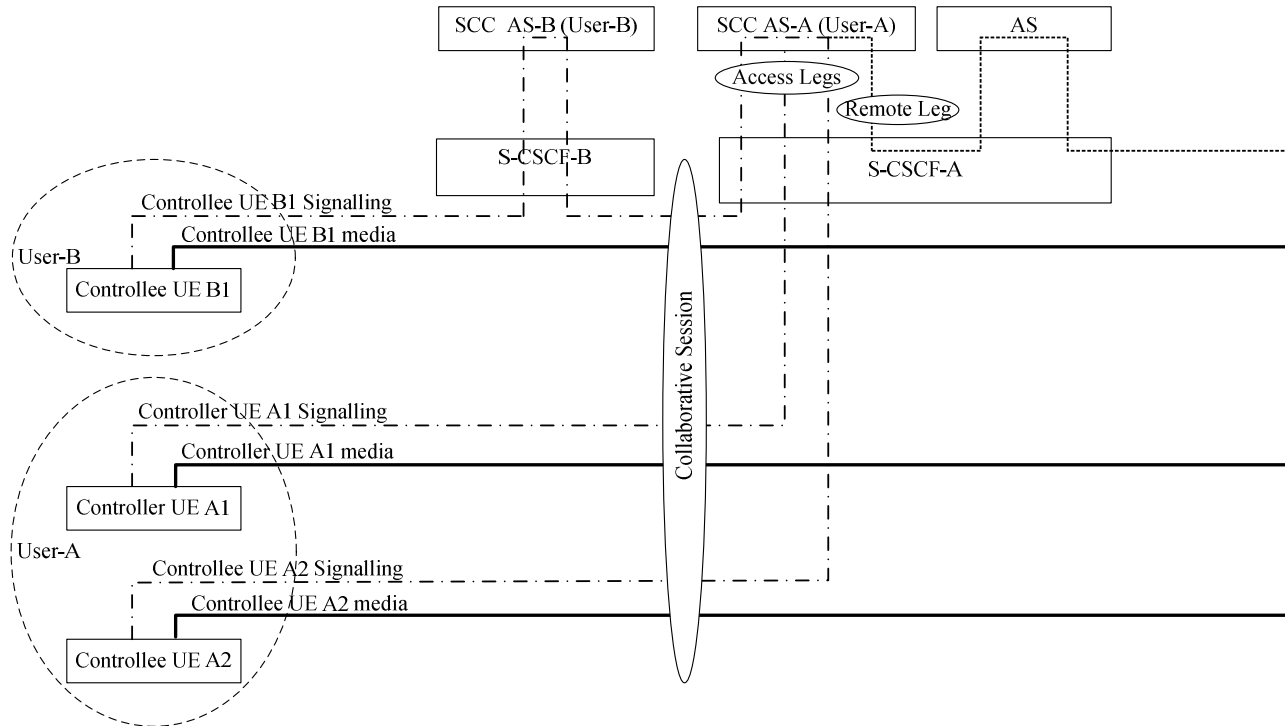

Figure 5.4.3a-1: Signaling and bearer paths for sessions with CS media using ATCF

NOTE: If the media path is not anchored in the ATGW, the media will go directly to the remote side.

## 5.5 IUT Collaborative Sessions

IUT for service continuity allows a multi media session to be split on the local end across two or more UEs that are part of a Collaborative Session. UEs that are part of a single Collaborative Session may belong to different IMS subscriptions under the same operator. Figure 5.5-1: provides signalling and bearer architecture for a Collaborative Session that involves three UEs belonging to two IMS subscriptions.



**Figure 5.5-1: Collaborative Session Signalling and Bearer architecture**

NOTE: The media in Controller UE A1 is optional.

The Controller UE (UE A1) provides the control for a Collaborative Session using IMS signalling on an Access Leg between Controller UE A1 and SCC AS-A. The Controller UE may transfer one or more media flow(s) to one or more target UEs (including itself), by using Collaborative Session control (e.g. in the SDP).

Controllee UE A2 and Controllee UE B1 provide the control for the media established on each respective UE using IMS signalling on the Access Leg associated for the media.

SCC AS-A in this figure is the Hosting SCC AS of the illustrated Collaborative Session. SCC AS-A combines the media descriptions and Collaborative Session Control on the Access Legs and presents one Remote Leg towards the remote end.

SCC AS-B in this figure relays service requests associated with the illustrated Collaborative Session towards SCC AS-A using standard IMS signalling. In order for SCC AS-B to determine that it shall simply relay service requests towards the Hosting SCC AS rather than execute them, handling of requests is applied as follows:

- if an SCC AS acts as the Hosting SCC AS of a Collaborative Session, it shall include a piece of service interaction information in the SIP signalling messages sent to other SCC-ASs, indicating that the Service Feature "Collaborative Session" has been performed;
- if an SCC AS receives a SIP message containing indication that the Service Feature "Collaborative Session" has been performed, it shall relay all service requests associated with the Collaborative Session towards the SCC AS that has inserted this indication.

## 5.6 Reference Architecture for SRVCC emergency session

To allow SRVCC for IMS emergency session with PS to CS Access Transfer procedures, an EATF is used for emergency sessions anchoring and transferring. For the overall IMS emergency reference architecture with EATF, refer to the reference architecture in TS 23.167 [23].

---

# 6 Procedures and flows for Access Transfer

## 6.0 Introduction

Some of the following figures contain a box labelled CS/IMS Intermediate Nodes. This is abstraction for CS/IMS functional elements that exist between the UE and the SCC AS which could include amongst others MSC Server enhanced for ICS, MSC Server enhanced for SRVCC or an MGCF and an MSC Server not enhanced for ICS.

## 6.1 Registration

### 6.1.1 General

Whenever the UE acquires IP connectivity via an IP-CAN, the UE registers in the IMS as defined in TS 23.228 [4]. The user profile contains a C-MSISDN which is bound to the IMS Private User Identity. The S-CSCF follows the procedures defined in TS 23.218 [13] for performing 3rd party registration towards the SCC AS.

When using CS access for media, the UE may be registered in IMS as specified in TS 23.292 [5].

When the SCC AS receives a 3rd party registration per procedures defined in TS 23.218 [13], the SCC AS shall obtain the C-MSISDN from the HSS. If the C-MSISDN is associated with any ongoing session(s), the SCC AS shall bind all the unique identities associated with the SIP Registration e.g. GRUUs, contact address, etc with the session identifier of the ongoing session.

If the SCC AS receives a third-party register without a STN-SR pointing to the ATCF and this third-party register is related to a contact address for which SRVCC is provided, the SCC AS shall clear any existing STN-SR that has been set in the HSS and provide a home network configured STN-SR. The SCC AS shall ensure that the home network configured STN-SR can be restored in case of SCC AS failure (e.g. by storing it separately in the HSS as transparent data).

### 6.1.2 Registration using ATCF enhancements

To ensure that the MSC Server selects the correct ATCF during SRVCC procedure, a routable STN-SR pointing to the ATCF shall be provided to the MME before SRVCC procedure is triggered.

The ATCF shall allocate the STN-SR when the user performs initial registration in the IMS. The STN-SR shall be provided through IMS and via third-party registration to the SCC AS. Depending on operator policy, the SCC AS may interrogate the HSS to know if the user is subscribed for SRVCC (via STN-SR) and if the UE is SRVCC capable. If both conditions are met, or based on operator policy, the SCC AS shall further provide the STN-SR to the HSS if the received STN-SR is different from the existing one that has been set, which in turn shall update the MME/SGSN.

The following figure shows an example of IMS registration flow where the ATCF provides the STN-SR to the home network. Existing IMS Registration procedures described in TS 23.228 [4] are used to register the user in IMS.



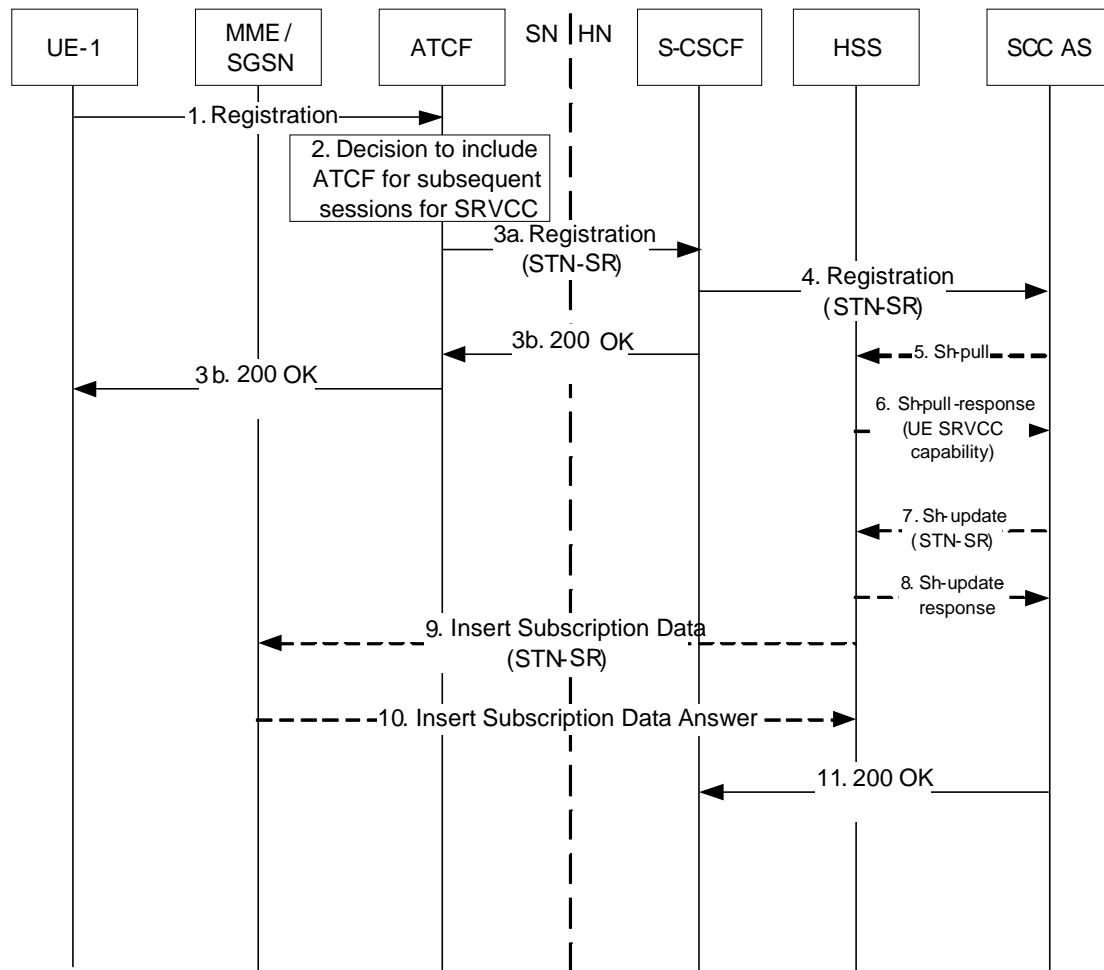

**Figure 6.1.2-1: IMS Registration using ATCF enhancements**

1. UE-1 sends an initial SIP REGISTER request to home network via ATCF (P-CSCF and I-CSCF not shown in flow).

NOTE 2: If the UE receives a new IP address, the UE will perform a new registration in the IMS according to TS 23.228 [4] and a new ATCF may be selected.

2. ATCF decides, based on operator policy and if the home network supports SRVCC enhanced with ATCF, to allocate a STN-SR. The ATCF includes itself in the signalling path for subsequent messages during the registration period. Additionally to the STN-SR, the ATCF allocates an ATCF management URI that can be used by SCC AS to address the ATCF directly.

3. If allocated, the STN-SR and ATCF management URI are included in the request forwarded to the S-CSCF.

NOTE 3: Service level agreements are used to understand whether the home network supports SRVCC enhanced with ATCF. In addition, as fall back, the ATCF will as well understand whether SRVCC enhanced with ATCF is activated in the SCC AS by the reception of C-MSISDN/ATU-STI.

4. The S-CSCF sends the SIP REGISTER request to the SCC AS according to the third-party registration procedure.

NOTE 4: In case of multiple registrations from the UE from multiple accesses, the SCC AS will only receive and use one STN-SR, from an ATCF in the mobile network.

5. Depending on the operator policy, the SCC AS sends Sh-Pull message to the HSS in order to know whether the UE is SRVCC capable, and to retrieve the STN-SR stored in the HSS.

6. The HSS replies to the SCC AS with a Sh-Pull Response message including the UE SRVCC capability if available, and the STN-SR if available.

7. The SCC-AS determines, based on operator policy or based on the outcome of Sh-pull procedure, that the user is subscribed for SRVCC via the presence of STN-SR and that the UE is SRVCC capable. If the STN-SR from the HSS is different from the STN-SR received from the ATCF, the SCC AS sends a Sh-Update to provide the STN-SR received from the ATCF to the HSS from the ATCF in order to replace the STN-SR pointing to the SCC AS or the previously stored STN-SR pointing to other ATCF.

NOTE 5: If an ATCF does not exist or the ATCF decided not to be included in step 2, the SCC AS allocates a STN-SR that can be used to route to this SCC AS and provides it to the HSS, thereby replacing any previously stored STN-SR if the user is subscribed for SRVCC. If the user is not subscribed for SRVCC, no STN-SR is set or provided to the MME/SGSN. If a user changes to not being subscribed for SRVCC by the HSS, the HSS deletes the STN-SR from the MME/SGSN.

NOTE 6: SCC AS only needs to update the STN-SR in the HSS at initial registration. If the STN-SR has not changed since previous initial registration, there no update is performed towards MME.

8. The HSS responds by sending Sh-Update Response message to the SCC AS.
9. If for a user subscribed for SRVCC, the HSS received a STN-SR in step7 that is different from the stored STN-SR, it updates the stored STN SR and provides the updated STN-SR to the MME/SGSN. Otherwise this procedure is skipped.
10. The MME/SGSN stores the updated STN-SR and responds to the HSS with Insert Subscriber Data Answer message.
11. The SCC AS returns 200 OK to the S-CSCF.

The SCC AS informs the UE SRVCC capability to ATCF during IMS registration by addressing the ATCF using the ATCF management URI. The SCC AS is able to retrieve the updated UE SRVCC capability status by sending Sh-Pull message to the HSS at any point. If SCC AS detects the UE SRVCC capability change, SCC AS then informs the ATCF about the updated SRVCC capability of the UE and the ATCF stores this information for deciding whether anchoring IMS voice originating sessions at the ATGW or not.

NOTE 7: The trigger for SCC AS to poll the HSS for the updated UE SRVCC capability status is not specified in this release of the specification.

NOTE 8: If the UE switches on/off its SRVCC capability during the lifetime of IMS registration, and the SCC AS has not polled the HSS in the meantime, the SCC AS and ATCF will not have the updated value of SRVCC capability.

## 6.1.3 Registration: CS to PS - Single Radio

### 6.1.3.1 IMS Registration by UE

As a prerequisite for CS to PS SRVCC to be applied, the UE shall be IMS registered over PS. The IMS Registration procedures of clause 6.1.2 apply. The UE shall include a pre-defined port and codec for the voice media that can be used during the access transfer to send downlink media to. The UE shall also include its CS to PS SRVCC capability in the registration request.

Additionally, a dynamic STI-rSR shall be provided to the UE from the ATCF in conjunction to the IMS Registration.

### 6.1.3.2 UE IMS Registration change update

As a prerequisite for CS to PS SRVCC to be applied, the UE shall be attached to an MSC Server enhanced for ICS and IMS-registered via CS access by this MSC Server using I2 reference point, as specified in TS 23.292 clause 7.2.1. In addition, as part of this registration procedure, the MSC Server enhanced for ICS shall indicate to the SCC AS that it needs to be updated with the UE's IMS registration status and/or changes to the ATCF management URI, as described below.

Figure 6.1.3.2-1 provides the procedures of how the MSC Server indicates to the SCC AS to retrieve the UE's IMS registration status and updates to ATCF management URI, and how it is updated with changes.

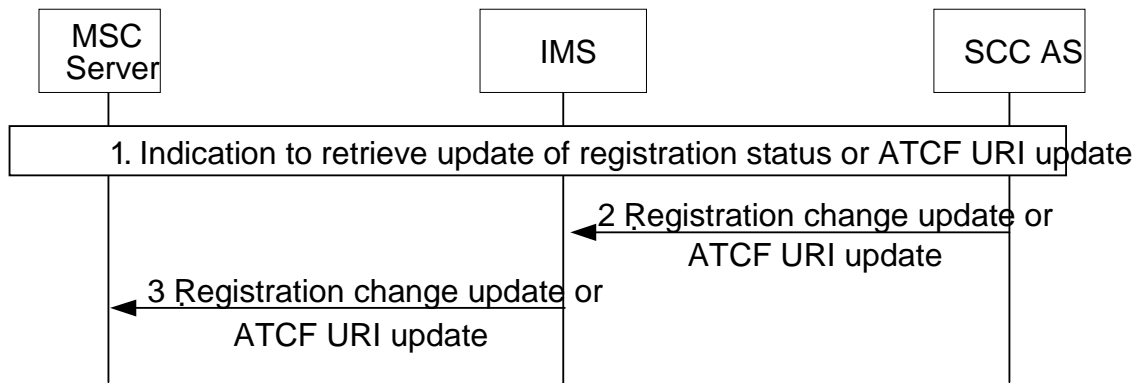

**Figure 6.1.3.2-1: Subscription to UE's IMS registration status**

1. As part of the IMS registration from the MSC Server, the MSC Server may indicate to the SCC AS the wish to be updated with the UE's IMS registration status and/or changes to the ATCF management URI.
- 2-3. If the UE's IMS registration status changes or the ATCF management URI changes for the UE's IMS registration, the SCC AS provides the information to the MSC Server. The UE CS to PS SRVCC capability is also provided in this message and is not updated further.

## 6.2 Origination and Termination

### 6.2.1 Origination

#### 6.2.1.1 Origination Procedures

UE initiated multimedia sessions are anchored at the SCC AS in order to enable IMS Service Continuity. Originating iFC for the SC subscriber results in routing of the session to the SCC AS in the home IMS network, where the SCC AS uses 3rd party call control as per TS 23.228 [4] to initiate a session to the remote party on behalf of the subscriber.

The SCC AS shall be the first Application Server of any Application Servers that need to remain in the path of the call after Session Origination.

#### 6.2.1.2 Originating sessions that use CS media

The UE originates sessions that use CS media by following the procedures specified in TS 23.292 [5], clause 7.3.2 Originating sessions that use CS media.

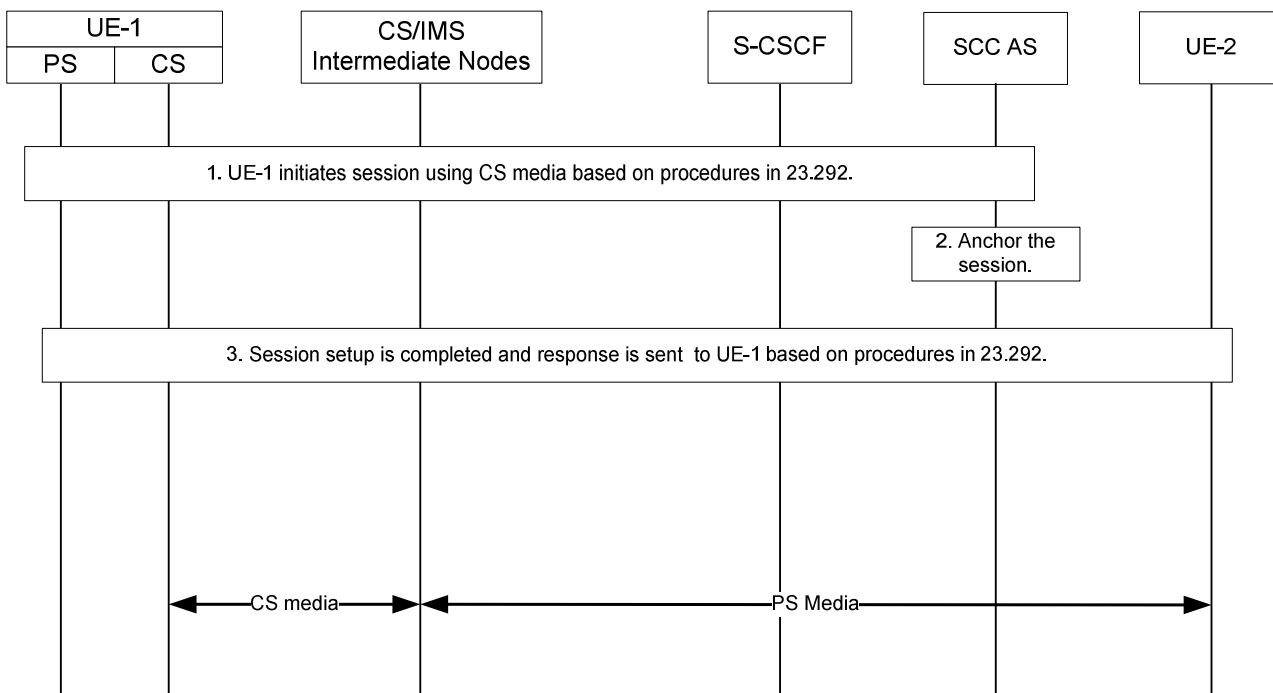

**Figure 6.2.1.2-1: Originating session that uses CS media**

1. UE-1 initiates a multimedia session to UE-2 and makes use of CS media. UE-1 sends the request to the SCC AS following the procedures specified in TS 23.292 [5], clause 7.3.2 Originating sessions that use CS media, for setting up CS bearer, anchoring the session at the SCC AS, merging multiples legs if necessary, and forwarding the combined session request to UE-2.
2. The SCC AS anchors the session. A dynamic STI is assigned for the anchored session.
3. The SCC AS completes session setup to UE-2 and sends a response to UE-1 based on the procedures specified in TS 23.292 [5]. The dynamic STI is communicated between the SCC AS and UE-1 if possible.

The session is set up with CS media. The session may also include PS media flow(s).

### 6.2.1.3 Originating sessions that use only PS media flow(s)

Existing Mobile Origination procedures described in TS 23.228 [4] are used to establish a session.

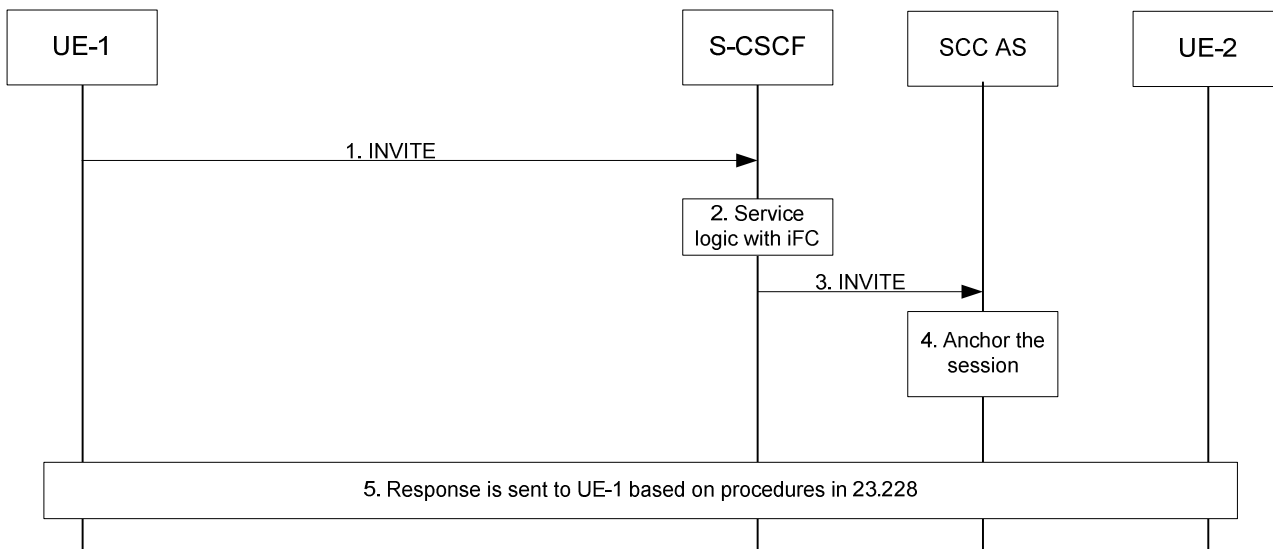
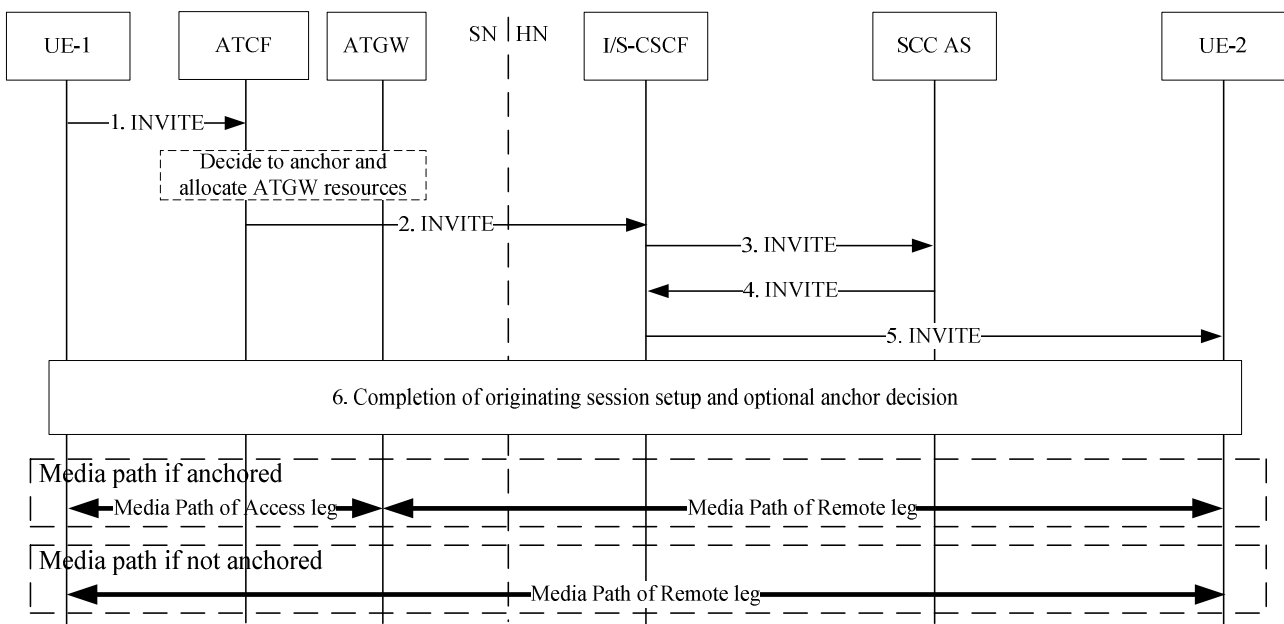

**Figure 6.2.1.3-1: Originating session that uses only PS media**

1. UE-1 initiates an IMS multimedia session to UE-2 and uses only PS media flow(s). The request is forwarded to S-CSCF following normal IMS session set up procedures.
- 2~3. The service logic with iFC causes the request to be forwarded to the SCC AS for anchoring the sessions to enable Session Transfer.
4. The SCC AS anchors the session. An STI is assigned for the anchored session.
5. The SCC AS completes the session setup to UE-2 and sends a response to UE-1.

### 6.2.1.4 Originating sessions for (v)SRVCC that use ATCF enhancements

Figure 6.2.1.4-1 shows an originating session when the ATCF has previously been included in the signalling path (see clause 6.1.2). If the ATCF was not included in the signalling path then existing Mobile Origination procedures described in previous clauses and TS 23.228 [4] are used.



**Figure 6.2.1.4-1: Originating session that uses only PS media (ATCF in signalling path).**

1. UE-1 initiates an IMS multimedia session to UE-2 and uses only PS media flow(s). The initial SIP INVITE request goes through the ATCF in the serving network. The ATCF may decide whether to anchor the session and allocate if needed ATGW resources to it.
- 2~5. ATCF forwards the initial SIP INVITE request, which is routed towards the UE-2.
6. Completion of originating session setup. As part of this step, the following is done:
  - If not already done, the ATCF may decide, based on information not available earlier in the procedure, to anchor the session and allocate ATGW resources for voice media or voice and video media and anchor the voice media or voice and video media in the ATGW. The ATCF will in such case update the far end with the media information of the ATGW in another offer/answer exchange (this may be done as part of other required session update).

NOTE 1: The ATCF is not modifying the dynamic STI that is exchanged between the UE and SCC AS.

NOTE 2: The Access Leg for the control has now been established between the UE and the SCC AS.

### 6.2.1.5 Originating sessions for CS to PS - Single Radio

The CS origination is done according to TS 23.292 [5], clause 7.3, with the addition that the call is routed through the ATCF.

Once the session is established, the ATCF will act as the access transfer function in the call.

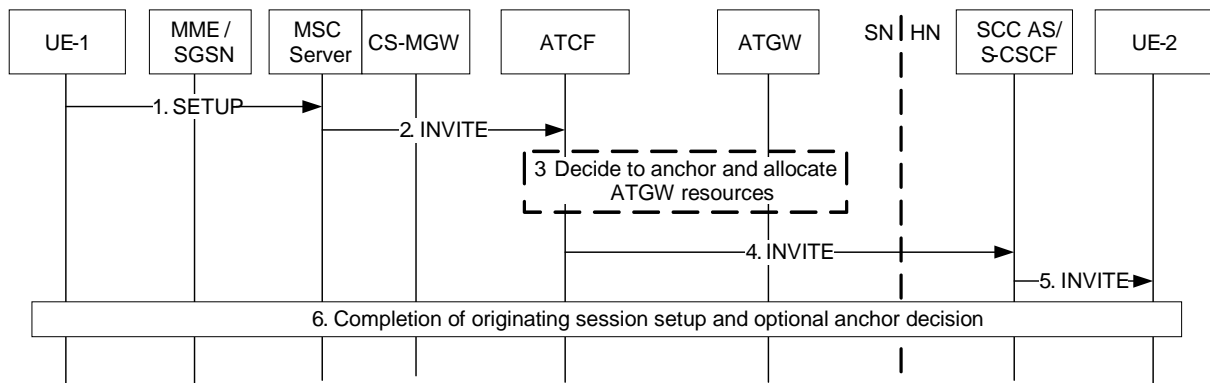

**Figure 6.3.3.5.3-1: Originating call setup over CS through ATCF**

1. The MSC Server receives the CS setup message.
2. The MSC Server initiates an INVITE origination according to TS 23.292 [5] clause 7.3, with the addition that it includes the ATCF in the path during the origination (based on the retrieved ATCF management URI). The INVITE shall include the C-MSISDN to the ATCF for further correlation purposes.
3. The ATCF may decide whether to anchor the media session and allocate if needed ATGW resources to it. Media anchoring criteria used for ATCF enhancements apply.
- 4-5. The call setup proceeds and is routed to the remote UE-2.
6. The call setup is completed.

## 6.2.2 Termination

### 6.2.2.1 Termination Procedures

IMS multimedia sessions towards SC subscribers in the PS or in the CS domain are anchored at the SCC AS to enable IMS Service Continuity. The execution of terminating iFC results in routing of the sessions to the SCC AS in the home IMS network, where the SCC AS uses 3rd party call control as per TS 23.228 [4] to terminate the session to the SC subscriber. The sessions may be delivered to the UE via the PS or CS access.

The SCC AS shall be the last Application Server of any Application Servers that need to remain in the path of the call after Session Termination.

### 6.2.2.2 Terminating sessions that use CS media

The procedures specified in TS 23.292 [5], clause 7.4.2 Terminating sessions that use CS media shall be followed to terminate sessions that use CS media to the SC subscriber.

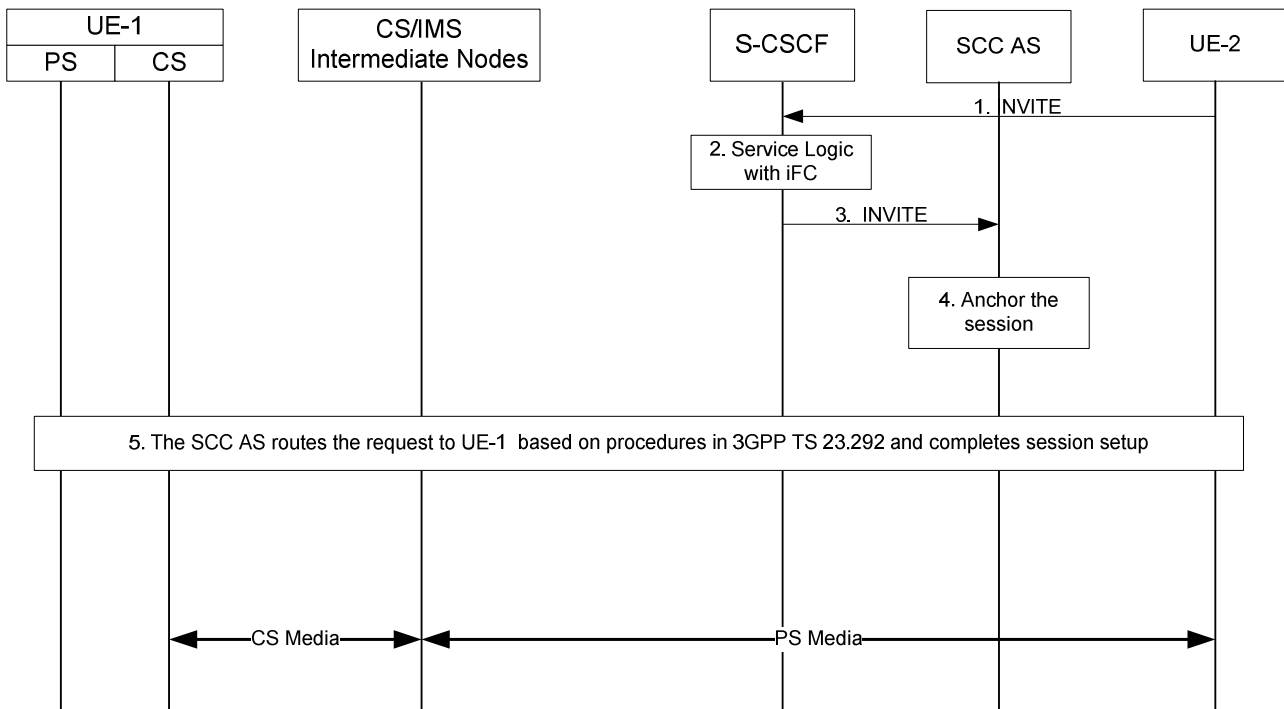

**Figure 6.2.2.2-1: Terminating session that uses CS media**

1. A request is received at S-CSCF serving UE-1 following standard IMS session set up procedures.
- 2 ~ 3. The service logic with iFC causes the request to be forwarded to the SCC AS so that the session is anchored for enabling Session Transfer.
4. The SCC AS anchors the incoming session. A dynamic STI is assigned for the anchored session.
5. The SCC AS forwards the request to UE-1 based on the procedures specified in TS 23.292 [5] for setting up CS bearer and splitting the media flow(s) if necessary. The dynamic STI is communicated between the SCC AS and the UE if possible. If the SCC AS decided to split the non-speech media and speech media for a certain UE, the T-ADS in the SCC AS delivers the split session only to this particular UE. The SCC AS uses the C-MSISDN for correlation.

The session is set up with CS media. The session may also include PS media flow(s).

### 6.2.2.3 Terminating sessions that use only PS media flow(s)

Existing Mobile Termination procedures described in TS 23.228 [4] are used to establish a session towards a SC subscriber.

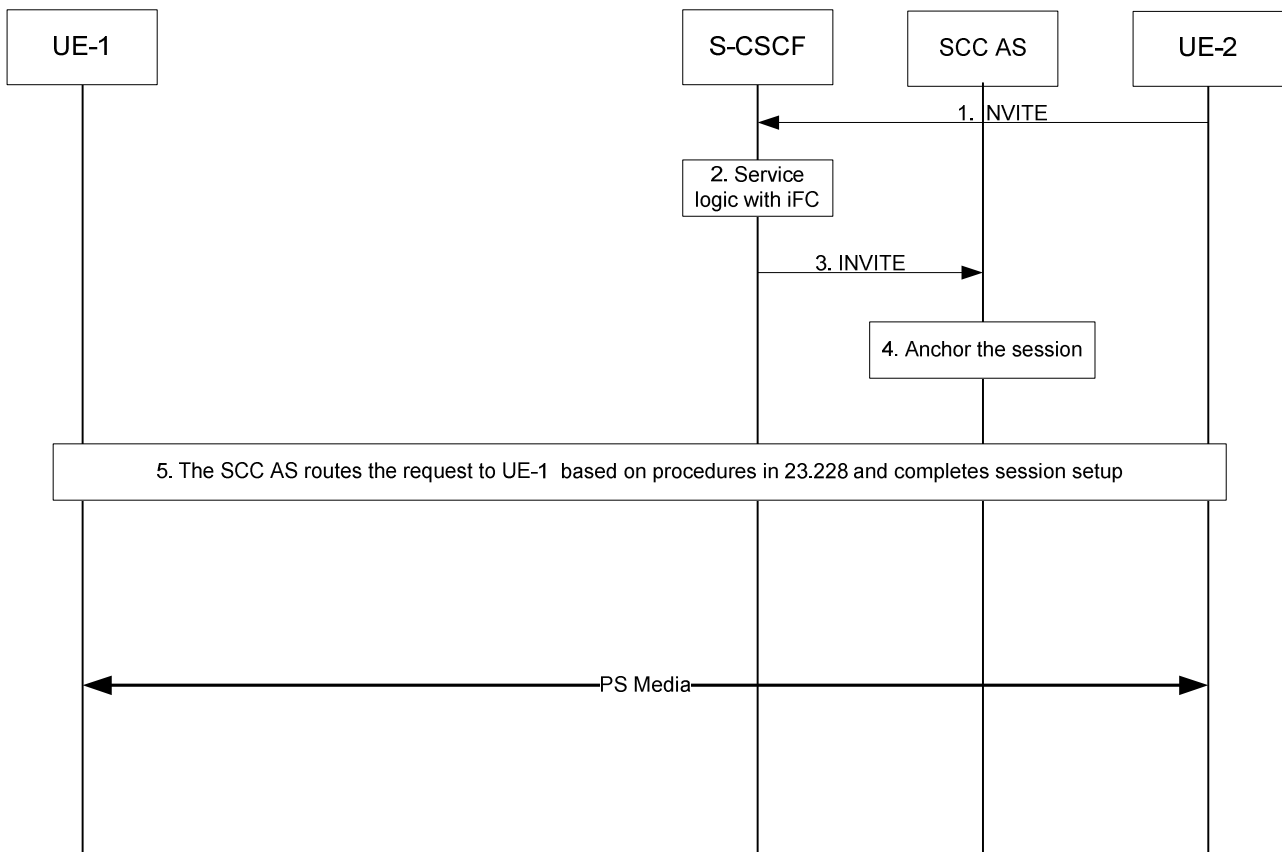

**Figure 6.2.2.3-1: Terminating session that uses only PS media**

1. The request is received at S-CSCF following normal IMS session set up procedures.
- 2 ~ 3. The service logic with iFC causes the request to be forwarded to the SCC AS so that the session can be anchored for potential session transfer.
4. The SCC AS anchors the session. An STI is assigned for the anchored session.
5. The SCC AS determines that the session is terminated to UE-1 with PS media flow(s) only and routes the request to UE-1.

#### 6.2.2.4 Terminating sessions over Gm where speech media is not accepted by the UE

If the SCC AS includes only bi-directional speech media, the procedures specified in TS 23.292 [5], clause 7.4.3 shall be followed.

If the SCC AS includes non-speech media in the request, in addition to bi-directional speech or CS media and if the UE decides to only accept the non-speech media, the UE returns a response to IMS that only bi-directional speech or CS media is rejected. The SCC AS, upon reception of the response, splits the non speech media from the bi-directional speech or CS media for this UE. The T-ADS in the SCC AS re-attempts the terminating call setup directly towards the same UE over CS domain if possible. The SCC AS uses the C-MSISDN for correlation.

#### 6.2.2.5 Terminating sessions for (v)SRVCC that use ATCF enhancements

Figure 6.2.2.5-1 shows a terminating session when the ATCF has previously been included in the signalling path (see clause 6.1.2). If the ATCF was not included in the signalling path then existing Mobile Termination procedures described in previous clauses and TS 23.228 [4] are used.



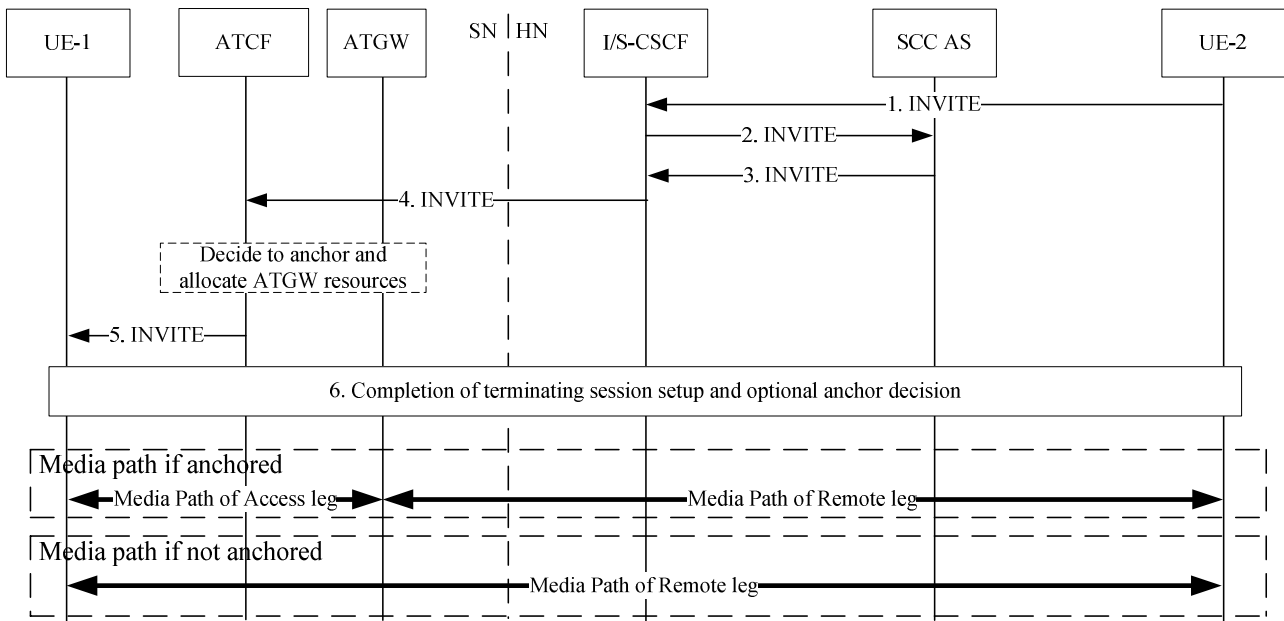

**Figure 6.2.2.5-1: Terminating session that uses only PS media (ATCF in signalling path)**

- 1-2. A Terminating session is sent towards UE-1 from UE-2. The initial SIP INVITE request is routed via the I/S-CSCF to the SCC AS.
3. The SCC AS performs necessary T-ADS procedures according to clause 5.3.1, and routes the request towards the UE-1.
4. The INVITE is routed towards the ATCF. When receiving the INVITE, the ATCF may decide whether to anchor the media for the session and allocate ATGW resources for it if needed.
5. The SIP INVITE is forwarded to UE-1 (P-CSCF not shown in flow).

NOTE 1: In case the UE-1 returns a response to IMS that bi-directional speech is rejected as specified in clause 6.2.2.4, the ATCF will release the ATGW resources allocated if any. The ATCF can then remove itself from the session path.

6. Session setup is completed. As part of this step, if not already done, the ATCF may decide, based on information not available earlier in the procedure, to anchor the session and allocate ATGW resources for voice media or voice and video media and anchor the voice media or voice and video media in the ATGW. The ATCF will in such case update the remote end with the media information of the ATGW in another offer/answer exchange (this may be done as part of other required session update).

NOTE 2: The ATCF is not modifying the dynamic STI that is exchanged between the UE and SCC AS.

NOTE 3: The Access Leg for the control has now been established between the UE and the SCC AS.

### 6.2.2.6 Terminating sessions for CS to PS - Single Radio

The CS termination is done according to TS 23.292 [5] clause 7.4, with the addition that the call is routed through the ATCF.

Once the session is established, the ATCF will act as the access transfer function in the call.

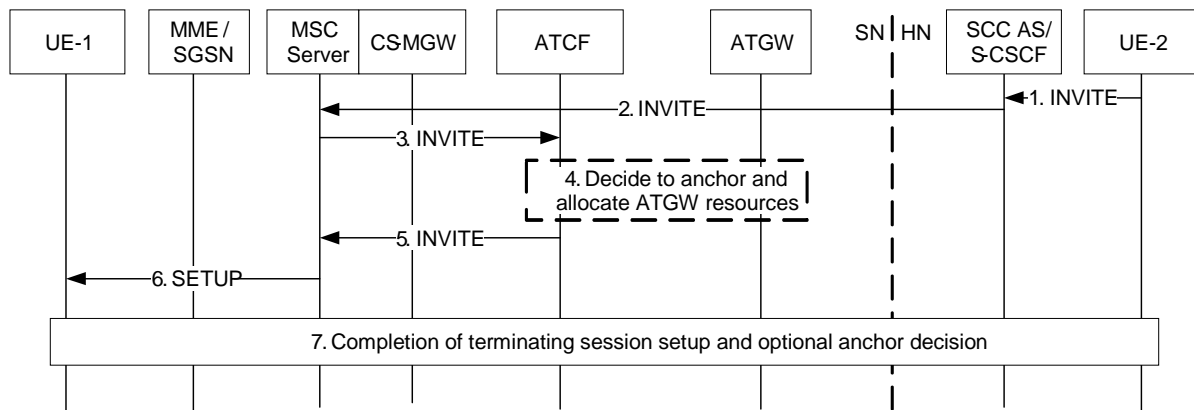

**Figure 6.2.6-1: Terminating call setup over CS through ATCF**

- 1-2. UE-2 sends an INVITE towards UE-1. The call is routed towards MSC Server using procedure according to TS 23.292 [5], clause 7.4.
3. The MSC Server routes the INVITE via ATCF using the ATCF management URI that it has received from SCC AS (see clause 6.1.3.2). The INVITE shall include the C-MSISDN to the ATCF for further correlation purposes.
4. The ATCF may decide whether to anchor the media session and allocate if needed ATGW resources to it. Media anchoring criteria used for ATCF enhancements apply.
- 5-6. The call setup proceeds and is routed toward UE-1.
7. The call setup is completed.

## 6.3 Access Transfer

### 6.3.1 Access Transfer Procedure

#### 6.3.1.1 Introduction

Access Transfer procedures enable service continuity between Access Networks. All Access Transfer procedures associated with a session, including initial and subsequent transfers, are executed and controlled in the user's home IMS network by the SCC AS upon the UE's request, except when using (v)SRVCC enhanced with ATCF. When (v)SRVCC enhanced with ATCF is used, PS to CS Access Transfer procedures are executed and controlled in the serving network. SCC AS and ATCF may handle the access transfer procedure with priority if the transfer request is initiated with priority indication.

**NOTE:** In order to support Access Transfer and Media Adding/Deleting procedures that involve the use of the Gm reference point on two IP-CANs, the UE and IMS network both have to support multiple simultaneous registrations of the UE and the UE has to be able to establish and maintain simultaneous connections to both IP-CANs at least for the duration of the Access Transfers or Media Adding/Deleting procedures.

The STN and STI are used during the execution of Access Transfers. The STN and STI are stored in the UE.

#### 6.3.1.2 Access Transfer Procedures

When the UE determines that Access Transfer is desirable and possible, a registration in IMS is performed by the UE via the transferring-in Access Network if the user is not already registered via that network.

If the UE does not have or is unable to use its ICS capabilities, then prior to dual-radio Access Transfer:

- If the MSC Server assisted mid-call feature is not used then the UE releases all but the most recently active bi-directional sessions.
- If the MSC Server assisted mid-call feature is used then:

- if the UE has more than one active bi-directional session, selects the second most recently active bidirectional session and it releases all remaining sessions except for the two most recently active bi-directional sessions;
- if the UE has one active bi-directional session and more than one inactive bi-directional session, it releases all sessions except for the active session and the inactive session which became inactive most recently.

NOTE: For the single-radio case the above applies but the UE locally releases the sessions based on the aforementioned priority.

For vSRVCC procedure, MSC server enhanced for vSRVCC negotiates with the SCC AS to determine whether the most recently active bi-directional sessions is voice or voice + video.

A new Access Leg is established by the UE toward the SCC AS, if needed. Signalling and bearer resources are allocated in the transferring-in Access Network and the user's sessions are transferred from the transferring-out Access Network. The SCC AS executes Access Transfer procedures. Resources in the transferring-out Access Network are subsequently released.

When the UE wants to perform Access Transfer and determines that there is a PS Access Leg in the transferring-in Access Network for the same session, the UE can use the existing PS Access Leg in the transferring-in Access Network, instead of establishing a new Target Access Leg, to execute Access Transfer. No new signalling resources need to be allocated in the transferring-in Access Network.

Based on UE and Access Network capabilities, the UE may also maintain some of the media flows in the transferring-out Access Network while transferring the other media flows to the transferring-in Access Network.

#### 6.3.1.2a Access Transfer Procedures using ATCF enhancements

A new Access Leg is established by the MSC Server toward the ATCF and then to SCC AS when performing a PS to CS access transfer. When performing a CS to PS access transfer, a new Access Leg is established by the UE toward the ATCF and then to SCC AS. The ATCF subdivides the new Access Leg into a Serving Leg and a Home Leg. Signalling and bearer resources are allocated in the transferring-in Access Network and the user's sessions are transferred from the transferring-out Access Network. The ATCF executes Access Transfer procedures in co-operation with the SCC AS. Resources in the transferring-out Access Network are subsequently released by the SCC AS.

#### 6.3.1.3 Enablement of Access Transfer procedures

A 3pcc (3rd party call control) function is employed to anchor IMS sessions at the SCC AS upon session establishment for enablement of Access Transfer. The SCC AS is invoked as part of originating or terminating iFC execution at the subscriber's S-CSCF. The SCC AS inserts itself in the signalling path of the SC subscriber's IMS sessions by implementing a 3pcc (3rd party call control) function. For an originating IMS session, the SCC AS terminates an Access Leg from the user and establishes a Remote Leg toward the remote end. For a terminating IMS session, the SCC AS terminates a Remote Leg from the remote end and establishes an Access Leg toward the user. The SCC AS subsequently coordinates the session control signalling exchange between the Access Leg and the Remote Leg associated with the anchored IMS session.

For 3pcc at the SCC AS when the Access Leg is established with CS media, refer to clause 5.4.3. For 3pcc at the SCC AS when the Access Leg is established with media flow over IP-CAN to illustrate its use as preparation for Access Transfer procedures, refer to clause 5.4.2.

An STI and STN for Access Transfer between CS and PS access shall be statically configured on the UE regardless of its ICS capabilities.

If the Gm or I1 reference point is used for the originating or terminating session, an STI is dynamically assigned for the Access Leg. An STI shall also be dynamically assigned for each new Access Leg established during Access Transfer.

NOTE: The dynamically assigned STI needs to be different from the STI and STN that are statically configured on the UE.

The statically configured STI shall be used for Dual Radio CS to PS Access Transfers only when no dynamically assigned STI was provided to the UE.

The STN is used for PS to CS Access Transfers when no Gm or I1 reference point is available.

The STN-SR as specified in TS 23.216 [10] is used for PS to CS Access Transfer using Single Radio VCC.

### 6.3.1.3a Enablement of Access Transfer procedures using ATCF enhancements

IMS sessions and media flows are anchored by the ATCF upon session establishment for enablement of Access Transfer using ATCF enhancements. For both originating and terminating IMS sessions, the ATCF subdivides the Access Leg into a Serving Leg and a Home Leg. During registration procedure, the ATCF allocates an STN-SR addressing itself and provides it to the SCC AS. The SCC AS provides the received STN-SR to the HSS and the HSS provides the STN-SR to the serving node(s), i.e. to SGSN and / or MME.

When CS to PS SRVCC is supported, a dynamic STI-rSR for Access Transfer shall be provided to the UE by the ATCF.

### 6.3.1.4 Execution of Access Transfer procedures

Upon detection of conditions requiring Access Transfer, the UE establishes a Target Access Leg with the SCC AS via the transferred-in Access Network to request Access Transfer to the transferred-in Access Network. When the UE initiates a Access Transfer request, it includes the STI and/or the STN.

The SCC AS executes the Access Transfer procedure by replacing the Source Access Leg currently communicating to the Remote Leg with the Target Access Leg. If no media flow is retained in the transferred-out access, the Source Access Leg is released as specified in clause 6.3.1.6. If the UE chooses to retain some media flow(s) in the transferred-out access, the Source Access Leg is updated to indicate which media flow(s) is retained in the transferred-out access. If such update is not done, the SCC AS releases the Source Access Leg as specified in clause 6.3.1.6 and updates the Remote Leg if necessary. When the switch of the Source Access Leg to the Target Access Leg is executed, the Remote Leg is also updated in order to forward the media flow(s) to the transferred-in Access Network.

#### 6.3.1.4a Execution of Access Transfer procedures using ATCF enhancements

The ATCF executes the Access Transfer procedure by replacing the Source Access Leg currently communicating to the Remote Leg with the Target Access Leg. If no media flow is retained in the transferred-out access, the Source Access Leg is released as specified in clause 6.3.1.6 by the SCC AS. If the UE chooses to retain some media flow(s) in the transferred-out access, the Source Access Leg is updated to indicate which media flow(s) is retained in the transferred-out access. If such update is not done, the SCC AS releases the Source Access Leg as specified in clause 6.3.1.6 and updates the Remote Leg. When the switch of the Source Access Leg to the Target Access Leg is executed and the ATCF did not anchor the media in the ATGW, the Remote Leg is also updated in order to forward the media flow(s) to the transferred-in Access Network.

### 6.3.1.5 Remote Leg Update

Upon receiving a request for execution of Access Transfer, the SCC AS performs the Remote Leg Update by switching the Access Leg communicating with the Remote Leg from Source Access Leg to Target Access Leg.

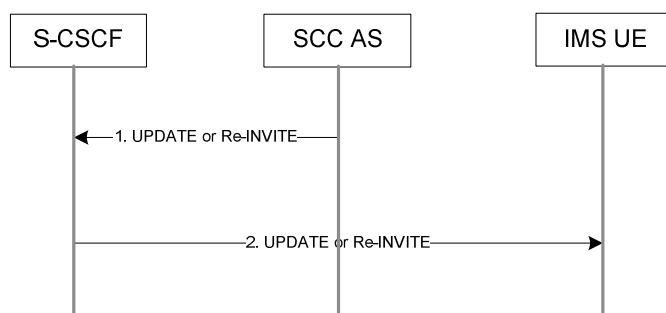
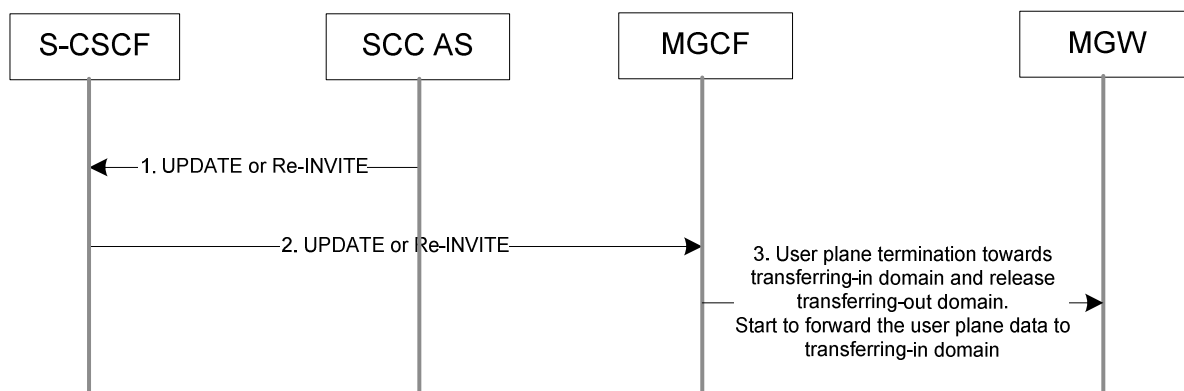

**Figure 6.3.1.5-1: Remote Leg Update**

The remote end in figure 6.3.1.5-1 represents a UE supporting terminations per TS 23.228 [4] (i.e. including NI-T).

- 1-2. The SCC AS updates the Remote Leg by communicating the SDP of the Target Access Leg established to the remote end via the user's S-CSCF. Remote Leg Update happens according to SIP session modification procedures (see RFC 3261 [8]). The priority indication from the Target Access leg (i.e., from the access transfer request) does not change the existing priority setting toward the remote leg between the SCC AS and remote end.

The remote end in figure 6.3.1.5-2 represents an MGCF for CS/PSTN Remote Party.



**Figure 6.3.1.5-2: Remote Leg Update**

- 1-2. These steps are the same procedures described in figure 6.3.1.5-1.
- 3. MGCF instructs MGW to update a termination towards the Target Access Leg to the context, and to release the termination for the Source Access Leg from the context.

### 6.3.1.6 Source Access Leg Release

When the session modification procedures are complete, the Source Access Leg Release is executed by initiating a session release. This is done for the Source Access Leg using the AS/UE session release procedures per TS 23.228 [4]. For non-emergency sessions, the UE and the SCC AS shall initiate the Session Release procedure when the switch to the Target Access Leg is complete. For emergency sessions, the UE and the EATF shall initiate the Session Release procedure when the switch to the Target Access Leg is complete. For (v)SRVCC, the source access leg release is only performed if the UE retains Gm after the PS-CS access transfer is completed; otherwise, the UE release the source access leg locally.

### 6.3.1.7 Access Transfer Information for ATCF

When SRVCC with ATCF enhancements are used, a prerequisite for the access transfer to take place, is that the ATCF have received the Access Transfer Information from the SCC AS. The Access Transfer Information includes the ATU-STI and the C-MSISDN.

The SCC AS initiates the Access Transfer Information information exchange

- after the registration, if ATCF is included in the path, and the UE is SRVCC capable, and
- in the event the UE changes SRVCC capability provided that ATCF is included in the registration.

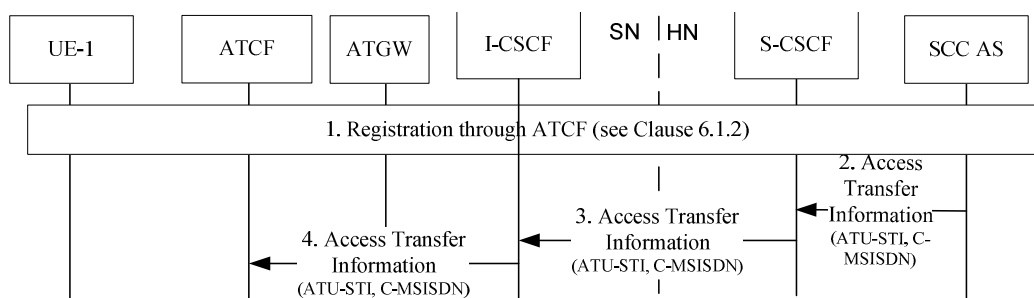

**Figure 6.3.1.7-1: Access Transfer Information provided to ATCF from SCC AS**

- 1. The UE performs an IMS registration that is sent through the ATCF according to the procedures of clause 6.1.2.
- 2-3. After the registration, at least prior any access transfer takes place, the SCC AS provides the Access Transfer Information towards the ATCF, by sending a message including the ATU-STI and C-MSISDN.

## 6.3.2 Access Transfer Information flows

### 6.3.2.0 General

This clause details the procedures and flows for Access Transfers. In the flows that pertain to I1, the assumptions specified in clause 7.0 of TS 23.292 [5] apply.

For PS - CS Access Transfer, both Single Radio and Dual Radio procedures are specified in the following clauses. Dual Radio is not supported between two different 3GPP RATs (i.e. 3GPP specifications do not provide the possibility for a UE to transmit/receive on two 3GPP RATs simultaneously). Single Radio PS - CS Access Transfer require the use of SRVCC (specified in TS 23.216 [10]) in the access networks.

### 6.3.2.1 PS – CS Access Transfer

#### 6.3.2.1.1 PS – CS Access Transfer: PS to CS - Dual Radio

Figure 6.3.2.1.1-1 PS – CS Access Transfer: PS to CS - Dual Radio, provides an information flow for Access Transfer of an IMS session in PS to CS direction. The flow requires that the user has an IMS originating or terminating session using PS media flow(s) at the time of initiation of Access Transfer to CS.

NOTE 1: This flow assumes the PS domain does not have any non real time media flow(s). If the PS domain has other non real time media flow(s), then the call flow in clause 6.3.2.3.1 applies.

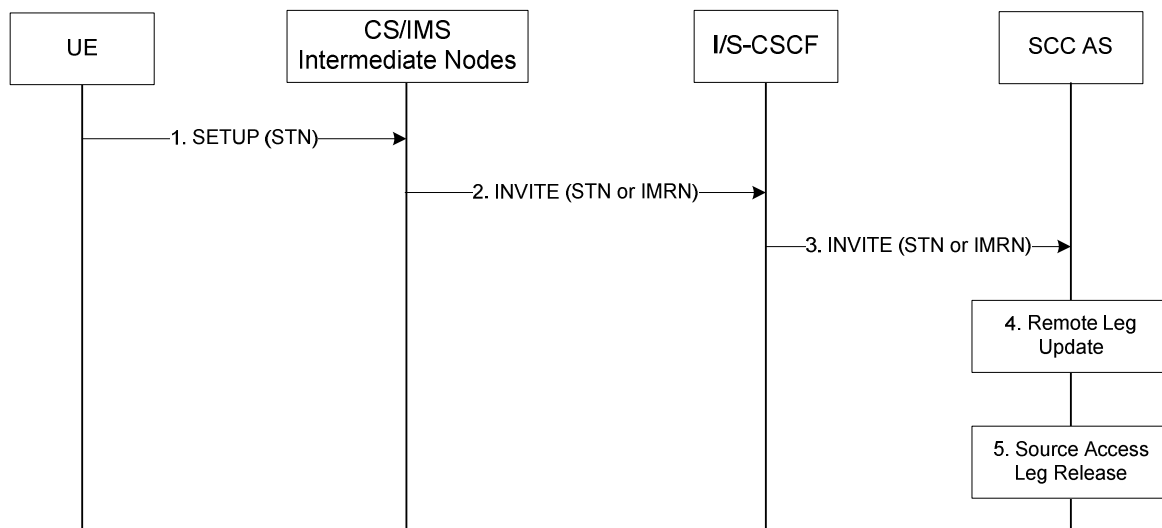

**Figure 6.3.2.1.1-1: PS – CS Access Transfer: PS to CS - Dual Radio**

1. If the user is not attached to the CS domain at the time when the UE determines a need for Access Transfer to CS, the UE performs a CS Attach as specified in TS 23.292 [5], clause 7.2.1. It subsequently originates a session that uses CS media using the STN to establish an Access Leg via the CS access and requests Access Transfer of the IMS session to CS access using the procedures described in TS 23.292 [5], clause 7.3.2 Originating Sessions that use CS media.
2. Standard procedures as specified in TS 23.292 [5], clause 7.3.2 Originating Sessions that use CS media are used in CS and IMS intermediate nodes which results in routing of the INVITE with the STN or an IMRN to the I/S-CSCF. The MSC Server enhanced for ICS includes the GRUU into the Access Transfer request if the user is registered in the IMS by the MSC Server enhanced for ICS as specified in TS 23.292 [5]. If the user is not registered in IMS then CS/IMS Interworking Nodes includes the C-MSISDN as calling party number into the Access Transfer request.
3. Standard procedures are used at I/S-CSCF for routing of the INVITE to the SCC AS.
4. The SCC AS completes the establishment of the Access Leg via the CS access. The SCC AS is able to identify the correct anchored session using either the C-MSISDN or the GRUU for session identification. The SCC AS determines if the state of the session to be transferred is active or inactive based on the session state information

in the source Access Leg. The SCC AS performs the Access Transfer by updating the Remote Leg with the connection information of the newly established Access Leg using the Remote Leg Update procedure as specified in clause 6.3.1.5. The SCC AS completes the session setup towards UE according to procedures defined in TS 23.228 [4].

- The Source Access Leg (which is the Access Leg previously established over PS access) is released as specified in clause 6.3.1.6

NOTE 2: Steps 4 and 5 consist of a sequence of messages, some of which may occur in parallel.

### 6.3.2.1.1a PS – CS Access Transfer: PS to CS – Dual Radio with Session State Information

Figure 6.3.2.1.1a-1 PS – CS Access Transfer: PS to CS – Dual Radio with Session State Information, provides an information flow for Access Transfer of an IMS session in PS to CS direction. The flow requires that the user has an active IMS originating or terminating session, together with at least one more IMS originating or terminating session (active and/or inactive), using PS media at the time of initiation of Access Transfer to CS and that the use of network capabilities to support MSC Server assisted mid-call feature during Access Transfer is supported by the UE and the network.

NOTE 0: When the UE is using a conference service, the procedures specified in clause 6.3.2.1.8 need to be performed in conjunction with this flow, for the conference service to be supported after the Access Transfer.

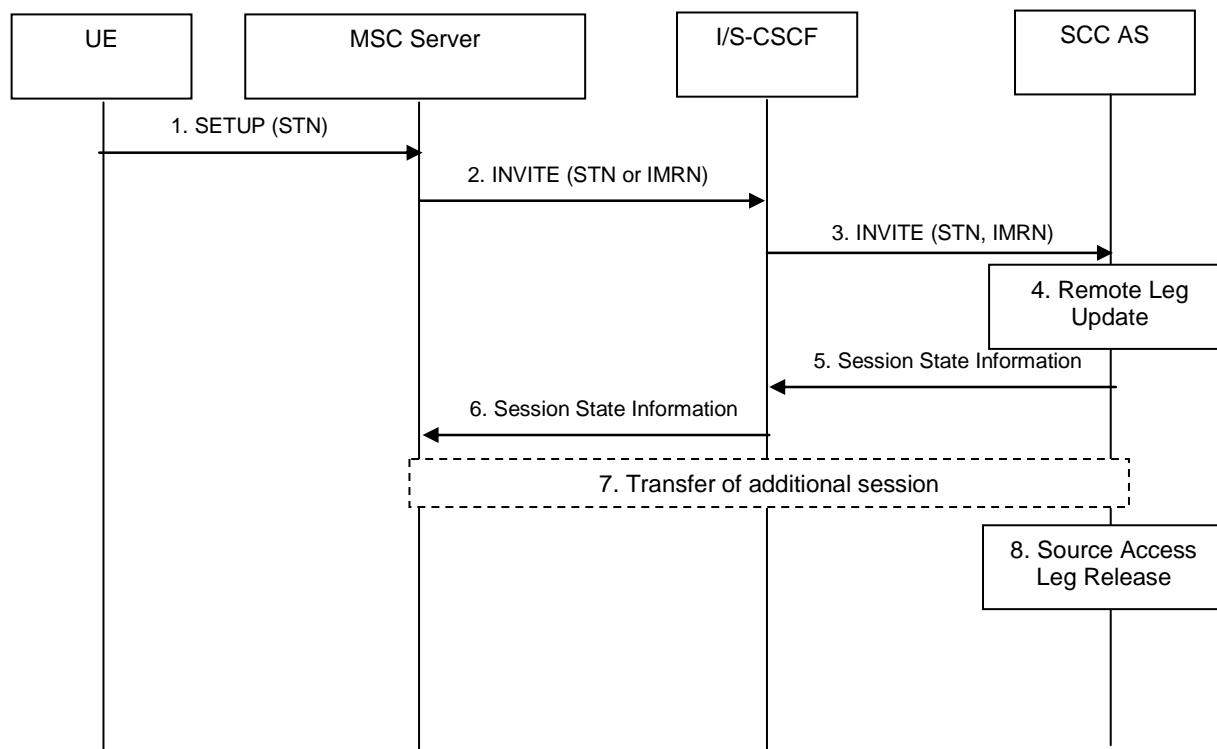

Figure 6.3.2.1.1a-1: PS – CS Access Transfer: PS to CS – Dual Radio with Session State Information

- If the user is not attached to the CS domain at the time when the UE determines a need for Access Transfer to CS, the UE performs a CS Attach as specified in TS 23.292 [5], clause 7.2.1. It subsequently originates a session that uses CS media using the STN to establish an Access Leg via the CS access and requests Access Transfer of the IMS session to CS access using the procedures described in TS 23.292 [5], clause 7.3.2.
- The procedures specified in TS 23.292 [5], clause 7.3.2, are used by the MSC Server, which results in routing of the INVITE with the STN to the I/S CSCF. The MSC Server includes the GRUU into the Access Transfer request, which can be used for session (and UE) correlation.

NOTE 1: The MSC Server enhanced for ICS obtains the GRUU during registration; the GRUU can be used for session (and UE) correlation.

NOTE 2: The MSC Server has indicated its capability to support MSC Server assisted mid-call feature during Access Transfer in the registration.

3. Standard procedures are used at I/S-CSCF for routing of the INVITE to the SCC AS.
4. The SCC AS completes the establishment of the Access Leg via the CS access. The SCC AS is able to identify the correct anchored session using the GRUU for session identification. The SCC AS performs the Access Transfer of the recently added active session or, if there is no active session, the inactive session which was active most recently, with bi-directional speech for the UE by updating the Remote Leg with the connection information of the newly established Access Leg using the Remote Leg Update procedure as specified in clause 6.3.1.5. The SCC AS completes the session setup towards the UE according to procedures defined in TS 23.228 [4].
5. The SCC AS provides Session State Information on the transferring-in leg. If there are more than two sessions with speech media before session transfer in the source Access Leg, the SCC AS performs the following:  
  
If there are no active sessions, the SCC AS performs the following:
  - besides the inactive session already handled in step 4, releases all other remaining inactive sessions;
  - includes the information that the session is inactive in the transfer response sent to the MSC Server;
  - skips following handling of step 5, 6 and 7, directly goes to step 8 in the information flow.  
If there are at least one active session, the SCC AS performs the following:
  - if there are two or more active speech sessions, selects the second-most recently active speech session, puts it on hold and releases all remaining active sessions;
  - selects the held session that has been most recently made inactive. Any other in-active sessions are released.  
the Session State Information of the selected inactive session is sent to the MSC Server.
6. The S-CSCF forwards the Session State Information to the MSC Server.
7. If the MSC Server receives the Session State Information on more than one active or inactive speech sessions, it initiates Access Transfer towards the SCC AS for the additional session.
8. The Source Access Leg (which is the Access Leg previously established over PS access) is released as specified in clause 6.3.1.6.

NOTE 3: Steps 4 and 8 consist of a sequence of messages, some of which may occur in parallel.

After completion of this procedure, the UE uses procedures as defined in TS 24.008 [24] to perform service control.

#### 6.3.2.1.2 PS – CS Access Transfer: CS to PS - Dual Radio

Figure 6.3.2.1.2-1 PS – CS Access Transfer: CS to PS - Dual Radio, provides an information flow for Access Transfer of an IMS session in the CS to PS direction. The flow requires that the user has an IMS originating or terminating session that uses CS media at the time of initiation of Access Transfer to PS.



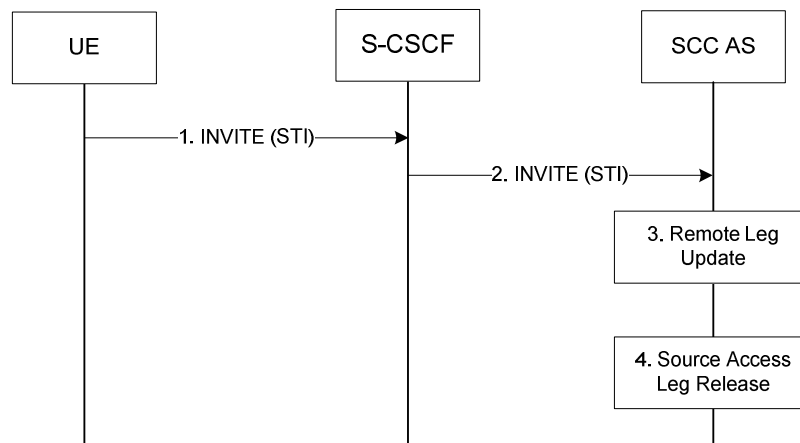

**Figure 6.3.2.1.2-1: PS – CS Access Transfer: CS to PS - Dual Radio**

1. When the UE determines a need for Access Transfer, the UE initiates registration with IMS (if not already registered in IMS) as specified in clause 6.1. It subsequently initiates an IMS originated session toward the SCC AS using a STI to establish an Access Leg via PS access and requests Access Transfer of the IMS session that is using CS media to PS access. The statically configured STI is used if no dynamically assigned STI has been provided to the UE during session establishment. Please refer to clause 6.2.1 - IMS Originating Sessions for details on IMS origination procedure.
2. Standard procedures are used at S-CSCF for routing of the INVITE to the SCC AS.
3. The SCC AS performs the Access Transfer by updating the Remote Leg with the session information, including session state and connection information, of the newly established Access Leg (see the Remote Leg Update procedure, clause 6.3.1.5). The SCC AS completes the establishment of the Access Leg according to procedures defined in TS 23.228 [4].
4. The source Access Leg which is the Access leg previously established over CS is subsequently released (see clause 6.3.1.6).

NOTE: Steps 3 and 4 consist of a sequence of messages, some of which may occur in parallel.

#### 6.3.2.1.2a PS – CS Access Transfer: CS to PS – Dual Radio with Session State Information

Figure 6.3.2.1.2a-1 PS – CS Access Transfer: CS to PS – Dual Radio with Session State Information, provides an example flow for dual radio CS to PS Access Transfer with Held and Active sessions.

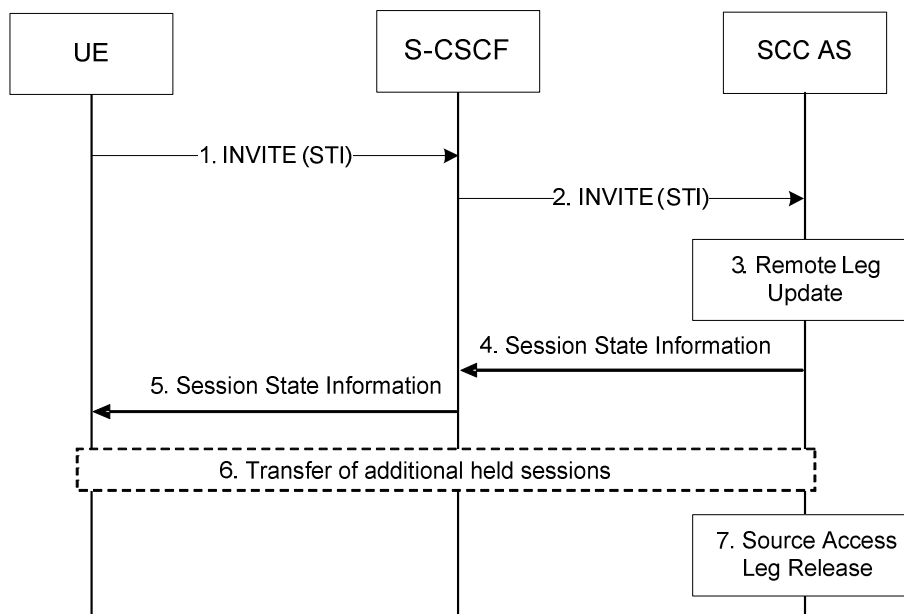

**Figure 6.3.2.1.2a-1: CS to PS Access Transfer - Dual Radio with Session State Information**

1. When the UE determines a need for Access Transfer, the UE initiates registration with IMS (if not already registered in IMS) as specified in TS 23.228 [4]. It subsequently initiates an IMS originated session towards the SCC AS using a static STI to establish an Access Leg via PS access and requests Access Transfer of the active session to PS access.

2. Standard procedures are used at the S-CSCF for routing of the INVITE to the SCC AS.

NOTE 1: During session establishment, the UE has indicated its capability to support MSC Server assisted mid-call feature during Access Transfer.

3. The SCC AS performs the Access Transfer by updating the Remote Leg with connection information of the newly established Access Leg (see the Remote Leg Update procedure, described in clause 6.3.1.5). The SCC AS completes the establishment of the Access Leg according to procedures defined in TS 23.228 [4].

4. The SCC AS provides Session State Information when both an active session and an inactive session are transferred. The Session State Information includes the additional held session with speech or speech and video media including dynamic STI needed for the held session on the transferring-in leg.

5. The S-CSCF forwards the Session State Information to the UE.

6. If the UE receives the Session State Information of the held session, it initiates a Access Transfer request towards the SCC AS using the dynamic STI for the held session.

7. The Source Access Leg, which is the Access Leg previously established over CS access, is released as specified in clause 6.3.1.6.

NOTE 2: Steps 3 and 7 consist of a sequence of messages, some of which may occur in parallel.

### 6.3.2.1.3 Subsequent Access Transfers

Procedures for subsequent Access Transfers to CS and PS access are the same as procedures for initial Access Transfers specified in clause 6.3.2.1.1 for PS to CS access and clause 6.3.2.1.2 for CS to PS access.

### 6.3.2.1.4 PS – CS Access Transfer: PS to CS – Single Radio

Figure 6.3.2.1.4-1 PS-CS: PS to CS – Single Radio, provides an information flow for Access Transfer of media flow(s) of an IMS session in PS to CS direction for Access Transfers within 3GPP access networks as specified in TS 23.216 [10].

The flow requires that the user is active or inactive in an IMS originating or terminating session; procedures and capabilities specified in TS 23.216 [10] are used for the switching of access networks at the transport layer. It further requires that the MSC Server assisted mid-call feature as described in clause 6.3.2.1.4a is not used.

NOTE 1: See TS 23.216 [10] for initiation of handover of only one voice PS bearer at EPC.

NOTE 2: The UE capable of procedures as specified in TS 23.216 [10] does not need to support session and access transfer procedures as specified in clauses 6.3.2.1.1 and 6.3.2.3 to support PS to CS Access Transfer.

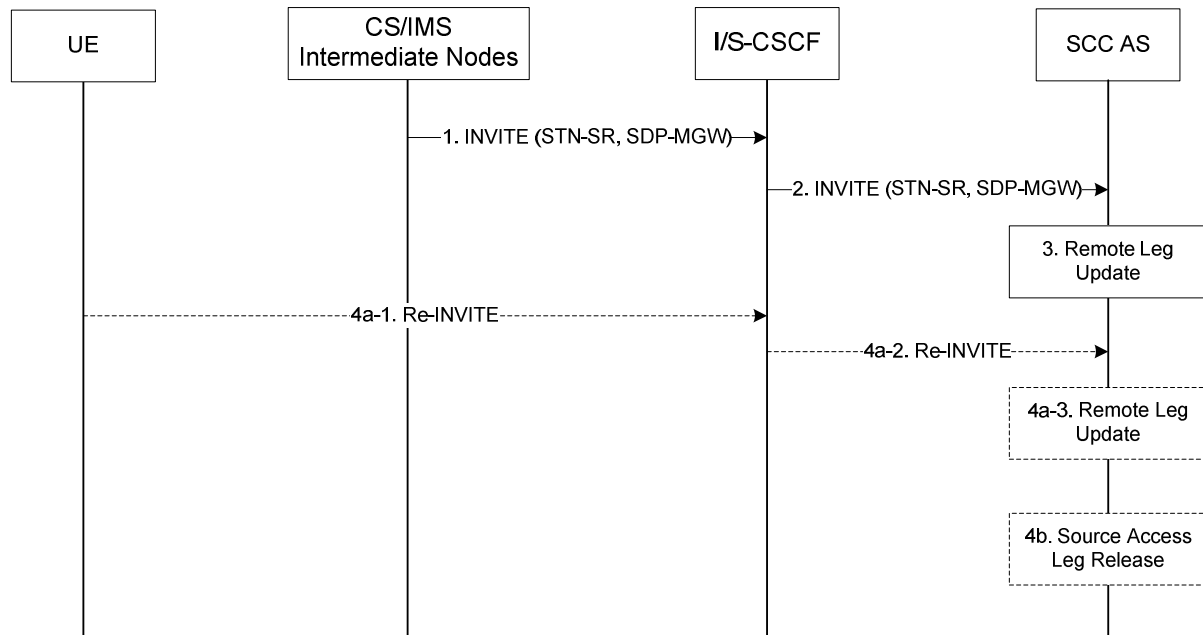

**Figure 6.3.2.1.4-1: PS-CS: PS to CS – Single Radio**

1. Procedures specified in TS 23.216 [10] result in an INVITE to be sent with an STN-SR indicating use of SRVCC procedures for Access Transfer to CS access. The MSC Server enhanced for SRVCC includes the C-MSISDN as calling party number. If SRVCC with priority is supported, MSC Server enhanced for SRVCC also includes a priority indication if received.
2. Standard procedures are used at I/S-CSCF for routing of the INVITE to the SCC AS.
3. The SCC AS uses the STN-SR to determine that Access Transfer using SRVCC is requested. The SCC AS may retrieve the C-MSISDN from the HSS. The SCC AS is able to identify the correct anchored session. The SCC AS determines if the state of the session to be transferred is active or inactive based on the session state information in the source Access Leg. The SCC AS proceeds with the Access Transfer of the session with bi-directional speech for the UE by updating the Remote Leg with the media description and other information using the Remote Leg Update procedure as specified in clause 6.3.1.5.

NOTE 3: Please refer to clause 4.3.1.2.2 for the behaviour of the SCC AS when the SCC AS finds multiple active sessions with bi-directional speech anchored for the UE.

4a. If the Gm reference point is retained upon PS handover procedure then

4a-1. The UE sends a Re-INVITE via the PS access to update the remaining non-voice media flow(s) associated with the recently added active session. If the UE is using ICS capabilities, this Re-INVITE also adds Gm service control to the active session and the UE subsequently sends Re-INVITES for any remaining inactive bi-directional speech sessions that are to be transferred.

4a-2. Standard procedures are used at S-CSCF for routing of the Re-INVITE(s) to the SCC AS.

4a-3. The SCC AS processes the Re-INVITE(s) and updates the Remote Leg if needed.

4b. If the Gm reference point is not retained upon PS handover procedure, e.g. because there was no other media flow(s) in the IMS session than the voice which was transferred to the target access, then the Source Access Leg is released as specified in clause 6.3.1.6.

NOTE 4: Some or all of the steps between steps 3 and 4b may consist of a sequence of messages, some of which may occur in parallel.

If the MSC Server above (located in the box labelled "CS/IMS Intermediate Nodes") is enhanced for ICS as defined in TS 23.292 [5], then it performs IMS registration after the transfer of the session is completed successfully i.e. after step 3. Registration is performed only if the ICS flag is received via the Sv reference point as specified in TS 23.216 [10] or as determined to by the procedure specified in clause 7.2.1.1 in TS 23.292 [5].

**6.3.2.1.4a PS – CS Access Transfer: PS to CS – Single Radio with Session State Information**

Figure 6.3.2.1.4a-1 PS-CS: PS to CS – Single Radio with Session State Information, provides an information flow for Access Transfer of media of an IMS session in PS to CS direction for Access Transfers within 3GPP access networks as specified in TS 23.216 [10].

The flow requires that the user has an active IMS originating or terminating session, together with at least one more IMS originating or terminating session (active and/or inactive), and that the use of network capabilities to support MSC Server assisted mid-call feature during Access Transfer is possible; procedures and capabilities specified in TS 23.216 [10] are used for the switching of access networks at the transport layer.

NOTE 0: When the UE is using a conference service, the procedures specified in clause 6.3.2.1.8 need to be performed in conjunction with this flow, for the conference service to be supported after the Access Transfer.

The flow is not applicable in case ICS UE capabilities can be used.

NOTE 1: See TS 23.216 [10] for initiation of hand-over of only one voice PS bearer in EPC.

NOTE 2: The UE capable of procedures as specified in TS 23.216 [10] does not need to support session and access transfer procedures as specified in clauses 6.3.2.1.1 and 6.3.2.3 to support PS to CS Access Transfer.

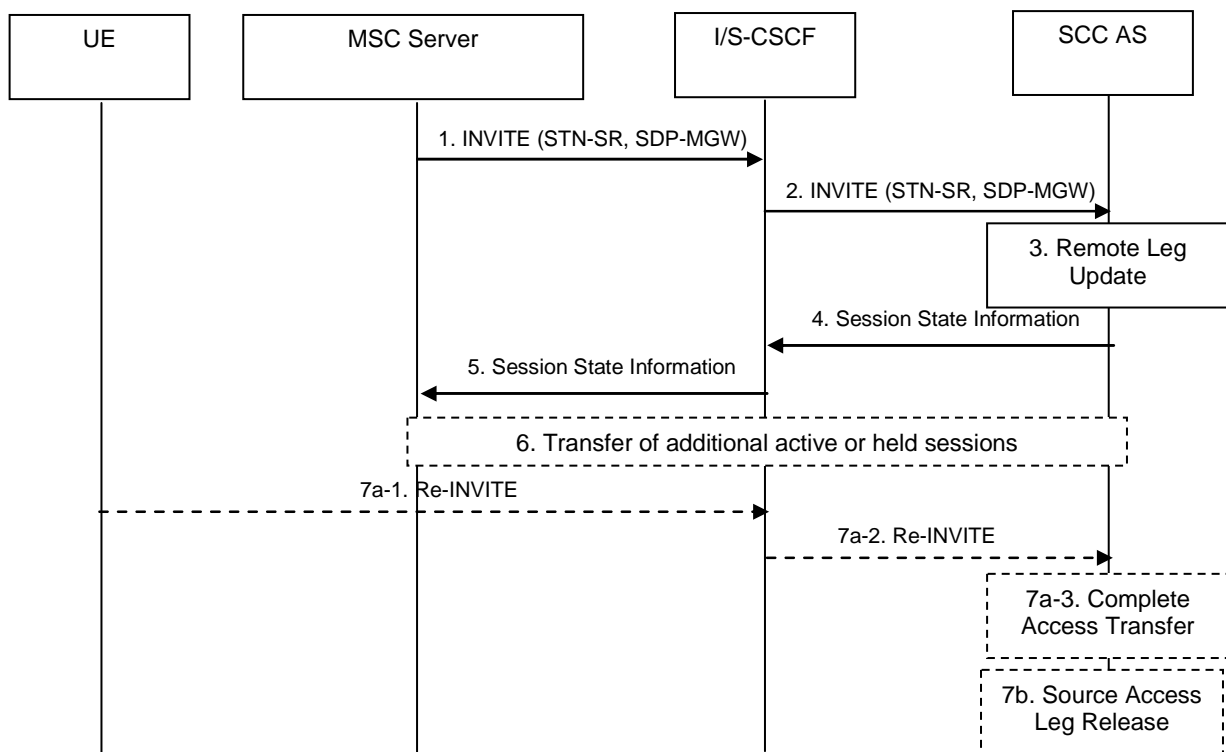

**Figure 6.3.2.1.4a-1: PS-CS: PS to CS – Single Radio with Session State Information**

1. Procedures specified in TS 23.216 [10], result in an INVITE to be sent with an STN-SR indicating use of Single Radio VCC procedures for Access Transfer to CS access. If the user is not IMS registered by the MSC Server, the MSC Server enhanced for SRVCC includes the C-MSISDN as calling party number. If the user is registered

in the IMS by the MSC Server, then the MSC Server includes the GRUU into the Access Transfer request. The MSC Server indicates its capability to support MSC Server assisted mid-call feature during Access Transfer.

2. Standard procedures are used at I/S-CSCF for routing of the INVITE to the SCC AS.
3. The SCC AS uses the STN-SR to determine that Access Transfer using Single Radio VCC is requested. The SCC AS may retrieve the C-MSISDN from the HSS. The SCC AS identifies the correct anchored session and proceeds with the Access Transfer of the recently added active session or, if there is no active session, the inactive session which was active most recently, with bi-directional speech for the UE by updating the Remote Leg with the media description and other information using the Remote Leg Update procedure as specified in clause 6.3.1.5.
4. The SCC AS provides Session State Information on the transferring-in leg. If there are more than two sessions with speech media before session transfer in the source Access Leg, the SCC AS performs the following:

If there are no active sessions, the SCC AS performs the following:

- includes the information that the session is inactive in the transfer response sent to the MSC Server;
- besides the inactive session already handled in step 3, releases all other remaining inactive sessions;
- skips following handling of step 4, 5 and 6 in the information flow.

If there are at least one active session, the SCC AS performs the following:

- if there are two or more active sessions, selects the second-most recently active session, puts it on hold and releases all remaining active sessions;

NOTE 3: If the first-most recently active session is speech session and the second-most recently active session is a speech and video session, the SCC AS removes the video parts of second-most recently active session and places it on hold. If the second-most recently active session needs to be released according to the operator's policy, the SCC AS releases this session after transfer. All the other remaining active sessions, if any, will be released and not be transferred.

- selects the held session that has been most recently made inactive. Any other inactive sessions are released;
- the Session State Information of the selected inactive session is sent to the MSC Server.

5. The S-CSCF forwards the Session State Information to the MSC Server.
6. If the MSC Server receives the Session State Information of more than one active or inactive speech sessions, it initiates Access Transfer towards SCC AS for the additional session.

NOTE 4: The SCC AS uses the C-MSISDN or GRUU to correlate the Access Transfer request, and additionally the Session State Information to select the correct session.

7a. If the Gm reference point is retained after PS handover procedure completion for non-voice media flows, then:

7a-1. The UE sends a Re-INVITE via the PS access to update the remaining non-voice media flow associated with the recently added active session.

7a-2. Standard procedures are used at S-CSCF for routing of the INVITE to the SCC AS.

7a-3. The SCC AS processes the Re-INVITE and updates the Remote Leg if needed.

7b. If the Gm reference point is not retained after PS handover procedure completion, e.g. because there was no other media in the IMS session than the voice that was transferred to the target access, then the Source Access Leg is released as specified in clause 6.3.1.6.

NOTE 5: Some or all of the steps between steps 3 and 4b consist of a sequence of messages, some of which may occur in parallel.

If the MSC Server above is enhanced for ICS as defined in TS 23.292 [5], then it performs IMS registration after the transfer of all sessions is completed successfully i.e. after step 6. Registration is performed only if the ICS flag is received via the Sv reference point as specified in TS 23.216 [10] or as determined to by the procedure specified in clause 7.2.1.1 in TS 23.292 [5].

After completion of this procedure, the UE uses procedures as defined in TS 24.008 [24] to perform service control.

**6.3.2.1.4b PS to CS Access Transfer: PS to CS – Single Radio; using I1 reference point**

Figure 6.3.2.1.4b PS-CS: PS to CS – Single Radio; using I1 reference point, provides an information flow for Access Transfer of media flow(s) of an IMS session in the PS to CS direction for Access Transfers within 3GPP access networks as specified in TS 23.216 [10], and with the use of I1 reference point for service control post transfer to CS.

The flow requires that the UE has indicated ICS capabilities and that the user is active in an IMS originating or terminating session; procedures specified in TS 23.216 [10] are used for the switching of access networks at the transport layer. The I1 reference point of ICS is used for control of IMS sessions established using CS media and a dynamically assigned STI is associated with each session.

NOTE 1: See TS 23.216 [10] for initiation of handover of only one voice PS bearer at EPC.

NOTE 2: The UE capable of procedures as specified in TS 23.216 [10] does not need to support session and access transfer procedures as specified in clauses 6.3.2.1.1 and 6.3.2.3 to support PS to CS Access Transfer.

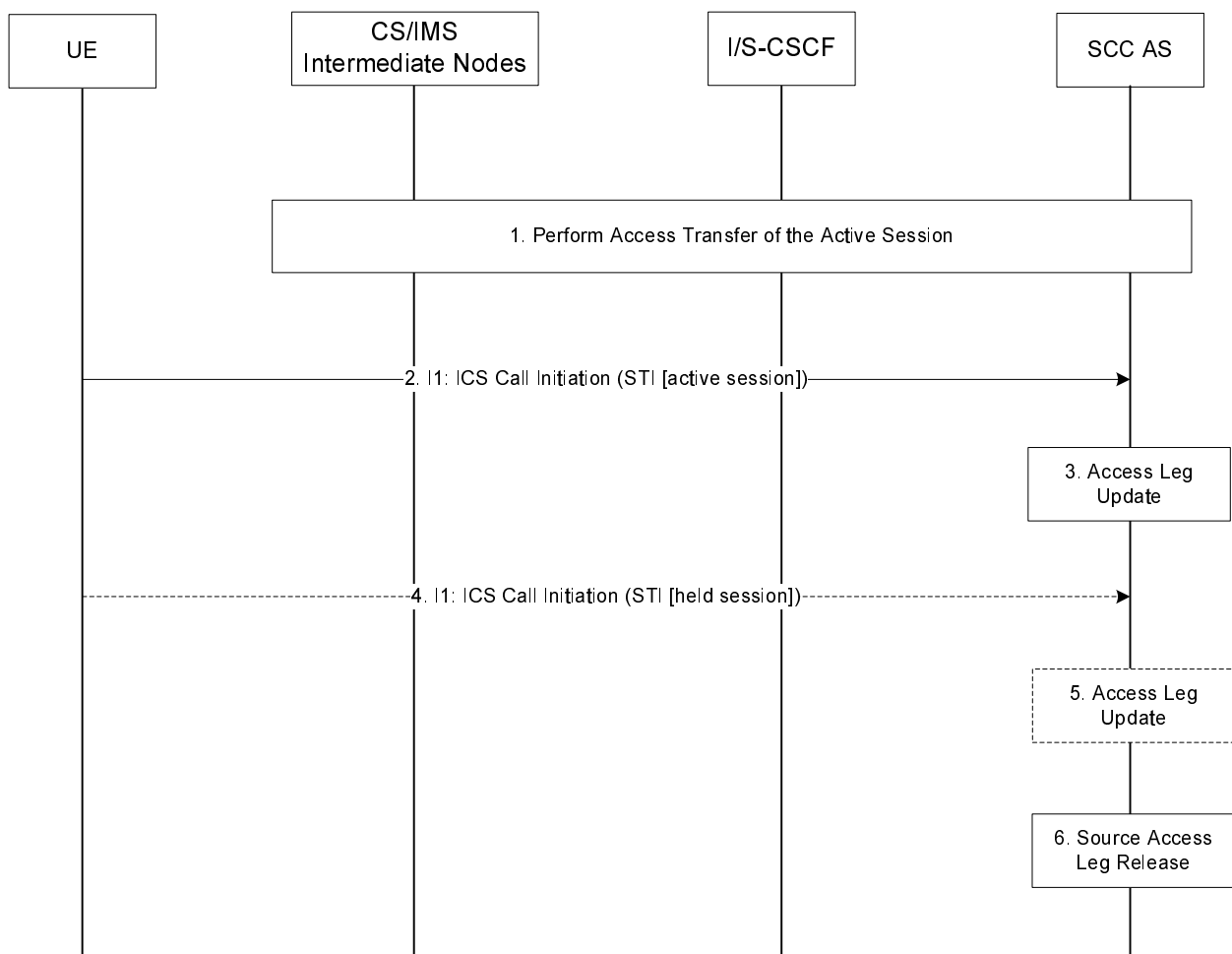

**Figure 6.3.2.1.4b-1: PS-CS: PS to CS – Single Radio; using I1 reference point**

1. Access Transfer of the active session with bi-directional speech is performed as defined in clause 6.3.2.1.4, steps 1-3.
2. The UE sends an I1: ICS Call Initiation via the CS access as specified in TS 23.292 [5] including an STI for continuation of establishment of the Access Leg using Single Radio VCC for the active session.
3. The SCC AS uses the STI to correlate the Access Transfer request received via the PS access with the Access Transfer request for the active session received via the CS access.

4. If there are any held sessions present at the time of Access Transfer, the UE proceeds with the Access Transfer of the first held session by sending an I1: ICS Call Initiation via the CS access (as described in TS 23.292 [5]) including an STI that identifies the held session.

NOTE 3: If the first-most recently active session is speech session and the selected held session is a speech and video session, the SCC AS removes the video parts of selected held session. If the held speech and video session needs to be released according to the operator's policy, the SCC AS releases this session after transfer. All the other remaining sessions, if any, will be released and not be transferred.

5. The SCC AS uses the STI to identify the held session and updates the session information on the Access Leg.

NOTE 4: CS media is not established for the held session. The media established upon the transfer of the currently active session is reused for the held session when it is resumed.

Steps 4 and 5 are repeated for the remaining held sessions.

6. The Source Access Leg is released as specified in clause 6.3.1.6.

#### 6.3.2.1.4c PS - CS Access Transfer: PS to CS - Single Radio, incoming voice or video call in alerting phase

Figure 6.3.2.1.4c-1 PS-CS: PS to CS - Single Radio, incoming call in alerting phase, provides an information flow for Access Transfer of media of an IMS session in PS to CS direction for Access Transfers as specified in TS 23.216 [10].

The flow requires that the user is active in a terminating IMS session in alerting state which the UE has not responded over the access leg and there is no other session (or there is one or more held sessions but mid-call service is not supported); procedures and capabilities specified in TS 23.216 [10] are used for the switching of access networks at the transport layer.

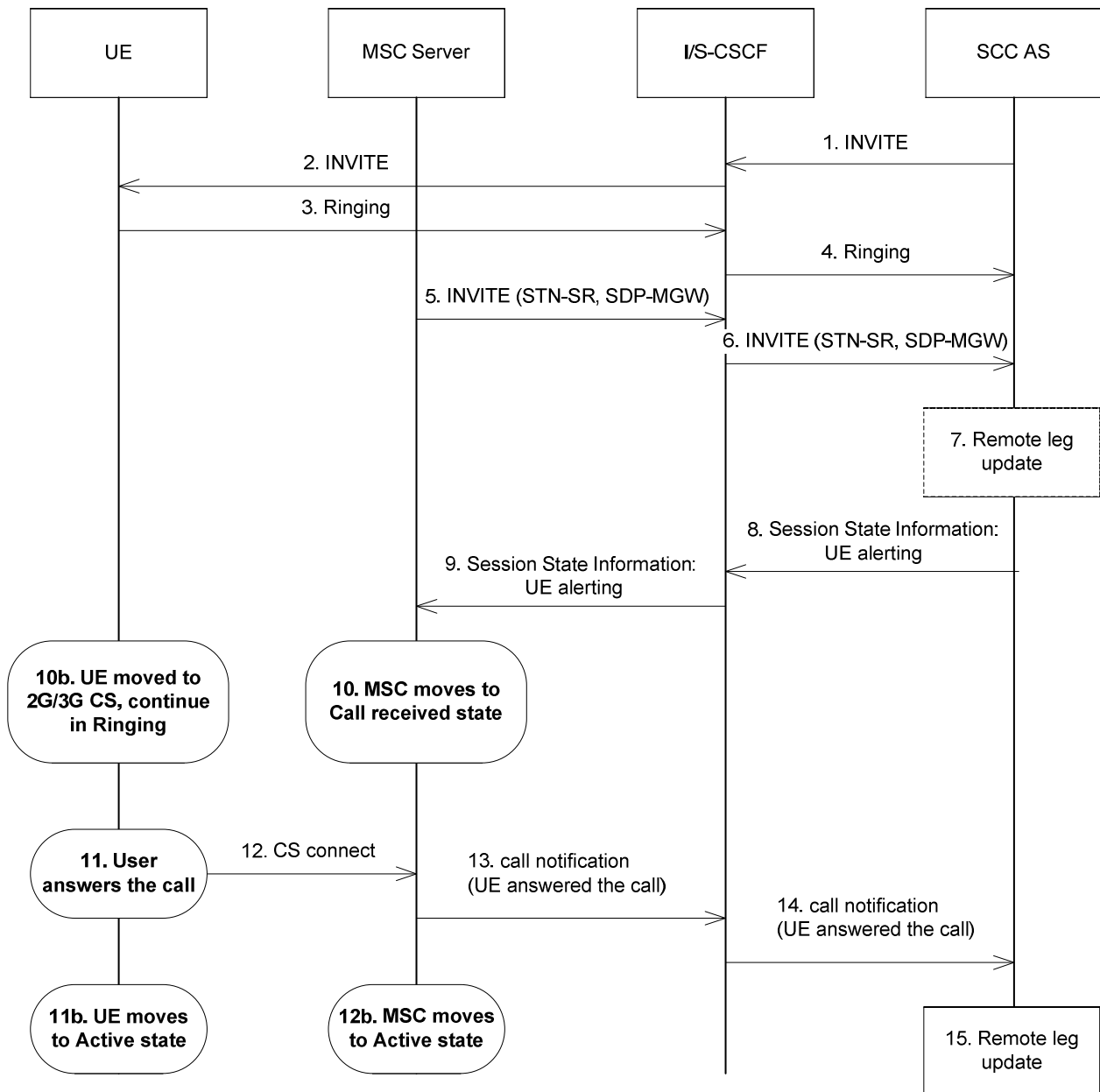

**Figure 6.3.2.1.4c-1: PS-CS: PS to CS - Single Radio, incoming voice or video call in alerting phase**

- 1-4. Standard procedures are used to initiate a SIP session towards the UE. The UE is alerting the user for the incoming voice or video-call session.
- 5. Procedures specified in TS 23.216 [10] result in an INVITE to be sent with an STN-SR indicating use of Single Radio VCC procedures for Access Transfer to CS access. The MSC Server enhanced for (v)SRVCC includes the C-MSISDN as calling party number. The MSC Server indicates its capability to support mid-call services during session transfer. For PS-CS transfer for vSRVCC the video Codecs are also included in the session transfer request.
- 6. Standard procedures are used at I/S-CSCF for routing of the INVITE to the SCC AS.
- 7. The SCC AS uses the STN-SR to determine that Access Transfer using Single Radio VCC is requested. The SCC AS may retrieve the C-MSISDN from the HSS. The SCC AS uses the C-MSISDN to identify the correct anchored session. The SCC AS proceeds with the Access Transfer of the recently added active session with bi-directional speech or bi-directional speech and synchronised video media for the UE by updating the Remote Leg with the media description and other information using the Remote Leg Update procedure as specified in clause 6.3.1.5.



NOTE 1: It is assumed the initial SDP negotiation has been completed prior to triggering the (v)SRVCC, thus the SCC AS can update the remote leg.

8. The SCC AS provides Session State Information on the incoming speech call in alerting state.

9. The S-CSCF forwards the Session State Information to the MSC Server.

10. The MSC moves to the corresponding CS call state, e.g. Call Received in TS 24.008 [24].

NOTE 2: In call received state the MSC does not generate an in-band ring tone to the calling party.

10b. In parallel to step 10, the UE has received the HO command as described in TS 23.216 [10]. The UE determines the local call state in the SIP session, and creates the corresponding CS call state, e.g. Call Received in TS 24.008 [24]. The UE continues to alert the user for incoming call.

11. The user answers to the call. For video call the UE may initiate at this stage the H.245 Codec negotiation.

11a. UE moves to Active state.

12. The UE uses the standard procedure to send the CS connect message to MSC as e.g. described in TS 24.008 [24].

NOTE 3: Solution for possible race conditions (e.g. MSC server receives the CS connect before the SCC AS responds) will be defined in Stage 3.

12b. The MSC moves to Active state.

13. The MSC notifies the SCC AS the user has answered the call.

14. Standard procedures are used at S-CSCF for routing of the notification to the SCC AS.

15. The SCC AS creates the corresponding SIP request to the remote end, updates the remote leg.

#### 6.3.2.1.4d PS - CS Access Transfer: PS to CS - Single Radio, outgoing voice or video call in alerting phase

Figure 6.3.2.1.4d-1 PS-CS: PS to CS - Single Radio, outgoing call in alerting phase, provides an information flow for Access Transfer of media of an IMS session in PS to CS direction for Access Transfers as specified in TS 23.216 [10].

The flow requires that the user is active in an outgoing IMS session in alerting state and there is no other session (or there is one or more held sessions but mid-call service is not supported); procedures and capabilities specified in TS 23.216 [10] are used for the switching of access networks at the transport layer.

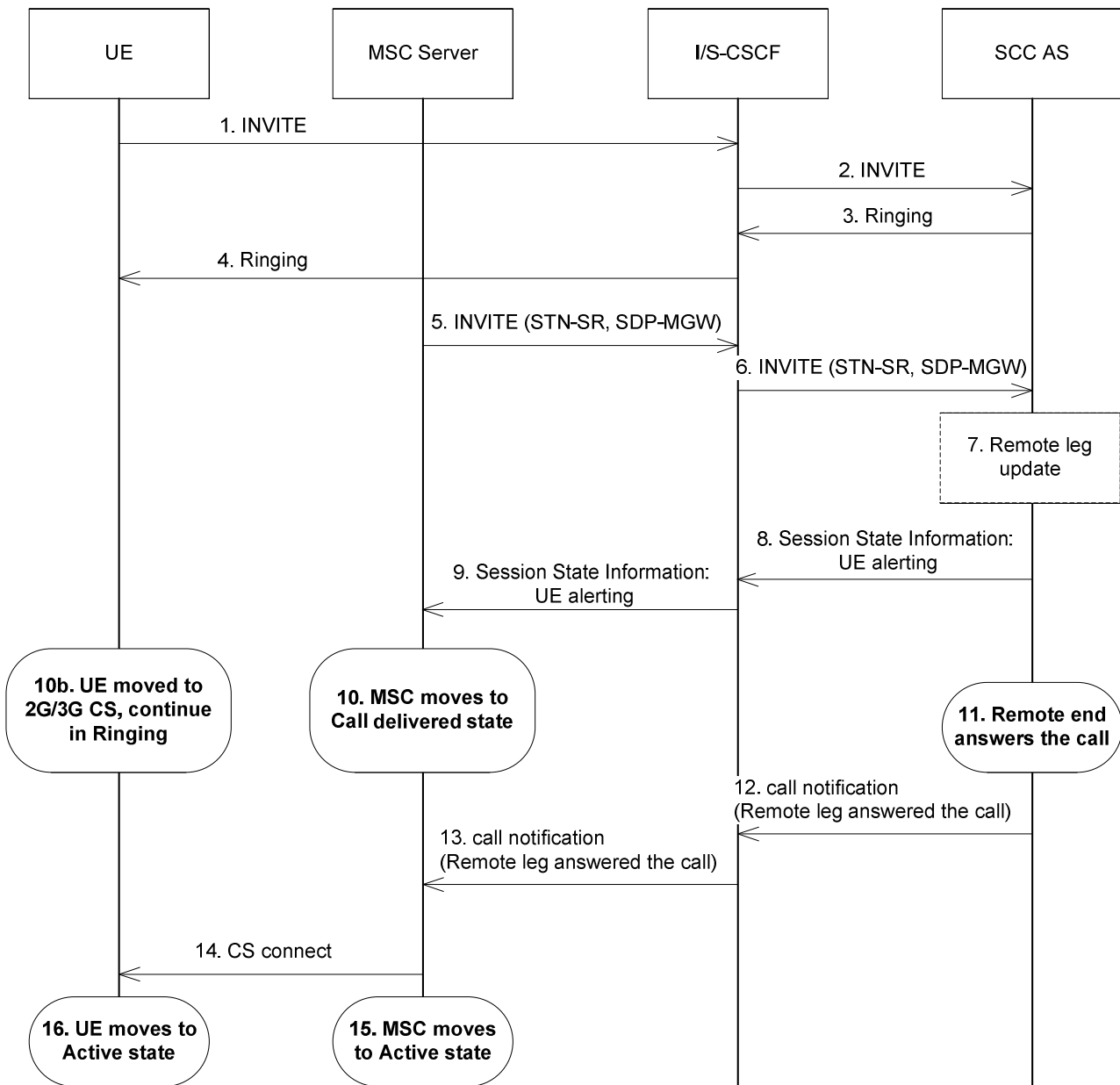

**Figure 6.3.2.1.4d-1: PS-CS: PS to CS – Single Radio, outgoing voice or video call in alerting phase**

- 1-4. Standard procedures are used to initiate a SIP session from the UE towards the remote end. The remote end is alerting the user for the incoming voice or video-call session.
- 5. Procedures specified in TS 23.216 [10] result in an INVITE to be sent with an STN-SR indicating use of Single Radio VCC procedures for Access Transfer to CS access. If the user is not IMS registered by the MSC Server, the MSC Server enhanced for (v)SRVCC includes the C-MSISDN as calling party number. If the user is registered in the IMS by the MSC Server, then the MSC Server includes the GRUU into the session transfer request. The MSC Server indicates its capability to support mid-call services during session transfer. For PS-CS transfer for vSRVCC the video Codecs are also included in the session transfer request.
- 6. Standard procedures are used at I/S-CSCF for routing of the INVITE to the SCC AS.
- 7. The SCC AS uses the STN-SR to determine that Access Transfer using Single Radio VCC is requested. The SCC AS may retrieve the C-MSISDN from the HSS. The SCC AS identifies the correct anchored session. The SCC AS proceeds with the Access Transfer of the recently added active session with bi-directional speech or bi-directional speech and synchronised video for the UE by updating the Remote Leg with the media description and other information using the Remote Leg Update procedure as specified in clause 6.3.1.5.

NOTE 1: It is assumed the initial SDP negotiation has been completed prior to triggering the (v)SRVCC, thus the SCC AS can update the remote leg.

NOTE 2: The SCC AS uses the C-MSISDN or GRUU to correlate the Access Transfer request.

8. The SCC AS provides Session State Information on the outgoing speech call in alerting state.
9. The S-CSCF forwards the Session State Information to the MSC Server.
10. The MSC moves to the corresponding CS call state, e.g. Call Delivered in TS 24.008 [24].
- 10b. In parallel to step 10, the UE has received the HO command as described in TS 23.216 [10]. The UE determines the local call state in the SIP session, and creates the corresponding CS call state, e.g. Call Delivered in TS 24.008 [24]. The UE ensures that the same ring back tone is played to the end user.
11. The remote end answers to the call.
12. The SCC AS notifies the MSC the remote end has answered the call.
13. Standard procedures are used at S-CSCF for routing of the notification to the MSC.
14. The MSC uses the standard procedure to send the CS connect message to UE as e.g. described in TS 24.008 [24]. For video call the UE may initiate at this stage the H.245 Codec negotiation.
15. The MSC moves to Active state.
16. The UE moves to Active state.

#### 6.3.2.1.4e PS - CS Access Transfer: PS to CS - Single Radio, voice and video

Figure 6.3.2.1.4e-1 describes the information flows for transferring voice and video from PS to CS access single radio.

The flow requires that the user is active in an IMS originating or terminating session with voice and synchronised video media; procedures and capabilities specified in TS 23.216 [10], clause 6.2.2.3 are used for the switching of access networks at the transport layer.

NOTE 1: The UE capable of procedures as specified in TS 23.216 [10] does not need to support session and access transfer procedures as specified in clauses 6.3.2.1.5 and 6.3.2.3 to support PS to CS Access Transfer.

In this flow, the SCC AS waits for the H.245 negotiation completion before updating Remote Leg.

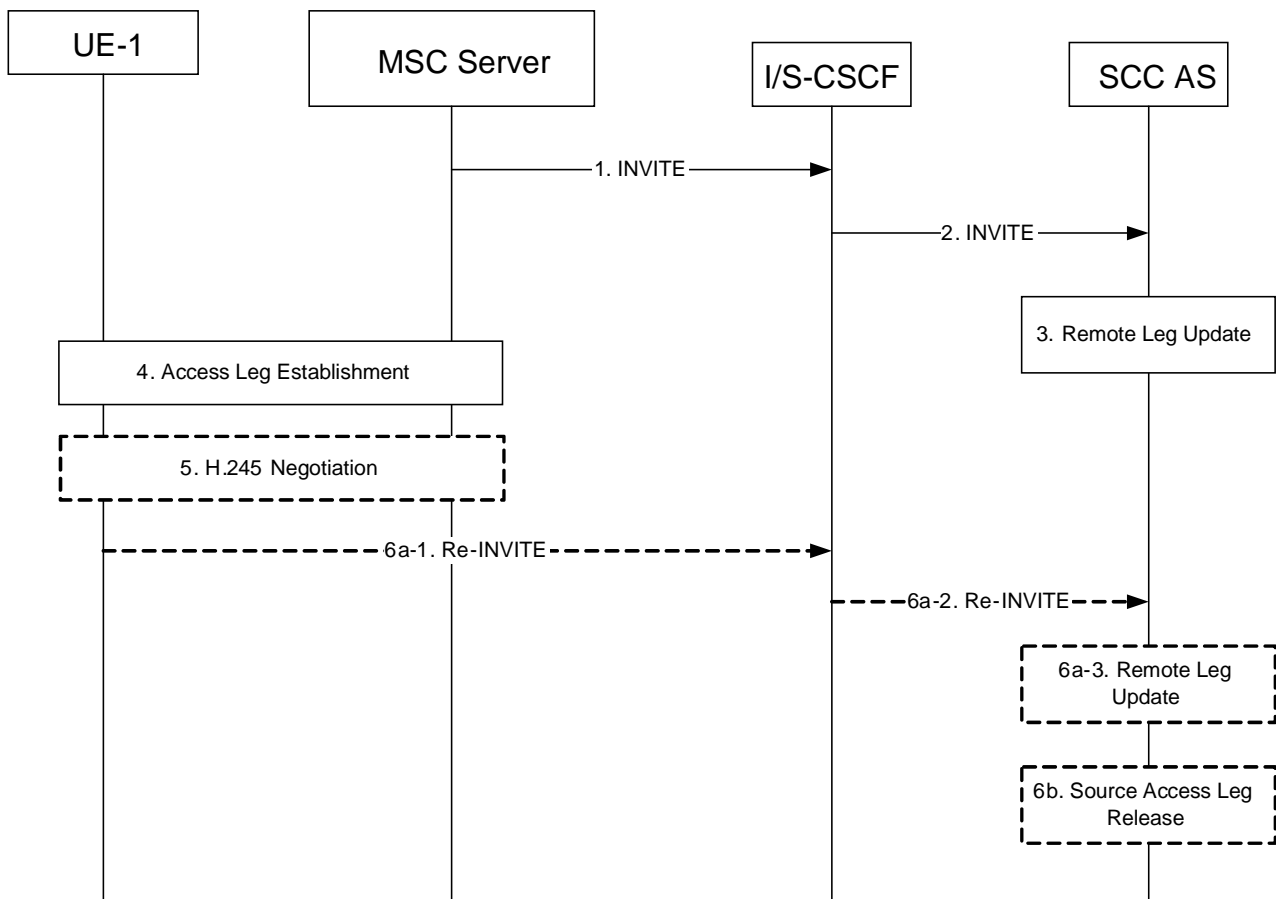

**Figure 6.3.2.1.4e-1: Information flow for voice and video transfer from PS to CS- single radio**

1-2. See clause 6.3.2.1.4 steps 1 and 2. MSC Server includes the SDP of the voice and video SDP of the predefined Codecs. If vSRVCC with priority is supported, MSC Server enhanced for vSRVCC also includes a priority indication if received. The SCC AS performs the Access Transfer of the most recently added active session for bidirectional voice and synchronised video media. The transfer of the alerting session is described 6.3.2.1.4c and 6.3.2.1.4d.

3. See clause 6.3.2.1.4 step 3. The SCC AS performs a remote leg update with the media type of the CS access leg for the voice and video session as specified in clause 6.3.1.5.

NOTE 2: If the remote end does not support the predefined Codecs, the MGW performs the appropriate transcoding.

4. The MSC Server completes the CS leg establishment with UE-1.

5. Predefined Codecs for voice and video with specific characteristics are initially used by the UE-1 after it establishes the circuit bearer to the target MSC. The predefined Codecs for voice and video are the default Codecs specified in TS 26.111 [32]. If needed, UE-1 and MSC Server may start in band H.245 negotiation right after the UE-1 establishes a circuit bearer to the MSC. 3G-324M codec negotiation for the video is executed (refer to TR 26.911 [29] for H.245 signalling optimizations) right after the UE-1 establishes a circuit bearer to the Target MSC.

6a. If the Gm reference point is retained upon PS handover procedure then:

6a-1. The UE-1 sends a Re-INVITE via the PS access to update the remaining non-voice and non-voice/non-video media flow(s) associated with the recently added active session. If the UE-1 is using ICS capabilities, this Re-INVITE also adds Gm service control to the active session and the UE-1 subsequently sends Re-INVITES for any remaining inactive bi-directional speech sessions that are to be transferred.

6a-2. Standard procedures are used at S-CSCF for routing of the Re-INVITE(s) to the SCC AS.

6a-3. The SCC AS processes the Re-INVITE(s) and updates the Remote Leg if needed.

6b. If the Gm reference point is not retained upon PS handover procedure, or if there was no other non-voice and non-voice/non-video media flow(s) in the IMS session than the voice+video which was transferred to the target access, then the Source Access Leg is released as specified in clause 6.3.1.6.

NOTE 3: Some or all of the steps between steps 3 and 6b may consist of a sequence of messages, some of which may occur in parallel.

### 6.3.2.1.5 PS – CS Access Transfer for voice and video, Dual Radio

Figure 6.3.2.1.5-1 describes the information flows for transferring voice and video from PS to CS access.

In this flow, the SCC AS waits for the H245 negotiation completion before updating Remote Leg.

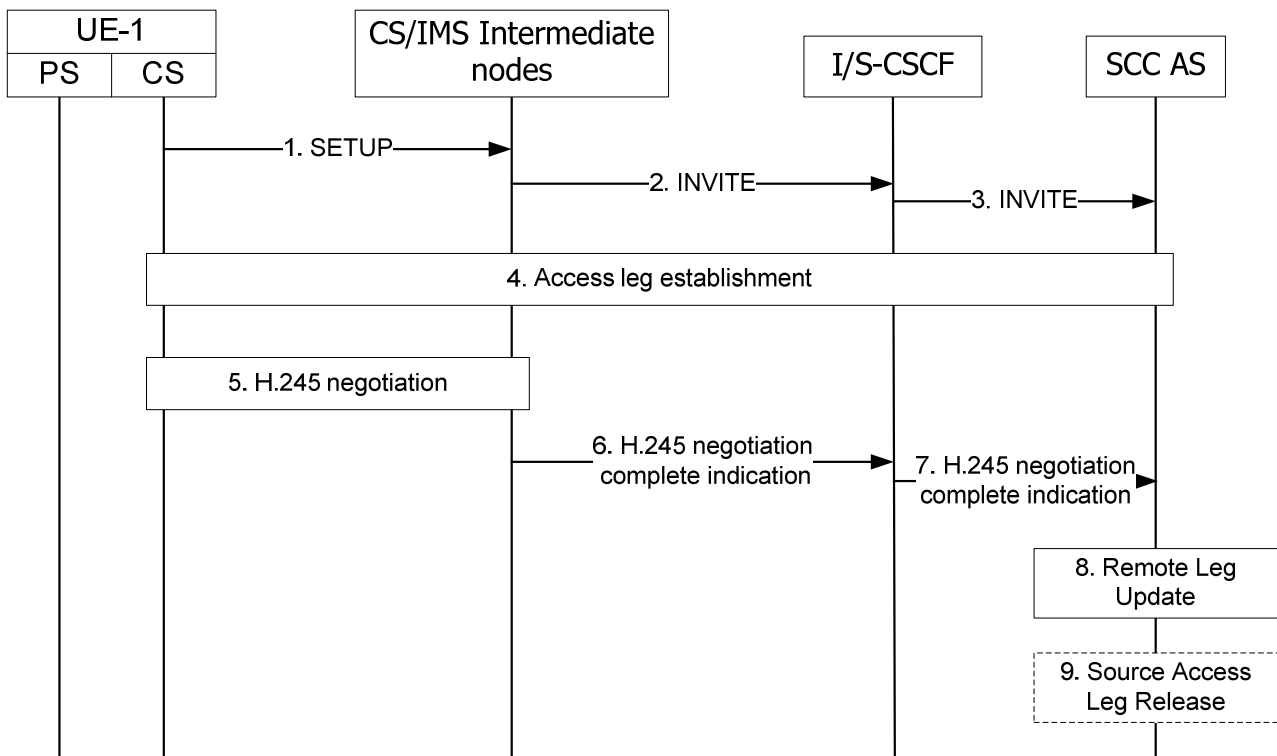

**Figure 6.3.2.1.5-1: Information flow for voice and video transfer from PS to CS**

- 1-3. UE-1 starts Access Transfer of multimedia session from PS to CS as specified in steps 1-3 of clause 6.3.2.1.1. The media types of voice and video, included in the INVITE message with STN in step 3, instruct the SCC AS to wait for H.245 negotiation complete to perform the Remote Leg update in step 8.
4. The SCC AS completes the CS leg establishment with UE-1.
5. UE-1 and CS/IMS intermediate node starts in band H.245 negotiation.
- 6-7. After the H.245 negotiation is done, CS/IMS intermediate node sends H.245 negotiation completion indication towards SCC AS.
8. On receipt of the H.245 negotiation complete indication, the SCC AS updates the Remote Leg as specified in step 4 of clause 6.3.2.1.1
9. The SCC AS may release the Source Access Leg as specified in step 5 of clause 6.3.2.1.1.

NOTE 1: If the non voice and video media flow is retained, the Source Access Leg may be updated by session re-negotiation.

NOTE 2: When using the MSC server enhanced for ICS, the H.245 negotiation with UE-1 shall be executed by the MSC server enhanced for ICS, and the H.245 negotiation complete indication shall be sent by the MSC server enhanced for ICS towards SCC AS.

### 6.3.2.1.6 PS – CS Access Transfer: PS to CS – Dual Radio, mid-call service with an active speech and video session

Figure 6.3.2.1.6-1 PS to CS with one active speech and video session, using SCUDIF, provides an information flow for Access Transfer of multiple IMS sessions in PS to CS direction. The flow requires that the user is active in an IMS originating or terminating speech and video session using PS media at the time of initiation of Access Transfer to CS and that the use of network capabilities to support mid-call services during session transfer is possible. It also requires that SCUDIF feature is supported by the UE and the CS network.

NOTE: When the UE is using a conference service, the procedures specified in clause 6.3.2.1.8 need to be performed in conjunction with this flow, for the conference service to be supported after the Access Transfer.

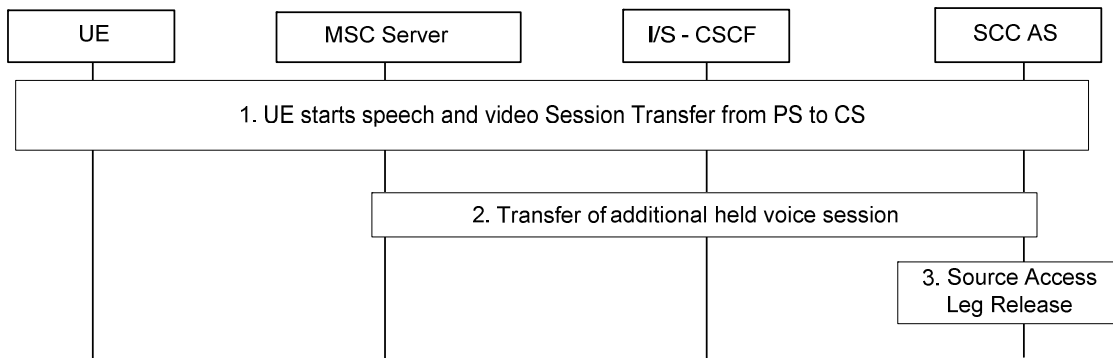

**Figure 6.3.2.1.6-1: PS to CS with one active speech and video session, using SCUDIF**

1. Standard procedure as specified in clause 6.3.2.1.5 PS – CS Access Transfer for voice and video is used for transferring the active speech and video session. The UE indicates SCUDIF support and provides two bearer capabilities (voice and multimedia) with multimedia preferred when initiating the transfer. Also, the SCC AS provides session state information on the inactive voice session including needed STI on the transferring-in leg to the MSC Server.
2. The MSC Server ICS initiates session transfer towards SCC AS for the additional inactive voice session on behalf the UE.
3. The Source Access Leg associated with the inactive voice session is released as specified in clause 6.3.1.6.

Subsequently, the UE can switch between the speech and video session and the voice session with different bearer capabilities activated using SCUDIF feature as specified in TS 23.292 [5].

If SCUDIF is not supported, the transfer can be performed as Figure 6.3.2.1.6-1 with the differences that in step 1 the UE initiates Access Transfer not using SCUDIF, and after the transfer video channel is closed via H.245 negotiation if the voice session is to be activated.

### 6.3.2.1.7 PS – CS Access Transfer: PS to CS – Dual Radio, mid-call service with one inactive speech and video session

Figure 6.3.2.1.7-1 PS to CS with one inactive speech and video session, using SCUDIF, provides an information flow for Access Transfer of multiple IMS sessions in PS to CS direction. The flow requires that the user is inactive in an IMS originating or terminating speech and video session using PS media at the time of initiation of Access Transfer to CS and that the use of network capabilities to support mid-call services during session transfer is possible. It also requires that SCUDIF feature is supported by the UE and the CS network.

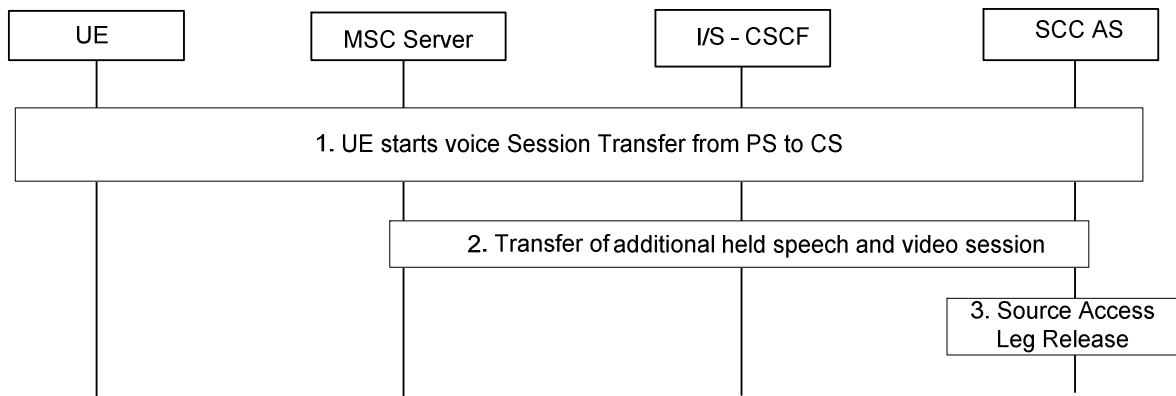

**Figure 6.3.2.1.7-1: PS to CS with one inactive speech and video session, using SCUDIF**

1. Standard procedure as specified in clause 6.3.2.1.1 PS – CS Access Transfer: PS to CS is used for transferring the active voice session. The UE indicates SCUDIF support and provides two bearer capabilities (voice and multimedia) with voice preferred when initiating the transfer. Also, the SCC AS provides session state information on the inactive speech and video session including needed STI on the transferring-in leg to the MSC Server.
2. The MSC Server initiates session transfer towards SCC AS for the additional inactive speech and video session on behalf the UE.
3. The Source Access Leg associated with the inactive speech and video session is released as specified in clause 6.3.1.6.

Subsequently, the UE can switch between the speech and video session and the voice session with different bearer capabilities activated using SCUDIF feature as specified in TS 23.292 [5].

If SCUDIF is not supported, the transfer can be performed as Figure 6.3.2.1.7-1 with the differences that in step 1 the UE initiates Access Transfer not using SCUDIF, and after the transfer redial mechanism can be used to switch between the speech and video call and the voice call as specified in TS 23.292 [5].

#### 6.3.2.1.7a PS - CS Access Transfer: PS to CS - Single Radio, mid-call service with an incoming waiting call in alerting phase

Figure 6.3.2.1.7a-1 provides an information flow for Access Transfer of media of an IMS session in PS to CS direction for Access Transfers as specified in TS 23.216 [10].

The flow requires that the user is active in an IMS originating or terminating session and an incoming waiting call is indicated to the user which is in call waiting state; procedures and capabilities specified in TS 23.216 [10] are used for the switching of access networks at the transport layer.

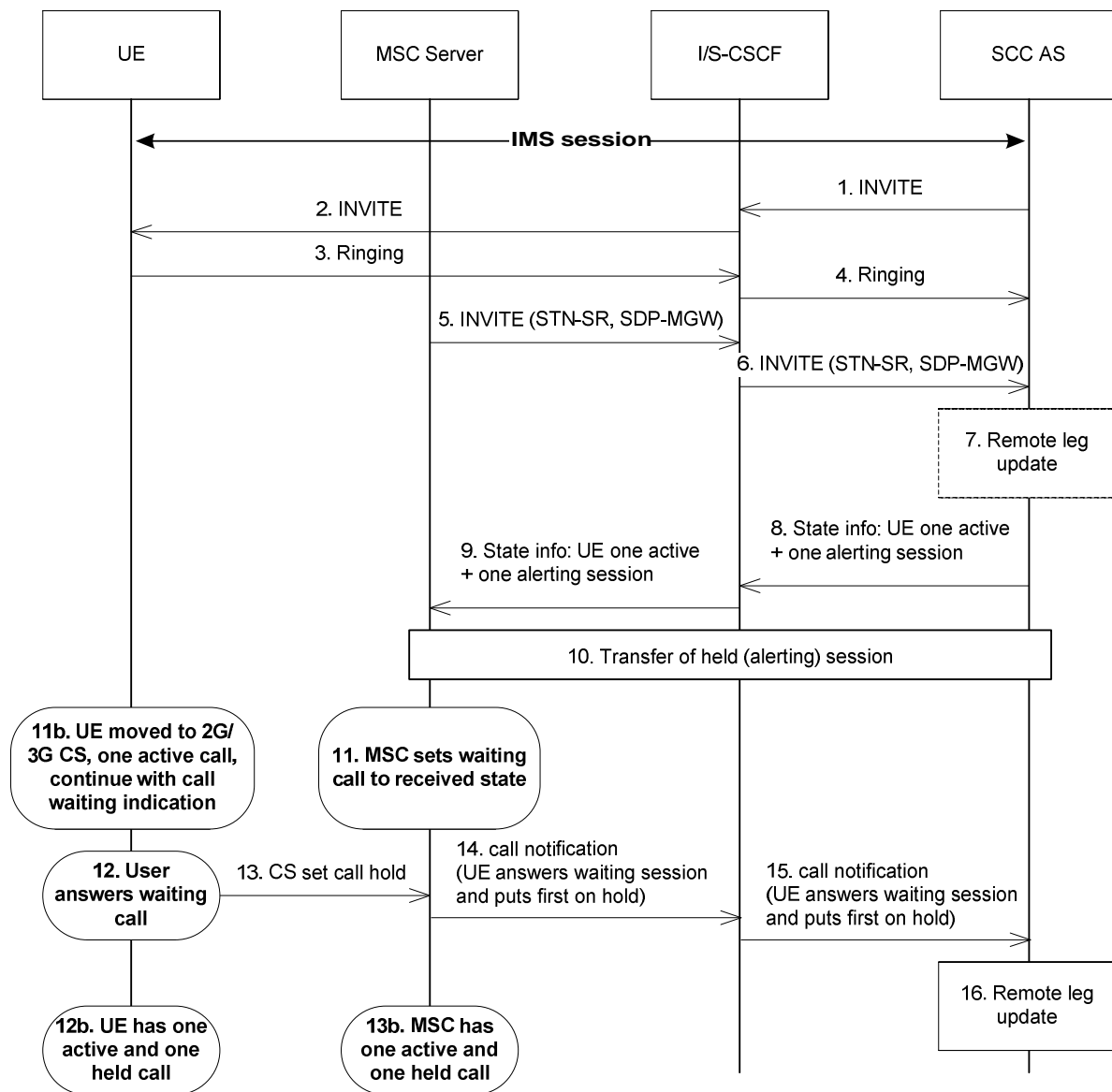

**Figure 6.3.2.1.7a-1: PS-CS: PS to CS - Single Radio, mid-call service with an incoming waiting call in alerting phase**

- 1-4. Standard procedures are used to initiate a SIP session towards the UE, which has already an ongoing session. The UE is notifying the user for the incoming waiting session.
5. Procedures specified in TS 23.216 [10] result in an INVITE to be sent with an STN-SR indicating use of Single Radio VCC procedures for Access Transfer to CS access. If the user is not IMS registered by the MSC Server, the MSC Server enhanced for SRVCC includes the C-MSISDN as calling party number. If the user is registered in the IMS by the MSC Server, then the MSC Server includes the GRUU into the session transfer request. The MSC Server indicates its capability to support mid-call services during session transfer.
6. Standard procedures are used at I/S-CSCF for routing of the INVITE to the SCC AS.
7. The SCC AS uses the STN-SR to determine that Access Transfer using Single Radio VCC is requested. The SCC AS may retrieve the C-MSISDN from the HSS. The SCC AS identifies the correct anchored session. The SCC AS proceeds with the Access Transfer of the recently added active session with bi-directional speech for the UE by updating the Remote Leg with the media description and other information using the Remote Leg Update procedure as specified in clause 6.3.1.5.

NOTE 1: It is assumed the initial SDP negotiation has been completed prior to triggering the SRVCC, thus the SCC AS can update the remote leg.



NOTE 2: The SCC AS uses the C-MSISDN or GRUU to correlate the Access Transfer request.

8. The SCC AS provides session state information on the incoming waiting call in alerting state.
9. The S-CSCF forwards the session state information to the MSC Server.
10. The MSC Server receives the Session State Information which indicates one active and one session in alerting state. The MSC Server initiates Access Transfer towards SCC AS for the alerting session.
11. The MSC moves to the corresponding CS call state for the alerting session, e.g. Call Received in TS 24.008 [24].

NOTE 3: In call received state the MSC does not generate an in-band ring tone to the calling party.

- 11b. In parallel to step 11, the UE has received the HO command as described in TS 23.216 [10]. The UE determines the local call states in the SIP sessions, and creates the corresponding CS call states. The UE continues to indicate the user about for the incoming waiting call.
12. The user answers the waiting call and the UE locally swaps the active call with the waiting call.
- 12b. UE has one active and one held call.
13. The UE uses the standard procedure to send the CS set call hold for the previously active call to MSC. The UE uses the standard procedure to send the CS connect message for the alerting call to MSC as e.g. described in TS 24.008 [24].

NOTE 4: Solution for possible race conditions (e.g. MSC server receives the CS set call hold before the SCC AS responds) will be defined in Stage 3.

- 13b. The MSC has one active and one held call for the UE.
14. The MSC notifies the SCC AS the user has swapped the two sessions, i.e. the user has answered the previously alerting call, and put the previously active call on hold.
15. Standard procedures are used at S-CSCF for routing of the notification to the SCC AS.
16. The SCC AS creates the corresponding SIP request to the remote end and updates the remote leg.

#### 6.3.2.1.7b PS - CS Access Transfer: PS to CS - Single Radio, mid-call service with an outgoing call in alerting phase

Figure 6.3.2.1.7b-1 provides an information flow for Access Transfer of media of an IMS session in PS to CS direction for Access Transfers as specified in TS 23.216 [10].

The flow requires that the user has a held IMS originating or terminating session and an outgoing IMS session in alerting state; procedures and capabilities specified in TS 23.216 [10] are used for the switching of access networks at the transport layer.

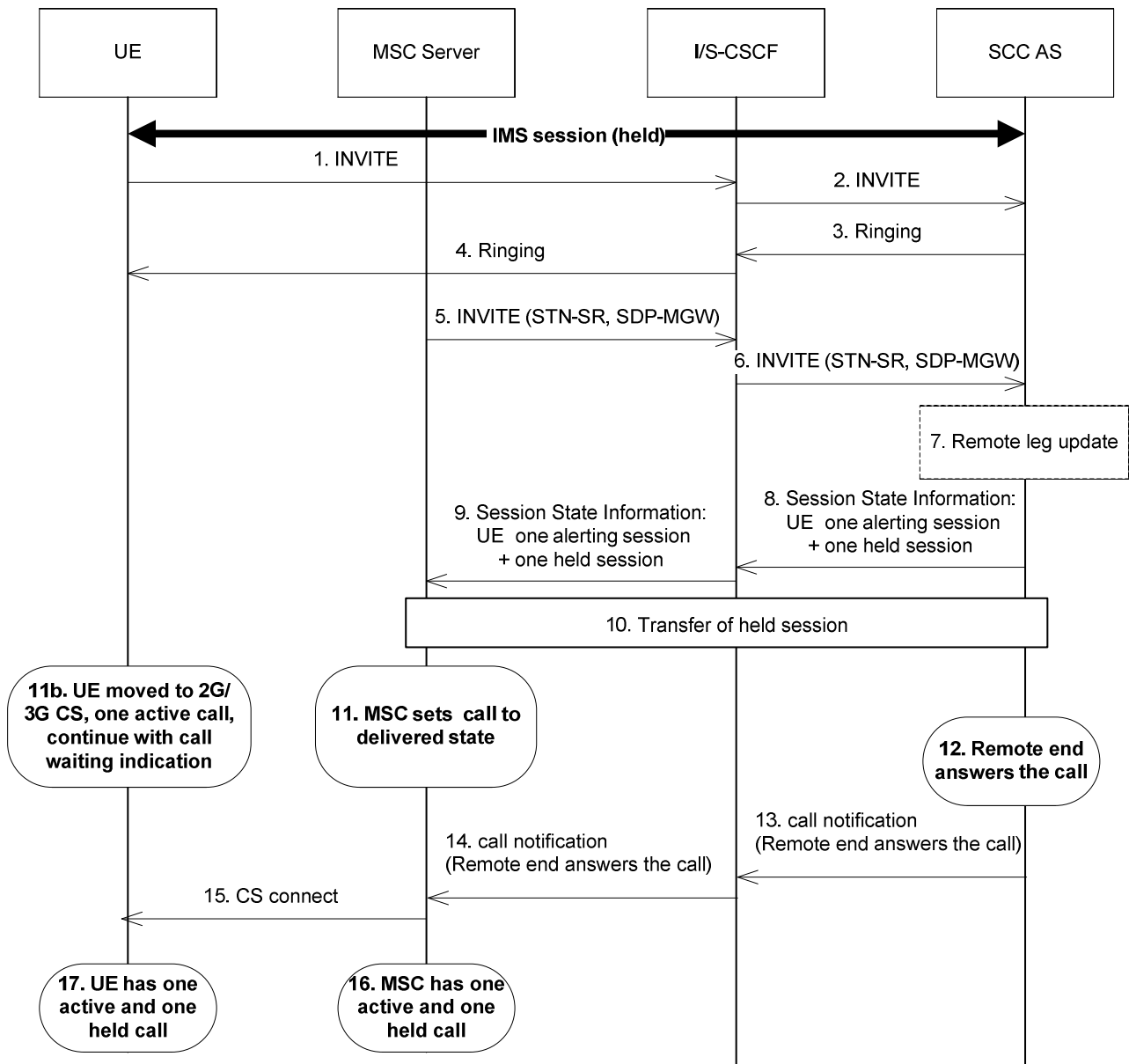

**Figure 6.3.2.1.7b-1: PS-CS: PS to CS - Single Radio, mid-call service with an outgoing call in alerting phase**

- 1-4. Standard procedures are used to initiate a SIP session from the UE, which has already an IMS session (held). The remote end is alerting the user for the incoming voice session.
- 5. Procedures specified in TS 23.216 [10] result in an INVITE to be sent with an STN-SR indicating use of Single Radio VCC procedures for Access Transfer to CS access. If the user is not IMS registered by the MSC Server, the MSC Server enhanced for SRVCC includes the C-MSISDN as calling party number. If the user is registered in the IMS by the MSC Server, then the MSC Server includes the GRUU into the session transfer request. The MSC Server indicates its capability to support mid-call services during session transfer.
- 6. Standard procedures are used at I/S-CSCF for routing of the INVITE to the SCC AS.
- 7. The SCC AS uses the STN-SR to determine that Access Transfer using Single Radio VCC is requested. The SCC AS may retrieve the C-MSISDN from the HSS. The SCC AS identifies the correct anchored session. The SCC AS proceeds with the Access Transfer of the outgoing alerting session for the UE by updating the Remote Leg with the media description and other information using the Remote Leg Update procedure as specified in clause 6.3.1.5, and put other IMS session on held if there are other active session on the UE.

NOTE 1: It is assumed the initial SDP negotiation has been completed prior to triggering the SRVCC, thus the SCC AS can update the remote leg.

NOTE 2: The SCC AS uses the C-MSISDN or GRUU to correlate the Access Transfer request.

8. The SCC AS provides Session State Information that the outgoing speech call in alerting state and other session information as specified in clause 6.3.2.1.4a.
9. The S-CSCF forwards the Session State Information to the MSC Server.
10. The MSC Server receives the Session State Information which indicates one held session and one session in alerting state. The MSC Server initiates Access Transfer towards SCC AS for the held session.
11. The MSC moves to the corresponding CS call state, e.g. Call Delivered in TS 24.008 [24].
- 11b. In parallel to step 11, the UE has received the HO command as described in TS 23.216 [10]. The UE determines the local call state in the SIP session, and creates the corresponding CS call state, e.g. Call Delivered in TS 24.008 [24]. The UE ensures that the same ring back tone is played to the end user.
12. The remote end answers to the call.
13. The SCC AS notifies the MSC the remote end has answered the call.
14. Standard procedures are used at S-CSCF for routing of the notification to the MSC.
15. The MSC uses the standard procedure to send the CS connect message to UE as e.g. described in TS 24.008 [24].
16. The MSC has one active and one held call for the UE.
17. The UE has one active and one held call.

#### 6.3.2.1.7c PS - CS Access Transfer: PS to CS - Single Radio, mid-call service with an incoming call in alerting phase and a held session

Figure 6.3.2.1.7c-1 provides an information flow for Access Transfer of media of an IMS session in PS to CS direction for Access Transfers as specified in TS 23.216 [10].

The flow requires that the user has a held IMS originating or terminating session and an incoming call in alerting state; procedures and capabilities specified in TS 23.216 [10] are used for the switching of access networks at the transport layer.

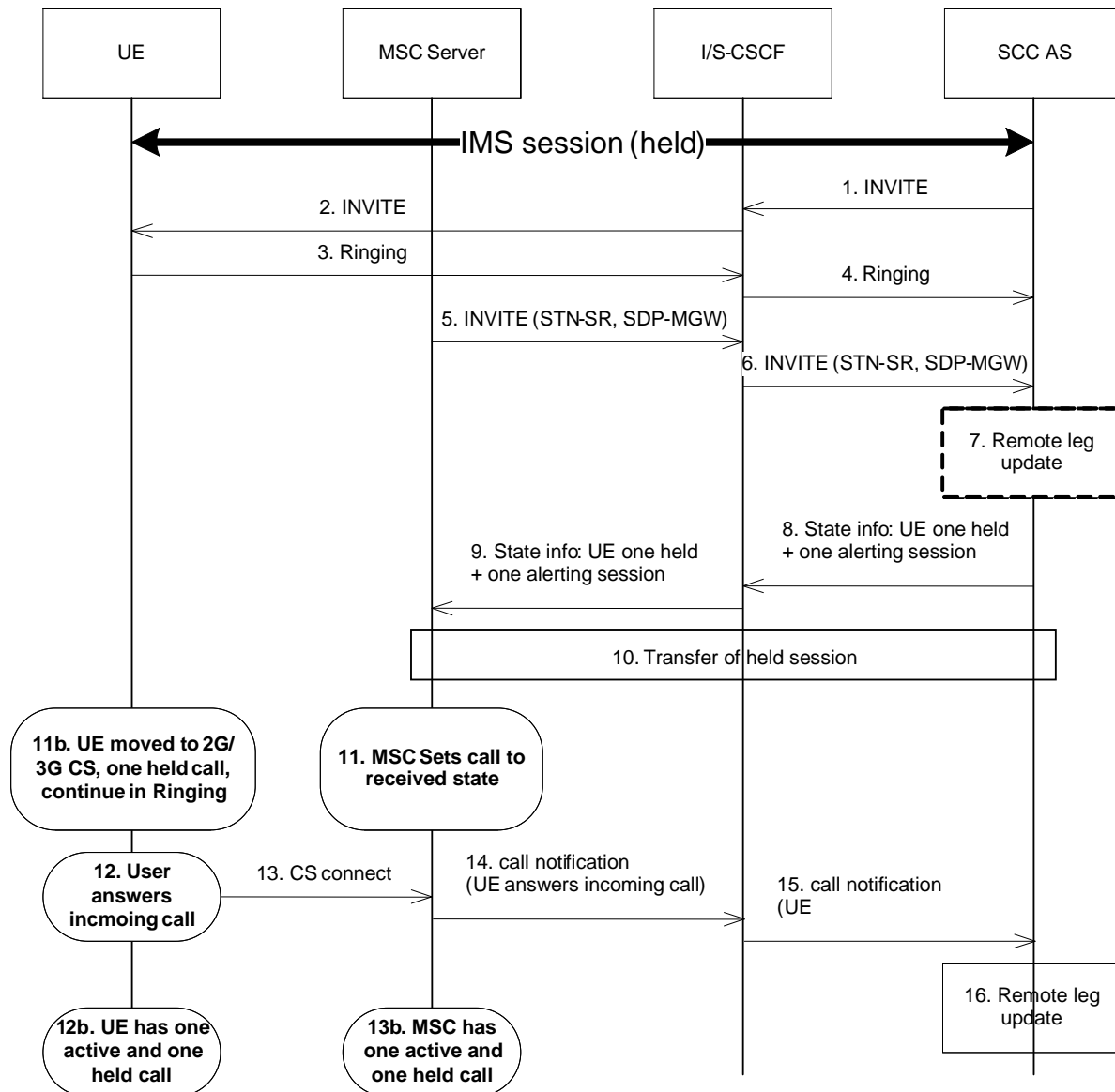

**Figure 6.3.2.1.7c-1: PS-CS: PS to CS - Single Radio, mid-call service with an incoming call in alerting phase**

- 1-4. Standard procedures are used to initiate a SIP session towards the UE, which has already an IMS session (held). The UE is notifying the user for the incoming session.
5. Procedures specified in TS 23.216 [10] result in an INVITE to be sent with an STN-SR indicating use of Single Radio VCC procedures for Access Transfer to CS access. If the user is not IMS registered by the MSC Server, the MSC Server enhanced for SRVCC includes the C-MSISDN as calling party number. If the user is registered in the IMS by the MSC Server, then the MSC Server includes the GRUU into the session transfer request. The MSC Server indicates its capability to support mid-call services during session transfer.
6. Standard procedures are used at I/S-CSCF for routing of the INVITE to the SCC AS.
7. The SCC AS uses the STN-SR to determine that Access Transfer using Single Radio VCC is requested. The SCC AS may retrieve the C-MSISDN from the HSS. The SCC AS identifies the correct anchored session. The SCC AS proceeds with the Access Transfer of the incoming alerting session for the UE by updating the Remote Leg with the media description and other information using the Remote Leg Update procedure as specified in clause 6.3.1.5.

NOTE 1: It is assumed the initial SDP negotiation has been completed prior to triggering the SRVCC, thus the SCC AS can update the remote leg.

NOTE 2: The SCC AS uses the C-MSISDN or GRUU to correlate the Access Transfer request.

8. The SCC AS provides session state information that the incoming speech call in alerting state and other session information as specified in clause 6.3.2.1.4a.
9. The S-CSCF forwards the session state information to the MSC Server.
10. The MSC Server receives the Session State Information which indicates one held and one session in alerting state. The MSC Server initiates Access Transfer towards SCC AS for the held session.
11. The MSC moves to the corresponding CS call state for the alerting session, e.g. Call Received in TS 24.008 [24].

NOTE 3: In call received state the MSC does not generate an in-band ring tone to the calling party.

- 11b. In parallel to step 11, the UE has received the HO command as described in TS 23.216 [10]. The UE determines the local call states in the SIP sessions, and creates the corresponding CS call states. The UE continues to indicate the user about for the incoming call.
12. The user answers the incoming call and the UE locally swaps the active call with the incoming call.
- 12b. UE has one active and one held call.
13. The UE uses the standard procedure to send the CS connect message for the alerting call to MSC as e.g. described in TS 24.008 [24].

NOTE 4: Solution for possible race conditions (e.g. MSC server receives the CS set call hold before the SCC AS responds) will be defined in Stage 3.

- 13b. The MSC has one active and one held call for the UE.
14. The MSC notifies the SCC AS the user has answered the call.
15. Standard procedures are used at S-CSCF for routing of the notification to the SCC AS.
16. The SCC AS creates the corresponding SIP request to the remote end and updates the remote leg.

### 6.3.2.1.8 PS - CS Access Transfer: Conferencing - for UEs not using ICS capabilities

When the UE is using a conference service and Access Transfer between PS and CS access networks happens, the conference information should be provided by the SCC AS.

The following procedures require that the use of network capabilities to support MSC Server assisted mid-call feature during Access Transfer is supported by the UE and the network according to clause 6.3.2.1.1a, clause 6.3.2.1.4a or clause 6.3.2.1.6 for PS to CS Access Transfer, and according to clause 6.3.2.1.2a for CS to PS Access Transfer. They further require that the MSC Server is enhanced for ICS as specified in TS 23.292 [5].

When the UE in an on-going conference performs Access Transfer from PS to CS, the SCC AS shall provide the conference information (i.e. conference URI, identifier of all participants, etc.) to the MSC Server on the Target Access Leg. When the MSC Server receives the conference information, it shall create a conference state in CS access network (i.e. call in MPTY). When multiple multi-media sessions including a conference exist, if the active session being transferred or the selected additional session to be transferred is a conference call, the conference information shall also be included in the session state information to be sent by the SCC AS to the MSC Server. The MSC Server enhanced for ICS using the conference information then performs conference control on behalf of the UE as specified in clause 7.6.2.8 of TS 23.292 [5]. The MSC Server not enhanced for ICS performs conference control as specified in clause 7.6.3.6 of TS 23.292 [5] after the Access Transfer from PS to CS.

NOTE 2: Neither the MSC Server enhanced for ICS nor the MSC Server not enhanced for ICS are informed about remote participants leaving the conference that have been added before SRVCC, see also TS 23.292 [5].

When the UE in an on-going conference performs Access Transfer from CS to PS, the SCC AS shall provide the conference information (i.e. conference URI, etc.) to the UE on the Target Access Leg. When multiple sessions including a conference exist, if the active session being transferred or the additional held session is a conference call, the conference information shall also be included in the Session State Information to be sent by the SCC AS to the UE. The UE then uses the conference information to control the conference in PS domain as specified in TS 24.147 [25].

## 6.3.2.1.9 PS – CS Access Transfer: PS to CS – Single Radio using ATCF enhancements

## 6.3.2.1.9.1 ATCF with media anchored in ATGW

This clause describes the main differences with the (v)SRVCC procedures specified in clauses 6.3.2.1.4 and 6.3.2.1.4a for the case when the media is anchored in the ATGW and the ATCF enhancements are used. A pre-requisite for this scenario is that the ATCF has been included during the IMS registration according to clause 6.1.2. Some of the procedures that are not impacted have been left out for clarity of the flow.

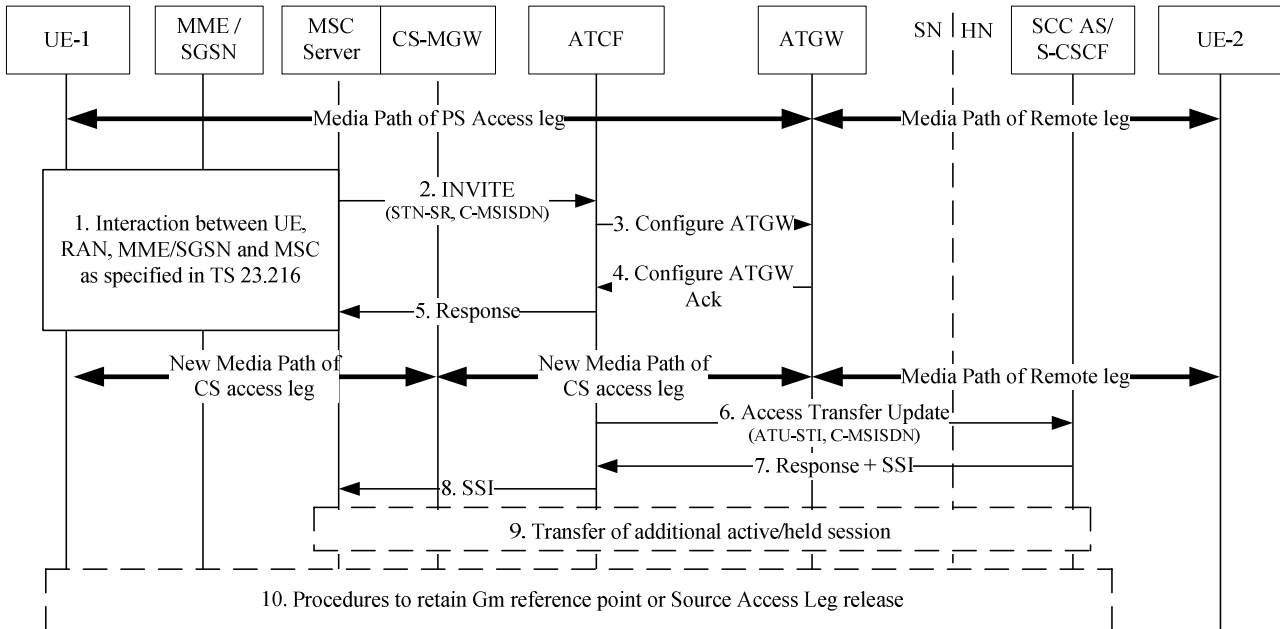

**Figure 6.3.2.1.9.1-1: PS to CS Access Transfer when using ATCF enhancements and media anchored.**

1. Interaction between UE, RAN, MME/SGSN and MSC Server as specified in TS 23.216 [10]. The following step is triggered after the MSC Server has received the PS to CS request from the MME / SGSN and has allocated resources in the RAN.

NOTE 1: In case of PS HO taking place in parallel, and according to TS 23.216 [10] clauses 6.2.2.2 and 6.3.2.2, both the MSC Server and the target SGSN send independently the Reloc / HO Req to the target RAN. The target RAN synchronizes the PS and CS resource allocation based on information (received in transparent containers provided by the source RAN) before responding to both MSC Server and SGSN, which in turn respond to the source MME/SGSN. The source MME/SGSN will instruct the UE to move to the target RAN when having received responses from both SGSN and MSC Server.

2. The MSC Server initiates Access Transfer message, and if supported, the MSC Server indicates its capability to support MSC Server assisted mid-call feature. The MSC Server provides all the supported Codecs for voice or voice and video in the Access Transfer message.

NOTE 2: It is expected that the CS MGW will support the Codecs used for the PS session, and thereby the likelihood is minimized that ATCF has to instruct the ATGW to insert Codecs (i.e. for transcoding).

3. The ATCF receives the Access Transfer message and correlates the transferred session using the C-MSISDN. The ATCF identifies the correct anchored session and proceeds with the Access Transfer of the most recently active speech session. The ATCF updates the ATGW by replacing the existing PS access leg media path information with the new CS access leg media path information, by sending a Configure ATGW message to ATGW. ATCF may provide priority handling if the Access Transfer message contains priority indication.

NOTE 3: The ATCF could instruct the ATGW to keep using the local port of the PS access leg media path for the new CS access leg media path.

4. The ATGW sends Configure ATGW Acknowledgment message back to ATCF.
5. The ATCF sends an Access Transfer response to the MSC Server. The media path is switched to CS when receiving SDP information.

NOTE 4: If the ATCF instructs the ATGW to use the local port of the PS access leg media path for the new CS access leg media path, the Access Transfer response can be sent right after step 3.

NOTE 5: Since step 2 to 5 are in parallel to step 1, the voice interruption starts when either the media is switched to the CS MGW controlled by the MSC Server enhanced for (v)SRVCC or when the UE starts to relocate to the target (whatever comes first). The media interruption ends when the UE has tuned to the target and media has switched to CS MGW (whatever comes last). It is assumed that the media is switched to CS MGW during the time the UE tunes to target.

6. After receiving the Access Transfer message, the ATCF re-establishes the communication with the SCC AS and updates the SCC AS that the transfer has taken place by sending an Access Transfer Update message to the SCC AS using the stored ATU-STI. If the MSC server indicated it supported mid-call feature, it also indicates this in the message to the SCC AS. The Access Transfer Update creates a new dialogue between the ATCF and SCC AS. The SCC AS correlates the new dialog with the remote dialog (e.g., using the C-MSISDN). As there is no update in the session description, no remote end update will be performed.

NOTE 6: The new dialog between ATCF and SCC AS is needed to replace the old dialog that has been setup over the PS access leg (and registration). This is to ensure that if the PS registration for the user expires, the new home leg will not be released / affected.

7. The SCC AS sends confirmation response to the ATCF. If the SCC AS and MSC Server supports mid call feature, the SCC AS provides the SSI according to clause 6.3.2.1.4a.
8. If the ATCF receives the SSI, it forwards the SSI to the MSC server.
9. If the MSC Server receives the Session State Information of more than one active or inactive speech sessions, it initiates Access Transfer towards SCC AS for the additional session.

NOTE 7: The Access Leg for the control has moved over to the CS access.

10. Procedures according to clause 6.3.2.1.4, steps 4a and 4b are used to handle the cases where the Gm reference point is either retained upon PS handover procedure, not retained upon PS handover, or if there was no other media flow(s) in the IMS session.

#### 6.3.2.1.9.2 ATCF without media anchored in ATGW

This clause describes the main differences with the (v)SRVCC procedures specified in clauses 6.3.2.1.4 and 6.3.2.1.4a for the case when the ATCF is included in the session path, but media has not been anchored in ATGW. Some of the procedures that are not impacted have been left out for clarity of the flow.

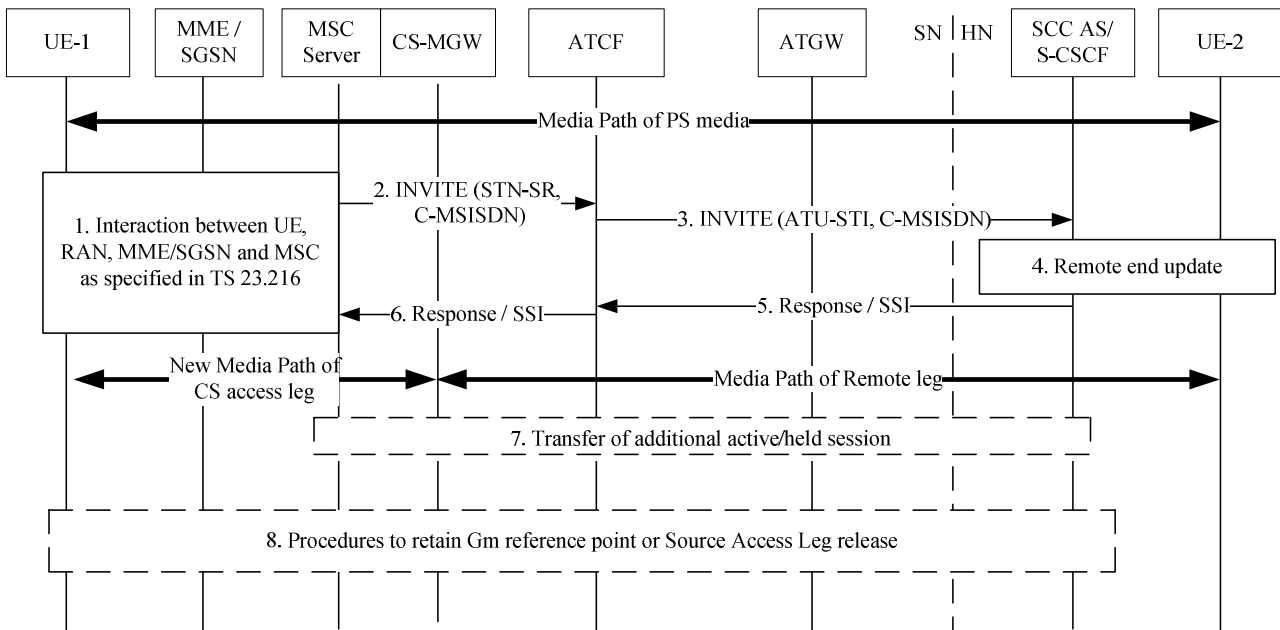

**Figure 6.3.2.1.9.2-1: PS to CS access transfer**

1. Interaction between UE, RAN, MME/SGSN and MSC Server as specified in TS 23.216 [10]. The following step is triggered after the MSC Server has received the PS to CS request from the MME / SGSN and has allocated resources in the RAN.

NOTE 1: In case of PS HO taking place in parallel, and according to TS 23.216 [10] clause 6.2.2.2 and clause 6.3.2.2, both the MSC Server and the target SGSN send independently the Reloc / HO Req to the target RAN. The target RAN synchronizes the PS and CS resource allocation based on information (received in transparent containers provided by the source RAN) before responding to both MSC Server and SGSN, which in turn respond to the source MME/SGSN. The source MME/SGSN will instruct the UE to move to the target RAN when having received responses from both SGSN and MSC Server.

2. The MSC Server initiates Access Transfer message and if supported, the MSC Server indicates its capability to support MSC Server assisted mid-call feature. The MSC Server provides all the supported Codecs for voice or voice and video in the Access Transfer message.
3. The ATCF receives the Access Transfer message and correlates the transferred session using the C-MSISDN. As the media flow has not been anchored in the ATGW, the ATCF forwards the Access Transfer message along with priority indication if received to the SCC AS using the stored ATU-STI. If the MSC server indicated it supported mid-call feature, it also indicates this in the message to the SCC AS.
4. The SCC AS correlates the incoming Access Transfer message. As the Session Description has changed, a remote end update is initiated according to clause 6.3.1.5.
5. The SCC AS sends an Access Transfer response to the MSC Server, and in the case MSC Server assisted mid-call feature is supported and used, the SCC AS provides Session State Information (SSI) according to clause 6.3.2.1.4a.
6. The ATCF forwards the response to the MSC server.
7. If the MSC Server receives the Session State Information of more than one active or inactive speech sessions, it initiates Access Transfer towards SCC AS for the additional session according to clause 6.3.2.1.4a.
8. Procedures according to clause 6.3.2.1.4, steps 4a and 4b are used to handle the cases where the Gm reference point is either retained upon PS handover procedure, not retained upon PS handover, or if there was no other media flow(s) in the IMS session.



6.3.2.1.9.3 ATCF not included during registration

If the decision by the ATCF during registration was not to be included at all, the SRVCC procedures will fall back to procedures according to clauses 6.3.2.1.4 and 6.3.2.1.4a.

6.3.2.1.10 PS - CS Access Transfer: CS to PS - Single Radio

6.3.2.1.10.1 CS to PS - Single Radio procedures with CS media anchored in ATGW

Figure 6.3.2.1.10.1-1 PS-CS: CS to PS - Single Radio, provides an information flow for Access Transfer of a CS speech media flow in CS to PS direction for Access Transfers within 3GPP access networks as specified in TS 23.216 [10].

The flow requires that the user is active or inactive in a CS originating or terminating speech session; procedures and capabilities specified in TS 23.216 [10] are used for the switching of access networks at the transport layer. It further requires that the UE has an active IMS registration prior the transfer take place.

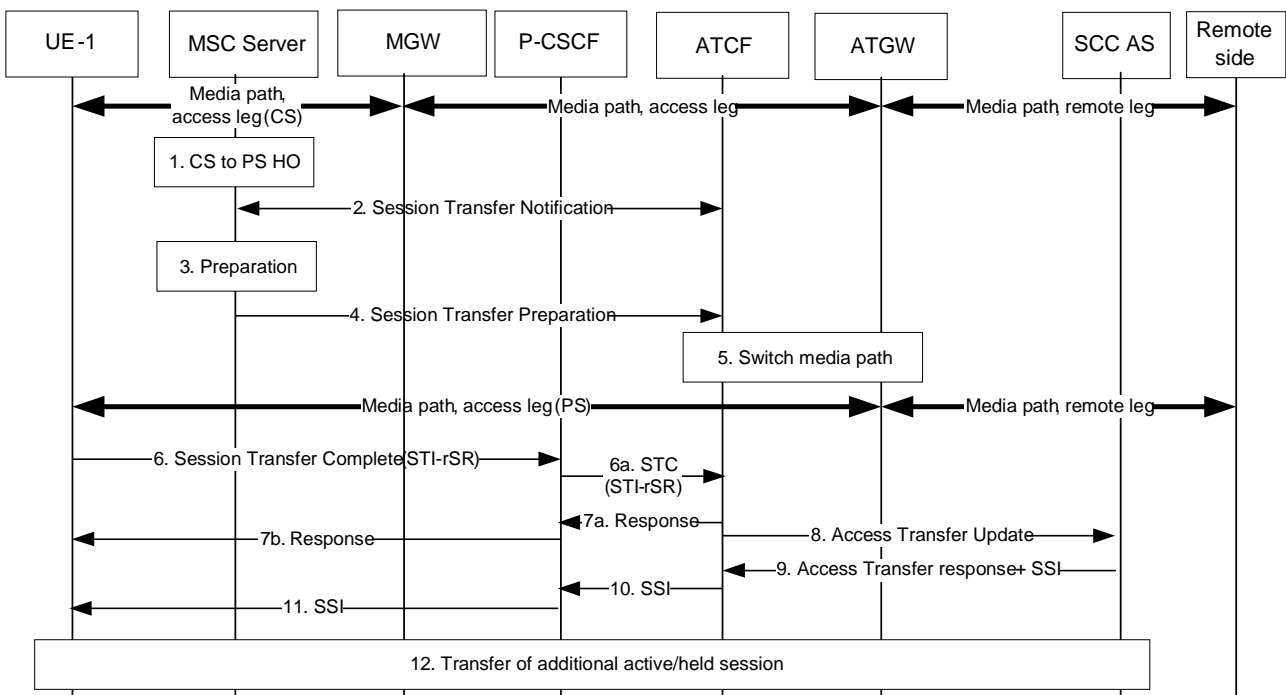

**Figure 6.3.2.1.10-1: CS to PS - Single Radio procedures with CS media anchored in ATGW**

1. Procedures specified in TS 23.216 [10] result in that the MSC Server receives a CS to PS HO request.
2. The MSC Server initiates a Session Transfer Notification towards the ATCF, which indicates to the ATCF that it should prepare for the transfer of media to PS. The ATCF responds with information required for the transfer, including allocated media IP/ports for UL direction and UE's port for DL direction and voice codec information allocated in the ATGW.

NOTE 1: The ATCF retrieves the ports/codec information from the UE during the IMS registration.

3. The MSC Server performs the CS to PS HO preparation procedures by interacting with target MME/SGSN to initiate the handover according to TS 23.216 [10].
4. When the target MME/SGSN have reserved appropriate resources in the target network, the MSC Server sends a Session Transfer Preparation request to the ATCF to instruct the ATCF that media should be switched to the target access and also triggers the UE to hand over to the target according to TS 23.216 [10].
5. The ATCF switches the media path in the ATGW from the source access to target access.

NOTE 2: The voice media will be sent on the target access on the pre-negotiated ports between UE and ATGW.

6. The UE initiates a Session Transfer Complete request to the ATCF to move the session control to the PS access. If mid-call and alerting is supported, the UE will include this in the request.
7. The ATCF sends a Session Transfer Complete response to the UE and releases the Source Access Leg toward the MSC Server.

NOTE 3: PCC interactions will be performed by the P-CSCF according to standard procedures of TS 23.228 [4] during step 6 and step 7. This will create the dedicated voice bearer for the session.

8. After receiving the Session Transfer Complete message, the ATCF re-establishes the communication with the SCC AS and updates the SCC AS that the transfer has taken place by sending an Access Transfer Update message to the SCC AS using the stored ATU-STI and C-MSISDN. If the UE indicated it supported mid-call feature and/or alerting, it also indicates this in the message to the SCC AS. The Access Transfer Update creates a new dialogue between the ATCF and SCC AS. The SCC AS correlates the new dialog with the remote dialog (e.g., using the C-MSISDN). As there is no update in the session description, no remote end update will be performed.
9. The SCC AS sends confirmation response to the ATCF. If the SCC AS and UE supports mid-call feature and/or alerting, the SCC AS provides the Session State Information (SSI) according to clause 6.3.2.1.2a. The Session State Information includes the additional held session with speech media including dynamic STI needed for the held session on the transferring-in leg.
- 10-11. If the ATCF receives the SSI, it forwards the SSI to the UE.
12. If the UE receives the Session State Information of the held session, it initiates a Access Transfer request towards the SCC AS using the dynamic STI for the held session.

#### 6.3.2.1.10.2 CS to PS - Single Radio procedures without CS media anchored in ATGW

Figure 6.3.2.1.10.1-2 PS-CS: CS to PS - Single Radio, provides an information flow for Access Transfer of a CS speech media flow in CS to PS direction for Access Transfers within 3GPP access networks as specified in TS 23.216 [10].

The flow requires that the user is active or inactive in a CS originating or terminating speech session; procedures and capabilities specified in TS 23.216 [10] are used for the switching of access networks at the transport layer. It further requires that the UE has an active IMS registration prior the transfer take place.

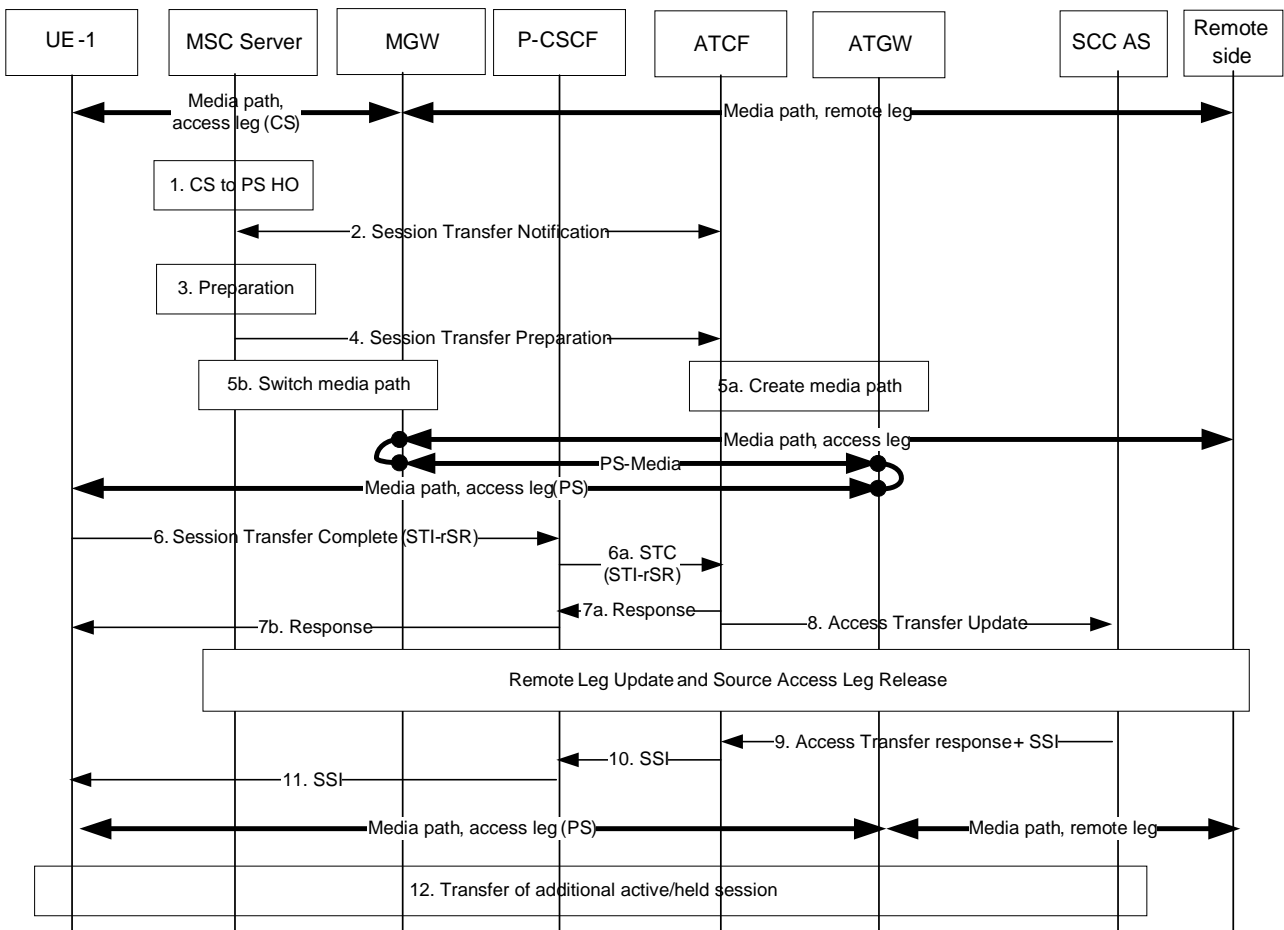

**Figure 6.3.2.1.10-2: CS to PS - Single Radio procedures without CS media anchored in ATGW**

1. Procedures specified in TS 23.216 [10] result in that the MSC Server receives an CS to PS HO request.
2. The MSC Server initiates a Session Transfer Notification towards the ATCF, which indicates to the ATCF that it should prepare for the transfer of media to PS. The ATCF responds with information required for the transfer, including allocated media IP/ports for UL direction and UE's port for DL direction and voice codec information allocated in the ATGW.

NOTE 1: The ATCF retrieves the ports/codec information from the UE during the IMS registration.

3. The MSC Server performs the CS to PS HO preparation procedures by interacting with target MME/SGSN to initiate the handover according to TS 23.216 [10].
4. When the target MME/SGSN have reserved appropriate resources in the target network, the MSC Server sends a Session Transfer Preparation request to the ATCF.
5. When receiving the Session Transfer Preparation request from the MSC Server, the ATCF reserves ATGW resources for the media path connected to MGW and then sends a Session Transfer Preparation response to the MSC Server. Upon receipt of the Session Transfer Preparation response, the MSC Server instructs the MGW to switch the media path from the source access (CS RAN) to the target access (ATGW), and also triggers the UE to hand over to the target according to TS 23.216 [10].

NOTE 2: The voice media will be sent on the target access on the designated ports between UE and ATGW.

6. The UE initiates a Session Transfer Complete request to the ATCF to move the session control to the PS access. If mid-call and alerting is supported, the UE will include this in the request.
7. The ATCF sends an Session Transfer Complete response to the UE.

NOTE 3: PCC interactions will be performed by the P-CSCF according to standard procedures of TS 23.228 [4] during step 6 and step 7. This will create the dedicated voice bearer for the session.

8. After receiving the Session Transfer Complete message, the ATCF re-establishes the communication with the SCC AS and updates the SCC AS that the transfer has taken place by sending an Access Transfer Update message to the SCC AS using the stored ATU-STI and C-MSISDN. If the UE indicated it supported mid-call feature and/or alerting, it also indicates this in the message to the SCC AS. The Access Transfer Update creates a new dialogue between the ATCF and SCC AS. The SCC AS correlates the new dialog with the remote dialog (e.g., using the C-MSISDN). As there is update in the session description, Remote Leg Update and Source Access Leg procedures (to release unused resources at the CS MGW) will be performed as specified in 6.3.1.5 and 6.3.1.6 respectively.
9. The SCC AS sends confirmation response to the ATCF. If the SCC AS and UE supports mid-call feature and/or alerting, the SCC AS provides the Session State Information (SSI) according to clause 6.3.2.1.2a. The Session State Information includes the additional held session with speech media including dynamic STI needed for the held session on the transferring-in leg.
- 10-11. If the ATCF receives the SSI, it forwards the SSI to the UE.
12. If the UE receives the Session State Information of the held session, it initiates an Access Transfer request towards the SCC AS using the dynamic STI for the held session.

### 6.3.2.2 PS - PS Access Transfer

NOTE: If a PS-PS session transfer occurs and there is a change in IP address, TCP-based media flow(s) using transferring-out access will break. Recovery procedures from broken TCP connections are application specific.

#### 6.3.2.2.1 PS-PS Access Transfer with full media transfer

UE-1 is attached to one IP-CAN and it registers to the S-CSCF. UE-1 establishes an active multimedia session with UE-2 via this IP-CAN. After changing to a new IP-CAN, obtaining new signalling and media addresses, and completing the Access Transfer procedures, UE-1 continues the multimedia session with UE-2 via the new IP-CAN.

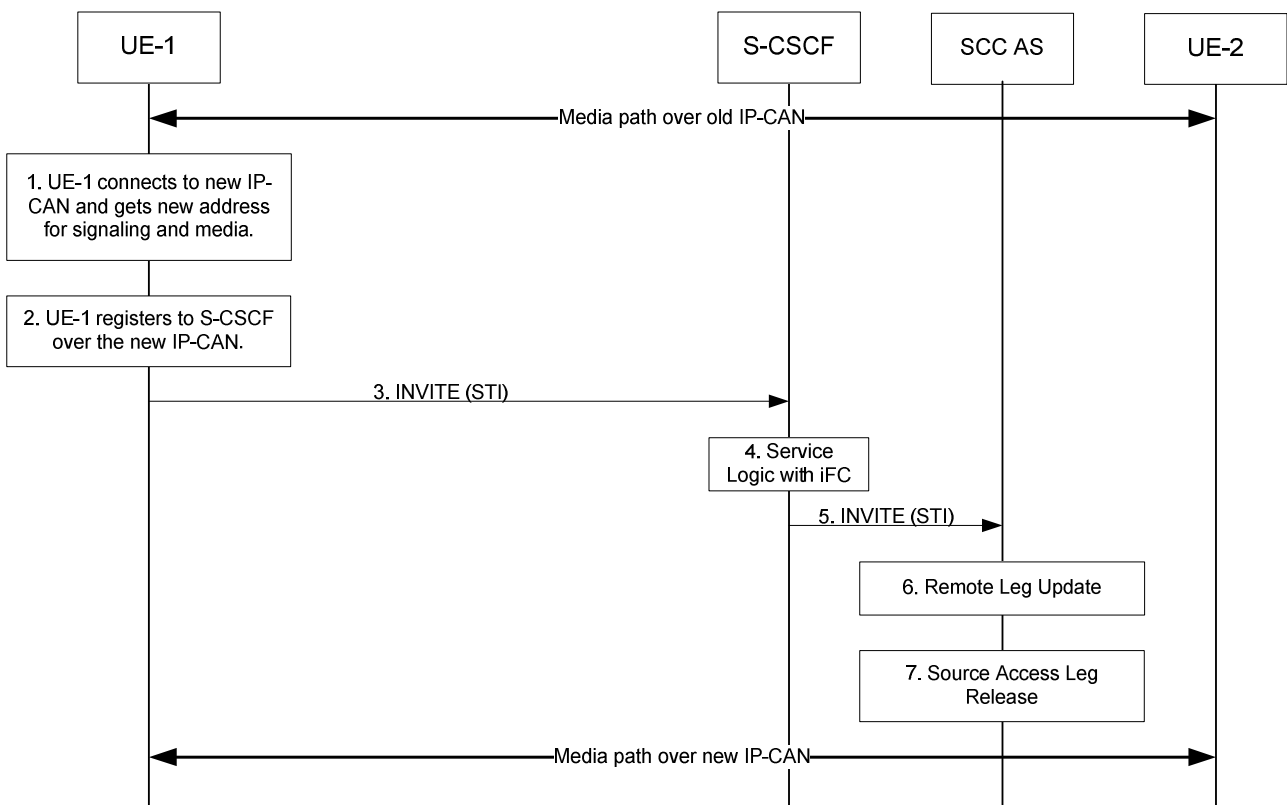

Figure 6.3.2.2.1-1: Information flow for PS-PS Access Transfer

1. UE-1 connects to a new IP-CAN and receives new IP address(es). UE-1 decides to perform PS to PS Access Transfer based on SC policy information.

2. UE-1 registers to the S-CSCF via the new IP-CAN. This registration may go through the same P-CSCF or a different P-CSCF.
- 3 ~ 5. UE-1 sends an INVITE message on the new IP-CAN towards the SCC AS. The INVITE message includes the STI identifying the session to be transferred. The INVITE message also indicates to the SCC AS that it performs Access Transfer with full media transfer.
6. The SCC AS identifies the session based on STI and updates the session over the remote access leg (see clause 6.3.1.5).
7. The SCC AS completes session setup with UE-1 on the new access leg and releases old session based on the standard IMS procedures.

#### 6.3.2.2.2 PS-PS Access Transfer with partial media transfer

UE-1 is on an active multimedia session with UE-2 via one IP-CAN. After changing to a new IP-CAN and obtaining new signalling and media addresses, UE-1 transfers part of the multimedia session with UE-2 to the new IP-CAN and keeps the remaining part on the original IP-CAN. UE-1 is attached to both the new and old IP-CANs after the Access Transfer procedures. The call flow is the same as shown in clause 6.3.2.2.1. The only difference is that in Step 3, the INVITE needs to indicate that the request is for a partial transfer and instead of releasing the old session in step 7, the UE updates session information over the old access leg. In this case, the INVITE message sent in step 3 shall indicate the media flow(s) which need to be transferred to the new IP-CAN.

#### 6.3.2.2.3 PS-PS Access Transfer with full media transfer for an incoming call in early dialog phase

UE-1 is attached to IP-CAN 1 and registered to IMS over that IP-CAN. UE-1 and is in the process of establishing an incoming multimedia session with UE-2 via this IP CAN. While an early dialog has been established over IP-CAN 1, UE-1 detects that an Access Transfer to IP-CAN 2 is required.

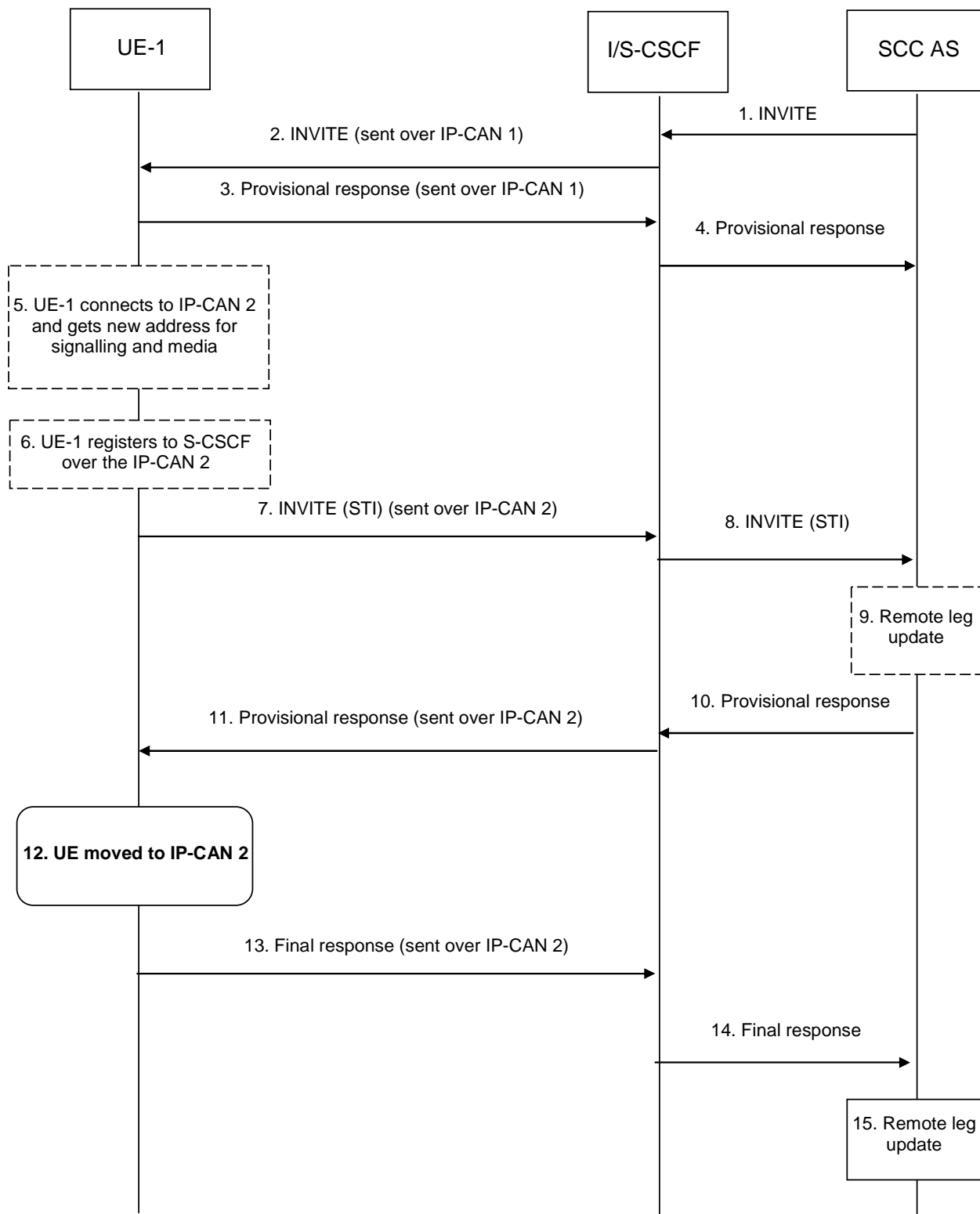

**Figure 6.3.2.3-1: PS-PS Access Transfer with full media transfer incoming call in early dialog phase**

1-4. Standard procedures are used to initiate a SIP session over IP CAN 1 from the remote end towards UE-1. An early dialog has been established and UE-1 might be alerting the user.

5-6. If it has not done it yet, UE-1 connects to a new IP-CAN, IP-CAN 2, and receives new IP address(es). It then registers to the S-CSCF via IP-CAN 2. This registration may go through the same P-CSCF or a different P-CSCF. UE 1 decides to perform PS to PS Access Transfer based on SC policy information.

7-8. UE 1 sends an INVITE message on IP-CAN2 towards the SCC AS. The INVITE message includes the STI identifying the session to be transferred. The INVITE message also indicates to the SCC AS that it performs Access Transfer with full media transfer.

9. The SCC AS identifies the early dialog, and updates the session over the remote access leg (see clause 6.3.1.5).

NOTE 1: It is assumed the initial SDP negotiation has been completed prior to triggering the PS-PS access transfer, thus the SCC AS can update the remote leg.

10-11. The SCC AS answers to UE-1 over IP-CAN 2 with the appropriate message to have the new session moved to the same state as the session on the transferred out access.

12. The UE determines that the session has been transferred to IP-CAN 2, and continues to alert the user for incoming call if appropriate.

13-15. UE-1 sends the final response. The remote end is notified, and the session starts over IP-CAN 2.

### 6.3.2.2.4 PS-PS Access Transfer with full media transfer for an outgoing call in early dialog phase

UE-1 is attached to IP-CAN 1 and registered to IMS over that IP-CAN. UE-1 is in the process of establishing an outgoing multimedia session with UE-2 via this IP-CAN. While an early dialog has been established over IP-CAN 1, UE-1 detects that an Access Transfer to IP-CAN 2 is required.

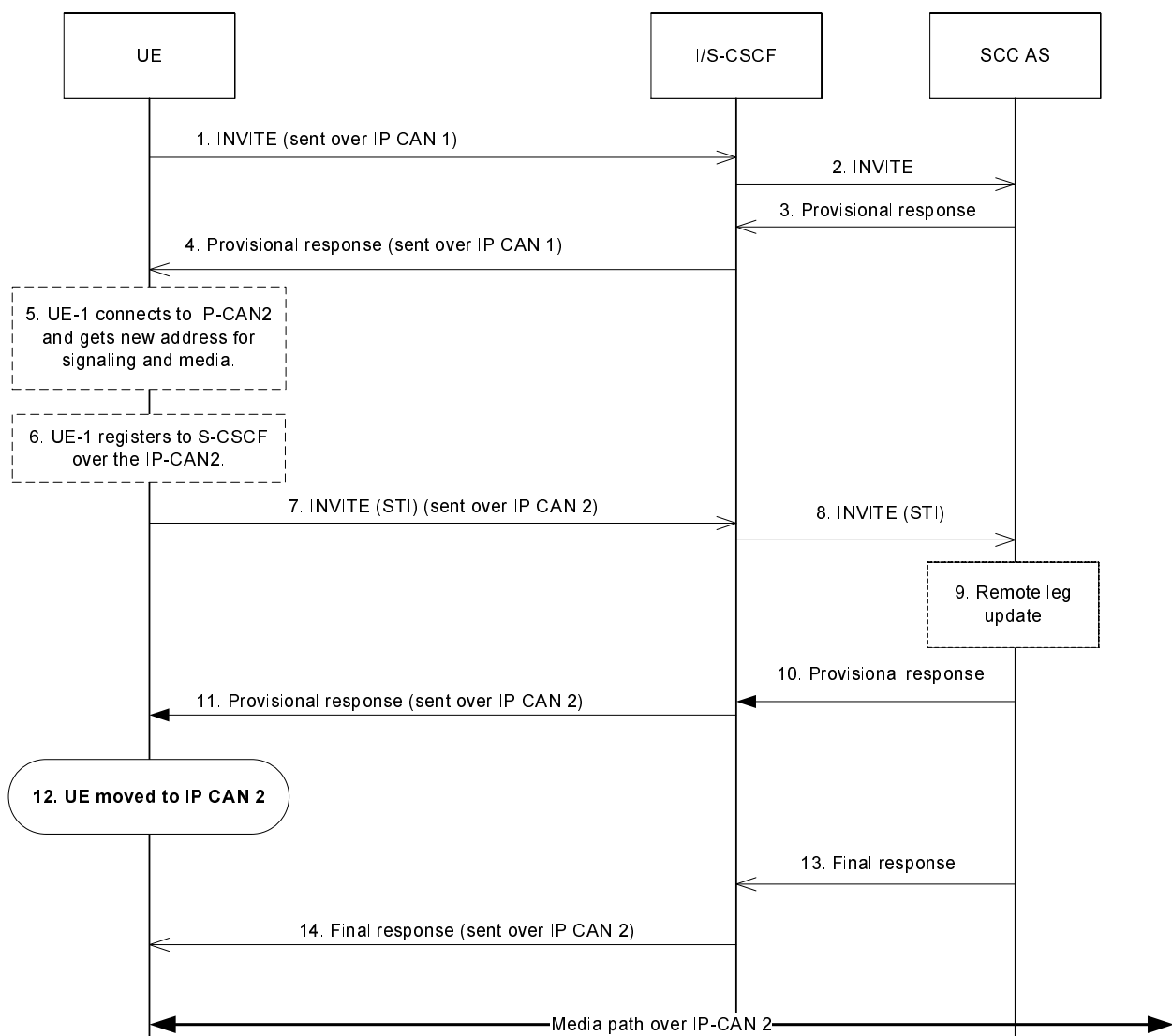

Figure 6.3.2.2.4-1: PS-PS Access Transfer with full media transfer outgoing call in early dialog phase

- 1-4. Standard procedures are used to initiate a SIP session over IP-CAN 1 from the UE towards the remote end. An early dialog has been established and the remote end might be alerting the user.
  - 5-6. If the UE has not done it yet, UE-1 connects to a new IP-CAN, IP-CAN 2, and receives new IP address(es). It then registers to the S-CSCF via IP-CAN 2. This registration may go through the same P-CSCF or a different P-CSCF. UE-1 decides to perform PS to PS Access Transfer based on SC policy information.
  - 7-8. UE-1 sends an INVITE message on IP-CAN2 towards the SCC AS. The INVITE message includes the STI identifying the session. The INVITE message also indicates to the SCC AS that it performs Access Transfer with full media transfer.
  9. The SCC AS identifies the early dialog, and updates the session over the remote access leg (see clause 6.3.1.5).
- NOTE 1: It is assumed the initial SDP negotiation has been completed prior to triggering the PS-PS access transfer, thus the SCC AS can update the remote leg.
- 10-11. The SCC AS answers to UE-1 over IP-CAN 2 with the appropriate message to have the new session moved to the same state as the session on the transferred out access.
  12. The UE determines that the session has been transferred to IP-CAN 2. The UE ensures that the same ringback tone is played to the end user if appropriate.
  - 13-14. The remote end sends the final response. UE-1 is notified, and the session starts over IP-CAN 2.

### 6.3.2.3 PS - PS in conjunction with PS - CS Access Transfer

#### 6.3.2.3.1 PS - PS in conjunction with PS - CS Access Transfer: PS to CS for UEs not using ICS capabilities

It is required that the UE has a single ongoing IMS session containing speech or speech and video and other media with the remote end. After the Access Transfer, the two sessions are treated as independent sessions on the transferring-in Access Legs for mid-call service (e.g. hold of PS or CS media).



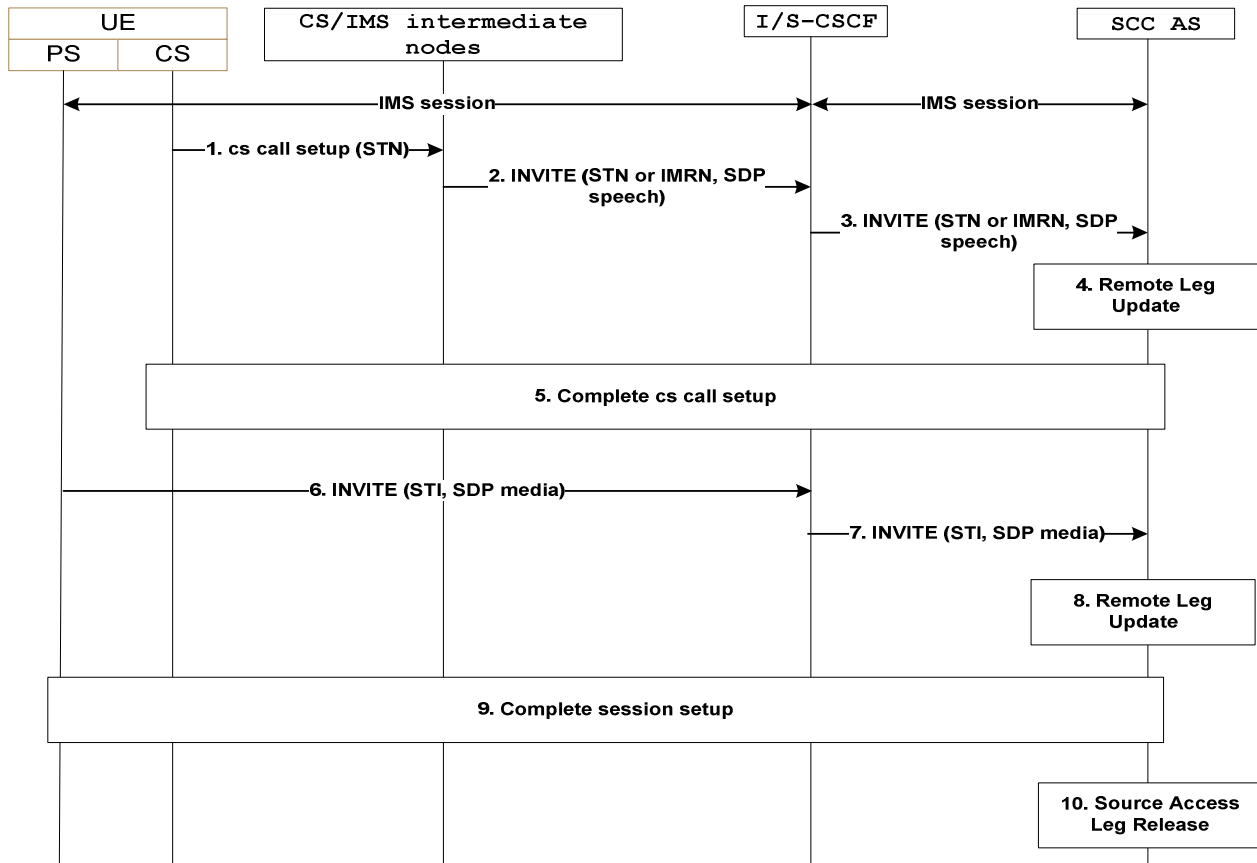

**Figure 6.3.2.3.1-1: PS-PS in conjunction with PS-CS Access Transfer: PS to CS**

1. When the UE determines a need for Access Transfer, the UE attaches to CS (if not already attached). It subsequently initiates the PS–CS Access Transfer by sending a CS call setup including the STN to establish the Access Leg via the CS access. A static STN preconfigured to the UE is used.
2. An INVITE is routed to the I/S-CSCF.
3. An INVITE is routed to the SCC AS.
4. The SCC AS performs the Remote Leg update by using procedures defined in clause 6.3.1.5. The SCC AS updates the speech or speech and video media being transferred in the session towards the Remote Leg.
5. The SCC AS completes the session setup towards UE according to procedures defined in TS 23.228 [4].
6. The UE initiates registration with IMS via the new PS access (if not already registered) as specified in clause 6.1. It subsequently initiates the PS–PS Access Transfer by sending an INVITE including the SDP for the non-real-time media flow(s) and STI to establish the Access Leg via the PS access. A dynamic STI allocated at the time of IMS session creation is used.
7. An INVITE is routed to the SCC AS.
8. The SCC AS identifies the session to be transferred using the STI. The SCC AS performs the Remote Leg update by using procedures defined in clause 6.3.1.5. The SCC AS updates the non-real-time media flow(s) in the session towards the Remote Leg.
9. The SCC AS completes the session setup towards UE according to procedures defined in TS 23.228 [4].
10. Source Access Leg Release is performed according to the procedures defined in clause 6.3.1.6.

NOTE: Steps 1-5 can be performed in reversed order with steps 6-8.

### 6.3.2.3.2 PS - PS in conjunction with PS - CS Access Transfer: CS to PS for UEs not using ICS capabilities

It is required that the UE has an ongoing CS call and a related IMS session with the remote end.

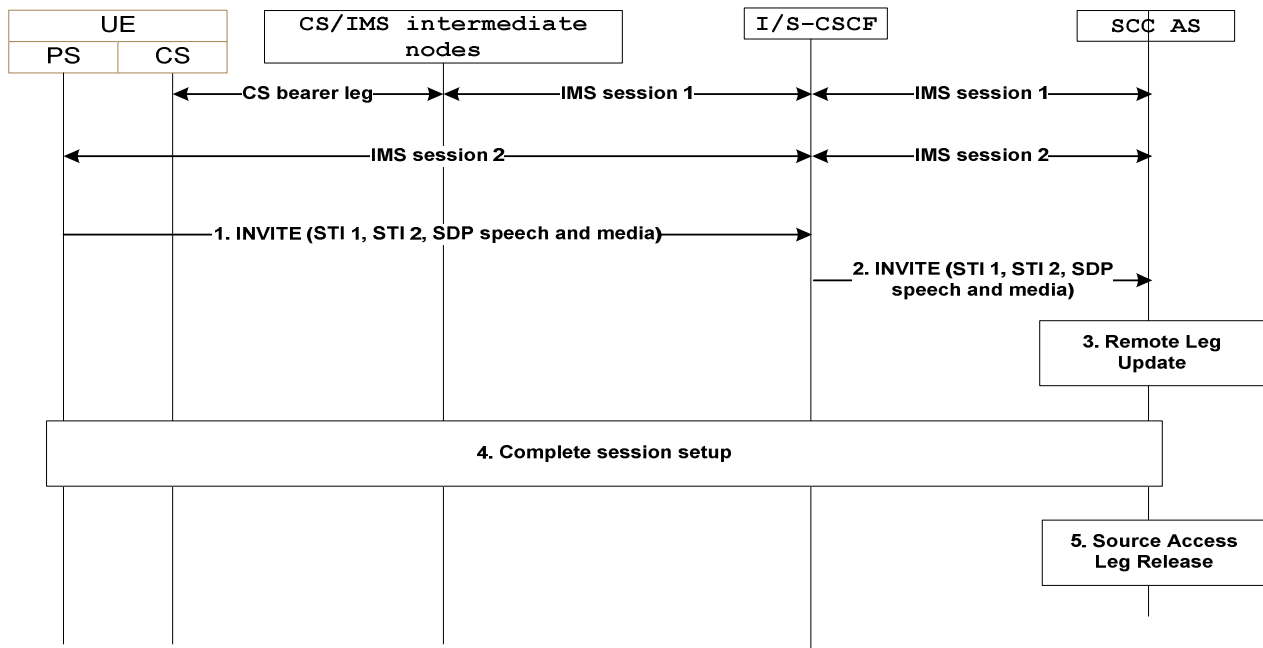

**Figure 6.3.2.3.2-1: PS-PS in conjunction with PS-CS Access transfer: CS to PS**

1. When the UE determines a need for Access Transfer, the UE initiates registration with IMS via the new PS access (if not already registered) as specified in clause 6.1. It subsequently initiates the Access Transfer by sending an INVITE to establish the Access Leg via the PS access. The INVITE includes the SDP for speech or speech and video and non-real-time media flow(s) and STI-1 and STI-2 respectively for the IMS session using CS and the IMS session using PS to be transferred. For STI-1 a static STI preconfigured to the UE is used. For STI-2 a dynamic STI allocated at the time of IMS session creation is used. STI-1 and STI-2 are never the same.
2. Standard procedures are used at S-CSCF for routing of the INVITE to the SCC AS.
3. The SCC AS identifies the session to be transferred using the STI-1 and STI-2. The SCC AS performs the Remote Leg Update by using procedures defined in clause 6.3.1.5. The SCC AS updates the combined session towards the Remote Leg.
4. The SCC AS completes the session setup towards UE-1 according to procedures defined in TS 23.228 [4].
5. Source Access Leg Release is performed according to the procedures defined in clause 6.3.1.6.

### 6.3.2.3.3 PS – PS in conjunction with PS - CS Access Transfer: PS to CS for UEs with ICS capabilities - Using Gm reference point

Figure 6.3.2.3.3-1 PS-PS in conjunction with PS-CS Access Transfer: PS to CS for UEs with ICS capabilities, provides an information flow for Access Transfer of real time media flow(s) of an IMS session in PS to CS direction and zero or more non real time media flow(s) in PS to PS direction. The UE may choose to retain some of the non real time media flow(s) in the original PS access.

The flow requires that the user is in an active or inactive IMS originating or terminating session; the Gm reference point of ICS is used for control of IMS sessions that use CS media.

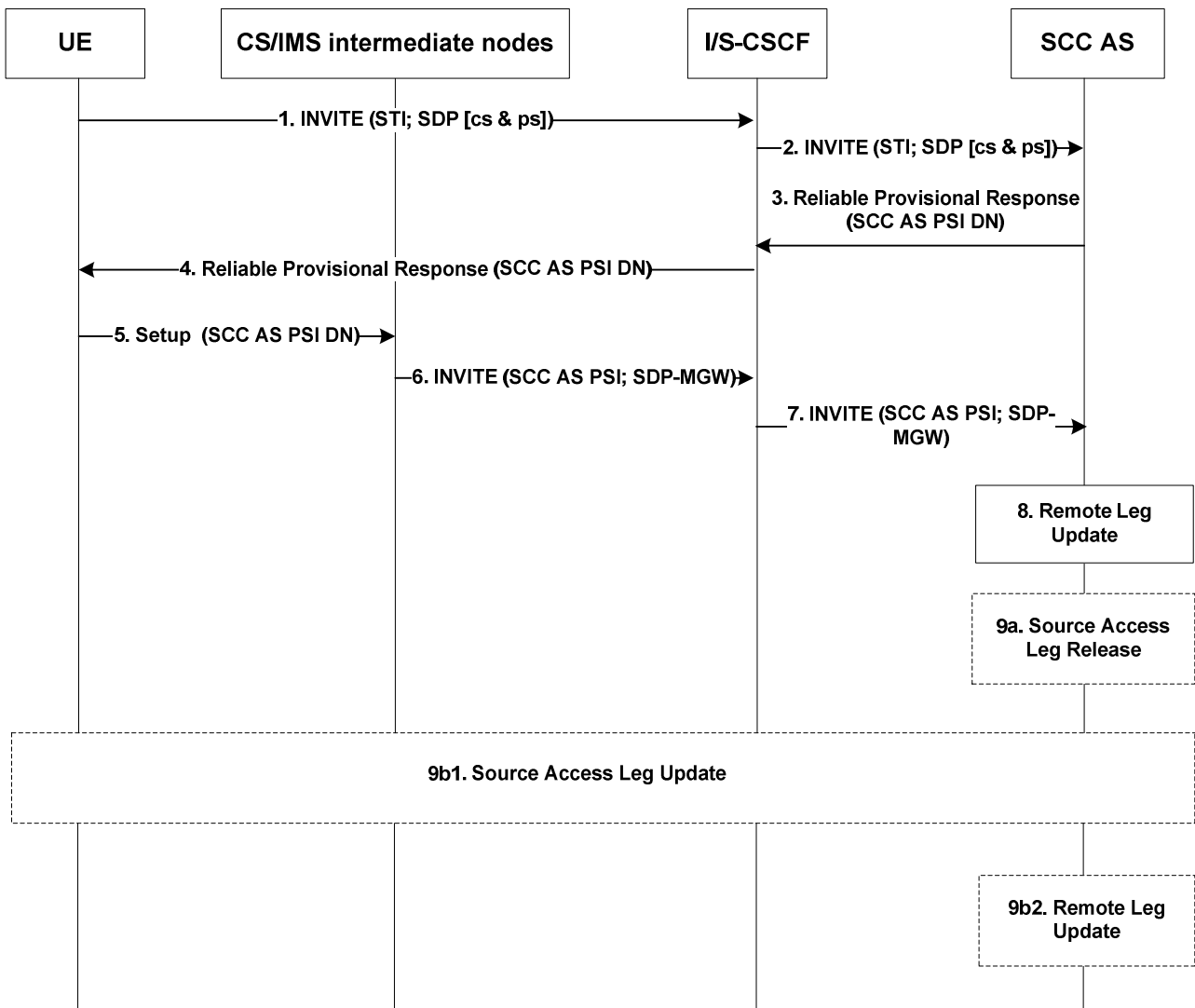

**Figure 6.3.2.3.3-1: PS-PS in conjunction with PS-CS Access transfer: PS to CS for UEs with ICS capabilities**

1. When the UE determines a need for Access Transfer, the UE initiates registration with IMS via the new PS access (if not already registered) as specified in clause 6.1. It subsequently initiates the "Originations with CS media using the Gm reference point" procedure as specified in TS 23.292 [5], clause 7.3.2.2.4 by sending an INVITE including the STI to establish the Access Leg via the PS access. The INVITE also includes an indication to use a CS bearer for the real time media and a description of non real time media flow(s) that are to be transferred to the new PS access if any non real time media is present at the time of initiation of Access Transfer.
2. Standard procedures are used at S-CSCF for routing of the INVITE to the SCC AS.
3. The SCC AS identifies the session to be transferred using the STI and the media flow(s), and continues the "Originations with CS media using the Gm reference point" procedure for completion of the setup of CS media for the Access Leg by allocating a SCC AS PSI DN and sending it in a reliable provisional response to the S-CSCF (see TS 23.292 [5] for SCC AS PSI DN).
4. The S-CSCF forwards the provisional response (containing the SCC AS PSI DN) to the UE.
5. The UE continues the "Originations with CS media using the Gm reference point" procedure by sending a Setup message including the SCC AS PSI DN to establish the CS media for the Access Leg.
6. The "Originations with CS media using Gm reference point procedure" is used at the CS and IMS intermediate nodes, resulting in routing of an INVITE to the I/S-CSCF.
7. The I/S-CSCF extends the INVITE with the SCC AS PSI and SDP of the MGW as part of the "Originations with CS media using the Gm reference point" procedure.

8. The SCC AS uses the SCC AS PSI to correlate the incoming session via the CS access with the Access Transfer request previously received via the PS access.

The SCC AS completes the establishment of the Access Leg by combining the description of the media established via the CS access with the description of the media flow(s) established via the PS access for the signalling associated with the Access Leg.

The SCC AS performs the Access Transfer by updating the Remote Leg with the media description and other information of the newly established Access Leg using the Remote Leg Update procedure as specified in clause 6.3.1.5.

- 9a. If the UE transfers all the non real time media flow(s) to the new PS access, the Source Access Leg (which is the Access Leg previously established over PS access) is released as specified in clause 6.3.1.6.

- 9b. If the UE chooses to retain some media flow(s) in the original PS access, then:

9b1. the UE sends an INVITE to the SCC AS (as part of the existing dialog) to update the session information over the Source Access Leg; and

9b2. the SCC AS performs the Remote Leg update (if necessary) by using procedures defined in clause 6.3.1.5. The Source Access Leg is not released in this case.

NOTE: Steps 8 and 9 consist of a sequence of messages, some of which may occur in parallel.

#### 6.3.2.3.4 PS - PS in conjunction with PS - CS Access Transfer: CS to PS for UEs with ICS capabilities - Using Gm reference point

The information flow for Access Transfer of real time media of an IMS session in CS to PS direction, and zero or more non real time media flow(s) in PS to PS direction is the same as the information flow for PS–CS Access Transfer: CS to PS access, as specified in clause 6.3.2.1.2.

The flow requires that the user is in an active or inactive IMS originating or terminating session; the Gm reference point of ICS is used for control of IMS sessions that use CS media; and a dynamic STI is associated with each session.

#### 6.3.2.3.5 PS – PS in conjunction with PS – CS Access Transfer: Active/Held sessions - Using Gm reference point

Figure 6.3.2.3.5-1 PS–PS in conjunction with PS–CS Access Transfer: Active/Held sessions, provides an information flow for Access Transfer of real time media flow(s) of one active and one or more held sessions between PS and CS, any of which may have zero or more non real time media flow(s) which is transferred within the PS access.

The flow requires that the user is in an active IMS originating and/or terminating sessions; the Gm reference point of ICS is used for control of IMS sessions that use CS media; and a dynamic STI is associated with each session.

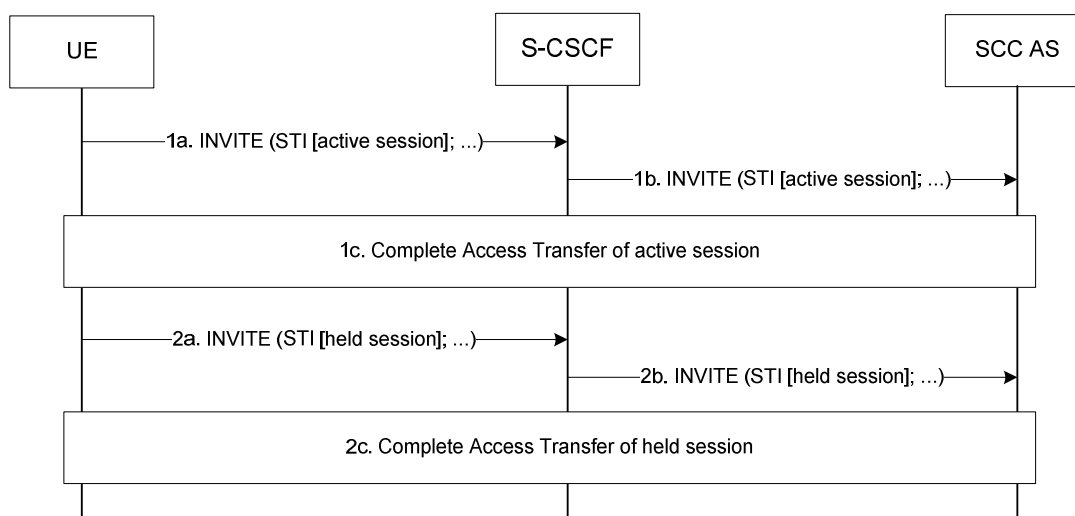

Figure 6.3.2.3.5-1: PS-PS in conjunction with PS-CS Access transfer: Active/Held sessions

1a, 1b. When the UE determines a need for Access Transfer, the UE initiates the Access Transfer of the active session as specified in clause 6.3.2.3.3 PS–PS in conjunction with PS–CS Access Transfer: PS to CS for UEs with ICS capabilities, or clause 6.3.2.3.4 PS–PS in conjunction with PS–CS Access Transfer: CS to PS for UEs with ICS capabilities, based on the direction of the Access Transfer of the real time media. The STI of the active session is used by SCC AS to identify the active session.

1c. The UE and the SCC AS complete the Access Transfer of the active session.

2a, 2b. The UE initiates the Access Transfer of the first held session using the same procedures as identified in steps 1a and 1b with a difference that for transfer to CS access, the CS media is not established for the held session; the media established upon the transfer of the currently active session is reused for the held session when it is resumed. The STI of the held session is used by SCC AS to identify the held session.

2c. The UE and the SCC AS complete the Access Transfer of the held session.

Steps 2a, 2b and 2c are repeated for the remaining held sessions.

NOTE 1: Steps 1c and 2c consist of a sequence of messages, which may occur in parallel.

NOTE 2: Another supported scenario is when there are no active sessions, i.e. the session in 1a and 1b may also be a held session.

#### 6.3.2.3.6 PS – PS in conjunction with PS – CS Access Transfer: Explicit Communication Transfer - Using Gm reference point

Prior to consultative transfer, the transferor UE may have one session with the transferee UE and one session with the transfer target UE. If the transferor UE performs Access Transfer in this case, the information flow for PS–PS in conjunction with PS–CS Access Transfer: Explicit Communication Transfer is the same as the information flow in clause 6.3.2.3.5 PS–PS in conjunction with PS–CS Access Transfer: Active/held sessions.

For all other cases in ECT service, there is only one session at the UE. Depending on the direction of the Access transfer, the following information flows apply:

- the information flow in clause 6.3.2.3.3 for PS-PS in conjunction with PS-CS Access Transfer: PS to CS; or,
- the information flow in clause 6.3.2.3.4 for PS-PS in conjunction with PS-CS Access Transfer: CS to PS.

The flow requires that the user is active in IMS originating and/or terminating sessions with the Explicit Communication Transfer service; the Gm reference point of ICS is used for control of IMS sessions that use CS media; and a dynamic STI is associated with each session.

#### 6.3.2.3.7 PS – PS in conjunction with PS – CS Access Transfer: Conferencing - Using Gm reference point

The information flows for PS–PS in conjunction with PS–CS Access Transfer: Conferencing in PS to CS and CS to PS directions, are the same as the information flows in clause 6.3.2.3.3 PS–PS in conjunction with PS–CS Access Transfer: PS to CS for UEs with ICS capabilities, and clause 6.3.2.3.4 PS–PS in conjunction with PS–CS Access Transfer: CS to PS for UEs with ICS capabilities respectively.

The flow requires that the user is in an active or inactive IMS originating and/or terminating sessions with the Conferencing service; the Gm reference point of ICS is used for control of IMS sessions that use CS media.

#### 6.3.2.3.8 PS – PS in conjunction with PS – CS Access Transfer: PS to CS – using I1 reference point

Figure 6.3.2.3.8-1 PS-CS in conjunction with PS-CS Access Transfer: PS to CS access - using I1 reference point, provides an information flow for Access Transfer of real time media flow(s) of an IMS session in PS to CS direction.

The flow requires that the user is in an active or inactive IMS originating or terminating session; the I1 reference point of ICS is used for control of IMS sessions that use CS media; and a unique STI is associated with each session.

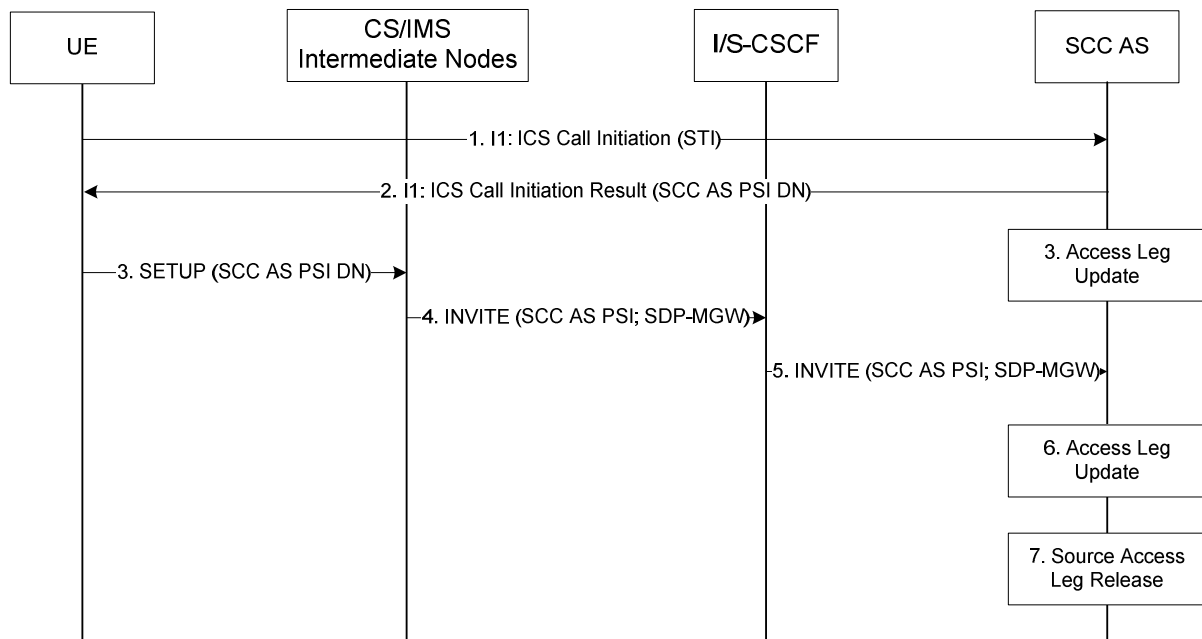

**Figure 6.3.2.3.8-1: PS–CS in conjunction with PS–CS Access Transfer: PS to CS access - using I1 reference point**

1. When the UE determines a need for Access Transfer, the UE initiates registration with IMS via the new PS access (if not already registered) as specified in clause 6.1. It subsequently initiates the "Originations to a SIP URI" procedure as specified in TS 23.292 [5], clause 7.3.2.2.1 by sending an I1, ICS Call Initiation including the STI to establish the Access Leg via the PS access.
2. The SCC AS identifies the session to be transferred using the STI, and continues the "Originations to a SIP URI" procedure for completion of the setup of CS media for the Access Leg by allocating a SCC AS PSI DN and sending it in an I1, ICS Call Initiation Result; see TS 23.292 [5] for SCC AS PSI DN.
3. The UE continues the "Originations to a SIP URI" procedure by sending a Setup message including the SCC AS PSI DN to establish the CS media for the Access Leg.
4. The "Originations to a SIP URI" procedure is used at the CS and IMS intermediate nodes, resulting in routing of an INVITE with the SCC AS PSI to the I/S-CSCF.
5. The I/S-CSCF forwards the INVITE with the SCC AS PSI and SDP of the MGW as part of the "Originations with CS media using the Gm reference point" procedure.
6. The SCC AS uses the SCC AS PSI to correlate the CS bearer control signalling request received via the CS access with the Access Transfer request previously received via the PS access.

The SCC AS completes the establishment of the Access Leg by combining the description of the media established via the CS access with the description of the media flow(s) established via the PS access for the signalling associated with the Access Leg.

The SCC AS performs the Access Transfer by updating the Remote Leg with the media description and other information of the newly established Access Leg using the Remote Leg Update procedure as specified in clause 6.3.5.

7. The Source Access Leg (which is the Access Leg previously established over PS access) is released as specified in clause 6.3.6.

NOTE: Steps 6 and 7 consist of a sequence of messages, some of which may occur in parallel.

### 6.3.2.3.9 PS - PS in conjunction with PS - CS Access Transfer: CS to PS - using I1 reference point

The information flow for Access Transfer of real time media of an IMS session in CS to PS direction when the I1 reference point is used for service control of sessions that use CS media, is the same as the information flow PS–CS Access Transfer: CS to PS access, as specified in clause 6.3.2.1.2.

The flow requires that the user is in an active or inactive IMS originating or terminating session; the I1 reference point of ICS is used for control of IMS sessions that use CS media; and a unique STI is associated with each session.

### 6.3.2.3.10 PS - PS in conjunction with PS - CS Access Transfer: PS to CS for Active/Held sessions - using I1 reference point

Figure 6.3.2.3.10-1 PS – PS in conjunction with PS – CS Access Transfer: PS to CS for Active/Held sessions – using I1 reference point, provides an information flow for Access Transfer of real time media of one active and one or more held sessions from PS to CS when the I1 reference point is used for service control of sessions that use CS media.

The flow requires that the user is active in IMS originating and/or terminating sessions; the I1 reference point of ICS is used for control of IMS sessions that use CS media; and a unique STI is associated with each session.

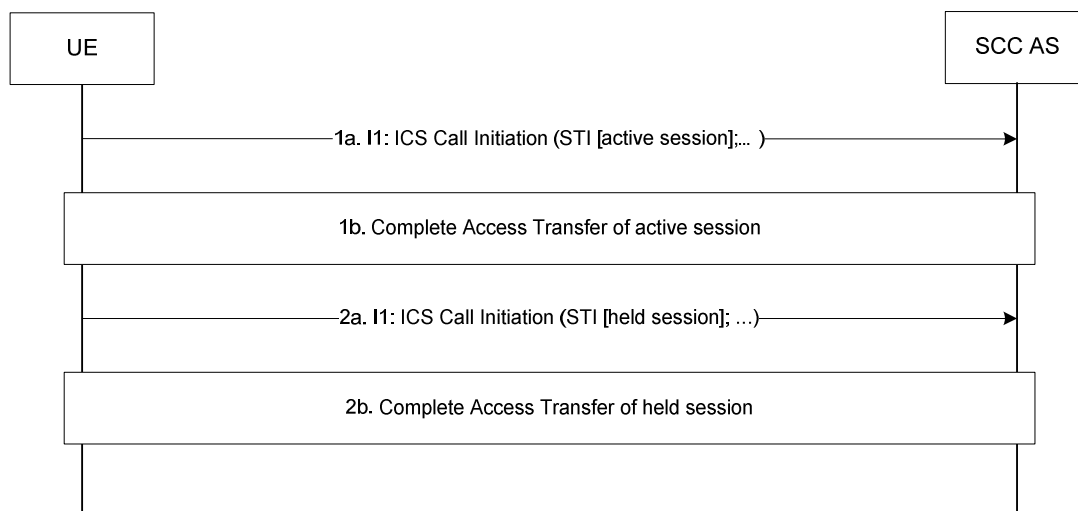

**Figure 6.3.2.3.10-1: PS – PS in conjunction with PS – CS Access Transfer: PS to CS for Active/Held sessions – using I1 reference point**

1a. When the UE determines a need for Access Transfer, the UE initiates the Access Transfer of the active session as specified in clause 6.3.2.3.8 PS – PS in conjunction with PS – CS Access Transfer: PS to CS – using I1 reference point. The STI of the active session is used by SCC AS to identify the active session.

1b. The UE and the SCC AS complete the Access Transfer of the active session.

2a. The UE initiates the Access Transfer of the first held session using the same procedures as identified in steps 1a and 1b with a difference that the CS media is not established for the held session; the media path established upon transfer of the currently active session is reused for the held session when it is resumed. The STI of the held session is used by SCC AS to identify the held session.

2b. The UE and the SCC AS complete the Access Transfer of the held session.

Steps 2a and 2b are repeated for the remaining held sessions.

NOTE 1: Steps 1b and 2b consist of a sequence of messages, which may occur in parallel.

NOTE 2: Another supported scenario is when there are no active sessions, i.e. the session in 1a and 1b may also be a held session.

### 6.3.2.3.11 PS - PS in conjunction with PS - CS Access Transfer: CS to PS for Active/Held sessions - using I1 reference point

Figure 6.3.2.3.11-1 PS – PS in conjunction with PS – CS Access Transfer: CS to PS for Active/Held sessions – using I1 reference point, provides an information flow for Access Transfer of real time media of one active and one or more held sessions from CS to PS when the I1 reference point is used for service control of sessions that use CS media.

The flow requires that the user is active in IMS originating and/or terminating sessions; the I1 reference point of ICS is used for control of IMS sessions that use CS media; and a unique STI is associated with each session.

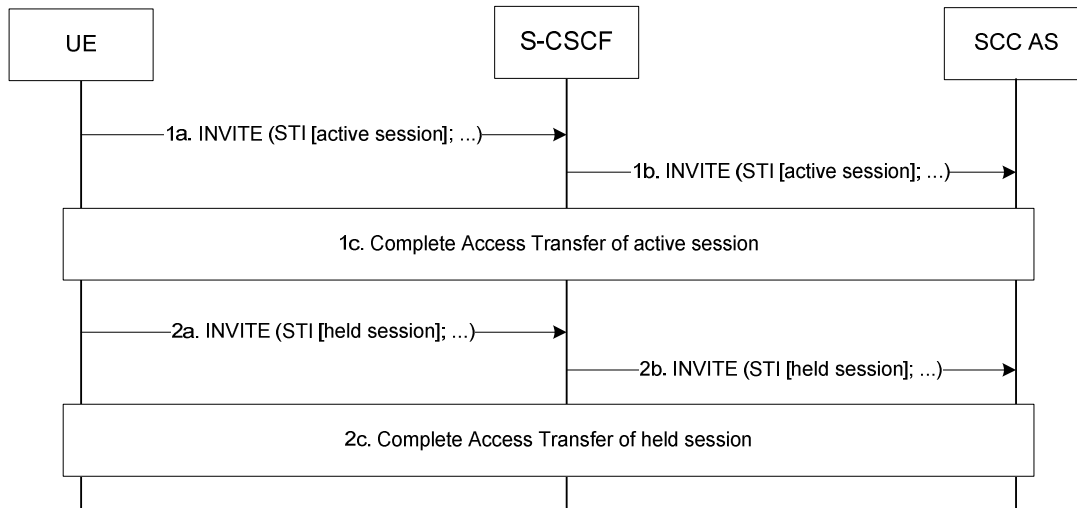

**Figure 6.3.2.3.11-1: PS – PS in conjunction with PS – CS Access Transfer: CS to PS for Active/Held sessions - using I1 reference point**

1a, 1b. When the UE determines a need for Access Transfer, the UE initiates the Access Transfer of the active session as specified in clause 6.3.2.3.9 PS – PS in conjunction with PS – CS Access Transfer: CS to PS - using I1 reference point. The STI of the active session is used by SCC AS to identify the active session.

1c. The UE and the SCC AS complete the Access Transfer of the active session.

2a, 2b. The UE initiates the Access Transfer of the first held session using the same procedures as identified in steps 1a, 1b and 1c. The STI of the held session is used by SCC AS to identify the held session.

2c. The UE and the SCC AS complete the Access Transfer of the held session.

Steps 2a, 2b and 2c are repeated for the remaining held sessions.

NOTE: Steps 1c and 2c consist of a sequence of messages, which may occur in parallel.

## 6.3.3 Media Adding/Deleting

### 6.3.3.1 Local End Initiation case: Adding new PS media to existing CS session

The call flow in figure 6.3.3.1-1 presents a scenario where UE-1 adds PS media flow(s) (e.g. video) to an existing multimedia session that only contains CS media. As a post condition the UE-1 has an ongoing CS call and a related IMS session with the remote end.



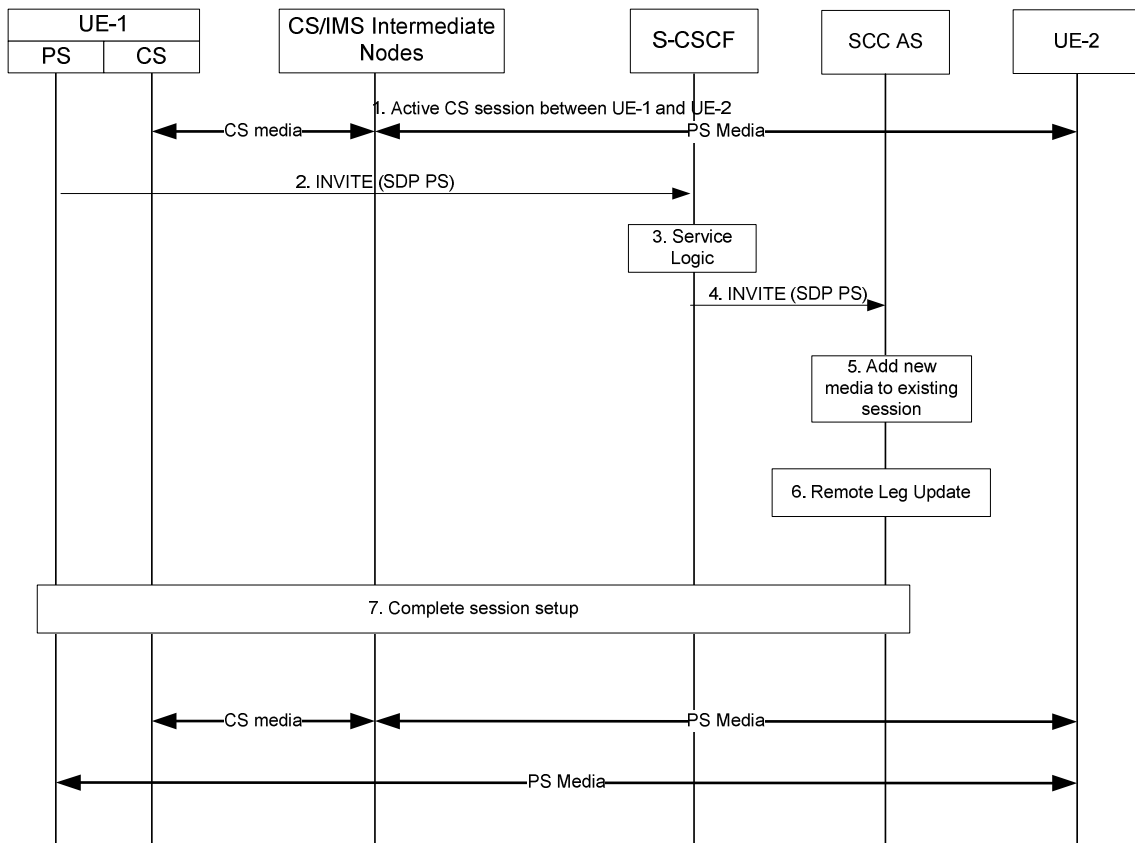

**Figure 6.3.3.1-1: Local End Initiation case: Adding new PS media to existing CS session**

1. A multimedia session between UE-1 and UE-2 is established as either originated or terminated session with CS media as described in TS 23.292 [5] clauses 7.3.2.1 and 7.4.2.1, respectively i.e. UE-1 is not using the ICS capability and therefore not using the Gm reference point during the session establishment.
2. UE-1 requests to add one or more PS media component(s) to the existing CS Call by sending an INVITE containing description of the new PS media towards SCC AS to establish a new Access Leg. UE-1 provides description of the new media and the information necessary for the SCC AS to identify the existing session.
3. The S-CSCF executes any service logic as appropriate.
4. The S-CSCF sends the INVITE to the SCC AS.
5. The SCC AS determines that the INVITE is related to an existing session using the information provided by UE-1 and decides to add the new media flow to the session.

NOTE: If SCC AS decides that the request is not related to an existing session, it handles the INVITE as a new session as described in clause 6.2.1.3 Session origination using PS media flow(s) only.

6. The SCC AS performs the Remote Leg Update using procedures defined in clause 6.3.1.5.
7. The SCC AS completes the session setup towards UE-1 according to procedures defined in TS 23.228 [4].

### 6.3.3.2 Local End Initiation case: Incorporating existing CS media in new IMS Session and Gm Service Control

The call flow in figure 6.3.3.2-1 presents a scenario where UE-1 adds PS media component(s) (e.g. video) and Gm Service Control Signalling Path to an existing multimedia session that only contains CS media. Following this scenario the session is controlled using ICS capability.

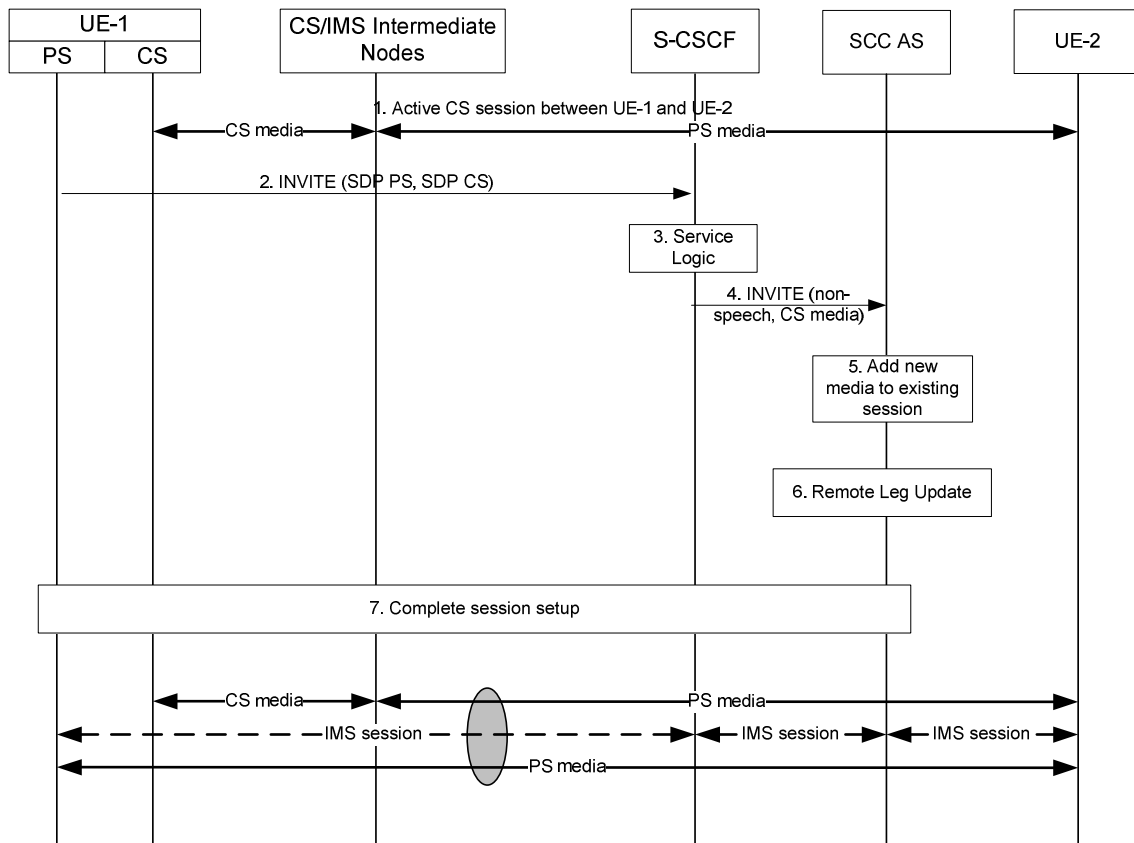
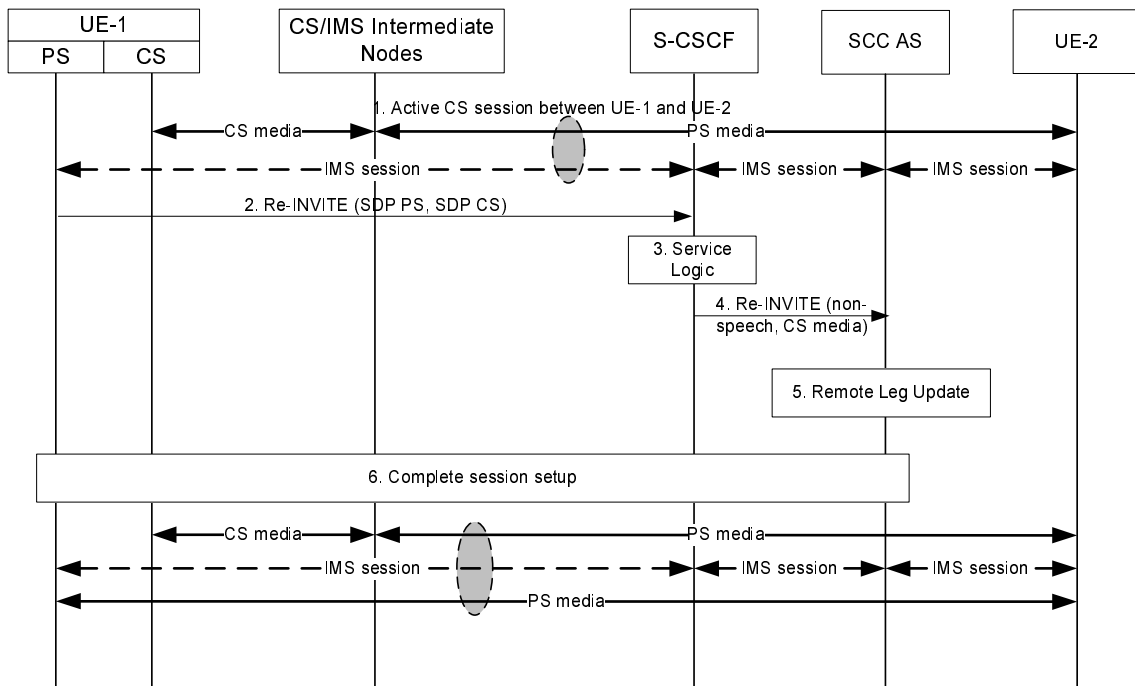

**Figure 6.3.3.2-1: Local End Initiation case: Incorporating existing CS media in new IMS Session and Gm Service Control Signalling Path**

1. A multimedia session between UE-1 and UE-2 is established as either originated or terminated session with CS media as described in TS 23.292 [5] clauses 7.3.2.1 and 7.4.2.1, respectively i.e. UE-1 is not using the ICS capability and therefore not using the Gm reference point during the session establishment.
2. UE-1 requests to add one or more PS media component(s) and to control the CS media using ICS capabilities by an INVITE towards SCC AS to establish a new session. The request contains the description of the new PS media and indicates that control of the existing CS media is transferred to the new session. UE-1 provides information necessary for the SCC AS to identify the existing session and to request addition of the media flow to the existing session.
3. The S-CSCF executes any service logic as appropriate.
4. The S-CSCF sends the INVITE to the SCC AS.
5. The SCC AS determines that the INVITE is related to an existing session using the information provided by UE-1 and adds the new media flow to the session.
6. The SCC AS performs the Remote Leg update using procedures defined in clause 6.3.1.5.
7. The SCC AS completes the session setup towards UE-1 according to procedures defined in TS 23.228 [4].

### 6.3.3.3 Local End Initiation case: Adding PS media to IMS session with CS media

The call flow in figure 6.3.3.3-1 presents a scenario where UE-1 adds PS media component(s) (e.g. video) to an existing multimedia session that contains CS media and is controlled using ICS capability.

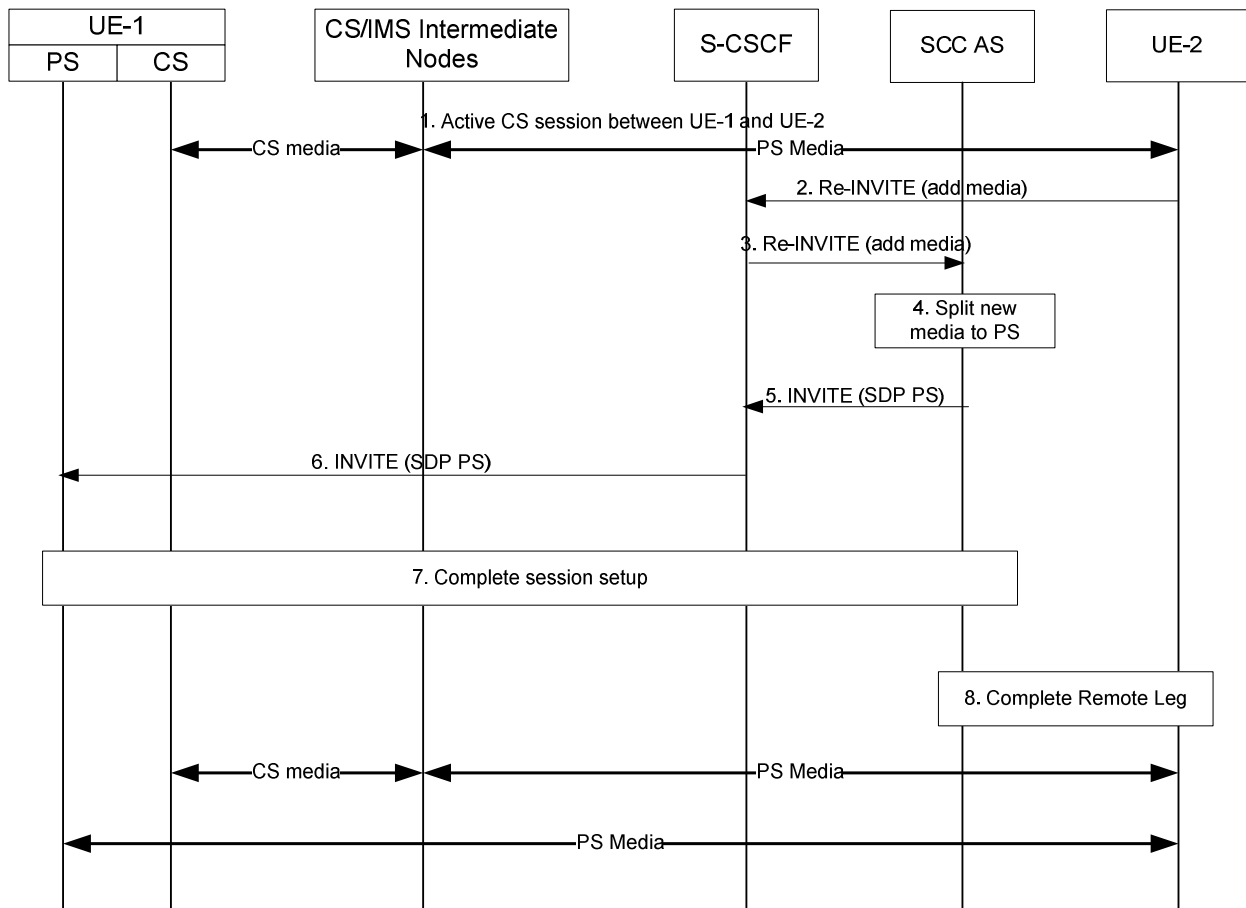

**Figure 6.3.3.3-1: Local End Initiation case: Adding PS media to IMS session with CS media**

1. An IMS session between UE-1 and UE-2 is established as either originated or terminated session with CS media as described in TS 23.292 [5] clauses 7.3.2.2.4 and 7.4.2.2.2.2, respectively i.e. UE-1 is using the ICS capability and therefore the Gm reference point during the session establishment.
2. UE-1 initiates a request to add the PS media flow(s) to the existing IMS session.
3. The S-CSCF executes any service logic as appropriate.
4. The S-CSCF sends the INVITE to the SCC AS.
5. The SCC AS performs the Remote Leg Update using procedures defined in clause 6.3.1.5.
6. The SCC AS completes the session setup towards UE-1 according to procedures defined in TS 23.228 [4].

### 6.3.3.4 Remote End Initiation case: Adding new PS media to existing CS session

The call flow in figure 6.3.3.4-1 presents a scenario where UE-1 has an existing CS session with UE-2 and UE-2 adds new media flow(s) to the session and the new media flow is delivered via PS access towards UE-1.

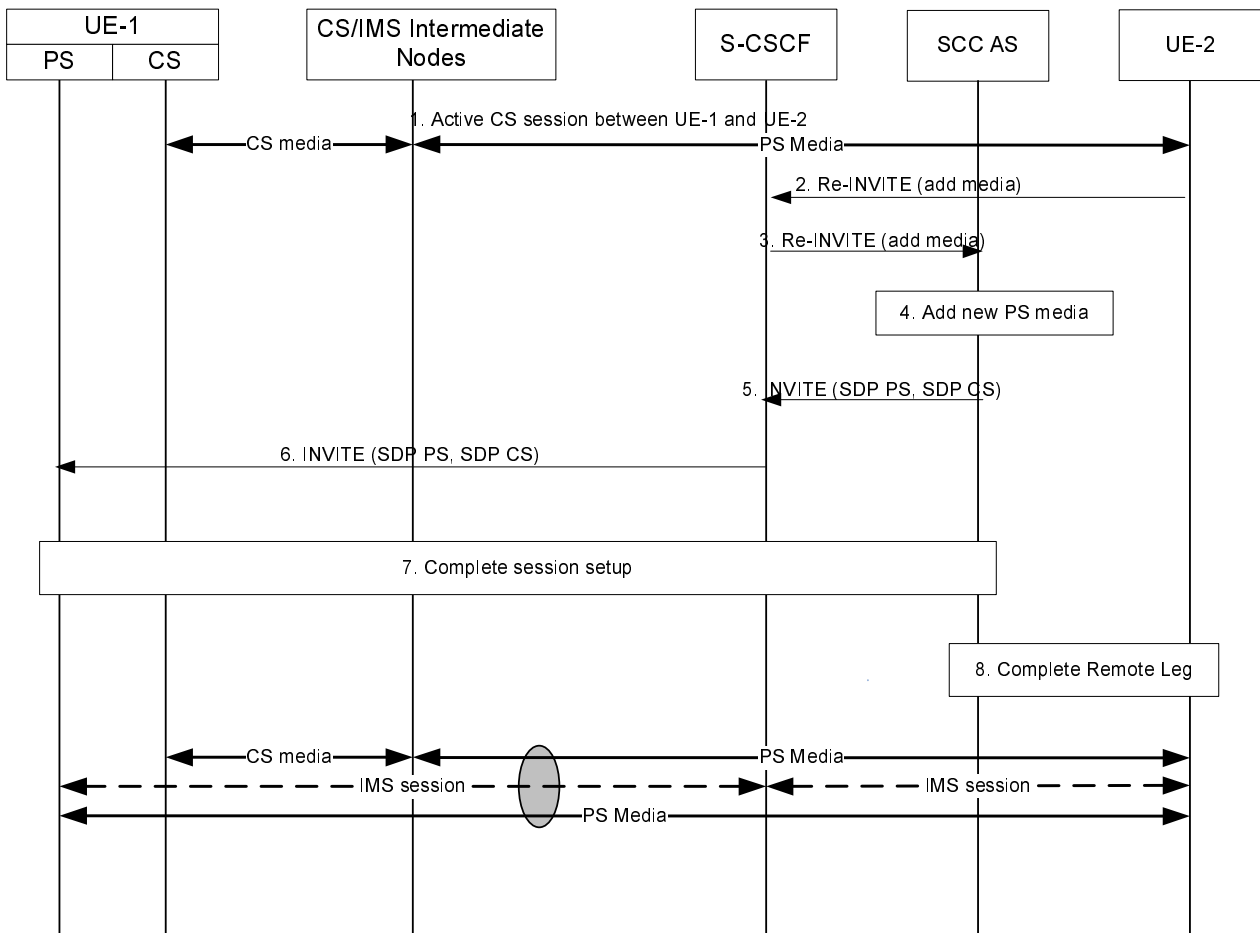

**Figure 6.3.3.4-1: Remote End Initiation case: Adding new PS media to existing CS session**

1. A CS session between UE-1 and UE-2 is established as either originated or terminated session with CS media as described in TS 23.292 [5] clauses 7.3.2.1 and 7.4.2.1, respectively, i.e. UE-1 is not using the ICS capability and therefore not using the Gm reference point during the session establishment.
2. S-CSCF receives a request from UE-2 to add new PS media flow(s) (e.g. video) to the existing session.
3. S-CSCF forwards the request to SCC AS, which is anchored on the session path.
4. The T-ADS function in the SCC AS decides that the new media flow is delivered to UE-1 via PS access and therefore splits the session. T-ADS in the SCC AS uses the C-MSISDN for correlation, and then ensures the split session is delivered only to UE-1, and not delivered to other UEs of the user.
- 5-6. SCC AS initiates a new session towards UE-1. The request includes the new PS media flow. The SCC AS includes enough information within the session request to allow UE-1 to correlate this new session with the existing CS session.
7. UE-1 accepts the new session and completes the session setup via PS access.
8. The SCC AS completes the Remote Leg towards UE-2 according to procedures defined in TS 23.228 [4].

**6.3.3.5 Remote End Initiation case: Incorporating existing CS media in new IMS Session and Gm Service Control**

The call flow in figure 6.3.3.5-1 presents a scenario where UE-1 has an existing CS session with UE-2 and UE-2 adds new media flow(s) to the session. The new media flow(s) is delivered via PS access towards UE-1 and Gm Service Control Signalling Path is added. Following this scenario the session is controlled using ICS capability.

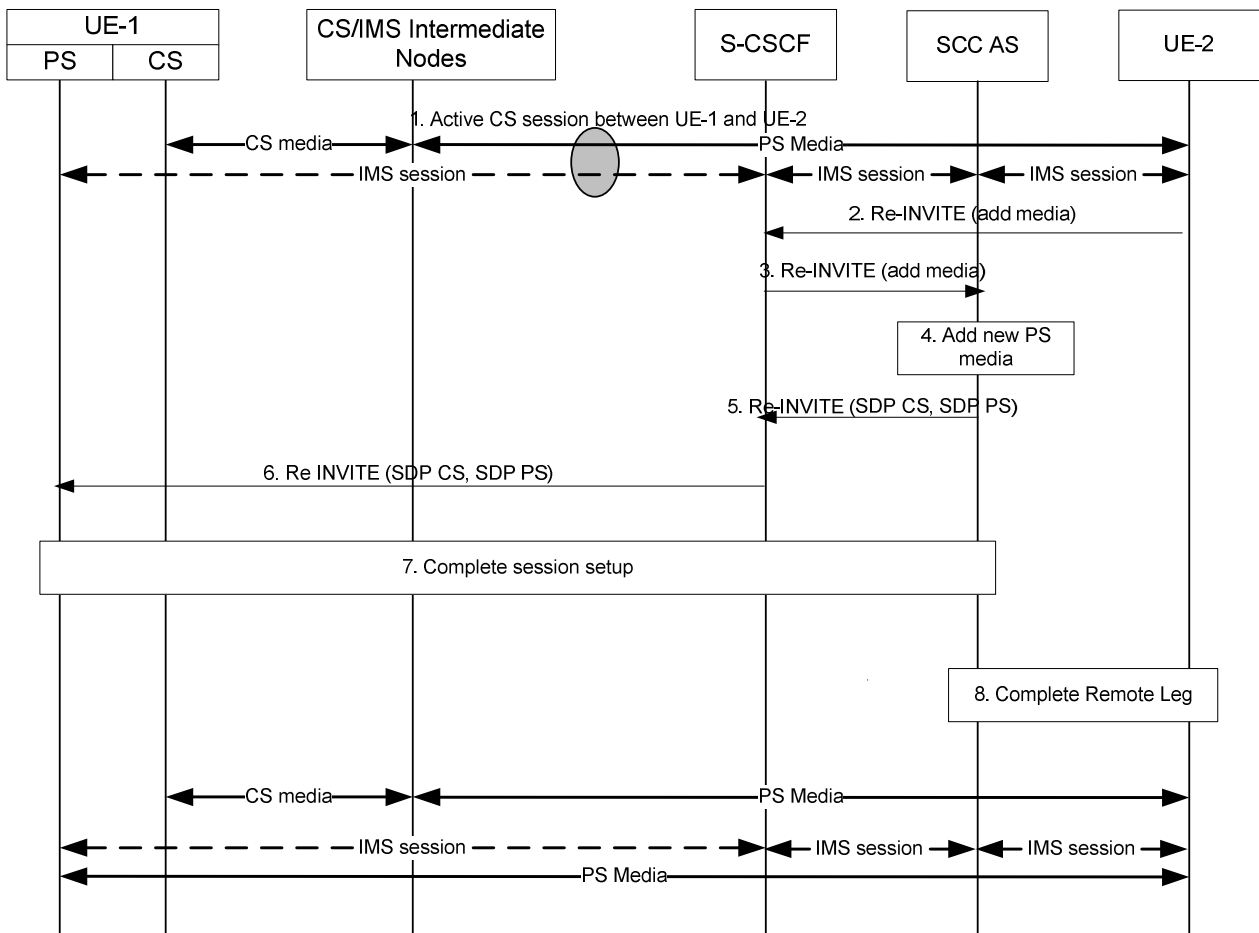

**Figure 6.3.3.5-1: Remote End Initiation case: Incorporating existing CS media in new IMS Session and Gm Service Control Signalling Path**

1. A CS session between UE-1 and UE-2 is established as either originated or terminated session with CS media as described in TS 23.292 [5] sections 7.3.2.1 and 7.4.2.1, respectively i.e. UE-1 is not using the ICS capability and therefore not using the Gm reference point during the session establishment.
2. S-CSCF receives a request from UE-2 to add new PS media flow (e.g. video) to the existing session.
3. S-CSCF forwards the request to SCC AS, which is anchored on the session path.
4. The T-ADS function in the SCC AS decides that the new media flow is delivered to UE-1 via PS access and therefore initiates a new session using the Gm reference point using ICS capabilities as specified in TS 23.292 [5]. SCC AS decides to establish the Gm Service Control Signalling Path together with the media addition using the ICS capability. T-ADS in the SCC AS uses the C-MSISDN for correlation, and then ensures the new session is delivered only to UE-1, and not delivered to other UEs of the user.
- 5-6. SCC AS initiates a new session towards UE-1. The request includes the new PS media and indicates that the existing CS media is moved to and controlled over this session.
7. UE-1 accepts the new session and completes the session setup via PS access.
8. The SCC AS completes the Remote Leg towards UE-2 according to procedures defined in TS 23.228 [4].

**6.3.3.6 Remote End Initiation case: Adding PS media to IMS session with CS media**

The call flow in figure 6.3.3.6-1 presents a scenario where UE-1 has an existing session that contains CS media and Gm Service Control Signalling Path with UE-2 and UE-2 adds new media to the session. The new media is delivered together with the Gm Service Control Signalling Path towards UE-1.

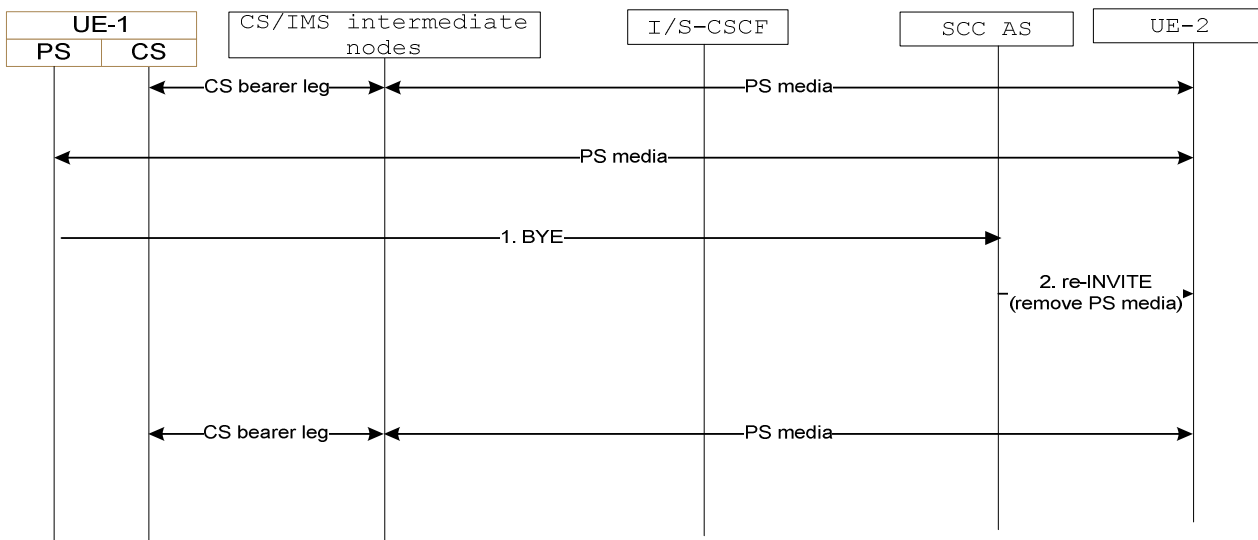

**Figure 6.3.3.6-1: Remote End Initiation case: adding PS media to IMS session with CS media**

1. A CS session between UE-1 and UE-2 is established as either originated or terminated session with CS media as described in TS 23.292 [5] clauses 7.3.2.2.4 and 7.4.2.2.2.2, respectively i.e. UE-1 is using the ICS capability and therefore the Gm reference point during the session establishment.
2. S-CSCF receives a request from UE-2 to add new PS media flow(s) (e.g. video) to the existing session.
3. S-CSCF forwards the request to SCC AS, which is anchored on the session path.
4. The T-ADS function in the SCC AS decides that the new media flow is delivered to UE-1 via PS access. The SCC decides to add the PS media to the existing Service Control Signalling Path that is established via Gm.
- 5-6. SCC AS initiates a request to add the PS media to the existing Service Control Signalling Path towards UE-2.
7. UE-1 accepts the new session and completes the session setup via PS access.
8. The SCC AS completes the Remote Leg towards UE-2 according to procedures defined in TS 23.228 [4].

### 6.3.3.7 Local End Initiation case – Removing media from split CS and PS sessions

The call flow in figure 6.3.3.7-1 presents a scenario where UE-1 has a CS call and an IMS multimedia session with the remote end in a manner that they are presented to UE-2 as one IMS session by the SCC AS and then removes PS media flow(s) by releasing the PS Access Leg.

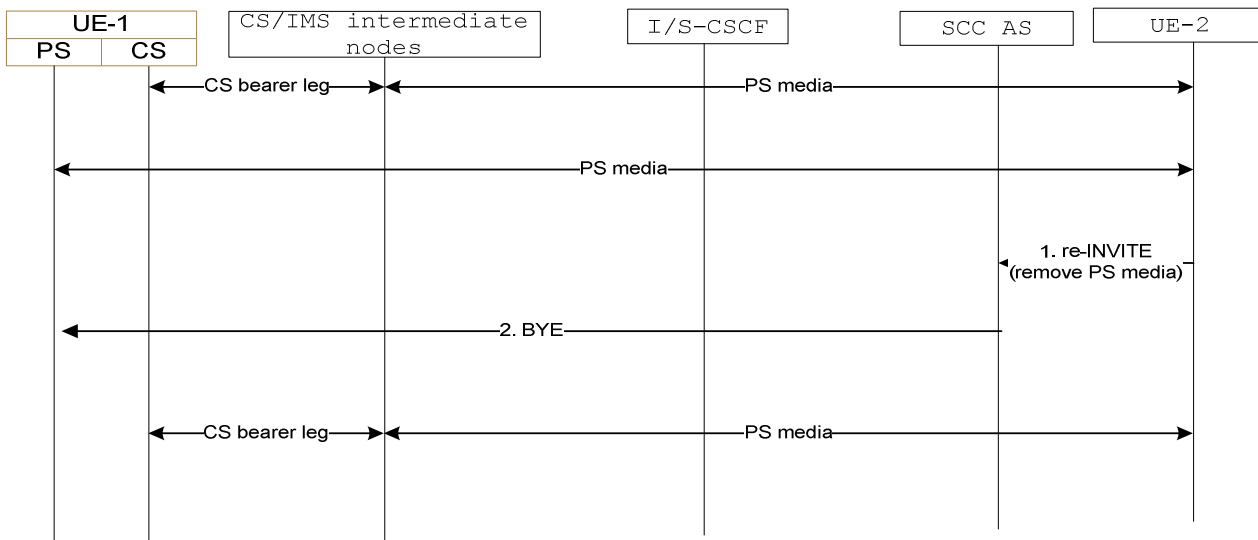

**Figure 6.3.3.7-1: Local End Initiation case – Removing media from split CS and PS sessions**

1. UE-1 uses standard IMS procedures defined in TS 23.228 [4] to remove one or more PS media flows from the session.
2. SCC AS sends a re-INVITE to UE-2 to remove the associated PS media flow(s) from the session. The SCC AS terminates the Source Access Leg as defined in 6.3.1.6.

### 6.3.3.8 Remote End Initiation case – Removing media from split CS and PS sessions

The call flow in figure 6.3.3.8-1 presents a scenario where UE-1 has a CS call and an IMS multimedia session with the remote end in a manner that they are presented to UE-2 as one IMS session by the SCC AS and where as a result of UE-2 requesting to remove PS media flow(s), the SCC AS terminates the Access Leg associated with the PS media flow(s).



**Figure 6.3.3.8-1: Remote End Initiation case – Removing media from split CS and PS sessions**

1. UE-2 uses standard IMS procedures defined in TS 23.228 [4] to remove one or more PS media flow(s) from the session.
2. SCC AS identifies the session from UE-2 as being split into two legs to UE-1. It determines the appropriate Access Leg over which to send the updated session information from UE-2. Since there is only a single PS media flow associated with the session, the SCC AS terminates the Access Leg associated with the PS media flow.

### 6.3.3.9 Local End Initiation case: Adding new PS media to existing PS session

This clause covers the scenario where UE 1 adds PS media flow(s) (e.g. video) over a new IP-CAN, IP-CAN2, to an existing multimedia session that uses PS media over IP-CAN1. As a post condition the UE 1 has an ongoing multimedia session with the remote end.

The call flow is the same as in figure 6.3.3.3-1 except that both the original media and the added media are on PS accesses and no CS intermediate nodes are involved.

### 6.3.3.10 Remote End Initiation case: Adding new PS media to existing PS session

This clause covers the scenario where UE 1 has an existing PS session with UE 2 using PS media over IP-CAN1 and UE 2 adds new media to the session and the new media flow is delivered using PS media over IP-CAN2 towards UE-1.

The call flow is the same as in clause 6.3.3.4 *Remote End Initiation case: Adding new PS media to existing CS session*, except that both the original media flow and the added media flows are on PS accesses and no CS intermediate nodes are involved. Consequently:

- in step 4. of the call flow, the T-ADS function in the SCC AS decides that the new media is delivered to UE 1 via PS through the access networks type corresponding to IP-CAN2;
- in step 5. of the call flow, the SCC AS includes enough information within the session request to ensure that the S-CSCF establishes the new session via the selected access networks type.

### 6.3.3.11 Local End Initiation case: Removing media from split PS sessions

This clause covers the scenario where local end UE-1 removes media flows from split PS sessions. As a precondition, UE-1 has an IMS multimedia session with the remote end. As a post-condition, UE-1 removes the PS session over one IP-CAN and continues IMS multimedia session with the remote end over the other IP-CAN.

The call flow is the same as in figure 6.3.3.7-1 except that all the media components are on PS accesses and no CS intermediate nodes are involved.

### 6.3.3.12 Remote End Initiation case: Removing media from split PS sessions

This clause covers the scenario where remote end UE-2 removes media flow(s) from split PS sessions. As a precondition, UE-1 has an IMS multimedia session with the remote end. As a post-condition, the PS session over one IP-CAN is removed and UE-1 continues IMS multimedia session with the remote end over the other IP-CAN.

The call flow is the same as in figure 6.3.3.8-1 except that all the media components are on PS accesses and no CS intermediate nodes are involved.

## 6.3.4 Void

## 6.3.5 Service continuity for ICS UE using MSC Server assisted mid-call feature while maintaining CS media

If the SCC AS detects that the ICS UE is not reachable over Service Control Signalling Path and if the UE and the network support the MSC Server assisted mid-call feature and the CS Bearer Control Signalling Path was established using the MSC Server enhanced for ICS, the same procedure as in clause 6.3.2.1.4a steps 4-6 are performed.

After completion of this procedure, the UE uses procedures as defined in TS 24.008 [24] to perform service control.

## 6.4 Operator Policy and User Preferences

Operator Policy is provisioned in the network by the operator, and should be communicated to the UE during initial provisioning or via OMA Device Management [7]. Operator policy should be communicated to the UE, via OMA Device Management, whenever the policy is updated by the operator.



Operator policy shall indicate, for each supported type of media or group of media:

- a list of access networks that are restricted for originating sessions and Access Transfer;
- a list of preferred access networks (in order of priority) to be used by the UE with SC capabilities for originating sessions and Access Transfer, when those access networks become available and Access Transfer is possible;
- whether the UE with SC capabilities "shall"/"should"/"may" start transferring media flow(s) to target access networks with higher priorities than the current access network, when the target access networks become available and Access Transfer is possible;
  - by indicating "shall" the operator mandates the UE to start Access Transfer according to the home operator's list of preferred access networks as soon as possible;
  - by indicating "should" the operator recommends the UE to start Access Transfer according to the home operator's list of preferred access networks, if Access Transfer is possible and desirable after having taken into account the Local Operating Environment Information;
  - by indicating "may" the operator leaves the UE free to decide whether or not to start Access Transfer in accordance with user preferences (when configured), if Access Transfer is possible and desirable after having taken into account the Local Operating Environment Information. Whenever user preferences are not configured, the UE shall to take into account the home operator's list of preferred access networks;
- whether to keep or drop non transferable media flow(s) in the case of partial Access Transfer.

NOTE 1: Operator policy for Access Transfer needs to be consistent with operator policy for T-ADS.

User preferences may indicate for example:

- preferred access/domain, i.e. CS preferred or IMS preferred, and which IP-CAN within IMS.

The Local Operating Environment Information is implementation specific and may comprise of such items as, radio environment information, quality of IP connection (jitter, delay and packet loss), application specific requirements, memory considerations, power considerations, etc.

The UE shall take in account operator policy, user preferences and the Local Operating Environment Information when deciding which access to use for outgoing sessions, performing UE assisted T-ADS, or before considering initiating Access Transfer.

NOTE 2: If the "IMS voice over PS Session Supported Indication" indicator, see TS 23.060 [27] and TS 23.401 [28], is not set for a specific 3GPP IP-CAN, this IP-CAN can not be used for voice, even if set to preferred by the user preferences.

## 6.5 Execution of supplementary services

### 6.5.1 General

This clause describes the SCC AS and UE procedures for execution of supplementary service as described in TS 22.173 [15].

The related interactions apply to scenarios when the media components for the UE are split into multiple Access Legs due to IMS Service Continuity procedures. The Remote Leg is presented with one session including all the media components.

For Access Leg where CS media is used, the interaction described in the following sections still applies and the service request should be sent via PS Access Leg. The operations on the CS media flows shall be handled based on the service request and shall follow the procedures as described in TS 23.292 [5].

When service invocation fails on one Access Leg, the UE and the SCC AS may retry on a different Access Leg.

### 6.5.2 Originating Identification Presentation (OIP)

The OIP service is not impacted.

### 6.5.3 Originating Identification Restriction (OIR)

The OIR service is not impacted.

### 6.5.4 Terminating Identification Presentation (TIP)

The TIP service is not impacted.

### 6.5.5 Terminating Identification Restriction (TIR)

The TIR service is not impacted.

### 6.5.6 Communication Diversion (CDIV)

Upon receiving an incoming session split across multiple Access Legs, if an UE wants to invoke the CDIV service, the UE may use any of the Access Legs to invoke the CDIV service following the procedures defined in TS 24.604 [21].

When the SCC AS splits an incoming session into multiple Access Legs and receives a CDIV request from the UE on any of the Access Legs, the SCC AS shall terminate the other Access Leg(s) and shall invoke the CDIV service following the procedures defined in TS 24.604 [21].

### 6.5.7 Communication Hold (HOLD)

If the UE wants to invoke the HOLD service on one or more media component(s) and the UE has multiple Access Legs, the UE shall invoke the HOLD procedures, as defined in TS 24.610 [16] on all the Access Legs which contain the affected media component(s). The SCC AS shall update the remote Access Leg using the procedures defined in TS 24.610 [16].

If the remote end initiates the HOLD service on one or more media component(s) and the UE has multiple Access Legs, the SCC AS shall forward the HOLD request on all the Access Legs which contain the affected media component(s).

### 6.5.8 Communication Barring (CB)

The CB service is not impacted.

### 6.5.9 Message Waiting Indication (MWI)

The MWI service is not impacted.

### 6.5.10 Conference (CONF)

When the UE wants to invoke the CONF services and has multiple Access Legs, the UE may send any CONF related requests, e.g. subscribe request for conference package or refer request to the conference, as defined in TS 24.605 [17], on any of the Access Legs.

When the UE has multiple Access Legs and the remote end sends a request for the CONF service to replace an existing session within the same dialog, the SCC AS may deliver the request for CONF service on any of the Access Legs.

When the UE has multiple Access Legs and receives a request on one of the Access Legs for a CONF service to replace an existing session, the UE shall follow the procedures specified in TS 24.605 [17] to establish a new session to the conference focus.

When the UE has multiple Access Legs and receives a request for a CONF service to replace an existing session outside the dialog, the UE shall follow the procedures specified in TS 24.605 [17] to establish a new session to the conference focus.

### 6.5.11 Explicit Communication Transfer (ECT)

When the UE acts as the transferor UE and has multiple Access Legs, the UE may send the request for ECT service, as specified in TS 24.629 [18], on any of the Access Legs.

When the UE acts as the transferee UE and has multiple Access Legs, the SCC AS may deliver the request for ECT service on any of the Access Legs.

When the UE has multiple Access Legs and receives an ECT request on one of the Access Legs, the UE shall follow the procedures specified in TS 24.629 [18] to establish a new session to the Transfer Target.

### 6.5.12 Advice of Charge (AOC)

When the AOC service specified in TS 24.647 [19] is active and the UE has multiple Access Legs, the SCC AS may deliver charging information during the communication to the UE over any of the Access Legs.

### 6.5.13 Closed User Groups (CUG)

The CUG service is not impacted.

### 6.5.14 Three-Party (3PTY)

The 3PTY service in TS 24.605 [17] is considered as a special case of CONF service and the interaction with Session Transfer is the same as that specified in clause 6.5.10 for CONF service.

### 6.5.15 Flexible Alerting (FA)

The FA service is not impacted.

### 6.5.16 Communication Waiting (CW)

Upon receiving an incoming session split across multiple Access Legs, if an UE wants to invoke the CW service, the UE may use any of the Access Legs to invoke the CW service following the procedures defined in TS 24.615 [22].

When the SCC AS splits an incoming session into multiple Access Legs and receives a CW request from the UE on any of the Access Legs, the SCC AS shall invoke the CW service following the procedures defined in TS 24.615 [22].

### 6.5.17 Completion of Communications to Busy Subscriber (CCBS)/Completion of Communications by No Reply (CCNR)

The CCBS/CCNR service is not impacted.

### 6.5.18 Customized Alerting Tones (CAT)

The CAT service is not impacted.

### 6.5.19 Malicious Communication Identification (MCID)

When invoking the MCID service in temporary subscription mode and there are multiple active Access Legs for the session, the UE may send the re-INVITE request for invoking MCID service as defined in TS 24.616 [20] on any of the Access Legs.

### 6.5.20 Reverse Charging

The Reverse Charging service is not specified.

## 6.5.21 Personal Network Management (PNM)

The PNM service is not specified.

## 6.5.22 Customized Ringing Signal (CRS)

The CRS service is not specified.

---

# 6a Procedures and flows for Inter-UE Transfer

## 6a.0 Introduction

In the following procedures and flows the UEs involved in IUT are labelled as UE-1, UE-2, etc. while the remote endpoint of the session is labelled as Remote Party. Flows are shown for IUT procedures establishing Collaborative Sessions as well as IUT procedures without establishing a Collaborative Session.

In the following information flows, when initiating IUT Media Control Related Procedures, the Controller UE can be replaced by the Controllee UE with IUT capabilities, with the difference that the Hosting SCC AS receiving a media control request from a Controllee UE with IUT capabilities shall send it to the Controller UE for authorization, or authorize it on behalf of the Controller UE (e.g. based on the user preferences associated with the Controller UE).

These information flows exemplify IUT procedures initiated by a UE sending a request received by the SCC AS. Scenarios pertaining to the SCC AS initiating IUT procedures based on different stimuli such as user preferences, other IMS signalling or service layer triggers are not precluded, but illustrative information flows are not included in this document except for the case of loss of Controller UE.

For the enablement of Inter-UE Transfer, originating and terminating sessions (without Collaborative Session establishment) are handled as specified in clause 6.2.

### 6a.0.1 Void

## 6a.1 IUT general procedures

### 6a.1.1 General

In all general IUT procedures the sessions are anchored in an SCC AS. These procedures do not apply for emergency sessions.

### 6a.1.2 Remote Leg Update

Remote Leg Update for IUT procedures are executed as shown in figures 6.3.1.5-1 and 6.3.1.5-2, in which the media descriptions applicable after the IUT procedure are communicated to the remote end. For an IUT procedure without establishing a Collaborative Session, the information of the new local end which continues the session with the remote end is also included.

## 6a.2 Information flows for Collaborative Session establishment

### 6a.2.1 Establish Collaborative Session by transferring media

There is an ongoing session between UE-1 and a remote party, which is anchored at the SCC AS. UE-1 transfers the media flow from UE-1 to UE-2 to establish a Collaborative Session. Following is an information flow for the

Collaborative Session establishment procedure when UE-1 initiates media transfer from UE-1 to UE-2. After the transfer, the UE-1 becomes Controller UE, and UE-2 becomes Controllee UE.

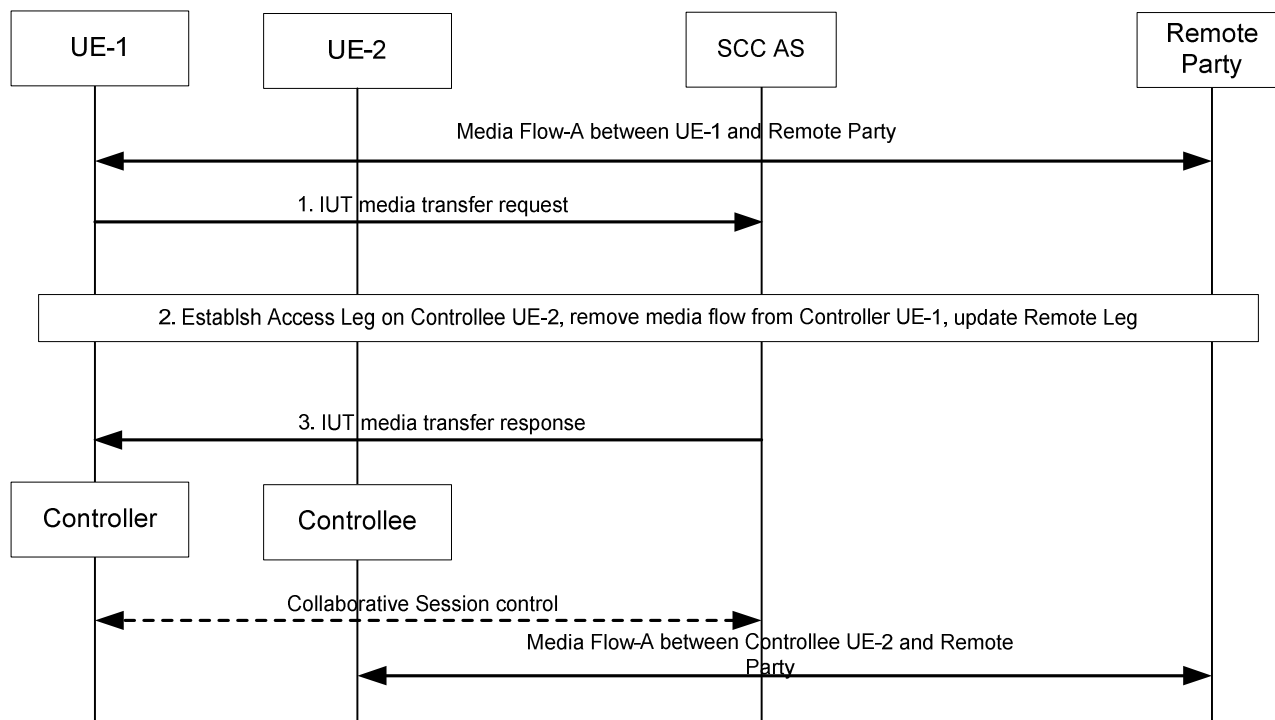

**Figure 6a.2.1-1: Establish Collaborative Session by transferring media**

1. UE-1 sends an IUT media transfer request to the SCC AS to transfer Media Flow-A from UE-1 to UE-2. The IUT media transfer request shall include the enough information for the SCC AS to:
  - identify that the transferred media flow is Media Flow-A;
  - identify that the target of the transferred media flow is UE-2;
  - keep the control of the Collaborative Session in UE-1.
2. The SCC AS performs authorization as specified in clause 6a.12, then sends request to establish Access Leg at UE-2 for Media Flow-A. The SCC AS removes Media Flow-A from UE-1, and updates the Remote Leg using the Remote Leg Update procedure as specified in clause 6a.1.2.
3. The SCC AS sends an IUT media transfer response to UE-1. A Collaborative Session is established, for which UE-1 becomes the Controller UE and UE-2 becomes a Controllee UE.

When the above transfer is completed the SCC AS retains the service state (e.g. media flows status) of UE-1 and UE-2, and UE-1 retains the control of the Collaborative Session.

NOTE 1: UE-1 can transfer other media flows from UE-1 by repeating the above steps 1-3.

NOTE 2: If, besides Media Flow-A, there are other media flows between UE-1 and the remote party, these other media flows shall not be impacted by the above Inter-UE Transfer operation, i.e. these other media flows remain on UE-1.

## 6a.2.2 Establish Collaborative Session with new media

The following information flow shows the Collaborative Session establishment procedure. There is an ongoing IMS session with Media Flow-A between UE-1 and a remote party, which is anchored at the SCC AS. UE-1 wants to add a new Media Flow-B on another UE-2 to the current ongoing IMS session to establish a Collaborative Session.

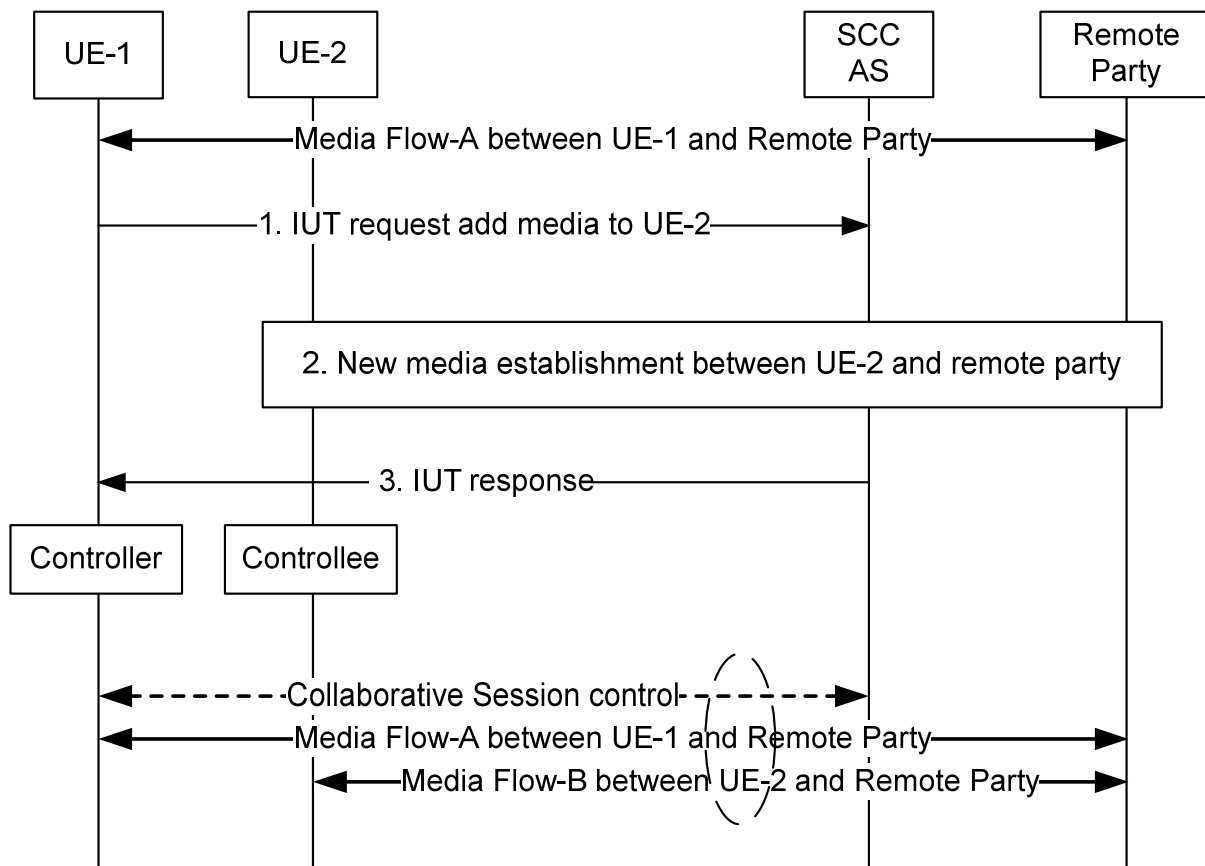
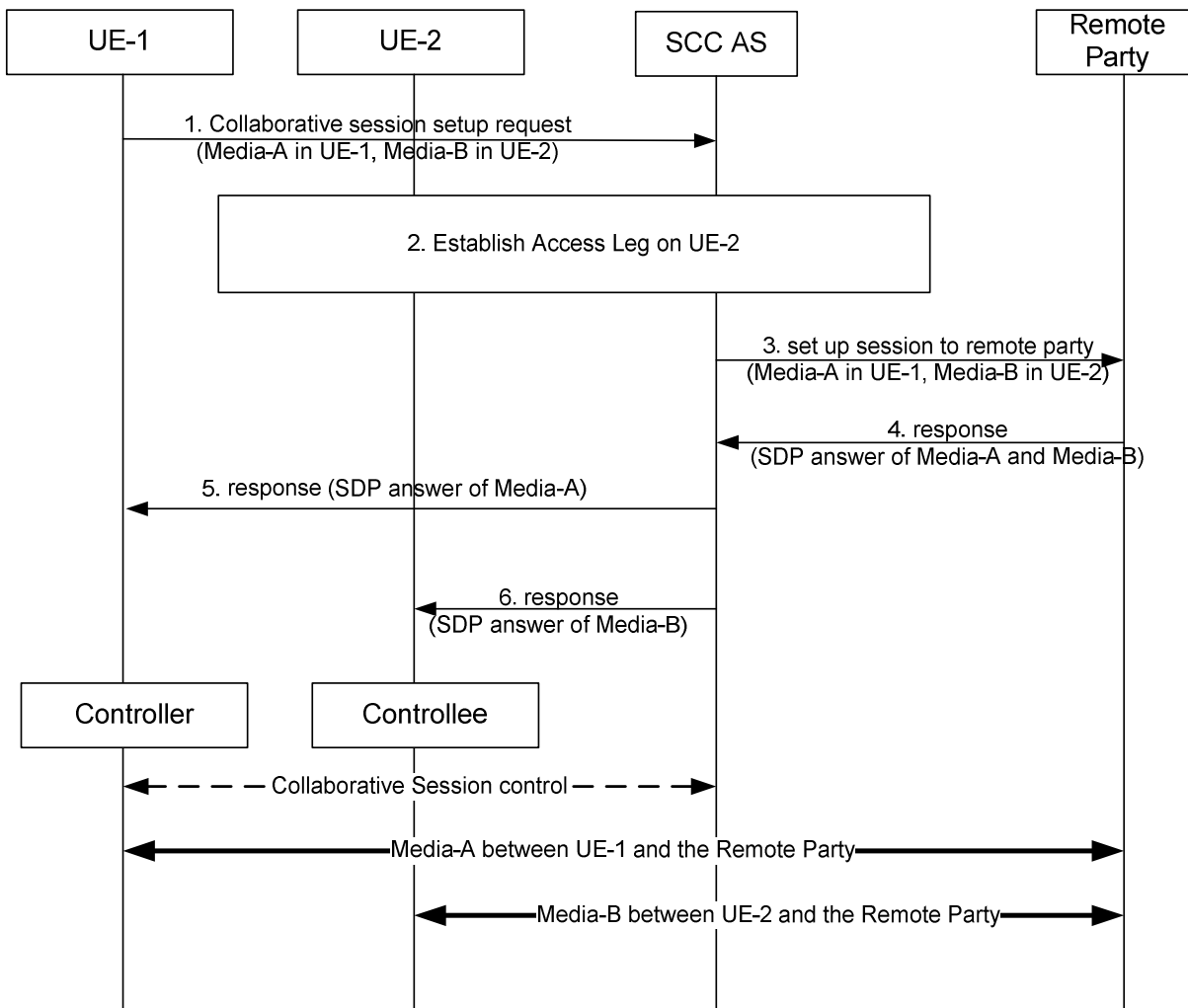

**Figure 6a.2.2-1: Flow for Collaborative Session establishment with new media flow on another UE**

1. UE-1 decides to add a new Media Flow-B to UE-2. It sends an IUT add media request to the SCC AS, indicating that a new Media Flow-B will be added to UE-2. The request shall include enough information for the SCC AS to:
  - identify that the added media flow is Media Flow-B;
  - identify that the target of the added media flow is UE-2;
  - keep the control of the Collaborative Session in UE-1;
2. The SCC AS performs authorization as specified in clause 6a.12, then sends the IUT add media request to UE-2, indicating that a new Media Flow-B will be created on UE-2. Media Flow-B between UE-2 and remote party is established. The Remote Leg is updated accordingly.
3. After the successful establishment of the Media Flow-B on UE-2, the SCC AS sends an IUT add media response back to UE-1. A Collaborative Session is established, for which UE-1 becomes the Controller UE and UE-2 becomes a Controllee UE and Media Flow-A and Media Flow-B become part of the Collaborative Session under the control of UE-1..

### 6a.2.3 Establish Collaborative Session at originating IMS session setup

The following information flow shows the Collaborative Session establishment procedure when there is no ongoing IMS session. Concurrent with a normal session set-up towards a remote party, UE-1 wants to establish a Collaborative Session, which is anchored at the SCC AS, with a new Media Flow-A on itself and a new Media Flow-B on another UE-2.



**Figure 6a.2.3-1: Establishment of Collaborative Session upon Originating IMS Session Setup**

1. UE-1 sends an IUT request to the SCC AS in order to set up a Collaborative Session to remote party with Media-A in UE-1, and with Media-B in UE-2. The session setup request shall include enough information for the SCC AS to:
  - identify the remote party of the session setup request;
  - identify that Media-A shall be established in UE-1;
  - identify that Media-B shall be established in UE-2 and the requested media type associated with Media-B (e.g. video);
  - keep the control of the Collaborative Session in UE-1.

2. The SCC AS performs authorization as specified in clause 6a.12, then sends a request to establish an Access Leg at UE-2 for Media-B.

NOTE: In order to obtain the full media description of Media-B, it is necessary to establish the Access Leg at UE-2 prior to engaging the remote party so that the SCC AS can send a proper (complete) SDP offer towards the remote party in step 3.

3. The SCC AS sends a session setup request to the remote party.
4. The remote party sends a response with the SDP answer of Media-A and Media-B to the SCC AS.
5. The SCC AS sends a response with the SDP answer of Media-A to UE-1 to establish Media-A in UE-1.
6. The SCC AS sends a response with the SDP answer of Media-B to UE-2 to establish Media-B in UE-2.

After the above operation, a Collaborative Session is established, for which UE-1 becomes the Controller UE and UE-2 becomes a Controllee UE. Media-A is established between Controller UE-1 and the remote party, and Media-B is established between Controllee UE-2 and the remote party.

#### 6a.2.4 Establish Collaborative Session at terminating IMS session setup

The following information flow shows the Collaborative Session establishment procedure when there is no ongoing IMS session. Concurrent with the response to a normal session invitation received from a remote party, UE-1 wants to establish a Collaborative Session, which is anchored at the SCC AS, with the requested Media Flow-A on itself and the requested Media Flow-B on another UE-2.

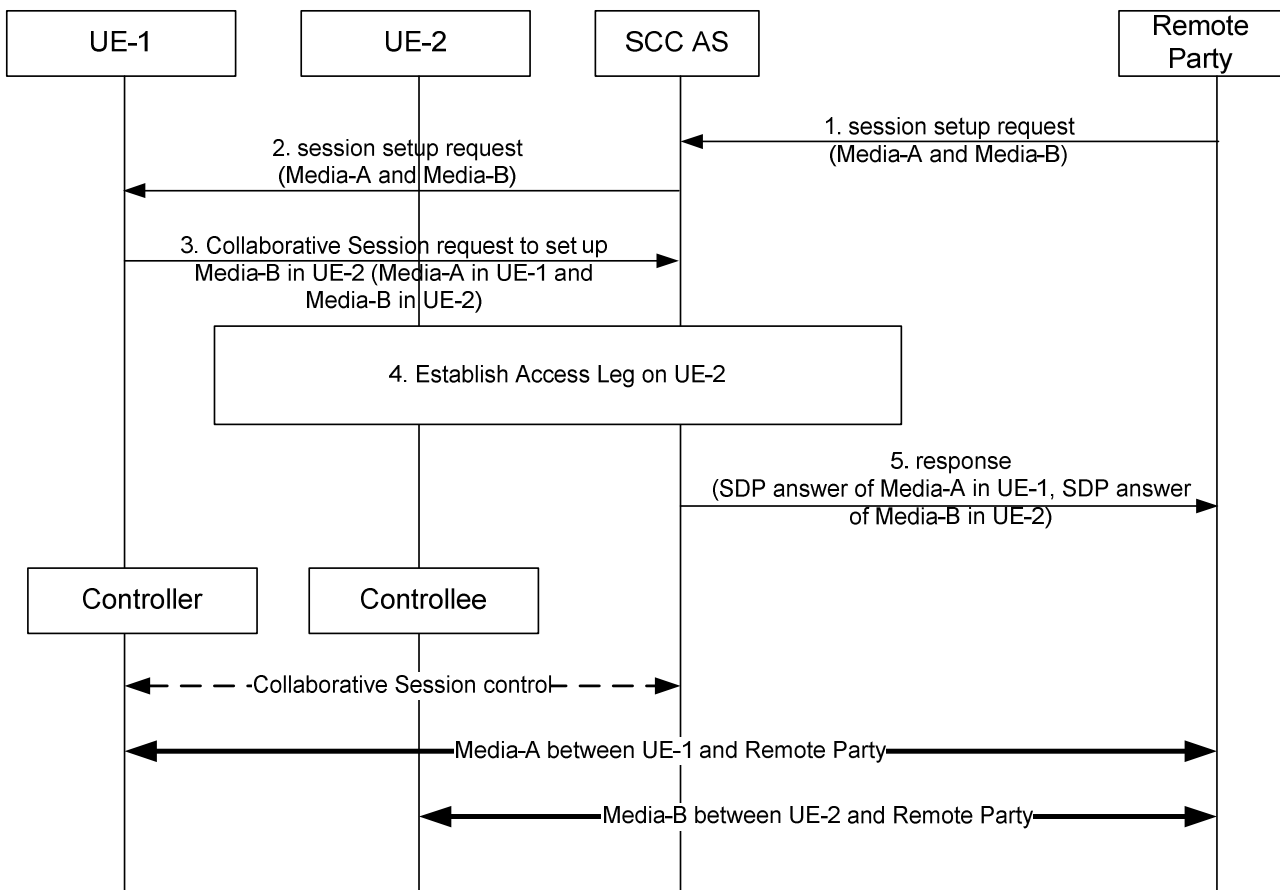

**Figure 6a.2.4-1: Establishment of Collaborative Session upon Terminating IMS Session Setup**

1. The remote party sends a session setup request to the SCC AS to set up Media-A and Media-B with UE-1.
2. The SCC AS forwards the session setup request to UE-1.
3. UE-1 sends a Collaborative Session request to the SCC AS to setup Media-B in UE-2. The session setup request includes enough information for the network to:
  - identify that Media-B shall be established in UE-2 and the requested media type associated with Media-B (e.g. video);
  - keep the control of the Collaborative Session in UE-1.
4. The SCC AS performs authorization as specified in clause 6a.12, then sends a request to establish an Access Leg at UE-2 for Media-B.
5. The SCC AS sends a response to the remote party. The response carries the SDP answer of Media-A in UE-1 and Media-B in UE-2.



After the above operation, a Collaborative Session is established, for which UE-1 becomes the Controller UE and UE-2 becomes a Controllee UE. Media-A is established between Controller UE-1 and the remote party, and Media-B is established between Controllee UE-2 and the remote party.

## 6a.3 Media Transfer within Collaborative Session

### 6a.3.1 Controller UE initiated media transfer from Controller UE to Controllee UE

#### 6a.3.1.1 Controller UE and Controllee UE belong to the same subscription

A Collaborative Session is already established using procedures shown in clause 6a.2. Following is an information flow for UE-1 performing media transfer to UE-2; after the transfer, the UE-1 keeps the role of the Controller UE, and UE-2 is Controllee UE. If UE-2 is not involved in the Collaborative Session controlled by UE-1 before the media transfer, there is at least another Controllee UE involved in the Collaborative Session before the media transfer, which is not shown in the information flow.

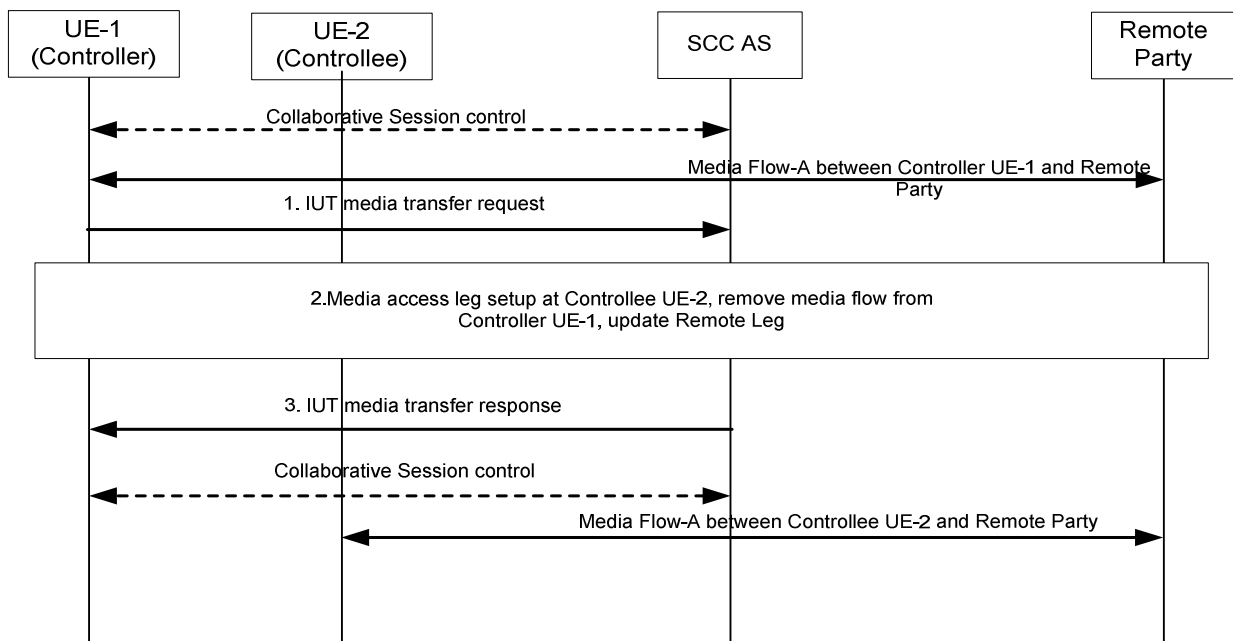

**Figure 6a.3.1.1-1: Controller UE initiated media transfer from Controller UE to Controllee UE belonging to the same IMS subscription**

1. UE-1 sends IUT media transfer request to the S-CSCF to transfer the Media-A from UE-1 to UE-2. The IUT media transfer request shall include the enough information for the SCC AS to:
  - identify that the transferred media flow is Media Flow-A;
  - identify that the source of the transferred media flow is UE-1;
  - identify that the target of the transferred media flow is UE-2;
  - keep the control of the Collaborative Session in UE-1.
2. The SCC AS performs authorization as specified in clause 6a.12, then sends transfer request to establish a session with UE-2 for the Media Flow-A, removes Media Flow-A from UE-1, and updates the Remote Leg using the Remote Leg Update procedure as specified in clause 6a.1.2.
3. The SCC AS sends media transfer response to UE-1.

When the above transfer is completed the SCC AS retains the service state (e.g. media flows status) of UE-1 and UE-2, and the UE-1 retains the control of the Collaborative Session.

NOTE 1: UE-1 can transfer other media flows from UE-1 by repeating the above steps 1-3.

NOTE 2: If, besides the Media Flow-A, there are other media flows in the Collaborative Session, these other media flows shall not be impacted by the above Inter-UE Transfer operation.

### 6a.3.1.2 Controller UE and Controllee UE belong to different subscriptions

The information flow below illustrates a transfer of media flow scenario in which the Controller UE transfers a flow to a UE that belongs to another user.

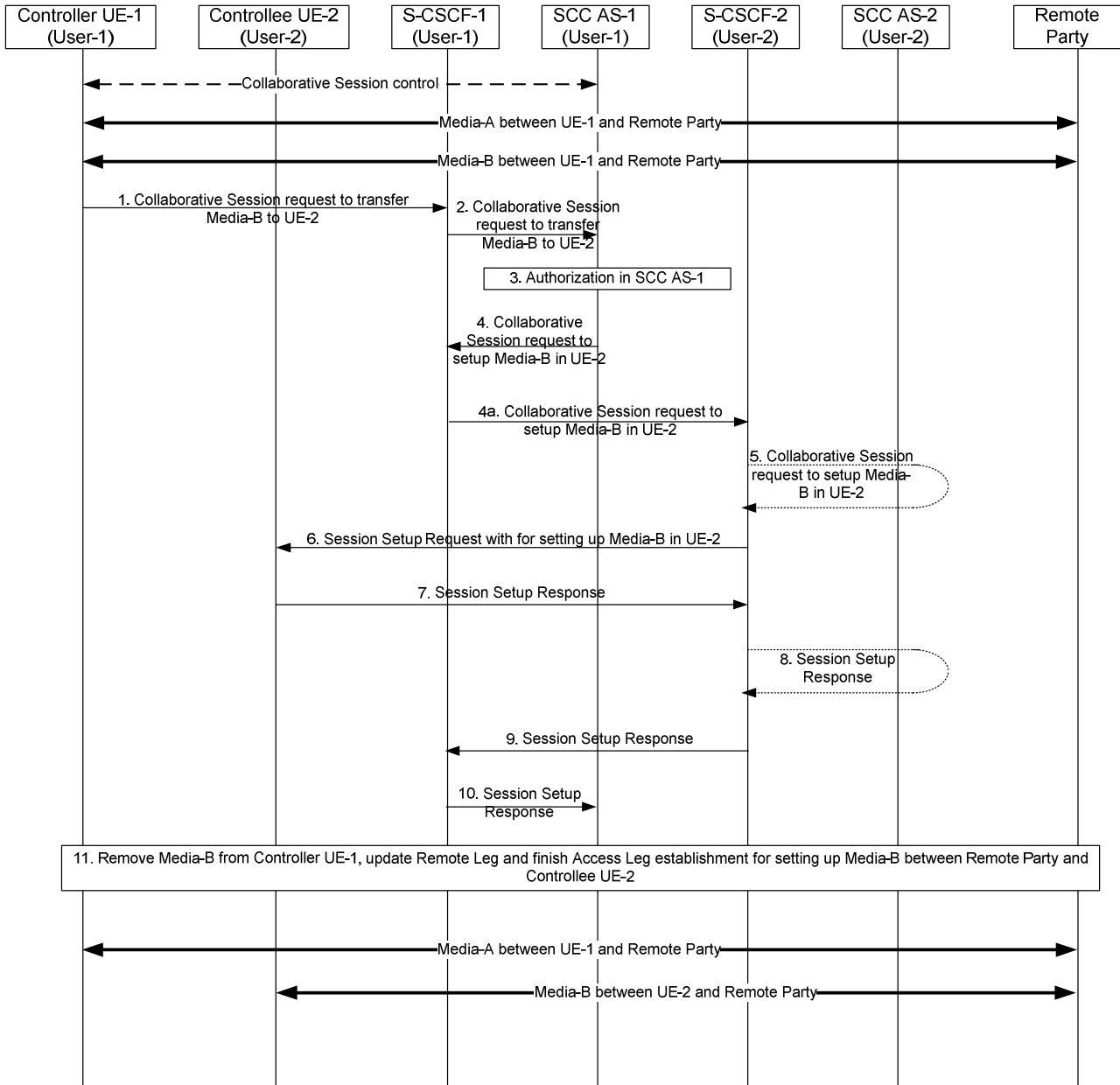

**Figure 6a.3.1.2-1: Transferring media from Controller UE to Controllee UE belonging to different IMS subscriptions**

There are Media-A and Media-B between Controller UE-1 and remote party.

1. UE-1 sends a request towards SCC AS-1 to transfer Media-B to UE-2. The request includes enough information for the network to:
  - identify that the media flow to be transferred is Media-B;
  - identify that the source of the media flow to be transferred is UE-1;

- identify that the target of the transferred media flow is UE-2.
2. S-CSCF-1 forwards the request to SCC AS-1.
  3. SCC AS-1 authorizes the request from UE-1 as specified in clause 6a.12.
  4. SCC AS-1 sends a request towards UE-2 to setup Media-B on UE-2. The request includes enough information for the network to:
    - identify the source of the transfer request as UE-1;
    - identify the remote party;
    - identify that the media flow to be transferred is Media-B;
    - identify that the source of the media flow to be transferred is Controller UE-1;
    - identify that the target of the media flow to be transferred is Controllee UE-2.
  - 4a. S-CSCF-1 forwards the request towards UE-2.
  5. If UE-2 is an IUT subscriber, the request is routed via SCC AS-2 which checks that UE-2 is authorized to receive the request. If so, SCC AS-2 notes that this request relates to the establishment of a Collaborative Session so that any requests by UE-2 related to this Collaborative Session will be forwarded back towards SCC AS-1. A Session Setup request is then routed on towards UE-2. If UE-2 is not an IUT subscriber, S-CSCF-2 routes the request according to normal procedures.
  6. S-CSCF-2 forwards the Session Setup request to Controllee UE-2.
  7. UE-2 sends a Session Setup response towards SCC AS-1.
  - 8 - 9. S-CSCF-2 routes the response back towards SCC AS-1 – via SCC AS-2 if UE-2 is an IUT subscriber.
  10. S-CSCF-1 forwards the session setup response to SCC AS-1.
  11. SCC AS-1 removes Media-B from UE-1, updates Remote Leg and finishes Access Leg establishment for setting up Media-B between remote party and UE-2.

After the above operation, Media-B has been transferred from Controller UE-1 to Controllee UE-2.

### 6a.3.2 Controller UE initiated media transfer from Controllee UE to Controller UE

A Collaborative Session is already established using procedures shown in clause 6a.2, the UE-1 keeps the role of the Controller UE, and UE-2 is Controllee UE. Following is an information flow for UE-1 initiating media transfer from UE-2 to UE-1.

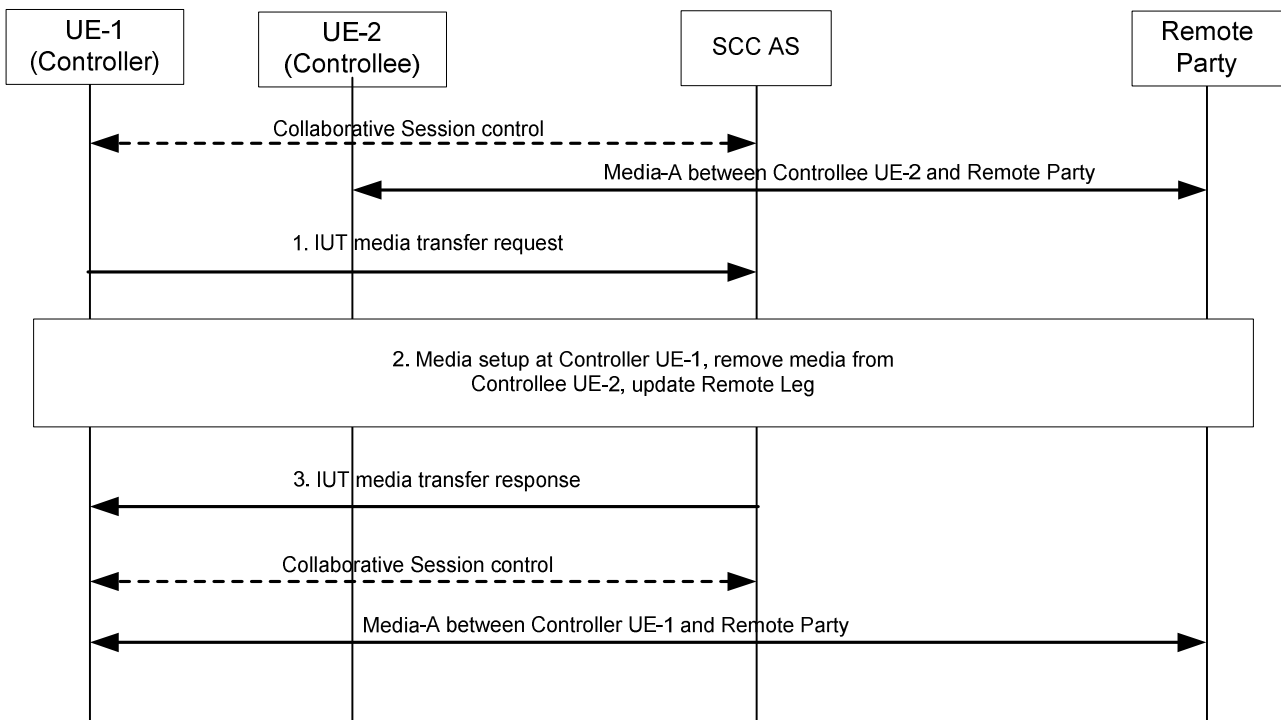

**Figure 6a.3.2-1: Controller UE initiated media transfer from Controllee UE to Controller UE**

1. UE-1 sends IUT media transfer request to the SCC-AS to transfer the Media-A from UE-2 to UE-1. The IUT media transfer request shall include the enough information for the SCC AS to:
    - identify that the transferred media flow is Media-A;
    - identify the source of the media flow is UE-2;
    - identify that the target of the transferred media flow is UE-1;
  2. The SCC AS performs authorization as specified in clause 6a.12, then initiates the transfer by setting up Media-A towards Controller UE-1, removing Media-A from Controllee UE-2, and updates the Remote Leg using the Remote Leg Update procedure as specified in clause 6a.1.2. After the transfer, Media-A will be between Controller UE-1 and remote party.
- NOTE 1: If no more media flow remains on the access leg between SCC AS and Controllee UE-2, the Access Leg between UE-2 and the SCC AS is released and Controllee UE-2 will no longer be part of the Collaborative Session.
3. The SCC AS sends media transfer response to UE-1.

When the above transfer is completed the SCC AS retains the service state (e.g. media flows status) of UE-1 and UE-2, and the UE-1 retains the control of the Collaborative Session.

NOTE 2: UE-1 can transfer other media flows from UE-2 by repeating the above steps 1-3.

NOTE 3: If, besides Media-A, there are other media flows in the Collaborative Session, these other media flows shall not be impacted by the above Inter-UE Transfer operation.

## 6a.3.3 Controller UE initiated media transfer from Controllee UE to another Controllee UE

### 6a.3.3.1 Controller UE and Controllee UEs belong to the same subscription

UE-1 and UE-2 are engaged in a Collaborative Session established using procedures shown in clause 6a.2 for which UE-1 is the Controller UE and UE-2 is a Controllee UE. UE-3 might or might not be part of the Collaborative Session before the media transfer. There is media flow, Media-A, between UE-2 and Remote Party. The following figure

presents an information flow of UE-1 performing IUT media transfer from UE-2 to UE-3 after which UE-1 retains the role of the Controller UE and UE-3 becomes Controllee UE.

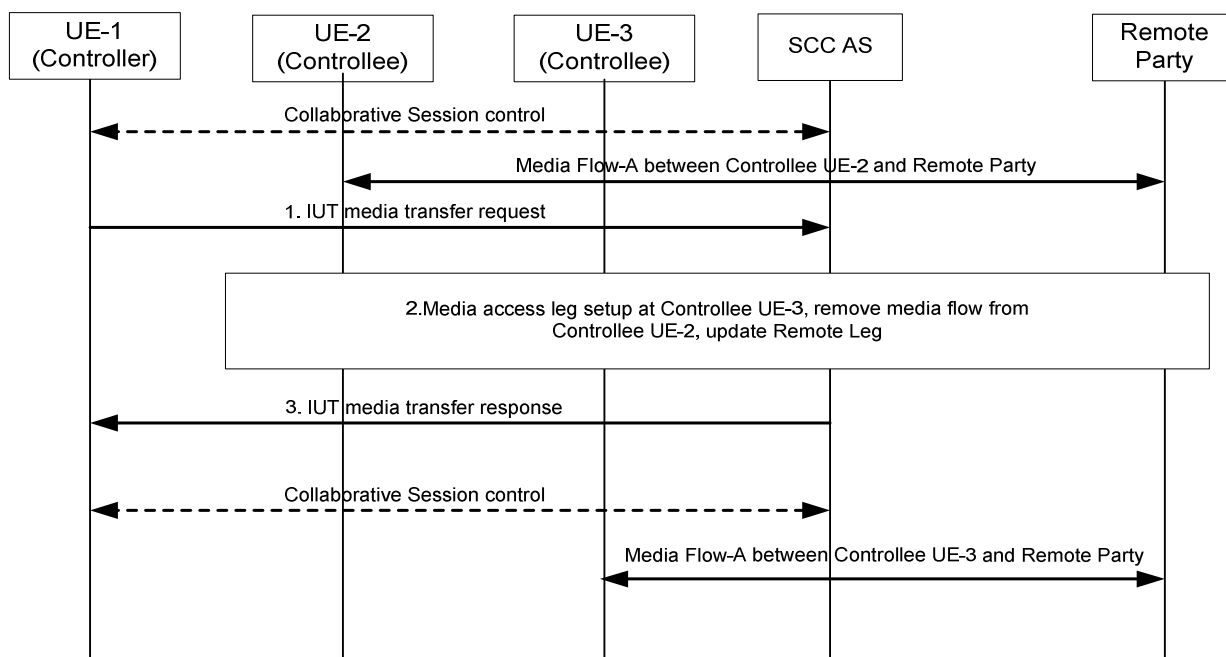

**Figure 6a.3.3.1-1: Controller UE initiated media transfer from Controllee UE to another Controllee UE (Controller and Controllee UEs belong to the same IMS subscription)**

1. UE-1 sends IUT media transfer request to the SCC AS to transfer the Media Flow-A from UE-2 to UE-3. The IUT media transfer request shall include the enough information for the SCC AS to:
    - identify that the transferred media flow is Media Flow-A;
    - identify that the target of the transferred media flow is UE-3;
    - keep the control of the Collaborative Session in UE-1.
  2. The SCC AS performs authorization as specified in clause 6a.12, then sends request to establish Access Leg on UE-3 for Media Flow-A, removes Media Flow-A from UE-2, and updates the Remote Leg using the Remote Leg Update procedure as specified in clause 6a.1.2.
- NOTE 1: If no more media flows remain on UE-2, then the Access Leg from UE-2 is released and UE-2 will no longer be part of the Collaborative Session.
3. The SCC AS sends media transfer response to UE-1.

When the Inter-UE Transfer is completed, UE-1 keeps the Collaborative Session Control.

NOTE 2: UE-1 can transfer other media flows from UE-2 by repeating the above steps 1-3.

NOTE 3: If, there are other media flows in the Collaborative Session besides the Media Flow-A, these other media flows are not impacted by the above Inter-UE Transfer operation.

### 6a.3.3.2 Controller UE and Controllee UEs belong to different subscriptions

For Controller and Controllee UEs belonging to different subscriptions, the following information flow shows the flow of media transferring from a Controllee (UE-2) to another Controllee (UE-3) initiated by Controller (UE-1). As a prerequisite, there exists a Collaborative Session with two media flows, Media-A on the Controller UE (UE-1) and Media-B on the Controllee UE (UE-2). UE-3 might or might not be part of Collaborative Session before the media transfer. Furthermore, UE-1, UE-2 and UE-3 profiles are served by different S-CSCFs, S-CSCF-1, S-CSCF-2 and S-CSCF-3, respectively. For simplicity, S-CSCF-1 is not shown in the following figure.

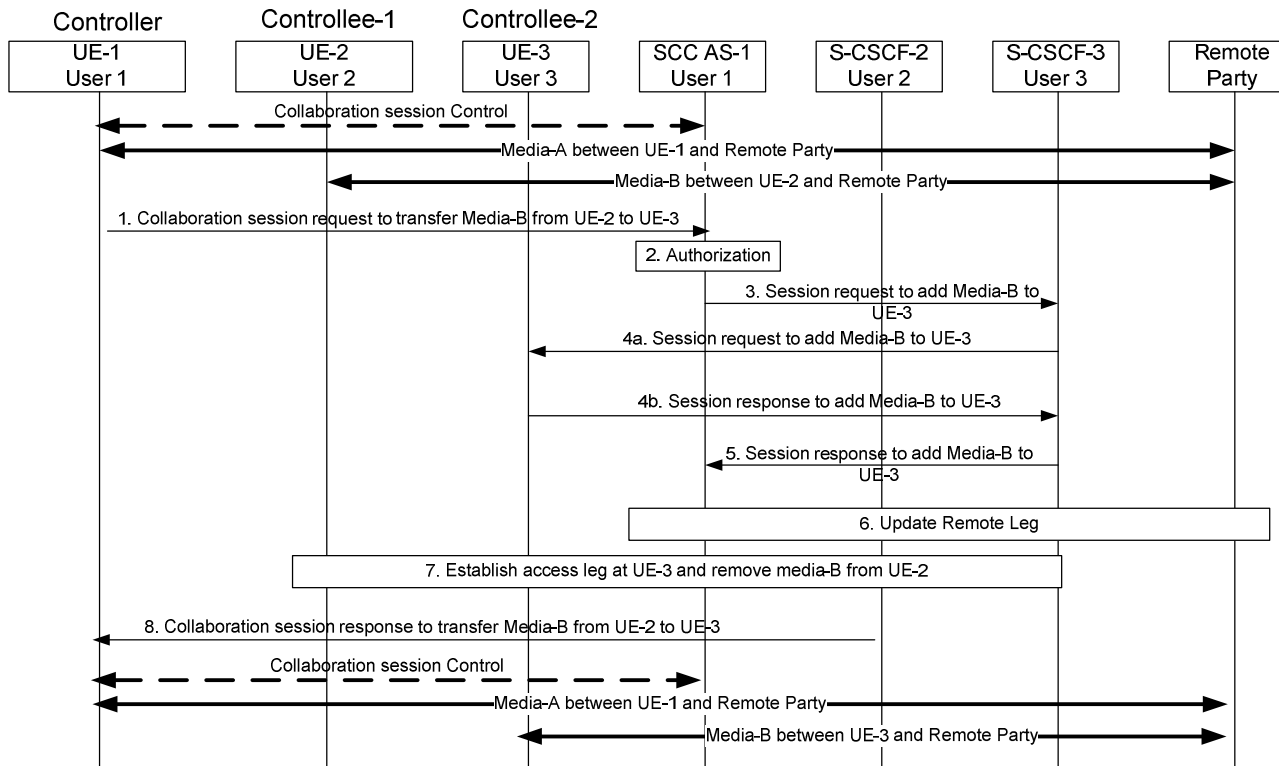

**Figure 6a.3.3.2-1: Controller UE initiated media transfer from Controllee UE to another Controllee UE (Controller and Controllee UEs belong to different IMS subscriptions)**

1. UE-1 sends a Collaboration session request to SCC AS-1 to transfer Media-B from UE-2 to UE-3. The Collaborative Session request includes enough information for the network to:
  - identify that the media to be transferred is Media-B;
  - identify that the media to be transferred is currently on UE-2;
  - identify that the media to be transferred to is UE-3;
  - identify the session that contains of the transferred media flow to be transferred;
  - keep the control of the Collaborative Session in UE-1.
2. SCC AS-1 verifies that UE-1 is the Controller UE and therefore is authorized to release the media from a Controllee UE-2 with a user belonging to another subscription and performs authorization as specified in clause 6a.12.
3. SCC AS-1 sends Session request to add Media-B to UE-3 via S-CSCF-3. Media-B in UE-3 is kept inactive until the remote end is updated. The Session request includes enough information for the network to:
  - identify the source of the transfer request as UE-1;
  - identify the remote party;
  - identify that the media flow to be added is Media-B;
  - identify that the source of the media flow to be transferred is Controllee UE-2;
  - identify that the target of the media flow to be transferred is Controllee UE-3;
- 4a. S-CSCF-3 forwards the Session request to UE-3.
- 4b. UE-3 sends a Session response to S-CSCF-3.

5. S-CSCF-3 forwards Session response to SCC AS-1.
6. SCC AS-1 updates remote leg with Remote Leg Update Procedure.
7. SCC AS-1 establishes the access leg at UE-3 and removes Media-B from UE-2.

NOTE 1: If no more media flows remain on UE-2, then the Access Leg from UE-2 is released and UE-2 will no longer be part of the Collaborative Session.

8. SCC AS-1 sends the Collaboration Session Response message to UE-1 confirming the successful transfer of Media-B from UE-2 to UE-3.

When the Inter-UE Transfer is completed, UE-1 keeps the Collaborative Session Control.

NOTE 2: UE-1 can transfer other media flows from UE-2 by repeating the above steps 1-8.

NOTE 3: If there are other media flows in the Collaborative Session besides the Media-B, then these other media flows are not impacted by the above Inter UE Transfer operation.

### 6a.3.3a Controllee UE Initiated Transfer Media from one Controllee UE to another Controllee UE

This information flow shows the Controllee UE-2 transferring a media flow from the Controllee (UE-2) to another Controllee (UE-2). As a pre-requisite, there exists a Collaborative Session with a media flow, Media-B, on the Controllee UE (UE-2). Furthermore, Controller UE 1 and Controllee UE 2 profiles are served by different IUT SCC AS, SCC AS-1, SCC AS-2 which are in turn attached to S-CSCF 1, S-CSCF 2 respectively. For simplicity, the S-CSCFs are not shown in the following figure.

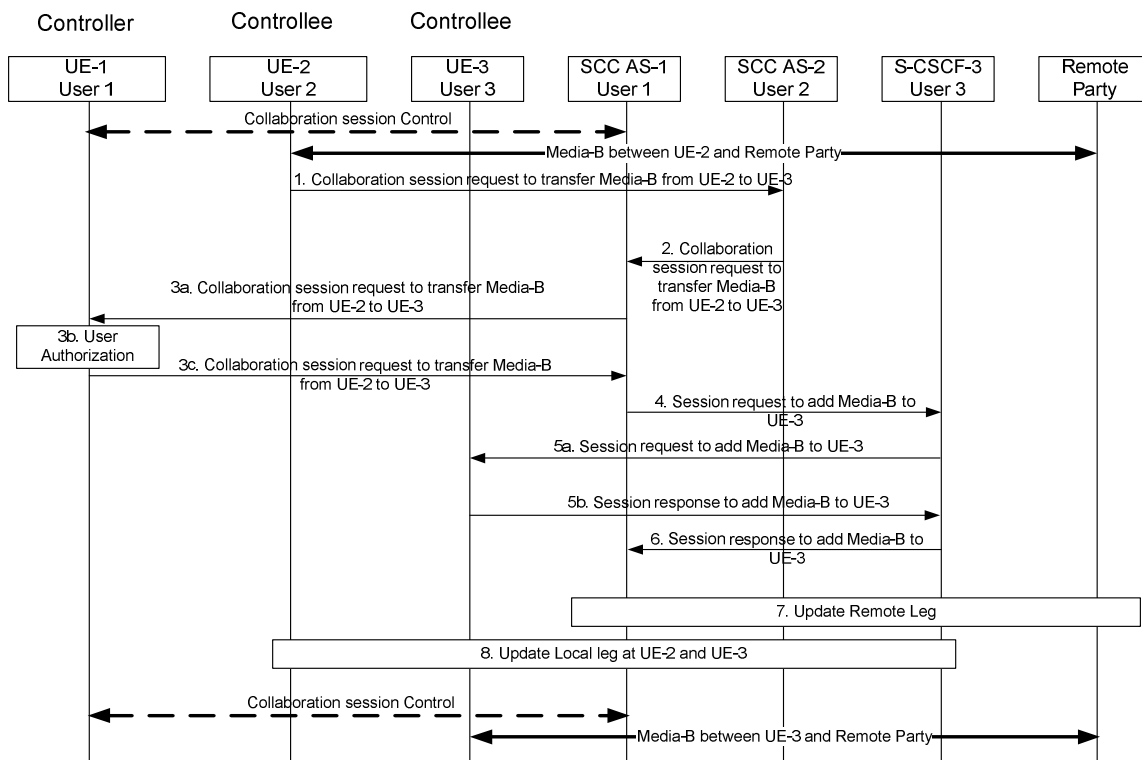

Figure 6a.3.4-1: Controllee initiated Transfer of media from Controllee UE to another Controllee (Controller and Controllee belong to different IMS subscriptions)

1. Controllee UE-2 sends a Collaborative session request to SCC AS-2 to transfer Media-B from UE-2 to Controllee UE-3. The Collaborative Session request includes enough information for the network to:

- identify that the media to be transferred is Media-B;
  - identify that the source for the media to be transferred is Controllee UE-2;
  - identify that the target for the media to be transferred is Controllee UE-3;
  - identify the session that contains of the media flow to be transferred;
  - Controller of the Collaborative Session is Controller UE-1.
2. SCC AS-2 authorizes the request from UE-2 as specified in clause 6a.12 and identifies that the session is a collaborative session anchored at SCC AS-1 and so forwards the "Collaborative session request to transfer Media-B" to SCC AS-1 which is the SCC AS for the Controller UE.
- 3a-3c. The SCC AS-1 sends a Collaborative session request to the Controller UE-1, and the Controller UE-1 authorizes the media transfer request.

NOTE 1: SCC AS-1 may be configured to authorize the request on behalf of UE-1.

4. SCC AS-1 sends the Session request to add media-B to UE-3 via S-CSCF-3. Media-B in UE-3 is kept inactive until the remote end is updated. The Collaborative Session request includes enough information for the network to:
- identify the source of the transfer request as UE-1;
  - identify the remote party;
  - identify that the media flow to be transferred is Media-B;
  - identify that the source of the media flow to be transferred is Controllee UE-2;
  - identify that the target of the media flow to be transferred is Controllee UE-3;
- 5a. S-CSCF-3 forwards the Session request to UE-3.
- 5b. UE-3 sends a Session response to S-CSCF-3.
6. S-CSCF-3 forwards Session response to SCC AS-1.
7. SCC AS-1 updates remote leg with Remote Leg Update Procedure.
8. SCC AS-1 activates media-B at UE-2 and releases media-B UE-3.

When the Inter UE Transfer is completed UE-1 keeps the Collaborative Session control.

## 6a.3.4 Void

### 6a.3.4.1 Void

### 6a.3.4.2 Void



## 6a.4 Media adding/deleting/modifying within Collaborative Session

### 6a.4.1 Controller UE initiated add new media on Controller UE

UE-1, UE-2 are engaged in a Collaborative Session established using procedures shown in clause 6a.2 for which UE-1 is the Controller UE and UE-2 is a Controllee UE, which has a media flow-A with the remote party. The following flows shows how the Controller UE-1 adds a media flow-B to itself, which may result in a new Access Leg, or it could be an additional media flow for an already existing session for the Controller UE-1.

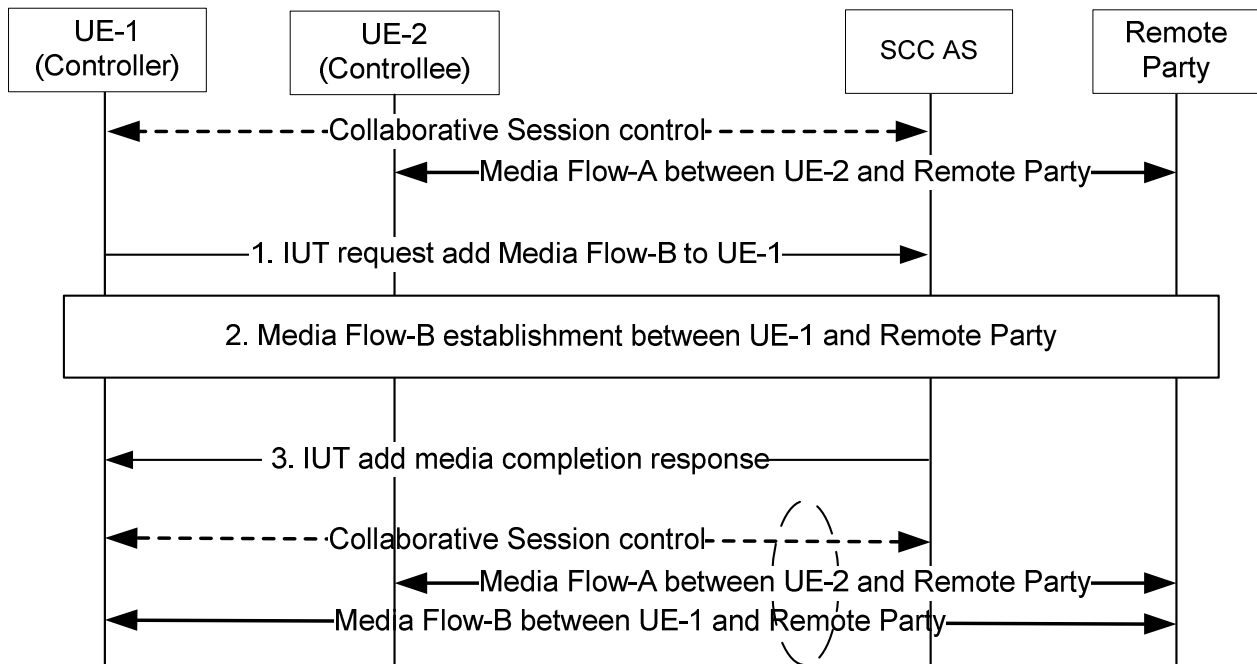

**Figure 6a.4.1-1: Controller UE initiated add new media On Controller UE**

- Controller UE-1 decides to add a new media flow-B to itself, and performs an IUT add media request for the particular media requested. The IUT media transfer request shall include enough information for the SCC AS to:
  - identify that the added media flow is media flow-B;
  - identify that the target of the added media flow is the Controller UE-1 itself;
- The SCC AS performs authorization as specified in clause 6a.12. Then, the new media flow-B is setup for Controller UE-1, and the Remote Leg is updated as well with the newly added media flow-B using the Remote Leg Update procedure as specified in clause 6a.1.2. After this, the new media flow-B will be established between the Controller UE-1 and the Remote Party.
- The IUT addition of media is completed.

### 6a.4.2 Controller UE initiated add new media on Controllee UE

#### 6a.4.2.1 Controller UE and Controllee UE belong to the same subscription

UE-1, UE-2 are engaged in a Collaborative Session established using procedures shown in clause 6a.2 for which UE-1 is the Controller UE and UE-2 is a Controllee UE, the following flows shows how the Controller UE-1 adds a media flow to Controllee UE-2 which could result in a new Access Leg for the Controllee UE-2, or it could be an additional media flow for an already existing session for the Controllee UE-2. The following information flow also applies to case in which UE-2 may not be part of Collaborative Session before the media addition. In this case, there is at least another Controllee UE involved in the Collaborative Session before the media addition, which is not shown in the information flow.

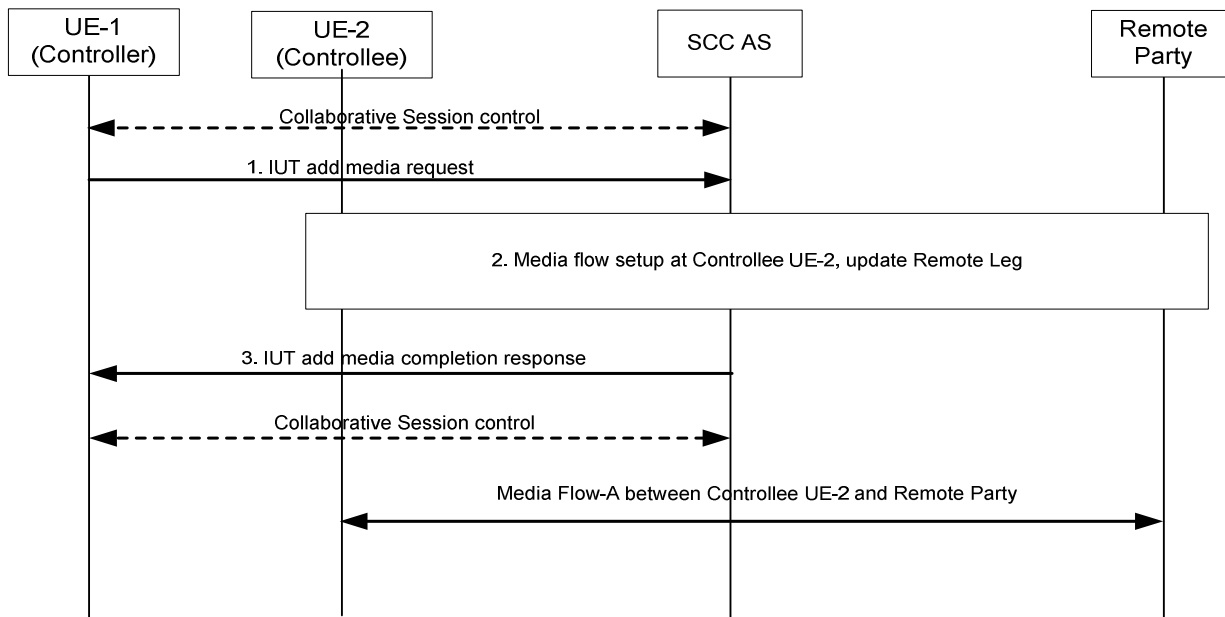
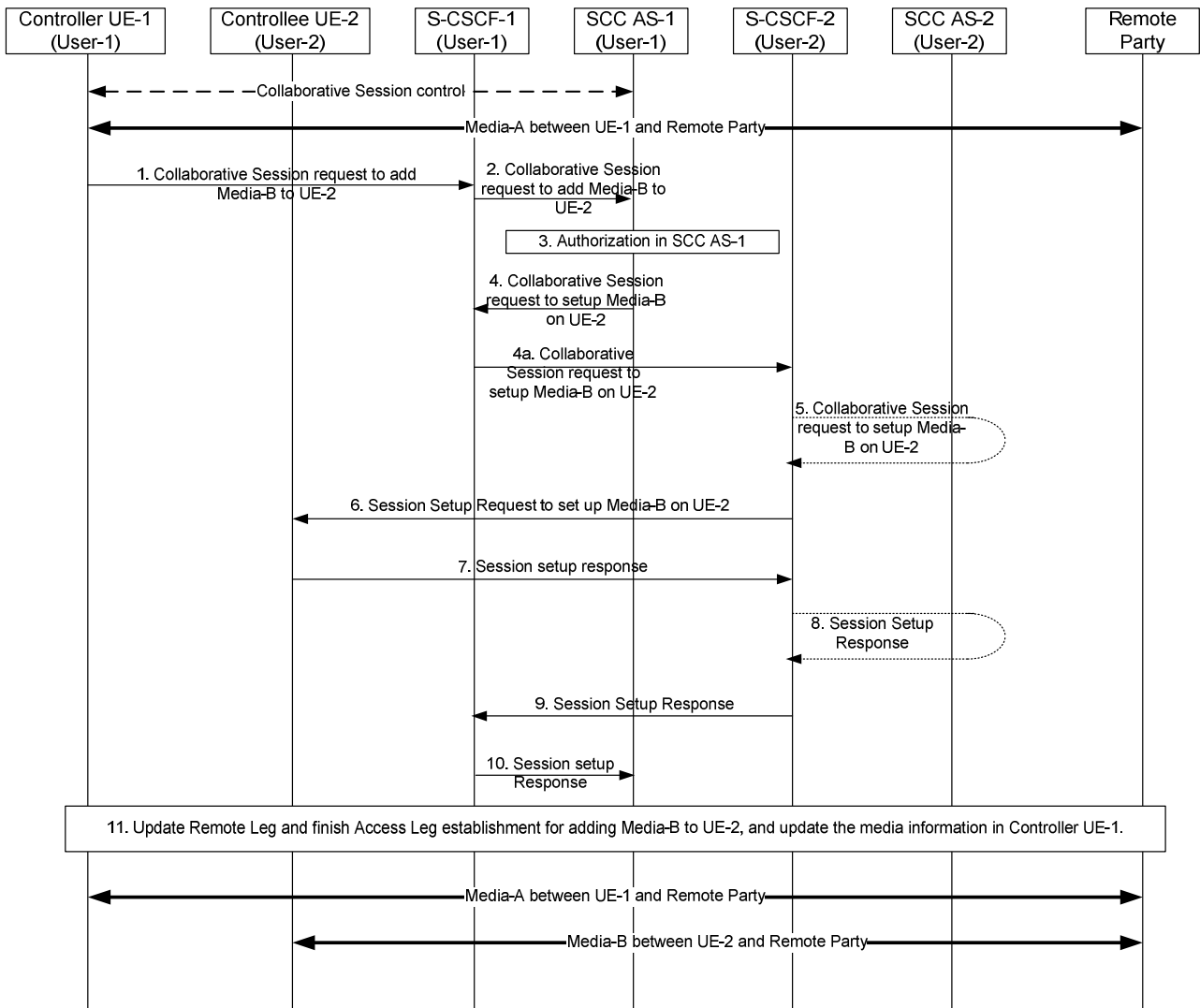

**Figure 6a.4.2.1-1: Controller UE initiated add new media on Controllee UE belonging to the same IMS subscription**

- 1 Controller UE-1 decides to add a new media flow to Controllee UE-2, and performs an IUT add media request for the particular media requested. The IUT add media request shall include enough information for the SCC AS to:
  - identify that the added media flow is Media Flow-A;
  - identify that the target of the added media flow is Controllee UE-2.
- 2 The SCC AS performs authorization as specified in clause 6a.12. Then, the new Media Flow-A is setup for Controllee UE-2. The Remote Leg is updated as well with the newly added media flow using the Remote Leg Update procedure as specified in clause 6a.1.2. After this, the new media flow will be established between Controllee UE-2 and the Remote Party.
3. The IUT addition of media is completed.

**6a.4.2.2 Controller UE and Controllee UE belong to different subscriptions**

The information flow below illustrates a scenario in which UE-1, the Controller UE of a Collaborative Session, invites a UE that belongs to a second user to participate in the Collaborative Session by adding a new media flow towards it; control of the Collaborative Session remains with UE-1.



**Figure 6a.4.2.2-1: Adding media by Controller UE to Controllee UE belonging to different IMS subscription**

There is Media-A between Controller UE-1 and remote party.

1. Controller UE-1 sends a request towards SCC AS-1 to add Media-B on UE-2, as part of the same Collaborative Session of Media-A. The request includes enough information for the network to:
  - identify that the added media flow is Media-B and the requested media type associated with Media-B (e.g. video);
  - identify that the target of the added media flow is UE-2.
2. S-CSCF-1 forwards the request to SCC AS-1.
3. SCC AS-1 authorizes the request from UE-1 as specified in clause 6a.12.
4. SCC AS-1 sends a request towards UE-2 for adding Media-B to Controllee UE-2. The request includes enough information for the network to:
  - identify the source of the request as UE-1;
  - identify the remote party;
  - identify that the added media flow is Media-B and the media type associated with Media-B (e.g., video);
  - identify that the source of the added media flow is Controller UE-1;

- identify that the target of the added media flow is Controllee UE-2.
- 4a. S-CSCF-1 forwards the request towards UE-2.
  5. If UE-2 is an IUT subscriber, the request is routed via SCC AS-2 which authorizes the request. SCC AS-2 notes that this request relates to the establishment of a Collaborative Session so that any requests by UE-2 related to this Collaborative Session will be forwarded back towards SCC AS-1. A Session Setup Request is then routed on towards UE-2. If UE-2 is not an IUT subscriber, S-CSCF-2 routes the request according to normal procedures.
  6. S-CSCF-2 forwards the Session Setup request towards UE-2.
  7. UE-2 sends a Session Setup response towards SCC AS-1. This request contains the full media description of Media-B.
  - 8 - 9. S-CSCF-2 routes the response back towards SCC AS-1 via SCC AS-2 if UE-2 is an IUT subscriber.
  10. S-CSCF-1 forwards the Session Setup response to SCC AS-1.
  11. SCC AS-1 updates Remote Leg and finishes Access Leg establishment for adding Media-B to UE-2, and updates the media information in Controller UE-1.

After the above operation, Media-B is established between Controllee UE-2 and remote party.

### 6a.4.3 Controller UE Initiated Release Media (media flow on the Controller UE)

The information flow shows the Controller UE releasing a media flow that is originated from the Controller UE. As a pre-requisite, there exists a Collaborative Session with two media flows, flow-A on the Controller UE (UE-1) and Flow-B on the Controllee UE (UE-2).

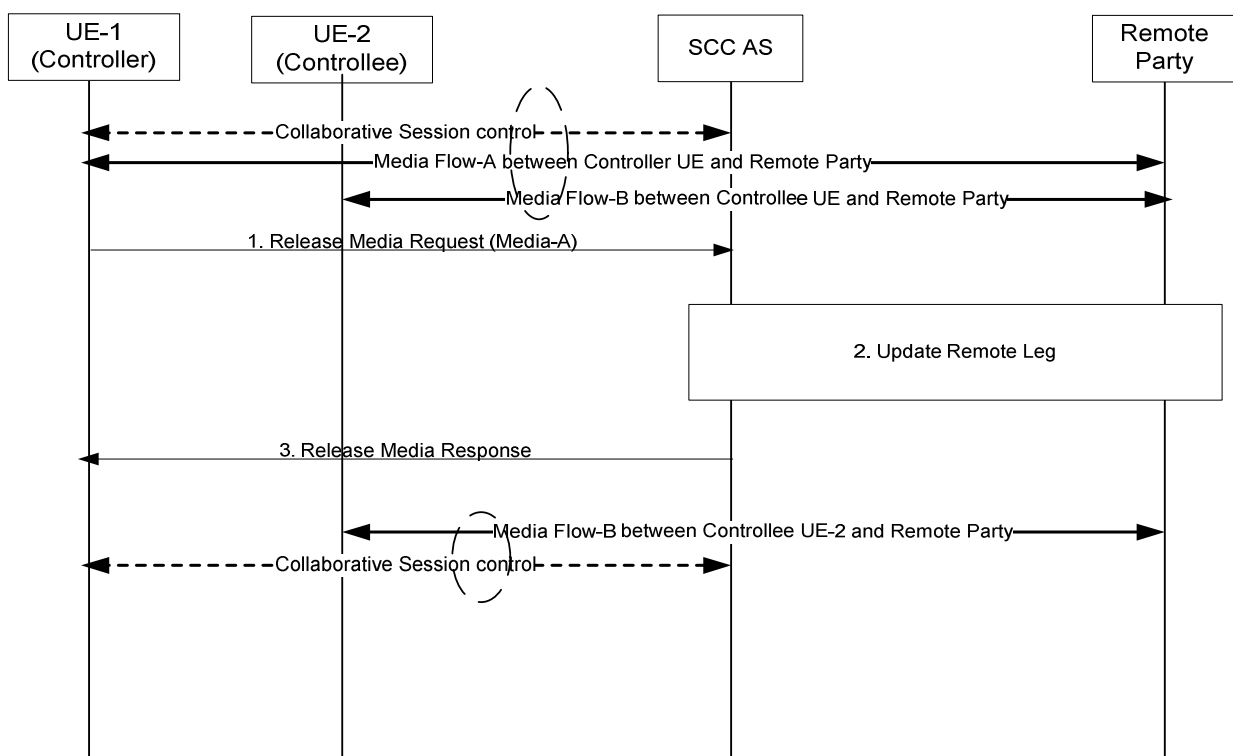

**Figure 6a.4.3-1: Controller UE Initiated Media release – media on Controller UE**

1. UE-1 sends a Release Media request to the SCC AS to remove Media-A from the Collaborative Session. The IUT media release request shall include enough information for the SCC AS to:
  - identify that the media is Media Flow-A;

- identify that the released media is on UE-1;
  - keep the control of Collaborative Session in UE-1.
2. The SCC AS updates the Remote Leg with media flow –A removed.
  3. The SCC AS sends release media response to UE-1. UE-1 releases media flow – A at its end.

The Collaborative Session continues to exist after the procedure is complete.

## 6a.4.4 Controller UE Initiated Release Media (media flow on the Controllee UE)

### 6a.4.4.1 Controller UE and Controllee UE belong to the same subscription

The information flow shows the Controller UE releasing a media flow from a Controllee UE. As a pre-requisite, there exists a Collaborative Session with two media flows, flow–A on the Controller UE (UE-1) and Flow–B on the Controllee UE (UE-2).

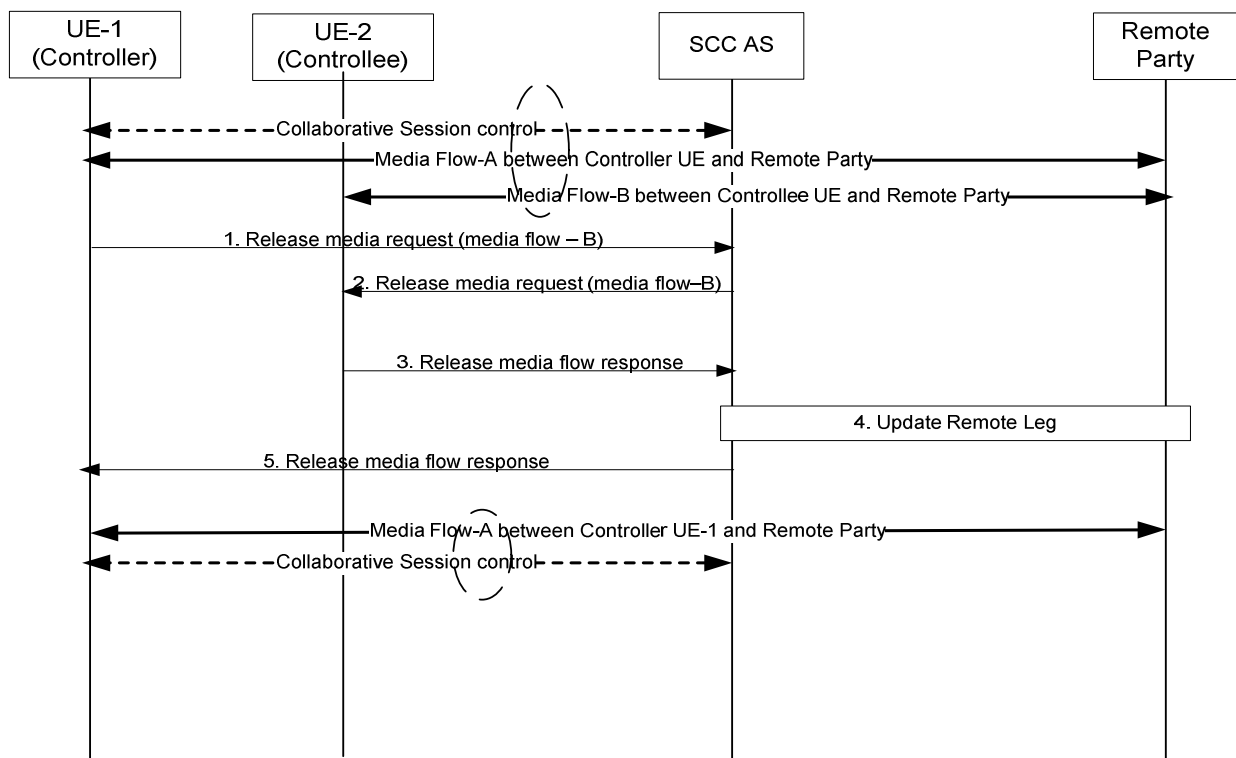

**Figure 6a.4.4.1-1: Controller UE Initiated Media release – media flow on Controllee UE (Controller and Controllee belong to the same IMS subscription)**

1. UE-1 sends a Release Media request to the SCC AS to remove Media-A from the Collaborative Session. The request includes the information pertaining to media flow -B:
  - identify that the released media is Media Flow-B;
  - identify that the released media is on UE-2;
  - keep the control of Collaborative Session in UE-1.
2. The SCC identifies media flow B as associated with UE-2 (controllee UE) and sends the Release Media Request to UE-2. The request identifies the media flow–B that needs to be removed and the media flow is removed. If no more media flows remain on UE-2 that are participating in the Collaborative Session, the SCC AS releases the access leg from UE-2.
3. UE-2 sends back Release Media response back to SCC AS.

4. The SCC AS updates the Remote Leg with media flow–B removed.

Step 2 and step 4 may be executed in any order.

5. The SCC AS sends release media response to UE-1.

If UE-2 has left the Collaborative Session at step 2 and no other Controllee UE remain in this Collaborative Session, this Collaborative Session becomes a normal IMS session.

### 6a.4.4.2 Controller UE and Controllee UE belong to different subscriptions

The following information flow shows the Controller UE releasing a media flow from the Controllee UE that belongs to different subscriptions. As a pre-requisite, there exists a Collaborative Session with two media flows, Media–A on the Controller UE (UE-1) and Media–B on the Controllee UE (UE-2). Furthermore, Controller UE and Controllee UE profiles are stored on different S-CSCFs, S-CSCF-1 and S-CSCF-2, respectively.

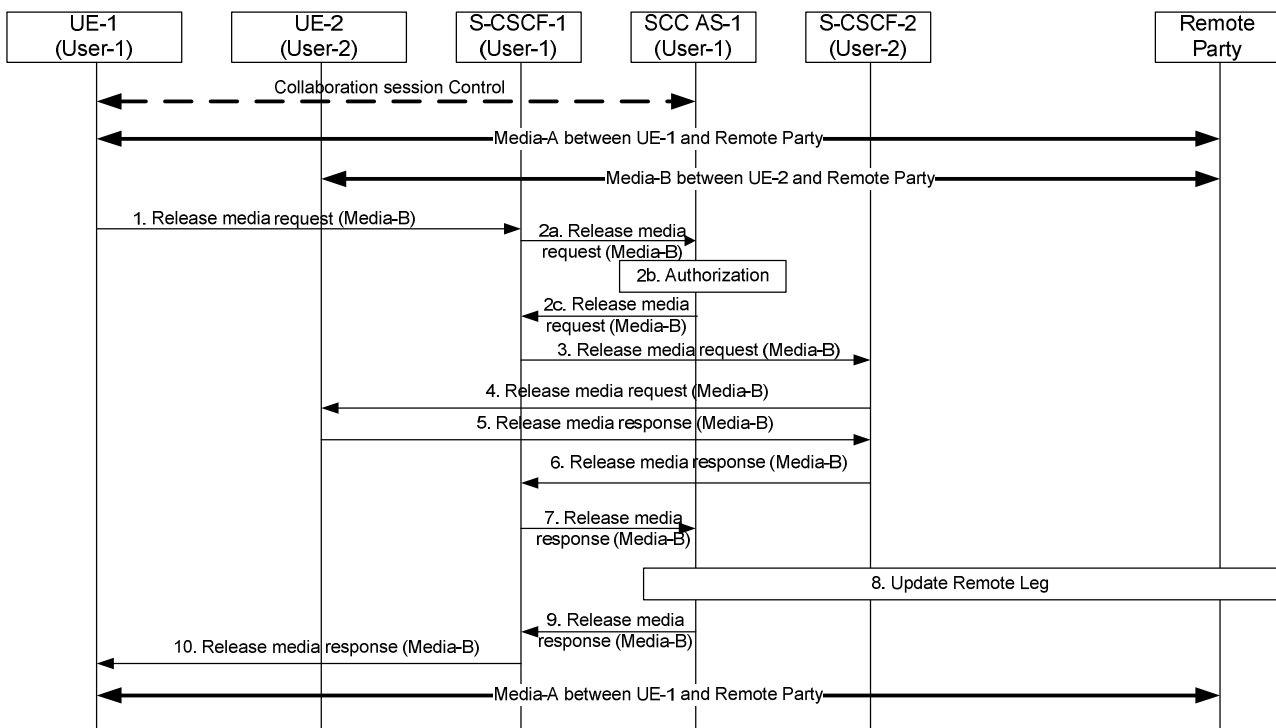

**Figure 6a.4.4.2-1: Controller initiated Release of media from Controllee UE (Controller and Controllee belong to different IMS subscriptions)**

1. Controller UE-1 sends a Release media request to SCC AS-1 to release Media-B on Controllee UE-2. The Collaborative Session request includes enough information for the network to:
  - identify that the media to be released is Media-B;
  - identify that the media to be held is on Controllee UE-2;
  - identify the session that contains of the media flow to be released;
  - keep the control of the Collaborative Session in Controller UE-1.
- 2a. S-CSCF-1 forwards the Release Media request to SCC AS-1.
- 2b. SCC AS-1 verifies that UE-1 is a Controller and therefore is authorized to release the media from a Controllee UE with a user belonging to another subscription.
- 2c. SCC AS-1 sends a Release Media request towards UE-2 to release Media-B on UE-2. The Collaborative Session request includes enough information for the network to:

- identify the source of the release media request as UE-1;
  - identify that the media flow to be released is Media-B;
  - identify that the source of the media flow to be released is Controllee UE-2.
3. S-CSCF-1 forwards the Release Media request towards S-CSCF-2.
  4. S-CSCF-2 forwards the Release Media Request towards the Controllee.
  5. Controllee UE-2 provides the Release Media Response to the S-CSCF-2.
  - 6-7. S-CSCF-2 forwards the Release Media Response to SCC-AS-1.
  8. The SCC AS-1 updates the remote leg of the collaborative session with Media-B released.
  - 9-10. The SCC AS-1 informs the Controller UE-1 via the S-CSCF-1 of successfully releasing Media-B from Controllee UE 2. Steps 9-10 could be performed in parallel to Step 10.

### 6a.4.4a Controller UE initiated modify media (media flow on the Controllee UE)

#### 6a.4.4a.1 Controller UE and Controllee UE belong to the same IMS subscription

The information flow shows a Controller UE modifying a Media Flow that is originated from or terminated at the Controllee UE belonging to the same IMS subscription. As a pre-requisite, there exists a Collaborative Session with two media flows, Media Flow-A on the Controller UE (UE-1) and Media Flow-B on the Controllee UE (UE-2). Controller UE-1 can initiate re-negotiation of media information of Controllee UE-2 with remote party.

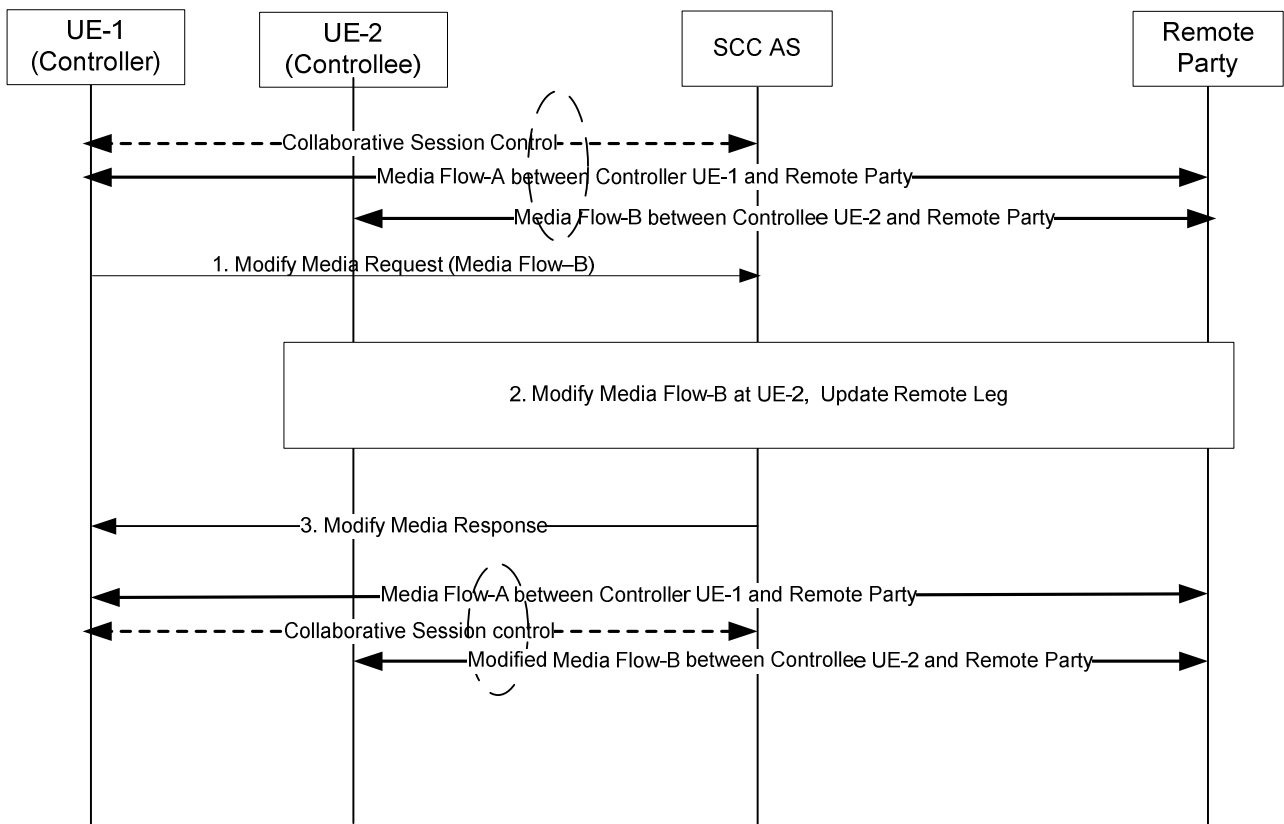
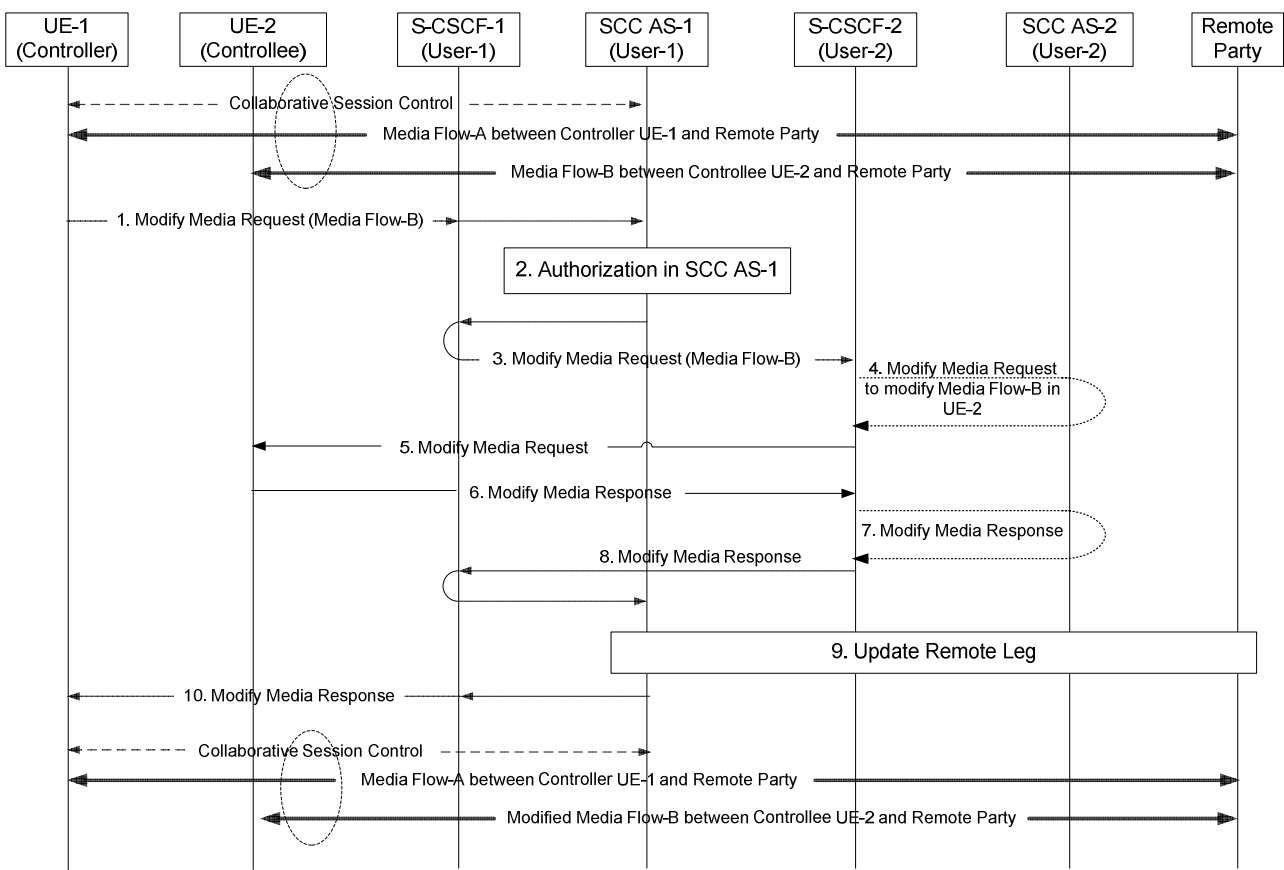

Figure 6a.4.4a.1-1: Controller UE initiated media modify on a Controllee UE belonging to the same IMS subscription

1. UE-1 sends a Modify Media Request to modify Media Flow-B on UE-2. The request includes media modification information pertaining to Media Flow-B. The IUT media modification request shall include enough information for the SCC AS to:
  - identify that the modified media is Media Flow-B;
  - identify that the modified media is on UE-2;
  - identify the modification requested to Media Flow-B;
  - keep the control of Collaborative Session in UE-1.
2. The SCC identifies Media Flow-B as associated with UE-2 and sends the Modify Media Request to UE-2. The request identifies the Media Flow-B that needs to be modified. UE-2 modifies the Media Flow-B. The SCC AS updates the Remote Leg with Media Flow-B modified.
3. The SCC AS sends Modify Media Response to UE-1.

### 6a.4.4a.2 Controller UE and Controllee UE belong to different IMS subscriptions under the same operator

The information flow shows a Controller UE modifying a Media Flow that is originated from or terminated at the Controllee UE belonging to different subscription. It is assumed that UE-1 and UE-2 belong to User-1 and User-2, respectively. As a pre-requisite, there exists a Collaborative Session with two media flows, Media Flow-A on the Controller UE (UE-1) and Media Flow-B on the Controllee UE (UE-2). Controller UE-1 can initiate re-negotiation of media information of Controllee UE-2 with remote party.



**Figure 6a.4.4a.2-1: Controller UE initiated media modify on a Controllee UE belonging to different IMS subscription**

1. UE-1 sends a Modify Media Request to SCC AS-1 serving UE-1 to modify Media Flow-B on UE-2. The request includes media modification information pertaining to Media Flow-B. The IUT media modification request shall include enough information for the SCC AS-1 to:



- identify that the modified media is Media Flow-B;
  - identify that the modified media is on UE-2;
  - identify the modification requested to Media Flow-B;
  - keep the control of Collaborative Session in UE-1.
2. The SCC AS-1 authorizes the request from UE-1 as specified in clause 6a.12.
  3. The SCC AS-1 sends the Modify Media Request to SCC AS-2 that serves UE-2 via S-CSCF-1 and S-CSCF-2.
  4. If UE-2 is an IUT subscriber, the request is routed via SCC AS-2 which authorizes the request. The Modify Media Request is then routed on towards UE-2. If UE-2 is not an IUT subscriber, S-CSCF-2 routes the request according to normal procedures.
  5. S-CSCF-2 forwards the Modify Media Request to UE-2. UE-2 modifies Media Flow-B.
  6. The UE-2 sends a Modify Media Response towards SCC AS-1.
  - 7 - 8. S-CSCF-2 routes the Modify Media Response back towards SCC AS-1 – via SCC AS-2 if UE-2 is an IUT subscriber.
  9. The SCC AS-1 updates the Remote Leg with Media Flow–B modified upon receiving the Modify Media Response from UE-2.
  10. The SCC AS-1 sends Modify Media Response to UE-1.

### 6a.4.5 Controllee UE initiated release media on itself

As per standard IMS UE behaviour, a Controllee UE may initiate a release of a media flow that it terminates. In this case, this media release on the access leg is notified to the Controller UE, which may decide to transfer this media flow to another UE under the same subscription, or to remove it from the Collaborative Session (i.e. remove it on the remote leg).

The following information flow shows a Controllee UE initiating the release of a media flow that it terminates, and Controller UE being informed of this release by the SCC AS. As a pre-requisite, there exists a Collaborative Session of which UE-1 is the Controller UE and UE-2 is a Controllee UE terminating a media flow, Media Flow A. There may be other media flows (on UE 1, UE-2 or other UEs) within the Collaborative Session; such media flows and UEs are not shown on this information flow; they shall not be impacted by this operation.

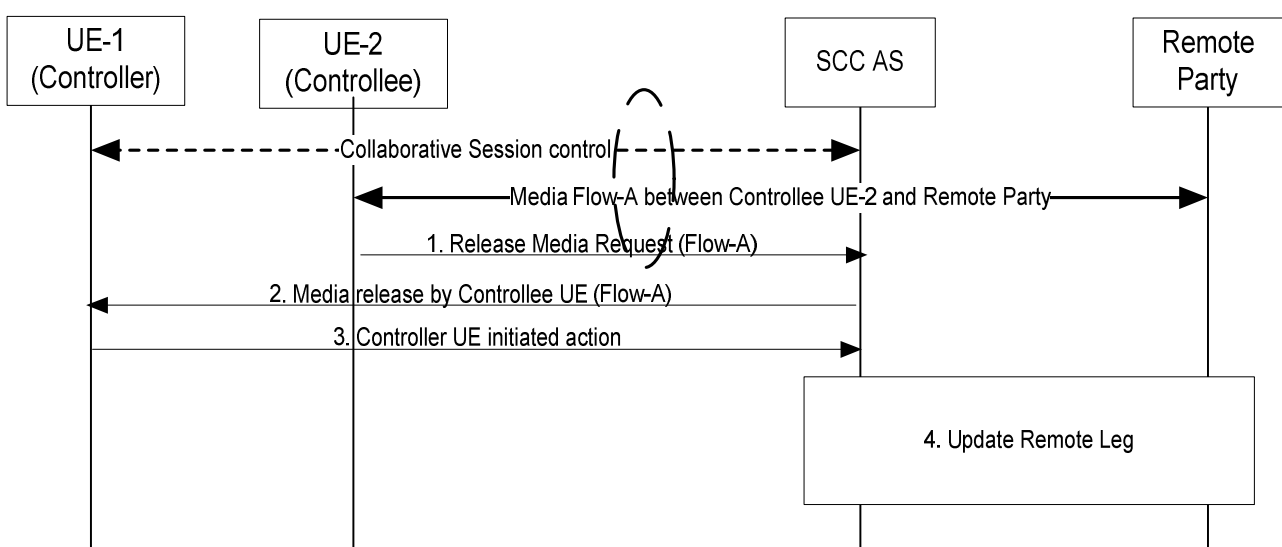

**Figure 6a.4.5-1: Controllee UE initiated release media flow on itself**

1. Controllee UE-2 sends a request to release Media Flow A (that it terminates), using standard IMS procedure.

2. The SCC AS identifies that Media Flow A is under Collaborative Session control of UE-1. The SCC AS indicates to Controller UE-1 that Controllee UE-2 has released Media Flow A.
3. Controller UE-1 initiates one of the following procedures, in order to transfer Media Flow A to another UE under the same subscription, or to remove it from the Collaborative Session:
  - Controller UE initiated media transfer from Controllee UE to Controller UE, specified in clause 6a.3.2;
  - Controller UE initiated media transfer from Controllee UE to another Controllee UE, specified in clause 6a.3.3;
  - Controller UE initiated release media (media flow on the Controllee UE), specified in clause 6a.4.3;
  - Controller UE initiated release Collaborative Session, specified in clause 6a.5.1.
4. The SCC AS updates the Remote Leg while executing the procedure initiated by Controller UE-1 at step 3.

### 6a.4.6 Controllee UE initiated modify media on itself

#### 6a.4.6.0 General

As per standard IMS UE behaviour, a Controllee UE may initiate a modification of a media flow that it terminates.

#### 6a.4.6.1 Controller UE and Controllee UE belong to the same IMS subscription

The following information flow shows a Controllee UE initiating the modification of a media flow that it terminates. As a pre-requisite, there exists a Collaborative Session of which UE-1 is the Controller UE and UE-2 is a Controllee UE terminating a media flow, Media Flow A. There may be other media flows (on UE-1, UE-2 or other UEs) within the Collaborative Session; such media flows and UEs are not shown on this information flow; they shall not be impacted by this operation.

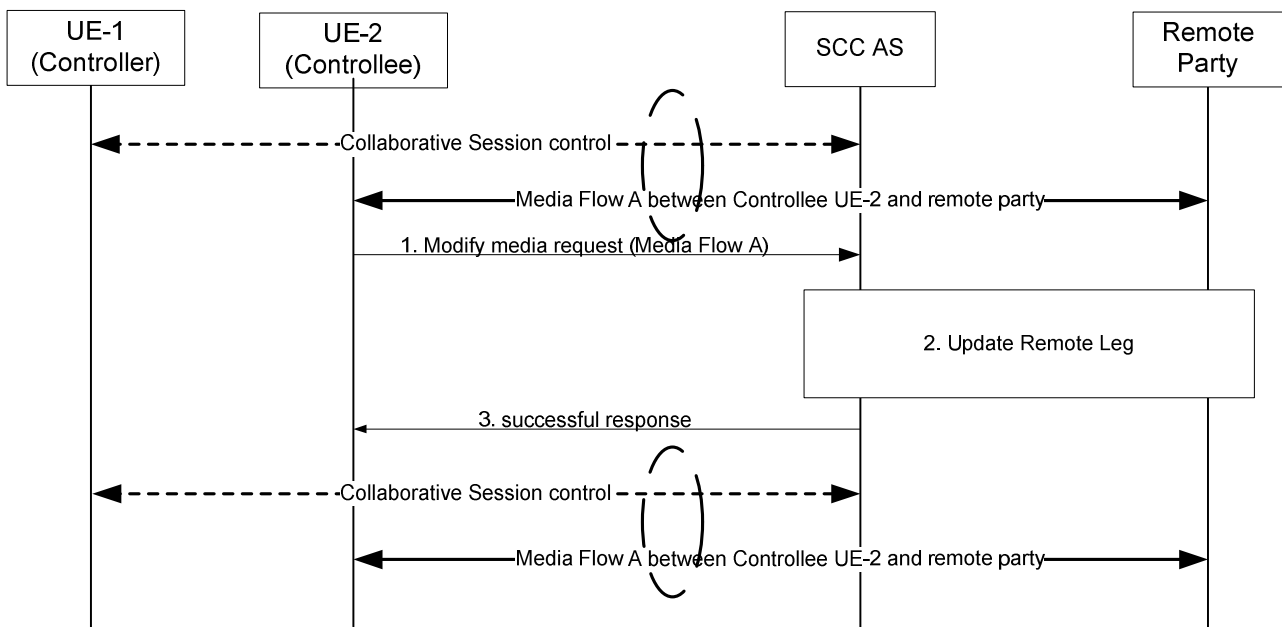

**Figure 6a.4.6.1-1: Controllee UE initiated modify media flow on itself (same IMS subscription)**

1. Controllee UE-2 sends a request to modify the characteristics of Media Flow-A (that it terminates), using standard IMS procedure.
2. The SCC AS updates the Remote Leg for allowed media changes, providing the new media flow characteristics from UE-2.

3. The SCC AS sends a successful response to the request sent by UE-2 at step 1.

### 6a.4.6.2 Controller UE and Controllee UE belong different IMS subscriptions under the same operator

The information flow shows a Controllee UE modifying a Media Flow that is originated from or terminated at the same Controllee UE. As a pre-requisite, there exists a Collaborative Session with two media flows, Media Flow-A on the Controller UE (UE-1) and Media Flow-B on the Controllee UE (UE-2).

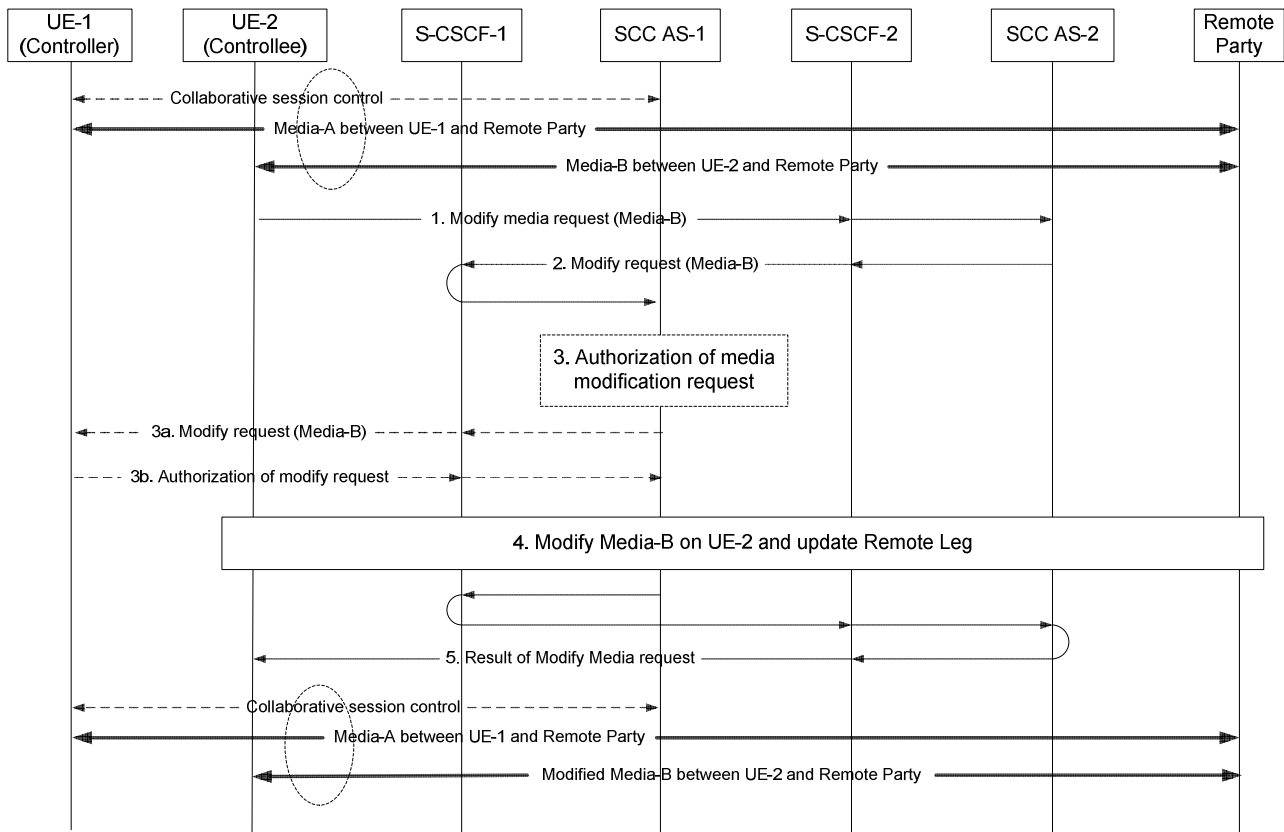

**Figure 6a.4.6.2-1: Controllee UE initiated media modify on itself (different IMS subscriptions under the same operator)**

1. UE-2 sends a Modify media request to modify Media Flow-B on itself. The request includes media modification information pertaining to Media Flow-B. The IUT media modification request shall include enough information for the SCC AS to:
  - identify that the modified media is Media Flow-B;
  - identify that the modified media is on UE-2; and
  - identify the modification requested to Media Flow-B.

2. The SCC AS-2 forwards the Media Modification Request to SCC AS-1 that serves the controller via S-CSCF-2 and S-CSCF-1.

3. The SCC AS-1 authorizes the Media Modification Request as specified in clause 6a.12.

3a~3b. If SCC AS-1 cannot authorize Media Modification Request, it queries controller UE-1 for authorization.

NOTE: Steps 3 (including 3a~3b) is optional depending on operator's configuration.

4. SCC AS-1 identifies Media Flow-B as associated with UE-2 and sends Modify Media Request to UE-2 via S-CSCF-1 and S-CSCF-2. UE-2 modifies the Media Flow. The SCC AS-1 updates the Remote Leg with Media Flow-B modified.

5. The SCC AS-1 sends result of modify media request to UE-2.

### 6a.4.6a Controllee UE initiated add new media on another Controllee UE

This information flow shows the Controllee UE-2 adding a media flow to another Controllee (UE-3). As a pre-requisite, there exists a Collaborative Session with a media flow, Media-A, on the Controllee UE (UE-2). UE-3 might or might not be part of the Collaborative Session before the media addition. Furthermore, Controller UE 1 and Controllee UE-2 profiles are served by different IUT SCC AS: SCC AS-1 and SCC AS-2, which are in turn attached to S-CSCF-1 and S-CSCF-2 respectively. For simplicity, these S-CSCFs are not shown in the following figure.

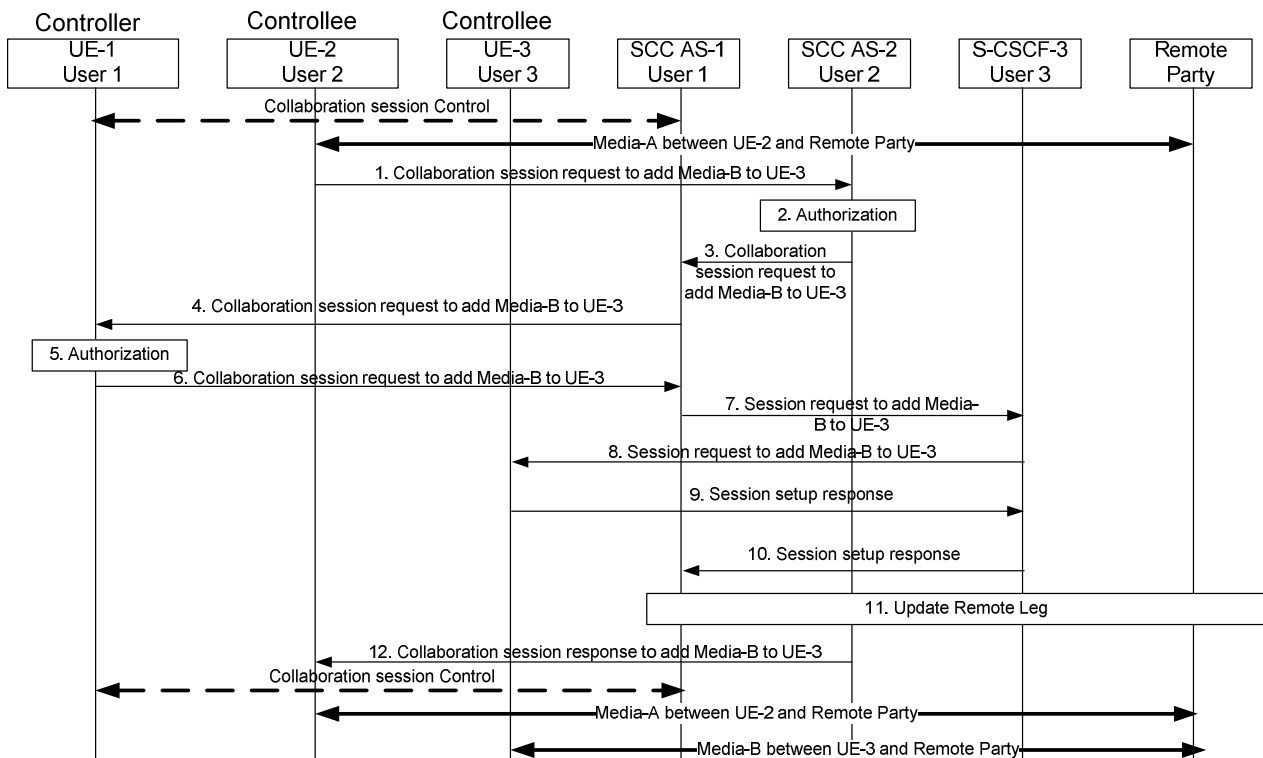

**Figure 6a.4.6a-1: Controllee initiated addition of media to another Controllee UE (Controller and Controllees belong to different IMS subscriptions)**

1. UE-2 sends a Collaborative session request to SCC AS-2 to add Media-B to UE-3. The Collaborative Session request includes enough information for the network to:
  - identify that the media to be added is Media-B;
  - identify that the target for the media to be added to is UE-3;
  - identify the session that contains of the media flow to be added;
  - Controller of the Collaborative Session is UE-1.
2. SCC AS-2 authorizes the request from UE-2 as specified in clause 6a.12 and identifies that the session is a Collaborative Session anchored at SCC AS-1.
3. SCC AS-2 then forwards the Collaborative session request to SCC AS-1 which is the SCC AS for the Controller UE in order to add Media-B to UE-3.
- 4-6. SCC AS-1 sends a Collaborative session request to the Controller UE-1, and the Controller UE-1 authorizes the media addition request.

NOTE 1: SCC AS-1 may be configured to authorize the request on behalf of UE-1.

7. SCC AS-1 sends Session request to add Media-B to UE-3 via S-CSCF-3. The Session request includes enough information for the network to:
  - identify the source of the addition request as UE-1;
  - identify the remote party;
  - identify that the media flow to be added is Media-B;
  - identify that the target of the media flow to be added is UE-3;
8. S-CSCF-3 forwards the Session request to UE-3.
9. UE-3 sends a Session response to S-CSCF-3.
10. S-CSCF-3 forwards Session response to SCC AS-1.
11. SCC AS-1 updates remote leg with Remote Leg Update Procedure.
12. SCC AS-2 sends the Collaborative session response to UE-2.

When the Inter-UE Transfer is completed, UE-1 keeps the Collaborative Session Control.

### 6a.4.7 Remote party initiated add new media

The following is an example of an information flow where remote party wants to modify an existing session with UE-1 to add Media Flow-B. In this information flow, UE-1 and UE-2 belong to the same user subscription. UE-1 is the Controller UE and UE-2 is a Controllee UE. If UE-2 is not involved in the Collaborative Session controlled by UE-1 before the media addition, there is at least another Controllee UE involved in the Collaborative Session before the media addition which is not shown in the information flow.

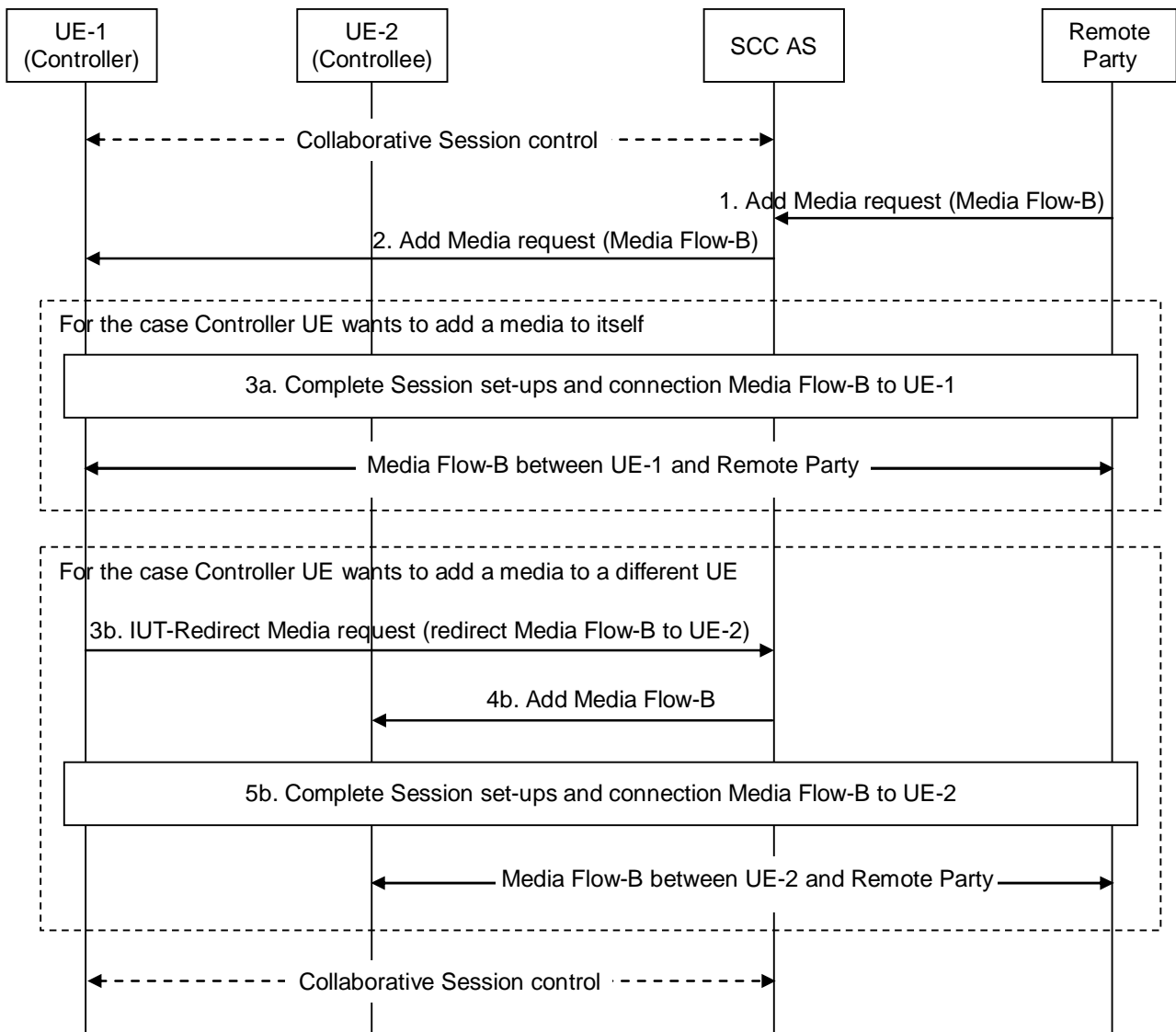

**Figure 6a.4.7-1: Remote party initiated add new media**

1. Remote party sends an Add Media request to add Media Flow-B to an existing session between UE-1 and remote party as per TS 23.228 [4].
2. SCC AS forwards the Add Media request to UE-1 according to the procedures defined in TS 23.228 [4].

Step 3a is for the case Controller UE wants to add Media Flow-B to itself.

- 3a. The session setup is completed. The new Media Flow-B will after this be established between UE-1 and remote party, and be involved in the Collaborative Session controlled by UE-1.

Steps 3b and 5b are for the case Controller UE wants to add Media Flow-B to a different UE while retaining control for the added media.

- 3b. Controller UE-1 sends an IUT-Redirect-Media request to SCC AS. The IUT-Redirect-Media request needs to include at least the following information:

- identify that Media Flow-B needs to be redirected to UE-2.

- 4b. SCC AS performs authorization as specified in clause 6a.12, then sends an Add Media Flow-B to UE-2.

- 5b. The session setup is completed. When the add media operation is completed, there is Media Flow-B between UE-2 and remote party. There is a Collaborative Session established between UE-1 and UE-2. The Media-B is controlled by UE-1.

NOTE 1: If UE-2 was not involved in the Collaborative Session controlled by UE-1 before the media addition, UE-2 becomes a Controllee UE when the media addition is completed.

NOTE 2: If remote party wants to add more than one media flows to an existing session, these media flows can be distributed to several different UEs by repeating the above steps 3b-5b.

### 6a.4.8 Remote party initiated release media

The following is an example of an information flow where remote party wants to remove one of media flows, Media Flow-B from an ongoing session. In this information flow, UE-1 and UE-2 belong to the same user subscription. UE-1 is a Controller UE and UE-2 is a Controllee UE.

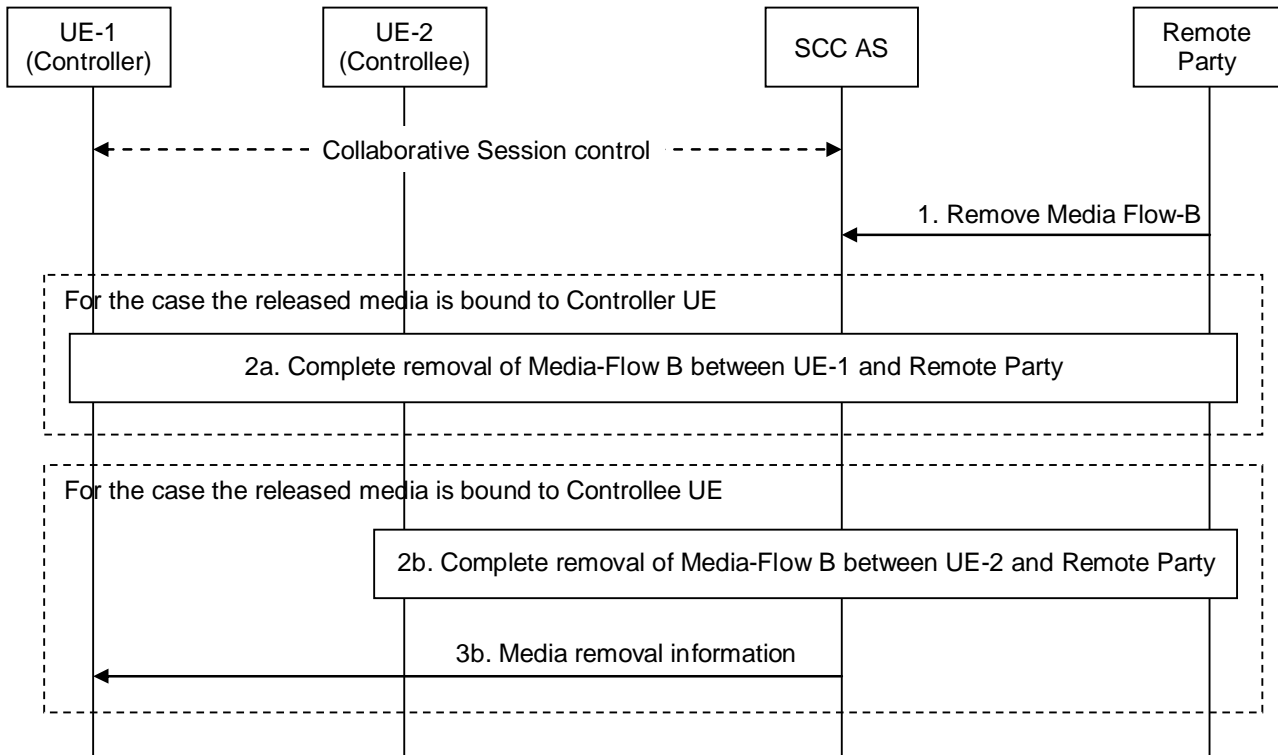

**Figure 6a.4.8-1: Remote party initiated release media**

1. Remote party uses standard IMS procedures defined in TS 23.228 [4] to remove Media Flow-B from the session.

Step 2a is for the case the released media is bound to Controller UE.

2a. The removal of Media Flow-B between Controller UE-1 and remote party is completed.

Steps 2b and 3b are for the case the released media is bound to Controllee UE.

2b. The removal of Media Flow-B between Controllee UE-2 and remote party is completed.

NOTE 1: If no more media remains on the Access Leg between SCC AS and Controllee UE-2, this Access Leg is released and Controllee UE-2 will no longer be part of the Collaborative Session.

3b. SCC AS informs Controller UE-1 that the Media Flow-B on UE-2 was removed.

NOTE 2: If no more Controllee UE remains after the media removal, the Collaborative Session is terminated and there will be a general IMS session between UE-1 and remote party.

## 6a.4.9 Remote party initiated media modification

A Collaborative Session is already established using procedures shown in clause 6a.2. The following is an example of an information flow where remote party wants to modify one of media flows, Media Flow-B from an ongoing session. In this information flow, UE-1 and UE-2 belong to the same user subscription. UE-1 is a Controller UE and UE-2 is a Controllee UE.

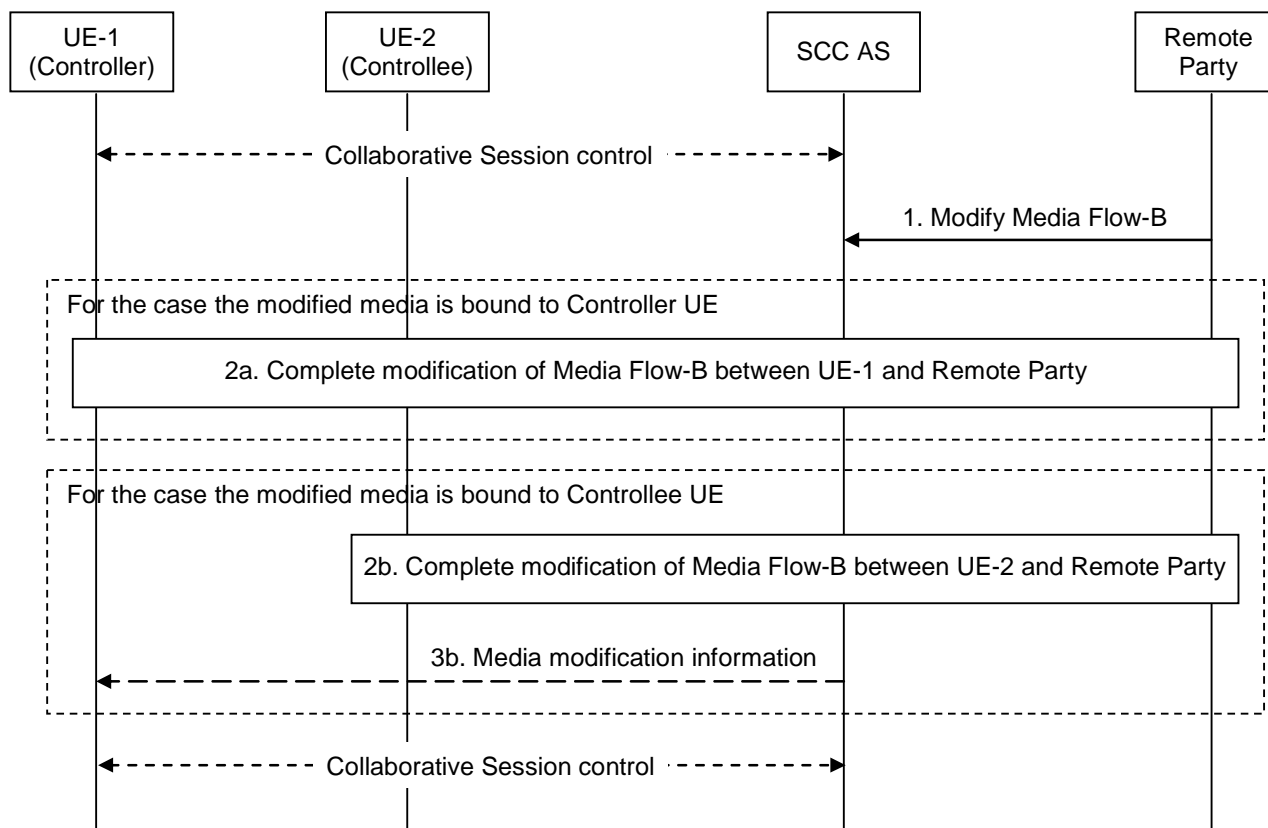

**Figure 6a.4.9-1: Remote party initiated media modification**

1. Remote party uses standard IMS procedures defined in TS 23.228 [4] to modify Media Flow-B from the session.

Step 2a is for the case the modified media is bound to Controller UE.

2a. The modification of Media Flow-B between Controller UE-1 and remote party is completed.

Steps 2b – 3b are for the case the modified media is bound to Controllee UE.

2b. The modification of Media Flow-B between Controllee UE-2 and remote party is completed.

3b. If the media modification is hold or resume, SCC AS informs Controller UE-1 that the Media Flow-B on UE-2 was modified.

## 6a.4a Transfer of Collaborative Session Control

### 6a.4a.1 Controller UE transfers Collaborative Session Control to a Controllee UE without Media Transfer

UE-1 and UE-2 are involved in a Collaborative Session with a remote party. The Collaborative Session is anchored at the SCC AS. UE-1 is the Controller UE of the Collaborative Session. UE-1 wishes to transfer the Collaborative Session Control to UE-2. The media flows to UE-1 and UE-2 from the remote party remain unaffected. The following information flow shows this procedure.



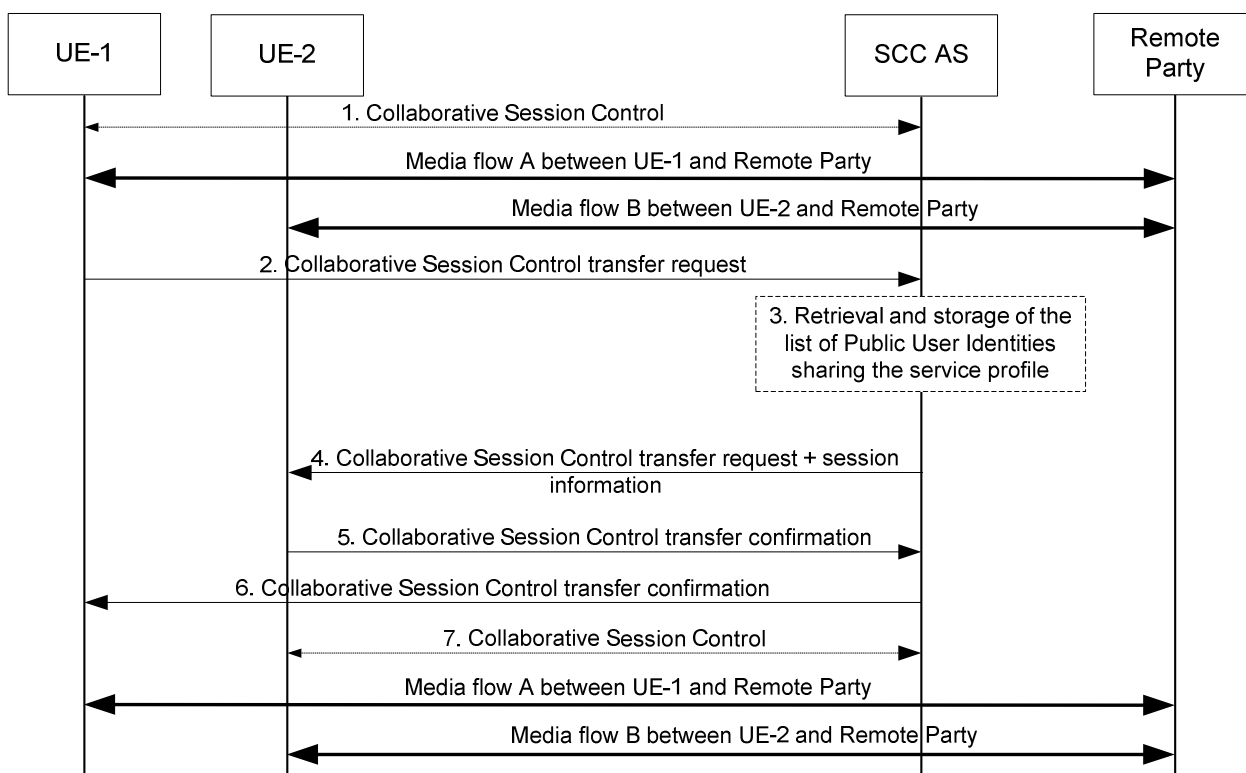
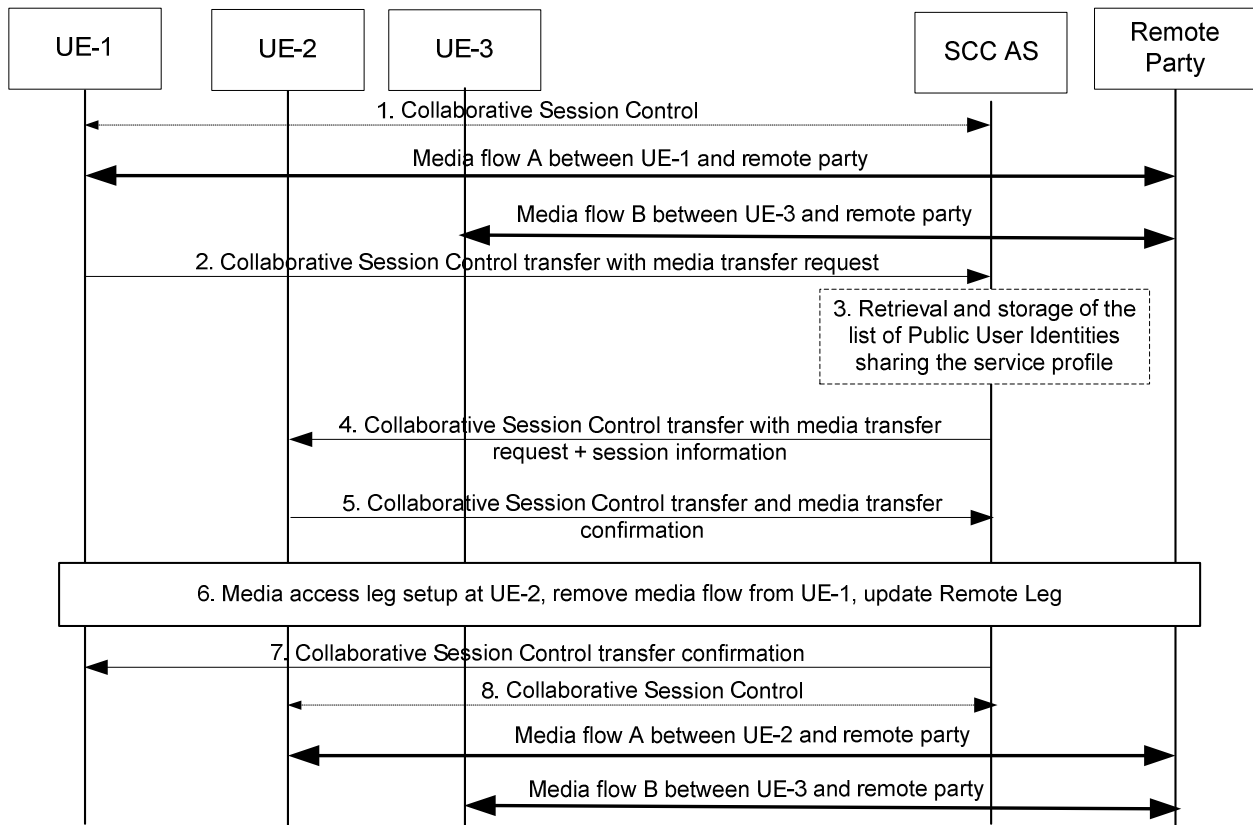

**Figure 6a.4a.1 -1: Controller UE initiated transfer of Collaborative Session Control**

1. A Collaborative Session is established between UE-1 and UE-2 and a remote party with UE-1 acting as the Controller UE and UE-2 acting as a Controllee UE. Each UE has a media flow with the remote party.
2. UE-1 wishes to transfer the Collaborative Session Control to UE-2. However, none of the existing media flows are affected. UE-1 sends a Collaborative Session Control transfer request to the SCC AS to relinquish Collaborative Session Control. This request includes a registered Public User Identity or public GRUU of UE-2.
3. If the SCC AS does not have the list of Public User Identities that share the service profile with the Public User Identity used by UE-1 for the Collaborative Session, the SCC AS retrieves this information. If the Collaborative Session Control transfer request indicates that UE-2 has the same Public User Identity (but different public GRUU) as UE-1, this step is skipped.
4. The SCC AS performs authorization as specified in clause 6a.12, ensures that UE-2 can act as the Controller UE for this Collaborative Session, and that the Public User Identity used by UE-2 shares the service profile with the Public User Identity used by UE-1 for the Collaborative Session. The SCC AS then sends a message to UE-2 requesting UE-2 to assume the role of Controller UE for this on-going Collaborative Session. Included in the request to UE-2 is session information associated with the Collaborative Session that UE-2 is requested to assume the role of Controller UE for.
5. UE-2 accepts the role of Controller UE for this Collaborative Session and indicates its acceptance to the SCC AS.
6. The SCC AS in turn provides an acknowledgement to UE-1 confirming that UE-2 is the new Controller UE for the Collaborative Session, and removes Collaborative Session Control from UE-1.
7. UE-2 has become the Controller UE and UE-1 has become a Controllee UE.

## 6a.4a.2 Controller UE transfers Collaborative Session Control to another UE with Media Transfer

UE-1 and UE-3 are involved in a Collaborative Session with a remote party. The Collaborative Session is anchored at the SCC AS. UE-1 is the Controller UE of the Collaborative Session. UE-1 wishes to transfer the Collaborative Session Control to UE-2 along with the media flow on UE-1. The media flow to UE-3 from the remote party remains unaffected. Following is an information flow for this procedure.



**Figure 6a.4a.2-1: Controller UE initiated transfer of Collaborative Session Control with transfer of media flow**

1. A Collaborative Session is established between UE-1 and UE-3 and a remote party with UE-1 acting as the Controller UE and the UE-3 acting as a Controllee UE. Each UE has a media flow with the remote party.
2. UE-1 wishes to transfer the Collaborative Session Control along with media flow A to UE-2. UE-1 sends a request to SCC AS to transfer media flow A and relinquish Collaborative Session Control. This request includes a registered Public User Identity or public GRUU of UE-2.
3. If the SCC AS does not have the list of Public User Identities that share the service profile with the Public User Identity used by UE-1 for the Collaborative Session, the SCC AS retrieves this information. If the Collaborative Session Control transfer request indicates that UE-2 has the same Public User Identity (but different public GRUU) with UE-1, this step is skipped.
4. The SCC AS performs authorization as specified in clause 6a.12, ensures that UE-2 can act as the Controller UE for this Collaborative Session, and that the Public User Identity used by UE-2 shares the service profile with the Public User Identity used by UE-1 for the Collaborative Session. The SCC-AS then sends a message to UE-2 requesting UE-2 to transfer media flow A and assume the role of Controller UE for this on-going Collaborative Session. Included in the request to UE-2 is session information associated with the Collaborative Session that UE-2 is requested to assume the role of Controller UE for.
5. UE-2 accepts transfer of media flow A and accepts the role of Controller UE for this Collaborative Session and indicates its acceptance to the SCC AS.

6. The SCC AS removes media flow A from UE-1, and updates the Remote Leg using the Remote Leg Update procedure as specified in clause 6a.1.2.
7. SCC AS in turn provides an acknowledgement to UE-1 confirming that UE-2 has accepted the media transfer and is the new Controller UE for the Collaborative Session.
8. UE-2 has become the Controller UE and UE-1 has become the Controllee UE and media flow A is now transferred to UE-2. If there is no media flow remaining on UE-1, UE-1 is released from the Collaborative Session.

### 6a.4a.3 Transfer of Collaborative Session Control upon loss of Controller UE

The Controller UE can lose the Collaborative Session Control as a result of, for example, losing underlying network connectivity. The figure below shows an information flow where the SCC AS has pre-configured Collaborative Session Control loss preferences, and acts upon the loss of Collaborative Session Control based on these preferences. There is no media on UE-1.

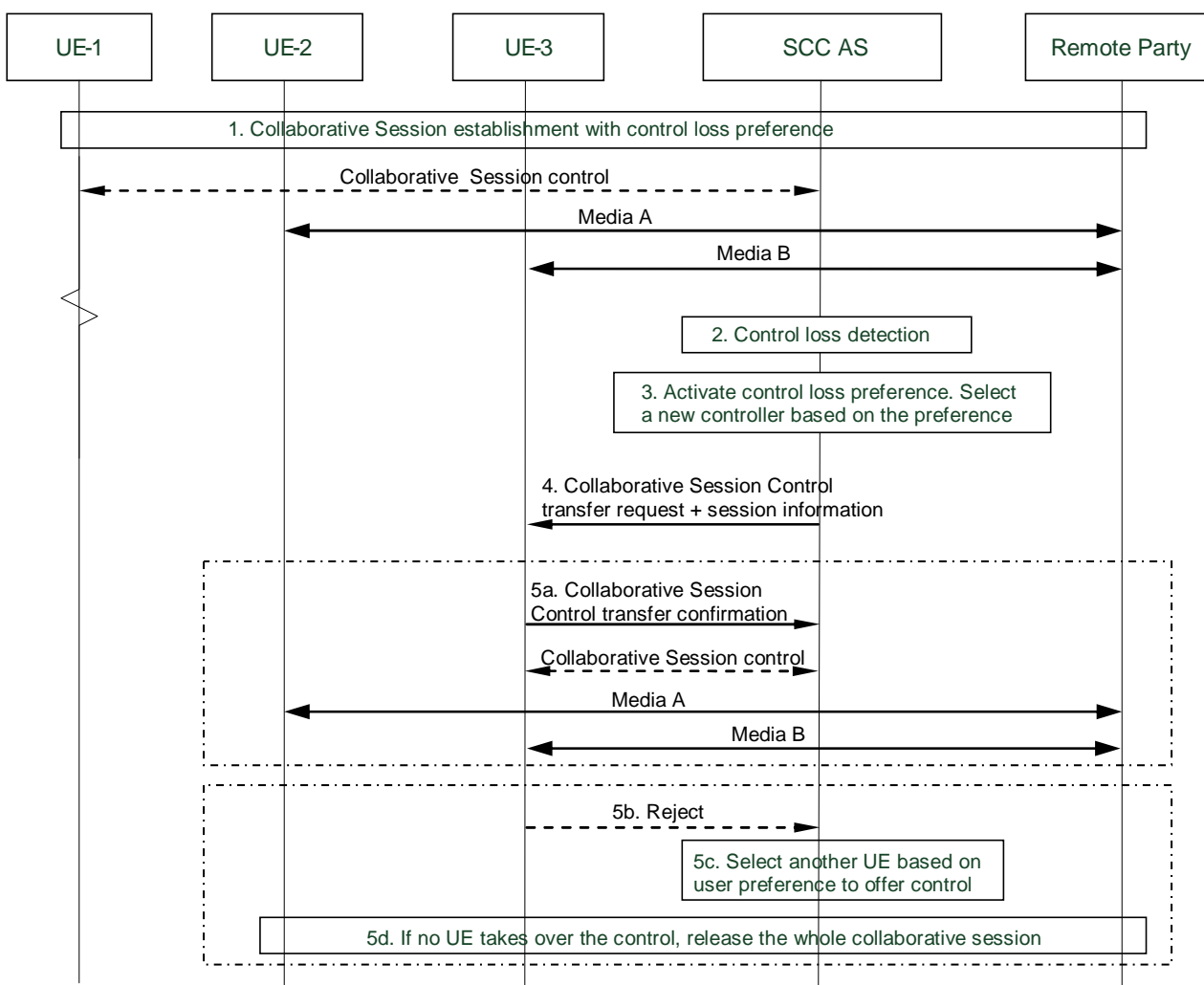

**Figure 6a.4a.3-1: Collaborative Session handling upon loss of Collaborative Session Control**

1. A Collaborative Session is established between UE-1, UE-2, UE-3 and a remote party. UE-1 is the Controller UE, and UE-2 and UE-3 are Controllee UEs. Collaborative Session Control loss preference is sent/updated to SCC AS at any time before or during the Collaborative Session, including:
  - the Public User Identity/ies or public GRUUs of the UE(s) which may be the successive Controller UE (in priority order), or
  - criteria on how to select the successive Controller UE.

NOTE 1: When the successive Controller UE is selected, the SCC AS ensures that this UE can act as the Controller UE for this Collaborative Session, and that the Public User Identity it uses shares the service profile with the Public User Identity used by UE-1 for the Collaborative Session, by performing step 3 of Figure 6a.4a.2-1 if necessary.

2. The SCC AS detects that the Collaborative Session Control has been lost during the session.

NOTE 2: How the SCC AS detects the loss of Collaborative Session Control is not within the scope of this document.

3. The loss of Collaborative Session Control triggers the activation of Collaborative Session Control loss preference. SCC AS performs authorization as specified in clause 6a.12, then selects a Controllee UE as the new Controller UE based on Collaborative Session Control loss preference.

NOTE 3: If no Collaborative Session Control loss preference is provided, SCC AS releases the Collaborative Session.

4. SCC AS offers Collaborative Session Control to the selected Controllee UE, UE-3. Included in the request to UE-3 is session information associated with the Collaborative Session that UE-3 is requested to assume the role of Controller UE for.

Step 5a is for the case where UE-3 accepts to become Controller UE.

5a. The Controllee UE-3 accepts the offer to become the new Controller UE.

Steps 5b-5d are for the case that the Controllee UE refuses to be a new Controller UE.

5b. Control transfer is not accepted by the Controllee UE.

NOTE 4: The Controllee UE may reject the offer because its user does not want to take over control, or the UE may not understand the transfer request; or the UE may not respond.

5c. If there is other candidate Controller UEs to which Collaborative Session control could be but has not yet been offered, the SCC AS offers them control of the collaborative session (repeat step 4) according to their priority order in user preference.

5d. If no candidate Controller UE accepts to take over the control of the collaborative session, SCC AS releases the Collaborative Session associated with lost Controller UE as specified in steps 2 to 4 of clause 6a.5.1.

## 6a.4a.4 Transfer of Collaborative Session Control with media flows upon loss of Controller UE

If the Collaborative Session Control is lost in the Controller UE and there was/were media flow(s) as part of the Collaborative Session in the old Controller UE, the media flow(s) may be transferred together with the Collaborative Session Control to the new Controller UE based on user preferences.

Figure 6a.4a.3a-1 shows an information flow of transferring the Collaborative Session Control with the media flows upon loss of the Controller UE. A Collaborative Session is established between UE-1, UE-2, UE-3 and the remote party. UE-1 is the Controller UE, and UE-2 and UE-3 are Controllee UEs. Media Flow-A, Media Flow-B and Media Flow-C are established respectively between UE-1, UE-2, UE-3 and the Remote Party.

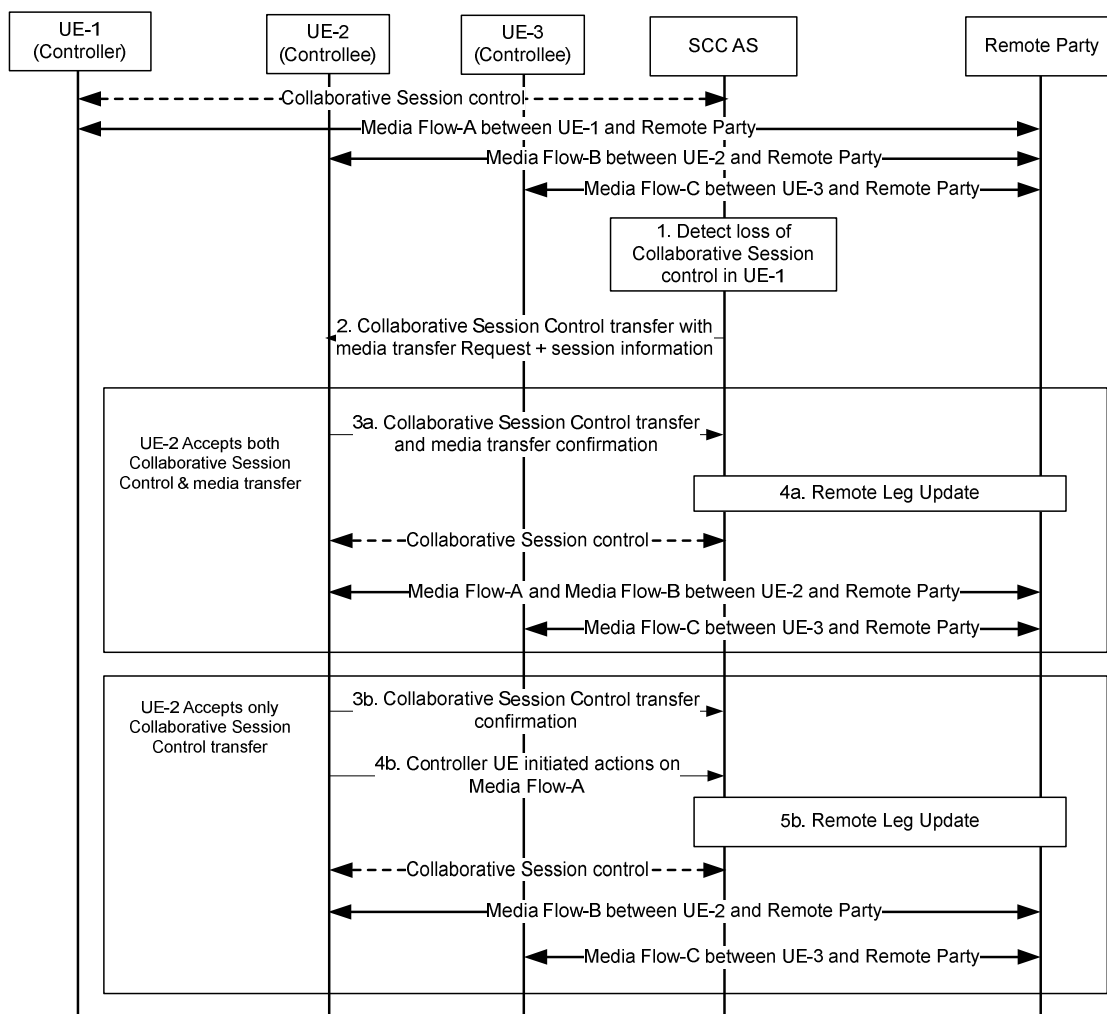

**Figure 6a.4a.3a-1: Transfer of Collaborative Session Control with media flow(s) upon loss of Collaborative Session control**

1. The SCC AS detects the loss of Controller UE-1.
2. Based on user preferences, the SCC AS performs authorization as specified in clause 6a.12, then sends a Collaborative Session Control transfer with media transfer request to Controllee UE-2, which is capable of being a Controller UE and has a Public User Identity sharing the same service profile with UE-1. The request indicates the Collaborative Session Control and Media Flow-A are to be transferred to UE-2 due to loss of Controller UE-1. Included in the request to UE-2 is session information associated with the Collaborative Session that UE-2 is requested to assume the role of Controller UE for.

Steps 3a - 4a are for the case of UE-2 accepting both the Collaborative Session Control and media transfer:

- 3a. UE-2 accepts the role of Collaborative Session Controller UE as well as the transfer of Media Flow-A, and sends a Collaborative Session Control transfer and media transfer confirmation to the SCC AS.
- 4a. The SCC AS performs Remote Leg Update procedure towards the remote party as specified in clause 6a.1.2.

Steps 3b - 5b are for the case of UE-2 accepting only the Collaborative Session Control transfer:

- 3b. UE-2 only accepts the role of Collaborative Session Controller UE, and sends a Collaborative Session Control transfer confirmation to the SCC AS.
- 4b. UE-2, the new Controller UE, initiates one of the following procedures, in order to transfer Media Flow-A to another UE, or to remove it from the Collaborative Session:

- Controller UE initiated media transfer from Controllee UE to another Controllee UE, specified in clause 6a.3.3;
- Controller UE initiated release media (media flow on the Controllee UE), specified in clause 6a.4.4;
- Controller UE initiated release Collaborative Session, specified in clause 6a.5.1.

5b. The SCC AS performs Remote Leg Update procedure towards the remote party as specified in clause 6a.1.2.

### 6a.4a.5 Transfer of Collaborative Session Control initiated by the target UE

UE-1 and UE-2 are involved in a Collaborative Session with a remote party. The Collaborative Session is anchored at the SCC AS. UE-1 is the Controller UE of the Collaborative Session. UE-2 wishes to transfer the Collaborative Session Control from UE-1 to itself. The media flows to UE-1 and UE-2 from the remote party remain unaffected. The following information flow shows this procedure. If UE-2 is not involved in the Collaborative Session controlled by UE-1 before the transfer of Collaborative Session Control, there is at least another Controllee UE involved in the Collaborative Session before the transfer of Collaborative Session Control, which is not shown in the information flow.

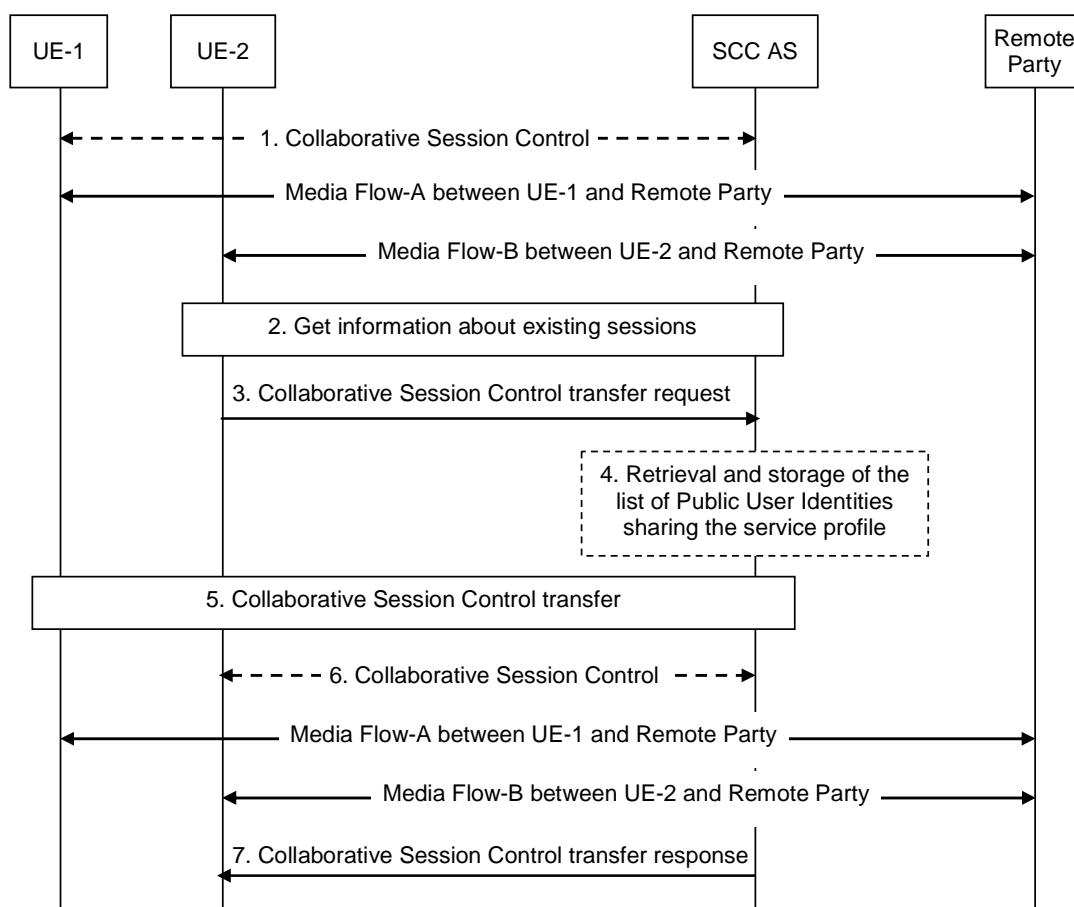

**Figure 6a.4a.5-1: Transfer of Collaborative Session Control initiated by the target UE**

1. A Collaborative Session is established between UE-1 and UE-2 and a remote party with UE-1 acting as the Controller UE and UE-2 acting as a Controllee UE. Each UE has a media flow with the remote party.
2. UE-2 obtains information about the existing sessions and UE-1's control of Collaborative Session which UE-2 is participating in according to procedure defined in clause 6a.8.3.2.
3. UE-2 wishes to transfer the Collaborative Session Control from UE-1 to itself. However, none of the existing media flows are affected. UE-2 sends a Collaborative Session Control transfer request to the SCC AS to obtain Collaborative Session Control. This request includes a registered Public User Identity or public GRUU of UE-1.
4. If the SCC AS does not have the list of Public User Identities that share the service profile with the Public User Identity used by UE-2 for the Collaborative Session, the SCC AS retrieves this information. If the Collaborative

Session Control transfer request indicates that UE-1 has the same Public User Identity (but different public GRUU) as UE-2, this step is skipped.

5. The SCC AS performs authorization as specified in clause 6a.12, ensures that UE-2 can act as the Controller UE for this Collaborative Session, and that the Public User Identity used by UE-1 shares the service profile with the Public User Identity used by UE-2 for the Collaborative Session. The SCC AS requests the Controller UE-1 to authorize the pull request or the SCC AS authorizes the request on behalf of UE-1 (e.g. pre-configured). If the request is authorized, SCC AS continues to transfer Collaborative Session Control to UE-2, and removes Collaborative Session Control from UE-1.
6. UE-2 has become the Controller UE and UE-1 has become a Controllee UE.
7. The SCC AS sends Collaborative Session Control transfer response to UE-2.

## 6a.5 Collaborative Session release

### 6a.5.1 Controller UE Initiated Release Collaborative Session

The following information flow shows the Controller UE releasing a Collaborative Session to release all the media flows with remote party. As a pre-requisite, there exists a Collaborative Session with two media flows, Media Flow-A on the Controller UE (UE-1) and Media Flow-B on the Controllee UE (UE-2).

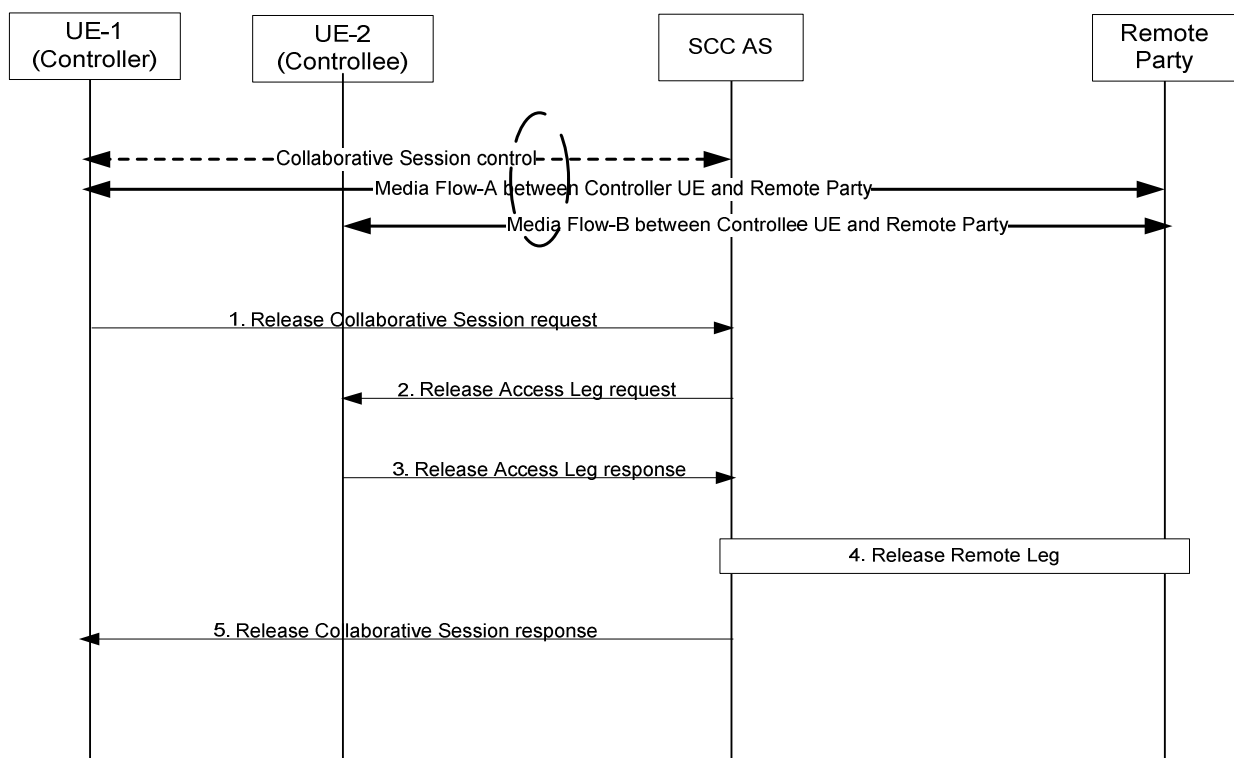

**Figure 6a.5.1-1: Controller UE initiated Collaborative Session release**

1. UE-1 sends a Release Collaborative Session request to the SCC AS to release the Collaborative Session and to release the Media Flow-B on UE-2: UE-1 removes Media Flow-A that is participating in the Collaborative Session.
2. The SCC AS identifies the Collaborative Session and the participating Access Leg from Controllee UE. SCC AS sends the Release Access Leg request to UE-2. The request identifies the Access Leg that needs to be released.
3. UE-2 releases the Access Leg and sends back Release Access Leg response to SCC AS.
4. The SCC AS releases the Remote Leg using IMS session release procedure as specified in TS 23.228 [4].
5. The SCC AS sends Release Collaborative Session response to UE-1.

## 6a.5.2 Remote Party Initiated Release Collaborative Session

The following shows the information flow where the remote party initiates the release of the session, which causes the SCC-AS to release the Collaborative Session.

UE-1 is a Controller UE and the other UEs are Controllee UEs.

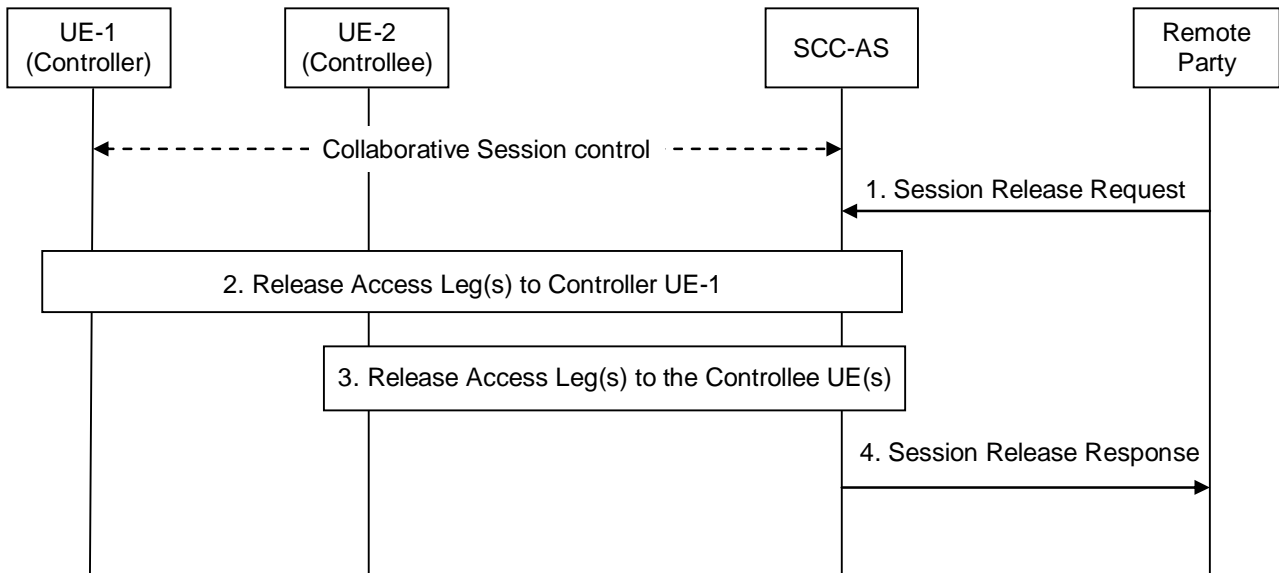

**Figure 6a.5.2-1: Remote Party Initiated Release Collaborative Session**

1. The Remote Party decides to release the session, and therefore a Session Release Request is sent by the remote party to the SCC-AS.
2. The SCC-AS releases the Access Leg(s) towards the Controller UE-1.
3. The SCC-AS releases the Access Leg(s) towards the different Controllee UEs. This occurs in parallel with step 2.
4. When all Access Legs that belonged to the Collaborative Session have been released, the SCC-AS responds to the remote party.

## 6a.6 Inter-UE Transfer without establishing a Collaborative Session

### 6a.6.1 Inter-UE Transfer initiated by the source UE

UE-1 and UE-2 are under the same user subscription. UE-1 is involved in IMS session with remote party. The information flow in Figure 6a.6.1-1 shows transfer of the session from UE-1 to UE-2. Since the entire session is transferred simultaneously, the roles of the Controller UE and Controllee UE are not applicable.

NOTE 1: This signalling flow does not require the UE-2 to have IUT capabilities.



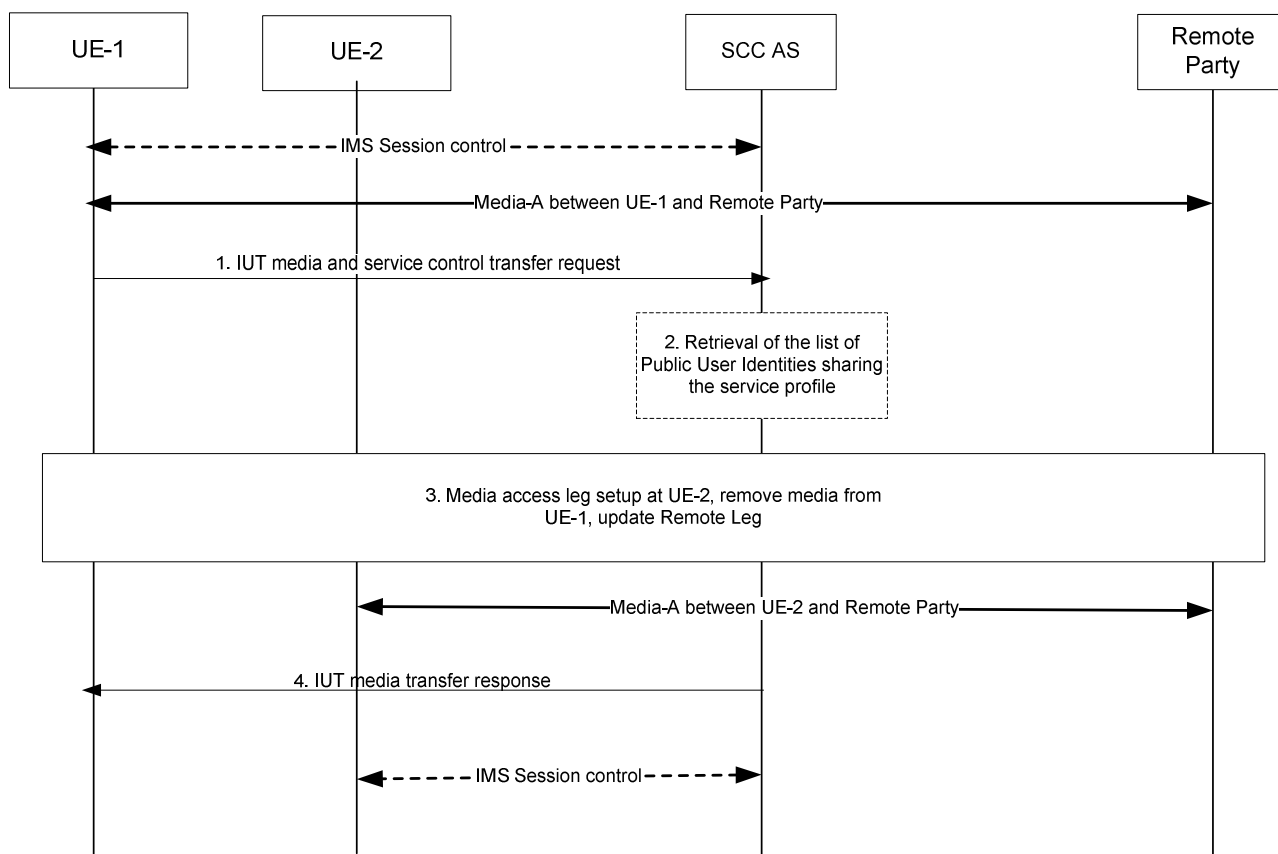

**Figure 6a.6.1-1: Inter-UE transfer without establishing Collaborative Session - initiated by the source UE**

1. UE-1 sends IUT media and service control transfer request to the SCC AS to transfer the session that includes Media-A from UE-1 to UE-2. The IUT media and service control transfer request shall include enough information for the network to:
  - identify the transferred session;
  - identify that the target of the transferred session is UE-2;
  - identify the access leg of UE-1 to be transferred to UE-2.
2. If the SCC AS does not have the list of Public User Identities that share the service profile with the Public User Identity used by UE-1 for the Collaborative Session, the SCC AS retrieves this information. If the Collaborative Session Control transfer request indicates that UE-2 has the same Public User Identity (but different public GRUU) as UE-1, this step is skipped.
3. The SCC AS ensures that the Public User Identity used by UE-2 shares the service profile with the Public User Identity used by UE-1 for the Collaborative Session. The SCC AS performs authorization as specified in clause 6a.12, then initiates the media session setup procedure with UE-2 for the Media-A, and updates the Remote Party.
4. The SCC AS releases the session with UE-1.

When the above transfer is completed the SCC AS retains the service state (e.g. media flows status) of UE-2, and the UE-2 has the control of the IMS session.

NOTE 2: If, besides the Media-A, there are other media flows in an unrelated session between UE-1 and Remote Party, the other media flows are not impacted by the above session transfer operation.

## 6a.6.2 Inter-UE Transfer initiated by the target UE

UE-1 and UE-2 are under the same IMS subscription. UE-1 is involved in IMS session with remote party. Figure 6a.6.2-1 shows session transfer from UE-1 to UE-2 requested by UE-2. Since all the media flow(s) are transferred from UE-1 to UE-2 simultaneously, the roles of the Controller UE and the Controllee UE are not applicable.

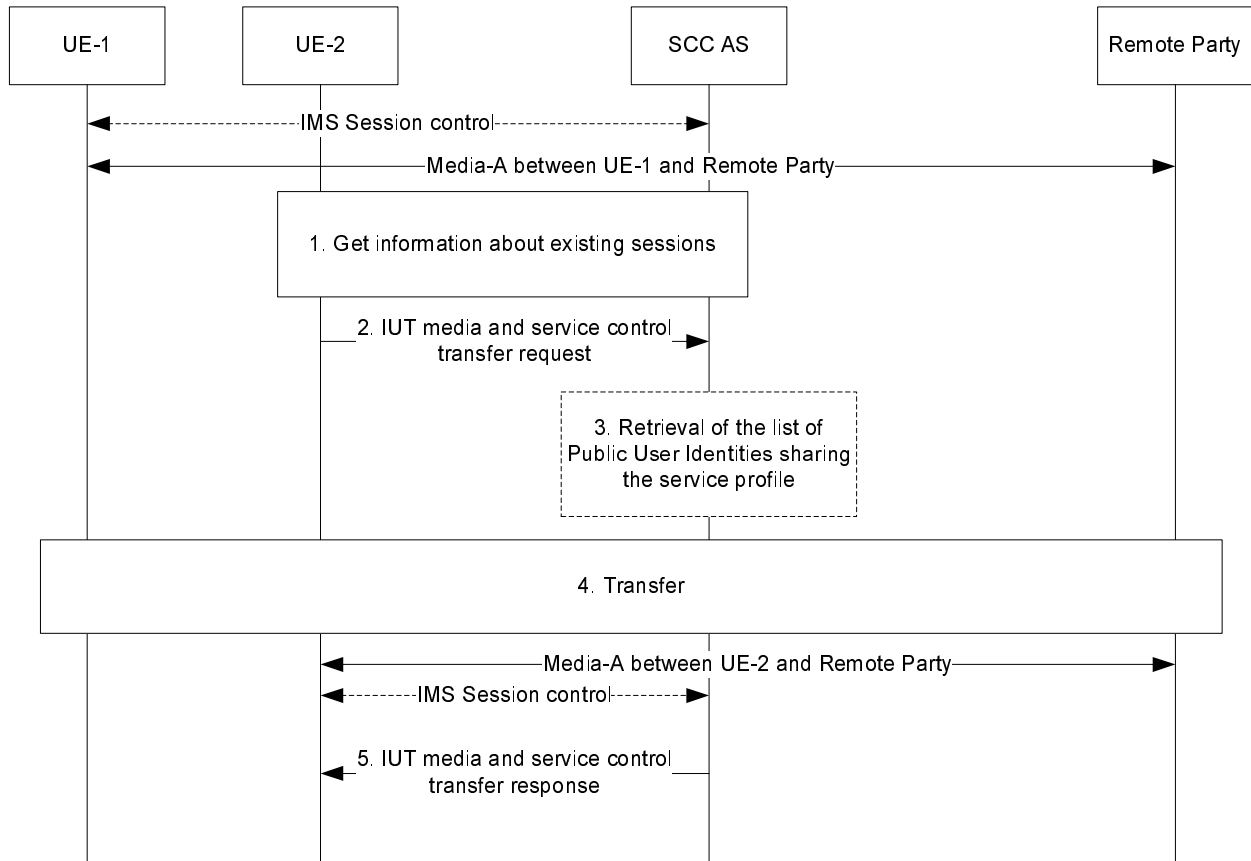

**Figure 6a.6.2-1: Inter UE Transfer initiated by UE not participating in the session – no Collaborative Session established**

1. UE-2 obtains information about the existing sessions and their media flows.
2. UE-2 sends IUT media and service control transfer request. The request shall include enough information for the network to:
  - identify the transferred session;
  - identify that the target of the transferred session is UE-2;
  - identify the access leg of UE-1 to be transferred to UE-2.
3. If the SCC AS does not have the list of Public User Identities that share the service profile with the Public User Identity used by UE-1 for the Collaborative Session, the SCC AS retrieves this information. If the Collaborative Session Control transfer request indicates that UE-2 has the same Public User Identity (but different public GRUU) as UE-1, this step is skipped.
4. The SCC AS ensures that the Public User Identity used by UE-1 shares the service profile with the Public User Identity used by UE-2 for the Collaborative Session. The SCC AS performs authorization as specified in clause 6a.12; in particular, the SCC AS requests the UE-1 to authorize the pull request or the SCC AS authorizes the request on behalf of UE-1 (e.g. pre-configured). The SCC AS will also authorize that the target UE is of the same subscription. If the request is authorized, SCC AS continues in accordance with step 2 of clause 6a.6.1, i.e.

SCC AS establishes a session with UE-2 for the Media-A, removes Media-A from UE-1, and updates Remote Leg using the Remote Leg Update procedure.

5. The SCC AS sends IUT media and service control transfer response to UE-2.

## 6a.7 Execution of supplementary services

### 6a.7.1 General

Even though the media components for the Collaborative Session are split onto multiple Access Legs of different UEs, the remote end is presented with one session including all the media components. This section describes the SCC AS and IUT UE procedures for handling supplementary services as described in TS 22.173 [15].

Whether or not the UEs involved in a Collaborative Session pertain to multiple IMS subscriptions, the Controllee UEs can be under a different service profile than the Controller UE. The service profile of the Controller UE shall determine the set of Application Servers and services that are invoked for the overall session with the remote end.

For a Controllee UE's Access Leg where CS media is used, the interaction described in the following sections still apply. However, the operations on the CS media follow the procedures as described in TS 23.292 [5].

With respect to identification presentation services (e.g. Originating Identification Presentation), the identifying information provided to the remote end is that of the Controller UE.

### 6a.7.2 Originating Identification Presentation (OIP)

The OIP service is not impacted by IUT.

### 6a.7.3 Originating Identification Restriction (OIR)

The OIR service is not impacted by IUT.

### 6a.7.4 Terminating Identification Presentation (TIP)

The TIP service is not impacted by IUT.

### 6a.7.5 Terminating Identification Restriction (TIR)

The TIR service is not impacted by IUT.

### 6a.7.6 Communication Diversion (CDIV)

The CDIV service is not impacted by IUT.

### 6a.7.7 Communication Hold (HOLD)

If the Controller UE wants to invoke the HOLD service on one or more media component(s), the Controller UE shall invoke the HOLD procedures, as defined in TS 24.610 [16]. The Hosting SCC AS shall act on the HOLD requests by updating all the Controllee UEs whose media status are changed and shall update the Remote Leg using the procedures defined in TS 24.610 [16].

If a Controllee UE wants to invoke the HOLD service on one or more media component(s) that it hosts, the request to do so must be authorized by the Controller UE (or by the network on behalf of the Controller UE). If the request is authorized, the Controllee UE shall invoke the HOLD procedures, as defined in TS 24.610 [16].

### 6a.7.7.1 Controller UE invoking the HOLD service on the media flow on a Controllee UE

The information flow shows a Controller UE invoking the HOLD service on the media flow that is originated from the Controllee UE. As a pre-requisite, there exists a Collaborative Session with two media flows, Media Flow-A on the Controller UE (UE-1) and Media Flow-B on the Controllee UE (UE-2).

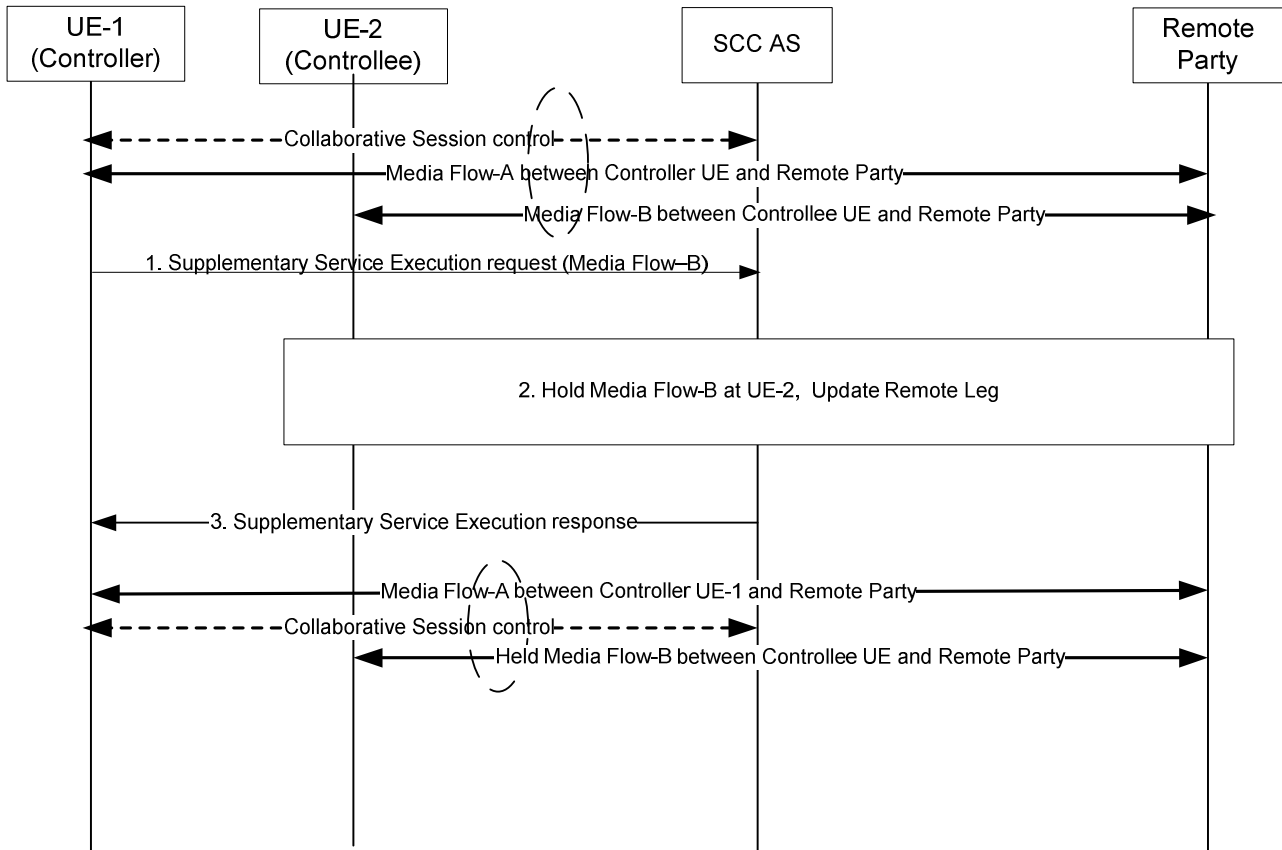

**Figure 6a.7.7.1-1: Controller UE invoking the HOLD service on the media flow on a Controllee UE**

1. UE-1 sends a Supplementary Service Execution request to invoke the HOLD service on Media Flow-B on UE-2. The IUT supplementary service execution request shall include enough information for the SCC AS to:
  - identify that the media to be held is Media Flow-B;
  - identify that the media to be held is on UE-2;
  - identify that the supplementary service to be executed on Media Flow-B is the HOLD service.
2. The SCC identifies Media Flow-B as associated with UE-2 and sends the Supplementary Service Execution request to UE-2. The request identifies the Media Flow-B that needs to be held. UE-2 holds the Media Flow-B. The SCC AS updates the Remote Leg with Media Flow-B held.
3. The SCC AS sends a Supplementary Service Execution response to UE-1.

### 6a.7.8 Communication Barring (CB)

The CB service is not impacted by IUT.

### 6a.7.9 Message Waiting Indication (MWI)

The MWI service is not impacted by IUT.

### 6a.7.10 Conference (CONF)

Only the Controller UE can invoke the CONF service for the Collaborative Session and it shall follow the procedures as defined in TS 24.605 [17] for any CONF service related operations. The SCC AS associated with a Controllee UE shall reject a request from the Controllee UE to invoke the CONF service.

When the remote end sends a request for the CONF service to replace an existing session which is locally a Collaborative Session, the SCC AS shall deliver the request for CONF service to the Controller UE, which then sets up a new session following the procedures defined in TS 24.605 [17]. If the user intends to invoke the CONF service for an ongoing Collaborative Session, the Controller UE shall establish a new Collaborative Session towards the conferencing AS using the procedure of Establish Collaborative Session at originating IMS session setup as specified in clause 6a.2.3, while the existing Access Legs between the SCC AS and the Controllee UE(s) can be reused (i.e. updated to be bound to the new Collaborative Session between the Controller UE and the conferencing AS).

### 6a.7.11 Explicit Communication Transfer (ECT)

Only the Controller UE can invoke the ECT service on behalf of the Collaborative Session and it shall follow the procedures as specified in TS 24.629 [18]. Upon receiving notification that ECT has been performed successfully, the Controller UE shall terminate the previous active session with the transferee UE by terminating all related media control sessions on the Controllee UEs. The SCC AS associated with a Controllee UE shall reject a request from the Controllee UE to invoke the ECT service.

Upon receiving an ECT transfer request from the remote end to transfer the Collaborative Session, the SCC AS shall deliver the request to the Controller UE.

Upon receiving an ECT transfer request to transfer the Collaborative Session, the Controller UE shall establish a new session towards the transfer target following the procedures defined in TS 24.629 [18]. If the communication to be transferred is a Collaborative Session (i.e. the transferee intends to use the Collaborative Session to communicate with the transfer target), the Controller UE shall establish a new Collaborative Session towards the transfer target using the procedure of Establish Collaborative Session at originating IMS session setup as specified in clause 6a.2.3, while the existing Access Legs between the SCC AS and the Controllee UE(s) can be reused (i.e. updated to be bound to the new Collaborative Session between the Controller UE and the transfer target).

### 6a.7.12 Advice of Charge (AOC)

When the AOC service specified in TS 24.647 [19] is active, the SCC AS shall deliver charging information during the communication to the Controller UE.

### 6a.7.13 Closed User Groups (CUG)

The CUG service is not impacted by IUT.

### 6a.7.14 Three-Party (3PTY)

The 3PTY service in TS 24.605 [17] is considered as a special case of CONF service and the interaction with IUT is the same as that specified in clause 4.8.10 for CONF service.

### 6a.7.15 Flexible Alerting (FA)

The FA service is not impacted by IUT.

### 6a.7.16 Communication Waiting (CW)

The CW service is not impacted.

### 6a.7.17 Completion of Communications to Busy Subscriber (CCBS)/Completion of Communications by No Reply (CCNR)

The CCBS/CCNR service is not impacted.

### 6a.7.18 Customized Alerting Tones (CAT)

For Collaborative Sessions established concurrently with terminating IMS session setup, the CAT provided by the network (under the control of the SCC AS associated with the Controller UE) to the remote party is the CAT associated with the Controller UE.

### 6a.7.19 Malicious Communication IDentification (MCID)

The MCID service is not impacted by IUT.

### 6a.7.20 Reverse Charging

The Reverse Charging service is not impacted by IUT.

### 6a.7.21 Personal Network Management (PNM)

The PNM service is not impacted by IUT.

### 6a.7.22 Customized Ringing Signal (CRS)

For Collaborative Sessions established concurrently with terminating IMS session setup, the Customized Ringing Signal (CRS) provided to the Controller UE is the CRS associated with the remote party. For Collaborative Sessions established concurrently with originating IMS session setup, the CRS provided to the remote party is the CRS associated with the Controller UE.

## 6a.8 IUT target discovery

### 6a.8.1 General

When initiating Inter-UE Transfer procedures, the UE may use the following information:

- other UEs belonging to the same IMS subscription;
- the availability (e.g. online, offline etc) of the UEs;
- the capabilities (e.g. support of audio/video formats, Controller UE capability, etc) of the UEs.

Determination of UEs belonging to the same IMS subscription is based on either or both of static list stored in the UE and based on IMS registration. When based on IMS registration, the UE gets notified when other UEs under the same Implicit Registration Set become available and their capabilities and contact details. The static list, which contains a list of eligible UEs for Inter-UE Transfer, can be created manually by the user.

The availability and capabilities of the target UE(s) can be determined by the information flow described in the subsequent section.

## 6a.8.2 Information flow for IUT target availability and capabilities discovery

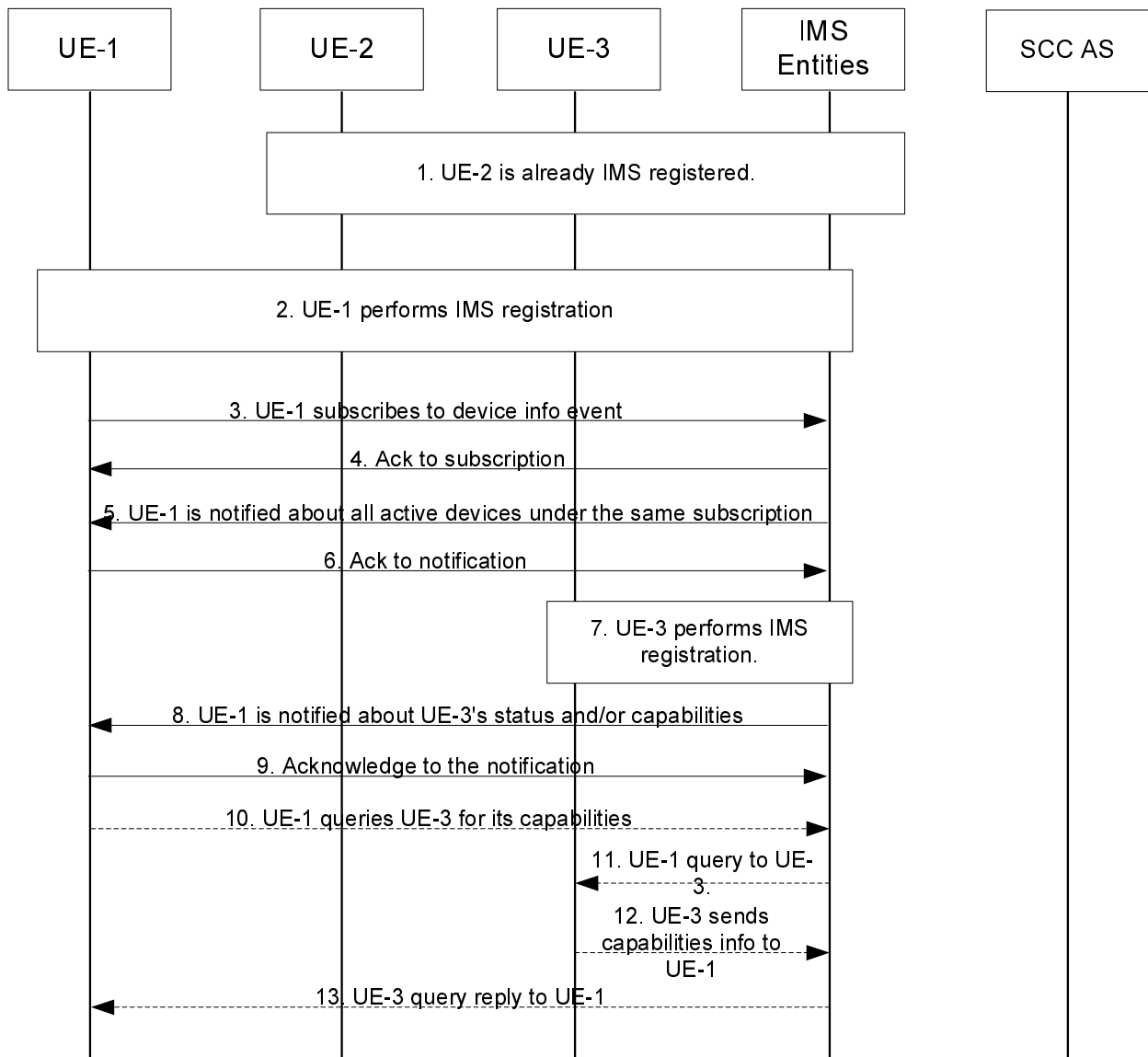

**Figure 6a.8.2-1 Inter-UE Transfer target discovery based on IMS registration**

1. UE-2 is IMS registered following the procedures defined in TS 23.228 [4].
2. UE-1 performs IMS registration following the procedures defined in TS 23.228 [4].
- 3 ~ 4. UE-1 is interested to discover the status and capabilities of other devices under the same subscription. It subscribes to an event package (e.g., reg-event, presence) for registration information and the capabilities information.
- 5 ~ 6. The IMS CN subsystem or presence AS notifies UE-1 of other devices (e.g. UE-2) status and, if available, capabilities information.
7. UE-3 performs IMS registration.
- 8 ~ 9. The IMS CN subsystem notifies UE-1 of UE-3's availability and, if available, capabilities information.

Optionally, if sufficient UE capabilities information is not included in step 8, then the following steps can be performed:

- 10 ~ 13. Among all the available devices, UE 1 is interested in performing Inter-UE transfer to UE-3. UE-1 performs capability query towards UE-3.

## 6a.8.3 Session Discovery

### 6a.8.3.1 General

In order to solicit the IUT of media flows or control of an ongoing session from other UE(s) under the same or different subscriptions of the same operator, it shall be possible for a UE capable of IUT to discover ongoing session information on other UE(s) as follows:

- Session information for the other UE(s), including session identifier, source UE identifier (e.g. GRUU or IMPU), remote end identifier, identity of the Controller UE for the related Collaborative Session;
- Media flow information for the ongoing session(s) in other UE(s), including: type (voice, video, etc.), status (held, active, etc.), media flow identifier;
- Service Identifier for the service the session is related to.

The UE may use the above information for IUT in addition to the availability and capabilities of other UE(s) as specified in clause 6a.8.1.

The SCC AS which serves target UE(s) of session discovery shall filter information on some or all of the sessions or media flows composing the session on the target UE(s) based on user service configuration or operator policy before providing ongoing session information to the UE which has requested session discovery.

### 6a.8.3.2 Discovery of ongoing session information on other UE(s) belonging to same IMS subscription

The figure below shows an information flow of UE-1 requesting ongoing session information for the other UEs, assuming that UE-1, UE-2 and UE-3 belong to the same IMS subscription and there is a session with Media Flow-A between UE-2 and the remote party and another session with Media Flow-B between UE-3 and the remote party.

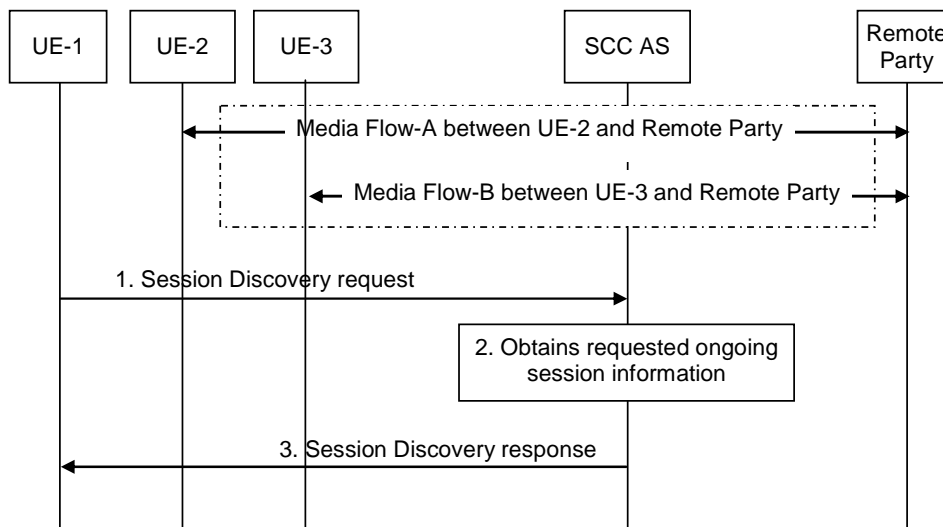

**Figure 6a.8.3.2-1 Discovery of ongoing session information on other UE(s) belonging to the same IMS subscription**

1. UE-1 sends the SCC AS a Session Discovery request for ongoing session information for the UEs belonging to the same IMS subscription. The Session Discovery request indicates the information requested to be provided in the response.
2. The SCC AS retrieves the requested information for all ongoing sessions for the user's UEs.
3. The SCC AS, if required, authorizes that UE-1 is allowed to receive the requested information, and sends the UE-1 a Session Discovery response containing the requested session related information for UE-2 and UE-3. The SCC AS performs filtering as specified in clause 6a.8.3.1 before sending a Session Discovery response to the UE-1.



### 6a.8.3.3 Discovery of ongoing session information on other UE(s) belonging to different IMS subscription

The figure below shows an information flow of UE-1 requesting ongoing session information for the other UEs, assuming that UE-1 belongs to User-1 while UE-2 and UE-3 belong to User-2. It is also assumed that there is a session with Media Flow-A between UE-2 and the remote party, and another session with Media Flow-B between UE-3 and the remote party.

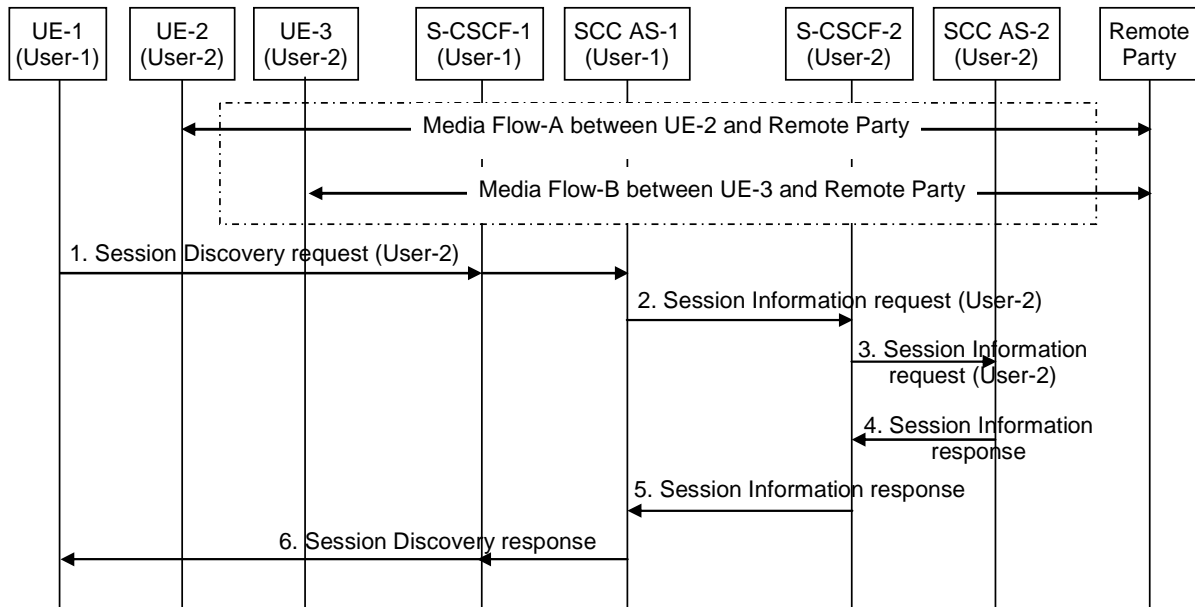

**Figure 6a.8.3.3-1 Discovery of ongoing session information on other UE(s) belonging to different IMS subscription**

1. UE-1 sends SCC AS-1 a Session Discovery request for ongoing session information for User-2's UEs. The Session Discovery request indicates the information requested to be provided in the response.
2. SCC AS-1 sends a Session Information request for ongoing session information for User-2's UEs to S-CSCF-2 which serves User-2.
3. S-CSCF-2 forwards the Session Information request to SCC AS-2 which serves User-2.
4. SCC AS-2, if required, authorizes that UE-1 is allowed to receive ongoing session information for User-2's UEs, and sends a Session Information response containing ongoing session information for UE-2 and UE-3. The SCC AS-2 performs filtering as specified in clause 6a.8.3.1 before sending a Session Information response.
5. S-CSCF-2 forwards the Session Information response to SCC AS-1.
6. SCC AS-1 sends UE-1 a Session Discovery response containing ongoing session information for UE-2 and UE-3.

## 6a.9 Inter-UE Transfer Initiated by Target UE

### 6a.9.1 Controller UE and Controllee UE belong to same IMS subscription

#### 6a.9.1.1 Initiated by UE not participating in ongoing Collaborative Session

UE-1, UE-2 and UE-3 are under the same IMS subscription. UE-1 and UE-2 are involved in Collaborative Session with remote party. The figure below shows media flow transfer from UE-1 to UE-3 requested by UE-3.

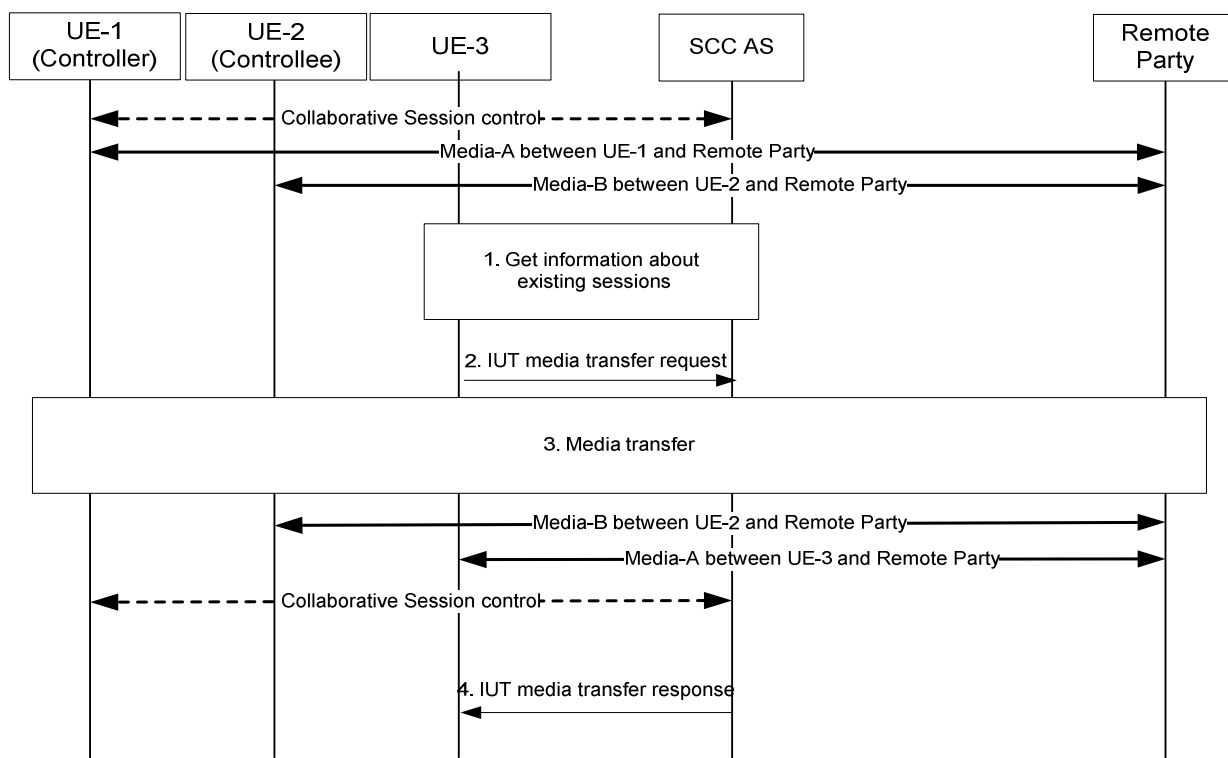
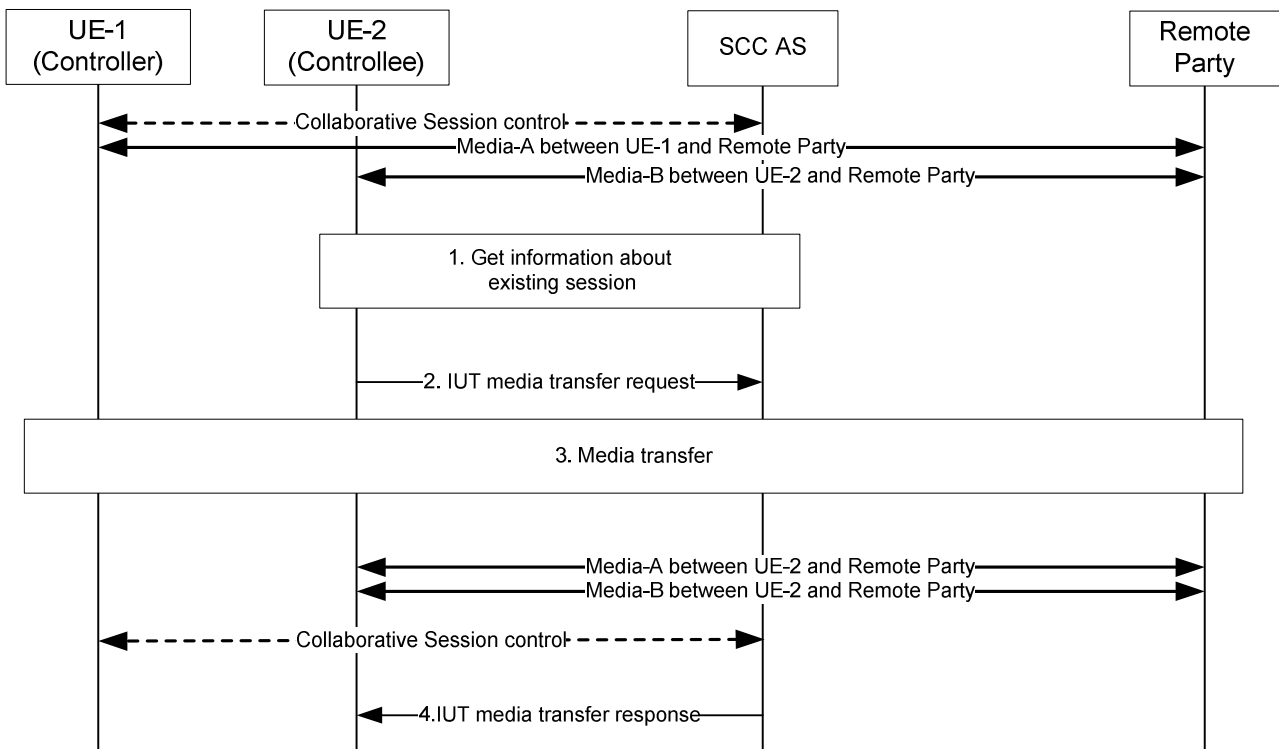

**Figure 6a.9.1.1-1: Inter-UE Transfer initiated by UE not participating in the Collaborative Session**

1. UE-3 obtains information about the existing sessions and their media flows.
  2. UE-3 sends IUT media transfer request to transfer the Media-A from UE-1 to UE-3. The request shall include the enough information for the network to:
    - identify the targeted Collaborative Session;
    - identify that the transferred media flow is Media-A;
    - identify that the target of the transferred media flow is UE-3;
    - keep the control of the Collaborative Session in UE-1;
    - other information.
  3. The SCC AS performs authorization as specified in clause 6a.12; in particular, the SCC AS requests the Controller UE-1 to authorize the pull request or the SCC AS authorizes the request on behalf of UE-1 (e.g. pre-configured). The SCC AS will also authorize that the target UE is of the same subscription. If the request is authorized, SCC AS continues in accordance with step 2 of clause 6a.3.1.1, i.e. SCC AS establishes a session with UE-3 for the Media-A, removes Media-A from UE-1, and updates the Remote Leg using the Remote Leg Update procedure. The UE-1 remains the Controller UE and UE-3 becomes a new Controllee UE.
- NOTE: If no more media flows remain on UE-2, then the Access Leg from UE-2 is released and UE-2 will no longer be part of the Collaborative Session.
4. The SCC AS sends IUT media transfer response to UE-3.

### 6a.9.1.2 Initiated by Controllee UE in ongoing Collaborative Session

UE-1 and UE-2 are under the same IMS subscription. UE-1 and UE-2 are involved in a Collaborative Session with remote party, in which UE-1 is the Controller UE and UE-2 is the Controllee UE. The figure below shows media flow transfer from UE-1 to UE-2 requested by UE-2.



**Figure 6a.9.1.2-1: Inter-UE Transfer initiated by Controllee UE in ongoing Collaborative Session**

1. UE-2 obtains the information about the media flows in its current participating Collaborative Session.
2. UE-2 sends IUT media transfer request to transfer the Media-A from UE-1 to UE-2. The request shall include enough information for the network to:
  - identify that the transferred media flow is Media-A;
  - identify that the target of the transferred media flow is UE-2;
  - keep the control of the Collaborative Session in UE-1;
  - other information.
3. The SCC AS performs authorization as specified in clause 6a.12; in particular, the SCC AS requests the Controller UE-1 to authorize the pull request or the SCC AS authorizes the request on behalf of UE-1 (e.g. pre-configured). If the request is authorized, SCC AS continues in accordance with step 2 of clause 6a.3.1.1 to transfer Media-A to UE-2, removes Media-A from UE-1, and updates the Remote Leg using the Remote Leg Update procedure. The UE-1 remains the Controller UE and UE-2 remains a Controllee UE.
4. The SCC AS sends IUT media transfer response to UE-2.

### 6a.9.1.3 IUT solicited by a target UE without prior information about the existing sessions

This realization of pull mode is particularly applicable to the cases where the UE to be target of an IUT operation does not have information about ongoing sessions, e.g. because of privacy restrictions.

It is based on extending the information provided in the event package used for the discovery of status and capabilities of potential target UEs, with information on the wish to be the target of an IUT operation.

The following information flow shows a UE in control of an IMS session or Collaborative Session, subscribing to a device info event to be notified of availability and capabilities of potential target UEs, this event package being extended with additional information on the wish to be the target of an IUT operation. The end user subsequently requests the transfer of a video to UE-2 by interacting with UE-2. UE-2 then updates its status to inform the network that it solicits an IUT to be performed to itself. In this example, the notification includes the type of media that UE-2

expects to be transferred. Alternatively, any other kind of IUT could be requested the same way, e.g. transfer of Collaborative Session Control.

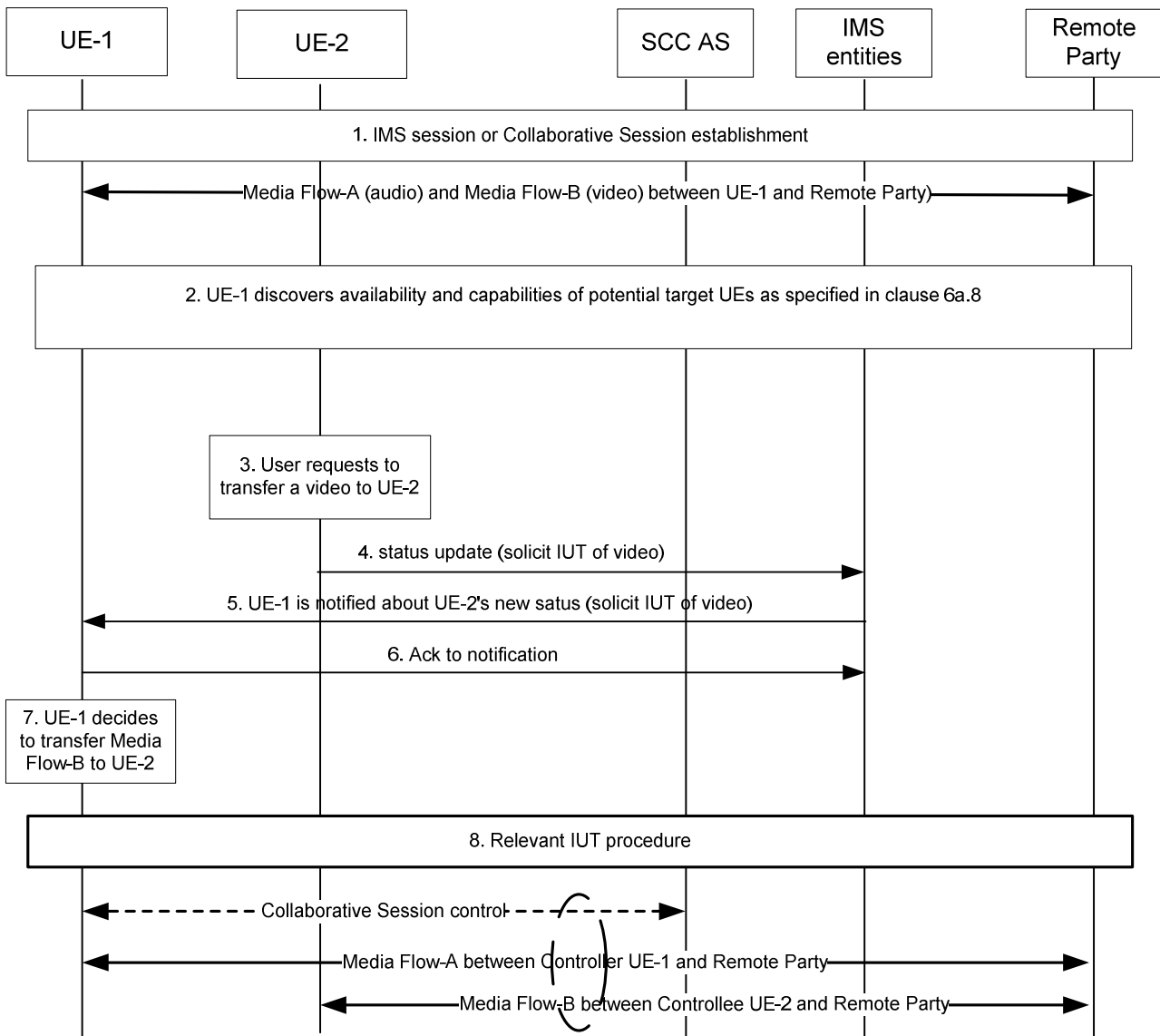

**Figure 6a.9.1.3-1: IUT solicited by a target UE without prior information about existing sessions**

1. An IMS session or a Collaborative Session is set-up, involving at least UE-1 and a remote party. In case of a Collaborative Session, UE-1 is the Controller UE. Two media are established: audio (Media Flow-A) and video (Media Flow-B).
2. UE-1 performs IUT target discovery and discovers UE-2 as specified in clause 6a.8.
3. By interacting with UE-2, the user requests the transfer of a video media to UE-2.
4. UE-2 updates its status, indicating that it solicits an IUT of a video media.
- 5 - 6. This status update is notified to UE-1.
7. UE-1 identifies that it controls Media Flow-B which corresponds to the solicitation (video) and decides whether to initiate the IUT solicited by UE-2 or not.
8. UE-1 uses the relevant IUT procedure to transfer Media Flow-B to UE-2.

## 6a.9.2 Controller UE and Controllee UE belong to different IMS subscriptions

### 6a.9.2.1 Initiated by UE not participating in the session - Collaborative Session established

The information flow below illustrates a transfer of media flow scenario in which a UE belonging to one subscription (UE-2) requests a media flow from a UE that belongs to another subscription (UE-1). At this time, the control of the transferred media flow remains at UE-1. After the transfer, a Collaborative Session is established, in which the UE-1 is Controller UE, and UE-2 is Controllee UE. It is assumed that, prior to the scenario, User-2 has discovered that there is an ongoing session between UE-1 and the remote party.

NOTE: If UE-1 does not support IUT media related procedures or is not an IUT subscriber, SCC AS-1 or UE-1 will return an error.

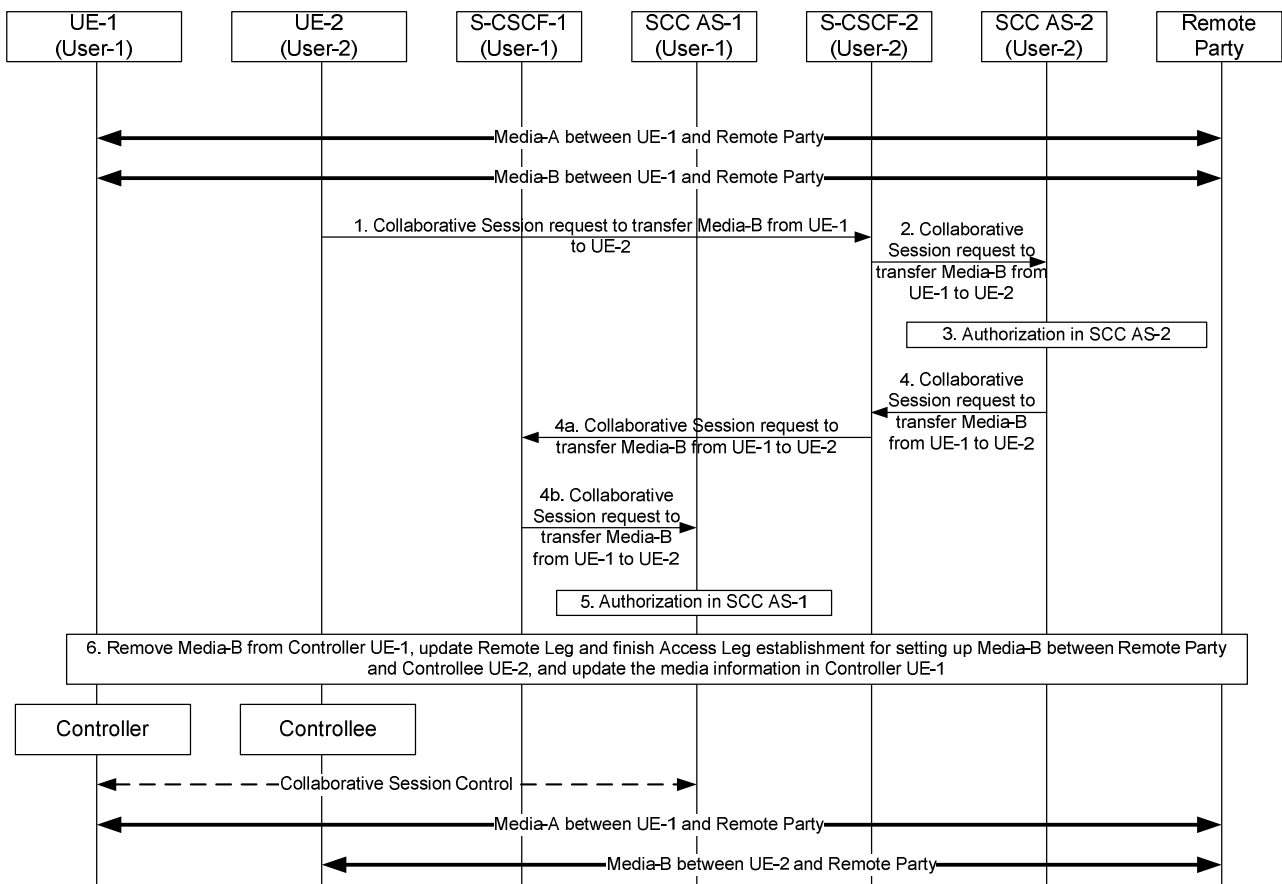

Figure 6a.9.2.1-1: Establish Collaborative Session by target UE initiated transferring media

There are Media-A and Media-B between UE-1 and remote party.

1. UE-2 sends a request towards UE-1 to transfer Media-B from UE-1 to UE-2. The request includes enough information for the network to:
  - identify that the media flow to be transferred is Media-B;
  - identify that the source of the media flow to be transferred is UE-1;
  - identify the session that contains the media flow to be transferred;
  - identify that the target of the transferred media flow is UE-2;
  - give control of the Collaborative Session to UE-1.

2. S-CSCF-2 forwards the request to SCC AS-2.
3. SCC AS-2 authorizes the request from UE-2.as specified in clause 6a.12
4. SCC AS-2 sends a request to S-CSCF-2 towards UE-1 to transfer Media-B from UE-1 to UE-2. The Collaborative Session request includes enough information for the network to:
  - identify the source of the transfer request as UE-2;
  - identify that the media flow to be transferred is Media-B;
  - identify that the target of the transferred media flow is UE-2;
  - give control of the Collaborative Session to Controller UE-1.
- 4a. S-CSCF-2 forwards the request towards UE-1.
- 4b. S-CSCF-1 forwards the request to SCC AS-1.
5. SCC AS-1 authorizes the request from UE-2.
6. SCC AS-1 removes Media-B from UE-1, updates Remote Leg and finishes Access Leg establishment for setting up Media-B between remote party and UE-2, and updates the media information in Controller UE-1.

After the above operation, a Collaborative Session is established, for which UE-1 becomes the Controller UE and UE-2 becomes a Controllee UE and Media Flow-A and Media Flow-B become part of the Collaborative Session under the control of UE 1.

This information flow is also applicable to the cases where a UE not participating in an ongoing Collaborative Session joins the Collaborative Session by initiating the transfer of media flow(s) from Controller UE which belongs to the different IMS subscription to itself.

#### 6a.9.2.2 Initiated by UE not participating in ongoing Collaborative Session - media on Controllee UE

UE-1 and UE-2 are involved in Collaborative Session with remote party. UE-1 and UE-2 belong to different subscriptions and SCC AS-1 serves the user of UE-1, SCC AS-2 serves the user of UE-2. UE-3 which is not in the Collaborative Session can belong to the same subscription as UE-1 or UE-2 or neither. The figure below shows the media flow transfer procedure from UE-2 to UE-3 requested by UE-3. For simplification, in the flow UE-3 belongs to the same subscription with UE-2.

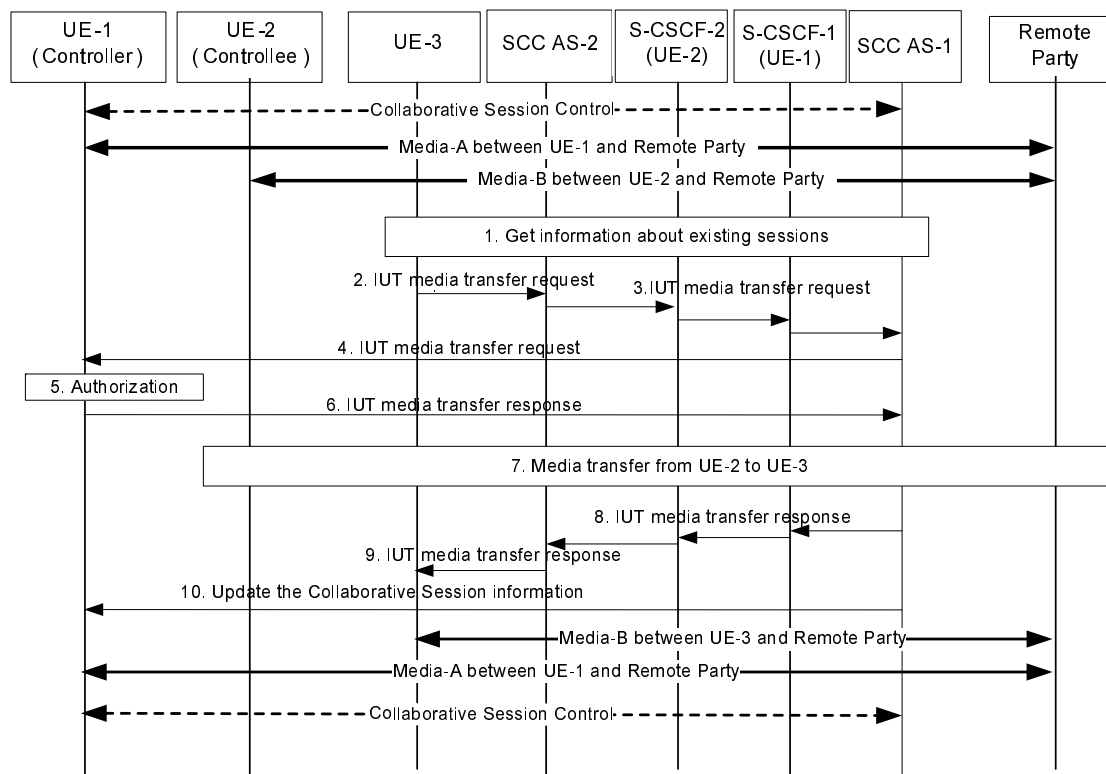

**Figure 6a.9.2.2-1: Inter UE Transfer initiated by target UE not participating in the Collaborative Session – media on the Controllee UE**

1. UE-3 obtains information about the existing sessions and their media flows of UE-2.
  2. UE-3 sends an IUT media transfer request towards UE-2 to transfer the Media-B from UE-2 to UE-3. The request shall include the enough information for the network to:
    - identify the targeted Collaborative Session;
    - identify that the transferred media flow is Media-B;
    - identify that the target of the transferred media flow is UE-3;
    - other information.
  3. Based on the identifier of the targeted Collaborative Session, SCC AS-2 knows itself to be the SCC AS serving the Controllee UE of the collaborative session, and relays the media transfer request via S-CSCF2/1 to the SCC AS-1 which serves the Controller UE of the collaborative session.
  - 4-6. SCC AS-1 sends a media transfer request to the Controller UE-1, and the Controller UE-1 authorizes the media transfer request. If SCC AS-1 is configured to authorize the request on behalf of UE-1, steps 4-6 are skipped.
  7. After obtaining authorization as specified in clause 6a.12, SCC AS-1 establishes a session with UE-3 for the Media-B, removes Media-B from UE-2, and updates the Remote Leg using the Remote Leg Update procedure as specified in clause 6a.1.2. The UE-3 becomes a new Controllee UE.
- NOTE 1: If no media flow as part of the Collaborative Session remains in UE-2 after the transfer, UE-2 shall be removed from the Collaborative Session.
8. SCC AS-1 sends the media transfer response via S-CSCF1/2 towards UE-3.
  9. SCC AS-2 sends the media transfer response towards UE-3.
  10. SCC AS-1 sends the Collaborative Session information to the Controller UE-1 to inform UE-1 of the change of the Collaborative Session.

NOTE 2: If the Controller UE-1 and the Controllee UE-2 belong to the same subscription, SCC AS-1 and SCC AS-2 are the same SCC AS.

## 6a.10 Media Flow Replication by network

### 6a.10.1 Replicating media in network from Controller UE to another UE belonging to same IMS subscription

The information flow in Figure 6a.10.1-1 illustrates a scenario in which the Controller UE of a Collaborative Session requests that the network replicate a media flow towards another UE that belongs to the same subscription. In this scenario, UE-2 is currently not involved in the Collaborative Session until after Media-A is replicated towards it.

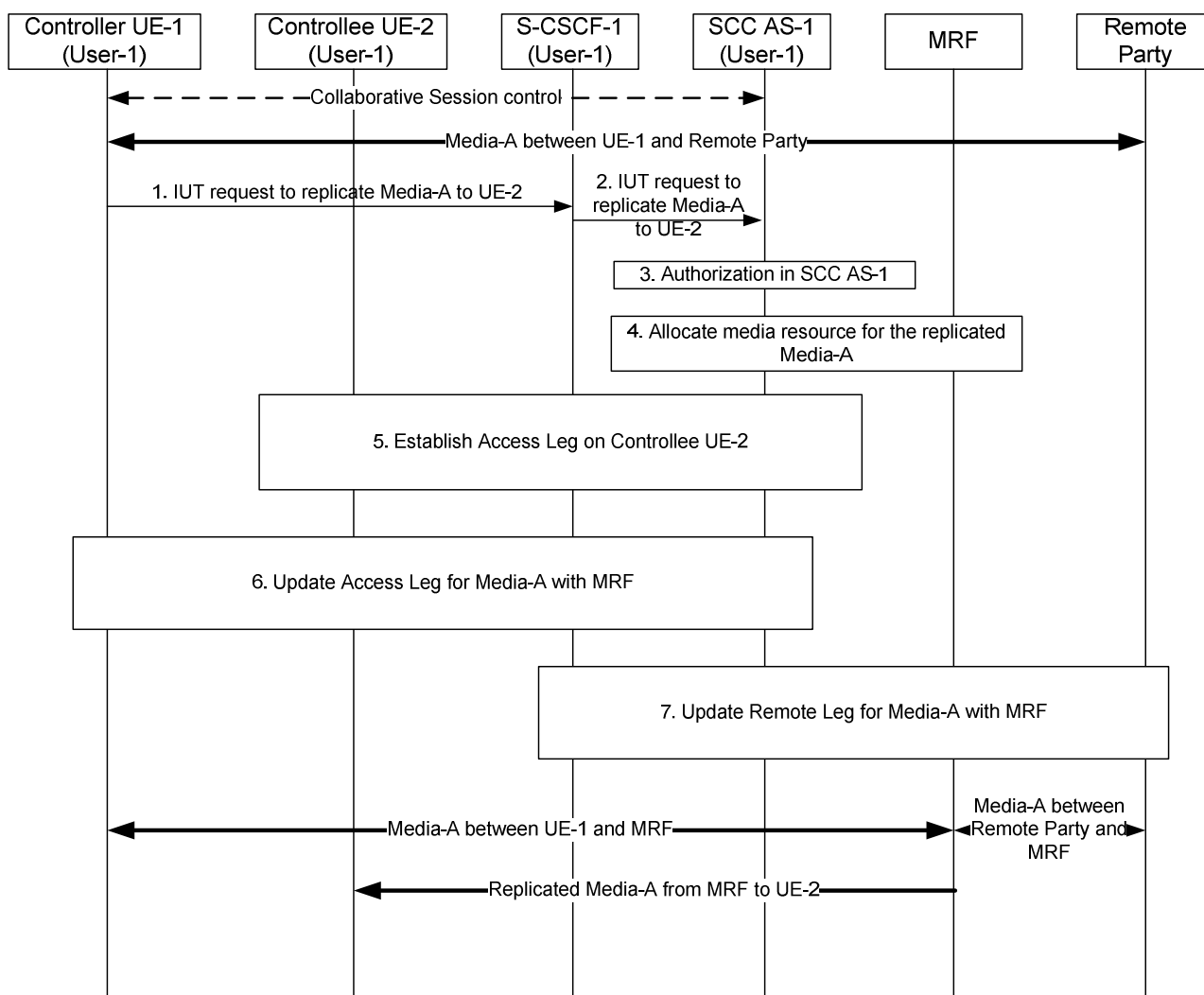

**Figure 6a.10.1-1: Replicating media in network from Controller UE to another UE belonging to same IMS subscription**

There is Media-A between Controller UE-1 and remote party.

1. Controller UE-1 sends a request towards SCC AS-1 to replicate Media-A to UE-2. The session setup request includes enough information for the network to:
  - identify that the media flow to be replicated is Media-A;
  - identify that the source of the media flow to be replicated is the remote party;
  - identify that the target of the media flow to be replicated is Controllee UE-2.



2. S-CSCF-1 forwards the request to SCC AS-1.
3. SCC AS-1 authorizes the request from UE-1 as specified in clause 6a.12.
4. SCC AS-1 allocates media resource in MRF for the Media-A to be replicated.
5. SCC AS-1 sends a request to establish an Access Leg at UE-2 for Media-A.
6. SCC AS-1 updates the Access Leg on Controller UE-1 for the replicated media flow (Media-A) with MRF.
7. SCC AS-1 updates the Remote Leg to communicate Media-A with MRF.

After the above operation, Media-A is established between Controller UE-1 and MRF, from MRF to Controllee UE-2, and between remote party and MRF.

## 6a.10.2 Replicating media in network from Controller UE to another UE belonging to different IMS subscription

The information flow in Figure 6a.10.2-1 illustrates a scenario in which a Collaborative Session is established in the context of an ongoing IMS session and as a result of UE-1 requesting to replicate media to another UE. The Controller UE requests that the network replicate a media flow towards a UE that belongs to a different subscription.

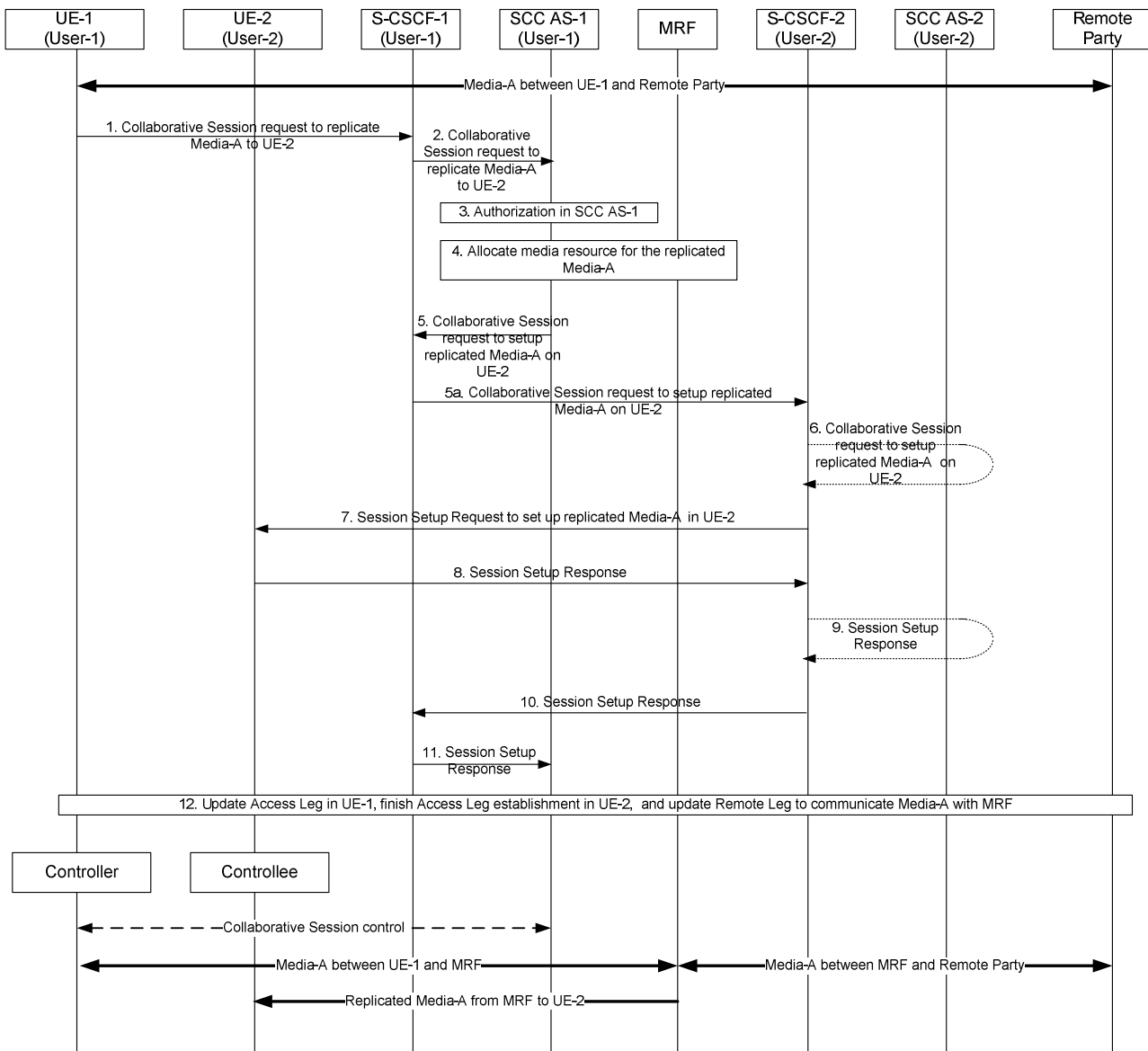

**Figure 6a.10.2-1: Replicating media in network from Controller UE to another UE belonging to different IMS subscription**

There is Media-A between UE-1 and remote party.

1. UE-1 sends a request towards SCC AS-1 to replicate Media-A to UE-2. The Collaborative Session request includes enough information for the network to:
  - identify that the media flow to be replicated is Media-A;
  - identify that the source of the media flow to be replicated is the remote party;
  - identify that the target of the media flow to be replicated is UE-2.
2. S-CSCF-1 forwards the request to SCC AS-1.
3. SCC AS-1 authorizes the request from UE-1 as specified in clause 6a.12.
4. SCC AS-1 allocates media resource for the replicated Media-A in MRF.
5. SCC AS-1 sends a request towards UE-2 to set up the replicated Media-A between UE-2 and the MRF. The request includes enough information for the network to:
  - identify the source of the request as UE-1;

- identify the remote party;
- identify that the replicated media flow is Media-A;
- identify the media resource information of SCC AS-1;
- identify that the target of the replicated media flow is UE-2.

5a. S-CSCF-1 routes the request towards UE-2.

6. If UE-2 is an IUT subscriber, the request is routed via SCC AS-2. SCC AS-2 notes that this request relates to the establishment of a Collaborative Session so that any requests by UE-2 related to this Collaborative Session will be forwarded back toward SCC AS-1. A Session Setup request is then routed on towards UE-2. If UE-2 is not an IUT subscriber, S-CSCF-2 routes the request according to normal procedures.

7. S-CSCF-2 forwards the Session Setup request towards UE-2.

8. UE-2 sends the Session Setup response towards SCC AS-1.

9 - 10. S-CSCF-2 routes the response back toward SCC AS-1 via SCC AS-2 if UE-2 is an IUT subscriber.

11. S-CSCF-1 forwards the response to SCC AS-1.

12. SCC AS-1 updates Access Leg in UE-1, finishes Access Leg establishment in UE-2, and updates Remote Leg to communicate Media-A with MRF.

After the above operation, a Collaborative Session is established where UE-1 is the Controller UE and UE-2 is a Controllee UE. Media-A is established between Controller UE-1 and MRF, from MRF to Controllee UE-2 and MRF, and between remote party and MRF.

### 6a.10.3 Replicating media in network from Controller UE to another UE belonging to same IMS subscription - pull mode

The information flow in Figure 6a.10.3-1 illustrates a Collaborative Session scenario in which a UE not participating in the session requests that the network replicate towards itself a media flow that pertains to a UE belonging to the same subscription. It is assumed that, prior to the scenario, UE-2 has discovered that there is an ongoing session between UE-1 and the remote party and that UE-1 is capable of supporting IUT related media procedures. If UE-1 does not support IUT related media procedures, SCC AS-1 or UE-1 will return an error. In the illustrated scenario, UE-2 is currently not involved in the Collaborative Session until after Media-A is replicated towards it.

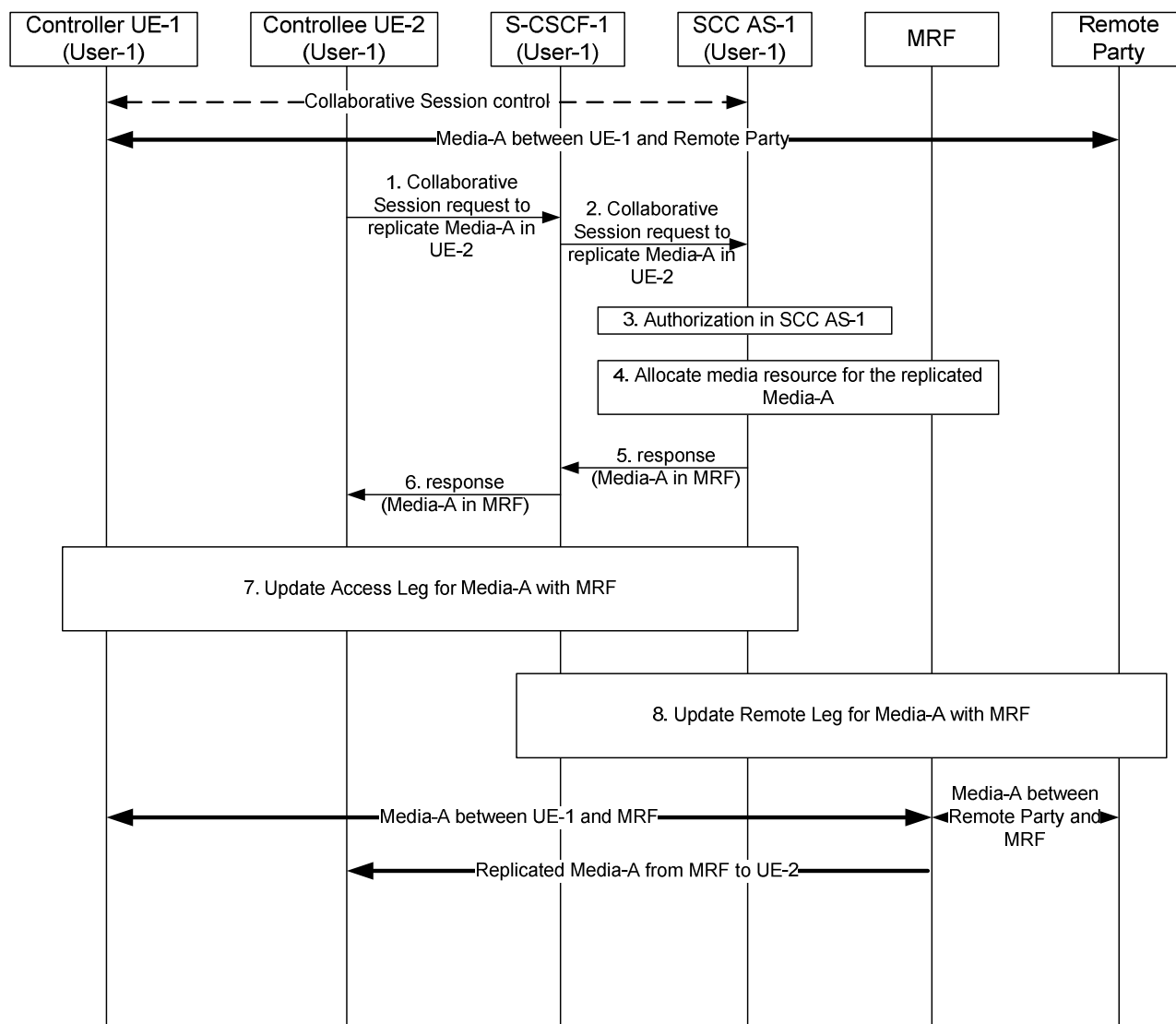

**Figure 6a.10.3-1: Replicating media in network from Controller UE to another UE belonging to same IMS subscription - pull mode**

There is Media-A between Controller UE-1 and remote party.

1. UE-2 sends a request towards SCC AS-1 to replicate Media-A of an existing session to UE-2. The session setup request includes enough information for the network to:
  - identify the session that contains the media flow to be replicated;
  - identify that the media flow to be replicated is Media-A;
  - identify that the source of the media flow to be replicated is the remote party;
  - identify that the target of the replicated media flow is UE-2.
2. S-CSCF-1 forwards the request to SCC AS-1.
3. SCC AS-1 authorizes the request from UE-2 as specified in clause 6a.12.
4. SCC AS-1 allocates media resource for the replicated Media-A.
5. SCC AS-1 sends response towards UE-2.
6. S-CSCF-1 forwards the response to UE-2.
7. SCC AS-1 updates the Access Leg on Controller UE-1 for the replicated media flow (Media-A) with MRF.

8. SCC AS-1 updates the Remote Leg to communicate Media-A with MRF.

After the above operation, Media-A is established between Controller UE-1 and MRF, from MRF to Controllee UE-2 and MRF, and between remote party and MRF.

## 6a.10.4 Replicating media in network from Controller UE to another UE belonging to different IMS subscription - pull mode

The information flow in Figure 6a.10.4-1 illustrates a Collaborative Session scenario in which a UE not participating in the session requests that the network replicate towards itself a media flow that pertains to a UE belonging to different subscription (User-1). It is assumed that User-1 is an IUT subscriber. It is also assumed that, prior to the scenario, the user that requests the media replication (User-2) has discovered that there is an ongoing session between UE-1 and the remote party. If UE-1 does not support IUT related media procedures or the user is not an IUT subscriber, SCC AS-1 or UE-1 will return an error. In the illustrated scenario, UE-2 is currently not involved in the Collaborative Session until after Media-A is replicated towards it.

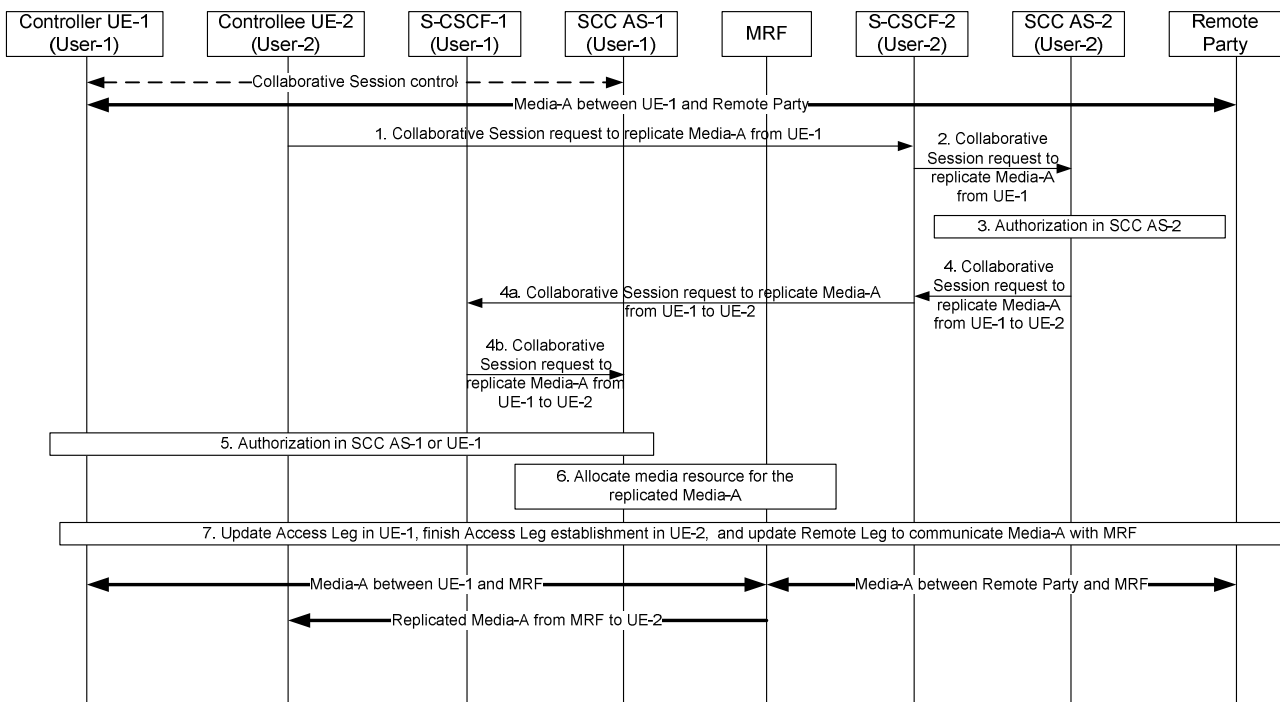

**Figure 6a.10.4-1: Replicating media in network from Controller UE to another UE belonging to different IMS subscription – pull mode**

There is Media-A between Controller UE-1 and remote party.

1. UE-2 sends a request towards UE-1 to replicate Media-A to UE-2. The request includes enough information for the network to:
  - identify the session that contains the media flow to be replicated;
  - identify that the media flow to be replicated is Media-A;
  - identify that the source of the media flow to be replicated is the remote party;
  - identify that the target of the replicated media flow is UE-2.
2. S-CSCF-2 forwards the request to SCC AS-2.
3. SCC AS-2 authorizes the request from UE-2 as specified in clause 6a.12.
4. SCC AS-2 sends a request towards UE-1 to replicate Media-A from the remote party to UE-2. The request includes enough information for the network to:

- identify the session that contains the media flow to be replicated;
- identify the source of the request as UE-2;
- identify that the replicated media flow is Media-A;
- identify that the source of the media flow to be replicated is the remote party;
- identify that the target of the replicated media flow is UE-2.

4a. S-CSCF-2 forwards the request towards UE-1.

4b. S-CSCF-1 forwards the request to SCC AS-1.

5. SCC AS-1 or UE-1 authorizes the request from UE-2.

6. SCC AS-1 allocates media resource for the replicated Media-A.

7. SCC AS-1 updates Access Leg in UE-1, finishes Access Leg establishment in UE-2, and updates Remote Leg to communicate Media-A with MRF.

After the above operation, Media-A is established between Controller UE-1 and MRF, from MRF to Controllee UE-2 and MRF, and between remote party and MRF.

## 6a.11 Session Replication by remote party

### 6a.11.1 Session replication initiated by target UE

The call flow in the figure below shows the scenario where UE-2 requests replication of a session ongoing between UE-1 and a remote UE. After the replication procedure is complete, the sessions are independent.

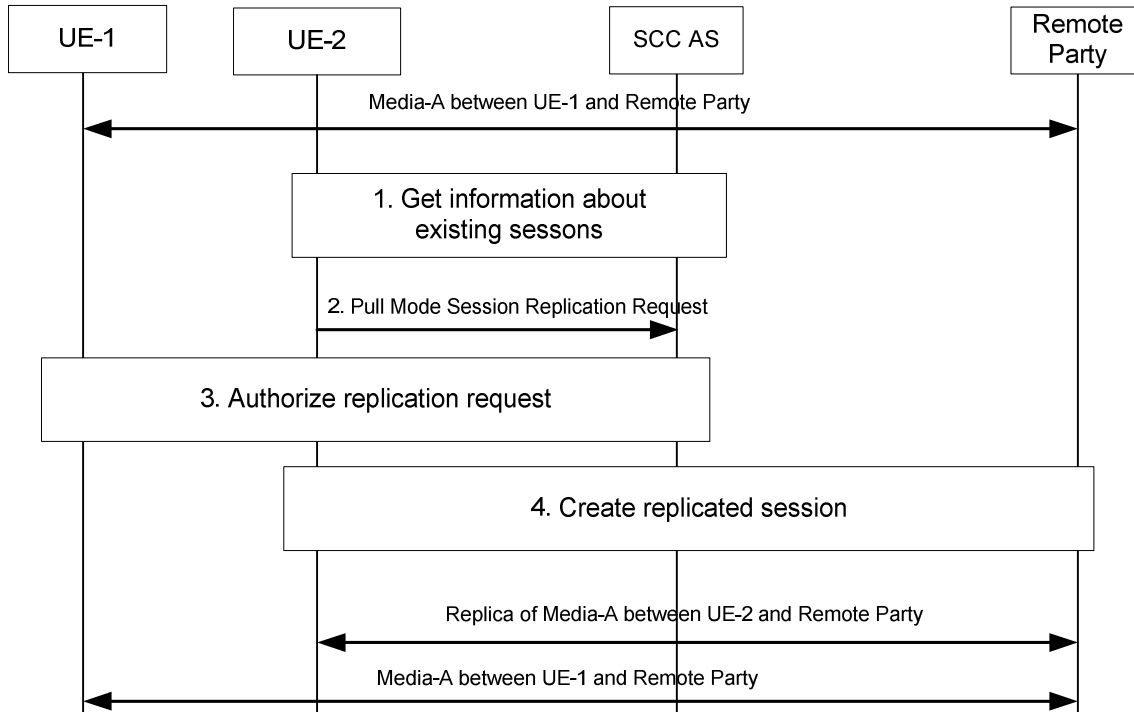

**Figure 6a.11.1-1: Session replication initiated by target UE**

1. UE-2 obtains information about the existing sessions and their media flows.
2. UE-2 uses the session information obtained and to send a session replication request towards the SCC AS. The request indicates that this request is for a session replication request.

3. The SCC AS performs authorization as specified in clause 6a.12; in particular, the SCC AS requests UE-1 to authorize the replication request or the SCC AS authorizes the request on behalf of UE-1 (e.g. pre-configured).
4. If the request is authorized, UE-2 creates a new session with the remote UE. When the new session is established, the state of the original media is replicated e.g. same playback state; same used media etc. is replicated. If the remote party does not support setting up a replicated session, the flow will fail.

NOTE: The session replication data and how it is conveyed from the source UE is not specified in this document.

5. A new session, where the media is a replica of Media-A, is established between UE-2 and the remote UE.

## 6a.11.2 Session replication initiated by source UE

The call flow in the figure below shows the scenario where UE-1 requests replication of a session ongoing between UE 1 and a remote UE to UE-2. After the replication procedure is complete, the sessions are independent. As a pre-requisite, there exists a Session with Media-A on UE-1.

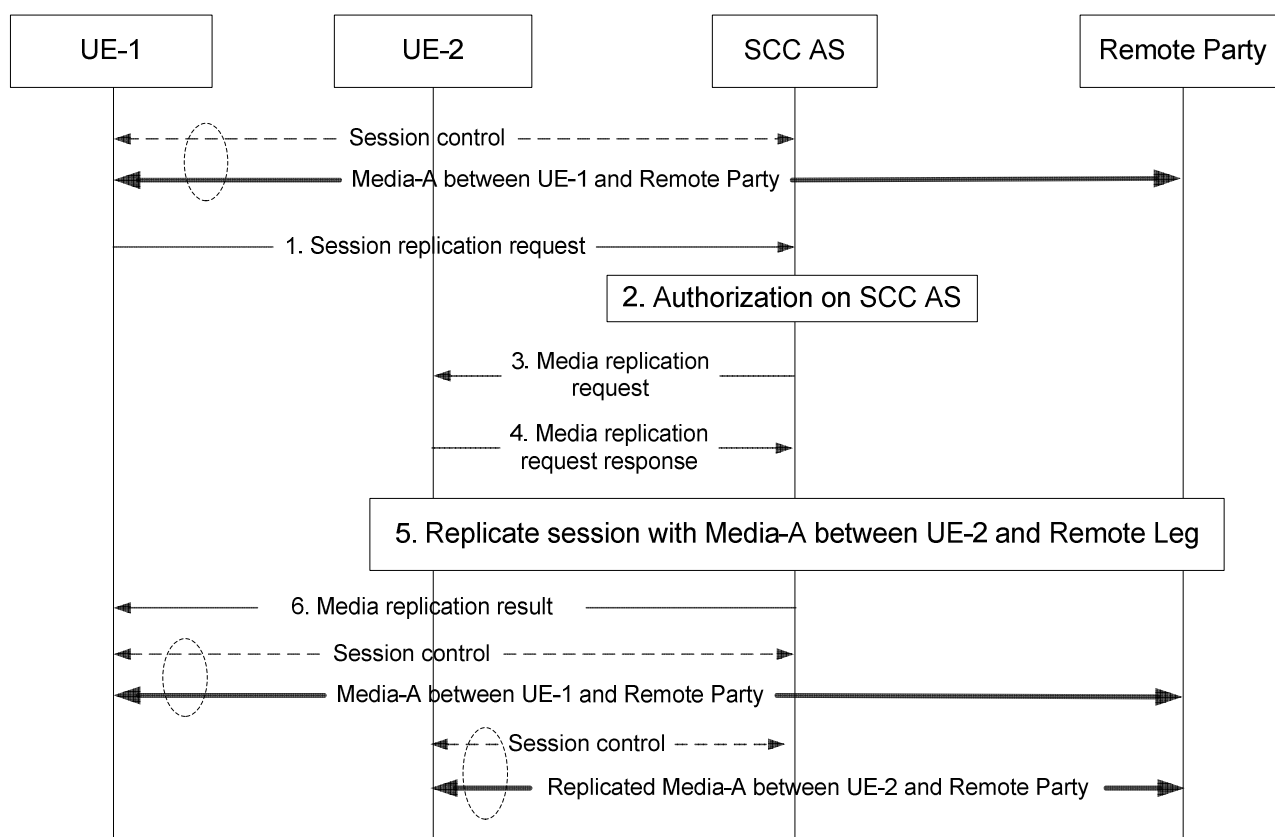

**Figure 6a.11.2-1: Session replication initiated by source UE**

1. UE-1 requests to replicate current session to UE-2 by sending Session Replication Request to SCC AS. The Session Replication Request should contain enough information for the SCC AS to:
  - identify that the session replication source is UE-1;
  - identify that the session replication target is UE-2;
  - identify the remote party.
2. SCC AS performs authorization as specified in clause 6a.12; in particular, the SCC AS checks UE-1 is eligible to request session replication for UE under the same subscription.
3. SCC AS sends Session Replication request to controllee UE-2.
4. UE-2 responds to the Session Replication request.

5. UE-2 initiates a new session with the remote UE. When the new session is established, the state of the original media is replicated, e.g. same playback state, same used media, etc. is replicated. If the remote party does not support setting up a replicated session, the flow will fail.

NOTE: The session replication data and how it is conveyed from the source UE is not specified in this document.

6. A new session, where the media are replica of Media-A, is established between UE-2 and the remote UE.

### 6a.11.3 Session replication initiated by source UE (different subscription)

The call flow in the figure below shows the scenario where UE-1 requests replication of a session ongoing between UE 1 and a remote UE to UE-2. After the replication procedure is complete, the sessions are independent. As a pre-requisite, there exists a Session Media-A on UE-1.

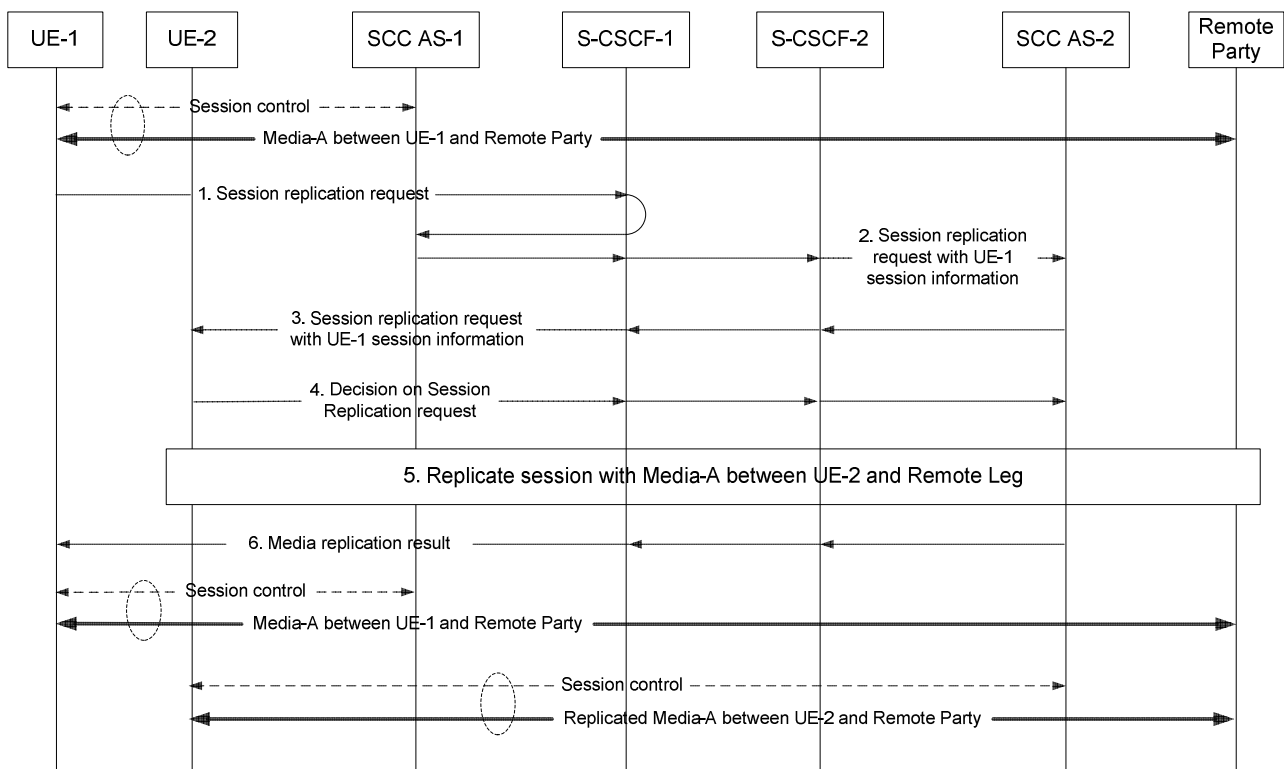

**Figure 6a.11.3-1: Session replication initiated by source UE, different subscriptions**

1. UE-1 requests to replicate current session to UE-2 by sending Session Replication Request to SCC AS-1. The Session Replication Request should contain enough information for the SCC AS to:
  - identify that the session replication source is UE-1;
  - identify that the session replication target is UE-2;
  - identify the remote party.
2. SCC AS-1 identify UE-2 is not under the same subscription as UE-1. It forwards the request to S-CSCF-2 that serves UE-2 together with the information of session on UE-1. S-CSCF-2 further forwards the request to SCC AS-2 that serves UE-2.
3. SCC AS-2 performs authorization as specified in clause 6a.12, then sends Session Replication request together with UE-1 session information to UE-2.
4. UE-2 decides to accept or reject the Session Replication request.
5. If the request is accepted by UE-2, UE-2 initiates a new session with the remote UE. When the new session is established, the state of the original media is replicated, e.g., same playback state, same used media, etc. is replicated.



NOTE 1: If either UE-2 or the remote party does not support setting up a replicated session, the flow will fail.

NOTE 2: The session replication data and how it is conveyed from the source UE is not specified in this document.

6. SCC AS-2 sends Media Replication result to UE-1. A new session, where the media are replica of Media-A, is established between UE-2 and the remote UE.

#### 6a.11.4 Session replication initiated by target UE (different subscription)

The call flow in the figure below shows the scenario where UE-2 requests replication of a session ongoing between UE-1 and a remote UE. UE-1 and UE-2 belongs to different subscriptions. After the replication procedure is complete, the sessions are independent.

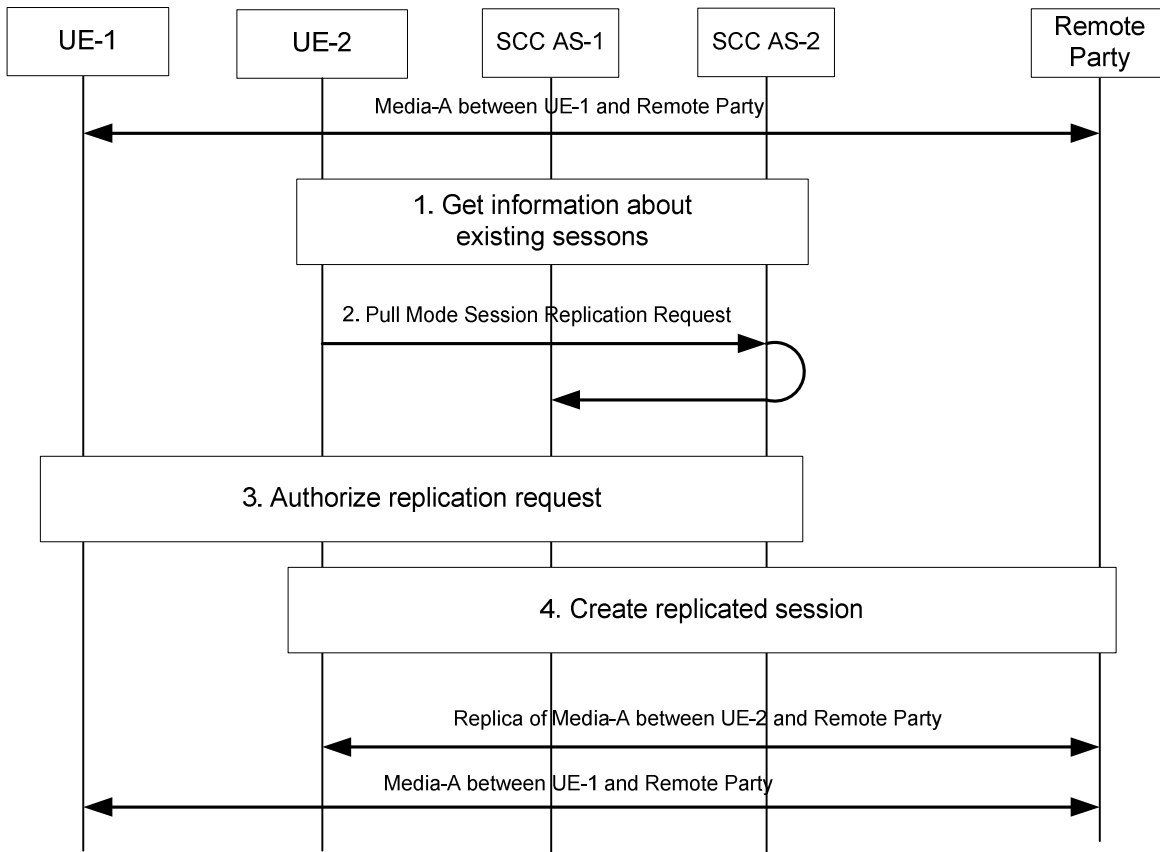

**Figure 6a.11.4-1: Session replication initiated by target UE, different subscriptions**

1. UE-2 obtains information about the existing sessions and their media flows. This information will be sent by the AS serving UE-1 i.e. SCC AS-1 and relayed to UE-1 by SCC AS-2.
2. UE-2 uses the session information obtained and to send a session replication request towards the SCC AS-2, which relays the request to SCC AS-1. The request indicates that this request is for a session replication request.
3. The SCC AS-1 performs authorization as specified in clause 6a.12; in particular, the SCC AS-1 requests UE-1 to authorize the replication request or the SCC AS-1 authorizes the request on behalf of UE-1 (e.g. pre-configured).
4. If the request is authorized, UE-2 creates a new session with the remote UE. When the new session is established, the state of the original media is replicated e.g. same playback state; same used media etc. is replicated. If the remote party does not support setting up a replicated session, the flow will fail.

NOTE: The session replication data and how it is conveyed from the source UE is not specified in this document.

5. A new session, where the media is a replica of Media-A, is established between UE-2 and the remote UE.

## 6a.12 User authorisation and preferences

There are two different kinds of authorization in the IUT architecture:

Authorization by the SCC AS. The SCC AS responsibilities includes:

- checking that the subscription allows the requested operation
- enforcing network based user preferences, e.g. check whether other UEs shall be allowed to retrieve session information related to the UE.
- enforcing restrictions provided by the remote party network. The SCC AS shall reject requests for Inter-UE Transfer operations on sessions where the remote party is served by a network that has expressed preferences to restrict Inter-UE transfer actions on on-going sessions between the remote party and an IUT user served by the SCC AS.

**NOTE:** The remote party network, through service agreements with the network operator serving the IUT user, can restrict IUT actions to be performed on sessions that users served by the remote party network are involved in. Such restrictions are expected to be applied on all sessions the remote party users are involved in. In the absence of privacy preferences indicated by the remote party network, the default behaviour of the SCC AS serving the IUT user is to carry out any requested IUT actions subject to other successful authorization checks.

Authorization of incoming request by the UE. The UE based authorization includes:

- authorization through end-user interaction, e.g. the end user authorizes requests for IUT Media Control Related Procedures by pressing a button on the device.
- automatic authorization by UE configuration, e.g. the UE automatically authorizes requests for IUT Media Control Related Procedures from a specific device.

The UE based authorization is considered to be a local implementation of the UE.

If the user requires configuring IUT authorisation and preference settings to the SCC AS, this shall be possible via the Ut interface. The information that can be configured includes:

- UEs authorised by the user to perform the IUT Media Control Related Procedures; and
- authorisation for the SCC AS to preferentially route incoming session invitations from the remote party towards Controller capable UE(s). The user may additionally define criteria to determine whether to preferentially route incoming session invitations from the remote party towards Controller capable UE(s). It shall be possible to apply, for example, the following criteria and combinations of the following criteria to the incoming request:
  - Calling party identity (Public User Identity);
  - Called party identity used;
  - Identification of the Service (Service Identifier); and
  - Media types being offered in the incoming request.

The SCC AS shall take in account operator policy and the above user preferences when determining:

- whether the UE is authorised to perform the Controller UE functions, and
- whether to preferentially route incoming session requests from a remote party towards Controller capable UE(s).

---

## 6b Void

## 6c Procedures and flows for SRVCC Emergency Session

### 6c.1 IMS Emergency origination flow for PS to CS SRVCC

Figure 6c.1-1 provides flow for an emergency session established in IMS, illustrating how the emergency session is anchored in the EATF.

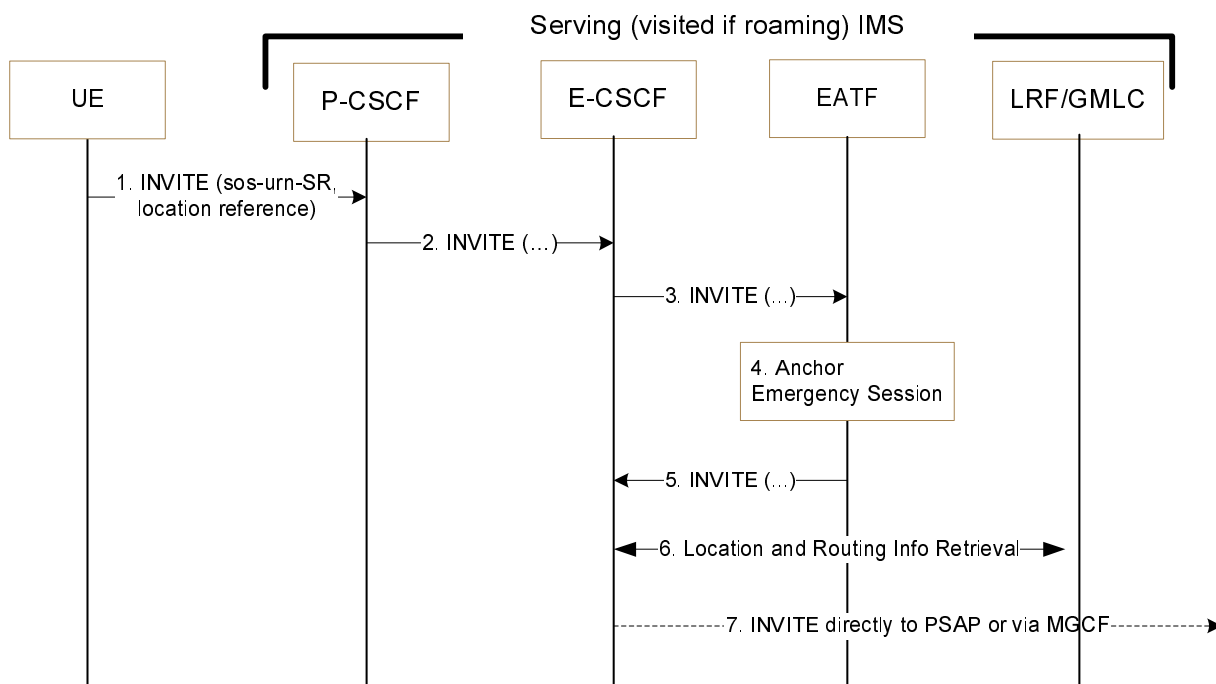
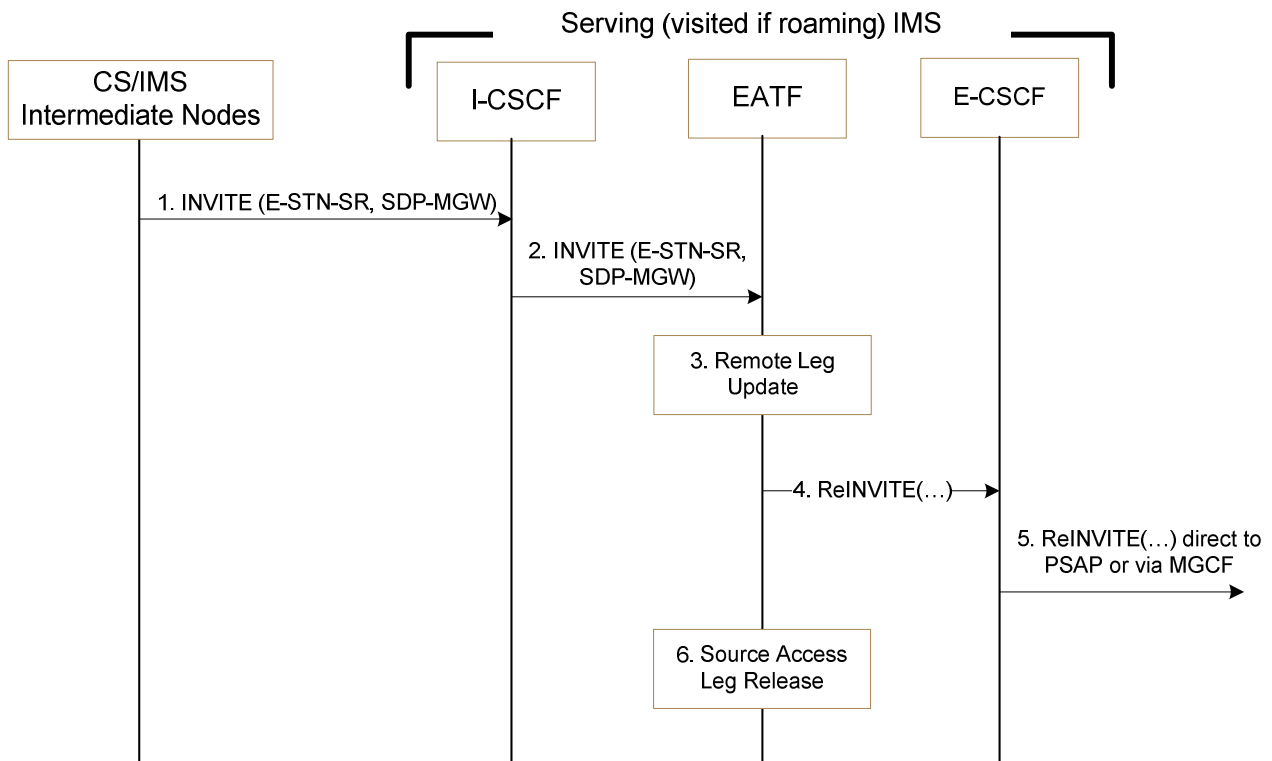

**Figure 6c.1-1: UE initiating an emergency session in IMS**

1. The UE initiates an IMS emergency session over EPS or GPRS and the procedures defined in TS 23.167 [23]. This involves the UE generating a SIP INVITE containing the UE's location information and the equipment identifier.
2. The P-CSCF selects an E-CSCF and forwards the INVITE to the E-CSCF.
3. The E-CSCF sends the INVITE to the EATF.
4. The EATF (acting as a routing B2BUA) anchors the emergency session, i.e. the EATF is inserted in the signalling path which invokes a 3pcc for enablement of Access Transfers for the call as specified in clause 6.3.1.3.
5. The EATF creates a new INVITE and sends it back to E-CSCF.
6. For this optional procedure, refer to TS 23.167 [23].
7. The E-CSCF uses the routing information to format the INVITE message, and it sends it directly to the PSAP, or to the PSAP via the MGCF.

### 6c.2 SRVCC session transfer of IMS emergency session for PS to CS

Figure 6c.2-1 provides flow for SRVCC for IMS emergency session.



**Figure 6c.2-1: IMS level Call flow for SRVCC for IMS emergency session with E-STN-SR**

1. MSC Server initiates the session transfer with the E-STN-SR and it includes the equipment identifier.
2. The I-CSCF routes the INVITE directly to the EATF via I5 by using similar procedures to that defined in TS 23.228 [4] for PSI based Application Server termination.

NOTE 1: The use of indirect routing for PSI based Application Server Termination as described in TS 23.228 [4] in clause 5.7.6 cannot be used for routing the INVITE to the EATF.

- 3 - 4. The EATF uses the E-STN-SR to determine that Access Transfer is requested. The EATF proceeds with the Access Transfer of the active session with bi-directional speech for the UE by updating the Remote Leg with the media description and other information using the Remote Leg Update procedure as specified in clause 6.3.1.5.
5. The E-CSCF forwards the Re-INVITE to the MGCF associated with the PSAP if the PSAP is located in the PSTN or CS Domain (the u-plane path is switched between the UE and the MGW) or the Re-INVITE is sent directly to an IP-capable PSAP (the u-plane path between the UE and the PSAP is switched end-to-end).
6. When session modification procedures complete, the source access leg (i.e. the access leg previously established over IMS) is released as specified in clause 6.3.1.6.

NOTE 2: If non-voice media was part of the original Multimedia emergency call session, the non-voice media will be released.

## 6c.3 SRVCC Support for UEs in Normal Mode

If the MSC enhanced for PS to CS SRVCC has a SIP interface, it shall use the mechanism specified in TS 24.229 [26] additionally to carry the equipment identifier to the EATF.

If the MSC enhanced for PS to CS SRVCC does not have a SIP interface, it shall convey the equipment identifier by using the IAM message to the MGCF. The MGCF shall use the mechanism specified in TS 24.229 [26] additionally to carry the equipment identifier to the EATF.

The EATF can then correlate the call legs according to the equipment identifier.

NOTE: The method for correlation of the call legs at the EATF if SIP or ISUP does not provide this information is implementation and configuration dependant.

## 6c.4 SRVCC Support for UEs in Limited Service Mode

To support SRVCC procedure for UEs in Limited Service Mode for PS to CS, the MSC enhanced for SRVCC will setup the call leg towards the EATF with the UE's equipment identifier.

If the MSC enhanced for PS to CS SRVCC has a SIP interface, it shall use the mechanism specified in TS 24.229 [26] to carry equipment identifier to the EATF.

If the MSC enhanced for PS to CS SRVCC does not have a SIP interface, it shall convey the equipment identifier by using the IAM message to the MGCF. The MGCF shall use the mechanism specified in TS 24.229 [26] to carry equipment identifier to the EATF.

NOTE: The method for correlation of the call legs at the EATF if SIP or ISUP does not provide this information is implementation dependant.

---

## 7 Security

### 7.1 General

There are no impacts on existing security mechanisms for the CS Domain or for IMS as a result of Session Transfers.

### 7.2 Access security for CS Domain

TS 33.102 [11] describes the Security Architecture for GSM and UMTS subscribers, SC places no additional requirements upon the CS domain security than those already in the detailed access specific specification e.g., above those described in TS 33.102 [11].

### 7.3 Access security for IMS

TS 33.203 [12] specifies the security features and mechanisms for secure access to the IM subsystem (IMS). SC places no additional requirements upon the IMS above those described in TS 33.203 [12].

---

## 8 Charging

### 8.1 Charging strategy

To ensure the completeness and correctness of charging during Session Transfer procedure, and to avoid possible double billing in IMS and CS, the following strategy should be applied:

- Provide cohesive charging records with a complete service continuity history for the whole duration of a SC subscriber multimedia session by the SCC AS.
- For cases of CS origination and CS termination, correlate the charging records generated in CS and IMS for the subscriber multimedia session, to avoid double billing to the subscriber.
- Treat the charging records generated in the transferring-in access network for the call(s)/session(s) established during the Session Transfer as subsequent Access Legs, and therefore do not impact the direction of the initial call(s)/session(s) for the purpose of charging.
- Keep the start of charging in the transferring-in access network align with the stop of charging in the transferring-out access network, to avoid double billing to the subscriber during the Session Transfer.

To avoid online charging correlation in IMS and CS domain, the SC online charging should be performed only in IMS, i.e. prepaid service logic in CS domain should not be invoked for anchored CS origination/termination call and subsequent CS origination call established for performing Session Transfer. In addition, the SCC AS should report

information related to the initial multimedia session establishment as well as the information related to the Session Transfer procedure to OCS for correct credit control purpose.

## 8.2 Accounting strategy

To assist in performing the settlement between operators, the following strategy shall be applied:

- Provide cohesive charging records with a complete service continuity history for the whole duration of a SC subscriber multimedia session by the SCC AS.
- Use the charging records for subsequent Access Legs generated in CS/IMS domain and the charging records generated in MGCF performing CS-IMS interworking, taking the complete service continuity history described above as reference, to perform the settlement between the providers of CS domain and IMS.
- Use the access network information in IMS charging records, taking the complete service continuity history described above as reference, to perform the settlement between the providers of IP-CAN and IMS Core.
- Additional reconciliation for I1 flows can also be applied, due to such flows being uniquely identifiable from other flows over the same bearer (see clause 5.4.1 of TS 23.292 [5] for more information).
- At least in roaming scenarios, the SCC-AS returns the ICID of the original access leg to the MSC-Server for the MSC-Server to include in charging records.

# Annex A (informative): Controller UE and Controllee UE operations

## A.1 General

Table A.1-1 provides an overview of Controller UE and Controllee UE operations. The operations of the Controllee UE without IUT capabilities are the same as those of the Controllee UE in Release 9

**Table A.1-1: Controller UE and Controllee UE operations**

Operations		Controller UE	Controller UE Comment	Controllee UE with IUT Capabilities	Controllee UE with IUT Capabilities Comment	Controllee UE without IUT Capabilities	Controllee UE without IUT Capabilities Comment
Add media flow (local end initiating case)	Add media flow by creating a new Access Leg on the same UE	Yes	Standard SC procedures.	Yes	Standard SC procedures.	No	
	Add media flow by creating a new Access Leg on a different UE	Yes	Rel-9 capability of IUT.	Yes	Rel-10 New capability of IUT.	No	
	Add media flow to an existing Access Leg on the same UE	Yes	Standard IMS procedures.	Yes	Standard IMS procedures.	No	
	Add media flow to an existing Access Leg on a different UE	Yes	Rel-9 capability of IUT.	Yes	Rel-10 New capability of IUT.	No	
Remove media flow (local end initiating case)	Remove media flow from an Access Leg on the same UE	Yes	Standard IMS procedures.	Yes	Standard IMS procedures.	Yes	Standard IMS procedures.
	Remove media flow from an Access Leg on a different UE	Yes	Rel-9 capability of IUT.	Yes	Rel-10 New capability of IUT.	No	
Invoke Supp Services	MMTEL service control with media on the same UE (TS 22.173 [15])	Yes	Standard IMS procedures.	Yes	Rel-10 New capability of IUT.	No	
	MMTEL service control with media on a different UE (TS 22.173 [15])	Yes	Rel-9 capability of IUT.	No		No	
Collaborative Session Release		Yes	Rel-9 capability of IUT.	No		No	

Operations		Controller UE	Controller UE Comment	Controllee UE with IUT Capabilities	Controllee UE with IUT Capabilities Comment	Controllee UE without IUT Capabilities	Controllee UE without IUT Capabilities Comment
Renegotiate media characteristics (local end initiating side)	Update of media characteristics on the same UE	Yes	Standard IMS procedures.	Yes	Standard IMS procedures.	Yes	Standard IMS procedures.
	Update of media characteristics on a different UE	Yes	Rel-10 New capability of IUT.	Yes	Rel-10 New capability of IUT.	No	
Transfer of media flow	Transfer media flow from the same UE to a different UE	Yes	Rel-9 capability of IUT.	Yes	Rel-10 New capability of IUT.	No	
	Transfer media flow from a different UE to another different UE	Yes	Rel-9 capability of IUT.	Yes	Rel-10 New capability of IUT.	No	
	Transfer media flow from a different UE to the same UE	Yes	Rel-9 capability of IUT.	Yes	Rel-10 New capability of IUT.	No	
Transfer of Collaborative Session control	Transfer Collaborative Session control from the same UE to a different UE	Yes	Rel-10 New capability of IUT. Only transfer to a different UE of the same service profile and same subscription is supported.	No		No	
	Transfer Collaborative Session control from a different UE to the same UE	No		Yes	Rel-10 New capability of IUT. Only transfer from a different UE of the same service profile and same subscription is supported.	No	
Replication of media flow	Replicate media flow from the same UE to a different UE	Yes	Rel-10 New capability of IUT.	Yes	Rel-10 New capability of IUT.	No	
	Replicate media flow from a different UE to another different UE	Yes	Rel-10 New capability of IUT.	Yes	Rel-10 New capability of IUT.	No	
	Replicate media flow from a different UE to the same UE	Yes	Rel-10 New capability of IUT.	Yes	Rel-10 New capability of IUT.	No	



## Annex B (informative): Change history

Change history								
Date	TSG #	TSG Doc.	CR	Rev	Cat	Subject/Comment	Old	New
2011-03	SP-51	SP-110075	0347	4	F	UE SRVCC capability support with ATCF enhancements	10.4.1	10.5.0
2011-03	SP-51	SP-110075	0348	1	F	Reference correction in clause 6.3.2.1.4	10.4.1	10.5.0
2011-03	SP-51	SP-110075	0352	1	F	Correcting the IP address change behaviour	10.4.1	10.5.0
2011-03	SP-51	SP-110075	0353	-	F	Editor's note cleanup	10.4.1	10.5.0
2011-03	SP-51	SP-110075	0354	-	F	ATGW transcoding support clarification	10.4.1	10.5.0
2011-03	SP-51	SP-110069	0358	1	F	IUT authorization by the SCC AS	10.4.1	10.5.0
2011-03	SP-51	SP-110069	0359	1	F	Check of service profile during IUT without establishing a Collaborative Session	10.4.1	10.5.0
2011-03	SP-51	SP-110063	0363	2	A	Correction to correlation of charging information collected at the MSC for SRVCC in roaming scenarios	10.4.1	10.5.0
2011-03	SP-51	SP-110081	0361	3	B	PS-CS Single Radio Access transfer for vSRVCC	10.5.0	11.0.0
2011-06	SP-52	SP-110342	0366	1	F	Remove editor's note for alerting in case of vSRVCC	11.0.0	11.1.0
2011-06	SP-52	SP-110342	0367	2	F	Remove editor's note on end-to-end video codec negotiation in case of vSRVCC	11.0.0	11.1.0
2011-06	SP-52	SP-110337	0370	1	A	Correction of Access Transfer Information handling for ATCF	11.0.0	11.1.0
2011-06	SP-52	SP-110329	0376	-	A	Correction on Controllee UE Role	11.0.0	11.1.0
2011-06	SP-52	SP-110329	0378	-	A	Correction on Remote Leg Update for IUT	11.0.0	11.1.0
2011-06	SP-52	SP-110329	0380	1	A	Clarification on Controller UE initiated media transfer from Controllee UE to another Controllee UE	11.0.0	11.1.0
2011-06	SP-52	SP-110329	0382	1	A	Correction and Clarification on Controllee UE initiated add new media on another Controllee UE	11.0.0	11.1.0
2011-06	SP-52	SP-110329	0384	-	A	Correction and Clarification on pull mode media transfer (same IMS subscription)	11.0.0	11.1.0
2011-09	SP-53	SP-110461	0391	2	A	Update of retrieval of C-MSISDN	11.1.0	11.2.0
2011-09	SP-53	SP-110461	0395	1	A	Update of SIP message routing due to AS PSI	11.1.0	11.2.0
2011-09	SP-53	SP-110461	0399	2	A	ATGW co-location clarification	11.1.0	11.2.0
2011-09	SP-53	SP-110461	0403	-	A	Clarification to SRVCC of the session in pre-alerting state	11.1.0	11.2.0
2011-09	SP-53	SP-110464	0400	1	B	eMPS for SRVCC on IMS level	11.1.0	11.2.0
2011-12	SP-54	SP-110737	0413	1	A	Source access leg release for IMS emergency sessions	11.2.0	11.3.0
2011-12	SP-54	SP-110737	0415	2	A	Update on interface reference between ATCF and ATGW and reference index alignment	11.2.0	11.3.0
2011-12	SP-54	SP-110745	0404	1	F	Clarification of predefined codecs and PS to CS transfer of speech and video	11.2.0	11.3.0
2011-12	SP-54	SP-110745	0405	-	F	Clarification of PS to CS transfer of speech and video in case of vSRVCC	11.2.0	11.3.0
2011-12	SP-54	SP-110747	0407	2	B	Introduction of SRVCC from CS to PS	11.2.0	11.3.0
2011-12	SP-54	SP-110740	0411	1	B	Clarification of emergency for SRVCC when using non-voice media	11.2.0	11.3.0
2011-12	SP-54	SP-110748	0417	2	B	Requirements for IUT remote end privacy preferences	11.2.0	11.3.0
2011-12	SP-54	SP-110748	0418	1	F	Clarification of the Source Access Leg Release procedure	11.2.0	11.3.0
2012-03	SP-55	SP-120075	0424	1	A	Removal of Instance ID in Session Transfer INVITE for SRVCC in alerting state	11.3.0	11.4.0
2012-03	SP-55	SP-120088	0420	1	F	PS to CS Dual Radio Access Transfer	11.3.0	11.4.0
2012-03	SP-55	SP-120088	0421	1	F	UE using ICS Capabilities in case of PS-CS Access Transfer	11.3.0	11.4.0
2012-03	SP-55	SP-120084	0422	-	F	Clarification on the media gateway between PGW/GGSN and ATGW.	11.3.0	11.4.0
2012-03	SP-55	SP-120084	0425	1	C	Emergency call handling in rSRVCC	11.3.0	11.4.0
2012-06	SP-56	SP-120242	0416	2	C	Clarification on eMPS SRVCC	11.4.0	11.5.0
2012-06	SP-56	SP-120250	0426	2	F	Single Radio and Dual Radio clarification	11.4.0	11.5.0
2012-06	SP-56	SP-120248	0427	3	F	Providing rSRVCC capability in IMS layer	11.4.0	11.5.0
2012-06	SP-56	SP-120245	0428	2	F	Clarification on vSRVCC additional call transfer	11.4.0	11.5.0
2012-06	SP-56	SP-120248	0429	-	F	ATU-STI alignments and corrections	11.4.0	11.5.0
2012-06	SP-56	SP-120250	0432	2	F	Single Radio and Dual Radio applicability	11.4.0	11.5.0
2012-12	SP-58	SP-120714	0438	1	A	Correction of the requirements for I2 interface and SRVCC corrections	11.5.0	11.6.0
2012-12	SP-58	SP-120714	0447	2	A	Correction to avoid the ATCF's STN-SR to be overwritten when a registration over I2 or non-3GPP access occurs	11.5.0	11.6.0
2012-12	SP-58	SP-120715	0449	2	A	Definition of the MSC Assisted Mid-call feature	11.5.0	11.6.0
2012-12	SP-58	SP-120726	0454	1	F	Suppression of announcements by MSC Server	11.5.0	11.6.0
2013-03	SP-59	SP-130087	0456	-	F	I2 registration for rSRVCC	11.6.0	11.7.0
2013-06	SP-60	SP-130213	0460	1	A	Clarification on aSRVCC mid-call	11.7.0	11.8.0

Change history								
Date	TSG #	TSG Doc.	CR	Rev	Cat	Subject/Comment	Old	New
2013-06	SP-60	SP-130223	0462	1	F	Clarification regarding conference call participants leaving the conference	11.7.0	11.8.0
2013-09	SP-61	SP-130378	0466	2	F	Correction of IMEI encoding	11.8.0	11.9.0

---

## History

<b>Document history</b>		
V11.5.0	November 2012	Publication
V11.6.0	January 2013	Publication
V11.7.0	April 2013	Publication
V11.8.0	June 2013	Publication
V11.9.0	September 2013	Publication