

# ETSI TS 123 272 V9.3.0 (2010-03)

---

*Technical Specification*

**Digital cellular telecommunications system (Phase 2+);  
Universal Mobile Telecommunications System (UMTS);  
LTE;  
Circuit Switched (CS)  
fallback in Evolved Packet System (EPS);  
Stage 2  
(3GPP TS 23.272 version 9.3.0 Release 9)**

---



---

**Reference**

RTS/TSGS-0223272v930

---

**Keywords**

GSM, LTE, UMTS

**ETSI**

---

650 Route des Lucioles  
F-06921 Sophia Antipolis Cedex - FRANCE

Tel.: +33 4 92 94 42 00 Fax: +33 4 93 65 47 16

Siret N° 348 623 562 00017 - NAF 742 C  
Association à but non lucratif enregistrée à la  
Sous-Préfecture de Grasse (06) N° 7803/88

---

**Important notice**

Individual copies of the present document can be downloaded from:

<http://www.etsi.org>

The present document may be made available in more than one electronic version or in print. In any case of existing or perceived difference in contents between such versions, the reference version is the Portable Document Format (PDF). In case of dispute, the reference shall be the printing on ETSI printers of the PDF version kept on a specific network drive within ETSI Secretariat.

Users of the present document should be aware that the document may be subject to revision or change of status. Information on the current status of this and other ETSI documents is available at

<http://portal.etsi.org/tb/status/status.asp>

If you find errors in the present document, please send your comment to one of the following services:

[http://portal.etsi.org/chaicor/ETSI\\_support.asp](http://portal.etsi.org/chaicor/ETSI_support.asp)

---

**Copyright Notification**

No part may be reproduced except as authorized by written permission.  
The copyright and the foregoing restriction extend to reproduction in all media.

© European Telecommunications Standards Institute 2010.  
All rights reserved.

**DECT™**, **PLUGTESTS™**, **UMTS™**, **TIPHON™**, the TIPHON logo and the ETSI logo are Trade Marks of ETSI registered for the benefit of its Members.

**3GPP™** is a Trade Mark of ETSI registered for the benefit of its Members and of the 3GPP Organizational Partners.

**LTE™** is a Trade Mark of ETSI currently being registered

for the benefit of its Members and of the 3GPP Organizational Partners.

**GSM®** and the GSM logo are Trade Marks registered and owned by the GSM Association.

---

## Intellectual Property Rights

IPRs essential or potentially essential to the present document may have been declared to ETSI. The information pertaining to these essential IPRs, if any, is publicly available for **ETSI members and non-members**, and can be found in ETSI SR 000 314: *"Intellectual Property Rights (IPRs); Essential, or potentially Essential, IPRs notified to ETSI in respect of ETSI standards"*, which is available from the ETSI Secretariat. Latest updates are available on the ETSI Web server (<http://webapp.etsi.org/IPR/home.asp>).

Pursuant to the ETSI IPR Policy, no investigation, including IPR searches, has been carried out by ETSI. No guarantee can be given as to the existence of other IPRs not referenced in ETSI SR 000 314 (or the updates on the ETSI Web server) which are, or may be, or may become, essential to the present document.

---

## Foreword

This Technical Specification (TS) has been produced by ETSI 3rd Generation Partnership Project (3GPP).

The present document may refer to technical specifications or reports using their 3GPP identities, UMTS identities or GSM identities. These should be interpreted as being references to the corresponding ETSI deliverables.

The cross reference between GSM, UMTS, 3GPP and ETSI identities can be found under <http://webapp.etsi.org/key/queryform.asp>.

# Contents

Intellectual Property Rights .....	2
Foreword.....	2
Foreword.....	6
1 Scope .....	7
2 References .....	7
3 Definitions and abbreviations.....	8
3.1 Definitions .....	8
3.2 Abbreviations .....	9
4 Overall Description .....	9
4.1 General Considerations .....	9
4.2 Reference Architecture.....	9
4.2.1 Reference points .....	10
4.3 Functional entities .....	10
4.3.1 UE.....	10
4.3.2 MME.....	11
4.3.3 MSC.....	11
4.3.4 E-UTRAN.....	11
4.3.5 SGSN.....	12
4.3.6 BSS .....	12
4.4 Control plane.....	12
4.4.1 MME - MSC Server.....	12
4.5 Co-existence with IMS services .....	12
4.6 Emergency Calls .....	12
5 Mobility Management.....	13
5.1 General .....	13
5.1A TAI list and LAI allocation .....	13
5.2 Attach procedure .....	13
5.3 Detach procedure.....	15
5.3.1 UE-initiated Detach procedure .....	15
5.3.2 MME-initiated Detach procedure .....	15
5.3.3 HSS-initiated Detach procedure .....	16
5.3.4 Administration of the MME - MSC/VLR Association .....	17
5.4 TA/LA Update procedure.....	17
5.4.0 General.....	17
5.4.1 Combined TA/LA Update Procedure .....	17
5.4.2 Periodic TA and LA Update Procedure .....	18
5.4.3 Non-EPS Alert procedure .....	19
5.4.4 Void .....	19
5.5 Idle Mode Signalling Reduction.....	19
5.6 Mobility Management for SMS over SGs only UEs .....	19
6 Mobile Originating Call .....	20
6.1 General .....	20
6.2 Mobile Originating call in Active Mode - PS HO supported .....	20
6.3 Mobile Originating call in Active Mode – No PS HO support .....	22
6.4 Mobile Originating call in Idle Mode.....	24
6.5 Returning back to E-UTRAN.....	24
7 Mobile Terminating Call.....	25
7.1 General .....	25
7.2 Mobile Terminating call in idle mode .....	25
7.3 Mobile Terminating call in Active Mode - PS HO supported .....	27
7.4 Mobile Terminating call in Active Mode - No PS HO support.....	30

7.5	Roaming Retry for CS fallback .....	33
7.6	Returning back to E-UTRAN .....	34
7.7	Interaction with ISR .....	34
7.7.1	Void .....	34
7.7.2	Mobile Terminating Call when ISR is active and SGs is active between MSC/VLR and MME .....	34
7.7.3	Void .....	35
7.8	Mobile Terminating Call when SGs is not active.....	35
8	Other CS Services .....	35
8.1	General .....	35
8.2	Short Message Service (SMS).....	35
8.2.1	General.....	35
8.2.2	Mobile originating SMS in Idle Mode.....	35
8.2.3	Mobile originating SMS in Active Mode .....	37
8.2.3a	Multiple Mobile originating SMSs .....	37
8.2.4	Mobile terminating SMS in idle mode.....	37
8.2.5	Mobile terminating SMS in Active Mode.....	38
8.2.5a	Multiple Mobile terminating SMSs .....	38
8.2.5b	Simultaneous Mobile terminating and Mobile originating SMSs.....	38
8.2.5c	Unsuccessful Mobile terminating SMS delivery attempt .....	38
8.2.5d	Non-SMS Mobile terminating activity during SMS delivery .....	39
8.2.5e	Non-SMS Mobile originating activity during SMS delivery .....	39
8.2.5f	Mobile Terminating SMS when ISR is active and SGs is active between MSC/VLR and MME .....	39
8.2.6	Co-Existence with SMS over generic 3GPP IP access .....	39
8.3	Location Services (LCS) .....	39
8.3.1	MO-LR procedure .....	39
8.3.2	MT-LR procedure .....	40
8.3.3	NI-LR procedure.....	41
8.3.4	Returning back to E-UTRAN .....	41
8.3.5	Co-Existence with Other Location Services .....	41
8.3.5.1	Co-Existence with SUPL .....	41
8.4	Call Independent Supplementary Services .....	41
8.4.1	Mobile-Initiated Call Independent SS procedure.....	41
8.4.2	NW-Initiated Call Independent SS procedure .....	42
8.4.3	Returning back to E-UTRAN .....	42
<b>Annex A:</b>	<b>    Void .....</b>	<b>43</b>
<b>Annex B (normative):</b>	<b>    CS Fallback to 1xRTT .....</b>	<b>44</b>
B.1	Overall Description .....	44
B.1.1	General Considerations .....	44
B.1.2	Reference Architecture .....	44
B.1.2.1	Reference points .....	45
B.1.3	Functional entities .....	45
B.1.3.1	UE.....	45
B.1.3.2	MME.....	45
B.1.3.3	E-UTRAN.....	46
B.1.4	Co-existence with IMS services .....	46
B.2	Procedures .....	46
B.2.1	Mobility Management .....	46
B.2.1.1	1x RTT CS Pre-Registration over EPS Procedure .....	46
B.2.1.2	S102 Tunnel Redirection .....	48
B.2.1.3	UE-initiated Detach Procedure .....	49
B.2.2	Mobile Originating Call in Active Mode .....	49
B.2.2a	Mobile Originating call in Idle Mode.....	51
B.2.3	Mobile Terminating Call .....	51
B.2.3a	Enhanced CS fallback to 1xRTT Procedure.....	53
B.2.3a.1	General .....	53
B.2.3a.2	Mobile Originating Call without concurrent PS handover, or with concurrent non-optimised PS handover or optimised idle-mode PS handover.....	53
B.2.3a.3	Mobile Originating Call with concurrent optimised PS handover .....	55

B.2.3a.4	Mobile Terminating Call without PS handover, or with concurrent non-optimised PS handover or optimised idle-mode PS handover.....	57
B.2.3a.5	Mobile Terminating Call with concurrent optimised PS handover .....	58
B.2.3a.6	Interaction between enhanced CS Fallback to 1xRTT and optimised PS handover.....	59
B.2.4	Short Message Service (SMS).....	59
B.2.4.1	General.....	59
B.2.4.2	Mobile originating SMS .....	60
B.2.4.3	Mobile terminating SMS .....	61
B.2.5	Emergency Calls .....	62
B.3	CS Fallback for UEs with dual Rx configuration.....	62
B.3.1	General Considerations .....	62
B.3.2	Procedures for leaving E-UTRAN .....	62
B.3.3	Procedures for returning to E-UTRAN .....	64
<b>Annex C (informative):</b>	<b>Change history .....</b>	<b>65</b>
History .....		67

---

## Foreword

This Technical Specification has been produced by the 3rd Generation Partnership Project (3GPP).

The contents of the present document are subject to continuing work within the TSG and may change following formal TSG approval. Should the TSG modify the contents of the present document, it will be re-released by the TSG with an identifying change of release date and an increase in version number as follows:

Version x.y.z

where:

- x the first digit:
  - 1 presented to TSG for information;
  - 2 presented to TSG for approval;
  - 3 or greater indicates TSG approved document under change control.
- y the second digit is incremented for all changes of substance, i.e. technical enhancements, corrections, updates, etc.
- z the third digit is incremented when editorial only changes have been incorporated in the document.

---

# 1 Scope

This document defines the Stage 2 architecture and specification for the CS Fallback and for SMS over SGs for EPS or CS Fallback and SMS over S102. The scope of this document includes the architecture enhancements for functionality to enable fallback from E-UTRAN access to UTRAN/GERAN CS domain access and to CDMA 1x RTT CS domain access, and functionality to reuse of voice and other CS-domain services (e.g. CS UDI video / LCS / USSD) by reuse of the CS domain. The functionality specified to support SMS over SGs does not trigger any CS Fallback to UTRAN/GERAN. The functionality specified to support SMS over S102 does not trigger any CS Fallback to CDMA 1xRTT CS domain.

The architecture enhancements to support CS fallback to CDMA 1x RTT CS domain access for UEs with single and dual receiver configurations are specified in Annex B.

In this Release of the specification no mechanisms are specified to support CS Fallback to both UTRAN/GERAN and CDMA 1xRTT in the same PLMN. So, even when a UE has the capability to support both CS Fallback to UTRAN/GERAN CS domain and CS Fallback to CDMA 1xRTT CS domain in a given PLMN, the PLMN implements only one of the two.

---

# 2 References

The following documents contain provisions which, through reference in this text, constitute provisions of the present document.

- References are either specific (identified by date of publication, edition number, version number, etc.) or non-specific.
- For a specific reference, subsequent revisions do not apply.
- For a non-specific reference, the latest version applies. In the case of a reference to a 3GPP document (including a GSM document), a non-specific reference implicitly refers to the latest version of that document *in the same Release as the present document*.

- [1] 3GPP TR 21.905: "Vocabulary for 3GPP Specifications".
- [2] 3GPP TS 23.401: "GPRS Enhancements for E-UTRAN Access".
- [3] 3GPP TS 23.060: "General Packet Radio Service (GPRS); Service description; Stage 2".
- [4] 3GPP TS 44.018: "Mobile radio interface layer 3 specification Radio Resource Control (RRC) protocol".
- [5] 3GPP TS 23.018: "Basic call handling; Technical realization".
- [6] 3GPP TS 48.008: "MSC-BSS interface layer 3 specification; Protocol specification".
- [7] 3GPP TS 25.331: "Radio Resource Control (RRC); Protocol specification".
- [8] 3GPP TS 23.271: "Functional stage 2 description of Location Services (LCS)".
- [9] Open Mobile Alliance, OMA AD SUPL: "Secure User Plane Location Architecture", <http://www.openmobilealliance.org>.
- [10] 3GPP TS 23.090: "Unstructured Supplementary Service Data (USSD); Stage 2".
- [11] Void.
- [12] 3GPP TS 44.060: "MS-BSS interface; RLC/MAC protocol".
- [13] 3GPP TS 24.010: "Supplementary services specification; General aspects".
- [14] 3GPP TS 23.040: "Technical realization of the Short Message Service (SMS)".



- [15] 3GPP TS 23.204: "Short Message Service (SMS) over generic 3GPP Internet Protocol (IP) access".
- [16] 3GPP2 A.S0008-C: "Interoperability Specification (IOS) for High Rate Packet Data (HRPD) Radio Access Network Interfaces with Session Control in the Access Network".
- [17] 3GPP2 A.S0009-C: "Interoperability Specification (IOS) for High Rate Packet Data (HRPD) Radio Access Network Interfaces with Session Control in the Packet Control Function".
- [18] 3GPP2 A.S0013-C: "Interoperability Specification (IOS) for cdma2000 Access Network Interfaces – part 3 Features".
- [19] 3GPP TR 36.938: "Improved Network Controlled Mobility between E-UTRAN and 3GPP2/Mobile WiMAX Radio Technologies".
- [20] 3GPP TS 23.216: "Single Radio Voice Call Continuity (SRVCC); Stage 2".
- [21] 3GPP TS 24.008: "Mobile radio interface Layer 3 specification; Core network protocols; Stage 3".
- [22] 3GPP2 X.S0042-0: "Voice Call Continuity between IMS and Circuit Switched System".
- [23] 3GPP TS 23.236: "Intra-domain connection of Radio Access Network (RAN) nodes to multiple Core Network (CN) nodes".
- [24] 3GPP TS 43.055: "Radio Access Network; Dual Transfer Mode (DTM); Stage 2".
- [25] 3GPP TS 23.292: "IMS Centralised Services (ICS); Stage 2".
- [26] 3GPP TS 23.221: "Architectural Requirements".
- [27] 3GPP TS 23.402: "Architecture enhancements for non-3GPP accesses".
- [28] 3GPP TS 24.011: "Point-to-Point (PP) Short Message Service (SMS) support on mobile radio interface".
- [29] 3GPP TS 25.413: "UTRAN Iu interface Radio Access Network Application Part (RANAP) signalling".
- [30] 3GPP TS 48.018: "General Packet Radio Service (GPRS); BSS GPRS Protocol (BSSGP)".
- [31] 3GPP TS 23.082: "Call Forwarding (CF) supplementary services; Stage 2".
- [32] 3GPP2 C.S0005-A: "Upper Layer (Layer 3) Signaling Standard for cdma2000 Spread Spectrum Systems - Release A, Addendum 2".
- [33] 3GPP TS 36.331: "Evolved Universal Terrestrial Radio Access (E-UTRA) Radio Resource Control (RRC)"

---

## 3 Definitions and abbreviations

### 3.1 Definitions

For the purposes of the present document, the terms and definitions given in TR 21.905 [1] apply. A term defined in the present document takes precedence over the definition of the same term, if any, in TR 21.905 [1].

**1xCS:** The 3GPP2 legacy circuit Switched signalling system as defined in 3GPP2 X.S0042-0 [22].

## 3.2 Abbreviations

For the purposes of the present document, the abbreviations given in TR 21.905 [1] apply. An abbreviation defined in the present document takes precedence over the definition of the same abbreviation, if any, in TR 21.905 [1].

1xCS IWS	Circuit Switched Fallback Interworking solution Function for 3GPP2 1xCS.
ICS	IMS Centralised Services
NEAF	Non-EPS Alert Flag.
SRVCC	Single Radio Voice Call Continuity

---

# 4 Overall Description

## 4.1 General Considerations

The CS fallback in EPS enables the provisioning of voice and other CS-domain services (e.g. CS UDI video/ LCS/ USSD) by reuse of CS infrastructure when the UE is served by E-UTRAN. A CS fallback enabled terminal, connected to E-UTRAN may use GERAN or UTRAN to connect to the CS-domain. This function is only available in case E-UTRAN coverage is overlapped by either GERAN coverage or UTRAN coverage.

CS Fallback and IMS-based services shall be able to co-exist in the same operator's network.

The ICS architecture as defined in TS 23.292 [25] shall be able to co-exist with utilising CS Fallback as the CS domain in the same operator's network.

This specification also specifies the architecture required for SMS over SGs. The MO SMS and MT SMS are signalled over SGs and do not cause any CS Fallback to GERAN/UTRAN RATs, and consequently does not require any overlapped GERAN/UTRAN coverage.

The support of SMS over SGs is mandatory for UE and MME and MSC supporting CS fallback, whereas UE and MME and MSC supporting SMS over SGs are not required to support CS fallback.

**NOTE:** An MME supporting only SMS over SGs (i.e. not supporting CS fallback) will either reply with "SMS-only" or reject an IMSI attach.

The support of CS fallback (and to a lesser extent SMS over SGs) can impose some operational constraints on Tracking Area boundary planning and the use of the "tracking area list concept" (see TS 23.401 [2]).

## 4.2 Reference Architecture

The CS fallback and SMS over SGs in EPS function is realized by using the SGs interface mechanism between the MSC Server and the MME.

The SGs interface functionality is based on the mechanisms specified for the Gs interface, TS 23.060 [3].

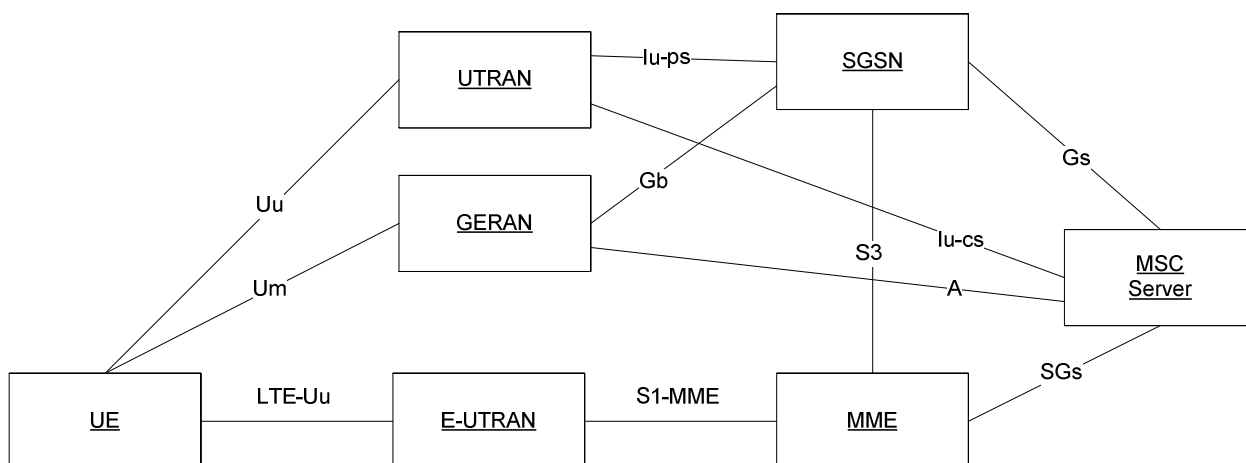

**Figure 4.2-1: EPS architecture for CS fallback and SMS over SGs**

NOTE 1: The MGW is not shown in the figure 4.2-1 since neither CS fallback in EPS nor SMS over SGs has any impacts on the U-plane handling.

NOTE 2: SGSN and S3 have additional functionality related to ISR and CS fallback/SMS over SGs. If ISR is not used, this functionality is not required.

### 4.2.1 Reference points

**SGs:** It is the reference point between the MME and MSC server. The SGs reference point is used for the mobility management and paging procedures between EPS and CS domain, and is based on the Gs interface procedures. The SGs reference point is also used for the delivery of both mobile originating and mobile terminating SMS. Additional procedures for alignment with the Gs reference point are not precluded.

**S3:** It is defined in TS 23.401 [2] with the additional functionality to support ISR for CS fallback/SMS over SGs as defined in this specification.

## 4.3 Functional entities

### 4.3.1 UE

The CS fallback capable UE supports access to E-UTRAN/EPC as well as access to the CS domain over GERAN and/or UTRAN.

The SMS over SGs capable UE supports access to E-UTRAN/EPC and may support access to the CS domain over GERAN and/or UTRAN.

The support of SMS over SGs is mandatory for a UE that supports CS fallback, whereas a UE that supports SMS over SGs is not required to support CS fallback.

These UEs support the following additional functions:

- Combined procedures specified in this document for EPS/IMSI attach, update and detach.
- CS fallback and/or SMS over SGs procedures specified in this document for using CS domain services.

A UE using CS fallback and/or SMS over SGs supports ISR according to TS 23.401 [2]. In particular a UE deactivates ISR at reception of LAU accept or at reception of combined RAU/LAU accept response with no ISR indication.

The coexistence with IMS services for voice/SMS is defined in clause 4.5.

There are no other CS fallback/SMS over SGs ISR-specifics for the UE compared to ISR description in TS 23.401 [2], i.e. if ISR is active the UE can change between all registered areas and RATs without performing update signalling. The UE listens for paging on the RAT it is currently camped on.

### 4.3.2 MME

The CS fallback and/or SMS over SGs enabled MME supports the following additional functions:

- Deriving a VLR number and LAI from the TAI of the current cell, or using a default VLR number and LAI.
- For CS fallback, generating a TAI list such that the UE has a low chance of "falling back" to a cell in a LA different to the derived LAI (e.g. the TAI list boundary should not cross the LA boundary).

NOTE: Alignment of the TAI list boundary with a LA boundary can prevent the MME from making effective use of the "tracking area list" concept. To compensate for this, appropriate cell reselection hysteresis may need to be used within the E-UTRAN.

- Maintaining of SGs association towards MSC/VLR for EPS/IMSI attached UE.
- Initiating IMSI detach at EPS detach.
- Initiating paging procedure specified in this document towards eNodeB when MSC pages the UE for CS services.
- Supporting SMS procedures defined in this document.
- Rejecting CS Fallback call request (e.g. due to O&M reasons)

An MME that supports CS Fallback uses the LAI and a hash value from the IMSI to determine the VLR number as defined in TS 23.236 [23] when multiple MSC/VLRs serve the same LAI. The same hash value/function is used by SGSN to determine the VLR number. An MME that supports SMS over SGs may use the same procedure as for CS Fallback.

### 4.3.3 MSC

The CS fallback and/or SMS over SGs enabled MSC supports the following additional functions:

- Maintaining SGs association towards MME for EPS/IMSI attached UE.
- Supporting SMS procedures defined in this document.

NOTE 1: The CS Fallback enabled MSC can also be enhanced to support ICS as defined in TS 23.292 [25] and/or SRVCC as defined in TS 23.216 [20].

NOTE 2: In order to speed up the potential LAU procedure during CS fallback the MSC may be configured to lower the frequency of Authentication, TMSI reallocation and Identity check for UEs that are EPS/IMSI attached via the SGs interface.

### 4.3.4 E-UTRAN

The CS fallback enabled E-UTRAN supports the following additional functions:

- Forwarding paging request for CS domain to the UE.
- Directing the UE to the target CS capable cell.
- The configuration of appropriate cell reselection hysteresis at Location Area boundaries (or across the whole E-UTRAN) to reduce Tracking Area Update traffic.
- To facilitate the configuration of TA boundaries with LA boundaries, the E-UTRAN can gather statistics (from the inbound inter-RAT mobility events of all UEs) of the most common LAs indicated in the RRC signalling.
- Configuration to permit the operator to choose the target 'fallback' RAT and frequency.

For SMS over SGs, no specific E-UTRAN functionality is required.

## 4.3.5 SGSN

If the SGSN supports ISR, SGSN shall follow the rules and procedures described in TS 23.401 [2] and TS 23.060 [3] with the following additions and clarifications:

- The SGSN shall not send the ISR activated indication at combined RAU/LAU procedure.

An SGSN that supports Gs uses LAI and a hash value from the IMSI to determine the VLR number as defined in TS 23.236 [23] when multiple MSC/VLRs serve the same LAI. The same hash value/function is used by MME to determine the VLR number.

## 4.3.6 BSS

If the network supports ISR, the CS fallback enabled BSS exhibits the following behaviour:

- Even if the network is operating in NMO II/III the BSS shall forward Gb interface paging messages onto the radio interface. The BSS in a network operating in NMO II/III shall not be configured to use PBCCH.

## 4.4 Control plane

### 4.4.1 MME - MSC Server

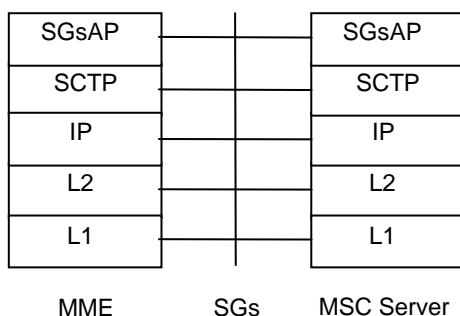

**Legend:**

**SGsAP:** This protocol is used to connect an MME to an MSC Server based on the BSSAP+.

**Stream Control Transmission Protocol (SCTP):** This protocol transfers signalling messages.

**Figure 4.4.1-1: SGs Interface**

## 4.5 Co-existence with IMS services

A CS Fallback and IMS capable UE shall follow the procedures for domain selection for UE originating session/calls according to TS 23.221 [26] 'Domain selection for UE originating sessions / calls'.

An IMS capable UE which supports SMS over IP networks shall follow the procedures for domain selection for UE originating SMS according to TS 23.221 [26] 'Domain selection for UE originating SMS'.

## 4.6 Emergency Calls

When UE is performing CS fallback procedure for Mobile Originating Call for the purpose of emergency call, it shall indicate to the MME that this CS fallback request is for emergency purpose. MME also indicates to the E-UTRAN via the appropriate S1-AP message that this CS fallback procedure is for emergency purpose.

**NOTE:** E-UTRAN may use the emergency indication for selecting a particular radio access network (2G or 3G) for CS emergency handling.

---

## 5 Mobility Management

### 5.1 General

The CS fallback and SMS over SGs in EPS is realized by using the SGs interface mechanism between the MSC Server and the MME.

The use of the "pool-area" concept as specified in TS 23.236 [23] allows to minimize the occurrence of MSC change at CS fallback.

#### 5.1A TAI list and LAI allocation

For CS fallback, the fallback procedure is likely to be faster if the network can allocate a Location Area to the UE that is the LA of the overlapping target RAT's coverage. For this situation, the MME should avoid allocating TAI lists that span multiple Location Areas of the target RAT (which may be contrary to the normal usage of the "tracking area list" concept described in TS 23.401 [2]).

This can be achieved by:

- configuring the E-UTRAN cell's TAI to take into account the LA boundary of the target RAT;
- the MME being configured to know which TAIs are within which LA; and
- the MME using the TAI of the current E-UTRAN cell to derive the LAI.

The operator should be able to configure the MME as to whether it either:

- provides normal usage of the "tracking area list" concept, or,
- the TAI list allocation is adjusted, for CS fallback mobiles, to provide "TAI lists that do not span multiple LAs".

The MME may use alternative approaches for LAI and TAI list allocation. In particular, this is appropriate for:

- the case of SMS over SGs without overlapping GERAN/UTRAN coverage; and
- the case when not all MSCs in the VPLMN support the SGs interface.

In these situations, one approach is to configure the MME to allocate a default (e.g. non-broadcast) LAI which is associated with a VLR that supports the SGs interface.

### 5.2 Attach procedure

The attach procedure for the CS fallback and SMS over SGs in EPS is realized based on the combined GPRS/IMSI Attach procedure specified in TS 23.060 [3].

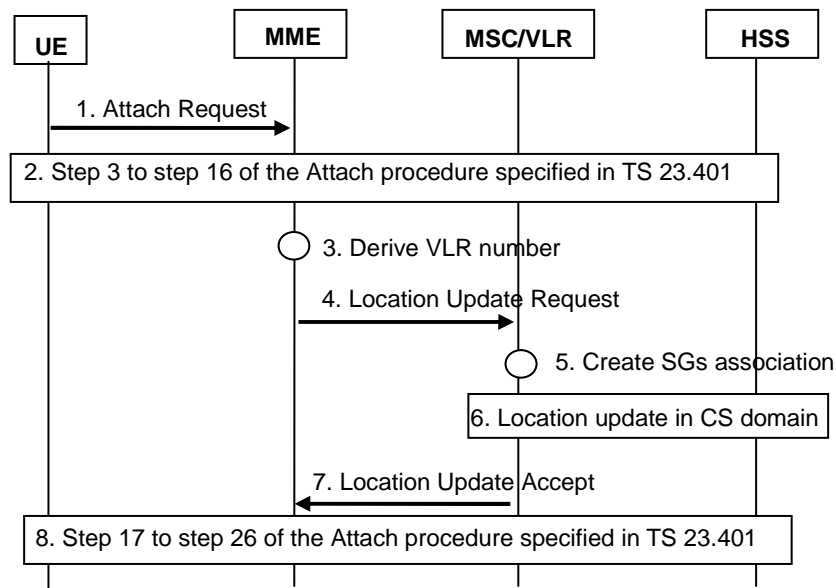

**Figure 5.2-1: Attach Procedure**

- 1) The UE initiates the attach procedure by the transmission of an Attach Request (parameters as specified in TS 23.401 [2]) including the Attach Type and Mobile Station Classmark 2) message to the MME. The Attach Type indicates that the UE requests a combined EPS/IMSI attach and informs the network that the UE is capable and configured to use CS fallback and/or SMS over SGs. If the UE needs SMS service but not CSFB, the UE shall include an "SMS-only" indication in the combined EPS/IMSI Attach Request. See clause 5.4.4.
- 2) Step 3 to step 16 of the EPS Attach procedure are performed as specified in TS 23.401 [2].
- 3) The VLR shall be updated according to the combined GPRS/IMSI Attach procedure in TS 23.060 [3] if the Attach Request message includes an Attach Type indicating that the UE requests a combined EPS/IMSI attach. The MME allocates a LAI for the UE.

The MME derives a VLR number based on the allocated LAI and on an IMSI hash function defined in TS 23.236 [23]. The MME starts the location update procedure towards the new MSC/VLR upon receipt of the subscriber data from the HSS in step 2). This operation marks the MS as EPS-attached in the VLR.

- 4) The MME sends a Location Update Request (new LAI, IMSI, MME name, Location Update Type) message to the VLR. MME name is a FQDN string.
- 5) The VLR creates an association with the MME by storing MME name.
- 6) The VLR performs Location Updating procedure in CS domain.
- 7) The VLR responds with Location Update Accept (VLR TMSI) to the MME.
- 8) The EPS Attach procedure is completed by performing step 17 to step 26 as specified in TS 23.401 [2]. Attach Accept message includes the parameters as specified in TS 23.401 [2]: VLR TMSI and LAI as allocated in step 3 above. The existence of LAI and VLR TMSI indicates successful attach to CS domain.

If the UE requests combined EPS/IMSI Attach Request without the "SMS-only" indication, and if the network supports only SMS over SGs, the network shall perform the IMSI attach and the MME shall indicate in the Attach Accept message that the IMSI attach is for "SMS-only". When the network accepts a combined EPS/IMSI attach without limiting to "SMS-only", the network may provide a "CSFB Not Preferred" indication to the UE.

If the UE requests combined EPS/IMSI Attach Request with the "SMS-only" indication, and if the network supports SMS over SGs only or if it supports CSFB and SMS over SGs, the network shall perform the IMSI attach and the MME shall indicate in the Attach Accept message that the IMSI attach is for "SMS-only".

The network provides the "SMS-only" or "CSFB Not Preferred" indications based on locally configured operator policies based on e.g. roaming agreement.

The UE behaviour upon receiving such indications is described in TS 23.221 [26].

NOTE: The case of unsuccessful attach to CS domain is documented in stage 3 specifications, taking into account reachability for CS services of UEs that have the user preference to prioritize voice over data services and are not configured/supporting to use IMS voice services.

## 5.3 Detach procedure

### 5.3.1 UE-initiated Detach procedure

The UE-initiated Detach procedure for the CS fallback and SMS over SGs in EPS is realized based on the MS-Initiated Detach Procedure specified in TS 23.060 [3].

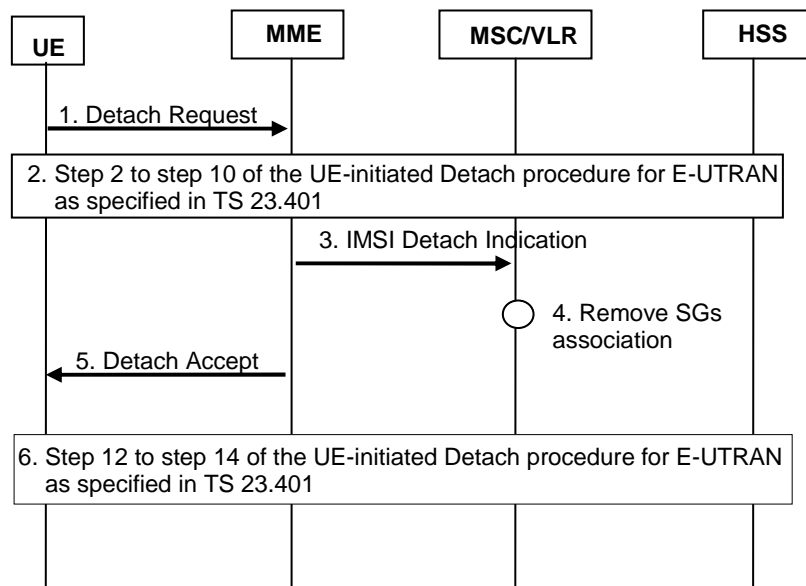

**Figure 5.3.1-1: UE-initiated Detach Procedure**

- 1) The UE initiates the detach procedure by the transmission of a Detach Request (parameters as specified in TS 23.401 [2], Detach Type) message to the MME. Detach Type indicates which type of detach is to be performed, i.e., IMSI Detach only or combined EPS and IMSI Detach.
- 2) If Detach Request is indicated in step 1, the UE-initiated Detach procedure for E-UTRAN is continued as specified in TS 23.401 [2].
- 3) The MME sends an IMSI Detach Indication (IMSI) message to the VLR.
- 4) The VLR removes the association with the MME.
- 5) The MME sends a Detach Accept message as specified in TS 23.401 [2].
- 6) The UE-initiated Detach procedure for E-UTRAN is completed with step 12 to step 14 as specified in TS 23.401 [2].

### 5.3.2 MME-initiated Detach procedure

The MME-initiated detach procedure for the CS fallback and SMS over SGs in EPS is realized based on the SGSN-Initiated Detach Procedure specified in TS 23.060 [3].



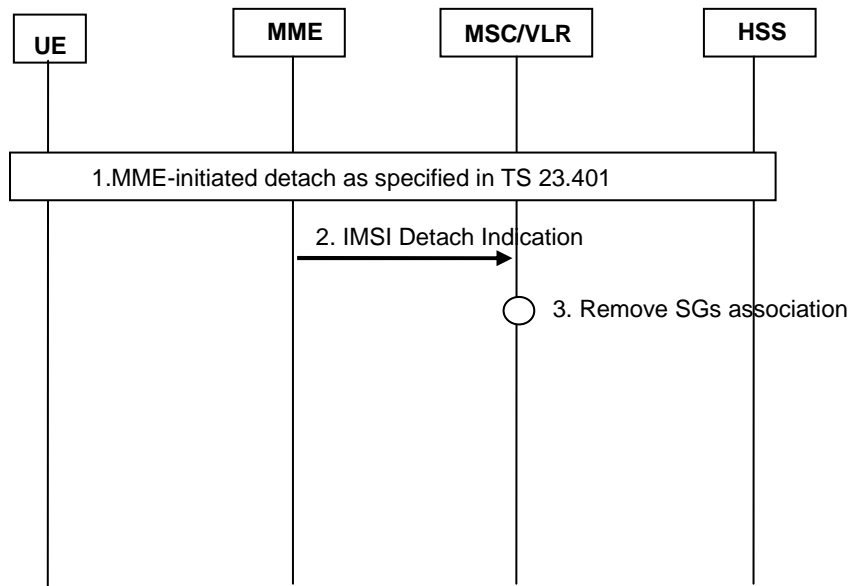
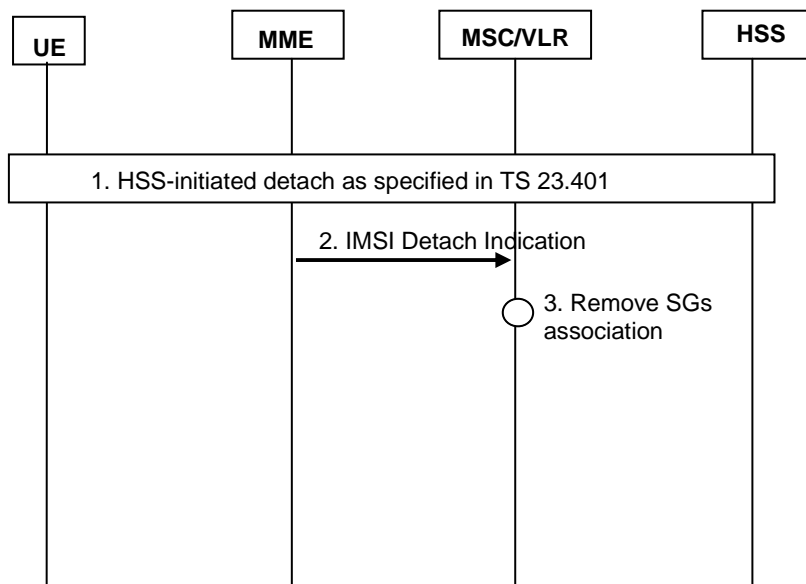

**Figure 5.3.2-1: MME-initiated Detach Procedure**

- 1) The MME-initiated Detach procedure is performed as specified in TS 23.401 [2].
- 2) The MME sends an IMSI Detach Indication (IMSI) message to the VLR.
- 3) The VLR removes the association with the MME.

### 5.3.3 HSS-initiated Detach procedure

The HSS-initiated detach procedure for the CS fallback and SMS over SGs in EPS is realized based on the HLR-Initiated Detach Procedure specified in TS 23.060 [3].



**Figure 5.3.3-1: HSS-initiated Detach Procedure**

- 1) The HSS-initiated Detach procedure is performed as specified in TS 23.401 [2].
- 2) The MME sends an IMSI Detach Indication (IMSI) message to the VLR.
- 3) The VLR removes the association with the MME.

### 5.3.4 Administration of the MME - MSC/VLR Association

The MME - MSC/VLR association is created at the following occasions:

- Combined EPS/ IMSI attach in clause 5.2.
- Combined TA/LA Update in clause 5.4.

The association is updated on the following occasions:

- When an UE changes MME.

The MME - MSC/VLR association is removed at the following occasions:

- UE-initiated Detach in clause 5.3.1.
- MME initiated Detach in clause 5.3.2.
- HSS initiated Detach in clause 5.3.3.
- Gs association establishment in 2/3G, see TS 23.060 [3].
- MSC/VLR receives a LA update via the A or Iu interface.

## 5.4 TA/LA Update procedure

### 5.4.0 General

When a CS fallback and/or SMS over SGs capable UE is EPS/IMSI attached, it initiates the combined TA/LA procedure based on the triggers specified in TS 23.401 [2].

When a CS fallback and/or SMS over SGs capable UE is not EPS/IMSI attached, it may initiate a combined TA/LA procedure in order to use CS Fallback or SMS over SGs services.

### 5.4.1 Combined TA/LA Update Procedure

NOTE: The combined TA/LA Update procedure for the CS fallback and SMS over SGs in EPS is realized based on the combined RA/LA Update procedure specified in TS 23.060 [3].

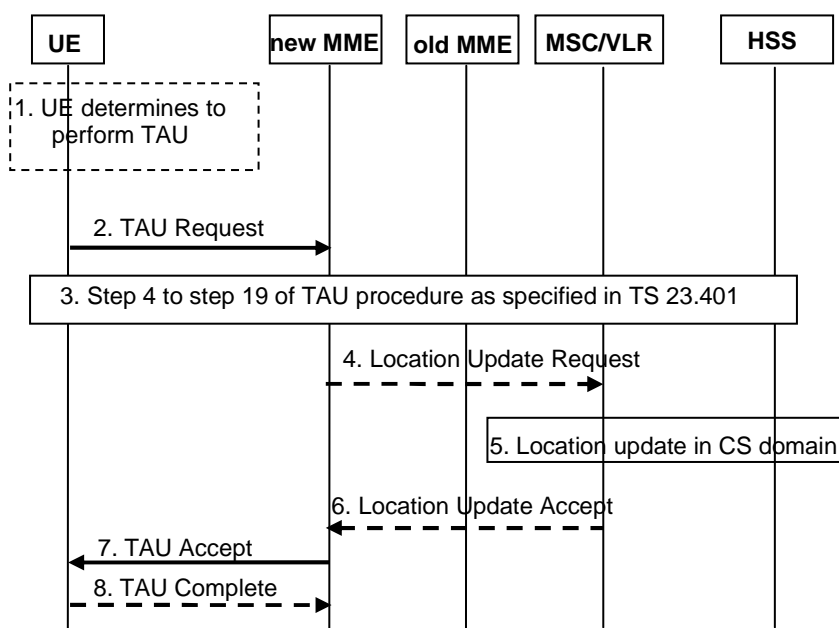

Figure 5.4.1-1: Combined TA / LA Update Procedure

- 1) The UE detects a change to a new TA by discovering that its current TAI is not in the list of TAIs that the UE registered with the network or the UE's TIN indicates the need for a TAU when re-selecting to E-UTRAN. The combined TA/LA Update Procedure is also performed in order to re-establish the SGs association.
- 2) The UE initiates the TAU procedure by sending a TAU Request (parameters as specified in TS 23.401 [2] including the Update Type and Mobile Station Classmark 2) message to the MME. The Update Type indicates that this is a combined Tracking Area/Location Area Update Request or a combined Tracking Area/Location Area Update with IMSI attach Request. If the UE needs SMS service but not CSFB, the UE shall include an "SMS-only" indication in the combined TA/LA Update procedure, see clause 5.4.4.
- 3) Step 4 to step 19 of the EPS TAU procedure are performed as specified in TS 23.401 [2].
- 4) If there is an associated VLR in the MM context, the VLR also needs to be updated. The MME allocates a LAI for the UE. If the association has to be established or if the LA changed, the new MME sends a Location Update Request (new LAI, IMSI, MME name, Location Update Type) message to the VLR. The MME retrieves the corresponding VLR number from the determined LAI. If multiple MSC/VLRs serve this LAI an IMSI hash function is used to retrieve the VLR number for the LAI as defined in TS 23.236 [23]. The Location Update Type shall indicate normal location update. The MME name is a FQDN string.
- 5) The VLR performs Location Update procedure in CS domain.
- 6) The VLR responds with Location Update Accept (VLR TMSI) to the MME.
- 7) The MME sends a TAU Accept (parameters as specified in TS 23.401 [2], LAI, VLR TMSI) message to the UE. The VLR TMSI is optional if the VLR has not changed. LAI is determined in step 4 above. The presence of the LAI indicates to the UE that it is IMSI attached. If the UE requests combined TA/LA Update Request without the "SMS-only" indication, and if the network supports SGs for SMS only, the network shall perform the IMSI attach and the MME shall indicate in the TAU Accept message that the IMSI attach is for "SMS-only".

If the UE requests combined TA/LA Update (or combined TA/LA Update with IMSI attach) without the "SMS-only" indication, and if the network supports only SMS over SGs, the network shall perform the combined TA/LA Update procedure and the MME shall indicate "SMS-only" in the TAU Accept message. However, if the network supports CSFB and SMS over SGs and accepts a combined TA/LA Update procedure but does not indicate "SMS-only", the MME may provide a "CSFB Not Preferred" indication to the UE.

If the UE requests combined TA/LA Update (or combined TA/LA Update with IMSI attach) with the "SMS-only" indication, and if the network only supports SMS over SGs or if it supports CSFB and SMS over SGs, the network shall perform the combined TA/LA Update procedure and the MME shall indicate in the TAU Accept message that the combined TA/LA Update procedure is for "SMS-only".

The network provides the "SMS-only" or "CSFB Not Preferred" indications based on locally configured operator policies based on e.g. roaming agreement.

The UE behaviour upon receiving such indications is described in TS 23.221 [26].

- 8) The UE may send a TAU complete message as specified in TS 23.401 [2] for the TAU procedure.

## 5.4.2 Periodic TA and LA Update Procedure

When the UE is camped on E-UTRAN, periodic LA updates shall not be performed, but periodic TA updates shall be performed. In this case, an SGs association is established and the MSC/VLR shall disable implicit detach for EPS-attached UEs and instead rely on the MME to receive periodic TA updates.

When a periodic TA update is not received in the MME, the MME clears the PPF. The lack of periodic TA update may be caused by reselection or handover to GERAN/UTRAN when ISR is active. To ensure CS paging can reach the EPS/IMSI attached UE, the UE shall perform combined RA/LA update in NMO I or LAU in NMO II/III when the periodic TAU timer expires and the UE is in GERAN/UTRAN (or next returns to coverage in GERAN/UTRAN) and ISR is active.

In addition, when a periodic TA update is not received in the MME, the MME may implicitly detach the UE as specified in TS 23.401 [2]. This MME implicit detach does not affect any SGSN attach status. At an implicit detach, the MME also releases the SGs association with the MSC/VLR. The MSC continues to maintain the registered LA for the UE. The MSC changes to supervise LA updates and pages in the still registered LA when mobile terminated services arrive.

When the UE camps on GERAN/UTRAN it may perform combined RA/LA updates. The combined RA/LA update procedures and the conditions for their usage are described in TS 23.060 [3].

### 5.4.3 Non-EPS Alert procedure

The MSC/VLR may request an MME to report activity from a specific UE. In this case, the MSC/VLR shall send a SGsAP Alert Request (IMSI) message to the MME where the UE is currently EPS-attached.

Upon reception of the SGsAP Alert Request (IMSI) message, the MME shall set NEAF (Non-EPS Alert Flag). If NEAF is set for an UE, the MME shall inform the MSC/VLR when the next activity from that UE (and the UE is both IMSI- and EPS attached) is detected, and shall clear NEAF.

If the activity detected by the MME leads to a procedure towards the MSC/VLR, the MME shall just follow this procedure. If the activity detected by the MME does not lead to any procedure towards the MSC/VLR, the MME shall send an UE Activity Indication (IMSI) message towards the MSC/VLR.

### 5.4.4 Void

## 5.5 Idle Mode Signalling Reduction

In relation with CSFB and/or SMS over SGs, when ISR is activated, the UE follows regular ISR behaviour. It may reselect between E-UTRAN and GERAN/UTRAN without a need to update the CN. When a mobile terminated service arrives, the MSC/VLR sends a paging message via SGs to the MME. The MME pages in the TA(s) registered for the UE, and, the MME uses the S3 interface to request the SGSN (i.e. the SGSN that has an ISR relation with the MME for that UE) to page the UE in the registered RA. When the UE is already connected with the MME, the MME forwards the paging request only to the UE via the established signalling connection.

When the UE is IMS registered for voice service, even if the UE is capable for "combined EPS/IMSI attach" it may need to ignore ISR activation based on the conditions for ISR activation/de-activation for UEs registered for IMS voice service as defined in TS 23.401 [2].

CSFB and/or SMS over SGs enabled UE includes the "combined EPS/IMSI attach capability" indication as part of the "MS Network Capability" in the Attach, RAU or combined RAU/LAU Request message, if the UE has been configured to use CSFB service and/or SMS over SGs. SGSN stores the "combined EPS/IMSI attach capability" indication for ISR operation. If the UE has not been configured to use CSFB or SMS over SGs, the CSFB/SMS over SGs capable UE shall not include the "combined EPS/IMSI attach capability" indication in the Attach, RAU or combined RAU/LAU Request message to SGSN.

ISR remains activated until the CSFB/SMS over SGs enabled UE performs a combined RAU/LAU procedure (e.g. a UE in NMO I moves to a new RA or LA or the periodic TAU timer expires while the UE is in NMO I of GERAN/UTRAN) or separate LAU procedure (e.g. a UE moves to a different LA in NMO II or III or the periodic TAU timer expires while the UE is in NMO II/III of GERAN/UTRAN). Normal re-selection between registered RA/TA(s) does not cause ISR deactivated condition. When the UE needs to perform a combined RAU/LAU, the SGSN checks the "combined EPS/IMSI attach capability" bit in MS Network Capability and if it indicates that CSFB and/or SMS over SGs is enabled then SGSN deactivates ISR by not indicating ISR activated in the RAU Accept message, which is a regular ISR functionality as specified in TS 23.401 [2]. So an SGSN in a CSFB/SMS over SGs configuration never indicates ISR activated in combined RAU procedures for CSFB/SMS over SGs enabled UEs. After a combined RA/LA update procedure, the MSC pages via Gs for mobile terminated services. When Gs is not used, the MSC/VLR pages in the LA via Iu/A for mobile terminated services.

If ISR is deactivated and the UE re-selects to E-UTRAN with the TIN indicating "P-TMSI", it initiates a TAU procedure, which is a regular ISR functionality as specified in TS 23.401 [2], and ISR can be activated again. The CS fallback/SMS over SGs enabled UE shall perform this TAU procedure as a combined TA/LA Update Procedure.

## 5.6 Mobility Management for SMS over SGs only UEs

UEs that need SMS service but not CSFB indicate this specific condition with the "SMS-only" indication in the EPS/IMSI Attach Request and combined TA/LA update procedures. This allows an operator to deploy the SGs for SMS

delivery over LTE only without the need for CSFB support. In addition, this allows the MME to use a dedicated algorithm for the selection of the MSC that supports those UEs.

NOTE: SMS delivery does not cause the terminal to fallback to the CS-capable network. It is possible that only certain MSCs in the network (one in minimum) is configured to support SGs when the network only supports SMS for SGs operation. However such a minimal configuration can cause inter-MSC location updates to be performed at every movement into/out of E-UTRAN coverage.

## 6 Mobile Originating Call

### 6.1 General

This clause describes the mobile originating call procedures for the CS Fallback in EPS.

### 6.2 Mobile Originating call in Active Mode - PS HO supported

This flow may be executed when the eNodeB knows that both the UE and the network support PS HO.

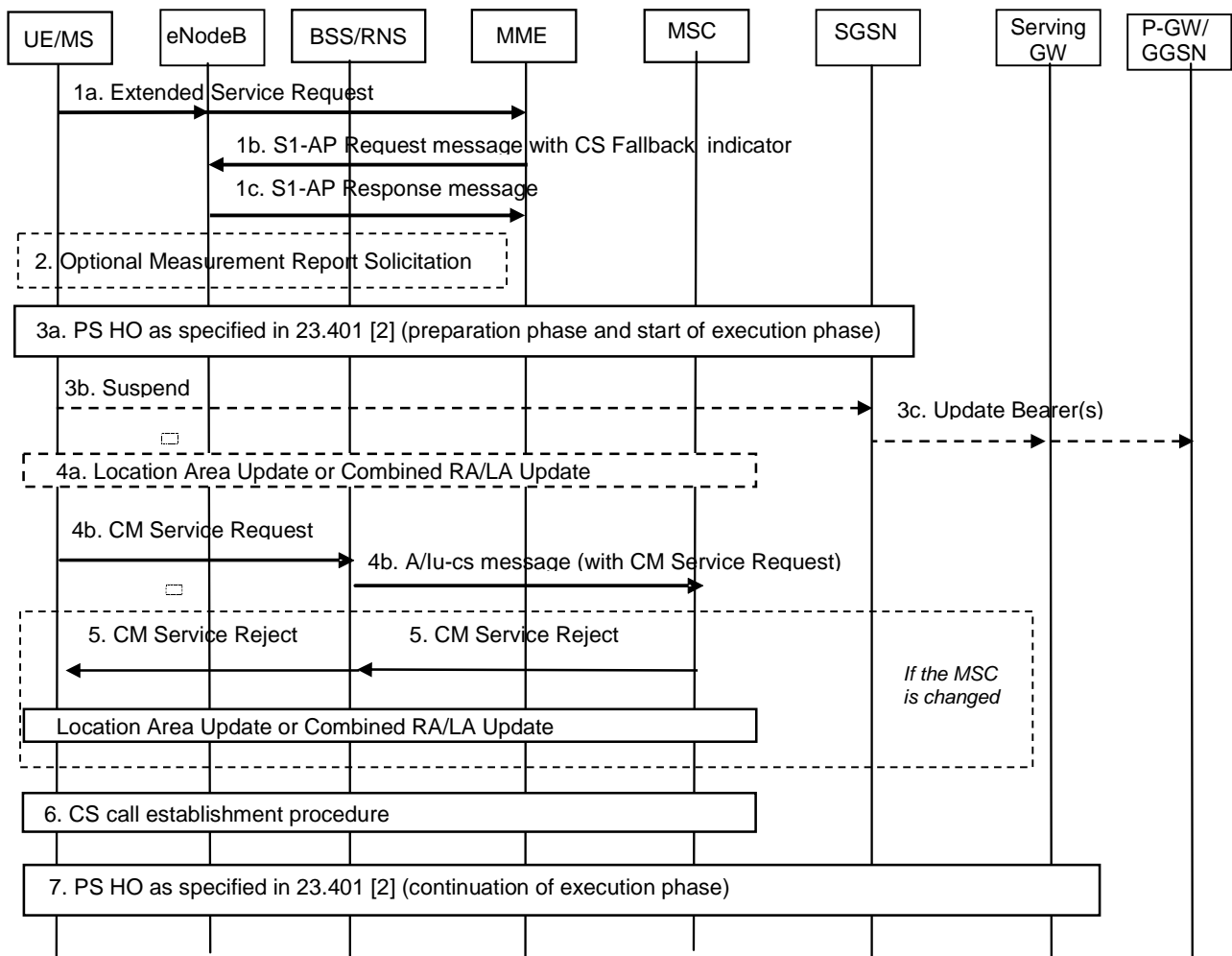

Figure 6.2-1: CS Call Request in E-UTRAN, Call in GERAN/UTRAN

NOTE 1: DTM is not mandatory for CS Fallback to work and is not linked to PS HO.

1a. The UE sends an Extended Service Request (CS Fallback Indicator) to MME. Extended Service Request message is encapsulated in RRC and S1-AP messages. CS Fallback Indicator indicates MME to perform CS Fallback. The UE only transmits this request if it is attached to CS domain (with a combined EPS/IMSI Attach)

and can not initiate an IMS voice session (because e.g. the UE is not IMS registered or IMS voice services are not supported by the serving IP-CAN, home PLMN or UE).

- 1b. The MME sends an S1-AP Request message to eNB that includes a CS Fallback indicator. This message indicates to the eNB that the UE should be moved to UTRAN/GERAN.
- 1c. The eNB shall reply with S1-AP Response message.
2. The eNodeB may optionally solicit a measurement report from the UE to determine the target GERAN/UTRAN cell to which PS handover will be performed.
- 3a. The eNodeB triggers PS handover to a GERAN/UTRAN neighbour cell by sending a Handover Required message to the MME. In the following an inter-RAT handover from E-UTRAN to UTRAN or GERAN as specified in TS 23.401 [2] begins. As part of this handover, the UE receives a HO from E-UTRAN Command and tries to connect to a cell in the target RAT. The HO from E-UTRAN Command may contain a CS Fallback Indicator which indicates to UE that the handover is triggered due to a CS fallback request. If the HO from E-UTRAN Command contains a CS Fallback Indicator and the UE fails to establish connection to the target RAT, then the UE considers that CS fallback has failed. Service Request procedure is considered to be successfully completed when PS Handover procedure is completed successfully.

NOTE 2: During the PS HO the SGSN does not create a Gs association with the MSC/VLR.

NOTE 3: Service Request procedure supervision timer shall be sufficiently long considering the optional measurement reporting at step 2.

When the UE arrives at the target cell, If the target RAT is UTRAN, the UE establishes CS signalling connection by sending an RRC Initial Direct Transfer message as specified in TS 25.331 [7] that contains a NAS message. The CN Domain Indicator is set to "CS" in the Initial Direct Transfer message.

If the target RAT is GERAN A/Gb mode: The UE establishes an RR connection by using the procedures specified in TS 44.018 [4] (i.e. UE requests and is assigned a dedicated channel where it sends a SABM containing a NAS message to the BSS and the BSS responds by sending a UA). Upon receiving the SABM (containing the NAS message) the BSS sends a COMPLETE LAYER 3 INFORMATION message (containing the NAS message) to the MSC which indicates CS resources have been allocated in the GERAN cell. After the establishment of the main signalling link as described in TS 44.018 [4] the UE enters either Dual Transfer Mode or Dedicated Mode.

- 3b. If the target RAT is GERAN, the UE starts the Suspend procedure unless both the UE and the Target cell support DTM.
- 3c. A Gn/Gp-SGSN that receives the Suspend message from the UE follows the Suspend procedure specified in TS 23.060 [3], clause 16.2.1.1.2

A S4-SGSN that receives the Suspend message from the UE follows the Suspend procedure specified in TS 23.060 [3] and starts the preservation and suspension of non-GBR bearers and the deactivation of GBR bearers towards S-GW and P-GW(s). The SGSN stores in the UE context that UE is in suspended status.

- 4a. If the UE cannot determine the LAI of the new UTRAN/GERAN cell or the LA of the new cell is different from the one stored in the UE, the UE should initiate a Location Area Update or a Combined RA/LA Update procedure as specified in TS 23.060 [3] for the different Network Modes of Operation (NMO). The UE shall set the "follow-on request" flag in the LAU Request in order to indicate to the MSC not to release the Iu/A connection after the LAU procedure completion. Further the UE performs any Routing Area Update procedure as specified by TS 23.060 [3].

NOTE 4: In UTRAN, UE does not need to wait for the LAI from the RNC, but the RNC also does not delay sending the LAI to the UE as the RAN Mobility Information might be used as a trigger for the UE to initiate NAS procedures.

In NMO I a CSFB UE may perform separate LAU with "follow-on request" flag and RAU procedures instead of a Combined RA/LA Update procedure to speed up the CSFB procedure.

- 4b. The UE sends a CM Service Request to the MSC.

5. If the UE is not registered in the MSC serving the 2G/3G target cell or the UE is not allowed in the LA, the MSC shall reject the service request, if implicit location update is not performed. The CM Service Reject shall trigger the UE to perform a Location Area Update procedure as specified in TS 23.060 [3].
6. The UE initiates the CS call establishment procedure.
7. The UE performs any remaining steps of the inter-RAT handover from E-UTRAN to UTRAN or GERAN as specified in TS 23.401 [2].

If the UE remains on UTRAN/GERAN after the CS voice call is terminated the UE performs normal mobility management procedures as defined in TS 23.060 [3] and TS 24.008 [21].

### 6.3 Mobile Originating call in Active Mode – No PS HO support

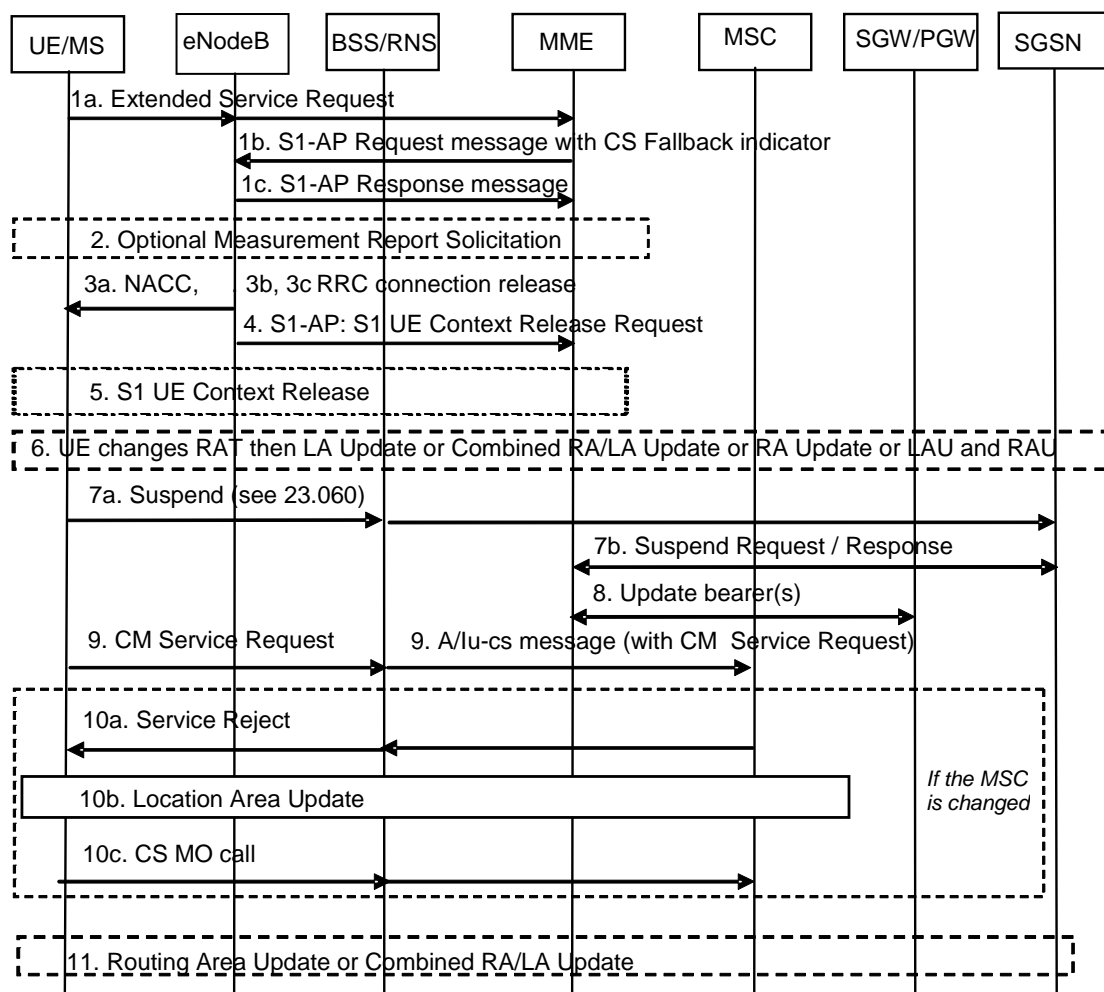

**Figure 6.3-1: CS Call Request in E-UTRAN, Call in GERAN/UTRAN without PS HO**

- 1a. The UE sends an Extended Service Request (CS Fallback Indicator) to the MME. Extended Service Request message is encapsulated in RRC and S1-AP messages. CS Fallback Indicator indicates MME to perform CS Fallback. The UE only transmits this request if it is attached to CS domain (with a combined EPS/IMSI Attach) and can not initiate an IMS voice session (because e.g. the UE is not IMS registered or IMS voice services are not supported by the serving IP-CAN, home PLMN or UE).
- 1b. The MME sends an S1-AP Request message to eNB that includes a CS Fallback Indicator. This message indicates to the eNB that the UE should be moved to UTRAN/GERAN.
- 1c. The eNB shall reply with S1-AP Response message.

2. The eNodeB may optionally solicit a measurement report from the UE to determine the target GERAN/UTRAN cell to which the redirection procedure will be performed.

**The network performs one of steps 3a or 3b or 3c.**

- 3a. If the UE and network support inter-RAT cell change order to GERAN and the target cell is GERAN:

The eNodeB can trigger an inter-RAT cell change order (optionally with NACC) to a GERAN neighbour cell by sending an RRC message to the UE. The inter-RAT cell change order may contain a CS Fallback Indicator which indicates to UE that the cell change order is triggered due to a CS fallback request. If the inter-RAT cell change order contains a CS Fallback Indicator and the UE fails to establish connection to the target RAT, then the UE considers that CS fallback has failed. Service Request procedure is considered to be successfully completed when cell change order procedure is completed successfully.

- 3b. If the UE or the network does not support inter-RAT handover from E-UTRAN to GERAN/UTRAN nor inter-RAT cell change order to GERAN or the network does not wish to use these procedures:

The eNodeB can trigger RRC connection release with redirection to GERAN or UTRAN.

- 3c. If the UE and network support "RRC connection release with redirection and Multi Cell System Information to GERAN/UTRAN":

The eNodeB can trigger RRC connection release with redirection to GERAN or UTRAN and include one or more physical cell identities and their associated System Information.

NOTE 1: Service Request procedure supervision timer shall be sufficiently long considering the optional measurement reporting at step 2.

4. The eNodeB sends an S1 UE Context Release Request message to the MME. If the target cell is GERAN and either the target cell or the UE does not support DTM the message includes an indication that the UE is not available for the PS service.
5. S1 UE Context in the eNodeB is released as specified in TS 23.401 [2], which also includes that the S-GW releases all eNodeB related information..

**The UE performs one of steps 6a or 6b or 6c and THEN performs step 6d.**

- 6a. (Step 6a is performed if step 3a, Cell Change Order to GERAN, was performed)

The UE moves to the new cell in GERAN. The UE uses the NACC information and/or receives the broadcast System Information and when it has all of the necessary information to access the GERAN cell, establishes a radio signalling connection.

- 6b. (Step 6b is performed if step 3b, RRC release with redirection, was performed).

The UE moves to the target RAT, identifies a suitable cell, receives the broadcast System Information and when it has the necessary information to access GERAN/UTRAN, establishes a radio signalling connection.

- 6c. (Step 6c is performed if step 3c, RRC connection release with redirection and Multi Cell System Information, was performed).

The UE moves to the target RAT and identifies a suitable cell. The UE uses the NACC information and/or receives the broadcast System Information and when it has all of the necessary information to access GERAN/UTRAN, the UE establishes the radio signalling connection.

- 6d. When the UE arrives at the target cell, if target RAT is UTRAN: The UE establishes CS signalling connection by sending an RRC Initial Direct Transfer message as specified in TS 25.331 [7] that contains a NAS message. The CN Domain Indicator is set to "CS" in the Initial Direct Transfer message.

If target RAT is GERAN A/Gb mode: The UE establishes an RR connection by using the procedures specified in TS 44.018 [4] (i.e. UE requests and is assigned a dedicated channel where it sends a SABM containing a NAS message to the BSS and the BSS responds by sending a UA). Upon receiving the SABM (containing the NAS message) the BSS sends a COMPLETE LAYER 3 INFORMATION message (containing the NAS message) to the MSC which indicates CS resources have been allocated in the GERAN cell. After the establishment of the main signalling link as described in TS 44.018 [4] the UE enters either Dual Transfer Mode or Dedicated Mode.



If the LA of the new cell is different from the one stored in the UE, the UE should initiate a Location Area Update or a Combined RA/LA Update procedure as specified in TS 23.060 [3] for the different Network Modes of Operation (NMO). The UE shall set the "follow-on request" flag in the LAU Request in order to indicate to the MSC not to release the Iu/A connection after the LAU procedure is complete. Further the UE performs any Routing Area Update procedure as specified by TS 23.060 [3].

NOTE 2: In UTRAN, UE does not need to wait for the LAI from the RNC, but the RNC also does not delay sending the LAI to the UE as the RAN Mobility Information might be used as a trigger for the UE to initiate NAS procedures.

In NMO I a CSFB UE may perform separate LAU with "follow-on request" flag and RAU procedures instead of a Combined RA/LA Update procedure to speed up the CSFB procedure.

7. If the target RAT is GERAN and DTM is not supported, the UE starts the Suspend procedure specified in TS 23.060 [3], clause 16.2.1.1.2. This triggers the SGSN to send a Suspend Request message to the MME. The MME returns a Suspend Response to the SGSN even though the GUTI cannot be derived from the P-TMSI and RAI pair.
8. If the S1 UE Context Release Request message, received from the eNodeB in step 4, indicates that the UE is not available for the PS service in the target cell the MME starts the preservation and suspension of non-GBR bearers and the deactivation of GBR bearers towards S-GW and P-GW(s). The MME stores in the UE context that UE is in suspended status.

NOTE 3: Step 8 can not be triggered by the Suspend procedure since the full GUTI can not be derived from the P-TMSI and RAI included in the Suspend Request message.

9. The UE continues with the MO call setup procedure with sending CM Service Request.
- 10a. If the UE is not registered in the MSC serving the 2G/3G cell or the UE is not allowed in the LA, the MSC shall reject the service request, if implicit location update is not performed.
- 10b. A UE detecting that the MSC rejected the service request shall perform the Location Area Update according to existing GERAN or UTRAN procedures as specified in TS 23.060 [3] for the different Network Modes of Operation (NMO).
- 10c. After completion of the Location Area Update the UE continues with a MO call setup procedure.
11. After the CS voice call is terminated and if the UE is in GERAN and PS services are suspended, then (as specified in TS 23.060 [3]) the UE shall resume PS services by sending a Routing Area Update Request message to the SGSN. A Gn/Gp -SGSN will follow TS 23.060 [3] to resume the PDP Context(s). An S4 SGSN will follow TS 23.060 [3] to resume the bearers, and informs the S-GW and P-GW(s) to resume the suspended bearers. If the UE has returned to E-UTRAN after the CS voice call was terminated, then the UE shall resume PS service by sending TAU to MME. The MME will in addition inform S-GW and P-GW(s) to resume the suspended bearers.

If the UE remains on UTRAN/GERAN after the CS voice call is terminated the UE performs normal mobility management procedures as defined in TS 23.060 [3] and TS 24.008 [21].

## 6.4 Mobile Originating call in Idle Mode

Mobile Originating call in Idle Mode procedure is specified by reusing the Mobile Originating Call in Active mode procedure with Extended Service Request (CS Fallback Indicator) to the MME. The UE is transited to ECM-CONNECTED mode by following the applicable procedures specified in TS 23.401 [2].

## 6.5 Returning back to E-UTRAN

Once CS service ends in CS domain, existing mechanisms can be used to move the UE to E-UTRAN, no specific CS Fallback mechanisms are needed.

When the UE moves to E-UTRAN, if the EPS service was suspended during the CS service, it is resumed according to the procedure shown in the figure 6.5-1 below.

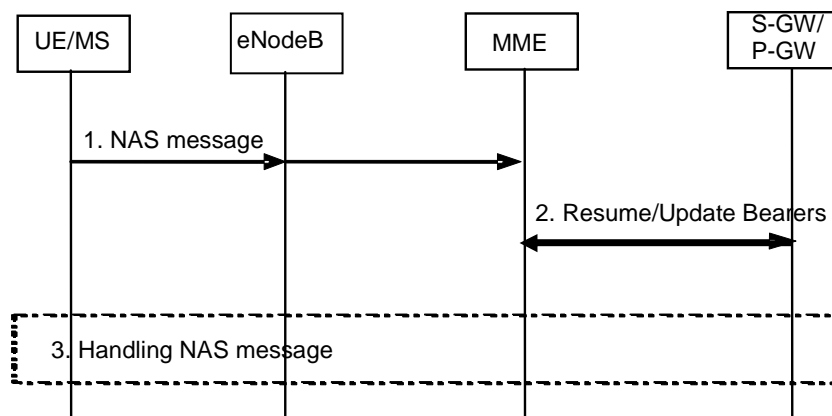

**Figure 6.5-1: Resume Procedure returning from CS fallback no PS HO**

1. The UE sends a NAS message, e.g. Service Request or TAU, to the MME.
2. If the UE context in the MME indicates that UE is in suspended status, the MME informs the S-GW and P-GW(s) to re-activate the EPS bearers for the UE.  
The S-GW and P-GW(s) acknowledges the re-activation of the bearers and clears the UE's suspending status.
3. The NAS message is processed accordingly.

---

## 7 Mobile Terminating Call

### 7.1 General

This clause describes the mobile terminating call procedures for the CS Fallback in EPS.

The MSC handles the timers, queuing and retransmission for sending the SGsAP-PAGING-REQUEST message on the SGs interface in the same way that it handles the sending of a PAGING message on the A or Iu interface. As a consequence, the MME and (if ISR is active) the SGSN shall not implement local retransmission schemes for this paging.

### 7.2 Mobile Terminating call in idle mode

The procedure for Mobile Terminating Call in idle mode is illustrated in figure 7.2-1.

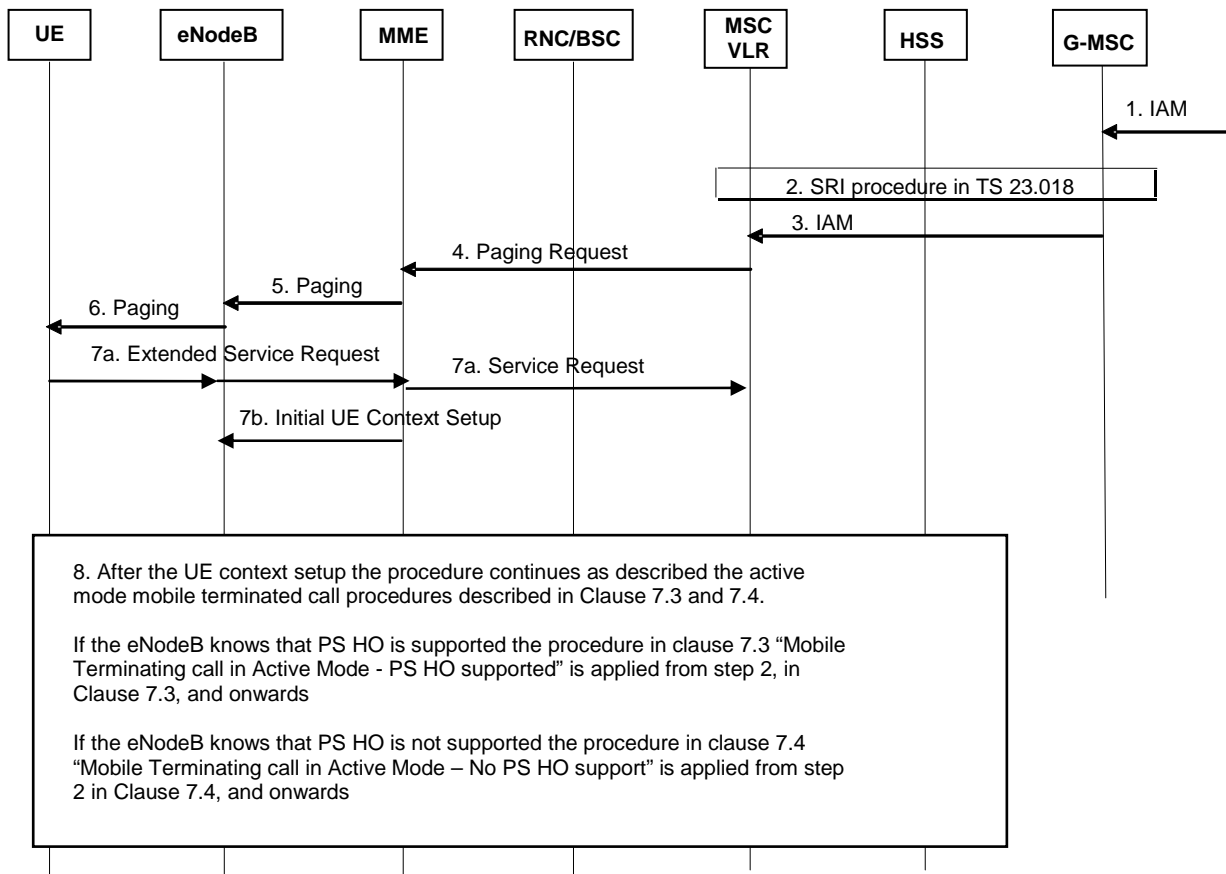

**Figure 7.2-1: Mobile Terminating Call in idle mode**

1. G-MSC receives IAM.
2. G-MSC retrieves routing information of the terminating UE by Send Routing Info procedures as specified in TS 23.018 [5].
3. G-MSC sends IAM to the MSC on the terminating side as specified in TS 23.018 [5].
4. The MME receives a Paging Request (IMSI, VLR TMSI, Location Information) message from the MSC over a SGs interface. The TMSI (or IMSI) received from the MSC is used by the MME to find the S-TMSI which is used as the paging address on the radio interface. If location information is reliably known by MME (i.e. MME stores the list of TAs), the MME shall page the UE in all the TAs. If the MME does not have a stored TA list for the UE, the MME should use the location information received from the MSC to page the UE.

NOTE 1: This procedure takes place before step 3, immediately after MSC receives MAP\_PRN from HSS, if pre-paging is deployed.

5. If the MME did not return an "SMS-only" indication to the UE during Attach or Combined TA/LA Update procedures, the MME sends a Paging (as specified in TS 23.401 [2]) message to each eNodeB. The Paging message includes a suitable UE Identity (i.e. S-TMSI or IMSI) and a CN Domain Indicator that indicates which domain (CS or PS) initiated the paging message. In this case it shall be set to "CS" by the MME.

If the MME returned the "SMS-only" indication to the UE during Attach or Combined TA/LA Update procedures, the MME shall not send the paging to the eNodeBs and sends Paging Reject towards MSC to stop CS Paging procedure and this CSFB procedure stops.

6. The radio resource part of the paging procedure takes place. The message contains a suitable UE Identity (i.e. S-TMSI or IMSI) and a CN Domain indicator.
- 7a. The UE establishes an RRC connection and sends an Extended Service Request (CS Fallback Indicator) to MME. The UE indicates its S-TMSI in the RRC signalling. The Extended Service Request message is encapsulated in RRC and S1-AP messages. The CS Fallback Indicator indicates to the MME that CS Fallback for this UE is required. The MME sends the SGs Service Request message to the MSC containing an indication

that the UE was in idle mode (and hence, for example, that the UE has not received any Calling Line Identification information). Receipt of the SGs Service Request message stops the MSC retransmitting the SGs interface Paging message.

NOTE 2: In order to avoid the calling party experiencing a potentially long period of silence, the MSC may use the SGs Service Request message containing the idle mode indication as a trigger to inform the calling party that the call is progressing.

7b. MME sends S1-AP: Initial UE Context Setup (UE capabilities, CS Fallback Indicator and other parameters specified in TS 23.401 [2]) to indicate the eNodeB to move the UE to UTRAN/GERAN.

7c. The eNB shall reply with S1-AP: Initial UE Context Setup Response message.

8a. If the eNodeB knows that both the UE and the network support PS handover: The information flow continues as described in clause 7.3 "Mobile Terminating call in Active Mode - PS HO supported" from step 2, in clause 7.3, and onwards.

. If the eNodeB knows that either the UE or the network does not support PS handover: The information flow continues as described in clause 7.4 "Mobile Terminating call in Active Mode – No PS HO support" from step 2, in clause 7.4, and onwards.

### 7.3 Mobile Terminating call in Active Mode - PS HO supported

This flow may be executed when the eNodeB knows that both the UE and the network support PS HO.

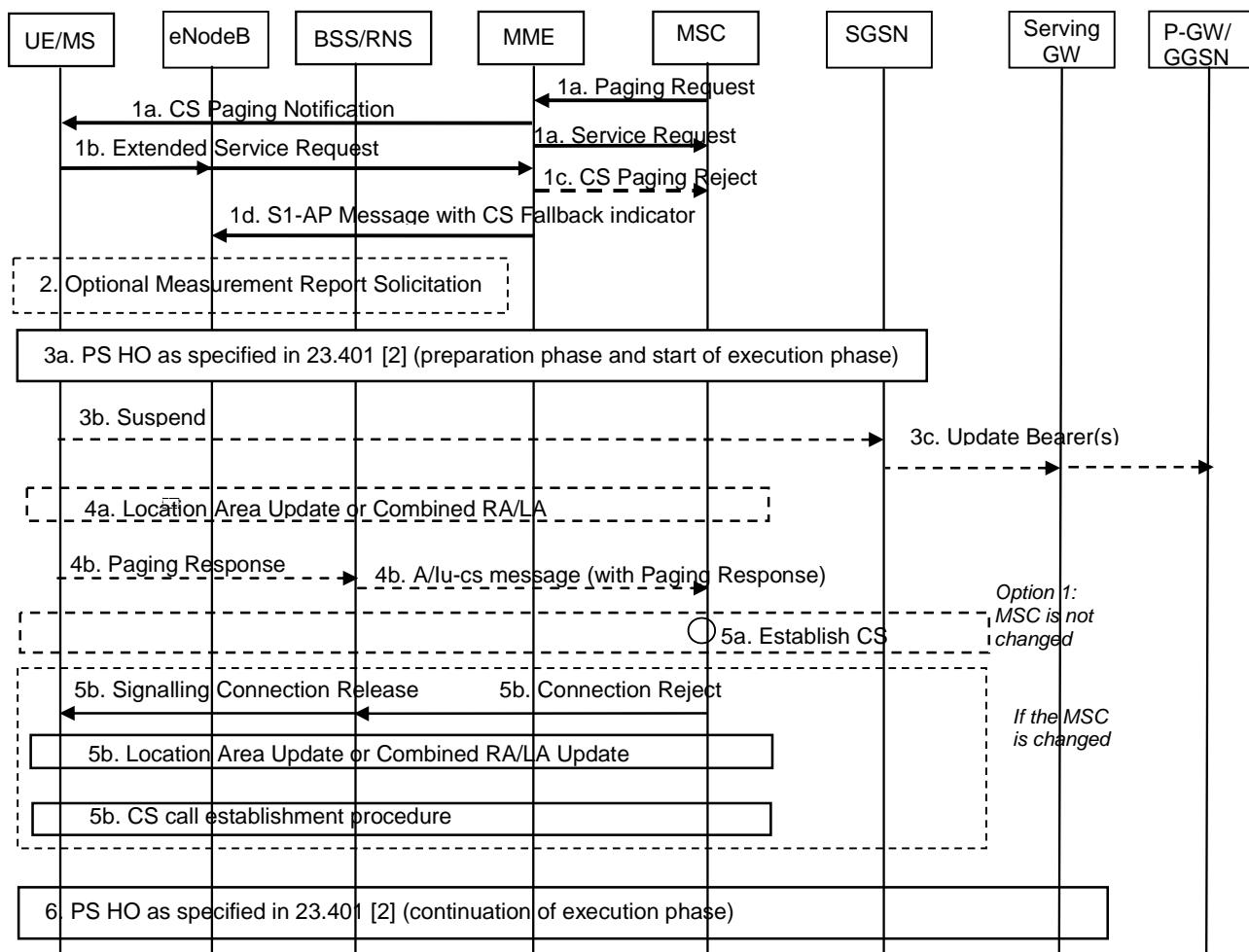

Figure 7.3-1: CS Page in E-UTRAN, Call in GERAN/UTRAN

1a. The MSC receives an incoming voice call and responds by sending a Paging Request (IMSI or TMSI, optional Caller Line Identification and Connection Management information, CS call indicator) to the MME over a SGs interface. The MSC only sends a CS Page for an UE that provides location update information using the SGs interface. In active mode the MME has an established S1 connection and if the MME did not return the "SMS-only" indication to the UE during Attach or Combined TA/LA Update procedures, the MME reuses the existing connection to relay the CS Page to the UE.

If the MME returned the "SMS-only" indication to the UE during Attach or Combined TA/LA Update procedures, the MME shall not send the CS Service Notification to the UE and shall send Paging Reject towards MSC to stop CS Paging procedure, and this CSFB procedure stops.

The eNB forwards the paging message to the UE. The message contains CN Domain indicator and, if received from the MSC, the Caller Line Identification.

The MME immediately sends the SGs Service Request message to the MSC containing an indication that the UE was in connected mode. The MSC uses this connected mode indication to start the Call Forwarding on No Reply timer for that UE and the MSC should send an indication of user alerting to the calling party. Receipt of the SGs Service Request message stops the MSC retransmitting the SGs interface Paging message.

NOTE 1: The pre-configured policy may be used by UE to avoid being disturbed without Caller Line Identification display and the detailed handling is to be decided by CT1 and CT6.

NOTE 2: This procedure can also take place immediately after MSC receives MAP\_PRN from HSS, if pre-paging is deployed. Caller Line Identification and CS call indicator are also provided in the case of pre-paging.

NOTE 3: In order to avoid the calling party experiencing a potentially long period of silence, the MSC may use the SGs Service Request message as a trigger to inform the calling party that the call is progressing.

1b. UE sends an Extended Service Request (CS Fallback Indicator, Reject or Accept) message to the MME. The Extended Service Request message is encapsulated in RRC and S1-AP messages. CS Fallback Indicator indicates to the MME to perform CS Fallback. The UE may decide to reject CSFB based on Caller Line Identification.

1c. Upon receiving the Extended Service Request (CSFB, Reject), the MME sends Paging Reject towards MSC to stop CS Paging procedure and this CSFB procedure stops.

1d. MME sends an S1-AP Request message to eNB that includes the UE Radio Capabilities and a CS Fallback Indicator. This message: indicates to the eNB that the UE should be moved to UTRAN/GERAN.

1e. The eNB shall reply with S1-AP Response message.

2. The eNodeB may optionally solicit a measurement report from the UE to determine the target GERAN/UTRAN cell to which PS handover will be performed.

3a. The eNodeB triggers PS handover to a GERAN/UTRAN neighbour cell by sending a Handover Required message to MME. In the following an inter-RAT handover from E-UTRAN to UTRAN or GERAN as specified in TS 23.401 [2] begins. As part of this handover, the UE receives a HO from E-UTRAN Command and tries to connect to a cell in the target RAT. The HO from E-UTRAN Command may contain a CS Fallback Indicator which indicates to UE that the handover was triggered due to a CS fallback request. If the HO from E-UTRAN Command contains a CS Fallback Indicator and the UE fails to establish connection to the target RAT, then the UE considers that CS fallback has failed.

The UE establishes the signalling connection as described in step 4b.

NOTE 4: During the PS HO the SGSN does not create a Gs association with the MSC/VLR.

3b. If the target RAT is GERAN, the UE starts the Suspend procedure unless both the UE and the Target cell support DTM.

3c. A Gn/Gp-SGSN that receives the Suspend message from the UE follows the Suspend procedure specified in TS 23.060 [3], clause 16.2.1.1.2.

An S4-SGSN that receives the Suspend message from the UE follows the Suspend procedure specified in TS 23.060 [3] and starts the preservation and suspension of non-GBR bearers and the deactivation of GBR bearers towards S-GW and P-GW(s). The SGSN stores in the UE context that UE is in suspended status.

- 4a. If the UE cannot determine the LAI of the new UTRAN/GERAN cell or the LA of the new cell is different from the one stored in the UE, the UE should initiate a Location Area Update or a Combined RA/LA procedure as specified in TS 23.060 [3] for the different Network Modes of Operation (NMO). Further the UE performs any Routing Area Update procedure as specified in TS 23.060 [3].

NOTE 5: In UTRAN, the UE does not need to wait for the LAI from the RNC, but the RNC also does not delay sending the LAI to the UE as the RAN Mobility Information might be used as a trigger for the UE to initiate NAS procedures.

In NMO I a CSFB UE may perform a LAU procedure instead of a Combined RA/LA Update procedure to speed up the procedure.

When the MSC receives a LA Update Request, it shall check for pending terminating CS calls and maintain the CS signalling connection after the Location Area Update procedure for pending terminating CS calls.

- 4b. If the UE does not initiate a LAU procedure, it shall respond with a Paging Response message to the MSC as follows:

- If the Target RAT is UTRAN or GERAN Iu mode: The UE establishes an RRC connection and responds to the paging by sending an RRC Paging Response as specified in TS 25.331 [7]. The CN Domain Indicator is set to "CS" in the Initial Direct Transfer message.
- If the Target RAT is GERAN A/Gb mode: The UE establishes an RR connection and responds to paging by using the procedures specified in TS 44.018 [4] (i.e. UE requests and is assigned a dedicated channel where it sends a SABM containing a Paging Response to the BSS and the BSS responds by sending a UA). Upon receiving the SABM (containing a Paging Response message) the BSS sends a COMPLETE LAYER 3 INFORMATION message (containing a Paging Response message) to the MSC which indicates CS resources have been allocated in the GERAN cell. After the establishment of the main signalling link as described in TS 44.018 [4] the UE enters Dual Transfer Mode and the CS call establishment procedure completes.

NOTE 6: The BSS should be prepared to receive a Paging Response even when the corresponding Paging Request has not been sent by this BSS.

- 5a. After performing the LAU procedure or after receiving the Paging Response the MSC shall establish the CS call if the UE is allowed in the LA.

- 5b. If the UE is not registered in the MSC that receives the Paging Response or the UE is not allowed in the LA, the MSC shall reject the Paging Response message by releasing the A/Iu-CS. The BSC/RNC in turn releases the signalling connection for UTRAN or GERAN CS domain. The signalling connection release shall trigger the UE to obtain the LAI, which causes the initiation of a Location Area Update procedure as specified in TS 23.060 [3] for the different Network Modes of Operation (NMO).

The Location Area Update triggers the Roaming Retry for CS Fallback procedure as defined in clause 7.5.

6. The UE performs any remaining steps of the inter-RAT handover from E-UTRAN to UTRAN or GERAN as specified in TS 23.401 [2]

With the exception of steps 1a and 1c, above, Call Forwarding (see TS 23.082 [31]) is performed on the basis of the TS 24.008 [21] signalling received on the GERAN/UTRAN cell.

If the UE remains on UTRAN/GERAN after the CS voice call is terminated the UE performs normal mobility management procedures as defined in TS 23.060 [3] and TS 24.008 [21].

## 7.4 Mobile Terminating call in Active Mode - No PS HO support

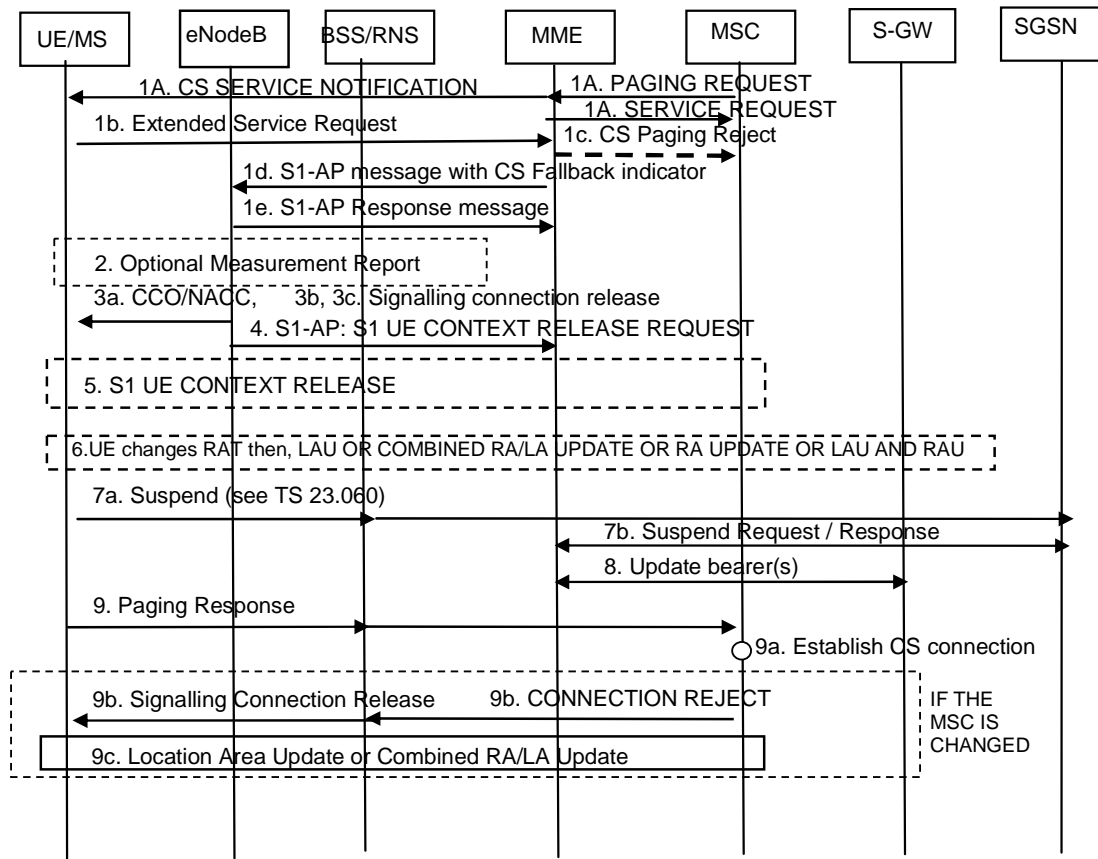

**Figure 7.4-1: CS Page in E-UTRAN, Call in GERAN/UTRAN without PS HO**

1a. The MSC receives an incoming voice call and responds by sending a Paging Request (IMSI or TMSI, optional Caller Line Identification and Connection Management information) to the MME over a SGs interface. The MSC only sends a CS Page for an UE that provides location update information using the SGs interface. In active mode the MME has an established S1 connection and if the MME did not return the "SMS-only" indication to the UE during Attach or Combined TA/LA Update procedures, the MME reuses the existing connection to relay the CS Service Notification to the UE.

If the MME returned the "SMS-only" indication to the UE during Attach or Combined TA/LA Update procedures, the MME shall not send the CS Page to the UE and sends CS Paging Reject towards MSC to stop CS Paging procedure, and this CSFB procedure stops.

The eNB forwards the paging message to the UE. The message contains CN Domain indicator and, if received from the MSC, the Caller Line Identification.

The MME immediately sends the SGs Service Request message to the MSC, containing an indication that the UE was in connected mode. The MSC uses this connected mode indication to start the Call Forwarding on No Reply timer for that UE and the MSC should send an indication of user alerting to the calling party. Receipt of the SGs Service Request message stops the MSC retransmitting the SGs interface Paging message.

NOTE 1: The pre-configured policy may be used by UE to avoid being disturbed without Caller Line Identification display and the detailed handling is to be decided by CT WG1 and CT WG6.

NOTE 2: This procedure can also take place immediately after MSC receives MAP\_PRN from HSS, if pre-paging is deployed. Caller Line Identification is also provided in the case of pre-paging.

1b. UE sends an Extended Service Request (CS Fallback Indicator, Reject or Accept) message to the MME. Extended Service Request message is encapsulated in RRC and S1-AP messages. CS Fallback Indicator indicates MME to perform CS Fallback. The UE may decide to reject CSFB based on Caller Line Identification.

- 1c. Upon receiving the Extended Service Request (CSFB, Reject), the MME sends Paging Reject towards MSC to stop CS Paging procedure and this CSFB procedure stops.
- 1d. The MME sends an S1-AP Request message to eNodeB that includes the UE Radio Capabilities and a CS Fallback Indicator. This message: indicates to the eNB that the UE should be moved to UTRAN/GERAN.
- 1e. The eNB shall reply with S1-AP Response message.
2. The eNodeB may optionally solicit a measurement report from the UE to determine the target GERAN/UTRAN cell to which the redirection procedure will be performed.

**The network performs one of steps 3a or 3b or 3c.**

- 3a. If the UE and network support inter-RAT cell change order to GERAN and the target cell is GERAN:

The eNodeB can trigger an inter-RAT cell change order (optionally with NACC) to a GERAN neighbour cell by sending an RRC message to the UE. The inter-RAT cell change order may contain a CS Fallback Indicator which indicates to UE that the cell change order is triggered due to a CS fallback request. If the inter-RAT cell change order contains a CS Fallback Indicator and the UE fails to establish connection to the target RAT, then the UE considers that CS fallback has failed. Service Request procedure is considered to be successfully completed when cell change order procedure is completed successfully.

- 3b. If the UE or the network does not support inter-RAT handover from E-UTRAN to GERAN/UTRAN nor inter-RAT cell change order to GERAN:

The eNodeB can trigger RRC connection release with redirection to GERAN or UTRAN instead of PS HO or NACC.

- 3c. If the UE and network support "RRC connection release with redirection and Multi Cell System Information to GERAN/UTRAN":

The eNodeB can trigger RRC connection release with redirection to GERAN or UTRAN and include one or more physical cell identities and their associated System Information.

NOTE 3: Service Request procedure supervision timer shall be sufficiently long considering the optional measurement reporting at step 2.

4. The eNodeB sends an S1 UE Context Release Request message to the MME. If the target cell is GERAN and either the target cell or the UE does not support DTM the message includes an indication that the UE is not available for PS service.
5. S1 UE Context in the eNodeB is released as specified in TS 23.401 [2], which also includes that the S-GW releases all eNodeB related information.

**The UE performs one of steps 6a or 6b or 6c and THEN performs step 6d.**

- 6a. (Step 6a is performed if step 3a, Cell Change Order to GERAN, was performed)

The UE moves to the new cell in GERAN. The UE uses the NACC information and/or receives the broadcast System Information and when it has the necessary information to access the GERAN cell, establishes a radio signalling connection.

- 6b. (Step 6b is performed if step 3b, RRC release with redirection, was performed)

The UE moves to the target RAT, identifies a suitable cell, receives the broadcast System Information and when it has the necessary information to access GERAN/UTRAN, establishes a radio signalling connection.

- 6c. (Step 6c is performed if step 3c, RRC connection release with redirection and Multi Cell System Information, was performed)

The UE moves to the target RAT and identifies a suitable cell. The UE uses the NACC information and/or receives the broadcast System Information and when it has the necessary information to access GERAN/UTRAN, the UE establishes the radio signalling connection.

- 6d. If the LA of the new cell is different from the one stored in the UE, the UE should initiate a Location Area Update or a Combined RA/LA Update as specified in TS 23.060 [3] for the different Network Modes of



Operation (NMO). In NMO I, the UE in GERAN may perform LA update over the RR connection instead of combined RA/LA update over the packet access as defined in TS 24.008 [21], clause 4.7.5.2.5, unless enhanced CS establishment in DTM is supported. Further the UE performs any Routing Area Update procedure as specified in TS 23.060 [3].

NOTE 4: In UTRAN, the UE does not need to wait for the LAI from the RNC, but the RNC also does not delay sending the LAI to the UE as the RAN Mobility Information might be used as a trigger for the UE to initiate NAS procedures.

In NMO I a CSFB UE may perform LAU and RAU procedures instead of a Combined RA/LA Update procedure to speed up the CSFB procedure.

When the MSC receives a LA Update Request, it shall check for pending terminating CS calls and maintain the CS signalling connection after the Location Area Update procedure for pending terminating CS calls.

7. If the target RAT is GERAN and DTM is not supported, the UE starts the Suspend procedure specified in TS 23.060 [3], clause 16.2.1.1.2. This triggers the SGSN to send a Suspend Request message to the MME. The MME returns a Suspend Response to the SGSN even though GUTI cannot be derived from the P-TMSI and RAI pair.
8. If the S1 UE Context Release Request message, received from the eNodeB in step 4, indicates that the UE is not available for the PS services in the target cell, the MME starts the preservation and suspension of non-GBR bearers and the deactivation of GBR bearers towards S-GW and P-GW(s). The MME stores in the UE context that the UE is in suspended status.

NOTE 5: Step 8 can not be triggered by the Suspend procedure since the full GUTI can not be derived from the P-TMSI and RAI included in the Suspend Request message.

9. If the UE does not initiate a LAU procedure, the UE responds to the paging by sending a Paging Response message as specified in TS 44.018 [4] or TS 25.331 [7]. When received at the BSS/RNS, the Paging Response is forwarded to the MSC.

NOTE 6: The MSC should be prepared to receive a Paging Response after a relatively long time from when the CS Paging Request was sent (step 1a).

- 9a. If UE is registered in the MSC serving the 2G/3G cell and the UE is allowed in the LA the MSC shall establish the CS call.
- 9b. If the UE is not registered in the MSC that receives the Paging Response or the UE is not allowed in the LA, the MSC shall reject the Paging Response by releasing the A/Iu-cs connection. The BSS/RNS in turn releases the signalling connection for CS domain.
- 9c. The signalling connection release shall trigger the UE to obtain the LAI, which causes the initiation of a Location Area Update procedure as specified in TS 23.060 [3] for the different Network Modes of Operation (NMO).

The Location Area Update triggers the Roaming Retry for CS Fallback procedure as defined in clause 7.5.

With the exception of steps 1a and 1c, above, Call Forwarding (see TS 23.082 [31]) is performed on the basis of the TS 24.008 [21] signalling received on the GERAN/UTRAN cell.

After the CS voice call is terminated and if the UE is still in GERAN and PS services are suspended, then (as specified in TS 23.060 [3]) the UE shall resume PS services by initiating a Routing Area Update procedure. A Gn/Gp- SGSN will follow TS 23.060 [10] to resume the PDP Context(s). An S4 SGSN will follow TS 23.060 [10] to resume the bearers, and informs the S-GW and P-GW(s) to resume the suspended bearers. If the UE has returned to E-UTRAN after the CS voice call was terminated, then the UE shall resume PS service by sending TAU to MME. The MME will in addition inform S-GW and P-GW(s) to resume the suspended bearers.

If the UE remains on UTRAN/GERAN after the CS voice call is terminated the UE performs normal mobility management procedures as defined in TS 23.060 [3] and TS 24.008 [21].

## 7.5 Roaming Retry for CS fallback

The procedure in this section is applied for mobile terminated calls where the MSC, to which the UE sends the LAU, is different from the MSC that sent the paging message to the UE. The procedure is based on the 'Mobile Terminating Roaming Retry Call' procedure defined in TS 23.018 [5] and there is an only minor adaptation of the procedure to support CS fallback.

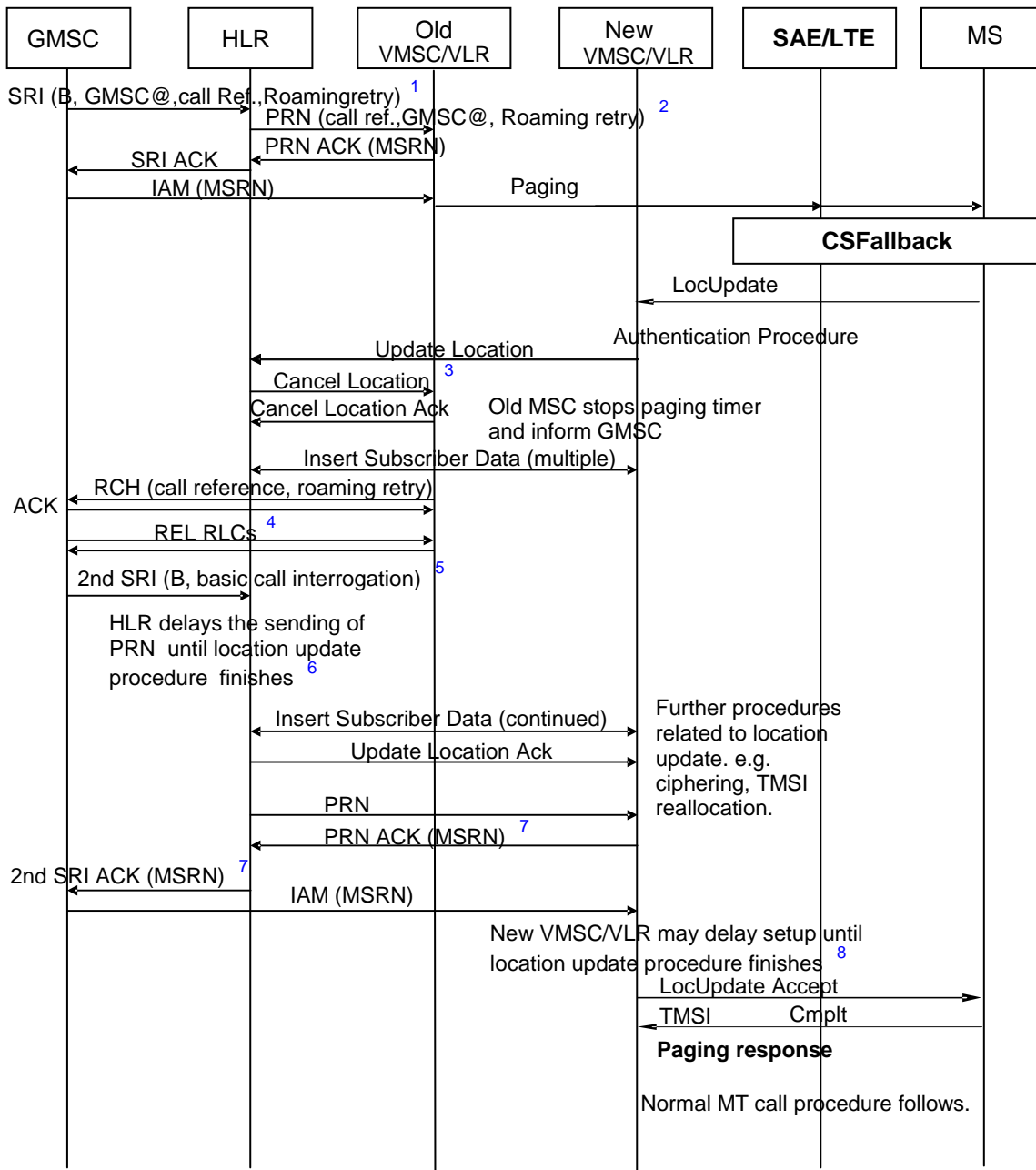

Figure 7.5-1: Roaming Retry for CS fallback

There are only 2 differences in this procedure compared to the 'Mobile Terminating Roaming Retry Call' procedure defined in TS 23.018 [5]. The first difference is that the paging message triggers the CS fallback including a location update in the new RAT. This functionality is already supported in the CS fallback flows for terminating calls and no additional functionality is needed. The second difference is that the UE may send a page response message after receiving Location Update Accept message. The new MSC will ignore or reject the page response message.

## 7.6 Returning back to E-UTRAN

Once CS service ends in CS domain, existing mechanisms can be used to move the UE to E-UTRAN, no specific CS Fallback mechanisms are needed.

When the UE moves to E-UTRAN, if the EPS service was suspended during the CS service, it is resumed as specified in clause 6.5.

## 7.7 Interaction with ISR

### 7.7.1 Void

### 7.7.2 Mobile Terminating Call when ISR is active and SGs is active between MSC/VLR and MME

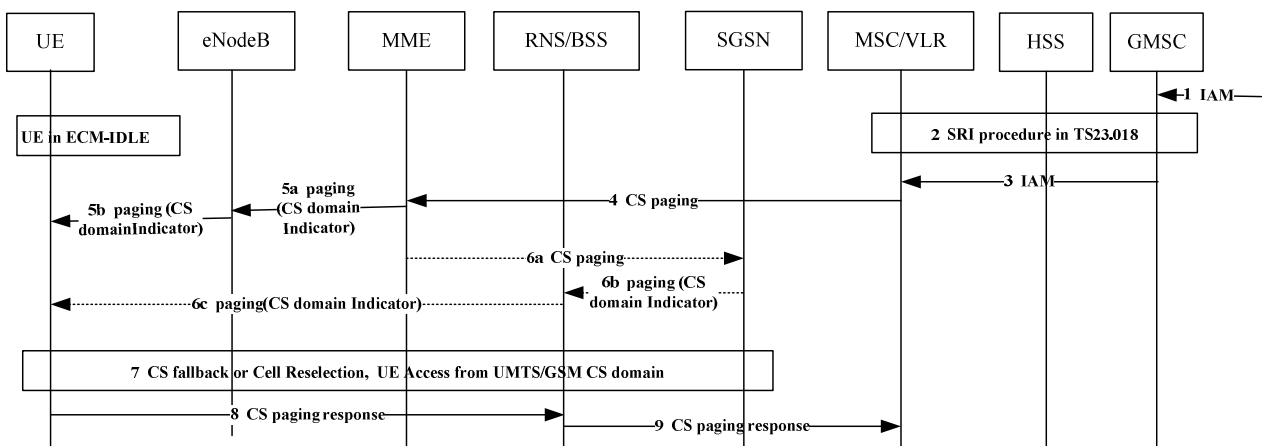

**Figure 7.7.2-1: Mobile Terminating Call when ISR is active and SGs is active between MSC/VLR and MME**

- 1) G-MSC receives IAM.
- 2) G-MSC retrieves routing information of the terminating UE by Send Routing Info procedures as specified in TS 23.018 [5].
- 3) G-MSC sends IAM to the MSC/VLR on the terminating side as specified in TS 23.018 [5].
- 4) The MSC/VLR sends a Page message to the MME via SGs (details on the Page message can be found in clauses 7.2 or 7.3).
- 5a) The MME receives the Page message from the MSC/VLR. If the UE is in ECM-IDLE state, the MME sends a Paging (as specified in TS 23.401 [2], and CN Domain Indicator) message to each eNodeB serving the TA list the UE is registered to as specified in clause 7.2. If the UE is in ECM-CONNECTED, the MME relays the CS Page message to the serving eNodeB over the S1 interface as specified in clause 7.3.
- 5b) The eNodeBs receive CS paging messages from the MME, and the procedures take place as specified in clause 7.2.
- 6a) As ISR is active and the UE is in ECM\_IDLE state, the MME forwards the CS paging message received from the MSC/VLR to the associated SGSN. The MME gets the SGSN information in the regular ISR activation process.
- 6b) The SGSN receives the CS paging message from the MME, the SGSN sends paging messages to RNS/BSSs, which is described in detail in TS 23.060 [3].

The SGSN shall not implement a local retransmission scheme for the Iu/Gb paging messages.

6c) When RNS/BSS nodes receive paging message from the SGSN, paging is initiated as described in detail in TS 23.060 [3].

NOTE: If ISR is not active or the UE is in ECM-CONNECTED state, the MME does not send the CS paging message to the SGSN. That means, the steps of 6a, 6b, 6c are not needed in the MT call procedure.

7) Upon receipt of a Paging Request message for a circuit-switched service, the CS Fallback (as defined in this specification) or Cell Reselection (as defined in TS 23.060[3]) take place, and the UE accesses CS domain from UMTS/GSM.

8) When the CS Fallback or Cell Reselection completes, the UE responds to the CS paging request and returns the CS paging response as described in detail in this specification and TS 23.060 [3] to the RNS/BSS.

9) When received at the RNS/BSS, the CS Paging Response message is sent to the MSC/VLR as described in detail in TS 23.060 [3]. The MSC/VLR receives CS paging response contained in corresponding message which shall then stop the paging response timer and establish the CS connection, then the MT call process as described in detail in TS 23.018 [5].

### 7.7.3 Void

## 7.8 Mobile Terminating Call when SGs is not active

Regular pre-Release 8 MSC procedures are performed without any ISR or SGs specifics.

---

# 8 Other CS Services

## 8.1 General

The MSC handles the timers, queuing and retransmission for sending the SGsAP-PAGING-REQUEST message on the SGs interface in the same way that it handles the sending of a PAGING message on the A or Iu interface. As a consequence, the MME and (if ISR is active) the SGSN shall not implement local retransmission schemes for this paging.

## 8.2 Short Message Service (SMS)

### 8.2.1 General

The procedures for SMS in this specification apply only if the UE is EPS/IMSI attached and the CS access domain is chosen by the UE and/or the home PLMN for delivering short messages.

This clause describes both the mobile originating and mobile terminating SMS over SGs procedures in EPS. SMS support is based on the connectionless SGs reference point between the MME and the MSC Server and use of NAS signalling between the UE and the MME, i.e. no CS Fallback is performed for SMS.

The SMS protocol entities are reused from the existing MS/UE and MSC implementations. This means that the SMS over SGs procedures reuse the different protocol layers as defined in TS 23.040 [14].

### 8.2.2 Mobile originating SMS in Idle Mode

The following sequence flow shows the delivery of mobile originating SMS in idle mode. The message flows between the ME/UE and MSC/VLR are also broadly applicable to the Memory Available Notification.

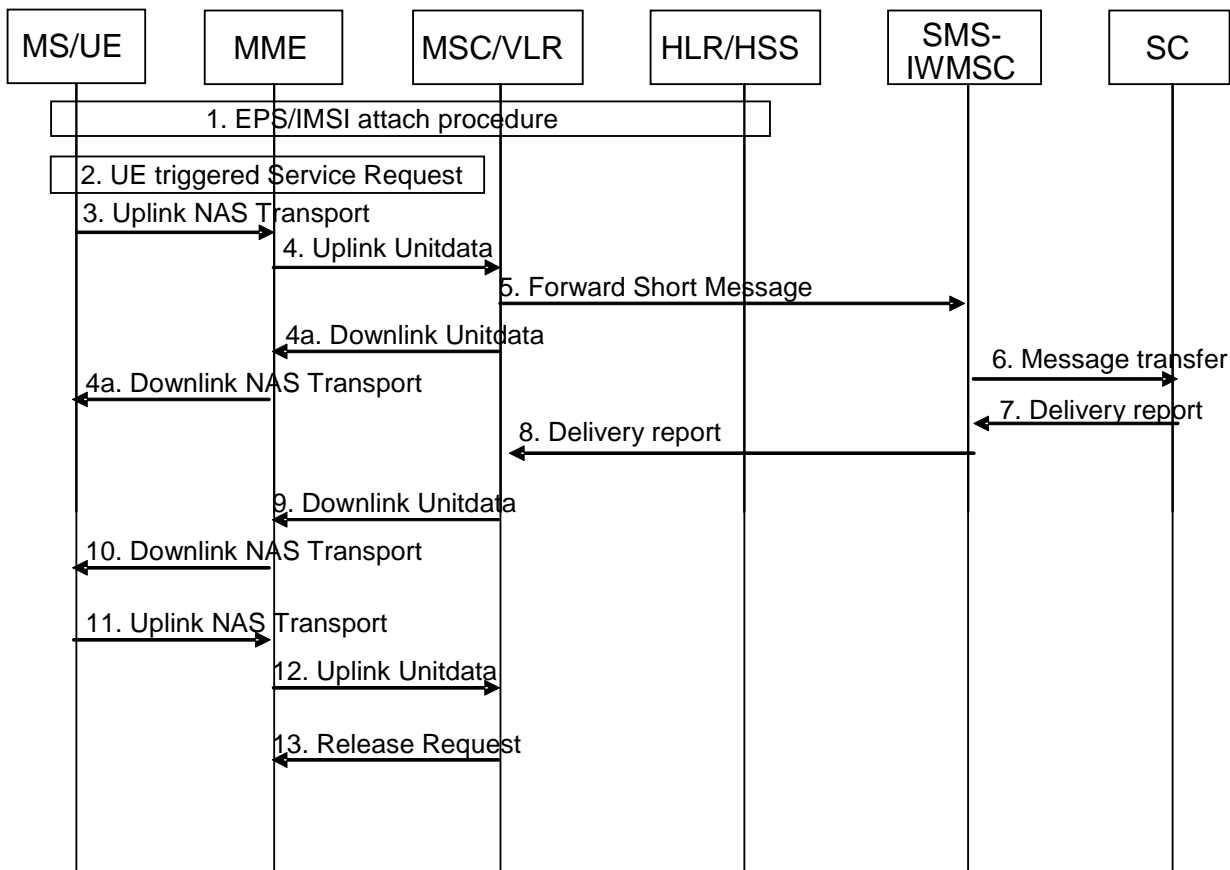

Figure 8.2.2-1: Mobile originating SMS in idle mode

1. The combined EPS/IMSI attach procedure as described in clause 5.2 has been performed earlier.
2. A mobile originating SMS is triggered and the MS/UE is in idle mode. The MS/UE initiates the UE triggered Service Request procedure, which is defined in TS 23.401 [2]. The UE indicates its S-TMSI in the RRC signalling.
3. The MS/UE builds the SMS message to be sent as defined in TS 23.040 [14] (i.e. the SMS message consists of CP-DATA/RP-DATA/TPDU/SMS-SUBMIT parts). Following the activation of the Radio Bearers, the SMS message is encapsulated in an NAS message and sent to the MME.
4. The MME forwards the SMS message to the MSC/VLR in an Uplink Unitdata message. In order to permit the MSC to create an accurate charging record, the MME adds the IMEISV, the local time zone, the Mobile Station Classmark 2, and the UE's current TAI and E-CGI.
- 4a. The MSC/VLR acknowledges receipt of the SMS to the UE.
- 5.-8. These steps are performed as defined in TS 23.040 [14]. The SMS message is forwarded to the SC that returns a delivery report message.
9. The MSC/VLR forwards the received delivery report to the MME associated with the MS/UE in a Downlink Unitdata message.
10. The MME encapsulates the received delivery report in an NAS message and sends the message to the MS/UE.
- 11, 12. The UE acknowledges receipt of the delivery report to the MSC/VLR.
13. The MSC/VLR indicates to the MME that no more NAS messages need to be tunnelled.

The MME should not use the SGs Release Request message as a trigger for the release of S1 resources.

NOTE: This is because the MME does not know whether the Service Request performed in step 2 was solely for the purpose of SMS, or, was for SMS and user plane data, or, whether or not the mobile has additional SMSs to send.

### 8.2.3 Mobile originating SMS in Active Mode

Mobile Originating SMS in active Mode procedure is specified by reusing the Mobile Originating SMS in Idle Mode with the following modification:

- The established signalling connection between the MS/UE and the MME is reused for the transport of the SMS message and the delivery report (i.e. the UE triggered Service Request procedure defined in step 2 is skipped).

### 8.2.3a Multiple Mobile originating SMSs

In clause 3.2 of TS 24.011 [28], the simultaneous transmission of more than one MO SMS/notification per domain is prohibited.

If the UE has more than one SMS/notification to send, the subsequent SMS/notification is sent at step 11 of clause 8.2.2 and the acknowledgement of the delivery report for the previous SMS/notification is not sent.

### 8.2.4 Mobile terminating SMS in idle mode

The following sequence flow shows the delivery of mobile terminating SMS in idle mode.

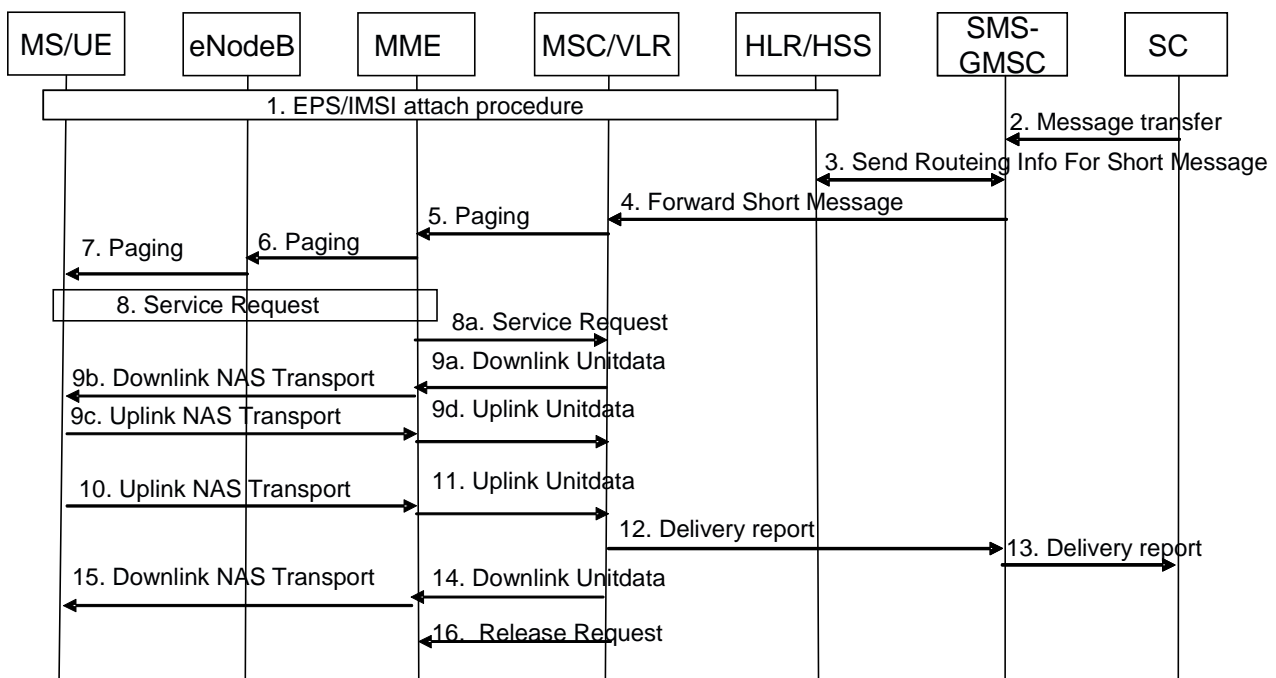

Figure 8.2.4-1: Mobile terminating SMS in idle mode

1. The combined EPS/IMSI attach procedure as described in clause 5.2 has been performed.
- 2-4. The SC initiates transfer of mobile terminating SMS. The HLR is requested for routing number for SMS services and the SMS message is forwarded to the MSC/VLR where the MS/UE is CS attached.
5. The MSC/VLR sends a Paging (IMSI, VLR TMSI, Location Information, SMS indicator) message to the MME.
6. The MME initiates the paging procedure by sending the Paging (as specified in TS 23.401 [2]) message to each eNodeB with cells belonging to the tracking area(s) in which the UE is registered. The UE is paged with its S-TMSI.
7. The MS/UE is paged by the eNodeBs.
8. The UE sends a Service Request message to the MME. The UE indicates its S-TMSI in the RRC signalling. The MME sends the S1-AP Initial Context Setup Request message to the eNodeB and the eNodeB establishes the Radio Bearers.

- 8a. The MME sends a Service Request message to the MSC. In order to permit the MSC to create an accurate charging record, the MME adds the IMEISV, the local time zone, the Mobile Station Classmark 2, and the UE's current TAI and E-CGI.
- 9a. The MSC/VLR builds the SMS message to be sent as defined in TS 23.040 [14] (i.e. the SMS message consists of CP-DATA/RP-DATA/TPDU/SMS-DELIVER parts). The MSC/VLR forwards the SMS message to the MME in a Downlink Unitdata message.
- 9b. The MME encapsulates the SMS message in a NAS message and sends the message to the MS/UE.
- 9c, 9d. The MS/UE acknowledges receipt of the SMS message to the MSC/VLR.
10. The MS/UE returns a delivery report as defined in TS 23.040 [14]. The delivery report is encapsulated in an NAS message and sent to the MME.
11. The MME forwards the delivery report to the MSC/VLR in an Uplink Unitdata message.
- 12-13. These steps are performed as defined in TS 23.040 [14]. The delivery report is forwarded to the SC.
- 14-15. In parallel to steps 12-13, the MSC/VLR acknowledges receipt of the delivery report to the MS/UE.
16. The MSC/VLR indicates to the MME that no more NAS messages need to be tunnelled.

The MME should not use the SGs Release Request message as a trigger for the release of S1 resources.

**NOTE:** Although the MME could use the RRC establishment cause (set to mt-Access) sent in the S1-AP Initial UE Message in step 8 to deduce that the MS/UE sent the Service Request solely for receiving the SMS), the MME does not know whether the MT-SMS might cause the initiation of user plane traffic or an MO SMS. So, for simplicity of MME implementation, the normal eNodeB procedures should be used to initiate the release of S1 resources.

## 8.2.5 Mobile terminating SMS in Active Mode

Mobile terminating SMS in Active Mode procedure is specified by reusing the Mobile Terminating SMS in Idle Mode with the following modification:

- There is no need for the MME to perform Paging of the MS/UE after step 5. MME continues with step 8a (i.e. steps 6 to 8 are skipped). The MME immediately sends a Downlink Unitdata to the UE.

### 8.2.5a Multiple Mobile terminating SMSs

In clause 3.2 of TS 24.011 [28], the simultaneous transmission of more than one MT SMS per domain is prohibited.

If the MSC/VLR has more than one SMS to send, the subsequent SMS is sent in a Downlink Unitdata message after step 14 and instead of the Release Request in step 16 of clause 8.2.4. i.e. the MSC/VLR does not need to send another SGs Paging message.

### 8.2.5b Simultaneous Mobile terminating and Mobile originating SMSs

The above sections on mobile originating and mobile terminating SMS handling in active and idle mode can be reused such that no special treatment is needed for this case.

### 8.2.5c Unsuccessful Mobile terminating SMS delivery attempt

As specified in clause 3.2.8 of TS 23.040 [14], setting the Mobile Station Not Reachable Flag (MNRF) in the MSC/VLR is mandatory. However, when using the SGs interface, the MSC/VLR has delegated the 'implicit detach' functionality to the MME (and/or, if Network Mode of Operation 1 is in use in GERAN/UTRAN, to the SGSN).

If an SGs based MT SMS delivery attempt fails, the MSC/VLR shall set its MNRF and send an SGs interface Alert Request message to the MME. Upon receipt of Alert Request message, MME shall set its Non-EPS Alert Flag (NEAF) and if ISR is activated, the MME shall then send an S3 interface Alert-MME-Request message to the SGSN.

Subsequently, if the UE makes radio contact with the SGSN, the SGSN informs the MME with an S3 interface UE-Activity-Indication. Upon receipt of the S3 interface UE-Activity-Indication, or, if the UE makes radio contact with the MME, the MME sends an SGs AP UE-Activity-Indication message to the MSC/VLR.

Upon receipt of an SGs AP UE-Activity-Indication message, or signalling on the A, Iu-cs or Gs interface for that UE, the MSC/VLR shall inform the HLR.

### 8.2.5d Non-SMS Mobile terminating activity during SMS delivery

While one or more SMS is being transferred, other mobile terminating requests (e.g. an MT voice call) may arrive in the MSC/VLR. If this happens the MSC/VLR continues the SMS activities but shall also send the SGs Paging message for the non-SMS activity to the MME. The MME shall handle this SGs Paging message as if no SMS transfers are ongoing. Typically this should lead to the MME invoking the handover/call redirection to GERAN/UTRAN features and it may lead to disruption of the SMS delivery. The MSC/VLR and UE shall recover from any such SMS disruption using the normal RP and CP layer retransmission timers/mechanisms.

### 8.2.5e Non-SMS Mobile originating activity during SMS delivery

While one or more SMS is being transferred, other mobile originating requests (e.g. an MO voice call or USSD) may be requested by the user. If this happens the MS/UE continues the SMS activities but shall also send the Extended Service Request message for the non-SMS activity to the MME. The MME shall handle this Extended Service Request message as if no SMS transfers are ongoing. Typically this should lead to the MME invoking the handover/call redirection to GERAN/UTRAN features and it may lead to disruption of the SMS delivery. The MSC/VLR and UE shall recover from any such SMS disruption using the normal RP and CP layer retransmission timers/mechanisms.

### 8.2.5f Mobile Terminating SMS when ISR is active and SGs is active between MSC/VLR and MME

When the MME receives the SGs Paging message for SMS, and ISR is active, and the UE is in idle mode, the MME sends the S1 interface paging message to the E-UTRAN (using the S-TMSI as temporary identity) and sends a CS paging message to the SGSN using the MSC TMSI as temporary identity (unless the MSC did not allocate a TMSI, in which case the IMSI is used for paging).

The UE is paged on E-UTRAN and by the SGSN on GERAN and/or UTRAN. For GERAN, the SGSN sends a PAGING CS message to the BSS (see TS 48.018 [30]). For UTRAN, the SGSN sends a PAGING message to the UTRAN (see TS 25.413 [29]) with the CN Domain Indicator set to 'CS domain'. The UE responds on the cell on which it is camped. When camped on E-UTRAN, the UE responds to the MME. When camped on GERAN or UTRAN, the UE responds to the MSC.

## 8.2.6 Co-Existence with SMS over generic 3GPP IP access

If the home operator has deployed SMS over generic 3GPP IP access and/or SMS-Instant Messaging Interworking as defined in TS 23.204 [15], and has configured the network and the UE for using SMS over IP or SMS-Instant Messaging Interworking, then an SMS or IM will be delivered over EPS in any visited network whether or not the visited network supports SMS over generic 3GPP IP access.

If the home operator has not deployed SMS over generic 3GPP IP access and the UE fails to successfully complete the combined EPS/IMSI attach procedure in the visited network (i.e. the visited network supports SMS over generic 3GPP IP access and does not support SGs for SMS capability), then the UE cannot execute MT or MO SMS procedures in the visited network.

## 8.3 Location Services (LCS)

### 8.3.1 MO-LR procedure

MO-LR procedure in the CS fallback in EPS is performed as specified in TS 23.271 [8].



When the MO-LR procedure is triggered by the UE's application, UE will check the LCS Support Indication provided by the Attach and TAU procedures as specified in TS 23.401 [2]:

- If the LCS Support Indication indicates EPC-MO-LR is supported, and if the UE supports EPC-MO-LR, the UE stays in LTE and initiates the EPC-MO-LR procedure.
- If EPC-MO-LR is not supported by either the network or the UE and if the LCS Support Indication indicates CS-MO-LR is supported, and the UE supports CS-MO-LR, the UE assumes CS-MO-LR is provided. In this case, if the previous combined EPS/IMSI Attach or Combined TA/LA Update is accepted with no "SMS only" indication, then the UE initiates CS Fallback to perform CS-MO-LR.

NOTE: Based on UE implementation, UE may avoid initiating CS-MO-LR when an IMS VoIP session is active.

- Otherwise, the UE shall not attempt the EPC-MO-LR procedure, i.e. neither EPC-MO-LR nor CS-MO-LR with CS Fallback.

If the UE decided to initiate the CS Fallback for the LCS based on LCS Support Indication check, then, the following is applied:

- When UE is in active mode, UE and the network follows the procedure in clause 6.2 "Mobile Originating Call in Active-Mode". After UE changes its RAT from E-UTRAN to UTRAN/GERAN, it performs CS-MO-LR procedures as specified in TS 23.271 [8].
- When UE is in active mode but there's no need for PS-Handover, then UE and the network follows the procedure in clause 6.3 "Mobile Originating Call in Active Mode - No PS HO Support in GERAN". After UE changes its RAT from E-UTRAN to UTRAN/GERAN, it performs CS-MO-LR procedure as specified in TS 23.271 [8].
- When UE is in idle mode, UE follows the procedure in clause 6.4 "Mobile Originating Call in Idle Mode". After UE changes its RAT from E-UTRAN to UTRAN/GERAN, it performs CS-MO-LR procedure as specified in TS 23.271 [8].

### 8.3.2 MT-LR procedure

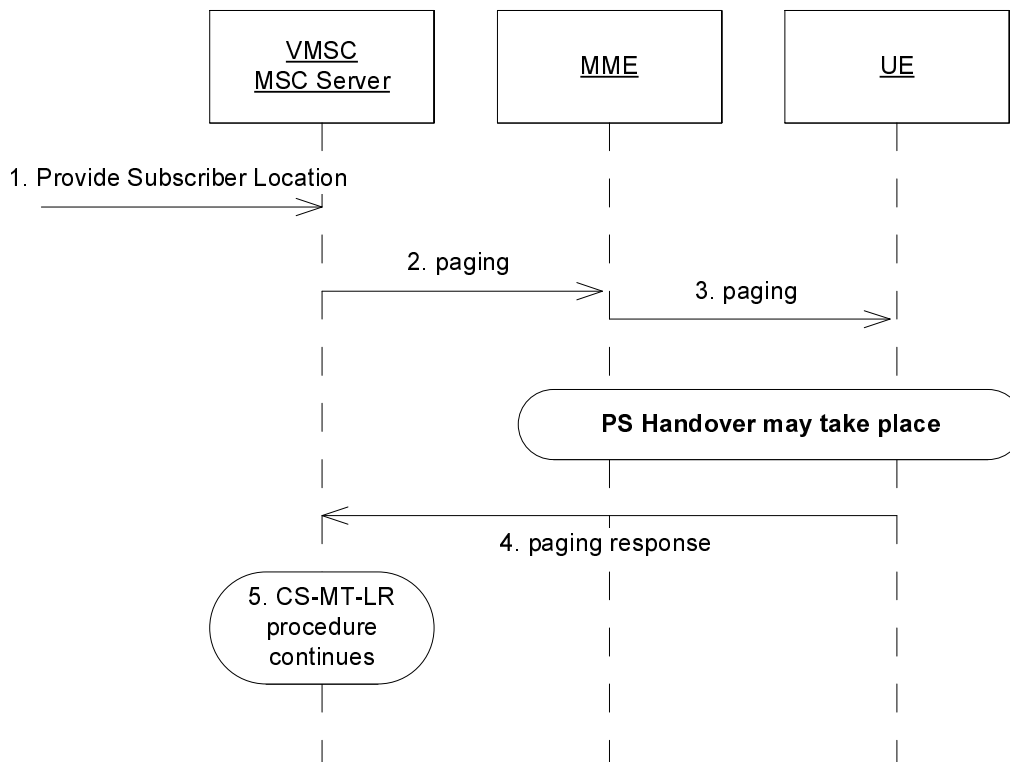

Figure 8.3.2-1: MT-LR procedure

1. MSC receives a PROVIDE\_SUBSCRIBER\_LOCATION message due to CS-MT-LR (TS 23.271 [8], clause 9.1.2).

2. MSC sends Paging (LCS Client Identity, LCS indicator) message to MME.
3. If the MME did not return the "SMS-only" indication to the UE during Attach or Combined TA/LA Update procedures, the MME sends Paging (parameters as specified in TS 23.401 [2], CN Domain Indicator, LCS Client Identity, LCS indicator) message to UE. LCS indicator is used to inform the UE that this paging is for MT-LR request. LCS Client Identity and LCS indicator are only included in CS Page if UE is in active mode.

If the MME returned the "SMS-only" indication to the UE during Attach or Combined TA/LA Update procedures, the MME shall not send Paging to the UE, and the MME sends CS Paging Reject towards MSC to stop CS Paging procedure and this CSFB procedure stops.

4. UE responds with Paging\_Resp message in UMTS/GERAN. Service based redirection/reselection or PS Handover may take place as specified in clause 7.
5. MSC continues with the CS-MT-LR procedure as defined in TS 23.271 [8], clause 9.1.2.

### 8.3.3 NI-LR procedure

NI-LR procedure takes place during emergency calls, and is thus performed in GERAN/UTRAN during the Mobile Originating call procedure.

### 8.3.4 Returning back to E-UTRAN

Once CS service ends in CS domain, existing mechanisms as specified in TS 23.401 [2] can be used to move the UE to E-UTRAN, no specific CS Fallback mechanisms are needed.

### 8.3.5 Co-Existence with Other Location Services

#### 8.3.5.1 Co-Existence with SUPL

There is no race condition between OMA AD SUPL [9] and CS Fallback for LCS. When network initiated SUPL procedure takes place, the paging message does not contain CN Domain Indicator by default. This prevents CS Fallback for LCS to take place. For SET initiated SUPL procedure, changing of RAT does not take place.

## 8.4 Call Independent Supplementary Services

### 8.4.1 Mobile-Initiated Call Independent SS procedure

When UE is in active mode, UE and the network follow the procedure in clause 6.2 "Mobile Originating Call in Active-Mode". After UE changes its RAT from E-UTRAN to UTRAN/GERAN, it performs Mobile-Initiated Call Independent Supplementary Service procedure as specified in TS 24.010 [13].

When UE is in active mode and network initiates NACC procedure, then UE and the network follow the procedure in clause 6.3 "Mobile Originating Call in Active Mode - No PS HO Support in GERAN". After UE changes its RAT from E-UTRAN to UTRAN/GERAN, it performs Supplementary Service procedure as specified in TS 24.010 [13].

When UE is in idle mode, UE and the network follows the procedure in clause "Mobile Originating Call in Idle Mode". After UE changes its RAT from E-UTRAN to UTRAN/GERAN, it performs Supplementary Services procedure as specified in specifications such as TS 23.090 [10].

## 8.4.2 NW-Initiated Call Independent SS procedure

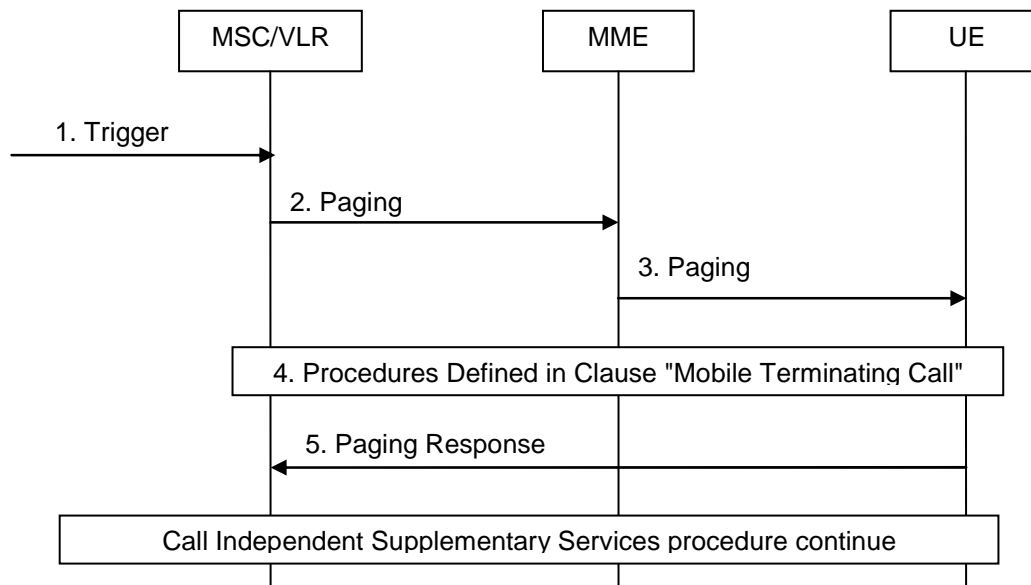

**Figure 8.4.2-1: NW-Initiated Call Independent Supplementary Service procedure**

1. MSC/VLR receives a trigger for NW-Initiated Call Independent SS procedure.
2. MSC/VLR sends Paging (optional Caller Line Identification, SS service ID) message to MME.
3. If the MME did not return the "SMS-only" indication to the UE during Attach or Combined TA/LA Update procedures, the MME sends Paging (parameters as specified in TS 23.401 [2], CN Domain Indicator, optional Caller Line Identification, SS service ID) message to UE. SS service ID is used to indicate the type of the supplementary service (e.g. USSD) to the UE. Caller Line Identification and SS service ID are only included in CS Page if UE is in active mode.  
  
If the MME returned the "SMS-only" indication to the UE during Attach or Combined TA/LA Update procedures, the MME shall not send the Paging to the UE, and the MME sends CS Paging Reject towards MSC to stop CS Paging procedure and this CSFB procedure stops.
4. The mobile terminating call procedure then takes place as specified in clause 7 "Mobile Terminating Call Procedure".
5. Once the paging is successfully returned to MSC, Supplementary Service procedures continues as specified in specifications such as TS 23.090 [10].

## 8.4.3 Returning back to E-UTRAN

Once CS service ends in CS domain, existing mechanisms as specified in TS 23.401 [2] can be used to move the UE to E-UTRAN, no specific CS Fallback mechanisms are needed.

Annex A:  
Void

---

## Annex B (normative): CS Fallback to 1xRTT

This annex describes a CS Fallback to 1xRTT and an SMS solution for dual mode 1xRTT/E-UTRAN terminals.

CS Fallback to 1xRTT is supported for UEs with both single Rx and dual Rx configuration (see TS 36.331 [33]). UEs with single Rx configuration are not able to camp in 1xRTT when they are active in E-UTRAN. The network therefore provides mechanisms for the UE to perform registration to 1xRTT, receive 1xRTT paging, SMS etc. while the UE is in E-UTRAN. UEs with dual Rx configuration can camp in 1xRTT while they are active in E-UTRAN, they may however not be able to stay in E-UTRAN when they handle a CS call and/or perform registration signalling, and/or sending or receiving SMS in 1xRTT.

Clause B.1 and B.2 describes the architecture and procedures for CS Fallback (and enhanced CS Fallback) to 1xRTT when the UE has single Rx or dual Rx configuration. In this scenario the network need to support the S102 interface between the MME and 1xCS system in order to support CS Fallback (this is indicated by the presence of CSFB registration parameters on E-UTRAN broadcast channel, TS 36.331 [33]).

Clause B.3 describes the procedures for CS Fallback when the UE has dual Rx configuration. In this scenario the network needs to support the Extended Service Request procedure with CSFB indication in order to support CS Fallback (this is indicated by either the presence of CSFB registration parameters or indication of support for dual rx CSFB on E-UTRAN broadcast channel, TS 36.331 [33]).

If the UE has a dual Rx configuration and indicates support for enhanced CS fallback to 1xRTT in the UE radio capabilities, the principles and procedures in clauses B.1 and B.2 are followed when the network indicates support for S102.

---

### B.1 Overall Description

#### B.1.1 General Considerations

The CS fallback for 1xRTT in EPS enables the delivery of CS-domain services (e.g. CS voice) by reuse of the 1xCS infrastructure when the UE is served by E-UTRAN. A CS fallback enabled terminal, while connected to E-UTRAN may register in the 1x RTT CS domain in order to be able to use 1xRTT access to establish one or more CS services in the CS domain. The CS Fallback function is only available where E-UTRAN coverage overlaps with 1xRTT coverage.

This specification also specifies the architecture required for SMS over S102 in EPS. The MO SMS and MT SMS are tunnelled in EPS and over S102 and do not cause any CS Fallback to CDMA 1xRTT, and consequently does not require any overlapped CDMA 1xRTT coverage.

CS Fallback to 1xRTT and IMS-based services shall be able to co-exist in the same operator's network.

CS Fallback to 1xRTT with PS Handover procedure to HRPD access for Optimised HO, non-Optimised HO, and Optimised Idle mode mobility as defined in TS 23.402 [27] shall be able to co-exist in the same operator's network.

#### B.1.2 Reference Architecture

The CS fallback to 1xRTT and SMS over S102 in EPS function is realised by reusing the S102 reference point between the MME and the 1xCS IWS. The reference architecture described in figure B.1.2-1 is similar to the SRVCC architecture for E-UTRAN to 3GPP2 1xCS described in TS 23.216 [20], with the additional aspect that the S102 session is long-lived (similar to pre-registration for S101).

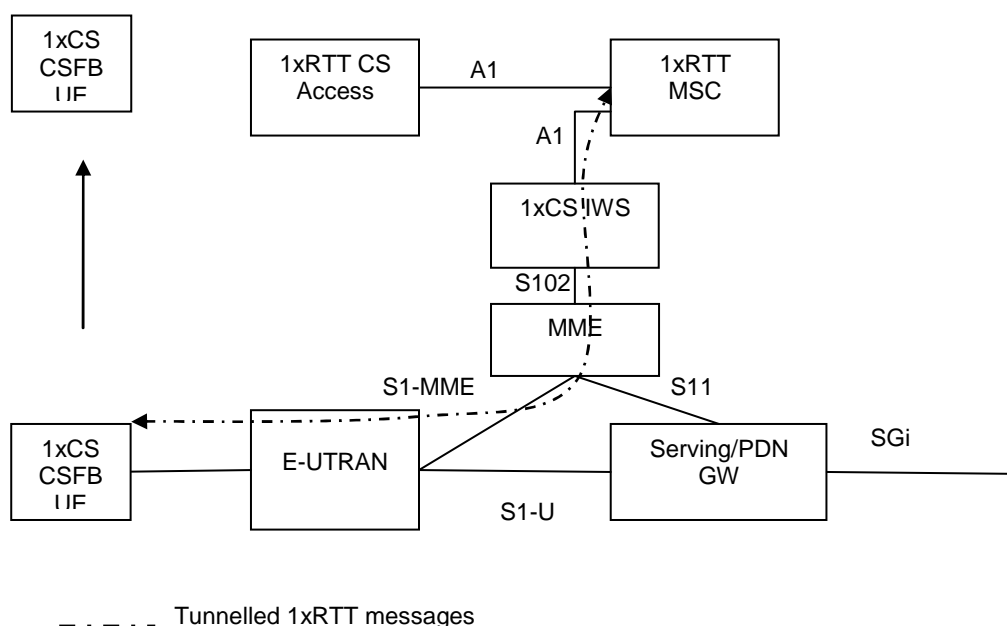

**Figure B.1.2-1: Reference architecture for CS fallback to 1xRTT CS**

Reference architecture for PS handover procedure between E-UTRAN and HRPD access is defined in TS 23.402 [27].

### B.1.2.1 Reference points

**S102:** It is the reference point between the MME and the 1xCS IWS. The S102 reference point provides a tunnel between MME and 3GPP2 1xCS IWS to relay 3GPP2 1xCS signalling messages. 1x CS signalling messages are those messages that are defined for A21 interface as described in 3GPP2 A.S0008-C [16] and 3GPP2 A.S0009 [17].

## B.1.3 Functional entities

### B.1.3.1 UE

The UE capable of CS fallback to 1xRTT and SMS over S102 supports access to E-UTRAN/EPC as well as access to the 1xCS domain over 1xRTT. It supports the following additional functions:

- 1xRTT CS registration over the EPS after the UE has completed the E-UTRAN attachment;
- 1xRTT CS re-registration due to mobility;
- CS fallback procedures specified for 1xRTT CS domain voice service;
- Procedures for mobile originated and mobile terminated SMS tunnelled over EPS and S102;
- Includes enhanced CS fallback to 1xRTT capability indication as part of the UE radio capabilities;
- Includes concurrent 1xRTT and HRPD capability indication as part of the UE radio capabilities if supported by the enhanced CS fallback to 1xRTT capable UE.

### B.1.3.2 MME

The MME enabled for CS fallback to 1xRTT supports the following additional functions:

- It serves as a signalling tunnelling end point towards the 3GPP2 1xCS IWS via S102 interface for sending/receiving encapsulated 3GPP2 1xCS signalling messages to/from the UE, which are encapsulated in S1-MME S1 Information Transfer messages, as defined in TR 36.938 [19];

- 1xCS-IWS (terminating S102 reference point) selection for CSFB procedures;
- Handling of S102 tunnel redirection in case of MME relocation;
- Buffering of messages received via S102 for UEs in idle state.

### B.1.3.3 E-UTRAN

The E-UTRAN enabled for CS fallback to 1xRTT supports the following additional functions:

- Provision of control information that causes the UE to trigger 1xCS registration;
- Forwarding 1x RTT CS paging request to the UE;
- Forwarding 1x RTT CS related messages between MME and UE;
- Release of E-UTRAN resources after UE leaves E-UTRAN coverage subsequent to a page for CS fallback to 1xRTT CS if PS handover procedure is not performed in conjunction with 1xCS fallback;
- Invoking the optimised or non-optimised PS handover procedure concurrently with enhanced 1xCS fallback procedure when supported by the network and UE, and based on network configuration.

## B.1.4 Co-existence with IMS services

Clause 4.4 of this specification also applies here.

---

## B.2 Procedures

### B.2.1 Mobility Management

#### B.2.1.1 1x RTT CS Pre-Registration over EPS Procedure

This clause describes how the UE in an E-UTRAN system establishes and maintains pre-registration in the 1xCS system.

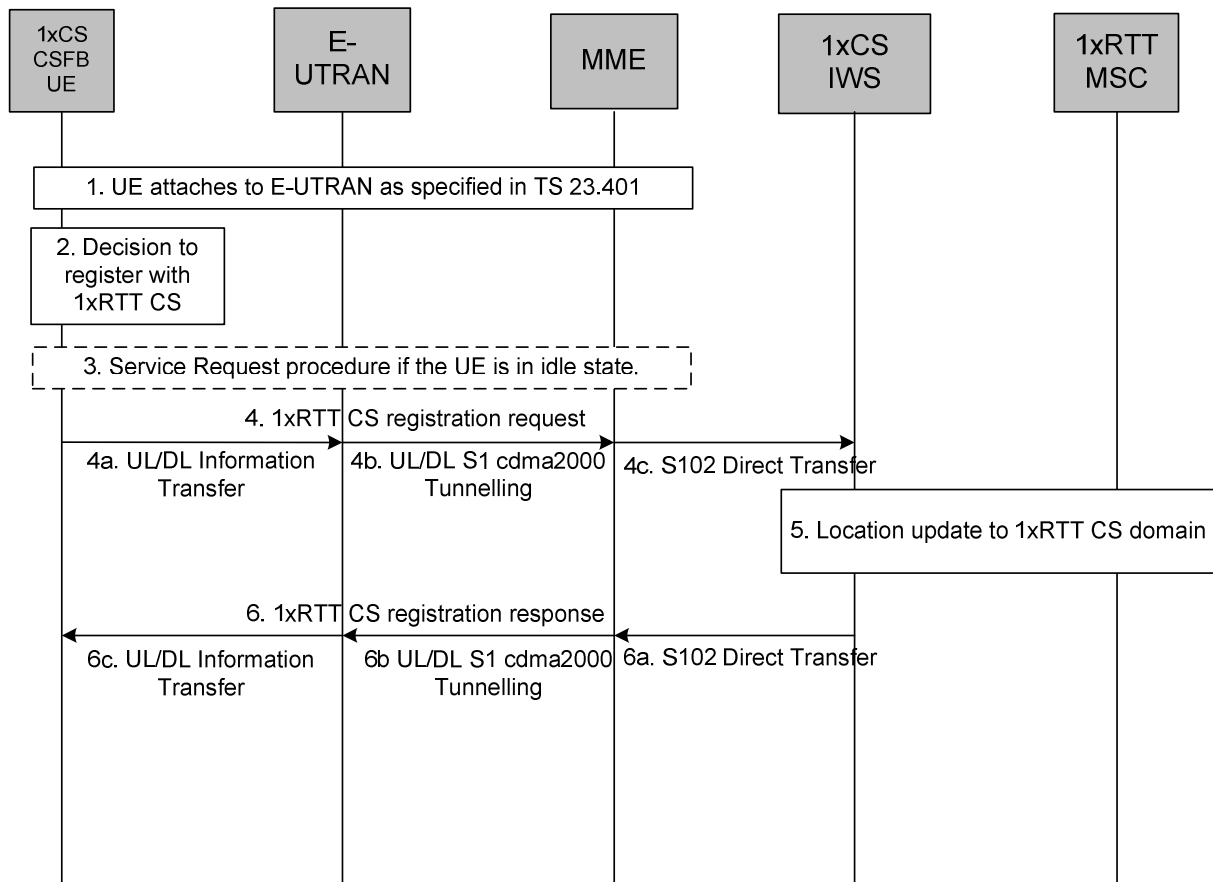

**Figure B.2.1.1-1: 1xRTT CS registration procedure**

1. The UE attaches to E-UTRAN as specified in TS 23.401 [2]. The UE includes an indication of enhanced CS fallback to 1xRTT and may also include concurrent 1xRTT and HRPD PS session handling capabilities as part of the UE radio capabilities.
2. Based on a radio layer trigger (e.g. an indication from the E-UTRAN when the UE is in connected state or an indication over the broadcast channel), the UE decides to register with the 1xRTT CS domain.
3. If the UE is in idle state, in order to create a signalling connection with the MME, it performs the Service Request procedure.
4. The UE generates a 1xRTT CS registration request.
  - 4a. The 1xRTT CS message is transferred from the UE to E-UTRAN.
  - 4b. E-UTRAN forwards the 1xRTT CS message to the MME including the CDMA2000 Reference Cell ID.
  - 4c. The MME selects a 1xCS IWS node based on the CDMA2000 Reference Cell ID. The IMSI is used to distinguish S102 signalling transactions belonging to different UEs. The MME sends a S102 Direct Transfer message (IMSI, 1xCS message) to the 1xCS IWS node.
5. 1xRTT CS registration is then performed by the 1xCS IWS node based on 3GPP2 A.S0008 [16].
  - 6a. 1xRTT CS registration response is tunnelled back to the MME in a S102 Direct Transfer message (IMSI, 1xCS message).
  - 6b. The MME forwards the 1xRTT CS message to the E-UTRAN.
  - 6c. The E-UTRAN forwards the 1xRTT CS message to the UE.

If the triggers for 1xCS registration change over time, the UE (both in idle or connected state), uses this information to update the 1xCS registration via the tunnel.



### B.2.1.2 S102 Tunnel Redirection

S102 Tunnel Redirection Procedure is used when the UE perform Tracking Area Update with MME change while the UE is registered with the 1xRTT CS domain as described in clause B.2.1.1 and the S102 session exists between the MME and the 1xCS IWS.

The detail procedure for the idle case is depicted as figure B.2.1.2-1.

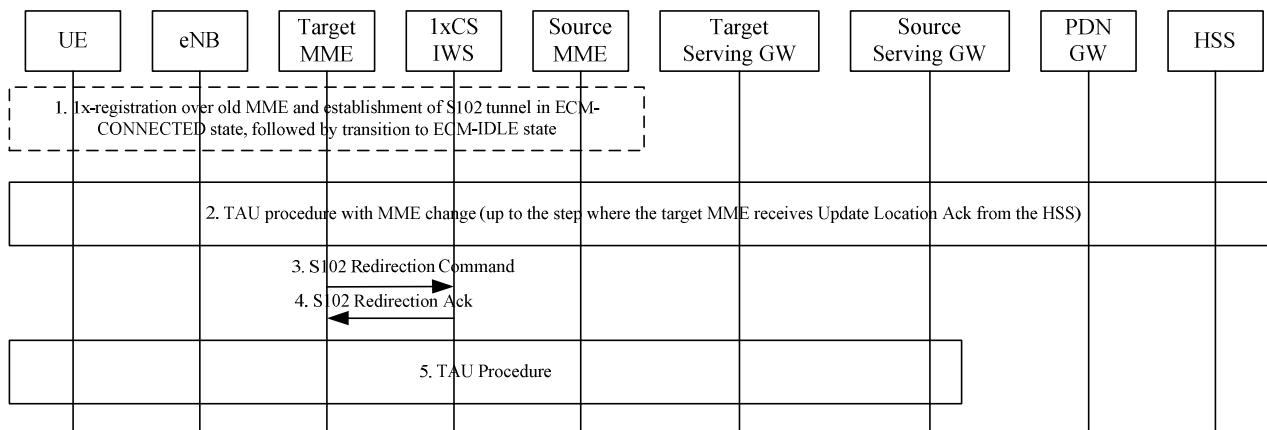

**Figure B.2.1.2-1: S102 tunnel redirection during TAU with MME change**

1. UE performs 1x-registration over the source MME while in ECM-CONNECTED state, followed by transition to ECM-IDLE state. The S102 tunnel exists between the source MME and the 1xCS IWS.
2. TAU procedure with MME change as described in TS 23.401 [4], figure 5.3.3.1-1, prior to the step where the target MME receives Update Location Ack from the HSS, is executed. The 1xCS IWS ID is transferred to the target MME via the Context Response message.
3. The target MME sends S102 Redirection Command message to the 1xCS IWS. After receiving this message, the 1xCS IWS associates the S102 tunnel for this specific UE with the target MME. Then the 1xCS IWS releases any context associated with the source MME.
4. In response to the S102 Redirection Command message, the 1xCS IWS sends a S102 Redirection Ack message to the target MME.
5. The TAU procedure is completed.

The detailed procedure for the active case is depicted as figure B.2.1.2-2.

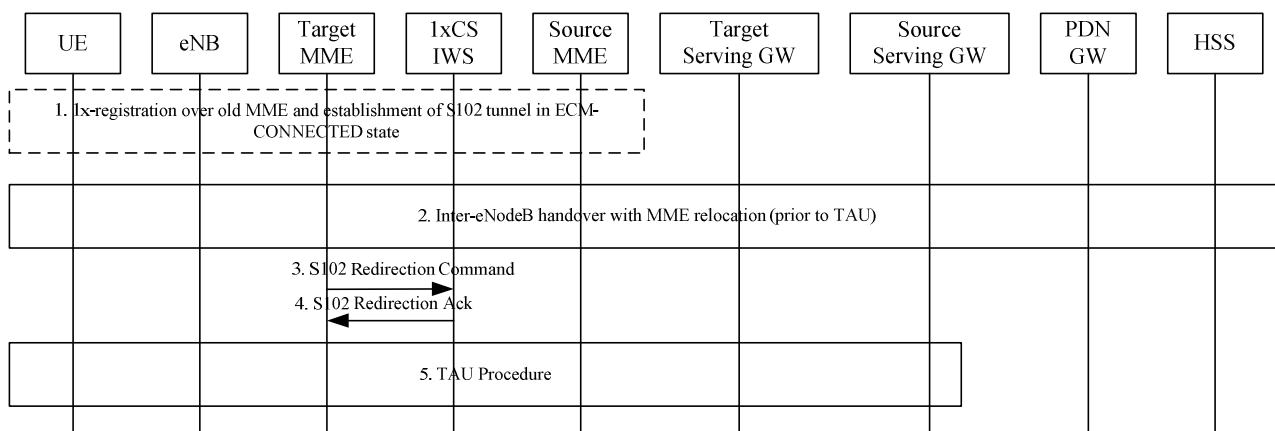

**Figure B.2.1.2-2: S102 tunnel redirection during inter-eNodeB handover with MME relocation**

1. UE performs 1x-registration over the source MME while in ECM-CONNECTED state. The S102 tunnel exists between the source MME and the 1xCS IWS.

2. Inter-eNodeB handover with MME relocation procedure as described in TS 23.401 [4], figure 5.5.1.2.2-1, steps prior to TAU, is executed. The 1xCS IWS ID is transferred to the target MME via the Forward Relocation Request message.
3. The target MME sends S102 Redirection Command message to the 1xCS IWS. After receiving this message, the 1xCS IWS associates the S102 tunnel with the target MME. Then the 1xCS IWS releases any context associated with the source MME.
4. In response to the S102 Redirection Command message, the 1xCS IWS sends a S102 Redirection Ack message to the target MME.
5. The TAU procedure occurs.

### B.2.1.3 UE-initiated Detach Procedure

If a 1xRTT CS Fallback UE, pre-registered to the 1xRTT CS system, initiates the detach procedure in E-UTRAN access due to switch off and the UE is required to perform a "power-down registration" in the 1xRTT CS system (see C.S0005-A [32]), the UE shall first perform the "power-down registration" procedure with the 1xRTT CS system via the S102 tunnel, before initiating the detach procedure in E-UTRAN access as specified in TS 23.401 [2].

A 1xCSF UE, pre-registered to the 1xCS system, performing detach due to reasons other than switch off is not required to perform "power-down registration" with the 1xCS system prior to performing the detach procedure in E-UTRAN.

## B.2.2 Mobile Originating Call in Active Mode

This clause describes the mobile originating call procedures for the CS Fallback to 1xRTT. For enhanced CS fallback to 1xRTT procedure, see clause B.2.3a.

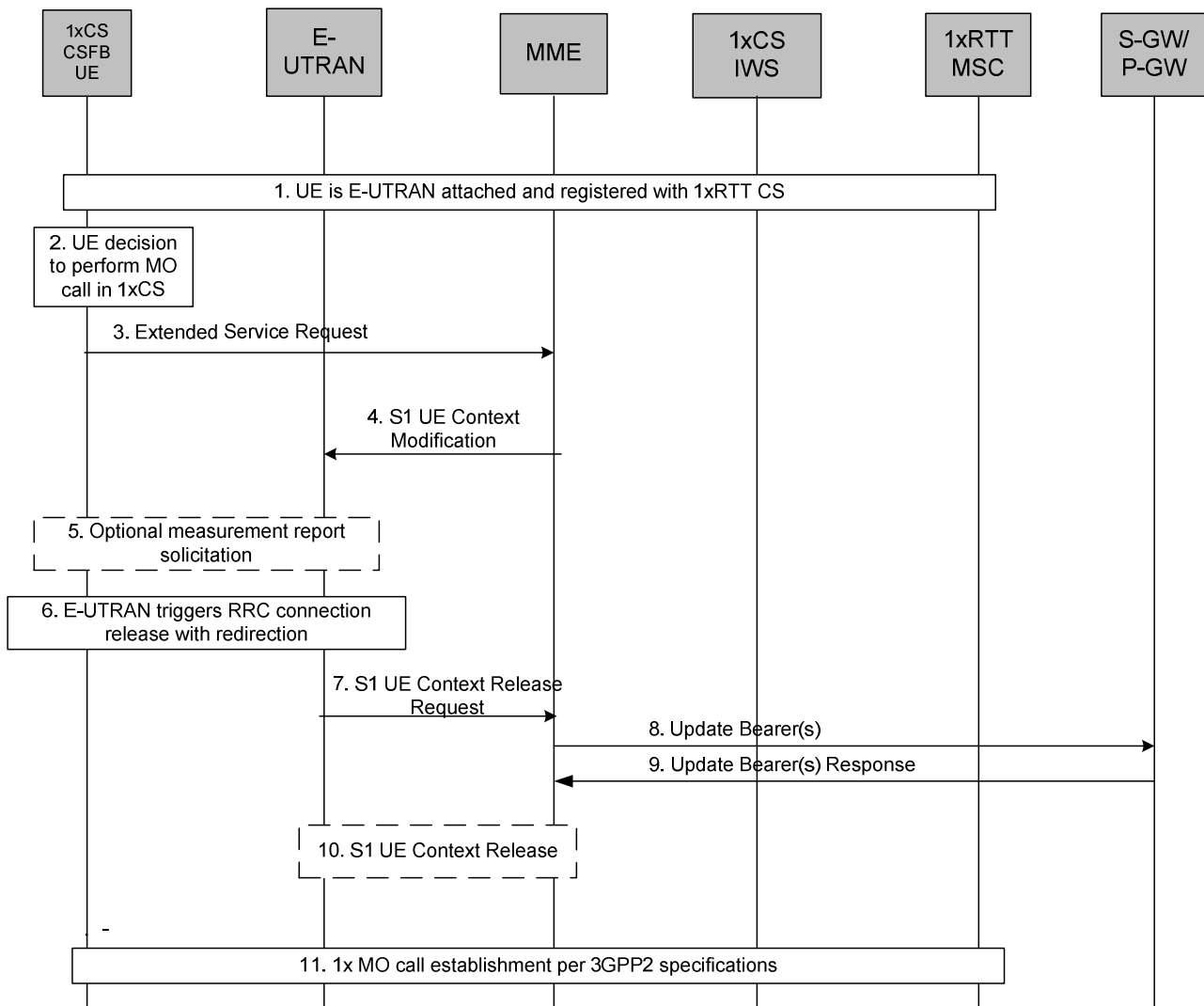

**Figure B.2.2-1: CS MO call using fallback to CDMA 1x RTT network**

1. UE is E-UTRAN attached and registered with 1xRTT CS as defined in clause B.2.1.1.
2. UE makes a decision to perform a mobile originated CS call.
3. UE sends an Extended Service Request (CS Fallback Indicator) to the MME.
4. MME sends a S1-AP message that includes: a CS Fallback Indicator to indicate the E-UTRAN to move the UE to 1xRTT.
5. E-UTRAN may optionally solicit a 1xRTT measurement report from the UE to determine the target 1xRTT cell to which the CS Fallback will be performed.
- 6a. The E-UTRAN triggers RRC connection release with redirection to 1xCS and continue with step 7.
7. E-UTRAN sends an S1 UE Context Release Request (Cause) message to the MME. Cause indicates that the S1 UE Context Release was caused by CS fallback to 1xRTT.
8. Suspend Notification: The S1-U bearers are released and the MME starts the preservation and suspension of non-GBR bearers and the deactivation of GBR bearers towards S-GW and P-GW(s).

9. S-GW and P-GW(s) acknowledges the bearer updates Suspend Notification and marks the UE as suspended. The P-GW discards downlink data if the UE is marked as suspended.
10. S1 UE Context in the E-UTRAN is released as specified in TS 23.401 [2].
11. UE moves to 1xRTT and performs the procedure for mobile originating call as specified in 3GPP2 A.S0013 [18].

Once CS service ends in the 1xCS domain, the UE returns to E-UTRAN by performing reselection. The EPS service is resumed as described in clause 6.5.

## B.2.2a Mobile Originating call in Idle Mode

Mobile Originating call in Idle Mode procedure is specified by reusing the Mobile Originating Call in Active mode procedure with Extended Service Request (CS Fallback Indicator) to the MME. UE is transitioned to ECM-CONNECTED mode by following the applicable procedures specified in TS 23.401 [2].

## B.2.3 Mobile Terminating Call

This clause describes the mobile terminating call procedures when the UE accepts or rejects CS paging for the CS Fallback to 1xRTT.

When the 1x MSC receives a registration from a UE, it makes note of the RAN equipment from which it received the registration. Subsequent paging activities may thus be directed toward that RAN equipment. However, paging activities by the 1xMSC are not limited to the single RAN equipment from which the registration was received. The MSC may choose to page a wider area, including inter-system paging. If the 1xMSC has direct interfaces to 1xCS IWS, as well as to 1xRTT access, the MSC may choose to do direct paging activities to both E-UTRAN and 1x RAN equipments in its attempts to contact the UE.

The 1x paging request sent by the 1xMSC to the 1xCS IWS is delivered to the UE via the tunnel. The UE tunes to 1xRTT access, acknowledges the 1x page and performs the 1xCS procedures for mobile terminated call. When the UE receives a page message, it may not want to accept it based on Caller Line Identification or pre-provisioned local policy. In that case, the UE sends the 1x Release Order to 1xCS IWS over a tunnel in E-UTRAN and EPC.

The detailed procedure using RRC connection release with redirection to 1xCS is described in figure B.2.3-1. For enhanced 1xRTT CS Fall Back procedure, see clause B.2.3a.

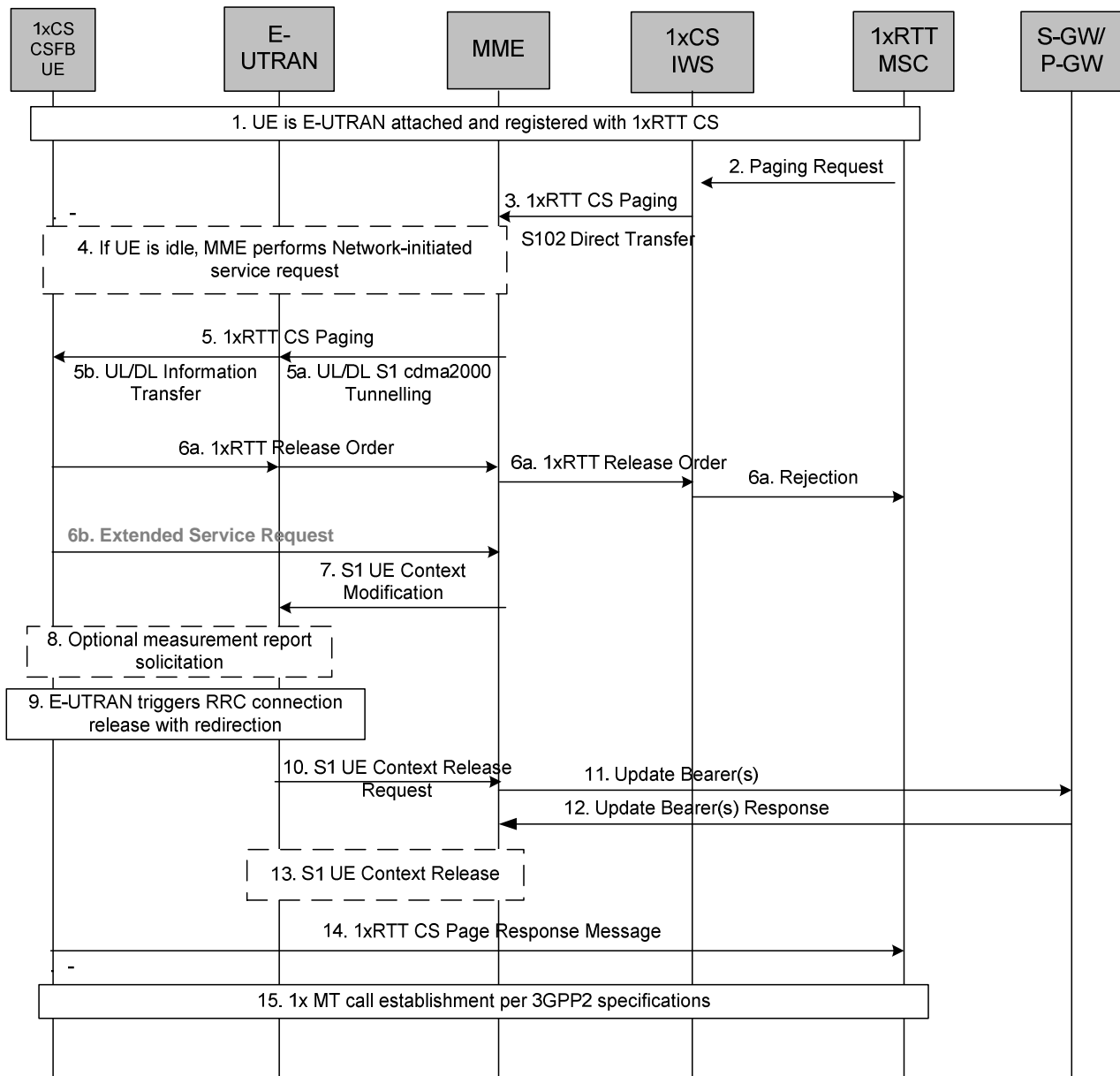

**Figure B.2.3-1: CS MT call using fallback to CDMA 1x RTT network**

1. UE is E-UTRAN attached and pre-registered with 1xRTT CS as defined in clause B.2.1.1.
2. 1xMSC sends a paging request to the 1xCS IWS node with Caller Line Identification if available.
3. 1xCS IWS node forwards the 1x RTT CS paging request with Caller Line Identification if available via the S102 tunnel to the MME.
4. If the UE is in idle state, the MME performs the network initiated Service Request procedure in order to bring the UE to active state prior to tunnelling of the 1x RTT CS paging request toward the UE.
5. MME forwards the 1xRTT CS paging request to the UE.
- 6a. If the UE decides to reject CSFB based on e.g. user decision by Caller Line Identification or UE locally pre-provisioned policy, then the UE rejects the 1x CS paging by sending an 1x Release Order to the MME. The MME forwards the 1x Release Order in an S102 Direct Transfer message to the 1xCS IWS and the 1x IWS sends a Rejection to the 1x MSC. This completes the procedure.

- 6b. If the UE accepts CS paging for the CS Fallback to 1xRTT, the UE sends an Extended Service Request (CS Fallback Indicator) to the MME and proceeds with step 7 to step 15 below.
7. MME sends S1-AP: UE Context Modification (CS Fallback Indicator) to indicate the E-UTRAN to move the UE to 1xRTT.
8. E-UTRAN may optionally solicit a 1xRTT measurement report from the UE to determine the target 1xRTT cell to which the CS Fallback will be performed.
9. E-UTRAN triggers RRC connection release with redirection to 1xCS.
10. E-UTRAN sends an S1 UE Context Release Request (Cause) message to the MME. Cause indicates that the S1 UE Context Release was caused by CS fallback to 1xRTT.
11. Suspend Notification: The S1-U bearers are released and the MME starts the preservation and suspension of non-GBR bearers and the deactivation of GBR bearers towards S-GW and P-GW(s).
12. S-GW and P-GW(s) acknowledges the bearer updates Suspend Notification and marks the UE as suspended. The P-GW discards downlink data if the UE is marked as suspended.
13. S1 UE Context in the E-UTRAN is released as specified in TS 23.401 [2].
14. UE tunes to 1xRTT and acknowledges the page by transmitting a 1xRTT Paging Response message over the 1x Access Channel.
15. Subsequently UE performs the procedure for mobile terminated call establishment as specified in 3GPP2 A.S0013 [18].

Once CS service ends in the 1xCS domain the UE returns to E-UTRAN by performing reselection. The EPS service is resumed as described in clause 6.5.

## B.2.3a Enhanced CS fallback to 1xRTT Procedure

### B.2.3a.1 General

Enhanced CS fallback to 1xRTT procedure may be used when the UE indicates its support of this capability to the network. If in addition, the UE also indicates its support of concurrent 1xRTT and HRPD PS session handling, this indication also allows the network to invoke optimised or non-optimised PS handover procedure concurrently with the enhanced CS fallback to 1xRTT procedure.

If enhanced CS fallback to 1xRTT procedure is not used by the network (i.e., not supported or not configured), the network uses RRC connection release with redirection as specified in clauses B.2.2 and B.2.3.

NOTE 1. Other 3GPP2 specific procedure (e.g. how UE performs concurrent operation in 3GPP2 network) is outside the scope of this specification.

NOTE 2. E-UTRAN may invoke concurrent optimised active-mode PS handover procedure or non-optimised PS handover procedure when it receives S1-AP: UE Context Modification with CSFB indication, based on UE capability and operator configuration.

### B.2.3a.2 Mobile Originating Call without concurrent PS handover, or with concurrent non-optimised PS handover or optimised idle-mode PS handover

The following figure describes the mobile originating call procedures for the enhanced CS Fallback to 1xRTT with concurrent non-optimised PS handover or optimised idle-mode PS handover, or without concurrent PS handover.

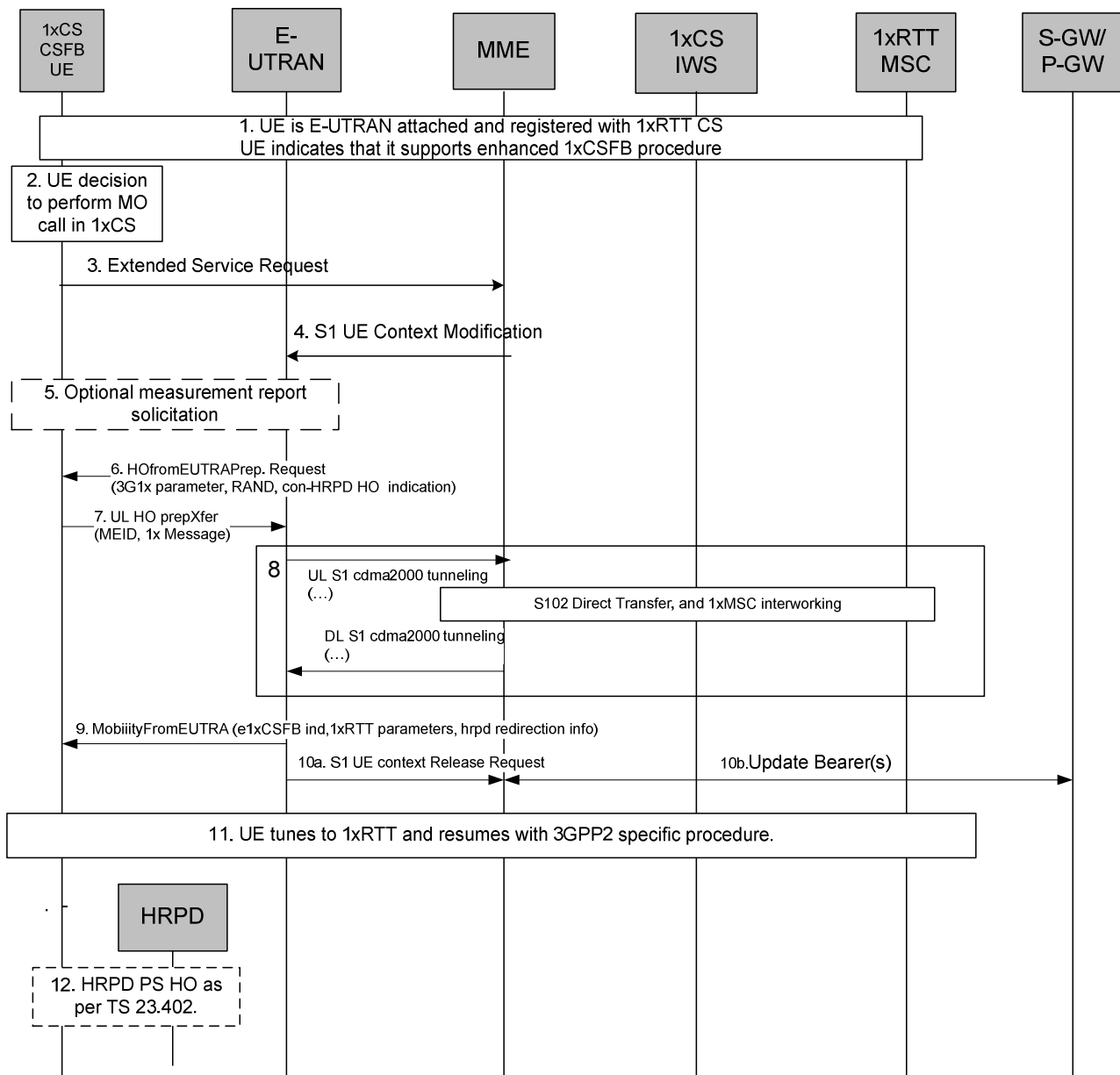

**Figure B.2.3a-2-1: Enhanced CS fallback to 1xRTT MO Call with no PS handover, or with concurrent non-optimised PS handover or optimised idle-mode PS handover**

1. UE is E UTRAN attached and registered with 1xRTT CS as defined in clause B.2.1.1 with enhanced CS fallback to 1xRTT capability indication to the network. The UE may also indicate that it supports concurrent 1xRTT and HRPD capability.. The UE may also be pre-registered with HRPD access using procedures defined in TS 23 402 [27], clause 9.3.1.
2. UE makes a decision to perform a mobile originated CS call.
3. UE sends an Extended Service Request (CS Fallback Indicator) to the MME.
4. MME sends a S1-AP message that includes: a CS Fallback Indicator to indicate the E UTRAN to move the UE to 1xRTT.
5. E-UTRAN may optionally solicit a 1xRTT measurement report from the UE to determine the target 1xRTT cell to which the CS Fallback will be performed.

If the network supports PS handover procedure to HRPD then E-UTRAN may optionally solicit an HRPD measurement report from the UE to determine whether the target HRPD candidates exist or not. If the network does not support PS handover procedure to HRPD or if no target HRPD candidates exist then E-UTRAN shall release the S1 UE context (see step 10a/b) after executing the enhanced CS fallback to 1xRTT procedure.

6. E-UTRAN sends a HandoverFromE-UTRAPreparation Request message to the UE to start the enhanced 1xCS fallback procedure. It includes 3G1x Overhead Parameters and RAND value. This message also includes an indication that concurrent HRPD handover preparation is not required.
7. The UE initiates signalling for establishment of the CS access leg by sending UL HandoverPreparation Transfer message which contains the 1xRTT Origination message with called party number.
8. Messages between MME and 1xIWS are tunnelled using the S102 interface. The 1xRTT MSC initiates the call with the called party number carried in the 1xRTT Origination message.
9. The E UTRAN sends Mobility from EUTRA Command to the UE with indication that this is for enhanced 1x CS Fallback operation, 1xRTT related information, and optionally the HRPD redirection information. The 1xRTT information contains 1xRTT messages related to 1x channel assignment and cause the UE to tune to and acquire this 1x channel. This is perceived by the UE as a Handover Command message to 1xRTT. If 1xRTT CS network cannot support this CSFB request (for example due to resource availability), the DL information transfer message is sent instead, with an embedded 1x message that indicates failure to the UE.
  - For either concurrent non-optimised PS handover procedure or optimised idle-mode PS handover procedure along with enhanced CS fallback to 1xRTT, E-UTRAN may also redirect the UE to HRPD as part of this procedure. This is indicated by the HRPD redirection information in the Mobility from EUTRA Command.
- 10a/b. If PS handover procedure is not performed then E-UTRAN sends an S1 UE Context Release Request (Cause) message to the MME. Cause indicates that the S1 UE Context Release was caused by CS fallback to 1xRTT. Suspend Notification: The S1-U bearers are released and the MME starts the preservation and suspension of non-GBR bearers and the deactivation of GBR bearers towards S-GW and P-GW(s). The MME sets the UE context to suspended status.
11. UE retunes to the 1xRTT radio access network and performs 1xchannel acquisition with the 1xRTT CS access (e.g. 1xRTT BSS).
12. UE and Network follow the appropriate procedure for handling non-optimised PS handover procedure or optimised idle-mode PS handover as defined in TS 23.402 [27] if performed. S1 UE Context release procedure is as specified in TS 23.402 [27] for non-optimised PS handover (clause 8.2.2) or optimised idle-mode PS handover (clause 9.4). This step occurs in parallel with step 11.

### B.2.3a.3 Mobile Originating Call with concurrent optimised PS handover

The following figure describes the mobile originating call procedures for the enhanced CS Fallback procedure to 1xRTT with concurrent optimised PS handover.



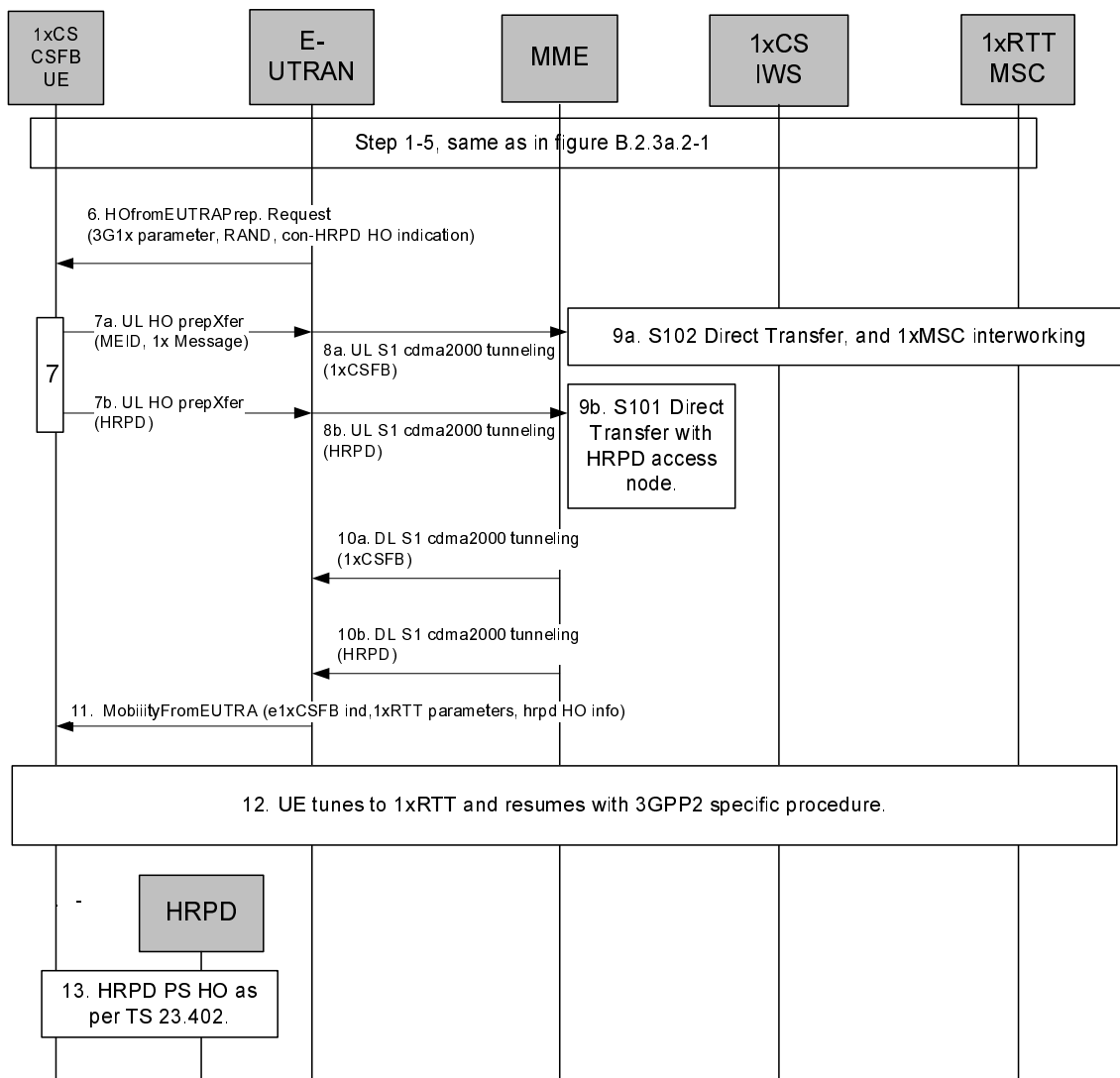

**Figure B.2.3a.3-1: Enhanced CS fallback to 1xRTT MO Call with concurrent optimised PS handover**

- 1-5. Same as steps 1-5 in figure B.2.3a.2-1. The UE indicates that it supports enhanced CS fallback to 1xRTT procedure and concurrent 1xRTT and HRPD capability.
- 6. E-UTRAN sends an Handover From E-UTRA Preparation Request message to the UE to start the enhanced 1xCs fallback procedure. It includes 3G1x Overhead Parameters and RAND value. This message also includes an indication that concurrent HRPD handover preparation is required.
- 7. UE starts the enhanced 1xCs fallback and optimised PS handover messages (7a, 7b) in a sequential manner. Step 7a contains the 1xRTT Origination message with called party number.
- 8a, 9a, 10a, and 8b, 9b, 10b. MME treats the enhanced 1xCs fallback and HRPD PS handover procedure independently (i.e. MME does not link the HRPD message and 1xCs fallback message together).
- 8a, 9a, 10a is same as shown in step 8 in figure B.2.3a.2-1
- 8b, 9b, 10b are messages/procedure for optimised E-UTRAN to HRPD handover procedure as defined in TS 23.402 [27], clause 9.3.2.

11. The E-UTRAN sends Mobility from EUTRA Command to the UE with indication that this is for enhanced 1x CS Fallback operation including the 1xRTT message and the HRPD message received over the S102 and S101 tunnels.

If handover preparation to HRPD is successful but preparation failure message is received from the 1xRTT CS network via the S102 tunnel, the message for 1xRTT preparation failure indication is sent to the UE as part of the Mobility from EUTRA Command. If handover to HRPD is successful and the eNB times out waiting for preparation completion message from 1xRTT, the E-UTRAN sends a Mobility from EUTRA command with only the HRPD message included. In the case that the preparation to HRPD failed but 1xRTT is successful, E-UTRAN may optionally include HRPD redirection info as part of the Mobility from EUTRA Command.

In case preparation on 1xRTT and HRPD failed with explicit failure messages received on S102 and S01 tunnels, the E-UTRAN forwards the received failure messages as DL Information transfers

12. UE retunes to the 1xRTT radio access network and performs 1x channel acquisition with the 1xRTT CS access (e.g. 1xRTT BSS), see TS 23.216 [20], clause 6.1.3.
13. UE and network follow the optimised E-UTRAN to HRPD handover procedure. UE context release procedure follows the optimised E-UTRAN to HRPD handover procedure as defined in TS 23.402 [27], clause 9.3.2. This step occurs in parallel with step 12.

#### **B.2.3a.4 Mobile Terminating Call without PS handover, or with concurrent non-optimised PS handover or optimised idle-mode PS handover**

The following figure describes the mobile terminating call procedures for the enhanced CS Fallback to 1xRTT with concurrent non-optimised PS handover or optimised idle-mode PS handover, or without PS handover.

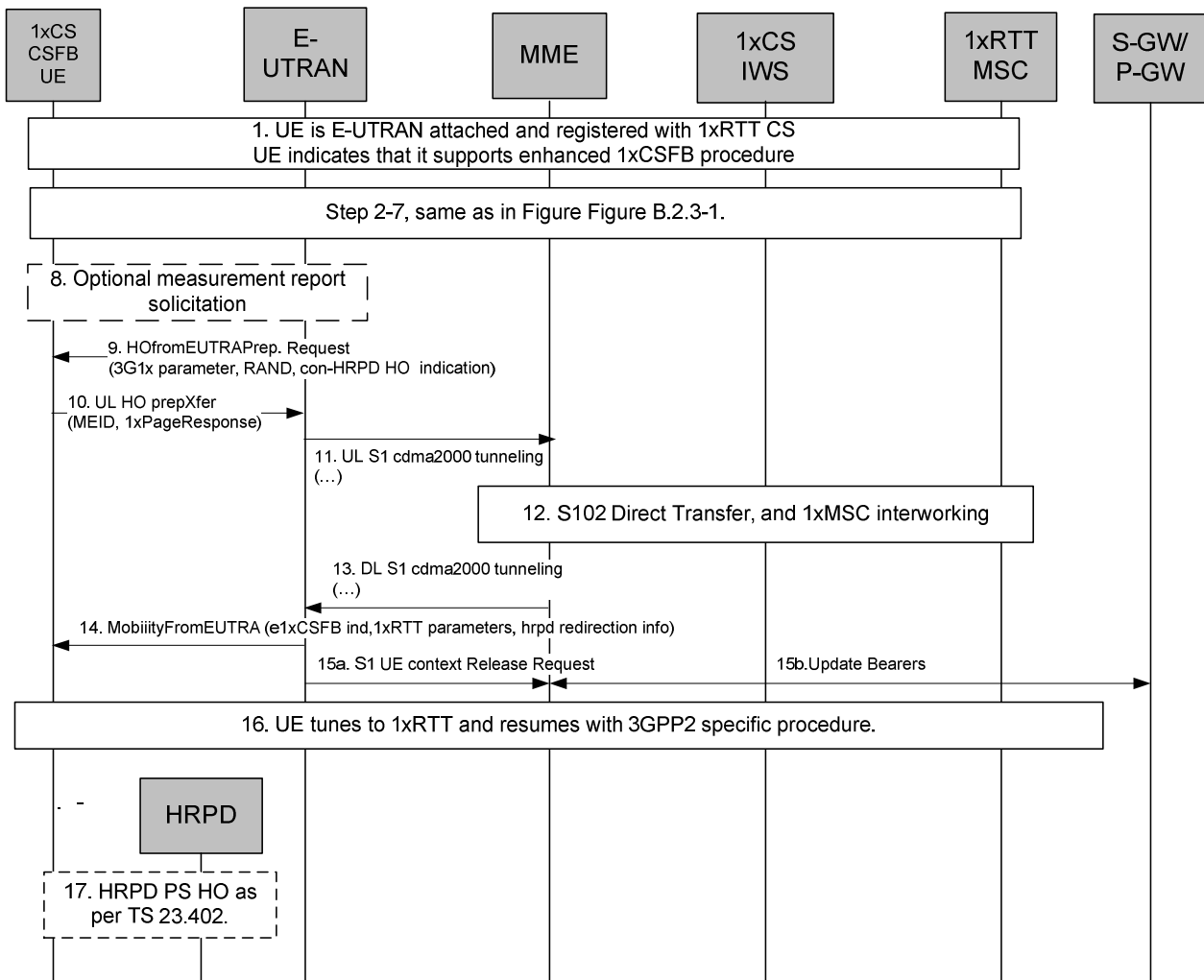
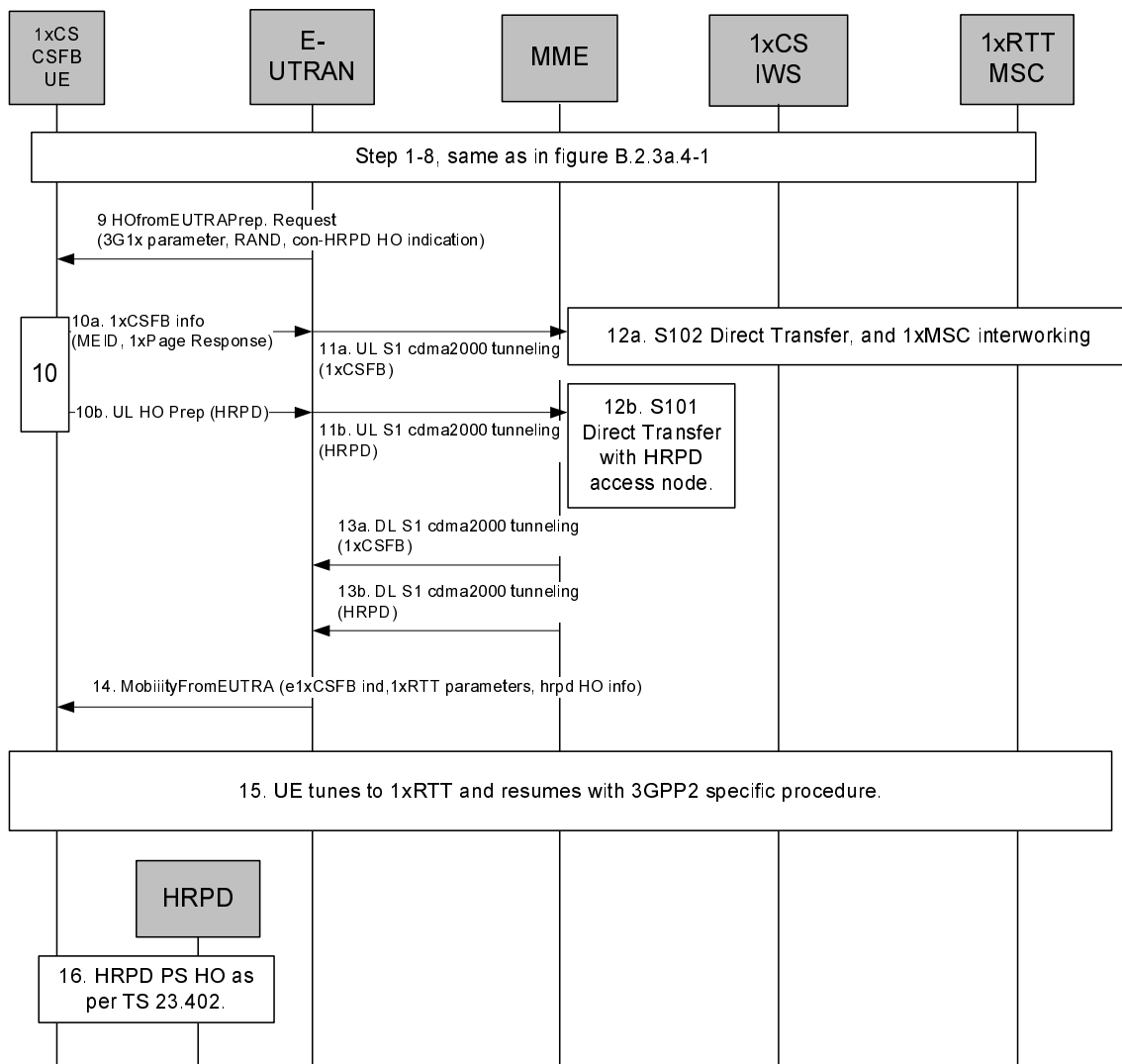

**Figure B.2.3a.4-1: Enhanced CS fallback to 1xRTT MT call without PS handover, or with concurrent non-optimised PS handover or optimised idle-mode PS handover**

1. UE is E-UTRAN attached and pre-registered with 1xRTT CS as defined in clause B.2.1.1 with enhanced CS fallback to 1xRTT capability indication to the network. The UE may also indicate that it supports concurrent 1xRTT and HRPD capability. The UE may also be pre-registered with HRPD access using procedures defined in TS 23.402 [27], clause 9.3.1.
- 2-7. Same as step 2-7 in figure B.2.3-1.
- 8-17. Same as steps 5 – 12 of Figure B.2.3a.2-1, with the only modification that the 1x message in step 7 of Figure B.2.3a.2-1 provided by the UE to the E-UTRAN is a 1xPage Response message.

**B.2.3a.5 Mobile Terminating Call with concurrent optimised PS handover**

The following figure describes the mobile terminating call procedures for the enhanced CS Fallback to 1xRTT with concurrent optimised PS handover.



**Figure B.2.3a.5-1: Enhanced CS fallback to 1xRTT MT Call with concurrent optimised PS handover**

1-8. Same as steps 1-8 in figure B.2.3a.4-1. The UE indicates that it supports enhanced CS fallback to 1xRTT procedures and concurrent 1xRTT and HRPD capability. The UE may also be pre-registered with HRPD access using procedures defined in TS 23.402 [27], clause 9.3.1.

9-16. Same as steps 6 – 13 of Figure B.2.3a.3-1, with the only modification that the 1x message in step 7 of Figure B.2.3a.2-1 provided by the UE to the E-UTRAN is a 1xPage Response message.

### B.2.3a.6 Interaction between enhanced CS Fallback to 1xRTT and optimised PS handover

For regular optimized PS handover procedure, it is possible that the UE receives 1xRTT CS paging from EPS while optimised PS handover to HRPD is in progress. In this case, UE shall ignore the 1xRTT CS paging locally.

## B.2.4 Short Message Service (SMS)

### B.2.4.1 General

The procedures for SMS in this annex apply only if the UE is 1xRTT CS Registered and the CS access domain is chosen by the UE and/or the home PLMN for delivering short messages.

This clause describes both the mobile originating and mobile terminating SMS over S102 which uses 1xCS procedures in EPS. SMS support is based on the S102 reference point between the MME and the 1xCS IWS, use of RRC

Information Transfer message between the UE and the E-UTRAN, and use of S1 cdma2000 Tunnelling message between the E-UTRAN and the MME.

### B.2.4.2 Mobile originating SMS

The following sequence flow shows the delivery of mobile originating SMS sent via the 1xMSC while in E-UTRAN.

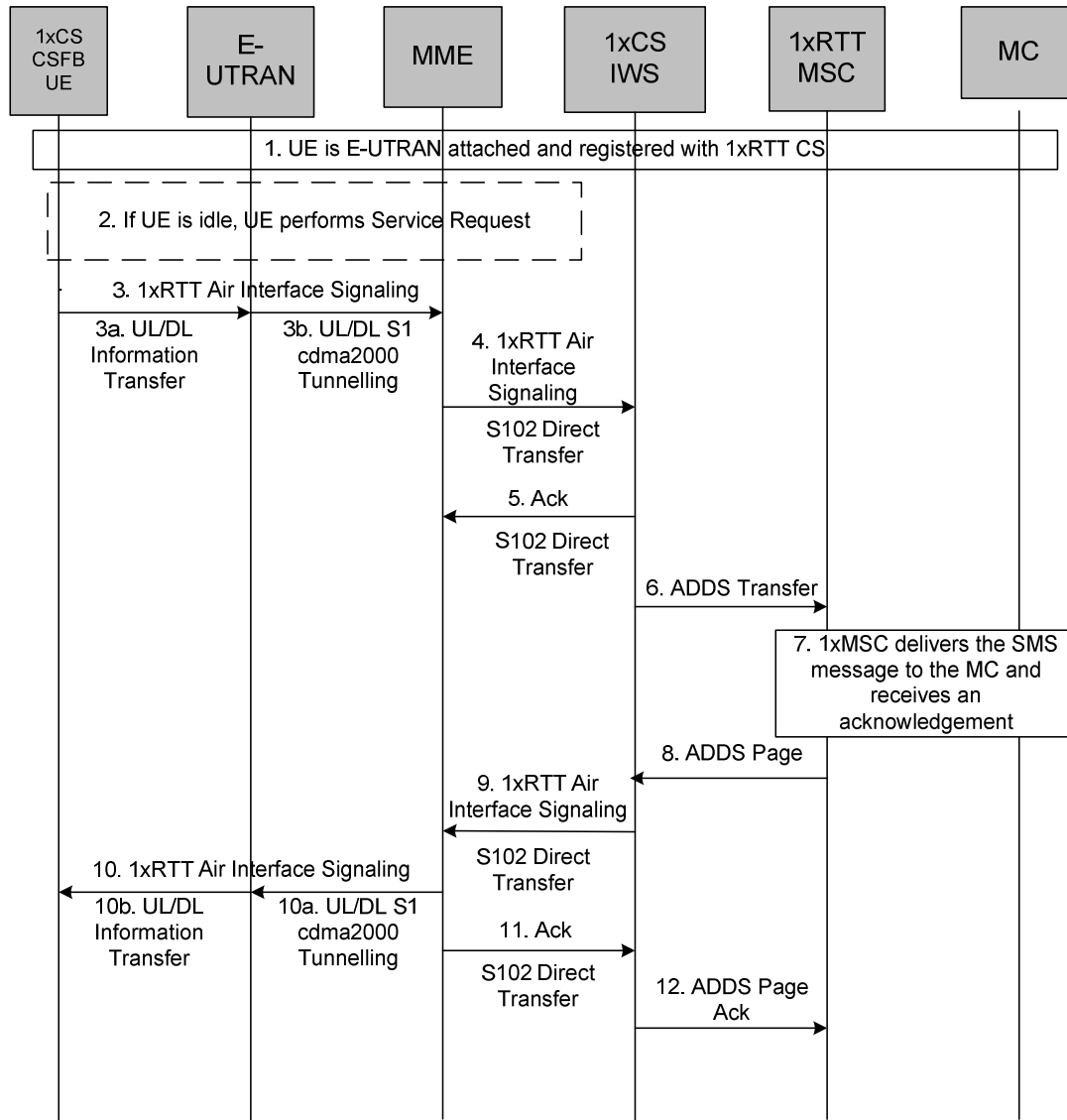

**Figure B.2.4.2-1: Mobile originating SMS sent via the 1xMSC while in E-UTRAN**

1. The 1xRTT CS Registration procedure as described in clause B.2.1.1 has been performed earlier.
2. A mobile originating short message is triggered. If the UE is in idle state, the UE performs the UE triggered Service Request procedure, which is defined in TS 23.401 [2].
3. The UE builds the SMS message to be sent as defined in 3GPP2 A.S0008 [16] and 3GPP2 A.S0009 [17].
- 3a. The 1xRTT SMS message is transferred from the UE to the E-UTRAN.
- 3b. The E-UTRAN forwards the SMS message to the MME.
4. The MME forwards the SMS message to the 1xCS IWS in an S102 Direct Transfer message.
5. The 1xCS IWS acknowledges the message.

6. The 1xCS IWS sends an ADDS Transfer message to the 1xMSC containing the SMS message as defined in 3GPP2 A.S0008 [16] and 3GPP2 A.S0009 [17].
7. The 1xMSC forwards the SMS message to the Message Centre (MC). If an acknowledgement was requested by the UE, the MC responds with an acknowledgement.
8. The 1xMSC forwards the SMS acknowledgement to the 1xCS IWS in an ADDS Page message.
9. The 1xCS IWS forwards the SMS acknowledgement to the MME in an S102 Direct Transfer message.
10. The MME forwards the SMS acknowledgement to the UE.
11. The MME sends an S102 Ack message to the 1xCS IWS. This occurs immediately after step 9 if the MSC has not requested an acknowledgement from the 1xCS IWS.
12. If the MSC requested an acknowledgement, the 1xCS IWS sends an ADDS Page Ack message to the 1xMSC.

### B.2.4.3 Mobile terminating SMS

The following sequence flow shows the delivery of mobile terminating SMS sent via the 1xMSC while in E-UTRAN.

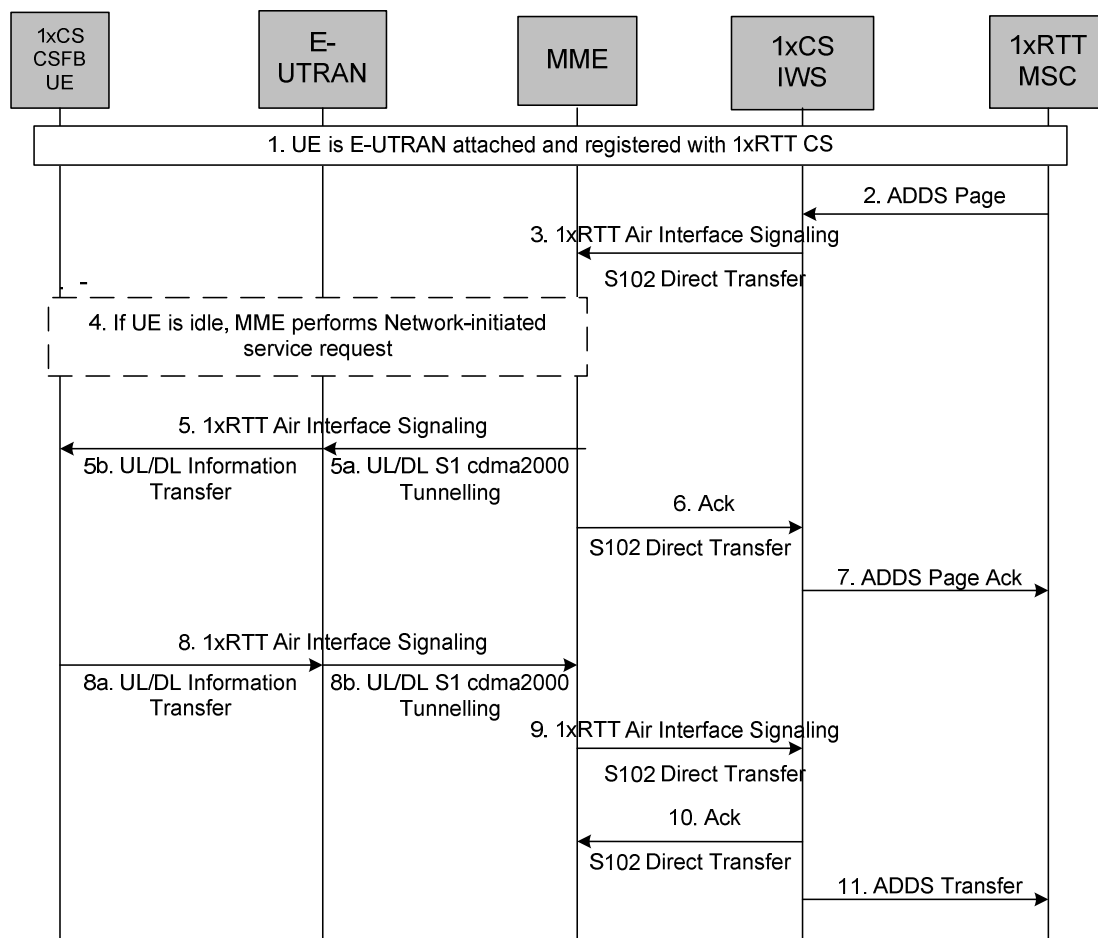

**Figure B.2.4.3-1: Mobile terminating SMS sent via the 1xMSC while in E-UTRAN**

1. The UE is E-UTRAN attached and registered with 1xRTT CS as defined in clause B.2.1.1.
2. The 1xMSC receives the SMS message from the MC and sends an ADDS Page message to the 1xCS as defined in 3GPP2 A.S0008 [16] and 3GPP2 A.S0009 [17]. The ADDS Page contains the SMS message.
3. The 1xCS IWS sends the SMS message in an S102 Direct Transfer message.
4. If the UE is in idle state, the MME performs the network initiated Service Request procedure to bring the UE to active state prior to tunnelling of the SMS message toward the UE.

5. The MME forwards the SMS message to the UE.
6. The MME sends an S102 Ack message to the 1xCS IWS. This occurs immediately after step 3 if the MSC has not requested an acknowledgement from the 1xCS IWS.
7. If the MSC requested an acknowledgement, the 1xCS IWS sends an ADDS Page Ack message to the 1xMSC.
8. After receiving the SMS message at step 5, the UE sends an SMS acknowledgement toward the MC.
9. The MME forwards the SMS acknowledgement in an S102 Direct Transfer message to the 1xCS IWS.
10. The 1xCS IWS sends an S102 Ack message to the MME.
11. The 1xCS IWS forwards the SMS acknowledgement to the 1xMSC. The 1xMSC then forwards the SMS acknowledgement to the MC.

## B.2.5 Emergency Calls

When UE is performing CS fallback procedure to 1xRTT for the purpose of emergency call, it shall indicate to the MME that this CS fallback request is for emergency purpose. MME also indicates to the E-UTRAN via the appropriate S1-AP message that this CS fallback procedure is for emergency purpose.

Emergency call with enhanced 1xRTT CS fallback procedure shall be executed without the concurrent PS handover procedure.

---

## B.3 CS Fallback for UEs with dual Rx configuration

### B.3.1 General Considerations

The following principles are used for supporting CS Fallback for dual receiver UEs:

- The UE with dual Rx configuration attaches separately to each RAT (E-UTRAN, 1xRTT) and maintains separate registration and mobility procedure handling to each RAT. No coordination is required between the E-UTRAN and 1xRTT network.
- The UE with dual Rx configuration is able to camp in 1xRTT at the same time as it is active or idle in E-UTRAN. Camping in 1xRTT includes performing 1xRTT cell re-selection, reading broadcast channels, monitoring paging, performing location updates, etc. according to 3GPP2 specifications.
- The UE with dual Rx configuration is allowed to leave E-UTRAN in order to handle a CS call and/or perform registration signalling, and/or sending or receiving SMS in 1xRTT. The procedures for leaving E-UTRAN is described in clause B.3.2 and are only allowed if the network indicates that it supports them (this is indicated by either the presence of CSFB registration parameters or indication of support for dual Rx CSFB on E-UTRAN broadcast channel, TS 36.331 [33]).
- The UE that reports dual Rx configuration to E-UTRAN does not require redirection information.

NOTE: Further clarification to the UE behaviour may be needed if the procedure in clause B.3.2, i.e. time between transmission of Extended Service Request (3) and reception of RRC Connection Release (5) takes too long.

### B.3.2 Procedures for leaving E-UTRAN

The UE with dual Rx configuration is allowed to leave E-UTRAN in order to handle a CS call and/or perform registration signalling, and/or perform location management signalling, and/or sending or receiving SMS in 1xRTT. When the UE needs to leave E-UTRAN it indicates this to E-UTRAN by using the Extended Service Request procedure with CS Fallback indication similar to how MT/MO calls are handed in clauses B.2.2, B.2.2a and B.2.3. The procedure is the same regardless what activity is performed in the 1xRTT system (e.g. if it is a page response, MO call, re-registration). The procedure is shown in Figure B.3.2-1.

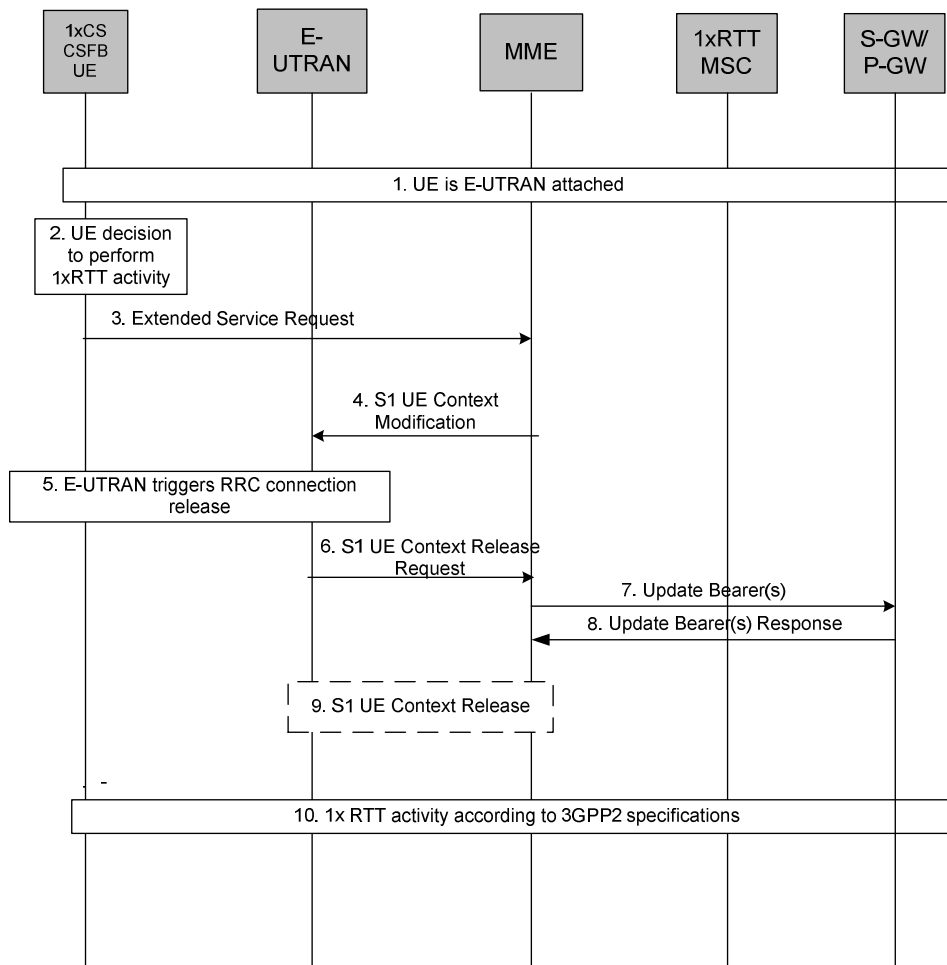

**Figure B.3.2-1: Performing 1xRTT related activity for dual receiver UEs**

1. UE is E-UTRAN attached the UE may also be registered in 1xRTT CS.
2. UE makes a decision that it needs to perform some 1xRTT activity (e.g. in order to respond to an incoming 1xRTT page, setup a MO call, perform location management signalling, or perform re-registration).
3. UE sends an Extended Service Request (CS Fallback Indicator) to the MME. The figure shows the case the UE is in active state in E-UTRAN but the same principles applies if the UE is in idle state, TS 23.401 [2].
4. MME sends a S1-AP message that includes: a CS Fallback Indicator to indicate the E-UTRAN to move the UE to 1xRTT.
5. The E-UTRAN triggers RRC connection release and continues with step 6. This step may include re-direction information if the E-UTRAN indicates support for S102. E-UTRAN that indicates support for dual Rx CSFB shall not include any redirection information towards the UE that indicates dual Rx configuration but no support for enhanced CS fallback to 1xRTT.
6. E-UTRAN sends an S1 UE Context Release Request (Cause) message to the MME. Cause indicates that the S1 UE Context Release was caused by CS fallback to 1xRTT.
7. Suspend Notification: The S1-U bearers are released and the MME starts the preservation and suspension of non-GBR bearers and the deactivation of GBR bearers towards S-GW and P-GW(s). The MME sets the UE context to suspended status.
8. The S-GW and P-GW(s) acknowledges the bearer updates Suspend Notification and marks the UE as suspended. When a downlink data arrives at the P-GW, the P-GW should not send downlink data if the UE is marked as suspended.
9. S1 UE Context in the E-UTRAN is released as specified in TS 23.401 [2].



### B.3.3 Procedures for returning to E-UTRAN

The procedure for returning to E-UTRAN is the same as specified in clause 6.5.

## Annex C (informative): Change history

Change history								
Date	TSG #	TSG Doc.	CR	Rev	Cat	Subject/Comment	Old	New
2008-06	SP-40	SP-080357	-	-	-	MCC Editorial update for presentation to TSG SA for Approval	1.2.0	2.0.0
2008-06	-	-	-	-	-	MCC Editorial update after TSG Approval to version 8.0.0 (Rel-8)	2.0.0	8.0.0
2008-09	SP-41	SP-080600	0005	2	F	Correction of flows for call origination in active mode	8.0.0	8.1.0
2008-09	SP-41	SP-080600	0006	2	F	Correction of flows for call termination in active mode	8.0.0	8.1.0
2008-09	SP-41	SP-080600	0008	1	B	SMS Support in 1XRTT Solution for CS Fallback	8.0.0	8.1.0
2008-09	SP-41	SP-080600	0009	2	F	Correction of flows for call termination in idle mode	8.0.0	8.1.0
2008-09	SP-41	SP-080600	0012	1	F	CS Fallback with Pre-Paging	8.0.0	8.1.0
2008-09	SP-41	SP-080600	0014	2	F	Terms alignments and other misc. correction in 3GPP TS 23.272	8.0.0	8.1.0
2008-09	SP-41	SP-080600	0015	2	F	SMS handling	8.0.0	8.1.0
2008-09	SP-41	SP-080600	0017	-	F	Clarification of ISR in 3GPP TS 23.272	8.0.0	8.1.0
2008-09	SP-41	SP-080600	0019	2	F	Aligning CS fallback for 1xRTT with CS fallback for GSM	8.0.0	8.1.0
2008-09	SP-41	SP-080600	0020	-	F	UE behaviour when it hands over to a non-DTM GERAN cell	8.0.0	8.1.0
2008-09	SP-41	SP-080600	0021	1	F	Correction of the Attach procedure	8.0.0	8.1.0
2008-09	SP-41	SP-080600	0023	1	F	Clarification on the case when access class control is applied in the legacy access	8.0.0	8.1.0
2008-09	SP-41	SP-080600	0024	2	F	Service indicator for LCS and Call Independent SS	8.0.0	8.1.0
2008-12	SP-42	SP-080831	0007	4	F	Release of SGs after fallback to UTRAN/GERAN	8.1.0	8.2.0
2008-12	SP-42	SP-080817	0027	2	F	Registration for CS-Fallback to 1xRTT	8.1.0	8.2.0
2008-12	SP-42	SP-080831	0040	1	F	Non-EPS Alert procedure in SGs.	8.1.0	8.2.0
2008-12	SP-42	SP-080831	0043	1	F	CSFB MT Flow Correction - Active Mode	8.1.0	8.2.0
2008-12	SP-42	SP-080831	0044	1	F	Correction to Roaming Retry for CSFB	8.1.0	8.2.0
2008-12	SP-42	SP-080831	0047	-	F	Void Informative Annex A	8.1.0	8.2.0
2008-12	SP-42	SP-080831	0048	1	F	Aligning TAU procedure with Attach	8.1.0	8.2.0
2008-12	SP-42	SP-080831	0049	7	F	Clarification of ISR usage for CSFB	8.1.0	8.2.0
2008-12	SP-42	SP-080831	0050	-	F	Removal of the Change Cell Order option for 1xCSFB	8.1.0	8.2.0
2008-12	SP-42	SP-080831	0051	-	F	Corrections to Mobile Originating Call and Mobile Terminating Call	8.1.0	8.2.0
2008-12	SP-42	SP-080831	0052	1	D	Minor corrections against 23.272	8.1.0	8.2.0
2008-12	SP-42	SP-080831	0054	-	F	Additional SGs procedures.	8.1.0	8.2.0
2008-12	SP-42	SP-080831	0055	1	F	Support of CS Fallback in EPS for Emergency Calls	8.1.0	8.2.0
2008-12	SP-42	SP-080831	0056	-	F	Correction to MT SMS in CSFB	8.1.0	8.2.0
2008-12	SP-42	SP-080831	0057	-	F	Correction to the resumption in CSFB with no PS HO support	8.1.0	8.2.0
2008-12	SP-42	SP-080817	0058	1	F	Clarification on Suspend Procedure	8.1.0	8.2.0
2008-12	SP-42	SP-080831	0060	1	F	UE behaviour at inter-RAT change due to CS fallback	8.1.0	8.2.0
2008-12	SP-42	SP-080831	0061	1	F	SGs association removal due to Gs establishment or LAU	8.1.0	8.2.0
2008-12	SP-42	SP-080831	0062	1	F	Mobile originating call in idle mode	8.1.0	8.2.0
2009-03	SP-43	SP-090122	0063	1	F	Correction to the ISR deactivation in CSFB	8.2.0	8.3.0
2009-03	SP-43	SP-090122	0064	-	F	Correction to the MT Call in Active Mode in CSFB	8.2.0	8.3.0
2009-03	SP-43	SP-090122	0065	2	F	Corrections to PS HO based procedures in CSFB	8.2.0	8.3.0
2009-03	SP-43	SP-090122	0067	1	F	Emergency Indication usage in CSFB	8.2.0	8.3.0
2009-03	SP-43	SP-090122	0068	2	F	ISR deactivation based on UE's CS Fallback capability	8.2.0	8.3.0
2009-03	SP-43	SP-090122	0069	-	F	Deletion of unnecessary MSC functionality	8.2.0	8.3.0
2009-03	SP-43	SP-090113	0070	2	F	MT 1xCS call fallback rejection	8.2.0	8.3.0
2009-03	SP-43	SP-090122	0073	1	F	Use of Extended SR	8.2.0	8.3.0
2009-06	SP-44	SP-090342	0074	1	F	Iu Release Procedure Clarification	8.3.0	8.4.0
2009-06	SP-44	SP-090342	0077	1	F	Erroneous Text on UE deactivates ISR at combined attach	8.3.0	8.4.0
2009-06	SP-44	SP-090342	0079	2	F	Clarification to the SGSN in CS fallback configuration.	8.3.0	8.4.0
2009-06	SP-44	SP-090342	0080	3	F	CS Fallback and ICS coexistence	8.3.0	8.4.0
2009-06	SP-44	SP-090330	0081	2	F	Add LTE-1xRTT MO call procedure in Idle Mode	8.3.0	8.4.0
2009-06	SP-44	SP-090342	0086	1	F	Correction to the UE behaviour in CSFB.	8.3.0	8.4.0
2009-06	SP-44	SP-090330	0088	2	F	CS Fallback and IMS coexistence clarifications	8.3.0	8.4.0
2009-06	SP-44	SP-090342	0094	2	F	CSFB based on redirection by RRC connection release	8.3.0	8.4.0
2009-06	SP-44	SP-090342	0095	1	F	Cleanup of some CSFB procedures	8.3.0	8.4.0
2009-06	SP-44	SP-090342	0096	-	F	Correction in B.2.1.2 and B.2.3	8.3.0	8.4.0
2009-06	SP-44	SP-090358	0091	1	B	1xRTT CSFB with PS handover	8.4.0	9.0.0
2009-09	SP-45	SP-090593	0097	1	A	SMS over SGs	9.0.0	9.1.0
2009-09	SP-45	SP-090593	0099	1	A	Insert Subscriber Data in the Attach Procedure	9.0.0	9.1.0
2009-09	SP-45	SP-090583	0104	1	A	Triggering combined TAU to check CSFB availability	9.0.0	9.1.0
2009-09	SP-45	SP-090593	0106	4	A	LAU/RAU procedure clarification for redirection/NACC based CSFB	9.0.0	9.1.0

Change history								
Date	TSG #	TSG Doc.	CR	Rev	Cat	Subject/Comment	Old	New
2009-09	SP-45	SP-090609	0107	3	C	Enhanced CS fallback to 1xRTT with PS Handover	9.0.0	9.1.0
2009-09	SP-45	SP-090593	0109	2	A	Pool area concept and CSFB clarification	9.0.0	9.1.0
2009-09	SP-45	SP-090641	0111	10	A	SMS over SGs for data centric UEs	9.0.0	9.1.0
2009-09	SP-45	SP-090593	0125	3	A	LAU clarification for ISR and CSFB interworking	9.0.0	9.1.0
2009-09	SP-45	SP-090593	0128	-	A	SMS over SGs: Correction of message flows; message waiting flag handling; and handling of CM layer interactions	9.0.0	9.1.0
2009-09	SP-45	SP-090593	0129	-	A	SMS over SGs: Online and offline charging aspects	9.0.0	9.1.0
2009-12	SP-46	SP-090773	0133	1	A	Correcting usage of "CSFB not preferred" and TA/LA update procedure	9.1.0	9.2.0
2009-12	SP-46	SP-090773	0135	1	A	Correction on referring to Attach steps in TS 23.401	9.1.0	9.2.0
2009-12	SP-46	SP-090773	0137	1	A	CS Fallback to UTRAN/GERAN and CS Fallback to 1xRTT in the same PLMN	9.1.0	9.2.0
2009-12	SP-46	SP-090773	0139	3	A	PS Bearer handling in redirection/NACC/CCO based CSFB	9.1.0	9.2.0
2009-12	SP-46	SP-090778	0151	-	A	Which nodes should/should not perform paging retransmission when using SGs?	9.1.0	9.2.0
2009-12	SP-46	SP-090773	0171	-	A	ISR and SMS over SGs	9.1.0	9.2.0
2009-12	SP-46	SP-090795	0123	1	F	MME name IE in SGsAP-LOCATION-UPDATE message	9.1.0	9.2.0
2009-12	SP-46	SP-090795	0145	-	F	SMS over S102	9.1.0	9.2.0
2009-12	SP-46	SP-090795	0159	1	F	Switch off detach by pre-registered 1xCSFB UE	9.1.0	9.2.0
2009-12	SP-46	SP-090795	0160	1	F	Clarification on CSFB and SMS over SGs support	9.1.0	9.2.0
2009-12	SP-46	SP-090795	0161	2	F	CS Fallback for MO-LR in Rel-9	9.1.0	9.2.0
2009-12	SP-46	SP-090771	0168	3	F	SGs Service Request for Voice calls and User Alerting/No reply timer and Correction to the CSFB figures related to the S1-AP interface	9.1.0	9.2.0
2009-12	SP-46	SP-090882	0170	6	B	Supporting dual-rx 1xCSFB terminals	9.1.0	9.2.0
2010-03	SP-47	SP-100153	0174	6	F	CS Fallback clarification for LCS	9.2.0	9.3.0
2010-03	SP-47	SP-100134	0178	-	A	Domain selection procedure for SMS to refer to 23.221	9.2.0	9.3.0
2010-03	SP-47	SP-100153	0187	1	F	Modify the error of Service Accept in S1-AP message in the clause 7.4	9.2.0	9.3.0
2010-03	SP-47	SP-100134	0193	-	A	Removing PRU timer expiration from the triggers of combined LA/RA update and LA update	9.2.0	9.3.0
2010-03	SP-47	SP-100165	0199	-	F	Correction of CSFB MO&MT call & Correction of suspend and resume behaviour & Multi-cell redirection.	9.2.0	9.3.0
2010-03	SP-47	SP-100134	0545	2	A	ISR and SMS over SGs	9.2.0	9.3.0
2010-03	SP-47	SP-100147	0546	3	F	ISR disabling related to T-ADS	9.2.0	9.3.0
2010-03	SP-47	SP-100153	0551	2	F	Clarifying how the network behaves with dual Rx 1xRTT UE	9.2.0	9.3.0
2010-03	SP-47	SP-100163	0557	4	F	TA and LA boundary Alignment	9.2.0	9.3.0
2010-03	SP-47	SP-100153	0561	1	F	MSC behaviour to avoid Authentication	9.2.0	9.3.0

---

# History

<b>Document history</b>		
V9.2.0	January 2010	Publication
V9.3.0	March 2010	Publication