

# ETSI TS 123 281 V14.3.0 (2017-10)



**LTE;**  
**Functional architecture and information flows to support**  
**Mission Critical Video (MCVideo);**  
**Stage 2**  
**(3GPP TS 23.281 version 14.3.0 Release 14)**



---

**Reference**

RTS/TSGS-0623281ve30

---

**Keywords**

LTE

**ETSI**

650 Route des Lucioles  
F-06921 Sophia Antipolis Cedex - FRANCE

---

Tel.: +33 4 92 94 42 00 Fax: +33 4 93 65 47 16

Siret N° 348 623 562 00017 - NAF 742 C  
Association à but non lucratif enregistrée à la  
Sous-Préfecture de Grasse (06) N° 7803/88

---

**Important notice**

---

The present document can be downloaded from:

<http://www.etsi.org/standards-search>

The present document may be made available in electronic versions and/or in print. The content of any electronic and/or print versions of the present document shall not be modified without the prior written authorization of ETSI. In case of any existing or perceived difference in contents between such versions and/or in print, the only prevailing document is the print of the Portable Document Format (PDF) version kept on a specific network drive within ETSI Secretariat.

Users of the present document should be aware that the document may be subject to revision or change of status.

Information on the current status of this and other ETSI documents is available at

<https://portal.etsi.org/TB/ETSIDeliverableStatus.aspx>

If you find errors in the present document, please send your comment to one of the following services:

<https://portal.etsi.org/People/CommiteeSupportStaff.aspx>

---

**Copyright Notification**

---

No part may be reproduced or utilized in any form or by any means, electronic or mechanical, including photocopying and microfilm except as authorized by written permission of ETSI.

The content of the PDF version shall not be modified without the written authorization of ETSI.

The copyright and the foregoing restriction extend to reproduction in all media.

© ETSI 2017.

All rights reserved.

**DECT™**, **PLUGTESTS™**, **UMTS™** and the ETSI logo are trademarks of ETSI registered for the benefit of its Members.

**3GPP™** and **LTE™** are trademarks of ETSI registered for the benefit of its Members and of the 3GPP Organizational Partners.

**oneM2M** logo is protected for the benefit of its Members.

**GSM®** and the GSM logo are trademarks registered and owned by the GSM Association.

---

## Intellectual Property Rights

IPRs essential or potentially essential to the present document may have been declared to ETSI. The information pertaining to these essential IPRs, if any, is publicly available for **ETSI members and non-members**, and can be found in ETSI SR 000 314: "*Intellectual Property Rights (IPRs); Essential, or potentially Essential, IPRs notified to ETSI in respect of ETSI standards*", which is available from the ETSI Secretariat. Latest updates are available on the ETSI Web server (<https://ipr.etsi.org>).

Pursuant to the ETSI IPR Policy, no investigation, including IPR searches, has been carried out by ETSI. No guarantee can be given as to the existence of other IPRs not referenced in ETSI SR 000 314 (or the updates on the ETSI Web server) which are, or may be, or may become, essential to the present document.

---

## Foreword

This Technical Specification (TS) has been produced by ETSI 3rd Generation Partnership Project (3GPP).

The present document may refer to technical specifications or reports using their 3GPP identities, UMTS identities or GSM identities. These should be interpreted as being references to the corresponding ETSI deliverables.

The cross reference between GSM, UMTS, 3GPP and ETSI identities can be found under <http://webapp.etsi.org/key/queryform.asp>.

---

## Modal verbs terminology

In the present document "**shall**", "**shall not**", "**should**", "**should not**", "**may**", "**need not**", "**will**", "**will not**", "**can**" and "**cannot**" are to be interpreted as described in clause 3.2 of the [ETSI Drafting Rules](#) (Verbal forms for the expression of provisions).

"**must**" and "**must not**" are **NOT** allowed in ETSI deliverables except when used in direct citation.

# Contents

Intellectual Property Rights .....	2
Foreword.....	2
Modal verbs terminology.....	2
Foreword.....	10
1 Scope .....	11
2 References .....	11
3 Definitions, symbols and abbreviations .....	12
3.1 Definitions .....	12
3.2 Symbols.....	13
3.3 Abbreviations .....	13
4 Introduction .....	13
5 Architectural requirements .....	13
5.1 Media routing requirements .....	13
5.2 MCVideo group affiliation and MCVideo group de-affiliation .....	14
5.3 Device inventory requirements.....	14
5.4 Device discovery requirements (off-network).....	14
5.5 Bearer management.....	14
5.5.1 General.....	14
5.5.2 EPS bearer considerations .....	14
5.5.3 EPS unicast bearer considerations for MCVideo.....	14
5.5.4 MBMS bearer management .....	15
5A Involved business relationships.....	15
6 MCVideo Functional model.....	15
6.1 Functional model description .....	15
6.1.1 On-network functional model.....	15
6.1.2 Off-network functional model .....	15
6.2 Functional entities description.....	16
6.2.1 General.....	16
6.2.2 MCVideo service application plane.....	16
6.2.2.1 General .....	16
6.2.2.2 Common services core .....	16
6.2.2.3 MCVideo application service.....	16
6.2.2.3.1 MCVideo client .....	16
6.2.2.3.2 MCVideo server .....	16
6.2.2.3.3 Media distribution function .....	17
6.2.2.3.4 Media mixer .....	17
6.2.2.3.5 MCVideo user database.....	17
6.2.2.3.6 Transmission control server.....	17
6.2.2.3.7 Transmission control participant .....	18
6.3 Reference points .....	18
6.3.1 Reference point MCVideo-1 (between the MCVideo client and the MCVideo server) .....	18
6.3.2 Reference point MCVideo-2 (between the MCVideo server and the MCVideo user database).....	18
6.3.3 Reference point MCVideo-3 (between the MCVideo server and the MCVideo server) .....	18
6.3.4 Reference point MCVideo-4 (between the transmission control participant and the transmission control server).....	18
6.3.4A Reference point MCVideo-5 (unicast between the media distribution function and the EPS) .....	18
6.3.4B Reference point MCVideo-6 (between the MCVideo server and the EPS) .....	19
6.3.5 Reference point MCVideo-7 (between the media distribution function and the media mixer) .....	19
6.3.6 Reference point MCVideo-8 (between the media distribution function and the media mixer) .....	19
6.3.7 Reference point MCVideo-9 (between the transmission control participant and the transmission control server).....	19

6A	Identities .....	19
6B	Application of functional model to deployments .....	19
7	Procedures and information flows .....	19
7.1	Group call .....	19
7.1.1	General .....	19
7.1.2	On-network group call .....	20
7.1.2.1	General .....	20
7.1.2.2	Information flows for group call in on-network .....	20
7.1.2.2.1	Group call request (MCVideo client – MCVideo server) .....	20
7.1.2.2.2	Group call request (MCVideo server – MCVideo client) .....	20
7.1.2.2.3	Group call response (MCVideo server – MCVideo client) .....	20
7.1.2.2.4	Group call response (MCVideo client – MCVideo server) .....	21
7.1.2.2.5	Group call release request (MCVideo server – MCVideo client) .....	21
7.1.2.2.6	Group call release request (MCVideo client – MCVideo server) .....	21
7.1.2.2.7	Group call release response (MCVideo client – MCVideo server) .....	21
7.1.2.2.8	Group call rejoin request (MCVideo client – MCVideo server) .....	22
7.1.2.2.9	Group call rejoin response (MCVideo server – MCVideo client) .....	22
7.1.2.2.10	Group call join request (MCVideo client – MCVideo server) .....	22
7.1.2.2.11	Group call join response (MCVideo server – MCVideo client) .....	23
7.1.2.2.12	Group call leave request (MCVideo server – MCVideo client) .....	23
7.1.2.2.13	Group call leave response (MCVideo client – MCVideo server) .....	23
7.1.2.2.14	MCVideo emergency alert request .....	23
7.1.2.2.15	MCVideo emergency alert response .....	24
7.1.2.2.16	MCVideo emergency state cancel request .....	24
7.1.2.2.17	MCVideo emergency state cancel response .....	25
7.1.2.2.18	MCVideo emergency group call request .....	25
7.1.2.2.19	MCVideo emergency group call response .....	25
7.1.2.2.20	MCVideo emergency group call cancel request .....	25
7.1.2.2.21	MCVideo emergency group call cancel response .....	26
7.1.2.2.22	MCVideo imminent peril group call request .....	26
7.1.2.2.23	MCVideo imminent peril group call response .....	26
7.1.2.2.24	MCVideo imminent peril group call cancel request .....	26
7.1.2.2.25	MCVideo imminent peril group call cancel response .....	27
7.1.2.3	Group call within one MC system .....	27
7.1.2.3.1	Group call models .....	27
7.1.2.3.1.1	Pre-arranged group call .....	27
7.1.2.3.1.2	Chat group call .....	32
7.1.2.3.2	Exiting group call due to de-affiliation .....	36
7.1.2.4	Broadcast group call .....	37
7.1.2.4.1	General .....	37
7.1.2.4.2	Common broadcast group call procedure .....	37
7.1.2.5	Emergency and imminent peril procedures .....	38
7.1.2.5.1	MCVideo emergency group call .....	38
7.1.2.5.1.1	MCVideo emergency group call commencement .....	38
7.1.2.5.1.2	MCVideo group call upgraded to an MCVideo emergency group call .....	40
7.1.2.5.1.3	MCVideo emergency group call cancel .....	42
7.1.2.5.2	MCVideo imminent peril group call .....	44
7.1.2.5.2.1	MCVideo imminent peril group call commencement .....	44
7.1.2.5.2.2	Imminent peril group call upgrade .....	46
7.1.2.5.2.3	MCVideo imminent peril group call cancel .....	48
7.1.2.6	MCVideo emergency alert .....	49
7.1.2.6.1	General .....	49
7.1.3	Off-network group communications .....	49
7.1.3.1	General .....	49
7.1.3.2	Information flows for off-network group communications .....	49
7.1.3.2.1	Group communication announcement .....	49
7.1.3.2.2	Group communication answer response .....	50
7.1.3.2.3	MCVideo upgrade to emergency group communication .....	50
7.1.3.2.4	MCVideo emergency group communication cancel .....	51
7.1.3.2.5	MCVideo upgrade to imminent peril group communication .....	51

7.1.3.2.6	MCVideo imminent peril group communication cancel .....	51
7.1.3.2.7	MCVideo emergency alert announcement .....	51
7.1.3.2.8	MCVideo emergency alert cancel announcement .....	52
7.1.3.3	Group communication setup .....	52
7.1.3.3.1	General .....	52
7.1.3.3.2	Procedure.....	52
7.1.3.4	Passive join to group communication .....	54
7.1.3.4.1	General .....	54
7.1.3.4.2	Procedure.....	54
7.1.3.5	Active join to group communication.....	55
7.1.3.5.1	General .....	55
7.1.3.5.2	Procedure.....	55
7.1.3.6	Broadcast group communication.....	56
7.1.3.7	Group communication release due to inactivity .....	57
7.1.3.8	Emergency and imminent peril procedures.....	57
7.1.3.8.1	Emergency group communication.....	57
7.1.3.8.2	MCVideo imminent peril.....	58
7.1.3.9	MCVideo emergency alert .....	59
7.1.3.9.1	General .....	59
7.2	Private call.....	59
7.2.1	General.....	59
7.2.2	Private call on-network .....	59
7.2.2.1	General .....	59
7.2.2.2	Information flows for private call in on-network .....	59
7.2.2.2.1	MCVideo private call request (MCVideo client – MCVideo server) .....	59
7.2.2.2.2	MCVideo private call request (MCVideo server – MCVideo client) .....	60
7.2.2.2.3	MCVideo private call response (MCVideo client – MCVideo server).....	60
7.2.2.2.4	MCVideo private call response (MCVideo server – MCVideo client).....	61
7.2.2.2.5	MCVideo call end request .....	61
7.2.2.3	Private call within one MC system .....	61
7.2.2.3.1	Private call setup in automatic commencement mode.....	61
7.2.2.3.2	Private call setup in manual commencement mode .....	63
7.2.2.3.2.1	Description.....	63
7.2.2.3.2.2	Procedure .....	63
7.2.2.3.3	Private call release.....	64
7.2.2.3.3.1	Client initiated.....	64
7.2.2.3.3.2	Server initiated.....	65
7.2.3	Off-network private communications .....	66
7.2.3.1	General .....	66
7.2.3.2	Information flows for off-network private communications .....	66
7.2.3.2.1	Private communication request .....	66
7.2.3.2.2	Private communication answer response.....	67
7.2.3.2.3	Private communication release request.....	67
7.2.3.2.4	Private communication release response .....	68
7.2.3.3	Use of ProSe for off-network private communications.....	68
7.2.3.4	Automatic commencement private communication.....	68
7.2.3.4.1	General .....	68
7.2.3.4.2	Procedure.....	68
7.2.3.5	Manual commencement private communication.....	70
7.2.3.5.1	General .....	70
7.2.3.5.2	Procedure – Communication accepted .....	70
7.2.3.5.3	Procedure – Communication rejected/ignored .....	72
7.2.3.6	Private communication release.....	73
7.2.3.6.1	General .....	73
7.2.3.6.2	Procedure.....	73
7.3	Video pull.....	74
7.3.1	General.....	74
7.3.2	On-network video pull .....	74
7.3.2.1	General .....	74
7.3.2.2	Information flows for on-network video pull.....	74
7.3.2.2.1	MCVideo pull from server request .....	75
7.3.2.2.2	MCVideo pull from server response.....	75

7.3.2.2.3	MCVideo pull from server complete request .....	75
7.3.2.2.4	MCVideo pull from server complete response .....	75
7.3.2.3	One-to-one video pull .....	76
7.3.2.3.1	General .....	76
7.3.2.3.2	One-to-one video pull – call setup .....	76
7.3.2.3.3	One-to-one video pull – call release .....	77
7.3.2.4	One-from-server video pull .....	77
7.3.2.4.1	General .....	77
7.3.2.4.2	Procedure .....	77
7.3.3	Off-network video pull .....	78
7.3.3.1	General .....	78
7.3.3.2	Information flows for off-network video pull .....	79
7.3.3.3	Video pull to self .....	79
7.3.3.3.1	General .....	79
7.3.3.3.2	Procedure .....	79
7.4	Video push .....	81
7.4.1	General .....	81
7.4.2	On-network video push .....	81
7.4.2.1	General .....	81
7.4.2.2	Information flows for on-network video push .....	81
7.4.2.2.1	Remote video push request .....	81
7.4.2.2.2	Remote video push response .....	82
7.4.2.2.3	Remote video push release request .....	82
7.4.2.2.4	MCVideo push to server request .....	83
7.4.2.2.5	MCVideo push to server response .....	83
7.4.2.2.6	MCVideo push to server complete request .....	83
7.4.2.2.7	MCVideo push to server complete response .....	84
7.4.2.3	One-to-one video push .....	84
7.4.2.3.1	General .....	84
7.4.2.3.2	One-to-one video push – call setup .....	84
7.4.2.3.3	One-to-one video push – call release .....	85
7.4.2.4	One-to-server video push .....	85
7.4.2.4.1	General .....	85
7.4.2.4.2	Procedure .....	85
7.4.2.5	Remotely initiated video push .....	87
7.4.2.5.1	General .....	87
7.4.2.5.2	Remotely initiated video push – call setup .....	87
7.4.2.5.3	Remotely initiated video push – call release by authorized user .....	88
7.4.2.6	Remotely initiated video push to group .....	89
7.4.2.6.1	General .....	89
7.4.2.6.2	Remotely initiated video push to group – call setup .....	89
7.4.2.6.3	Remotely initiated video push to group – call release by authorized user .....	90
7.4.3	Off-network video push .....	91
7.4.3.1	General .....	91
7.4.3.2	Information flows for off-network video push .....	91
7.4.3.2.1	Remote video push request .....	91
7.4.3.2.2	Video push trying response .....	91
7.4.3.2.3	Notification of video push .....	91
7.4.3.3	Video push to another MCVideo user .....	92
7.4.3.3.1	General .....	92
7.4.3.3.2	Procedure .....	92
7.4.3.4	Remotely initiated video push .....	93
7.4.3.4.1	General .....	93
7.4.3.4.2	Procedure .....	93
7.4.3.5	Remotely initiated video push to a group .....	95
7.4.3.5.1	General .....	95
7.4.3.5.2	Procedure .....	95
7.5	Capability information sharing .....	96
7.5.1	General .....	96
7.5.2	On-network capability information sharing .....	96
7.5.2.1	General .....	96
7.5.2.2	Information flows for on-network capability information sharing .....	96

7.5.2.2.1	Update MCVideo capabilities info request.....	96
7.5.2.2.2	Update MCVideo capabilities info response .....	97
7.5.2.2.3	Get MCVideo capabilities info request .....	97
7.5.2.2.4	Get MCVideo capabilities info response.....	97
7.5.2.2.5	Subscribe MCVideo capabilities info request .....	97
7.5.2.2.6	Subscribe MCVideo capabilities info response .....	97
7.5.2.2.7	Notify MCVideo capabilities info request.....	98
7.5.2.2.8	Notify MCVideo capabilities info response .....	98
7.5.2.3	Update MCVideo capabilities information at the MCVideo server .....	98
7.5.2.4	Retrieve MCVideo capabilities information by the MCVideo client.....	98
7.5.2.5	Subscription and notification for MCVideo capabilities information .....	99
7.5.3	Off-network capability information sharing .....	100
7.5.3.1	General .....	100
7.5.3.2	Information flows for Off-network capability information sharing .....	100
7.5.3.2.1	Capability request.....	100
7.5.3.2.2	Capability announcement .....	100
7.5.3.2.3	Activity status request .....	101
7.5.3.2.4	Activity status announcement.....	101
7.5.3.3	Periodic capability announcements .....	102
7.5.3.3.1	General .....	102
7.5.3.3.2	Procedure.....	102
7.5.3.4	Request capabilities from client(s).....	103
7.5.3.4.1	General .....	103
7.5.3.4.2	Request clients with particular capabilities .....	103
7.5.3.4.3	Request capabilities from a particular client.....	104
7.5.3.5	Request activity status from client(s) .....	104
7.5.3.5.1	General .....	104
7.5.3.5.2	Request activity status of group members .....	104
7.5.3.5.3	Request activity status from a particular client.....	105
7.6	Ambient viewing call .....	106
7.6.1	General.....	106
7.6.2	Information flows for ambient viewing call.....	106
7.6.2.1	Ambient viewing call request.....	106
7.6.2.2	Ambient viewing call response .....	107
7.6.2.3	Ambient viewing call release request.....	107
7.6.2.4	Ambient viewing call release response .....	107
7.6.2.5	Ambient viewing call release notification.....	108
7.6.3	Procedures.....	108
7.6.3.1	Remotely initiated ambient viewing call setup procedure.....	108
7.6.3.2	Locally initiated ambient viewing call setup procedure.....	109
7.6.3.3	Ambient viewing call release – server initiated .....	110
7.6.3.4	Ambient viewing call release – "viewing" user initiated .....	111
7.6.3.5	Ambient viewing call release – "viewed to" user initiated.....	112
7.7	Transmission control .....	113
7.7.1	Transmission control for on-network MCVideo service.....	113
7.7.1.1	General .....	113
7.7.1.2	Information flows for transmission control for on-network.....	113
7.7.1.2.1	General .....	113
7.7.1.2.2	Transmit media request .....	113
7.7.1.2.3	Transmit media granted.....	114
7.7.1.2.4	Transmit media rejected .....	114
7.7.1.2.5	Media transmission notification .....	114
7.7.1.2.6	Receive media request.....	114
7.7.1.2.7	Receive media response.....	115
7.7.1.2.8	Media reception notification.....	115
7.7.1.2.9	Queue position info .....	115
7.7.1.2.10	Transmission revoked.....	115
7.7.1.2.11	Queue position request .....	116
7.7.1.2.12	Transmit media cancel request .....	116
7.7.1.2.13	Transmit media cancel response.....	116
7.7.1.2.14	Transmit media cancel request notify.....	116
7.7.1.2.15	Transmit media end request.....	117



7.7.1.2.16	Transmit media end response .....	117
7.7.1.2.17	Remote transmit media request .....	117
7.7.1.2.18	Remote transmit media response .....	117
7.7.1.2.19	Remote transmit media end request.....	118
7.7.1.2.20	Remote transmit media end response .....	118
7.7.1.2.21	Media reception end request.....	118
7.7.1.2.22	Media reception end response .....	118
7.7.1.2.23	Media reception override notification .....	119
7.7.1.2.24	Transmit media end notify.....	119
7.7.1.3	Transmission control within one MC system for MCVideo service .....	119
7.7.1.3.1	Transmission control during an MCVideo session .....	119
7.7.1.3.2	Reception control during an MCVideo session .....	120
7.7.1.3.2A	End media reception – receiving user initiated.....	122
7.7.1.3.2B	End media reception – transmission control server initiated .....	122
7.7.1.3.2C	Reception control on overridden – mandatory mode.....	123
7.7.1.3.2D	Reception control on overridden – negotiated mode .....	124
7.7.1.3.3	Transmission revoke during an MCVideo session .....	125
7.7.1.3.4	Queue position during an MCVideo session .....	126
7.7.1.3.5	Transmit media request cancellation from the video transmission queue .....	127
7.7.1.3.5.1	Transmit media request cancellation from the queue – MCVideo user initiated .....	127
7.7.1.3.5.2	Transmit media request cancellation from the queue - transmission control server initiated ..	128
7.7.1.3.6	End a media transmission during an MCVideo session.....	129
7.7.1.3.6.1	End a media transmission – MCVideo user initiated .....	129
7.7.1.3.6.2	End a media transmission – transmission control server initiated .....	130
7.7.1.3.6.3	End a media transmission – remote MCVideo user initiated .....	131
7.7.1.3.7	Remotely initiated media transmission during an MCVideo session .....	132
7.7.2	Off-network transmission control .....	133
7.7.2.1	General .....	133
7.7.2.2	Information flows for off-network transmission control.....	133
7.7.2.2.1	Transmission request .....	133
7.7.2.2.2	Transmission granted.....	134
7.7.2.2.3	Transmission release .....	134
7.7.2.2.4	Transmission rejected.....	134
7.7.2.2.5	Transmission revoked.....	134
7.7.2.2.6	Transmission arbitration taken .....	135
7.7.2.2.7	Transmission arbitration release .....	135
7.7.2.3	Initializing transmission control – single arbitrator approach .....	135
7.7.2.3A	Initializing transmission control – self arbitration approach .....	136
7.7.2.4	Transmission permission granted.....	137
7.7.2.5	Transmission permission rejected .....	138
7.7.2.6	Releasing transmission permission .....	139
7.7.2.7	Transmission override.....	140
7.7.2.8	Transmission override (revoke self).....	141
7.7.2.9	Transmission arbitration release.....	143
7.7.2.9.1	Transmission arbitration release .....	143
7.7.2.9.2	Transmission arbitration release with delegation .....	143
7.7.2.10	Simultaneous transmission requests.....	144
7.8	MCVideo service configuration .....	145
7.9	Affiliation and de-affiliation to/from MCVideo group(s) .....	145
7.10	Use of MBMS transmission (on-network) .....	146
7.10.1	Information flows for MBMS Transmission .....	146
7.10.1.1	General .....	146
7.10.1.2	MapGroupToBearer .....	146
7.10.1.3	UnmapGroupFromBearer .....	146
7.10.2	Use of pre-established MBMS bearers .....	147
7.10.3	Use of dynamic MBMS bearer establishment .....	147
7.10.4	Video call connect and disconnect over MBMS.....	147
7.10.4.1	General .....	147
7.10.4.2	Procedure .....	148
7.10.4.2.1	Call connect over MBMS .....	148
7.10.4.2.2	Call disconnect over MBMS .....	149
7.10.5	Switching from MBMS bearer to unicast bearer .....	150

7.11	Simultaneous session for MCVideo calls (on-network) .....	150
7.12	User authentication and authorization for MCVideo service .....	150
7.13	Support for multiple devices .....	151
7.14	Location information (on-network) .....	151
<b>Annex A (normative): MCVideo related configuration data .....</b>		<b>152</b>
A.1	General .....	152
A.2	MCVideo UE configuration data .....	152
A.3	MCVideo user profile configuration data.....	153
A.4	MCVideo related Group configuration data.....	160
A.5	MCVideo service configuration data.....	162
<b>Annex B (informative): Change history .....</b>		<b>164</b>
History .....		167

---

# Foreword

This Technical Specification has been produced by the 3<sup>rd</sup> Generation Partnership Project (3GPP).

The contents of the present document are subject to continuing work within the TSG and may change following formal TSG approval. Should the TSG modify the contents of the present document, it will be re-released by the TSG with an identifying change of release date and an increase in version number as follows:

Version x.y.z

where:

- x the first digit:
  - 1 presented to TSG for information;
  - 2 presented to TSG for approval;
  - 3 or greater indicates TSG approved document under change control.
- y the second digit is incremented for all changes of substance, i.e. technical enhancements, corrections, updates, etc.
- z the third digit is incremented when editorial only changes have been incorporated in the document.

---

# 1 Scope

This document specifies the functional model, procedures and information flows needed for the mission critical video (MCVideo) service. Support for both MCVideo group streaming and MCVideo private streaming operating in on-network and off-network modes of operation is specified.

The corresponding service requirements are defined in 3GPP TS 22.280 [2], and 3GPP TS 22.281 [3].

The present document is applicable primarily to mission critical video service using E-UTRAN access based on the common functional architecture for mission critical services defined in 3GPP TS 23.280 [6] and the EPC architecture defined in 3GPP TS 23.401 [8].

The MCVideo service can be used for public safety applications and also for general commercial applications e.g. utility companies and railways.

---

# 2 References

The following documents contain provisions which, through reference in this text, constitute provisions of the present document.

- References are either specific (identified by date of publication, edition number, version number, etc.) or non-specific.
- For a specific reference, subsequent revisions do not apply.
- For a non-specific reference, the latest version applies. In the case of a reference to a 3GPP document (including a GSM document), a non-specific reference implicitly refers to the latest version of that document *in the same Release as the present document*.

- [1] 3GPP TR 21.905: "Vocabulary for 3GPP Specifications".
- [2] 3GPP TS 22.280: "Mission Critical Common Requirements (MCCoRe); Stage 1".
- [3] 3GPP TS 22.281: "Mission Critical Video services over LTE".
- [4] 3GPP TS 23.002: "Network Architecture".
- [5] 3GPP TS 23.228: "IP Multimedia Subsystem (IMS); Stage 2".
- [6] 3GPP TS 23.280: "Common functional architecture to support mission critical services; Stage 2".
- [7] 3GPP TS 23.303: "Proximity-based services (ProSe); Stage 2".
- [8] 3GPP TS 23.401: "General Packet Radio Service (GPRS) enhancements for Evolved Universal Terrestrial Radio Access Network (E-UTRAN) access".
- [9] 3GPP TS 23.468: "Group Communication System Enablers for LTE (GCSE\_LTE); Stage 2".
- [10] 3GPP TS 33.179: "Security of Mission Critical Push-To-Talk (MCPTT)".
- [11] 3GPP TS 23.203: "Policy and charging control architecture".
- [12] 3GPP TS 36.331: "Evolved Universal Terrestrial Radio Access (E-UTRA); Radio Resource Control (RRC); Protocol specification".
- [13] 3GPP TS 29.468: "Group Communication System Enablers for LTE (GCSE\_LTE); MB2 reference point; Stage 3".
- [14] 3GPP TS 33.180: "Security of the mission critical service".

---

## 3 Definitions, symbols and abbreviations

### 3.1 Definitions

For the purposes of the present document, the terms and definitions given in 3GPP TR 21.905 [1] and the following apply. A term defined in the present document takes precedence over the definition of the same term, if any, in 3GPP TR 21.905 [1].

**MCVideo client:** An instance of an MC service client that provides the client application function for the MCVideo service.

**MCVideo group:** An MC service group configured for MCVideo service.

**MCVideo group affiliation:** An MC service group affiliation for MCVideo.

**MCVideo group de-affiliation:** An MC service group de-affiliation for MCVideo.

**MCVideo group home system:** The mission critical system where the MCVideo group is defined.

**MCVideo group host server:** The MCVideo server within a mission critical system which provides centralised support for MCVideo services of an MCVideo group defined in a MCVideo group home system.

**MCVideo ID:** An instance of an MC service ID within the MCVideo service.

**MCVideo server:** An instance of an MC service server that provides the server application function for the MCVideo service.

**MCVideo service:** A video communication service supporting applications for mission critical organizations and mission critical applications for other businesses and organizations (e.g., utilities, railways) with strong security, high availability, reliability and priority handling.

**MCVideo system:** The collection of applications, services, and enabling capabilities required to provide Mission Critical video for a Mission Critical Organization.

**MCVideo UE:** An MC service UE that can be used to participate in MCVideo services.

**MCVideo user:** An MC service user who is authorized for MCVideo services via an MCVideo UE.

**Transmission control:** Video transmitting control mechanism in an MCVideo service that determines which participants have the authority to transmit video, and determines the onward downlink video transmission during a video call.

For the purposes of the present document, the following terms and definitions given in 3GPP TS 22.280 [2] apply:

**Mission Critical**  
**Mission Critical Applications**  
**Mission Critical Service**  
**Mission Critical Organization**  
**Mission Critical System**

For the purposes of the present document, the following terms and definitions given in 3GPP TS 22.281 [3] apply:

**Real Time**  
**Real Time Video**

For the purposes of the present document, the following terms and definitions given in 3GPP TS 23.280 [6] apply:

**MC service client**  
**MC service group**  
**MC service group affiliation**  
**MC service group de-affiliation**  
**MC service group home system**

MC service group host  
 MC service ID  
 MC service server

## 3.2 Symbols

For the purposes of the present document, the following symbols given in 3GPP TS 22.280 [2] apply:

Nc2

## 3.3 Abbreviations

For the purposes of the present document, the abbreviations given in 3GPP TR 21.905 [1] and the following apply. An abbreviation defined in the present document takes precedence over the definition of the same abbreviation, if any, in 3GPP TR 21.905 [1].

E-UTRAN	Evolved Universal Terrestrial Radio Access Network
EPC	Evolved Packet Core
GCS AS	Group Communication Service Application Server
GCSE_LTE	Group Communication Service Enabler over LTE
HTTP	Hyper Text Transfer Protocol
IMS	IP Multimedia Subsystem
MC	Mission Critical
MCVideo	Mission Critical Video
MCVideo group ID	MCVideo group identity
MCVideo ID	MCVideo user identity
ProSe	Proximity-based Services
SIP	Session Initiated Protocol

---

## 4 Introduction

The MCVideo service supports video media communication between several users (i.e. group call), where each user has the ability to gain access to the permission to stream video in an arbitrated manner. The MCVideo service also supports private calls between two users.

The MCVideo architecture is based on the functional architecture for mission critical communication services defined in 3GPP TS 23.280 [6].

---

## 5 Architectural requirements

### 5.1 Media routing requirements

The video media flow for a private call shall be routed according to one of the following two options:

- a) Option 1:
  - 1) Through the primary MCVideo system if both users in the call belong to the same organisation; or
  - 2) Through the primary MCVideo system of each users, if the users in the call do not belong to the same organisation.
- b) Option 2: The video media flow may be routed locally, under the control of the primary MCVideo system, through an entity allowing the duplication of the media flow to the primary MCVideo system of each user.

The video media flow for a group call shall be routed to the group home MCVideo system.

## 5.2 MCVideo group affiliation and MCVideo group de-affiliation

MCVideo group affiliation shall be as specified in clause 5.2.5 of 3GPP TS 23.280 [6]. In addition, the following requirements shall be fulfilled by the MCVideo service for MCVideo users affiliated to MCVideo groups:

- MCVideo users receive notifications for MCVideo group call setup and invitations for their affiliated MCVideo group(s).
- MCVideo users select an affiliated MCVideo group to initiate a new group MCVideo call or transmit media in an existing MCVideo group call.
- MCVideo users receive media and events from their affiliated MCVideo group(s).

## 5.3 Device inventory requirements

The MCVideo service shall provide device inventory capabilities for MCVideo UEs. The device inventory capabilities shall include:

- device information registration;
- device information storage; and
- device information query.

## 5.4 Device discovery requirements (off-network)

The MCVideo service shall provide device discovery for devices as requested by the MCVideo user according to the MC service provider policy for off-network operations.

## 5.5 Bearer management

### 5.5.1 General

The MCVideo UE shall use the APNs as defined in subclause 5.2.7.0 of 3GPP TS 23.280 [6]. The MCVideo UE shall use the MC services APN as defined in subclause 5.2.7.0 of 3GPP TS 23.280 [6] for the SIP-1 reference point.

### 5.5.2 EPS bearer considerations

The EPS bearer considerations specified in subclause 5.2.7.2 of 3GPP TS 23.280 [6] shall apply.

### 5.5.3 EPS unicast bearer considerations for MCVideo

For an MCVideo call session request, resources shall be requested utilising interaction with dynamic PCC. The MCVideo system shall request resources over Rx to a PCRF. The dedicated bearer(s) for video media and control of the video media (i.e. MCVideo-4 and MCVideo-7) shall utilise the QCI values depending on the MCVideo mode of the MCVideo call/session, as per table 5.5.3-1. The request of resources over Rx shall include an application identifier for MCVideo in order for the PCRF to evaluate the correct QCI.

**Table 5.5.3-1: QCI values to use for EPS unicast bearers for each MCVideo mode**

MCVideo mode	QCI value utilised (as specified in 3GPP TS 23.203 [11])
Urgent real-time mode	2
Non-urgent real-time mode	2
Non real-time mode	4

The UE is required to support at minimum one UM bearer, which is used for MCVideo (see annex A in 3GPP TS 36.331 [12]).

## 5.5.4 MBMS bearer management

The MBMS bearer management for MC services is specified in subclause 5.2.7.1 of 3GPP TS 23.280 [6].

---

# 5A Involved business relationships

The description of the involved business relationships for the MCVideo service is contained in clause 6 of 3GPP TS 23.280 [6].

---

# 6 MCVideo Functional model

## 6.1 Functional model description

### 6.1.1 On-network functional model

Figure 6.1.1-1 shows the functional model for the application plane of MCVideo service for on-network operations.

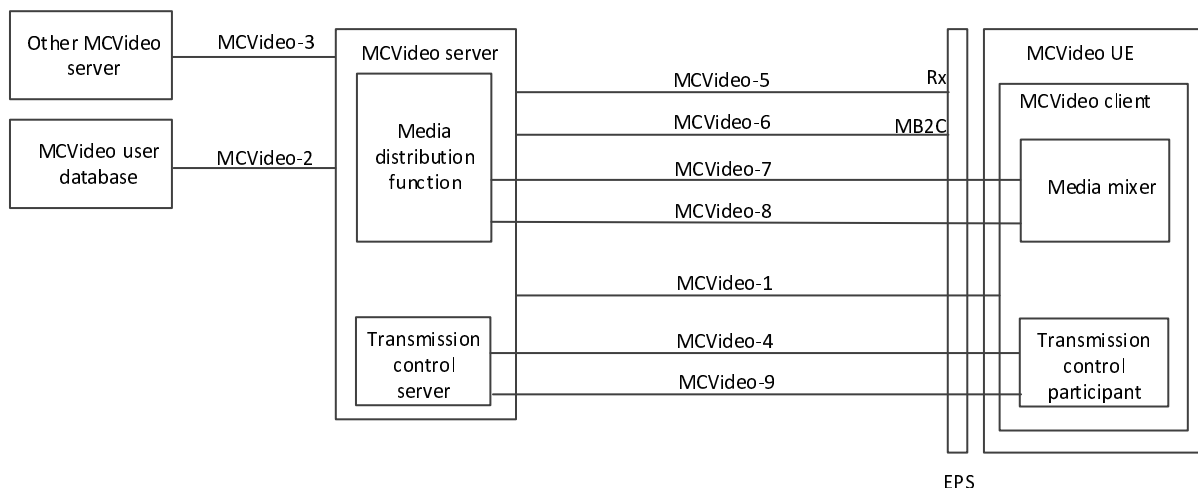

**Figure 6.1.1-1: Functional model for application plane of MCVideo service**

In the model shown in figure 6.1.1-1, the following apply:

- The MCVideo server is an instantiation of a MC service server in accordance with 3GPP TS 23.280 [6].
- The MCVideo server is an instantiation of a GCS AS in accordance with 3GPP TS 23.468 [9].
- MCVideo-9 carries signalling over multicast bearer between the transmission control server of the MCVideo server and the transmission control participant of the MCVideo UE.
- MCVideo-4 carries signalling over unicast bearer between the transmission control server of the MCVideo server and the transmission control participant of the MCVideo UE.

### 6.1.2 Off-network functional model

Figure 6.1.2-1 shows the functional model for the application plane of MCVideo service for off-network operations.



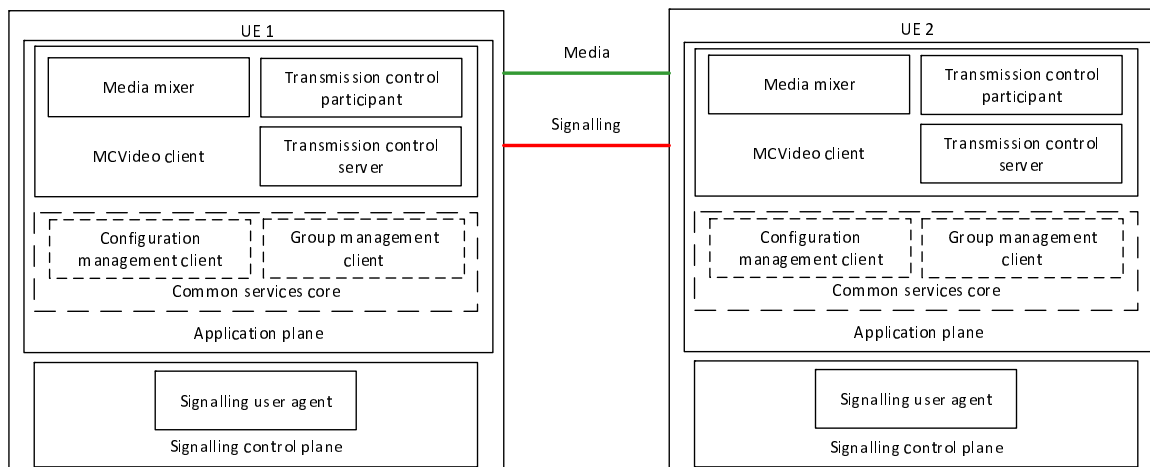

**Figure 6.1.2-1: Functional model for application plane of off-network MCVideo service**

## 6.2 Functional entities description

### 6.2.1 General

Each subclause is a description of a functional entity and does not imply a physical entity.

### 6.2.2 MCVideo service application plane

#### 6.2.2.1 General

Entities within the application plane of MCVideo service provide application control, media transmission control and distribution functions.

#### 6.2.2.2 Common services core

The description of the common services core entities are contained in common functional architecture for MC services over LTE in 3GPP TS 23.280 [6].

#### 6.2.2.3 MCVideo application service

##### 6.2.2.3.1 MCVideo client

The MCVideo client functional entity acts as the user agent for all MCVideo application transactions.

The MCVideo client is responsible for remote device control. This functional entity is located in the UE for both on-network and off-network operations.

##### 6.2.2.3.2 MCVideo server

The MCVideo server functional entity provides centralised support for MCVideo services.

All the MCVideo clients supporting users belonging to a single group are required to use the same MCVideo server for that group. An MCVideo client supporting a user involved in multiple groups can have relationships with multiple MCVideo servers.

The MCVideo server is an instantiation of a MC service server in accordance with 3GPP TS 23.280 [6].

The MCVideo server functional entity represents a specific instantiation of the GCS AS described in 3GPP TS 23.468 [9] to control multicast and unicast operations for group communications.

The MCVideo server functional entity is supported by the SIP AS, HTTP client and HTTP server functional entities of the signalling control plane.

This MCVideo server provides support for centralised media transmission control for on-network and distributed media transmission control for off-network operation.

The MCVideo server is responsible for managing and providing the device information that can participate in MCVideo communications. The device information is further associated to MCVideo users to manage remote device control authorization. The device information is provisioned to the MCVideo server by the MCVideo service provider, mission critical organization and the MCVideo user.

#### 6.2.2.3.3 Media distribution function

The media distribution function is responsible for the distribution of media to MCVideo clients. By means of information provided by the MCVideo server (e.g. IP addresses, transport layer ports), it will provide the following functionality:

- provide for the reception of uplink MCVideo UE media transmission by means of the MCVideo-7 reference point;
- storing the received media stream as MCVideo content files;
- replicate the media as needed for distribution to those participants using unicast transport;
- distribute downlink media to MCVideo UEs by IP unicast transmission to those participants utilizing unicast transport by means of the MCVideo-7 reference point;
- distribute downlink media to MCVideo UEs using multicast downlink transport of media for the call by means of the MCVideo-8 reference point; and
- provide a media mixing function where multiple media streams are combined into a single media stream for transmission to the MCVideo UE.

NOTE 1: If media mixing function occurs within the media distribution function, it operates independently of the media mixer in the UE.

NOTE 2: A media mixing function within the media distribution function is not possible where the media is end to end encrypted.

#### 6.2.2.3.4 Media mixer

This functional entity exists on the UE and provides support for sending and receiving one or multiple media streams. It also provides support for combining multiple media streams into one media stream through the enforcement of media policy information. It supports the storing of a media stream as MCVideo content files.

#### 6.2.2.3.5 MCVideo user database

This functional entity contains information of the MCVideo user profile associated with an MCVideo ID that is held by the MCVideo service provider at the application plane. The MCVideo user profile is determined by the mission critical organization, the MCVideo service provider, and potentially the MCVideo user.

The MCVideo ID is a MC service ID as described in clause 8 of 3GPP TS 23.280 [6]. The MCVideo user profile is a MC service user profile as described in clause 10.1.4 of 3GPP TS 23.280 [6].

The MCVideo user profile can be co-located with other MC service user profiles and stored in a common MC service user database.

#### 6.2.2.3.6 Transmission control server

This functional entity provides support for centralised transmission control for on-network and distributed transmission control for off-network operation. It may schedule transmission requests according to uplink criteria from different

transmission control participants, send a notification to all transmission control participants to allow them to receive the video according to downlink criteria if the transmission request is granted, and provide queuing in cases of contention. Transmission control applies to all MCVideo communications including group call and private call. For on-network operation, this functional entity is located with the MCVideo server. For off-network operation, this functional entity is located in the UE.

#### 6.2.2.3.7 Transmission control participant

The transmission control participant functional entity is responsible for handling outgoing transmission requests and the incoming video stream invitations and notifications. This functional entity is located in the UE for both on-network and off-network operations.

## 6.3 Reference points

### 6.3.1 Reference point MCVideo-1 (between the MCVideo client and the MCVideo server)

The MCVideo-1 reference point, which exists between the MCVideo client and the MCVideo server, is used for MCVideo application signalling for establishing a session in support of MCVideo service.

### 6.3.2 Reference point MCVideo-2 (between the MCVideo server and the MCVideo user database)

The MCVideo-2 reference point, which exists between the MCVideo server and the MCVideo user database, is used by the MCVideo server to obtain information about a specific user.

### 6.3.3 Reference point MCVideo-3 (between the MCVideo server and the MCVideo server)

The MCVideo-3 reference point, which exists between the MCVideo server and another MCVideo server from an MC service provider for MCVideo application signalling.

### 6.3.4 Reference point MCVideo-4 (between the transmission control participant and the transmission control server)

The MCVideo-4 reference point, which exists between the transmission control participant and the transmission control server, is used for MCVideo transmission control signalling over unicast. The MCVideo-4 reference point uses the SGi reference point defined in 3GPP TS 23.002 [4].

### 6.3.4A Reference point MCVideo-5 (unicast between the media distribution function and the EPS)

The MCVideo-5 reference point, which exists between the media distribution function and the EPS, is used, subject to the conditions below, by the media distribution function of the MCVideo server to obtain unicast bearers with appropriate QoS from the EPS. It utilises the Rx interface of the EPS according to 3GPP TS 23.203 [11].

MCVideo-5 is not used when the MCVideo service provider and the PLMN operator do not have an operational agreement for QoS control to be provided directly from the MCVideo service provider domain.

MCVideo-5 may be used when the MCVideo service provider and the PLMN operator have an operational agreement where QoS control is provided directly from the MCVideo service provider domain.

**NOTE:** Any coordination between the P-CSCF use of Rx and the MCVideo server use of Rx (via MCVideo-5) from the MCVideo service provider domain is not specified in this release of this specification.

### 6.3.4B Reference point MCVideo-6 (between the MCVideo server and the EPS)

The MCVideo-6 reference point, which exists between the MCVideo server and the EPS, is used to request the allocation and activation of multicast transport resources for MCPTT application usage. The MCVideo-6 reference point uses the MB2-C interface as defined in 3GPP TS 29.468 [13].

### 6.3.5 Reference point MCVideo-7 (between the media distribution function and the media mixer)

The MCVideo-7 reference point, which exists between the media distribution function and the media mixer, is used to exchange unicast media between the media distribution function of the MCVideo server and the media mixer of the MCVideo client. The MCVideo-7 reference point uses the SGi reference point defined in 3GPP TS 23.002 [4].

### 6.3.6 Reference point MCVideo-8 (between the media distribution function and the media mixer)

The MCVideo-8 reference point, which exists between the media distribution function and the media mixer, is used by the media distribution function of the MCVideo server to send multicast media to the media mixer of the MCVideo client. The MCVideo-8 reference point uses the MB2-U interface defined in 3GPP TS 23.468 [9].

### 6.3.7 Reference point MCVideo-9 (between the transmission control participant and the transmission control server)

The MCVideo-9 reference point, which exists between the transmission control participant and the transmission control server, is used MCVideo transmission control signalling over multicast. The MCVideo-9 reference point uses the MB2-U interface defined in 3GPP TS 23.468 [9].

---

## 6A Identities

The MCVideo service specific identities (e.g. MCVideo ID, MCVideo group ID) are described in clause 8 of 3GPP TS 23.280 [6].

---

## 6B Application of functional model to deployments

The application of the functional model to deployments, and description of various deployment scenarios for the MCVideo service, can be found in clause 9 of 3GPP TS 23.280 [6].

---

## 7 Procedures and information flows

### 7.1 Group call

#### 7.1.1 General

Group calls are enabled in both on-network and off-network.

## 7.1.2 On-network group call

### 7.1.2.1 General

This subclause contains procedures for group call across a single and multiple MCVideo servers, and associated functions such as emergency call, broadcast call and others.

Two variations of group call model are described in subclause 7.1.2.3, the pre-arranged group call and the chat group call. Each of the subsequent group call types in subclause 7.1.2.4 onwards are applicable to either call model.

### 7.1.2.2 Information flows for group call in on-network

#### 7.1.2.2.1 Group call request (MCVideo client – MCVideo server)

Table 7.1.2.2.1-1 describes the information flow group call request from the MCVideo client to the MCVideo server.

**Table 7.1.2.2.1-1: Group call request (MCVideo client – MCVideo server)**

Information Element	Status	Description
MCVideo ID	M	The MCVideo ID of the calling party
MCVideo group ID	M	The MCVideo group ID of the group on which the call is requested
SDP offer	M	Media parameters of MCVideo clients
Implicit transmit media request	O	When originating client requests the permission to transmit media, this element shall be included
Broadcast indicator	O	Indicates that the group call request is for a broadcast group call

#### 7.1.2.2.2 Group call request (MCVideo server – MCVideo client)

Table 7.1.2.2.2-1 describes the information flow group call request from the MCVideo server to the MCVideo client.

**Table 7.1.2.2.2-1: Group call request (MCVideo server – MCVideo client)**

Information Element	Status	Description
MCVideo ID	M	The MCVideo ID of the calling party
MCVideo group ID	M	The MCVideo group ID of the group on which the call is initiated
SDP offer	M	Media parameters of MCVideo server
Broadcast indicator	O	Indicates that the group call request is for a broadcast group call

#### 7.1.2.2.3 Group call response (MCVideo server – MCVideo client)

Table 7.1.2.2.3-1 describes the information flow group call response from the MCVideo server to the MCVideo client.

**Table 7.1.2.2.3-1: Group call response (MCVideo server – MCVideo client)**

Information Element	Status	Description
MCVideo ID	M	The MCVideo ID of the calling party
MCVideo group ID	M	The MCVideo group ID of the group on which the call is requested
SDP answer	M	Media parameters selected

#### 7.1.2.2.4 Group call response (MCVideo client – MCVideo server)

Table 7.1.2.2.4-1 describes the information flow group call response from the MCVideo client to the MCVideo server.

**Table 7.1.2.2.4-1: Group call response (MCVideo client – MCVideo server)**

Information Element	Status	Description
MCVideo ID	M	The MCVideo ID of the target MCVideo group member
MCVideo group ID	M	The MCVideo group ID of the group on which the call is initiated
SDP answer	M	Media parameters selected

#### 7.1.2.2.5 Group call release request (MCVideo server – MCVideo client)

Table 7.1.2.2.5-1 describes the information flow group call release request from the MCVideo server to the MCVideo client.

**Table 7.1.2.2.5-1: Group call release request (MCVideo server – MCVideo client)**

Information Element	Status	Description
MCVideo ID	M	The MCVideo ID of the MCVideo group member
MCVideo group ID	M	The MCVideo group ID of the group on which the call is released

#### 7.1.2.2.6 Group call release request (MCVideo client – MCVideo server)

Table 7.1.2.2.6-1 describes the information flow group call release request from the MCVideo client to the MCVideo server.

**Table 7.1.2.2.6-1: Group call release request (MCVideo client – MCVideo server)**

Information Element	Status	Description
MCVideo ID	M	The MCVideo ID of the MCVideo group member
MCVideo group ID	M	The MCVideo group ID of the group on which the call is released

#### 7.1.2.2.7 Group call release response (MCVideo client – MCVideo server)

Table 7.1.2.2.7-1 describes the information flow group call release response from the MCVideo client to the MCVideo server.

**Table 7.1.2.2.7-1: Group call release response (MCVideo client – MCVideo server)**

Information Element	Status	Description
MCVideo ID	M	The MCVideo ID of the MCVideo group member
MCVideo group ID	M	The MCVideo group ID of the group on which the call is released

#### 7.1.2.2.8 Group call rejoin request (MCVideo client – MCVideo server)

Table 7.1.2.2.8-1 describes the information flow group call rejoin request from the MCVideo client to the MCVideo server.

**Table 7.1.2.2.8-1: Group call rejoin request (MCVideo client – MCVideo server)**

Information Element	Status	Description
MCVideo ID	M	The MCVideo ID of the re-joining MCVideo group member
MCVideo group ID	M	The MCVideo group ID of the group on which the call is on-going
SDP offer	M	Media parameters of MCVideo client

#### 7.1.2.2.9 Group call rejoin response (MCVideo server – MCVideo client)

Table 7.1.2.2.9-1 describes the information flow group call rejoin response from the MCVideo server to the MCVideo client.

**Table 7.1.2.2.9-1: Group call rejoin response (MCVideo server – MCVideo client)**

Information Element	Status	Description
MCVideo ID	M	The MCVideo ID of the MCVideo group member rejoining the group call
MCVideo group ID	M	The MCVideo group ID of the group on which the call is on-going
SDP answer	M	Media parameters selected

#### 7.1.2.2.10 Group call join request (MCVideo client – MCVideo server)

Table 7.1.2.2.10-1 describes the information flow group call join request from the MCVideo client to the MCVideo server.

**Table 7.1.2.2.10-1: Group call join request (MCVideo client – MCVideo server)**

Information Element	Status	Description
MCVideo ID	M	The MCVideo ID of the MCVideo group member joining the group communications for the group
MCVideo group ID	M	The MCVideo group ID of the group to which the group communication is requested
SDP offer	M	Media parameters of MCVideo client

### 7.1.2.2.11 Group call join response (MCVideo server – MCVideo client)

Table 7.1.2.2.11-1 describes the information flow group call join response from the MCVideo server to the MCVideo client.

**Table 7.1.2.2.11-1: Group call join response (MCVideo server – MCVideo client)**

Information Element	Status	Description
MCVideo ID	M	The MCVideo ID of the MCVideo group member joining the group communications for the group
MCVideo group ID	M	The MCVideo group ID of the group to which the group communication is requested
SDP answer	M	Media parameters selected

### 7.1.2.2.12 Group call leave request (MCVideo server – MCVideo client)

Table 7.1.2.2.12-1 describes the information flow group call leave request from the MCVideo server to the MCVideo client.

**Table 7.1.2.2.12-1: Group call leave request (MCVideo server – MCVideo client)**

Information Element	Status	Description
MCVideo ID	M	The MCVideo ID of the MCVideo group member which has been de-affiliated
MCVideo group ID	M	The MCVideo group ID of the group on which the call is on-going

### 7.1.2.2.13 Group call leave response (MCVideo client – MCVideo server)

Table 7.1.2.2.13-1 describes the information flow group call leave response from the MCVideo client to the MCVideo server.

**Table 7.1.2.2.13-1: Group call leave response (MCVideo client – MCVideo server)**

Information Element	Status	Description
MCVideo ID	M	The MCVideo ID of the MCVideo group member which has been de-affiliated
MCVideo group ID	M	The MCVideo group ID of the group on which the call is on-going

### 7.1.2.2.14 MCVideo emergency alert request

Table 7.1.2.2.14-1 describes the information flow MCVideo emergency alert request from the MCVideo client to the MCVideo server, for the procedures defined in 3GPP TS 23.280 [6].



**Table 7.1.2.2.14-1: MCVideo emergency alert request (MCVideo client – MCVideo server)**

Information Element	Status	Description
MCVideo ID	M	The identity of the alerting party
MCVideo group ID	M	The MCVideo group ID with which the alert is associated
Location	O	The alerting MCVideo client's location

Table 7.1.2.2.14-2 describes the information flow MCVideo emergency alert request from the MCVideo server to the MCVideo client, for the procedures defined in 3GPP TS 23.280 [6].

**Table 7.1.2.2.14-2: MCVideo emergency alert request (MCVideo server – MCVideo client)**

Information Element	Status	Description
MCVideo ID	M	The identity of the alerting party
MCVideo group ID	M	The MCVideo group ID with which the alert is associated
Organization name	M	The alerting MCVideo user's mission critical organization name
Location	O	The alerting MCVideo client's location

#### 7.1.2.2.15 MCVideo emergency alert response

Table 7.1.2.2.15-1 describes the information flow MCVideo emergency alert response from the MCVideo client to the MCVideo server and from the MCVideo server to the MCVideo client, for the procedures defined in 3GPP TS 23.280 [6].

**Table 7.1.2.2.15-1: MCVideo emergency alert response**

Information Element	Status	Description
MCVideo ID	M	The identity of the alerting party
MCVideo group ID	M	The MCVideo group ID with which the alert is associated

#### 7.1.2.2.16 MCVideo emergency state cancel request

Table 7.1.2.2.16-1 describes the information flow MCVideo emergency state cancel request from the MCVideo client to the MCVideo server and from the MCVideo server to the MCVideo client, for the procedures defined in 3GPP TS 23.280 [6].

**Table 7.1.2.2.16-1: MCVideo emergency state cancel request**

Information Element	Status	Description
MCVideo ID	M	The identity of the cancelling party
MCVideo group ID	M	The MCVideo group ID with which the alert is associated
Client emergency state cancel inform (NOTE)	O	Requests cancellation of the emergency state associated with this MCVideo client
Group emergency condition cancel request (NOTE)	O	Requests cancellation of the emergency condition of the group
NOTE: At least one of these information elements shall be present		

### 7.1.2.2.17 MCVideo emergency state cancel response

Table 7.1.2.2.17-1 describes the information flow MCVideo emergency state cancel response from the MCVideo client to the MCVideo server and from the MCVideo server to the MCVideo client, for the procedures defined in 3GPP TS 23.280 [6].

**Table 7.1.2.2.17-1: MCVideo emergency state cancel response**

Information Element	Status	Description
MCVideo ID	M	The identity of the cancelling party
MCVideo group ID	M	The MCVideo group ID with which the alert is associated

### 7.1.2.2.18 MCVideo emergency group call request

Table 7.1.2.2.18-1 describes the information flow emergency group call request from the MCVideo client to the MCVideo server and from the MCVideo server to the MCVideo client.

**Table 7.1.2.2.18-1: MCVideo emergency group call request**

Information Element	Status	Description
MCVideo ID	M	The identity of the calling party
MCVideo group ID	M	The MCVideo group ID on which the call is to be conducted
Emergency indicator	M	Indicates that the group call request is an MCVideo emergency call
Alert indicator	M	Indicates whether an emergency alert is to be sent

### 7.1.2.2.19 MCVideo emergency group call response

Table 7.1.2.2.19-1 describes the information flow emergency group call response from the MCVideo client to the MCVideo server and from the MCVideo server to the MCVideo client.

**Table 7.1.2.2.19-1: MCVideo emergency group call response**

Information Element	Status	Description
MCVideo ID	M	The identity of the calling party
MCVideo group ID	M	The MCVideo group ID on which the call is to be conducted

### 7.1.2.2.20 MCVideo emergency group call cancel request

Table 7.1.2.2.20-1 describes the information flow emergency group call cancel request from the MCVideo client to the MCVideo server.

**Table 7.1.2.2.20-1: MCVideo emergency group call cancel request**

Information Element	Status	Description
MCVideo ID	M	The identity of the cancelling party
MCVideo group ID	M	The MCVideo group ID on which the MCVideo emergency is in progress
Alert indicator	O	Indicates whether the emergency alert is to be cancelled

#### 7.1.2.2.21 MCVideo emergency group call cancel response

Table 7.1.2.2.21-1 describes the information flow emergency group call cancel response from the MCVideo server to the MCVideo client.

**Table 7.1.2.2.21-1: MCVideo emergency group call cancel response**

Information Element	Status	Description
MCVideo ID	M	The identity of the cancelling party
MCVideo group ID	M	The MCVideo group ID on which the MCVideo emergency is in progress

#### 7.1.2.2.22 MCVideo imminent peril group call request

Table 7.1.2.2.22-1 describes the information flow MCVideo imminent peril group call request from the MCVideo client to the MCVideo server and from the MCVideo server to the MCVideo client.

**Table 7.1.2.2.22-1: MCVideo imminent peril group call request**

Information Element	Status	Description
MCVideo ID	M	The identity of the calling party
MCVideo group ID	M	The MCVideo group ID on which the call is to be conducted
Imminent peril indicator	M	Indicates that the group call request is an imminent peril call

#### 7.1.2.2.23 MCVideo imminent peril group call response

Table 7.1.2.2.23-1 describes the information flow MCVideo imminent peril group call response from the MCVideo client to the MCVideo server and from the MCVideo server to the MCVideo client.

**Table 7.1.2.2.23-1: MCVideo imminent peril group call response**

Information Element	Status	Description
MCVideo ID	M	The identity of the calling party
MCVideo group ID	M	The MCVideo group ID on which the call is to be conducted

#### 7.1.2.2.24 MCVideo imminent peril group call cancel request

Table 7.1.2.2.24-1 describes the information flow MCVideo imminent peril group call cancel request from the MCVideo client to the MCVideo server and from the MCVideo server to the MCVideo client.

**Table 7.1.2.2.24-1: MCVideo imminent peril group call cancel request**

Information Element	Status	Description
MCVideo ID	M	The identity of the cancelling party
MCVideo group ID	M	The MCVideo group ID on which the imminent peril is to be cancelled

### 7.1.2.2.25 MCVideo imminent peril group call cancel response

Table 7.1.2.2.25-1 describes the information flow MCVideo imminent peril group call cancel response from the MCVideo client to the MCVideo server and from the MCVideo server to the MCVideo client.

**Table 7.1.2.2.25-1: MCVideo imminent peril group call cancel response**

Information Element	Status	Description
MCVideo ID	M	The identity of the cancelling party
MCVideo group ID	M	The MCVideo group ID on which the imminent peril is to be cancelled

## 7.1.2.3 Group call within one MC system

### 7.1.2.3.1 Group call models

#### 7.1.2.3.1.1 Pre-arranged group call

##### 7.1.2.3.1.1.1 General

A pre-arranged group call is initiated by one of the group members. The initiation of a pre-arranged group call results in all other affiliated group members being invited.

##### 7.1.2.3.1.1.2 Pre-arranged group call setup

The procedure enables the scenario where an MCVideo client is initiating an MCVideo group call with unicast signalling for communicating with the affiliated members of that group.

Procedures in figure 7.1.2.3.1.1.2-1 are the signalling control plane procedures for the MCVideo client initiating establishment of an MCVideo group call with a pre-arranged group i.e., MCVideo users on client 1, client 2 and client 3 belong to the same group which is defined in the group management server.

Pre-conditions:

1. A pre-arranged group is an MCVideo group that is pre-defined with MC service group ID and member list in the group management server. All members of the group belong to the same MC system.
2. It is assumed that MCVideo users on MCVideo client 1, MCVideo client 2 and MCVideo client 3 are already registered for receiving MCVideo service and affiliated.

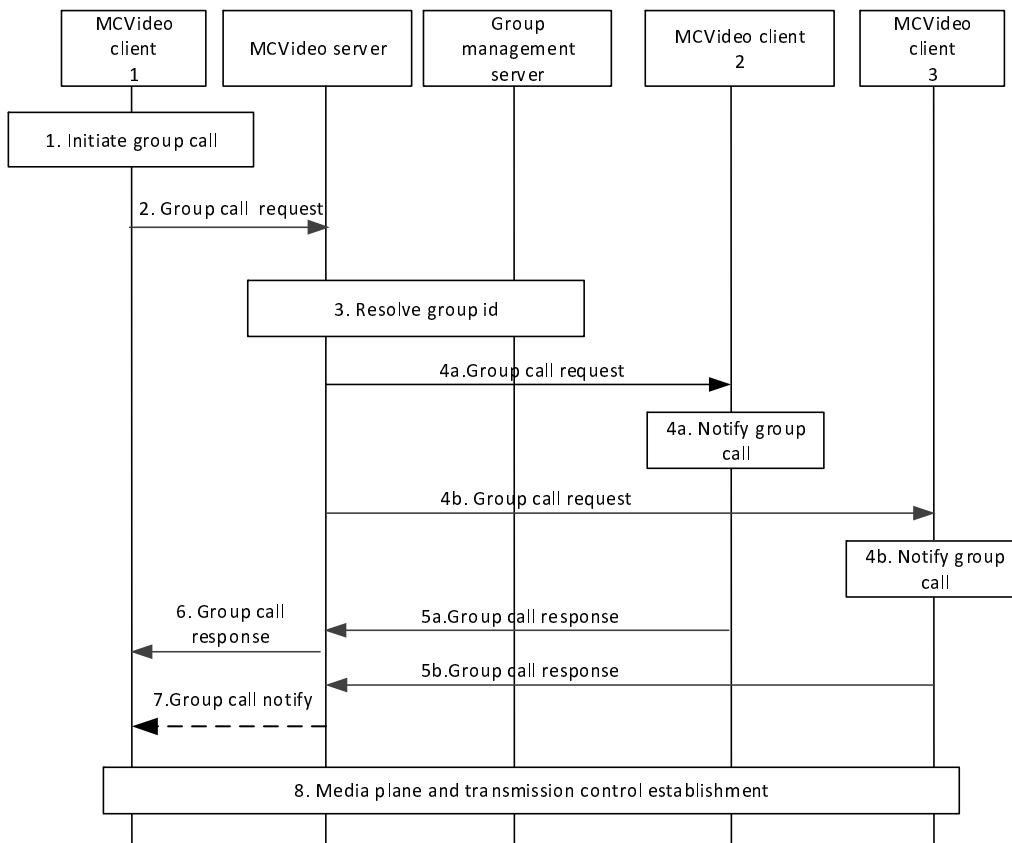

**Figure 7.1.2.3.1.1.2-1: Pre-arranged group call setup**

1. User at MCVideo client 1 would like to initiate an MCVideo group call with a selected group (identified by MC service group ID).
2. MCVideo client 1 sends a group call request towards the MCVideo server via the SIP core, which hosts the group selected by the user and identified by MC service group ID. The group call request also contains the MC service group ID and an SDP offer containing the MCVideo client media parameters. If there is a transmit media request, then the group call request contains an indication for the implicit transmit media request.
3. MCVideo server checks whether the user of MCVideo client 1 is authorized to initiate a group call for the selected group. If authorized and the group call is ongoing for that MC service group ID, the MCVideo server adds the requesting MCVideo client 1 to the existing MCVideo group call and notifies the MCVideo client 1 that the MCVideo group call is already in progress. Otherwise, MCVideo server resolves the MC service group ID to determine the members of that group and their affiliation status, based on the information from the group management server.

NOTE 1: MCVideo server can have already retrieved the user/group configuration data and locally cached. If the user/group configuration data is not locally cached on the MCVideo server then MCVideo server requests the user/group configuration data from the MCVideo user database/group management server.

4. MCVideo server includes information that it communicates using MCVideo service, offers the same media parameters or a subset of the media parameters contained in the initial received request and sends the corresponding group call request via the SIP core towards the MCVideo clients of each of those affiliated group members. MCVideo users are notified about the incoming group call. The MCVideo server indicates whether acknowledgement is required for the call.
5. The receiving MCVideo clients accept the group call request, and a group call response is sent to the group host MCVideo server. This response may contain an acknowledgement. The conditions for sending acknowledgement may be based on configuration.

6. MCVideo server sends the group call response including the selected media parameters to the MCVideo client 1 through the signalling path to inform about successful call establishment.

NOTE 2: Step 6 can occur at any time following step 4b, and prior to step 7 depending on the conditions to proceed with the call.

7. If the initiating MCVideo user requires the acknowledgement from affiliated MCVideo group members, and the required MCVideo group members do not acknowledge the call setup within a configured time (the "acknowledged call setup timeout"), then the MCVideo server may proceed with or abandon the call and then notify the initiating MCVideo user that the acknowledgements did not include all required members according to group policy. This notification may be sent to the initiating MCVideo user by the MCVideo server more than once during the call when MCVideo users join or leave the MCVideo group call.
8. MCVideo client 1, client 2 and client 3 have successfully established media plane and transmission control for communication.

#### 7.1.2.3.1.1.3 Release pre-arranged group call

The procedure enables the scenario where an MCVideo server initiates the termination of an ongoing MCVideo group call for all the participants of that group call, since at least one of the termination conditions are met e.g., last participant leaving, second last participant leaving, initiator leaving, or minimum number of affiliated MCVideo group members are not present.

NOTE: The procedure for MCVideo user leaving the group call is a different scenario and is not considered in this solution.

Procedures in figure 7.1.2.3.1.1.3-1 are the signalling control plane procedures for the MCVideo server initiating termination of an ongoing MCVideo group call.

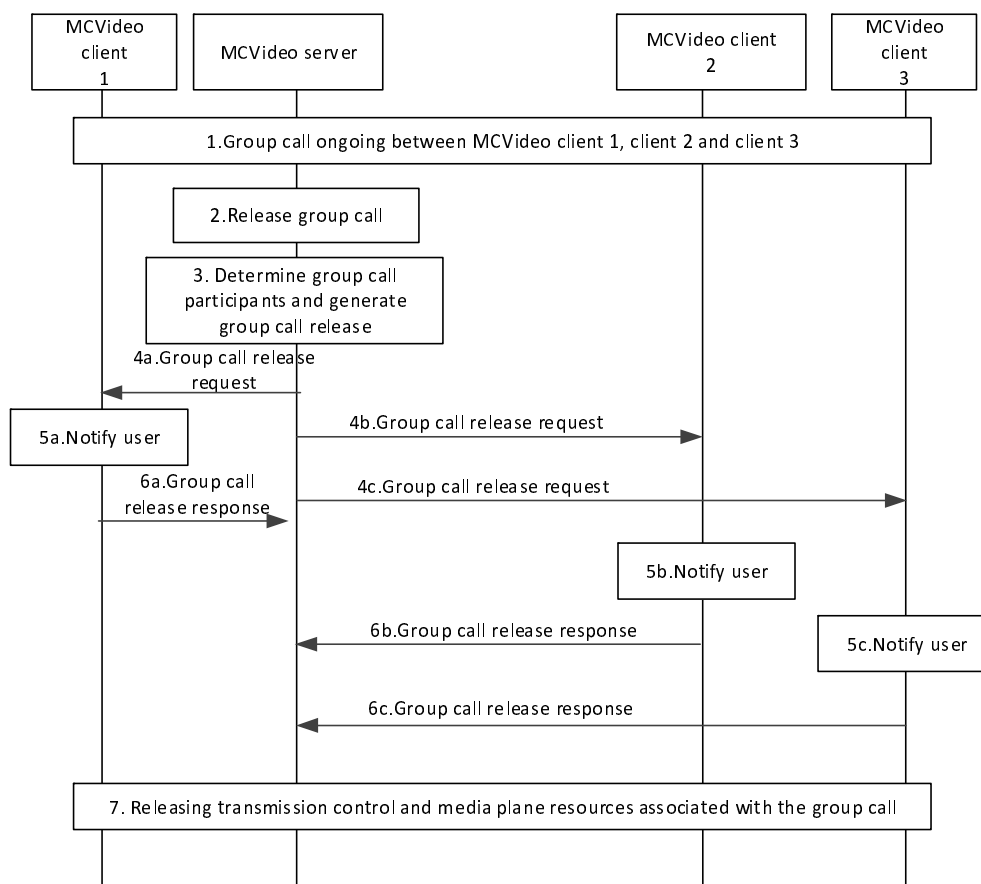

**Figure 7.1.2.3.1.1.3-1: Release pre-arranged group call**

1. It is assumed that MCVideo users on MCVideo client 1, client 2 and client 3 are already part of the ongoing group call (e.g., as a result of pre-arranged group call setup).
2. MCVideo server would like to release the MCVideo group call which is ongoing e.g., last participant leaving, initiator leaving, or minimum number of affiliated group members are not present.
3. MCVideo server identifies the participants of the ongoing group call and generates group call release request to release ongoing session.
4. MCVideo server sends a group call release request via SIP core towards each participant of the ongoing group call.
5. MCVideo users are notified about the release of the group call.
6. MCVideo client(s) receiving group call release request, acknowledge towards the MCVideo server by sending a group call release response.
7. MCVideo client 1, client 2 and client 3 have successfully released the media transmission control and media plane resources associated with the group call that is terminated.

#### 7.1.2.3.1.1.4 Late entry pre-arranged group call

Procedures in figure 7.1.2.3.1.1.4-1 are the signalling control plane procedures for the MCVideo server requesting a newly affiliated member or a member coming back from out of coverage to join an ongoing MCVideo group call.

Pre-conditions:

1. MCVideo group is previously defined on the group management server with MCVideo users affiliated to that group. All members of the group belong to the same MC system.
2. It is assumed that MCVideo users on MCVideo client 2 to MCVideo client n are on an ongoing call.

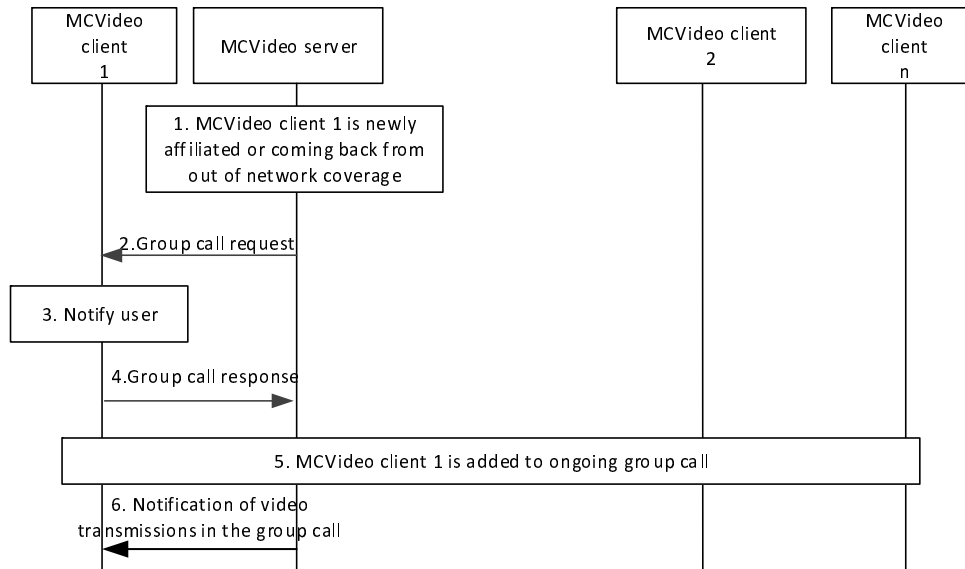

**Figure 7.1.2.3.1.1.4-1: Late entry pre-arranged group call**

1. MCVideo server determines that MCVideo client 1 which is newly affiliated or coming back from out of coverage has to be invited to join an ongoing group call (late entry).
2. MCVideo server generates group call request including the information such as MCVideo service identifier (possible for the SIP core to route the request to the MCVideo server), MC service group ID of the group invited to join, offer one or more media types and sends towards the MCVideo client 1 via SIP core.
3. MCVideo user at MCVideo client 1 is notified about the incoming group call.
4. Upon MCVideo user at MCVideo client 1 accepting the incoming group call request, MCVideo client 1 sends the group call response including the selected media types to the MCVideo server through the signalling path. If the incoming group call request is rejected by the MCVideo client 1, the MCVideo server should not resend the group call request
5. MCVideo client 1 is successfully added to the ongoing group call and MCVideo users at MCVideo client 1 to MCVideo client n may be notified about the MCVIDEO client 1 joining the group call.
6. A notification with the information of media transmissions in the group call is sent to MCVideo client1.

**7.1.2.3.1.1.5 Rejoining call**

Procedures in figure 7.1.2.3.1.1.5-1 are the signalling control plane procedures for the MCVideo client to rejoin an ongoing MCVideo group call (e.g. coming back from out of coverage).

Pre-condition:

- It is assumed that MCVideo users on MCVideo client 2 to MCVideo client n are on an ongoing call.



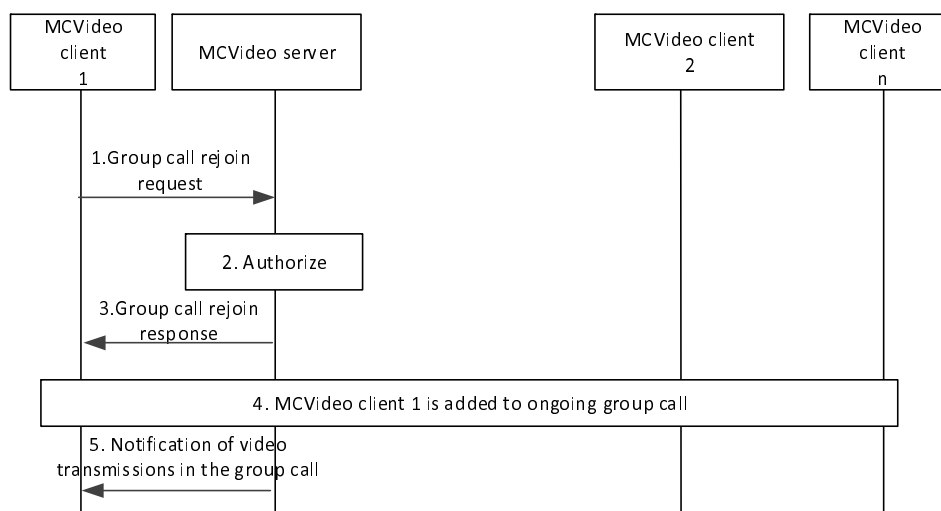

**Figure 7.1.2.3.1.1.5-1: Rejoin call**

1. MCVideo client 1 has necessary information for rejoining an ongoing group call, then the MCVideo client 1 initiates group call rejoin request including the ongoing group call information.
2. MCVideo server checks whether the MCVideo client 1 can rejoin the ongoing call (e.g. based upon affiliation status).
3. MCVideo client 1 is informed that the group call rejoin is successful by sending a group call rejoin response.
4. MCVideo client 1 is successfully added to the ongoing group call and MCVideo users at MCVideo client 1 to MCVideo client n may be notified about the MCVideo client 1 joining the group call.
5. A notification with the information of media transmissions in the group call is sent to MCVideo client 1.

#### 7.1.2.3.1.2 Chat group call

##### 7.1.2.3.1.2.1 General

In a chat group call model, the MCVideo user individually joins a group call without being explicitly invited by the MCVideo server. The establishment of a chat group call does not result in other group members being invited.

Figure 7.1.2.3.1.2.2-1 describes the basic procedure for the MCVideo client initiating an MCVideo group call which uses the chat group call model. The chat group call model can be used to realize the video conferencing service where only users that have been configured as participants for the video conferencing are allowed to join the group communications for the given group.

Chat group call join mechanism:

- Each MCVideo client sends a group call join request when the MCVideo user wants to participate in the group communication for the group. (This message does not impact the MCVideo user's membership in the group; the MCVideo server will verify that the MCVideo user is an authorized member of the group.)
- The group call join request may include a transmit media request. It is assumed that the group call join request will be delivered from MCVideo client to MCVideo server using SIP.
- The group call join request is used to indicate to the MCVideo server that the MCVideo user associated with the given MCVideo client wishes to participate (begin to receive notifications for media transmissions) from the group.

- The group call join request may cause the MCVideo server to generate an implicit affiliation for the MCVideo user to the group, if the user is not already affiliated to the group.
- The group call join request normally contains the information needed to negotiate media parameters between MCVideo server and MCVideo client for the group call. The group call join request can take the form of a SIP invite.

Subsequent participation in a group call when the group is using the chat model:

- Once an MCVideo client successfully joins a group call which is using the chat model, the MCVideo client connects to the media plane for the media transmission if the media transmission is currently ongoing.
- If the MCVideo group call is not currently ongoing (i.e.: when MCVideo clients on the group call are not sending or receiving media) then the newly joined MCVideo client will only have pre-established its media parameters for the call.
- If the newly joined MCVideo user wishes to transmit media to the affiliated users of the group using the chat model, then the MCVideo client using its associated transmission control participant would follow a normal transmission control procedure for transmitting the media.
- Subsequent group call media transmissions are controlled using transmission control signalling.
- The MCVideo server may tear down the media plane between successive group calls using the chat model, or the MCVideo server may allow the media plane to remain up between successive group calls using the chat model depending on resources.

#### 7.1.2.3.1.2.2 Chat group call setup

MCVideo client 1, client 2, and client 3 are served by the home MCVideo service provider in figure 7.1.2.3.1.2.2-1.

Pre-conditions:

1. The MCVideo server may use the group call join request to generate an implicit affiliation (using the affiliation procedure for MCVideo) on behalf of the client that sends the MCVideo group call join request.
2. MCVideo user 2 and MCVideo user 3 have previously joined (affiliated) to the group call. MCVideo client 1, client 2, and client 3 are registered and all users (MCVideo user 1, user 2, and user 3) have been authenticated and authorized to use the MCVideo service. No call is currently in progress for the group.

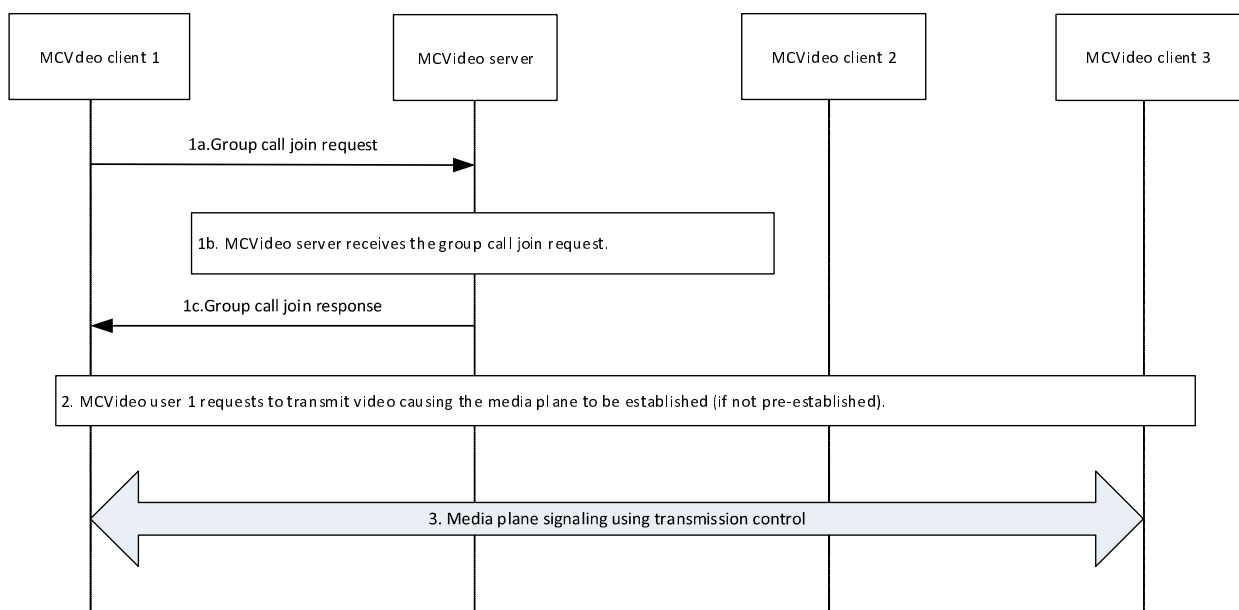

Figure 7.1.2.3.1.2.2-1: MCVideo chat group call

1. MCVideo user 1 indicates to join the group communication for the group. This may include a transmit media request.
  - 1a. MCVideo client 1 sends a group call join request with the MC service group ID of the desired group. It contains the MCVideo user's MCVideo ID and the MCVideo client media parameters. If there is a request for media transmission, then the group call join request contains an indication of the transmit media request.
  - 1b. The MCVideo server receives the group call join request. MCVideo server generates an implicit affiliation (if the MCVideo user is not already affiliated to the group) and verifies that MCVideo user 1 is authorized to affiliate to the group by following the affiliation procedure for MCVideo.
  - 1c. The MCVideo server replies with a group call join response indicating the acceptance of the group call join request and also returns the MCVideo server selected media parameters for the group call in the group call join response.
2. If MCVideo user 1 requests to transmit media by sending transmit media request to MCVideo server, the MCVideo server establishes the media plane (if not already established) for the call.
3. Transmission control will continue to be used by the transmission control participants associated with MCVideo client 1, MCVideo client 2 and MCVideo client 3 for the duration of the call.

#### 7.1.2.3.1.2.3 Release chat group call

The procedure describes the case where the MCVideo server releases an ongoing MCVideo group call for all the participants of that group call, since at least one of the conditions for release are met e.g. due to chat duration expiry, last participant leaving or initiator leaving.

NOTE 1: The procedure for an MCVideo user leaving the group call is a different procedure.

Procedures in figure 7.1.2.3.1.2.3-1 are the procedures for the MCVideo server initiating the release of an ongoing MCVideo group call.

The following precondition applies:

- A group call is ongoing between MCVideo clients 1, 2 and 3

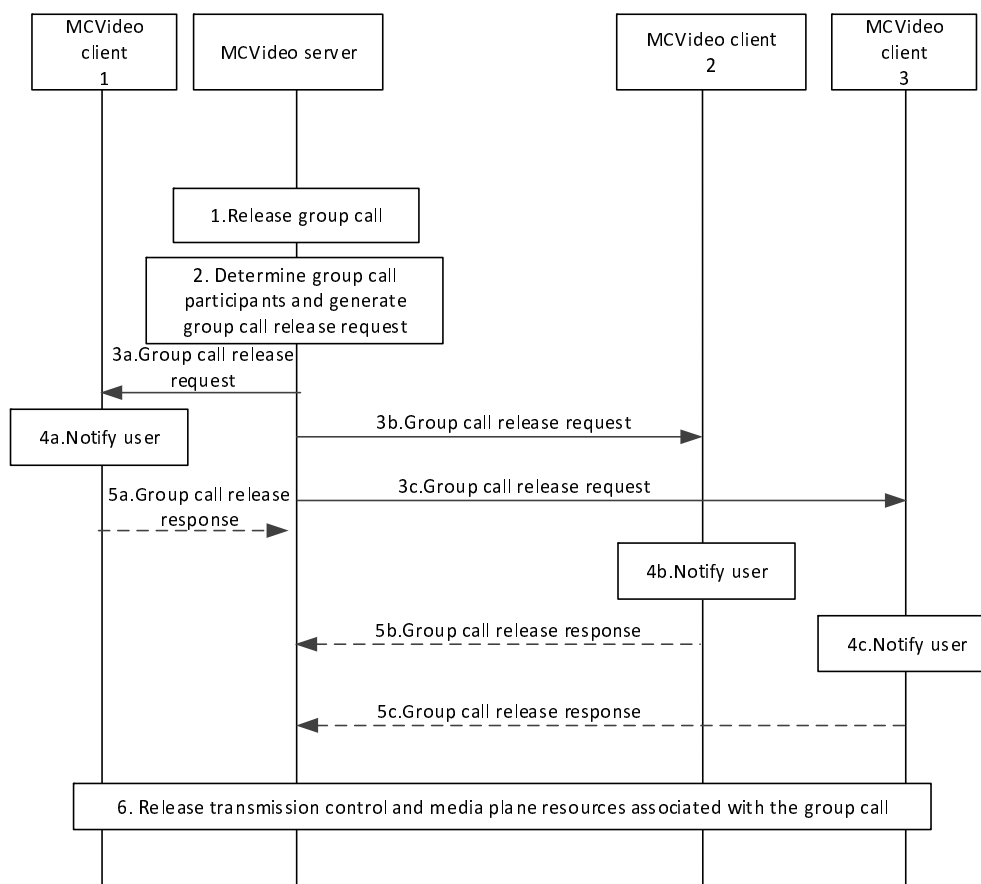

**Figure 7.1.2.3.1.2.3-1: Release chat group call**

1. MCVideo server would like to release the MCVideo group call which is ongoing e.g., due to chat duration expiry, last participant leaving, or initiator leaving.
2. MCVideo server identifies the participants of the ongoing group call and generates group call release request to release the ongoing session.
3. MCVideo server sends a group call release request towards each participant of the ongoing group call.

NOTE 2: The group call release request can also be sent over SIP signalling on the signalling plane.

4. MCVideo users are notified about the release of the group call.
5. Optionally the MCVideo client(s) receiving group call release request, may send a group call release response to the MCVideo server.

NOTE 3: The MCVideo client can send group call release response when the group call release request is sent using a unicast bearer.

6. MCVideo client 1, client 2 and client 3 release the transmission control and media plane resources associated with the group call that is released. Successful release of the group call does not affect the status of affiliation of any of the clients.

#### 7.1.2.3.1.2.4 Rejoin a chat group call

Procedures in figure 7.1.2.3.1.2.4-1 are for the MCVideo server rejoining a MCVideo client coming back from out of coverage to rejoin an ongoing MCVideo group call using chat group call model.

Pre-conditions:

1. MCVideo group is previously defined on the group management server with MCVideo users affiliated to that group. All members of the group belong to the same MC system.
2. MCVideo users using MCVideo client 2 to MCVideo client n are in an ongoing MCVideo chat group call.

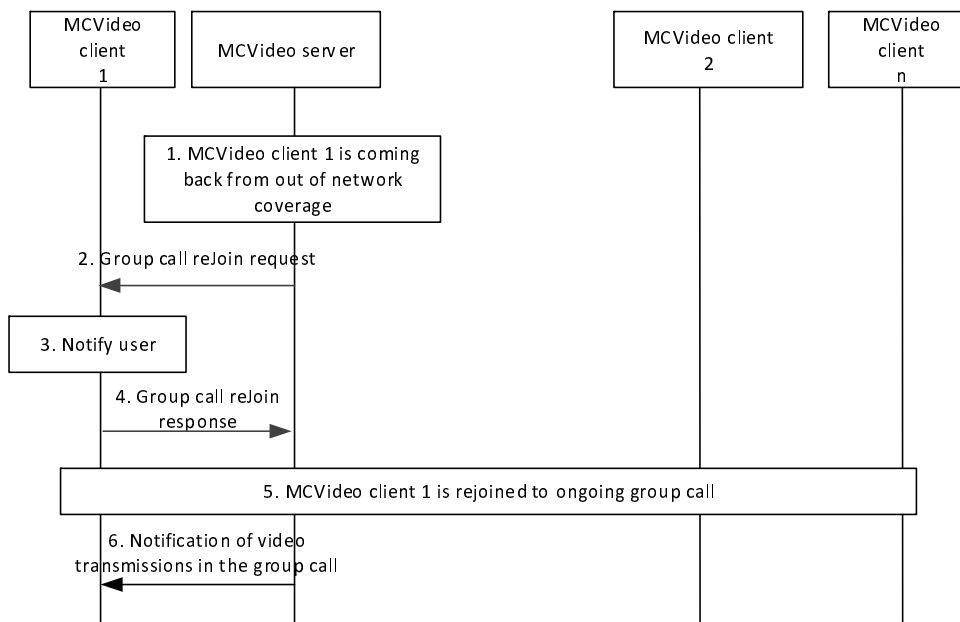

**Figure 7.1.2.3.1.2.4-1: Rejoin an on-going chat group call**

1. MCVideo server determines that MCVideo client 1 requires to rejoin an on-going chat group call which has returned from being out of coverage.
2. MCVideo server sends group call rejoin request to MCVideo client 1.
3. MCVideo user at MCVideo client 1 is notified to rejoin an on-going chat group call.
4. Upon MCVideo client 1 accepting the group call rejoin request, MCVideo client 1 sends a group call rejoin response to the MCVideo server.
5. MCVideo client 1 is successfully rejoined the ongoing group call and MCVideo users at MCVideo client 1 to MCVideo client n may be notified about the MCVideo client 1 joining the group call.
6. Notification with the information of the media transmissions in the group call is sent to MCVideo client 1.

### 7.1.2.3.2 Exiting group call due to de-affiliation

Procedures in figure 7.1.2.3.2-1 are the signalling control plane procedures for the MCVideo server requesting a newly de-affiliated member to leave an ongoing MCVideo group call.

Pre-conditions:

1. MCVideo group is previously defined on the group management server with MCVideo users affiliated to that group. All members of the group belong to the same MC system.
2. MCVideo users on MCVideo client 1 to MCVideo client n are on an ongoing call.
3. MCVideo client 1 has been de-affiliated from the MCVideo group.

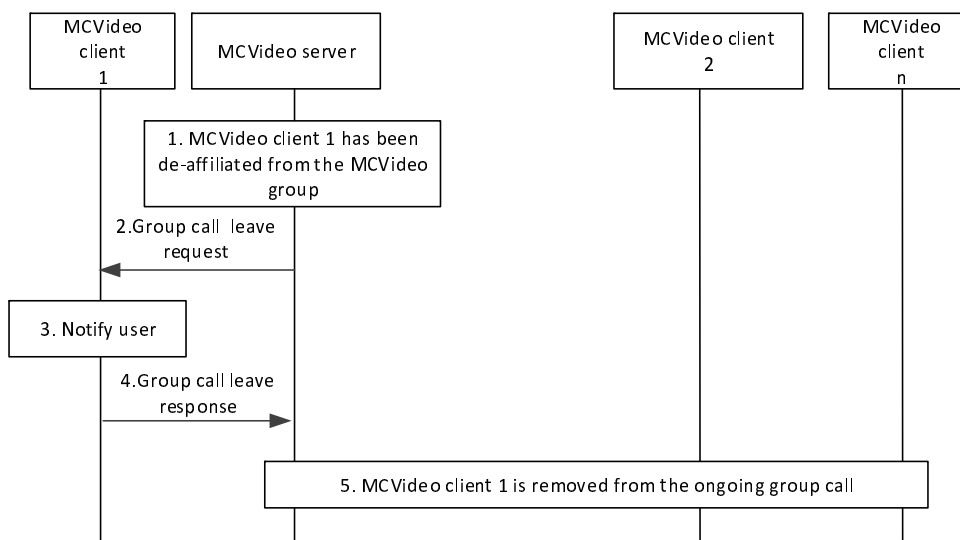

**Figure 7.1.2.3.2-1: Exiting MCVideo group call due to de-affiliation**

1. MCVideo client 1 which has been de-affiliated is instructed to leave the ongoing group call.
2. MCVideo server sends a group call leave request to MCVideo client 1.
3. MCVideo user at MCVideo client 1 is notified about leaving the group call.
4. MCVideo client 1 sends the group call leave response and leaves the group call.
5. MCVideo client 1 is now removed from the ongoing group call and MCVideo users at MCVideo client 2 to MCVideo client n may be notified that MCVideo client 1 has left the group call.

## 7.1.2.4 Broadcast group call

### 7.1.2.4.1 General

A broadcast group call is a special group call where the initiating MCVideo user expects no response from the other MCVideo users, i.e. no response from the recipients is required to start media transmission and the call ends when the media transmission is complete.

### 7.1.2.4.2 Common broadcast group call procedure

Only the call originator can transmit media during the broadcast group call and the broadcast group call is released when the transmission is complete.

Figure 7.1.2.4.2-1 illustrates the common procedure both for group-broadcast group call and user-broadcast group call.

Pre-condition:

1. MCVideo client 1 and MCVideo client 2 are members of a group-broadcast group/user-broadcast group.

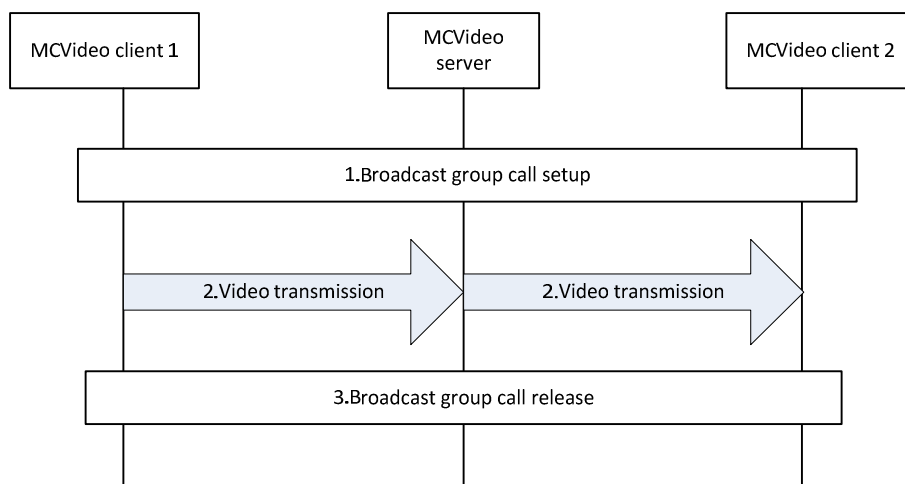

**Figure 7.1.2.4.2-1: Broadcast group call**

1. MCVideo user at MCVideo client 1 initiates the broadcast group call setup procedure with the indication of broadcast group call. The signalling procedure is identical to the group call setup as described in subclause 7.1.2.3.1.1 with the inclusion of the parameter for broadcast group call indicator.
2. MCVideo client 1 starts to transmit media.

NOTE 1: Only the call originating MCVideo user is allowed to transmit media on broadcast group call.

NOTE 2: A broadcast group call transmitted on a user-broadcast group has priority over group calls involving users within the user hierarchy. A broadcast group call transmitted on a group-broadcast group has priority over group calls on its subordinate groups.

3. If the media transmission from call originating MCVideo user is complete, the broadcast group call is released.

## 7.1.2.5 Emergency and imminent peril procedures

### 7.1.2.5.1 MCVideo emergency group call

#### 7.1.2.5.1.1 MCVideo emergency group call commencement

The procedure describes the case where an MCVideo client is initiating an MCVideo emergency group call with the affiliated MCVideo group members of that MCVideo group. An MCVideo client in the MCVideo emergency state gains elevated access privilege for all of the MCVideo user's mission critical applications.

Procedures in figure 7.1.2.5.1.1-1 are the signalling control plane procedures for the MCVideo client initiating establishment of an MCVideo emergency group call with an MCVideo group i.e., MCVideo users on MCVideo client 1, MCVideo client 2 and MCVideo client 3 belong to the same MCVideo group which is defined on group management server.

NOTE 1: For simplicity, a single MCVideo server is shown in place of a user home MCVideo server and a group hosting MCVideo server.

Pre-conditions:

1. The MCVideo group is previously defined on the group management server with MCVideo client 2 and MCVideo client 3 affiliated to that MCVideo group.
2. All members of the MCVideo group belong to the same MC system.
3. The initiating MCVideo client 1 has been provisioned with an MCVideo group that has been designated via provisioning as the MCVideo emergency group.

NOTE 2: Alternatively, the client could have been provisioned for emergency behaviour on the selected group.

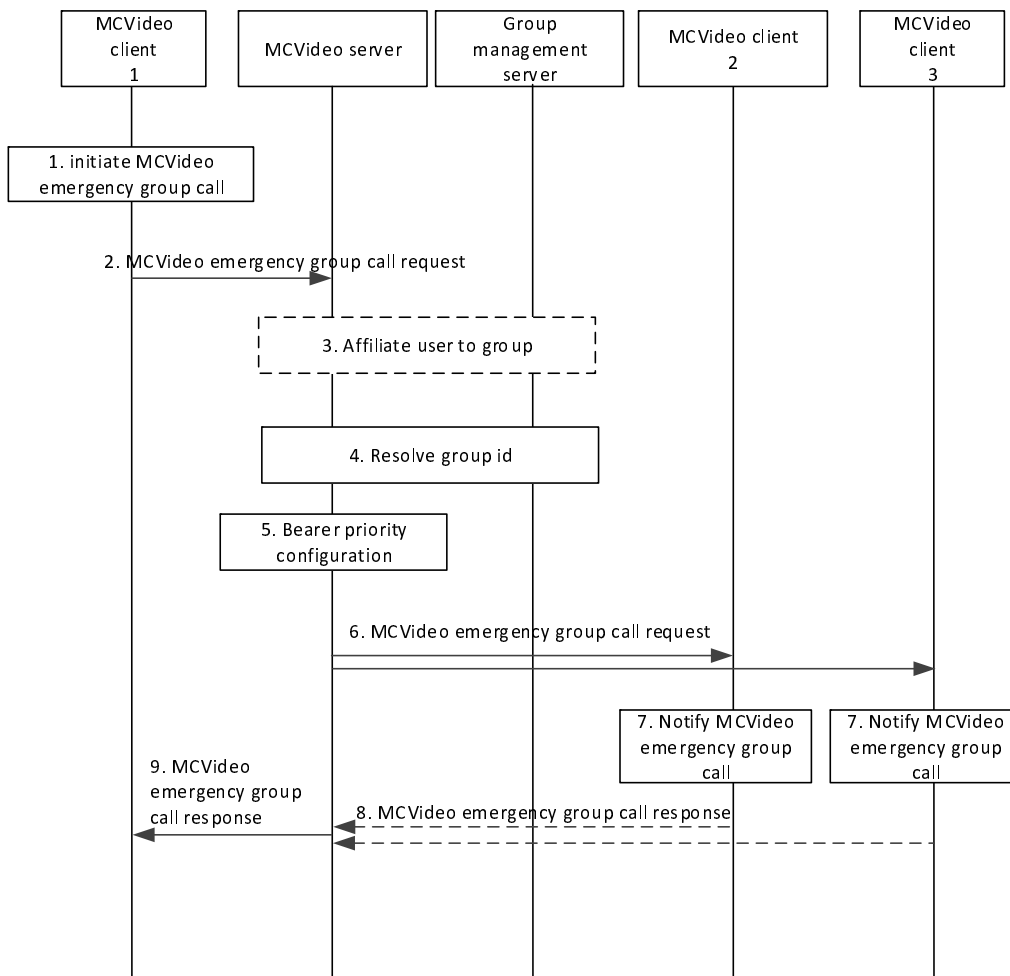

**Figure 7.1.2.5.1.1-1: MCVideo emergency group call**

1. The user at the MCVideo client 1 initiates an MCVideo emergency group call. MCVideo client 1 sets its MCVideo emergency state. The MCVideo emergency state is retained until explicitly cancelled.
2. MCVideo client 1 sends an MCVideo group call request towards the MCVideo server. The request contains an indication of the MCVideo emergency. The MCVideo server records the identity of the MCVideo user that initiated the MCVideo emergency group call until the MCVideo emergency is cancelled. Once an MCVideo emergency call has been initiated, the MCVideo group is considered to be in an in-progress emergency state until cancelled. If configured to send an MCVideo emergency alert when initiating an MCVideo emergency group call, the request also contains an indication that an MCVideo emergency alert is to be initiated. The request may contain an indication of an implicit transmit media request.
3. The MCVideo server implicitly affiliates MCVideo client 1 to the emergency group if the client is not already affiliated.
4. MCVideo server checks whether the MCVideo user of MCVideo client 1 is authorized for initiation of MCVideo emergency calls on the indicated MCVideo group, and if authorized, it resolves the MCVideo group ID to determine the members of that MCVideo group and their affiliation status, based on the information from group management server.
5. The MCVideo server configures the priority of the underlying bearers for all participants in the MCVideo group.

NOTE 3: Successive calls during the MCVideo group's in-progress emergency state will all receive the adjusted bearer priority.

6. MCVideo server sends the MCVideo emergency group call request towards the MCVideo clients of each of those affiliated MCVideo group members. The request contains an indication of the in-progress emergency. The



request contains an indication of an MCVideo emergency alert if the request from the originator indicated MCVideo emergency alert.

7. MCVideo users are notified of the incoming MCVideo group call.
8. The receiving MCVideo clients send the MCVideo emergency group call response to the MCVideo server to acknowledge the MCVideo emergency group call request. For a multicast call, these acknowledgements are not sent.
9. The MCVideo server sends the MCVideo emergency group call response to the MCVideo user 1 to inform the successful MCVideo emergency call establishment.

NOTE 4: Step 9 can occur at any time following step 5, and prior to step 10 depending on the conditions to proceed with the call.

MCVideo client 1, MCVideo client 2 and MCVideo client 3 have successfully established media plane for communication. MCVideo transmission control participant 1, transmission control participant 2 and transmission control participant 3 exchange transmission control information e.g., MCVideo client 1 receives the transmit media granted information over the established media plane, while the other MCVideo clients receive media available notification with forced reception information. MCVideo client 1 indicates to the MCVideo user that the permission is granted to transmit media, while the other MCVideo clients in the MCVideo emergency group call will be receiving that media. MCVideo client 1 can override other clients in the call except those that are also in the MCVideo emergency state.

#### 7.1.2.5.1.2 MCVideo group call upgraded to an MCVideo emergency group call

The procedure describes the case where an authorized MCVideo user is upgrading an MCVideo group call to an MCVideo emergency group call while the MCVideo group call is already in progress.

Procedures in figure 7.1.2.5.1.2-1 are the signalling control plane procedures for the MCVideo client upgrading an MCVideo group call on an MCVideo group to an MCVideo emergency group call.

NOTE 1: For simplicity, a single MCVideo server is shown in place of a user home MCVideo server and a group hosting MCVideo server.

Pre-conditions:

1. The MCVideo group is previously defined on the group management server with MCVideo client 2 and MCVideo client 3 affiliated to that MCVideo group.
2. All members of the MCVideo group belong to the same MC system.
3. An MCVideo group call is already in progress.
4. The initiating MCVideo client 1 has been configured to send an MCVideo emergency alert when upgrading an MCVideo emergency group call.

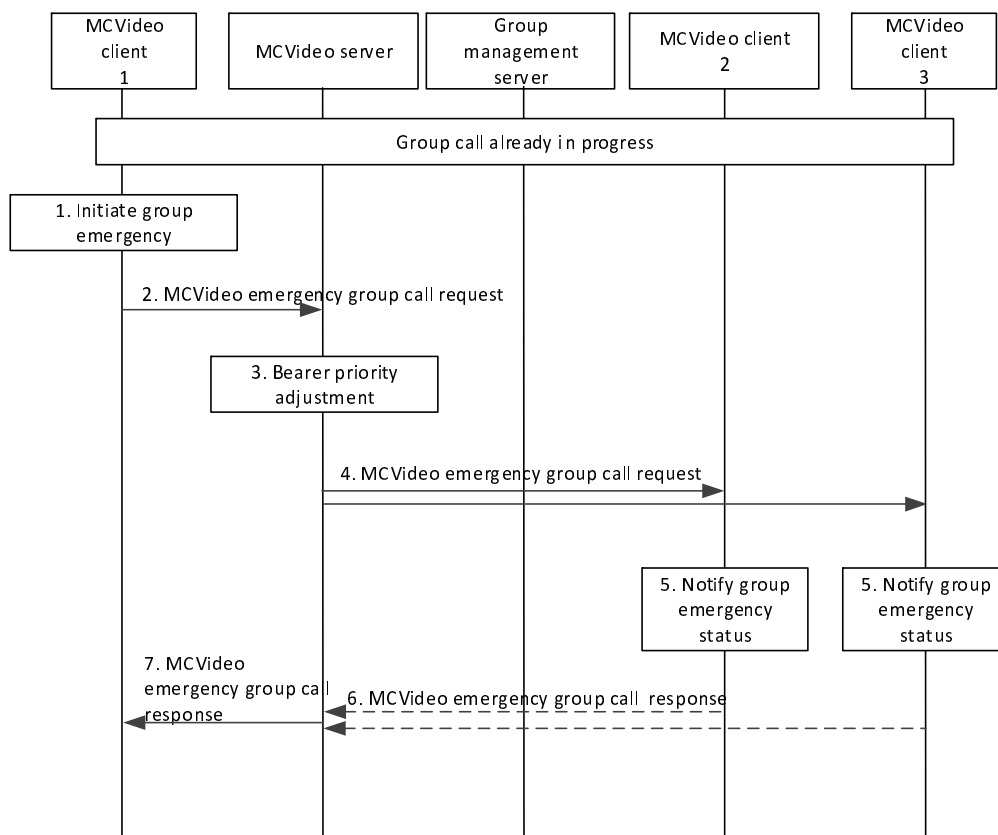

**Figure 7.1.2.5.1.2-1: MCVideo group call upgraded to an MCVideo emergency group call**

1. The MCVideo user at MCVideo client 1 initiates a group emergency. MCVideo client 1 sets its MCVideo emergency state. The MCVideo emergency state is retained until explicitly cancelled.
2. MCVideo client 1 requests the MCVideo server to upgrade the MCVideo group to an in-progress emergency state by sending an MCVideo emergency group call request. If configured to send an MCVideo alert when initiating an MCVideo emergency upgrade, the request also contains an indication that an MCVideo alert is to be initiated. The request may contain an indication of an implicit transmit media request.
3. The MCVideo server adjusts the priority of the underlying bearer for all participants in the MCVideo group.
4. MCVideo server sends the MCVideo emergency group call request towards the MCVideo clients of each of those affiliated MCVideo group members. The request contains an indication of an MCVideo emergency alert if the request from the originator indicated MCVideo emergency alert.
5. MCVideo users are notified of the in-progress emergency state of the MCVideo group.
6. The receiving MCVideo clients send the MCVideo emergency group call response to the MCVideo server to acknowledge the MCVideo group emergency request. For a multicast call, these acknowledgements are not sent.
7. The MCVideo server sends the MCVideo emergency group call response to the MCVideo user 1 to confirm the upgrade request. If the MCVideo emergency request contained an implicit transmit media request, the OK message contains the result of the implicit transmit media request.

NOTE 2: Step 7 can occur at any time following step 3, and prior to step 8 depending on the conditions to proceed with the call.

MCVideo client 1, MCVideo client 2 and MCVideo client 3 continue with the MCVideo group call, which has been transformed into an MCVideo emergency group call. MCVideo client 1 can override other clients in the call except those that are also in the MCVideo emergency state.

#### 7.1.2.5.1.3 MCVideo emergency group call cancel

The procedure describes the case where an MCVideo client cancels an MCVideo group's in-progress emergency.

Procedures in figure 7.1.2.5.1.3-1 are the signalling control plane procedures for the MCVideo client cancelling an in-progress emergency.

NOTE 1: For simplicity, a single MCVideo server is shown in place of a user home MCVideo server and a group hosting MCVideo server.

NOTE 2: The end of the MCVideo emergency group call does not cancel the MCVideo group's in-progress emergency state. It is explicitly cancelled by an authorized user.

Pre-conditions:

1. The MCVideo group is previously defined on the group management server with MCVideo client 2 and MCVideo client 3 affiliated to that MCVideo group.
2. All members of the MCVideo group belong to the same MC system.
3. MCVideo group members have been notified about the in-progress emergency.
4. The MCVideo group is in the in-progress emergency state and has prioritized bearer support.
5. MCVideo client 1 previously initiated the in-progress emergency.

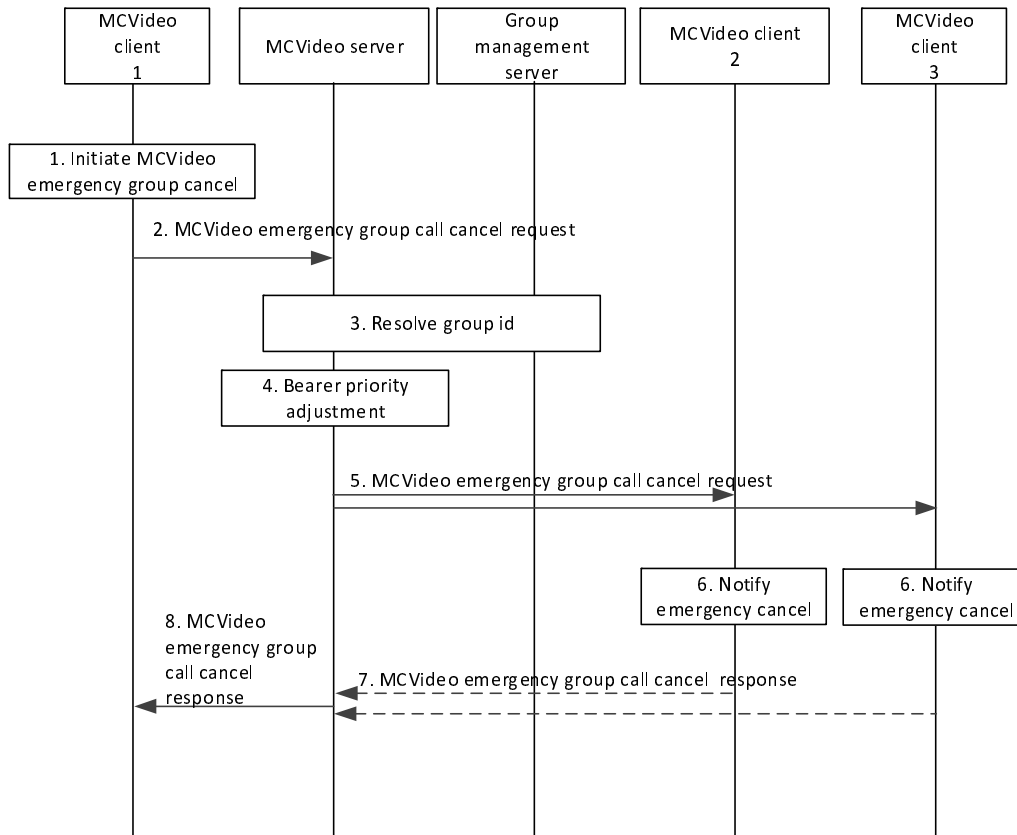

**Figure 7.1.2.5.1.3-1: MCVideo emergency group cancel**

1. The user at the MCVideo client 1 initiates an MCVideo emergency group cancel.

NOTE 3: An MCVideo user authorized to cancel in-progress emergencies on the MCVideo group can also be authorised to cancel the MCVideo emergency alert in addition to the initiator. However, only the initiator can cancel the initiator's local MCVideo emergency state.

2. MCVideo client 1 sends an MCVideo emergency group call cancel request to the MCVideo server.

NOTE 4: When MCVideo emergency alerts are in effect together with an MCVideo emergency group condition on the same MCVideo group, the MCVideo emergency alert can, under some circumstances be cancelled at the same time. In that case, the MCVideo emergency group cancel request carries an indication that the alert is also being cancelled.

3. MCVideo server resolves the MCVideo group ID to determine the members of that MCVideo group and their affiliation status, based upon the information from group management server.

4. The MCVideo server adjusts the priority of the underlying bearer; priority treatment is no longer required. The MCVideo server cancels/resets the emergency in-progress state of the MCVideo group.

5. The MCVideo server sends an MCVideo emergency group call cancel request to the MCVideo group members.

6. MCVideo group members are notified of the MCVideo emergency cancel.

7. The receiving MCVideo clients send the MCVideo emergency group call cancel response to the MCVideo server to acknowledge the MCVideo emergency cancel. For a multicast call scenario, these acknowledgements are not sent.

8. The MCVideo server sends the MCVideo emergency group call cancel response to the MCVideo user 1 to confirm the MCVideo emergency group cancel. MCVideo client 1 resets its local emergency status since it is the one requesting the MCVideo emergency group cancel.

NOTE 5: Step 8 can occur at any time following step 4, depending on the conditions to proceed with the call.

#### 7.1.2.5.2 MCVideo imminent peril group call

##### 7.1.2.5.2.1 MCVideo imminent peril group call commencement

The procedure focuses on the case where an authorized MCVideo user is initiating an imminent peril group call for communicating with the affiliated MCVideo members of that MCVideo group. This procedure will gain elevated access privilege for the MCVideo client if it is not already in that state. The access privilege for other applications will not necessarily be affected.

Procedures in figure 7.1.2.5.2.1-1 are the signalling control plane procedures for the MCVideo client initiating establishment of an imminent peril group call with an MCVideo group i.e., MCVideo users on MCVideo client 1, MCVideo client 2 and MCVideo client 3 belong to the same MCVideo group which is defined on MCVideo group management server.

Pre-conditions:

1. The MCVideo group is previously defined on the group management server with MCVideo client 2 and MCVideo client 3 affiliated to that MCVideo group.
2. All members of the MCVideo group belong to the same MC system.
3. The initiating MCVideo client 1 has been provisioned with an MCVideo group that has been designated in the provisioning to be used for imminent peril communications.

NOTE 1: Alternatively, the client could have been provisioned for imminent peril behaviour on the selected group.

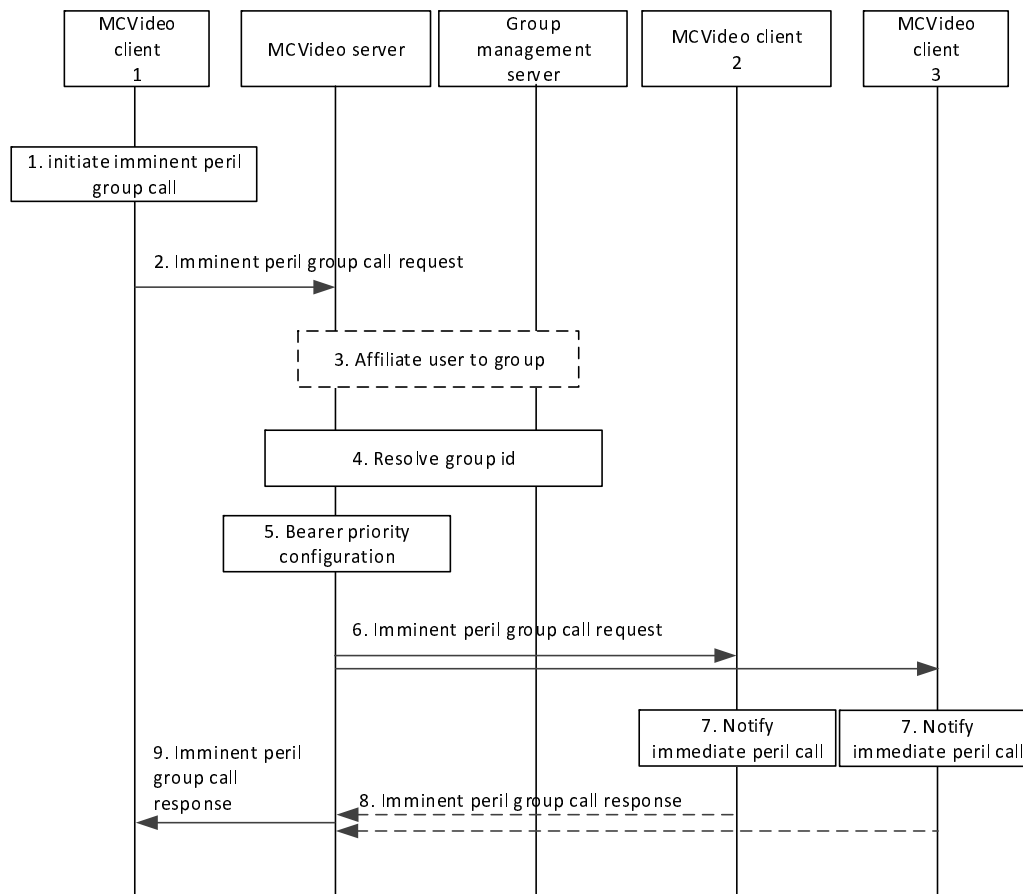

**Figure 7.1.2.5.2.1-1: MCVideo imminent peril group call**

1. The user at the MCVideo client 1 initiates an imminent peril group call.
  2. MCVideo client 1 sends an MCVideo imminent peril group call request towards the MCVideo server. The request contains an indication of the in-progress imminent peril. The MCVideo server records the identity of the MCVideo user that initiated the imminent peril group call until the in-progress imminent peril state is cancelled. Once an imminent peril group call has been initiated, the MCVideo group is considered to be in an in-progress imminent peril state until cancelled. The request may contain an indication of an implicit transmit media request.
  3. The MCVideo server implicitly affiliates MCVideo client 1 to the imminent peril group if the client is not already affiliated.
  4. MCVideo server checks whether the MCVideo user of MCVideo client 1 is authorized for initiation of imminent peril group calls on the indicated MCVideo group, and if authorized, it resolves the MCVideo group ID to determine the members of that MCVideo group and their affiliation status, based on the information from group management server.
  5. The MCVideo server configures the priority of the underlying bearers for all participants in the MCVideo group.
- NOTE 2: Successive calls during the in-progress imminent peril state will all receive the adjusted bearer priority.
6. MCVideo server sends the imminent peril group call request towards the MCVideo clients of each of those affiliated MCVideo group members. The request contains an indication of the in-progress imminent peril.
  7. MCVideo users are notified of the incoming imminent peril call.

8. The receiving MCVideo clients send the MCVideo imminent peril group call response to the MCVideo server to acknowledge the imminent peril call request. For a multicast call, these acknowledgements are not set.
9. The MCVideo server sends the MCVideo imminent peril group call response to the MCVideo user 1 to inform the successful imminent peril call establishment. If the MCVideo imminent peril request contained an implicit transmit media request, the OK message contains the result of the implicit transmit media request.

NOTE 3: Step 9 can occur at any time following step 5, and prior to step 10 depending on the conditions to proceed with the imminent peril call.

MCVideo client 1, MCVideo client 2 and MCVideo client 3 have successfully established media plane for communication. MCVideo transmission control participant 1, transmission control participant 2 and transmission control participant 3 exchange transmission control information e.g., MCVideo client 1 receives the transmit media granted information over the established media plane, while the other MCVideo clients receive media available notification with forced reception mode information. MCVideo client 1 indicates to the MCVideo user that the permission is granted to transmit media, while the other MCVideo clients in the imminent peril call will be receiving that media.

#### 7.1.2.5.2.2 Imminent peril group call upgrade

The procedure focuses on the case where an authorized MCVideo user is upgrading an MCVideo group call to an imminent peril group call while the MCVideo group call is already in progress.

Procedures in figure 7.1.2.5.2.2-1 are the signalling control plane procedures for the MCVideo client upgrading an MCVideo group call on an MCVideo group to an imminent peril group call.

Pre-conditions:

1. The MCVideo group is previously defined on the group management server with MCVideo client 1, MCVideo client 2 and MCVideo client 3 affiliated to that MCVideo group.
2. All members of the MCVideo group belong to the same MC system.
3. An MCVideo group call is already in progress.

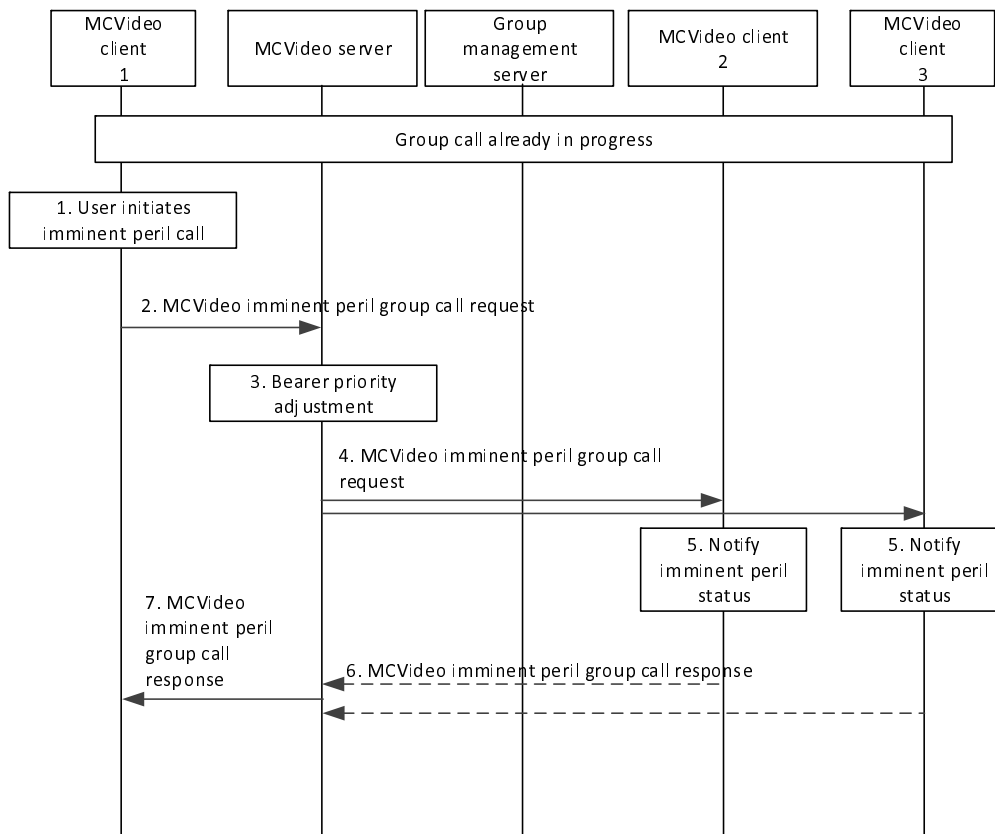

**Figure 7.1.2.5.2.2-1: MCVideo group call upgrade to an imminent peril group call**

1. The MCVideo user at MCVideo client 1 initiates an imminent peril call.
2. MCVideo client 1 requests the MCVideo server to upgrade the MCVideo group to an in-progress imminent peril state by sending an MCVideo imminent peril group call request. The request may contain an indication of an implicit transmit media request.
3. The MCVideo server adjusts the priority of the underlying bearer for all participants in the MCVideo group.
4. MCVideo server sends the MCVideo imminent peril group call request towards the MCVideo clients of each of those affiliated MCVideo group members.
5. MCVideo users are notified of the in-progress imminent peril state of the MCVideo group.
6. The receiving MCVideo clients send the MCVideo imminent peril group call response to the MCVideo server to acknowledge the MCVideo imminent peril group call request. For a multicast call, these acknowledgements are not set.
7. The MCVideo server sends the MCVideo imminent peril group call response to the MCVideo user 1 to confirm the upgrade request. If the MCVideo imminent peril group call request contained an implicit transmit media request, the OK message contains the result of the implicit transmit media request.

NOTE: Step 7 can occur at any time following step 4, and prior to step 8 depending on the conditions to proceed with the call.

MCVideo client 1, MCVideo client 2 and MCVideo client 3 continue with the MCVideo group call, which has been transformed into an imminent peril group call.



7.1.2.5.2.3 MCVideo imminent peril group call cancel

The procedure focuses on the case where an authorized MCVideo user cancels an MCVideo group's in-progress imminent peril state.

Procedures in figure 7.1.2.5.2.3-1 are the signalling control plane procedures for the MCVideo client cancelling an MCVideo group's in-progress imminent peril state.

NOTE 1: The end of the imminent peril call does not cancel the MCVideo group's in-progress imminent peril state. It is explicitly cancelled by an authorized user.

Pre-conditions:

1. The MCVideo group is previously defined on the group management server with MCVideo client 1, MCVideo client 2 and MCVideo client 3 affiliated to that MCVideo group.
2. All members of the MCVideo group belong to the same MC system.
3. The MCVideo group is an in-progress imminent peril state and has prioritized bearer support.
4. MCVideo group members have been notified about the MCVideo group's in-progress imminent peril state.
5. MCVideo client 1 previously initiated the in-progress imminent peril.

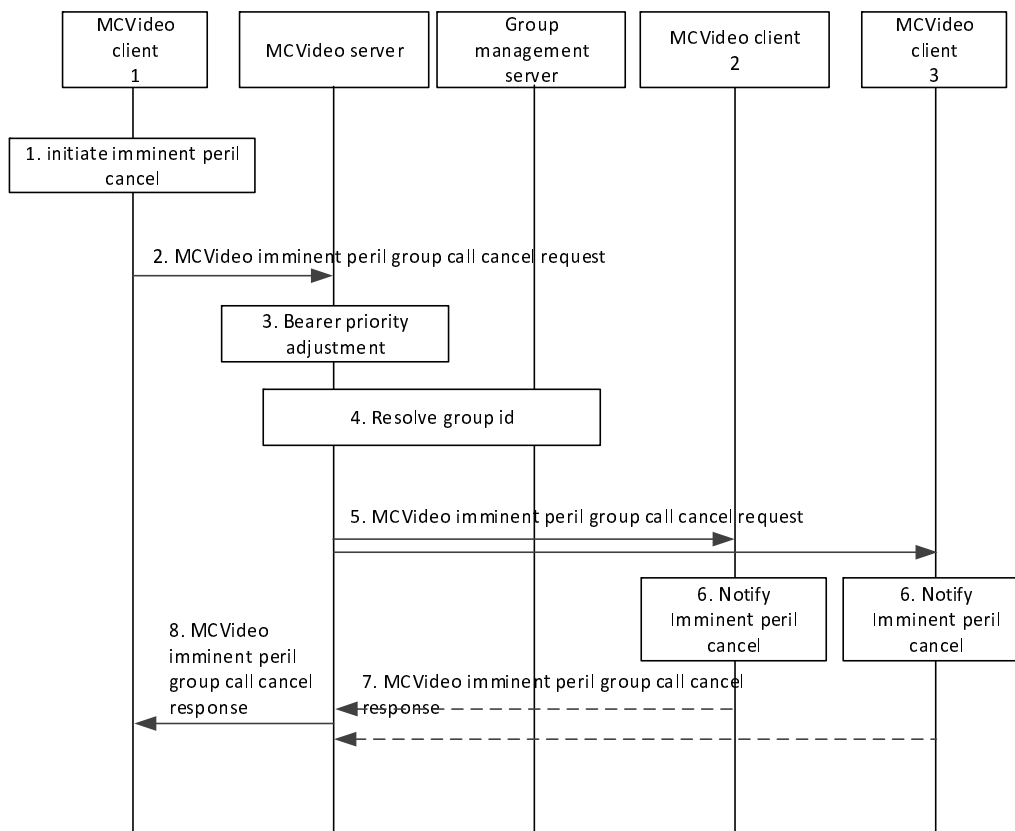

Figure 7.1.2.5.2.3-1: MCVideo imminent peril group call cancel

1. The user at the MCVideo client 1 initiates an imminent peril cancel.
2. MCVideo client 1 sends an MCVideo imminent peril group call cancel request to the MCVideo server.

3. The MCVideo server adjusts the priority of the underlying bearer; priority treatment is no longer required. The MCVideo server cancels/resets the in-progress imminent peril state.
4. MCVideo server resolves the MCVideo group ID to determine the members of that MCVideo group and their affiliation status, based upon the information from group management server.
5. The MCVideo server sends an MCVideo imminent peril group call cancel request to the MCVideo group members.
6. MCVideo group members are notified of the in-progress imminent peril cancel.
7. The receiving MCVideo group members send the MCVideo imminent peril group call cancel response to the MCVideo server to acknowledge the in-progress MCVideo imminent peril group call cancel request. For a multicast scenario, these acknowledgements are not set.
8. The MCVideo server sends the MCVideo imminent peril group call cancel response to the MCVideo user 1 to confirm the MCVideo imminent peril group call cancel request.

NOTE 2: Step 8 can occur at any time following step 4, depending on the conditions to proceed with the call.

## 7.1.2.6 MCVideo emergency alert

### 7.1.2.6.1 General

The MCVideo server and MCVideo client use emergency alert initiation and emergency state cancel procedures defined in 3GPP TS 23.280 [6] using MCVideo-1 reference point, with the following clarifications:

- The MC service ID is the MCVideo ID; and
- The MC service group ID is the MCVideo group ID.

## 7.1.3 Off-network group communications

### 7.1.3.1 General

This subclause contains procedures for group communications directly between multiple MCVideo clients without involving the network to provide associated functions.

The group communication setup is described in subclause 7.1.3.3 and two variations of joining an existing communication group communication are described, the passive variant in subclause 7.1.3.4 and the active variant in subclause 7.1.3.5.

NOTE: When the MCVideo client receives a message that is not addressed to either its MCVideo ID or to any MCVideo group of which the MCVideo client is an affiliated group member, the MCVideo client ignores the message.

### 7.1.3.2 Information flows for off-network group communications

#### 7.1.3.2.1 Group communication announcement

Table 7.1.3.2.1-1 describes the information flow for the group communication announcement sent from the MCVideo client to other MCVideo clients.

**Table 7.1.3.2.1-1: Group communication announcement**

Information Element	Status	Description
MCVideo ID	M	The identity of the MCVideo user sending the announcement
MCVideo group ID	M	The MCVideo group ID towards which the announcement was sent
Media codec	M	The media characteristics like codec, resolution, frame rate and video mode to be used for the communication
Multi-cast port	M	Multicast port number for media
Transmission control port number	M	Port number for transmission control protocol
Announcement period	M	Period of the group communication announcement
Encryption parameters	O	Encryption parameters to be used for the communication, if the communication is to be encrypted
Confirm mode indication	O	Indicates whether the receiving MCVideo user needs to confirm participation
Emergency indication	O	Indicates that the MCVideo group communication is an MCVideo emergency communication
Imminent peril indication	O	Indicates that the MCVideo group communication is an MCVideo imminent peril communication
Broadcast communication indication	O	Indicates that the MCVideo communication is a broadcast communication
Video push indication	O	Indicates that the MCVideo communication is for video push
Video pull indication	O	Indicates that the MCVideo communication is for video pull

### 7.1.3.2.2 Group communication answer response

Table 7.1.3.2.2-1 describes the information flow for the group communication answer response sent from the MCVideo client to other MCVideo clients.

**Table 7.1.3.2.2-1: Group communication answer response**

Information Element	Status	Description
MCVideo ID	M	The identity of the MCVideo user sending the response
MCVideo group ID	M	The identity of the MCVideo group on which the call is requested

### 7.1.3.2.3 MCVideo upgrade to emergency group communication

Table 7.1.3.2.3-1 describes the information flow for the MCVideo upgrade to emergency sent from the MCVideo client to other MCVideo clients.

**Table 7.1.3.2.3-1: MCVideo upgrade to emergency group communication**

Information Element	Status	Description
MCVideo ID	M	The identity of the MCVideo user upgrading the communication
MCVideo group ID	M	The MCVideo group ID towards which the upgrade was sent

#### 7.1.3.2.4 MCVideo emergency group communication cancel

Table 7.1.3.2.4-1 describes the information flow for the MCVideo emergency group communication cancel sent from the MCVideo client to other MCVideo clients.

**Table 7.1.3.2.4-1: MCVideo emergency group communication cancel**

Information Element	Status	Description
MCVideo ID	M	The identity of the MCVideo user cancelling the upgrade
MCVideo group ID	M	The MCVideo group ID towards which the cancel was sent

#### 7.1.3.2.5 MCVideo upgrade to imminent peril group communication

Table 7.1.3.2.5-1 describes the information flow for the MCVideo upgrade to imminent peril sent from the MCVideo client to other MCVideo clients.

**Table 7.1.3.2.5-1: MCVideo upgrade to imminent peril group communication**

Information Element	Status	Description
MCVideo ID	M	The identity of the MCVideo user upgrading the communication
MCVideo group ID	M	The MCVideo group ID towards which the upgrade was sent

#### 7.1.3.2.6 MCVideo imminent peril group communication cancel

Table 7.1.3.2.6-1 describes the information flow for MCVideo imminent peril group communication cancel sent from the MCVideo client to other MCVideo clients.

**Table 7.1.3.2.6-1: MCVideo imminent peril group communication cancel**

Information Element	Status	Description
MCVideo ID	M	The identity of the MCVideo user cancelling the upgrade
MCVideo group ID	M	The MCVideo group ID towards which the cancel was sent

#### 7.1.3.2.7 MCVideo emergency alert announcement

Table 7.1.3.2.7-1 describes the information flow for the MCVideo emergency alert announcement sent from the MCVideo client to the other MCVideo clients, for the procedures defined in 3GPP TS 23.280 [6].

**Table 7.1.3.2.7-1: MCVideo emergency alert announcement**

Information Element	Status	Description
MCVideo ID	M	The identity of the MCVideo user sending emergency alert
MCVideo group ID	M	The MCVideo group ID towards which the alert was sent
Organization name	M	The alerting user's mission critical organization name
Location	O	The alerting client's location, if known

### 7.1.3.2.8 MCVideo emergency alert cancel announcement

Table 7.1.3.2.8-1 describes the information flow for the MCVideo emergency alert cancel sent from the MCVideo client to other MCVideo clients, for the procedures defined in 3GPP TS 23.280 [6].

**Table 7.1.3.2.8-1: MCVideo emergency alert cancel announcement**

Information Element	Status	Description
MCVideo ID	M	The identity of the MCVideo user cancelling emergency alert
MCVideo group ID	M	The MCVideo group ID towards which the cancel was sent

## 7.1.3.3 Group communication setup

### 7.1.3.3.1 General

A group communication setup is initiated by one member of a pre-configured MCVideo group and ends up with an established MCVideo group between multiple MCVideo clients ready for video sharing.

### 7.1.3.3.2 Procedure

Figure 7.1.3.3.2-1 describes procedures to establish a MCVideo group communication with other MCVideo clients.

Once the MCVideo group communication is established the MCVideo clients send Group communication announcement periodically.

Pre-conditions:

1. Information for ProSe direct communications corresponding to the MCVideo group and its mapping to ProSe Layer-2 Group ID are pre-configured in MCVideo client 1 to client N.
2. MCVideo client 1 to MCVideo client N are members of the same MCVideo group.
3. MCVideo user 1 has initiated MCVideo group communication.

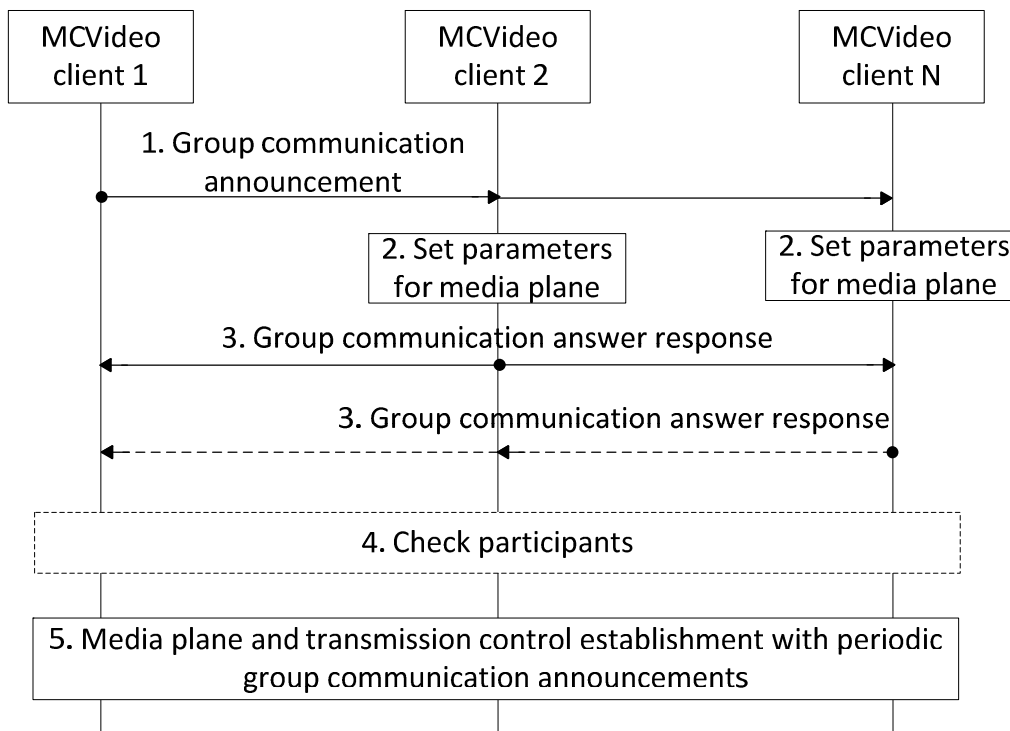

**Figure 7.1.3.3.2-1: MCVidEo group communication setup**

1. MCVidEo client 1 sends a Group communication announcement message to the MCVidEo group.
2. Upon receiving the Group communication announcement message, all MCVidEo clients that are not part of an ongoing group communication for the MCVidEo group indicated in the Group communication announcement message set parameters for the media plane as described in the Group communication announcement message.
3. The MCVidEo clients send a group communication answer response to the MCVidEo group confirming the participation in the MCVidEo group communication. On receiving a group communication answer response message from at least one MCVidEo client, other MCVidEo clients need not send a group communication answer response message. If the Group communication announcement message included a confirm mode indication, then the MCVidEo clients should send a group communication answer response message.

NOTE 1: MCVidEo client 1 should wait for at least one group communication answer response message before transmitting video to the MCVidEo group.

4. MCVidEo client 1 checks the participants of the MCVidEo group communication through the received group communication answer response messages.

NOTE 2: Due to the movement of the participants (in and out of the radio coverage) during the off-network group communication, the Group communication announcement message, including parameters for media delivery, is periodically sent.

NOTE 3: Group communication announcement may include user ID, group ID, media type codec, control port for transmission video, video resolution and video frame rate, video mode, last change time of video mode etc.

5. MCVidEo client 1, MCVidEo client 2 and MCVidEo client 3 have successfully established the media plane and transmission control for communication.

### 7.1.3.4 Passive join to group communication

#### 7.1.3.4.1 General

There is ongoing group communication between multiple MCVideo clients. Another MCVideo client, after becoming aware of that group communication and after it has received periodically sent communication parameters, joins the group with or without sending an indication to other group members.

#### 7.1.3.4.2 Procedure

Figure 7.1.3.4.2-1 describes procedures to join a MCVideo group communication passively.

The MCVideo client X passively waits for a Group communication announcement message. Upon receiving a periodic Group communication announcement message, MCVideo client X establishes media plane and joins the MCVideo group communication.

Pre-conditions:

1. Information for ProSe direct communications corresponding to the MCVideo group and its mapping to ProSe Layer-2 Group ID are pre-configured in MCVideo client 1 to client N and client X.
2. MCVideo client 1 to MCVideo client N and MCVideo client X are members of the same MCVideo group.
3. MCVideo client 1 to MCVideo client N are part of an ongoing MCVideo group communication.

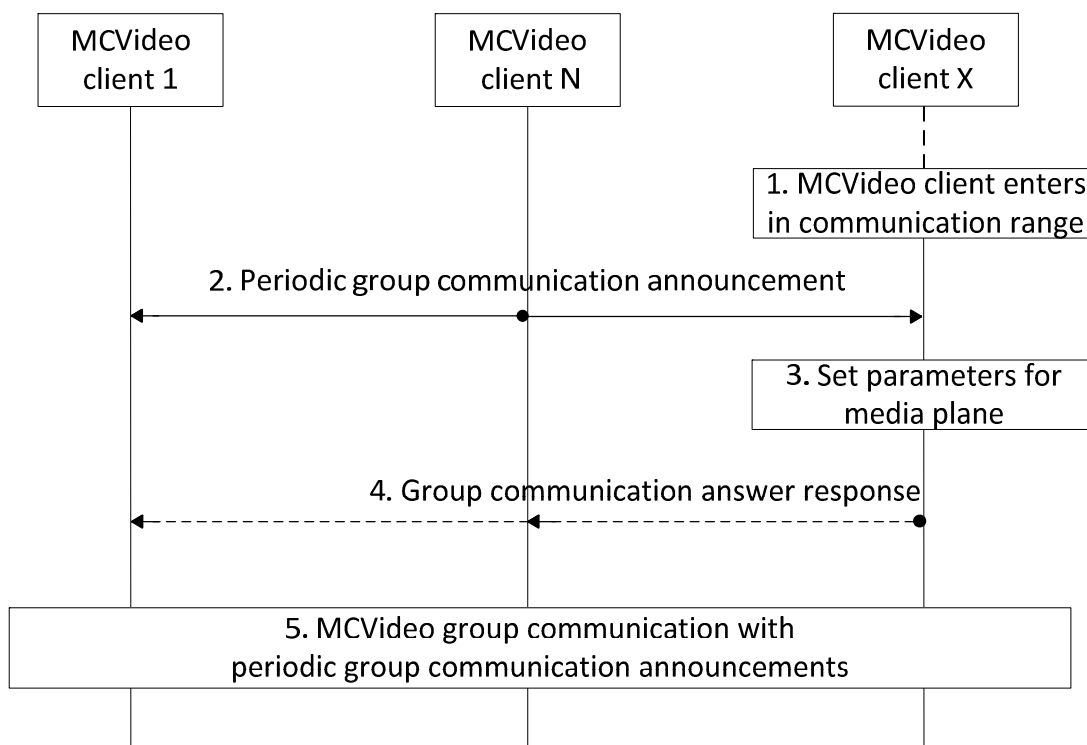

**Figure 7.1.3.4.2-1: Passive join to MCVideo group communication**

1. Another MCVideo client X enters in the communication range after the MCVideo group communication establishment. The MCVideo client X does not do anything and passively waits for a periodic Group communication announcement message.
2. An MCVideo client which is part of the ongoing MCVideo group communication eventually sends a periodic Group communication announcement message.

3. Upon receiving the periodic Group communication announcement message MCVideo client X sets the parameters for media plane as described in the Group communication announcement message.
4. If the Group communication announcement message included a confirm mode indication, MCVideo client X may send a group communication answer response towards MCVideo group to inform all MCVideo group members of its participation in the MCVideo group communication.
5. MCVideo group communication continues with the MCVideo client X.

### 7.1.3.5 Active join to group communication

#### 7.1.3.5.1 General

There is ongoing group communication between multiple MCVideo clients. Another MCVideo client, after becoming aware of that group communication, sends a request to get the required communication parameters and after feedback joins the group with or without sending an indication to other group members.

#### 7.1.3.5.2 Procedure

Figure 7.1.3.5.2-1 describes procedures to join a MCVideo group communication actively.

The MCVideo client X sends a Group communication announcement message towards the MCVideo group.

Upon receiving a Group communication announcement message with new communication parameters, such as communication identifier, a MCVideo client participating in the on-going group communication for the MCVideo group sends a Group communication announcement message.

The Group communication announcement message contains parameters for the on-going MCVideo group communication. MCVideo client X upon receiving such a Group communication announcement message establishes the media plane as described in the message and joins the MCVideo group communication.

Pre-conditions:

1. Information for ProSe direct communications corresponding to the MCVideo group and its mapping to ProSe Layer-2 Group ID are pre-configured in MCVideo client 1 to client N and client X.
2. MCVideo client 1 to MCVideo client N and MCVideo client X are members of the same MCVideo group.
3. MCVideo client 1 to MCVideo client N are part of an ongoing MCVideo group communication.



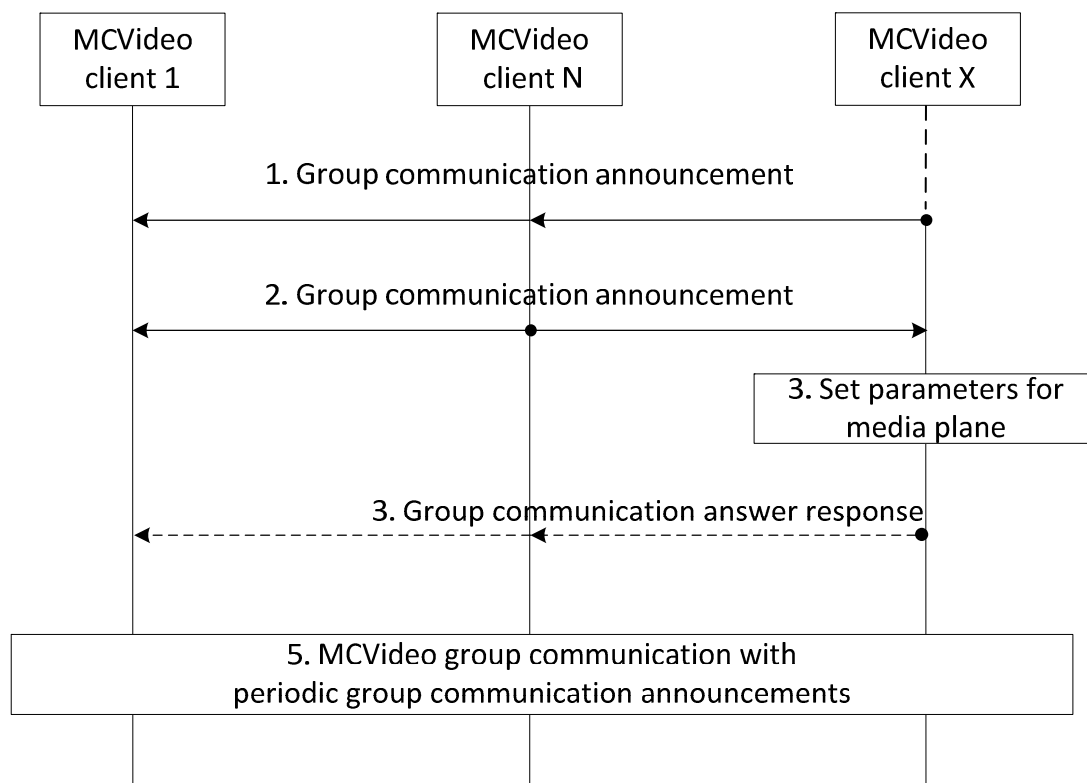

**Figure 7.1.3.5.2-1: Active join to MCVideo group communication**

1. Another MCVideo client X enters in the communication range after the MCVideo group communication establishment. The MCVideo client X sends a Group communication announcement message to start a new MCVideo group communication.
2. Upon receiving a Group communication announcement message with new communication parameters, such as communication identifier, another MCVideo client, which is part of the ongoing MCVideo group communication sends a Group communication announcement message.
3. Upon receiving the Group communication announcement message MCVideo client X sets parameters for the media plane as described in the Group communication announcement message.
4. If the Group communication announcement message included a confirm mode indication, MCVideo client X may send a group communication answer response towards MCVideo group to inform all MCVideo group members of its participation the MCVideo group communication.
5. MCVideo group communication continues with the MCVideo client X.

### 7.1.3.6 Broadcast group communication

Figure 7.1.3.6-1 describes procedures for broadcast group communication.

Broadcast group communication over group-broadcast group and over user-broadcast group are handled without distinction in off-network.

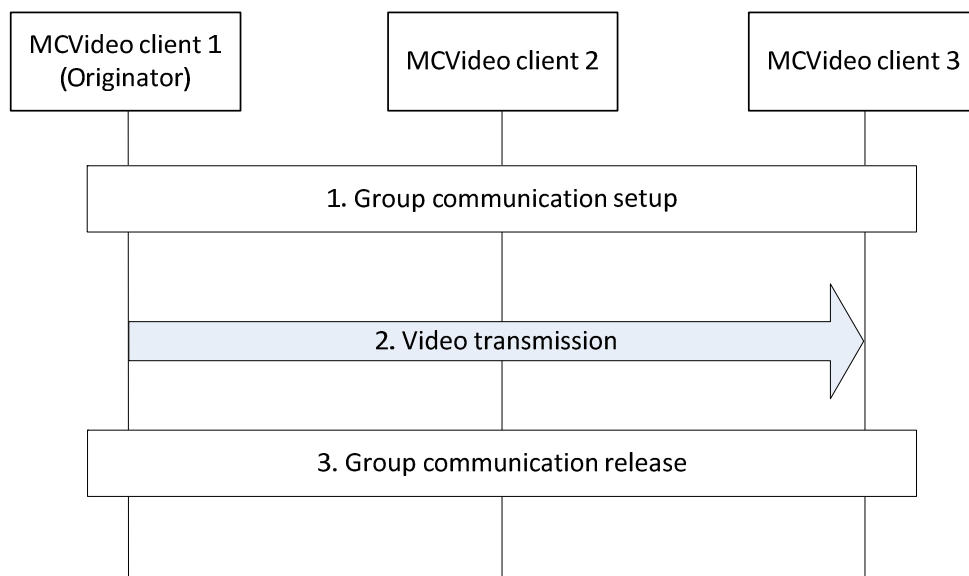

**Figure 7.1.3.6-1: Broadcast group communication**

1. MCVideo client 1 initiates group communication setup as described in subclause 7.1.3.3. The group communication announcement message includes the indication of broadcast group communication.
2. MCVideo client 1 initiating broadcast group communication starts to transmit video.

NOTE: Other clients of the group member are not allowed to transmit media in broadcast group communication.

3. The broadcast group communication is released as described in subclause 7.1.3.7.

### 7.1.3.7 Group communication release due to inactivity

If the on-going MCVideo group communication is inactive for a specific duration, the participating MCVideo clients release the MCVideo group communication. Inactivity is defined as absence of any transmission to or from other communication participants.

NOTE: Inactivity time can be set according to the policy of MC service provider.

### 7.1.3.8 Emergency and imminent peril procedures

#### 7.1.3.8.1 Emergency group communication

The off-network emergency group communication is a special case of off-network (non-emergency) group communication as defined in subclause 7.1.3.2, subclause 7.1.3.3, subclause 7.1.3.4, subclause 7.1.3.5, subclause 7.1.3.6 and subclause 7.1.3.7. The following are modifications to the aforementioned subclauses to support MCVideo emergency group communications:

- As a pre-condition, the client initiating the emergency communication has previously been provisioned with an MCVideo group designated as the MCVideo emergency group. The MCVideo client initiates MCVideo emergency group communications on this group. Alternatively, the MCVideo client could have been provisioned for emergency behaviour on the selected MCVideo group.
- The group communication announcement contains an indication that the MCVideo group communication is to be an MCVideo emergency communication regardless of whether or not the MCVideo client is in communication. Group communication participants learn of the MCVideo group's in-progress emergency condition from the indication.

- Every communication initiated by the MCVideo client will be an emergency communication while the MCVideo client is in MCVideo emergency state.
- The MCVideo client enters the MCVideo emergency state when initiating an MCVideo emergency communication. Only the MCVideo user of the MCVideo client can clear the client's local MCVideo emergency state.
- The MCVideo group in-progress emergency state is cancelled when the communication ends.
- The MCVideo user who initiated the emergency communication, or upgraded the group communication to emergency group communication, or an authorized user, may cancel the in-progress emergency state with an MCVideo emergency group communication cancel message. The message is sent to the MCVideo group.
- When the MCVideo group is no longer in the in-progress emergency state, every client returns the value of ProSe Per Packet Priority to its default value.
- An in-progress MCVideo group communication is upgraded to an emergency group communication when the periodic group communication announcement contains the emergency indicator.
- The value of ProSe Per Packet Priority is upgraded according to emergency state of MCVideo group communication.
- An MCVideo group communication upgraded to emergency group communication does not affect the state of other MCVideo communication(s) in the client.
- The MCVideo group remains in the in-progress emergency state until the emergency group communication ends or the in-progress emergency state is cancelled.

#### 7.1.3.8.2 MCVideo imminent peril

The off-network imminent peril group communication is a special case of off-network (non-imminent peril) group communication as defined in subclause 7.1.3.2, subclause 7.1.3.3, subclause 7.1.3.4, subclause 7.1.3.5, subclause 7.1.3.6 and subclause 7.1.3.7. The following are modifications to the aforementioned subclauses to support MCVideo imminent peril communications:

- As a pre-condition, the user initiating the imminent peril communication has previously been provisioned with an MCVideo group to be used as the MCVideo imminent peril group. The MCVideo client initiates MCVideo imminent peril group communications on this group. Alternatively, the MCVideo client could have been provisioned for imminent peril behaviour on the selected MCVideo group.
- The group communication announcement contains an indication that the MCVideo group communication is to be an MCVideo imminent peril communication. Group communication participants learn of the MCVideo group's in-progress imminent peril condition from the indication.
- The MCVideo group in-progress imminent peril state is considered cancelled when the communication ends.
- The MCVideo user who initiated the in-progress imminent peril communication or upgraded the group communication to imminent peril group communication, or an authorized user may cancel the in-progress imminent peril state with an MCVideo imminent peril group communication cancel message. The message is sent to the communication participants.
- When the MCVideo group is no longer in the in-progress imminent peril state, every MCVideo client returns the value of ProSe Per Packet Priority to its default value.
- An in-progress MCVideo group communication is upgraded to an imminent peril group communication when the periodic group communication announcement contains the imminent peril indicator.
- The value of ProSe Per Packet Priority is upgraded according to imminent peril state of MCVideo group communication.
- The MCVideo group remains in the in-progress imminent peril state until the imminent peril group communication ends or the in-progress imminent peril state is cancelled.

### 7.1.3.9 MCVideo emergency alert

#### 7.1.3.9.1 General

The MCVideo client use emergency alert initiation and emergency state cancel procedures defined in 3GPP TS 23.280 [6], with the following clarifications:

- The MC service ID is the MCVideo ID; and
- The MC service group ID is the MCVideo group ID.

## 7.2 Private call

### 7.2.1 General

Private calls are enabled in both on-network and off-network.

Private calls can be setup in two different commencement modes, automatic commencement mode and manual commencement mode.

### 7.2.2 Private call on-network

#### 7.2.2.1 General

The private call setup in automatic commencement mode is described in subclause 7.2.2.3.1, manual commencement mode in subclause 7.2.2.3.2 and private call release (client or server initiated) in subclause 7.2.2.3.3.

#### 7.2.2.2 Information flows for private call in on-network

##### 7.2.2.2.1 MCVideo private call request (MCVideo client – MCVideo server)

Table 7.2.2.2.1-1 describes the information flow MCVideo private call request from the MCVideo client to the MCVideo server.

**Table 7.2.2.2.1-1: MCVideo private call request (MCVideo client – MCVideo server)**

Information Element	Status	Description
MCVideo ID	M	The MCVideo ID of the calling party
MCVideo ID	M	The MCVideo ID of the called party
Transmit media request indication	M	This element indicates whether transmission control will be used for the private call.
SDP offer	M	Media parameters of MCVideo client.
Requested commencement mode	O	An indication that is included if the user is requesting a particular commencement mode
Implicit transmit media request	O	An indication that the user is also requesting the permission to transmit video
Push indication	O	Indicates that the private call request is for a one-to-one push call
Pull indication	O	Indicates that the private call request is for a one-to-one pull call

#### 7.2.2.2.2 MCVideo private call request (MCVideo server – MCVideo client)

Table 7.2.2.2.2-1 describes the information flow MCVideo private call request from the MCVideo server to the MCVideo client.

**Table 7.2.2.2.2-1: MCVideo private call request (MCVideo server – MCVideo client)**

Information Element	Status	Description
MCVideo ID	M	The MCVideo ID of the calling party
MCVideo ID	M	The MCVideo ID of the called party
Transmit media request indication	M	This element indicates whether transmission control will be used for the private call.
SDP offer	M	Media parameters of MCVideo client.
Requested commencement mode	O	An indication that is included if the user is requesting a particular commencement mode
Implicit transmit media request	O	An indication that the user is also requesting the permission to transmit video

#### 7.2.2.2.3 MCVideo private call response (MCVideo client – MCVideo server)

Table 7.2.2.2.3-1 describes the information flow MCVideo private call response from the MCVideo client to the MCVideo server.

**Table 7.2.2.2.3-1: MCVideo private call response (MCVideo client – MCVideo server)**

Information Element	Status	Description
MCVideo ID	M	The MCVideo ID of the calling party
MCVideo ID	O	The MCVideo ID of the called party
SDP answer	M	Media parameters selected
Requested commencement mode	O	An indication of the commencement mode to be used.

#### 7.2.2.2.4 MCVideo private call response (MCVideo server – MCVideo client)

Table 7.2.2.2.4-1 describes the information flow MCVideo private call response from the MCVideo server to the MCVideo client.

**Table 7.2.2.2.4-1: MCVideo private call response (MCVideo server – MCVideo client)**

Information Element	Status	Description
MCVideo ID	M	The MCVideo ID of the calling party
MCVideo ID	O	The MCVideo ID of the called party
Acceptance confirmation	O	An indication whether the user has positively accepted the call.
SDP answer	M	Media parameters selected

#### 7.2.2.2.5 MCVideo call end request

Table 7.2.2.2.5-1 describes the information flow MCVideo call end request from the MCVideo client to the MCVideo server and from the MCVideo server to the MCVideo client.

**Table 7.2.2.2.5-1: MCVideo call end request**

Information Element	Status	Description
MCVideo ID	M	The MCVideo ID of the calling party
MCVideo ID	M	The MCVideo ID of the called party

### 7.2.2.3 Private call within one MC system

#### 7.2.2.3.1 Private call setup in automatic commencement mode

The procedure describes the scenario where an MCVideo user is initiating an MCVideo private call for communicating with another MCVideo user, with or without transmission control enabled, in an automatic commencement mode.

Procedures in figure 7.2.2.3.1-1 are the basic signalling control plane procedures for the MCVideo client initiating establishment of MCVideo private call with the chosen MCVideo user.

Pre-conditions:

1. MCVideo users on MCVideo client 1 and MCVideo client 2 are already registered for receiving MCVideo service.
2. The calling MCVideo user has selected automatic commencement mode for the call; or
3. The called MCVideo client is set to automatic commencement mode.

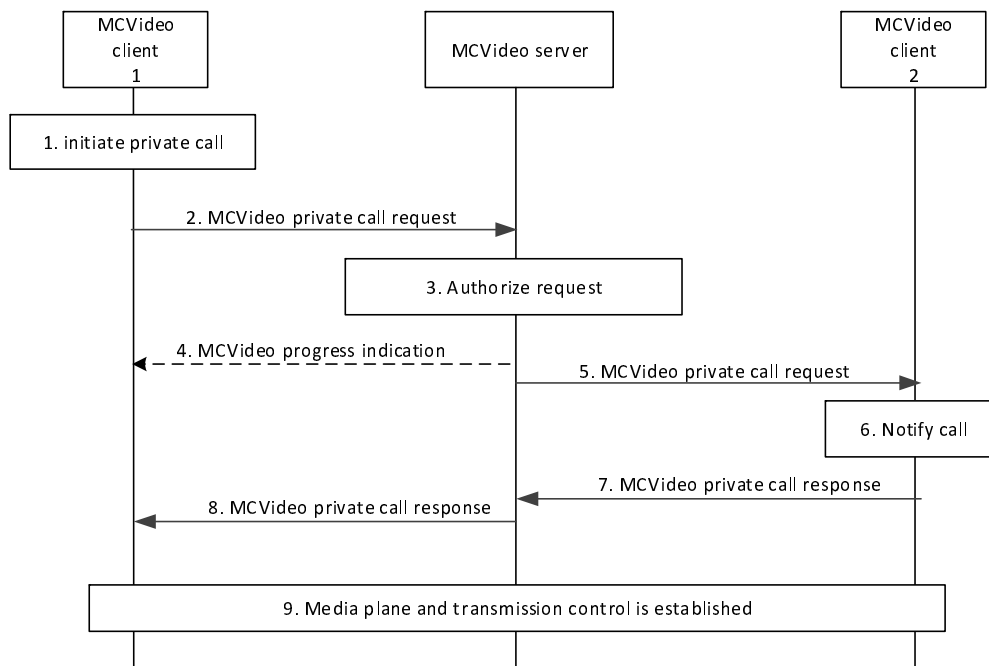

**Figure 7.2.2.3.1-1: Private call setup in automatic commencement mode– MCVideo users in the same MC system**

1. User at MCVideo client 1 would like to initiate an MCVideo private call for the chosen MCVideo user.
2. MCVideo client 1 sends an MCVideo private call request towards the MCVideo server (via SIP core) using a service identifier as defined in 3GPP TS 23.228 [5] for MCVideo, for establishing a private call with the chosen MCVideo user. The MCVideo private call request contains the MCVideo ID of invited user, an SDP offer containing one or more media types. The MCVideo client 1 may include a Requested commencement mode that indicates that the call is to be established in automatic commencement mode if automatic commencement mode is requested by the initiating user.
3. MCVideo server checks whether the MCVideo user at MCVideo client 1 is authorized to initiate the private call, and that MCVideo user at MCVideo client 2 is authorized to receive the private call. If the MCVideo private call request requested automatic commencement mode then the MCVideo server also checks whether the MCVideo user at MCVideo client 1 is authorized to initiate a private call in automatic commencement mode.
4. MCVideo server may provide a progress indication to MCVideo client 1 to indicate progress in the call setup process.

NOTE: Step 4 can occur at any time following step 3, and prior to step 8.

5. If authorized, MCVideo server includes information that it communicates using MCVideo service, offers the same media types or a subset of the media types contained in the initial received request, includes the requested automatic commencement mode indication based on a requested automatic commencement mode by the calling user or based upon the setting of the called MCVideo client and sends the corresponding MCVideo private call request towards the MCVideo client 2, including the MC service ID of the calling MCVideo user 1. If the called MCVideo user has registered to the MCVideo service with multiple MCVideo UEs and has designated the MCVideo UE for receiving the private calls, then the incoming MCVideo private call request is delivered only to the designated MCVideo UE.
6. The receiving MCVideo client 2 notifies the user about the incoming private call.
7. The receiving MCVideo client 2 accepts the private call automatically, and an MCVideo private call response is sent to the MCVideo server (via SIP core).
8. Upon receiving the MCVideo private call response from MCVideo client 2 accepting the private call request, the MCVideo server informs the MCVideo client 1 about successful call establishment.

9. MCVideo client 1 and MCVideo client 2 have successfully established media plane and transmission control for communication and both users can transmit media.

### 7.2.2.3.2 Private call setup in manual commencement mode

#### 7.2.2.3.2.1 Description

Figure 7.2.2.3.2.2-1 describes the basic procedure for the MCVideo client initiating an MCVideo private call that uses manual commencement mode. The flow may use a transmit media request in the MCVideo private call request indicating that the originator will be granted permission to transmit when the call starts and eliminates the need for a separate initial transmit media request message during media plane establishment. Alternatively the call initiation may be sent without the transmit media request, which allows the called party to transmit media request first.

#### 7.2.2.3.2.2 Procedure

Both clients are served by the primary MC service provider in figure 7.2.2.3.2.2-1.

Pre-conditions:

1. MCVideo client 1 and MCVideo client 2 are both registered and their respective users, MCVideo user 1 and MCVideo user 2, are authenticated and authorized to use the MCVideo service.
2. The calling MCVideo user has selected manual commencement mode or has not specified a commencement mode for the call; and
3. The called MCVideo client is set to manual commencement mode.

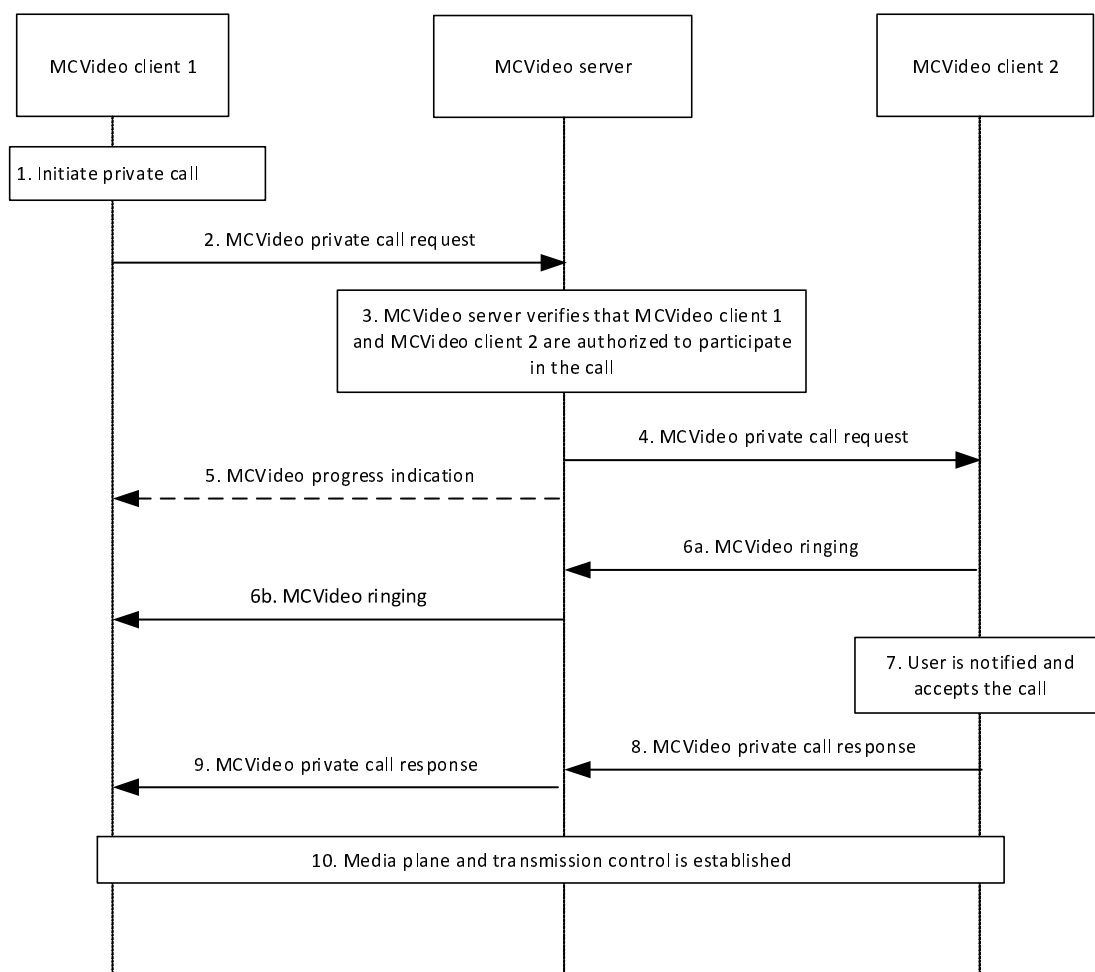

Figure 7.2.2.3.2.2-1: MCVideo private call in manual commencement mode– MCVideo users in the same MC system



1. MCVideo user at MCVideo client 1 would like to initiate an MCVideo private call for the selected MCVideo user.
2. MCVideo client 1 sends an MCVideo private call request addressed to the MC service ID of MCVideo user 2 using an MCVideo service identifier as defined in 3GPP TS 23.228 [5] (possible for the SIP core to route the request to the MCVideo server). The MCVideo private call request contains the MC service ID of invited user and an SDP offer containing one or more media types. The MCVideo client 1 may include a requested commencement mode that indicates that the call is to be established in manual commencement mode if manual commencement mode is requested by the initiating user.
3. The MCVideo server confirms that both MCVideo users are authorized for the private call. The MCVideo server checks the commencement mode setting of the called MCVideo client and also checks whether the MCVideo user at MCVideo client 1 is authorized to initiate a call in manual commencement mode.
4. The MCVideo server includes information that it communicates using MCVideo service, offers the same media types or a subset of the media types contained in the initial received request and sends an MCVideo private call request for the call to MCVideo client 2, including the MC service ID of the calling MCVideo user 1. If the called MCVideo user has registered to the MCVideo service with multiple MCVideo UEs and has designated the MCVideo UE for receiving the private calls, then the incoming MCVideo private call request is delivered only to the designated MCVideo UE.
5. MCVideo server may provide a progress indication to MCVideo client 1 to indicate progress in the call setup process.

NOTE: Step 5 can occur at any time following step 3, and prior to step 6b.

- 6a. The MCVideo user is alerted. MCVideo client 2 sends an MCVideo ringing to the MCVideo server.
- 6b. The MCVideo server sends an MCVideo ringing to MCVideo client 1, indicating that MCVideo client 2 is being alerted.
7. MCVideo user 2 is notified and has accepted the call using manual commencement mode (i.e., has taken some action to accept via the user interface).
8. The MCVideo client 2 sends an MCVideo private call response to the MCVideo server. If MCVideo user 2 has not accepted the incoming call, the MCVideo client 2 sends a call failure response to the MCVideo server without adding reason for call failure.
9. The MCVideo server sends an MCVideo private call response to MCVideo client 1 indicating that MCVideo user 2 has accepted the call, including the accepted media parameters.
10. The media plane and transmission control for communication is established.

### 7.2.2.3.3 Private call release

#### 7.2.2.3.3.1 Client initiated

The procedure describes the scenario where an MCVideo client is requesting to release an ongoing MCVideo private call (with or without transmission control) and the call established in either of the two commencement modes (manual or automatic).

Procedures in figure 7.2.2.3.3.1-1 are the basic signalling control plane procedures for the MCVideo client initiating the release of an ongoing MCVideo private call.

Pre-condition:

1. It is assumed that MCVideo users on MCVideo client 1 and MCVideo client 2 are already registered for receiving MCVideo service and are involved in private call as described in subclause 7.2.2.3.1 and subclause 7.2.2.3.2.

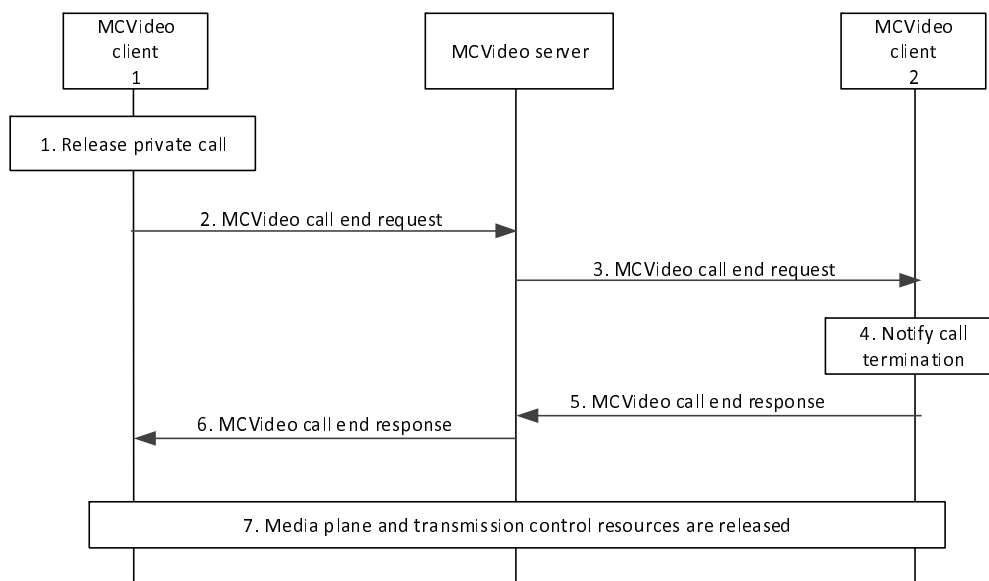

**Figure 7.2.2.3.3.1-1: Private call release – client initiated**

1. User at MCVideo client 1 would like to release an ongoing MCVideo private call with MCVideo client 2.
2. MCVideo client 1 sends an MCVideo call end request towards the MCVideo server (via SIP core), for tearing down the private call with the other client.
3. MCVideo server sends the corresponding MCVideo call end request towards the MCVideo client specified in the original MCVideo call end request.
4. MCVideo user is notified about the release of the private call.
5. The receiving MCVideo client 2 acknowledges the MCVideo call end request with a MCVideo call end response.
6. After receiving the MCVideo call end response from MCVideo client 2, the MCVideo server generates an MCVideo call end response for the MCVideo client 1's MCVideo call end request.
7. MCVideo clients release all the media plane resources used for the private call. Further, if the private call was established with transmission control, transmission control resources are released.

#### 7.2.2.3.3.2 Server initiated

The procedure describes the scenario where an MCVideo server is terminating an ongoing MCVideo private call and the call established in either of the two commencement modes (manual or automatic), upon conditions to terminate call e.g., MCVideo administrator configured maximum duration for MCVideo private calls has expired or timed out due to MCVideo private call without transmission/reception.

Procedures in figure 7.2.2.3.3.2-1 are the basic signalling control plane procedures for the MCVideo server initiating termination of an ongoing MCVideo private call.

Pre-condition:

1. It is assumed that MCVideo users on MCVideo client 1 and MCVideo client 2 are already registered for receiving MCVideo service and are involved in private call established either in manual or automatic commencement mode.

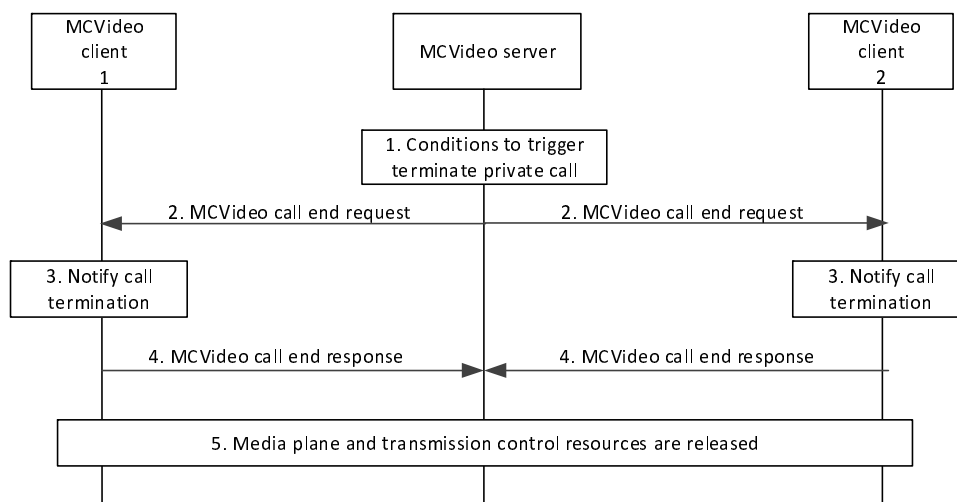

**Figure 7.2.2.3.3.2-1: End private call – server initiated**

1. Upon conditions to terminate call e.g., MCVideo administrator configured maximum duration for MCVideo private calls has expired or timed out due to MCVideo private call without transmission/reception, the MCVideo server decides to initiate termination of an ongoing MCVideo private call between MCVideo client 1 and MCVideo client 2.
2. MCVideo server sends an MCVideo call end request towards the MCVideo clients 1 and 2 (via SIP core), for tearing down the private call between them.
3. MCVideo users at client 1 and client 2 are notified about the termination of the private call.
4. The MCVideo call end request receiving MCVideo clients 1 and 2 acknowledge the request with MCVideo call end response.
5. MCVideo clients release all the media plane resources used for the private call. Further, if the private call was established with transmission control, transmission control resources are released.

## 7.2.3 Off-network private communications

### 7.2.3.1 General

The private call setup in automatic commencement mode is described in subclause 7.2.3.4, manual commencement mode in subclause 7.2.3.5 and private call release in subclause 7.2.3.6.

### 7.2.3.2 Information flows for off-network private communications

#### 7.2.3.2.1 Private communication request

Table 7.2.3.2.1-1 describes the information flow for the private communication request sent from one MCVideo client to another MCVideo client.

**Table 7.2.3.2.1-1: Private communication request**

Information element	Status	Description
MCVideo ID	M	The identity of the MCVideo user requesting the communication
MCVideo ID	M	The identity of the MCVideo user with whom communication was requested
SDP offer	M	SDP with media information offered by the caller
Video push indication	O	Indicates that the MCVideo private communication is for video push
Video pull indication	O	Indicates that the MCVideo private communication is for video pull

NOTE 1: For video push, 'the identity of the MCVideo user requesting the communication' refers to the user who will be the source of the video, and 'the identity of the MCVideo user with whom the communication was requested' refers to the user who will receive the video.

NOTE 2: For video pull, 'the identity of the MCVideo user requesting the communication' refers to the user who wants to receive the video, and 'the identity of the MCVideo user with whom the communication was requested' refers to the user who will be the source of the video.

### 7.2.3.2.2 Private communication answer response

Table 7.2.3.2.2-1 describes the information flow for the response of private communication request sent from one MCVideo client to another MCVideo client.

**Table 7.2.3.2.2-1: Private communication answer response**

Information element	Status	Description
MCVideo ID	M	The identity of the MCVideo user requesting the communication
MCVideo ID	M	The identity of the MCVideo user with whom communication was requested
SDP answer	M	SDP with media information accepted by the callee

NOTE 1: For video push, 'the identity of the MCVideo user requesting the communication' refers to the user who will be the source of the video, and 'the identity of the MCVideo user with whom the communication was requested' refers to the user who will receive the video.

NOTE 2: For video pull, 'the identity of the MCVideo user requesting the communication' refers to the user who wants to receive the video, and 'the identity of the MCVideo user with whom the communication was requested' refers to the user who will be the source of the video.

### 7.2.3.2.3 Private communication release request

Table 7.2.3.2.3-1 describes the information flow for the private communication release request sent from one MCVideo client to another MCVideo client.

**Table 7.2.3.2.3-1: Private communication release request**

Information element	Status	Description
MCVideo ID	M	The identity of the MCVideo user requesting the communication
MCVideo ID	M	The identity of the MCVideo user with whom communication was requested
MCVideo private communication release reason	O	Reason for the private communication release.

NOTE 1: For video push, 'the identity of the MCVideo user requesting the communication' refers to the user who will be the source of the video, and 'the identity of the MCVideo user with whom the communication was requested' refers to the user who will receive the video.

NOTE 2: For video pull, 'the identity of the MCVideo user requesting the communication' refers to the user who wants to receive the video, and 'the identity of the MCVideo user with whom the communication was requested' refers to the user who will be the source of the video.

#### 7.2.3.2.4 Private communication release response

Table 7.2.3.2.4-1 describes the information flow for the private communication release response sent from one MCVideo client to another MCVideo client.

**Table 7.2.3.2.4-1: Private communication release response**

Information element	Status	Description
MCVideo ID	M	The identity of the MCVideo user requesting the communication
MCVideo ID	M	The identity of the MCVideo user with whom communication was requested

NOTE 1: For video push, 'the identity of the MCVideo user requesting the communication' refers to the user who will be the source of the video, and 'the identity of the MCVideo user with whom the communication was requested' refers to the user who will receive the video.

NOTE 2: For video pull, 'the identity of the MCVideo user requesting the communication' refers to the user who wants to receive the video, and 'the identity of the MCVideo user with whom the communication was requested' refers to the user who will be the source of the video.

#### 7.2.3.3 Use of ProSe for off-network private communications

To enable an MCVideo user, using a ProSe-enabled UE, to communicate with another MCVideo user, using ProSe-enabled UE, the MCVideo client retrieves the ProSe discovery group ID and user info ID of the target MCVideo user from the "List of user(s) who can be communicated privately" in the MCVideo user profile and requests the IP address of the MCVideo UE associated with the target MCVideo user, from the ProSe layer.

The MCVideo client enables the ProSe layer to determine the IP address for the target MCVideo UE by providing the ProSe discovery group ID and user info ID (as defined in specification 3GPP TS 23.303 [7]) of the target MCVideo user. This may trigger the ProSe layer procedure (e.g. discovery). The user info ID of the target MCVideo user is used by the ProSe layer as the target info (as defined in specification 3GPP TS 23.303 [7]). The ProSe layer can then provide the IP address related to the target MCVideo user's MCVideo ID to the MCVideo client.

#### 7.2.3.4 Automatic commencement private communication

##### 7.2.3.4.1 General

A private call request is sent by a MCVideo client directly to another MCVideo client, which checks the request, establishes the MCVideo session without further user interaction and notifies its user that the MCVideo session has been established.

##### 7.2.3.4.2 Procedure

Figure 7.2.3.4.2-1 describes procedures to establish an off-network automatic commencement private communication between MCVideo user A MCVideo user B.

Pre-conditions:

1. MCVideo user A has initiated automatic commencement private communication with MCVideo user B.

2. MCVideo user B has indicated MCVideo client B as the designated MCVideo client for MCVideo private communications.
3. MCVideo client A and MCVideo client B are members of the same ProSe Discovery group and are ProSe 1:1 direct communication capable.
4. MCVideo client A has discovered MCVideo client B in proximity, associated with MCVideo user B, using ProSe Discovery procedures.

**Editor's Note: How MCVideo client A determines that MCVideo client B is the designated MCVideo client of MCVideo user B for private communications is FFS.**

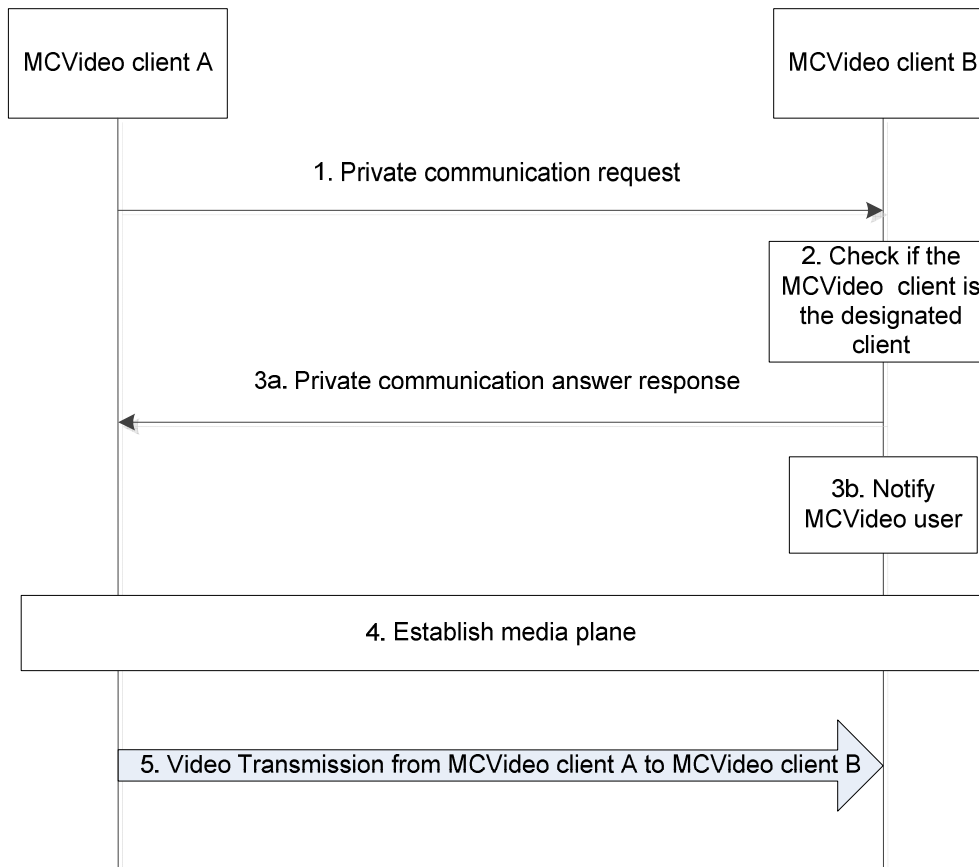

**Figure 7.2.3.4.2-1: Off-network automatic commencement private communication**

1. The MCVideo client A sends the Private communication request towards MCVideo client associated with MCVideo user B. The Private communication request contains an indication for automatic commencement and the SDP offer.
2. On receiving a Private communication request with an indication for automatic commencement, the MCVideo client checks if it is the designated MCVideo client for off-network MCVideo private communications.
- 3a. The designated MCVideo client B automatically accepts the Private communication request, and sends a Private communication answer response, indicating the successful receipt of communication request to the MCVideo client A. The Private communication answer response contains the SDP answer.
- 3b. The designated MCVideo client B notifies the MCVideo user B about the incoming Private communication request.

NOTE 1: Step 3a and step 3b can occur in any order.

4. The MCVideo client A and the MCVideo client B establish the media plane for Private Communication.

NOTE 2: If a MCVideo client fails to establish the communication, the MCVideo client should send a Private communication failed response indicating the failure reason to the appropriate MCVideo client.

5. MCVideo media is transmitted from the MCVideo client A to the MCVideo client B and is presented to the MCVideo user B.

NOTE 3: If a Private communication failed response is received by a MCVideo client, before or after establishing the media session, if already established, the session is terminated and the MCVideo user is notified about the failure and its reason, if any.

### 7.2.3.5 Manual commencement private communication

#### 7.2.3.5.1 General

A private call request is sent by a MCVideo client directly to another MCVideo client, which checks the request, establishes the MCVideo session without further user interaction and notifies its user about the incoming MCVideo session request. The MCVideo user may accept, reject or ignore the MCVideo session request.

#### 7.2.3.5.2 Procedure – Communication accepted

Figure 7.2.3.5.2-1 describes procedures to establish an off-network manual commencement private communication between MCVideo user A MCVideo user B, which is accepted by the MCVideo user B.

Pre-conditions:

1. MCVideo user A has initiated manual commencement private communication with MCVideo user B.
2. MCVideo user B has indicated MCVideo client B as the designated MCVideo client for MCVideo private communications, if the MCVideo user B has signed on to the MCVideo service with multiple MCVideo clients.
3. MCVideo client A and MCVideo client B are members of the same ProSe Discovery group and are ProSe 1:1 direct communication capable.
4. MCVideo client A has discovered MCVideo clients B in proximity, associated with MCVideo user B, using ProSe Discovery procedures.

**Editor's Note: How MCVideo client A determines that MCVideo client B is the designated MCVideo client of MCVideo user B for private communications is FFS.**

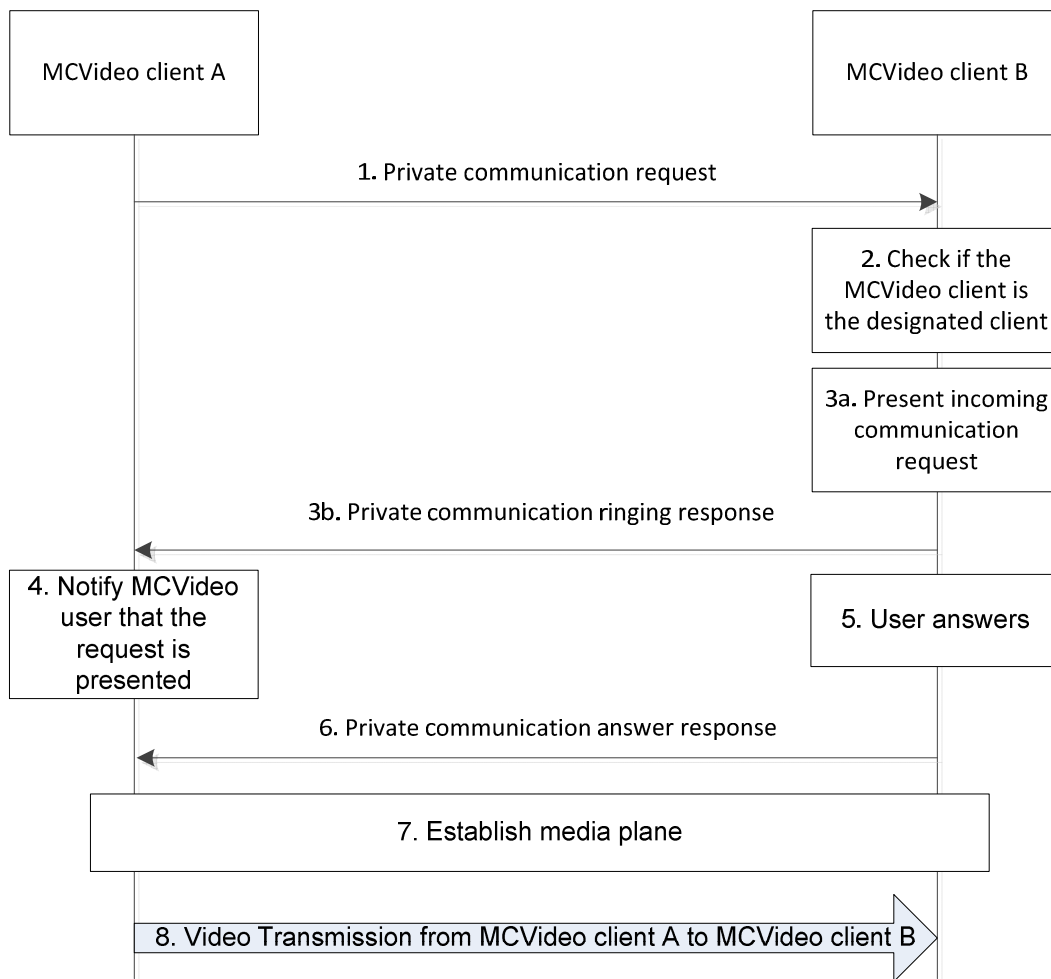

**Figure 7.2.3.5.2-1: Off-network manual commencement private communication – Accepted**

1. The MCVideo client A sends the Private communication request towards MCVideo client associated with MCVideo user B. The Private communication request contains an indication for manual commencement and the SDP offer.
2. On receiving a Private communication request, the MCVideo client checks if it is the designated MCVideo client for off-network MCVideo private communications.
- 3a. The designated MCVideo client B presents the incoming Private communication request to the MCVideo user B.
- 3b. The MCVideo client B sends back a Private communication ringing response to the MCVideo client A.

NOTE 1: Step 3a and step 3b can occur in any order.

4. The MCVideo client A notifies the ringing status to the MCVideo user A.
5. The MCVideo user B accepts the Private communication request.
6. The MCVideo client B sends the Private communication answer response to the MCVideo client A. The Private communication response contains the SDP answer.
7. The MCVideo client A and the MCVideo client B establish the media plane for Private communication.

NOTE 2: If a MCVideo client fails to establish the communication, the MCVideo client should send a Private communication failed response indicating the failure reason to the appropriate MCVideo client.



8. MCVideo media is transmitted from the MCVideo client A to the MCVideo client B and is presented to the MCVideo user B.

NOTE 3: If a Private communication failed response is received by a MCVideo client, before or after establishing the media session, if already established, the session is terminated and the MCVideo user is notified about the failure and its reason, if any.

### 7.2.3.5.3 Procedure – Communication rejected/ignored

Figure 7.2.3.5.3-1 describes procedures to initiate an off-network manual commencement private communication between MCVideo user A MCVideo user B, which is rejected or ignored by the MCVideo user B.

Pre-conditions:

1. MCVideo user A has initiated manual commencement private communication with MCVideo user B.
2. MCVideo user B has indicated MCVideo client B as the designated MCVideo client for MCVideo Private Communications, if the MCVideo user B has signed on to the MCVideo service with multiple MCVideo clients.
3. MCVideo client A and MCVideo client B are members of the same ProSe Discovery group and are ProSe 1:1 direct communication capable.
4. MCVideo client A has discovered MCVideo clients B in proximity, associated with MCVideo user B, using ProSe Discovery procedures.

**Editor's Note: How MCVideo client A determines that MCVideo client B is the designated MCVideo client of MCVideo user B for private communications is FFS.**

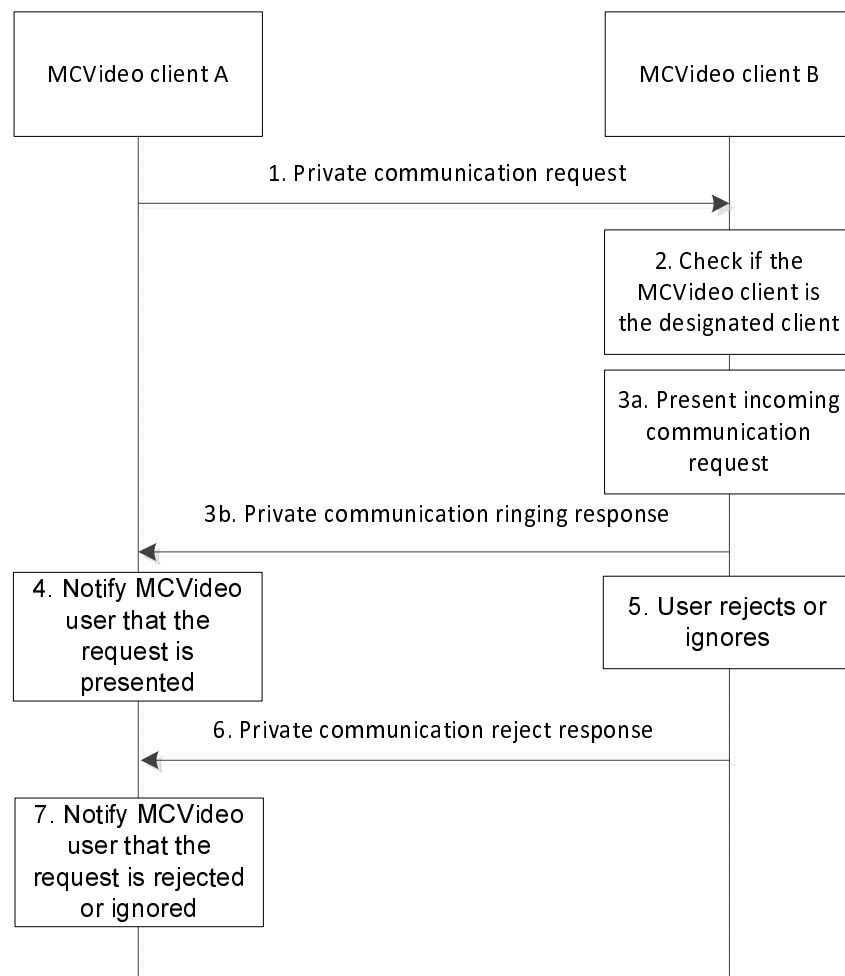

**Figure 7.2.3.5.3-1: Off-network manual commencement private communication – Rejected or Ignored**

1. The MCVideo client A sends the private communication request towards MCVideo client associated with MCVideo user B. The private communication request contains an indication for manual commencement and the SDP offer.
2. On receiving a Private communication request, the MCVideo client checks if it is the designated MCVideo client for off-network MCVideo private communications.
- 3a. The designated MCVideo client B presents the incoming Private communication request to the MCVideo user B.
- 3b. The MCVideo client B sends back a Private communication ringing response to the MCVideo client A.

NOTE 1: Step 3a and step 3b can occur in any order.

4. The MCVideo client A notifies the ringing status to the MCVideo user A.
5. The MCVideo user B rejects (or ignores) the Private communication request.

NOTE 2: The MCVideo client B determines that the MCVideo user B has ignored the Private communication request, if the MCVideo user B does not respond within a configured time limit.

6. The MCVideo client B sends a Private communication reject response to the MCVideo client A. The Private communication reject response may indicate that the MCVideo user B has ignored the Private communication request.
7. The MCVideo client A notifies the MCVideo user A that the Private communication request was rejected (or ignored).

### 7.2.3.6 Private communication release

#### 7.2.3.6.1 General

Either of the MCVideo users involved in a private communication may release the unidirectional media plane or the whole private communication at any time.

#### 7.2.3.6.2 Procedure

Figure 7.2.3.6.2-1 describes procedures to release an ongoing MCVideo Private communication (either automatic commencement private communication or manual commencement private communication).

Either of the MCVideo users, the initiator or the receiver of the Private communication can request to release the Private communication.

The Private communication release request can be to release an individual (unidirectional) media plane or to terminate the Private communication. Based on the request the requested media plane or both the media planes are terminated in step 3.

Pre-conditions:

1. MCVideo client A and MCVideo client B are engaged in a Private communication.
2. MCVideo user A at MCVideo client A initiates release of the Private communication.

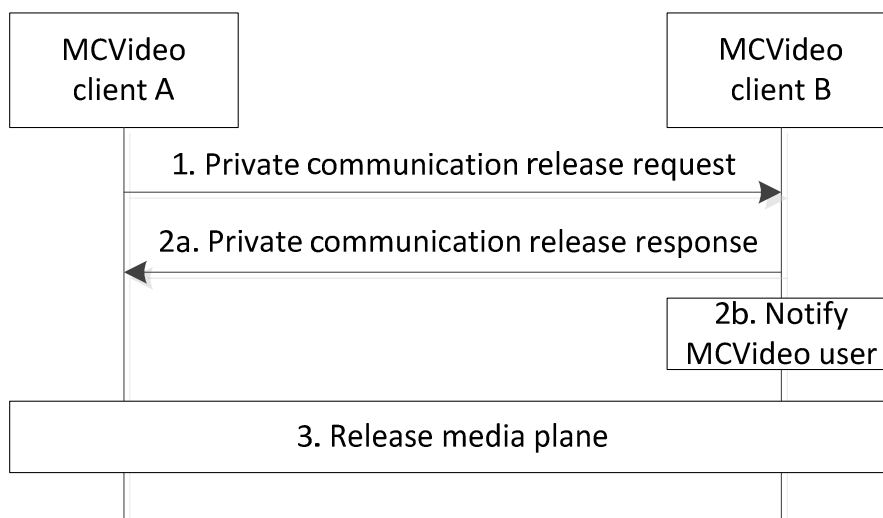

**Figure 7.2.3.6.2-1: Off-network Private communication release**

- 1, The MCVideo client A sends the Private communication release request to the MCVideo client B.
  - 2a. The MCVideo client B sends a Private communication release response indicating successful receipt of the request to the MCVideo client A.
  - 2b. The MCVideo client B notifies the MCVideo user B about the Private communication release request.
- NOTE: Step 2a and step 2b can occur in any order.
3. MCVideo client A and MCVideo client B release the requested media plane. If both the media planes are released, the Private communication is terminated.

## 7.3 Video pull

### 7.3.1 General

MCVideo pull is enabled in both on-network and off-network mode.

For on-network MCVideo pull is supported between MCVideo clients, or between a MCVideo client and a MCVideo server.

For off-network MCVideo pull is supported between MCVideo clients only.

### 7.3.2 On-network video pull

#### 7.3.2.1 General

A MCVideo user triggers its MCVideo client to pull a video either from another MCVideo client or from a MCVideo server.

#### 7.3.2.2 Information flows for on-network video pull

The following information flows for private call specified in subclause 7.2.2.2 is used for on-network video pull:

- MCVideo private call request (MCVideo client – MCVideo server)

- MCVideo private call request (MCVideo server – MCVideo client)
- MCVideo private call response (MCVideo client – MCVideo server)
- MCVideo private call response (MCVideo server – MCVideo client)
- MCVideo call end request

#### 7.3.2.2.1 MCVideo pull from server request

Table 7.3.2.2.1-1 describes the information flow MCVideo pull from server request from the MCVideo client to the MCVideo server.

**Table 7.3.2.2.1-1: MCVideo pull from server request**

Information Element	Status	Description
MCVideo ID	M	The MCVideo ID of the calling party
File URL	M	URL of the video file to be streamed
SDP offer	M	Media parameters of MCVideo client

#### 7.3.2.2.2 MCVideo pull from server response

Table 7.3.2.2.2-1 describes the information flow MCVideo pull from server response from the MCVideo server to the MCVideo client.

**Table 7.3.2.2.2-1: MCVideo pull from server response**

Information Element	Status	Description
MCVideo ID	M	The MCVideo ID of the calling party
SDP answer	M	Media parameters selected

#### 7.3.2.2.3 MCVideo pull from server complete request

Table 7.3.2.2.3-1 describes the information flow MCVideo pull from server complete request from the MCVideo client to the MCVideo server or from the MCVideo server to the MCVideo client..

**Table 7.3.2.2.3-1: MCVideo pull from server complete request**

Information Element	Status	Description
MCVideo ID	M	The MCVideo ID of the calling party
Cause	M	End of communication cause

#### 7.3.2.2.4 MCVideo pull from server complete response

Table 7.3.2.2.4-1 describes the information flow MCVideo pull from server complete response from the MCVideo client to the MCVideo server or from the MCVideo server to the MCVideo client..

**Table 7.3.2.2.4-1: MCVideo pull from server complete response**

Information Element	Status	Description
MCVideo ID	M	The MCVideo ID of the calling party

### 7.3.2.3 One-to-one video pull

#### 7.3.2.3.1 General

One-to-one video pull is a private call that only allows the called party to transmit video to the calling party, and the private call ends when the video transmission is completed.

#### 7.3.2.3.2 One-to-one video pull – call setup

The procedure describes the case where an MCVidéo user is initiating an MCVidéo private call to pull video from called MCVidéo user in an automatic or manual commencement mode. Only the called party is allowed to transmit video.

Procedures in figure 7.3.2.3.2-1 are the basic signalling control plane procedures for the MCVidéo client initiating establishment of MCVidéo private call with the chosen MCVidéo user for video pull.

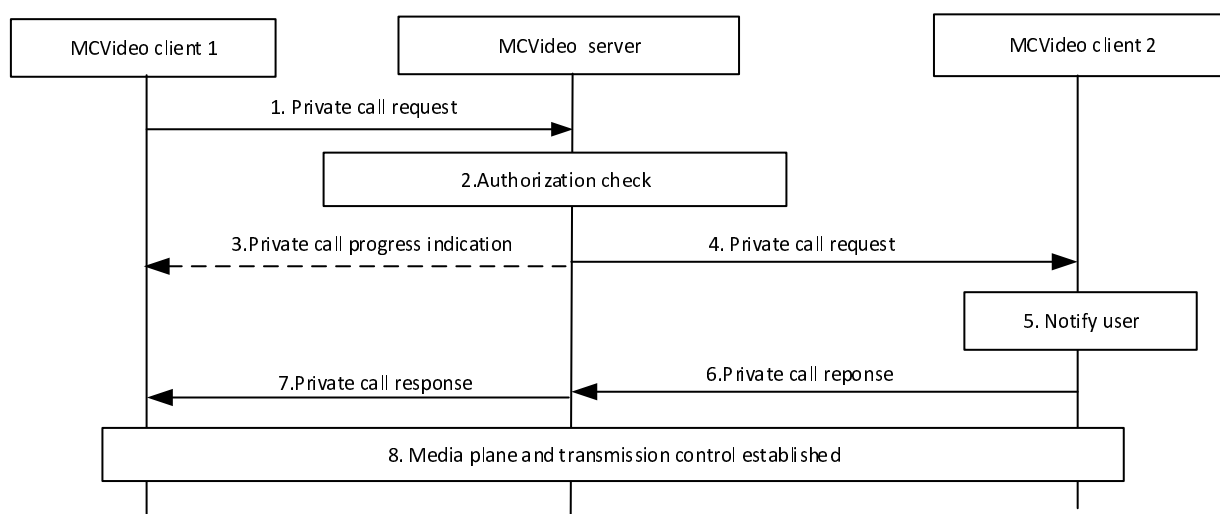

**Figure 7.3.2.3.2-1: One-to-one video pull**

1. MCVidéo user on MCVidéo client 1 initiates video pull from MCVidéo client 2, by sending a private call request to the MCVidéo server using a service identifier as defined in 3GPP TS 23.228 [5] for MCVidéo, for establishing a private call with the chosen MCVidéo user for video pull. The MCVidéo private call request contains MCVidéo ID of invited user, an SDP offer containing one or more media types and the video pull indication to indicate that invited user is requested to transmit video to the requester.
  2. MCVidéo server checks whether the MCVidéo user at MCVidéo client 1 is authorized to initiate the private call for video pull, and that MCVidéo user at MCVidéo client 2 is authorized to receive the private call for video pull.
  3. MCVidéo server may provide a progress indication to MCVidéo client 1 to indicate progress in the call setup process.
- NOTE 1: Step 3 can occur at any time following step 4, and prior to step 6.
4. If authorized, MCVidéo server includes information that it communicates using MCVidéo service, offers the same media types or a subset of the media types contained in the initial received request, includes the requested automatic commencement mode indication based on a requested commencement mode by the calling user or based upon the setting of the called MCVidéo client and sends the corresponding MCVidéo private call request towards the MCVidéo client 2, including the MCVidéo ID of the calling MCVidéo user 1. If the called MCVidéo user has registered to the MCVidéo service with multiple MCVidéo UEs and has designated the MCVidéo UE for receiving the private calls, then the incoming MCVidéo private call request is delivered only to the designated MCVidéo UE.
  5. The MCVidéo client 2 notifies the user about the incoming private call for video pull.

6. The receiving MCVideo client 2 accepts the private call for video pull, and sends an MCVideo private call response to the MCVideo server with an implicit transmit media request.
7. Upon receiving the MCVideo private call response from MCVideo client 2 accepting the private call request for video pull, the MCVideo server informs the MCVideo client 1 about successful call establishment via a private call response message.
8. MCVideo client 1 and MCVideo client 2 have successfully established media plane and transmission control for media communication.

NOTE 2: When the video transmission is completed, the private call is released.

#### 7.3.2.3.3 One-to-one video pull – call release

The private call release procedure specified in subclause 7.2.2.3.3 is used for one-to-one video pull call release.

#### 7.3.2.4 One-from-server video pull

##### 7.3.2.4.1 General

One-from-server video pull is a private call between the calling party and the MCVideo server that allows the calling party to request streaming of a video from the server where it is stored in a file. The one-from-server video pull ends typically when the end of the video file has been reached or when the transmission is stopped by the calling user or by the MCVideo server.

NOTE: This procedure fulfills the requirements for the stage 1 replay of stored video feature.

##### 7.3.2.4.2 Procedure

Procedure in figure 7.3.2.4.2-1 is the basic signalling control plane procedures for the MCVideo client initiating establishment of MCVideo video pull from the MCVideo server.

Pre-conditions:

1. MCVideo user 1 on MCVideo client 1 has been authenticated and authorized to use MCVideo service.
2. MCVideo client 1 is registered.
3. MCVideo client 1 has been received the URL of a video file available on the MCVideo server, e.g. within an MCDATA SDS.

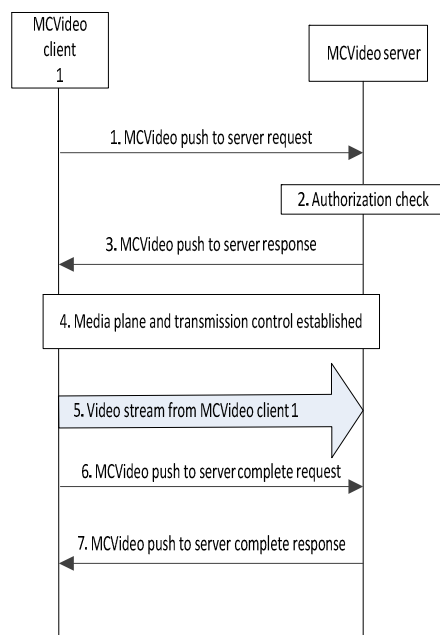

**Figure 7.3.2.4.2-1: One-from-server video pull**

1. MCVideo user on MCVideo client 1 initiates the pull of a video from the server and sends an MCVideo pull from server request to the MCVideo server. The request contains the URL of the video file and an SDP offer with media description..
2. MCVideo server checks whether MCVideo client 1 is authorized to pull the requested video from the server.
3. MCVideo server accepts the pull from server request and sends an MCVideo pull from server response. The response contains the SDP answer.

NOTE 1: The SDP may contain a media description that allows the receiving party to remote control the stream (e.g. rewind, fast forward).

4. MCVideo client 1 and MCVideo server have successfully established the media plane and transmission control for the video stream.
5. Video stream is transmitted from MCVideo server to MCVideo client 1. The MCVideo client 1 may be able to remote control the video stream, subject to SDP negotiation.
6. MCVideo user on MCVideo client 1 stops the video pull from the server and sends an MCVideo pull from server complete request.
7. MCVideo server acknowledges the end of the communication.

NOTE 2: Alternatively, based on internal criteria (e.g. maximum duration of the video playback, end of the video file), the MCVideo server can end the transmission.

## 7.3.3 Off-network video pull

### 7.3.3.1 General

A MCVideo client pulls a video from another MCVideo client directly, i.e. without involving the network.

### 7.3.3.2 Information flows for off-network video pull

The following information flows for private call specified in subclause 7.2.3.2 are used for off-network video pull:

- Private communication request; and
- Private communication answer response.

### 7.3.3.3 Video pull to self

#### 7.3.3.3.1 General

A MCVideo user requests another MCVideo user to deliver a video from its MCVideo client.

#### 7.3.3.3.2 Procedure

Figure 7.3.3.3.2-1 describes procedures for an off-network MCVideo video pull, initiated by MCVideo user A at MCVideo client A with another MCVideo client B, to pull a video to MCVideo client A.

MCVideo client B can be an autonomous MCVideo client or can be a human controlled MCVideo client. In either case, following procedure should be followed.

Pre-conditions:

1. MCVideo user A has initiated MCVideo video pull with MCVideo user B.
2. MCVideo client A and MCVideo client B are members of the same ProSe Discovery group and are ProSe 1:1 direct communication capable.
3. MCVideo client A has discovered MCVideo client B in proximity, associated with MCVideo user B, using ProSe Discovery procedures.



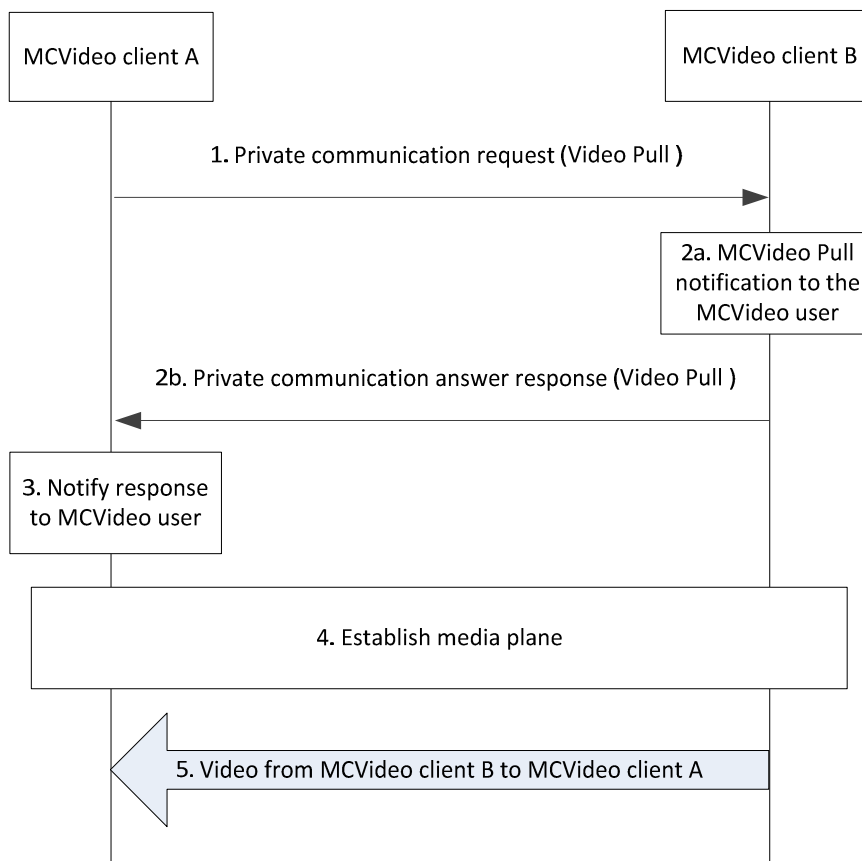

**Figure 7.3.3.3.2-1: Off-network video pull to self**

1. The MCVideo client A sends a Private communication request towards the MCVideo client B. The Private communication request includes a video pull request and indicates MCVideo client A as the intended recipient of the video pull. Private communication request contains the SDP offer.
- 2a. The MCVideo client B notifies the MCVideo user B about the incoming video pull request.
- 2b. The MCVideo client B automatically accepts the video pull request, and sends a Private communication answer response indicating the acceptance of the video pull request. The Private communication answer response contains SDP answer.

NOTE 1: Step 2a and step 2b can occur in any order.

3. The MCVideo client A notifies MCVideo user A about the incoming Private communication answer response as an indication of acceptance of MCVideo video pull request.
4. The MCVideo client A and the MCVideo client B establish the media plane for communication.

NOTE 2: If a MCVideo client fails to establish the communication, the MCVideo client should send a Private communication failed response indicating the failure reason to the appropriate MCVideo client.

5. Media is transmitted from MCVideo client B to MCVideo client A and presented to the MCVideo user A.

NOTE 3: If a Private communication failed response is received by a MCVideo client, before or after establishing the media session, if already established, the session is terminated and the MCVideo user is notified about the failure and its reason, if any.

## 7.4 Video push

### 7.4.1 General

MCVideo push is enabled in both on-network and off-network mode.

For on-network MCVideo push is supported between MCVideo clients, or between a MCVideo client and a MCVideo server.

For off-network MCVideo push is supported between MCVideo clients only.

### 7.4.2 On-network video push

#### 7.4.2.1 General

A MCVideo user triggers its MCVideo client to push a video to another MCVideo client or a MCVideo server.

A MCVideo user triggers its MCVideo client to trigger a remote video push, i.e. a second MCVideo client pushes a video to a third MCVideo client or to a MCVideo group.

#### 7.4.2.2 Information flows for on-network video push

The following information flows for private call specified in subclause 7.2.2.2 is used for on-network video push:

- MCVideo private call request (MCVideo client – MCVideo server)
- MCVideo private call request (MCVideo server – MCVideo client)
- MCVideo private call response (MCVideo client – MCVideo server)
- MCVideo private call response (MCVideo server – MCVideo client)
- MCVideo call end request

##### 7.4.2.2.1 Remote video push request

Table 7.4.2.2.1-1 describes the information flow remote video push request from the MCVideo client to the MCVideo server and from the MCVideo server to the MCVideo client.

**Table 7.4.2.2.1-1: Remote video push request**

Information Element	Status	Description
MCVideo ID	M	The MCVideo ID of the call originating party
MCVideo ID	M	The MCVideo ID of the source party who should transmit media
MCVideo ID	O (see NOTE)	The MCVideo ID of the destination party who should receive media
MCVideo group ID	O (see NOTE)	The MCVideo group ID of the destination group whose affiliated group members should receive media
SDP offer	O	Media parameters of MCVideo client.
Requested commencement mode	O	An indication that is included if the user is requesting a particular commencement mode
NOTE: MCVideo ID information element is present if remote video push to destination user is requested. MCVideo group ID information element is present if remote video push to group is requested.		

#### 7.4.2.2.2 Remote video push response

Table 7.4.2.2.2-1 describes the information flow remote video push request from the MCVideo server to the MCVideo client and from the MCVideo client to the MCVideo server.

**Table 7.4.2.2.2-1: Remote video push response**

Information Element	Status	Description
MCVideo ID	M	The MCVideo ID of the call originating party
MCVideo ID	M	The MCVideo ID of the source party who should transmit media
MCVideo ID	O (see NOTE)	The MCVideo ID of the destination party who should receive media
MCVideo group ID	O (see NOTE)	The MCVideo group ID of the destination group whose affiliated group members should receive media
Acceptance confirmation	O	An indication whether the user or group members have positively accepted the call.
SDP answer	M	Media parameters selected
NOTE: MCVideo ID information element is present if remote video push to destination user is requested. MCVideo group ID information element is present if remote video push to group is requested.		

#### 7.4.2.2.3 Remote video push release request

Table 7.4.2.2.3-1 describes the information flow Remote video push release request from the MCVideo client to the MCVideo server and from the MCVideo server to the MCVideo client.

**Table 7.4.2.2.3-1: Remote video push release request**

Information Element	Status	Description
MCVideo ID	M	The MCVideo ID of the call originating party
MCVideo ID	M	The MCVideo ID of the source party who should transmit media
MCVideo ID	O (see NOTE)	The MCVideo ID of the destination party who should receive media
MCVideo group ID	O (see NOTE)	The MCVideo group ID of the destination group whose affiliated group members should receive media
NOTE: MCVideo ID information element is present if remote video push to destination user is requested. MCVideo group ID information element is present if remote video push to group is requested.		

#### 7.4.2.2.4 MCVideo push to server request

Table 7.4.2.2.4-1 describes the information flow MCVideo push to server request from the MCVideo client to the MCVideo server.

**Table 7.4.2.2.4-1: MCVideo push to server request**

Information Element	Status	Description
MCVideo ID	M	The MCVideo ID of the calling party
Time limit	O	Requested duration of the stream to be recorded
SDP offer	M	Media parameters of MCVideo client

#### 7.4.2.2.5 MCVideo push to server response

Table 7.4.2.2.5-1 describes the information flow MCVideo push to server response from the MCVideo server to the MCVideo client.

**Table 7.4.2.2.5-1: MCVideo push to server response**

Information Element	Status	Description
MCVideo ID	M	The MCVideo ID of the calling party
Time limit	O	Accepted or imposed duration limit of the stream to be recorded
File URL	M	URL of the file the stream will be recorded to
SDP answer	M	Media parameters selected

#### 7.4.2.2.6 MCVideo push to server complete request

Table 7.4.2.2.6-1 describes the information flow MCVideo push to server complete request from the MCVideo client to the MCVideo server or from the MCVideo server to the MCVideo client.

**Table 7.4.2.2.6-1: MCVideo push to server complete request**

Information Element	Status	Description
MCVideo ID	M	The MCVideo ID of the calling party
Cause	M	End of communication cause

7.4.2.2.7 MCVideo push to server complete response

Table 7.4.2.2.7-1 describes the information flow MCVideo push to server complete response from the MCVideo client to the MCVideo server or from the MCVideo server to the MCVideo client.

**Table 7.4.2.2.7-1: MCVideo push to server complete response**

Information Element	Status	Description
MCVideo ID	M	The MCVideo ID of the calling party

7.4.2.3 One-to-one video push

7.4.2.3.1 General

One-to-one video push is a private call that only allows the calling party to transmit video to the called party, and the private call ends when the video transmission is completed.

7.4.2.3.2 One-to-one video push – call setup

Procedures in figure 7.4.2.3.2-1 are the basic signalling control plane procedures for the MCVideo client initiating establishment of MCVideo private call with the chosen MCVideo user for video push.

Pre-conditions:

This procedure is initiated either manually by the authorized MCVideo users at MCVideo client 1, or automatically due to triggers set by authorized MCVideo users at MCVideo client 1.

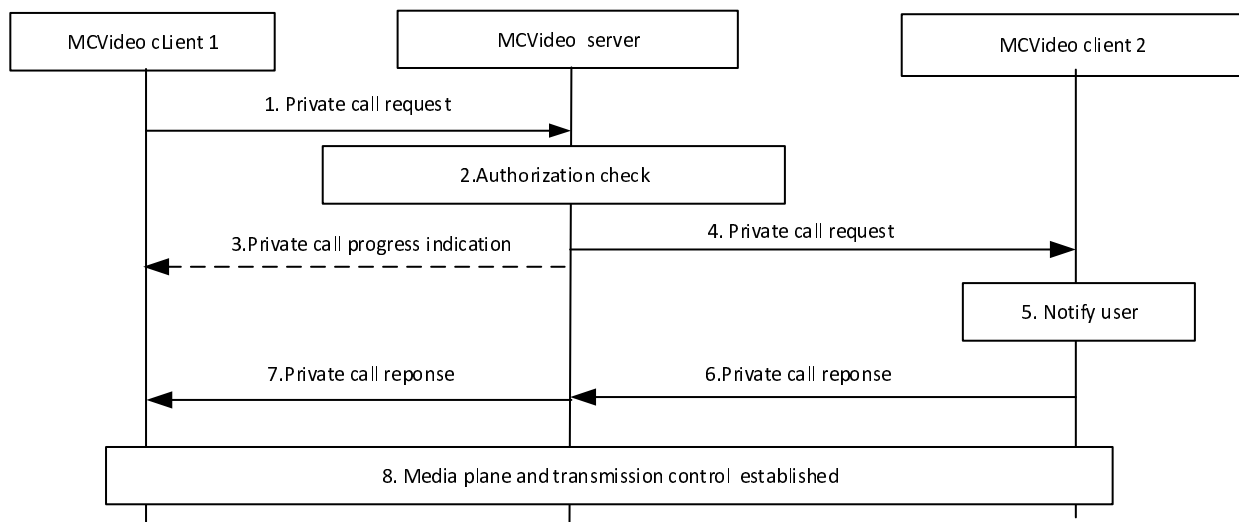

**Figure 7.4.2.3.2-1: One-to-one video push**

1. MCVideo client 1 initiates push video to MCVideo client 2, and sends a private call request to the MCVideo server using a service identifier as defined in 3GPP TS 23.228 [5] for MCVideo, for establishing a private call with the chosen MCVideo user for video push. The MCVideo private call request contains MCVideo ID of invited user, an SDP offer containing one or more media types and the video push indication to indicate that requestor is requesting to transmit video to the called party.

2. MCVideo server checks whether the MCVideo user at MCVideo client 1 is authorized to initiate the private call for video push, and that MCVideo user at MCVideo client 2 is authorized to receive the private call for video push.
3. MCVideo server may provide a progress indication to MCVideo client 1 to indicate progress in the call setup process.

NOTE 1: Step 3 can occur at any time following step 4, and prior to step 6.

4. If authorized, MCVideo server includes information that it communicates using MCVideo service, offers the same media types or a subset of the media types contained in the initial received request, includes the requested automatic commencement mode indication based on a requested commencement mode by the calling user or based upon the setting of the called MCVideo client and sends the corresponding MCVideo private call request towards the MCVideo client 2, including the MCVideo ID of the calling MCVideo user 1. If the called MCVideo user has registered to the MCVideo service with multiple MCVideo UEs and has designated the MCVideo UE for receiving the private calls, then the incoming MCVideo private call request is delivered only to the designated MCVideo UE.
5. The MCVideo client 2 notifies the user about the incoming private call for video push.
6. The MCVideo client 2 accepts the private call for video push, and sends an MCVideo private call response to the MCVideo server.
7. Upon receiving the MCVideo private call response from MCVideo client 2 accepting the private call request for video push, the MCVideo server informs the MCVideo client 1 about successful call establishment via a private call response message.
8. MCVideo client 1 and MCVideo client 2 have successfully established media plane and transmission control for media communication.

NOTE 2: When the video transmission is completed, the private call is released.

#### 7.4.2.3.3 One-to-one video push – call release

The private call release procedure specified in subclause 7.2.2.3.3 is used for one-to-one video push call release.

#### 7.4.2.4 One-to-server video push

##### 7.4.2.4.1 General

One-to-server video push is a private call between the calling party and the MCVideo server that allows the calling party to transmit video to the server for it to be recorded to a file. The one-to-server video push ends when the video transmission is stopped by the calling party or by the MCVideo server.

NOTE: This procedure fulfils part of the requirements for the stage 1 video processing capabilities feature.

##### 7.4.2.4.2 Procedure

Procedure in figure 7.4.2.4.2-1 is the basic signalling control plane procedures for the MCVideo client initiating establishment of MCVideo video push to the MCVideo server.

Pre-conditions:

1. MCVideo user 1 on MCVideo client 1 has been authenticated and authorized to use MCVideo service.
2. MCVideo client 1 is registered.

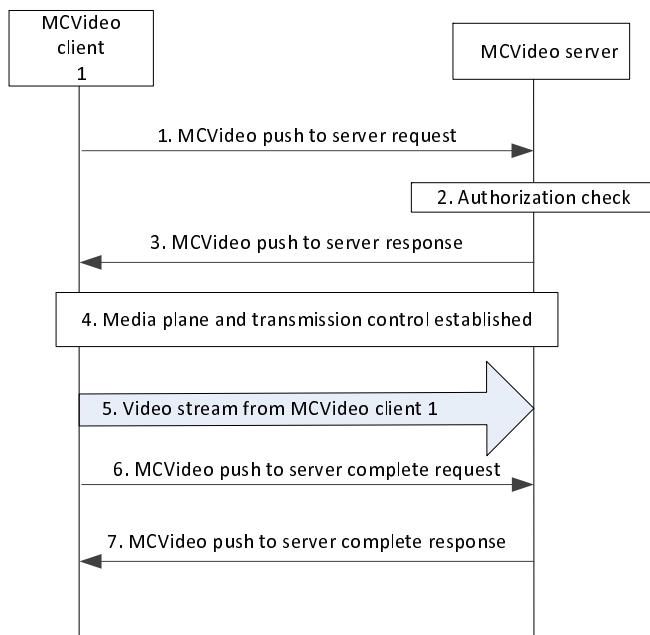

**Figure 7.4.2.4.2-1: One-to-server video push**

1. MCVideo user on MCVideo client 1 initiates the push of a video to the server and sends an MCVideo push to server request to the MCVideo server. The request contains an SDP offer with media.
2. MCVideo server checks whether MCVideo client 1 is authorized to push a video to the server.
3. MCVideo server accepts the push to server request and sends an MCVideo push to server response. The response contains the SDP answer and the URL of the file where the video stream will be recorded.

NOTE 1: Push request and response can include a negotiated maximum duration for the transmission.

4. MCVideo client 1 and MCVideo server have successfully established the media plane and transmission control for the video stream.
5. Video stream is transmitted from MCVideo client 1 to MCVideo server. The MCVideo server records the stream to the file whose URL has been given in the MCVideo push to server response.

NOTE 2: Notifications of new media availability can be sent by the initiating MCVideo user or by the MCVideo server using the URL received in the MCVideo push to server response.

NOTE 3: MCVideo clients which receive the notification can initiate a pull of the video stream from the server using the URL provided in the notification, at their convenience, using the procedure defined in subclause 7.3.2.4.2.

6. MCVideo user on MCVideo client 1, or MCVideo client 1 based on pre-defined criteria (e.g. duration), stops the video push to the server and sends an MCVideo push to server complete request.
7. MCVideo server acknowledges the end of the communication.

NOTE 4: Alternatively, based on internal criteria (e.g. maximum duration of the recorded video), the MCVideo server can end the transmission.

## 7.4.2.5 Remotely initiated video push

### 7.4.2.5.1 General

Remotely initiated video push is a private call remotely initiated by a user that only allows a source user to transmit video to a destination, and the private call ends when the video transmission is completed or released by the authorized user who remotely initiated video push call.

### 7.4.2.5.2 Remotely initiated video push – call setup

The procedure describes the case where an authorized MCVideo user is initiating an remotely initiated video push call from source MCVideo user to a destination MCVideo user. Only the source user is allowed to transmit video to the destination user.

Procedures in figure 7.4.2.5.2-1 are the basic signalling control plane procedures for the MCVideo client remotely initiating establishment of MCVideo private call between the source and destination MCVideo users.

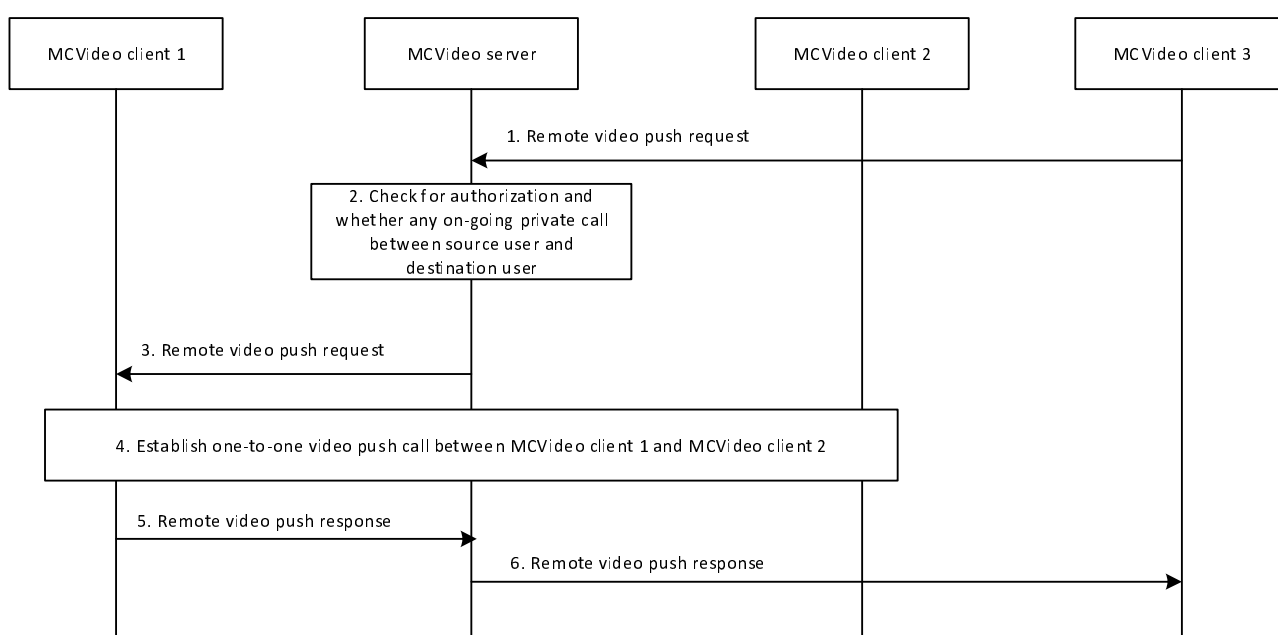

**Figure 7.4.2.5.2-1: Remotely initiated video push – call setup**

1. MCVideo user on MCVideo client 3 initiates remote video push from MCVideo client 1 to MCVideo client 2, by sending a remote video push request to the MCVideo server for establishing a one-to-one video push call between MCVideo client 1 and MCVideo client 2. The remote video push call request contains MCVideo ID of source (MCVVideo client 1) and destination (MCVVideo client 2) users
2. MCVideo server checks whether the MCVideo user at MCVideo client 3 is authorized to remotely initiate video push call between the source user and the destination user. MCVideo server also checks if there is any on-going call between the source user and the destination user.
3. If MCVideo client 3 is authorized and there is no on-ongoing private call between source user and destination user, the MCVideo server sends the remote video push request message to MCVideo client 1 including the information of MCVideo ID of source and destination users.
4. The MCVideo client 1 accepts the remote video push request and establishes a one-to-one video push call between MCVideo client 1 and MCVideo client 2 as described in the subclause 7.4.2.3.2. The video is transmitted from MCVideo client 1 to MCVideo Client 2.
5. The MCVideo client 1 sends a remote video push response message to MCVideo server indicating success or failure of call establishment between MCVideo client 1 and MCVideo client 2.



- Upon receiving the remote video push response from MCVideo client 1, the MCVideo server informs the MCVideo client 3 about success or failure of the call establishment by sending a remote video push response message.

NOTE: Steps 5 and 6 can occur before step 4.

#### 7.4.2.5.3 Remotely initiated video push – call release by authorized user

The procedure describes the case where an authorized MCVideo user is releasing an remotely initiated video push call.

Procedures in figure 7.4.2.5.3-1 are the basic signalling control plane procedures for the MCVideo client releasing the remotely initiated video push call between the source and destination users.

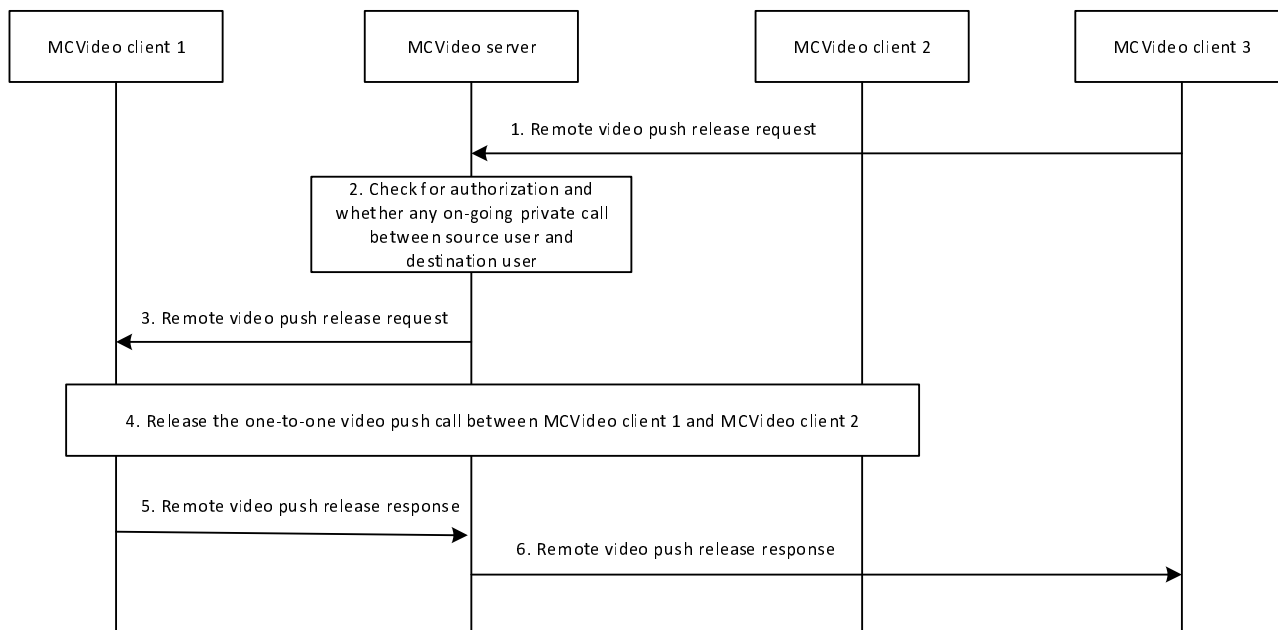

**Figure 7.4.2.5.3-1: Remotely initiated video push – call release by authorized user**

- MCVideo user on MCVideo client 3 initiates release of remotely initiated video push call between MCVideo client 1 and MCVideo client 2, by sending a remote video push release request to the MCVideo server for releasing a one-to-one video push call between MCVideo client 1 and MCVideo client 2. The remote video push release request contains MCVideo ID of source user (MCVideo client 1) and destination user (MCVideo client 2).
- MCVideo server checks whether the MCVideo user at MCVideo client 3 is authorized to release the remotely initiated video push call between MCVideo client 1 and MCVideo client 2, and whether there is any on-going one-to-one video push call between MCVideo client 1 and MCVideo client 2.
- MCVideo server sends the remote video push release request to MCVideo client 1 for releasing the on-going one-to-one video push call between MCVideo client 1 and MCVideo client 2.
- The MCVideo client 1 accepts the remote video push release request and performs the release procedure for the one-to-one video push call between MCVideo client 1 and MCVideo client 2 as described in the subclause 7.4.2.3.3.
- The MCVideo client 1 sends a remote video push release response to the MCVideo server indicating the release of the one-to-one video push call between MCVideo client 1 and MCVideo client 2.
- Upon receiving the remote video push release response from MCVideo client 1, the MCVideo server informs the MCVideo client 3 about the one-to-one video push call release by sending a remote video push release response message.

NOTE: Steps 5 and 6 can occur before step 4.

## 7.4.2.6 Remotely initiated video push to group

### 7.4.2.6.1 General

Remotely initiated video push to group is a type of broadcast group call that only allows the originating user to remotely request a source user to transmit video to the group, and the group call ends when the video transmission is completed or the authorized user releases the remotely initiated video push to group call.

### 7.4.2.6.2 Remotely initiated video push to group – call setup

The procedure describes the case where an authorized MCVideo user is initiating video push to group call for transmitting video from a source MCVideo user to the group. Only the source MCVideo user is allowed to transmit video.

Procedures in figure 7.4.2.6.2-1 are the basic signalling control plane procedures for the MCVideo client remotely initiating a video push to group call.

Pre-conditions:

1. MCVideo client 1 and MCVideo client 2 are affiliated members of the group X.
2. The user on MCVideo client 1 is authorized to remotely initiate a video push to group call to enable transmitting the video from the user on MCVideo client 2.

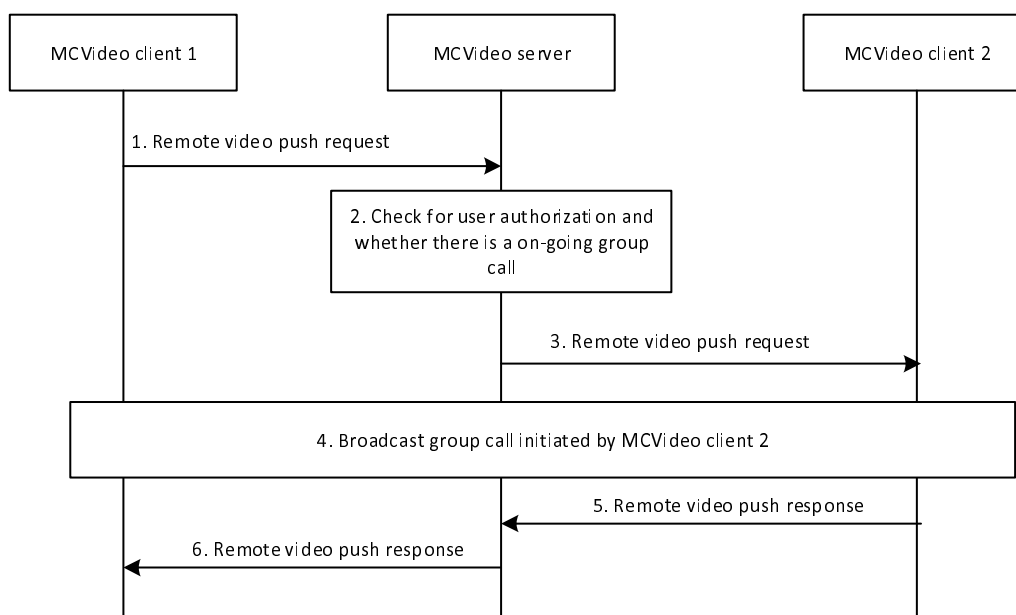

**Figure 7.4.2.6.2-1: Remotely initiated video push to group – call setup procedure**

1. MCVideo user on MCVideo client 1 remotely initiates a video push to group from MCVideo client 2, by sending a remote video push request to the MCVideo server. The remote video push request contains MCVideo ID of the source user (user of MCVideo client 2) and the MC service group ID of the group X to which the video transmission is requested.
2. MCVideo server checks whether the MCVideo user at MCVideo client 1 is authorized to remotely initiate a video push to group, and also checks whether MCVideo client 2 is transmitting video in any on-going MCVideo group call on group X. If MCVideo client 2 is already transmitting video to group X then a suitable response is provided in step 6 to MCVideo client 1.
3. The MCVideo server sends a remote video push request initiated by MCVideo client 1 to MCVideo client 2. The remote video push request contains MCVideo ID of the source user, the MC service group ID of the group X to which the video transmission is to be initiated by the source user and an SDP offer containing one or more media types.

4. MCVideo client 2 initiates a MCVideo broadcast group call on group X. The MCVideo client 2 begins to transmit video to the group X.
5. The MCVideo client 2 sends a remote video push response message to MCVideo server indicating success or failure in remotely initiating the video push to group X.
6. The MCVideo server sends a remote video push response message to MCVideo client 1 indicating success or failure in remotely initiating the video push to group X by the MCVideo client 2.

NOTE: Steps 5 and 6 can occur before step 4.

#### 7.4.2.6.3 Remotely initiated video push to group – call release by authorized user

The procedure describes the case where an MCVideo user is remotely releasing a video push to group call for ending the video transmission from the source MCVideo user.

Procedures in figure 7.4.2.6.3-1 are the basic signalling control plane procedures for the MCVideo client remotely releasing a video push to group call.

Pre-condition:

- MCVideo client 1 and MCVideo client 2 are affiliated members of the group X and there is an on-going broadcast group call on group X from MCVideo client 2 remotely initiated by MCVideo client 1 as described in subclause 7.4.2.6.2.

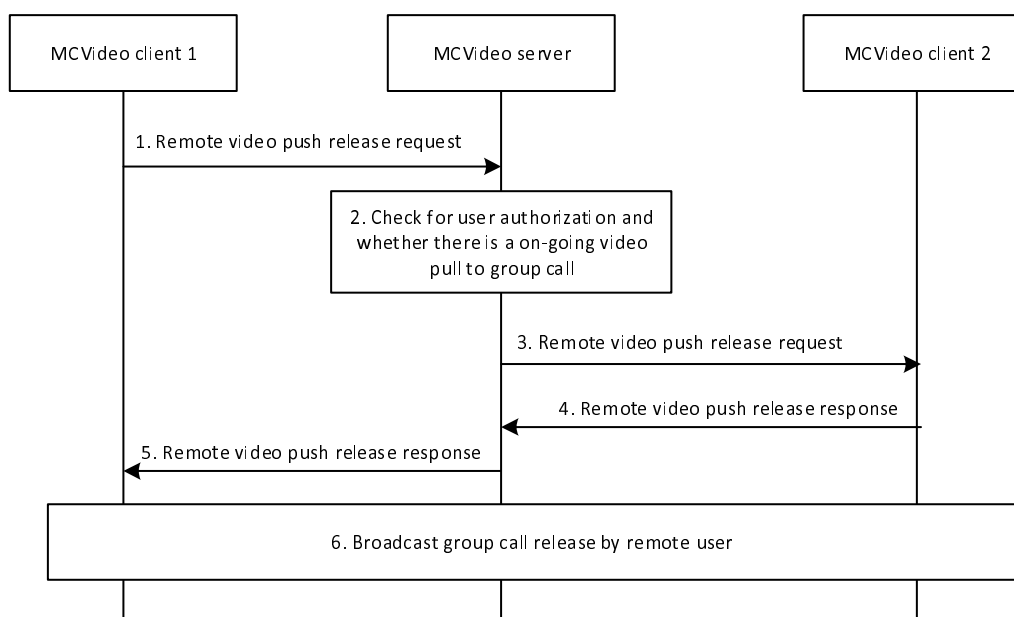

**Figure 7.4.2.6.3-1: Remotely initiated video push to group – call release by authorized user**

1. MCVideo user on MCVideo client 1 remotely initiates a release of the video push to group call from MCVideo client 2, by sending a remote video push release request to the MCVideo server. The remote video push release request contains MCVideo ID of the source user (user of MCVideo client 2) and the MC service group ID of the group X to which the video transmission is to be released.
2. MCVideo server checks whether the MCVideo user at MCVideo client 1 is authorized to remotely release a video push to group call, and also checks whether MCVideo client 2 is transmitting video in an on-going MCVideo group call on group X remotely initiated by MCVideo client 1. If MCVideo client 2 is not transmitting video on group X then a suitable response is provided in step 5 to MCVideo client 1.
3. The MCVideo server sends a remote video push release request initiated by MCVideo client 1 to MCVideo client 2. The remote video push release request contains MCVideo ID of the source user, the MC service group ID of the group X to which the video transmission is to be released.
4. The MCVideo client 2 sends a remote video push release response message to MCVideo server indicating the release of video push to group call.

5. The MCVideo server sends a remote video push release response message to MCVideo client 1 indicating the release of video push to group call.
6. MCVideo client 2 stops the video transmission to the group X and releases the MCVideo broadcast group call on group X remotely initiated by MCVideo client 1.

NOTE: Step 6 can occur before steps 4 and 5.

## 7.4.3 Off-network video push

### 7.4.3.1 General

A MCVideo user triggers its MCVideo client to push a video to another MCVideo client.

A MCVideo user triggers its MCVideo client to trigger a remote video push, which requests a second MCVideo client to push a video to a third MCVideo client or to a MCVideo group.

Off-network remote video push works without involving the network.

### 7.4.3.2 Information flows for off-network video push

#### 7.4.3.2.1 Remote video push request

Table 7.4.3.2.1-1 describes the information flow for the remote video push request sent from one MCVideo client to other MCVideo client(s).

**Table 7.4.3.2.1-1: Remote video push request**

Information element	Status	Description
MCVideo ID	M	The identity of the MCVideo user remotely requesting the video push
MCVideo ID	M	The identity of the MCVideo user from whom the video push is requested
Video information	O	Information identifying the video
MCVideo group ID	O	The MCVideo group ID to which the video is to be transmitted.

#### 7.4.3.2.2 Video push trying response

Table 7.4.3.2.2-1 describes the information flow for the video push trying response sent from one MCVideo client to another MCVideo client.

**Table 7.4.3.2.2-1: Video push trying response**

Information element	Status	Description
MCVideo ID	M	The identity of the MCVideo user sending the trying response
MCVideo ID	M	The identity of the MCVideo user to whom the trying response is sent
MCVideo ID	M	The identity of the MCVideo user to whom the video is attempted

#### 7.4.3.2.3 Notification of video push

Table 7.4.3.2.3-1 describes the information flow for the notification of video push sent from one MCVideo client to another MCVideo client.

**Table 7.4.3.2.3-1: Notification of video push**

Information element	Status	Description
MCVideo ID	M	The identity of the MCVideo user sending the notification
MCVideo ID	M	The identity of the MCVideo user to whom the notification is sent
MCVideo ID	M	The identity of the MCVideo user to whom the video is pushed

### 7.4.3.3 Video push to another MCVideo user

#### 7.4.3.3.1 General

The MCVideo Push is the capability of a MCVideo user to push a video to another MCVideo user. A MCVideo user can push a video which is:

- being received by the MCVideo user from another a MCVideo client; or
- being recorded live on the MCVideo client.

#### 7.4.3.3.2 Procedure

Figure 7.4.3.3.2-1 describes procedures for an off-network MCVideo video push, initiated by MCVideo client B with another MCVideo client C, to push a video received from MCVideo client A to MCVideo client C.

MCVideo client A or MCVideo client C or both can be autonomous MCVideo clients or can be human controlled MCVideo clients. In any such combination, following the procedure is followed.

MCVideo client A and MCVideo client B may belong to the same MCVideo user.

Pre-conditions:

1. MCVideo client A and MCVideo client B are engaged in MCVideo communication, where MCVideo client B is receiving media from MCVideo client A.
2. MCVideo user B has initiated MCVideo video push with MCVideo user C.
3. MCVideo client B and MCVideo client C are members of the same ProSe Discovery group and are ProSe 1:1 direct communication capable.
4. MCVideo client B has discovered MCVideo client C in proximity, associated with MCVideo user C, using ProSe Discovery procedures.

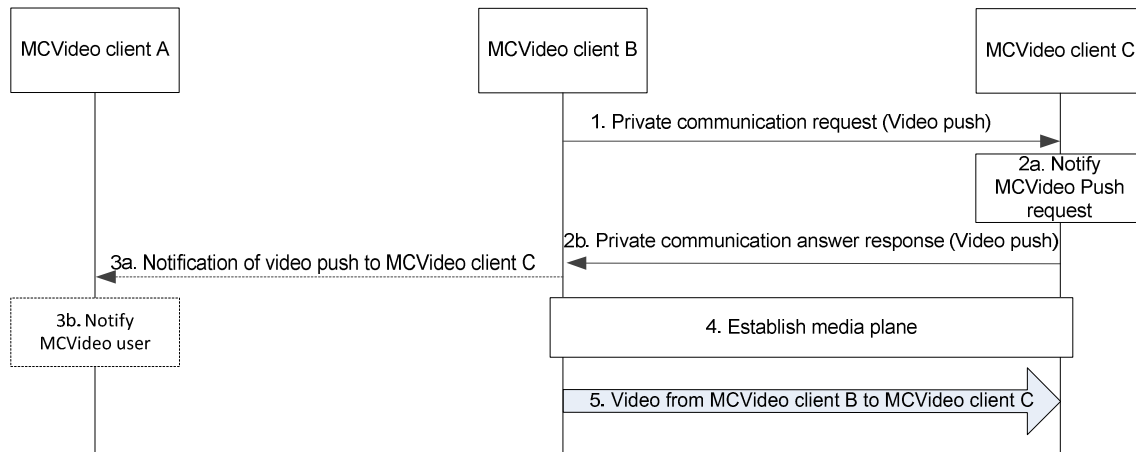

**Figure 7.4.3.3.2-1: Off-network Video push to another MCVideo user**

1. The MCVideo client B sends a Private communication request towards MCVideo client C. The Private communication request indicates that the request is for video push and contains the SDP offer.
- 2a. The MCVideo client C may notify the MCVideo user C about the MCVideo Push request (if the MCVideo client C is human controlled)
- 2b. The MCVideo client C automatically accepts the Private communication request for video push and sends a Private communication answer response to MCVideo client B. The Private communication answer response contains SDP answer.

NOTE 1: Step 2a and step 2b can occur in any order.

- 3a. If configured, the MCVideo client B notifies MCVideo client A about the video being pushed to MCVideo client C by sending a notification message to MCVideo client A.
- 3b. If configured, the MCVideo client A may notify the MCVideo user A about the video being pushed to MCVideo client C.
4. The MCVideo client B and MCVideo client C establish the media plane for communication.
5. Video being received by MCVideo client B from MCVideo client A is transmitted from MCVideo client B to MCVideo client C and presented to the MCVideo user C.

NOTE 2: If a MCVideo client fails to establish the communication, the MCVideo client should send a Private communication failed response indicating the failure reason to the appropriate MCVideo client(s).

NOTE 3: If a Private communication failed response is received by a MCVideo client, before or after establishing the media session, if already established, the session is terminated and the MCVideo user is notified about the failure and its reason, if any.

## 7.4.3.4 Remotely initiated video push

### 7.4.3.4.1 General

The MCVideo push is the capability of a MCVideo user to push a video from a second MCVideo user to a third MCVideo user.

### 7.4.3.4.2 Procedure

Figure 7.4.3.4.2-1 describes procedures for a remotely initiated off-network MCVideo video push, initiated by MCVideo user A at MCVideo client A with another MCVideo client B, to push a video to MCVideo client C.

MCVideo client B can be an autonomous MCVideo client or can be a human controlled MCVideo client. In either case, following procedure is followed.

Pre-conditions:

1. MCVideo user A has remotely initiated MCVideo video push with MCVideo user B.
2. MCVideo client A and MCVideo client B are members of the same ProSe Discovery group and are ProSe 1:1 direct communication capable.
3. MCVideo client A has discovered MCVideo client B in proximity, associated with MCVideo user B, using ProSe Discovery procedures.

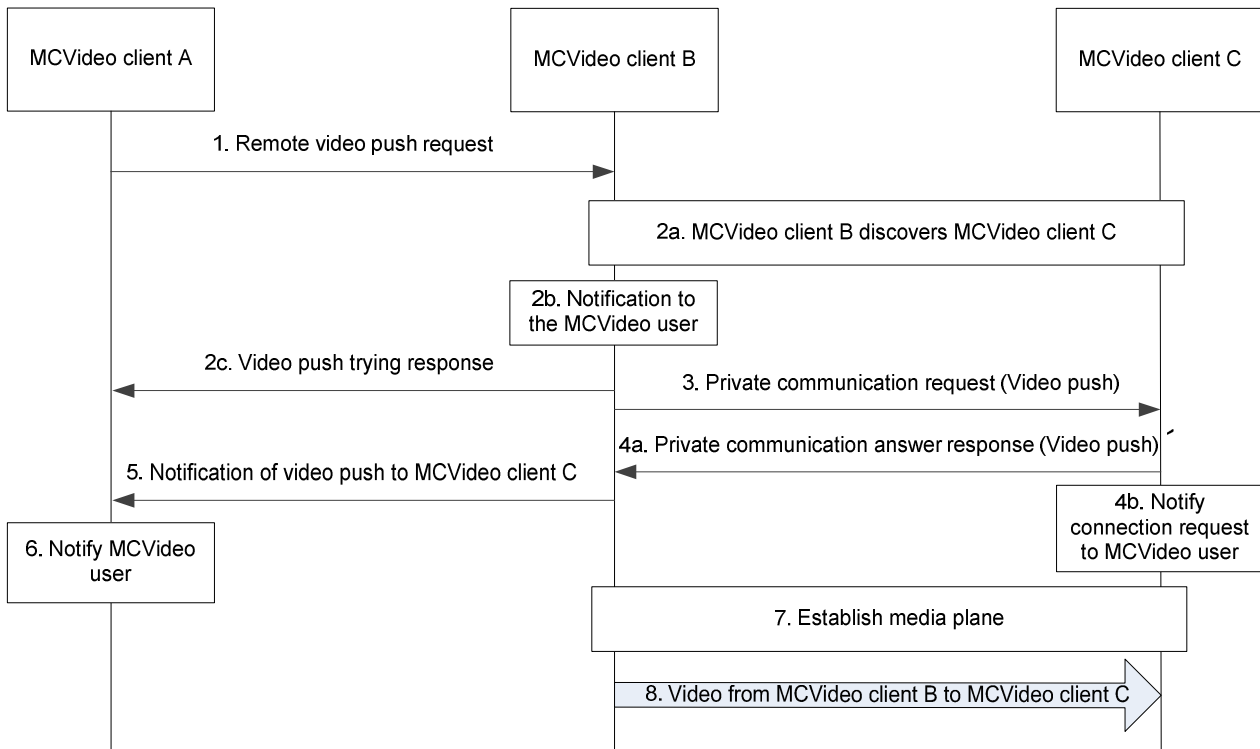

**Figure 7.4.3.4.2-1: Remotely initiated off-network video push**

1. The MCVideo client A sends a Video push request towards the MCVideo client B. The Video push request indicates MCVideo client C as the intended recipient.
- 2a. The MCVideo client B checks whether there is on-going private communication with MCVideo client C. If there is on-going private communication with MCVideo client C, then step 3, step 4 and step 5 are skipped, else MCVideo client B enables ProSe layer to discover MCVideo client C as specified in subclause 7.2.3.

NOTE 1: MCVideo client A may provide the IP address of the MCVideo client C as part of the Video push request to the MCVideo B client. If such is the case, MCVideo client B does not require discovering MCVideo client C.

2b. The MCVideo client B notifies the MCVideo user B about the incoming Video push request (if MCVideo client B is human controlled).

2c. The MCVideo client B sends a video push trying response to MCVideo client A indicating that it is attempting to establish a connection with MCVideo client C,

NOTE 2: Step 2a, 2b and 2c can occur in any order.

3. Once the required details of MCVideo client C are obtained (either by discovery or from MCVideo client A) the MCVideo client B accepts the Video push request, and sends a Private communication request to MCVideo client C. The Private communication request indicates that the request was in response to the video push request from the MCVideo client A. The Private communication request contains the SDP offer.

4a. MCVideo client C sends a Private communication answer response to MCVideo client B in response to the Private communication request. The Private communication answer response contains the SDP answer.

4b: The MCVideo client C notifies MCVideo user C about the incoming Private communication request as an indication of incoming video.

NOTE 3: Step 4a and step 4b can occur in any order.

5. Upon receiving a Private communication answer response from the MCVideo client C, the MCVideo client B sends a notification message to the MCVideo client A indicating that MCVideo client C has accepted the request.

6. MCVideo client A notifies the MCVideo user A about the acceptance of the request by MCVideo client C (if the MCVideo client A is human controlled)

7. The MCVideo client B and the MCVideo client C establish the media plane for communication.

NOTE 4: If a MCVideo client fails to establish the communication, the MCVideo client should send a Private communication failed response indicating the failure reason to the appropriate MCVideo client.

8: Media is transmitted from MCVideo client B to MCVideo client C and presented to the MCVideo user C.

NOTE 5: If a Private communication failed response is received by a MCVideo client, before or after establishing the media session, if already established, the session is terminated and the MCVideo user is notified about the failure and its reason, if any.

NOTE 6: If the MCVideo client B fails to transmit the video to MCVideo client C, it should send a notification to MCVideo client A, indicating the reason.

### 7.4.3.5 Remotely initiated video push to a group

#### 7.4.3.5.1 General

The MCVideo push is the capability of a MCVideo user to push a video from a second MCVideo user to a MCVideo group.

#### 7.4.3.5.2 Procedure

Figure 7.4.3.5.2-1 describes procedures for an off-network remote video push request, initiated by MCVideo user A at MCVideo client A towards a MCVideo client B, to initiate a video push to MCVideo group G.

MCVideo client B can be an autonomous MCVideo client or can be a human controlled MCVideo client. In either case, following procedure should be followed.

Pre-conditions:

1. MCVideo client A and MCVideo client B are members of MCVideo group G.
2. MCVideo user A has initiated remote video push request with MCVideo user B to initiate a video push to MCVideo group G.



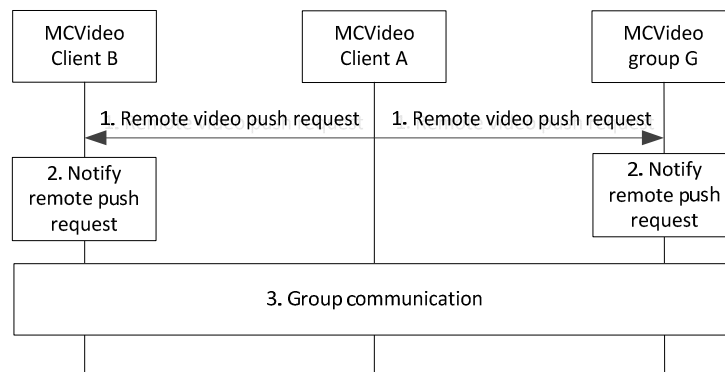

**Figure 7.4.3.5.2-1: Remotely initiated video push to a group**

1. MCVideo client A sends a remote video push request towards the MCVideo group. The remote video push request indicates MCVideo client B as the intended target of the request and MCVideo group G as the intended recipient.
2. Upon receiving the remote video push request as the intended target of the request, the MCVideo client B notifies the MCVideo user B of the remote video push request, if the MCVideo client B is human controlled. Other MCVideo group members notify their respective MCVideo users of the remote video push request.
3. The MCVideo client B automatically accepts the remote video push request and sends a group communication announcement message with video push indication towards the MCVideo group, as described in subclause 7.1.3.3. The group communication announcement message contains an SDP body and an indication that the group communication announcement is for video push.

## 7.5 Capability information sharing

### 7.5.1 General

The MCVideo UE can store its capabilities information at the MCVideo server which can be retrieved by authorized users or MCVideo group members during on-network operations. The MCVideo UE can share their capabilities periodically or on-demand to another MCVideo UE or to MCVideo group members during off-network operations.

### 7.5.2 On-network capability information sharing

#### 7.5.2.1 General

The MCVideo UE can store and update its capabilities information at the MCVideo server. Authorized MCVideo users or MCVideo group members can retrieve the capabilities information from the MCVideo server directly or via subscription and notification.

#### 7.5.2.2 Information flows for on-network capability information sharing

##### 7.5.2.2.1 Update MCVideo capabilities info request

Table 7.5.2.2.1-1 describes the information flow update MCVideo capabilities info request from the MCVideo client to the MCVideo server.

**Table 7.5.2.2.1-1: Update MCVideo capabilities info request**

Information element	Status	Description
MCVideo ID	M	Identity of the MCVideo user who is logged into the MCVideo UE
MCVideo capabilities	M	List of capabilities available at the MCVideo UE

NOTE: The device identification associated with MCVideo UE used for providing the MCVideo capabilities when the user logs on to multiple MCVideo UEs is specified by stage 3.

#### 7.5.2.2.2 Update MCVideo capabilities info response

Table 7.5.2.2.2-1 describes the information flow update MCVideo capabilities info response from the MCVideo server to the MCVideo client.

**Table 7.5.2.2.2-1: Update MCVideo capabilities info response**

Information element	Status	Description
Result	M	Indicates success or failure

#### 7.5.2.2.3 Get MCVideo capabilities info request

Table 7.5.2.2.3-1 describes the information flow get MCVideo capabilities info request from the MCVideo client to the MCVideo server.

**Table 7.5.2.2.3-1: Get MCVideo capabilities info request**

Information element	Status	Description
MCVideo ID	M	Identity of the requesting MCVideo user
MCVideo ID	O	Identity of the target MCVideo user

#### 7.5.2.2.4 Get MCVideo capabilities info response

Table 7.5.2.2.4-1 describes the information flow get MCVideo capabilities info response from the MCVideo server to the MCVideo client.

**Table 7.5.2.2.4-1: Get MCVideo capabilities info response**

Information element	Status	Description
Result	M	Indicates success or failure
MCVideo capabilities	M	List of capabilities available at the requested MCVideo user's UE

#### 7.5.2.2.5 Subscribe MCVideo capabilities info request

Table 7.5.2.2.5-1 describes the information flow subscribe MCVideo capabilities info request from the MCVideo client to the MCVideo server.

**Table 7.5.2.2.5-1: Subscribe MCVideo capabilities info request**

Information element	Status	Description
MCVideo ID	M	Identity of the requesting MCVideo user
MCVideo ID	O	Identity of the target MCVideo user

#### 7.5.2.2.6 Subscribe MCVideo capabilities info response

Table 7.5.2.2.6-1 describes the information flow subscribe MCVideo capabilities info response from the MCVideo server to the MCVideo client.

**Table 7.5.2.2.6-1: Subscribe MCVideo capabilities info response**

Information element	Status	Description
Result	M	Indicates success or failure

7.5.2.2.7 Notify MCVideo capabilities info request

Table 7.5.2.2.7-1 describes the information flow notify MCVideo capabilities info request from the MCVideo server to the MCVideo client.

**Table 7.5.2.2.7-1: Notify MCVideo capabilities info request**

Information element	Status	Description
MCVideo ID	M	Identity of the MCVideo user logged in at the target MCVideo UE
MCVideo capabilities	M	List of capabilities available at the target MCVideo user's UE

7.5.2.2.8 Notify MCVideo capabilities info response

Table 7.5.2.2.8-1 describes the information flow notify MCVideo capabilities info response from the MCVideo client to the MCVideo server.

**Table 7.5.2.2.8-1: Notify MCVideo capabilities info response**

Information element	Status	Description
Result	M	Indicates success or failure

7.5.2.3 Update MCVideo capabilities information at the MCVideo server

The procedure for updating the MCVideo capabilities information at the MCVideo server is described in figure 7.5.2.3-1.

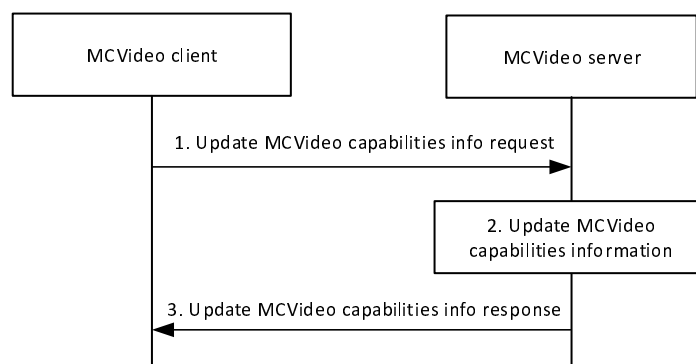

**Figure 7.5.2.3-1: Update MCVideo capabilities information at the MCVideo server**

1. The MCVideo client sends a update MCVideo capabilities info request message to MCVideo server to update the capabilities information available at the MCVideo client
2. The MCVideo server stores the updated MCVideo capabilities information received from the MCVideo client.
3. The MCVideo server provides a Update MCVideo capabilities info response indicating success or failure.

7.5.2.4 Retrieve MCVideo capabilities information by the MCVideo client

The procedure for retrieval of MCVideo capabilities information by the MCVideo client is described in figure 7.5.2.4-1.

Pre-conditions:

- The MCVideo server has received MCVideo capabilities information from MCVideo clients and has stored this information;
- The MCVideo user is authorized to access the MCVideo capabilities information from the MCVideo server.

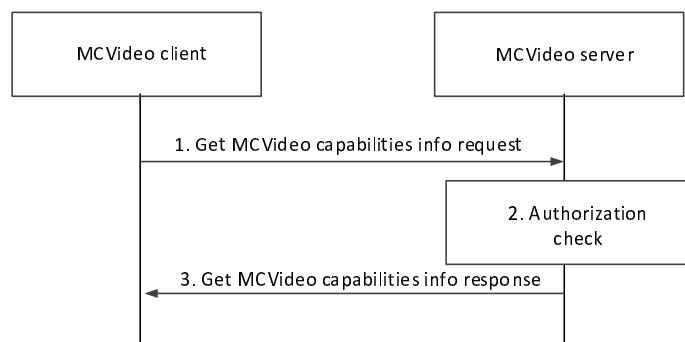

**Figure 7.5.2.4-1: Retrieve MCVideo capabilities information by the MCVideo client**

1. The MCVideo client requests the MCVideo capabilities information by specifying some criteria (e.g. parameters, MCVideo ID).
2. The MCVideo server checks whether the user of the MCVideo client is authorized to retrieve the requested MCVideo capabilities information.
3. If authorized, the MCVideo server provides the requested MCVideo capabilities information to the MCVideo client.

### 7.5.2.5 Subscription and notification for MCVideo capabilities information

The procedure for subscription for MCVideo capabilities information as described in figure 7.5.2.5-1 is used by the MCVideo client to indicate to the MCVideo server that it wishes to receive updates of MCVideo capabilities information for which it is authorized.

Pre-conditions:

- The MCVideo server has some MCVideo capabilities information stored.

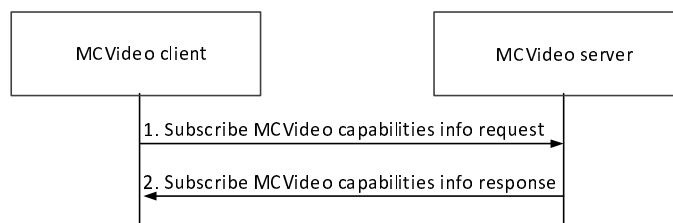

**Figure 7.5.2.5-1: Subscription for MCVideo capabilities information**

1. The MCVideo client subscribes to the MCVideo capabilities information stored at the MCVideo server using the subscribe MCVideo capabilities info request.
2. The MCVideo server provides a subscribe MCVideo capabilities info response to the MCVideo client indicating success or failure of the request.

The procedure for notification of MCVideo capabilities information as described in figure 7.5.2.5-2 is used by the MCVideo server to inform the MCVideo client that new or updated MCVideo capabilities information is available.

Pre-conditions:

- The MCVideo client has subscribed to the MCVideo capabilities information
- The MCVideo server has received and stored new or updated MCVideo capabilities information.

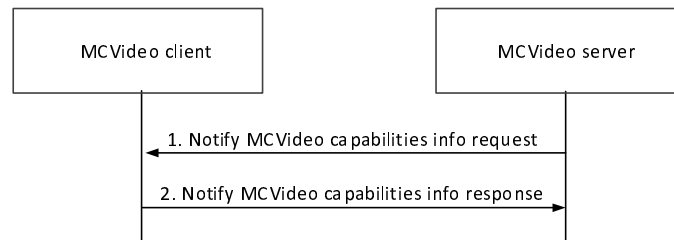

**Figure 7.5.2.5-2: Notification of MCVideo capabilities information**

1. The MCVideo server provides the notification to the MCVideo client, who previously subscribed for the MCVideo capabilities information.
2. The MCVideo client provides a notify MCVideo capabilities info response to the MCVideo server.

If the MCVideo server has notified the MCVideo client about new or updated MCVideo capabilities information through this procedure, the MCVideo client may then follow the procedure described in subclause 7.5.2.4 in order to retrieve that MCVideo capabilities information.

## 7.5.3 Off-network capability information sharing

### 7.5.3.1 General

Each MCVideo client within a MCVideo group needs to share its video capabilities with other members of the MCVideo group.

Video capability sharing can be done by sending information periodically as described in subclause 7.5.3.3 or on request as described in subclause 7.5.3.4.

The receiving MCVideo clients need to store and update the video capability information from the sharing MCVideo client.

### 7.5.3.2 Information flows for Off-network capability information sharing

#### 7.5.3.2.1 Capability request

Table 7.5.3.2.1-1 describes the information flow for the capability request sent from the MCVideo client to other MCVideo client(s).

**Table 7.5.3.2.1-1: Capability request**

Information Element	Status	Description
MCVideo ID	M	The identity of the MCVideo user requesting the capabilities
MCVideo ID	O	The identity of the MCVideo user towards whom the capability request was sent.
MCVideo group ID	O	The MCVideo group ID towards which the request was sent
Search criteria	O	A criteria filter for the capability request (e.g. category tags, video capabilities etc.)

#### 7.5.3.2.2 Capability announcement

Table 7.5.3.2.2-1 describes the information flow for the capability announcement sent from the MCVideo client to other MCVideo client(s).

**Table 7.5.3.2.2-1: Capability announcement**

Information Element	Status	Description
MCVideo ID	M	The identity of the MCVideo user announcing the capabilities
MCVideo ID	O	The identity of the MCVideo user towards whom the capability announcement was sent.
MCVideo group ID	O	The MCVideo group ID towards which the announcement was sent
Category tags	O	Category tags associated with a specific MCVideo UE or a video
Video capabilities	O	Set of video capabilities (e.g. codecs), camera capabilities (e.g. self-activated camera, wide field of view etc.)
Location	O	The location of the MCVideo user announcing the capabilities, if known

### 7.5.3.2.3 Activity status request

Table 7.5.3.2.3-1 describes the information flow for the activity status request sent from the MCVideo client to other MCVideo client(s).

**Table 7.5.3.2.3-1: Activity status request**

Information Element	Status	Description
MCVideo ID	M	The identity of the MCVideo user requesting the activity status
MCVideo ID	O	The identity of the MCVideo user towards whom the activity status request was sent.
MCVideo group ID	O	The MCVideo group ID towards which the activity status request was sent

### 7.5.3.2.4 Activity status announcement

Table 7.5.3.2.4-1 describes the information flow for the activity status announcement sent from the MCVideo client to other MCVideo client(s).

**Table 7.5.3.2.4-1: Activity status announcement**

Information Element	Status	Description
MCVideo ID	M	The identity of the MCVideo user announcing the activity status
Activity status	M	Current status of MCVideo UE's activities (e.g. receiving video, transmitting video, or recording video)
Video details	O	Details of the video like category tags or bit rate.
MCVideo ID	O	The identity of the MCVideo user towards whom the activity status announcement was sent.
MCVideo group ID	O	The MCVideo group ID towards which the activity status announcement was sent

### 7.5.3.3 Periodic capability announcements

#### 7.5.3.3.1 General

The MCVideo client periodically provides its video capability information to other members of the MCVideo group.

#### 7.5.3.3.2 Procedure

Figure 7.5.3.3.2-1 describes procedures for periodic capability announcements.

Each MCVideo client periodically sends a Capability announcement messages to the MCVideo group. This Capability announcement message is received by all other members of MCVideo group members.

Upon receiving such a Capability announcement message, the MCVideo client stores/updates the information about the transmitting MCVideo client.

Pre-conditions:

1. Information for ProSe direct communications corresponding to the MCVideo group and its mapping to ProSe Layer-2 Group ID are pre-configured in MCVideo client 1.
2. MCVideo client 1 to MCVideo client N are members of the same MCVideo group.

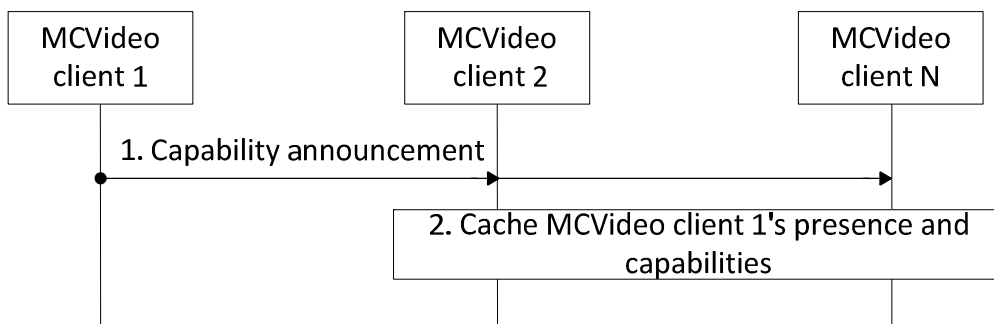

**Figure 7.5.3.3.2-1: Periodic capability announcements**

1. MCVideo client 1 periodically sends a Capability announcement message, which contains its capability information with other relevant information.

- Other MCVideo clients, upon receiving a Capability announcement message from MCVideo client 1, cache its presence and capability information along with other relevant information.

NOTE: Capability announcement may include specific category tags (e.g. certain video camera), video capabilities of the client, location, camera angles, camera orientation, etc.

### 7.5.3.4 Request capabilities from client(s)

#### 7.5.3.4.1 General

The MCVideo client requests video capability information from other members of the MCVideo group.

#### 7.5.3.4.2 Request clients with particular capabilities

Figure 7.5.3.4.2-1 describes procedures for a mechanism to request other MCVideo clients having particular characteristics to share their capabilities.

MCVideo client sends a Capability request message to other MCVideo clients with search criteria. The search criteria may include MCVideo user ID or MCVideo client ID or a set of capabilities or a particular category of capabilities, or a mix of such criterions, etc.

Upon receiving the Capability request message, the MCVideo client that fulfils the search criteria responds to the received Capability request message with a Capability announcement message.

Pre-conditions:

- Information for ProSe direct communications corresponding to the MCVideo group and its mapping to ProSe Layer-2 Group ID are pre-configured in MCVideo client 1.
- MCVideo client 1 to MCVideo client N are members of the same MCVideo group.

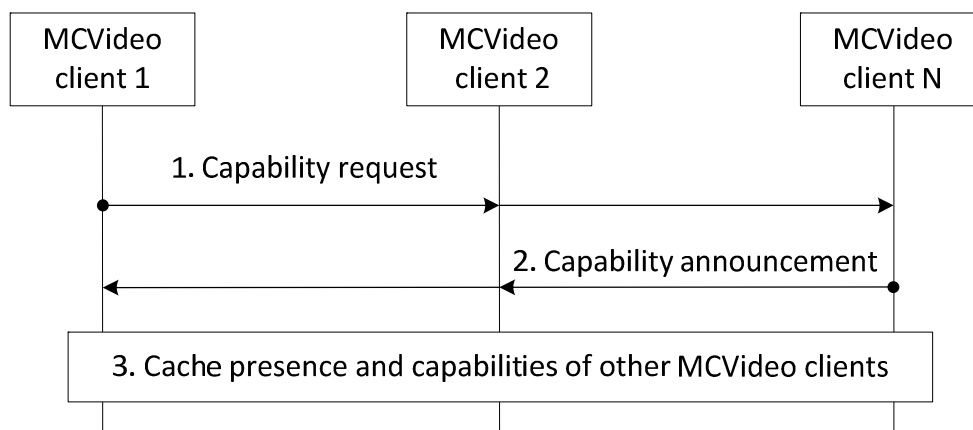

**Figure 7.5.3.4.2-1: Request clients with particular capabilities**

- MCVideo client 1 sends a Capability request message with search criteria to request MCVideo clients of the MCVideo group, with particular characteristics, to share their capabilities.
- Upon receiving a Capability request message with search criteria, all MCVideo clients which fulfil the search criteria respond with a Capability announcement message, which contains its capability information with other relevant information.

NOTE 1: If the Capability request message does not contain a search criteria, all the MCVideo clients that receive the Capability request message respond with a Capability announcement message.

- MCVideo clients, upon receiving a Capability announcement message from another MCVideo client, cache its presence and capability information along with other relevant information.



NOTE 2: Capability announcement may include specific category tags (e.g. certain video camera), video capabilities of the client, location, camera angles, camera orientation, etc.

### 7.5.3.4.3 Request capabilities from a particular client

Figure 7.5.3.4.3-1 describes procedures for a mechanism to request a particular MCVideo client in proximity, for its capabilities.

MCVideo client sends a Capability request message to the other MCVideo client.

Upon receiving the Capability request message, the MCVideo client responds to the received Capability request message by sending a Capability announcement message to the sender of the Capability request message.

Pre-conditions:

1. Information for ProSe direct communications corresponding to the MCVideo client 2 is pre-configured in MCVideo client 1.
2. MCVideo client 1 has discovered MCVideo client 2 in proximity using ProSe Discovery procedures.

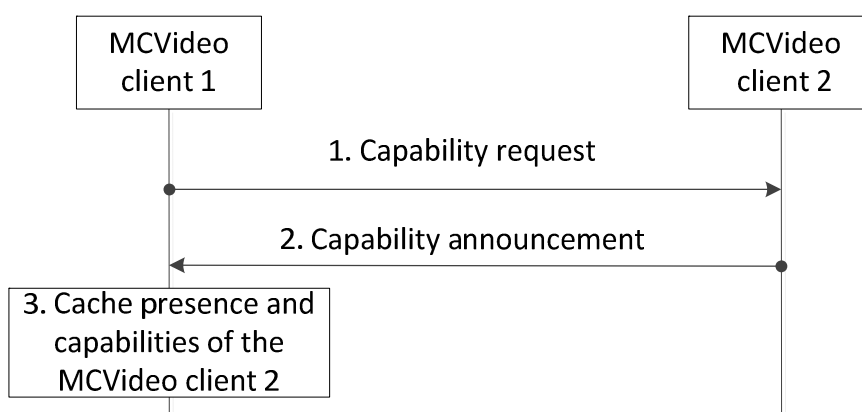

**Figure 7.5.3.4.3-1: Request capabilities from a particular client**

1. MCVideo client 1 sends a Capability request message towards MCVideo client 2.
2. Upon receiving the Capability request message the MCVideo client 2 responds with a Capability announcement message, which contains its capability information with other relevant information.
3. MCVideo client 1, upon receiving a Capability announcement message, caches MCVideo client 2's presence and capability information along with other relevant information.

NOTE: Capability announcement may include specific category tags (e.g. certain video camera), video capabilities of the client, location, camera angles, camera orientation, etc.

### 7.5.3.5 Request activity status from client(s)

#### 7.5.3.5.1 General

The MCVideo client requests activity status information from other members of the MCVideo group.

#### 7.5.3.5.2 Request activity status of group members

Figure 7.5.3.5.2-1 describes procedures to request activity status of other MCVideo clients having particular characteristics.

MCVideo client sends an activity status request message to other MCVideo clients with search criteria. The search criteria may include MCVideo user ID or MCVideo client ID or a set of capabilities or a particular category of capabilities, or a mix of such criterions, etc.

Upon receiving the activity status request message, the MCVideo client that fulfils the search criteria responds to the received activity status request message with an activity status announcement message.

Pre-conditions:

1. Information for ProSe direct communications corresponding to the MCVideo group and its mapping to ProSe Layer-2 Group ID are pre-configured in MCVideo client 1.
2. MCVideo client 1 to MCVideo client N are members of the same MCVideo group.

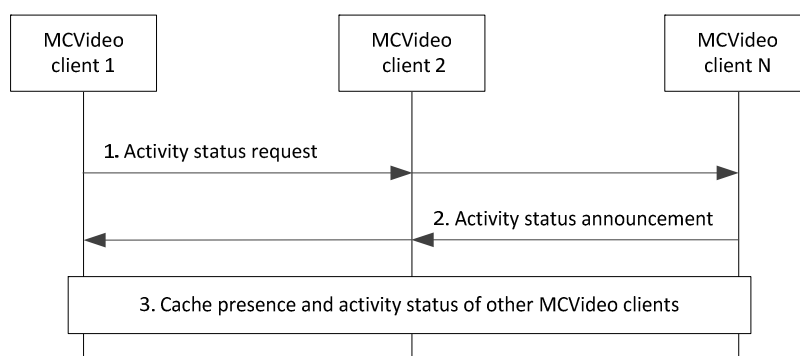

**Figure 7.5.3.5.2-1: Request activity status of group members**

1. MCVideo client 1 sends an activity status request message with search criteria to request MCVideo clients of the MCVideo group, with particular characteristics, to share their activity status.
2. Upon receiving an activity status request message with search criteria, all MCVideo clients which fulfil the search criteria respond with an activity status announcement message, which contains its activity status information.

NOTE 1: If the activity status request message does not contain a search criteria, all the MCVideo clients that receive the activity status request message respond with an activity status announcement message.

3. MCVideo clients, upon receiving an activity status announcement message from another MCVideo client, cache its presence and activity status information.

### 7.5.3.5.3 Request activity status from a particular client

Figure 7.5.3.5.3-1 describes procedures to request a particular MCVideo client in proximity, for its activity status.

MCVideo client sends an activity status request message to the other MCVideo client.

Upon receiving the activity status request message, the MCVideo client responds to the received activity status request message by sending an activity status announcement message to the sender of the activity status request message.

Pre-conditions:

1. Information for ProSe direct communications corresponding to the MCVideo client 2 is pre-configured in MCVideo client 1.
2. MCVideo client 1 has discovered MCVideo client 2 in proximity using ProSe Discovery procedures.

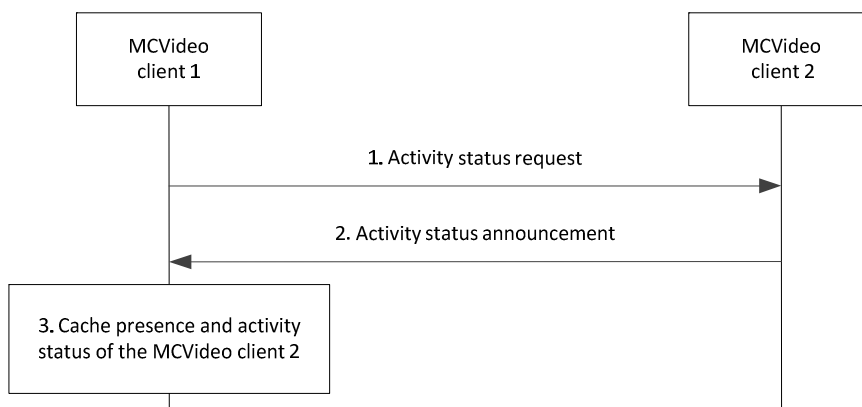

**Figure 7.5.3.5.3-1: Request activity status from a particular client**

1. MCVideo client 1 sends an activity status request message towards MCVideo client 2.
2. Upon receiving the activity status request message the MCVideo client 2 responds with an activity status announcement message, which contains its activity status information.
3. MCVideo client 1, upon receiving an activity status announcement message, caches MCVideo client 2's presence and activity status information.

## 7.6 Ambient viewing call

### 7.6.1 General

The ambient viewing call is a type of a private MCVideo call that only allows a "viewed to" user to transmit media to a "viewing" user such that there is no indication on the MCVideo UE of the "viewed to" user about the call and the media transmission.

NOTE 1: "viewed to" user refers to the user who is transmitting media in an ambient viewing call.

NOTE 2: "viewing" user refers to the user who is receiving media in an ambient viewing call.

There are two types of ambient viewing call as below:

- Remotely initiated ambient viewing is initiated by the authorized user (e.g., dispatcher) who wants to view to another user. In this case, the "viewed to" user is the called party, and shall automatically accept the call without causing any indication about the call and transmit the media to the "viewing" user.
- Locally initiated ambient viewing is initiated by an authorized user who wants another user to view to the MCVideo UE communication. In this case, the "viewed to" user is the calling party and shall automatically transmit the media to the "viewing" user without causing any indication about the call processing and media transmission.

### 7.6.2 Information flows for ambient viewing call

#### 7.6.2.1 Ambient viewing call request

Table 7.6.2.1-1 describes the information flow for the ambient viewing call request from MCVideo client and MCVideo sever and MCVideo server to the MCVideo client.

**Table 7.6.2.1-1: Ambient viewing call request**

Information Element	Status	Description
MCVideo ID	M	The MCVideo ID of the "viewing" user to view
MCVideo ID	M	The MCVideo ID of the "viewed to" user
SDP offer	M	Media parameters of MCVideo client.
Ambient viewing type	M	The ambient viewing type indicates remotely initiated ambient viewing call or locally initiated ambient viewing call.

### 7.6.2.2 Ambient viewing call response

Table 7.6.2.2-1 describes the information flow ambient viewing call response from the MCVideo client to the MCVideo server and MCVideo server to the MCVideo client.

**Table 7.6.2.2-1: Ambient viewing call response**

Information Element	Status	Description
MCVideo ID	M	The MCVideo ID of the "viewing" user
MCVideo ID	M	The MCVideo ID of the "viewed to" user
SDP answer	M	Media parameters
Ambient viewing type	M	The ambient viewing type indicates remotely initiated ambient viewing call or locally initiated ambient viewing call.

### 7.6.2.3 Ambient viewing call release request

Table 7.6.2.3-1 describes the information flow ambient viewing call release request from the MCVideo client to the MCVideo server and MCVideo server to the MCVideo client.

**Table 7.6.2.3-1: Ambient viewing call release request**

Information Element	Status	Description
MCVideo ID	M	The MCVideo ID of the "viewing" user
MCVideo ID	M	The MCVideo ID of the "viewed to" user
Ambient viewing type	M	The ambient viewing type indicates remotely initiated ambient viewing call or locally initiated ambient viewing call.

### 7.6.2.4 Ambient viewing call release response

Table 7.6.2.4-1 describes the information flow ambient viewing call release response from the MCVideo client to the MCVideo server and MCVideo server to the MCVideo client.

**Table 7.6.2.4-1: Ambient viewing call release response**

Information Element	Status	Description
MCVideo ID	M	The MCVideo ID of the "viewing" user
MCVideo ID	M	The MCVideo ID of the "viewed to" user
Ambient viewing type	M	The ambient viewing type indicates remotely initiated ambient viewing call or locally initiated ambient viewing call.

### 7.6.2.5 Ambient viewing call release notification

Table 7.6.2.5-1 describes the information flow ambient viewing call release notification from the MCVideo server to the MCVideo client.

**Table 7.6.2.5-1: Ambient viewing call release notification**

Information Element	Status	Description
MCVideo ID	M	The MCVideo ID of the user to view
MCVideo ID	M	The MCVideo ID of the user to be viewed to
Call release reason	M	The reason for call release by the MCVideo server
Ambient viewing type	M	The ambient viewing type indicates remotely initiated ambient viewing call or locally initiated ambient viewing call.

## 7.6.3 Procedures

### 7.6.3.1 Remotely initiated ambient viewing call setup procedure

The MCVideo service provides the capability for an authorised user to initiate a remotely initiated ambient viewing call.

Figure 7.6.3.1-1 illustrates the high level procedure of remotely initiated ambient viewing call setup procedure.

Pre-conditions:

- MCVideo client 1 is the client of the authorized user who is authorized to invoke a remotely initiated ambience viewing call with MCVideo client 2.
- MCVideo user 1 is the "viewing" user at MCVideo client 1, and MCVideo user 2 is the "viewed to" user at MCVideo client 2.

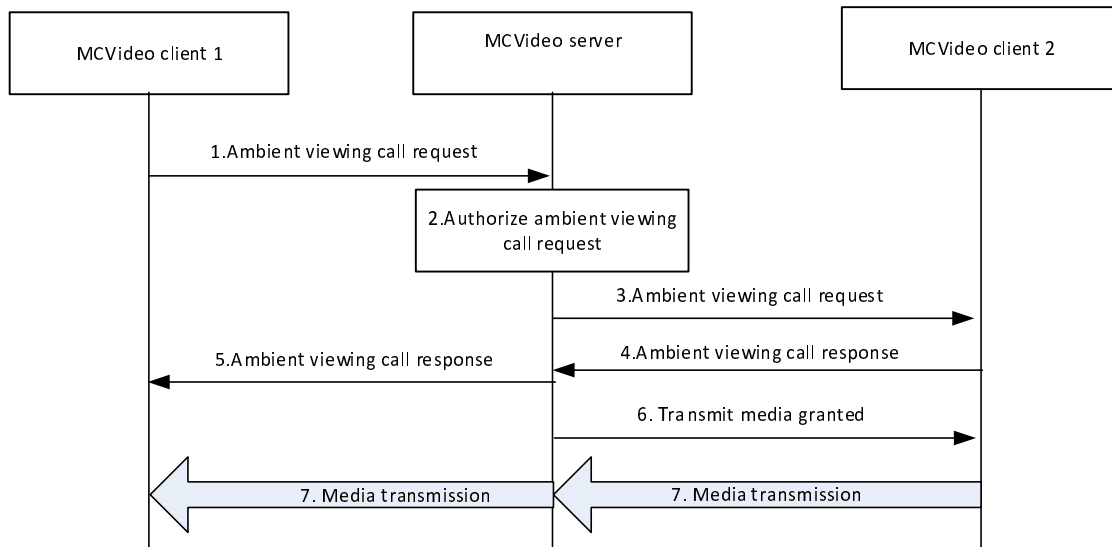

**Figure 7.6.3.1-1: Remotely initiated ambient viewing call setup**

1. MCVideo client 1 initiates a remotely initiated ambient viewing call to MCVideo client 2 by sending an ambient viewing request to MCVideo server. The remotely initiated ambient viewing call type is included.
2. The MCVideo server performs an authorization check for the authorized user 1 for the remotely initiated ambient viewing call. If authorization fails, the MCVideo server provides a failure response to MCVideo client 1.
3. The MCVideo server sends the ambient viewing call request to MCVideo client 2.
4. MCVideo client 2 returns the ambient viewing call response to the MCVideo server.
5. MCVideo server provides an ambient viewing call response to MCVideo client 1, indicating that whether the remotely initiated ambient viewing call is set up successfully or not.
6. The transmission control server of the MCVideo server then sends a media transmit granted message to MCVideo client 2 according to the ambient viewing type received in step 1.
7. After receiving the media transmit granted message, the MCVideo client to be viewed to transmit video to the MCVideo client 1 for viewing.

NOTE: MCVideo client 2 does not provide any indication of the ambient viewing call release to its user.

### 7.6.3.2 Locally initiated ambient viewing call setup procedure

The MCVideo service provides the capability for an authorised user to initiate a locally initiated ambient viewing call.

Figure 7.6.3.2-1 illustrates the high level procedure of locally initiated ambient viewing call setup procedure.

Pre-conditions:

- MCVideo client 2 is the client of the authorized user who is authorized to invoke a locally initiated ambient viewing call from MCVideo client 2.
- MCVideo user 1 is the "viewing" user at MCVideo client 1, and MCVideo user 2 is the "viewed to" user at MCVideo client 2.

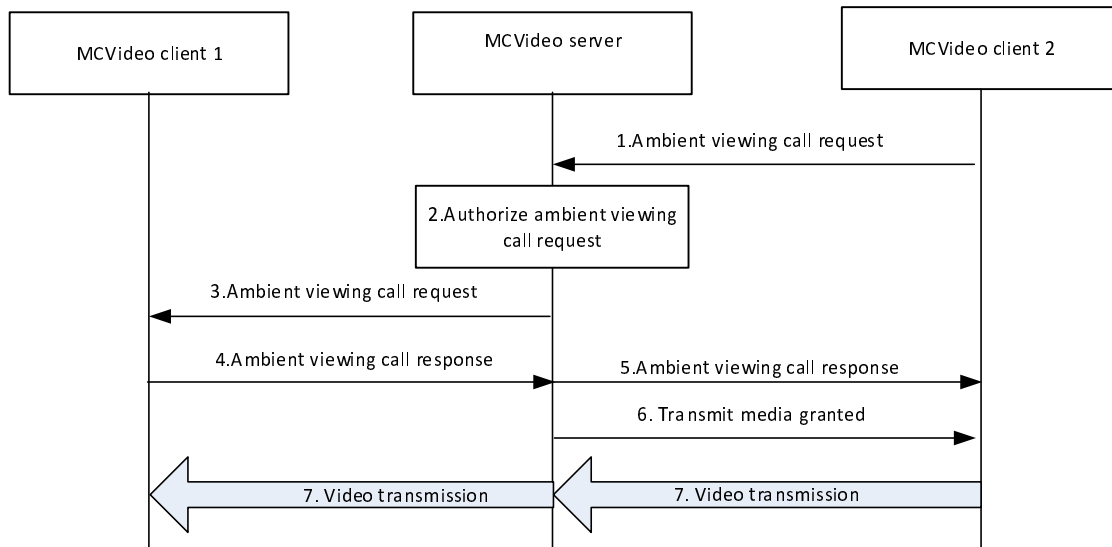

**Figure 7.6.3.2-1: Locally initiated ambient viewing call setup**

1. MCVideo client 2 initiates a locally initiated ambient viewing call to MCVideo client 1 by sending an ambient viewing request to MCVideo server. The locally initiated ambient viewing call type is included.
2. The MCVideo server performs an authorization check for the authorized user 2 for the locally initiated ambient viewing call. If authorization fails, the MCVideo server provides a failure response to MCVideo client 2.
3. The MCVideo server sends the ambient viewing call request to MCVideo client 1.
4. MCVideo client 1 returns the ambient viewing call response to the MCVideo server.
5. MCVideo server provides an ambient viewing call response to MCVideo client 2, indicating that whether the locally initiated ambient viewing call is set up successfully or not.
6. The transmission control server of the MCVideo server then sends a media transmit granted message to MCVideo client 2 according to the ambient viewing type received in step 1.
7. After receiving the media transmit granted message, the MCVideo client to be viewed to, transmits video to the MCVideo client 1 for viewing.

NOTE: MCVideo client 2 does not provide any indication of the ambient viewing call release to its user.

### 7.6.3.3 Ambient viewing call release – server initiated

Figure 7.6.3.3-1 illustrates the information flow for ambient viewing call release – server initiated when trigger by the MCVideo administrator. This procedure is applied for both remotely initiated ambient viewing call and the locally initiated ambient viewing call.

Pre-conditions:

- MCVideo client 1 is the MCVideo client of the authorized user, who initiated the ambient viewing call at MCVideo client 2.
- There is an ongoing ambient viewing call between MCVideo client 2 and MCVideo client 1.
- MCVideo user 1 is the "viewing" user at MCVideo client 1, and MCVideo user 2 is the "viewed to" user at MCVideo client 2.

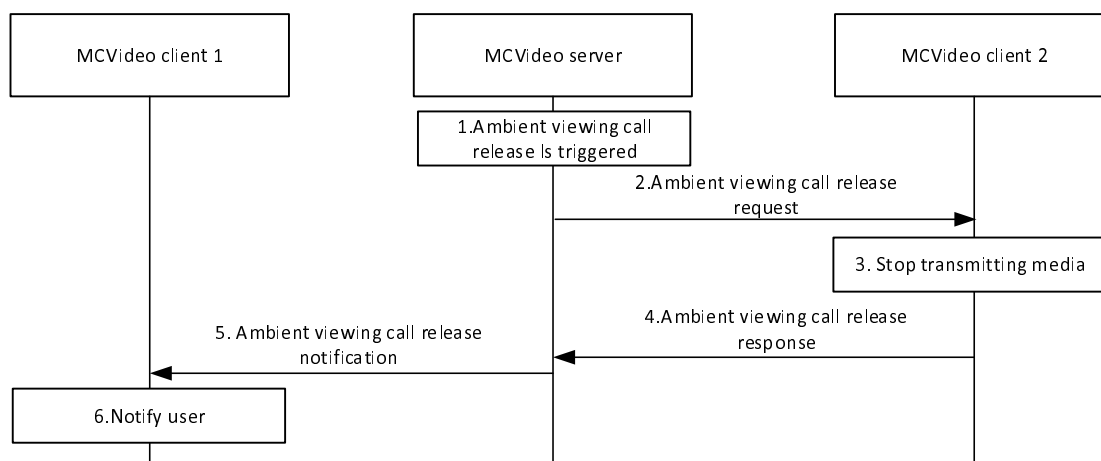

**Figure 7.6.3.3-1: Ambient viewing call release – server initiated**

1. The ambient viewing call release criteria by the MCVideo administrator.
2. The MCVideo server sends an ambient viewing call release request to MCVideo client 2.
3. MCVideo client 2 stops transmitting media to MCVideo client 1.

NOTE: MCVideo client 2 does not provide any indication of the ambient viewing call release to its user.

4. MCVideo client 2 provides an ambient viewing call release response to the MCVideo server.
5. The MCVideo server sends an ambient viewing call release notification to MCVideo client 1 together with a reason code identifying that the call was released.
6. MCVideo client 1 notifies the authorized MCVideo user 1.

#### 7.6.3.4 Ambient viewing call release – "viewing" user initiated

Figure 7.6.3.4-1 illustrates the information flow for ambient viewing call release – "viewing" user initiated. This procedure is applied for both remotely initiated ambient viewing call and the locally initiated ambient viewing call.

Pre-conditions:

- MCVideo client 1 is the client of the authorized user, who is authorized to release the ambient viewing call at MCVideo client 2.
- There is an ongoing ambient viewing call between MCVideo client 2 and MCVideo client 1.
- MCVideo user 1 is the "viewing" user at MCVideo client 1, and MCVideo user 2 is the "viewed to" user at MCVideo client 2.



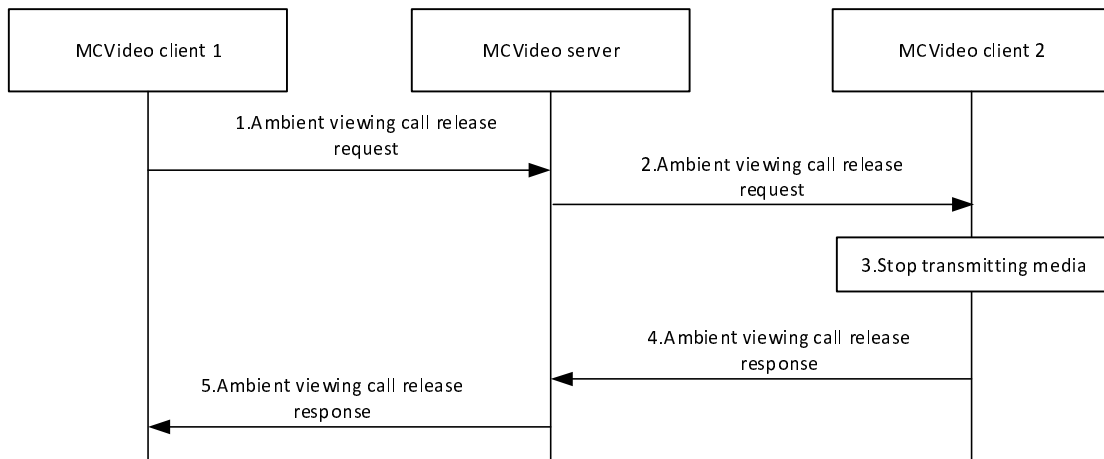

**Figure 7.6.3.4-1: Ambient viewing call release – "viewing" user initiated**

1. The authorized user 1 at MCVideo client 1 initiates the ambient viewing call release to MCVideo client 2 by sending an ambient viewing call release request to the MCVideo server.
  2. The MCVideo server sends an ambient viewing call release request to MCVideo client 2.
  3. MCVideo client 2 stops transmitting media to MCVideo client 1.
- NOTE: MCVideo client 2 does not provide any indication of the ambient viewing call release to its user.
4. MCVideo client 2 provides an ambient viewing call release response to the MCVideo server.
  5. The MCVideo server provides the ambient viewing call release response to MCVideo client 1.

**7.6.3.5 Ambient viewing call release – "viewed to" user initiated**

Figure 7.6.3.5-1 illustrates the information flow for ambient viewing call release – "viewed to" user initiated. This procedure is only applied for the locally initiated ambient viewing call.

Pre-conditions:

- MCVideo client 2 is the client of the authorized user, who is authorized to release the locally initiated ambient viewing call at MCVideo client 2.
- There is an ongoing ambient viewing call between MCVideo client 1 and MCVideo client 2.
- MCVideo user 1 is the current user at MCVideo client 1 who is viewing, and MCVideo user 2 is the current user at MCVideo client 2 who is being viewed to.

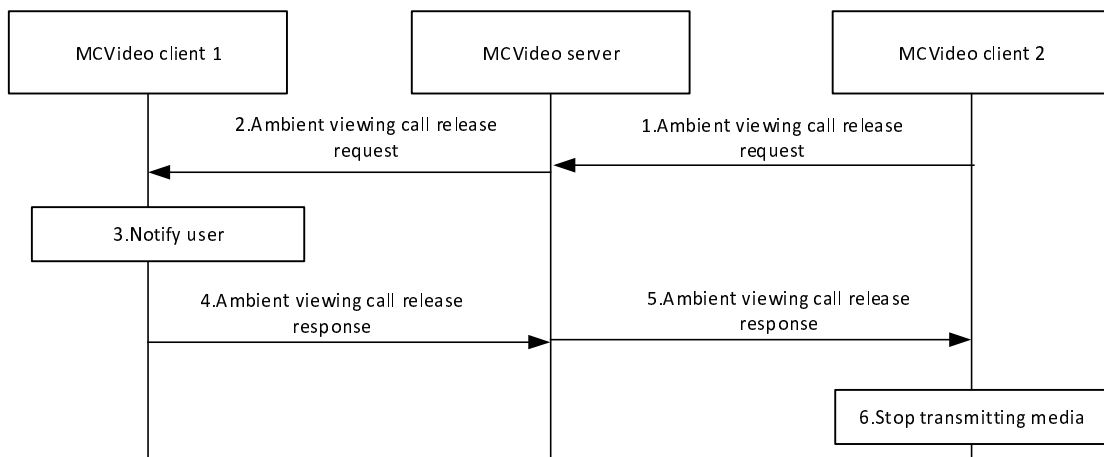

**Figure 7.6.3.5-1: Ambient viewing call release – "viewed to" user initiated**

1. The authorized user 2 at MCVideo client 2 initiates the ambient viewing call release by sending an ambient viewing call release request to the MCVideo server.
2. The MCVideo server provides an ambient viewing call release request to MCVideo client 1.
3. MCVideo client 1 is notified about the ambient viewing call release.
4. MCVideo client 1 provides an ambient viewing call release response to the MCVideo server.
5. The MCVideo server provides the ambient viewing call release response to MCVideo client 2.
6. MCVideo client 1 stops transmitting media to MCVideo client 2.

NOTE: MCVideo client 1 does not provide any indication of the ambient viewing call release to its user.

## 7.7 Transmission control

### 7.7.1 Transmission control for on-network MCVideo service

#### 7.7.1.1 General

The procedure is for providing a transmission control to MCVideo UE in an on-network case and applies for both private call and group call. Transmission control is performed by using transmission control information flows between the transmission control participant and the transmission control server.

#### 7.7.1.2 Information flows for transmission control for on-network

##### 7.7.1.2.1 General

When the transmission control server receives a transmit media request from the transmission control participant, it decides whether to give a grant or not. The result is informed to the requesting transmission control participant. When the transmission control participant receives a transmit media granted message, it can send video media over the uplink bearer established beforehand. The transmit media revoked message can be used as part of revoke. The transmit media queue status request can be used to know current position in the queue for media transmission.

Some transmission control information flows can also piggyback call control information flows to provide efficient call setup and clearing:

- Call setup request is optionally carried in transmit media request (uplink); and
- Call release request is optionally carried in media transmission release (uplink).

##### 7.7.1.2.2 Transmit media request

Table 7.7.1.2.2-1 describes the information flow transmit media request, from the transmission control participant to the transmission control server, which is used to request the transmit media request. This information flow is sent in unicast to the transmission control server.

**Table 7.7.1.2.2-1: Transmit media request**

Information element	Status	Description
MCVideo ID	M	Identity of the user whose media transmission is requested
Media identifier	O	Identifies the communication, e.g. by identifying the media flow within a media multiplex, present only if media multiplexing

### 7.7.1.2.3 Transmit media granted

Table 7.7.1.2.3-1 describes the information flow transmit media granted, from the transmission control server to the transmission control participant, which is used to indicate that a transmit media request is granted and media transmission is possible. This information flow is sent in unicast (to the granted transmission control participant).

**Table 7.7.1.2.3-1: Transmit media granted**

Information element	Status	Description
Media identifier	O	Identifies the communication, e.g. by identifying the media flow within a media multiplex, present only if media multiplexing
Acknowledgement required	O	Indicates if acknowledgement from the transmission control participant is required

### 7.7.1.2.4 Transmit media rejected

Table 7.7.1.2.4-1 describes the information flow transmit media rejected, from the transmission control server to the transmission control participant, which is used to indicate that a transmit media request is rejected. This information flow is sent in unicast (to the refused transmission control participant).

**Table 7.7.1.2.4-1: Transmit media rejected**

Information element	Status	Description
Media identifier	O	Identifies the communication, e.g. by identifying the media flow within a media multiplex, present only if media multiplexing
Rejection cause	O	Indicates the cause for transmit media rejection
Acknowledgement required	O	Indicates if acknowledgement from the transmission control participant is required

### 7.7.1.2.5 Media transmission notification

Table 7.7.1.2.5-1 describes the information flow media transmission notification, from the transmission control server to the transmission control participant, which is used to indicate that a media transmission is available from another user. This information flow is sent in unicast (to the receiving transmission control participant).

**Table 7.7.1.2.5-1: Media transmission notification**

Information element	Status	Description
MCVideo ID	M	Identity of the user who is transmitting the media
Media identifier	O	Identifies the communication, e.g. by identifying the media flow within a media multiplex, present only if media multiplexing

### 7.7.1.2.6 Receive media request

Table 7.7.1.2.6-1 describes the information flow receive media request, from the transmission control participant to the transmission control server, which is used to request the reception of the media from another user. This information flow is sent in unicast (to the transmission control server).

**Table 7.7.1.2.6-1: Receive media request**

Information element	Status	Description
MCVideo ID	M	Identity of the user who is requesting the reception of the media
Source MCVideo ID	M	Identify of the user who is transmitting the media
Media identifier	O	Identifies the communication, e.g. by identifying the media flow within a media multiplex, present only if media multiplexing

### 7.7.1.2.7 Receive media response

Table 7.7.1.2.7-1 describes the information flow receive media response, from the transmission control server to the transmission control participant, which is used to indicate whether the media reception is possible or not. This information flow is sent in unicast (to the receiving transmission control participant).

**Table 7.7.1.2.7-1: Receive media response**

Information element	Status	Description
Result	M	Indicates whether media reception is possible as per the request
Rejection cause	O	Indicates the cause for rejecting the media receive request
Media identifier	O	Identifies the communication, e.g. by identifying the media flow within a media multiplex, present only if media multiplexing

### 7.7.1.2.8 Media reception notification

Table 7.7.1.2.8-1 describes the information flow media reception notification, from the transmission control server to the transmission control participant, which is used to indicate that a media reception has been initiated to a user. This information flow is sent in unicast (to the transmitting transmission control participant).

**Table 7.7.1.2.8-1: Media reception notification**

Information element	Status	Description
MCVideo ID	M	Identity of the user who is receiving the media
Media identifier	O	Identifies the communication, e.g. by identifying the media flow within a media multiplex, present only if media multiplexing

### 7.7.1.2.9 Queue position info

Table 7.7.1.2.9-1 describes the information flow queue position info, from the transmission control server to the transmission control participant, which is used to indicate that the transmit media request is queued and the queue position to the transmit media requesting UE. The MCVideo server and the MCVideo client support queuing of the transmit media requests shall support this information flow. This information flow is sent in unicast (to the queued transmission control participant).

**Table 7.7.1.2.9-1: Queue position info**

Information element	Status	Description
Queue position info	M	Position of the queued transmit media request in the queue
Media identifier	O	Identifies the communication, e.g. by identifying the media flow within a media multiplex, present only if media multiplexing
Acknowledgement required	O	Indicates if acknowledgement from the transmission control participant is required

### 7.7.1.2.10 Transmission revoked

Table 7.7.1.2.10-1 describes the information flow transmission revoked, from the transmission control server to the transmission control participant, which is used to indicate that the on-going video transmission is queued and the queue position is provided or the on-going video transmission is terminated. This information flow is sent in unicast (to the queued transmission control participant).

**Table 7.7.1.2.10-1: Transmission revoked**

Information element	Status	Description
Revoke reason	M	The reason for revoke like queue or termination of on-going video transmission
Queue position info	O (see NOTE1)	Position of the queued transmit media request in the queue
Media identifier	O (see NOTE2)	Identifies the communication, e.g. by identifying the media flow within a media multiplex, present only if media multiplexing
Acknowledgement required	O	Indicates if acknowledgement from the transmission control participant is required
NOTE1: If revoke reason is queuing, then queue position info is included.		
NOTE2: If revoke reason is termination, then media identifier is included.		

#### 7.7.1.2.11 Queue position request

Table 7.7.1.2.11-1 describes the information flow queue position request, from the transmission control participant to the transmission control server, which is used to request the position in the video transmission queue. The MCVideo server and the MCVideo client support queuing of the transmission control requests shall support this information flow. This information flow is sent in unicast to the transmission control server.

**Table 7.7.1.2.11-1: Queue position request**

Information element	Status	Description
Media identifier	O	Identifies the communication, e.g. by identifying the media flow within a media multiplex, present only if media multiplexing

#### 7.7.1.2.12 Transmit media cancel request

Table 7.7.1.2.12-1 describes the information flow transmit media cancel request, from the transmission control participant to the transmission control server. This information flow is sent in unicast to the transmission control server.

**Table 7.7.1.2.12-1: Transmit media cancel request**

Information element	Status	Description
MCVideo ID	M	Identity of the user whose media transmission is requested for cancellation
Media identifier	O	Identifies the communication, e.g. by identifying the media flow within a media multiplex, present only if media multiplexing

#### 7.7.1.2.13 Transmit media cancel response

Table 7.7.1.2.13-1 describes the information flow transmit media cancel response, from the transmission control server to the transmission control participant. This information flow is sent in unicast to the transmission control server.

**Table 7.7.1.2.13-1: Transmit media cancel response**

Information element	Status	Description
Media identifier	O	Identifies the communication, e.g. by identifying the media flow within a media multiplex, present only if media multiplexing

#### 7.7.1.2.14 Transmit media cancel request notify

Table 7.7.1.2.14-1 describes the information flow transmit media cancel request notify, from the transmission control server to the transmission control participant. This information flow is sent in unicast to the transmission control server.

**Table 7.7.1.2.14-1: Transmit media cancel request notify**

Information element	Status	Description
Media identifier	O	Identifies the communication, e.g. by identifying the media flow within a media multiplex, present only if media multiplexing

#### 7.7.1.2.15 Transmit media end request

Table 7.7.1.2.15-1 describes the information flow transmit media end request, from the transmission control participant to the transmission control server and from the transmission control server to the transmission control participant. This information flow is sent in unicast to the transmission control server/transmission control participant.

**Table 7.7.1.2.15-1: Transmit media end request**

Information element	Status	Description
MCVideo ID	M	Identity of the user whose media transmission is requested to be terminated.
Media identifier	O	Identifies the communication, e.g. by identifying the media flow within a media multiplex, present only if media multiplexing

#### 7.7.1.2.16 Transmit media end response

Table 7.7.1.2.16-1 describes the information flow transmit media end response, from the transmission control participant and the transmission control server and from the transmission control server to the transmission control participant. This information flow is sent in unicast to the transmission control server/transmission control participant.

**Table 7.7.1.2.16-1: Transmit media end response**

Information element	Status	Description
Media identifier	O	Identifies the communication, e.g. by identifying the media flow within a media multiplex, present only if media multiplexing

#### 7.7.1.2.17 Remote transmit media request

Table 7.7.1.2.17-1 describes the information flow remote transmit media request, from the transmission control participant to the transmission control server. This information flow is sent in unicast to the transmission control server.

**Table 7.7.1.2.17-1: Remote transmit media request**

Information element	Status	Description
MCVideo ID	M	Identity of the user who remotely initiated the media transmission of another user.
MCVideo ID	M	Identity of the user whose media transmission is requested
Media identifier	O	Identifies the communication, e.g. by identifying the media flow within a media multiplex, present only if media multiplexing

#### 7.7.1.2.18 Remote transmit media response

Table 7.7.1.2.18-1 describes the information flow remote transmit media response, from the transmission control server to the transmission control participant. This information flow is sent in unicast to the transmission control participant.

**Table 7.7.1.2.18-1: Remote transmit media response**

Information element	Status	Description
Media identifier	O	Identifies the communication, e.g. by identifying the media flow within a media multiplex, present only if media multiplexing

#### 7.7.1.2.19 Remote transmit media end request

Table 7.7.1.2.19-1 describes the information flow remote transmit media end request, from the transmission control participant to the transmission control server. This information flow is sent in unicast to the transmission control server.

**Table 7.7.1.2.19-1: Remote transmit media end request**

Information element	Status	Description
MCVideo ID	M	Identity of the user whose media transmission is requested for cancellation
Media identifier	O	Identifies the communication, e.g. by identifying the media flow within a media multiplex, present only if media multiplexing

#### 7.7.1.2.20 Remote transmit media end response

Table 7.7.1.2.20-1 describes the information flow transmit media end response, from the transmission control server to the transmission control participant. This information flow is sent in unicast to the transmission control server.

**Table 7.7.1.2.20-1: Remote transmit media end response**

Information element	Status	Description
Media identifier	O	Identifies the communication, e.g. by identifying the media flow within a media multiplex, present only if media multiplexing

#### 7.7.1.2.21 Media reception end request

Table 7.7.1.2.21-1 describes the information flow media reception end request, from the transmission control server to the transmission control participant and from the transmission control participant to the transmission control server.

**Table 7.7.1.2.21-1: Media reception end request**

Information element	Status	Description
MCVideo ID	M	Identity of the user whose media receipt is requested for cancellation
Media identifier	M	Identifies the communication, e.g. by identifying the media flow within a media multiplex, present only if media multiplexing

#### 7.7.1.2.22 Media reception end response

Table 7.7.1.2.22-1 describes the information flow media reception end response, from the transmission control server to the transmission control participant and from the transmission control participant to the transmission control server.

**Table 7.7.1.2.22-1: Media reception end response**

Information element	Status	Description
/Media identifier	M	Identifies the communication, e.g. by identifying the media flow within a media multiplex, present only if media multiplexing

### 7.7.1.2.23 Media reception override notification

Table 7.7.1.2.23-1 describes the information flow media reception override notification, from the transmission control server to the transmission control participant.

**Table 7.7.1.2.23-1: Media reception override notification**

Information element	Status	Description
MCVideo ID	M	Identity of the user who is requesting the reception of the media
MCVideo ID	O	Identify of the user of the overriding media
Media identifier	M	Identifies the communication of overriding media, e.g. by identifying the media flow within a media multiplex, present only if media multiplexing
MCVideo ID	O	Identify of the user of the overridden media
Media identifier	M	Identifies the communication of overridden media, e.g. by identifying the media flow within a media multiplex, present only if media multiplexing

### 7.7.1.2.24 Transmit media end notify

Table 7.7.1.2.24-1 describes the information flow transmit media end notify, from the transmission control server to the transmission control participant. This information flow is sent in unicast to the transmission control server.

**Table 7.7.1.2.24-1: Transmit media end notify**

Information element	Status	Description
MCVideo ID	M	Identity of the user whose media transmission has been released
Media identifier	O	Identifies the communication, e.g. by identifying the media flow within a media multiplex, present only if media multiplexing

## 7.7.1.3 Transmission control within one MC system for MCVideo service

### 7.7.1.3.1 Transmission control during an MCVideo session

Figure 7.7.1.3.1-1 describes the procedure for transmission control between the transmission control participant and the transmission control server during an MCVideo session. Only two UEs involved in the session are shown for the simplicity.

Pre-condition:

1. MCVideo session is established between MCVideo clients (client A and client B) and MCVideo server
2. Transmission control is established between transmission control participants and transmission control server and there is no ongoing media transmission.



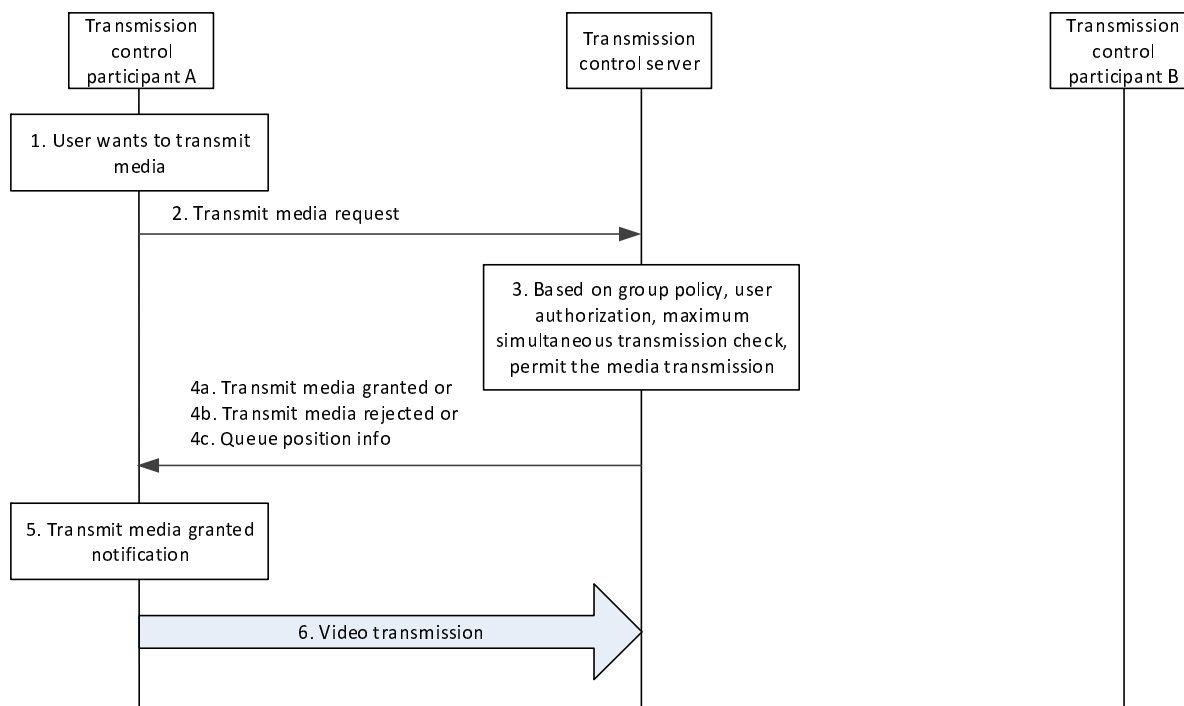

**Figure 7.7.1.3.1-1: Transmission control during an MCVidéo session**

1. Transmission control participant A wants to send video media over the session.
2. Transmission control participant A sends a transmit media request message to transmission control server which includes transmission priority and other information as necessary.
3. Transmission control server makes the determination on what action (grant, deny, or queue) to take on the request based on transmission control criteria (e.g., group policy) and determines to accept the transmit media request from transmission control participant A.
4. Transmission control server responds with a transmit media granted message (4a) to transmission control participant A. Transmission control server may send transmit media rejected message (4b) indicating the cause of rejection or queue position info message (4c) indicating that the transmit media request has been queued.
5. The transmit media granted shall cause the user of UE A where the transmission control participant A is located to be notified.
6. Transmission control participant A starts sending video media over the session established to the transmission control server.

### 7.7.1.3.2 Reception control during an MCVidéo session

Figure 7.7.1.3.2-1 describes the procedure for the reception control between the transmission control participant and the transmission control server during an MCVidéo session. Only two UEs involved in the session are shown for the simplicity.

Pre-condition:

1. MCVidéo session is established between MCVidéo clients (client A and client B) and MCVidéo server
2. Transmission control is established between transmission control participants and transmission control server.
3. Transmission control participant A has been granted the permission to transmit media.

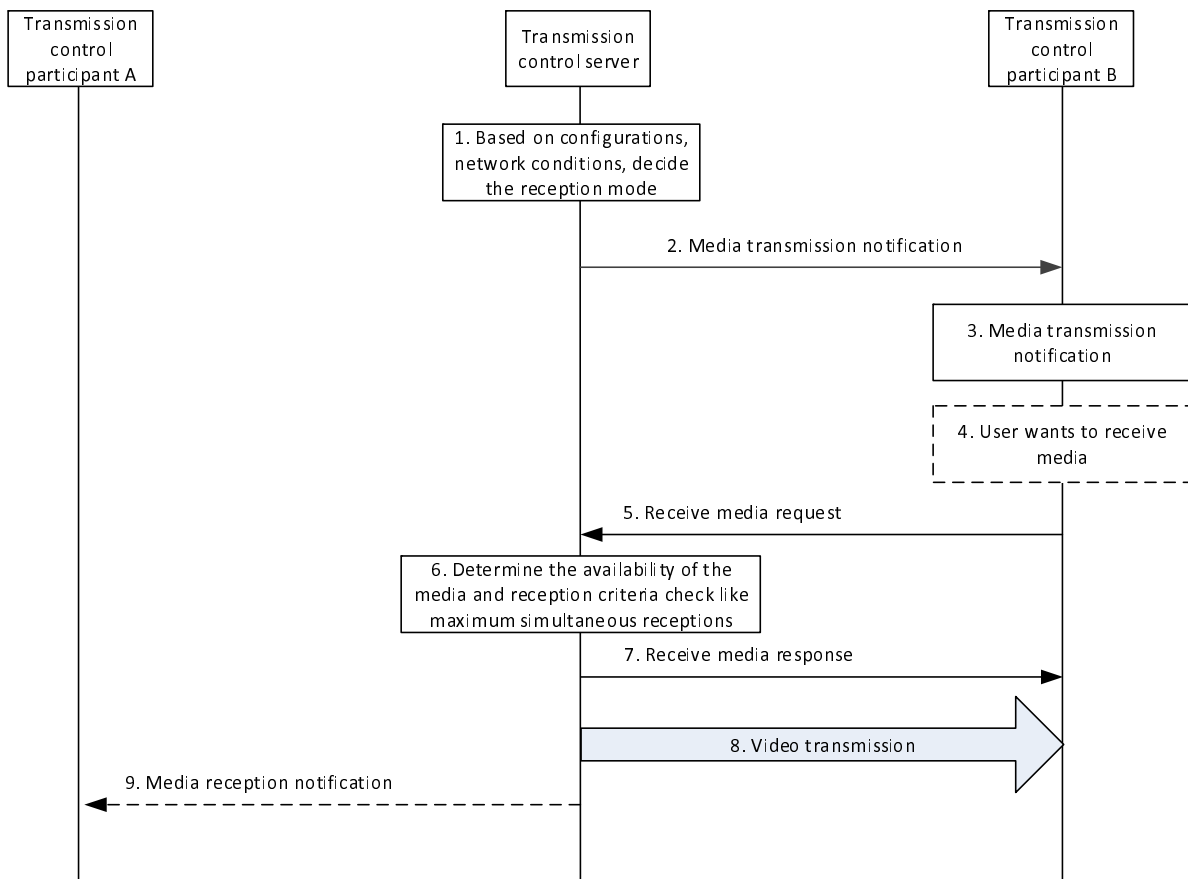

**Figure 7.7.1.3.2-1: Reception control during an MCVideo session**

1. The transmission control server determines the reception mode for downlink transmission control participants for the media transmission permitted to transmission control participant A. The manual and forced reception modes are determined based on configurations (e.g. auto-receive video transmissions, auto-receive emergency video transmissions) as described in Annex A.
2. Transmission control server sends a media transmission notification message to the transmission control participant B including information about the video transmitter and the reception mode.
3. The receipt of the media transmission notification is used to inform the user of UE B the details of video transmission and the video transmitter.
4. Based on the notification received, the user of UE B may want take actions (receive, reject or cancel) regarding the media available for reception.
5. If user of UE B wants to receive the media or it required to receive the media via forced reception, it causes the transmission control participant B to send a media receive request message to the transmission control server.
6. Transmission control server makes the determination on what action (e.g., real-time stream downlink, make stream downloadable, reject) to take on the request based on reception control criteria (e.g., allowed simultaneous reception) and determines to accept the media receive request from transmission control participant B. Transmission control server will also determine the availability of the media at the server to initiate the downlink reception.
7. Transmission control server sends a receive media response message to transmission control participant B.
8. Transmission control server sends video media to transmission control participant B.
9. Optionally, the transmission control server sends media reception notification message to transmission control participant A which includes the information about the video recipient (transmission control participant B).

### 7.7.1.3.2A End media reception – receiving user initiated

Figure 7.7.1.3.2A-1 describes the procedure for the receiving user initiated media reception end. Only two UEs involved in the session are shown for the simplicity.

Pre-condition:

1. MCVideo session is established between MCVideo clients (client A and client B) and MCVideo server
2. Transmission control is established between transmission control participants and transmission control server.
3. Transmission control participant A has been granted the permission to transmit media.

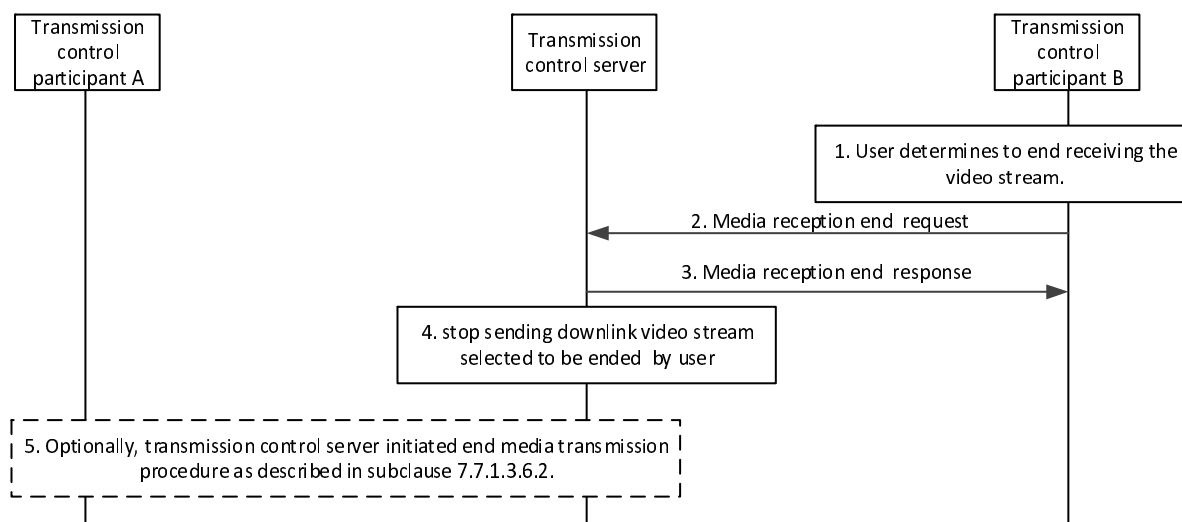

**Figure 7.7.1.3.2A-1: End media reception – receiving user initiated**

1. The MCVideo user determines to end a receiving video stream.
2. The user sends an media reception end request including the video stream to be ended to the transmission control server.
3. The transmission control server returns a media reception end response.
4. Upon receiving the media reception end request, the transmission control server stops sending the video stream selected to the transmission control participant B.
5. If the end media reception at transmission control participant B causes the video transmission continuation condition to fail, then the transmission control server initiates the media transmission end procedure as described in subclause 7.7.1.3.6.2.

### 7.7.1.3.2B End media reception – transmission control server initiated

Figure 7.7.1.3.2B-1 describes the procedure for the transmission control server initiated media reception end. Only two UEs involved in the session are shown for the simplicity.

Pre-condition:

1. MCVideo session is established between MCVideo clients (client A and client B) and MCVideo server
2. Transmission control is established between transmission control participants and transmission control server.
3. Transmission control participant A has been granted the permission to transmit media.

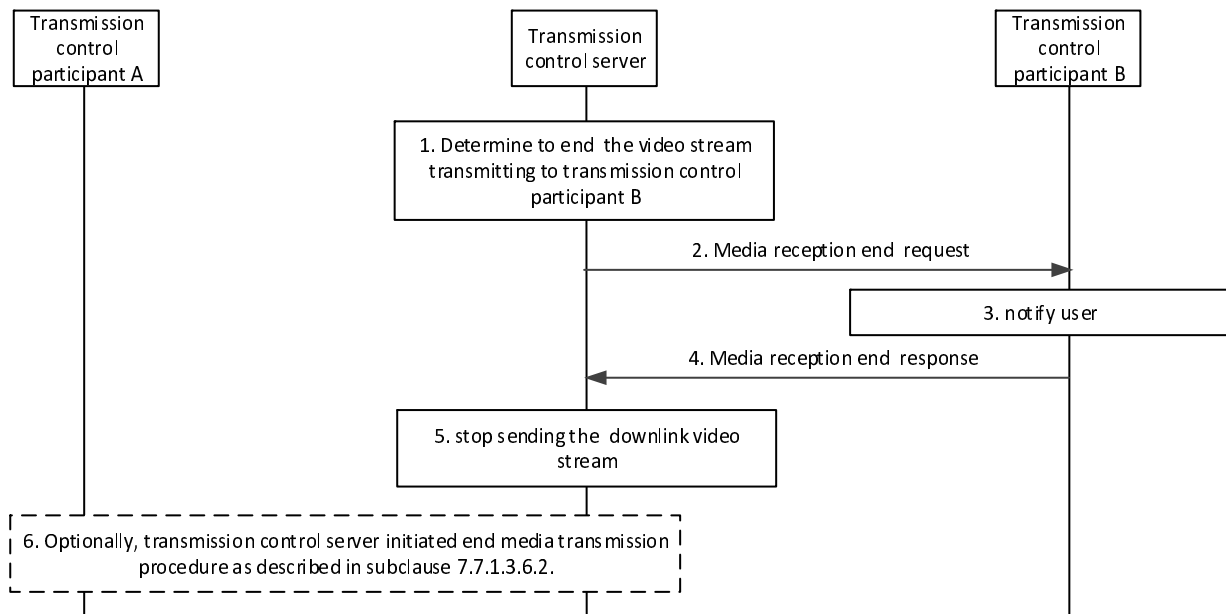

**Figure 7.7.1.3.2B-1: End media reception – transmission control server initiated**

1. The transmission control server determines to end a video stream transmitting to transmission control participant B according to events or configurations.
2. The transmission control server sends an media reception end request including the video stream to be ended to the transmission control participant B.
3. The MCVideo user is notified about the media reception end.
4. The transmission control participants B returns a media reception end response.
5. The transmission control server stops sending the video stream selected to the transmission control participant B.
6. If the end media reception at transmission control participants B causes the continuation conditions to fail, then the transmission control server initiates media transmission end procedure as described in subclause 7.7.1.3.6.2.

**7.7.1.3.2C Reception control on overridden – mandatory mode**

Figure 7.7.1.3.2C-1 describes the procedure for the reception control on overridden with mandatory mode that the transmission control server determines the video stream to be overridden. Only two UEs involved in the session are shown for the simplicity.

Pre-condition:

1. MCVideo session is established between MCVideo clients (client A and client B) and MCVideo server.
2. Transmission control is established between transmission control participants and transmission control server.
3. Transmission control participant A has been granted the permission to transmit media.

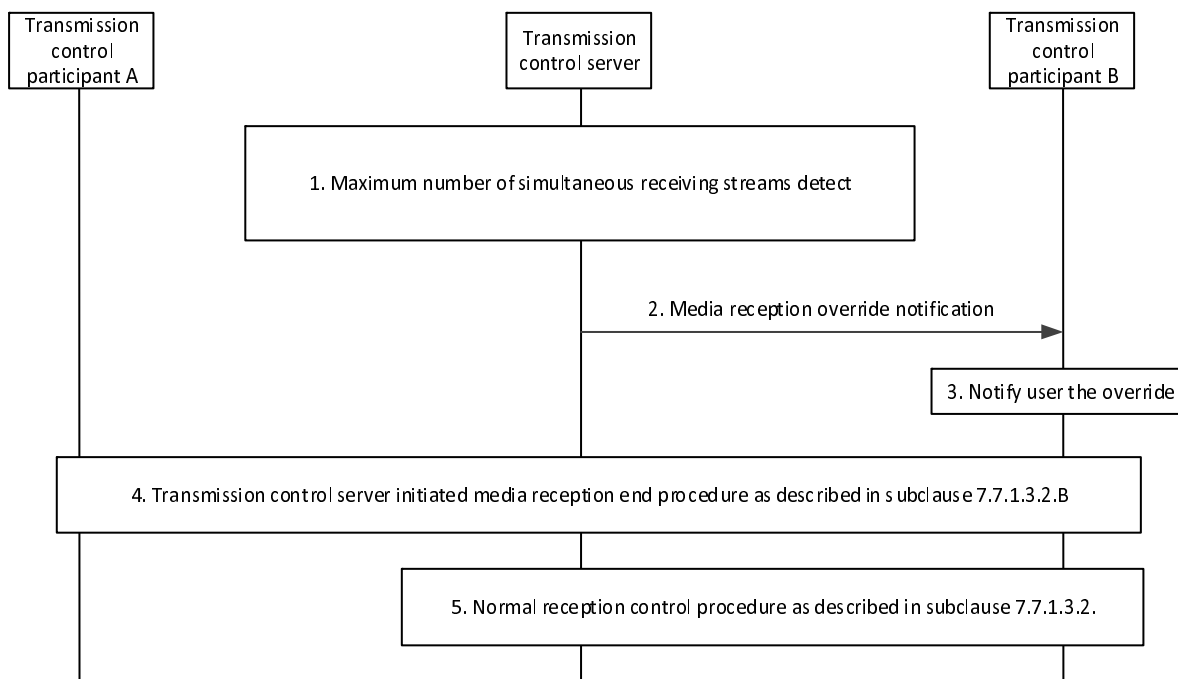

**Figure 7.7.1.3.2C-1: Reception control on overriding/overridden – mandatory mode**

1. A new media stream is to be delivered to the transmission control participant B while the maximum number of simultaneous streams is reached. The transmission control server determines to override another media stream being received by the transmission control participant B accord to the media stream characteristics.
2. Transmission control server sends a media reception override notification message to the transmission control participant B including information about the video stream being overridden and stop the downlink delivery of the overridden video stream to the transmission control participant B. The overriding video stream information maybe also included.
3. The user of UE B is notified about the details of overriding/overridden.
4. The transmission control server initiates the media reception end procedure as described in subclause 7.7.1.3.2.B.
5. The transmission control server performs the normal reception control procedure as described in subclause 7.7.1.3.2.

#### 7.7.1.3.2D Reception control on overridden – negotiated mode

Figure 7.7.1.3.2D-1 describes the procedure for the reception control on overridden with negotiated mode that the transmission control participant determines the video stream to be overridden. Only two UEs involved in the session are shown for the simplicity.

Pre-condition:

1. MCVideo session is established between MCVideo clients (client A and client B) and MCVideo server
2. Transmission control is established between transmission control participants and transmission control server.
3. Transmission control participant A has been granted the permission to transmit media.

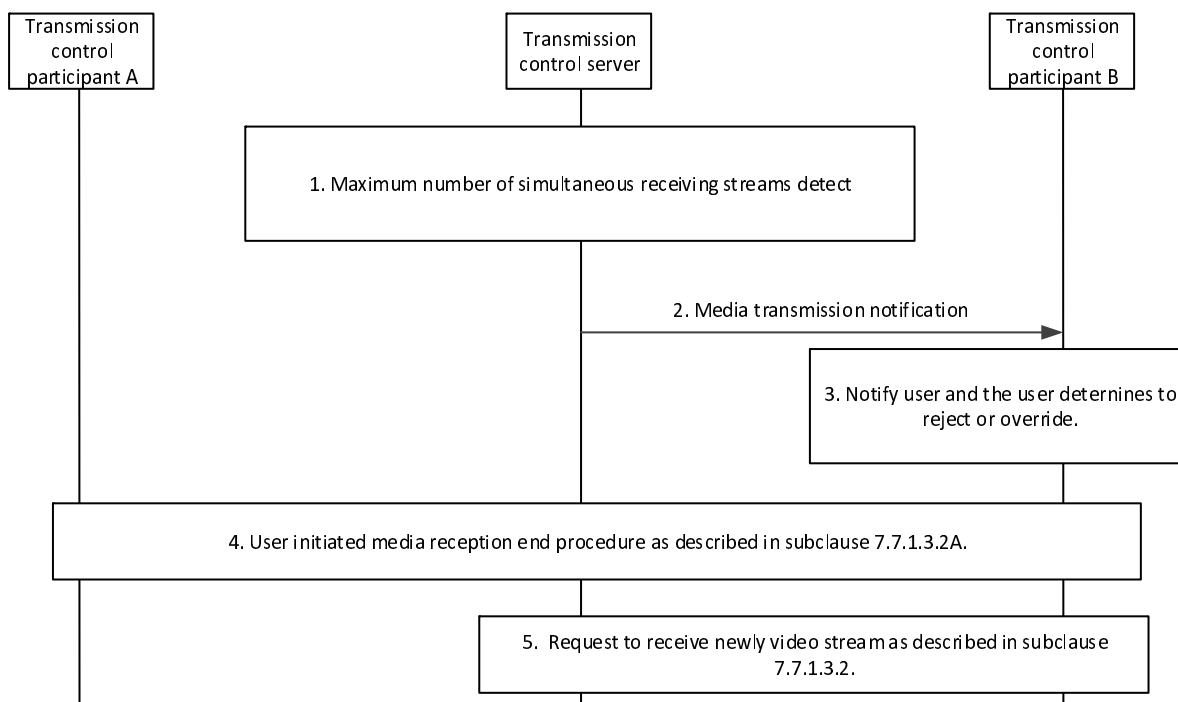

**Figure 7.7.1.3.2D-1: Reception control on overriding/overridden – negotiated mode**

1. A new media stream is to be delivered to the transmission control participant B while the maximum number of simultaneous streams is received. The transmission control server determines to override another media stream being received by the transmission control participant B according to the media stream characteristics.
2. Transmission control server sends a media transmission notification message to the transmission control participant B including information about the new video stream.
3. The user of transmission control participant B is notified about the maximum number of simultaneous streams received. The MCVideo user determines to reject the video stream or accept the video streaming by overriding a receiving video stream.
4. The transmission control participant initiates the media reception end procedure as described in subclause 7.7.1.3.2A.
5. Then the transmission control participant B requests to receive the new video stream as the normal reception control procedure described in subclause 7.7.1.3.2.

### 7.7.1.3.3 Transmission revoke during an MCVideo session

Figure 7.7.1.3.3-1 describes the procedure for transmission revoke during an MCVideo session. Only two UEs involved in the session are shown for the simplicity.

Pre-condition:

1. MCVideo session is established between MCVideo clients (client A and client B) and MCVideo server
2. Transmission control is established between transmission control participants and transmission control server.
3. Transmission control participant B has been granted the permission to transmit media and there may be ongoing media transmission from transmission control participant B.
4. The maximum media transmission limit for the MCVideo session is reached.

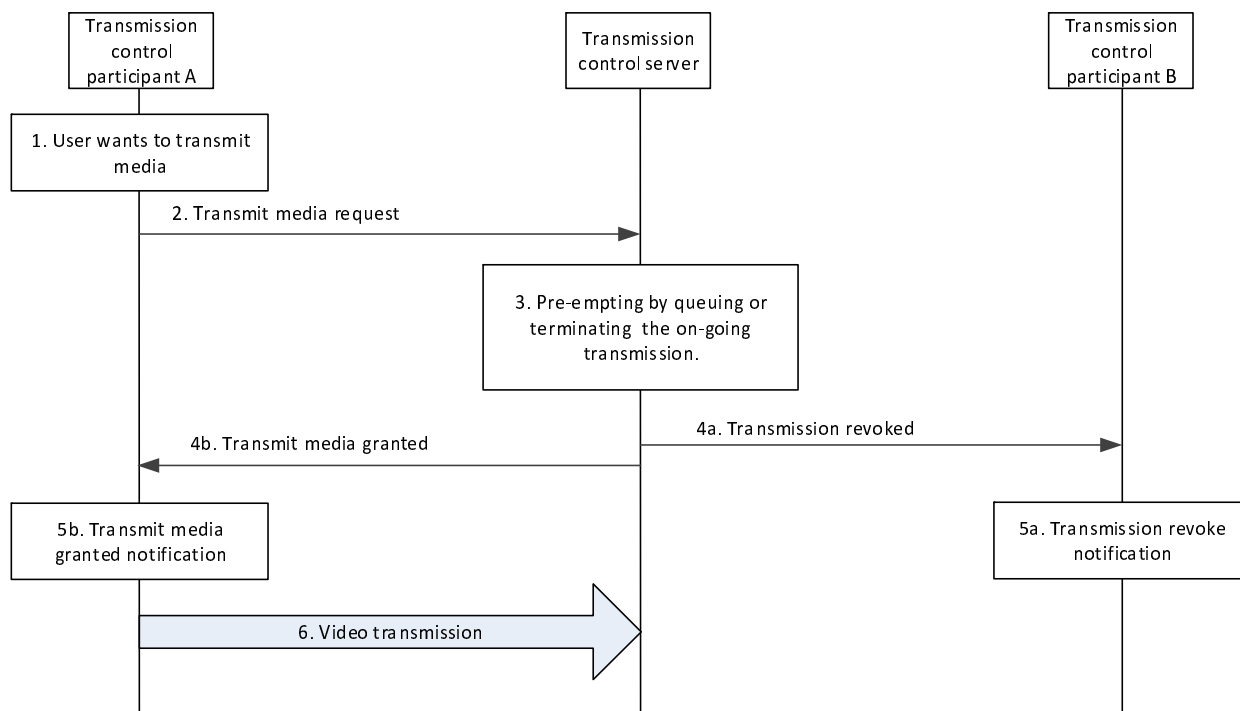
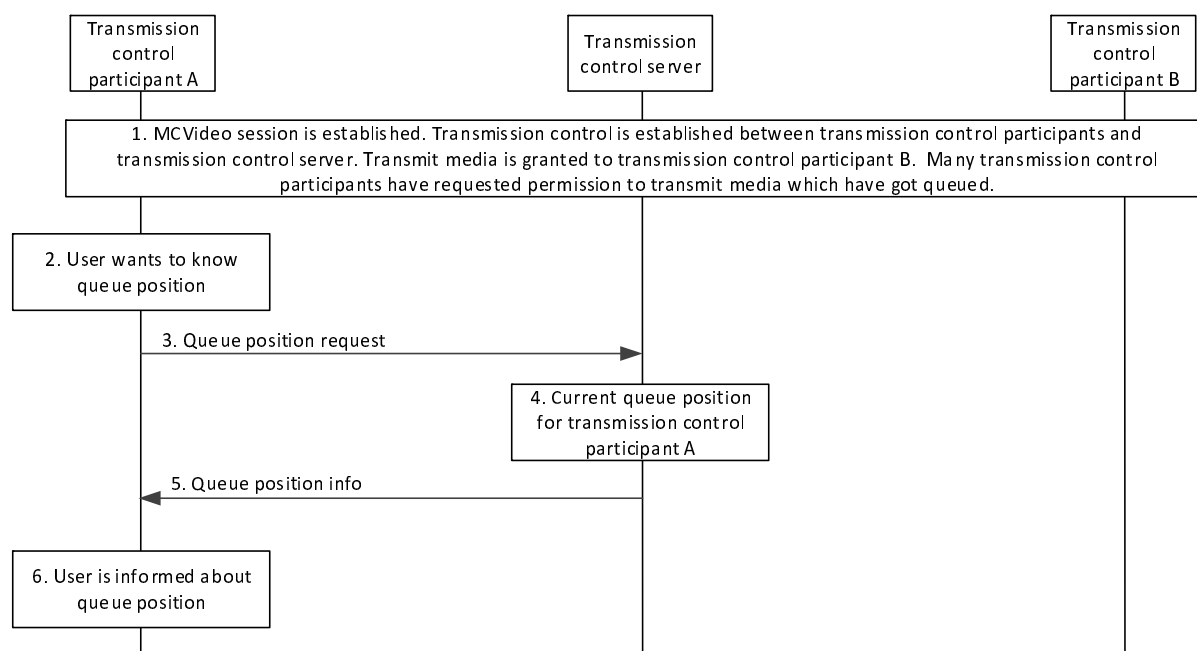

**Figure 7.7.1.3.3-1: Transmission revoke during an MCVideo session**

1. Transmission control participant A wants to send video media over the session.
2. Transmission control participant A sends a transmit media request message to transmission control server which includes transmission priority and other information as necessary.
3. Transmission control server determines to accept the transmit media request from transmission control participant A and decides to pre-empt the on-going video transmission from transmission control participant B by queuing or ending the on-going video transmission.
4. Transmission control server responds with a transmission revoked message (4a) to transmission control participant B with the action of pre-emption whether queued or terminated. Transmission control server responds with a transmit media granted message (4b) to transmission control participant A.
5. The transmission revoked shall cause the transmission control participant B to be notified of the revoke (5a) of the on-going video transmission by queuing or termination. The transmit media granted shall cause the user of UE A where the transmission control participant A is located to be notified.
6. Transmission control participant A starts sending video media over the session established to the transmission control server.

#### 7.7.1.3.4 Queue position during an MCVideo session

Figure 7.7.1.3.4-1 describes the procedure where the transmission control is conducted for the MCVideo session already established between MCVideo clients (with transmit media granted to transmission control participant B) and server (with an revoke determination at transmission control server). Only two UEs involved in the session are shown for the simplicity.



**Figure 7.7.1.3.4-1: Queue status during an MCVideo session**

1. It is assumed that transmission control participant B has been granted permission to transmit media and is transmitting video media. There are several other transmission control participants (including transmission control participant A) requesting video transmission which get queued at the transmission control server.
2. Transmission control participant A would like to know its current position in the video transmission queue.
3. Transmission control participant A sends a queue position request message to the transmission control server.
4. Transmission control server determines the current queue position of transmission control participant A from the video transmission queue.
5. Transmission control server responds with the current position in queue position info message.
6. User at transmission control participant A is informed about the current queue position.

### 7.7.1.3.5 Transmit media request cancellation from the video transmission queue

#### 7.7.1.3.5.1 Transmit media request cancellation from the queue – MCVideo user initiated

Figure 7.7.1.3.5.1-1 illustrates the procedure for transmit media request cancellation from the video transmission queue initiated by the MCVideo user. The MCVideo user may be an authorized user who has rights to cancel the transmit media requests of other MCVideo users, whose transmit media requests are in video transmission queue.

Pre-conditions:

- It is assumed that transmission control participant B has been granted the permission for video transmission and is transmitting video. There are several other transmission control participants (including transmission control participant A and transmission control participant C) requesting the permission to transmit media which have been queued at the transmission control server.



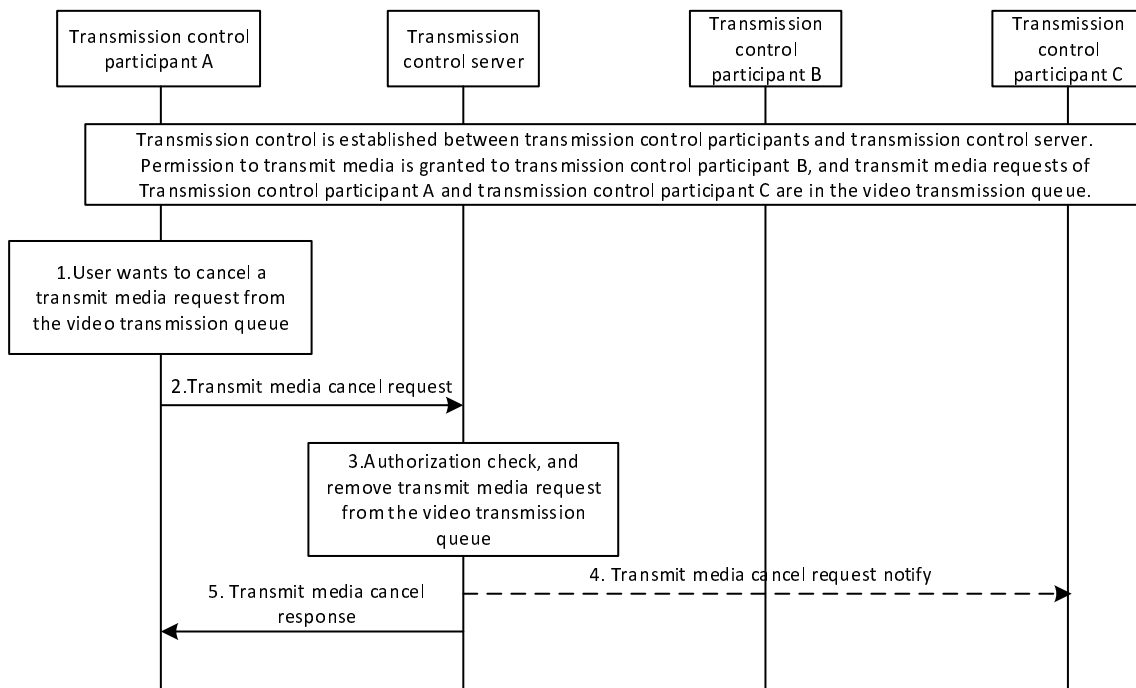

**Figure 7.7.1.3.5.1-1: Transmit media request cancellation from queue initiated by MCVideo user**

1. The transmission control participant A wants to remove the transmit media request from the video transmission queue. If transmission control participant A is an authorized MCVideo user with the rights to cancel another MCVideo user's transmit media request, the authorized MCVideo user may request for transmit media request cancellation for one or more transmission control participants, whose transmit media request needs to be removed from the video transmission queue.
2. The transmission control participant A sends a transmit media cancel request (initiating MCVideo ID) message to the transmission control server. If the transmission control participant A wants to remove the transmit media request(s) of other participant(s), the target participant(s)' MCVideo ID should be included in this message.
3. The transmission control server shall check whether the requesting transmission control participant has authorization to cancel the transmit media request(s). If authorized, the transmit media request(s) will be removed from the video transmission queue. When the on-going transmissions are completed and are within the limit of the maximum simultaneous transmissions, the transmission control server will process the transmit media request from the updated video transmission queue.
4. If the transmit media cancel request in step 3 is sent by an authorized user (e.g., dispatcher) to cancel the transmit media request(s) of other participant(s) from the video transmission queue, the transmit media cancel request notify message is sent to the transmission control participant whose transmit media request was cancelled from the video transmission queue.
5. The transmission control server provides a transmit media cancel response to the transmission control participant A when the transmit media request cancellation is completed. Optionally, the new queue position information may be notified to the transmission control participants whose transmit media requests are in the video transmission queue (not shown in the figure).

**7.7.1.3.5.2 Transmit media request cancellation from the queue - transmission control server initiated**

Figure 7.7.1.3.5.2-1 illustrates the procedure for transmit media request cancellation from the queue initiated by the transmission control server. Only two UEs involved in the session are shown for the simplicity.

Pre-conditions:

- It is assumed that transmission control participant B has been granted the permission to transmit media and is transmitting video. There are several other transmission control participants (including transmission control participant A and participant C) requesting the permission to transmit media which have been queued at the transmission control server.

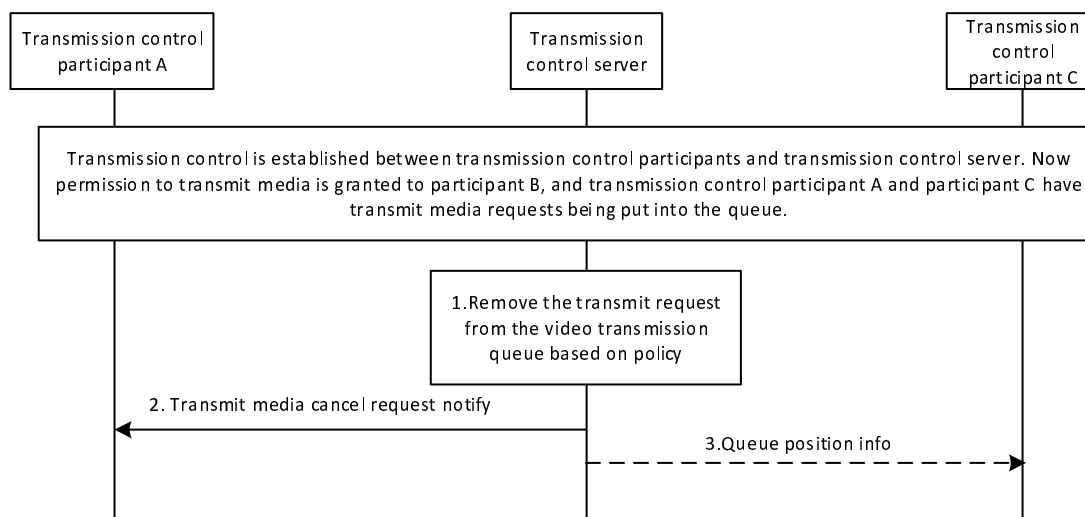

**Figure 7.7.1.3.5.2-1: Transmit media request cancellation from queue initiated by transmission control server**

1. The transmission control server removes the transmit media request from the video transmission queue based on policy. e.g., expiration of a timer. In the case when transmission control server receives repeated transmit media requests from a transmission control participant while the limit for maximum simultaneous media transmissions has reached, the new transmit media request is accepted and added into the video transmission queue and the existing/former transmit media request is removed from the video transmission queue or the new transmit media request is rejected and the existing/former transmit media request of this transmission control participant is retained in the video transmission queue.
2. The transmission control server sends a transmit media cancel request notify to the transmission control participant(s) whose transmit media request is removed from the video transmission queue.
3. Optionally, the new queue position information is notified to the other transmission control participants whose transmit media requests are queued.

### 7.7.1.3.6 End a media transmission during an MCVideo session

#### 7.7.1.3.6.1 End a media transmission – MCVideo user initiated

Figure 7.7.1.3.6.1-1 describes the procedure for ending a media transmission during an MCVideo session by a MCVideo user. Only two UEs involved in the session are shown for the simplicity.

Pre-condition:

1. MCVideo session is established between MCVideo clients (client A and client B) and MCVideo server
2. Transmission control is established between transmission control participants and transmission control server.
3. Transmission control participant A and participant B have been granted the permission to transmit media and there are ongoing media transmission from transmission control participant A and participant B.

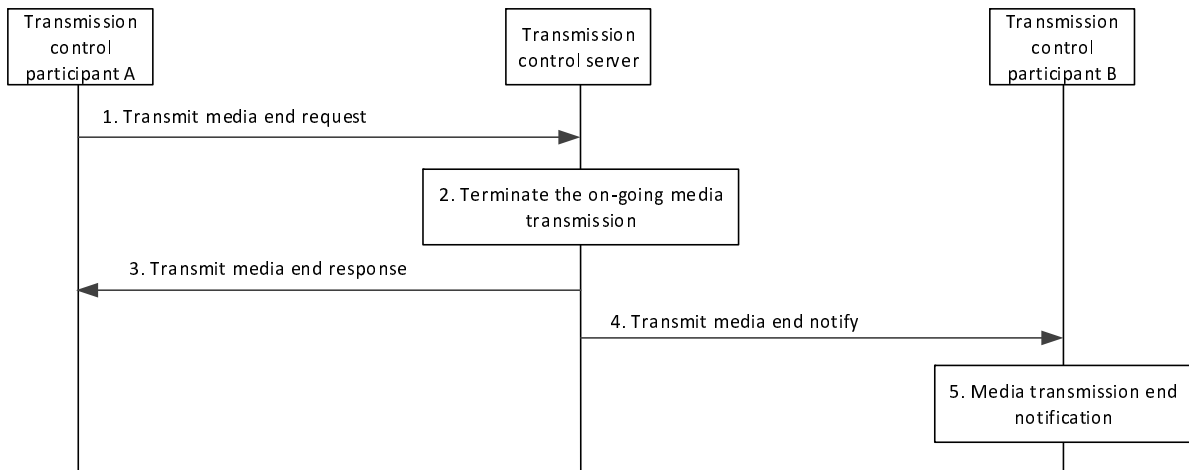

**Figure 7.7.1.3.6.1-1: End a media transmission by an MCVidéo user**

1. Transmission control participant A wants to end its media transmission in a session and sends a transmit media end request message to transmission control server.
2. Transmission control server terminates the on-going media transmission from transmission control participant A.
3. Transmission control server responds with a transmit media end response message to transmission control participant A indicating that the transmission control server has terminated the media transmission.
4. Transmission control server sends a transmit media end notify message to transmission control participant B indicating that the media transmission from transmission control participant A is terminated by the user.
5. The transmit media end notification shall cause the user of the transmission control participant B to be notified of the media transmission termination by the sending user.

**7.7.1.3.6.2 End a media transmission – transmission control server initiated**

Figure 7.7.1.3.6.2-1 describes the procedure for ending a media transmission during an MCVidéo session by the transmission control server. Only two UEs involved in the session are shown for the simplicity.

Pre-condition:

1. MCVidéo session is established between MCVidéo clients (client A and client B) and MCVidéo server
2. Transmission control is established between transmission control participants and transmission control server.
3. Transmission control participant A and participant B have been granted the permission to transmit media and there are ongoing media transmission from transmission control participant A and participant B.

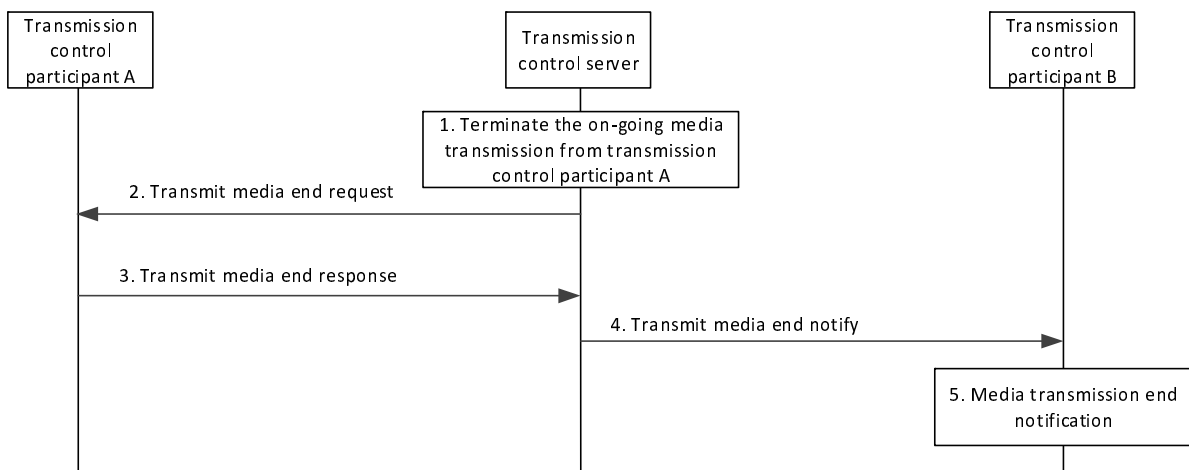

**Figure 7.7.1.3.6.2-1: End a media transmission by the transmission control server**

1. Transmission control server terminates the on-going media transmission from transmission control participant A due to a termination event (e.g. revoke for another priority media transmission or there are no receiving participants).
2. Transmission control server sends a transmit media end request message to transmission control participant A indicating the reason for ending the media transmission.
3. Transmission control participant A responds with a transmit media end response message to transmission control server as acknowledgement
4. Transmission control server sends a transmit media end notify message to transmission control participant B indicating that the media transmission from transmission control participant A is terminated by the transmission control server.
5. The transmit media end notification shall cause the user of the transmission control participant B to be notified of the media transmission termination by the transmission control server.

#### 7.7.1.3.6.3 End a media transmission – remote MCVideo user initiated

Figure 7.7.1.3.6.3-1 describes the procedure for ending a media transmission during an MCVideo session by a remote MCVideo user. Only two UEs involved in the session are shown for the simplicity.

Pre-condition:

1. MCVideo session is established between MCVideo clients (client A and client B) and MCVideo server
2. Transmission control is established between transmission control participants and transmission control server.
3. Transmission control participant B has been granted the permission to transmit media and there is ongoing media transmission from transmission control participant B.
4. Transmission control participant A is authorized to end the on-going media termination from transmission control participant B.

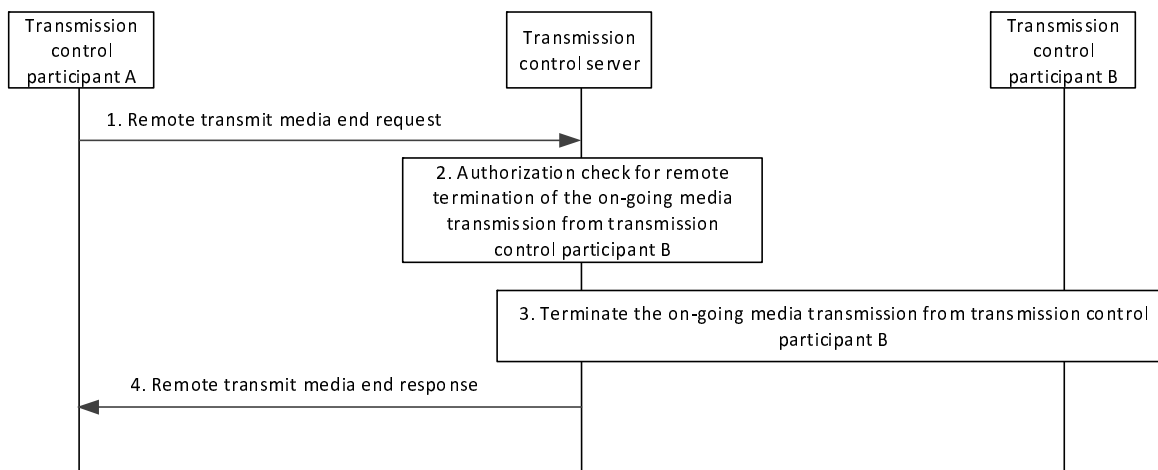

**Figure 7.7.1.3.6.3-1: End a media transmission by a remote MCVideo user**

1. Transmission control participant A sends a remote transmit media end request message to transmission control server including the MCVideo ID of the user at the UE of the transmission control participant B and the MCVideo ID of the user at the UE of the transmission control participant A.
2. Transmission control server checks whether the user at the UE of transmission control participant A is authorized to end the on-going media transmission from transmission control participant B. If authorized, the transmission control server ends the media transmission from transmission control participant B.
3. Transmission control server ends the on-going media transmission from transmission control participant B. The transmission control server shall send transmit media end notify messages to the transmission control participants receiving the media transmission from transmission control participant B, indicating that the transmission has ended.

4. Transmission control server responds with a remote transmit media end response message to transmission control participant A indicating that the transmission control server has ended the requested media transmission.

### 7.7.1.3.7 Remotely initiated media transmission during an MCVideo session

Figure 7.7.1.3.7-1 describes the procedure for remotely initiated media transmission during an MCVideo session by an authorized user. Only two UEs involved in the session are shown for the simplicity.

Pre-condition:

1. MCVideo session is established between MCVideo clients (client A and client B) and MCVideo server
2. Transmission control is established between transmission control participants and transmission control server and there is no ongoing media transmission.
3. The user of the UE at the transmission control participant A is authorized to remotely initiate a media transmission from transmission control participant B

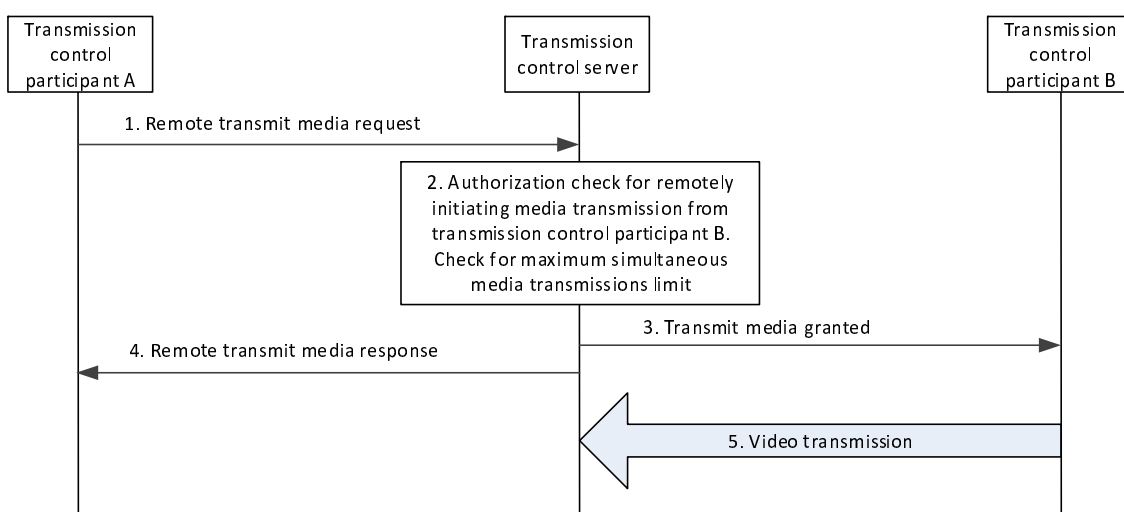

**Figure 7.7.1.3.7-1: Remotely initiated media transmission during an MCVideo session**

1. Transmission control participant A sends a remote transmit media request message to transmission control server including the MCVideo ID of the user at the UE of the transmission control participant B and the MCVideo ID of the user at the UE of the transmission control participant A.
2. Transmission control server checks whether the user at the UE of transmission control participant A is authorized to remotely initiate a media transmission from transmission control participant B. If authorized, the transmission control server makes the determination on what action (grant, deny, or queue) to take on the request based on transmission control criteria (e.g., group policy) and determines to accept the remotely initiated transmit media request from transmission control participant A.
3. Transmission control server sends a transmit media granted message to transmission control participant B.
4. Transmission control server provides a remote transmit media response message to transmission control participant A indicating success (media transmission occurs from transmission control participant B) or a failure reason.
5. Transmission control participant B starts sending video media over the session established to the transmission control server.

## 7.7.2 Off-network transmission control

### 7.7.2.1 General

The procedure is for providing transmission control to MCVideo UE in an off-network case. Transmission control is performed by using transmission control information flows between the transmission control participant and the transmission control arbitrator. The transmission control arbitrator is a member MCVideo UE of the MCVideo group where the transmission rules are applied.

Transmission control in off-network can be performed in two ways:

- Single arbitrator: transmission participants rely on a single participant designated as transmission arbitrator for the arbitration of transmission requests.
- Self arbitration: each transmission participant arbitrates its own transmission based on its view of the topology.

Both of the approaches, as appropriate for the deployment model, can be adopted for MCVideo group using a configurable parameter (as defined in Annex A.4).

In the single arbitrator approach, one MCVideo client assumes the responsibility for arbitration of transmission requests for all group members within range. All requests for transmission are directed to the arbitrator, and the arbitrator checks the configured limits on the simultaneous transmissions, and grants or denies the request. If an MCVideo client is out of range of the current arbitrator, the MCVideo client is allowed to transmit and also become a transmission arbitrator. If there is insufficient capacity to carry an extra transmission i.e. the configured limit for simultaneous transmissions is reached, the MCVideo client may request that an existing transmitting MCVideo client is pre-empted; the pre-emption request is sent to the transmission arbitrator.

In the self arbitration approach, each MCVideo client decides for itself whether there is sufficient capacity to carry the transmission. If it determines that there is insufficient capacity i.e. the configured limit for simultaneous transmissions is reached, and from its perspective another transmitting MCVideo client has a lower priority, the requesting MCVideo client may send an override request directly to this other transmitting MCVideo client, which will either accept the override request and give way, or deny the override request.

In both the single arbitrator approach and the self arbitration approach, if there is insufficient capacity to carry the communication i.e. the configured limit on the simultaneous transmissions is reached, the MCVideo client may report this to the MCVideo user. The MCVideo user may decide to transmit anyway, and instruct the MCVideo client to proceed with the transmission.

**NOTE:** The ProSe function within the MCVideo client could determine that there is insufficient capacity to carry an MCVideo call requested by the MCVideo client, however interactions between the MCVideo client and the ProSe function are outside the scope of the present document.

Further subclauses apply to one or both of the single arbitrator approach and the self arbitration approach. Applicability is explicitly indicated in each of the relevant subclauses.

### 7.7.2.2 Information flows for off-network transmission control

#### 7.7.2.2.1 Transmission request

Table 7.7.2.2.1-1 describes the information flow for the transmission request sent by a transmission participant to request for the transmission permission. This information flows is sent in unicast or broadcast.

**Table 7.7.2.2.1-1: Transmission request**

Information element	Status	Description
MCVideo ID	M	The identity of the MCVideo user requesting the transmission permission
Transmission priority	M	Priority of the request
Source identifier	O	Identifies the communication, e.g. by identifying the media flow within a media multiplex, present only if media multiplexing

### 7.7.2.2.2 Transmission granted

Table 7.7.2.2.2-1 describes the information flow for the transmission granted sent by the transmission arbitrator, to indicate that a request for transmission is granted and media may be transmitted. This information flows is sent in unicast or broadcast.

**Table 7.7.2.2.2-1: Transmission granted**

Information element	Status	Description
MCVideo ID	M	Identity of the user whose client is acting as transmission arbitrator
MCVideo ID	M	Identity of the user that has been granted transmission permission
Duration	M	The time for which the granted party is allowed to transmit
Source identifier	O	Identifies the communication, e.g. by identifying the media flow within a media multiplex, present only if media multiplexing
MCVideo ID of subsequent arbitrator	O	Subsequent transmission arbitrator's identity
Acknowledgement required	O	Indicates if acknowledgement from the transmission participant is required

### 7.7.2.2.3 Transmission release

Table 7.7.2.2.3-1 describes the information flow for transmission release sent by the transmission participant, to indicate that the media transmission is complete and transmission permission is released. This information flows is sent in unicast or broadcast.

**Table 7.7.2.2.3-1: Transmission release**

Information element	Status	Description
MCVideo ID	M	Identity of user releasing transmission
Source identifier	O	Identifies the communication, e.g. by identifying the media flow within a media multiplex, present only if media multiplexing

### 7.7.2.2.4 Transmission rejected

Table 7.7.2.2.4-1 describes the information flow for transmission rejected sent by the transmission arbitrator, to indicate that a request for the transmission is rejected. This information flows is sent in unicast or broadcast.

**Table 7.7.2.2.4-1: Transmission rejected**

Information element	Status	Description
MCVideo ID	M	Identity of the user whose client is acting as transmission arbitrator
MCVideo ID of rejected party	M	Identity of user whose transmission request has been rejected
Source identifier	O	Identifies the communication, e.g. by identifying the media flow within a media multiplex, present only if media multiplexing
Rejection cause	O	Indicates the cause for transmission rejection
Acknowledgement required	O	Indicates if acknowledgement from the transmission participant is required

### 7.7.2.2.5 Transmission revoked

Table 7.7.2.2.5-1 describes the information flow for transmission revoked sent by the transmission arbitrator, to indicate that the transmission permission, that was earlier granted, is revoked. This information flows is sent in unicast or broadcast.

**Table 7.7.2.2.5-1: Transmission revoked**

Information element	Status	Description
MCVideo ID	M	Identity of the user whose client is acting as transmission arbitrator
MCVideo ID	M	Identity of user whose transmission permission has been revoked
Source identifier	O	Identifies the communication, e.g. by identifying the media flow within a media multiplex, present only if media multiplexing
Acknowledgement required	O	Indicates if acknowledgement from the transmission participant is required

### 7.7.2.2.6 Transmission arbitration taken

Table 7.7.2.2.6-1 describes the information flow for transmission taken sent by the transmission participant, to indicate that the transmission participant has taken the responsibility of transmission arbitration. This information flows is sent in unicast or broadcast.

**Table 7.7.2.2.6-1: Transmission arbitration taken**

Information element	Status	Description
MCVideo ID	M	Identity of the MCVideo user taking responsibility of transmission arbitration
Source identifier	O	Identifies the communication, e.g. by identifying the media flow within a media multiplex, present only if media multiplexing
Permission to request the transmission	O	Indicates whether receiving parties are allowed to request the transmission or not (e.g. broadcast call).
Acknowledgement required	O	Indicates if acknowledgement from the transmission participant is required

### 7.7.2.2.7 Transmission arbitration release

Table 7.7.2.2.7-1 describes the information flow for transmission arbitration release sent by the transmission arbitrator, to indicate that the responsibility of transmission arbitration is released. This information flows is sent in unicast or broadcast.

**Table 7.7.2.2.7-1: Transmission arbitration release**

Information element	Status	Description
MCVideo ID	M	Identity of the user whose client is acting as transmission arbitrator
MCVideo ID	O	Identity of the user whose client is being delegated transmission arbitrator function
Source identifier	O	Identifies the communication, e.g. by identifying the media flow within a media multiplex, present only if media multiplexing

## 7.7.2.3 Initializing transmission control – single arbitrator approach

This subclause is applicable only in single arbitrator approach.

Figure 7.7.2.3-1 describes procedures for transmission participants when an MCVideo client initializes transmission control. The MCVideo client sends a transmission request to detect presence of a transmission arbitrator. If the MCVideo client does not receive a response to the transmission request, it sends a transmission arbitration taken message and becomes the transmission arbitrator. The MCVideo client may now transmit a video. This procedure applies when either there have been no recent MCVideo transmissions within the MCVideo group and therefore no arbitrator has been selected, or where there have been recent MCVideo transmissions which may still be ongoing, but



the arbitrator cannot be reached, e.g. where MCVideo client that wants to transmit video has gone out of range of the arbitrator.

Pre-conditions:

1. An off-network group communication has been established.
2. MCVideo client 1 wishes to transmit video, and has determined that the pre-configured limit on the number of transmissions within the MCVideo group has not been reached.

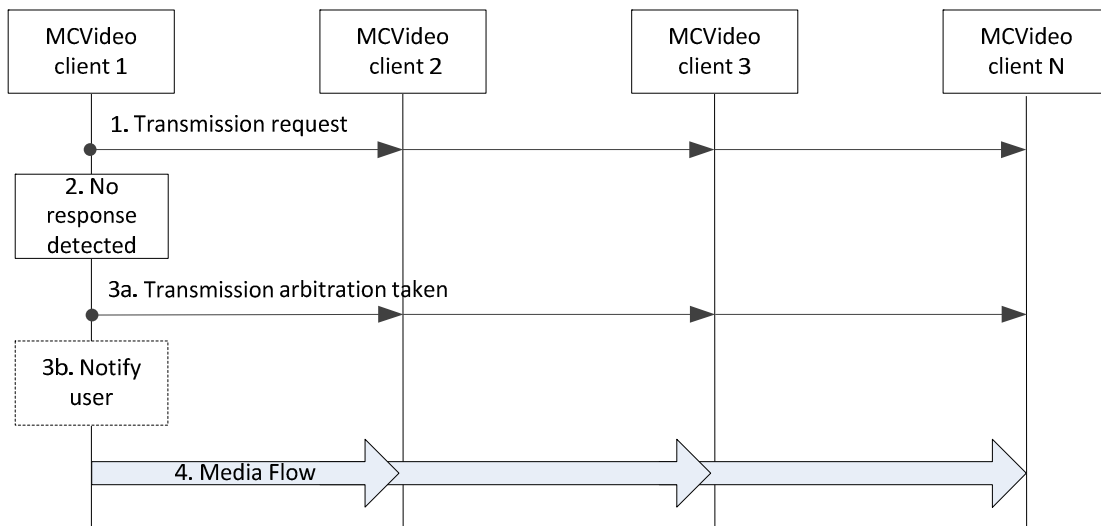

**Figure 7.7.2.3-1: Initializing transmission control, single arbitrator case**

1. MCVideo client 1 sends a transmission request message to the MCVideo group.
2. MCVideo client 1 does not detect any response to the transmission request.
- 3a. MCVideo client 1 sends a transmission arbitration taken message to the MCVideo group.
- 3b. MCVideo user may be notified that the video can now be transmitted.
4. MCVideo client 1 transmits video to the MCVideo group.

### 7.7.2.3A Initializing transmission control – self arbitration approach

This subclause is applicable only in self arbitration approach.

Figure 7.7.2.3a-1 describes procedures for transmission participants when an MCVideo client initializes transmission control.

Pre-conditions:

1. An off-network group communication has been established.
2. MCVideo client 1 wishes to transmit video.

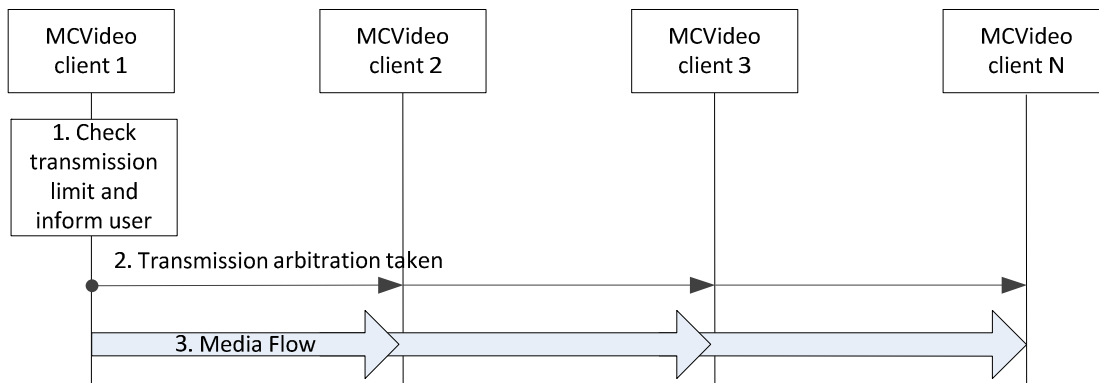

**Figure 7.7.2.3a-1: Initializing transmission control, self arbitration case**

1. The MCVideo client checks whether the pre-configured limit on the number of transmissions within the MCVideo group has been reached and informs the user. If the pre-configured limit on the number of transmissions within the MCVideo group has been reached, the MCVideo user may defer the transmission, or request an override as specified in subclause 7.7.2.8, or decide to continue with the transmission anyway.

NOTE: If the MCVideo user decides to transmit even if the pre-configured limit on the number of transmissions within the MCVideo group has been reached, the MCVideo user decides to accept any consequences of interference.

2. MCVideo client 1 sends a transmission arbitration taken message to the MCVideo group.
3. MCVideo client 1 transmits video to the MCVideo group.

#### 7.7.2.4 Transmission permission granted

This subclause is applicable only in single arbitrator approach.

Figure 7.7.2.4-1 describes procedures for transmission participants when an MCVideo client requests for transmission permission.

The MCVideo client has detected presence of a transmission arbitrator e.g., by receiving responses to transmission arbitration control message. The MCVideo client sends a transmission request and waits for a response. The MCVideo client upon receiving a transmission granted message may transmit a video.

Pre-conditions:

1. An off-network group communication has been established.
2. At least one participant is currently transmitting video.

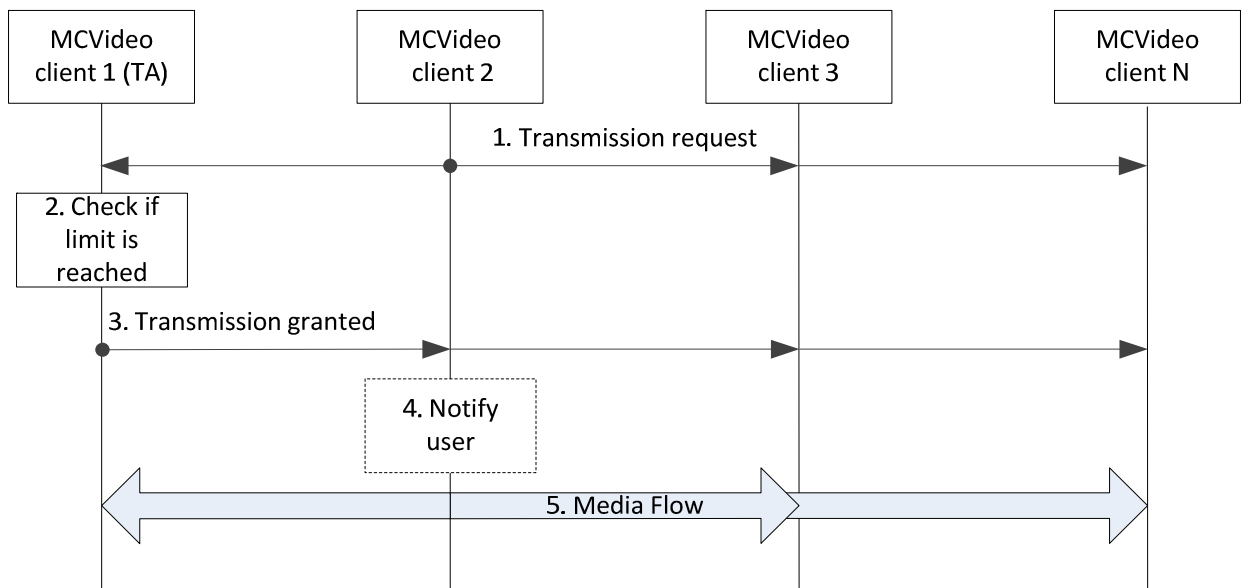

**Figure 7.7.2.4-1: Requesting transmission permission**

1. MCVideo client 2 sends a transmission request message to the MCVideo group.
2. MCVideo client 1, being the transmission arbitrator, checks if the configured limit of maximum simultaneous transmissions is already reached.
3. If the maximum simultaneous transmissions limit is not reached, MCVideo client 1 sends a transmission granted message to the MCVideo group. Transmission granted message indicates MCVideo client 2 as the intended recipient.
4. MCVideo user at MCVideo client 2 may be notified that the video can now be transmitted.
5. MCVideo client 2 transmits video to the MCVideo group.

### 7.7.2.5 Transmission permission rejected

This subclause is applicable only in single arbitrator approach.

Figure 7.7.2.5-1 describes procedures for transmission participants when an MCVideo client requests for transmission permission.

The MCVideo client has detected presence of a transmission arbitrator e.g., by receiving responses to transmission arbitration control message. The MCVideo client sends a transmission request and waits for a response.

Pre-conditions:

1. An off-network group communication has been established.
2. At least one participant is currently transmitting video.

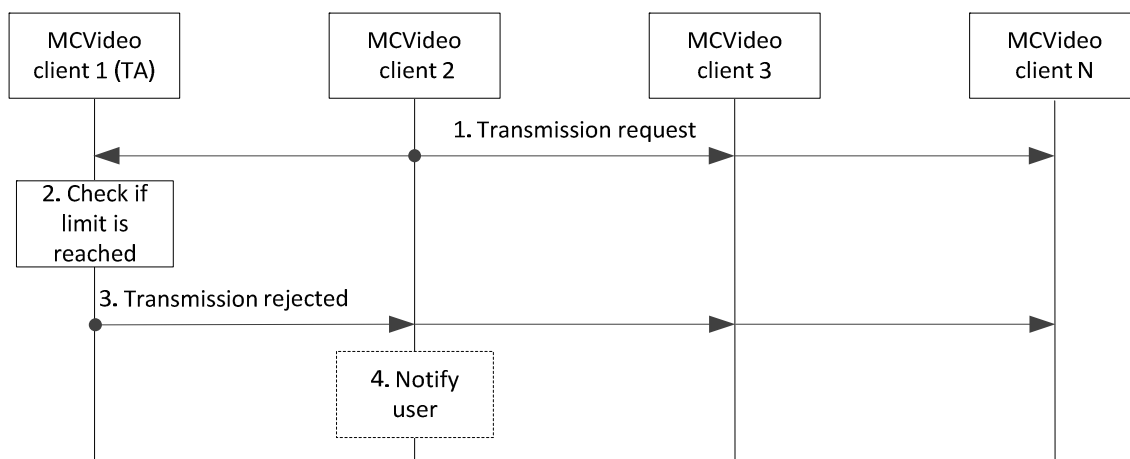

**Figure 7.7.2.5-1: Requesting transmission permission**

1. MCVideo client 2 sends a transmission request message to the MCVideo group.
2. MCVideo client 1, being the transmission arbitrator, checks if the configured limit of maximum simultaneous transmissions is already reached.
3. If the maximum simultaneous transmissions limit has reached, MCVideo client 1 sends a transmission rejected message to the MCVideo group. Transmission denied message indicates MCVideo client 2 as the intended recipient. The transmission rejected message may include a rejection cause which indicates that the configured maximum transmissions limit has been reached.
4. MCVideo user at MCVideo client 2 may be notified that the video cannot be transmitted right now.

Following step 4, the MCVideo user at MCVideo client 2 may decide to transmit anyway, for example if the user knows the topology of the off-network MCVideo group and locations of the MCVideo group members and needs to transmit video to other local MCVideo group members despite causing a potential conflict with one or more other existing MCVideo transmissions within the MCVideo group. In this case, the MCVideo client follows the procedure in subclause 7.7.2.3.

### 7.7.2.6 Releasing transmission permission

This subclause is applicable in both the single arbitrator and self arbitration approaches.

Figure 7.7.2.6-1 describes procedures for transmission participants when an MCVideo client releases transmission permission.

The MCVideo client has detected presence of a transmission arbitrator e.g., by receiving responses to transmission arbitration control message. The MCVideo client stops the video transmission and sends a transmission release request.

Pre-conditions:

1. An off-network group communication has been established.
2. MCVideo client has requested transmission permission and may have received transmission permission.

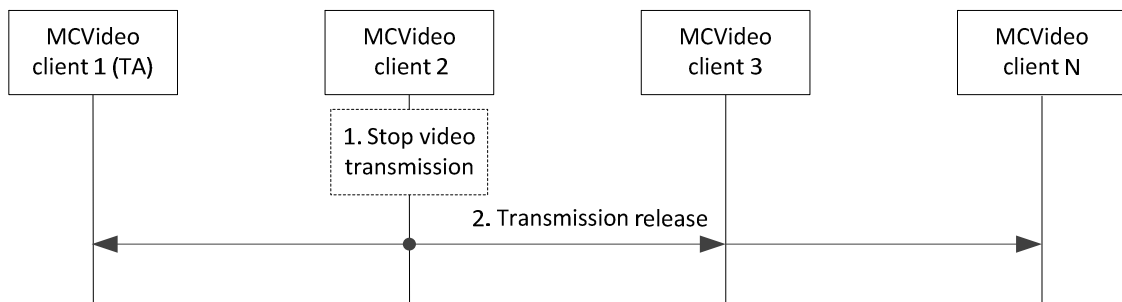

**Figure 7.7.2.6-1: Requesting transmission permission**

1. If transmitting, the MCVideo client 2 stops the transmission of the video.
2. MCVideo client 2 sends a transmission release message to the MCVideo group.

**NOTE:** The transmission arbitrator does not respond to a pending (not granted or denied) transmission request if a transmission release notification is received from the MCVideo client.

### 7.7.2.7 Transmission override

This subclause is applicable in the single arbitrator in the approach.

Figure 7.7.2.7-1 describes procedures for transmission participants when an MCVideo client authorized to override, requests for transmission permission.

The MCVideo client has detected presence of a transmission arbitrator e.g., by receiving responses to transmission arbitration control message. The MCVideo client sends a transmission request and waits for a response.

Pre-conditions:

1. An off-network group communication has been established.
2. Maximum simultaneous transmissions limit has been reached.

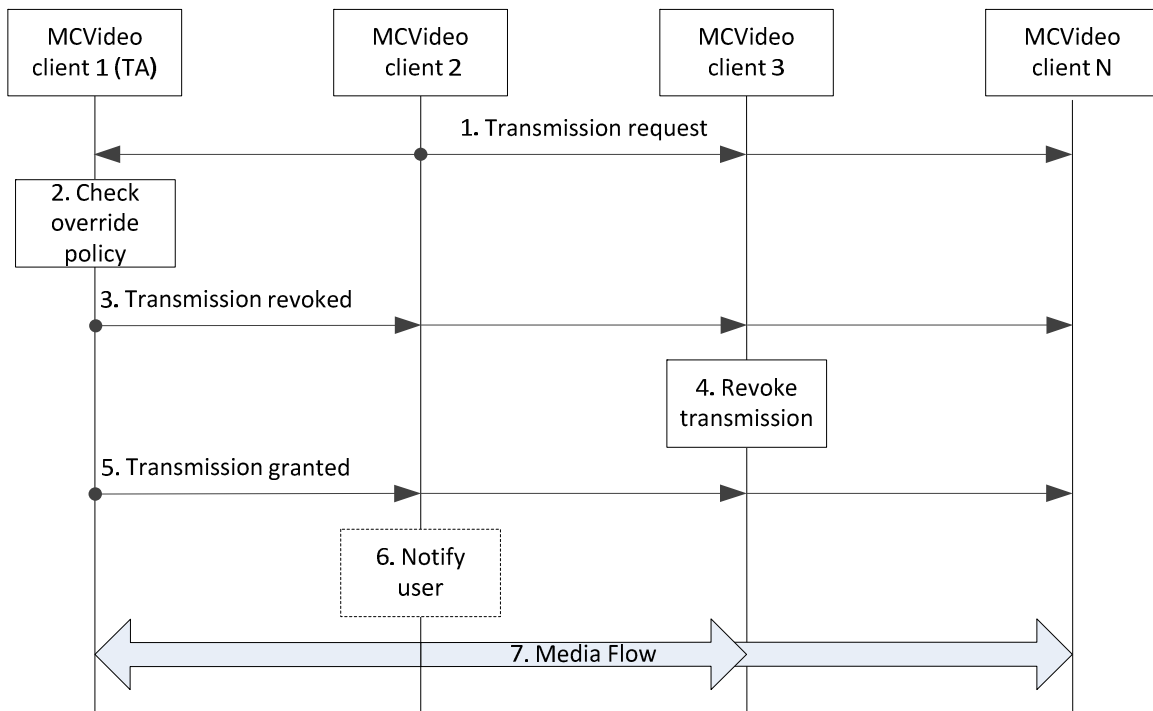

**Figure 7.7.2.7-1: Transmission override**

1. MCVideo client 2 sends a transmission request message to the MCVideo group.
2. As the configured limit of maximum simultaneous transmissions is already reached, MCVideo client 1, being the transmission arbitrator, checks the override policy.
3. If MCVideo client 2 is authorized to override (based on e.g., transmission priority), MCVideo client 1 sends a transmission revoked message to the MCVideo group. Transmission revoked message indicates the MCVideo client from which the permission is revoked, as the intended recipient.
4. MCVideo client 3 stops transmission of video and MCVideo user at MCVideo client 3 may be notified that the transmission permission has been revoked.
5. MCVideo client 1 sends a transmission granted message to the MCVideo group. Transmission granted message indicates MCVideo client 2 as the intended recipient.
6. MCVideo user at MCVideo client 2 may be notified that the video can now be transmitted.
7. MCVideo client 2 transmits video to the MCVideo group.

### 7.7.2.8 Transmission override (revoke self)

This subclause is applicable in the single arbitrator approach.

**Editor's note: transmission override in the self arbitration approach is FFS.**

Figure 7.7.2.8-1 describes procedures for transmission participants when an MCVideo client authorized to override, requests for transmission permission.

The MCVideo client has detected presence of a transmission arbitrator e.g., by receiving responses to transmission arbitration control message. The MCVideo client sends a transmission request and waits for a response.

Pre-conditions:

1. An off-network group communication has been established.

2. Maximum simultaneous transmissions limit has been reached.

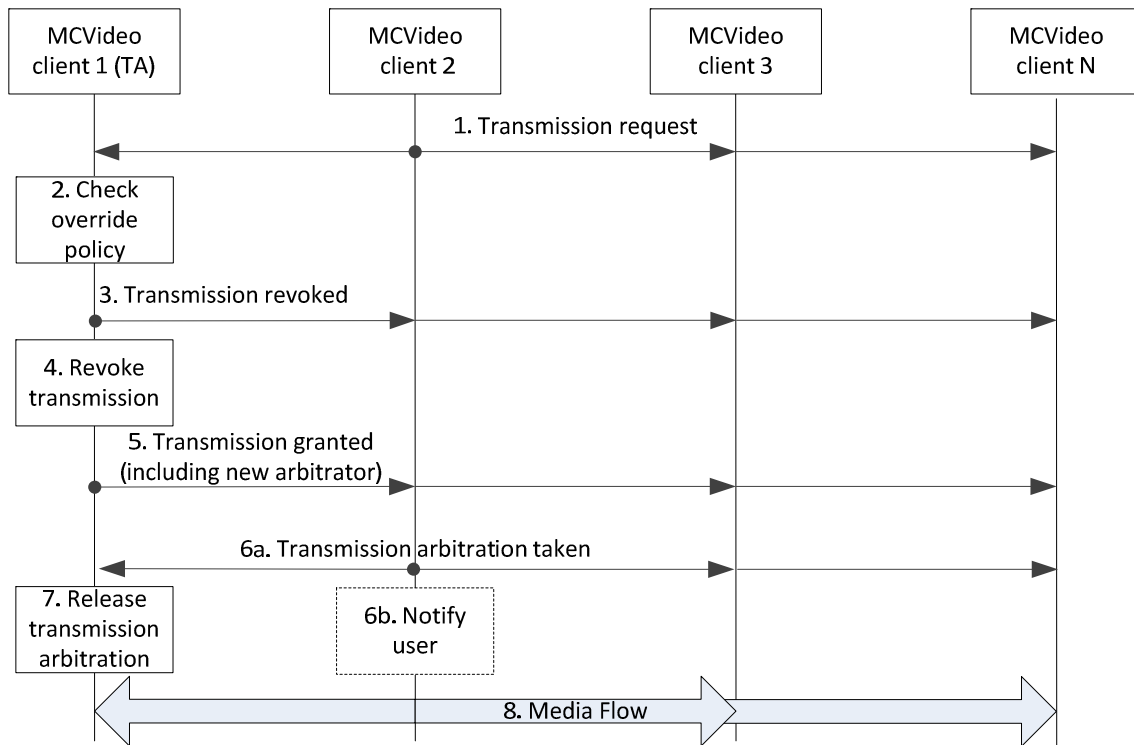

**Figure 7.7.2.8-1: Transmission override**

1. MCVideo client 2 sends a transmission request message to the MCVideo group.
  2. As the configured limit of maximum simultaneous transmissions is already reached, MCVideo client 1, being a transmission arbitrator, checks the override policy.
  3. If MCVideo client 2 is authorized to override (based on e.g., transmission priority), MCVideo client 1 may send a transmission revoked message to the MCVideo group. Transmission revoked message indicates the MCVideo client 1, the current arbitrator, whose permission is revoked.
  4. MCVideo client 1 stops transmission of video and MCVideo user at MCVideo client 1 may be notified that the transmission permission has been revoked.
  5. MCVideo client 1 sends a transmission granted message to the MCVideo group. The transmission granted message indicates MCVideo client 2 as the intended recipient and MCVideo client 2 as the subsequent transmission arbitrator.
  - 6a. MCVideo client 2 sends a transmission arbitration taken message to the MCVideo group.
  - 6b. MCVideo user at MCVideo client 2 may be notified that the video can now be transmitted.
- NOTE: Step 6a and step 6b can occur in any order.
7. MCVideo client 1, upon receiving the transmission arbitration taken message releases transmission arbitration.
  8. MCVideo client 2 transmits video to the MCVideo group.

## 7.7.2.9 Transmission arbitration release

### 7.7.2.9.1 Transmission arbitration release

This subclause is applicable only in single arbitrator approach.

Figure 7.7.2.9.1-1 describes procedures for an MCVideo client to release transmission arbitration. There is no other MCVideo client to which transmission arbitration can be delegated.

Pre-conditions:

1. An off-network group communication has been established.
2. Only MCVideo client 1 is transmitting a video.

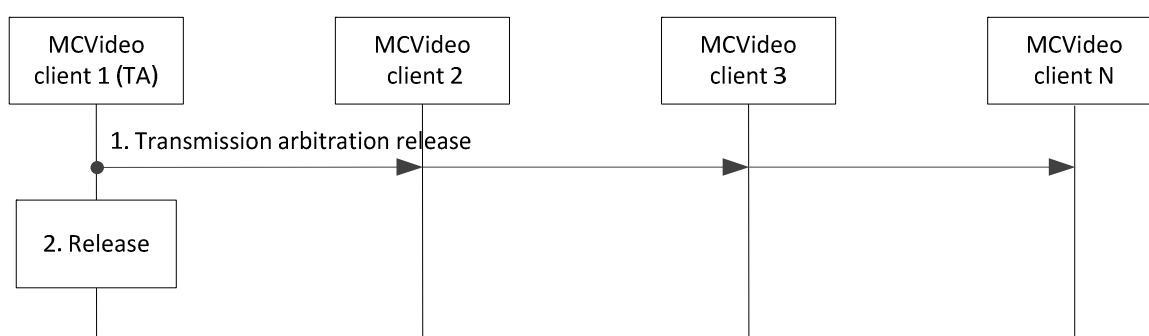

**Figure 7.7.2.9.1-1: Transmission arbitration release without delegation**

1. MCVideo client 1 sends a transmission release message to the MCVideo group.
2. MCVideo client 1 stops transmission of the video.

### 7.7.2.9.2 Transmission arbitration release with delegation

This subclause is applicable only in single arbitrator approach.

Figure 7.7.2.9.2-1 describes procedures for an MCVideo client to release transmission arbitration. There are other MCVideo clients currently transmitting to which transmission arbitration can be delegated.

Pre-conditions:

1. An off-network group communication has been established.
2. At least one more MCVideo client is transmitting video other than the current transmission arbitrator.



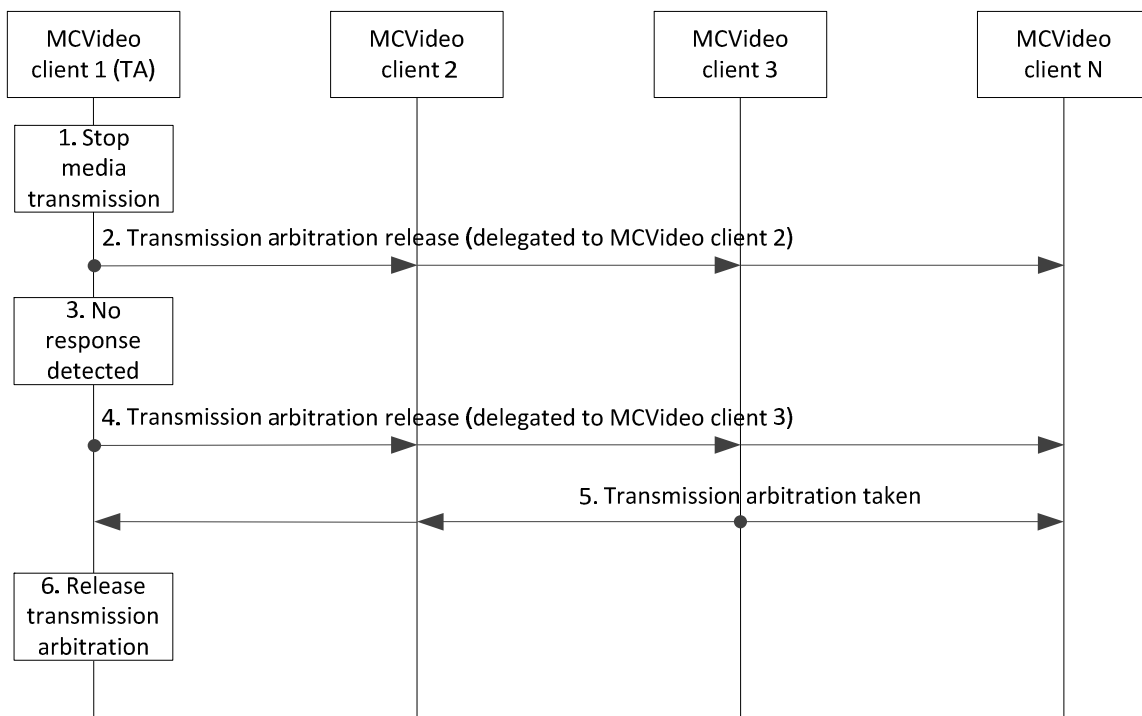

**Figure 7.7.2.9.2-1: Transmission arbitration release with delegation**

1. MCVideo client 1 stops video transmission but does not release transmission arbitration.
2. MCVideo client 1 sends a transmission arbitration release message. The transmission arbitration release message indicates a MCVideo client which is currently transmitting video, MCVideo client 2, as the subsequent transmission arbitrator. The MCVideo client 1 waits for a confirmation before releasing transmission arbitration.
3. MCVideo client 1 detects no response from MCVideo client 2.
4. MCVideo client 1 sends another transmission arbitration release message. The transmission arbitration release message indicates another MCVideo client which is currently transmitting video, MCVideo client 3, as the subsequent transmission arbitrator. The MCVideo client 1 waits for a confirmation before releasing transmission arbitration.
5. MCVideo client 3 sends a transmission arbitration taken message to the MCVideo group.
6. MCVideo client 1, upon receiving the transmission arbitration taken message releases transmission arbitration.

### 7.7.2.10 Simultaneous transmission requests

This subclause is applicable in both the single arbitrator and self arbitration approaches.

Figure 7.7.2.10-1 describes procedures for transmission participants when simultaneous transmission requests are generated when more than one MCVideo client initializes transmission control.

Figure 7.7.2.10-1 shows the expected behaviour if simultaneous transmission requests are generated in the following scenarios:

- a single arbitrator approach is used but there is currently no arbitrator; or
- self arbitration is used.

Pre-conditions:

1. An off-network group communication has been established.

2. MCPTT client 1 has higher transmission priority than MCPTT client 2.

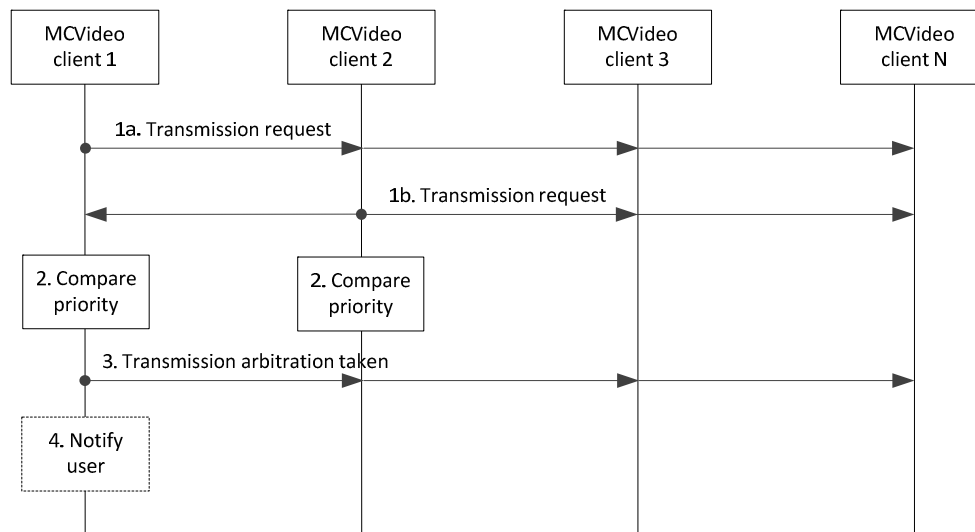

**Figure 7.7.2.10-1: Simultaneous transmission requests**

- 1a. The MCPTT client 1 sends the transmission request message to the MCPTT group.  
 1b. The MCPTT client 2 sends the transmission request message to the MCPTT group.

NOTE: Step 1a and 1b happen in parallel

2. On receiving a transmission request message, while waiting for a response to the sent transmission request message, the MCVideo client compares its transmission priority with the transmission priority indicated in the received transmission request message.
3. On determining that it has higher transmission priority than the received transmission request message(s), and no response to the sent transmission request message is received, the MCVideo client 1 sends the transmission arbitration taken message to the MCVideo group.
4. MCVideo user may be notified that the video can now be transmitted.

## 7.8 MCVideo service configuration

The MCVideo service shall support the procedures and related information flows as specified in subclause 10.1 of 3GPP TS 23.280 [6] with the following clarifications:

- The MC service client is the MCVideo client;
- The MC service server is the MCVideo server;
- The MC service ID is the MCVideo ID; and
- The MC service user profile index is the MCVideo user profile index.

## 7.9 Affiliation and de-affiliation to/from MCVideo group(s)

The MCVideo service shall support the procedures and related information flows as specified in subclause 10.8 of 3GPP TS 23.280 [6] with the following clarifications:

- The MC service client is the MCVideo client;

- The MC service server is the MCVideo server;
- The MC service group is the MCVideo group;
- The MC service ID is the MCVideo ID; and
- The MC service group ID is the MCVideo group ID.

When an MCVideo user has affiliated to an MCVideo group then the MCVideo user can send and receive MCVideo related media for that MCVideo group. When an MCVideo user has de-affiliated from an MCVideo group then the MCVideo user cannot send and receive MCVideo related media to and from that MCVideo group.

## 7.10 Use of MBMS transmission (on-network)

### 7.10.1 Information flows for MBMS Transmission

#### 7.10.1.1 General

Information flows for generic MBMS procedures are defined in 3GPP TS 23.280 [6].

#### 7.10.1.2 MapGroupToBearer

Table 7.10.1.2-1 describes the information flow to associate a MCVideo group call to a MBMS bearer. It is sent from the MCVideo server to the MCVideo client.

**Table 7.10.1.2-1: MapGroupToBearer**

Information element	Status	Description
MCVideo group ID	M	This element identifies the MCVideo group, in which the call is started.
Media stream identifier (video)	M	This element identifies the media stream of the SDP used for the Video group call (e.g. MBMS subchannel).
Media stream identifier (audio)	O	This element identifies the audio media stream of the SDP used for the Video group call (e.g. MBMS subchannel). This is used if separate codecs are used for video and audio.
TMGI (NOTE)	O	The MBMS bearer identifier if the media of the MCVideo group call is not sent on the same MBMS bearer as this MapGroupToBearer message.
Call acknowledgement indicator	O	Indication that the MCVideo group call requires acknowledgement from receiving MCVideo clients.
NOTE: TMGI shall be present if this message is sent over a different MBMS bearer than the media of the group call; TMGI may be present if this message is sent over the same MBMS bearer as the media of the group call.		

#### 7.10.1.3 UnmapGroupFromBearer

Table 7.10.1.3-1 describes the information flow to disconnect a MCVideo group call from a MBMS bearer. It is sent from the MCVideo server to the MCVideo client.

**Table 7.10.1.3-1: UnmapGroupFromBearer**

Information element	Status	Description
MCVideo group ID	M	This element identifies the MCVideo group which will no longer use the MBMS bearer.

## 7.10.2 Use of pre-established MBMS bearers

The MCVideo service shall support the procedure for using pre-established MBMS bearers as specified 3GPP TS 23.280 [6] with the following clarifications:

- The MC service client is the MCVideo client;
- The MC service server is the MCVideo server; and
- The MC service ID is the MCVideo ID.

The MCVideo service shall use the MCVideo-1, MCVideo-8 and MCVideo-9 reference points for this procedure.

MCVideo may use pre-established MBMS bearer for the different types of MCVideo group calls. Both pre-arranged group calls and chat group calls can use the pre-established MBMS bearer for distributing the media. The MBMS bearer can be used by any group. Depending on the capacity of the MBMS bearer, the bearer can be used to broadcast one or more group calls in parallel.

Both the media packets as well as the transmission control messages to the receiving MCVideo clients are sent on the MBMS bearer. Optionally a separate MBMS bearer could be used for the transmission control messages, due to different bearer characteristic requirements.

When using the pre-established MBMS bearer for MCVideo, the MCVideo server perform the procedure of call connect and disconnect over MBMS as defined in subclause 7.10.4 at the group communication session establishment step.

## 7.10.3 Use of dynamic MBMS bearer establishment

The MCVideo service shall support the procedure for using dynamic MBMS bearers as specified 3GPP TS 23.280 [6] with the following clarifications:

- The MC service client is the MCVideo client;
- The MC service server is the MCVideo server; and
- The MC service ID is the MCVideo ID.

The MCVideo service shall use the MCVideo-1, MCVideo-4, MCVideo-7, MCVideo-8 and MCVideo-9 reference points for this procedure.

MCVideo may use dynamic MBMS bearer establishment for the different types of MCVideo group calls. Both pre-arranged group calls and chat group calls can use the dynamic MBMS bearer for distributing the media.

Both the media packets as well as the transmission control messages to the receiving MCVideo clients are sent on the MBMS bearer.

When using the procedures for dynamic MBMS bearer establishment for MCVideo, the MCVideo server perform the procedure of mapping group communication to MBMS bearer as defined in subclause 7.10.4 at the group communication session establishment step.

## 7.10.4 Video call connect and disconnect over MBMS

### 7.10.4.1 General

MBMS bearer can be used for MCVideo group calls. One MBMS bearer is not permanently associated to one specific group or group call. Before sending media packets of a group call over MBMS bearer, the MCVideo server shall send the association information between group call and the MBMS bearer. The group call setup procedure indicates the media stream or media streams within one MBMS bearer that is used for the specific MCVideo group call. When the group call over the MBMS bearer is finished, this temporary association information of an MCVideo group call to specific resources on a MBMS bearer is undone. The procedure in figure 7.10.4.2.1-1 requires that the group session is setup before the call start. This eliminates the need for the receiving clients to continuously use a unicast bearer. Prior to this the MBMS bearer is activated and announced to the MCVideo clients.

## 7.10.4.2 Procedure

### 7.10.4.2.1 Call connect over MBMS

In figure 7.10.4.2.1-1 the MCVideo client 1 is the client that initiate an MCVideo chat group call and also the transmitting client. MCVideo client 1 may, but does not have to be in an MBMS service area. The MCVideo client 2 and MCVideo client 3 represents MCVideo clients receiving the MCVideo call over an MBMS bearer. There may be other receiving clients both over unicast bearers and over this or other MBMS bearer(s), however they are not illustrated in this figure.

The same procedure as for chat group call can also be applied for pre-arranged calls.

Pre-conditions:

- All users participating in the MCVideo group call are already affiliated to the group.
- All participating users have joined the group session.

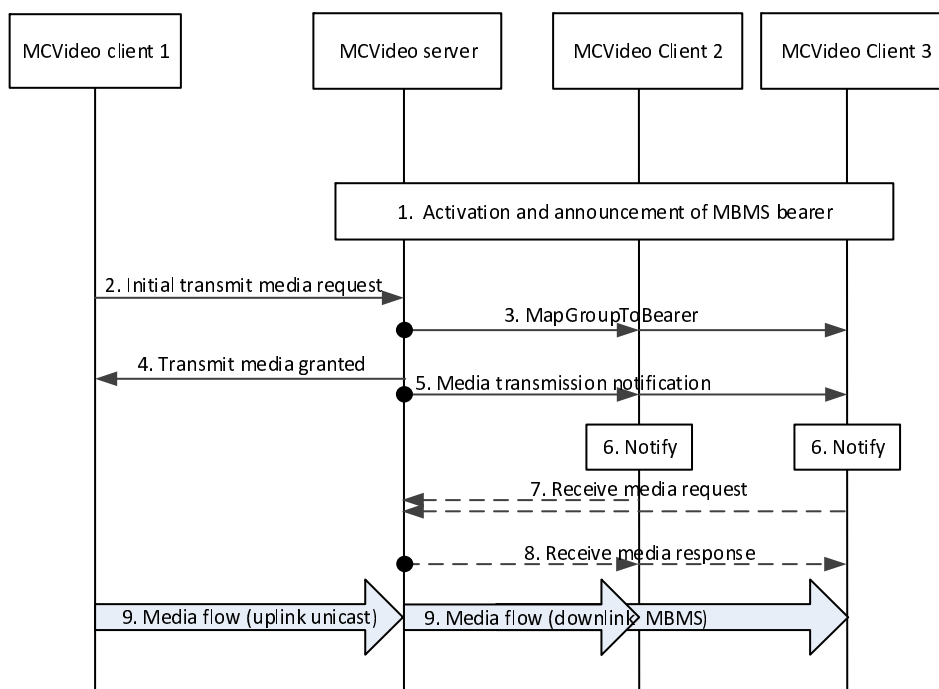

**Figure 7.10.4.2.1-1: Chat group call connect on MBMS bearer**

1. Activation and announcement of MBMS bearer availability.

NOTE 1: The procedure does not include the steps for MCVideo client location reporting, or for MBMS capability information exchange.

2. MCVideo client 1 initiate the MCVideo group call by sending an initial transmit media request over a unicast bearer to the MCVideo server (reference point MCVideo-4).
3. The MCVideo server will send a MapGroupToBearer message over a previously activated MBMS bearer to all users that will receive the call over an MBMS bearer. The MapGroupToBearer message includes association information between the group call and MBMS bearer. The MapGroupToBearer message includes MCVideo group ID and information about the media stream identifier or media stream identifiers of the activated MBMS bearer and may include the identifier (i.e. the TMGI) of the MBMS bearer broadcasting the call. The message is sent over reference point MCVideo-9.

NOTE 2: Step 3 can be deferred until step 5 and the MapGroupToBearer message can then be included in the transmission arbitration taken message.

4. The MCVideo server grants the right to transmit for MCVideo client 1 and by that sends a transmit media granted message to the MCVideo client 1. This message is sent over a unicast bearer (reference point MCVideo-4).
5. A media transmission notification message is sent from the MCVideo server to all receiving users. This message includes the MCVideo ID of the transmitting MCVideo client as well as the MCVideo group ID. The message is sent over a MBMS bearer to all users that have previously been setup to receive calls over the MBMS bearer. The message is sent over reference point MCVideo-9.
6. The users of MCVideo clients are informed about the details of video transmission and the video transmitter.
7. The MCVideo clients may send a receive media request to the MCVideo server, to indicate the reception of media over the MBMS bearer.
8. MCVideo server accepts the media receive request and sends a receive media response message to MCVideo clients over a MBMS bearer by using reference point MCVideo-9.

NOTE 3: The receive media response can also be sent by unicast to the MCVideo clients that request to receive media over the MBMS bearer.

NOTE 4: Step 7 and 8 may be omitted when auto-receive transmission mode is used, e.g. for emergency group calls.

9. The media is sent from MCVideo client 1 to the MCVideo server over unicast bearer and from the MCVideo server to the MCVideo client 2 and MCVideo client 3 over MBMS bearer.

NOTE 5: Additional transmission request messages in the same call will not trigger the MapGroupToBearer message to be sent.

#### 7.10.4.2.2 Call disconnect over MBMS

Figure 7.10.4.2.2-1 shows the high level procedure where an UnmapGroupFromBearer message is sent by the MCVideo server to the MCVideo clients to indicate that the MCVideo group call is being dissociated from the MBMS bearer.

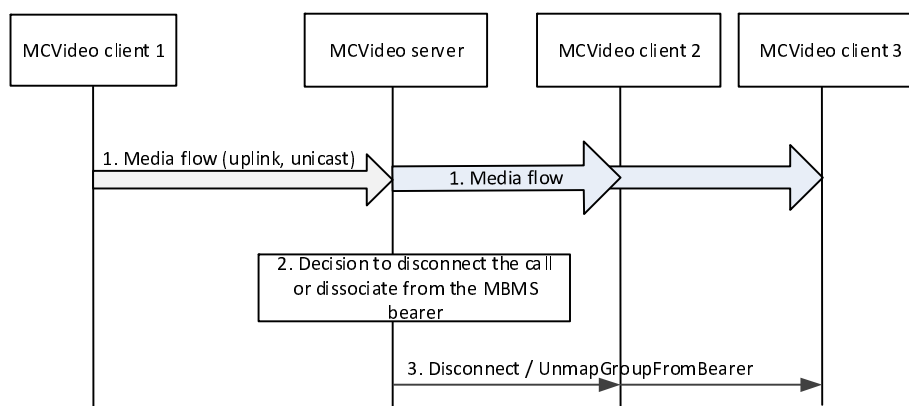

**Figure 7.10.4.2.2-1: Chat group call disconnect on MBMS bearer**

1. An MCVideo group call is ongoing; the media is broadcasted over MBMS bearer to MCVideo client 2 and MCVideo client 3.
2. MCVideo server has determined to disconnect the call over the MBMS bearer for the MCVideo clients
3. An UnmapGroupFromBearer message is sent by the MCVideo server to MCVideo client 2, MCVideo client 3 and possibly to MCVideo client 1 (if in MBMS coverage area) on MBMS bearer(s).

NOTE 4: The UnmapGroupFromBearer message can be sent as part of other messages.

NOTE 5: The UnmapGroupFromBearer message and the MapGroupToBearer message can be combined, to facilitate switching bearers in one signalling step, as necessary.

## 7.10.5 Switching from MBMS bearer to unicast bearer

The MCVideo service shall support the procedure for switching from MBMS bearer to unicast bearer as specified 3GPP TS 23.280 [6] with the following clarifications:

- The MC service client is the MCVideo client;
- The MC service server is the MCVideo server; and
- The MC service ID is the MCVideo ID.

The MCVideo service shall use the MCVideo-1, MCVideo-4, MCVideo-7, MCVideo-8 and MCVideo-9 reference points for this procedure.

## 7.11 Simultaneous session for MCVideo calls (on-network)

An MCVideo client and MCVideo server may use a simultaneous session as defined in 3GPP TS 23.280 [6] for MCVideo calls. The MCVideo client becomes involved in a simultaneous session for MCVideo calls by inviting, joining or accepting more than one MCVideo call, or affiliating to a group.

**NOTE:** An MCVideo client affiliating to multiple MCVideo groups with active calls will result in the MCVideo client being invited simultaneously to multiple MCVideo calls.

The MCVideo client can also still handle multiple MCVideo calls in parallel at the same time i.e. using multiple dialogs.

The simultaneous session is established during either an originating on-demand call establishment or during pre-established session establishment or a modification of an already established pre-established session or on-demand call.

It is possible to change the prioritisation while the MCVideo client is engaged in multiple MCVideo calls. The setting of the priority can be made at MCVideo call setup or by performing a modification after the MCVideo call is established. This may result in more than one media bearer.

## 7.12 User authentication and authorization for MCVideo service

**NOTE:** Flow 7.12-1 is a high level user authentication and authorization flow. 3GPP TS 33.179 [10] defines the specific user authentication and authorization architecture required by the MCVideo service in order to realize the MCVideo user authentication and authorization requirements as defined in 3GPP TS 22.280 [2].

A procedure for user authentication is illustrated in figure 7.12-1. The user authentication is performed based on the procedure specified in 3GPP TS 23.280[6].

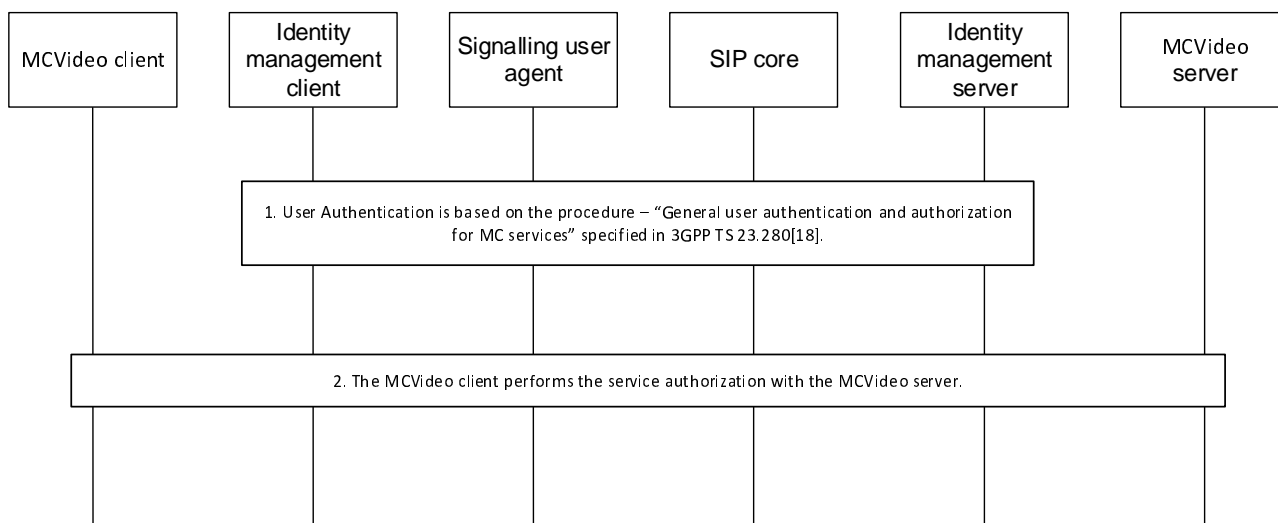

**Figure 7.12-1: MCVideo user authentication and registration, single domain**

1. The user authentication is performed as per the general user authentication procedure specified in 3GPP TS 23.280[6].
2. MCVideo client performs the MCVideo service authorization for the user. Step 2 utilizes the results of step 1.

## 7.13 Support for multiple devices

An MCVideo user may be authorized to use the MCVideo service from multiple MCVideo UEs as per the procedure in subclause 7.12.

If an MCVideo server receives a service authorization request for an MCVideo user who is previously MCVideo service authorized on another MCVideo UE, then the MCVideo server shall process this service authorization request as described in subclause 7.12. In the MCVideo service authorization response to the MCVideo user, the MCVideo server shall also indicate that the MCVideo user is already MCVideo service authorized from another MCVideo UE.

## 7.14 Location information (on-network)

The MCVideo system makes use of all of the procedures for location management as specified in 3GPP TS 23.280 [6], utilising the CSC-14 reference point between the location management client and location management server and the CSC-15 reference point between the MCVideo server and location management server.

- The MC service client is the MCVideo client;
- The MC service server is the MCVideo server;
- The MC service group is the MCVideo group;
- The MC service ID is the MCVideo ID; and
- The MC service group ID is the MCVideo group ID.



---

# Annex A (normative): MCVideo related configuration data

## A.1 General

This Annex provides information about the static data needed for configuration for the MCVideo service, which belongs to one of the following categories:

- MCVideo UE configuration data (see subclause A.2);
- MCVideo user profile configuration data (see subclause A.3);
- MCVideo related group configuration data (see subclause A.4); and
- MCVideo service configuration data (see subclause A.5).

For each configuration category, data is split between configuration data that is applicable to both on network and off network, configuration data that is applicable to on-network only, and configuration data that is applicable to off-network only. The configuration data in each configuration category corresponds to a single instance of the category type i.e. the MCVideo UE, MCVideo group, MCVideo user and MCVideo service configuration data refers to the information that will be stored against each MCVideo UE, MCVideo group, MCVideo user and MCVideo service. This means that the three separate tables (on-network and off-network, on-network only, off-network only) for each configuration category represent the complete set of data for each configuration data category element.

The columns in the tables have the following meanings:

- Reference: the reference of the corresponding requirement in 3GPP TS 22.281 [3] or 3GPP TS 22.280 [2] or the corresponding subclause from either the present document or the referenced document.
- Parameter description: A short definition of the semantics of the corresponding item of data, including denotation of the level of the parameter in the configuration hierarchy.
- When it is not clear to which functional entities the parameter is configured, then one or more columns indicating this are provided where the following nomenclature is used:
  - "Y" to denote "Yes" i.e. the parameter denoted for the row needs to be configured to the functional entity denoted for the column.
  - "N" to denote "No" i.e. the parameter denoted for the row does not need to be configured to the functional entity denoted for the column.

Parameters within a set of configuration data have a level within a hierarchy that pertains only to that configuration data. The hierarchy of the configuration data is common across all three tables of on-network and off-network, on network only and off network only. The level of a parameter within the hierarchy of the configuration data is denoted by use of the character ">" in the parameter description field within each table, one per level. Parameters that are at the top most level within the hierarchy have no ">" character. Parameters that have one or more ">" characters are child parameters of the first parameter above them that has one less ">" character. Parent parameters are parameters that have one or more child parameters. Parent parameters act solely as a "grouping" of their child parameters and therefore do not contain an actual value themselves i.e. they are just containers for their child parameters.

Each parameter that can be configured online shall only be configured through one online reference point. Each parameter that can be configured offline shall only be configured through one offline reference point. The most recent configuration data made available to the MCVideo UE shall always overwrite previous configuration data, irrespective of whether the configuration data was provided via the online or offline mechanism.

---

## A.2 MCVideo UE configuration data

The general aspects of UE configuration are specified in 3GPP TS 23.280 [6]. Data in tables A.2-1 and A.2-2 have to be known by the MCVideo UE after MCVideo authorization.

Data in table A.2-1 can be configured offline using the CSC-11 reference point. Table A.2-1 contains the UE configuration required to support the use of off-network MCVideo service.

**Table A.2-1: UE configuration data (on and off network)**

Reference	Parameter description
[R-5.4.2-002] of 3GPP TS 22.280 [2]	Maximum number of simultaneous MCVideo group calls (Nc4)
[R-5.4.2-003] of 3GPP TS 22.280 [2]	Maximum number of video transmissions (Nc5) in a group
[R-5.4.2-004] of 3GPP TS 22.280 [2]	Requested presentation priority of MCVideo Group calls

**Table A.2-2: UE configuration data (on network)**

Reference	Parameter description
Subclause 5.2.3 of 3GPP TS 23.280 [6]	Relay service (Y/N)
Subclause 5.2.3 of 3GPP TS 23.280 [6]	List of allowed relayed MCVideo groups and their relay service code (as specified in 3GPP TS 23.303 [7]) (optional) (see NOTE)
	> MCVideo group ID
	> Relay service code (as specified in 3GPP TS 23.303 [7])
Subclause 5.7 of 3GPP TS 23.280 [6]	Indication of whether the UE shall use IPv4 or IPv6 for on-network MCVideo
NOTE:	When the value of the parameter Relay service is N, this parameter and its child parameters are not needed.

## A.3 MCVideo user profile configuration data

The general aspects of MC service user profile configuration data are specified in 3GPP TS 23.280 [6]. The MCVideo user profile configuration data is stored in the MCVideo user database. The MCVideo server obtains the MCVideo user profile configuration data from the MCVideo user database (MCVideo-2).

Tables A.3-1 and A.3-2 contain the MCVideo user profile configuration required to support the use of on-network MCVideo service. Tables A.3-1 and A.3-3 contain the MCVideo user profile configuration required to support the use of off-network MCVideo service. Data in table A.3-1 and table A.3-3 can be configured offline using the CSC-11 reference point.

**Table A.3-1: MCVideo user profile configuration data (on and off network)**

Reference	Parameter description	MCVideo UE	MCVideo Server	Configuration management server	MCVideo user database
Subclause 5.2.11 of 3GPP TS 23.280 [6]	MCVideo identity (MCVideo ID)	Y	Y	Y	Y
3GPP TS 33.180 [14]	KMSUri for security domain of MCVideo ID (see NOTE 1)	Y	Y	Y	Y
Subclause 5.2.11 of 3GPP TS 23.280 [6]	Pre-selected MCVideo user profile indication (see NOTE 2)	Y	Y	Y	Y
Subclause 5.2.11 of 3GPP TS 23.280 [6]	MCVideo user profile index	Y	Y	Y	Y
Subclause 5.2.11 of 3GPP TS 23.280 [6]	MCVideo user profile name	Y	Y	Y	Y
[R-5.17-007], [R-6.13.4-002] of 3GPP TS 22.280 [2]	User profile status (enabled/disabled)		Y	Y	Y
[R-5.7-001] [R-6.9-003] of 3GPP TS 22.280 [2]	Authorised to create and delete aliases of an MCVideo user and its associated user profiles.			Y	Y
[R-5.7-002], [R-6.9-003] of 3GPP TS 22.280 [2]	Alphanumeric aliases of user	Y	Y	Y	Y
[R-5.1.1-005], [R-5.9-001] of 3GPP TS 22.280 [2]	Participant type of the user	Y	Y	Y	Y
[R-5.1.8-006], [R-5.3-002], [R-5.9-001], [R-5.16.2-001], [R-5.16.2-002] of 3GPP TS 22.280 [2]	User's Mission Critical Organization (i.e. which organization a user belongs to)	Y	Y	Y	Y
[R-5.2.2-003] of 3GPP TS 22.280 [2]	Authorisation to create a group-broadcast group			Y	Y
[R-5.2.2-003] of 3GPP TS 22.280 [2]	Authorisation to create a user-broadcast group			Y	Y
[R-5.6.2.4.1-002] of 3GPP TS 22.280 [2]	Authorised to activate MCVideo emergency alert	Y	Y	Y	Y
[R-5.6.2.4.1-004] [R-5.6.2.4.1-008] [R-5.6.2.4.1-012] of 3GPP TS 22.280 [2]	Group / user recipient of an MCVideo emergency alert (Pre-defined group, currently selected group, pre-defined recipient/ user locally defined recipient/ default if no recipient selected)	Y	Y	Y	Y
[R-5.6.2.4.2-002] of 3GPP TS 22.280 [2]	Authorisation to cancel an MCVideo emergency alert	Y	Y	Y	Y
[R-5.1.2.1.2-004] of 3GPP TS 22.281 [3]	Authorisation to modify the video settings of the transmitted video stream of another MCVideo User	Y	Y	Y	Y
[R-5.1.2.1.2-006] of 3GPP TS 22.281 [3]	Authorisation to renegotiate a codec during a video transmission.	Y	Y	Y	Y
[R-5.1.2.1.2-007] of 3GPP TS 22.281 [3]	Authorisation to remotely control the video capabilities or parameters for a camera on an MCVideo UE	Y	Y	Y	Y
[R-5.1.2.2.2-001] of 3GPP TS 22.281 [3]	Authorisation to remotely control the video capabilities or parameters of a remote MCVideo UE	Y	Y	Y	Y
[R-5.1.2.2.2-004] of 3GPP TS 22.281 [3]	Authorisation to receive and display the capabilities of a remote MCVideo UE	Y	Y	Y	Y

[R-5.1.3.1.2-004] of 3GPP TS 22.281 [3]	Authorisation to remotely activate another MCVideo User's camera	Y	Y	Y	Y
[R-5.1.9.2.2-002] of 3GPP TS 22.281 [3]	Authorisation to push a video to another MCVideo user .	Y	Y	Y	Y
[R-5.1.9.2.2-003] of 3GPP TS 22.281 [3]	Authorisation to enable and to disable the automatic sending of notification to a second MCVideo User that a video is being pushed to a third MCVideo User	Y	Y	Y	Y
[R-5.1.9.2.2-004] of 3GPP TS 22.281 [3]	List of MCVideo users for whom to receive notifications about video being pushed to them	Y	Y	Y	Y
	> MCVideo IDs				
[R-5.1.9.2.2-005] of 3GPP TS 22.281 [3]	List of specific video categories to receive (see NOTE 3)	Y	Y	Y	Y
	> Video categories				
[R-6.7.3-007] of 3GPP TS 22.280 [2]	List of user(s) who can be called in MCVideo private call				
	> MCVideo ID	Y	Y	Y	Y
	> Presentation priority relative to other users and groups (see NOTE 4)	Y	Y	Y	Y
3GPP TS 33.180	> KMSUri for security domain of MCVideo ID (see NOTE 1)	Y	Y	Y	Y
<p>NOTE 1: If this parameter is absent, the KMSUri shall be that identified in the initial MC service UE configuration data (on-network) configured in table A.6-1 of 3GPP TS 23.280 [6].</p> <p>NOTE 2: As specified in 3GPP TS 23.280 [6], for each MCVideo user's set of MCVideo user profiles, only one MCVideo user profile shall be indicated as being the pre-selected MCVideo user profile.</p> <p>NOTE 3: If this list is blank then this implies that all video categories are acceptable for the MCVideo user.</p> <p>NOTE 4: The use of this parameter by the MCVideo UE is outside the scope of the present document.</p>					

**Table A.3-2: MCVideo user profile configuration data (on network)**

Reference	Parameter description	MCVideo UE	MCVideo Server	Configuration management server	MCVideo user database
[R-5.1.5-001], [R-5.1.5-002], [R-5.10-001], [R-6.4.7-002], [R-6.8.1-008], [R-6.7.4-002] of 3GPP TS 22.280 [2]	List of on-network MCVideo groups for use by an MCVideo user				
	> MCVideo Group ID	Y	Y	Y	Y
	> Application plane server identity information of group management server where group is defined				
	>> Server URI	Y	N	Y	Y
	> Application plane server identity information of identity management server which provides authorization for group (see NOTE 1)				
	>> Server URI	Y	N	Y	Y
3GPP TS 33.180 [14]	> KMSUri for security domain of group (see NOTE 4)	Y	Y	Y	Y
	> Presentation priority of the group relative to other groups and users (see NOTE 2)	Y	Y	Y	Y
Subclause 5.2.5 of 3GPP TS 23.280 [6]	List of groups user implicitly affiliates to after MCVideo service authorization for the user				
	> MCVideo Group ID	Y	Y	Y	Y
[R-6.4.2-006] of 3GPP TS 22.280 [2]	Authorisation of an MCVideo user to request a list of which MCVideo groups a user has affiliated to		Y	Y	Y
[R-6.4.6.1-002], [R-6.4.6.1-003] of 3GPP TS 22.280 [2]	Authorisation to change affiliated groups of other specified user(s)		Y	Y	Y
[R-6.4.6.2-001], [R-6.4.6.2-002] of 3GPP TS 22.280 [2]	Authorisation to recommend to specified user(s) to affiliate to specific group(s)		Y	Y	Y
[R-6.6.1-004] of 3GPP TS 22.280 [2]	Authorisation to perform regrouping	Y	Y	Y	Y
[R-6.7.2-001] of 3GPP TS 22.280 [2]	Presence status is available/not available to other users	Y	Y	Y	Y
[R-6.7.1-002], [R-6.7.2-002] of 3GPP TS 22.280 [2]	List of MCVideo users that MCVideo user is authorised to obtain presence of				
	> MCVideo IDs	Y	Y	Y	Y
[R-6.8.7.4.2-001], [R-6.8.7.4.2-002] of 3GPP TS 22.280 [2]	Authorisation of a user to cancel an emergency alert on any MCVideo UE of any user		Y	Y	Y
[R-6.13.4-001] of 3GPP TS 22.280 [2]	Authorisation for an MCVideo user to enable/disable an MCVideo user		Y	Y	Y
[R-6.13.4-003], [R-6.13.4-005], [R-6.13.4-006], [R-6.13.4-007] of 3GPP TS 22.280 [2]	Authorisation for an MCVideo user to (permanently /temporarily) enable/disable a UE		Y	Y	Y
[R-7.14-002], [R-7.14-003] of 3GPP TS 22.280 [2]	Authorization for manual switch to off-network while in on-network	Y	Y	Y	Y
[R-5.1.5-004] of 3GPP TS 22.280 [2]	Limitation of number of affiliations per user (Nc2)	N	Y	Y	Y
[R-6.4.6.1-001], [R-6.4.6.1-004] of 3GPP TS 22.280 [2]	List of MCVideo users whose selected groups are authorized to be remotely changed	Y	Y	Y	Y

[R-5.2.3.2-002], [R-5.2.3.2-003] of 3GPP TS 22.281 [3]	Period after which MCVideo data on a MCVideo UE is to be deleted if no action is taken by an authorized MCVideo user	Y	Y	Y	Y
[R-5.2.6.2.2-004] of 3GPP TS 22.281 [3]	Maximum number of simultaneous video streams that can be received (see NOTE 3)	Y	Y	Y	Y
[R-5.2.6.2.2-005] of 3GPP TS 22.281 [3]	Authorisation to automatically receive video communications	Y	Y	Y	Y
[R-5.2.6.2.2-006] of 3GPP TS 22.281 [3]	Authorisation to automatically receive emergency video streams	Y	Y	Y	Y
[R-5.2.6.2.2-007] of 3GPP TS 22.281 [3]	Authorisation to automatically receive imminent peril video streams	Y	Y	Y	Y
[R-5.2.6.2.2-008] of 3GPP TS 22.281 [3]	List of MCVideo groups for which video can be automatically/mandatorily received	Y	Y	Y	Y
	> MC service group IDs				
[R-5.2.7.2-001] of 3GPP TS 22.281 [3]	Authorisation to request to override an active MCVideo transmission	Y	Y	Y	Y
[R-5.2.7.2-002] of 3GPP TS 22.281 [3]	Authorisation to select MCVideo transmissions that can be overridden	Y	Y	Y	Y
[R-5.2.7.2-004] of 3GPP TS 22.281 [3]	Authorisation to allow MCVideo private communications to override or not to override active MCVideo group communications	Y	Y	Y	Y
[R-5.2.8-005], [R-5.2.8-006] of 3GPP TS 22.281 [3]	Maximum length of time of a single video transmission	Y	Y	Y	Y
<p>NOTE 1: If this parameter is not configured, authorization to use the group shall be obtained from the identity management server identified in the initial MC service UE configuration data (on-network) configured in table A.6-1 of TS 23.280 [6].</p> <p>NOTE 2: The use of this parameter by the MCVideo UE is outside the scope of the present document.</p> <p>NOTE 3: The parameter can be set to an unlimited number of simultaneous streams received that can be received.</p> <p>NOTE 4: If this parameter is absent, the KMSUri shall be that identified in the initial MC service UE configuration data (on-network) configured in table A.6-1 of 3GPP TS 23.280 [6].</p>					



**Table A.3-3: MCVideo user profile configuration data (off network)**

Reference	Parameter description	MCVideo UE	MCVideo Server	Configuration management server	MCVideo user database
[R-7.2-003], [R-7.6-004] of 3GPP TS 22.280 [2]	List of off-network MCVideo groups for use by an MCVideo user				
	> MCVideo Group IDs	Y	N	Y	Y
	> Application plane server identity information of group management server where group is defined				
	>> Server URI	Y	N	Y	Y
	> Application plane server identity information of identity management server which provides authorization for group (see NOTE 1)				
	>> Server URI	Y	N	Y	Y
3GPP TS 33.180 [14]	> KMSUri for security domain of group (see NOTE 3)	Y	N	Y	Y
	> Presentation priority of the group relative to other groups and users (see NOTE 2)	Y	N	Y	Y
[R-7.12-002], [R-7.12-003] of 3GPP TS 22.280 [2]	Authorization for off-network services	Y	N	Y	Y
Subclause 7.2.3.3	User info id (as specified in 3GPP TS 23.303 [7])	Y	N	Y	Y
NOTE 1: If this parameter is not configured, authorization to use the group shall be obtained from the identity management server identified in the initial MC service UE configuration data (on-network) configured in table A.6-1 of TS 23.280 [6].					
NOTE 2: The use of this parameter by the MCVideo UE is outside the scope of the present document.					
NOTE 3: If this parameter is absent, the KMSUri shall be that identified in the initial MC service UE configuration data (on-network) configured in table A.6-1 of 3GPP TS 23.280 [6].					

## A.4 MCVideo related Group configuration data

The general aspects of group configuration are specified in 3GPP TS 23.280 [6].

Parameters specified in table A.4-1 are child parameters of the MCVideo configuration parameter specified in table A.4-1 in 3GPP TS 23.280 [6]. Parameters specified in table A.4-2 are child parameters of the MCVideo configuration parameter specified in table A.4-2 in 3GPP TS 23.280 [6]. Parameters specified in table A.4-3 are child parameters of the MCVideo configuration parameter specified in table A.4-3 in 3GPP TS 23.280 [6].

Table A.4-1: Group configuration data (on and off network)

Reference	Parameter description	MCVideo UE	MCVideo Server	Group management server
[R-5.12-001] of 3GPP TS 22.280 [2]	>> Media confidentiality and integrity protection (see NOTE)	Y	Y	Y
[R-5.12-001] of 3GPP TS 22.280 [2]	>> Transmission control confidentiality and integrity protection (see NOTE)	Y	Y	Y
[R-5.12-001] of 3GPP TS 22.280 [2]	>> Group media protection security material (see NOTE)	Y	N	Y
[R-5.1.1.1-010] of 3GPP TS 22.281 [3]	>> List of allowed sets of video codecs and related information in order of preference			
[R-5.1.1.1-010] of 3GPP TS 22.281 [3]	>>> Video codecs	Y	Y	Y
[R-5.1.1.1-010] of 3GPP TS 22.281 [3]	>>> List of allowed video resolution			
	>>>> Video resolutions	Y	Y	Y
[R-5.1.1.1-010] of 3GPP TS 22.281 [3]	>>> List of allowed video frame rates			
	>>>> Video frame rates	Y	Y	Y
[R-5.1.1.3.2-002] of 3GPP TS 22.281 [3]	>> Allowed video modes			
	>>> Urgent real time mode allowed	N	Y	Y
	>>> Non-urgent real time mode allowed	N	Y	Y
	>>> Non real time mode allowed	N	Y	Y
[R-5.1.1.3.2-002] of 3GPP TS 22.281 [3]	>> Active video mode (urgent real time mode, non urgent real time mode, non real time mode)	Y	Y	Y
[R-5.3.2.2-002] of 3GPP TS 22.281 [3]	>> Allowed maximum simultaneous MCVideo transmitting group members	N	Y	Y
NOTE: Security mechanisms are specified in 3GPP TS 33.179 [10].				

Table A.4-2: Group configuration data (on network)

Reference	Parameter description	MCVideo UE	MCVideo Server	Group management server
[R-6.4.5-001], [R-6.4.5-003] of 3GPP TS 22.280 [2]	>> Authorisation of a user to request a list of affiliated members of a group	Y	Y	Y
[R-5.1.7-002], [R-6.2.2-001], [R-6.6.2.2-006], [R-6.8.7.2-003] of 3GPP TS 22.280 [2]	>> Priority of the group	N	Y	Y

**Table A.4-3: Group configuration data (off network)**

Reference	Parameter description	MCVideo UE	MCVideo Server	Group management server
Subclause 7.7.2.1	>> Indication of whether the UE shall use single arbitrator approach or self arbitration approach.	Y	N	Y
[R-5.3.2.2-003] of 3GPP TS 22.281 [3]	>> Allowed maximum number of simultaneous transmissions (N9)	Y	Y	Y
Subclause 7.1.3	>> Default Prose Per-Packet priority (as specified in 3GPP TS 23.303 [7]) values			
	>>> MCVideo group call signalling	Y	N	Y
	>>> MCVideo group call media	Y	N	Y
	>>> MCVideo emergency group call signalling	Y	N	Y
	>>> MCVideo emergency group call media	Y	N	Y
	>>> MCVideo imminent peril group call signalling	Y	N	Y
	>>> MCVideo imminent peril group call media	Y	N	Y

## A.5 MCVideo service configuration data

The general aspects of MC service configuration are specified in 3GPP TS 23.280 [6]. The MCVideo service configuration data is stored in the MCVideo server.

Tables A.5-1 and A.5-2 describe the configuration data required to support the use of on-network MCVideo service. Tables A.5-1 and A.5-3 describe the configuration data required to support the use of off-network MCVideo service. Data in table A.5-1 and table A.5-3 can be configured offline using the CSC-11 reference point.

**Table A.5-1: MCVideo service configuration data (on and off network)**

Reference	Parameter description	MCVideo UE	MCVideo Server	Configuration management server
[R-5.2.2-001] of 3GPP TS 22.280 [2]	Levels of group hierarchy for group-broadcast groups (Bc1)	Y	Y	Y
[R-5.2.3-001] of 3GPP TS 22.280 [2]	Levels of user hierarchy for user-broadcast groups (Bc2)	Y	Y	Y
[R-5.7-002] of 3GPP TS 22.280 [2]	Minimum length (Nc3) of an alphanumeric identifier (i.e. alias) assigned by an MCVideo administrator.	Y	N	Y

**Table A.5-2: MCVideo service configuration data (on network)**

Reference	Parameter description	MCVideo UE	MCVideo Server	Configuration management server
[R-5.12-001] of 3GPP TS 22.280 [2]	Protect confidentiality of signalling (see NOTE)	Y	Y	Y
[R-5.12-001] of 3GPP TS 22.280 [2]	Protect integrity of signalling (see NOTE)	Y	Y	Y
[R-5.12-001] of 3GPP TS 22.280 [2]	Use signalling protection between MCVideo servers (see NOTE)	N	Y	Y
[R-5.12-001] of 3GPP TS 22.280 [2]	Use transmission control protection between MCVideo servers (see NOTE)	N	Y	Y
NOTE: Security mechanisms are specified in 3GPP TS 33.179 [10].				

**Table A.5-3: MCVideo service configuration data (off network)**

Reference	Parameter description	MCVideo UE	MCVideo Server	Configuration management server
[R-7.6-001], [R-7.6-002], [R-7.6-003] of 3GPP TS 22.280 [2]	Default ProSe Per-Packet priority (as specified in 3GPP TS 23.303 [7]) values			
	> MCVideo private call signalling	Y	N	Y
	> MCVideo private call media	Y	N	Y
	> MCVideo Emergency private call signalling	Y	N	Y
	> MCVideo Emergency private call media	Y	N	Y
Subclause 7.5.3.3	Periodicity interval (in seconds) of Capability announcement (see NOTE)	Y	N	Y
NOTE: If the value of the periodicity interval is set to zero, the capability announcement is not sent.				

## Annex B (informative): Change history

Date	Meeting	TDoc	CR	Rev	Cat	Subject/Comment	New version
2016-04						Initial version.	0.0.0
2016-06						Implemented the following pCRs approved in SA6#11: S6-160535, S6-160536, S6-160589 Title aligned with the title in MCVideo WID.	0.1.0
2016-08						Implemented the following pCRs approved in SA6#12: S6-160800, S6-160805, S6-160881, S6-160882, S6-160931	0.2.0
2016-10						Implemented the following pCRs approved in SA6#13: S6-161155, S6-161166, S6-161226, S6-161227, S6-161233, S6-161234, S6-161235, S6-161236, S6-161237, S6-161239, S6-161240, S6-161241, S6-161264	0.3.0
2016-11						Implemented the following pCRs approved in SA6#14: S6-161461, S6-161464, S6-161465, S6-161468, S6-161469, S6-161473, S6-161474, S6-161476, S6-161479, S6-161481, S6-161482, S6-161483, S6-161485, S6-161497, S6-161566, S6-161567, S6-161568, S6-161569, S6-161570, S6-161574, S6-161575, S6-161585, S6-161588, S6-161599, S6-161600, S6-161601, S6-161602, S6-161603, S6-161608	0.4.0
2016-11	SA#74	SP-160877				Submitted for Approval at SA#74	1.0.0
2016-12	SA#74	SP-160877				MCC Editorial update for publication after TSG SA approval (SA#74)	14.0.0
2017-03	SA#75	SP-170070	0001	1	F	Alignment of definitions	14.1.0
2017-03	SA#75	SP-170070	0002	2	F	Alignment of group affiliation and de-affiliation requirements	14.1.0
2017-03	SA#75	SP-170070	0003	1	F	Alignment of bearer management	14.1.0
2017-03	SA#75	SP-170070	0004	2	F	Adding descriptive text for several general sections	14.1.0
2017-03	SA#75	SP-170070	0005	1	F	MCVideo call connect and disconnect on MBMS	14.1.0
2017-03	SA#75	SP-170070	0007		F	Alignment of business relationships, identities, and application of functional model to deployments	14.1.0
2017-03	SA#75	SP-170070	0008	1	F	Functional model update	14.1.0
2017-03	SA#75	SP-170070	0009	1	F	Location related description alignment	14.1.0
2017-03	SA#75	SP-170070	0010	1	F	Reception control at receiving participant	14.1.0
2017-03	SA#75	SP-170070	0011	1	F	Feedback between reception control and transmission control	14.1.0
2017-03	SA#75	SP-170070	0013	1	F	Activity status sharing	14.1.0
2017-03	SA#75	SP-170070	0014	1	F	Corrections to video push	14.1.0
2017-03	SA#75	SP-170070	0017		F	Obsolete editor's notes	14.1.0
2017-03	SA#75	SP-170070	0018		F	Response message	14.1.0
2017-03	SA#75	SP-170070	0020	1	F	Clarification on Editor's notes in subclause 7.3.3.2 in MCVideo	14.1.0
2017-03	SA#75	SP-170070	0021	1	F	Clarification on Editor's notes in MCVideo	14.1.0
2017-03	SA#75	SP-170070	0022	1	F	Clarification on transmission control	14.1.0
2017-03	SA#75	SP-170070	0023		D	Editorial corrections in MCVideo	14.1.0
2017-03	SA#75	SP-170070	0024	2	F	MCVideo configurations	14.1.0
2017-03	SA#75	SP-170070	0027	1	F	Addition of definition for MCVideo ID	14.1.0
2017-03	SA#75	SP-170070	0028	1	F	Correction of requirement reference for list of implicitly affiliated groups in MCVideo user profile config	14.1.0
2017-03	SA#75	SP-170070	0029	3	F	Off-network transmission arbitration	14.1.0
2017-06	SA#76	SP-170391	0042	1	F	Miscellaneous corrections to configuration	14.2.0
2017-06	SA#76	SP-170391	0043	5	F	Addition of identity management server address per group	14.2.0
2017-06	SA#76	SP-170391	0044		F	Clarifications on off-network group call answer response	14.2.0
2017-06	SA#76	SP-170391	0045	1	F	Clarifications on off-network group call procedure descriptions	14.2.0
2017-06	SA#76	SP-170391	0046	1	F	Clarifications on pre-conditions of group communication in off-network	14.2.0
2017-06	SA#76	SP-170391	0048		F	Remove Editor's Note on broadcast group communication in 23281	14.2.0
2017-06	SA#76	SP-170391	0049		F	Remove Editor's Note on Video details in Video pull and push in 23281	14.2.0
2017-06	SA#76	SP-170391	0050	2	F	Remove Editor's Note on Device ID used for Capabilities info request in 23281	14.2.0
2017-06	SA#76	SP-170391	0051	1	F	Remove Editor's Note on Clarifications for periodic capability announcements in 23281	14.2.0
2017-06	SA#76	SP-170391	0052	1	F	Some clarifications on off-network group call	14.2.0
2017-06	SA#76	SP-170391	0060	1	F	Editorial correction in chapter Release chat group call of MCVideo	14.2.0

2017-06	SA#76	SP-170391	0061	2	F	Inclusion of KMSUri to allow multiple security domains	14.2.0
2017-06	SA#76	SP-170391	0062		F	Addition of ProSe Per Packet Priority to group configuration	14.2.0
2017-06	SA#76	SP-170391	0063	1	F	Configuration for emergency alerts	14.2.0
2017-06	SA#76	SP-170391	0066	1	F	Video modes usage	14.2.0
2017-06	SA#76	SP-170391	0067	2	F	Communications remote control	14.2.0
2017-06	SA#76	SP-170391	0069	3	F	Alignment of MCVideo user profile configurations	14.2.0
2017-06	SA#76	SP-170391	0071		F	Corrections to Group configuration data for all MC services	14.2.0
2017-09	SA#77	SP-170680	0073	1	F	CR on MCVideo capabilities information retrieval and remote transmit media end	14.3.0
2017-09	SA#77	SP-170680	0074	2	F	CR on MCVideo call connect	14.3.0

---

# History

<b>Document history</b>		
V14.1.0	May 2017	Publication
V14.2.0	July 2017	Publication
V14.3.0	October 2017	Publication