

ETSI TS 123 334 V10.5.0 (2013-01)



Technical Specification

**Digital cellular telecommunications system (Phase 2+);
Universal Mobile Telecommunications System (UMTS);
LTE;
IP Multimedia Subsystem (IMS)
Application Level Gateway (IMS-ALG)
– IMS Access Gateway (IMS-AGW)
interface: Procedures descriptions
(3GPP TS 23.334 version 10.5.0 Release 10)**



Reference

RTS/TSGC-0423334va50

Keywords

GSM,LTE,UMTS

ETSI

650 Route des Lucioles
F-06921 Sophia Antipolis Cedex - FRANCE

Tel.: +33 4 92 94 42 00 Fax: +33 4 93 65 47 16

Siret N° 348 623 562 00017 - NAF 742 C
Association à but non lucratif enregistrée à la
Sous-Préfecture de Grasse (06) N° 7803/88

Important notice

Individual copies of the present document can be downloaded from:

<http://www.etsi.org>

The present document may be made available in more than one electronic version or in print. In any case of existing or perceived difference in contents between such versions, the reference version is the Portable Document Format (PDF). In case of dispute, the reference shall be the printing on ETSI printers of the PDF version kept on a specific network drive within ETSI Secretariat.

Users of the present document should be aware that the document may be subject to revision or change of status. Information on the current status of this and other ETSI documents is available at

<http://portal.etsi.org/tb/status/status.asp>

If you find errors in the present document, please send your comment to one of the following services:

http://portal.etsi.org/chaicor/ETSI_support.asp

Copyright Notification

No part may be reproduced except as authorized by written permission.
The copyright and the foregoing restriction extend to reproduction in all media.

© European Telecommunications Standards Institute 2013.
All rights reserved.

DECT™, PLUGTESTS™, UMTS™ and the ETSI logo are Trade Marks of ETSI registered for the benefit of its Members.
3GPP™ and LTE™ are Trade Marks of ETSI registered for the benefit of its Members and
of the 3GPP Organizational Partners.
GSM® and the GSM logo are Trade Marks registered and owned by the GSM Association.

Intellectual Property Rights

IPRs essential or potentially essential to the present document may have been declared to ETSI. The information pertaining to these essential IPRs, if any, is publicly available for **ETSI members and non-members**, and can be found in ETSI SR 000 314: *"Intellectual Property Rights (IPRs); Essential, or potentially Essential, IPRs notified to ETSI in respect of ETSI standards"*, which is available from the ETSI Secretariat. Latest updates are available on the ETSI Web server (<http://ipr.etsi.org>).

Pursuant to the ETSI IPR Policy, no investigation, including IPR searches, has been carried out by ETSI. No guarantee can be given as to the existence of other IPRs not referenced in ETSI SR 000 314 (or the updates on the ETSI Web server) which are, or may be, or may become, essential to the present document.

Foreword

This Technical Specification (TS) has been produced by ETSI 3rd Generation Partnership Project (3GPP).

The present document may refer to technical specifications or reports using their 3GPP identities, UMTS identities or GSM identities. These should be interpreted as being references to the corresponding ETSI deliverables.

The cross reference between GSM, UMTS, 3GPP and ETSI identities can be found under <http://webapp.etsi.org/key/queryform.asp>.

Contents

Intellectual Property Rights	2
Foreword.....	2
1 Scope	7
2 References	7
3 Definitions, symbols and abbreviations	8
3.1 Definitions	8
3.2 Symbols.....	9
3.3 Abbreviations	9
4 Architecture.....	9
4.1 Reference architecture	9
4.2 NAT Function	10
4.3 ATCF/ATGW Function	11
5 Functional Requirements.....	11
5.1 General	11
5.2 Gate Control & Local NAT	11
5.3 IP realm indication and availability.....	12
5.4 Remote NAT traversal support.....	12
5.5 Remote Source Address/Port Filtering	12
5.6 Traffic Policing	13
5.7 Hanging Termination Detection	13
5.8 QoS Packet Marking	13
5.9 Handling of RTCP streams.....	13
5.10 Media Inactivity Detection	14
5.11 IMS Media Plane Security	14
5.11.1 General.....	14
5.11.2 End-to-access-edge Security	14
5.11.2.1 End-to-access-edge security using SDES.....	14
5.11.3 End-to-end Security	15
5.12 Explicit Congestion Notification support	16
5.12.1 General.....	16
5.12.2 Incoming SDP offer with ECN.....	16
5.12.3 Incoming SDP offer without ECN	16
5.12.4 Detection of ECN failures by IMS-AGW	16
5.13 Transcoding.....	16
6 IMS-ALG to IMS-AGW Procedures	17
6.1 Non-Call Related Procedures	17
6.1.1 General.....	17
6.1.2 IMS-AGW Unavailable	17
6.1.3 IMS-AGW Available.....	18
6.1.4 IMS-AGW Recovery	19
6.1.5 IMS-ALG Recovery	20
6.1.5.1 General	20
6.1.5.2 IMS-ALG Restoration.....	20
6.1.6 IMS-AGW Re-register.....	20
6.1.7 IMS-AGW Re-registration Ordered by IMS-ALG	21
6.1.8 Audit of IMS-AGW	21
6.1.8.1 Audit of Value.....	21
6.1.8.2 Audit of Capability.....	22
6.1.9 IMS-AGW Capability Change.....	22
6.1.10 IMS-ALG Out of service	22
6.1.11 IMS-AGW Resource Congestion Handling - Activate	23
6.1.12 MGW Resource Congestion Handling -Indication	23
6.1.13 Control association monitoring.....	23

6.1.14	Realm Availability Monitoring.....	24
6.1.15	Failure of IP Port, Interface or Group of Interfaces	25
6.2	Call Related Procedures	25
6.2.1	Gate Control & Local NA(P)T procedure.....	25
6.2.2	IP realm indication procedure.....	28
6.2.3	Remote NA(P)T traversal support procedure	28
6.2.4	Remote Source Address/Port Filtering	28
6.2.5	Traffic Policing.....	29
6.2.6	Hanging Termination Detection	29
6.2.7	QoS Packet Marking.....	30
6.2.8	Media Inactivity Detection	30
6.2.9	Handling of RTCP streams	30
6.2.10	IMS end-to-access-edge Media Plane Security.....	31
6.2.11	Change Through-Connection.....	31
6.2.12	Emergency Calls.....	31
6.2.13	Explicit Congestion Notification support	31
6.2.13.1	General.....	31
6.2.13.2	ECN Active Indicated (ECN transparent).....	31
6.2.13.3	ECN support requested (ECN endpoint).....	32
6.2.13.4	ECN Failure Indication (ECN endpoint).....	32
6.2.14	Access Transfer procedures with media anchored in IMS-AGW (ATGW)	33
6.2.14.1	General.....	33
6.2.14.2	H.248 context model.....	33
6.2.14.3	PS session origination or termination with media anchoring in IMS-AGW (ATGW) signaling procedures	34
6.2.14.4	PS to CS Access Transfer procedure with media anchored in IMS-AGW (ATGW).....	36
6.2.14.5	ECN support during PS to CS Access Transfer procedure with media anchored in IMS-AGW (ATGW).....	37
7	Charging.....	38
8	Messages/Procedures and Contents.....	38
8.1	General	38
8.2	Reserve and Configure AGW Connection Point.....	39
8.3	Reserve AGW Connection Point Procedure.....	43
8.4	Configure AGW Connection Point Procedure	46
8.5	Release AGW Termination	49
8.6	Termination heartbeat indication.....	50
8.7	IMS-AGW Out-of-Service	50
8.8	IMS-AGW Communication Up	51
8.9	IMS-AGW Restoration.....	51
8.10	IMS-AGW Register.....	52
8.11	IMS-ALG Restoration.....	52
8.12	IMS-AGW Re-register	53
8.13	IMS-ALG Ordered Re-registration	53
8.14	Audit Value	54
8.15	Audit Capability	54
8.16	Capability Update.....	55
8.17	IMS-ALG Out of Service	55
8.18	IMS-AGW Resource Congestion Handling - Activate.....	56
8.19	IMS-AGW Resource Congestion Handling - Indication.....	56
8.20	Inactivity Timeout Activate.....	57
8.21	Inactivity Timeout Notification.....	57
8.22	Command Reject	58
8.23	Realm Availability Activate.....	58
8.24	Realm Availability Notification	59
8.25	IP Bearer Released	59
8.26	Media Inactivity Notification	60
8.27	Termination Out-of-Service	60
8.28	Change Through-Connection	61
8.29	Change Flow Direction	61
8.30	ECN Failure Indication	62

Annex A (informative): **Change history**63
History64

Foreword

This Technical Specification has been produced by the 3rd Generation Partnership Project (3GPP).

The contents of the present document are subject to continuing work within the TSG and may change following formal TSG approval. Should the TSG modify the contents of the present document, it will be re-released by the TSG with an identifying change of release date and an increase in version number as follows:

Version x.y.z

where:

- x the first digit:
 - 1 presented to TSG for information;
 - 2 presented to TSG for approval;
 - 3 or greater indicates TSG approved document under change control.
- y the second digit is incremented for all changes of substance, i.e. technical enhancements, corrections, updates, etc.
- z the third digit is incremented when editorial only changes have been incorporated in the document.

1 Scope

Annex G of 3GPP TS 23.228 [2] gives out an IMS Application Level Gateway (IMS-ALG) and IMS Access Media Gateway (IMS-AGW) based reference model to support NAPT-PT, gate control and traffic policing between IP-CAN and IMS domain.

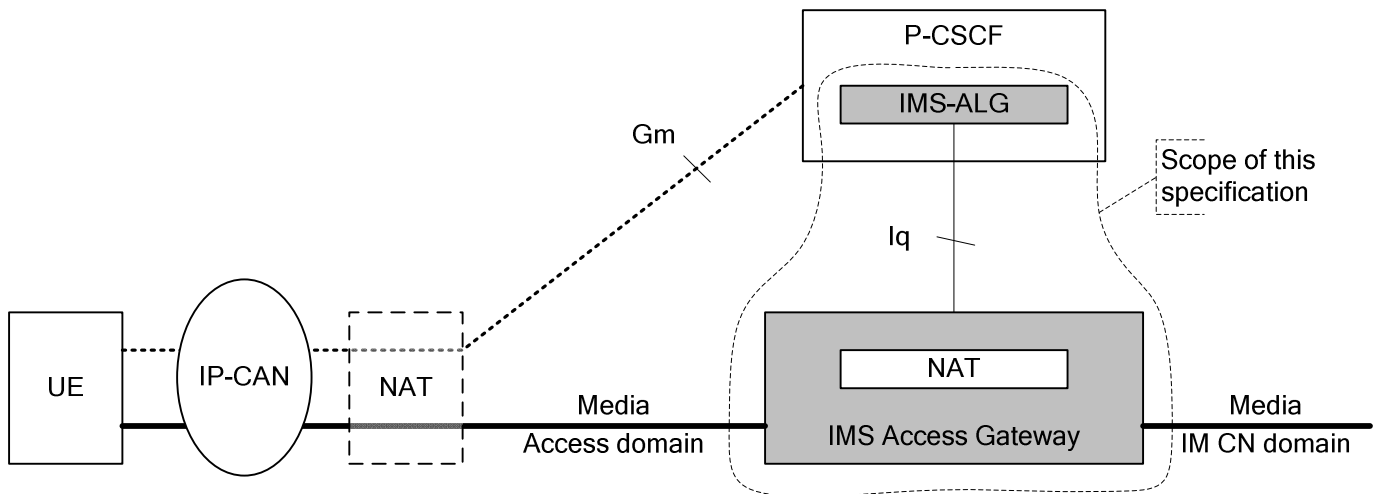

Figure 1.1: Scope of the specification

Figure 1.1 illustrates the reference model for Iq:

- the dashed line represents the IP signalling-path with SIP (at Gm) as call/session control protocol between the UE and the P-CSCF (IMS-ALG);
- the bold, horizontal line represents the IP media-path (also known as (IP) bearer-path or (IP) data-path; the notion 'media' is used as generic term for "IP application data"); and
- the vertical line represents the Iq control-path with H.248 as gateway/policy control protocol between the IMS-ALG and the IMS-AGW (H.248 messages are transported over IP).

The Iq reference point is between the P-CSCF (IMS-ALG) and the IMS-AGW. It conveys the necessary information that is needed to allocate, modify and release (IP) transport addresses.

The present document defines the stage 2 description for the Iq reference point. The stage 2 shall cover the information flow between the P-CSCF (IMS-ALG) and IMS-AGW. The protocol used over the Iq interface is the gateway control protocol according ITU-T Recommendation H.248 (which is specified for Iq by an H.248 profile according 3GPP TS 29.334 [3]).

2 References

The following documents contain provisions which, through reference in this text, constitute provisions of the present document.

- References are either specific (identified by date of publication, edition number, version number, etc.) or non-specific.
- For a specific reference, subsequent revisions do not apply.
- For a non-specific reference, the latest version applies. In the case of a reference to a 3GPP document (including a GSM document), a non-specific reference implicitly refers to the latest version of that document *in the same Release as the present document*.

[1] 3GPP TR 21.905: "Vocabulary for 3GPP Specifications".

- [2] 3GPP TS 23.228: "IP Multimedia Subsystem (IMS), stage 2".
- [3] 3GPP TS 29.334: "IMS Application Level Gateway (IMS-ALG) – IMS Access Gateway (IMS-AGW) Iq interface, stage 3".
- [4] IETF RFC 2663: "IP Network Address Translator (NAT) Terminology and Considerations".
- [5] 3GPP TS 32.260: "Telecommunication management; Charging management; IP Multimedia Subsystem (IMS) charging".
- [6] IETF RFC 3556: "Session Description Protocol (SDP) Bandwidth Modifiers for RTP Control Protocol (RTCP) Bandwidth".
- [7] IETF RFC 3605: "Real Time Control Protocol (RTCP) attribute in Session Description Protocol (SDP)".
- [8] 3GPP TS 23.205: "Bearer independent circuit-switched core network; Stage 2".
- [9] ITU-T Recommendation H.248.1 (05/2002): "Gateway Control Protocol: Version 2" including the Corrigendum1 for Version 2 (03/04).
- [10] IETF RFC 2216: "Network Element Service Template".
- [11] 3GPP TS 24.229: "IP Multimedia Call Control Protocol based on SIP and SDP".
- [12] 3GPP TS 33.328: "IMS Media Plane Security".
- [13] IETF RFC 4568: "Session Description Protocol (SDP) Security Descriptions for Media Streams".
- [14] IETF RFC 3711: "The Secure Real-time Transport Protocol (SRTP)".
- [15] IETF RFC 5124: "Extended Secure RTP Profile for Real-time Transport Control Protocol (RTCP)-Based Feedback (RTP/SAVPF)".
- [16] IETF RFC 3168: "The Addition of Explicit Congestion Notification (ECN) to IP".
- [17] IETF RFC 6679: "Explicit Congestion Notification (ECN) for RTP over UDP".
- [18] 3GPP TS 23.237: "IP Multimedia subsystem (IMS) Service Continuity; Stage 2".
- [19] 3GPP TS 24.237: "IP Multimedia subsystem (IMS) Service Continuity; Stage 3".
- [20] 3GPP TS 29.162: "Interworking between the IM CN subsystem and IP networks".
- [21] 3GPP TS 26.114: "IP Multimedia Subsystem (IMS); Multimedia Telephony; Media handling and interaction".

3 Definitions, symbols and abbreviations

3.1 Definitions

For the purposes of the present document, the terms and definitions given in TR 21.905 [1] and the following apply. A term defined in the present document takes precedence over the definition of the same term, if any, in TR 21.905 [1].

Network Address Translation (NA(P)T): see definition in 3GPP TS 23.228 [2].

NAT-PT/NAPT-PT: see definition in 3GPP TS 23.228 [2].

Local (near-end) NAPT control: the operation of providing network address mapping information and NAPT policy rules to a near-end NAT in the media flow.

Remote (far-end) NAT traversal: the operation of adapting the IP addresses so that the packets in the media flow can pass through a far-end (remote) NAT.

NAPT control and NAT traversal: controls network address translation for both near-end NA(P)T and far-end NA(P)T

Convention:

Wherever the **term NAT** is used in this specification, it may be replaced by **NA(P)T or NA(P)T-PT**.

For the purposes of the present document, the following terms and definitions given in 3GPP TS 23.237 [18] apply:

Access Leg
Access Transfer Control Function (ATCF)
Access Transfer Gateway (ATGW)
Remote Leg
Target Access Leg
Source Access Leg

3.2 Symbols

For the purposes of the present document, the following symbols apply:

Iq Interface between the IMS Application Level Gateway and the IMS Access Media Gateway

3.3 Abbreviations

For the purposes of the present document, the abbreviations given in TR 21.905 [1] and the following apply. An abbreviation defined in the present document takes precedence over the definition of the same abbreviation, if any, in TR 21.905 [1].

ATCF	Access Transfer Control Function
ATGW	Access Transfer Gateway
e2ae security	End-to-access-edge security
e2e security	End-to-end security
ECN	Explicit Congestion Notification
ECN-CE	ECN Congestion Experienced
IMS-AGW	IMS Access Media Gateway
IMS-ALG	IMS Application Level Gateway
IM CN	IMS Core Network
NA(P)T	Network Address and optional Port Translation
NAPT	Network Address Port Translation
NAT	Network Address Translation
NA(P)T-PT	NAT Address (and optional Port-) Translation and Protocol Translation
P-CSCF	Proxy-CSCF
SRVCC	Single Radio Voice Call Continuity

4 Architecture

4.1 Reference architecture

The reference architecture for the IMS-ALG and the IMS-AGW when NAT is invoked between the UE and the IMS domain is shown in figure 4.1.1 below.

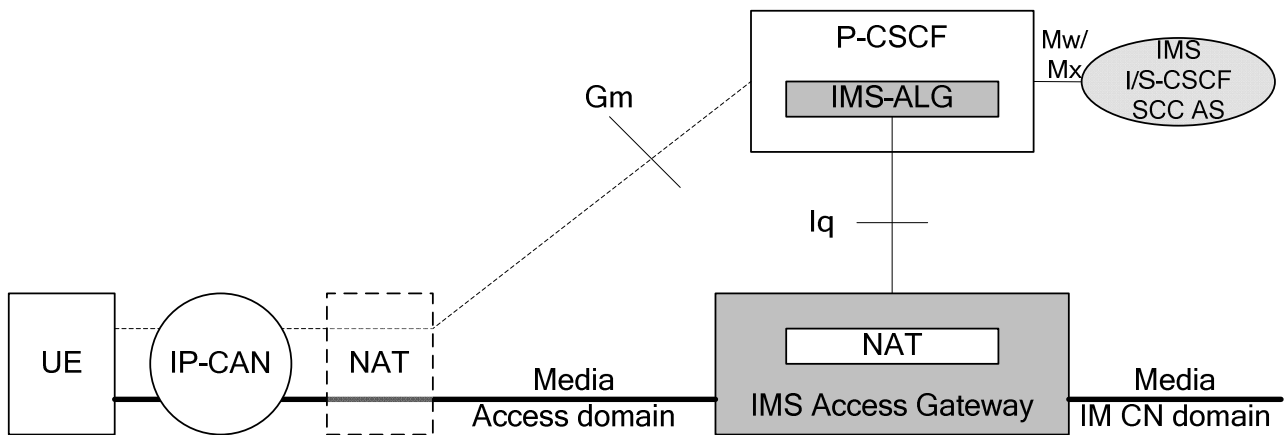

Figure 4.1.1: Reference Architecture with NAT invoked between the UE and the IMS domain

See 3GPP TS 23.228 [2] Annexes G.1 and G.2 for a comprehensive description of the reference models.

The reference architecture for the IMS-ALG and the IMS-AGW supporting the ATCF/ATGW function is shown in figure 4.1.2 below.

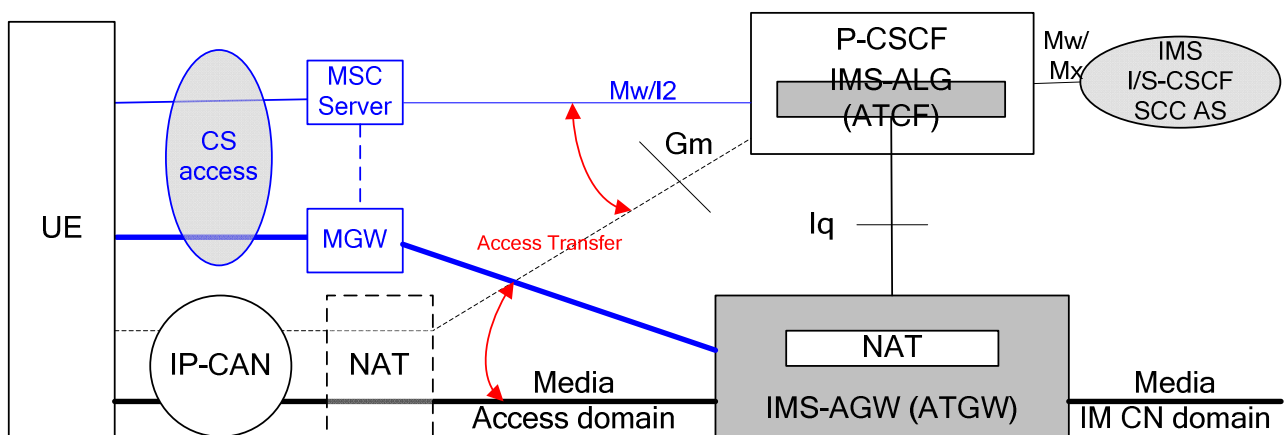

Figure 4.1.2: Reference Architecture for IMS-ALG/IMS-AGW with ATCF/ATGW function

See 3GPP TS 23.237 [18] subclause 5.2 for a comprehensive description of the reference model.

4.2 NAT Function

An operator may need NAT function between UE and IMS domain. Such function can be provided by the IMS-AGW and can be called local (near-end) NAT or IM CN hosted NAT (see subclause 5.2). There can also be an independent NAT device between UE and IMS domain (see subclause 5.4), referred as remote (far end) NAT. Thus the IMS-AGW shall support remote NA(P)T traversal.

Figure 4.1.1 illustrates the particular IP media-path scenario with both a remote NAT and local NAT function. Each NAT function is partitioning an IP domain into two address domains, or partitioning the used IP address space (realm) into two realms.

The reference architecture of Figure 4.1.1 may be mapped on various network scenarios, like e.g. to three IPv4 realms, indicated by a) IP-CAN (connectivity access network), b) (Media) Access Domain and c) (Media) IM CN domain. If there would not be any remote NAT device between the UE and IMS-AGW, then there would be just two IP domains (a and c).

The two types of NATs are also typically different from control perspective: local (near-end) NAT can be controlled by the operators directly, and remote (far-end) NAT that cannot be controlled by the operators directly.

The support of local NAT is thus implicitly leading to the requirement for IP realm indication at Iq (see subclause 5.3).

The edge node of the IP-CAN may be a remote (far-end) NAT device (see Figure 4.1.1). This NAT device provides NAT or NAPT or NA(P)T-PT for IP traffic in the media-path and signalling path (e.g. IP network addresses and possibly L4 transport port values may be translated of SIP Gm messages).

The remote NAT device cannot be directly controlled by the operators of the (Media) Access and IP CN domain. The IMS-ALG is consequently lacking the direct information with regards to the applied NAT bindings by the remote NAT device.

4.3 ATCF/ATGW Function

The ATCF/ATGW functions may be supported by the IMS-ALG/IMS-AGW when SRVCC enhanced with ATCF is used. In this case, the Iq reference point is used for IMS sessions that the IMS-ALG (ATCF) decides to anchor at the IMS-AGW (ATGW) to provide the following functions:

- reservation and configuration of IMS-AGW (ATGW) resources for media anchoring during PS session origination or termination;
- reconfiguration of IMS-AGW (ATGW) resources during access transfer to the CS domain;
- release of IMS-AGW (ATGW) resources upon completion of the access transfer or release of the session;
- media transcoding if the media that was used prior to the access transfer is not supported by the MSC server;
- IP version interworking if different IP versions are used between the access and the remote legs;
- Indication of IP realm during allocation of transport addresses/resources (the PS and CS accesses may be reachable via different IP realms);
- the ability to configure ECN properties towards the transferred to Access if ECN is supported/requested;
- the ability to reconfigure the ECN mode e.g. from ECN transparent to ECN endpoint towards the IMS CN if ECN transparent cannot be maintained after access transfer to the CS domain.

See 3GPP TS 23.237 [18] and 3GPP TS 24.237 [19] for a comprehensive description of the ATCF and ATGW functions.

5 Functional Requirements

5.1 General

A single IMS-ALG may control one or multiple IMS-AGW(s).

5.2 Gate Control & Local NAT

The IMS-ALG shall provide the NAPT control function, i.e. obtain the address binding information (according to IETF RFC 2663 [4]) and perform the NAPT policy control along with gate control (i.e. instruct the opening/closing of a gate).

The IMS-ALG shall request the IMS-AGW to allocate transport addresses/resources to enable media to traverse the IMS-AGW. The IMS-ALG may indicate the corresponding IP realm to the IMS-AGW – see subclause 5.3. The IMS-AGW shall provide the corresponding external transport addresses to the IMS-ALG.

Terminations for the Iq interface may be pre-defined with different levels of granularity for specific IP ports, interfaces, or groups of interfaces. These may then be defined as an IP realm (see subclause 5.3) known by both the IMS-ALG and the IMS-AGW, however IP Realms may also be defined for multiple physical interfaces. In order to efficiently report a failure affecting a large number of terminations associated to specific physical interfaces, the IMS-AGW shall, when allocating a new termination, return to the IMS-ALG an associated Interface ID.

An IMS-AGW not supporting this procedure may allocate the same Interface ID for all IP terminations.

An IMS-AGW supporting the Termination Out-of-Service procedure (see subclause 6.1.15) shall maintain a local mapping of Interface ID to its internal resources.

The IMS-AGW shall provide the NAPT enforcement function, i.e. change the address and port number of the media packets as they traverse the IMS-AGW, along with gate control (i.e. open/close a gate under the control of the IMS-ALG).

The IMS-AGW may provide IP version inter-working.

The IMS-ALG shall request the IMS-AGW to release its transport resources at the end of a session.

5.3 IP realm indication and availability

The IMS-ALG and the IMS-AGW shall support IP realm indication.

The IMS-ALG, when requesting the allocation of transport resources at the IMS-AGW, may indicate the correspondent IP realm to the IMS-AGW. The IMS-AGW shall assign the IP termination in the IP realm indicated. The same IP realm shall be applied to all media streams associated with the termination. The IP realm identifier cannot be changed after the initial assignment.

A default IP realm may be configured such that if the IMS-AGW has not received the IP realm identifier and the IMS-AGW supports multiple IP realms then the default IP realm shall be used.

In order to prevent the IMS-ALG requesting an unavailable IP Realm, the IMS-ALG may audit the list of currently available realms on the IMS-AGW and may request the IMS-AGW to report any changes to that list as they occur over time.

The monitoring of IP realm availability is optional and if supported by IMS-AGW may be requested by the IMS-ALG.

5.4 Remote NAT traversal support

The IMS-ALG and the IMS-AGW shall support remote NA(P)T traversal support.

The IMS-ALG is responsible for determining whether there is a remote NAT device (the mechanism by which this achieved is out of scope of the current document).

If a remote NAT device is present, the IMS-ALG shall request the IMS-AGW to perform latching or re-latching when requesting the IMS-AGW to reserve transport addresses/resources.

If remote NAT is applicable, the IMS-AGW shall not use the remote media address/port information (supplied by the IMS-ALG) as the destination address for outgoing media. Instead, the IMS-AGW shall dynamically learn the required destination address via the source address/port of incoming media. This mechanism is known as "latching".

When remote NAT Traversal is applied to a stream associated with multiple flows (e.g. RTP and RTCP), the IMS-AGW shall perform individual latching and/or re-latching on the various flows. This means that an RTP and an RTCP flow of a single stream can be latched to different remote addresses and/or ports.

5.5 Remote Source Address/Port Filtering

The IMS-ALG may support and the IMS-AGW shall support policing of the remote source address/port of incoming media flow(s).

The IMS-ALG may determine that the source address/port of received media packets should be policed.

When the IMS-ALG requests the IMS-AGW to reserve transport addresses/resources, the IMS-ALG may indicate to the IMS-AGW that policing of source address and/or port of received media packets is required.

If such policing is applicable, the IMS-AGW shall check the source address and/or port of all received media packets and silently discard any packets that do not conform to the expected source address and/or port.

5.6 Traffic Policing

The IMS-ALG may support traffic policing of incoming media flows.

The IMS-AGW shall support traffic policing of the maximum average bitrate, defined as sustainable data rate (see IETF RFC 2216 [10]) of incoming media flows and may support traffic policing of the peak data rate of incoming media flows.

The IMS-ALG may require the IMS-AGW to police the media flows to ensure that they conform to the expected data rates.

When the IMS-ALG requests the IMS-AGW to reserve transport addresses/resources, the IMS-ALG may indicate to the IMS-AGW that policing of the related media streams is required and provide traffic policing related parameters as detailed in subclause 6.2.5.

If such policing is requested, the IMS-AGW shall police the corresponding media streams as detailed in subclause 6.2.5 by measuring the data rate for the received packets within that media stream. If the permissible data rate provided by the IMS-ALG is exceeded, the IMS-AGW shall discard packets to reduce their data rate to the permissible data rate.

For RTP flows where RTCP resources are reserved together with the RTP resources (see subclause 5.9), the permissible data rate shall include the bandwidth used by RTP and RTCP together.

5.7 Hanging Termination Detection

The IMS-ALG and the IMS-AGW shall support detection of hanging termination.

The IMS-ALG, when requesting the IMS-AGW to reserve an AGW connection point, shall indicate to the IMS-AGW to perform detection of hanging terminations.

The IMS-AGW shall determine a termination to be hanging if there is no signalling sent/received within a specified period.

On being informed of the hanging termination, the IMS-ALG shall check/determine whether the cited termination is valid and initiate any appropriate corrective action, e.g. release an invalid termination.

5.8 QoS Packet Marking

The IMS-ALG may support and the IMS-AGW shall support control via the Iq interface of the setting of the DiffServ Code Point (DSCP) for media packets sent on a termination.

When the IMS-ALG requests the IMS-AGW to reserve transport addresses/resources, the IMS-ALG may indicate to the IMS-AGW that the DSCP of outgoing media packets shall be explicitly set or copied from the DSCP of the corresponding received packet.

If such modification of the DSCP is required by the IMS-ALG, the IMS-AGW shall set the DSCP for outgoing packets on a termination.

5.9 Handling of RTCP streams

The IMS-ALG and the IMS-AGW shall support control via the Iq interface of the specific RTCP behaviour associated to an RTP flow.

When the IMS-ALG requests the IMS-AGW to reserve transport addresses/resources for an RTP flow, the IMS-ALG should also request the IMS-AGW to reserve resources for the corresponding RTCP flow, but may alternatively request the IMS-AGW not to reserve resources for the corresponding RTCP flow. When the IMS-ALG requests the IMS-AGW to reserve transport addresses/resources for a non-RTP flow, the IMS-ALG shall not request the IMS-AGW to reserve resources for an RTCP flow.

To request the IMS-AGW to reserve resources for an RTCP flow, the IMS ALG shall provide the RTCP handling information element with a value indicating that resources for RTCP shall be reserved.

To request the IMS-AGW not to reserve resources for an RTCP flow, the IMS ALG shall either provide the RTCP handling information element with a value indicating that resources for RTCP shall not be reserved or omit the RTCP handling information element.

If the IMS-AGW receives the indication to reserve RTCP resources, the IMS-AGW shall allocate a local port with even number for an RTP flow also reserve the consecutive local port with odd number for the associated RTCP flow, and it shall send and be prepared to receive RTCP.

If the IMS-AGW receives the indication to not reserve RTCP resources, or if it does not receive any indication at all, it shall not allocate an RTCP port when allocating a port for an RTP flow. The IMS-AGW shall not send any RTCP packets and shall silently discard any received RTCP packets.

When RTCP resources are requested, the IMS-ALG may also specify:

- the remote RTCP port, and optionally the remote address, where to send RTCP packets; if not specified, the IMS-AGW shall send RCTP packets to the port contiguous to the remote RTP port;
- bandwidth allocation requirements for RTCP, if the RTCP bandwidth level for the session is different than the default RTCP bandwidth as specified in RFC 3556 [6].

NOTE: In line with the recommendations of RFC 3605 [7], separate address or non-contiguous RTCP port numbers will not be allocated by the IMS-ALG / IMS-AGW.

The IMS-AGW shall return an error if it can not allocate the requested RTCP resources.

5.10 Media Inactivity Detection

The IMS-ALG and the IMS-AGW may support the detection of inactive media flows.

The IMS-ALG may require an IMS-AGW that supports media inactivity detection to detect if a media flow is inactive.

NOTE: The decision to apply or not media inactivity is general for all sessions with the same media characteristics (i.e. not user specific). It is for further study under which conditions inactivity media detection may be requested.

When the IMS-ALG requests the IMS-AGW to reserve transport addresses/resources, the IMS-ALG may indicate to the IMS-AGW that detection of an inactive media flow is required and may additionally specify inactivity detection time and inactivity detection direction.

The IMS-AGW shall determine a media flow on termination to be inactive if there is no media sent and/or received within the inactivity detection time period.

On being informed of the inactive media, the IMS-ALG shall initiate any appropriate corrective action.

5.11 IMS Media Plane Security

5.11.1 General

The IMS-ALG and the IMS-AGW may support IMS media plane security as specified in 3GPP TS 33.328 [12]. They may support end-to-access edge security, or end-to-end security, or both. If supported the IMS-ALG and the IMS-AGW shall use the procedures in the following two subclauses.

NOTE: For the support of end-to-end security, the presence of an IMS-ALG is not required.

5.11.2 End-to-access-edge Security

5.11.2.1 End-to-access-edge security using SDES

Procedures for the IMS-ALG to determine if end-to-access edge security is applicable to a session and to exchange cryptography related SDP parameters with the served UE during the SIP session setup are specified in 3GPP TS 33.328 [12] and 3GPP TS 24.229[11].

For media lines that can be subject to e2ae security, the IMS-ALG will receive "RTP/AVP" or "RTP/AVPF" as transport protocol in SDP from the core network. When the IMS-ALG determines that e2ae security is applicable, it will indicate "RTP/SAVP" (see IETF RFC 3711 [14]) or "RTP/SAVPF" (see IETF RFC 5124 [15]), respectively, as transport protocol in the corresponding SDP media lines send towards the served UE. When e2ae security is applied, the IMS-ALG will also receive "RTP/SAVP" or "RTP/SAVPF" in SDP from the served UE. The IMS-ALG will then indicate "RTP/AVP" or "RTP/AVPF" respectively, as transport protocol in the corresponding SDP media lines send towards the core network. When the IMS-ALG requests the IMS-AGW to reserve transport addresses/resources for media to which e2ae security is applicable, the IMS ALG shall configure "RTP/SAVP" or "RTP/SAVPF" as transport protocol at the access side termination. The IMS ALG shall configure "RTP/AVP" or "RTP/AVPF" as transport protocol at the core network side termination for media where e2ae security is applicable.

When the IMS-ALG determines that e2ae security is applicable, it will generate appropriate cryptographic context parameters, in particular key(s), and will transfer them to the served UE within SDES SDP "crypto" attribute(s) according to IETF RFC 4568 [13]. The IMS-ALG will also receive cryptographic context parameters, in particular key(s), from the served UE within SDES SDP "crypto" attribute(s). When the IMS-ALG requests the IMS-AGW to reserve or configure transport addresses/resources for media to which e2ae security is applicable, the IMS-ALG shall provide cryptography related parameters as SDES SDP "crypto" attributes applicable at the access side termination.

On the originating side of the SIP session setup, the IMS-ALG shall provide as "Remote cryptographic SDES attribute" the SDES crypto attribute it selected from the ones received from the IMS UE in the SDP Offer . The IMS-ALG shall provide as "Local cryptographic SDES attribute" the SDES crypto attribute the IMS-ALG generated and inserted in the SDP Answer sent to IMS UE.

On the terminating side of the SIP session setup, the IMS-ALG shall provide as "Remote cryptographic SDES attribute" the SDES crypto attribute received from the IMS UE in the SDP Answer. The IMS-ALG shall provide as "Local cryptographic SDES attribute" the SDES crypto attribute selected by the UE from the ones the IMS-ALG generated and inserted in the SDP Offer sent to UE. If the IMS-ALG offers only one SDES crypto attribute to the UE, the IMS-ALG may provide this attribute as "Local cryptographic SDES attribute" within the Reserve AGW Connection Point Procedure before receiving the SDP answer from the UE. In the present release, a modification of an established e2ae crypto session is not supported. Thus, the IMS-ALG shall not modify any previously provided "Local cryptographic SDES attribute" or "Remote cryptographic SDES attribute".

The IMS Access GW shall, upon reception of an SDES crypto attribute, establish an SRTP security context (as described in RFC 4568 [13] and RFC 3711 [14]) and be prepared to convert RTP packets to SRTP packets and vice versa, using the corresponding SRTP security contexts.

5.11.3 End-to-end Security

For the support of e2e-security, IMS-ALG and IMS-AGW shall support "RTP/SAVP" (see IETF RFC 3711 [14]) and/or "RTP/SAVPF" (see IETF RFC 5124 [15]) as transport protocol.

If the IMS-ALG receives SDP containing media lines with "RTP/SAVP" (see IETF RFC 3711 [14]) or "RTP/SAVPF" (see IETF RFC 5124 [15]) as transport protocol, the IMS-ALG shall:

- forward the SDP with unmodified transport protocol for those media lines;
- provide "RTP/SAVP" or "RTP/SAVPF", as received in the SDP, to the IMS-AGW as transport protocol for all related terminations, and provide no media related information to these terminations, to configure the IMS-AGW to pass media transparently.

If the IMS-ALG receives SDP containing SDES SDP attribute(s) according to IETF RFC 4568 [13] , and does not apply e2ae security, it shall forward the SDP with unmodified SDES SDP attribute(s), but shall not provide the SDES SDP attribute(s) to the IMS-AGW.

5.12 Explicit Congestion Notification support

5.12.1 General

An IMS-ALG and IMS-AGW may support Explicit Congestion Notification (see IETF RFC 3168 [16], IETF RFC 6679 [17] and 3GPP TS 26.114 [21]).

An IMS-ALG and IMS-AGW which supports ECN shall support the ECN transparent procedure i.e. the transparent forwarding of ECN bits in the IP header (see IETF RFC 3168 [16]). If the IMS-AGW does not support the transparent forwarding of ECN bits then the IMS-ALG shall not permit ECN in the SDP Offer/Answer negotiation.

The IMS-AGW shall treat RTCP for ECN as a RTP translator with no media translation.

An IMS-ALG and IMS-AGW which supports ECN may then act as an ECN endpoint to enable ECN towards the IMS access network or/and towards the IMS Core Network. The subsequent sub-sections describe the general support for ECN, further details on the support of ECN during PS to CS access transfer is described in sub-clause 6.2.14.3.

NOTE: It is out of the scope of this profile to support interworking with a non-3GPP ECN IP terminal.

An IMS-ALG and IMS-AGW that support ECN Transparent as well as transcoding shall also support the ECN endpoint procedure.

An IMS-ALG/IMS-AGW supporting the ATCF/ATGW function and ECN shall support ECN Endpoint (see sub-clause 6.2.14).

When acting as an ECN endpoint, the IMS-AGW shall be capable of enabling end-to-end rate adaptation between the local terminal and the remote entity by performing the following towards the ECN-capable peer:

- trigger rate adaptation request towards the ECN-capable peer when receiving in the incoming IMS media flow IP packets marked with ECN-CE, regardless of whether the IMS-AGW applies or does not apply transcoding;
- forward adaptation requests between the local and the remote peer when the IMS-AGW bridges compatible codec configurations between the interfaces without applying a transcoding function;
- perform media adaptation (e.g. reduce media bit-rate) towards the ECN-capable peer when receiving from the latter an adaptation request. and the IMS-AGW applies transcoding.

5.12.2 Incoming SDP offer with ECN

The IMS-ALG and IMS-AGW shall apply the requirements specified in clause 10.2.13.2 of 3GPP TS 29.162 [20] replacing the IBCF and TrGW with IMS-ALG and IMS-AGW respectively.

5.12.3 Incoming SDP offer without ECN

The IMS-ALG and IMS-AGW shall apply the requirements specified in clause 10.2.13.3 of 3GPP TS 29.162 [20] replacing the IBCF and TrGW with IMS-ALG and IMS-AGW respectively with the following additions:

- if the IMS-ALG or IMS-AGW does not support the procedure to act as an ECN endpoint, the IMS-ALG shall not include the "a=ecn-capable-rtp" attribute in the SDP offer it forwards to the succeeding node.

5.12.4 Detection of ECN failures by IMS-AGW

An IMS-ALG and IMS-AGW that support the procedure to act as an ECN endpoint shall support the requirements specified in clause 10.2.13.3a of 3GPP TS 29.162 [20] replacing the IBCF and TrGW with IMS-ALG and IMS-AGW respectively.

5.13 Transcoding

The transcoding functionality, where the IMS-AGW processes and possibly converts media data (like e.g. RTP payload) is optional for the P-CSCF and IMS-AGW to support. Transcoding should be supported if the IMS-ALG and

IMS-AGW support the ATCF and ATGW functions for use after an SRVCC handover if the media that was used prior to the access transfer is not supported by the MSC Server.

An IMS-ALG and IMS-AGW that support transcoding shall support the requirements specified for Media Control in clause 10.2.5 of 3GPP TS 29.162 [20] respectively for the IBCF and TrGW, with the following additions:

- During an originating or terminating PS session establishment, the IMS-ALG (ATCF) may remove codecs when passing SDP offers (e.g. codecs known not to be supported by either the IMS-AGW (ATGW) or the MSC Server), but the IMS-ALG (ATCF) should pass SDP offers without adding codecs to the SDP offer and pass SDP answers without modification to the contained codecs to avoid the potential need for transcoding in the IMS-AGW (ATGW) before the PS to CS access transfer;
- During the PS to CS access transfer procedure, the IMS-ALG (ATCF) shall preferentially select from the SDP offer it receives from the MSC Server the codec already configured on the corresponding remote leg, if available.

The procedures for the IMS-ALG (ATCF) and IMS-AGW (ATGW) are further detailed in subclause 6.2.x.

6 IMS-ALG to IMS-AGW Procedures

6.1 Non-Call Related Procedures

6.1.1 General

The non-call related procedures are based on corresponding procedures of 3GPP TS 23.205 [8] where the IMS-ALG takes the place of the MSC server and the IMS-AGW takes the place of the MGW.

6.1.2 IMS-AGW Unavailable

The IMS-ALG server recognises that the IMS-AGW is unavailable in the following 4 cases:

1. The signalling connection is unavailable

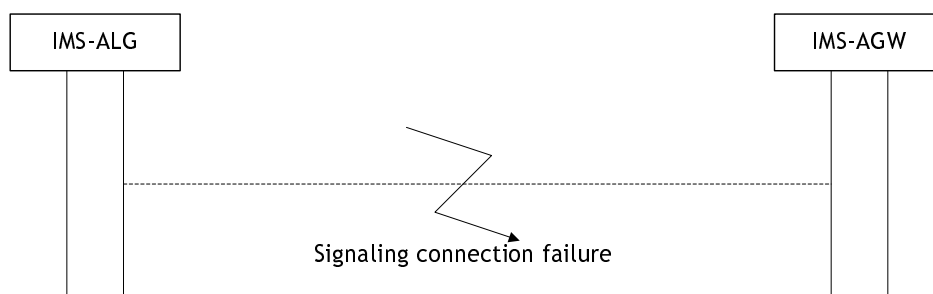

Figure 6.1.2.1: Signalling connection failure

2. The IMS-AGW indicates the failure or the maintenance locking condition to all connected IMS-ALG servers

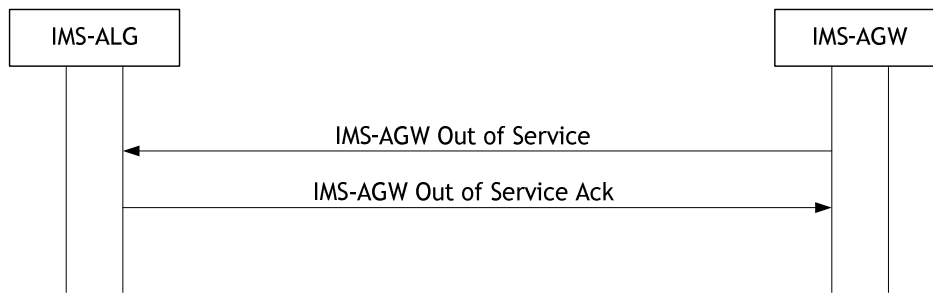

Figure 6.1.2.2: IMS-AGW indicates the Failure/Maintenance locking

The failure or maintenance locking indication indicates that the IMS-AGW is locked for new calls or will soon go out of service and that no new connections should be established using this IMS-AGW. The IMS-AGW can choose between the "graceful" and the "forced" method. In the graceful method the connections are cleared when the corresponding calls are disconnected. In the forced method all connection are cleared immediately.

3. The IMS-ALG recognises that the IMS-AGW is not functioning correctly, e.g. because there is no reply on periodic sending of Audits. The periodic sending of Audits by IMS-ALG should go on.

In all of the above cases the IMS-ALG shall prevent the usage of the IMS-AGW until the IMS-AGW has recovered or the communication with the IMS-AGW is restored.

6.1.3 IMS-AGW Available

The IMS-ALG discovers that the IMS-AGW is available when it receives an IMS-AGW Communication Up message or an IMS-AGW Restoration message. If the IMS-ALG does not wish to sustain an association with the IMS-AGW, the response sent to the IMS-AGW may indicate an alternative IMS-ALG signalling address, in which case the IMS-AGW shall not consider itself registered and should preferably attempt to re-register with this alternative IMS-ALG before any further alternate IMS-ALGs. Otherwise, the response shall not indicate any alternative IMS-ALG signalling address.

When the IMS-ALG discovers that the IMS-AGW is available the following shall occur:

1. Signalling recovery

The IMS-AGW indicates to all connected IMS-ALGs that the signalling connection is restored.

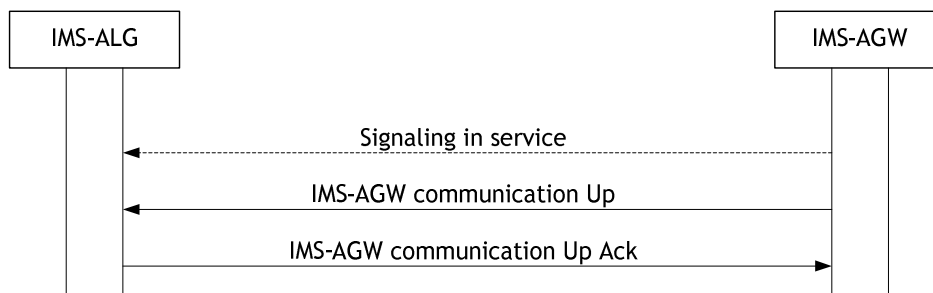

Figure 6.1.3.1: Communication goes up

2. IMS-AGW restoration/maintenance unlocking indication.

The IMS-AGW indicates to all connected IMS-ALGs that normal operation has resumed.

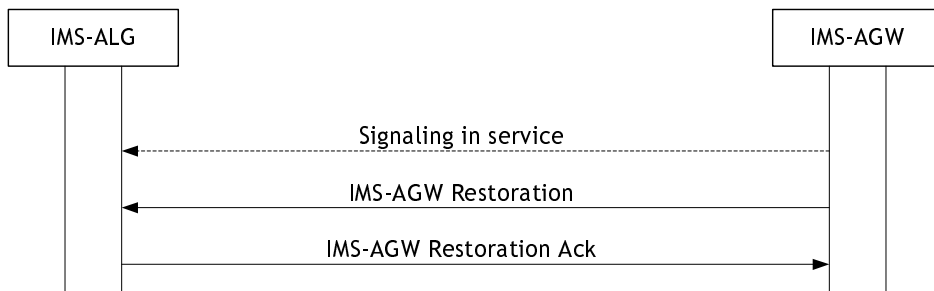

Figure 6.1.3.2: IMS-AGW indicates recovery from a failure/or maintenance unlocking

NOTE: This procedure may be used after recovery from a signalling failure.

- 3. The IMS-ALG recognises that the IMS-AGW is now functioning correctly, e.g. because there is a reply on periodic sending of Audits.

After this the IMS-ALG can use the IMS-AGW.

If none of 1, 2, and 3 happens the IMS-ALG server can initiate the IMS-ALG Ordered Re-register procedure.

6.1.4 IMS-AGW Recovery

If the IMS-AGW recovers from a failure, is maintenance unlocked, or it has been restarted, it registers to its known IMS-ALGs using the IMS-AGW Restoration procedure or the IMS-AGW Registration procedure. The IMS-AGW can indicate whether the Service has been restored or whether it has restarted with a cold or warm boot. If the IMS-ALG does not wish to sustain an association with the IMS-AGW, the response sent to the IMS-AGW may indicate an alternative IMS-ALG signalling address, in which case the IMS-AGW shall not consider itself registered and should preferably attempt to re-register with this alternative IMS-ALG before any further alternate IMS-ALGs. Otherwise, the response shall not indicate any alternative IMS-ALG signalling address.

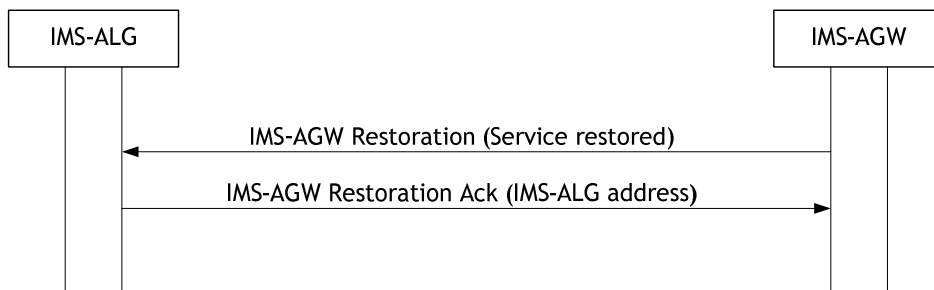

Figure 6.1.4.1: IMS-AGW Restoration

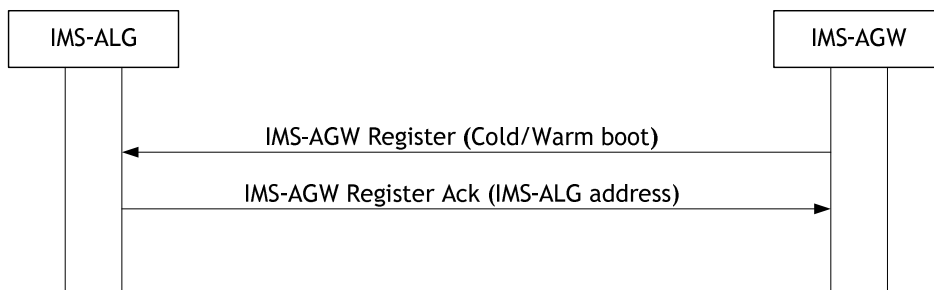

Figure 6.1.4.2 IMS-AGW Registration

After the recovery the IMS-ALG can use the IMS-AGW.

6.1.5 IMS-ALG Recovery

6.1.5.1 General

If an IMS-AGW-unavailable condition is provoked by a failure/recovery action, the IMS-ALG recovery sequence will, from an information flow point of view, look like IMS-AGW unavailable and then IMS-AGW available. If an IMS-AGW-unavailable condition is not provoked, the IMS-ALG recovery sequence will look like IMS-AGW available.

After the information flow, the terminations affected by the recovery action are released.

6.1.5.2 IMS-ALG Restoration

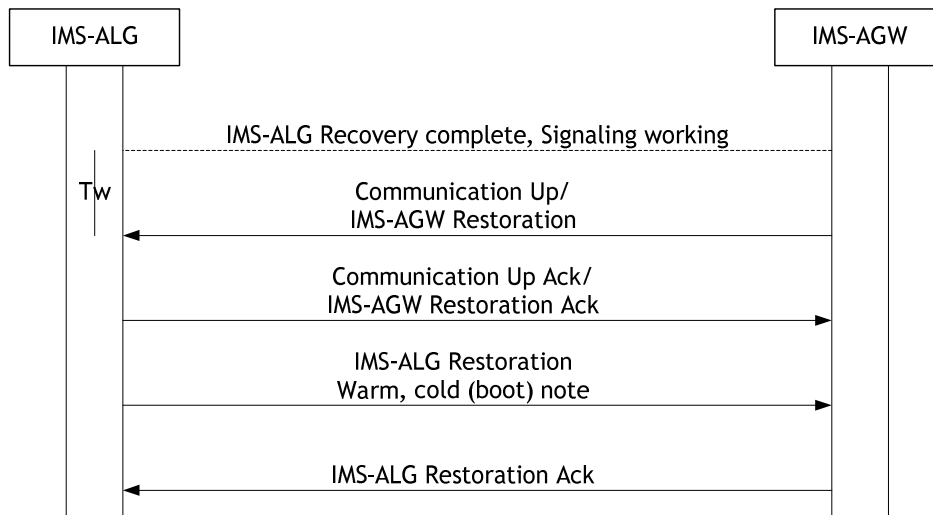

NOTE: Normal release procedure may also be initiated.

Figure 6.1.5.2.1: IMS-ALG Restoration

After the recovery action is complete and it is possible to signal to the IMS-AGW the IMS-ALG starts a timer Tw. If recovery indications are not received (IMS-AGW Communication Up or IMS-AGW Restoration) from the IMS-AGW during Tw an Audit is sent. If the IMS-ALG receives a recovery indication or IMS-AGW communication up indication, it shall acknowledge the indication before the IMS-ALG Restoration may be sent or the release procedure is initiated.

6.1.6 IMS-AGW Re-register

When the IMS-ALG requests an IMS-AGW to perform a registration (see subclauses 6.1.3, 6.1.4 and 6.1.7), the IMS-AGW performs a re-registration to the IMS-ALG which is defined in the IMS-ALG address.

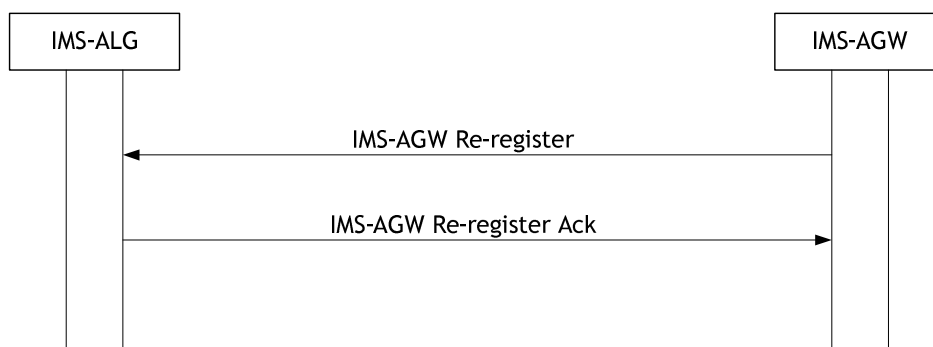

Figure 6.1.6.1: Re-registration of an IMS-AGW

6.1.7 IMS-AGW Re-registration Ordered by IMS-ALG

If the IMS-ALG knows that communication is possible, but the IMS-AGW has not registered, the IMS-ALG can order re-registration of the IMS-AGW.



Figure 6.1.7.1: Re-registration ordered by the IMS-ALG

If the re-registration request is accepted the IMS-AGW uses the IMS-AGW Re-register procedure to register with the IMS-ALG.

6.1.8 Audit of IMS-AGW

6.1.8.1 Audit of Value

The IMS-ALG may request the IMS-AGW to report the current values assigned to distinct objects in the IMS-AGW. This procedure may be used when a change has occurred in the IMS-ALG such that the IMS-ALG is unsure of the current Service State of Terminations.

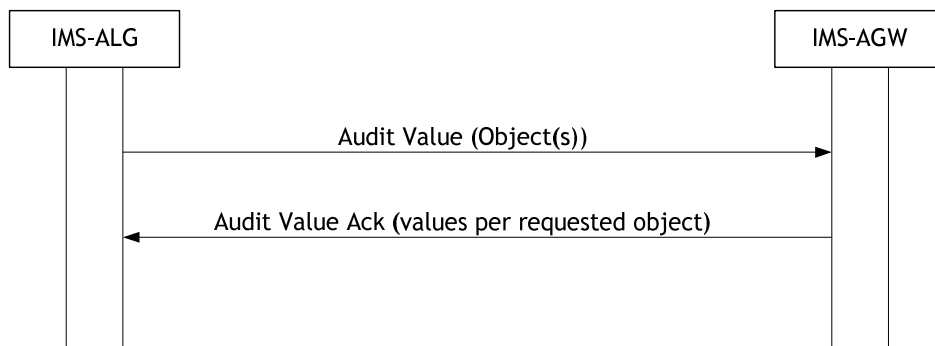

Figure 6.1.8.1.1: Audit Value

6.1.8.2 Audit of Capability

The IMS-ALG may request the IMS-AGW to report the capabilities of distinct objects in the MGW.

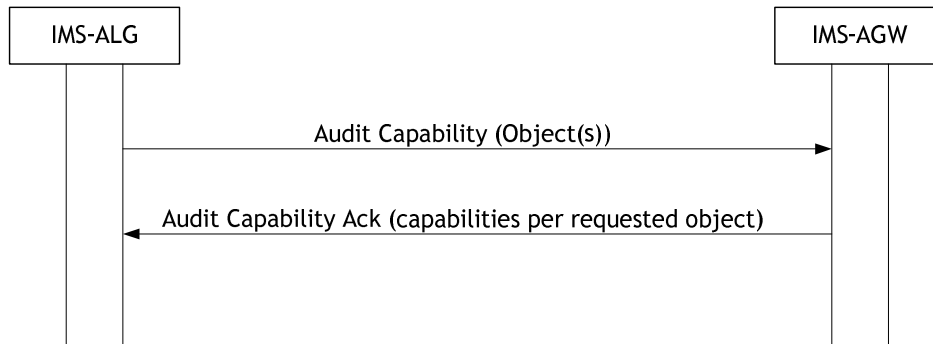

Figure 6.1.8.2.1: Audit Capability

6.1.9 IMS-AGW Capability Change

The IMS-AGW reports a change of capability of distinct objects in the MGW.

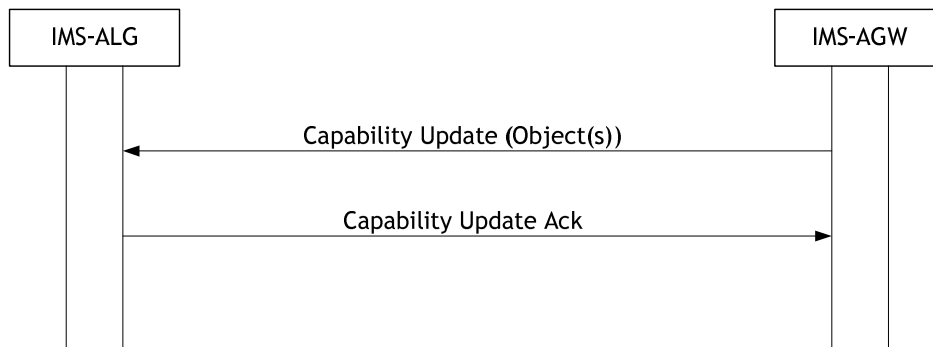

Figure 6.1.9.1: Capability Update

The IMS-ALG may use the Audit Value and/or Audit Capability procedures to obtain further information, about the objects whose capabilities have changed.

6.1.10 IMS-ALG Out of service

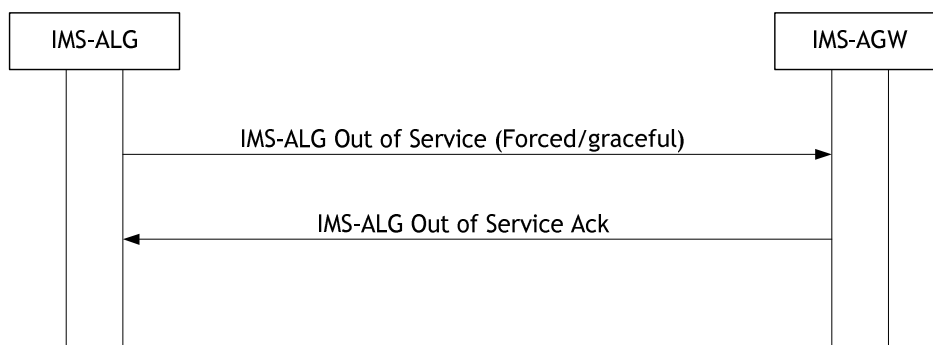

Figure 6.1.10.1: IMS-ALG Out of Service

If an IMS-ALG discovers that it wants to go out of service it may start an IMS-ALG Out of Service procedure. The IMS-ALG can indicate whether it requires the context to be cleared immediately (forced) or cleared as the bearer control protocol clears the bearer (Graceful).

6.1.11 IMS-AGW Resource Congestion Handling - Activate

When the IMS-ALG requires that an IMS-AGW congestion notification mechanism be applied in the MGW, the IMS-ALG shall use the IMS-AGW Resource Congestion Handling - Activate procedure towards the IMS-AGW.

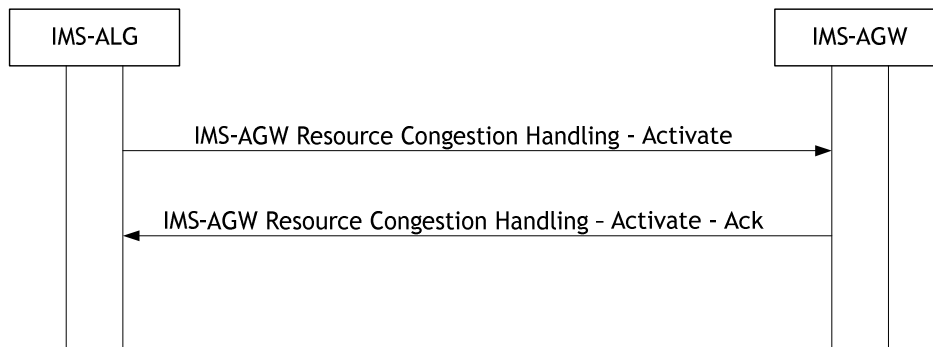

Figure 6.1.11.1: IMS-AGW Resource Congestion Handling - Activate

6.1.12 MGW Resource Congestion Handling - Indication

When the IMS-ALG receives a load reduction notification from the IMS-AGW via the IMS-AGW Resource Congestion Handling - Indication procedure, the IMS-ALG tries to reduce the processing load that the IMS-ALG creates on the IMS-AGW. The IMS-AGW shall decide the actual level of traffic reduction.

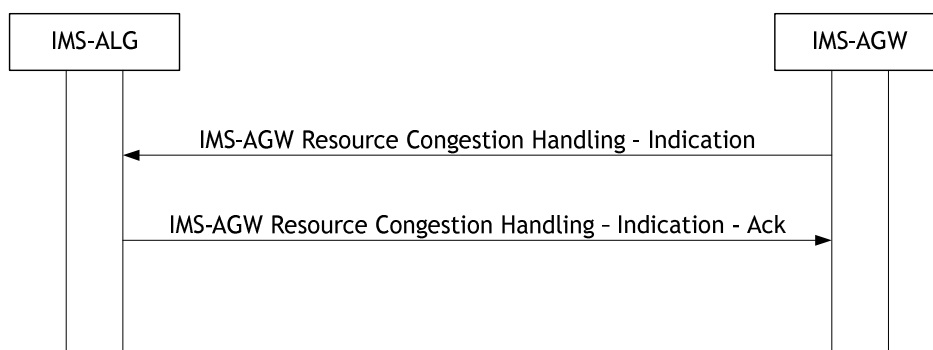

Figure 6.1.12.1: IMS-AGW Resource Congestion Handling – Indication

6.1.13 Control association monitoring

Monitoring of the H.248 control association may be performed by monitoring the status of the transport link association where the transport protocol provides sufficient coupling to the H.248.1 protocol, i.e. if the transport link association is disconnected when no local H.248.1 protocol connection exists.

An alternative method for the IMS-AGW to detect loss of the IMS-ALG may be achieved by requesting the IMS-AGW to poll the IMS-ALG periodically

Upon registration of an IMS-AGW, the IMS-ALG may use the Inactivity Timeout - Activate procedure towards the IMS-AGW to request the IMS-AGW to monitor incoming messages for periods of silence exceeding the maximum inactivity timer value.

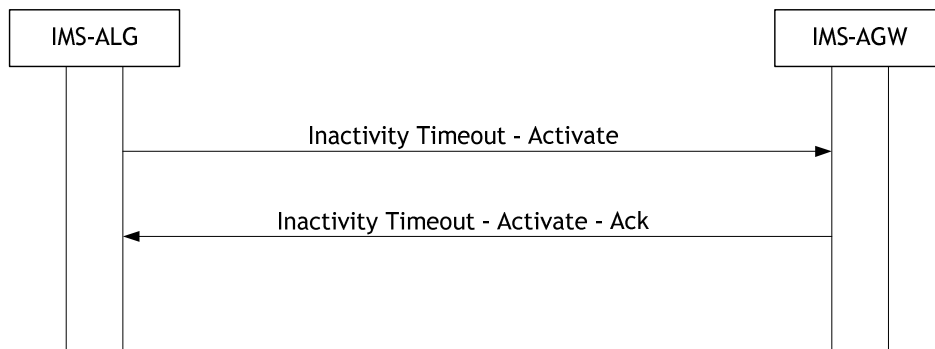

Figure 6.1.13.1: Inactivity Timeout - Activate

Upon receipt of an inactivity timeout notification from the IMS-AGW via the Inactivity Timeout - Indication procedure, the IMS-ALG shall send a reply to the IMS-AGW. If the IMS-ALG has failed, the IMS-AGW will not receive a reply.

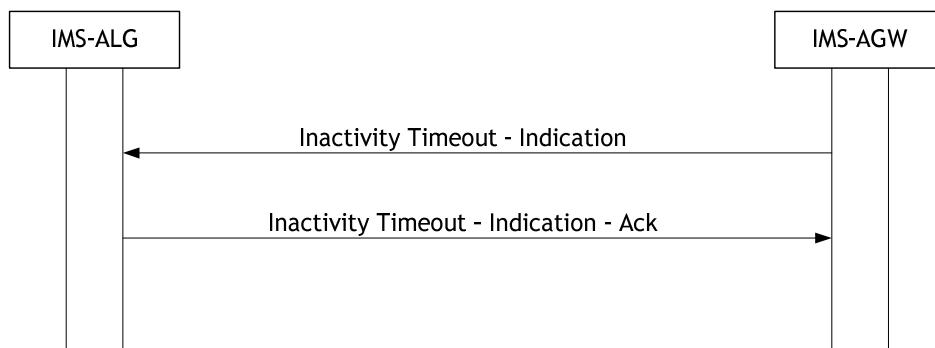

Figure 6.1.13.2: Inactivity Timeout - Indication

If no Inactivity Timeout – Indication Ack reply is received, the IMS-AGW shall consider the IMS-ALG to have failed. The IMS-AGW may then attempt to re-contact its controlling IMS-ALG by performing IMS-AGW Communication Up. If not successful, the IMS-AGW may then attempt to register to a new IMS-ALG.

6.1.14 Realm Availability Monitoring

If the IMS-AGW supports IP Realm Availability monitoring, the IMS-ALG may request the monitoring of the available IP Realms by the IMS-AGW; the IMS-AGW shall inform the IMS-ALG of any changes in realm availability.

NOTE: The IMS-ALG can use the AuditValue procedure to determine which IP realms are currently available.

The IMS-ALG may use the Realm Availability - Activate procedure towards the IMS-AGW to request the IMS-AGW to monitor the status of its IP Realms.



Figure 6.1.14.1: Realm Availability - Activate

The IMS-AGW shall inform the IMS-ALG via the Realm Availability – Notification procedure.

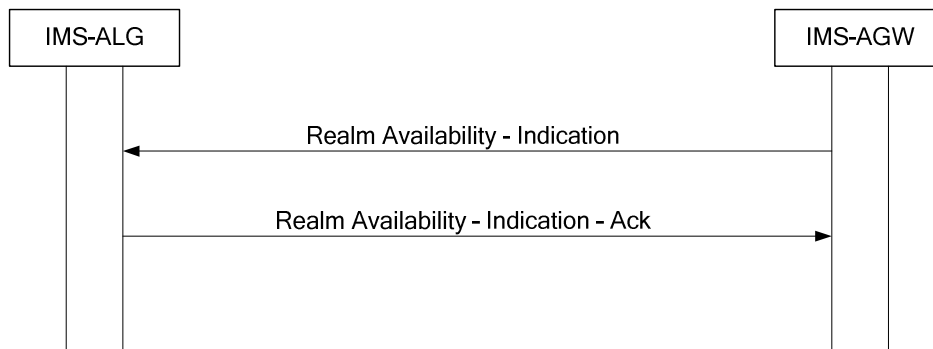

Figure 6.1.14.2: Realm Availability - Indication

On being informed of newly available/unavailable realms, IMS-ALG shall take appropriate action (e.g. update its list of available realms etc.).

6.1.15 Failure of IP Port, Interface or Group of Interfaces

This procedure only applies when text encoding is used on the H.248 interface.

The IMS-ALG shall and the IMS-AGW may support the Termination Out-of-Service procedure.

If the IMS AGW suffers a loss of physical IP device(s) that pertain to a whole IP Realm it may report the IP Realm as unavailable (see subclause 6.1.14). However, it is possible that a failure affects a physical port or group of ports that forms a subset of the IP Realm and therefore many terminations are affected. In such cases the IMS-AGW may initiate a Termination Out of Service procedure to inform the IMS-ALG that the set of terminations is out of service. This is shown in Figure 6.1.15.1.

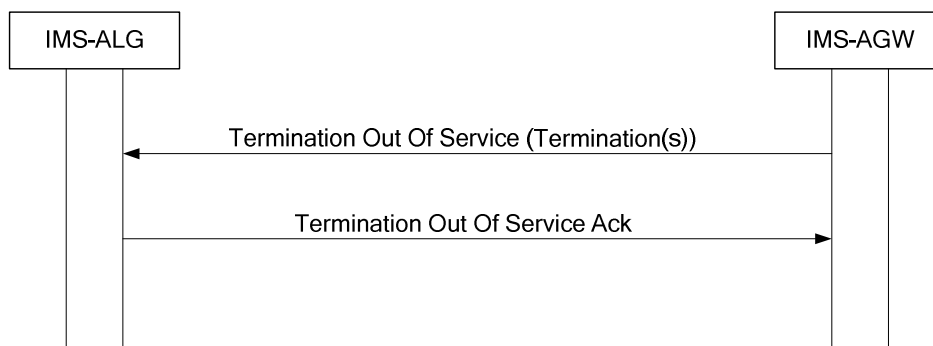

Figure 6.1.15.1: Termination Out of Service

On receipt of the Termination Out Of Service the IMS-ALG shall initiate the appropriate actions, e.g. by subtracting the affected terminations and releasing the affected calls.

NOTE: This procedure provides an alternative failure reporting to the IP Bearer Released procedure (which allows reporting the failure of one IP Bearer / termination). The Termination Out-of-Service procedure avoids sending an avalanche of notifications when the failure affects multiple ephemeral terminations.

6.2 Call Related Procedures

6.2.1 Gate Control & Local NA(P)T procedure

The session establishment and session release procedures are specified in 3GPP TS 23.228 [2] Annex G.4.3 and G.4.

Figure 6.2.1.2 depicts the signalling flow for a session setup from the IMS access network towards the IMS core network when the P-CSCF invokes the IMS-ALG function for a session. The same signalling flow applies for a session setup from the IMS core network towards the IMS access network with the exception that terminations T1 and T2 are then exchanged.

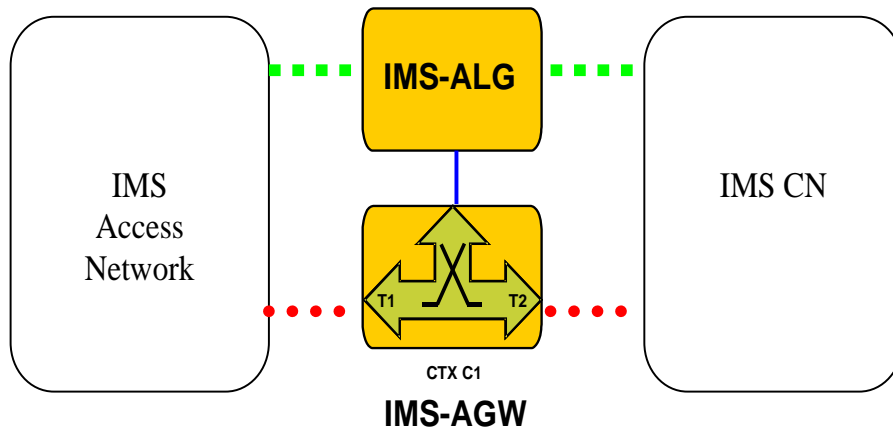

Figure 6.2.1.1: H.248 Context Model

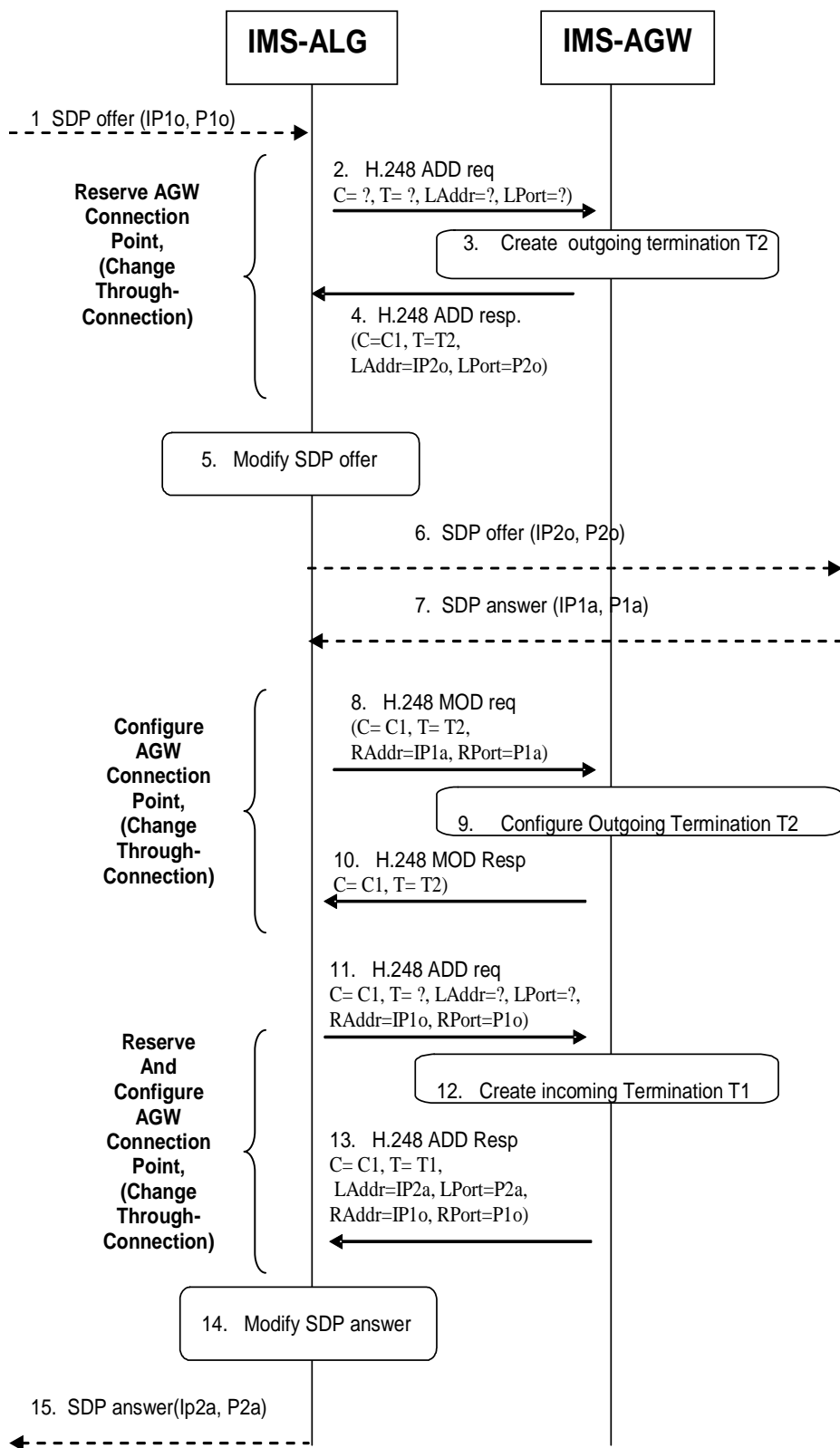

Figure 6.2.1.2: IMS-ALG and IMS-AGW interaction at session establishment

Upon receipt of a session initiation request, the IMS-ALG shall extract the offerer's destination network address(es) and port number(s) from the signalling message body received from the calling party endpoint. It shall then request the IMS-AGW to allocate transport resources (T2) via the Reserve AGW Connection Point procedure. Upon receipt of the

response from the IMS-AGW, the IMS-ALG shall modify the offerer's destination address(es) and/or port(s) contained in the application signalling message body and propagate the session establishment toward the terminating party.

On receipt of the terminating end SDP in the session establishment response, the IMS-ALG shall pass the information to the IMS-AGW in the Configure AGW Connection Point procedure and shall request the IMS-AGW to allocate transport resources (T1) via the Reserve and Configure AGW Connection Point. Upon receiving the response from the IMS-AGW, the IMS-ALG shall modify the answerer's destination address(es) and/or port(s) contained in the application signalling message body and pass the information to the originating party.

On session termination, the IMS-ALG shall request the IMS-AGW to release its transport resources via the Release AGW Termination procedure.

6.2.2 IP realm indication procedure

This procedure is identical to that of subclause 6.2.1 apart from the IMS-ALG optionally specifying the required IP Realm to the IMS-AGW when requesting the allocation of transport resources on the IMS-AGW.

6.2.3 Remote NA(P)T traversal support procedure

This procedure is identical to that of subclause 6.2.1 apart from the IMS-ALG optionally indicating to the IMS-AGW that the remote media address/port information (supplied by the IMS-ALG) shall not be used as the destination address for outgoing media. Instead, the IMS-AGW shall "latch" or "relatch" onto the required destination address via the source address/port of the incoming media. The IMS-ALG may command the IMS-AGW to latch once (on the first received packet) or to re-latch (i.e. to check for a change of source address on the incoming media stream and latch once on this new address).

6.2.4 Remote Source Address/Port Filtering

This procedure is identical to that of subclause 6.2.1 apart from the IMS-ALG optionally specifying the required IP address and/or port to be used to screen received media packets on a termination.

This subclause considers when the IMS-ALG is acting as an Entry point and remote source transport address filtering is required towards the external network.

As a security related option, on request from the IMS-ALG, filtering may be enabled to check/validate the source address or source address and port number of incoming packets from the external network. If the IMS-ALG requests address filtering, it may additionally provide an address specification, which may identify either a single address or a range of addresses, against which filtering is to be performed. The absence of such an address specification in the request shall implicitly request filtering against the IP address of the remote connection address. In addition to address filtering, the IMS-ALG may also request port filtering. If the IMS-ALG requests port filtering, it may additionally include either a port or a range of ports, against which filtering is to be performed. The absence of a port specification in the request shall implicitly request filtering against the port of the remote connection address.

If the IMS-AGW is requested to apply source IP address and possibly source port filtering, it shall only pass incoming IP packets from the identified source, and discard IP packets from other sources.

If remote source address filtering is required for the created termination, then the IMS-ALG shall include the information element "Remote source address filtering" in the request sent to the IMS-AGW. In addition, it may also include the information element "Remote source address mask" in order to request filtering of a range of addresses.

If remote source port filtering is required for the created termination (in addition to remote source address filtering), then the IMS-ALG shall include the information element "Remote source port filtering" in the request sent to the IMS-AGW. It may also include one of the information elements "Remote source port" or "Remote source port range".

Subsequently, the IMS-AGW shall apply filtering as requested to the packets arriving from the external network. Any packet arriving, which does not meet the filtering requirement, shall be discarded.

6.2.5 Traffic Policing

This procedure is identical to that of subclause 6.2.1 apart from the IMS-ALG optionally requesting the IMS-AGW to police the media stream flow according to one or more of the following media policing(s) through the IMS-AGW, in accordance with IETF RFC 2216 [10].

The following media policing shall be supported at the IMS-AGW:

- **Sustainable Data Rate (SDR) Policing:**

To request policing of the sustainable data rate of a media stream, the IMS-ALG shall request media policing for that media stream and shall provide the sustainable data rate, and shall provide a maximum burst size (MBS) indicating the expected maximum size of packet bursts for that media stream. The IMS-AGW shall then measure the data rate for the received packets within that media stream as per IETF RFC 2216 [10] for "Token Bucket", where $r = \text{SDR}$ and $b = \text{MBS}$. If the permissible sustainable data rate is exceeded, the IMS-AGW shall discard packets to reduce the data rate to the permissible sustainable data rate.

NOTE 1: The IMS-ALG can derive the sustainable data rate from bandwidth parameters if it receives them within an SDP description.

The following media policing may be supported in addition at the IMS-AGW ; if supported then the following applies:

- **Peak Data Rate Policing:**

To request policing of the peak data rate of a media stream, the IMS-ALG shall request media policing for that media stream and shall provide the peak data rate, and may provide a Delay Variation Tolerance indicating the expected maximum delay variation due to jitter for that media stream. The IMS-AGW shall then measure the data rate for the received packets within that media stream. If the permissible peak data rate is exceeded, the IMS-AGW shall discard packets to reduce the data rate to the permissible peak data rate. If both peak data rate and sustainable data rate have been provided for the same media stream, the IMS-AGW shall discard packets to reduce the data rate to the permissible peak data rate and should discard packets to reduce the data rate to the permissible sustainable data rate.

NOTE 2: The decision to apply or not traffic policing is general for all sessions with the same media characteristics (i.e. not user specific). The conditions which media policings to apply are beyond the scope of the specification. This can be based on the media characteristics of the session (e.g. media type).

6.2.6 Hanging Termination Detection

This procedure is identical to that of subclause 6.2.1 apart from the IMS-ALG requesting the IMS-AGW to periodically report termination heartbeat indications to detect hanging context and termination in the IMS-AGW that may result e.g. from a loss of communication between the IMS-ALG and the IMS-AGW.

When the IMS-ALG receives a termination heartbeat notification from the IMS-AGW via the Termination heartbeat - Indication procedure, the IMS-ALG shall return a Termination heartbeat - Indication Ack (without an error) if the context id / termination identity combination exists in the IMS-ALG. If it does not exist, the IMS-ALG shall return an error and shall correct the mismatch, e.g. by requesting the IMS-AGW to subtract the indicated termination and to clear any associated context.

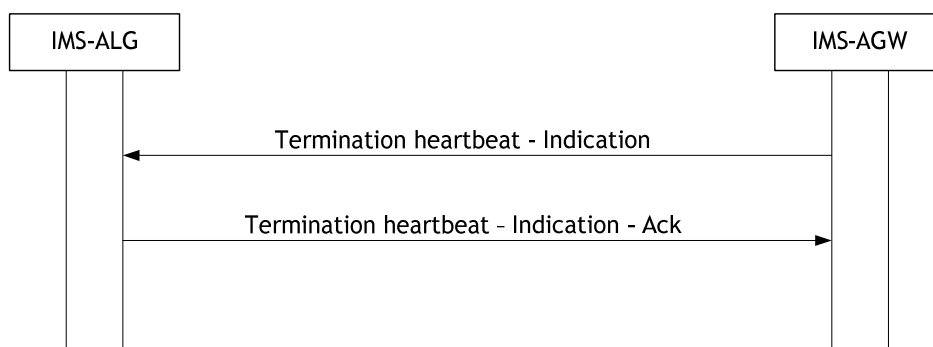

Figure 6.2.6.1: Termination heartbeat – Indication

6.2.7 QoS Packet Marking

This procedure is identical to that of subclause 6.2.1 apart from the IMS-ALG optionally specifying the setting of the DSCP for outgoing packets on a termination. The DSCP value may be explicitly set by the IMS-AGW or else copied from that received in the corresponding received packet.

If differentiated services are required for the created termination, then the IMS-ALG shall include the information elements "DiffServ Code Point" and/or "DiffServ Tagging Behaviour" in the request sent to the IMS-AGW.

Subsequently, for all egress packets, the IMS-AGW shall set the DiffServ Code Point in the IP header as specified by the IMS-ALG:

- If the DiffServ Tagging Behaviour information element was received with a value to indicate that the DiffServ Code Point should be copied, then the DiffServ Code Point in the IP header of the egress packet is copied from the ingress packet.
- If the Diffserv Tagging Behaviour information element was not received, or was received with a value to indicate that the DiffServ Code Point should be set to a specific value, then:
 - If the DiffServ Code Point information element was received, then the DiffServ Code Point in the IP header of the egress packet shall be set to the value received in the DiffServ Code Point information element.
 - If the DiffServ Code Point information element was not received, then the DiffServ Code Point in the IP header of the egress packet shall be set to a configured default value.

6.2.8 Media Inactivity Detection

This procedure is identical to that of subclause 6.2.1 apart from the IMS-ALG optionally requesting the IMS-AGW to detect inactive media.

If media inactivity detection is required for the created termination, the IMS-ALG may include the information elements "Inactivity detection time" and "Inactivity detection direction" in the request sent to the IMS-AGW. The IMS-ALG may request the detection of media inactivity on a termination or a stream basis.

When the IMS-ALG receives a notification of inactive media from the IMS-AGW via the Media Inactivity Notification procedure, the IMS-ALG shall return a Media Inactivity Notification Ack and shall take appropriate action (e.g. release the termination).

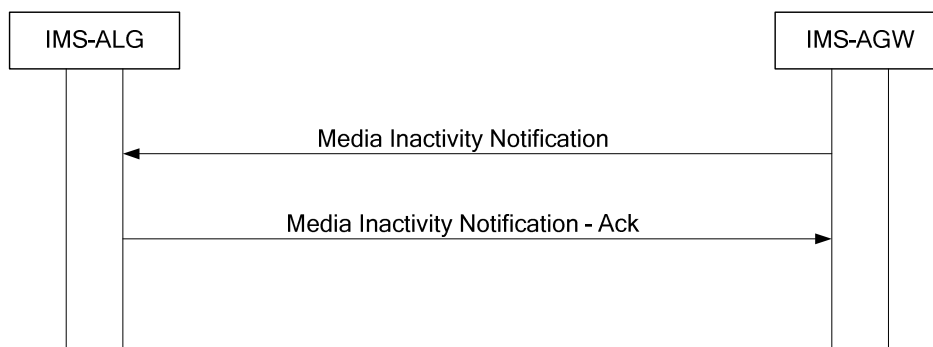

Figure 6.2.8.1: Media Inactivity Notification

6.2.9 Handling of RTCP streams

This procedure is identical to that of subclause 6.2.1 apart from the IMS-ALG optionally requesting the IMS-AGW to allocate or not allocate RTCP resources, and if RTCP is requested, optionally specifying the remote RTCP port and address, and bandwidth allocation for RTCP.

6.2.10 IMS end-to-access-edge Media Plane Security

This procedure is identical to that of subclause 6.2.1 apart from the IMS-ALG optionally requesting the IMS-AGW to provide IMS media plane security in accordance with 3GPP TS 33.328 [12].

The IMS-ALG shall provide the following media plane security related parameters to the IMS-AGW:

- The SDES crypto attributes

6.2.11 Change Through-Connection

The Change Through-Connection procedure is used for opening and closing of gates and is mandatory for IMS-ALG and IMS-AGW to support. The IMS-ALG sets the Stream mode parameter using the Change Through-Connection procedure to request the IMS-AGW to one-way or both-way through-connect or block media streams on a termination.

The IMS-ALG may combine the Change Through-Connection procedure with the Reserve and Configure AGW Connection Point, Reserve AGW Connection Point or Configure AGW Connection Point procedure as in Figure 6.2.1.2., or may apply this procedure separately.

6.2.12 Emergency Calls

This procedure is identical to that of subclause 6.2.1 apart from the IMS-ALG requesting the IMS-AGW to treat the call as emergency call with a preferential handling by including the information element "Emergency Call Indicator" within the "Reserve and Configure AGW Connection Point" or "Reserve AGW Connection Point procedure".

6.2.13 Explicit Congestion Notification support

6.2.13.1 General

An IMS-ALG may configure the IMS-AGW to transfer the ECN bits in the IP header transparent (see subclause 6.2.13.2) or to act as an ECN endpoint (see subclause 6.2.13.3). See subclause 5.12.

6.2.13.2 ECN Active Indicated (ECN transparent)

Figure 6.2.13.2.1 shows the message sequence chart example for indicating ECN transparent.

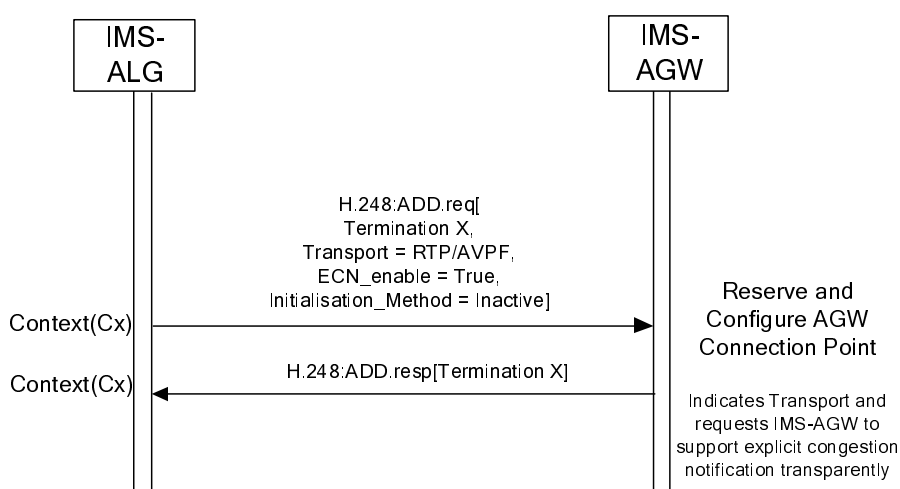

Figure 6.2.13.2.1: Procedure to indicate ECN transparent negotiated

Upon receipt of the indication that ECN transparent has been negotiated, the IMS-AGW shall forward ECN bits within IP packets unmodified. Any RTCP feedback received shall be passed unchanged.

6.2.13.3 ECN support requested (ECN endpoint)

Figure 6.2.13.3.1 shows the message sequence chart example for requesting ECN endpoint.

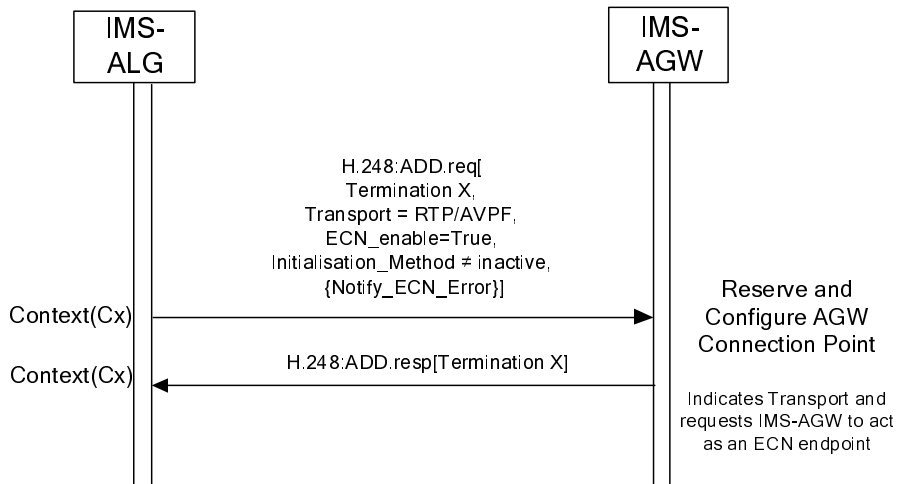

Figure 6.2.13.3.1: Procedure to Request ECN endpoint

Upon receipt of a request to apply ECN the IMS-AGW shall set the ECN field of the IP header in accordance with 3GPP TS 26.114 [21] when sending any data packets.

Upon receipt of any IP headers indicating ECN Congestion Experienced (ECN-CE) the IMS-AGW shall trigger rate adaptation in accordance with 3GPP TS 26.114 [21].

NOTE: ECN endpoint requires the IMS-ALG to configure the IMS-AGW with all media attributes to allow rate adaptation even if no transcoding is required/supported in the IMS-AGW.

6.2.13.4 ECN Failure Indication (ECN endpoint)

Figure 6.2.13.4.1 shows the message sequence chart example for an ECN Failure Event.

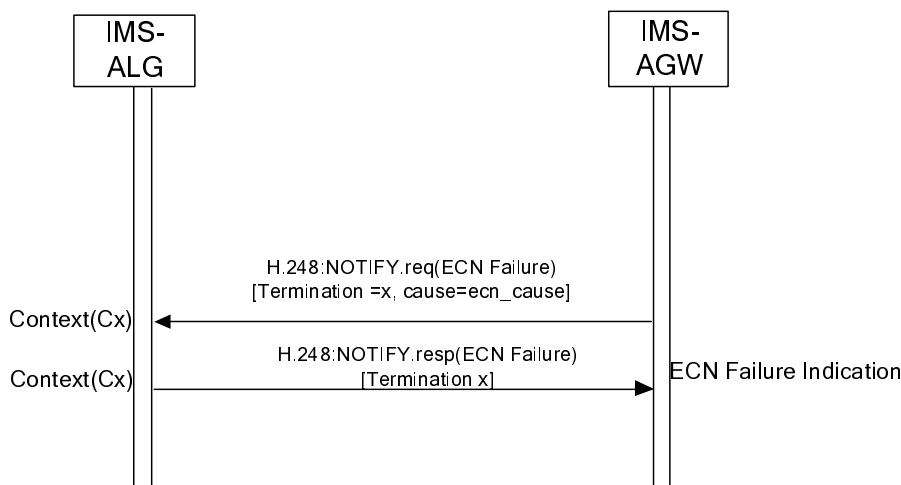

Figure 6.2.13.4.1: Procedure to Report ECN Failure

When the IMS-ALG receives a Notification indicating that a failure has occurred, the IMS-ALG may trigger a new SDP offer to disable ECN.

6.2.14 Access Transfer procedures with media anchored in IMS-AGW (ATGW)

6.2.14.1 General

This clause describes extensions to the Iq signalling procedures and their interactions with SIP signalling in the control plane and with user plane procedures to support the "SRVCC enhanced with ATCF" procedures between the IMS-ALG (ATCF) and IMS-AGW (ATGW) when the IMS-ALG and IMS-AGW support the ATCF and ATGW functionality, as specified in 3GPP TS 23.237 [18] and 3GPP TS 24.237 [19].

The Access Transfer procedures are optional to support on the Iq reference point. The requirements in this clause shall apply if these procedures are supported.

All message sequence charts in this clause are examples.

6.2.14.2 H.248 context model

Figure 6.2.14.2.1 shows the H.248 context model after the PS originating or terminating session establishment and before the PS to CS access transfer procedure. The "squared" line represents the call control signalling. The "dotted" line represents the bearer. The bearer termination T1 is used for the media path of the PS access leg, the bearer termination T2 is used for the media path of the remote leg.

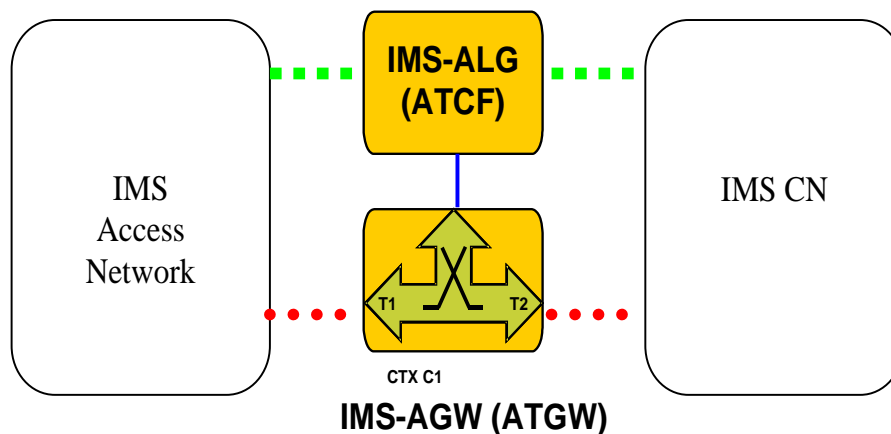

Figure 6.2.14.2.1: H.248 Context Model before Access Transfer

Figure 6.2.14.2.2 shows the H.248 context model during the PS to CS access transfer procedure. The IMS-ALG (ATCF) may seize a new bearer termination T3 for the new media path of the CS access leg, e.g. if the PS and CS nodes before and after the handover are reachable via different IP realms or use a different IP version. The IMS-ALG (ATCF) may alternatively reconfigure the T1 termination with the new remote configuration (e.g. IP address and media) instead of seizing a new termination; in that case, the H.248 context model remains as before access transfer.

Bi-casting is not supported during access transfer, i.e. the IMS-AGW (ATGW) does not duplicate downlink media packets received from the remote leg to the source and target access legs simultaneously. ■

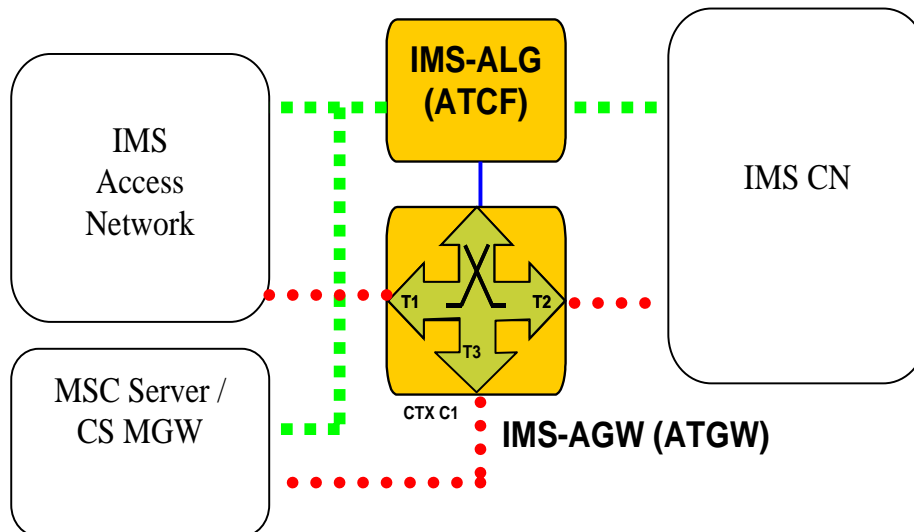

Figure 6.2.14.2.2: H.248 Context Model during Access Transfer

Figure 6.2.14.2.3 shows the H.248 context model after the PS to CS access transfer procedure if the source access leg is released. If the UE chooses to retain some media flow(s) in the transferred-out access, the H.248 context model remains as during access transfer.

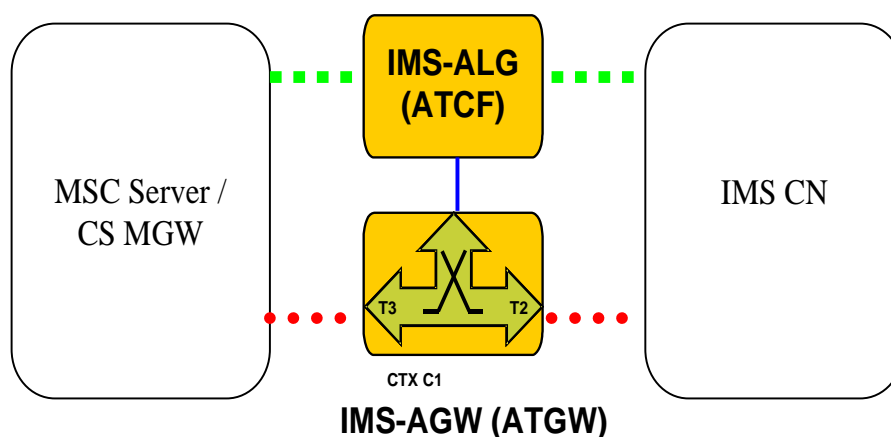

Figure 6.2.14.2.3: H.248 Context Model after Access Transfer

6.2.14.3 PS session origination or termination with media anchoring in IMS-AGW (ATGW) signaling procedures

If the IMS-ALG (ATCF) decides to anchor the media of a session in the IMS-AGW (ATGW) the call related procedures shall follow the basic procedures for IMS ALG (i.e. as specified in clause 6.2.1) with the following differences:

- The IMS-ALG (ATCF) shall seize a termination towards the terminating user, using the "Reserve AGW Connection Point" procedure before sending a SDP offer to the terminating user. The IMS-ALG (ATCF) may signal media related information to the IMS-AGW (ATGW) or omit media when adding the IP termination at this stage.

NOTE : The signalling of media related information to a MGW requires that it reserve the indicated resources before returning a positive response to the H.248 command, by omitting media related information the IMS-AGW (ATGW) does not need to reserve any associated resources at this stage.

- When the IMS-ALG (ATCF) receives the SDP offer from the terminating user, the IMS-ALG (ATCF) shall configure the IMS-AGW (ATGW) accordingly by either supplying the same media related information for all interconnected terminations or by omitting the media related information.

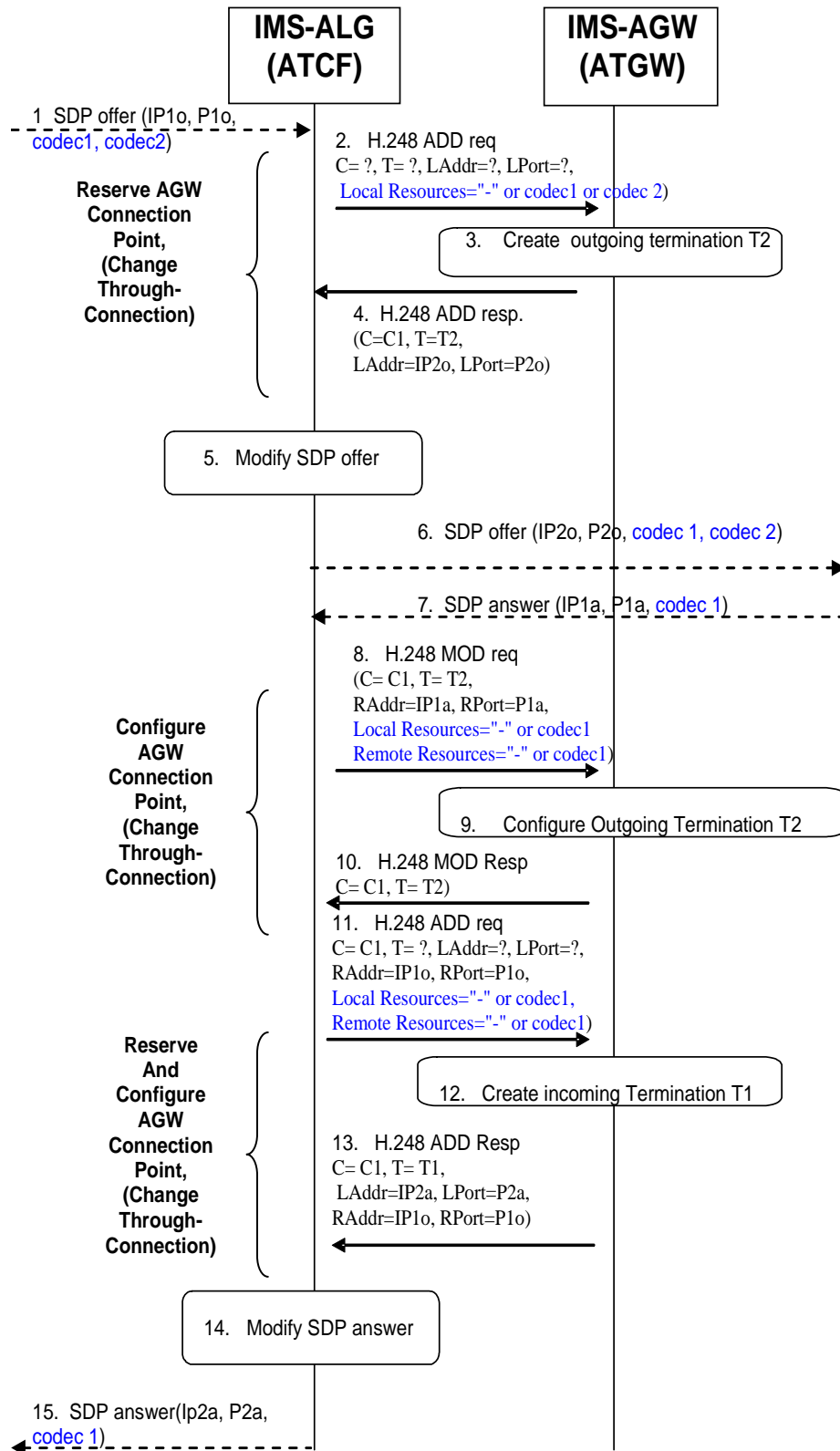

Figure 6.2.14.3.1: PS session establishment with media anchoring in IMS-AGW (ATGW)

1. The IMS-ALG (ATCF) receives an SDP offer in SIP signalling. The IMS-ALG (ATCF) requires an IMS-AGW (ATGW) for media anchoring (or for another IMS-AGW use case) but does not offer transcoding.
2. The IMS-ALG (ATCF) sends a H.248 ADD request command to create the outgoing termination and to request IP resources to execute ATGW function. As no media transcoding is required this may be indicated by signalling "-". Alternatively any codec (e.g. Codec 1) can be signalled. If the IMS-ALG (ATCF) selects an IMS-AGW (ATGW) that does not support transcoding, the IMS-ALG (ATCF) may signal media related sub-fields in the media descriptor to the IMS-AGW (ATGW) if the IMS-AGW (ATGW) supports media encoding. The IMS-AGW (ATGW) shall accept the ADD request even though it cannot reserve any transcoding resources for the indicated media.
3. The IMS-AGW (ATGW) creates the outgoing termination.
4. The IMS-AGW (ATGW) replies to IMS-ALG (ATCF) with a H.248 ADD reply command and provides the local address and port of the outgoing termination.
5. The IMS-ALG (ATCF) replaces the IP address inside the SDP using the information coming from IMS-AGW (ATGW).
6. The IMS-ALG (ATCF) forwards the new offer to the succeeding node.
7. The SDP answer is received by IMS-ALG (ATCF). In this example the codec1 received in the original SDP offer in step1 has been selected.
8. The IMS-ALG (ATCF) sends a H.248 MOD request command to configure the outgoing termination with address and port information. As no media transcoding is needed this may be indicated by signalling "-". Alternatively the selected codec (Codec 1) can be signalled.
9. The IMS-AGW (ATGW) configures the outgoing termination.
10. The IMS-AGW (ATGW) replies to IMS-ALG (ATCF) with a H.248 MOD reply command.
11. The IMS-ALG (ATCF) sends a H.248 ADD command to create the incoming termination to configure this termination with remote address and port information and to request resources to execute ATGW function. As no media transcoding is needed this may be indicated by signalling "-". Alternatively media related sub-fields in the media descriptor for the codec indicated to the incoming termination may be signalled (e.g. the selected codec received in step 7 (Codec 1)).
12. The IMS-AGW (ATGW) creates the incoming termination.
13. The IMS-AGW (ATGW) replies to the IMS-ALG (ATCF) with a H.248 ADD reply command and provides the local address and port of the incoming termination.
14. The IMS-ALG (ATCF) replaces the IP address inside the SDP answer using the information coming from IMS-AGW (ATGW).
15. SDP answer is sent to the network at the incoming side.

Similar principles shall apply during the establishment of a mobile terminating session.

6.2.14.4 PS to CS Access Transfer procedure with media anchored in IMS-AGW (ATGW)

The signalling flow shown in figure 6.2.14.4.1 gives an example for PS to CS access transfer with media anchored in the IMS-AGW (ATGW). In this case, the media has been anchored in IMS-AGW (ATGW) as specified in subclause 6.2.14.3.

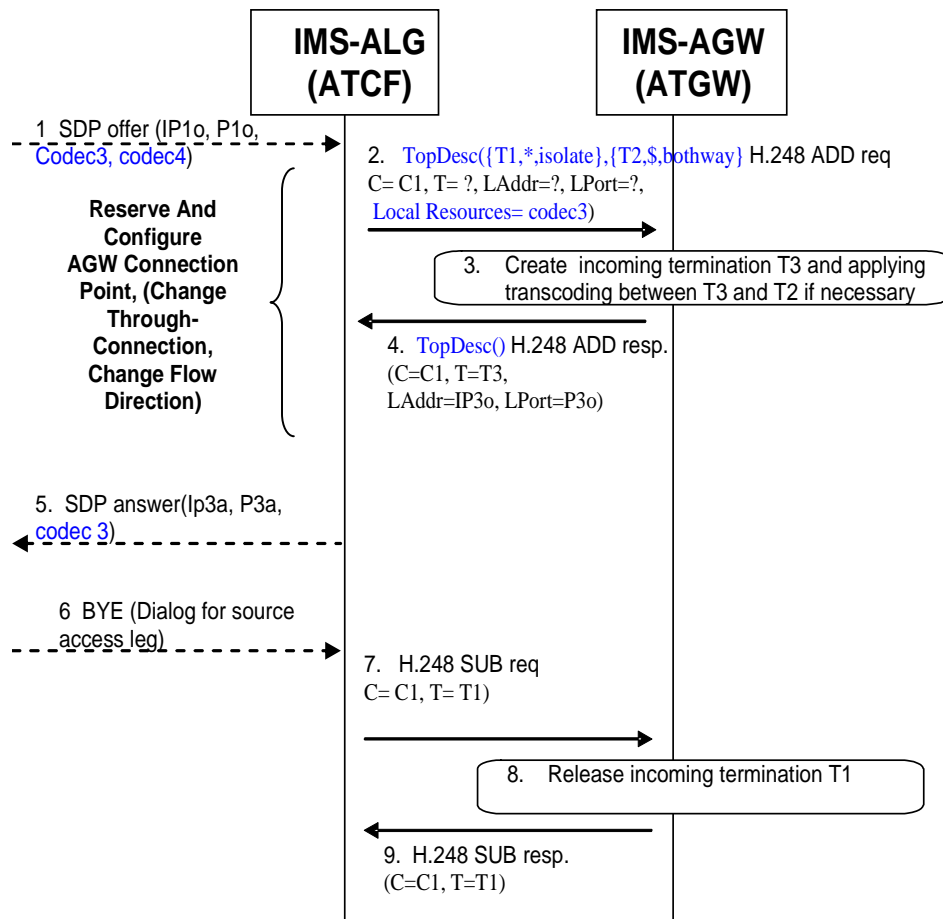

1. The IMS-ALG (ATCF) receives an SDP offer in SIP signalling from the MSC Server. The IMS-ALG (ATCF) checks whether transcoding is required. 2. The IMS-ALG (ATCF) sends a H.248 ADD request command to create the target access leg termination and to request IP resources to execute ATGW function. Topology is changed and media reconfigured to connect media between T2 and T3. If no media transcoding is required this may be indicated by signalling "-" or by signalling the same media information on T3 as is configured on T2, following the principles specified in subclause 6.2.14.3. If media transcoding is required (as illustrated in this example), the IMS-ALG (ATCF) signals media related sub-fields in the media descriptor to the IMS-AGW (ATGW). The IMS-AGW (ATGW) determines from the media configuration whether transcoding is required on a stream between two terminations between which data flow is permitted.
3. The IMS-AGW (ATGW) creates the target access leg termination T3 and starts to apply transcoding between T2 and T3 (if required).
4. The IMS-AGW (ATGW) replies to IMS-ALG (ATCF) with a H.248 ADD reply command and provides the local address and port of the outgoing termination.
5. The IMS-ALG (ATCF) returns an SDP answer to the MSC Server; the IP address inside the SDP uses the information coming from IMS-AGW (ATGW).
6. Upon successful completion of the access transfer procedure, the IMS-ALG (ATCF) receives a BYE request from the SCC AS if there is no more media flows on the PS access.
7. The IMS-ALG (ATCF) sends a H.248 SUB request command to subtract the source access leg termination.
8. The IMS-AGW (ATGW) releases the source access leg termination.
9. The IMS-AGW (ATGW) replies to IMS-ALG (ATCF) with a H.248 SUB reply command.

Figure 6.2.14.4.1: PS to CS Access Transfer with transcoding in IMS-AGW (ATGW)

6.2.14.5 ECN support during PS to CS Access Transfer procedure with media anchored in IMS-AGW (ATGW)

The signalling flow shown in figure 6.2.14.4.1 gives an example for PS to CS access transfer with media anchored in the IMS-AGW (ATGW). The following additional actions are required if ECN is supported by the IMS-ALG/IMS-AGW:

1.
 - a) If ECN was supported during the PS session transparently and the SDP offer received from the MSC Server does not indicate ECN support, it is not possible to maintain transparent ECN support to the IMS CN. The IMS-ALG (ATCF) shall modify the Termination T2 to act as an ECN endpoint toward the IMS CN (see Subclause 5.12). Additionally the IMS-ALG (ATCF) shall disable ECN on the termination T3 (or T1).
 - b) If ECN was supported during the PS session transparently and the SDP offer received from the MSC Server does indicate ECN support and no transcoding is required (codec types and modes are aligned between ICS side and IMS CN), then the IMS-ALG (ATCF) shall request ECN transparent properties when seizing T3 and respond to the MSC Server with ECN supported in the SDP answer (step 5).
 - c) If ECN was supported during the PS session transparently and the SDP offer received from the MSC Server does indicate ECN support and transcoding is required between the CS leg and the IMS-CN, then the IMS-ALG (ATCF) shall request ECN endpoint properties when seizing T3 (or modify the termination T1 with ECN endpoint properties) and respond to the MSC Server with ECN supported in the SDP answer (step 5). Additionally the IMS-ALG (ATCF) shall modify the Termination T2 to act as an ECN endpoint toward the IMS CN (see Subclause 5.12).
 - d) If ECN was not supported during the PS session and the SDP Offer received from the MSC Server indicates ECN support, the IMS-ALG (ATCF) shall not accept ECN support in the SDP answer (step 5).

7 Charging

The charging is specified in 3GPP TS 32.260 [5]. No requirements are identified for the Iq interface.

8 Messages/Procedures and Contents

8.1 General

This clause describes logical signalling procedures between the IMS-ALG and IMS-AGW. The procedures within this clause are intended to be implemented using the standard H.248 procedure as defined in ITU recommendation H.248.1 [9] with appropriate parameter combinations.

8.2 Reserve and Configure AGW Connection Point

This procedure is used to reserve multimedia-processing resources for the Iq interface connection.

Table 8.2.1: Procedures between IMS-ALG and IMS-AGW: Reserve and Configure AGW Connection Point

Procedure	Initiated	Information element name	Information element required	Information element description
Reserve and Configure AGW Connection Point	IMS-ALG	Context/Context Request	M	This information element indicates the existing context or requests a new context for the bearer termination.
		Emergency Call Indicator	O	This information element identifies the call as emergency call that requires a preferential handling.
		Bearer Termination Request	M	This information element indicates the existing bearer termination or requests a new bearer termination for the bearer to be established.
		Local IP Resources	O	This information element indicates the resource(s) for which the IMS-AGW shall be prepared to receive user data. May be excluded (i.e. "-" is used in SDP m-line) if no transcoding or media related functions are required. For terminations supporting any combination of video, audio and messaging this IE shall contain separate resources per stream.
		ReserveValue	O	This information element indicates if multiple local resources are to be reserved. This information element shall be included if a speech codec and auxiliary payload types are configured.
		Remote IP Resources	O	This information element indicates the resource(s) for which the IMS-AGW shall send data. For terminations supporting any combination of video, audio and messaging this IE shall contain separate resources per stream. May be excluded (i.e. "-" is used in SDP m-line) if no transcoding or media related functions are required.
		Local Connection Address Request	M	This information element requests an IP address and port number(s) on the IMS-AGW that the remote end can send user plane data to. For terminations supporting any combination of video, audio and messaging this may contain multiple addresses.
		Remote Connection Address	M	This information element indicates the remote IP address and port number(s) that the IMS-AGW can send user plane data to. For terminations supporting any combination of video, audio and messaging this may contain multiple addresses.

		Notify termination heartbeat	M	This information element requests termination heartbeat indications. This information element shall be included when requesting a new bearer termination. Otherwise the information element is optional.
		Notify Released Bearer	O	This information element requests a notification of a released bearer.
		Latching Requirement	O	This information element indicates that the IMS-AGW should (re)latch onto the address of received media packets to determine the corresponding destination address.
		IP Realm Identifier	O	This information element indicates the IP realm of the bearer termination.
		Remote Source Address Filtering	O	This information element indicates that remote source address filtering is required.
		Remote Source Address Mask	C	This information element provides information on the valid remote source addresses. This is required if a range of remote source address filtering is required.
		Remote Source Port Filtering	O	This information element indicates that remote source port filtering is required.
		Remote Source Port	C	This information element identifies the valid remote source port. This may be included if remote source port filtering is included. (NOTE 1)
		Remote Source Port Range	C	This information element identifies a range of valid remote source ports. This may be included if remote source port filtering is included. (NOTE 1)
		Traffic Policing Required	O	This information element indicates that policing of the media flow is required.
		Peak Data Rate	O	This information element may be present if Policing is required and specifies the permissible peak data rate for a media stream. (NOTE 2)..
		Sustainable Data Rate	O	This information element may be present if Policing is required and specifies the permissible sustainable data rate for a media stream. (NOTE 2).
		Delay Variation Tolerance	O	This information element may be present if Policing on Peak Data Rate is required and specifies the maximum expected delay variation tolerance for the corresponding media stream.
		Maximum Burst Size	C	This information element shall be present if Policing on Sustainable Data Rate is required and specifies the maximum expected burst size for the corresponding media stream.
		DiffServ Code Point	O	This information element indicates a specific DiffServ code point to be used in the IP header in packets sent on the bearer termination.
		DiffServ Tagging Behaviour	O	This information element indicates whether the Diffserv code point in the IP header in packets sent on the bearer termination shall be copied from the received value or set to a specific value.
		Media Inactivity Detection Required	O	This information element indicates that detection of inactive media flows is required.
		Media Inactivity Detection Time	C	This information element may be present if Inactive Media Detection is required and specifies the Inactivity Detection time.
		Media Inactivity Detection Direction	C	This information element may be present if Inactive Media Detection is required and specifies the Inactivity Detection direction.

		RTCP handling	O	This information element is present if IMS-ALG wants explicitly control the reservation of RTCP resources by the IMS-AGW.
		Local cryptographic SDES attribute	C	This information element is present if IMS-ALG wants that the media is encrypted and/or integrity protected by the IMS-AGW (NOTE 3). It indicates the SDES local cryptographic parameters such as key(s)
		Remote cryptographic SDES attribute	C	This information element is present if IMS-ALG wants that the media is decrypted, and/or integrity checked by the IMS-AGW (NOTE 3). It indicates the SDES remote cryptographic parameters such as key(s)
		ECN Enable	O	This information element requests the IMS-AGW to apply ECN procedures.
		ECN Initiation Method	C	This information element specifies the ECN Initiation method and requests the IMS-AGW to perform IP header settings as an ECN endpoint, or indicates that ECN bits shall be passed transparently. It may be included only if ECN is enabled.
		Notify ECN Failure Event	C	This information element requests a notification if a ECN failure occurs due to ECN. It may only be supplied if ECN is enabled and the IMS-AGW acts as ECN endpoint.
Reserve and Configure AGW Connection Point Ack	IMS-AGW	Context	M	This information element indicates the context where the command was executed.
		Bearer Termination	M	This information element indicates the bearer termination where the command was executed.
		Local IP Resources	C	This information element indicates the resource(s) for which the IMS-AGW shall be prepared to receive user data. This IE shall be present if it was contained in the request. If the IE was not contained in the request, it may be present in the reply. For terminations supporting any combination of video, audio and messaging this IE shall contain separate resources per stream.
		Remote IP Resources	O	This information element indicates the resource(s) for which the IMS-AGW shall send data. For terminations supporting any combination of video, audio and messaging this IE shall contain separate resources per stream.
		Local Connection Address	M	This information element indicates the IP address and port number(s) the IMS-AGW shall receive user plane data from IMS. For terminations supporting any combination of video, audio and messaging this may contain multiple addresses.
		Remote Connection Address	O	This information element indicates the remote IP address and port number(s) that the IMS-AGW can send user plane data to. For terminations supporting any combination of video, audio and messaging this may contain multiple addresses.

		Local cryptographic SDES attribute	C	This information element may be present only if it was contained in the request. It indicates the SDES local cryptographic parameters such as key(s)
		Remote cryptographic SDES attribute	C	This information element may be present only if it was contained in the request. It indicates the SDES remote cryptographic parameters such as key(s)
NOTE 1: Remote Source Port and Remote Source Port Range are mutually exclusive. NOTE 2: One of those IEs shall at least be present when policing is required. NOTE 3: This IE may only be present for access network terminations.				

8.3 Reserve AGW Connection Point Procedure

This procedure is used to reserve local connection addresses and local resources in IMS-AGW.

Table 8.3.1: Procedures between IMS-ALG and IMS-AGW: Reserve AGW Connection Point

Procedure	Initiated	Information element name	Information element required	Information element description
Reserve AGW Connection Point	IMS-ALG	Context /Context Request	M	This information element indicates the existing context or requests a new context for the bearer termination.
		Emergency Call Indicator	O	This information element identifies the call as emergency call that requires a preferential handling.
		Bearer Termination Request	M	This information element requests a new bearer termination
		Local IP Resources	O	This information element indicates the resource(s) for which the IMS-AGW shall be prepared to receive user data. For terminations supporting any combination of video, audio and messaging this IE shall contain separate resources per stream. May be excluded (i.e. "-" is used in SDP m-line) if no transcoding or media related functions are required.
		ReserveValue	O	This information element indicates if multiple local resources are to be reserved. This information element shall be included if a speech codec and auxiliary payload types are configured.
		Local Connection Address Request	M	This information element requests an IP address and port number(s) on the IMS-AGW that the remote end can send user plane data to. For terminations supporting any combination of video, audio and messaging this may contain multiple addresses.
		Notify termination heartbeat	M	This information element requests termination heartbeat indications.
		Notify Released Bearer	O	This information element requests a notification of a released bearer.
		Latching Requirement	O	This information element indicates that the IMS-AGW should (re)latch onto the address of received media packets to determine the corresponding destination address.
		IP Realm Identifier	O	This information element indicates the IP realm of the bearer termination.
		Remote Source Address Filtering	O	This information element indicates that remote source address filtering is required.
		Remote Source Address Mask	C	This information element provides information on the valid remote source addresses. This is required if a range of remote source address filtering is required.
Remote Source Port Filtering	O	This information element indicates that remote source port filtering is required.		

		Remote Source Port	C	This information element identifies the valid remote source port. This may be included if remote source port filtering is included. (NOTE 1)
		Remote Source Port Range	C	This information element identifies a range of valid remote source ports. This may be included if remote source port filtering is included. (NOTE 1)
		Policing Required	O	This information element indicates that policing of the media flow is required.
		Peak Data Rate	O	This information element may be present if Policing is required and specifies the permissible peak data rate for a media stream. (NOTE 2).
		Sustainable Data Rate	O	This information element may be present if Policing is required and specifies the permissible sustainable data rate for a media stream. (NOTE 2).
		Delay Variation Tolerance	O	This information element may be present if Policing on Peak Data Rate is required and specifies the maximum expected delay variation tolerance for the corresponding media stream.
		Maximum Burst Size	C	This information element shall be present if Policing on Sustainable Data Rate is required and specifies the maximum expected burst size for the corresponding media stream.
		DiffServ Code Point	O	This information element indicates a specific DiffServ code point to be used in the IP header in packets sent on the bearer termination.
		DiffServ Tagging Behaviour	O	This information element indicates whether the Diffserv code point in the IP header in packets sent on the bearer termination should be copied from the received value or set to a specific value.
		Media Inactivity Detection Required	O	This information element indicates that detection of inactive media flows is required.
		Media Inactivity Detection Time	C	This information element may be present if Inactive Media Detection is required and specifies the Inactivity Detection time.
		Media Inactivity Detection Direction	C	This information element may be present if Inactive Media Detection is required and specifies the Inactivity Detection direction.
		RTCP handling	O	This information element is present if IMS-ALG wants explicitly control the reservation of RTCP resources by the IMS-AGW.
		Local cryptographic SDES attribute	C	This information element is present if IMS-ALG wants that the media is encrypted and/or integrity protected by the IMS-AGW (NOTE 3). It indicates the SDES local cryptographic parameters such as key(s).
		ECN Enable	O	This information element requests the IMS-AGW to apply ECN procedures.
		ECN Initiation Method	C	This information element specifies the ECN Initiation method and requests the IMS-AGW to perform IP header settings as an ECN endpoint, or indicates that ECN bits shall be passed transparently. It may be included only if ECN is enabled.
		Notify ECN Failure Event	C	This information element requests a notification if a ECN failure occurs due to ECN. It may only be supplied if ECN is enabled and the IMS-AGW acts as ECN endpoint.
Reserve AGW Connection	IMS-AGW	Context	M	This information element indicates the context where the command was executed.

Point Ack	Bearer Termination	M	This information element indicates the bearer termination where the command was executed.
	Local IP Resources	C	This information element indicates the resource(s) for which the IMS-AGW shall be prepared to receive user data. This IE shall be present if it was contained in the request. If the IE was not contained in the request, it may be present in the reply. For terminations supporting any combination of video, audio and messaging this IE shall contain separate resources per stream.
	Local Connection Address	M	This information element indicates the IP address and port number(s) the IMS-AGW shall receive user plane data from IMS. For terminations supporting any combination of video, audio and messaging this may contain multiple addresses.
	Local cryptographic SDES attribute	C	This information element may be present only if it was contained in the request. It indicates the SDES local cryptographic parameters such as key(s)
<p>NOTE 1: Remote Source Port and Remote Source Port Range are mutually exclusive.</p> <p>NOTE 2: One of those IEs shall at least be present when policing is required.</p> <p>NOTE 3: This IE may only be present for access network terminations, and only if the IMS-ALG includes only one SDES crypto attribute in the SDP sent towards the served UE.</p>			

8.4 Configure AGW Connection Point Procedure

This procedure is used to select or modify multimedia-processing resources for the Iq interface connection.

Table 8.4.1: Procedures between IMS-ALG and IMS-AGW: Configure AGW Connection Point

Procedure	Initiated	Information element name	Information element required	Information element description
Configure AGW Connection Point	IMS-ALG	Context	M	This information element indicates the context for the bearer termination.
		Bearer Termination	M	This information element indicates the existing bearer termination.
		Local IP Resources	O	This information element indicates the resource(s) for which the IMS-AGW shall be prepared to receive user data. For terminations supporting any combination of video, audio and messaging this IE shall contain separate resources per stream. May be excluded (i.e. "-" is used in SDP m-line) if no transcoding or media related functions are required.
		Remote IP Resources	O	This information element indicates the resource(s) for which the IMS-AGW shall send data. For terminations supporting any combination of video, audio and messaging this IE shall contain separate resources per stream. May be excluded (i.e. "-" is used in SDP m-line) if no transcoding or media related functions are required.
		Local Connection Address	O	This information element indicates the IP address and port number(s) on the IMS-AGW that the IMS user can send user plane data to. For terminations supporting video any combination of video, audio and messaging may contain multiple addresses.
		Remote Connection Address	O	This information element indicates the remote IP address and port number(s) that the IMS-AGW can send user plane data to. For terminations supporting any combination of video, audio and messaging this may contain multiple addresses.
		Latching Requirement	O	This information element indicates that the IMS-AGW should (re)latch onto the address of received media packets to determine the corresponding destination address.
		IP Realm Identifier	O	This information element indicates the IP realm of the bearer termination. (NOTE 3)
		Remote Source Address Filtering	O	This information element indicates that remote source address filtering is required.

		Remote Source Address Mask	C	This information element provides information on the valid remote source addresses. This is required if a range of remote source address filtering is required.
		Remote Source Port Filtering	O	This information element indicates that remote source port filtering is required.
		Remote Source Port	C	This information element identifies the valid remote source port. This may be included if remote source port filtering is included. (NOTE 1)
		Remote Source Port Range	C	This information element identifies a range of valid remote source ports. This may be included if remote source port filtering is included. (NOTE 1)
		Policing Required	O	This information element indicates that policing of the media flow is required.
		Peak Data Rate	O	This information element may be present if Policing is required and specifies the permissible peak data rate for a media stream. (NOTE 2).
		Sustainable Data Rate	O	This information element may be present if Policing is required and specifies the permissible sustainable data rate for a media stream. (NOTE 2).
		Delay Variation Tolerance	O	This information element may be present if Policing on Peak Data Rate is required and specifies the maximum expected delay variation tolerance for the corresponding media stream.
		Maximum Burst Size	C	This information element shall be present if Policing on Sustainable Data Rate is required and specifies the maximum expected burst size for the corresponding media stream.
		DiffServ Code Point	O	This information element indicates a specific DiffServ code point to be used in the IP header in packets sent on the bearer termination.
		DiffServ Tagging Behaviour	O	This information element indicates whether the Diffserv code point in the IP header in packets sent on the bearer termination should be copied from the received value or set to a specific value.
		Media Inactivity Detection Required	O	This information element indicates that detection of inactive media flows is required.
		Media Inactivity Detection Time	C	This information element may be present if Inactive Media Detection is required and specifies the Inactivity Detection time.
		Media Inactivity Detection Direction	C	This information element may be present if Inactive Media Detection is required and specifies the Inactivity Detection direction.
		RTCP handling	O	This information element is present if IMS-ALG wants explicitly control the reservation of RTCP resources by the IMS-AGW.

		Local cryptographic SDES attribute	C	This information element is present if IMS-ALG wants that the media is encrypted and/or integrity protected by the IMS-AGW (NOTE 4). It indicates the SDES local cryptographic parameters such as key(s).
		Remote cryptographic SDES attribute	C	This information element is present if IMS-ALG wants that the media is decrypted, and/or integrity checked by the IMS-AGW (NOTE 4). It indicates the SDES remote cryptographic parameters such as key(s).
		ECN Enable	O	This information element requests the IMS-AGW to apply ECN procedures.
		ECN Initiation Method	C	This information element specifies the ECN Initiation method and requests the IMS-AGW to perform IP header settings as an ECN endpoint, or indicates that ECN bits shall be passed transparently. It may be included only if ECN is enabled.
		Notify ECN Failure Event	C	This information element requests a notification if a ECN failure occurs due to ECN. It may only be supplied if ECN is enabled and the IMS-AGW acts as ECN endpoint.
Configure AGW Connection Point Ack	IMS-AGW	Context	M	This information element indicates the context where the command was executed.
		Bearer Termination	M	This information element indicates the bearer termination where the command was executed.
		Local IP Resources	O	This information element indicates the resource(s) for which the IMS-AGW shall be prepared to receive user data For terminations supporting any combination of video, audio and messaging this IE shall contain separate resources per stream.
		Remote IP Resources	O	This information element indicates the resource(s) for which the IMS-AGW shall send data. For terminations supporting any combination of video, audio and messaging this IE shall contain separate resources per stream.
		Local Connection Address	O	This information element indicates the IP address and port number(s) on the IMS-AGW that the IMS user can send user plane data to. For terminations supporting any combination of video, audio and messaging this may contain multiple addresses.
		Remote Connection Address	O	This information element indicates the remote IP address and port number(s) that the IMS-AGW can send user plane data to. For terminations supporting any combination of video, audio and messaging this may contain multiple addresses.

		Local cryptographic SDES attribute	C	This information element may be present only if it was contained in the request. It indicates the SDES local cryptographic parameters such as key(s)
		Remote cryptographic SDES attribute	C	This information element may be present only if it was contained in the request. It indicates the SDES remote cryptographic parameters such as key(s)
NOTE 1: Remote Source Port and Remote Source Port Range are mutually exclusive.				
NOTE 2: One of those IEs shall at least be present when policing is required.				
NOTE 3: Additional streams may be added by the Configure AGW Connection Point procedure. The additional streams shall then carry the same IP Realm Identifier as the very first Stream.				
NOTE 4: This IE may only be present for access network terminations.				

Editor's Note : The details of how the transparent indication included in ECN Control is subject of stage 3 specification. It also needs to be determined if this indication is needed on both incoming and outgoing terminations.

8.5 Release AGW Termination

This procedure is used to release a termination towards the IMS and free all related resources.

Table 8.5.1: Procedures between IMS-ALG and IMS-AGW: Release AGW Termination

Procedure	Initiated	Information element name	Information element required	Information element description
Release AGW Termination	IMS-ALG	Context	M	This information element indicates the existing context for the bearer termination.
		Bearer Termination	M	This information element indicates the bearer termination to be released.
Release AGW Termination Ack	IMS-AGW	Context	M	This information element indicates the context where the command was executed.
		Bearer Termination	M	This information element indicates the bearer termination where the command was executed.

8.6 Termination heartbeat indication

This procedure is used to report a termination heartbeat.

Table 8.6.1: Procedures between IMS-ALG and IMS-AGW: Termination heartbeat indication

Procedure	Initiated	Information element name	Information element required	Information element description
Termination heartbeat indication	IMS-AGW	Context	M	This information element indicates the context for the bearer termination.
		Bearer Termination	M	This information element indicates the bearer termination for which the termination heartbeat is reported.
		Termination heartbeat	M	Hanging Termination event, as defined in 3GPP TS 29.334 [3].
Termination heartbeat indication Ack	IMS-ALG	Context	M	This information element indicates the context where the command was executed.
		Bearer Termination	M	This information element indicates the bearer termination where the command was executed.

8.7 IMS-AGW Out-of-Service

This procedure is used to indicate that the IMS-AGW will go out of service or is maintenance locked.

Table 8.7.1: Procedures between IMS-ALG and IMS-AGW: IMS-AGW Out-of-Service

Procedure	Initiated	Information element name	Information element required	Information element description
IMS-AGW Out-of-Service	IMS-AGW	Context	M	This information element indicates the context for the command.
		Root Termination	M	This information element indicates the root termination for the command.
		Reason	M	This information element indicates the reason for service change.
		Method	M	This information element indicates the method for service change.
IMS-AGW Out-of-Service Ack	IMS-ALG	Context	M	This information element indicates the context where the command was executed.
		Root Termination	M	This information element indicates the root termination where the command was executed.

8.8 IMS-AGW Communication Up

This procedure is used to indicate that the IMS-AGW is back in service using an existing control association.

Table 8.8.1: Procedures between IMS-ALG and IMS-AGW: IMS-AGW Communication Up

Procedure	Initiated	Information element name	Information element required	Information element description
IMS-AGW Communication Up	IMS-AGW	Context	M	This information element indicates the context for the command.
		Root Termination	M	This information element indicates the root termination for the command.
		Reason	M	This information element indicates the reason for service change.
		Method	M	This information element indicates the method for service change.
IMS-AGW Communication Up Ack	IMS-ALG	Context	M	This information element indicates the context where the command was executed.
		Root Termination	M	This information element indicates the root termination where the command was executed.
		IMS-ALG Address	O	This information element indicates the IMS-ALG signalling address to which the IMS-AGW should preferably attempt to re-register.

8.9 IMS-AGW Restoration

This procedure is used to indicate the IMS-AGW has recovered from a failure.

Table 8.9.1: Procedures between IMS-ALG and IMS-AGW: IMS-AGW Restoration

Procedure	Initiated	Information element name	Information element required	Information element description
IMS-AGW Restoration	IMS-AGW	Context	M	This information element indicates the context for the command.
		Root Termination	M	This information element indicates the root termination for the command.
		Reason	M	This information element indicates the reason for the service change.
		Method	M	This information element indicates the method for service change.
IMS-AGW Restoration Ack	IMS-ALG	Context	M	This information element indicates the context where the command was executed.
		Root Termination	M	This information element indicates the root termination where the command was executed.
		IMS-ALG Address	O	This information element indicates the IMS-ALG signalling address to which the IMS-AGW should preferably attempt to re-register.

8.10 IMS-AGW Register

This procedure is used to register the IMS-AGW after a cold/warm boot.

Table 8.10.1: Procedures between IMS-ALG and IMS-AGW: IMS-AGW Register

Procedure	Initiated	Information element name	Information element required	Information element description
IMS-AGW Register	IMS-AGW	Context	M	This information element indicates the context for the command.
		Root Termination	M	This information element indicates the root termination for the command.
		Reason	M	This information element indicates the reason for the service change.
		Method	M	This information element indicates the method for service change.
		Protocol Version	M	This information element indicates the protocol version for Iq interface requested by the IMS-AGW.
		Service Change Profile	M	This information element indicates the profile for the Iq interface requested by the IMS-AGW.
IMS-AGW Register Ack	IMS-ALG	Context	M	This information element indicates the context where the command was executed.
		Root Termination	M	This information element indicates the root termination where the command was executed.
		Protocol Version	O	This information element indicates the protocol version for Iq interface supported by the IMS-ALG.
		Service Change Profile	O	This information element indicates the profile for the Iq interface supported by the IMS-ALG.
		IMS-ALG Address	O	This information element indicates the IMS-ALG signalling address to which the IMS-AGW should preferably attempt to re-register.

8.11 IMS-ALG Restoration

This procedure is used to indicate the IMS-ALG has recovered from a failure.

Table 8.11.1: Procedures between IMS-ALG and IMS-AGW: IMS-ALG Restoration

Procedure	Initiated	Information element name	Information element required	Information element description
IMS-ALG Restoration	IMS-ALG	Context	M	This information element indicates the context for the command.
		Root Termination	M	This information element indicates the root termination for the command.
		Reason	M	This information element indicates the reason for the service change.
		Method	M	This information element indicates the method for service change.
IMS-ALG Restoration Ack	IMS-AGW	Context	M	This information element indicates the context where the command was executed.
		Root Termination	M	This information element indicates the root termination where the command was executed.

8.12 IMS-AGW Re-register

This procedure is used to re-register the IMS-AGW (having been requested to do so by the IMS-ALG).

Table 8.12.1: Procedures between IMS-ALG and IMS-AGW: IMS-AGW Re-register

Procedure	Initiated	Information element name	Information element required	Information element description
IMS-AGW Re-register	IMS-AGW	Context	M	This information element indicates the context for the command.
		Root Termination	M	This information element indicates the root termination for the command.
		Reason	M	This information element indicates the reason for the service change.
		Method	M	This information element indicates the method for service change.
		Protocol Version	M	This information element indicates the protocol version for Iq interface requested by the IMS-AGW.
		Service Change Profile	M	This information element indicates the profile for the Iq interface requested by the IMS-AGW.
IMS-AGW Re-register Ack	IMS-ALG	Context	M	This information element indicates the context where the command was executed.
		Root Termination	M	This information element indicates the root termination where the command was executed.
		Protocol Version	O	This information element indicates the protocol version for Iq interface supported by the IMS-ALG.
		Service Change Profile	O	This information element indicates the profile for the Iq interface supported by the IMS-ALG.
		IMS-ALG Address	O	This information element indicates the IMS-ALG signalling address to which the IMS-AGW should preferably attempt to re-register.

8.13 IMS-ALG Ordered Re-registration

This procedure is used by the IMS-ALG to request the IMS-AGW to re-register.

Table 8.13.1: Procedures between IMS-ALG and IMS-AGW: IMS-ALG Ordered Re-register

Procedure	Initiated	Information element name	Information element required	Information element description
IMS-ALG Ordered Re-register	IMS-ALG	Context	M	This information element indicates the context for the command.
		Root Termination	M	This information element indicates the root termination for the command.
		Reason	M	This information element indicates the reason for the service change.
		IMS-ALG Address	O	This information element indicates the IMS-ALG signalling address.
IMS-ALG Ordered Re-register Ack	IMS-AGW	Context	M	This information element indicates the context where the command was executed.
		Root Termination	M	This information element indicates the root termination where the command was executed.

8.14 Audit Value

This procedure is used to audit values of different object(s).

Table 8.14.1: Procedures between IMS-ALG and IMS-AGW: Audit Value

Procedure	Initiated	Information element name	Information element required	Information element description
Audit Value	IMS-ALG	Context	M	This information element indicates the context for the command.
		Bearer Termination	M	This information element indicates the bearer termination(s) for the command.
		Object(s)	M	This information element indicates the object(s) to be audited.
Audit Value Ack	IMS-AGW	Context	M	This information element indicates the context where the command was executed.
		Bearer Termination	M	This information element indicates the bearer termination where the command was executed.
		Value(s)	M	This information element indicates the value(s) of the object(s).

8.15 Audit Capability

This procedure is used to audit capabilities of different object(s).

Table 8.15.1: Procedures between IMS-ALG and IMS-AGW: Audit Capability

Procedure	Initiated	Information element name	Information element required	Information element description
Audit Capability	IMS-ALG	Context	M	This information element indicates the context for the command.
		Bearer Termination	M	This information element indicates the bearer termination(s) for the command.
		Object(s)	M	This information element indicates the object(s) which capability is requested.
Audit Capability Ack	IMS-AGW	Context	M	This information element indicates the context where the command was executed.
		Bearer Termination	M	This information element indicates the bearer termination where the command was executed.
		Capabilities(s)	M	This information element indicates the capabilities of the object(s).

8.16 Capability Update

This procedure is used to indicate update of an object capability.

Table 8.16.1: Procedures between IMS-ALG and IMS-AGW: Capability Update

Procedure	Initiated	Information element name	Information element required	Information element description
Capability Update	IMS-AGW	Context	M	This information element indicates the context for the command.
		Bearer Termination	M	This information element indicates the bearer termination(s) for the command.
		Reason	M	This information element indicates the reason for service change.
		Method	M	This information element indicates the method for service change.
Capability Update Ack	IMS-ALG	Context	M	This information element indicates the context where the command was executed.
		Bearer Termination	M	This information element indicates the bearer termination where the command was executed.

8.17 IMS-ALG Out of Service

This procedure is used to indicate that IMS-ALG has gone out of service.

Table 8.17.1: Procedures between IMS-ALG and IMS-AGW: IMS-ALG Out of Service

Procedure	Initiated	Information element name	Information element required	Information element description
IMS-ALG Out of Service	IMS-ALG	Context	M	This information element indicates the context for the command.
		Root Termination	M	This information element indicates the root termination for the command.
		Reason	M	This information element indicates the reason for the service change.
		Method	M	This information element indicates the method for service change.
IMS-ALG Out of Service Ack	IMS-AGW	Context	M	This information element indicates the context where the command was executed.
		Root Termination	M	This information element indicates the root termination where the command was executed.

8.18 IMS-AGW Resource Congestion Handling - Activate

This procedure is used to activate the congestion handling mechanism.

Table 8.18.1: Procedures between IMS-ALG and IMS-AGW: IMS-AGW Resource Congestion Handling - Activate

Procedure	Initiated	Information element name	Information element required	Information element description
IMS-AGW Resource Congestion Handling – Activate	IMS-ALG	Context	M	This information element indicates that all context are applicable for the root termination.
		Root Termination	M	This information element indicates that root termination is where the congestion mechanism is activated.
		Congestion Activate	M	This information element requests to activate the congestion mechanism.
IMS-AGW Resource Congestion Handling - Activate Ack	IMS-AGW	Context	M	This information element indicates that all context are where the command was executed.
		Root Termination	M	This information element indicates that root termination is where the command was executed.

8.19 IMS-AGW Resource Congestion Handling - Indication

This procedure is used to inform the IMS-ALG that traffic restriction is advised.

Table 8.19.1: Procedures between IMS-ALG and IMS-AGW: IMS-AGW Resource Congestion Handling -Indication

Procedure	Initiated	Information element name	Information element required	Information element description
IMS-AGW Resource Congestion Handling - Indication	IMS-AGW	Context	M	This information element indicates all context are applicable for the root termination.
		Root Termination	M	This information element indicates that root termination is where the congestion mechanism was activated.
		Reduction	M	This information element indicates the load percentage to be reduced.
IMS-AGW Resource Congestion Handling - Indication Ack	IMS-ALG	Context	M	This information element indicates all context are where the command was executed.
		Root Termination	M	This information element indicates that root termination is where the command was executed.

8.20 Inactivity Timeout Activate

This procedure is used to activate the inactivity timeout mechanism.

Table 8.20.1: Procedures between IMS-ALG and IMS-AGW: Inactivity Timeout Activate

Procedure	Initiated	Information element name	Information element required	Information element description
Inactivity Timeout Activate	IMS-ALG	Context	M	This information element indicates all context are applicable for the root termination.
		Root Termination	M	This information element indicates that root termination is where inactivity timeout mechanism was activated.
		Inactivity Timeout Activate	M	This information element activates the Inactivity Timeout request.
		Inactivity Timeout	O	This information element indicates the maximum length of time before triggering the related notification.
Inactivity Timeout Activate Ack	IMS-AGW	Context	M	This information element indicates all context are where the command was executed.
		Root Termination	M	This information element indicates that root termination is where the command was executed.

8.21 Inactivity Timeout Notification

This command is used to notify the IMS-ALG of an inactive control association.

Table 8.21.1: Procedures between IMS-AGW and IMS-ALG: Inactivity Timeout Notification

Procedure	Initiated	Information element name	Information element required	Information element description
Inactivity Timeout Notification	IMS-AGW	Context	M	This information element indicates all context are applicable for the root termination.
		Root Termination	M	This information element indicates that root termination is where the inactivity timeout mechanism was activated.
		Inactivity Timeout Notification	M	This information element notifies the IMS-ALG of an inactivity time period.
Inactivity Timeout Notification Ack	IMS-ALG	Context	M	This information element indicates all context are where the command was executed.
		Root Termination	M	This information element indicates that root termination is where the command was executed.

8.22 Command Reject

This command is used to reject the received command request. It may be used as response to any of the procedures.

Table 8.22.1: Procedures between IMS-ALG and IMS-AGW: Command Reject

Procedure	Initiated	Information element name	Information element required	Information element description
Command Reject	Both	Context	O	This information element indicates the context where the command was rejected.
		Bearer Termination	O	This information element indicates the bearer termination where the command was rejected.
		Error	M	This information element indicates the error that caused command rejection.

8.23 Realm Availability Activate

This command is used to request the IMS-AGW to monitor the status of its IP Realms and to report any changes to the IMS-ALG.

Table 8.23.1: Procedures between IMS-ALG and IMS-AGW: Realm Availability Activate

Procedure	Initiated	Information element name	Information element required	Information element description
Realm Availability Activate	IMS-ALG	Context	M	This information element indicates all context are applicable for the root termination.
		Root Termination	M	This information element indicates that root termination is where the realm availability monitoring was activated.
		Realm Availability Activate	M	This information element activates the monitoring of the availability of IP Realms on the IMS-AGW.
Realm Availability Activate Ack	IMS-AGW	Context	M	This information element indicates all context are where the command was executed.
		Root Termination	M	This information element indicates that root termination is where the command was executed.

8.24 Realm Availability Notification

This command is used to notify the IMS-ALG of any changes in the availability of IP Realms on the IMS-AGW.

Table 8.24.1: Procedures between IMS-ALG and IMS-AGW: Realm Availability Notification

Procedure	Initiated	Information element name	Information element required	Information element description
Realm Availability Notification	IMS-AGW	Context	M	This information element indicates all context are applicable for the root termination.
		Root Termination	M	This information element indicates that root termination is where the realm availability monitoring was activated.
		Realm Availability Changes	M	This information element notifies the IMS-ALG of newly available/unavailable IP Realms.
Realm Availability Notification Ack	IMS-ALG	Context	M	This information element indicates all context are where the command was executed.
		Root Termination	M	This information element indicates that root termination is where the command was executed.

8.25 IP Bearer Released

Table 8.25.1: Procedures between IMS-ALG and IMS-AGW: IP Bearer Released

Procedure	Initiated	Information element name	Information element required	Information element description
IP Bearer Released	IMS-AGW	Context	M	This information element indicates the context for the bearer termination.
		Bearer Termination	M	This information element indicates the bearer termination where the bearer was released.
		Bearer Released	M	This information element notifies a bearer release.
		Release Cause	M	This information element indicates the cause of a bearer release.
IP Bearer Released Ack	IMS-ALG	Context	M	This information element indicates all context are where the command was executed.
		Bearer Termination	M	This information element indicates that Bearer termination is where the command was executed.

8.26 Media Inactivity Notification

This command is used to notify the IMS-ALG of media inactivity on the IMS-AGW.

Table 8.26.1: Procedures between IMS-ALG and IMS-AGW: Media Inactivity Notification

Procedure	Initiated	Information element name	Information element required	Information element description
Media Inactivity Notification	IMS-AGW	Context	M	This information element indicates the existing context for the bearer termination.
		Bearer Termination	M	This information element indicates that bearer termination is where the media inactivity detection was activated.
		Media Inactivity	M	This information element notifies the IMS-ALG of Media inactivity detection on the bearer termination.
Media Inactivity Notification Ack	IMS-ALG	Context	M	This information element indicates the context where the command was executed.
		Bearer Termination	M	This information element indicates the bearer termination where the command was executed.

8.27 Termination Out-of-Service

This procedure is used to indicate that a termination on the IMS-AGW has gone out of service

Table 8.27.1: Procedures between IMS-ALG and IMS-AGW: Termination Out-of-Service

Procedure	Initiated	Information element name	Information element required	Information element description
Termination Out-of-Service	IMS-AGW	Context	M	This information element indicates the context for the command.
		Bearer Termination	M	This information element indicates the bearer termination(s) for the command.
		Reason	M	This information element indicates the reason for service change.
		Method	M	This information element indicates the method for service change.
Termination Out-of-Service Ack	IMS-ALG	Context	M	This information element indicates the context where the command was executed.
		Bearer Termination	M	This information element indicates the bearer termination(s) where the command was executed.

8.28 Change Through-Connection

This procedure is used to change the through-connection in the bearer termination

Table 8.28.1: Procedures between IMS-ALG and IMS-AGW: Change Through-Connection

Procedure	Initiated	Information element name	Information element required	Information element description
Change Through-Connection	IMS-ALG	Context/Context Request	M	This information element indicates the existing context or requests a new context for the bearer termination.
		Bearer Termination/Bearer Termination Request	M	This information element indicates the existing bearer termination or requests a new bearer termination where the through-connection is changed.
		Through-Connection	M	This information element indicates the through-connection of the bearer termination
Change Through-Connection Ack	IMS-AGW	Context	M	This information element indicates the context where the command was executed.
		Bearer Termination	M	This information element indicates the bearer termination where the command was executed.

NOTE: This procedure may be combined with Reserve and Configure AGW Connection Point, Reserve AGW Connection Point or Configure AGW Connection Point procedure. This list of procedures is not exhaustive.

8.29 Change Flow Direction

This procedure is used to change the flow direction between bearer terminations within the context.

Table 8.29: Procedures between IMS-ALG and IMS-AGW: Configure AGW Connection Point

Procedure	Initiated	Information element name	Information element required	Information element description
Change Flow Direction	IMS-ALG	Context/Context Request	M	This information element indicates the existing context or a new context where the flow direction is changed.
		Bearer Termination 1/ Bearer Termination 1 Request	M	This information element indicates the existing bearer termination or a new bearer termination from where the new flow direction is applied.
		Bearer Termination 2/ Bearer Termination 2 Request	M	This information element indicates the existing bearer termination or a new bearer termination where to the new flow direction is applied.
		Flow Direction	M	This information element indicates the flow direction from the bearer termination 1 to bearer termination 2 within the context.
Change Flow Direction Ack	IMS-AGW	Context	M	This information element indicates the context where the command was executed.

8.30 ECN Failure Indication

This procedure is used to report ECN related failures (see clause 6.2.13.4).

Table 8.30.1: Procedures between IMS-ALG and IMS-AGW: ECN Failure Indication

Procedure	Initiated	Information element name	Information element required	Information element description
ECN Failure Indication	IMS-AGW	Context	M	This information element indicates the context for the bearer termination.
		Bearer Termination	M	This information element indicates the bearer termination for which the ECN failure is reported.
		ECN Error Indication	M	This information element indicates an ECN failure event.
ECN Failure Indication Ack	IMS-ALG	Context	M	This information element indicates the context where the command was executed.

Annex A (informative): Change history

Change history							
Date	TSG #	TSG Doc.	CR	Rev	Subject/Comment	Old	New
2009-12	CT#46	CP-090822			3GPP TS Presented for approval in CT#46	2.0.0	9.0.0
2009-12					Editorial clean up	9.0.0	9.0.1
2010-03	CT#47	CP-100050	0001	2	IMS media plane security stage 2	9.0.1	9.1.0
2010-06	CT#48	CP-100289	0003	1	Transport protocol to be indicated to gateway for end-to-end media security	9.1.0	9.2.0
		CP-100284	0004	1	Handling of Through Connection		
			0005	-	Handling of RTCP streams requirement update		
2010-09	CT#49	CP-100461	0006	1	Procedures for Emergency call	9.2.0	9.3.0
			0007	1	Local IP Resources IE: changing of property		
2010-12	CT#50	CP-100685	0008	-	Support of ECN	9.3.0	10.0.0
2011-03	CT#51	CP-110058	0009	2	Handling of ICE Initialisation method for ECN	10.0.0	10.1.0
			0010	2	ECN Support in Iq Interface		
2011-09	CT#53	CP-110573	0011	2	Transcoding at ATCF/ATGW during eSRVCC	10.1.0	10.2.0
2011-12	CT#54	CP-110798	0012	1	Explicit Congestion Notification	10.2.0	10.3.0
		CP-110798	0013	1	Corrections to Stage 2 Procedures for Access Transfer Function		
2012-06	CT#56	CP-120226	0017	1	Reference update: draft-ietf-avtcore-ecn-for-rtp	10.3.0	10.4.0
2012-12	CT#58	CP-120723	0024	-	Reference update: RFC 6679	10.4.0	10.5.0

History

Document history		
V10.1.0	April 2011	Publication
V10.2.0	October 2011	Publication
V10.3.0	January 2012	Publication
V10.4.0	July 2012	Publication
V10.5.0	January 2013	Publication