

ETSI TS 124 244 V12.1.0 (2015-01)



**Universal Mobile Telecommunications System (UMTS);
LTE;
Wireless LAN control plane protocol
for trusted WLAN access to EPC;
Stage 3
(3GPP TS 24.244 version 12.1.0 Release 12)**



Reference

RTS/TSGC-0124244vc10

Keywords

LTE,UMTS

ETSI

650 Route des Lucioles
F-06921 Sophia Antipolis Cedex - FRANCE

Tel.: +33 4 92 94 42 00 Fax: +33 4 93 65 47 16

Siret N° 348 623 562 00017 - NAF 742 C
Association à but non lucratif enregistrée à la
Sous-Préfecture de Grasse (06) N° 7803/88

Important notice

The present document can be downloaded from:

<http://www.etsi.org>

The present document may be made available in electronic versions and/or in print. The content of any electronic and/or print versions of the present document shall not be modified without the prior written authorization of ETSI. In case of any existing or perceived difference in contents between such versions and/or in print, the only prevailing document is the print of the Portable Document Format (PDF) version kept on a specific network drive within ETSI Secretariat.

Users of the present document should be aware that the document may be subject to revision or change of status. Information on the current status of this and other ETSI documents is available at

<http://portal.etsi.org/tb/status/status.asp>

If you find errors in the present document, please send your comment to one of the following services:

http://portal.etsi.org/chaicor/ETSI_support.asp

Copyright Notification

No part may be reproduced or utilized in any form or by any means, electronic or mechanical, including photocopying and microfilm except as authorized by written permission of ETSI.

The content of the PDF version shall not be modified without the written authorization of ETSI.

The copyright and the foregoing restriction extend to reproduction in all media.

© European Telecommunications Standards Institute 2015.

All rights reserved.

DECT™, **PLUGTESTS™**, **UMTS™** and the ETSI logo are Trade Marks of ETSI registered for the benefit of its Members. **3GPP™** and **LTE™** are Trade Marks of ETSI registered for the benefit of its Members and of the 3GPP Organizational Partners.

GSM® and the GSM logo are Trade Marks registered and owned by the GSM Association.

Intellectual Property Rights

IPRs essential or potentially essential to the present document may have been declared to ETSI. The information pertaining to these essential IPRs, if any, is publicly available for **ETSI members and non-members**, and can be found in ETSI SR 000 314: *"Intellectual Property Rights (IPRs); Essential, or potentially Essential, IPRs notified to ETSI in respect of ETSI standards"*, which is available from the ETSI Secretariat. Latest updates are available on the ETSI Web server (<http://ipr.etsi.org>).

Pursuant to the ETSI IPR Policy, no investigation, including IPR searches, has been carried out by ETSI. No guarantee can be given as to the existence of other IPRs not referenced in ETSI SR 000 314 (or the updates on the ETSI Web server) which are, or may be, or may become, essential to the present document.

Foreword

This Technical Specification (TS) has been produced by ETSI 3rd Generation Partnership Project (3GPP).

The present document may refer to technical specifications or reports using their 3GPP identities, UMTS identities or GSM identities. These should be interpreted as being references to the corresponding ETSI deliverables.

The cross reference between GSM, UMTS, 3GPP and ETSI identities can be found under <http://webapp.etsi.org/key/queryform.asp>.

Modal verbs terminology

In the present document "**shall**", "**shall not**", "**should**", "**should not**", "**may**", "**may not**", "**need**", "**need not**", "**will**", "**will not**", "**can**" and "**cannot**" are to be interpreted as described in clause 3.2 of the [ETSI Drafting Rules](#) (Verbal forms for the expression of provisions).

"**must**" and "**must not**" are **NOT** allowed in ETSI deliverables except when used in direct citation.

Contents

Intellectual Property Rights	2
Foreword.....	2
Modal verbs terminology.....	2
Foreword.....	6
1 Scope	7
2 References	7
3 Definitions and abbreviations.....	7
3.1 Definitions	7
3.2 Abbreviations	8
4 General	8
4.1 Overview	8
4.2 Protocol stack	8
4.2.1 General.....	8
4.2.2 UDP port numbers for WLCP.....	9
4.2.2.1 General	9
4.2.2.2 UE procedure	9
4.2.2.3 TWAG procedure.....	9
4.2.3 IP addresses of WLCP message.....	9
4.2.3.1 General	9
4.2.3.2 UE procedure	9
4.2.3.3 TWAG procedure.....	10
4.2.4 DTLS usage	10
4.3 WLCP layer states	10
4.3.1 General	10
4.3.2 WLCP layer states in the UE	10
4.3.2.1 PDN CONNECTIVITY NOT ESTABLISHED	10
4.3.2.2 PDN CONNECTIVITY ESTABLISHED	10
4.3.2.3 PROCEDURE TRANSACTION INACTIVE	11
4.3.2.4 PROCEDURE TRANSACTION PENDING	11
4.3.3 WLCP layer states in the TWAG.....	11
4.3.3.1 PDN CONNECTIVITY NOT ESTABLISHED	11
4.3.3.2 PDN CONNECTIVITY PENDING.....	11
4.3.3.3 PDN CONNECTIVITY ESTABLISHED	11
4.3.3.4 PDN DISCONNECT PENDING	11
4.3.3.5 PROCEDURE TRANSACTION INACTIVE	12
4.3.3.6 PROCEDURE TRANSACTION PENDING	12
4.4 IP address allocation.....	12
5 Wireless LAN control plane protocol Procedures.....	13
5.1 General	13
5.1.1 Overview	13
5.1.2 Services provided by lower layers	13
5.1.3 Principles of address handling for WLCP procedures	13
5.1.4 Abnormal cases in the UE	13
5.1.5 Abnormal cases in the TWAG.....	13
5.1.6 Handling of APN based congestion control.....	14
5.2 PDN connectivity establishment procedure	14
5.2.1 General.....	14
5.2.2 PDN connectivity establishment procedure initiation.....	14
5.2.3 PDN connectivity establishment procedure accepted by the TWAG	15
5.2.3.1 PDN connectivity establishment accepted by the UE	16
5.2.3.2 PDN connectivity establishment not accepted by the UE	16
5.2.4 PDN connectivity procedure not accepted by the TWAG	16

5.2.5	Abnormal cases in the UE	17
5.2.6	Abnormal cases on the network side	18
5.3	TWAG initiated PDN disconnection procedure	18
5.3.1	General.....	18
5.3.2	Procedure description	18
5.3.3	Abnormal cases in the UE	19
5.3.4	Abnormal cases in the TWAG.....	19
5.4	UE requested PDN disconnection procedure	19
5.4.1	General.....	19
5.4.2	Procedure description	20
5.4.3	Abnormal cases in the UE	20
5.4.4	Abnormal cases in the TWAG.....	20
5.5	STATUS message	21
6	Handling of unknown, unforeseen, and erroneous protocol data	21
6.1	General	21
6.2	Message too short.....	22
6.3	Unknown or unforeseen procedure transaction identity or PDN connection ID	22
6.3.1	Procedure transaction identity.....	22
6.3.2	PDN connection ID.....	22
6.4	Unknown or unforeseen message type	23
6.5	Non-semantic mandatory information element errors	23
6.5.1	Common procedures	23
6.5.2	PDN connection management.....	24
6.6	Unknown and unforeseen IEs in the non-imperative message part.....	24
6.6.1	IEs unknown in the message	24
6.6.2	Out of sequence IEs	24
6.6.3	Repeated IEs	24
6.7	Non-imperative message part errors.....	24
6.7.1	General.....	24
6.7.2	Syntactically incorrect optional IEs	25
6.7.3	Conditional IE errors	25
6.8	Messages with semantically incorrect contents.....	25
7	Message functional definitions and contents.....	25
7.1	PDN connectivity request.....	25
7.1.1	Message definition.....	25
7.1.2	Access point name	26
7.1.3	Protocol configuration options.....	26
7.2	PDN connectivity accept.....	26
7.2.1	Message definition.....	26
7.2.2	Protocol configuration options.....	26
7.2.3	Cause	26
7.3	PDN connectivity reject	26
7.3.1	Message definition.....	26
7.3.2	Protocol configuration options.....	27
7.3.3	Tw1 value	27
7.4	PDN disconnect request	27
7.4.1	Message definition.....	27
7.4.2	Protocol configuration options.....	27
7.5	PDN disconnect accept.....	28
7.5.1	Message definition.....	28
7.5.2	Protocol configuration options.....	28
7.6	PDN disconnect reject	28
7.6.1	Message definition.....	28
7.6.2	Protocol configuration options.....	28
7.7	PDN connectivity complete.....	29
7.7.1	Message definition.....	29
7.8	Status message.....	29
7.8.1	Message definition.....	29
8	General message format and information elements coding.....	29
8.1	General	29

8.2	Message type	30
8.3	Procedure transaction identity	30
8.4	Request type	31
8.5	PDN type	31
8.6	Access point name	31
8.7	Protocol configuration options	31
8.8	PDN address	31
8.9	PDN connection ID	31
8.10	User plane connection ID	32
8.11	Cause	32
8.12	GPRS timer 3	32
9	List of system parameters	33
9.1	Timers	33
Annex A (Informative):	IANA UDP port registration form	34
Annex B (informative):	Change history	36
History		37

Foreword

This Technical Specification has been produced by the 3rd Generation Partnership Project (3GPP).

The contents of the present document are subject to continuing work within the TSG and may change following formal TSG approval. Should the TSG modify the contents of the present document, it will be re-released by the TSG with an identifying change of release date and an increase in version number as follows:

Version x.y.z

where:

- x the first digit:
 - 1 presented to TSG for information;
 - 2 presented to TSG for approval;
 - 3 or greater indicates TSG approved document under change control.
- y the second digit is incremented for all changes of substance, i.e. technical enhancements, corrections, updates, etc.
- z the third digit is incremented when editorial only changes have been incorporated in the document.

1 Scope

The present document specifies the procedures of the Wireless LAN control plane protocol (WLCP) for trusted WLAN access to EPC which is used between User Equipment (UE) and Trusted WLAN Access Gateway (TWAG) for multi-connection mode as specified in 3GPP TS 23.402 [2].

This document also defines the message format, information elements coding, error handling and system parameters applied by the WLCP protocol.

2 References

The following documents contain provisions which, through reference in this text, constitute provisions of the present document.

- References are either specific (identified by date of publication, edition number, version number, etc.) or non-specific.
- For a specific reference, subsequent revisions do not apply.
- For a non-specific reference, the latest version applies. In the case of a reference to a 3GPP document (including a GSM document), a non-specific reference implicitly refers to the latest version of that document *in the same Release as the present document*.

- [1] 3GPP TR 21.905: "Vocabulary for 3GPP Specifications".
- [2] 3GPP TS 23.402: "Architecture Enhancements for non-3GPP accesses".
- [3] 3GPP TS 24.302: "Access to the 3GPP Evolved Packet Core (EPC) via non-3GPP access networks; Stage 3".
- [4] 3GPP TS 24.008: "Mobile radio interface Layer 3 specification; Core network protocols; Stage 3".
- [5] 3GPP TS 24.301: "Non-Access-Stratum (NAS) protocol for Evolved Packet System (EPS); Stage 3".
- [6] IEEE Std 802-2014: "IEEE Standard for Local and Metropolitan Area Networks: Overview and Architecture", 30th June 2014.
- [7] 3GPP TS 24.007: "Mobile radio interface signalling layer 3; General aspects".
- [8] IETF RFC 768: "User Datagram Protocol"
- [9] 3GPP TS 33.402: "3GPP System Architecture Evolution (SAE); Security aspects of non-3GPP accesses".

3 Definitions and abbreviations

3.1 Definitions

For the purposes of the present document, the terms and definitions given in 3GPP TR 21.905 [1] and the following apply. A term defined in the present document takes precedence over the definition of the same term, if any, in 3GPP TR 21.905 [1].

3.2 Abbreviations

For the purposes of the present document, the abbreviations given in 3GPP TR 21.905 [1] and the following apply. An abbreviation defined in the present document takes precedence over the definition of the same abbreviation, if any, in 3GPP TR 21.905 [1].

APN	Access Point Name
DTLS	Datagram Transport Layer Security
EAP	Extensible Authentication Protocol
EPC	Evolved Packet Core Network
ID	Identifier
IE	Information Element
IEI	Information Element Identifier
LSB	Least Significant Bit
MAC	Media Access Control
MSB	Most Significant Bit
PCO	Protocol Configuration Options
PDN	Packet Data Network
PDN GW	Packet Data Network Gateway
PTI	Procedure Transaction Identity
TWAG	Trusted WLAN Access Gateway
UE	User Equipment
WLAN	Wireless Local Area Network
WLCP	Wireless LAN control plane protocol

4 General

4.1 Overview

WLCP is used between user equipment (UE) and trusted wLAN access gateway (TWAG) for multi-connection mode as specified in 3GPP TS 23.402 [2].

The WLCP comprises procedures for:

- establishment of PDN connections including initial request and handover from a 3GPP access;
- requesting the release of a PDN connection by the UE or notifying the UE of the release of a PDN connection;
- transport of parameters related to PDN connections, such as APN, PDN type, PCO, handover indication, user-plane MAC address of the TWAG etc.; and
- IP address allocation.

Generally, WLCP procedures described in the clause 5 can be performed only after the UE has successfully completed the following steps:

- Authentication and negotiation of the multi-connection mode for the trusted WLAN access as specified in 3GPP TS 24.302 [3]; and
- Establishment of a DTLS connection with the TWAG, according to subclause 4.2.4.

4.2 Protocol stack

4.2.1 General

The protocol stack of WLCP is shown in figure 4.2.1.

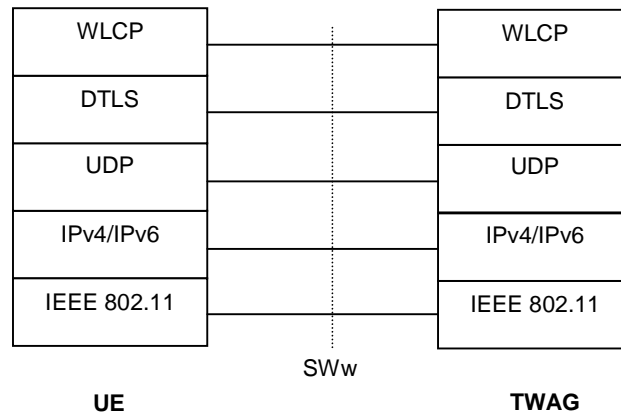

Figure 4.2.1: Protocol stack of WLCP

4.2.2 UDP port numbers for WLCP

4.2.2.1 General

The WLCP messages are transported over UDP layer as specified in IETF RFC 768 [8]. The security is provided by the DTLS layer.

The WLCP UDP Port number is xxxx.

Editor's note: The value of the WLCP UDP port number xxxx is not yet known, and is pending to the IANA 'Expert Review' procedure.

4.2.2.2 UE procedure

The UE shall use the WLCP UDP port number as the source UDP port and the destination UDP port of WLCP messages.

4.2.2.3 TWAG procedure

The TWAG shall use the WLCP UDP port number as the source UDP port and the destination UDP port of WLCP messages.

4.2.3 IP addresses of WLCP message

4.2.3.1 General

The WLCP/DTLS/UDP packet shall be carried via IPv6 with link local addressing scope or IPv4 as specified in 3GPP TS 23.402 [2].

4.2.3.2 UE procedure

The UE receives one or two TWAG control plane addresses during the EAP authentication and authorization procedure specified in 3GPP TS 23.402 [2].

NOTE: If two TWAG control plane addresses are received, one includes IPv4 address and other includes IPv6 address.

If the UE receives one TWAG control plane address, the UE shall select the TWAG control plane address. If the UE receives two TWAG control plane addresses, the UE shall select one of the TWAG control plane addresses.

The UE shall use IP address of the selected TWAG control plane address as the destination IP address of WLCP message.

The UE shall apply the following procedures to set the source IP address of the WLCP message:

- if the TWAG IP address for WLCP is an IPv4 address and if the UE supports IPv4, the UE shall obtain an IPv4 address via DHCPv4 to be used as the source IP address for WLCP;
- if the TWAG IP address for WLCP is an IPv6 link local address and if the UE supports IPv6, the UE shall use the IPv6 link local address configured on the WLAN interface as the source IP address for WLCP; and
- if the TWAG IP addresses for WLCP are an IPv4 address and an IPv6 link local address, which IP version the UE selects is implementation dependent.

4.2.3.3 TWAG procedure

When the UE initiates a WLCP procedure:

- the TWAG shall use a TWAG control plane address which was included in TWAG_CP_ADDRESS item provided to the UE during EAP-AKA' authentication as described in 3GPP TS 24.302 [3], as the source IP address for WLCP. If two TWAG control plane addresses were included in TWAG_CP_ADDRESS item provided to the UE during EAP-AKA' authentication as described in 3GPP TS 24.302 [3], the TWAG shall use the TWAG control plane address of the same IP version as the IP version received from the UE in the WLCP message; and
- the TWAG shall use the source IP address received from the UE in the WLCP message as the destination IP address for further WLCP message to the UE.

When the TWAG initiates a WLCP procedure:

- the TWAG shall use a TWAG control plane address which was included in TWAG_CP_ADDRESS item provided to the UE during EAP-AKA' authentication as described in 3GPP TS 24.302 [3], as the source IP address for WLCP. If two TWAG control plane addresses were included in TWAG_CP_ADDRESS item provided to the UE during EAP-AKA' authentication as described in 3GPP TS 24.302 [3], the TWAG shall use the TWAG control plane address of the same IP version as the IP version received from the UE in the WLCP message; and
- the TWAG shall use the source IP address received from the UE in the earlier WLCP message as the destination IP address for further WLCP message to the UE.

4.2.4 DTLS usage

The UE and the TWAG shall use DTLS according to 3GPP TS 33.402 [9].

4.3 WLCP layer states

4.3.1 General

In this subclause the possible states of WLCP state machine in the UE and in the TWAG are described. Each PDN connection to EPC is associated with an individual state machine.

4.3.2 WLCP layer states in the UE

4.3.2.1 PDN CONNECTIVITY NOT ESTABLISHED

No PDN connectivity to EPC exists over TWAN (see figure 4.3.2.2.1).

4.3.2.2 PDN CONNECTIVITY ESTABLISHED

The PDN connectivity to EPC is established in the UE (see figure 4.3.2.2.1).

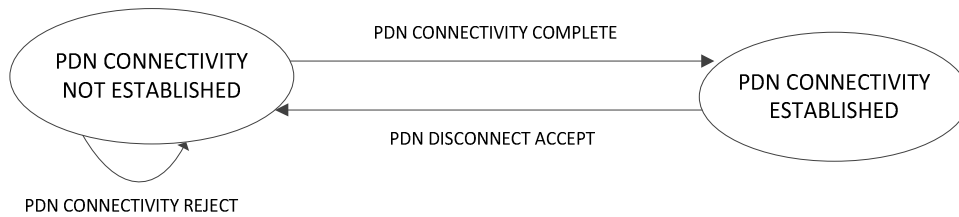

Figure 4.3.2.2.1: The WLCP state machine in the UE (overview)

4.3.2.3 PROCEDURE TRANSACTION INACTIVE

No procedure transaction exists (see figure 4.3.2.4.1).

4.3.2.4 PROCEDURE TRANSACTION PENDING

The UE has initiated a procedure transaction towards the TWAG (see figure 4.3.2.4.1).

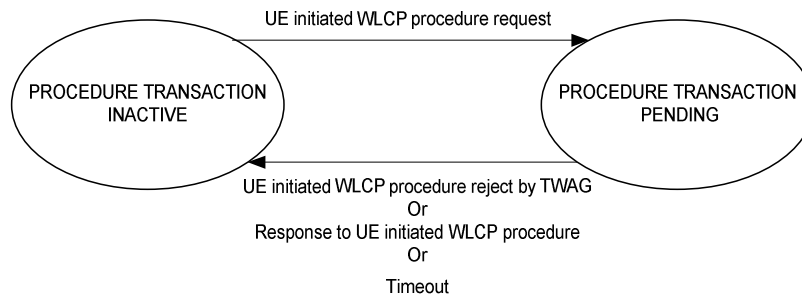

Figure 4.3.2.4.1: The procedure transaction states in the UE (overview)

4.3.3 WLCP layer states in the TWAG

4.3.3.1 PDN CONNECTIVITY NOT ESTABLISHED

No PDN connectivity to EPC exists for the UE (see figure 4.3.3.4.1).

4.3.3.2 PDN CONNECTIVITY PENDING

The TWAG has sent PDN connectivity accept towards the UE (see figure 4.3.3.4.1).

4.3.3.3 PDN CONNECTIVITY ESTABLISHED

The PDN connectivity is established in the TWAG (see figure 4.3.3.4.1).

4.3.3.4 PDN DISCONNECT PENDING

The TWAG has initiated a PDN disconnect towards the UE (see figure 4.3.3.4.1).

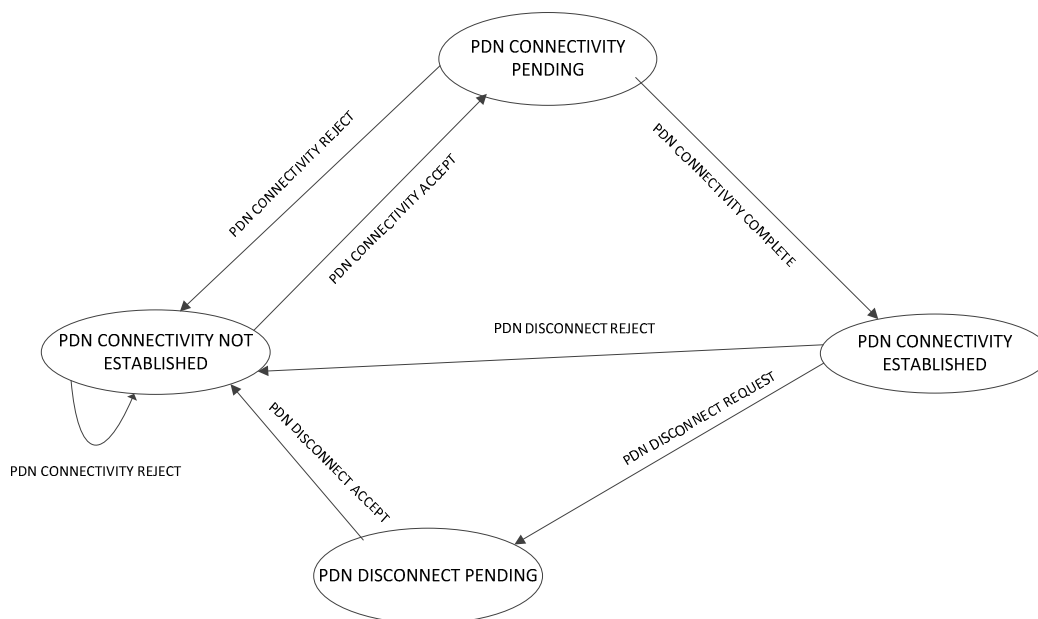

Figure 4.3.3.4.1: The WLCP states for PDN connectivity handling in the TWAG (overview)

4.3.3.5 PROCEDURE TRANSACTION INACTIVE

No procedure transaction exists.

4.3.3.6 PROCEDURE TRANSACTION PENDING

The TWAG has initiated a procedure transaction towards the UE (see figure 4.3.3.6.1).

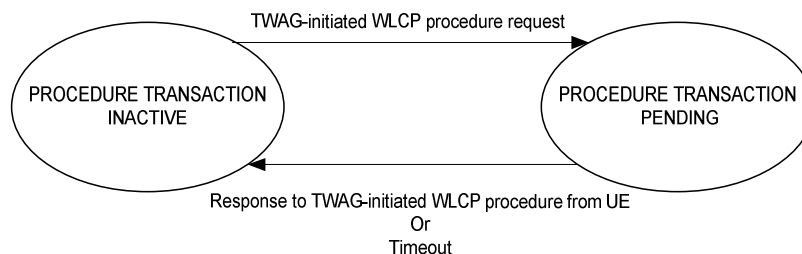

Figure 4.3.3.6.1: The procedure transaction states in the TWAG (overview)

4.4 IP address allocation

WLCP provides the following functionalities related to IP address allocation for multi-connection mode:

- requesting PDN type by the UE;
- allocating IPv4 address to the UE; and
- allocating IPv6 interface identifier to the UE.

IPv6 network prefix is assigned via stateless address autoconfiguration method as specified in 3GPP TS 23.402 [2].

Deferred IPv4 address allocation is not supported in the current release of this specification.

5 Wireless LAN control plane protocol Procedures

5.1 General

5.1.1 Overview

This clause describes principles and procedures used for Wireless LAN control plane protocol for PDN connectivity handling in the UE and in the TWAG.

Re-transmission of WLCP messages for ensuring reliability of WLCP procedures is supervised by timers.

NOTE: This document is not supposed to be used to support emergency calls. The protocol specified in the document only does not preclude making emergency calls using IMS over implementations conforming to this document.

5.1.2 Services provided by lower layers

Unless explicitly stated otherwise, WLCP procedures can be performed only if the UE has been authenticated and has successfully negotiated the multi-connection mode for trusted WLAN access as specified in 3GPP TS 24.302 [3].

5.1.3 Principles of address handling for WLCP procedures

WLCP procedures use the PTI as address parameter in the WLCP message header. When the UE or the TWAG initiates a WLCP procedure, it shall include a valid PTI value in the message header (see subclause 8.3).

In the response message, the sending entity shall include the PTI value received with the request message.

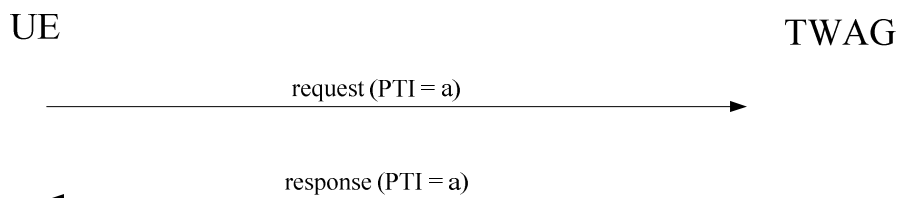

Figure 5.1.3.1: Procedure initiated by the UE

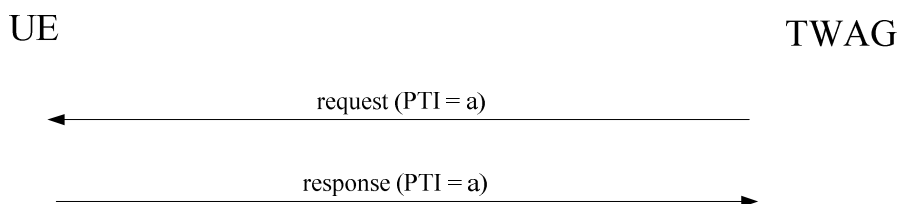

Figure 5.1.3.2: Procedure initiated by the TWAG

5.1.4 Abnormal cases in the UE

No abnormal cases have been identified.

5.1.5 Abnormal cases in the TWAG

The following abnormal cases can be identified:

- a) Failure of EAP-AKA' re-authentication:

When the TWAG receives a failure indication of the re-authentication procedure, the TWAG shall initiate TWAG-initiated PDN disconnection procedure.

5.1.6 Handling of APN based congestion control

As specified in subclause 5.2.4, TWAG can reject PDN connection request for an APN from a UE and provide the backoff timer value to the UE.

5.2 PDN connectivity establishment procedure

5.2.1 General

The purpose of the PDN connectivity establishment procedure is to establish PDN connectivity between the UE and the EPC. The procedure is used either to establish the first PDN connection or to establish subsequent PDN connections. The procedure can be initiated only after successful EAP authentication and authorization has been completed and multi-connection mode of operation has been negotiated, as specified in 3GPP TS 24.302 [3].

The UE and the TWAG may include a Protocol configuration options IE in PDN connectivity establishment procedure if they wish to exchange (protocol) data (e.g. configuration parameters, error codes or messages/events).

5.2.2 PDN connectivity establishment procedure initiation

The UE requests PDN connectivity establishment by sending a PDN CONNECTIVITY REQUEST message to the TWAG.

In order to request connectivity to a PDN using the default APN, the UE includes the Access point name IE in the PDN CONNECTIVITY REQUEST message according to the following conditions:

- if use of a PDN using the default APN requires PAP/CHAP, then the UE should include the Access point name IE; and
- in all other conditions, the UE need not include the Access point name IE.

In order to request connectivity to a non-default APN or to an additional PDN, the UE shall send a PDN CONNECTIVITY REQUEST message to the TWAG including the requested APN.

After sending the PDN CONNECTIVITY REQUEST message the UE shall start timer T3582 and enter the state PROCEDURE TRANSACTION PENDING (see example in figure 5.2.2.1).

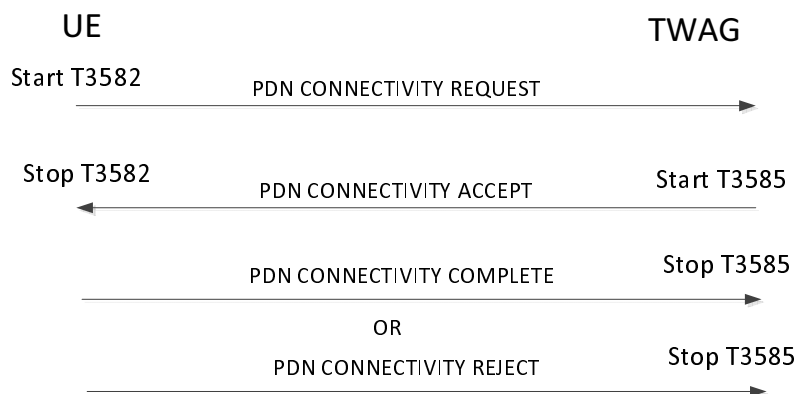

Figure 5.2.2.1: PDN connectivity establishment procedure

The UE shall set the PDN type IE in the PDN CONNECTIVITY REQUEST message to IPv4 if:

- the UE is only IPv4 capable; or

- the UE is both IPv4 and IPv6 capable, has been allocated an IPv6 address for this APN and received the ESM cause #52 "single address bearers only allowed".

The UE shall set the PDN type IE in the PDN CONNECTIVITY REQUEST message to IPv6 if:

- the UE is only IPv6 capable; or
- the UE is both IPv4 and IPv6 capable, has been allocated an IPv4 address for this APN and received the ESM cause #52 "single address bearers only allowed".

The UE shall set the PDN type IE in the PDN CONNECTIVITY REQUEST message to IPv4v6 if:

- the UE is both IPv4 and IPv6 capable and has not been allocated an IP address for this APN; or
- the UE capability is unknown in the UE (as in the case when the MT and TE are separated and the capability of the TE is not known in the MT).

The UE shall set the request type to "initial request" when the UE is establishing a new PDN connectivity. The UE shall set the request type to "handover" when the connectivity to a PDN is established upon handover from a 3GPP access network and the UE was connected to that PDN before the handover to the trusted WLAN access network.

5.2.3 PDN connectivity establishment procedure accepted by the TWAG

Upon receipt of the PDN CONNECTIVITY REQUEST message, the TWAG checks if connectivity with the requested PDN can be established. If no requested APN is included in the PDN CONNECTIVITY REQUEST message the TWAG shall use the default APN as the requested APN.

If the requested PDN connection can be established, the TWAG shall send a PDN CONNECTIVITY ACCEPT message towards the UE. The TWAG shall retrieve the PTI from the PDN CONNECTIVITY REQUEST message and include it in the PDN CONNECTIVITY ACCEPT message. Both the network identifier part and the operator identifier part shall be included in the Access Point Name IE. Additionally, the TWAG shall include:

- PDN connection ID to identify the PDN connection between the UE and the TWAG; and
- MAC address of the TWAG to the UE. This MAC address is used by the UE and the TWAG to send the user plane packets for this PDN connection.

If connectivity with the requested PDN is accepted, but with a restriction of IP version (i.e. both an IPv4 address and an IPv6 prefix is requested, but only one particular IP version, or only single IP version bearers are supported/allowed by the network), cause #50 "PDN type IPv4 only allowed", #51 "PDN type IPv6 only allowed", or #52 "single address bearers only allowed", respectively, shall be included in the PDN CONNECTIVITY ACCEPT message. Upon sending the message the TWAG shall enter the state PDN CONNECTIVITY PENDING and PROCEDURE TRANSACTION PENDING and start the timer T3585.

If the UE requested PDN type IPv4v6, but the PDN GW configuration or UE subscription dictates the use of IPv4 only or IPv6 only for this APN, the network shall override the PDN type requested by the UE to limit it to a single address PDN type (IPv4 or IPv6). In the PDN CONNECTIVITY ACCEPT message the TWAG shall set the PDN type IE to either "IPv4" or "IPv6" and the ESM cause value to #50 "PDN type IPv4 only allowed", or #51 "PDN type IPv6 only allowed", respectively. The UE shall not subsequently initiate another UE requested PDN connectivity procedure to the same APN to obtain a PDN type different from the one allowed by the network until:

- a new EAP Authentication procedure is performed (e.g. a new WLAN is selected);
- the PDN type which is used to access to the APN is changed;
- the UE is switched off; or
- the USIM is removed.

If the UE requested PDN type IPv4v6, but the operator uses single addressing per bearer, e.g. due to interworking with nodes of earlier releases, the network shall override the PDN type requested by the UE to a single IP version only. In the PDN CONNECTIVITY ACCEPT message sent to the UE, the TWAG shall set the PDN type IE to either "IPv4" or "IPv6" and the ESM cause value to #52 "single address bearers only allowed". The UE should subsequently request another PDN connection for the other IP version using the PDN connectivity establishment procedure to the same APN with a single address PDN type (IPv4 or IPv6) other than the one already activated.

The TWAG shall set the value of the IP Address IE in the PDN CONNECTIVITY ACCEPT message as follows:

- If the PDN type IE in the PDN CONNECTIVITY ACCEPT message is set to IPv4 or IPv4v6, the PDN Address IE shall contain an IPv4 address for the UE; and
- If the PDN type IE in the PDN CONNECTIVITY ACCEPT message is set to IPv6 or IPv4v6, the PDN Address IE shall contain an IPv6 interface identifier.

Upon receipt of the PDN CONNECTIVITY ACCEPT message, the UE shall check the PTI to identify the UE requested PDN connectivity, stop timer T3582 and enter the state PROCEDURE TRANSACTION INACTIVE. The UE should ensure that the PTI assigned to this procedure is not released immediately. The way to achieve this is implementation dependent. While the PTI value is not released, the UE regards any received PDN CONNECTIVITY ACCEPT message with the same PTI value as a network retransmission.

If the UE receives an IPv6 interface identifier in the PDN CONNECTIVITY ACCEPT message, the UE may wait for the Router Advertisement from the network with the IPv6 prefix information or it may send a Router Solicitation if necessary.

5.2.3.1 PDN connectivity establishment accepted by the UE

If the UE accepts the PDN connection the UE shall send a PDN CONNECTIVITY COMPLETE message and enter the state PDN CONNECTION ESTABLISHED.

Upon receipt of the PDN CONNECTIVITY COMPLETE message, the TWAG shall enter the state PDN CONNECTION ESTABLISHED and stop the timer T3585, if the timer is running (see example in figure 5.2.2.1).

5.2.3.2 PDN connectivity establishment not accepted by the UE

If the UE does not accept the PDN connection the UE shall send a PDN CONNECTIVITY REJECT message and enter the state PDN CONNECTIVITY NOT ESTABLISHED.

The PDN CONNECTIVITY REJECT message contains a cause that typically indicates one of the following cause values:

- #31: request rejected, unspecified; or
- #95 – 111: protocol errors.

Upon receipt of the PDN CONNECTIVITY REJECT message, the TWAG shall enter the state PDN CONNECTIVITY NOT ESTABLISHED and PROCEDURE TRANSACTION INACTIVE and stop the timer T3585, if the timer is running (see example in figure 5.2.2.1).

5.2.4 PDN connectivity procedure not accepted by the TWAG

If connectivity with the requested PDN cannot be accepted by the network, the TWAG shall send a PDN CONNECTIVITY REJECT message to the UE (see example in figure 5.2.4.1). The message shall contain the PTI and a cause value indicating the reason for rejecting the UE requested PDN connectivity.



Figure 5.2.4.1: PDN connectivity establishment procedure not accepted by TWAG

The cause IE typically indicates one of the following cause values:

- #8: operator determined barring;

- #26: insufficient resources;
- #27: missing or unknown APN;
- #28: unknown PDN type;
- #30: request rejected by PDN GW;
- #31: request rejected, unspecified;
- #32: service option not supported;
- #33: requested service option not subscribed;
- #34: service option temporarily out of order;
- #35: PTI already in use;
- #38: network failure;
- #50: PDN type IPv4 only allowed;
- #51: PDN type IPv6 only allowed;
- #52: single address bearers only allowed;
- #54: PDN connection does not exist;
- #55: multiple PDN connections for a given APN not allowed;
- #95 – 111: protocol errors;

If the cause value is #26 "insufficient resources", the network may include a value for timer Tw1 in the PDN CONNECTIVITY REJECT message.

Upon receipt of the PDN CONNECTIVITY REJECT message, the UE shall stop timer T3582 and enter the state PROCEDURE TRANSACTION INACTIVE.

If the cause value is #26 "insufficient resources" and Tw1 value IE is included the UE shall take different actions depending on the timer value received for timer Tw1:

- if the timer value indicates neither zero nor deactivated, the UE shall start timer Tw1 and not send another PDN CONNECTIVITY REQUEST message for the same APN until timer Tw1 expires, the timer Tw1 is stopped, the UE is switched off or the USIM is removed;
- if the timer value indicates that this timer is deactivated, the UE shall not send another PDN CONNECTIVITY REQUEST message for the same APN until the UE is switched off or the USIM is removed; and
- if the timer value indicates zero, the UE may send another PDN CONNECTIVITY REQUEST message for the same APN;
- if the UE is switched off when the timer Tw1 is running, the UE shall behave as follows when the UE is switched on:
 - let t1 be the time remaining for Tw1 timeout at switch off and let t be the time elapsed between switch off and switch on. If t1 is greater than t, then the timer shall be restarted with the value t1 – t. If t1 is equal to or less than t, then the timer need not be restarted. If the UE is not capable of determining t, then the UE shall restart the timer with the value t1.

If the cause value is #26 "insufficient resources" and the Tw1 IE is not included, the UE may send a PDN CONNECTIVITY REQUEST message for the same APN.

5.2.5 Abnormal cases in the UE

The following abnormal cases can be identified:

- a) Expiry of timer T3582:

- On the first expiry of the timer T3582, the UE shall resend the PDN CONNECTIVITY REQUEST and shall reset and restart timer T3582. This retransmission is repeated four times, i.e. on the fifth expiry of timer T3582, the UE shall abort the procedure, release the PTI allocated for this invocation and enter the state PROCEDURE TRANSACTION INACTIVE;

5.2.6 Abnormal cases on the network side

The following abnormal cases can be identified:

- a) UE initiated PDN connectivity request for an already existing PDN connection:

If the network receives a PDN CONNECTIVITY REQUEST message with the same combination of APN and PDN type as an already existing PDN connection:

- if the information elements in the PDN CONNECTIVITY REQUEST message do not differ from the ones received within the previous PDN CONNECTIVITY REQUEST message, and the TWAG has not received the PDN CONNECTIVITY COMPLETE message from UE, the TWAG shall re-send the PDN CONNECTIVITY ACCEPT message and continue the previous procedure; and
- if one or more information elements in the PDN CONNECTIVITY REQUEST message differ from the ones received within the previous PDN CONNECTIVITY REQUEST message, and multiple PDN connections for a given APN are not allowed, the network may release the existing PDN connection locally without notification to the UE and proceed with the requested PDN connectivity procedure or may reject this PDN connectivity procedure including the cause #55 "multiple PDN connections for a given APN not allowed", in the PDN CONNECTIVITY REJECT message; and

- b) UE initiated PDN connectivity request with request type "handover" for a PDN connection that does not exist:

If the network receives a PDN CONNECTIVITY REQUEST message for either a default APN or a specific APN with request type set to "handover" and the TWAG does not have any information about that PDN connection, then TWAG shall reject the PDN connectivity request procedure including the cause #54 "PDN connection does not exist", in the PDN CONNECTIVITY REJECT message.

- c) Expiry of timer T3585:

On the first expiry of the timer T3585, the TWAG shall resend the PDN CONNECTIVITY ACCEPT message, reset and restart timer T3585. This retransmission is repeated four times, i.e. on the fifth expiry of timer T3585, the TWAG shall release possibly allocated resources for this activation and shall abort the procedure.

5.3 TWAG initiated PDN disconnection procedure

5.3.1 General

The purpose of the PDN disconnection procedure is to disconnect the UE from a PDN. With this procedure, all resources associated with this PDN connection are released.

5.3.2 Procedure description

The TWAG shall initiate the PDN disconnection procedure by sending a PDN DISCONNECT REQUEST message to the UE, start the timer T3595, and enter the state PDN DISCONNECT PENDING and PROCEDURE TRANSACTION PENDING (see example in figure 5.3.2.1). The PDN DISCONNECT REQUEST message contains a cause typically indicating one of the following:

- #8: operator determined barring;
- #36: regular deactivation;
- #38: network failure; or
- #39: reactivation requested.

The TWAG may include a PCO IE in the PDN DISCONNECT REQUEST message (e.g. configuration parameters, error codes or messages/events).

If the UE is not authenticated when the TWAG initiates the PDN disconnection procedure, the TWAG shall locally disconnect the PDN connection towards the UE without any WLCP signalling between the TWAG and the UE.

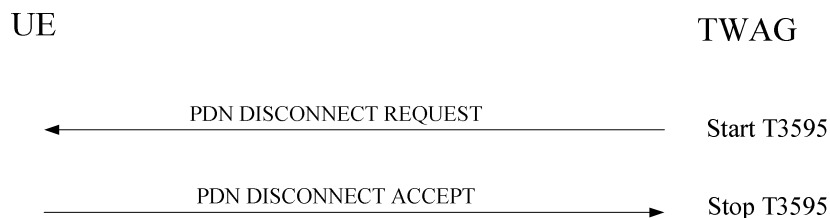

Figure 5.3.2.1: PDN disconnect procedure

Upon receipt of the PDN DISCONNECT REQUEST message, the UE shall release all the resources associated with the PDN connection and respond to the TWAG with the PDN DISCONNECT ACCEPT.

Upon sending the PDN DISCONNECT ACCEPT message, the UE shall enter the state PDN CONNECTIVITY NOT ESTABLISHED.

If the PDN DISCONNECT REQUEST message includes cause #39 "reactivation requested" the UE should stop timer Tw1 if it is running for the APN associated with the PDN connection and re-initiate the PDN connectivity procedure for the same APN as the disconnected PDN.

NOTE: User interaction may be necessary in some cases when the UE cannot re-activate the PDN connection automatically.

Upon receipt of the PDN DISCONNECT ACCEPT message, the TWAG shall enter the states PDN CONNECTIVITY NOT ESTABLISHED and PROCEDURE TRANSACTION INACTIVE and stop the timer T3595.

5.3.3 Abnormal cases in the UE

Apart from the case described in subclause 5.1.3, no abnormal cases have been identified.

5.3.4 Abnormal cases in the TWAG

The following abnormal cases can be identified:

a) Expiry of timer T3595:

On the first expiry of the timer T3595, the TWAG shall resend the PDN DISCONNECT REQUEST message and shall reset and restart timer T3595. This retransmission is repeated four times, i.e. on the fifth expiry of timer T3595, the TWAG shall abort the procedure and deactivate the PDN connection locally without any peer-to-peer WLCP signalling between the TWAG and the UE; and

b) Collision of UE-initiated and TWAG-initiated PDN disconnection procedure:

When the TWAG receives a PDN DISCONNECT REQUEST message during the TWAG-initiated PDN disconnection procedure the TWAG shall proceed with the PDN disconnection procedure.

5.4 UE requested PDN disconnection procedure

5.4.1 General

The purpose of the UE requested PDN disconnection procedure is for a UE to request disconnection from one PDN. With this procedure, all resources associated with this PDN connection are released.

5.4.2 Procedure description

In order to request PDN disconnection from a PDN, the UE shall send a PDN DISCONNECT REQUEST message to the TWAG, start the timer T3592 and enter the state PROCEDURE TRANSACTION PENDING (see example in figure 5.4.2.1).

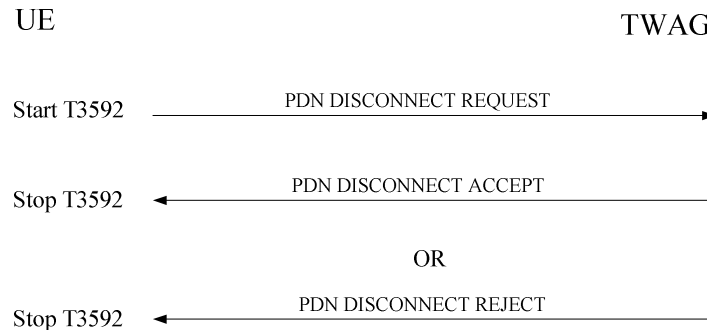

Figure 5.4.2.1: UE requested PDN disconnection procedure

Upon receipt of the PDN DISCONNECT REQUEST message, the TWAG shall release all the resources associated with the PDN connection and respond to the UE with the PDN DISCONNECT ACCEPT message.

Upon receipt of the PDN DISCONNECT ACCEPT message, the UE shall stop the timer T3592, deactivate all resources associated with this PDN connection and enter the states PROCEDURE TRANSACTION INACTIVE and PDN CONNECTIVITY NOT ESTABLISHED.

If the PDN DISCONNECT REQUEST message is not accepted by the network, the TWAG shall send a PDN DISCONNECT REJECT message to the UE. The PDN DISCONNECT REJECT message shall contain the PTI and a cause IE that typically indicates one of the following cause values:

- #35: PTI already in use; and
- #95 – 111: protocol errors.

Upon receipt of the PDN DISCONNECT REJECT message, the UE shall stop the timer T3592, enter the state PROCEDURE TRANSACTION INACTIVE and abort the PDN disconnection procedure. Additionally, the UE shall deactivate all resources associated with this PDN connection locally without peer-to-peer signalling between the UE and the TWAG and enter the state PDN CONNECTIVITY NOT ESTABLISHED.

5.4.3 Abnormal cases in the UE

The following abnormal cases can be identified:

- a) Expiry of timer T3592:

On the first expiry of the timer T3592, the UE shall resend the PDN DISCONNECT REQUEST and shall reset and restart timer T3592. This retransmission is repeated four times, i.e. on the fifth expiry of timer T3592, the UE shall abort the procedure, release all resources associated with this PDN connection locally without peer-to-peer signalling between the UE and the TWAG, release the PTI allocated for this invocation and enter the state PROCEDURE TRANSACTION INACTIVE.

5.4.4 Abnormal cases in the TWAG

The following abnormal cases can be identified:

- a) No PDN connection with the same PTI:

If the PTI included in the PDN DISCONNECT REQUEST message does not belong to an established PDN connection, the TWAG shall reply with a PDN DISCONNECT REJECT message with cause #54 "PDN connection does not exist";

5.5 STATUS message

The purpose of the sending of the STATUS message is to report at any time certain error conditions detected upon receipt of WLCP protocol data. The STATUS message can be sent by both the TWAG and the UE (see example in figure 5.5.1).

If the WLCP entity of the UE receives a STATUS message the UE shall take different actions depending on the received cause value:

#81 (Invalid PTI value);

The UE shall abort any ongoing WLCP procedure related to the received PTI value and stop any related timer.

#97 (Message type non-existent or not implemented);

The UE shall abort any ongoing WLCP procedure related to the PTI and stop any related timer.

On receipt of a STATUS message with any other cause value no state transition and no specific action shall be taken as seen from the WLAN radio interface, i.e. local actions are possible.

If the WLCP entity of the TWAG receives a STATUS message the TWAG shall take different actions depending on the received cause value:

#81 (Invalid PTI value);

The TWAG shall abort any ongoing WLCP procedure related to the received PTI value and stop any related timer.

#97 (Message type non-existent or not implemented);

The TWAG shall abort any ongoing WLCP procedure related to the PTI and stop any related timer.

The local actions to be taken by the TWAG on receipt of an STATUS message with any other cause value are implementation dependent.

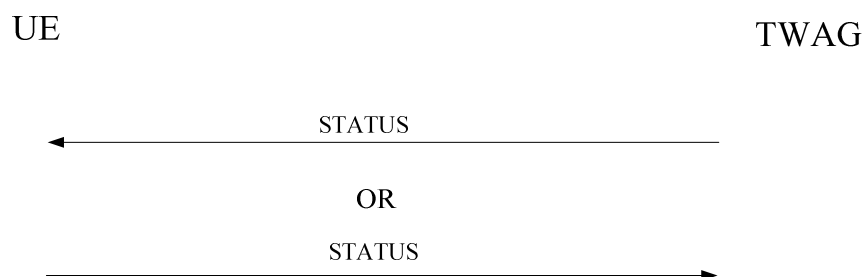

Figure 5.5.1: STATUS message

6 Handling of unknown, unforeseen, and erroneous protocol data

6.1 General

The procedures specified in the present document apply to those messages which pass the checks described in this subclause.

This clause also specifies procedures for the handling of unknown, unforeseen, and erroneous protocol data by the receiving entity. These procedures are called "error handling procedures", but in addition to providing recovery mechanisms for error situations they define a compatibility mechanism for future extensions of the protocols.

Subclauses 6.1 to 6.8 shall be applied in order of precedence, starting with subclause 6.1.

Most error handling procedures are mandatory for the UE.

Detailed error handling procedures in the TWAG are implementation dependent and may vary from PLMN to PLMN. However, when extensions of this protocol are developed, TWAG will be assumed to have the error handling that is indicated in this subclause as mandatory ("shall") and that is indicated as strongly recommended ("should").

Also, the error handling of the TWAG is only considered as mandatory or strongly recommended when certain thresholds for errors are not reached during a dedicated connection.

6.2 Message too short

When the UE receives a WLCP message which is too short to contain a complete message type information element, the UE shall discard the message.

The TWAG shall take the same approach.

6.3 Unknown or unforeseen procedure transaction identity or PDN connection ID

6.3.1 Procedure transaction identity

The following TWAG procedures shall apply for handling an unknown, erroneous, or unforeseen PTI received in a WLCP message:

- a) If the TWAG receives a PDN CONNECTIVITY REQUEST message with a reserved PTI value, the TWAG shall respond with a PDN CONNECTIVITY REJECT message including ESM cause #81 "invalid PTI value";
- b) If the TWAG receives a PDN DISCONNECT REQUEST message with a reserved PTI value, the TWAG shall respond with a PDN DISCONNECT REJECT message including ESM cause #81 "invalid PTI value"; and
- c) If the TWAG receives a WLCP message other than those listed in items a through b above with a reserved PTI value, the TWAG shall ignore the message.

The following UE procedures shall apply for handling an unknown, erroneous, or unforeseen PTI received in a WLCP message:

- a) If the UE receives a PDN CONNECTIVITY REJECT message in which the PTI value is an unassigned or reserved value, or an assigned value that does not match any PTI in use, the UE shall ignore the message;
- b) If the UE receives a PDN DISCONNECT REJECT message in which the PTI value is an unassigned or reserved value, or an assigned value that does not match any PTI in use, the UE shall ignore the message; and
- c) If the UE receives a WLCP message other than those listed in items a through b with a reserved PTI value or an assigned value that does not match any PTI in use, the UE shall ignore the message.

6.3.2 PDN connection ID

The following TWAG procedures shall apply for handling an unknown, erroneous, or unforeseen PDN connection ID received in the header of a WLCP message:

- a) If the TWAG receives a PDN CONNECTIVITY REQUEST message which includes an assigned or reserved PDN connection ID value, the TWAG shall respond with a PDN CONNECTIVITY REJECT message including ESM cause #43 "invalid EPS bearer identity";
- b) If the TWAG receives a PDN DISCONNECT REQUEST message which includes an unassigned or reserved PDN connection ID value, the TWAG shall respond with a PDN DISCONNECT REJECT message including ESM cause #43 "invalid EPS bearer identity"; and

- c) If the TWAG receives a WLCP message other than those listed in items a through b above in which the message includes a reserved PDN connection ID value or an assigned value that does not match an existing PDN connection ID, the TWAG shall ignore the message.

The following UE procedures shall apply for handling an unknown, erroneous, or unforeseen PDN connection ID received in the header of a WLCP message:

- a) If the UE receives a PDN CONNECTIVITY REJECT message which includes an assigned or reserved PDN connection ID value, the UE shall ignore the message;
- b) If the UE receives a PDN DISCONNECT REJECT message which includes an unassigned or reserved PDN connection ID value or an assigned PDN connection ID value which does not match existing PDN connection, the UE shall ignore the message;
- c) If the UE receives a PDN DISCONNECT REQUEST message which includes an unassigned or reserved PDN connection ID value or an assigned PDN connection ID value which does not match existing PDN connection, the UE shall ignore the message; and
- d) If the UE receives a WLCP message other than those listed in items a through c in which the message includes an unassigned or reserved PDN connection ID value or a value that does not match an existing PDN connection ID, the UE shall ignore the message.

6.4 Unknown or unforeseen message type

If UE receives a WLCP message with message type not defined or not implemented, the UE shall return a status message with cause #97 "message type non-existent or not implemented".

If the TWAG receives a WLCP message with message type not defined or not implemented, the TWAG shall ignore the message except that the TWAG should return a status message with cause #97 "message type non-existent or not implemented".

6.5 Non-semantic mandatory information element errors

6.5.1 Common procedures

When on receipt of a message,

- an "imperative message part" error; or
- a "missing mandatory IE" error

is diagnosed or when a message containing:

- a syntactically incorrect mandatory IE;
- an IE unknown in the message, but encoded as "comprehension required" (see 3GPP TS 24.007 [7]); or
- an out of sequence IE encoded as "comprehension required" (see 3GPP TS 24.007 [7]) is received,

the UE shall proceed as follows:

The UE shall return a status message with cause #96 "invalid mandatory information"; and

the TWAG shall proceed as follows:

The TWAG shall either:

- try to treat the message (the exact further actions are implementation dependent); or
- ignore the message except that the TWAG should return a status message with cause #96 "invalid mandatory information".

6.5.2 PDN connection management

The following UE procedures shall apply for handling an error encountered with a mandatory information element in a WLCP message:

- a) If the message is a PDN CONNECTIVITY REQUEST, a PDN CONNECTIVITY REJECT message with ESM cause #96 "invalid mandatory information", shall be returned.
- b) If the message is a PDN DISCONNECT REQUEST, a PDN DISCONNECT ACCEPT message shall be returned. All resources associated with that PDN connection shall be released.

The following TWAG procedures shall apply for handling an error encountered with a mandatory information element in a WLCP message:

- a) If the message is a PDN CONNECTIVITY REQUEST, a PDN CONNECTIVITY REJECT message with ESM cause #96 "invalid mandatory information", shall be returned.
- b) If the message is a PDN DISCONNECT REQUEST, a PDN DISCONNECT REJECT message with ESM cause #96 "invalid mandatory information", shall be returned.

6.6 Unknown and unforeseen IEs in the non-imperative message part

6.6.1 IEs unknown in the message

The UE shall ignore all IEs unknown in a message which are not encoded as "comprehension required" (see 3GPP TS 24.301 [5]).

The TWAG shall take the same approach.

6.6.2 Out of sequence IEs

The UE shall ignore all out of sequence IEs in a message which are not encoded as "comprehension required" (see 3GPP TS 24.301 [5]).

The TWAG shall take the same approach.

6.6.3 Repeated IEs

If an information element with format V, TV, or TLV is repeated in a message in which repetition of the information element is not specified in clause 7 of the present document, the UE shall handle only the contents of the information element appearing first and shall ignore all subsequent repetitions of the information element. When repetition of information elements is specified, the UE shall handle only the contents of specified repeated information elements. If the limit on repetition of information elements is exceeded, the UE shall handle the contents of information elements appearing first up to the limit of repetitions and shall ignore all subsequent repetitions of the information element.

The TWAG shall follow the same procedures.

6.7 Non-imperative message part errors

6.7.1 General

This category includes:

- syntactically incorrect optional IEs; and
- conditional IE errors.

6.7.2 Syntactically incorrect optional IEs

The UE shall treat all optional IEs that are syntactically incorrect in a message as not present in the message.

The TWAG shall take the same approach.

6.7.3 Conditional IE errors

When upon receipt of a WLCP message the UE diagnoses a "missing conditional IE" error or an "unexpected conditional IE" error, or when the UE receives a WLCP message containing at least one syntactically incorrect conditional IE, the UE shall ignore the message and shall return a status message with cause #100 "conditional IE error".

When the TWAG receives a message and diagnoses a "missing conditional IE" error or an "unexpected conditional IE" error or when the TWAG receives a message containing at least one syntactically incorrect conditional IE, the TWAG shall either:

- try to treat the message (the exact further actions are implementation dependent); or
- ignore the message except that the TWAG should return a status message with cause #100 "conditional IE error".

6.8 Messages with semantically incorrect contents

When a message with semantically incorrect contents is received, the UE shall perform the foreseen reactions of the procedural part of the present document (i.e. of clauses 5). If however no such reactions are specified, the UE shall ignore the message except that the UE shall return a status message with cause #95 "semantically incorrect message".

The TWAG should follow the same procedure except that a status message is not normally transmitted.

7 Message functional definitions and contents

7.1 PDN connectivity request

7.1.1 Message definition

This message is sent by the UE to the network to initiate establishment of a PDN connection. See table 7.1.1.1.

Message type: PDN CONNECTIVITY REQUEST

Direction: UE to network

Table 7.1.1.1: PDN CONNECTIVITY REQUEST message content

IEI	Information Element	Type/Reference	Presence	Format	Length
	PDN connectivity request message identity	Message type 8.2	M	V	1
	Procedure transaction identity	Transaction identifier 8.3	M	V	1
	Request type	Request type 8.4	M	V	1/2
	PDN type	PDN type 8.5	M	V	1/2
28	Access point name	Access point name 8.6	O	TLV	3-102
27	Protocol configuration options	Protocol configuration options 8.7	O	TLV	3-253

7.1.2 Access point name

This IE is included in the message when the UE wishes to request network connectivity as defined by a certain access point name during the PDN connection establishment procedure.

7.1.3 Protocol configuration options

This IE is included in the message when the UE wishes to transmit (protocol) data (e.g. configuration parameters, error codes or messages/events) to the network.

7.2 PDN connectivity accept

7.2.1 Message definition

This message is sent by the network to the UE to acknowledge activation of a PDN connection. See table 7.2.1.1.

Message type: PDN CONNECTIVITY ACCEPT

Direction: network to UE

Table 7.2.1.1: PDN CONNECTIVITY ACCEPT message content

IEI	Information Element	Type/Reference	Presence	Format	Length
	PDN connectivity accept message identity	Message type 8.2	M	V	1
	Procedure transaction identity	Transaction identifier 8.3	M	V	1
	Access point name	Access point name 8.6	M	LV	2-101
	PDN Address	PDN address 8.8	M	LV	6-14
	PDN connection ID	PDN connection ID 8.9	M	V	1
	User Plane Connection ID	User Plane Connection ID 8.10	M	V	6
27	Protocol configuration options	Protocol configuration options 8.7	O	TLV	3-253
58	Cause	Cause 8.11	O	TV	2

7.2.2 Protocol configuration options

This IE is included in the message when the network wishes to transmit (protocol) data (e.g. configuration parameters, error codes or messages/events) to the UE.

7.2.3 Cause

The network shall include this IE, if the network allocated a PDN address of a PDN type which is different from the PDN type requested by the UE.

7.3 PDN connectivity reject

7.3.1 Message definition

This message is sent by the network to the UE to reject activation of a PDN connection. See table 7.3.1.1.

Message type: PDN CONNECTIVITY REJECT

Direction: network to UE

Table 7.3.1.1: PDN CONNECTIVITY REJECT message content

IEI	Information Element	Type/Reference	Presence	Format	Length
	PDN connectivity reject message identity	Message type 8.2	M	V	1
	Procedure transaction identity	Transaction identifier 8.3	M	V	1
	Cause	Cause 8.11	M	V	1
27	Protocol configuration options	Protocol configuration options 8.7	O	TLV	3-253
37	Tw1 value	GPRS timer 3 8.12	O	TLV	3

7.3.2 Protocol configuration options

This IE is included in the message when the network wishes to transmit (protocol) data (e.g. configuration parameters, error codes or messages/events) to the UE.

7.3.3 Tw1 value

This IE may be included in the message when the cause is #26 "insufficient resources".

7.4 PDN disconnect request

7.4.1 Message definition

This message is sent by the network or the UE to initiate release of a PDN connection. See table 7.4.1.1.

Message type: PDN DISCONNECT REQUEST

Direction: both

Table 7.4.1.1: PDN DISCONNECT REQUEST message content

IEI	Information Element	Type/Reference	Presence	Format	Length
	PDN disconnect request message identity	Message type 8.2	M	V	1
	Procedure transaction identity	Transaction identifier 8.3	M	V	1
	PDN connection ID	PDN connection ID 8.9	M	V	1
58	Cause	Cause 8.11	O	TV	2
27	Protocol configuration options	Protocol configuration options 8.7	O	TLV	3-253

7.4.2 Protocol configuration options

This IE is included in the message when the UE or the network wishes to transmit (protocol) data (e.g. configuration parameters, error codes or messages/events) to the peer entity.

7.5 PDN disconnect accept

7.5.1 Message definition

This message is sent by the network or the UE to acknowledge release of a PDN connection. See table 7.5.1.1.

Message type: PDN DISCONNECT ACCEPT

Direction: both

Table 7.5.1.1: PDN DISCONNECT ACCEPT message content

IEI	Information Element	Type/Reference	Presence	Format	Length
	PDN connectivity accept message identity	Message type 8.2	M	V	1
	Procedure transaction identity	Transaction identifier 8.3	M	V	1
	PDN connection ID	PDN connection ID 8.9	M	V	1/2
27	Protocol configuration options	Protocol configuration options 8.7	O	TLV	3-253

7.5.2 Protocol configuration options

This IE is included in the message when the UE or the network wishes to transmit (protocol) data (e.g. configuration parameters, error codes or messages/events) to the peer entity.

7.6 PDN disconnect reject

7.6.1 Message definition

This message is sent by the network to the UE to reject release of a PDN connection. See table 7.6.1.1.

Message type: PDN DISCONNECT REJECT

Direction: network to UE

Table 7.6.1.1: PDN DISCONNECT REJECT message content

IEI	Information Element	Type/Reference	Presence	Format	Length
	PDN connectivity reject message identity	Message type 8.2	M	V	1
	Procedure transaction identity	Transaction identifier 8.3	M	V	1
	PDN connection ID	PDN connection ID 8.9	M	V	1
58	Cause	Cause 8.11	M	V	1
27	Protocol configuration options	Protocol configuration options 8.7	O	TLV	3-253

7.6.2 Protocol configuration options

This IE is included in the message when the network wishes to transmit (protocol) data (e.g. configuration parameters, error codes or messages/events) to the UE.

7.7 PDN connectivity complete

7.7.1 Message definition

This message is sent by the UE to acknowledge establishment of a PDN connection. See table 7.7.1.1.

Message type: PDN CONNECTIVITY COMPLETE

Direction: UE to network

Table 7.7.1.1: PDN CONNECTIVITY COMPLETE message content

IEI	Information Element	Type/Reference	Presence	Format	Length
	PDN connectivity complete	Message type 8.2	M	V	1
	Procedure transaction identity	Transaction identifier 8.3	M	V	1
	PDN connection ID	PDN connection ID 8.9	M	TV	1

7.8 Status message

7.8.1 Message definition

This message is sent by the network or the UE to report certain error conditions detected upon receipt of WLCP protocol data as specified in subclause 5.5. See table 7.8.1.1.

Message type: STATUS

Direction: both

Table 7.8.1.1: STATUS message content

IEI	Information Element	Type/Reference	Presence	Format	Length
	Status	Message type 8.2	M	V	1
	Procedure transaction identity	Transaction identifier 8.3	M	V	1
	PDN connection ID	PDN connection ID 8.9	M	TV	1
	Cause	Cause 8.11	M	V	1

8 General message format and information elements coding

8.1 General

The least significant bit of a field is represented by the lowest numbered bit of the highest numbered octet of the field. When the field extends over more than one octet, the order of bit values progressively decreases as the octet number increases.

Figure 8.1.1 shows an example of a field where the most significant bit of the field is marked MSB and the least significant bit of the field is marked LSB.

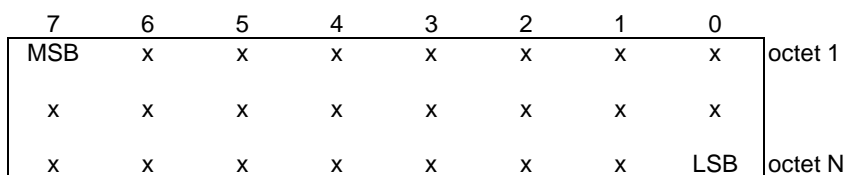

Figure 8.1.1: Example of bit ordering of a field

Within the protocols defined in the present document, the WLCP message consists of the following parts:

- a) Message type;
- b) Procedure transaction identity;
- c) other information elements, as required.

The organization of a message is illustrated in the example shown in figure 8.1.2.

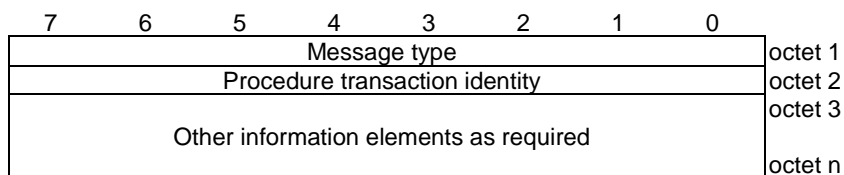

Figure 8.1.2: General message organization example for a WLCP message

Unless specified otherwise in the message descriptions of clause 7, a particular information element shall not be present more than once in a given message.

8.2 Message type

The message type octet is the first octet in a WLCP message. Table 8.2.1 defines the value part of the message type IE used in the WLCP protocol. Bit 6 to 7 are coded as "01" indicating it is a WLCP message.

Table 8.2.1: Message types for WLCP

Bits		
7	6	5 4 3 2 1 0
1	0	- - - - - WLCP messages
1	0	0 0 0 0 0 1 PDN connectivity request
1	0	0 0 0 0 0 1 0 PDN connectivity accept
1	0	0 0 0 0 0 1 1 PDN connectivity reject
1	0	0 0 0 0 1 0 0 PDN connectivity complete
1	0	0 0 0 0 1 0 1 PDN disconnect request
1	0	0 0 0 0 1 1 0 PDN disconnect accept
1	0	0 0 0 0 1 1 1 PDN disconnect reject
1	0	1 0 1 0 1 0 0 0 Status

8.3 Procedure transaction identity

The procedure transaction identity (PTI) octet is the second octet in a WLCP message. The PTI allows distinguishing up to 254 different bi-directional messages flows for a given message type. Such a message flow is called a transaction. The procedure transaction identity is released when the procedure is completed. Table 8.3.1 defines the value part of the Procedure transaction identity IE used in the WLCP.

Table 8.3.1: Procedure transaction identity

Bits								
7	6	5	4	3	2	1	0	
0	0	0	0	0	0	0	0	No procedure transaction identity assigned
0	0	0	0	0	0	0	1	\ } Procedure transaction identity value
1	1	1	1	1	1	1	0	
1	1	1	1	1	1	1	1	Reserved

In this version of the protocol the sending entity shall not set the PTI to the value 0. Any entity receiving a request with a PTI set to the value 0 shall consider that as a syntactical error (see subclause 6.5.1).

8.4 Request type

See subclause 10.5.6.17 in 3GPP TS 24.008 [4].

8.5 PDN type

See subclause 9.9.4.10 in 3GPP TS 24.301 [5].

8.6 Access point name

See subclause 10.5.6.1 in 3GPP TS 24.008 [4].

8.7 Protocol configuration options

See subclause 10.5.6.3 in 3GPP TS 24.008 [4].

8.8 PDN address

See subclause 9.9.4.9 in 3GPP TS 24.301 [5].

8.9 PDN connection ID

The purpose of the PDN connection ID is to identify the PDN connection between the UE and the TWAG.

The PDN connection ID information element is coded as shown in figure 8.9.1 and table 8.9.1.

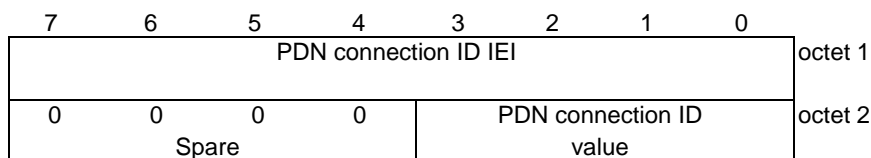

Figure 8.9.1: PDN connection ID information element

Table 8.9.1: PDN connection ID information element

PDN connection ID (bits 1-4)				
3	2	1	0	
0	0	0	0	
to				Reserved
0	1	0	0	
0	1	0	1	PDN connection ID value 5
0	1	1	0	PDN connection ID value 6
0	1	1	1	PDN connection ID value 7
1	0	0	0	PDN connection ID value 8
1	0	0	1	PDN connection ID value 9
1	0	1	0	PDN connection ID value 10
1	0	1	1	PDN connection ID value 11
1	1	0	0	PDN connection ID value 12
1	1	0	1	PDN connection ID value 13
1	1	1	0	PDN connection ID value 14
1	1	1	1	PDN connection ID value 15

8.10 User plane connection ID

The purpose of the user plane connection ID is to identify the user plane for one PDN connection between the UE and the TWAG.

The user plane connection ID value is the MAC address of the TWAG with a length of 6 octets. The MAC address is defined in subclause 8 of IEEE Std 802 [6].

The user plane connection ID information element is coded as shown in figure 8.10.1.

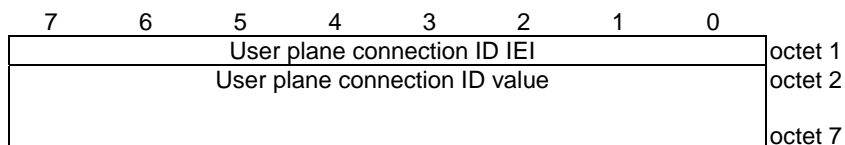

Figure 8.10.1: User plane connection ID information element

8.11 Cause

See subclause 9.9.4.4 in 3GPP TS 24.301 [5].

8.12 GPRS timer 3

See subclause 10.5.7.4a in 3GPP TS 24.008 [4].

9 List of system parameters

9.1 Timers

Table 9.1.1: WLCP timers – UE side

TIMER	TIMER VALUE	STATE	CAUSE OF START	NORMAL STOP	ON THE 1st, 2nd, 3rd, 4th EXPIRY (NOTE 1)
T3582	8s	PROCEDURE TRANSACTION PENDING	PDN CONNECTIVITY REQUEST sent	PDN CONNECTIVITY ACCEPT received or PDN CONNECTIVITY REJECT received	Retransmission of the same message
T3592	6s	PROCEDURE TRANSACTION PENDING	PDN DISCONNECT REQUEST sent	PDN DISCONNECT ACCEPT received or PDN DISCONNECT REJECT received	Retransmission of the same message
Tw1	NOTE 2	PDN CONNECTIVITY PENDING or SCM_RESPONSE (defined in 3GPP TS 24.302 [3]) reception	PDN CONNECTIVITY REJECT with a timer value for Tw1 received, SCM_RESPONSE (defined in 3GPP TS 24.302 [3]) with a timer value for Tw1 received	PDN DISCONNECT REQUEST with cause #39 "reactivation requested"	None
NOTE 1: Typically, the procedures are aborted on the fifth expiry of the relevant timer. Exceptions are described in the corresponding procedure description.					
NOTE 2: The value of this timer can be provided by the network operator when a request to activate a PDN connection is rejected by the network with a certain cause or when a request to activate a PDN connection in single-connection mode (defined in 3GPP TS 24.302 [3]) is rejected by the network with a certain cause.					

Table 9.1.2: WLCP timers – TWAG side

TIMER	TIMER VALUE	STATE	CAUSE OF START	NORMAL STOP	ON THE 1st, 2nd, 3rd, 4th EXPIRY (NOTE 1)
T3585	8s	PDN CONNECTIVITY PENDING PROCEDURE TRANSACTION PENDING	PDN CONNECTIVITY ACCEPT sent	PDN CONNECTIVITY COMPLETE received or PDN CONNECTIVITY REJECT received	Retransmission of the same message
T3595	8s	PDN DISCONNECT PENDING PROCEDURE TRANSACTION PENDING	PDN DISCONNECT REQUEST sent	PDN DISCONNECT ACCEPT received	Retransmission of the same message
NOTE 1: Typically, the procedures are aborted on the fifth expiry of the relevant timer. Exceptions are described in the corresponding procedure description.					

Annex A (Informative): IANA UDP port registration form

This annex contains information to be provided to IANA for WLCP UDP port registration. The following information are to be used to register WLCP user port number and service name in the "IANA Service Name and Transport Protocol Port Number Registry" and specifically "Service Name and Transport Protocol Port Number Registry".

Editor's note: The registration should be performed by MCC at the end of Rel-12. The information are to be inserted at <http://www.iana.org/form/ports-services>

Resources required	Port number and service name
Transport Protocols	UDP
Service Code	
Service Name	wlcp
Desired Port Number	
Description	<p>Wireless LAN Control plane Protocol (WLCP) is a 3GPP control protocol used by the User Equipment (UE) for access to the Evolved Packet Core via trusted Wireless Local Area Network. It enables the management of the Packet Data Network (PDN) connections between the User Equipment (UE) and the Trusted WLAN Access Gateway (TWAG).</p> <p>Wireless LAN Control plane Protocol (WLCP) uses UDP as a transport protocol.</p>
Reference	3GPP TS 24.244
Defined TXT keys	N/A
If broadcast/multicast is used, how and what for?	Neither broadcast, nor multicast are used.
If UDP is requested, please explain how traffic is limited, and whether the protocol reacts to congestion.	<p>At maximum a few WLCP messages per seconds are expected in communication between a given User Equipment (UE) and a given Trusted WLAN Access Gateway (TWAG).</p> <p>Wireless LAN Control plane Protocol does not support any reaction to congestion.</p>
If UDP is requested, please indicate whether the service is solely for the discovery of hosts supporting this protocol.	Wireless LAN Control plane Protocol is not used solely for discovery of hosts supporting this protocol.
Please explain how your protocol supports versioning.	Wireless LAN Control plane Protocol does not support versioning.
If your request is for more than one transport, please explain in detail how the protocol differs over each transport.	N/A
Please describe how your protocol supports security. Note that presently there is no IETF consensus on when it is appropriate to use a second port for an insecure version of a protocol.	Wireless LAN Control plane Protocol does not support security. It relies on the security mechanisms of the lower layers, including EAP-AKA" authentication and IEEE 802.1x encryption.

<p>Please explain why a unique port assignment is necessary as opposed to a port in range (49152-65535) or existing port.</p>	<p>An assigned User Port would make network management easier. It is possible that packets containing WLCP messages need to traverse several firewalls of the network operator during the signalling exchange between the User Equipment (UE) and the Trusted WLAN Access Gateway (TWAG). The firewalls of the network operator are configured to discard packets other than those containing the WLCP messages and other than those authorized by the WLCP messages. If a dynamic ephemeral port is used for WLCP messages, the firewall configuration needs to be updated whenever a new port starts being used for WLCP messages in the Trusted WLAN Access Gateway (TWAG).</p> <p>An assigned User Port would make roaming agreements between network operators easier. If a dynamic port is used, each operator will need to provide the port number used by its TWAG to other operators, then the home operator needs to configure in its AAA sever the list of port numbers (in addition to the IP addresses) of the TWAGs of its roaming partners. If dynamic port is used, the port number can change frequently (while the IP address of the TWAG does not change frequently). Each time the port number changes, the roaming agreement documents needs to be updated. If dynamic port is used, the procedure to update the port numbers on the AAA server can cause a short interruption of the service.</p> <p>As a general principle, 3GPP protocols use assigned User Ports, e.g. GTP-C uses UDP port number 2123, GTP-U uses UDP port number 2152, S1AP uses SCTP port number 36412, X2AP uses SCTP port number 36422. IKEv2 is an example of an IETF protocol between the terminal and a gateway that uses a well-known port number.</p> <p>An assigned UDP port number would simplify the UE implementation. The UDP port number management between the application processor (AP) and the cellular modem would be simplified if the UDP port for WLCP could be set as a well-known port number. Specifically, there would be a need for an additional API between the WLCP client in the AP and the modem to identify the WLCP packets if dynamic ports are used.</p>
<p>Please explain the state of development of your protocol.</p>	<p>Protocol Standard definition. No implementation exists yet.</p>
<p>If SCTP is requested, is there an existing TCP and/or UDP service name or port number assignment? If yes, provide the existing service name and port number.</p>	<p>N/A</p>
<p>What specific SCTP capability is used by the application such that a user who has the choice of both TCP (and/or UDP) and SCTP ports for this application would choose SCTP? See RFC 4960 section 7.1.</p>	<p>N/A</p>
<p>Please provide any other information that would be helpful in understanding how this protocol differs from existing assigned services</p>	<p>This protocol is between the UE (i.e. mobile device) and the Trusted WLAN Gateway. The UDP ports previously assigned to 3GPP were for protocols between network elements.</p>

Annex B (informative): Change history

Change history							
Date	TSG #	TSG Doc.	CR	Rev	Subject/Comment	Old	New
2013-10					Draft skeleton provided		0.0.0
2013-10	CT1#84bis				Includes the following contribution agreed by CT1 at CT1#84bis: C1-134145	0.0.0	0.1.0
2013-11	CT1#85				Includes the following contributions agreed by CT1 at CT#85: C1-134919, C1-134924, C1-135207.	0.1.0	0.2.0
2014-01	CT1#86				Includes the following contributions agreed by CT1 at CT#86: C1-140385, C1-140386, C1-130388, C1-140705.	0.2.0	0.3.0
2014-02	CT-63	CP-140112			Version 1.0.0 created for presentation to plenary for information	0.3.0	1.0.0
2014-04	CT1#86bis				Includes the following contribution agreed by CT1 at CT1#86bis: C1-140813, C1-141260, C1-141262, C1-141265, C1-141266, C1-141267, C1-141309, C1-141580.	1.0.0	1.1.0
2014-05	CT1#87				Includes the following contribution agreed by CT1 at CT1#87: C1-142127, C1-142128, C1-142129, C1-142519.	1.1.0	1.2.0
2014-07	CT1#88				Includes the following contribution agreed by CT1 at CT1#88: C1-142739, C1-143004, C1-143006, C1-143044, C1-143320, C1-143369.	1.2.0	1.3.0
2014-09	CT-65	CP-140631			Version 2.0.0 created for presentation to plenary for approval	1.3.0	2.0.0
2014-09	CT-65	CP-140718			Plenary tdoc revised to include missing cover sheet	1.3.0	2.0.0
2014-09	Post CT-65				Version 12.0.0 created after approval at CT-65	2.0.0	12.0.0
2014-12	CT-66	CP-140840	000	1	WLCP security	12.0.0	12.1.0
2014-12	CT-66	CP-140840	000	1	Correct the reference on IPv6 network prefix allocation	12.0.0	12.1.0
2014-12	CT-66	CP-140840	000	4	Correct the timer name	12.0.0	12.1.0
2014-12	CT-66	CP-140840	000	5	Tx value IE	12.0.0	12.1.0
2014-12	CT-66	CP-140840	000	2	Update to reference IEEE 802	12.0.0	12.1.0
2014-12	CT-66	CP-140840	000	1	Procedure transaction identity	12.0.0	12.1.0
2014-12	CT-66	CP-140840	000	1	Corrections and editorials to WLCP	12.0.0	12.1.0

History

Document history		
V12.0.0	October 2014	Publication
V12.1.0	January 2015	Publication