

# ETSI TS 124 483 V14.1.0 (2017-07)



**LTE;  
Mission Critical Services (MCS) Management Object (MO)  
(3GPP TS 24.483 version 14.1.0 Release 14)**



---

Reference

RTS/TSGC-0124483ve10

---

Keywords

LTE

**ETSI**

650 Route des Lucioles  
F-06921 Sophia Antipolis Cedex - FRANCE

Tel.: +33 4 92 94 42 00 Fax: +33 4 93 65 47 16

Siret N° 348 623 562 00017 - NAF 742 C  
Association à but non lucratif enregistrée à la  
Sous-Préfecture de Grasse (06) N° 7803/88

---

**Important notice**

The present document can be downloaded from:

<http://www.etsi.org/standards-search>

The present document may be made available in electronic versions and/or in print. The content of any electronic and/or print versions of the present document shall not be modified without the prior written authorization of ETSI. In case of any existing or perceived difference in contents between such versions and/or in print, the only prevailing document is the print of the Portable Document Format (PDF) version kept on a specific network drive within ETSI Secretariat.

Users of the present document should be aware that the document may be subject to revision or change of status.

Information on the current status of this and other ETSI documents is available at

<https://portal.etsi.org/TB/ETSIDeliverableStatus.aspx>

If you find errors in the present document, please send your comment to one of the following services:

<https://portal.etsi.org/People/CommiteeSupportStaff.aspx>

---

**Copyright Notification**

No part may be reproduced or utilized in any form or by any means, electronic or mechanical, including photocopying and microfilm except as authorized by written permission of ETSI.

The content of the PDF version shall not be modified without the written authorization of ETSI.

The copyright and the foregoing restriction extend to reproduction in all media.

© ETSI 2017.  
All rights reserved.

**DECT™**, **PLUGTESTS™**, **UMTS™** and the ETSI logo are Trade Marks of ETSI registered for the benefit of its Members.  
**3GPP™** and **LTE™** are Trade Marks of ETSI registered for the benefit of its Members and of the 3GPP Organizational Partners.

**oneM2M** logo is protected for the benefit of its Members  
**GSM®** and the GSM logo are Trade Marks registered and owned by the GSM Association.

---

## Intellectual Property Rights

IPRs essential or potentially essential to the present document may have been declared to ETSI. The information pertaining to these essential IPRs, if any, is publicly available for **ETSI members and non-members**, and can be found in ETSI SR 000 314: *"Intellectual Property Rights (IPRs); Essential, or potentially Essential, IPRs notified to ETSI in respect of ETSI standards"*, which is available from the ETSI Secretariat. Latest updates are available on the ETSI Web server (<https://ipr.etsi.org>).

Pursuant to the ETSI IPR Policy, no investigation, including IPR searches, has been carried out by ETSI. No guarantee can be given as to the existence of other IPRs not referenced in ETSI SR 000 314 (or the updates on the ETSI Web server) which are, or may be, or may become, essential to the present document.

---

## Foreword

This Technical Specification (TS) has been produced by ETSI 3rd Generation Partnership Project (3GPP).

The present document may refer to technical specifications or reports using their 3GPP identities, UMTS identities or GSM identities. These should be interpreted as being references to the corresponding ETSI deliverables.

The cross reference between GSM, UMTS, 3GPP and ETSI identities can be found under <http://webapp.etsi.org/key/queryform.asp>.

---

## Modal verbs terminology

In the present document "**shall**", "**shall not**", "**should**", "**should not**", "**may**", "**need not**", "**will**", "**will not**", "**can**" and "**cannot**" are to be interpreted as described in clause 3.2 of the [ETSI Drafting Rules](#) (Verbal forms for the expression of provisions).

"**must**" and "**must not**" are **NOT** allowed in ETSI deliverables except when used in direct citation.

# Contents

Intellectual Property Rights .....	2
Foreword.....	2
Modal verbs terminology.....	2
Foreword.....	16
1 Scope .....	17
2 References .....	18
3 Definitions and abbreviations.....	19
3.1 Definitions .....	19
3.2 Abbreviations .....	19
4 MCPTT UE configuration MO .....	19
4.1 General .....	19
4.2 MCPTT UE configuration MO parameters .....	20
4.2.1 General.....	20
4.2.2 Node: <x> .....	20
4.2.3 /<x>/Name .....	20
4.2.4 /<x>/Ext/ .....	21
4.2.5 /<x>/Common .....	21
4.2.6 /<x>/Common/PrivateCall .....	21
4.2.7 /<x>/Common/PrivateCall/MaxCallN10 .....	21
4.2.8 /<x>/Common/MCPTTGroupCall.....	21
4.2.9 /<x>/Common/MCPTTGroupCall/MaxCallN4 .....	22
4.2.10 /<x>/Common/MCPTTGroupCall/MaxTransmissionN5 .....	22
4.2.11 /<x>/Common/MCPTTGroupCall/PrioritizedMCPTTGroup.....	22
4.2.12 /<x>/Common/MCPTTGroupCall/PrioritizedMCPTTGroup/<x> .....	22
4.2.13 /<x>/Common/MCPTTGroupCall/PrioritizedMCPTTGroup/<x>/MCPTTGroupID .....	22
4.2.14 /<x>/Common/MCPTTGroupCall/PrioritizedMCPTTGroup/<x>/MCPTTGroupPriorityHierarchy.....	23
4.2.15 /<x>/OnNetwork .....	23
4.2.16 /<x>/OnNetwork/RelayService.....	23
4.2.17 /<x>/OnNetwork/IPv6Preferred.....	23
4.2.18 /<x>/OnNetwork/RelayedMCPTTGroup.....	24
4.2.19 /<x>/OnNetwork/RelayedMCPTTGroup/<x> .....	24
4.2.20 /<x>/OnNetwork/RelayedMCPTTGroup/<x>/MCPTTGroupID .....	24
4.2.21 /<x>/OnNetwork/RelayedMCPTTGroup/<x>/RelayServiceCode .....	24
5 MCPTT user profile MO.....	24
5.1 General .....	24
5.2 MCPTT user profile MO parameters.....	27
5.2.1 General.....	27
5.2.2 Node: <x> .....	27
5.2.3 /<x>/Name .....	27
5.2.4 /<x>/Ext/ .....	27
5.2.5 /<x>/<x> .....	27
5.2.6 /<x>/<x>/Common .....	28
5.2.7 /<x>/<x>/Common/MCPTTUserID.....	28
5.2.7A /<x>/<x>/Common/MCPTTUserProfileIndex .....	28
5.2.7B /<x>/<x>/Common/MCPTTUserProfileName.....	28
5.2.7C /<x>/<x>/Common/PreSelectedIndication.....	28
5.2.8 /<x>/<x>/Common/UserAliases.....	29
5.2.8A /<x>/<x>/Common/UserAliases/<x>.....	29
5.2.8B /<x>/<x>/Common/UserAliases/<x>/UserAlias .....	29
5.2.9 /<x>/<x>/Common/AuthorisedAlias.....	29
5.2.10 /<x>/<x>/Common/ParticipantType .....	30
5.2.11 /<x>/<x>/Common/Organization.....	30
5.2.12 /<x>/<x>/Common/PrivateCall.....	30

5.2.13	/<x>/<x>/Common/PrivateCall/Authorised .....	30
5.2.14	/<x>/<x>/Common/PrivateCall/AuthorisedAny .....	30
5.2.15	/<x>/<x>/Common/PrivateCall/UserList.....	31
5.2.16	/<x>/<x>/Common/PrivateCall/UserList/<x> .....	31
5.2.16A	/<x>/<x>/Common/PrivateCall/UserList/<x>/Entry .....	31
5.2.17	/<x>/<x>/Common/PrivateCall/UserList/<x>/Entry/MCPTTID.....	31
5.2.18	/<x>/<x>/Common/PrivateCall/UserList/<x>/Entry/DiscoveryGroupID.....	31
5.2.19	/<x>/<x>/Common/PrivateCall/UserList/<x>/Entry/UserInfoID .....	32
5.2.19A	/<x>/<x>/Common/PrivateCall/UserList/<x>/Entry/DisplayName .....	32
5.2.20	/<x>/<x>/Common/PrivateCall/ManualCommence.....	32
5.2.21	/<x>/<x>/Common/PrivateCall/AutoCommence.....	32
5.2.22	/<x>/<x>/Common/PrivateCall/AutoAnswer.....	32
5.2.23	/<x>/<x>/Common/PrivateCall/FailRestrict .....	33
5.2.24	/<x>/<x>/Common/PrivateCall/AllowedMediaProtection.....	33
5.2.25	/<x>/<x>/Common/PrivateCall/AllowedFloorControlProtection .....	33
5.2.26	/<x>/<x>/Common/PrivateCall/EmergencyCall .....	33
5.2.27	/<x>/<x>/Common/PrivateCall/EmergencyCall/Authorised .....	34
5.2.28	/<x>/<x>/Common/PrivateCall/EmergencyCall/CancelPriority .....	34
5.2.29	/<x>/<x>/Common/PrivateCall/EmergencyCall/MCPTTPrivateRecipient .....	34
5.2.29A	/<x>/<x>/Common/PrivateCall/EmergencyCall/MCPTTPrivateRecipient/Entry .....	34
5.2.29B	/<x>/<x>/Common/PrivateCall/EmergencyCall/MCPTTPrivateRecipient/Entry/ID .....	35
5.2.29C	/<x>/<x>/Common/PrivateCall/EmergencyCall/MCPTTPrivateRecipient/Entry/DiscoveryGroupID .....	35
5.2.29D	/<x>/<x>/Common/PrivateCall/EmergencyCall/MCPTTPrivateRecipient/Entry/UserInfoID.....	35
5.2.29E	/<x>/<x>/Common/PrivateCall/EmergencyCall/MCPTTPrivateRecipient/Entry/DisplayName .....	35
5.2.29F	/<x>/<x>/Common/PrivateCall/EmergencyCall/MCPTTPrivateRecipient/Entry/Usage .....	36
5.2.30	/<x>/<x>/Common/MCPTTGroupCall.....	36
5.2.31	/<x>/<x>/Common/MCPTTGroupCall/MaxSimultaneousCallsN6.....	36
5.2.32	/<x>/<x>/Common/MCPTTGroupCall/EmergencyCall .....	36
5.2.33	/<x>/<x>/Common/MCPTTGroupCall/EmergencyCall/Enabled .....	37
5.2.34	/<x>/<x>/Common/MCPTTGroupCall/EmergencyCall/MCPTTGroupInitiation .....	37
5.2.34A	/<x>/<x>/Common/MCPTTGroupCall/EmergencyCall/MCPTTGroupInitiation/Entry.....	37
5.2.34B	/<x>/<x>/Common/MCPTTGroupCall/EmergencyCall/MCPTTGroupInitiation/Entry/GroupID.....	37
5.2.34C	...../<x>/<x>/Common/MCPTTGroupCall/EmergencyCall/MCPTTGroupInitiation/Entry/DisplayName .....	38
5.2.34D	/<x>/<x>/Common/MCPTTGroupCall/EmergencyCall/MCPTTGroupInitiation/Entry/Usage .....	38
5.2.35	/<x>/<x>/Common/MCPTTGroupCall/EmergencyCall/CancelMCPTTGroup .....	38
5.2.36	/<x>/<x>/Common/MCPTTGroupCall/ImminentPerilCall .....	39
5.2.37	/<x>/<x>/Common/MCPTTGroupCall/ImminentPerilCall/Authorised .....	39
5.2.38	/<x>/<x>/Common/MCPTTGroupCall/ImminentPerilCall/Cancel .....	39
5.2.39	/<x>/<x>/Common/MCPTTGroupCall/ImminentPerilCall/MCPTTGroupInitiation .....	39
5.2.39A	/<x>/<x>/Common/MCPTTGroupCall/ImminentPerilCall/MCPTTGroupInitiation/Entry .....	39
5.2.39B	/<x>/<x>/Common/MCPTTGroupCall/ImminentPerilCall/MCPTTGroupInitiation/Entry/GroupID.....	40
5.2.39C	/<x>/<x>/Common/MCPTTGroupCall/ImminentPerilCall/MCPTTGroupInitiation/DisplayName .....	40
5.2.39D	/<x>/<x>/Common/MCPTTGroupCall/ImminentPerilCall/MCPTTGroupInitiation/Entry/Usage .....	40
5.2.40	/<x>/<x>/Common/MCPTTGroupCall/EmergencyAlert .....	41
5.2.41	/<x>/<x>/Common/MCPTTGroupCall/EmergencyAlert/Authorised.....	41
5.2.42	/<x>/<x>/Common/MCPTTGroupCall/EmergencyAlert/Cancel .....	41
5.2.43	Void .....	41
5.2.43A	/<x>/<x>/Common/MCPTTGroupCall/EmergencyAlert/Entry .....	41
5.2.43B	/<x>/<x>/Common/MCPTTGroupCall/EmergencyAlert/Entry/ID .....	41
5.2.43C	Void .....	42
5.2.43D	/<x>/<x>/Common/MCPTTGroupCall/EmergencyAlert/Entry/DisplayName.....	42
5.2.43E	/<x>/<x>/Common/MCPTTGroupCall/EmergencyAlert/Entry/Usage .....	42
5.2.43F	/<x>/<x>/Common/MCPTTGroupCall/Priority .....	42
5.2.44	Void .....	43
5.2.45	/<x>/<x>/Common/MCPTTGroupBroadcast .....	43
5.2.46	/<x>/<x>/Common/MCPTTGroupBroadcast/Authorised.....	43
5.2.47	/<x>/<x>/Common/UserBroadcast .....	43
5.2.48	/<x>/<x>/Common/UserBroadcast/Authorised.....	43
5.2.48A	/<x>/<x>/OnNetwork.....	43
5.2.48B1	/<x>/<x>/OnNetwork/MCPTTGroupList .....	44

5.2.48B2	/<x>/<x>/OnNetwork/MCPTTGroupList/<x> .....	44
5.2.48B3	/<x>/<x>/OnNetwork/MCPTTGroupList/<x>/Entry .....	44
5.2.48B4	/<x>/<x>/OnNetwork/MCPTTGroupList/<x>/Entry/MCPTTGroupID .....	44
5.2.48B5	/<x>/<x>/OnNetwork/MCPTTGroupList/<x>/Entry/DisplayName .....	44
5.2.48C1	/<x>/<x>/OnNetwork/ImplicitAffiliations .....	45
5.2.48C2	/<x>/<x>/OnNetwork/ImplicitAffiliations/<x> .....	45
5.2.48C3	/<x>/<x>/OnNetwork/ImplicitAffiliations/<x>/Entry .....	45
5.2.48C4	/<x>/<x>/OnNetwork/ImplicitAffiliations/<x>/Entry/MCPTTGroupID .....	45
5.2.48C5	/<x>/<x>/OnNetwork/ImplicitAffiliations/<x>/Entry/DisplayName .....	45
5.2.48D	/<x>/<x>/OnNetwork/AllowedRegroup .....	45
5.2.48E	/<x>/<x>/OnNetwork/AllowedPresenceStatus .....	46
5.2.48F	/<x>/<x>/OnNetwork/AllowedPresence .....	46
5.2.48G	/<x>/<x>/OnNetwork/EnabledParticipation .....	46
5.2.48H	/<x>/<x>/OnNetwork/AllowedTransmission .....	46
5.2.48I	/<x>/<x>/OnNetwork/AllowedManualSwitch .....	47
5.2.48J	/<x>/<x>/OnNetwork/PrivateCall .....	47
5.2.48K	/<x>/<x>/OnNetwork/PrivateCall/EmergencyAlert .....	47
5.2.48L	/<x>/<x>/OnNetwork/PrivateCall/EmergencyAlert/Entry .....	47
5.2.48M	/<x>/<x>/OnNetwork/PrivateCall/EmergencyAlert/Entry/ID .....	48
5.2.48N	/<x>/<x>/OnNetwork/PrivateCall/EmergencyAlert/Entry/DisplayName .....	48
5.2.48O	/<x>/<x>/OnNetwork/PrivateCall/EmergencyAlert/Entry/Usage .....	48
5.2.48P	/<x>/<x>/OnNetwork/PrivateCall/AllowedCallBackRequest .....	48
5.2.48Q	/<x>/<x>/OnNetwork/PrivateCall/AllowedCallBackCancelRequest .....	49
5.2.48R	/<x>/<x>/OnNetwork/PrivateCall/AllowedRemoteInitiatedAmbientListening .....	49
5.2.48S	/<x>/<x>/OnNetwork/PrivateCall/AllowedLocallyInitiatedAmbientListening .....	49
5.2.48T	/<x>/<x>/OnNetwork/PrivateCall/AllowedRequestFirstToAnswerCall .....	49
5.2.48U1	/<x>/<x>/OnNetwork/RemoteGroupSelection .....	50
5.2.48U2	/<x>/<x>/OnNetwork/RemoteGroupSelection/<x> .....	50
5.2.48U3	/<x>/<x>/OnNetwork/RemoteGroupSelection/<x>/Entry .....	50
5.2.48U4	/<x>/<x>/OnNetwork/RemoteGroupSelection/<x>/Entry/MCPTTID .....	50
5.2.48U5	/<x>/<x>/OnNetwork/RemoteGroupSelection/<x>/Entry/DisplayName .....	50
5.2.48V1	/<x>/<x>/OnNetwork/GroupServerInfo .....	51
5.2.48V2	/<x>/<x>/OnNetwork/GroupServerInfo/GMSServList .....	51
5.2.48V3	/<x>/<x>/OnNetwork/GroupServerInfo/GMSServList/<x> .....	51
5.2.48V4	/<x>/<x>/OnNetwork/GroupServerInfo/GMSServList/<x>/Entry .....	51
5.2.48V5	/<x>/<x>/OnNetwork/GroupServerInfo/GMSServList/<x>/Entry/GMSServID .....	51
5.2.48V6	/<x>/<x>/OnNetwork/GroupServerInfo/IDMSTokenEndpointList .....	52
5.2.48V7	/<x>/<x>/OnNetwork/GroupServerInfo/IDMSTokenEndpointList/<x> .....	52
5.2.48V8	/<x>/<x>/OnNetwork/GroupServerInfo/IDMSTokenEndpointList/<x>/Entry .....	52
5.2.48V9	/<x>/<x>/OnNetwork/GroupServerInfo/IDMSTokenEndpointList/<x>/Entry/IDMSTokenID .....	52
5.2.49	/<x>/<x>/OffNetwork .....	52
5.2.50	/<x>/<x>/OffNetwork/Authorised .....	53
5.2.51	/<x>/<x>/OffNetwork/MCPTTGroupInfo .....	53
5.2.52	/<x>/<x>/OffNetwork/MCPTTGroupInfo/<x> .....	53
5.2.52A	/<x>/<x>/OffNetwork/MCPTTGroupInfo/<x>/Entry .....	53
5.2.53	/<x>/<x>/OffNetwork/MCPTTGroupInfo/<x>/Entry/MCPTTGroupID .....	53
5.2.53A	/<x>/<x>/OffNetwork/MCPTTGroupInfo/<x>/Entry/DisplayName .....	54
5.2.54	/<x>/<x>/OffNetwork/AllowedListen .....	54
5.2.55	/<x>/<x>/OffNetwork/AllowedTransmission .....	54
5.2.56	/<x>/<x>/OffNetwork/EmergencyCallChange .....	54
5.2.57	/<x>/<x>/OffNetwork/ImminentPerilCallChange .....	55
5.2.58	/<x>/<x>/OffNetwork/UserInfoID .....	55
5.2.59	/<x>/Status .....	55
6	MCS group configuration MO .....	55
6.1	General .....	55
6.2	MCS group configuration MO parameters .....	60
6.2.1	General .....	60
6.2.2	Node: <x> .....	60
6.2.3	/<x>/Name .....	60
6.2.4	/<x>/Ext/ .....	60
6.2.5	/<x>/<x> .....	60

6.2.6	/<x>/<x>/Common .....	61
6.2.7	/<x>/<x>/Common/MCPTTGroupID .....	61
6.2.8	/<x>/<x>/Common/MCPTTGroupAlias .....	61
6.2.9	/<x>/<x>/Common/MCPTTGroupMemberList .....	61
6.2.10	/<x>/<x>/Common/MCPTTGroupMemberList/<x> .....	61
6.2.11	/<x>/<x>/Common/MCPTTGroupMemberList/<x>/MCPTTID .....	62
6.2.12	/<x>/<x>/Common/MCPTTGroupMemberList/<x>/UserPriority .....	62
6.2.13	/<x>/<x>/Common/MCPTTGroupMemberList/<x>/ParticipantType .....	62
6.2.14	Void .....	62
6.2.15	/<x>/<x>/Common/MCPTTGroupOwner .....	62
6.2.16	/<x>/<x>/Common/PreferredVoiceCodec .....	63
6.2.17	/<x>/<x>/Common/MCPTTGroupLevel .....	63
6.2.18	/<x>/<x>/Common/UserLevel .....	63
6.2.19	/<x>/<x>/Common/AllowedEmergencyCall .....	63
6.2.20	/<x>/<x>/Common/AllowedImminentPerilCall .....	64
6.2.21	/<x>/<x>/Common/AllowedEmergencyAlert .....	64
6.2.22	/<x>/<x>/Common/MediaProtectionRequired .....	64
6.2.23	/<x>/<x>/Common/FloorControlProtectionRequired .....	64
6.2.23A	/<x>/<x>/Common/MediaProtectionSecurityMaterial .....	65
6.2.23B	/<x>/<x>/Common/MCData .....	65
6.2.23C	/<x>/<x>/Common/MCData/MediaProtectionRequired .....	65
6.2.23D	/<x>/<x>/Common/MCData/TxControlProtectionRequired .....	65
6.2.23E	/<x>/<x>/Common/MCData/MediaProtectionSecurityMaterial .....	66
6.2.23F	/<x>/<x>/Common/MCData/AllowedSDS .....	66
6.2.23G	/<x>/<x>/Common/MCData/AllowedFD .....	66
6.2.23H	/<x>/<x>/Common/MCData/AllowedConvMgmt .....	66
6.2.23I	/<x>/<x>/Common/MCData/AllowedTxControl .....	66
6.2.23J	/<x>/<x>/Common/MCData/AllowedRxControl .....	67
6.2.23K	/<x>/<x>/Common/MCData/AllowedEnhSvc .....	67
6.2.23L	/<x>/<x>/Common/MCData/EnhSvcOpValues .....	67
6.2.23M	/<x>/<x>/Common/MCData/EnhSvcOpValues/<x> .....	67
6.2.23N	/<x>/<x>/Common/MCData/EnhSvcOpValues/<x>/EnhSvcOpValue .....	67
6.2.23O	/<x>/<x>/Common/MCData/AllowedTransmitDataInGroup .....	68
6.2.23P	/<x>/<x>/Common/MCData/MaxDataSingleRequest .....	68
6.2.23Q	/<x>/<x>/Common/MCData/MaxTimeSingleRequest .....	68
6.2.23R	/<x>/<x>/Common/MCVideo .....	68
6.2.23S	/<x>/<x>/Common/MCVideo/MediaProtectionRequired .....	68
6.2.23T	/<x>/<x>/Common/MCVideo/TxControlProtectionRequired .....	69
6.2.23U	/<x>/<x>/Common/MCVideo/MediaProtectionSecurityMaterial .....	69
6.2.23V	/<x>/<x>/Common/MCVideo/AllowedAudioCodecs .....	69
6.2.23W	/<x>/<x>/Common/MCVideo/AllowedAudioCodecs/<x> .....	69
6.2.23X	/<x>/<x>/Common/MCVideo/AllowedAudioCodecs/<x>/AudioCodec .....	70
6.2.23Y	/<x>/<x>/Common/MCVideo/AllowedVideoCodecs .....	70
6.2.23Z	/<x>/<x>/Common/MCVideo/AllowedVideoCodecs/<x> .....	70
6.2.23AA	/<x>/<x>/Common/MCVideo/AllowedVideoCodecs/<x>/VideoCodec .....	70
6.2.23AB	/<x>/<x>/Common/MCVideo/AllowedVideoResolutions .....	70
6.2.23AC	/<x>/<x>/Common/MCVideo/AllowedVideoResolutions/<x> .....	71
6.2.23AD	/<x>/<x>/Common/MCVideo/AllowedVideoResolutions/<x>/VideoResolution .....	71
6.2.23AE	/<x>/<x>/Common/MCVideo/AllowedVideoFrameRates .....	71
6.2.23AF	/<x>/<x>/Common/MCVideo/AllowedVideoFrameRates/<x> .....	71
6.2.23AG	/<x>/<x>/Common/MCVideo/AllowedVideoFrameRates/<x>/FrameRate .....	71
6.2.23AH	/<x>/<x>/Common/MCVideo/AllowedUrgentRealTimeMode .....	72
6.2.23AI	/<x>/<x>/Common/MCVideo/AllowedNonUrgentRealTimeMode .....	72
6.2.23AJ	/<x>/<x>/Common/MCVideo/AllowedNonRealTimeMode .....	72
6.2.23AK	/<x>/<x>/Common/MCVideo/ActiveNonRealTimeMode .....	72
6.2.23AL	/<x>/<x>/Common/MCVideo/MaxTransmitMembers .....	73
6.2.24	/<x>/<x>/OffNetwork .....	73
6.2.25	/<x>/<x>/OffNetwork/MCPTTGroupParameter .....	73
6.2.26	/<x>/<x>/OffNetwork/MCPTTGroupParameter/<x> .....	73
6.2.27	/<x>/<x>/OffNetwork/MCPTTGroupParameter/<x>/ProSeLayer2GroupID .....	73
6.2.28	/<x>/<x>/OffNetwork/MCPTTGroupParameter/<x>/IPMulticastAddress .....	74
6.2.29	/<x>/<x>/OffNetwork/MCPTTGroupParameter/<x>/RelayServiceCode .....	74

6.2.30	/<x>/<x>/OffNetwork/MCPTTGroupParameter/<x>/IPVersions .....	74
6.2.31	/<x>/<x>/OffNetwork/EmergencyCallCancel .....	74
6.2.32	/<x>/<x>/OffNetwork/ImminentPerilCallCancel .....	75
6.2.33	/<x>/<x>/OffNetwork/HangTime .....	75
6.2.34	/<x>/<x>/OffNetwork/MaxDuration .....	75
6.2.34A	/<x>/<x>/OffNetwork/QueueUsage .....	75
6.2.35	/<x>/<x>/OffNetwork/DefaultPPPP .....	76
6.2.36	/<x>/<x>/OffNetwork/DefaultPPPP/MCPTTGroupCallSignalling.....	76
6.2.37	/<x>/<x>/OffNetwork/DefaultPPPP/MCPTTGroupCallMedia.....	76
6.2.38	/<x>/<x>/OffNetwork/DefaultPPPP/MCPTTEmergencyGroupCallSignalling.....	76
6.2.39	/<x>/<x>/OffNetwork/DefaultPPPP/MCPTTEmergencyGroupCallMedia.....	77
6.2.40	/<x>/<x>/OffNetwork/DefaultPPPP/MCPTTImminentPerilGroupCallSignalling.....	77
6.2.41	/<x>/<x>/OffNetwork/DefaultPPPP/MCPTTImminentPerilGroupCallMedia.....	77
6.2.42	/<x>/<x>/OffNetwork/MCData .....	78
6.2.43	/<x>/<x>/OffNetwork/MCData/DefaultPPPP .....	78
6.2.44	/<x>/<x>/OffNetwork/MCData/DefaultPPPP/MCDataGroupCallSignalling .....	78
6.2.45	/<x>/<x>/OffNetwork/MCData/DefaultPPPP/MCDataGroupCallMedia.....	78
6.2.46	/<x>/<x>/OffNetwork/MCVideo.....	79
6.2.47	/<x>/<x>/OffNetwork/MCVideo/ArbitrationApproach.....	79
6.2.48	/<x>/<x>/OffNetwork/MCVideo/MaxTransmissions .....	79
6.2.49	/<x>/<x>/OffNetwork/MCVideo/DefaultPPPP .....	79
6.2.50	/<x>/<x>/OffNetwork/MCVideo/DefaultPPPP/MCVideoGroupCallSignalling .....	80
6.2.51	/<x>/<x>/OffNetwork/MCVideo/DefaultPPPP/MCVideoGroupCallMedia .....	80
6.2.52	/<x>/<x>/OffNetwork/MCVideo/DefaultPPPP/MCVideoEmergencyGroupCallSignalling .....	80
6.2.53	/<x>/<x>/OffNetwork/MCVideo/DefaultPPPP/MCVideoEmergencyGroupCallMedia .....	81
6.2.54	/<x>/<x>/OffNetwork/MCVideo/DefaultPPPP/MCVideoImminentPerilGroupCallSignalling .....	81
6.2.55	/<x>/<x>/OffNetwork/MCVideo/DefaultPPPP/MCVideoImminentPerilGroupCallMedia .....	81
7	MCPTT service configuration MO .....	82
7.1	General .....	82
7.2	MCPTT service configuration MO parameters .....	83
7.2.1	General.....	83
7.2.2	Node: <x> .....	83
7.2.3	/<x>/Name .....	83
7.2.4	/<x>/Ext/ .....	83
7.2.5	/<x>/Common .....	83
7.2.6	/<x>/Common/BroadcastMCPTTGroupCall .....	84
7.2.7	/<x>/Common/BroadcastMCPTTGroupCall/NumLevelGroupHierarchy .....	84
7.2.8	/<x>/Common/BroadcastMCPTTGroupCall/NumLevelUserHierarchy.....	84
7.2.9	/<x>/Common/MinLengthAliasID.....	84
7.2.10	/<x>/OffNetwork .....	84
7.2.11	/<x>/OffNetwork/PrivateCall .....	85
7.2.12	/<x>/OffNetwork/PrivateCall/MaxDuration .....	85
7.2.13	/<x>/OffNetwork/PrivateCall/HangTime .....	85
7.2.14	/<x>/OffNetwork/PrivateCall/CancelTimeout.....	85
7.2.15	/<x>/OffNetwork/EmergencyCall.....	86
7.2.16	/<x>/OffNetwork/EmergencyCall/MCPTTGroupTimeout.....	86
7.2.17	/<x>/OffNetwork/NumLevelHierarchy .....	86
7.2.18	/<x>/OffNetwork/TransmitTimeout.....	86
7.2.19	/<x>/OffNetwork/TransmissionWarning .....	86
7.2.20	/<x>/OffNetwork/HangTimeWarning .....	87
7.2.21	/<x>/OffNetwork/DefaultPPPP.....	87
7.2.22	/<x>/OffNetwork/DefaultPPPP/MCPTTPrivateCallSignalling .....	87
7.2.23	/<x>/OffNetwork/DefaultPPPP/MCPTTPrivateCallMedia .....	87
7.2.24	/<x>/OffNetwork/DefaultPPPP/MCPTTEmergencyPrivateCallSignalling .....	88
7.2.25	/<x>/OffNetwork/DefaultPPPP/MCPTTEmergencyPrivateCallMedia .....	88
7.2.26	/<x>/OffNetwork/LogMetadata .....	88
8	MCS UE initial configuration MO .....	88
8.1	General .....	88
8.2	MCS UE initial configuration MO parameters.....	93
8.2.1	General.....	93



8.2.2	Node: <x> .....	93
8.2.3	/<x>/Name .....	93
8.2.4	/<x>/Ext/ .....	93
8.2.5	/<x>/DefaultUserProfile.....	94
8.2.6	/<x>/DefaultUserProfile/UserID.....	94
8.2.7	/<x>/DefaultUserProfile/UserProfileIndex .....	94
8.2.8	/<x>/OnNetwork .....	94
8.2.9	/<x>/OnNetwork/GMSURI.....	95
8.2.9A	/<x>/OnNetwork/GroupCreationXUI .....	95
8.2.9B	/<x>/OnNetwork/GMSXCAPRootURI .....	95
8.2.9C	/<x>/OnNetwork/CMSXCAPRootURI .....	95
8.2.10	/<x>/OnNetwork/Timers.....	95
8.2.11	/<x>/OnNetwork/Timers/T100 .....	96
8.2.12	/<x>/OnNetwork/Timers/T101 .....	96
8.2.13	/<x>/OnNetwork/Timers/T103 .....	96
8.2.14	/<x>/OnNetwork/Timers/T104 .....	96
8.2.15	/<x>/OnNetwork/Timers/T132 .....	96
8.2.16	/<x>/OnNetwork/HPLMN .....	97
8.2.17	/<x>/OnNetwork/HPLMN/PLMN .....	97
8.2.18	/<x>/OnNetwork/HPLMN/Service .....	97
8.2.19	/<x>/OnNetwork/HPLMN/Service/MCPTTToConRef .....	97
8.2.20	/<x>/OnNetwork/HPLMN/Service/MCPTTToConRef/<x> .....	97
8.2.21	/<x>/OnNetwork/HPLMN/Service/MCPTTToConRef/<x>/ConRef .....	98
8.2.22	/<x>/OnNetwork/HPLMN/Service/MCCommonCoreToConRef.....	98
8.2.23	/<x>/OnNetwork/HPLMN/Service/MCCommonCoreToConRef/<x> .....	98
8.2.24	/<x>/OnNetwork/HPLMN/Service/MCCommonCoreToConRef/<x>/ConRef.....	98
8.2.25	/<x>/OnNetwork/HPLMN/Service/MCIDMToConRef .....	98
8.2.26	/<x>/OnNetwork/HPLMN/Service/MCIDMToConRef/<x>.....	99
8.2.27	/<x>/OnNetwork/HPLMN/Service/MCIDMToConRef/<x>/ConRef .....	99
8.2.28	/<x>/OnNetwork/HPLMN/VPLMN .....	99
8.2.29	/<x>/OnNetwork/HPLMN/VPLMN/PLMN .....	99
8.2.30	/<x>/OnNetwork/HPLMN/VPLMN/Service .....	99
8.2.31	/<x>/OnNetwork/HPLMN/VPLMN/Service/MCPTTToConRef .....	100
8.2.32	/<x>/OnNetwork/HPLMN/VPLMN/Service/MCPTTToConRef/<x> .....	100
8.2.33	/<x>/OnNetwork/HPLMN/VPLMN/Service/MCPTTToConRef/<x>/ConRef .....	100
8.2.34	/<x>/OnNetwork/HPLMN/VPLMN/Service/MCCommonCoreToConRef.....	100
8.2.35	/<x>/OnNetwork/HPLMN/VPLMN/Service/MCCommonCoreToConRef/<x> .....	100
8.2.36	/<x>/OnNetwork/HPLMN/VPLMN/Service/MCCommonCoreToConRef/<x>/ConRef.....	101
8.2.37	/<x>/OnNetwork/HPLMN/VPLMN/Service/MCIDMToConRef .....	101
8.2.38	/<x>/OnNetwork/HPLMN/VPLMN/Service/MCIDMToConRef/<x>.....	101
8.2.39	/<x>/OnNetwork/HPLMN/VPLMN/Service/MCIDMToConRef/<x>/ConRef .....	101
8.2.40	/<x>/OnNetwork/AppServerInfo .....	102
8.2.41	/<x>/OnNetwork/AppServerInfo/IDMSAuthEndpoint.....	102
8.2.41A	/<x>/OnNetwork/AppServerInfo/IDMSTokenEndpoint .....	102
8.2.42	/<x>/OnNetwork/AppServerInfo/GMS .....	102
8.2.43	/<x>/OnNetwork/AppServerInfo/CMS.....	102
8.2.44	/<x>/OnNetwork/AppServerInfo/KMS .....	103
8.2.45	/<x>/OffNetwork .....	103
8.2.46	/<x>/OffNetwork/Timers .....	103
8.2.47	/<x>/OffNetwork/Timers/TFG1 .....	103
8.2.48	/<x>/OffNetwork/Timers/TFG2 .....	104
8.2.49	/<x>/OffNetwork/Timers/TFG3 .....	104
8.2.50	/<x>/OffNetwork/Timers/TFG4 .....	104
8.2.51	/<x>/OffNetwork/Timers/TFG5 .....	104
8.2.52	/<x>/OffNetwork/Timers/TFG11 .....	105
8.2.53	/<x>/OffNetwork/Timers/TFG12 .....	105
8.2.54	/<x>/OffNetwork/Timers/TFG13 .....	105
8.2.55	/<x>/OffNetwork/Timers/TFP1 .....	105
8.2.56	/<x>/OffNetwork/Timers/TFP2 .....	106
8.2.57	/<x>/OffNetwork/Timers/TFP3 .....	106
8.2.58	/<x>/OffNetwork/Timers/TFP4 .....	106
8.2.59	/<x>/OffNetwork/Timers/TFP5 .....	106

8.2.60	/<x>/OffNetwork/Timers/TFP6 .....	107
8.2.61	/<x>/OffNetwork/Timers/TFP7 .....	107
8.2.62	/<x>/OffNetwork/Timers/TFB1 .....	107
8.2.63	/<x>/OffNetwork/Timers/TFB2 .....	107
8.2.64	/<x>/OffNetwork/Timers/TFB3 .....	108
8.2.65	/<x>/OffNetwork/Timers/T201 .....	108
8.2.66	/<x>/OffNetwork/Timers/T203 .....	108
8.2.67	/<x>/OffNetwork/Timers/T204 .....	108
8.2.68	/<x>/OffNetwork/Timers/T205 .....	109
8.2.69	/<x>/OffNetwork/Timers/T230 .....	109
8.2.70	/<x>/OffNetwork/Timers/T233 .....	109
8.2.71	/<x>/OffNetwork/Timers/TFE1 .....	109
8.2.72	/<x>/OffNetwork/Timers/TFE2 .....	109
8.2.73	/<x>/OffNetwork/Counters .....	110
8.2.74	/<x>/OffNetwork/Counters/CFP1 .....	110
8.2.75	/<x>/OffNetwork/Counters/CFP3 .....	110
8.2.76	/<x>/OffNetwork/Counters/CFP4 .....	110
8.2.77	/<x>/OffNetwork/Counters/CFP6 .....	111
8.2.78	/<x>/OffNetwork/Counters/CFP11 .....	111
8.2.79	/<x>/OffNetwork/Counters/CFP12 .....	111
8.2.80	/<x>/OffNetwork/Counters/C201 .....	111
8.2.81	/<x>/OffNetwork/Counters/C204 .....	111
8.2.82	/<x>/OffNetwork/Counters/C205 .....	112
9	MCDData UE configuration MO .....	112
9.1	General .....	112
9.2	MCDData UE configuration MO parameters .....	113
9.2.1	General .....	113
9.2.2	Node: <x> .....	113
9.2.3	/<x>/Name .....	113
9.2.4	/<x>/Ext/ .....	114
9.2.5	/<x>/Common .....	114
9.2.6	/<x>/Common/MCDDataGroupTxns .....	114
9.2.7	/<x>/Common/MCDDataGroupTxns/MaxSDSNc4 .....	114
9.2.8	/<x>/Common/MCDDataGroupTxns/SDSPresentationPriority .....	115
9.2.9	/<x>/Common/MCDDataGroupTxns/SDSPresentationPriority/<x> .....	115
9.2.10	/<x>/Common/MCDDataGroupTxns/SDSPresentationPriority/<x>/MCDDataGroupID .....	115
9.2.11	/<x>/Common/MCDDataGroupTxns/SDSPresentationPriority/<x>/MCDDataGroupPriorityHierarchy .....	115
9.2.12	/<x>/Common/MCDDataGroupTxns/MaxFDNc4 .....	115
9.2.13	/<x>/Common/MCDDataGroupTxns/FDPresentationPriority .....	116
9.2.14	/<x>/Common/MCDDataGroupTxns/FDPresentationPriority/<x> .....	116
9.2.15	/<x>/Common/MCDDataGroupTxns/FDPresentationPriority/<x>/MCDDataGroupID .....	116
9.2.16	/<x>/Common/MCDDataGroupTxns/FDPresentationPriority/<x>/MCDDataGroupPriorityHierarchy .....	116
9.2.17	/<x>/Common/MCDDataGroupTxns/ConversationPresentationPriority .....	117
9.2.18	/<x>/Common/MCDDataGroupTxns/ConversationPresentationPriority/<x> .....	117
9.2.19	/<x>/Common/MCDDataGroupTxns/ConversationPresentationPriority/<x>/MCDDataGroupID .....	117
9.2.20	/<x>/Common/MCDDataGroupTxns/ConversationPresentationPriority/<x>/MCDDataGroupPriorityHierarchy .....	117
9.2.21	/<x>/Common/MCDDataGroupTxns/MaxTCNc4 .....	118
9.2.22	/<x>/Common/MCDDataGroupTxns/MaxTCNc5 .....	118
9.2.23	/<x>/Common/MCDDataGroupTxns/DataPresentationPriority .....	118
9.2.24	/<x>/Common/MCDDataGroupTxns/DataPresentationPriority/<x> .....	118
9.2.25	/<x>/Common/MCDDataGroupTxns/DataPresentationPriority/<x>/MCDDataGroupID .....	118
9.2.26	/<x>/Common/MCDDataGroupTxns/DataPresentationPriority/<x>/MCDDataGroupPriorityHierarchy .....	119
9.2.27	/<x>/Common/MCDDataGroupTxns/MaxRCNc4 .....	119
9.2.28	/<x>/Common/MCDDataGroupTxns/MaxRCNc5 .....	119
9.2.29	/<x>/OnNetwork .....	119
9.2.30	/<x>/OnNetwork/RelayService .....	119
9.2.31	/<x>/OnNetwork/IPv6Preferred .....	120
9.2.32	/<x>/OnNetwork/RelayedMCDDataGroup .....	120
9.2.33	/<x>/OnNetwork/RelayedMCDDataGroup/<x> .....	120

9.2.34	/<x>/OnNetwork/RelayedMCDataGroup/<x>/MCDataGroupID .....	120
9.2.35	/<x>/OnNetwork/RelayedMCDataGroup/<x>/RelayServiceCode .....	121
10	MCData user profile MO .....	121
10.1	General .....	121
10.2	MCData user profile MO parameters .....	124
10.2.1	General.....	124
10.2.2	Node: <x> .....	124
10.2.3	/<x>/Name .....	124
10.2.4	/<x>/Ext/ .....	125
10.2.5	/<x>/<x> .....	125
10.2.6	/<x>/<x>/Common .....	125
10.2.7	/<x>/<x>/Common/MCDataUserID .....	125
10.2.8	/<x>/<x>/Common/MCDataUserProfileIndex.....	125
10.2.9	/<x>/<x>/Common/MCDataUserProfileName .....	126
10.2.10	/<x>/<x>/Common/PreSelectedIndication.....	126
10.2.11	/<x>/<x>/Common/UserAliases .....	126
10.2.12	/<x>/<x>/Common/UserAliases/<x>.....	126
10.2.13	/<x>/<x>/Common/UserAliases/<x>UserAlias .....	126
10.2.14	/<x>/<x>/Common/AuthorisedAlias.....	127
10.2.15	/<x>/<x>/Common/ParticipantType .....	127
10.2.16	/<x>/<x>/Common/Organization.....	127
10.2.17	/<x>/<x>/Common/FileDistribution .....	127
10.2.18	/<x>/<x>/Common/FileDistribution/CancelList.....	127
10.2.19	/<x>/<x>/Common/FileDistribution/CancelList/<x> .....	128
10.2.20	/<x>/<x>/Common/FileDistribution/CancelList/<x>/Entry .....	128
10.2.21	/<x>/<x>/Common/FileDistribution/CancelList/<x>/Entry/MCDataID .....	128
10.2.22	/<x>/<x>/Common/FileDistribution/CancelList/<x>/Entry/DisplayName .....	128
10.2.23	/<x>/<x>/Common/TxRxControl.....	128
10.2.24	/<x>/<x>/Common/TxRxControl/AuthorisedTransmit .....	129
10.2.25	/<x>/<x>/Common/TxRxControl/MaxData1To1.....	129
10.2.26	/<x>/<x>/Common/TxRxControl/MaxTime1To1 .....	129
10.2.27	/<x>/<x>/Common/TxRxControl/ReleaseList.....	129
10.2.28	/<x>/<x>/Common/TxRxControl/ReleaseList/<x> .....	130
10.2.29	/<x>/<x>/Common/TxRxControl/ReleaseList/<x>/Entry .....	130
10.2.30	/<x>/<x>/Common/TxRxControl/ReleaseList/<x>/Entry/MCDataID .....	130
10.2.31	/<x>/<x>/Common/TxRxControl/ReleaseList/<x>/Entry/DisplayName .....	130
10.2.32	/<x>/<x>/Common/MCDataGroupBroadcast .....	130
10.2.33	/<x>/<x>/Common/MCDataGroupBroadcast/Authorised .....	130
10.2.34	/<x>/<x>/Common/UserBroadcast .....	131
10.2.35	/<x>/<x>/Common/UserBroadcast/Authorised.....	131
10.2.36	/<x>/<x>/Common/GroupEmergencyAlert .....	131
10.2.37	/<x>/<x>/Common/GroupEmergencyAlert/Entry .....	131
10.2.38	/<x>/<x>/Common/GroupEmergencyAlert/Entry/ID .....	131
10.2.39	/<x>/<x>/Common/GroupEmergencyAlert/Entry/DisplayName .....	132
10.2.40	/<x>/<x>/Common/GroupEmergencyAlert/Entry/Usage .....	132
10.2.41	/<x>/<x>/Common/AllowedActivateAlert .....	132
10.2.42	/<x>/<x>/Common/AllowedCancelAlert .....	132
10.2.43	/<x>/<x>/OnNetwork.....	133
10.2.44	/<x>/<x>/OnNetwork/MCDataGroupList.....	133
10.2.45	/<x>/<x>/OnNetwork/MCDataGroupList/<x>.....	133
10.2.46	/<x>/<x>/OnNetwork/MCDataGroupList/<x>/Entry .....	133
10.2.47	/<x>/<x>/OnNetwork/MCDataGroupList/<x>/Entry/MCDataGroupID.....	133
10.2.48	/<x>/<x>/OnNetwork/MCDataGroupList/<x>/Entry/DisplayName .....	134
10.2.49	/<x>/<x>/OnNetwork/MCDataGroupList/<x>/Entry/GMSAppServList .....	134
10.2.50	/<x>/<x>/OnNetwork/MCDataGroupList/<x>/Entry/GMSAppServList/<x> .....	134
10.2.51	/<x>/<x>/OnNetwork/MCDataGroupList/<x>/Entry/GMSAppServList/<x>/GMSAppServId .....	134
10.2.52	/<x>/<x>/OnNetwork/MCDataGroupList/<x>/Entry/IdMSTokenEndPointList .....	134
10.2.53	/<x>/<x>/OnNetwork/MCDataGroupList/<x>/Entry/IdMSTokenEndPointList/<x> .....	135
10.2.54	/<x>/<x>/OnNetwork/MCDataGroupList/<x>/Entry/IdMSTokenEndPointList/<x>/IdMSTokenEndPoint .....	135

10.2.55	/<x>/<x>/OnNetwork/MCDataGroupList/<x>/Entry/PresentationPriority .....	135
10.2.56	/<x>/<x>/OnNetwork/ImplicitAffiliations .....	135
10.2.57	/<x>/<x>/OnNetwork/ImplicitAffiliations/<x> .....	136
10.2.58	/<x>/<x>/OnNetwork/ImplicitAffiliations/<x>/Entry .....	136
10.2.59	/<x>/<x>/OnNetwork/ImplicitAffiliations/<x>/Entry/MCDataGroupID .....	136
10.2.60	/<x>/<x>/OnNetwork/ImplicitAffiliations/<x>/Entry/DisplayName .....	136
10.2.61	/<x>/<x>/OnNetwork/PresenceStatus .....	136
10.2.62	/<x>/<x>/OnNetwork/PresenceStatus/<x> .....	136
10.2.63	/<x>/<x>/OnNetwork/PresenceStatus/<x>/Entry .....	137
10.2.64	/<x>/<x>/OnNetwork/PresenceStatus/<x>/Entry/MCDataGroupID .....	137
10.2.65	/<x>/<x>/OnNetwork/PresenceStatus/<x>/Entry/DisplayName .....	137
10.2.66	/<x>/<x>/OnNetwork/RemoteGroupChange .....	137
10.2.67	/<x>/<x>/OnNetwork/RemoteGroupChange/<x> .....	137
10.2.68	/<x>/<x>/OnNetwork/RemoteGroupChange/<x>/Entry .....	138
10.2.69	/<x>/<x>/OnNetwork/RemoteGroupChange/<x>/Entry/MCDataGroupID .....	138
10.2.70	/<x>/<x>/OnNetwork/RemoteGroupChange/<x>/Entry/DisplayName .....	138
10.2.71	/<x>/<x>/OnNetwork/MaxAffiliationsN2 .....	138
10.2.72	/<x>/<x>/OnNetwork/ConversationManagement .....	138
10.2.73	/<x>/<x>/OnNetwork/ConversationManagement/GroupHangTime .....	139
10.2.74	/<x>/<x>/OnNetwork/ConversationManagement/GroupHangTime/<x> .....	139
10.2.75	/<x>/<x>/OnNetwork/ConversationManagement/GroupHangTime/<x>/Entry .....	139
10.2.76	/<x>/<x>/OnNetwork/ConversationManagement/GroupHangTime/<x>/Entry/MCDataGroupID .....	139
10.2.77	/<x>/<x>/OnNetwork/ConversationManagement/GroupHangTime/<x>/Entry/DisplayName .....	140
10.2.78	/<x>/<x>/OnNetwork/ConversationManagement/GroupHangTime/<x>/Entry/HangTime .....	140
10.2.79	/<x>/<x>/OnNetwork/ConversationManagement/DeliveredDisposition .....	140
10.2.80	/<x>/<x>/OnNetwork/ConversationManagement/DeliveredDisposition/<x> .....	140
10.2.81	/<x>/<x>/OnNetwork/ConversationManagement/DeliveredDisposition/<x>/Entry .....	141
10.2.82	/<x>/<x>/OnNetwork/ConversationManagement/DeliveredDisposition/<x>/Entry/MCDataID .....	141
10.2.83	/<x>/<x>/OnNetwork/ConversationManagement/DeliveredDisposition/<x>/Entry/DisplayName .....	141
10.2.84	/<x>/<x>/OnNetwork/ConversationManagement/ReadDisposition .....	141
10.2.85	/<x>/<x>/OnNetwork/ConversationManagement/ReadDisposition/<x> .....	142
10.2.86	/<x>/<x>/OnNetwork/ConversationManagement/ReadDisposition/<x>/Entry .....	142
10.2.87	/<x>/<x>/OnNetwork/ConversationManagement/ReadDisposition/<x>/Entry/MCDataID .....	142
10.2.88	/<x>/<x>/OnNetwork/ConversationManagement/ReadDisposition/<x>/Entry/DisplayName .....	142
10.2.89	/<x>/<x>/OnNetwork/OneToOneEmergencyAlert .....	143
10.2.90	/<x>/<x>/OnNetwork/OneToOneEmergencyAlert/Entry .....	143
10.2.91	/<x>/<x>/OnNetwork/OneToOneEmergencyAlert/Entry/ID .....	143
10.2.92	/<x>/<x>/OnNetwork/OneToOneEmergencyAlert/Entry/DisplayName .....	143
10.2.93	/<x>/<x>/OnNetwork/OneToOneEmergencyAlert/Entry/Usage .....	143
10.2.94	/<x>/<x>/OnNetwork/AllowedRegroup .....	144
10.2.95	/<x>/<x>/OnNetwork/AllowedPresenceStatus .....	144
10.2.96	/<x>/<x>/OnNetwork/AllowedPresence .....	144
10.2.97	/<x>/<x>/OnNetwork/AllowedManualSwitch .....	144
10.2.98	/<x>/<x>/OffNetwork .....	145
10.2.99	/<x>/<x>/OffNetwork/Authorised .....	145
10.2.100	/<x>/<x>/OffNetwork/MCDataGroupList .....	145
10.2.101	/<x>/<x>/OffNetwork/MCDataGroupList/<x> .....	145
10.2.102	/<x>/<x>/OffNetwork/MCDataGroupList/<x>/Entry .....	145
10.2.103	/<x>/<x>/OffNetwork/MCDataGroupList/<x>/Entry/MCDataGroupID .....	146
10.2.104	/<x>/<x>/OffNetwork/MCDataGroupList/<x>/Entry/DisplayName .....	146
10.2.105	/<x>/<x>/OffNetwork/MCDataGroupList/<x>/Entry/GMSAppServList .....	146
10.2.106	/<x>/<x>/OffNetwork/MCDataGroupList/<x>/Entry/GMSAppServList/<x> .....	146
10.2.107	/<x>/<x>/OffNetwork/MCDataGroupList/<x>/Entry/GMSAppServList/<x>/GMSAppServId .....	146
10.2.108	/<x>/<x>/OffNetwork/MCDataGroupList/<x>/Entry/IdMSTokenEndPointList .....	147
10.2.109	/<x>/<x>/OffNetwork/MCDataGroupList/<x>/Entry/IdMSTokenEndPointList/<x> .....	147
10.2.110	/<x>/<x>/OffNetwork/MCDataGroupList/<x>/Entry/IdMSTokenEndPointList/<x>/IdMSTokenEndPoint .....	147
10.2.111	/<x>/<x>/OffNetwork/MCDataGroupList/<x>/Entry/PresentationPriority .....	147
10.2.112	/<x>/<x>/OffNetwork/UserInfoID .....	148
10.2.113	/<x>/<x>/OffNetwork/OnetoOne .....	148
10.2.114	/<x>/<x>/OffNetwork/OnetoOne/UserList .....	148

10.2.115	/<x>/<x>/OffNetwork/OnetoOne/UserList/<x> .....	148
10.2.116	/<x>/<x>/OffNetwork/OnetoOne/UserList/<x>/Entry .....	148
10.2.117	/<x>/<x>/OffNetwork/OnetoOne/UserList/<x>/Entry/MCDataID .....	149
10.2.118	/<x>/<x>/OffNetwork/OnetoOne/UserList/<x>/Entry/DiscoveryGroupID .....	149
10.2.119	/<x>/<x>/OffNetwork/OnetoOne/UserList/<x>/Entry/UserInfoID .....	149
10.2.120	/<x>/<x>/OffNetwork/OnetoOne/UserList/<x>/Entry/DisplayName .....	149
10.2.121	/<x>/Status .....	149
11	MCDData service configuration MO .....	150
11.1	General .....	150
11.2	MCDData service configuration MO parameters .....	150
11.2.1	General .....	150
11.2.2	Node: <x> .....	150
11.2.3	/<x>/Name .....	151
11.2.4	/<x>/Ext/ .....	151
11.2.5	/<x>/Common .....	151
11.2.6	/<x>/Common/TxRxControl .....	151
11.2.7	/<x>/Common/TxRxControl/TimeTempDataWaiting .....	152
11.2.8	/<x>/Common/TxRxControl/TimePeriodicAnnouncement .....	152
11.2.9	/<x>/OffNetwork .....	152
11.2.10	/<x>/OffNetwork/DefaultPPPP .....	152
11.2.11	/<x>/OffNetwork/DefaultPPPP/MCDDataOneToOneCallSignalling .....	152
11.2.12	/<x>/OffNetwork/DefaultPPPP/MCDDataOneToOneCallMedia .....	153
12	MCVideo UE configuration MO .....	153
12.1	General .....	153
12.2	MCVideo UE configuration MO parameters .....	154
12.2.1	General .....	154
12.2.2	Node: <x> .....	154
12.2.3	/<x>/Name .....	154
12.2.4	/<x>/Ext/ .....	155
12.2.5	/<x>/Common .....	155
12.2.6	/<x>/Common/MCVideoGroupCall .....	155
12.2.7	/<x>/Common/MCVideoGroupCall/MaxCallNc4 .....	155
12.2.8	/<x>/Common/MCVideoGroupCall/MaxTransmissionNc5 .....	155
12.2.9	/<x>/Common/MCVideoGroupCall/PrioritizedMCVideoGroup .....	156
12.2.10	/<x>/Common/MCVideoGroupCall/PrioritizedMCVideoGroup/<x> .....	156
12.2.11	/<x>/Common/MCVideoGroupCall/PrioritizedMCVideoGroup/<x>/MCVideoGroupID .....	156
12.2.12	... /<x>/Common/MCVideoGroupCall/PrioritizedMCVideoGroup/<x>/MCVideoGroupPriorityHierarchy .....	156
12.2.13	/<x>/OnNetwork .....	156
12.2.14	/<x>/OnNetwork/RelayService .....	157
12.2.15	/<x>/OnNetwork/IPv6Preferred .....	157
12.2.16	/<x>/OnNetwork/RelayedMCVideoGroup .....	157
12.2.17	/<x>/OnNetwork/RelayedMCVideoGroup/<x> .....	157
12.2.18	/<x>/OnNetwork/RelayedMCVideoGroup/<x>/MCVideoGroupID .....	158
12.2.19	/<x>/OnNetwork/RelayedMCVideoGroup/<x>/RelayServiceCode .....	158
13	MCVideo user profile MO .....	158
13.1	General .....	158
13.2	MCVideo user profile MO parameters .....	161
13.2.1	General .....	161
13.2.2	Node: <x> .....	161
13.2.3	/<x>/Name .....	161
13.2.4	/<x>/Ext/ .....	161
13.2.5	/<x>/<x> .....	162
13.2.6	/<x>/<x>/Common .....	162
13.2.7	/<x>/<x>/Common/MCVideoUserID .....	162
13.2.8	/<x>/<x>/Common/MCVideoUserProfileIndex .....	162
13.2.9	/<x>/<x>/Common/MCVideoUserProfileName .....	162
13.2.10	/<x>/<x>/Common/PreSelectedIndication .....	163
13.2.11	/<x>/<x>/Common/UserAliases .....	163

13.2.12	/<x>/<x>/Common/UserAliases/<x>.....	163
13.2.13	/<x>/<x>/Common/UserAliases/<x>/UserAlias .....	163
13.2.14	/<x>/<x>/Common/AuthorisedAlias .....	163
13.2.15	/<x>/<x>/Common/ParticipantType .....	164
13.2.16	/<x>/<x>/Common/Organization.....	164
13.2.17	/<x>/<x>/Common/MCVideoGroupBroadcast.....	164
13.2.18	/<x>/<x>/Common/MCVideoGroupBroadcast/Authorised .....	164
13.2.19	/<x>/<x>/Common/UserBroadcast .....	165
13.2.20	/<x>/<x>/Common/UserBroadcast/Authorised.....	165
13.2.21	/<x>/<x>/Common/AllowedModifyVideo .....	165
13.2.22	/<x>/<x>/Common/AllowedRenegotiateCodec .....	165
13.2.23	/<x>/<x>/Common/AllowedCameraControl.....	165
13.2.24	/<x>/<x>/Common/AllowedRemoteControl.....	166
13.2.25	/<x>/<x>/Common/AllowedDisplayRemoteUE .....	166
13.2.26	/<x>/<x>/Common/AllowedRemoteCamera .....	166
13.2.27	/<x>/<x>/Common/AllowedPushVideo.....	167
13.2.28	/<x>/<x>/Common/AllowedAutoSendNotify.....	167
13.2.29	/<x>/<x>/Common/AllowedActivateAlert .....	167
13.2.30	/<x>/<x>/Common/AllowedCancelAlert.....	167
13.2.31	/<x>/<x>/Common/NotifyList.....	168
13.2.32	/<x>/<x>/Common/NotifyList/<x> .....	168
13.2.33	/<x>/<x>/Common/NotifyList/<x>/Entry .....	168
13.2.34	/<x>/<x>/Common/NotifyList/<x>/Entry/MCVideoID .....	168
13.2.35	/<x>/<x>/Common/NotifyList/<x>/Entry/DisplayName .....	168
13.2.36	/<x>/<x>/Common/VideoCategories.....	169
13.2.37	/<x>/<x>/Common/VideoCategories/<x> .....	169
13.2.38	/<x>/<x>/Common/VideoCategories/<x>/VideoCat .....	169
13.2.39	/<x>/<x>/OnNetwork.....	169
13.2.40	/<x>/<x>/OnNetwork/MCVideoGroupList.....	169
13.2.41	/<x>/<x>/OnNetwork/MCVideoGroupList/<x>.....	169
13.2.42	/<x>/<x>/OnNetwork/MCVideoGroupList/<x>/Entry.....	170
13.2.43	/<x>/<x>/OnNetwork/MCVideoGroupList/<x>/Entry/MCVideoGroupID .....	170
13.2.44	/<x>/<x>/OnNetwork/MCVideoGroupList/<x>/Entry/DisplayName .....	170
13.2.45	/<x>/<x>/OnNetwork/MCVideoGroupList/<x>/Entry/GMSAppServList .....	170
13.2.46	/<x>/<x>/OnNetwork/MCVideoGroupList/<x>/Entry/GMSAppServList/<x> .....	171
13.2.47	/<x>/<x>/OnNetwork/MCVideoGroupList/<x>/Entry/GMSAppServList/<x>/GMSAppServId .....	171
13.2.48	/<x>/<x>/OnNetwork/MCVideoGroupList/<x>/Entry/IdMSTokenEndPointList.....	171
13.2.49	/<x>/<x>/OnNetwork/MCVideoGroupList/<x>/Entry/IdMSTokenEndPointList/<x>.....	171
13.2.50	/<x>/<x>/OnNetwork/MCVideoGroupList/<x>/Entry/IdMSTokenEndPointList/<x>/IdMSTokenEndPoi nt.....	172
13.2.51	/<x>/<x>/OnNetwork/MCVideoGroupList/<x>/Entry/PresentationPriority.....	172
13.2.52	/<x>/<x>/OnNetwork/ImplicitAffiliations.....	172
13.2.53	/<x>/<x>/OnNetwork/ImplicitAffiliations/<x>.....	172
13.2.54	/<x>/<x>/OnNetwork/ImplicitAffiliations/<x>/Entry .....	172
13.2.55	/<x>/<x>/OnNetwork/ImplicitAffiliations/<x>/Entry/MCVideoGroupID.....	173
13.2.56	/<x>/<x>/OnNetwork/ImplicitAffiliations/<x>/Entry/DisplayName .....	173
13.2.57	/<x>/<x>/OnNetwork/PresenceStatus .....	173
13.2.58	/<x>/<x>/OnNetwork/PresenceStatus/<x> .....	173
13.2.59	/<x>/<x>/OnNetwork/PresenceStatus/<x>/Entry .....	173
13.2.60	/<x>/<x>/OnNetwork/PresenceStatus/<x>/Entry/MCVideoGroupID.....	174
13.2.61	/<x>/<x>/OnNetwork/PresenceStatus/<x>/Entry/DisplayName.....	174
13.2.62	/<x>/<x>/OnNetwork/RemoteGroupChange .....	174
13.2.63	/<x>/<x>/OnNetwork/RemoteGroupChange/<x> .....	174
13.2.64	/<x>/<x>/OnNetwork/RemoteGroupChange/<x>/Entry .....	174
13.2.65	/<x>/<x>/OnNetwork/RemoteGroupChange/<x>/Entry/MCVideoGroupID .....	175
13.2.66	/<x>/<x>/OnNetwork/RemoteGroupChange/<x>/Entry/DisplayName.....	175
13.2.67	/<x>/<x>/OnNetwork/MaxAffiliationsNc2 .....	175
13.2.68	/<x>/<x>/OnNetwork/AllowedRegroup .....	175
13.2.69	/<x>/<x>/OnNetwork/AllowedPresenceStatus .....	175
13.2.70	/<x>/<x>/OnNetwork/AllowedPresence .....	176
13.2.71	/<x>/<x>/OnNetwork/AllowedManualSwitch.....	176

13.2.72	/<x>/<x>/OnNetwork/DeletionPeriod .....	176
13.2.73	/<x>/<x>/OnNetwork/MaxSimultaneousVideoStreams .....	176
13.2.74	/<x>/<x>/OnNetwork/MaxSimultaneousVideoStreams/MaxStreams .....	177
13.2.75	/<x>/<x>/OnNetwork/MaxSimultaneousVideoStreams/AllowedUnlimited.....	177
13.2.76	/<x>/<x>/OnNetwork/AllowedAutoRecv .....	177
13.2.77	/<x>/<x>/OnNetwork/AllowedAutoRecvEmergency .....	177
13.2.78	/<x>/<x>/OnNetwork/AllowedAutoRecvImminentPeril .....	178
13.2.79	/<x>/<x>/OnNetwork/MandatoryReceiveGroups .....	178
13.2.80	/<x>/<x>/OnNetwork/MandatoryReceiveGroups/<x> .....	178
13.2.81	/<x>/<x>/OnNetwork/MandatoryReceiveGroups/<x>/Entry .....	178
13.2.82	/<x>/<x>/OnNetwork/MandatoryReceiveGroups/<x>/Entry/MCVideoGroupID.....	178
13.2.83	/<x>/<x>/OnNetwork/MandatoryReceiveGroups/<x>/Entry/DisplayName.....	179
13.2.84	/<x>/<x>/OnNetwork/AllowedRequestOverride .....	179
13.2.85	/<x>/<x>/OnNetwork/AllowedSelectOverride .....	179
13.2.86	/<x>/<x>/OnNetwork/AllowedOverrideGroupCall .....	179
13.2.87	/<x>/<x>/OnNetwork/MaxTimeSingleTransmit .....	180
13.2.88	/<x>/<x>/OffNetwork .....	180
13.2.89	/<x>/<x>/OffNetwork/Authorised .....	180
13.2.90	/<x>/<x>/OffNetwork/MCVideoGroupList .....	180
13.2.91	/<x>/<x>/OffNetwork/MCVideoGroupList/<x> .....	180
13.2.92	/<x>/<x>/OffNetwork/MCVideoGroupList/<x>/Entry .....	181
13.2.93	/<x>/<x>/OffNetwork/MCVideoGroupList/<x>/Entry/MCVideoGroupID .....	181
13.2.94	/<x>/<x>/OffNetwork/MCVideoGroupList/<x>/Entry/DisplayName .....	181
13.2.95	/<x>/<x>/OffNetwork/MCVideoGroupList/<x>/Entry/GMSAppServList .....	181
13.2.96	/<x>/<x>/OffNetwork/MCVideoGroupList/<x>/Entry/GMSAppServList/<x>.....	182
13.2.97	/<x>/<x>/OffNetwork/MCVideoGroupList/<x>/Entry/GMSAppServList/<x>/GMSAppServId .....	182
13.2.98	/<x>/<x>/OffNetwork/MCVideoGroupList/<x>/Entry/IdMSTokenEndPointList .....	182
13.2.99	/<x>/<x>/OffNetwork/MCVideoGroupList/<x>/Entry/IdMSTokenEndPointList/<x> .....	182
13.2.100	/<x>/<x>/OffNetwork/MCVideoGroupList/<x>/Entry/IdMSTokenEndPoint .....	183
	EndPoint .....	183
13.2.101	/<x>/<x>/OffNetwork/MCVideoGroupList/<x>/>/Entry/PresentationPriority .....	183
13.2.102	/<x>/<x>/OffNetwork/UserInfoID .....	183
13.2.103	/<x>/Status .....	183
14	MCVideo service configuration MO .....	184
14.1	General .....	184
14.2	MCVideo service configuration MO parameters .....	184
14.2.1	General.....	184
14.2.2	Node: <x> .....	184
14.2.3	/<x>/Name .....	185
14.2.4	/<x>/Ext/ .....	185
14.2.5	/<x>/Common .....	185
14.2.6	/<x>/Common/BroadcastMCVideoGroupCall .....	185
14.2.7	/<x>/Common/BroadcastMCVideoGroupCall/NumLevelGroupHierarchy .....	186
14.2.8	/<x>/Common/BroadcastMCVideoGroupCall/NumLevelUserHierarchy .....	186
14.2.9	/<x>/Common/MinLengthAliasID.....	186
14.2.10	/<x>/OffNetwork .....	186
14.2.11	/<x>/OffNetwork/DefaultPPPP.....	187
14.2.12	/<x>/OffNetwork/DefaultPPPP/MCVideoPrivateCallSignalling .....	187
14.2.13	/<x>/OffNetwork/DefaultPPPP/MCVideoPrivateCallMedia.....	187
14.2.14	/<x>/OffNetwork/DefaultPPPP/MCVideoEmergencyPrivateCallSignalling .....	187
14.2.15	/<x>/OffNetwork/DefaultPPPP/MCVideoEmergencyPrivateCallMedia.....	188
<b>Annex A (informative):</b>	<b>MCPTT UE configuration MO DDF .....</b>	<b>189</b>
<b>Annex B (informative):</b>	<b>MCPTT user profile MO DDF .....</b>	<b>190</b>
<b>Annex C (informative):</b>	<b>MCPTT group configuration MO DDF.....</b>	<b>191</b>
<b>Annex D (informative):</b>	<b>MCPTT service configuration MO DDF .....</b>	<b>192</b>
<b>Annex E (informative):</b>	<b>MCPTT UE initial configuration MO DDF .....</b>	<b>193</b>

<b>Annex F (informative):</b>	<b>MCVideo UE configuration MO DDF .....</b>	<b>194</b>
<b>Annex G (informative):</b>	<b>MCVideo user profile configuration MO DDF .....</b>	<b>195</b>
<b>Annex H (informative):</b>	<b>MCVideo service configuration MO DDF .....</b>	<b>196</b>
<b>Annex I (informative):</b>	<b>MCDData UE configuration MO DDF .....</b>	<b>197</b>
<b>Annex J (informative):</b>	<b>MCDData user profile configuration MO DDF .....</b>	<b>198</b>
<b>Annex K (informative):</b>	<b>MCDData service configuration MO DDF .....</b>	<b>199</b>
<b>Annex L (informative):</b>	<b>Change history .....</b>	<b>200</b>
<b>History .....</b>		<b>202</b>



---

# Foreword

This Technical Specification has been produced by the 3<sup>rd</sup> Generation Partnership Project (3GPP).

The contents of the present document are subject to continuing work within the TSG and may change following formal TSG approval. Should the TSG modify the contents of the present document, it will be re-released by the TSG with an identifying change of release date and an increase in version number as follows:

Version x.y.z

where:

- x the first digit:
  - 1 presented to TSG for information;
  - 2 presented to TSG for approval;
  - 3 or greater indicates TSG approved document under change control.
- y the second digit is incremented for all changes of substance, i.e. technical enhancements, corrections, updates, etc.
- z the third digit is incremented when editorial only changes have been incorporated in the document.

---

# 1 Scope

The present document defines a number of Mission Critical Services (MCSs) Management Objects (MO) that are configured for the UE for the operation of MCSs. The management objects are compatible with OMA Device Management protocol specifications, version 1.2 and upwards, and is defined using the OMA DM Device Description Framework as described in the Enabler Release Definition OMA OMA-ERELD\_DM-V1\_2 [2].

MCSs are services that require preferential handling compared to normal telecommunication services, e.g. in support of police or fire brigade.

MCSs can be used for public safety applications and also for general commercial applications (e.g., utility companies and railways).

The present document is applicable to an UE supporting on-line, off-line or both on-line and off-line configuration of the configuration management client.

The present document is applicable to an UE supporting off-line configuration of the group management client.

The parameters defined by the management objects in the present document are configured in the UE using on-line configuration over the CSC-4 reference point and using off-line configuration over the CSC-11 and CSC-12 reference points. Other specifications define how these parameters are used in the operation of MCSs, and whether they are applicable to on-network operation or off-network operation, or both:

- 3GPP TS 24.379 [7];
- 3GPP TS 24.380 [8];
- 3GPP TS 24.481 [9];
- 3GPP TS 24.482 [11];
- 3GPP TS 24.484 [12];
- 3GPP TS 24.282 [16];
- 3GPP TS 24.582 [17];
- 3GPP TS 24.281 [18]; and
- 3GPP TS 24.581 [19].

The common network operation means both on-network operation and off-network operation in the present document.

The following management objects are defined in the present document:

- MCPTT UE configuration MO;
- MCPTT user profile MO;
- MCS group configuration MO;
- MCPTT service configuration MO;
- MCS UE initial configuration MO;
- MCDData UE configuration MO;
- MCDData user profile MO;
- MCDData service configuration MO;
- MCVideo UE configuration MO;
- MCVideo user profile MO; and
- MCVideo service configuration MO.

The MOs listed above define repositories of data in the ME.

---

## 2 References

The following documents contain provisions which, through reference in this text, constitute provisions of the present document.

- References are either specific (identified by date of publication, edition number, version number, etc.) or non-specific.
- For a specific reference, subsequent revisions do not apply.
- For a non-specific reference, the latest version applies. In the case of a reference to a 3GPP document (including a GSM document), a non-specific reference implicitly refers to the latest version of that document *in the same Release as the present document*.

- [1] 3GPP TR 21.905: "Vocabulary for 3GPP Specifications".
- [2] OMA OMA-ERELD-DM-V1\_2-20070209-A: "Enabler Release Definition for OMA Device Management, Version 1.2".
- [3] OMA OMA-TS-DM\_Protocol-V1\_2: "OMA Device Management Protocol".
- [4] OMA OMA-TS-XDM\_Group-V1\_1-20120403-A: "Group XDM Specification".
- [5] 3GPP TS 23.003: "Numbering, addressing and identification".
- [6] 3GPP TS 23.303: "Proximity-based Services (ProSe); Stage 2".
- [7] 3GPP TS 24.379: "Mission Critical Push To Talk (MCPTT) call control Protocol specification".
- [8] 3GPP TS 24.380: "Mission Critical Push To Talk (MCPTT) media plane control Protocol specification".
- [9] 3GPP TS 24.481: "Mission Critical Services (MCS) group management Protocol specification".
- [10] 3GPP TS 31.102: "Characteristics of the USIM Application".
- [11] 3GPP TS 24.482: "Mission Critical Services (MCS) identity management Protocol specification".
- [12] 3GPP TS 24.484: "Mission Critical Services (MCS) configuration management Protocol specification".
- [13] IETF RFC 4566 (July 2006): "Session Description Protocol".
- [14] Void.
- [15] 3GPP TS 23.179: "Functional architecture and information flows to support mission critical communication services; Stage 2".
- [16] 3GPP TS 24.282: "Mission Critical Data (MCData) signalling control Protocol specification".
- [17] 3GPP TS 24.582: "Mission Critical Data (MCData) media plane control Protocol specification".
- [18] 3GPP TS 24.281: "Mission Critical Video (MCVideo) signalling control Protocol specification".
- [19] 3GPP TS 24.581: "Mission Critical Video (MCVideo) media plane control Protocol specification".
- [20] 3GPP TS 33.180: "Security of the mission critical service".

---

## 3 Definitions and abbreviations

### 3.1 Definitions

For the purpose of the present document, the following terms and definitions given in 3GPP TS 23.179 [15] apply:

#### Pre-selected MCPTT user profile

### 3.2 Abbreviations

For the purposes of the present document, the abbreviations given in 3GPP TR 21.905 [1] and the following apply. An abbreviation defined in the present document takes precedence over the definition of the same abbreviation, if any, in 3GPP TR 21.905 [1].

ACL	Access Control List
CMS	Configuration Management Server
DDF	Device Description Framework
DM	Device Management
GMS	Group Management Server
MCS	Mission Critical Service
MCSs	Mission Critical Services
MCPTT	Mission Critical Push To Talk
ME	Mobile Equipment
MO	Management Object
OMA	Open Mobile Alliance
ProSe	Proximity-based Services
RFC	Request For Comments
URI	Uniform Resource Identifier
URN	Uniform Resource Name
XCAP	XML Configuration Access Protocol
XML	eXtensible Markup Language
XUI	XCAP Unique Identifier

---

## 4 MCPTT UE configuration MO

### 4.1 General

The MCPTT UE configuration Management Object (MO) is used to configure MCPTT Client behaviour for the on-network or off-network MCPTT Service. The MCPTT UE configuration parameters may be stored in the ME, or in the USIM as specified in 3GPP TS 31.102 [10], or in both the ME and the USIM. If both the ME and the USIM contain the same parameters, the values stored in the USIM shall take precedence.

The Management Object Identifier is: urn:oma:mo:ext-3gpp-MCPTT-UE-configuration:1.0.

Protocol compatibility: This MO is compatible with OMA OMA DM 1.2 [3].

The OMA DM ACL property mechanism (see OMA OMA-ERELED-DM-V1\_2 [2]) may be used to grant or deny access rights to OMA DM servers in order to modify nodes and leaf objects of the MCPTT UE configuration MO.

The following nodes and leaf objects are possible under the MCPTT UE configuration node as described in figure 4.1.1:

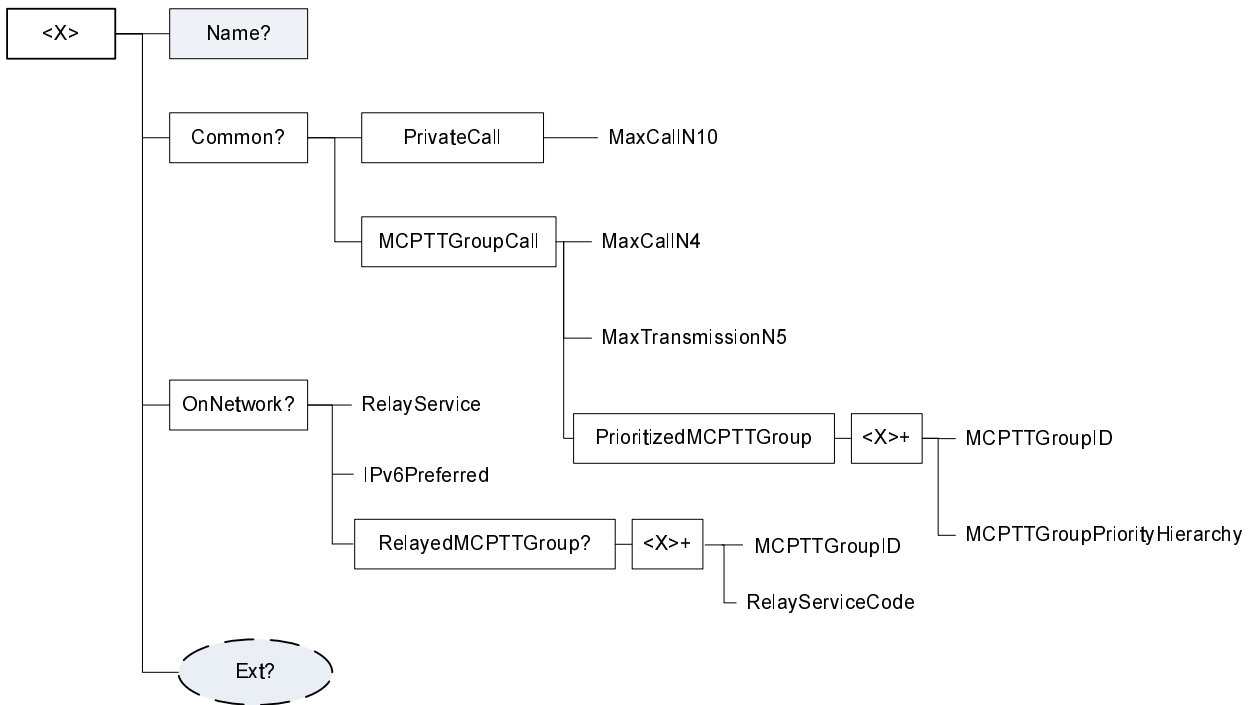

Figure 4.1.1: The MCPTT UE configuration MO

## 4.2 MCPTT UE configuration MO parameters

### 4.2.1 General

This clause describes the parameters for the MCPTT UE configuration Management Object (MO).

### 4.2.2 Node: <x>

Table 4.2.2.1: Node: <x>

<x>

Status	Occurrence	Format	Min. Access Types
Required	OneOrMore	node	Get

This interior node acts as a placeholder for the MCPTT UE configuration Management Object (MO).

For the MCPTT UE configuration MO, the namespace specific string is: "urn:oma:mo:oma-dm-mcptt-ue-configuration:1.0"

- Values: N/A

### 4.2.3 /<x>/Name

Table 4.2.3.1: /<x>/Name

Name

Status	Occurrence	Format	Min. Access Types
Required	ZeroOrOne	chr	Get

The Name leaf is a name for the MCPTT UE configuration settings.

- Values: <User displayable name>

#### 4.2.4 /<x>/Ext/

**Table 4.2.4.1: /<x>/Ext/**

Ext

Status	Occurrence	Format	Min. Access Types
Optional	ZeroOrOne	node	Get, Replace

The Ext is an interior node for where the vendor specific information about the MCPTT UE configuration MO is being placed.

Usually the vendor extension is identified by vendor specific name under the ext node and contains the vendor meaning application vendor, device vendor etc. The tree structure under the vendor identified is not defined and can therefore include one or more un-standardized sub-trees.

- Values: N/A

#### 4.2.5 /<x>/Common

**Table 4.2.5.1: /<x>/Common**

Common

Status	Occurrence	Format	Min. Access Types
Required	ZeroOrOne	node	Get, Replace

This interior node represents a container for the common network operation which means both on-network operation and off-network operation.

#### 4.2.6 /<x>/Common/PrivateCall

**Table 4.2.6.1: /<x>/Common/PrivateCall**

Common/PrivateCall

Status	Occurrence	Format	Min. Access Types
Required	One	node	Get, Replace

This interior node is a placeholder for the private call configuration.

#### 4.2.7 /<x>/Common/PrivateCall/MaxCallN10

**Table 4.2.7.1: /<x>/Common/PrivateCall/MaxCallN10**

Common/PrivateCall/MaxCallN10

Status	Occurrence	Format	Min. Access Types
Required	One	int	Get, Replace

This leaf node indicates the maximum number of private calls.

- Values: 0-255

#### 4.2.8 /<x>/Common/MCPTTGroupCall

**Table 4.2.8.1: /<x>/Common/MCPTTGroupCall**

Common/MCPTTGroupCall

Status	Occurrence	Format	Min. Access Types
Required	One	node	Get, Replace

This interior node is a placeholder for the MCPTT group call configuration.

#### 4.2.9 /<x>/Common/MCPTTGroupCall/MaxCallN4

**Table 4.2.9.1: /<x>/Common/MCPTTGroupCall/MaxCallN4**

Common/MCPTTGroupCall/MaxCallN4

Status	Occurrence	Format	Min. Access Types
Required	One	int	Get, Replace

This leaf node indicates the maximum number of simultaneous group calls.

- Values: 0-255

#### 4.2.10 /<x>/Common/MCPTTGroupCall/MaxTransmissionN5

**Table 4.2.10.1: /<x>/Common/MCPTTGroupCall/MaxTransmissionN5**

Common/MCPTTGroupCall/MaxTransmissionN5

Status	Occurrence	Format	Min. Access Types
Required	One	int	Get, Replace

This leaf node indicates the maximum number of transmissions in a group.

- Values: 0-255

#### 4.2.11 /<x>/Common/MCPTTGroupCall/PrioritizedMCPTTGroup

**Table 4.2.11.1: /<x>/Common/MCPTTGroupCall/PrioritizedMCPTTGroup**

Common/MCPTTGroupCall/PrioritizedMCPTTGroup

Status	Occurrence	Format	Min. Access Types
Required	ZeroOrOne	node	Get, Replace

This interior node is a placeholder for the prioritized MCPTT group call configuration.

#### 4.2.12 /<x>/Common/MCPTTGroupCall/PrioritizedMCPTTGroup/<x>

**Table 4.2.12.1: /<x>/Common/MCPTTGroupCall/PrioritizedMCPTTGroup/<x>**

Common/MCPTTGroupCall/PrioritizedMCPTTGroup /<x>

Status	Occurrence	Format	Min. Access Types
Required	OneOrMore	node	Get, Replace

This interior node is a placeholder for one or more prioritized MCPTT group call configuration.

#### 4.2.13

#### /<x>/Common/MCPTTGroupCall/PrioritizedMCPTTGroup/<x>/MCPTTGroupID

**Table 4.2.13.1: /<x>/Common/MCPTTGroupCall/PrioritizedMCPTTGroup/<x>/MCPTTGroupID**

Common/MCPTTGroupCall/PrioritizedMCPTTGroup/<x>/MCPTTGroupID

Status	Occurrence	Format	Min. Access Types
Required	One	chr	Get, Replace

This leaf node indicates the associated MCPTT group ID.

The value is a "uri" attribute specified in OMA OMA-TS-XDM\_Group-V1\_1 [4].

## 4.2.14

### /<x>/Common/MCPTTGroupCall/PrioritizedMCPTTGroup/<x>/MCPTTGroupPriorityHierarchy

**Table 4.2.14.1:**

#### /<x>/Common/MCPTTGroupCall/PrioritizedMCPTTGroup/<x>/MCPTTGroupPriorityHierarchy

Common/MCPTTGroupCall/PrioritizedMCPTTGroup/&lt;x&gt;/MCPTTGroupPriorityHierarchy

Status	Occurrence	Format	Min. Access Types
Required	One	int	Get, Replace

This leaf node indicates the requested presentation priority of group call.

- Values: 0-7

The group with the lowest MCPTTGroupPriorityHierarchy value shall be considered as the group having the lowest priority among the groups.

## 4.2.15 /&lt;x&gt;/OnNetwork

**Table 4.2.15.1: /<x>/OnNetwork**

OnNetwork

Status	Occurrence	Format	Min. Access Types
Required	ZeroOrOne	node	Get, Replace

This interior node represents a container for on-network operation.

## 4.2.16 /&lt;x&gt;/OnNetwork/RelayService

**Table 4.2.16.1: /<x>/OnNetwork/RelayService**

OnNetwork/RelayService

Status	Occurrence	Format	Min. Access Types
Required	One	bool	Get, Replace

This leaf node indicates the authorisation to use a relay service.

When set to "true" the MCPTT group is allowed to use a relay service.

When set to "false" the MCPTT group is not allowed to use a relay service.

## 4.2.17 /&lt;x&gt;/OnNetwork/IPv6Preferred

**Table 4.2.17.1: /<x>/OnNetwork/IPv6Preferred**

OnNetwork/IPv6Preferred

Status	Occurrence	Format	Min. Access Types
Required	One	bool	Get, Replace

This leaf node indicates whether IPv6 is preferred over IPv4 for on-network operation when the MCPTT UE has both IPv4 and IPv6 host configuration.

If the MCPTT UE has both IPv4 and IPv6 host configuration and:

- if IPv6Preferred is set to "true" then the UE uses IPv6 for all on-network signalling and media; otherwise
- if IPv6Preferred is set to "false" then the UE uses IPv4 for all on-network signalling and media.



## 4.2.18 /<x>/OnNetwork/RelayedMCPTTGroup

**Table 4.2.18.1: /<x>/OnNetwork/RelayedMCPTTGroup**

OnNetwork/RelayedMCPTTGroup

Status	Occurrence	Format	Min. Access Types
Optional	One	node	Get, Replace

This interior node is a placeholder for the allowed relayed MCPTT groups.

## 4.2.19 /<x>/OnNetwork/RelayedMCPTTGroup/<x>

**Table 4.2.19.1: /<x>/OnNetwork/RelayedMCPTTGroup/<x>**

OnNetwork/RelayedMCPTTGroup/<x>

Status	Occurrence	Format	Min. Access Types
Required	OneOrMore	node	Get, Replace

This interior node is a placeholder for one or more allowed relayed MCPTT groups.

## 4.2.20 /<x>/OnNetwork/RelayedMCPTTGroup/<x>/MCPTTGroupID

**Table 4.2.20.1: /<x>/OnNetwork/RelayedMCPTTGroup/<x>/MCPTTGroupID**

OnNetwork/RelayedMCPTTGroup/<x>/MCPTTGroupID

Status	Occurrence	Format	Min. Access Types
Required	One	chr	Get, Replace

This leaf node indicates the associated MCPTT group ID.

The value is a "uri" attribute specified in OMA OMA-TS-XDM\_Group-V1\_1 [4].

## 4.2.21 /<x>/OnNetwork/RelayedMCPTTGroup/<x>/RelayServiceCode

**Table 4.2.21.1: /<x>/OnNetwork/RelayedMCPTTGroup/<x>/RelayServiceCode**

OnNetwork/RelayedMCPTTGroup/<x>/RelayServiceCode

Status	Occurrence	Format	Min. Access Types
Required	One	chr	Get, Replace

This leaf node indicates the connectivity service that the ProSe UE-to-network relay provides to public safety applications as specified in 3GPP TS 23.303 [6].

---

# 5 MCPTT user profile MO

## 5.1 General

The MCPTT user profile configuration Management Object (MO) is used to configure the MCPTT Client behaviour for the on-network or off-network MCPTT Service. The MCPTT UE configuration parameters may be stored in the ME, or in the USIM as specified in 3GPP TS 31.102 [10], or in both the ME and the USIM. If both the ME and the USIM contain the same parameters, the values stored in the USIM shall take precedence.

The Management Object Identifier is: urn:oma:mo:ext-3gpp-MCPTT-user-profile:1.0.

Protocol compatibility: This MO is compatible with OMA OMA DM 1.2 [3].

The OMA DM ACL property mechanism (see OMA OMA-ERELED-DM-V1\_2 [2]) may be used to grant or deny access rights to OMA DM servers in order to modify nodes and leaf objects of the MCPTT user profile MO.

The following nodes and leaf objects are possible under the MCPTT user profile node as described in figure 5.1.1 and figure 5.1.2:

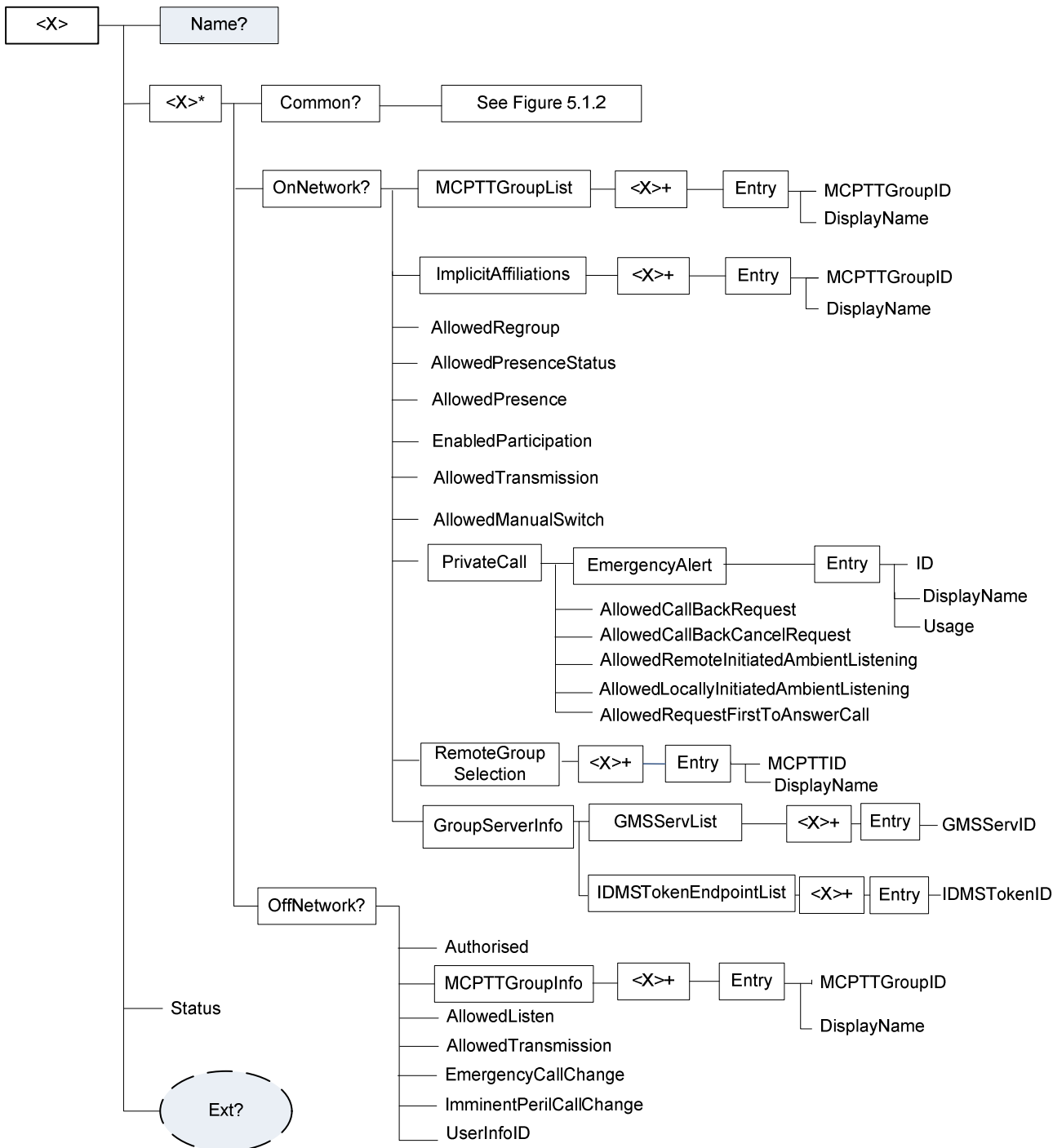

Figure 5.1.1: The MCPTT user profile MO (1 of 2)

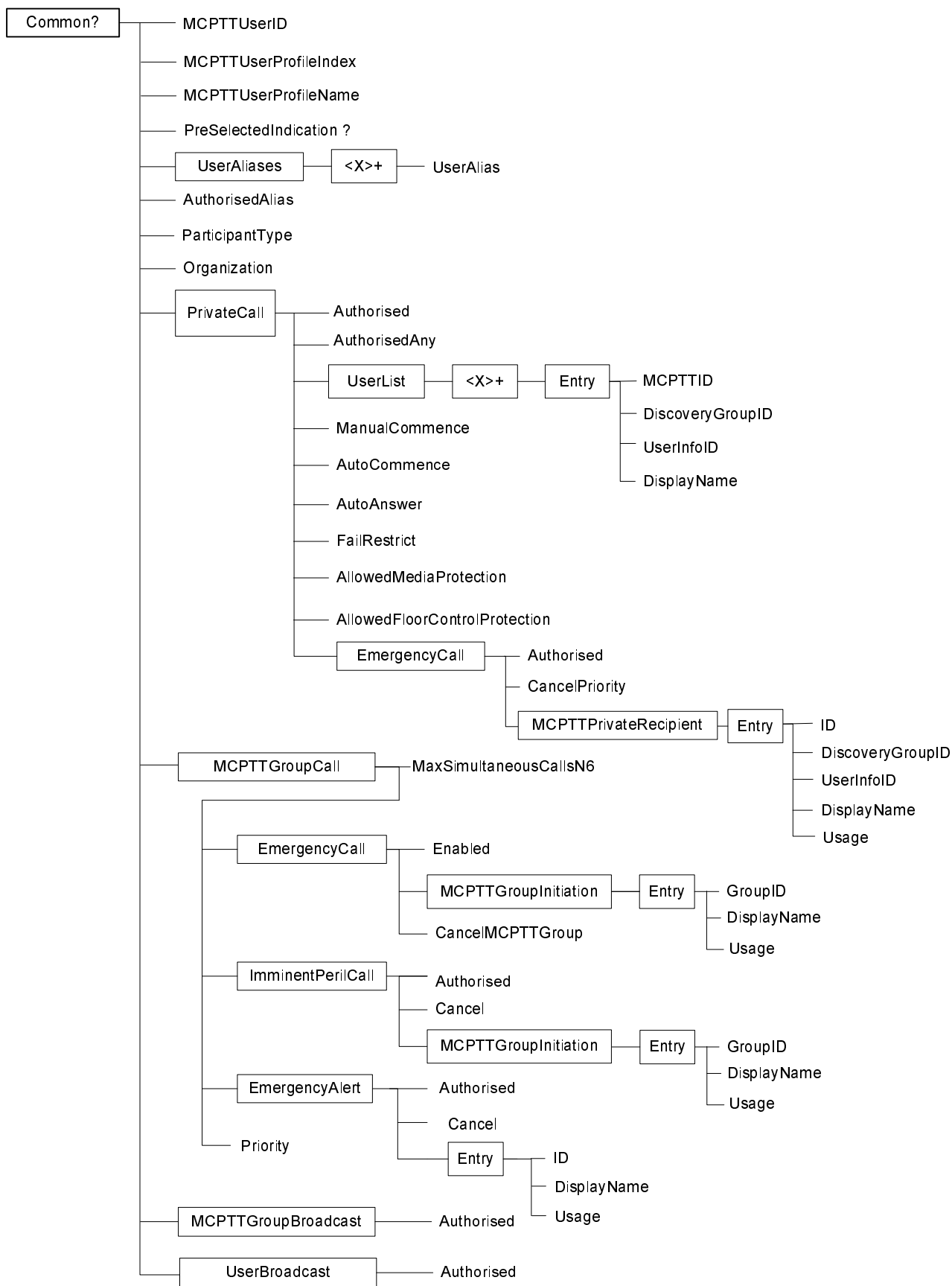

Figure 5.1.2: The MCPTT user profile MO (2 of 2)

## 5.2 MCPTT user profile MO parameters

### 5.2.1 General

This clause describes the parameters for the MCPTT user profile Management Object (MO).

### 5.2.2 Node: <x>

**Table 5.2.2.1: Node: <x>**

<x>

Status	Occurrence	Format	Min. Access Types
Required	OneOrMore	node	Get

This interior node acts as a placeholder for the MCPTT user profile Management Object (MO).

For the MCPTT user profile MO, the namespace specific string is: "urn:oma:mo:oma-dm-mcptt-user-profile:1.0"

- Values: N/A

### 5.2.3 /<x>/Name

**Table 5.2.3.1: /<x>/Name**

Name

Status	Occurrence	Format	Min. Access Types
Required	ZeroOrOne	chr	Get

The Name leaf is a name for the MCPTT user profile settings.

- Values: <User displayable name>

### 5.2.4 /<x>/Ext/

**Table 5.2.4.1: /<x>/Ext/**

Ext

Status	Occurrence	Format	Min. Access Types
Optional	ZeroOrOne	node	Get, Replace

The Ext is an interior node for where the vendor specific information about the MCPTT user profile MO is being placed.

Usually the vendor extension is identified by vendor specific name under the ext node and contains the vendor meaning application vendor, device vendor etc. The tree structure under the vendor identified is not defined and can therefore include one or more un-standardized sub-trees.

- Values: N/A

### 5.2.5 /<x>/<x>

**Table 5.2.5.1: /<x>/<x>**

<x>

Status	Occurrence	Format	Min. Access Types
Required	OneOrMore	node	Get, Replace

This interior node represents a container for on-network operation and off-network operation.

## 5.2.6 /<x>/<x>/Common

**Table 5.2.6.1: /<x>/<x>/Common**

<x>/Common

Status	Occurrence	Format	Min. Access Types
Required	OneOrMore	node	Get, Replace

This interior node represents a container for the common network operation which means both on-network operation and off-network operation.

## 5.2.7 /<x>/<x>/Common/MCPTTUserID

**Table 5.2.7.1: /<x>/<x>/Common/MCPTTUserID**

<x>/Common/MCPTTUserID

Status	Occurrence	Format	Min. Access Types
Required	One	chr	Get, Replace

This leaf node indicates an MCPTT user identity (MCPTT ID) which is a globally unique identifier within the MCPTT service that represents the MCPTT user.

### 5.2.7A /<x>/<x>/Common/MCPTTUserProfileIndex

**Table 5.2.7A.1: /<x>/<x>/Common/MCPTTUserProfileIndex**

<x>/Common/MCPTTUserProfileIndex

Status	Occurrence	Format	Min. Access Types
Required	One	int	Get, Replace

This leaf node indicates an index for the particular MCPTT user profile.

- Values: 0-255

### 5.2.7B /<x>/<x>/Common/MCPTTUserProfileName

**Table 5.2.7B.1: /<x>/<x>/Common/MCPTTUserProfileName**

<x>/Common/MCPTTUserProfileName

Status	Occurrence	Format	Min. Access Types
Optional	One	chr	Get, Replace

This leaf node indicates a profile name for the particular MCPTT user profile.

### 5.2.7C /<x>/<x>/Common/PreSelectedIndication

**Table 5.2.7C.1: /<x>/<x>/Common/PreSelectedIndication**

<x>/Common/PreSelectedIndication

Status	Occurrence	Format	Min. Access Types
Optional	ZeroOrOne	null	Get, Replace

This leaf node indicates that this MCPTT user profile MO is designated to be the pre-selected MCPTT user profile as defined by 3GPP TS 23.179 [15]

- Values: null

When this leaf node is present, this MCPTT user profile MO is designated as the pre-selected MCPTT user profile.

When this leaf node is absent, this MCPTT user profile MO is not designated as the pre-selected MCPTT user profile.

If more than one MCPTT user profile MO is specified for the MCPTT user, then only one MCPTT user profile MO for the MCPTT user shall contain the `<x>/Common/PreSelectedIndication` leaf node.

If there is only one MCPTT user profile MO specified for the MCPTT user, then it is optional to include the `<x>/Common/PreSelectedIndication` leaf node.

## 5.2.8 `<x>/<x>/Common/UserAliases`

**Table 5.2.8.1: `<x>/<x>/Common/UserAliases`**

`<x>/Common/UserAliases`

Status	Occurrence	Format	Min. Access Types
Required	One	node	Get, Replace

This interior node is a placeholder for a list of aliases of an MCPTT user.

### 5.2.8A `<x>/<x>/Common/UserAliases/<x>`

**Table 5.2.8A.1: `<x>/<x>/Common/UserAliases/<x>`**

`<x>/Common/UserAliases/<x>`

Status	Occurrence	Format	Min. Access Types
Required	OneOrMore	node	Get, Replace

This interior node is a placeholder for one or more aliases of an MCPTT user.

### 5.2.8B `<x>/<x>/Common/UserAliases/<x>/UserAlias`

**Table 5.2.8B.1: `<x>/<x>/Common/UserAliases/<x>/UserAlias`**

`<x>/Common/UserAliases/<x>/UserAlias`

Status	Occurrence	Format	Min. Access Types
Required	One	chr	Get, Replace

This leaf node indicates an alphanumeric alias of the MCPTT user.

## 5.2.9 `<x>/<x>/Common/AuthorisedAlias`

**Table 5.2.9.1: `<x>/<x>/Common/AuthorisedAlias`**

`<x>/Common/AuthorisedAlias`

Status	Occurrence	Format	Min. Access Types
Optional	One	bool	Get, Replace

This leaf node indicates authorisation to create and delete aliases of other MCPTT users and their associated MCPTT user profiles.

When set to "true" the MCPTT user is authorised to create and delete aliases of other MCPTT users and their associated MCPTT user profiles.

When set to "false" the MCPTT user is not authorised to create and delete aliases of other MCPTT user and their associated MCPTT user profiles. This is the default if this leaf node is not present.

## 5.2.10 /<x>/<x>/Common/ParticipantType

**Table 5.2.10.1: /<x>/<x>/Common/ParticipantType**

<x>/Common/ParticipantType

Status	Occurrence	Format	Min. Access Types
Required	One	chr	Get, Replace

This leaf node indicates the participant type of the MCPTT user.

The ParticipantType means the functional category of the participant (e.g., first responder, second responder, dispatch, dispatch supervisor), typically defined by the MCPTT administrators.

## 5.2.11 /<x>/<x>/Common/Organization

**Table 5.2.11.1: /<x>/<x>/Common/Organization**

<x>/Common/Organization

Status	Occurrence	Format	Min. Access Types
Required	One	chr	Get, Replace

This leaf node indicates the organization an MCPTT user belongs to.

## 5.2.12 /<x>/<x>/Common/PrivateCall

**Table 5.2.12.1: /<x>/<x>/Common/PrivateCall**

<x>/Common/PrivateCall

Status	Occurrence	Format	Min. Access Types
Required	One	node	Get, Replace

This interior node is a placeholder for the MCPTT private call configuration.

## 5.2.13 /<x>/<x>/Common/PrivateCall/Authorised

**Table 5.2.13.1: /<x>/<x>/Common/PrivateCall/Authorised**

<x>/Common/PrivateCall/Authorised

Status	Occurrence	Format	Min. Access Types
Required	One	bool	Get, Replace

This leaf node indicates the authorisation to make a MCPTT private call.

When set to "true" the MCPTT user is allowed to make a MCPTT private call.

When set to "false" the MCPTT user is not allowed to make a MCPTT private call.

## 5.2.14 /<x>/<x>/Common/PrivateCall/AuthorisedAny

**Table 5.2.14.1: /<x>/<x>/Common/PrivateCall/AuthorisedAny**

<x>/Common/PrivateCall/AuthorisedAny

Status	Occurrence	Format	Min. Access Types
Required	One	bool	Get, Replace

This leaf node indicates the authorisation to make a MCPTT private call to any MCPTT user.

When set to "true" any MCPTT user is authorised to make an MCPTT private call to any MCPTT user.

When set to "false" any MCPTT user is not authorised to make an MCPTT private call to any MCPTT user.

### 5.2.15 /<x>/<x>/Common/PrivateCall/UserList

**Table 5.2.15.1: /<x>/<x>/PrivateCall/UserList**

<x>/Common/ PrivateCall/UserList

Status	Occurrence	Format	Min. Access Types
Required	One	node	Get, Replace

This interior node is a placeholder for a list of MCPTT user(s) who can be called in a MCPTT private call.

### 5.2.16 /<x>/<x>/Common/PrivateCall/UserList/<x>

**Table 5.2.16.1: /<x>/<x>/Common/PrivateCall/UserList/<x>**

<x>/Common/PrivateCall/UserList/<x>

Status	Occurrence	Format	Min. Access Types
Optional	OneOrMore	node	Get, Replace

This interior node is a placeholder for one or more list of MCPTT users who can be called in a MCPTT private call.

### 5.2.16A /<x>/<x>/Common/PrivateCall/UserList/<x>/Entry

**Table 5.2.16A.1: /<x>/<x>/Common/PrivateCall/UserList/<x>/Entry**

<x>/Common/PrivateCall/UserList/<x>/Entry

Status	Occurrence	Format	Min. Access Types
Required	One	node	Get, Replace

This interior node is a placeholder for one or more MCPTT users who can be called in a private call.

### 5.2.17 /<x>/<x>/Common/PrivateCall/UserList/<x>/Entry/MCPTTID

**Table 5.2.17.1: /<x>/<x>/Common/PrivateCall/UserList/<x>/Entry/MCPTTID**

<x>/Common/PrivateCall/UserList/<x>/Entry/MCPTTID

Status	Occurrence	Format	Min. Access Types
Optional	One	chr	Get, Replace

This leaf node indicates an MCPTT user identity (MCPTT ID) which is a globally unique identifier within the MCPTT service that represents the MCPTT user.

The value is a "uri" attribute specified in OMA OMA-TS-XDM\_Group-V1\_1 [4].

### 5.2.18 /<x>/<x>/Common/PrivateCall/UserList/<x>/Entry/DiscoveryGroupID

**Table 5.2.18.1: /<x>/<x>/Common/PrivateCall/UserList/<x>/Entry/DiscoveryGroupID**

<x>/Common/PrivateCall/UserList/<x>/Entry/DiscoveryGroupID

Status	Occurrence	Format	Min. Access Types
Optional	One	int	Get, Replace

This leaf node indicates a discovery group ID as specified in 3GPP TS 23.303 [6].

The value is used as the discovery group ID in the ProSe discovery procedures as specified in 3GPP TS 23.303 [6].



## 5.2.19 /<x>/<x>/Common/PrivateCall/UserList/<x>/Entry/UserInfoID

**Table 5.2.19.1: /<x>/<x>/Common/PrivateCall/<x>/UserList/Entry/UserInfoID**

<x>/Common/PrivateCall/UserList/<x>/Entry/UserInfoID

Status	Occurrence	Format	Min. Access Types
Optional	One	int	Get, Replace

This leaf node indicates a ProSe user info ID as specified in 3GPP TS 23.303 [6].

## 5.2.19A /<x>/<x>/Common/PrivateCall/UserList/<x>/Entry/DisplayName

**Table 5.2.19A.1: /<x>/<x>/Common/PrivateCall/<x>/UserList/Entry/DisplayName**

<x>/Common/PrivateCall/UserList/<x>/Entry/DisplayName

Status	Occurrence	Format	Min. Access Types
Optional	One	chr	Get, Replace

This leaf node contains a human readable name.

## 5.2.20 /<x>/<x>/Common/PrivateCall/ManualCommence

**Table 5.2.20.1: /<x>/<x>/Common/PrivateCall/ManualCommence**

<x>/Common/PrivateCall/ManualCommence

Status	Occurrence	Format	Min. Access Types
Required	One	bool	Get, Replace

This leaf node indicates the authorisation to make a MCPTT private call with manual commencement.

When set to "true" the MCPTT user is authorised to make a MCPTT private call in manual commencement mode.

When set to "false" the MCPTT user is not authorised to make a MCPTT private call in manual commencement mode.

## 5.2.21 /<x>/<x>/Common/PrivateCall/AutoCommence

**Table 5.2.21.1: /<x>/<x>/Common/PrivateCall/AutoCommence**

<x>/Common/PrivateCall/AutoCommence

Status	Occurrence	Format	Min. Access Types
Required	One	bool	Get, Replace

This leaf node indicates the authorisation to make a MCPTT private call with automatic commencement.

When set to "true" the MCPTT user is authorised to make a MCPTT private call in automatic commencement mode.

When set to "false" the MCPTT user is not authorised to make a MCPTT private call in automatic commencement mode.

## 5.2.22 /<x>/<x>/Common/PrivateCall/AutoAnswer

**Table 5.2.22.1: /<x>/<x>/Common/PrivateCall/AutoAnswer**

<x>/Common/PrivateCall/AutoAnswer

Status	Occurrence	Format	Min. Access Types
Required	One	bool	Get, Replace

This leaf node indicates the authorisation of MCPTT user to force automatic answer for a MCPTT private call.

When set to "true" the MCPTT user is authorised to force automatic answer for a MCPTT private call.

When set to "false" the MCPTT user is not authorised to force automatic answer for a MCPTT private call.

### 5.2.23 /<x>/<x>/Common/PrivateCall/FailRestrict

**Table 5.2.23.1: /<x>/<x>/Common/PrivateCall/FailRestrict**

<x>/Common/PrivateCall/FailRestrict

Status	Occurrence	Format	Min. Access Types
Required	One	bool	Get, Replace

This leaf node indicates the authorisation to restrict the provision of a notification of call failure reason for a MCPTT private call.

When set to "true" the MCPTT user is authorised to restrict notification of call failure reason for MCPTT private call.

When set to "false" the MCPTT user is not authorised to restrict notification of call failure reason for MCPTT private call.

### 5.2.24 /<x>/<x>/Common/PrivateCall/AllowedMediaProtection

**Table 5.2.24.1: /<x>/<x>/Common/PrivateCall/AllowedMediaProtection**

<x>/Common/PrivateCall/AllowedMediaProtection

Status	Occurrence	Format	Min. Access Types
Required	One	bool	Get, Replace

This leaf node indicates authorisation to protect confidentiality and integrity of media for MCPTT private calls.

When set to "true" the MCPTT user is authorised to protect confidentiality and integrity of media for MCPTT private calls.

When set to "false" the MCPTT user is not authorised to protect confidentiality and integrity of media for MCPTT private calls.

The default value is set to "true".

### 5.2.25 /<x>/<x>/Common/PrivateCall/AllowedFloorControlProtection

**Table 5.2.25.1: /<x>/<x>/Common/PrivateCall/AllowedFloorControlProtection**

<x>/Common/PrivateCall/AllowedFloorControlProtection

Status	Occurrence	Format	Min. Access Types
Required	One	bool	Get, Replace

This leaf node indicates authorisation to protect confidentiality and integrity of floor control signalling for MCPTT private calls.

When set to "true" the MCPTT user is authorised to protect confidentiality and integrity of floor control signalling for MCPTT private calls.

When set to "false" the MCPTT user is not authorised to protect confidentiality and integrity of floor control signalling for MCPTT private calls.

The default value is set to "true".

### 5.2.26 /<x>/<x>/Common/PrivateCall/EmergencyCall

**Table 5.2.26.1: /<x>/<x>/Common/PrivateCall/EmergencyCall**

<x>/Common/PrivateCall/EmergencyCall

Status	Occurrence	Format	Min. Access Types
--------	------------	--------	-------------------

Required	One	node	Get, Replace
----------	-----	------	--------------

This interior node is a placeholder for the MCPTT emergency call policy.

## 5.2.27 /<x>/<x>/Common/PrivateCall/EmergencyCall/Authorised

**Table 5.2.27.1: /<x>/<x>/Common/PrivateCall/EmergencyCall/Authorised**

<x>/Common/PrivateCall/EmergencyCall/Authorised

Status	Occurrence	Format	Min. Access Types
Required	One	bool	Get, Replace

This leaf node indicates the authorisation to make an MCPTT emergency private call.

When set to "true" the MCPTT user is authorised to make an MCPTT emergency private call.

When set to "false" the MCPTT user is not authorised to make an MCPTT emergency private call.

## 5.2.28 /<x>/<x>/Common/PrivateCall/EmergencyCall/CancelPriority

**Table 5.2.28.1: /<x>/<x>/Common/PrivateCall/EmergencyCall/CancelPriority**

<x>/Common/PrivateCall/EmergencyCall/CancelPriority

Status	Occurrence	Format	Min. Access Types
Required	One	bool	Get, Replace

This leaf node indicates the authorisation to cancel emergency priority in an MCPTT emergency private call by an authorised MCPTT user.

When set to "true" the MCPTT user is authorised to cancel an emergency priority in an MCPTT private call.

When set to "false" the MCPTT user is not authorised to cancel an emergency priority in an MPCTT private call.

## 5.2.29

### /<x>/<x>/Common/PrivateCall/EmergencyCall/MCPTTPrivateRecipient

**Table 5.2.29.1: /<x>/<x>/Common/PrivateCall/EmergencyCall/MCPTTPrivateRecipient**

<x>/Common/PrivateCall/EmergencyCall/MCPTTPrivateRecipient

Status	Occurrence	Format	Min. Access Types
Optional	One	node	Get, Replace

This interior node is a placeholder for the MCPTT private recipient for an MCPTT emergency private call.

## 5.2.29A

### /<x>/<x>/Common/PrivateCall/EmergencyCall/MCPTTPrivateRecipient/Entry

**Table 5.2.29A.1: /<x>/<x>/Common/PrivateCall EmergencyCall/MCPTTPrivateRecipient/Entry**

<x>/Common/PrivateCall/EmergencyCall/MCPTTPrivateRecipient/Entry

Status	Occurrence	Format	Min. Access Types
Required	One	node	Get, Replace

This interior node is a placeholder for the details of the MCPTT private recipient for an MCPTT emergency private call.

## 5.2.29B

`<x>/<x>/Common/PrivateCall/EmergencyCall/MCPTTPrivateRecipient/Entry/ID`

**Table 5.2.29B.1: `<x>/<x>/Common/PrivateCall/EmergencyCall/MCPTTPrivateRecipient/Entry/ID`**

`<x>/Common/PrivateCall/EmergencyCall/MCPTTPrivateRecipient/Entry/ID`

Status	Occurrence	Format	Min. Access Types
Optional	One	chr	Get, Replace

This leaf node indicates the MCPTT private recipient used upon certain criteria on initiation of an MCPTT emergency private call.

## 5.2.29C

`<x>/<x>/Common/PrivateCall/EmergencyCall/MCPTTPrivateRecipient/Entry/DiscoveryGroupID`

**Table 5.2.29C.1:**

**`<x>/<x>/Common/PrivateCall/EmergencyCall/MCPTTPrivateRecipient/Entry/DiscoveryGroupID`**

`<x>/Common/PrivateCall/EmergencyCall/MCPTTPrivateRecipient/Entry/DiscoveryGroupID`

Status	Occurrence	Format	Min. Access Types
Optional	One	int	Get, Replace

This leaf node indicates the discovery group ID as specified in 3GPP TS 23.303 [6].

## 5.2.29D

`<x>/<x>/Common/PrivateCall/EmergencyCall/MCPTTPrivateRecipient/Entry/UserInfoID`

**Table 5.2.29D.1:**

**`<x>/<x>/Common/PrivateCall/EmergencyCall/MCPTTPrivateRecipient/Entry/UserInfoID`**

`<x>/Common/PrivateCall/EmergencyCall/MCPTTPrivateRecipient/Entry/UserInfoID`

Status	Occurrence	Format	Min. Access Types
Optional	One	int	Get, Replace

This leaf node indicates a ProSe user info ID as specified in 3GPP TS 23.303 [6].

The "UserInfoID" element identifies the MCPTT private recipient when making an off-network private call.

## 5.2.29E

`<x>/<x>/Common/PrivateCall/EmergencyCall/MCPTTPrivateRecipient/Entry/DisplayName`

**Table 5.2.29E.1:**

**`<x>/<x>/Common/PrivateCall/EmergencyCall/MCPTTPrivateRecipient/Entry/DisplayName`**

`<x>/Common/PrivateCall/EmergencyCall/MCPTTPrivateRecipient/Entry/DisplayName`

Status	Occurrence	Format	Min. Access Types
Optional	One	chr	Get, Replace

This leaf node contains a human readable name that corresponds to the MCPTT private recipient ID.

## 5.2.29F

### /<x>/<x>/Common/PrivateCall/EmergencyCall/MCPTTPrivateRecipient/Entry/Usage

**Table 5.2.29F.1: /<x>/<x>/Common/PrivateCall/EmergencyCall/MCPTTPrivateRecipient/Entry/Usage**

<x>/Common/PrivateCall/EmergencyCall/MCPTTPrivateRecipient/Entry/Usage

Status	Occurrence	Format	Min. Access Types
Required	One	chr	Get, Replace

This leaf node indicates the criteria to determine when initiation of an MCPTT emergency private call uses the MCPTT private recipient ID.

The valid values are 'LocallyDetermined' and 'UsePreConfigured'.

When set to 'LocallyDetermined' then if the MCPTT user selects an MCPTT ID then use that MCPTT ID for the MCPTT emergency private call, if the MCPTT user does not select a MCPTT ID then use the MCPTT ID identified by the MCPTT private recipient ID in subclause 5.2.29B for an on-network MCPTT emergency private call.

When set to 'UsePreConfigured' then use the MCPTT ID identified by the MCPTT private recipient ID in subclause 5.2.29B for an on-network MCPTT emergency private call.

When set to 'LocallyDetermined' then if the MCPTT user selects an MCPTT user then use the UserInfoID that corresponds to that MCPTT user for the MCPTT emergency private call, if the MCPTT user does not select a MCPTT user then use the User Info ID identified by the UserInfoID in subclause 5.2.29D for an off-network MCPTT emergency private call.

When set to 'UsePreConfigured' then use the User Info ID identified by the UserInfoID in subclause 5.2.29D for an off-network MCPTT emergency private call.

### 5.2.30 /<x>/<x>/Common/MCPTTGroupCall

**Table 5.2.30.1: /<x>/<x>/Common/MCPTTGroupCall**

<x>/Common/MCPTTGroupCall

Status	Occurrence	Format	Min. Access Types
Required	One	node	Get, Replace

This interior node is a placeholder for the MCPTT group call configuration.

### 5.2.31 /<x>/<x>/Common/MCPTTGroupCall/MaxSimultaneousCallsN6

**Table 5.2.31.1: /<x>/<x>/Common/MCPTTGroupCall/MaxSimultaneousCallsN6**

<x>/Common/MCPTTGroupCall/MaxSimultaneousCallsN6

Status	Occurrence	Format	Min. Access Types
Required	One	int	Get, Replace

This leaf node indicates the maximum number of simultaneously received MCPTT group calls (N6).

### 5.2.32 /<x>/<x>/Common/MCPTTGroupCall/EmergencyCall

**Table 5.2.32.1: /<x>/<x>/Common/MCPTTGroupCall/EmergencyCall**

<x>/Common/MCPTTGroupCall/EmergencyCall

Status	Occurrence	Format	Min. Access Types
Required	One	node	Get, Replace

This interior node is a placeholder for the MCPTT emergency call policy.

### 5.2.33 /<x>/<x>/Common/MCPTTGroupCall/EmergencyCall/Enabled

**Table 5.2.33.1: /<x>/<x>/Common/MCPTTGroupCall/EmergencyCall/Enabled**

<x>/Common/MCPTTGroupCall/EmergencyCall/Enabled

Status	Occurrence	Format	Min. Access Types
Optional	One	bool	Get, Replace

This leaf node indicates the authorisation to make an MCPTT emergency group call functionality enabled for MCPTT user.

When set to "true" the MCPTT user is authorised to make an MCPTT emergency group call functionality enabled.

When set to "false" the MCPTT user is not authorised to make an MCPTT emergency group call functionality enabled.

### 5.2.34

#### /<x>/<x>/Common/MCPTTGroupCall/EmergencyCall/MCPTTGroupInitiation

**Table 5.2.34.1: /<x>/<x>/Common/MCPTTGroupCall/EmergencyCall/MCPTTGroupInitiation**

<x>/Common/MCPTTGroupCall/EmergencyCall/MCPTTGroupInitiation

Status	Occurrence	Format	Min. Access Types
Required	One	node	Get, Replace

This interior node is a placeholder for the group used on initiation of an MCPTT emergency group call.

### 5.2.34A

#### /<x>/<x>/Common/MCPTTGroupCall/EmergencyCall/MCPTTGroupInitiation/Entry

**Table 5.2.34A.1: /<x>/<x>/Common/MCPTTGroupCall/EmergencyCall/MCPTTGroupInitiation/Entry**

<x>/Common/MCPTTGroupCall/EmergencyCall/MCPTTGroupInitiation/Entry

Status	Occurrence	Format	Min. Access Types
Required	One	node	Get, Replace

This interior node is a placeholder for the details of the group used on initiation of an MCPTT emergency group call.

### 5.2.34B

#### /<x>/<x>/Common/MCPTTGroupCall/EmergencyCall/MCPTTGroupInitiation/Entry/GroupID

**Table 5.2.34BA.1:**

**/<x>/<x>/Common/MCPTTGroupCall/EmergencyCall/MCPTTGroupInitiation/Entry/GroupID**

<x>/Common/MCPTTGroupCall/EmergencyCall/MCPTTGroupInitiation/Entry/GroupID

Status	Occurrence	Format	Min. Access Types
Optional	One	chr	Get, Replace

This leaf node indicates the group used upon certain criteria on initiation of an MCPTT emergency group call.

## 5.2.34C

`<x>/<x>/Common/MCPTTGroupCall/EmergencyCall/MCPTTGroupInitiation/Entry/DisplayName`

Table 5.2.34C.1:

`<x>/<x>/Common/MCPTTGroupCall/EmergencyCall/MCPTTGroupInitiation/Entry/DisplayName`

`<x>/Common/MCPTTGroupCall/EmergencyCall/MCPTTGroupInitiation/Entry/DisplayName`

Status	Occurrence	Format	Min. Access Types
Optional	One	chr	Get, Replace

This leaf node contains a human readable name that corresponds to the Group ID.

## 5.2.34D

`<x>/<x>/Common/MCPTTGroupCall/EmergencyCall/MCPTTGroupInitiation/Entry/Usage`

Table 5.2.34D.1:

`<x>/<x>/Common/MCPTTGroupCall/EmergencyCall/MCPTTGroupInitiation/Entry/Usage`

`<x>/Common/MCPTTGroupCall/EmergencyCall/MCPTTGroupInitiation/Entry/Usage`

Status	Occurrence	Format	Min. Access Types
Required	One	chr	Get, Replace

This leaf node indicates the criteria to determine when initiation of an MCPTT emergency group call uses the GroupID.

The valid values are 'UseCurrentlySelectedGroup' and 'DedicatedGroup'.

When set to 'UseCurrentlySelectedGroup' then if the MCPTT user has currently selected an MCPTT group then use that MCPTT group for an on-network MCPTT emergency group call, if the MCPTT user does not have a currently selected MCPTT group then use the MCPTT group identified by the GroupID in subclause 5.2.34B for an MCPTT emergency group call.

When set to 'DedicatedGroup' then use the MCPTT group identified by the GroupID in subclause 5.2.34B for an MCPTT emergency group call.

## 5.2.35

`<x>/<x>/Common/MCPTTGroupCall/EmergencyCall/CancelMCPTTGroup`

Table 5.2.35.1: `<x>/<x>/Common/MCPTTGroupCall/EmergencyCall/CancelMCPTTGroup`

`<x>/Common/MCPTTGroupCall/EmergencyCall/CancelMCPTTGroup`

Status	Occurrence	Format	Min. Access Types
Required	One	bool	Get, Replace

This leaf node indicates the authorisation to cancel an in progress MCPTT emergency group call associated with a group.

When set to "true" the MCPTT user is authorised to cancel a MCPTT emergency group call.

When set to "false" the MCPTT user is not authorised to cancel a MCTT emergency group call.

## 5.2.36 /<x>/<x>/Common/MCPTTGroupCall/ImminentPerilCall

**Table 5.2.36.1: /<x>/<x>/Common/MCPTTGroupCall/ImminentPerilCall**

<x>/Common/MCPTTGroupCall/ImminentPerilCall

Status	Occurrence	Format	Min. Access Types
Required	One	node	Get, Replace

This interior node is a placeholder for the MCPTT imminent peril call policy.

## 5.2.37 /<x>/<x>/Common/MCPTTGroupCall/ImminentPerilCall/Authorised

**Table 5.2.37.1: /<x>/<x>/Common/MCPTTGroupCall/ImminentPerilCall/Authorised**

<x>/Common/MCPTTGroupCall/ImminentPerilCall/Authorised

Status	Occurrence	Format	Min. Access Types
Required	One	bool	Get, Replace

This leaf node indicates the authorisation to make an Imminent Peril group call.

When set to "true" the MCPTT user is authorised to create an MCPTT imminent peril group call.

When set to "false" the MCPTT user is not authorised to create an MCPTT imminent peril group call.

## 5.2.38 /<x>/<x>/Common/MCPTTGroupCall/ImminentPerilCall/Cancel

**Table 5.2.38.1: /<x>/<x>/Common/MCPTTGroupCall/ImminentPerilCall/Cancel**

<x>/Common/MCPTTGroupCall/ImminentPerilCall/Cancel

Status	Occurrence	Format	Min. Access Types
Required	One	bool	Get, Replace

This leaf node indicates the authorisation for in-progress MCPTT imminent peril cancelation.

When set to "true" the MCPTT user is authorised to cancel an MCPTT imminent peril call.

When set to "false" the MCPTT user is not authorised to cancel an MCPTT imminent peril call.

## 5.2.39

### /<x>/<x>/Common/MCPTTGroupCall/ImminentPerilCall/MCPTTGroupInitiation

**Table 5.2.39.1: /<x>/<x>/Common/MCPTTGroupCall/ImminentPerilCall/MCPTTGroupInitiation**

<x>/Common/MCPTTGroupCall/ImminentPerilCall/MCPTTGroupInitiation

Status	Occurrence	Format	Min. Access Types
Optional	One	node	Get, Replace

This interior node is a placeholder for the group used on initiation of an MCPTT imminent peril group call.

## 5.2.39A

### /<x>/<x>/Common/MCPTTGroupCall/ImminentPerilCall/MCPTTGroupInitiation/Entry

**Table 5.2.39A.1: /<x>/<x>/Common/MCPTTGroupCall/ImminentPerilCall/MCPTTGroupInitiation/Entry**

<x>/Common/MCPTTGroupCall/ImminentPerilCall/MCPTTGroupInitiation/Entry

Status	Occurrence	Format	Min. Access Types
Required	One	node	Get, Replace



This interior node is a placeholder for the details of the group used on initiation of an imminent peril call.

### 5.2.39B

`<x>/<x>/Common/MCPTTGroupCall/ImminentPerilCall/MCPTTGroupInitiation/Entry/GroupID`

**Table 5.2.39B.1:**

`<x>/<x>/Common/MCPTTGroupCall/ImminentPerilCall/MCPTTGroupInitiation/Entry/GroupID`

`<x>/Common/MCPTTGroupCall/ImminentPerilCall/MCPTTGroupInitiation/Entry/GroupID`

Status	Occurrence	Format	Min. Access Types
Required	One	chr	Get, Replace

This leaf node indicates the group used upon certain criteria on initiation of an MCPTT imminent peril group call.

### 5.2.39C

`<x>/<x>/Common/MCPTTGroupCall/ImminentPerilCall/MCPTTGroupInitiation/Entry/DisplayName`

**Table 5.2.39C.1:**

`<x>/<x>/Common/MCPTTGroupCall/ImminentPerilCall/MCPTTGroupInitiation/Entry/DisplayName`

`<x>/Common/MCPTTGroupCall/ImminentPerilCall/MCPTTGroupInitiation/Entry/DisplayName`

Status	Occurrence	Format	Min. Access Types
Optional	One	chr	Get, Replace

This leaf node contains a human readable name that corresponds to the Group ID.

### 5.2.39D

`<x>/<x>/Common/MCPTTGroupCall/ImminentPerilCall/MCPTTGroupInitiation/Entry/Usage`

**Table 5.2.39D.1:**

`<x>/<x>/Common/MCPTTGroupCall/ImminentPerilCall/MCPTTGroupInitiation/Entry/Usage`

`<x>/Common/MCPTTGroupCall/ImminentPerilCall/MCPTTGroupInitiation/Entry/Usage`

Status	Occurrence	Format	Min. Access Types
Required	One	chr	Get, Replace

This leaf node indicates the criteria to determine when initiation of an MCPTT imminent peril group call uses the GroupID.

The valid values are 'UseCurrentlySelectedGroup' and 'DedicatedGroup'.

When set to 'UseCurrentlySelectedGroup' then if the MCPTT user has currently selected an MCPTT group then use that MCPTT group for an on-network MCPTT imminent peril group call, if the MCPTT user does not have a currently selected MCPTT group then use the MCPTT group identified by the GroupID in subclause 5.2.39B for an MCPTT imminent peril group call.

When set to 'DedicatedGroup' then use the MCPTT group identified by the GroupID in subclause 5.2.39B for an MCPTT imminent peril group call.

## 5.2.40 /<x>/<x>/Common/MCPTTGroupCall/EmergencyAlert

**Table 5.2.40.1: /<x>/<x>/Common/MCPTTGroupCall/EmergencyAlert**

<x>/Common/MCPTTGroupCall/EmergencyAlert

Status	Occurrence	Format	Min. Access Types
Required	One	node	Get, Replace

This interior node is a placeholder for the MCPTT emergency alert policy.

## 5.2.41 /<x>/<x>/Common/MCPTTGroupCall/EmergencyAlert/Authorised

**Table 5.2.41.1: /<x>/<x>/Common/MCPTTGroupCall/EmergencyAlert/Authorised**

<x>/Common/MCPTTGroupCall/EmergencyAlert/Authorised

Status	Occurrence	Format	Min. Access Types
Required	One	bool	Get, Replace

This leaf node indicates the authorisation to activate an MCPTT emergency alert.

When set to "true" the MCPTT user is authorised to make an MCPTT emergency alert.

When set to "false" the MCPTT user is not authorised to make an MCPTT emergency alert.

## 5.2.42 /<x>/<x>/Common/MCPTTGroupCall/EmergencyAlert/Cancel

**Table 5.2.42.1: /<x>/<x>/Common/MCPTTGroupCall/EmergencyAlert/Cancel**

<x>/Common/MCPTTGroupCall/EmergencyAlert/Cancel

Status	Occurrence	Format	Min. Access Types
Required	One	bool	Get, Replace

This leaf node indicates the authorisation to cancel an MCPTT emergency alert.

When set to "true" the MCPTT user is authorised to cancel an MCPTT emergency alert.

When set to "false" the MCPTT user is not authorised to cancel an MCPTT emergency alert.

## 5.2.43 Void

## 5.2.43A /<x>/<x>/Common/MCPTTGroupCall/EmergencyAlert/Entry

**Table 5.2.39A.1: /<x>/<x>/Common/MCPTTGroupCall/EmergencyAlert/Entry**

<x>/Common/MCPTTGroupCall/EmergencyAlert/Entry

Status	Occurrence	Format	Min. Access Types
Required	One	node	Get, Replace

This interior node is a placeholder for the details of the MCPTT group of an MCPTT emergency alert.

## 5.2.43B /<x>/<x>/Common/MCPTTGroupCall/EmergencyAlert/Entry/ID

**Table 5.2.43B.1: /<x>/<x>/Common/MCPTTGroupCall/EmergencyAlert/Entry/ID**

<x>/Common/MCPTTGroupCall/EmergencyAlert/Entry/ID

Status	Occurrence	Format	Min. Access Types
Required	One	chr	Get, Replace

This leaf node indicates the MCPTT group used upon certain criteria on initiation of an MCPTT emergency alert.

## 5.2.43C Void

## 5.2.43D

`/<x>/<x>/Common/MCPTTGroupCall/EmergencyAlert/Entry/DisplayName`

**Table 5.2.43D.1: `/<x>/<x>/Common/MCPTTGroupCall/EmergencyAlert/Entry/DisplayName`**

`<x>/Common/MCPTTGroupCall/EmergencyAlert/Entry/DisplayName`

Status	Occurrence	Format	Min. Access Types
Optional	One	chr	Get, Replace

This leaf node contains a human readable name that corresponds to the ID.

5.2.43E `/<x>/<x>/Common/MCPTTGroupCall/EmergencyAlert/Entry/Usage`

**Table 5.2.43E.1: `/<x>/<x>/Common/MCPTTGroupCall/EmergencyAlert/Entry/Usage`**

`<x>/Common/MCPTTGroupCall/EmergencyAlert/Entry/Usage`

Status	Occurrence	Format	Min. Access Types
Required	One	chr	Get, Replace

This leaf node indicates the criteria to determine when initiation of an MCPTT emergency alert uses the ID.

The valid values are 'LocallyDetermined', 'UseCurrentlySelectedGroup', 'UsePreConfigured' and 'DedicatedGroup'.

When set to 'LocallyDetermined' then if the MCPTT user selects an MCPTT ID then use that MCPTT ID for an on-network MCPTT emergency alert, if the MCPTT user does not select a MCPTT ID then use the MCPTT ID identified by the ID in subclause 5.2.43B for an on-network MCPTT emergency alert.

When set to 'UseCurrentlySelectedGroup' then if the MCPTT user has currently selected an MCPTT group then use that MCPTT group for an on-network MCPTT emergency alert, if the MCPTT user does not have a currently selected MCPTT group then use the MCPTT group identified by the ID in subclause 5.2.43B for an MCPTT emergency alert.

When set to 'UsePreConfigured' then use the ID identified by the ID in subclause 5.2.43B for an on-network MCPTT emergency alert.

When set to 'DedicatedGroup' then use the MCPTT group identified by the ID in subclause 5.2.43B for an MCPTT emergency alert.

5.2.43F `/<x>/<x>/Common/MCPTTGroupCall/Priority`

**Table 5.2.43F.1: `/<x>/<x>/Common/MCPTTGroupCall/Priority`**

`<x>/Common/MCPTTGroupCall/Priority`

Status	Occurrence	Format	Min. Access Types
Required	One	int	Get, Replace

This leaf node indicates the priority of the MCPTT group calls.

- Values: 0-255

The MCPTT group call with the lowest Priority value shall be considered as the MCPTT group call having the lowest level among the MCPTT group calls.

## 5.2.44 Void

## 5.2.45 /<x>/<x>/Common/MCPTTGroupBroadcast

**Table 5.2.45.1: /<x>/<x>/Common/MCPTTGroupBroadcast**

<x>/Common/MCPTTGroupBroadcast

Status	Occurrence	Format	Min. Access Types
Required	One	node	Get, Replace

This interior node is a placeholder for the group-broadcast group policy.

## 5.2.46 /<x>/<x>/Common/MCPTTGroupBroadcast/Authorised

**Table 5.2.46.1: /<x>/<x>/Common/MCPTTGroupBroadcast/Authorised**

<x>/Common/MCPTTGroupBroadcast/Authorised

Status	Occurrence	Format	Min. Access Types
Required	One	bool	Get, Replace

This leaf node indicates the authorisation to create a group-broadcast group.

When set to "true" the MCPTT user is authorised to create a group-broadcast group.

When set to "false" the MCPTT user is not authorised to create a group-broadcast group.

## 5.2.47 /<x>/<x>/Common/UserBroadcast

**Table 5.2.47.1: /<x>/<x>/Common/UserBroadcast**

<x>/Common/UserBroadcast

Status	Occurrence	Format	Min. Access Types
Required	One	node	Get, Replace

This interior node is a placeholder for the user-broadcast group policy.

## 5.2.48 /<x>/<x>/Common/UserBroadcast/Authorised

**Table 5.2.48.1: /<x>/<x>/Common/UserBroadcast/Authorised**

<x>/Common/UserBroadcast/Authorised

Status	Occurrence	Format	Min. Access Types
Required	One	bool	Get, Replace

This leaf node indicates the authorisation to create a user-broadcast group.

When set to "true" the MCPTT user is authorised to create a user-broadcast group.

When set to "false" the MCPTT user is not authorised to create a user-broadcast group.

## 5.2.48A /<x>/<x>/OnNetwork

**Table 5.2.48A.1: /<x>/<x>/OnNetwork**

<x>/OnNetwork

Status	Occurrence	Format	Min. Access Types
Required	ZeroOrOne	node	Get, Replace

This interior node represents a container for on-network operation.

## 5.2.48B1/ <x>/<x>/OnNetwork/MCPTTGroupList

**Table 5.2.48B1.1: /<x>/<x>/OnNetwork/MCPTTGroupList**

<x>/OnNetwork/MCPTTGroupList

Status	Occurrence	Format	Min. Access Types
Required	One	node	Get, Replace

This interior node is a placeholder for the list of on-network MCPTT groups that the MCPTT user is allowed to affiliate to.

## 5.2.48B2/ <x>/<x>/OnNetwork/MCPTTGroupList/<x>

**Table 5.2.48B2.1: /<x>/<x>/OnNetwork/MCPTTGroupList/<x>**

<x>/OnNetwork/MCPTTGroupList/<x>

Status	Occurrence	Format	Min. Access Types
Required	OneOrMore	node	Get, Replace

This interior node is a placeholder for one or more list of on-network MCPTT groups that the MCPTT user is allowed to affiliate to.

## 5.2.48B3/ <x>/<x>/OnNetwork/MCPTTGroupList/<x>/Entry

**Table 5.2.48B3.1: /<x>/<x>/OnNetwork/MCPTTGroupList/<x>/Entry**

<x>/OnNetwork/MCPTTGroupList/<x>/Entry

Status	Occurrence	Format	Min. Access Types
Optional	One	node	Get, Replace

This interior node is a placeholder for the details of the on-network MCPTT groups that the MCPTT user is allowed to affiliate to.

## 5.2.48B4/ <x>/<x>/OnNetwork/MCPTTGroupList/<x>/Entry/MCPTTGroupID

**Table 5.2.48B4.1: /<x>/<x>/OnNetwork/MCPTTGroupList/<x>/Entry/MCPTTGroupID**

<x>/OnNetwork/MCPTTGroupList/<x>/Entry/MCPTTGroupID

Status	Occurrence	Format	Min. Access Types
Required	One	chr	Get, Replace

This leaf node indicates the MCPTT group ID for the on-network MCPTT group that the MCPTT user is allowed to affiliate to.

The value is a "uri" attribute specified in OMA OMA-TS-XDM\_Group-V1\_1 [4].

## 5.2.48B5/ <x>/<x>/OnNetwork/MCPTTGroupList/<x>/Entry/DisplayName

**Table 5.2.48B5.1: /<x>/<x>/OnNetwork/MCPTTGroupList/<x>/Entry/DisplayName**

<x>/OnNetwork/MCPTTGroupList/<x>/Entry/DisplayName

Status	Occurrence	Format	Min. Access Types
Optional	One	chr	Get, Replace

This leaf node contains a human readable name that corresponds to the MCPTT Group ID.

## 5.2.48C1 /&lt;x&gt;/&lt;x&gt;/OnNetwork/ImplicitAffiliations

**Table 5.2.48C1.1: /<x>/<x>/OnNetwork/ImplicitAffiliations**

&lt;x&gt;/OnNetwork/ImplicitAffiliations

Status	Occurrence	Format	Min. Access Types
Required	One	chr	Get, Replace

This interior node is a placeholder for the implicit affiliation configuration.

## 5.2.48C2 /&lt;x&gt;/&lt;x&gt;/OnNetwork/ImplicitAffiliations/&lt;x&gt;

**Table 5.2.48C2.1: /<x>/<x>/OnNetwork/ImplicitAffiliations/<x>**

&lt;x&gt;/OnNetwork/ImplicitAffiliations/&lt;x&gt;

Status	Occurrence	Format	Min. Access Types
Required	OneOrMore	node	Get, Replace

This interior node is a placeholder for one or more implicit affiliation configuration.

## 5.2.48C3 /&lt;x&gt;/&lt;x&gt;/OnNetwork/ImplicitAffiliations/&lt;x&gt;/Entry

**Table 5.2.48C3.1: /<x>/<x>/OnNetwork/ImplicitAffiliations/<x>/Entry**

&lt;x&gt;/OnNetwork/ImplicitAffiliations/&lt;x&gt;/Entry

Status	Occurrence	Format	Min. Access Types
Optional	One	node	Get, Replace

This interior node is a placeholder for the details of the on-network MCPTT groups that the MCPTT user is implicitly affiliated to.

## 5.2.48C4 /&lt;x&gt;/&lt;x&gt;/OnNetwork/ImplicitAffiliations/&lt;x&gt;/Entry/MCPTTGroupID

**Table 5.2.48C4.1: /<x>/<x>/OnNetwork/ImplicitAffiliations/<x>/ Entry/MCPTTGroupID**

&lt;x&gt;/OnNetwork/ImplicitAffiliations/&lt;x&gt;/ Entry/MCPTTGroupID

Status	Occurrence	Format	Min. Access Types
Required	One	chr	Get, Replace

This leaf node indicates a MCPTT group ID to which the MCPTT user is implicitly affiliated to.

The value is a "uri" attribute specified in OMA OMA-TS-XDM\_Group-V1\_1 [4].

## 5.2.48C5 /&lt;x&gt;/&lt;x&gt;/OnNetwork/ImplicitAffiliations/&lt;x&gt;/Entry/DisplayName

**Table 5.2.48C5.1: /<x>/<x>/OnNetwork/ImplicitAffiliations/<x>/Entry/DisplayName**

&lt;x&gt;/OnNetwork/ImplicitAffiliations/&lt;x&gt;/Entry/DisplayName

Status	Occurrence	Format	Min. Access Types
Optional	One	chr	Get, Replace

This leaf node contains a human readable name that corresponds to the MCPTT Group ID.

## 5.2.48D /&lt;x&gt;/&lt;x&gt;/OnNetwork/AllowedRegroup

**Table 5.2.48D.1: /<x>/<x>/OnNetwork/AllowedRegroup**

&lt;x&gt;/OnNetwork/AllowedRegroup

Status	Occurrence	Format	Min. Access Types
Required	One	bool	Get, Replace

This leaf node indicates whether the MCPTT user is authorised to perform dynamic regrouping operations.

When set to "true" the MCPTT user is authorised to perform dynamic regrouping operations.

When set to "false" the MCPTT user is not authorised to perform dynamic regrouping operations.

## 5.2.48E /<x>/<x>/OnNetwork/AllowedPresenceStatus

**Table 5.2.48E.1: /<x>/<x>/OnNetwork/AllowedPresenceStatus**

<x>/OnNetwork/AllowedPresenceStatus

Status	Occurrence	Format	Min. Access Types
Optional	One	bool	Get, Replace

This leaf node indicates the presence status on the network of this MCPTT user is available.

When set to "true" the presence status on the network of this MCPTT user is available.

When set to "false" the presence status on the network of this MCPTT user is not available. This is the default if this leaf node is not present.

## 5.2.48F /<x>/<x>/OnNetwork/AllowedPresence

**Table 5.2.48F.1: /<x>/<x>/OnNetwork/AllowedPresence**

<x>/OnNetwork/AllowedPresence

Status	Occurrence	Format	Min. Access Types
Optional	One	bool	Get, Replace

This leaf node indicates whether the MCPTT user is authorised to obtain whether a particular MCPTT User is present on the network.

When set to "true" the MCPTT user is authorised to obtain whether a particular MCPTT User is present on the network.

When set to "false" the MCPTT user is not authorised to obtain whether a particular MCPTT User is present on the network.

## 5.2.48G /<x>/<x>/OnNetwork/EnabledParticipation

**Table 5.2.48G.1: /<x>/<x>/OnNetwork/EnabledParticipation**

<x>/OnNetwork/EnabledParticipation

Status	Occurrence	Format	Min. Access Types
Required	One	bool	Get, Replace

This leaf node indicates whether the MCPTT user is allowed to participate in MCPTT private calls that they are invited to.

When set to "true" the MCPTT user is allowed to participate in MCPTT private calls that they are invited to.

When set to "false" the MCPTT user is not allowed to participate in MCPTT private calls that they are invited to.

## 5.2.48H /<x>/<x>/OnNetwork/AllowedTransmission

**Table 5.2.48H.1: /<x>/<x>/OnNetwork/AllowedTransmission**

<x>/OnNetwork/AllowedTransmission

Status	Occurrence	Format	Min. Access Types
Required	One	bool	Get, Replace

This leaf node indicates whether the MCPTT user is authorised to override transmission in a MCPTT private call.

When set to "true" the MCPTT user is authorised to override transmission in a MCPTT private call.

When set to "false" the MCPTT user is not authorised to override transmission in a MCPTT private call.

## 5.2.48I /<x>/<x>/OnNetwork/AllowedManualSwitch

**Table 5.2.48I.1: /<x>/<x>/OnNetwork/AllowedManualSwitch**

<x>/OnNetwork/AllowedManualSwitch

Status	Occurrence	Format	Min. Access Types
Required	One	bool	Get, Replace

This leaf node indicates whether the MCPTT user is authorised to manually switch to off-network operation while in on-network operation.

When set to "true" the MCPTT user is authorised to manually switch to off-network operation while in on-network operation.

When set to "false" the MCPTT user is not authorised to manually switch to off-network operation while in on-network operation.

## 5.2.48J /<x>/<x>/OnNetwork/PrivateCall

**Table 5.2.48J.1: /<x>/<x>/OnNetwork/PrivateCall**

<x>/OnNetwork/PrivateCall

Status	Occurrence	Format	Min. Access Types
Required	One	node	Get, Replace

This interior node is a placeholder for the MCPTT private call configuration.

## 5.2.48K /<x>/<x>/OnNetwork/PrivateCall/EmergencyAlert

**Table 5.2.48K.1: /<x>/<x>/OnNetwork/PrivateCall/EmergencyAlert**

<x>/OnNetwork/PrivateCall/EmergencyAlert

Status	Occurrence	Format	Min. Access Types
Required	One	node	Get, Replace

This interior node is a placeholder for the MCPTT private emergency alert policy.

## 5.2.48L /<x>/<x>/OnNetwork/PrivateCall/EmergencyAlert/Entry

**Table 5.2.48L.1: /<x>/<x>/OnNetwork/PrivateCall/EmergencyAlert/Entry**

<x>/OnNetwork/PrivateCall/EmergencyAlert/Entry

Status	Occurrence	Format	Min. Access Types
Required	One	node	Get, Replace

This interior node is a placeholder for the details of an MCPTT private emergency alert for on-network.



## 5.2.48M /<x>/<x>/OnNetwork/PrivateCall/EmergencyAlert/Entry/ID

**Table 5.2.48M.1: /<x>/<x>/OnNetwork/PrivateCall/EmergencyAlert/Entry/ID**

<x>/OnNetwork/PrivateCall/EmergencyAlert/Entry/ID

Status	Occurrence	Format	Min. Access Types
Required	One	chr	Get, Replace

This leaf node indicates the MCPTT user ID used upon certain criteria on initiation of an MCPTT private emergency alert for on-network.

## 5.2.48N

### /<x>/<x>/OnNetwork/PrivateCall/EmergencyAlert/Entry/DisplayName

**Table 5.2.48N.1: /<x>/<x>/OnNetwork/PrivateCall/EmergencyAlert/Entry/DisplayName**

<x>/OnNetwork/PrivateCall/EmergencyAlert/Entry/DisplayName

Status	Occurrence	Format	Min. Access Types
Optional	One	chr	Get, Replace

This leaf node contains a human readable name that corresponds to the ID.

## 5.2.48O /<x>/<x>/OnNetwork/PrivateCall/EmergencyAlert/Entry/Usage

**Table 5.2.48O.1: /<x>/<x>/OnNetwork/PrivateCall/EmergencyAlert/Entry/Usage**

<x>/OnNetwork/PrivateCall/EmergencyAlert/Entry/Usage

Status	Occurrence	Format	Min. Access Types
Required	One	chr	Get, Replace

This leaf node indicates the criteria to determine when initiation of an MCPTT private emergency alert uses the ID.

The valid values are 'LocallyDetermined' and 'UsePreConfigured'.

When set to 'LocallyDetermined' then if the MCPTT user selects an MCPTT ID then use that MCPTT ID for an on-network MCPTT private emergency alert, if the MCPTT user does not select a MCPTT ID then use the MCPTT ID identified by the ID in subclause 5.2.48M for an on-network MCPTT private emergency alert.

When set to 'UsePreConfigured' then use the ID identified by the ID in subclause 5.2.48M for an on-network MCPTT private emergency alert.

## 5.2.48P /<x>/<x>/OnNetwork/PrivateCall/AllowedCallBackRequest

**Table 5.2.48P.1: /<x>/<x>/OnNetwork/PrivateCall/AllowedCallBackRequest**

<x>/OnNetwork/PrivateCall/AllowedCallBackRequest

Status	Occurrence	Format	Min. Access Types
Optional	One	bool	Get, Replace

This leaf node indicates whether the MCPTT user is allowed to request a private call call-back.

When set to "true" the MCPTT user is allowed to request a private call call-back.

When set to "false" the MCPTT user is not allowed to request a private call call-back.

## 5.2.48Q /<x>/<x>/OnNetwork/PrivateCall/AllowedCallBackCancelRequest

**Table 5.2.48Q.1: /<x>/<x>/OnNetwork/PrivateCall/AllowedCallBackCancelRequest**

<x>/OnNetwork/PrivateCall/AllowedCallBackCancelRequest

Status	Occurrence	Format	Min. Access Types
Optional	One	bool	Get, Replace

This leaf node indicates whether the MCPTT user is allowed to cancel an outstanding private call call-back request.

When set to "true" the MCPTT user is allowed to cancel an outstanding private call call-back request.

When set to "false" the the MCPTT user is not allowed to cancel an outstanding private call call-back request.

## 5.2.48R

### /<x>/<x>/OnNetwork/PrivateCall/AllowedRemoteInitiatedAmbientListening

**Table 5.2.48R.1: /<x>/<x>/OnNetwork/PrivateCall/AllowedRemoteInitiatedAmbientListening**

<x>/OnNetwork/PrivateCall/AllowedRemoteInitiatedAmbientListening

Status	Occurrence	Format	Min. Access Types
Optional	One	bool	Get, Replace

This leaf node indicates whether the MCPTT user is allowed to request a remote initiated ambient listening call.

When set to "true" the MCPTT user is allowed to request a remote initiated ambient listening call.

When set to "false" the MCPTT user is not allowed to request a remote initiated ambient listening call.

## 5.2.48S

### /<x>/<x>/OnNetwork/PrivateCall/AllowedLocallyInitiatedAmbientListening

**Table 5.2.48S.1: /<x>/<x>/OnNetwork/PrivateCall/AllowedLocallyInitiatedAmbientListening**

<x>/OnNetwork/PrivateCall/AllowedLocallyInitiatedAmbientListening

Status	Occurrence	Format	Min. Access Types
Optional	One	bool	Get, Replace

This leaf node indicates whether the MCPTT user is allowed to request a locally initiated ambient listening call.

When set to "true" the MCPTT user is allowed to request a locally initiated ambient listening call.

When set to "false" the MCPTT user is not allowed to request a locally initiated ambient listening call.

## 5.2.48T /<x>/<x>/OnNetwork/PrivateCall/AllowedRequestFirstToAnswerCall

**Table 5.2.48T.1: /<x>/<x>/OnNetwork/PrivateCall/AllowedRequestFirstToAnswerCall**

<x>/OnNetwork/PrivateCall/AllowedRequestFirstToAnswerCall

Status	Occurrence	Format	Min. Access Types
Optional	One	bool	Get, Replace

This leaf node indicates whether the MCPTT user is allowed to request a first to answer call.

When set to "true" the MCPTT user is allowed to request a first to answer call.

When set to "false" the MCPTT user is not allowed to request a first to answer call.

## 5.2.48U1 /<x>/<x>/OnNetwork/RemoteGroupSelection

**Table 5.2.48U1.1: /<x>/<x>/OnNetwork/RemoteGroupSelection**

<x>/OnNetwork/RemoteGroupSelection

Status	Occurrence	Format	Min. Access Types
Required	One	node	Get, Replace

This interior node is a placeholder for the remote group selection configuration.

## 5.2.48U2 /<x>/<x>/OnNetwork/RemoteGroupSelection/<x>

**Table 5.2.48U2.1: /<x>/<x>/OnNetwork/RemoteGroupSelection/<x>**

<x>/OnNetwork/RemoteGroupSelection/<x>

Status	Occurrence	Format	Min. Access Types
Required	OneOrMore	node	Get, Replace

This interior node is a placeholder for one or more remote group selection configuration elements.

## 5.2.48U3 /<x>/<x>/OnNetwork/RemoteGroupSelection/<x>/Entry

**Table 5.2.48U3.1: /<x>/<x>/OnNetwork/RemoteGroupSelection/<x>/Entry**

<x>/OnNetwork/RemoteGroupSelection/<x>/Entry

Status	Occurrence	Format	Min. Access Types
Optional	One	node	Get, Replace

This interior node is a placeholder for the details of the on-network MCPTT users whose selected MCPTT group is allowed to be remotely changed by the MCPTT user.

## 5.2.48U4 /<x>/<x>/OnNetwork/RemoteGroupSelection/<x>/Entry/MCPTTID

**Table 5.2.48U4.1: /<x>/<x>/OnNetwork/RemoteGroupSelection/<x>/Entry/MCPTTID**

<x>/OnNetwork/RemoteGroupSelection/<x>/Entry/MCPTTID

Status	Occurrence	Format	Min. Access Types
Required	One	chr	Get, Replace

This leaf node indicates a MCPTT ID of an MCPTT user whose selected MCPTT group is allowed to be remotely changed by the MCPTT user.

The value is a "uri" attribute specified in OMA OMA-TS-XDM\_Group-V1\_1 [4].

## 5.2.48U5

/<x>/<x>/OnNetwork/RemoteGroupSelection/<x>/Entry/DisplayName

**Table 5.2.48U5.1: /<x>/<x>/OnNetwork/RemoteGroupSelection/<x>/Entry/DisplayName**

<x>/OnNetwork/RemoteGroupSelection/<x>/Entry/DisplayName

Status	Occurrence	Format	Min. Access Types
Optional	One	chr	Get, Replace

This leaf node contains a human readable name that corresponds to the MCPTT ID of the MCPTT user.

## 5.2.48V1/ <x>/ <x>/OnNetwork/GroupServerInfo

**Table 5.2.48V1.1: / <x>/ <x>/OnNetwork/GroupServerInfo**

<x>/OnNetwork/ GroupServerInfo

Status	Occurrence	Format	Min. Access Types
Required	One	node	Get, Replace

This interior node is a placeholder for the configured identity management an group management servers for the groups contained in the MCPTTGroupList

## 5.2.48V2/ <x>/ <x>/OnNetwork/GroupServerInfo/GMSServList

**Table 5.2.48V2.1: / <x>/ <x>/OnNetwork/GroupServerInfo/GMSServList**

<x>/OnNetwork/ GroupServerInfo/GMSServList

Status	Occurrence	Format	Min. Access Types
Required	One	node	Get, Replace

This interior node is a placeholder for the list of MCPTT group management server for the groups contained in the MCPTTGroupList.

## 5.2.48V3/ <x>/ <x>/OnNetwork/GroupServerInfo/GMSServList/ <x>

**Table 5.2.48V3.1: / <x>/ <x>/OnNetwork/GroupServerInfo/GMSServList/ <x>**

<x>/OnNetwork/ GroupServerInfo/GMSServList/ <x>

Status	Occurrence	Format	Min. Access Types
Required	OneOrMore	node	Get, Replace

This interior node is a placeholder for the list of MCPTT group management server for the groups contained in the MCPTTGroupList.

## 5.2.48V4/ <x>/ <x>/OnNetwork/GroupServerInfo/GMSServList/ <x>/Entry

**Table 5.2.48V4.1: / <x>/ <x>/OnNetwork/GroupServerInfo/GMSServList/ <x>/Entry**

<x>/OnNetwork/GroupServerInfo/GMSServList/ <x>/Entry

Status	Occurrence	Format	Min. Access Types
Optional	One	node	Get, Replace

This interior node is a placeholder for identity of the GMS owning a specific group contained in the MCPTTGroupList.

## 5.2.48V5

### / <x>/ <x>/OnNetwork/GroupServerInfo/GMSServList/ <x>/Entry/GMSServID

**Table 5.2.48V5.1: / <x>/ <x>/OnNetwork/GroupServerInfo/GMSServList/ <x>/Entry/GMSServID**

<x>/OnNetwork/GroupServerInfo/GMSServList/ <x>/Entry/GMSServID

Status	Occurrence	Format	Min. Access Types
Required	One	chr	Get, Replace

This leaf node indicates the identity (URI) of the GMS owning a specific group contained in the MCPTTGroupList.

## 5.2.48V6/ &lt;x&gt;/ &lt;x&gt;/OnNetwork/GroupServerInfo/IDMSTokenEndpointList

**Table 5.2.48V6.1: / <x>/ <x>/OnNetwork/GroupServerInfo/IDMSTokenEndpointList**

&lt;x&gt;/OnNetwork/GroupServerInfo/IDMSTokenEndpointList

Status	Occurrence	Format	Min. Access Types
Required	One	node	Get, Replace

This interior node is a placeholder for the list of MCPTT IDMS token endpoints for the groups contained in the MCPTTGroupList.

## 5.2.48V7/ &lt;x&gt;/ &lt;x&gt;/OnNetwork/GroupServerInfo/IDMSTokenEndpointList/ &lt;x&gt;

**Table 5.2.48V7.1: / <x>/ <x>/OnNetwork/GroupServerInfo/IDMSTokenEndpointList/ <x>**

&lt;x&gt;/OnNetwork/GroupServerInfo/IDMSTokenEndpointList/ &lt;x&gt;

Status	Occurrence	Format	Min. Access Types
Optional	One	node	Get, Replace

This interior node is a placeholder for the IDMS token endpoint for a specific groups contained in the MCPTTGroupList.

## 5.2.48V8/ &lt;x&gt;/ &lt;x&gt;/OnNetwork/GroupServerInfo/IDMSTokenEndpointList/ &lt;x&gt;/Entry

**Table 5.2.48V8.1: / <x>/ <x>/OnNetwork/GroupServerInfo/IDMSTokenEndpointList/ <x>/Entry**

&lt;x&gt;/OnNetwork/GroupServerInfo/IDMSTokenEndpointList/ &lt;x&gt;/Entry

Status	Occurrence	Format	Min. Access Types
Optional	One	node	Get, Replace

This interior node is a placeholder for the IDMS token endpoint for a specific groups contained in the MCPTTGroupList.

## 5.2.48V9

## / &lt;x&gt;/ &lt;x&gt;/OnNetwork/GroupServerInfo/IDMSTokenEndpointList/ &lt;x&gt;/Entry/IDMSTokenID

**Table 5.2.48V9.1:****/ <x>/ <x>/OnNetwork/GroupServerInfo/IDMSTokenEndpointList/ <x>/Entry/IDMSTokenID**

&lt;x&gt;/OnNetwork/GroupServerInfo/IDMSTokenEndpointList/ &lt;x&gt;/Entry/IDMSTokenID

Status	Occurrence	Format	Min. Access Types
Required	One	chr	Get, Replace

This leaf node indicates the identity (URI) of the IDMS token endpoint for a specific group contained in the MCPTTGroupList. If the value is empty, the IDMS identities (IDMSAuthEndpoint and IDMSTokenEndpoint) present in the MCS UE initial configuration MO are used.

## 5.2.49 / &lt;x&gt;/ &lt;x&gt;/OffNetwork

**Table 5.2.49.1: / <x>/ <x>/OffNetwork**

&lt;x&gt;/OffNetwork

Status	Occurrence	Format	Min. Access Types
Required	ZeroOrOne	node	Get, Replace

This interior node represents a container for off-network operation.

## 5.2.50 /<x>/<x>/OffNetwork/Authorised

**Table 5.2.50.1: /<x>/<x>/OffNetwork/Authorised**

<x>/OffNetwork/Authorised

Status	Occurrence	Format	Min. Access Types
Required	One	bool	Get, Replace

This leaf node indicates the authorisation for off-network services.

When set to "true" the MCPTT user is authorised for off-network.

When set to "false" the MCPTT user is not authorised for off-network operation.

## 5.2.51 /<x>/<x>/OffNetwork/MCPTTGroupInfo

**Table 5.2.51.1: /<x>/<x>/OffNetwork/MCPTTGroupInfo**

<x>/OffNetwork/MCPTTGroupInfo

Status	Occurrence	Format	Min. Access Types
Required	One	node	Get, Replace

This interior node is a placeholder for group information.

## 5.2.52 /<x>/<x>/OffNetwork/MCPTTGroupInfo/<x>

**Table 5.2.52.1: /<x>/<x>/OffNetwork/MCPTTGroupInfo/<x>**

<x>/OffNetwork/MCPTTGroupInfo/<x>

Status	Occurrence	Format	Min. Access Types
Required	OneOrMore	node	Get, Replace

This interior node is a placeholder for one or more group information.

## 5.2.52A /<x>/<x>/OffNetwork/MCPTTGroupInfo/<x>/Entry

**Table 5.2.52A.1: /<x>/<x>/OffNetwork/MCPTTGroupInfo/<x>/Entry**

<x>/OffNetwork/MCPTTGroupInfo/<x>/Entry

Status	Occurrence	Format	Min. Access Types
Required	One	node	Get, Replace

This interior node is a placeholder for one or more off-network MCPTT groups for use by an MCPTT user.

## 5.2.53 /<x>/<x>/OffNetwork/MCPTTGroupInfo/<x>/Entry/MCPTTGroupID

**Table 5.2.53.1: /<x>/<x>/OffNetwork/MCPTTGroupInfo/<x>/Entry/MCPTTGroupID**

<x>/OffNetwork/MCPTTGroupInfo/<x>/Entry/MCPTTGroupID

Status	Occurrence	Format	Min. Access Types
Required	One	int	Get, Replace

This leaf node indicates an off-network MCPTT group for use by an MCPTT user.

## 5.2.53A /<x>/<x>/OffNetwork/MCPTTGroupInfo/<x>/Entry/DisplayName

**Table 5.2.53A.1: /<x>/<x>/OffNetwork/MCPTTGroupInfo/<x>/Entry/DisplayName**

<x>/OffNetwork/MCPTTGroupInfo/<x>/Entry/DisplayName

Status	Occurrence	Format	Min. Access Types
Optional	One	chr	Get, Replace

This leaf node contains a human readable name that corresponds to the MCPTT group represented by the MCPTT group ID.

## 5.2.54 /<x>/<x>/OffNetwork/AllowedListen

**Table 5.2.54.1: /<x>/<x>/OffNetwork/AllowedListen**

<x>/OffNetwork/AllowedListen

Status	Occurrence	Format	Min. Access Types
Required	One	bool	Get, Replace

This leaf node indicates whether the MCPTT user is allowed to listen both overriding and overridden.

When set to "true" the MCPTT user is allowed to listen both overriding and overridden.

When set to "false" the MCPTT user is not allowed to listen both overriding and overridden.

## 5.2.55 /<x>/<x>/OffNetwork/AllowedTransmission

**Table 5.2.55.1: /<x>/<x>/OffNetwork/AllowedTransmission**

<x>/OffNetwork/AllowedTransmission

Status	Occurrence	Format	Min. Access Types
Required	One	bool	Get, Replace

This leaf node indicates whether the MCPTT user is allowed to transmit in case of override (overriding and/or overridden).

When set to "true" the MCPTT user is allowed to transmit in case of override (overriding and/or overridden).

When set to "false" the MCPTT user is not allowed to transmit in case of override (overriding and/or overridden).

## 5.2.56 /<x>/<x>/OffNetwork/EmergencyCallChange

**Table 5.2.56.1: /<x>/<x>/OffNetwork/EmergencyCallChange**

<x>/OffNetwork/EmergencyCallChange

Status	Occurrence	Format	Min. Access Types
Required	One	bool	Get, Replace

This leaf node indicates the authorization for a participant to change an off-network group call in-progress to an off-network MCPTT emergency group call.

When set to "true" the MCPTT user is authorised to change an MCPTT emergency group call.

When set to "false" the MCPTT user is not authorised to change an MCPTT emergency group call.

## 5.2.57 /<x>/<x>/OffNetwork/ImminentPerilCallChange

**Table 5.2.57.1: /<x>/<x>/OffNetwork/ImminentPerilCallChange**

<x>/OffNetwork/ImminentPerilCallChange

Status	Occurrence	Format	Min. Access Types
Required	One	bool	Get, Replace

This leaf node indicates the authorization for a participant to change an off-network group call in-progress to an off-network MCPTT imminent peril group call.

When set to "true" the MCPTT user is authorised to change an MCPTT imminent peril group call.

When set to "false" the MCPTT user is not authorised to change an MCPTT imminent peril group call.

## 5.2.58 /<x>/<x>/OffNetwork/UserInfoID

**Table 5.2.58.1: /<x>/<x>/OffNetwork/UserInfoID**

<x>/OffNetwork/UserInfoID

Status	Occurrence	Format	Min. Access Types
Required	One	chr	Get, Replace

This leaf node indicates the ProSe user info ID as specified in 3GPP TS 23.303 [6].

## 5.2.59 /<x>/Status

**Table 5.2.59.1: /<x>/Status**

Status

Status	Occurrence	Format	Min. Access Types
Optional	One	bool	Get, Replace

This leaf node indicates whether this MCPTT user profile is enabled or disabled.

When set to "true" this MCPTT user profile is enabled.

When set to "false" this MCPTT user profile is disabled.

# 6 MCS group configuration MO

## 6.1 General

The MCS group configuration Management Object (MO) is used to configure the MCS Client behaviour for the on-network or off-network MC services. The MCS group configuration parameters may be stored in the ME, or in the USIM as specified in 3GPP TS 31.102 [10], or in both the ME and the USIM. If both the ME and the USIM contain the same parameters, the values stored in the USIM shall take precedence.

**NOTE:** For historical reasons some of the elements in the MCS group configuration Management Object (MO) use the terminology "MCPTT", however this MO is common to all MCS with some MCPTT specific elements, some MCDATA specific elements and some MCVideo specific elements. Not all elements that contain the terminology "MCPTT" are just MCPTT specific. In the subclauses that follow, it is made clear what aspects are specific to MCPTT and what aspects are specific to all MC services. MCDATA specific elements are contained under "MCDATA" nodes. MCVideo specific elements are contained under "MCVideo" nodes.

The Management Object Identifier is: urn:oma:mo:ext-3gpp-MCPTT-group-configuration:1.0.

Protocol compatibility: This MO is compatible with OMA OMA DM 1.2 [3].



The OMA DM ACL property mechanism (see OMA OMA-ERELD-DM-V1\_2 [2]) may be used to grant or deny access rights to OMA DM servers in order to modify nodes and leaf objects of the MCS group configuration MO.

The following nodes and leaf objects are possible under the MCS group configuration node as described in figure 6.1.1:

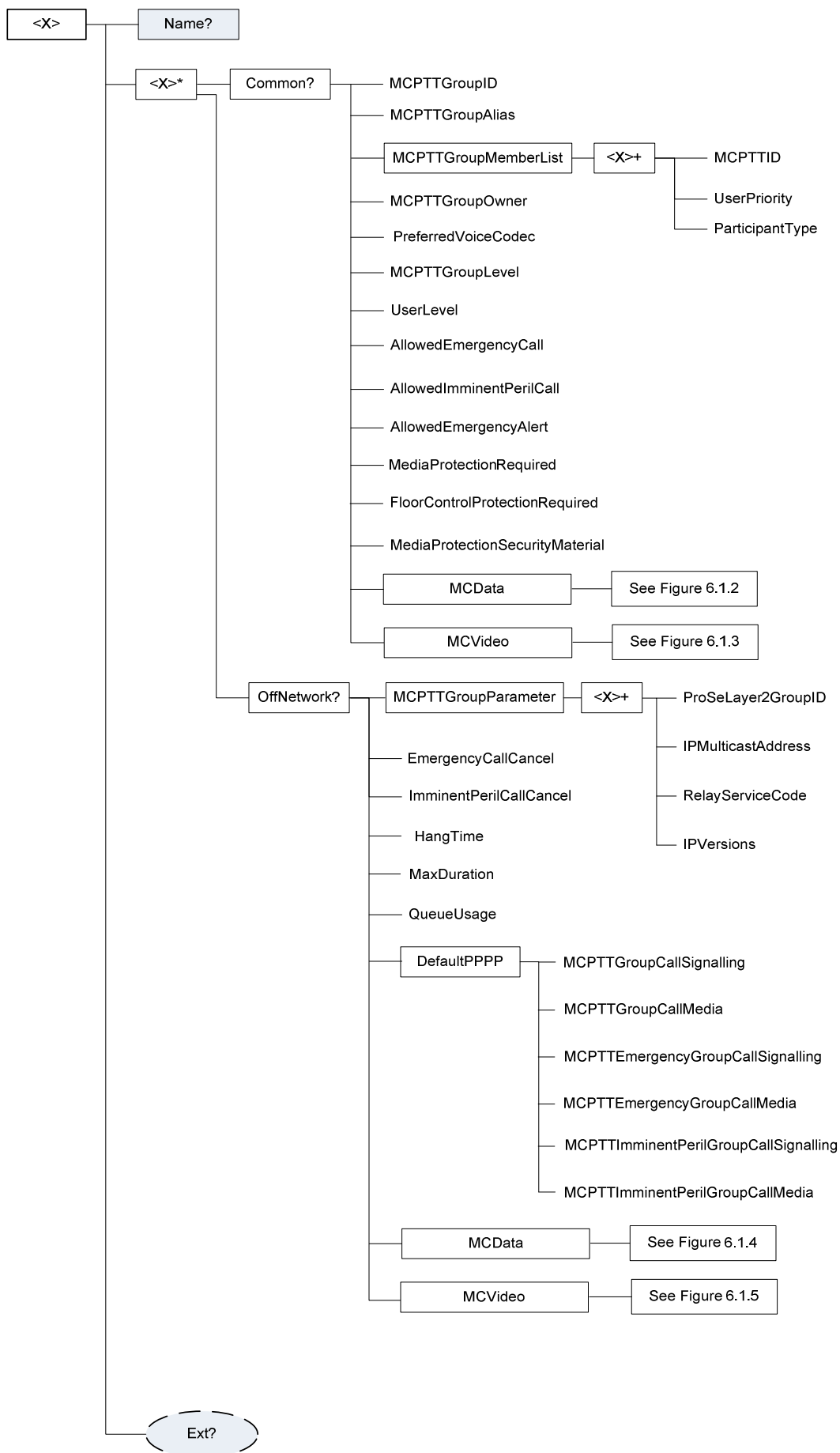

Figure 6.1.1: The MCS group configuration MO (1 of 5)

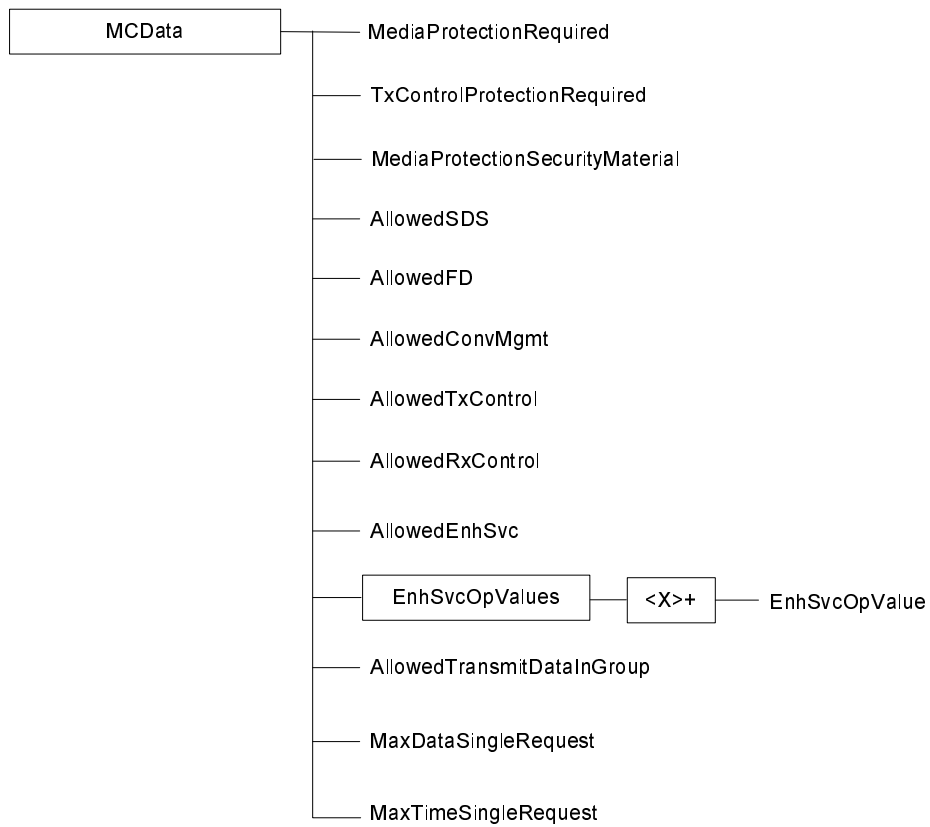

Figure 6.1.2: The MCS group configuration MO (2 of 5)

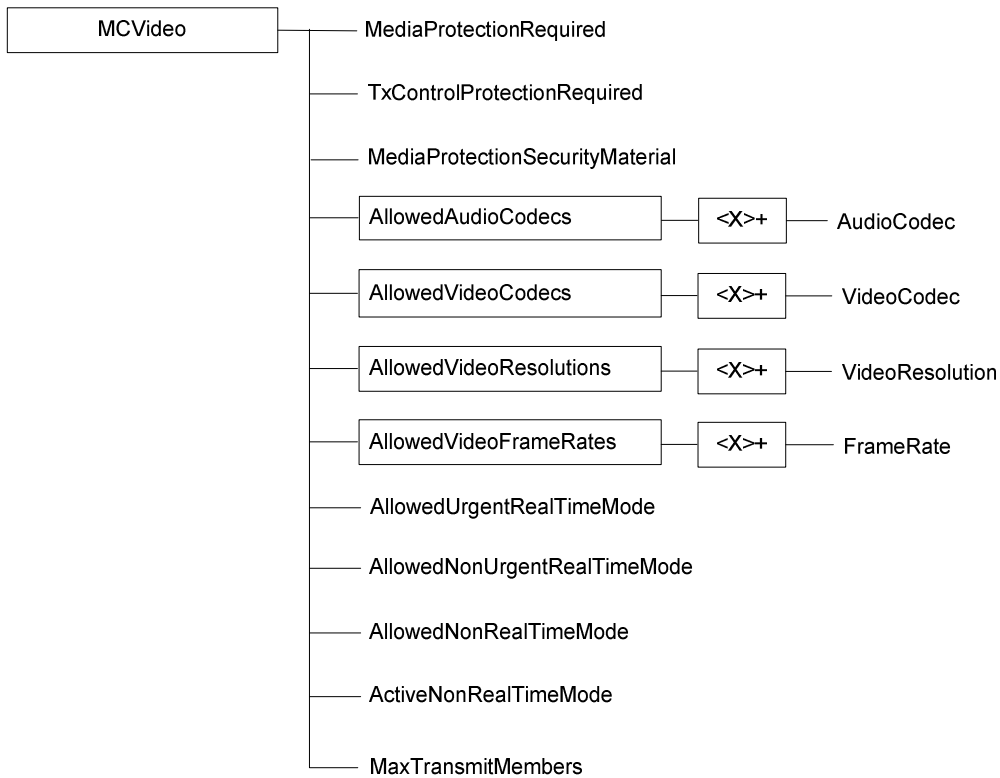

Figure 6.1.3: The MCS group configuration MO (3 of 5)

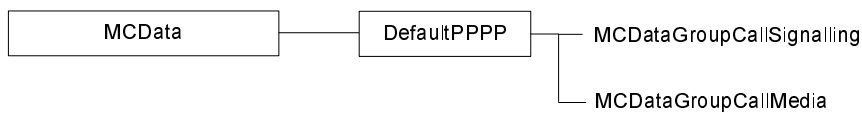

Figure 6.1.4: The MCS group configuration MO (4 of 5)

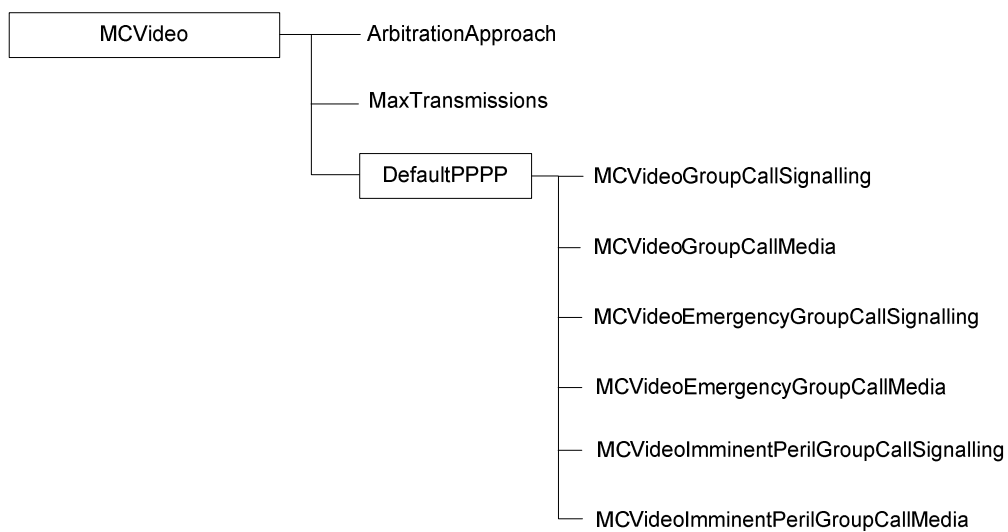

Figure 6.1.5: The MCS group configuration MO (5 of 5)

## 6.2 MCS group configuration MO parameters

### 6.2.1 General

This clause describes the parameters for the MCS group configuration Management Object (MO).

### 6.2.2 Node: <x>

**Table 6.2.2.1: Node: <x>**

<x>

Status	Occurrence	Format	Min. Access Types
Required	OneOrMore	node	Get

This interior node acts as a placeholder for the MCS group configuration Management Object (MO).

For the MCS group configuration MO, the namespace specific string is: "urn:oma:mo:oma-dm-mcptt-group configuration:1.0"

- Values: N/A

### 6.2.3 /<x>/Name

**Table 6.2.3.1: Node: <x>**

Name

Status	Occurrence	Format	Min. Access Types
Required	ZeroOrOne	chr	Get

The Name leaf is a name for the MCS group configuration settings.

- Values: <User displayable name>

### 6.2.4 /<x>/Ext/

**Table 6.2.4.1: /<x>/Ext/**

Ext

Status	Occurrence	Format	Min. Access Types
Optional	ZeroOrOne	node	Get, Replace

The Ext is an interior node for where the vendor specific information about the MCSgroup configuration MO is being placed.

Usually the vendor extension is identified by vendor specific name under the ext node and contains the vendor meaning application vendor, device vendor etc. The tree structure under the vendor identified is not defined and can therefore include one or more un-standardized sub-trees.

- Values: N/A

### 6.2.5 /<x>/<x>

**Table 6.2.5.1: /<x>/<x>**

<x>

Status	Occurrence	Format	Min. Access Types
Required	ZeroOrMore	node	Get, Replace

This interior node represents a container for on-network operation and off-network operation.

## 6.2.6 /<x>/<x>/Common

**Table 6.2.6.1: /<x>/<x>/Common**

<x>/Common

Status	Occurrence	Format	Min. Access Types
Required	ZeroOrOne	node	Get, Replace

This interior node represents a container for the common network operation which means both on-network operation and off-network operation.

## 6.2.7 /<x>/<x>/Common/MCPTTGroupID

**Table 6.2.7.1: /<x>/<x>/Common/MCPTTGroupID**

<x>/Common/MCPTTGroupID

Status	Occurrence	Format	Min. Access Types
Required	One	chr	Get, Replace

This leaf node indicates the MCS group ID.

The value is a "uri" attribute specified in OMA OMA-TS-XDM\_Group-V1\_1 [4].

NOTE: This element is common for all MC services.

## 6.2.8 /<x>/<x>/Common/MCPTTGroupAlias

**Table 6.2.8.1: /<x>/<x>/Common/MCPTTGroupAlias**

<x>/Common/MCPTTGroupAlias

Status	Occurrence	Format	Min. Access Types
Required	One	chr	Get, Replace

This leaf node indicates the MCS group alias.

The value is a <display-name> element specified in OMA OMA-TS-XDM\_Group-V1\_1 [4].

NOTE: This element is common for all MC services.

## 6.2.9 /<x>/<x>/Common/MCPTTGroupMemberList

**Table 6.2.9.1: /<x>/<x>/Common/MCPTTGroupMemberList**

<x>/Common/MCPTTGroupMemberList

Status	Occurrence	Format	Min. Access Types
Required	One	node	Get, Replace

This interior node is a placeholder for a list of MCS group members (group membership information).

NOTE: This element is common for all MC services.

## 6.2.10 /<x>/<x>/Common/MCPTTGroupMemberList/<x>

**Table 6.2.10.1: /<x>/<x>/Common/MCPTTGroupMemberList/<x>**

<x>/Common/MCPTTGroupMemberList/<x>

Status	Occurrence	Format	Min. Access Types
Required	OneOrMore	node	Get, Replace

This interior node is a placeholder for one or more list(s) of MCS group members.

NOTE: This element is common for all MC services.

## 6.2.11 /<x>/<x>/Common/MCPTTGroupMemberList/<x>/MCPTTID

**Table 6.2.11.1: /<x>/<x>/Common/MCPTTGroupMemberList/<x>/MCPTTID**

<x>/Common/MCPTTGroupMemberList/<x>/MCPTTID

Status	Occurrence	Format	Min. Access Types
Required	One	chr	Get, Replace

This leaf node indicates an MCS user identity (MC Service ID) which is a globally unique identifier within the MC service that represents the MCS user.

The value is a "uri" attribute specified in OMA OMA-TS-XDM\_Group-V1\_1 [4].

NOTE: This element is common for all MC services.

## 6.2.12 /<x>/<x>/Common/MCPTTGroupMemberList/<x>/UserPriority

**Table 6.2.12.1: /<x>/<x>/Common/MCPTTGroupMemberList/<x>/UserPriority**

<x>/Common/MCPTTGroupMemberList/<x>/UserPriority

Status	Occurrence	Format	Min. Access Types
Required	One	int	Get, Replace

This leaf node indicates the user priority for the group.

The value is a <user-priority> element specified in 3GPP TS 24.481 [9] subclause 7.2.4.2.

NOTE: This element is common for all MC services.

## 6.2.13 /<x>/<x>/Common/MCPTTGroupMemberList/<x>/ParticipantType

**Table 6.2.13.1: /<x>/<x>/Common/MCPTTGroupMemberList/<x>/ParticipantType**

<x>/Common/MCPTTGroupMemberList/<x>/ParticipantType

Status	Occurrence	Format	Min. Access Types
Required	One	chr	Get, Replace

This leaf node indicates the participant type for the group.

The ParticipantType values are defined and configured by the Mission Critical Organisation (e.g.first responder, second responder, dispatcher, dispatch supervisor, MCS administrator).

NOTE: This element is common for all MC services.

## 6.2.14 Void

## 6.2.15 /<x>/<x>/Common/MCPTTGroupOwner

**Table 6.2.15.1: /<x>/<x>/Common/MCPTTGroupOwner**

<x>/Common/MCPTTGroupOwner

Status	Occurrence	Format	Min. Access Types
Required	One	chr	Get, Replace

This leaf node indicates the group's owner (Mission Critical Organisation).

NOTE: This element is common for all MC services.

## 6.2.16 /<x>/<x>/Common/PreferredVoiceCodec

**Table 6.2.16.1: /<x>/<x>/Common/PreferredVoiceCodec**

<x>/Common/PreferredVoiceCodec

Status	Occurrence	Format	Min. Access Types
Required	One	chr	Get, Replace

This leaf node indicates the MCPTT preferred voice codec for an MCS group.

The value of the preferred voice codec is a RTP payload format name specified in IETF RFC 4566 [13].

NOTE: This element is specific for MCPTT.

## 6.2.17 /<x>/<x>/Common/MCPTTGroupLevel

**Table 6.2.17.1: /<x>/<x>/Common/MCPTTGroupLevel**

<x>/Common/MCPTTGroupLevel

Status	Occurrence	Format	Min. Access Types
Required	One	int	Get, Replace

This leaf node indicates the level within a group hierarchy (only applicable for group-broadcast group).

- Values: 0-255

The group-broadcast group with the lowest MCPTTGroupLevel value shall be considered as the group-broadcast group having the lowest level among the groups.

NOTE: This element is common for all MC services.

## 6.2.18 /<x>/<x>/Common/UserLevel

**Table 6.2.18.1: /<x>/<x>/Common/UserLevel**

<x>/Common/UserLevel

Status	Occurrence	Format	Min. Access Types
Required	One	int	Get, Replace

This leaf node indicates the level within user hierarchy (only applicable for user-broadcast group).

The user-broadcast group with the lowest UserLevel value shall be considered as the user-broadcast group having the lowest level among the groups.

NOTE: This element is common for all MC services.

## 6.2.19 /<x>/<x>/Common/AllowedEmergencyCall

**Table 6.2.19.1: /<x>/<x>/Common/AllowedEmergencyCall**

<x>/Common/AllowedEmergencyCall

Status	Occurrence	Format	Min. Access Types
Required	One	bool	Get, Replace

This leaf node indicates whether an MCPTT emergency group call is permitted on the MCS group.

When set to "true" the MCPTT emergency group call is allowed on the group.

When set to "false" the MCPTT emergency group call is not allowed on the group.

NOTE: This element is specific for MCPTT.



## 6.2.20 /<x>/<x>/Common/AllowedImminentPerilCall

**Table 6.2.20.1: /<x>/<x>/Common/AllowedImminentPerilCall**

<x>/Common/AllowedImminentPerilCall

Status	Occurrence	Format	Min. Access Types
Required	One	bool	Get, Replace

This leaf node indicates whether an MCPTT imminent peril group call is permitted on the MCS group.

When set to "true" the MCPTT imminent peril group call is allowed on the group.

When set to "false" the MCPTT imminent peril group call is not allowed on the group.

NOTE: This element is specific for MCPTT.

## 6.2.21 /<x>/<x>/Common/AllowedEmergencyAlert

**Table 6.2.21.1: /<x>/<x>/Common/AllowedEmergencyAlert**

<x>/Common/AllowedEmergencyAlert

Status	Occurrence	Format	Min. Access Types
Required	One	bool	Get, Replace

This leaf node indicates whether an MCPTT emergency alert is possible on the MCS group.

When set to "true" the MCPTT emergency alert is allowed on the group.

When set to "false" the MCPTT emergency alert is not allowed on the group.

NOTE: This element is for specific for MCPTT.

## 6.2.22 /<x>/<x>/Common/MediaProtectionRequired

**Table 6.2.22.1: /<x>/<x>/Common/MediaProtectionRequired**

<x>/Common/MediaProtectionRequired

Status	Occurrence	Format	Min. Access Types
Required	One	bool	Get, Replace

This leaf node indicates whether confidentiality and integrity of MCPTT media is required on the MCS group.

When set to "true" confidentiality and integrity of media is required on the group.

When set to "false" confidentiality and integrity of media is not required on the group.

The default value is set to "true".

NOTE: This element is specific for MCPTT.

## 6.2.23 /<x>/<x>/Common/FloorControlProtectionRequired

**Table 6.2.23.1: /<x>/<x>/Common/FloorControlProtectionRequired**

<x>/Common/FloorControlProtectionRequired

Status	Occurrence	Format	Min. Access Types
Required	One	bool	Get, Replace

This interior node indicates whether confidentiality and integrity of MCPTT floor control signalling is required on the MCS group.

When set to "true" confidentiality and integrity of floor control signalling is required on the group.

When set to "false" confidentiality and integrity of floor control signalling is not required on the group.

The default value is set to "true".

NOTE: This element is specific for MCPTT.

## 6.2.23A /<x>/<x>/Common/MediaProtectionSecurityMaterial

**Table 6.2.23A.1: /<x>/<x>/Common/MediaProtectionSecurityMaterial**

<x>/Common/MediaProtectionSecurityMaterial

Status	Occurrence	Format	Min. Access Types
Required	One	chr	Get, Replace

This leaf node indicates security material (as specified in 3GPP TS 33.180 [20]) for MCPTT media protection in the MCS group.

NOTE: This element is specific for MCPTT.

## 6.2.23B /<x>/<x>/Common/MCData

**Table 6.2.23B.1: /<x>/<x>/Common/MCData**

<x>/Common/MCData

Status	Occurrence	Format	Min. Access Types
Required	One	node	Get, Replace

This interior node is a placeholder for a Common MCData group information

## 6.2.23C /<x>/<x>/Common/MCData/MediaProtectionRequired

**Table 6.2.23C.1: /<x>/<x>/Common/MCData/MediaProtectionRequired**

<x>/Common/MCData/MediaProtectionRequired

Status	Occurrence	Format	Min. Access Types
Required	One	bool	Get, Replace

This leaf node indicates whether confidentiality and integrity of media is required for MCData transactions on the MCS group.

When set to "true" confidentiality and integrity of MCData media is required on the group.

When set to "false" confidentiality and integrity of MCData media is not required on the group.

The default value is set to "true".

## 6.2.23D /<x>/<x>/Common/MCData/TxControlProtectionRequired

**Table 6.2.23D.1: /<x>/<x>/Common/MCData/TxControlProtectionRequired**

<x>/Common/MCData/TxControlProtectionRequired

Status	Occurrence	Format	Min. Access Types
Required	One	bool	Get, Replace

This leaf node indicates whether confidentiality and integrity protection is required for on-network and off-network MCData transmission control signalling on the MCS group

When set to "true" confidentiality and integrity of MCData transmission control signalling is required on the group.

When set to "false" confidentiality and integrity of MCData transmission control signalling is not required on the group.

The default value is set to "true".

## 6.2.23E /&lt;x&gt;/&lt;x&gt;/Common/MCData/MediaProtectionSecurityMaterial

**Table 6.2.23E.1: /<x>/<x>/Common/MCData/MediaProtectionSecurityMaterial**

&lt;x&gt;/Common/MCData/MediaProtectionSecurityMaterial

Status	Occurrence	Format	Min. Access Types
Required	One	chr	Get, Replace

This leaf node indicates security material (as specified in 3GPP TS 33.180 [xx]) for MCData media protection in the MCS group.

## 6.2.23F /&lt;x&gt;/&lt;x&gt;/Common/MCData/AllowedSDS

**Table 6.2.23F.1: /<x>/<x>/Common/MCData/AllowedSDS**

&lt;x&gt;/Common/MCData/AllowedSDS

Status	Occurrence	Format	Min. Access Types
Required	One	bool	Get, Replace

This leaf node indicates whether Short Data Service (SDS) is enabled for the group.

When set to "true" the Short Data Service (SDS) is allowed on the group.

When set to "false" the Short Data Service (SDS) is not allowed on the group.

## 6.2.23G /&lt;x&gt;/&lt;x&gt;/Common/MCData/AllowedFD

**Table 6.2.23G.1: /<x>/<x>/Common/MCData/AllowedFD**

&lt;x&gt;/Common/MCData/AllowedFD

Status	Occurrence	Format	Min. Access Types
Required	One	bool	Get, Replace

This leaf node indicates whether File Distribution (FD) is enabled for the group.

When set to "true" File Distribution (FD) is allowed on the group.

When set to "false" File Distribution (FD) is not allowed on the group.

## 6.2.23H /&lt;x&gt;/&lt;x&gt;/Common/MCData/AllowedConvMgmt

**Table 6.2.23H.1: /<x>/<x>/Common/MCData/AllowedConvMgmt**

&lt;x&gt;/Common/MCData/AllowedConvMgmt

Status	Occurrence	Format	Min. Access Types
Required	One	bool	Get, Replace

This leaf node indicates whether conversation management is enabled for the group.

When set to "true" conversation management is allowed on the group.

When set to "false" conversation management is not allowed on the group.

## 6.2.23I /&lt;x&gt;/&lt;x&gt;/Common/MCData/AllowedTxControl

**Table 6.2.23I.1: /<x>/<x>/Common/MCData/AllowedTxControl**

&lt;x&gt;/Common/MCData/AllowedTxControl

Status	Occurrence	Format	Min. Access Types
Required	One	bool	Get, Replace

This leaf node indicates whether transmission control is enabled for the group.

When set to "true" transmission control is allowed on the group.

When set to "false" transmission control is not allowed on the group.

## 6.2.23J /<x>/<x>/Common/MCData/AllowedRxControl

**Table 6.2.23J.1: /<x>/<x>/Common/MCData/AllowedRxControl**

<x>/Common/MCData/AllowedRxControl

Status	Occurrence	Format	Min. Access Types
Required	One	bool	Get, Replace

This leaf node indicates whether reception control is enabled for the group.

When set to "true" reception control is allowed on the group.

When set to "false" reception control not allowed on the group.

## 6.2.23K /<x>/<x>/Common/MCData/AllowedEnhSvc

**Table 6.2.23K.1: /<x>/<x>/Common/MCData/AllowedEnhSvc**

<x>/Common/MCData/AllowedEnhSvc

Status	Occurrence	Format	Min. Access Types
Required	One	bool	Get, Replace

This leaf node indicates whether Enhanced Service is enabled for the group.

When set to "true" Enhanced Service is allowed on the group.

When set to "false" Enhanced Service is not allowed on the group.

## 6.2.23L /<x>/<x>/Common/MCData/EnhSvcOpValues

**Table 6.2.23L.1: /<x>/<x>/Common/MCData/EnhSvcOpValues**

<x>/Common/MCData/EnhSvcOpValues

Status	Occurrence	Format	Min. Access Types
Required	One	node	Get, Replace

This interior node is a placeholder for a list of operational values for Enhanced Service.

## 6.2.23M /<x>/<x>/Common/MCData/EnhSvcOpValues/<x>

**Table 6.2.23M.1: /<x>/<x>/Common/MCData/EnhSvcOpValues/<x>**

<x>/Common/MCData/EnhSvcOpValues/<x>

Status	Occurrence	Format	Min. Access Types
Optional	OneOrMore	node	Get, Replace

This interior node is a placeholder for one or more list of operational values for Enhanced Service.

## 6.2.23N /<x>/<x>/Common/MCData/EnhSvcOpValues/<x>/EnhSvcOpValue

**Table 6.2.23N.1: /<x>/<x>/Common/MCData/EnhSvcOpValues/<x>/EnhSvcOpValue**

<x>/Common/MCData/EnhSvcOpValues/<x>/EnhSvcOpValue

Status	Occurrence	Format	Min. Access Types
Optional	One	chr	Get, Replace

This leaf node indicates an enhanced service operational value.

## 6.2.23O /<x>/<x>/Common/MCData/AllowedTransmitDataInGroup

**Table 6.2.23O.1: /<x>/<x>/Common/MCData/AllowedTransmitDataInGroup**

<x>/Common/MCData/AllowedTransmitDataInGroup

Status	Occurrence	Format	Min. Access Types
Required	One	bool	Get, Replace

This leaf node indicates whether an MC data user is permitted to transmit data in the group.

When set to "true" an MC data user is allowed to transmit data in the group.

When set to "false" an MC data user is not allowed to transmit data in the group.

## 6.2.23P /<x>/<x>/Common/MCData/MaxDataSingleRequest

**Table 6.2.23P.1: /<x>/<x>/Common/MCData/MaxDataSingleRequest**

<x>/Common/MCData/MaxDataSingleRequest

Status	Occurrence	Format	Min. Access Types
Required	One	int	Get, Replace

This leaf node indicates the maximum amount of data (in megabytes) that an MCData user can transmit in a single request during group communication.

- Values: 0-65535

The MaxData1to1 size is in megabytes..

## 6.2.23Q /<x>/<x>/Common/MCData/MaxTimeSingleRequest

**Table 6.2.23Q.1: /<x>/<x>/Common/MCData/MaxTimeSingleRequest**

<x>/Common/MCData/MaxTimeSingleRequest

Status	Occurrence	Format	Min. Access Types
Required	One	int	Get, Replace

This leaf node indicates the maximum amount of time that an MCData user can transmit for in a single request during group communication.

- Values: 0-65535

The MaxTime1To1 time is in seconds.

## 6.2.23R /<x>/<x>/Common/MCVideo

**Table 6.2.23R.1: /<x>/<x>/Common/MCVideo**

<x>/Common/MCVideo

Status	Occurrence	Format	Min. Access Types
Required	One	node	Get, Replace

This interior node is a placeholder for a Common MCVideo group information

## 6.2.23S /<x>/<x>/Common/MCVideo/MediaProtectionRequired

**Table 6.2.23S.1: /<x>/<x>/Common/MCVideo/MediaProtectionRequired**

<x>/Common/MCVideo/MediaProtectionRequired

Status	Occurrence	Format	Min. Access Types
Required	One	bool	Get, Replace

This leaf node indicates whether confidentiality and integrity of media is required for MCVideo calls on the MCS group.

When set to "true" confidentiality and integrity of MCvideo media is required on the group.

When set to "false" confidentiality and integrity of MCvideo media is not required on the group.

The default value is set to "true".

## 6.2.23T /<x>/<x>/Common/MCVideo/TxControlProtectionRequired

**Table 6.2.23T.1: /<x>/<x>/Common/MCVideo/TxControlProtectionRequired**

<x>/Common/MCVideo/TxControlProtectionRequired

Status	Occurrence	Format	Min. Access Types
Required	One	bool	Get, Replace

This leaf node indicates whether confidentiality and integrity protection is required for on-network and off-network MCVideo transmission control signalling on the MCS group

When set to "true" confidentiality and integrity of MCVideo transmission control signalling is required on the group.

When set to "false" confidentiality and integrity of MCVideo transmission control signalling is not required on the group.

The default value is set to "true".

## 6.2.23U /<x>/<x>/Common/MCVideo/MediaProtectionSecurityMaterial

**Table 6.2.23U.1: /<x>/<x>/Common/MCVideo/MediaProtectionSecurityMaterial**

<x>/Common/MCVideo/MediaProtectionSecurityMaterial

Status	Occurrence	Format	Min. Access Types
Required	One	chr	Get, Replace

This leaf node indicates security material (as specified in 3GPP TS 33.180 [xx]) for MCVideo media protection in the MCS group.

## 6.2.23V /<x>/<x>/Common/MCVideo/AllowedAudioCodecs

**Table 6.2.23V.1: /<x>/<x>/Common/MCVideo/AllowedAudioCodecs**

<x>/Common/MCVideo/AllowedAudioCodecs

Status	Occurrence	Format	Min. Access Types
Required	One	node	Get, Replace

This interior node is a placeholder for a list of allowed audio codecs for MCVideo sessions on the group

## 6.2.23W /<x>/<x>/Common/MCVideo/AllowedAudioCodecs/<x>

**Table 6.2.23W.1: /<x>/<x>/Common/MCVideo/AllowedAudioCodecs/<x>**

<x>/Common/MCVideo/AllowedAudioCodecs/<x>

Status	Occurrence	Format	Min. Access Types
Optional	OneOrMore	node	Get, Replace

This interior node is a placeholder for one or more list of allowed audio codecs for MCVideo sessions on the group

## 6.2.23X /&lt;x&gt;/&lt;x&gt;/Common/MCVideo/AllowedAudioCodecs/&lt;x&gt;/AudioCodec

**Table 6.2.23X.1: /<x>/<x>/Common/MCVideo/AllowedAudioCodecs/<x>/AudioCodec**

&lt;x&gt;/Common/MCVideo/AllowedAudioCodecs/&lt;x&gt;/AudioCodec

Status	Occurrence	Format	Min. Access Types
Optional	One	chr	Get, Replace

This leaf node indicates the preferred RTP payload format to be used for audio encoding in MCVideo group sessions for the group.

## 6.2.23Y /&lt;x&gt;/&lt;x&gt;/Common/MCVideo/AllowedVideoCodecs

**Table 6.2.23Y.1: /<x>/<x>/Common/MCVideo/AllowedVideoCodecs**

&lt;x&gt;/Common/MCVideo/AllowedVideoCodecs

Status	Occurrence	Format	Min. Access Types
Required	One	node	Get, Replace

This interior node is a placeholder for a list of allowed video codecs for MCVideo sessions on the group

## 6.2.23Z /&lt;x&gt;/&lt;x&gt;/Common/MCVideo/AllowedVideoCodecs/&lt;x&gt;

**Table 6.2.23Z.1: /<x>/<x>/Common/MCVideo/AllowedVideoCodecs/<x>**

&lt;x&gt;/Common/MCVideo/AllowedVideoCodecs/&lt;x&gt;

Status	Occurrence	Format	Min. Access Types
Optional	OneOrMore	node	Get, Replace

This interior node is a placeholder for one or more list of allowed video codecs for MCVideo sessions on the group

## 6.2.23AA

## /&lt;x&gt;/&lt;x&gt;/Common/MCVideo/AllowedVideoCodecs/&lt;x&gt;/VideoCodec

**Table 6.2.23AA.1: /<x>/<x>/Common/MCVideo/AllowedVideoCodecs/<x>/VideoCodec**

&lt;x&gt;/Common/MCVideo/AllowedVideoCodecs/&lt;x&gt;/VideoCodec

Status	Occurrence	Format	Min. Access Types
Optional	One	chr	Get, Replace

This leaf node indicates the preferred RTP payload format to be used for video encoding in MCVideo group sessions for the group.

## 6.2.23AB /&lt;x&gt;/&lt;x&gt;/Common/MCVideo/AllowedVideoResolutions

**Table 6.2.23AB.1: /<x>/<x>/Common/MCVideo/AllowedVideoResolutions**

&lt;x&gt;/Common/MCVideo/AllowedVideoResolutions

Status	Occurrence	Format	Min. Access Types
Required	One	node	Get, Replace

This interior node is a placeholder for a list of allowed video resolutions used in MCVideo group sessions for the group.

## 6.2.23AC /&lt;x&gt;/&lt;x&gt;/Common/MCVideo/AllowedVideoResolutions/&lt;x&gt;

**Table 6.2.23AC.1: /<x>/<x>/Common/MCVideo/AllowedVideoResolutions/<x>**

&lt;x&gt;/Common/MCVideo/AllowedVideoResolutions/&lt;x&gt;

Status	Occurrence	Format	Min. Access Types
Optional	OneOrMore	node	Get, Replace

This interior node is a placeholder for one or more list of allowed video resolutions used in MCVideo group sessions for the group.

## 6.2.23AD

## /&lt;x&gt;/&lt;x&gt;/Common/MCVideo/AllowedVideoResolutions/&lt;x&gt;/VideoResolution

**Table 6.2.23AD.1: /<x>/<x>/Common/MCVideo/AllowedVideoResolutions/<x>/VideoResolution**

&lt;x&gt;/Common/MCVideo/AllowedVideoResolutions/&lt;x&gt;/VideoResolution

Status	Occurrence	Format	Min. Access Types
Optional	One	chr	Get, Replace

This leaf node indicates a video resolution (number of horizontal pixels x number of vertical pixels) to be used in MCVideo group sessions for the group.

## 6.2.23AE /&lt;x&gt;/&lt;x&gt;/Common/MCVideo/AllowedVideoFrameRates

**Table 6.2.23AE.1: /<x>/<x>/Common/MCVideo/AllowedVideoFrameRates**

&lt;x&gt;/Common/MCVideo/AllowedVideoFrameRates

Status	Occurrence	Format	Min. Access Types
Required	One	node	Get, Replace

This interior node is a placeholder for a list of allowed video frame rates to be used in MCVideo group sessions for the group.

## 6.2.23AF /&lt;x&gt;/&lt;x&gt;/Common/MCVideo/AllowedVideoFrameRates/&lt;x&gt;

**Table 6.2.23AF.1: /<x>/<x>/Common/MCVideo/AllowedVideoFrameRates/<x>**

&lt;x&gt;/Common/MCVideo/AllowedVideoFrameRates/&lt;x&gt;

Status	Occurrence	Format	Min. Access Types
Optional	OneOrMore	node	Get, Replace

This interior node is a placeholder for one or more list of allowed video frame rates to be used in MCVideo group sessions for the group.

## 6.2.23AG

## /&lt;x&gt;/&lt;x&gt;/Common/MCVideo/AllowedVideoFrameRates/&lt;x&gt;/FrameRate

**Table 6.2.23AG.1: /<x>/<x>/Common/MCVideo/AllowedVideoFrameRates/<x>/FrameRate**

&lt;x&gt;/Common/MCVideo/AllowedVideoFrameRates/&lt;x&gt;/FrameRate

Status	Occurrence	Format	Min. Access Types
Optional	One	chr	Get, Replace

This leaf node indicates a video frame rate (in frames per second) to be used in MCVideo group sessions for the group.



## 6.2.23AH /<x>/<x>/Common/MCVideo/AllowedUrgentRealTimeMode

**Table 6.2.23AH.1: /<x>/<x>/Common/MCVideo/AllowedUrgentRealTimeMode**

<x>/Common/MCVideo/AllowedUrgentRealTimeMode

Status	Occurrence	Format	Min. Access Types
Required	One	bool	Get, Replace

This leaf node indicates whether urgent real time mode is allowed for MCVideo sessions on the group.

When set to "true" urgent real-time video mode is allowed for MCVideo sessions on the group.

When set to "false" urgent real-time video mode is not allowed for MCVideo sessions on the group.

## 6.2.23AI /<x>/<x>/Common/MCVideo/AllowedNonUrgentRealTimeMode

**Table 6.2.23AI.1: /<x>/<x>/Common/MCVideo/AllowedNonUrgentRealTimeMode**

<x>/Common/MCVideo/AllowedNonUrgentRealTimeMode

Status	Occurrence	Format	Min. Access Types
Required	One	bool	Get, Replace

This leaf node indicates whether non-urgent real time mode is allowed for MCVideo sessions on the group.

When set to "true" non-urgent real-time video mode is allowed for MCVideo sessions on the group.

When set to "false" non-urgent real-time video mode is not allowed for MCVideo sessions on the group.

## 6.2.23AJ /<x>/<x>/Common/MCVideo/AllowedNonRealTimeMode

**Table 6.2.23AJ.1: /<x>/<x>/Common/MCVideo/AllowedNonRealTimeMode**

<x>/Common/MCVideo/AllowedNonRealTimeMode

Status	Occurrence	Format	Min. Access Types
Required	One	bool	Get, Replace

This leaf node indicates whether non-real time mode is allowed for MCVideo sessions on the group.

When set to "true" non-real-time video mode is allowed for MCVideo sessions on the group.

When set to "false" non-real-time video mode is not allowed for MCVideo sessions on the group.

## 6.2.23AK /<x>/<x>/Common/MCVideo/ActiveNonRealTimeMode

**Table 6.2.23AK.1: /<x>/<x>/Common/MCVideo/ActiveNonRealTimeMode**

<x>/Common/MCVideo/ActiveNonRealTimeMode

Status	Occurrence	Format	Min. Access Types
Required	One	chr	Get, Replace

This leaf node indicates the active non-real-real mode used for MCVideo sessions on the group.

The valid values are:

- a) "urgent-real-time";
- b) "non-urgent-real-time"; and
- c) "non-real-time".

## 6.2.23AL /<x>/<x>/Common/MCVideo/MaxTransmitMembers

**Table 6.2.23AL.1: /<x>/<x>/Common/MCVideo/MaxTransmitMembers**

<x>/Common/MCVideo/MaxTransmitMembers

Status	Occurrence	Format	Min. Access Types
Required	One	int	Get, Replace

This leaf node indicates the maximum number of simultaneous transmitting group members for MCVideo sessions on the group.

- Values: 0-65535

## 6.2.24 /<x>/<x>/OffNetwork

**Table 6.2.24.1: /<x>/<x>/OffNetwork**

<x>/OffNetwork

Status	Occurrence	Format	Min. Access Types
Required	ZeroOrOne	node	Get, Replace

This interior node represents a container for off-network operation.

## 6.2.25 /<x>/<x>/OffNetwork/MCPTTGroupParameter

**Table 6.2.25.1: /<x>/<x>/OffNetwork/MCPTTGroupParameter**

<x>/OffNetwork/MCPTTGroupParameter

Status	Occurrence	Format	Min. Access Types
Required	One	node	Get, Replace

This interior node is a placeholder for the group parameters.

## 6.2.26 /<x>/<x>/OffNetwork/MCPTTGroupParameter/<x>

**Table 6.2.26.1: /<x>/<x>/OffNetwork/MCPTTGroupParameter/<x>**

<x>/OffNetwork/MCPTTGroupParameter/<x>

Status	Occurrence	Format	Min. Access Types
Required	OneOrMore	node	Get, Replace

This interior node is a placeholder for one or more group parameters.

## 6.2.27

### /<x>/<x>/OffNetwork/MCPTTGroupParameter/<x>/ProSeLayer2GroupID

**Table 6.2.27.1: /<x>/<x>/OffNetwork/MCPTTGroupParameter/<x>/ProSeLayer2GroupID**

<x>/OffNetwork/MCPTTGroupParameter/<x>/ProSeLayer2GroupID

Status	Occurrence	Format	Min. Access Types
Required	One	chr	Get, Replace

This leaf node indicates the Prose layer-2 group ID as specified in 3GPP TS 23.303 [6].

NOTE: This element is common for all MC services.

## 6.2.28

`<x>/<x>/OffNetwork/MCPTTGroupParameter/<x>/IPMulticastAddress`

**Table 6.2.28.1: `<x>/<x>/OffNetwork/MCPTTGroupParameter/<x>/IPMulticastAddress`**

`<x>/OffNetwork/MCPTTGroupParameter/<x>/IPMulticastAddress`

Status	Occurrence	Format	Min. Access Types
Required	One	chr	Get, Replace

This leaf node indicates the ProSe group IP multicast address as specified in 3GPP TS 23.303 [6].

The value is an IPv4 address or an IPv6 address.

NOTE: This element is common for all MC services.

## 6.2.29

`<x>/<x>/OffNetwork/MCPTTGroupParameter/<x>/RelayServiceCode`

**Table 6.2.29.1: `<x>/<x>/OffNetwork/MCPTTGroupParameter/<x>/RelayServiceCode`**

`<x>/OffNetwork/MCPTTGroupParameter/<x>/RelayServiceCode`

Status	Occurrence	Format	Min. Access Types
Required	One	chr	Get, Replace

This leaf node indicates the connectivity service that the ProSe UE-to-network relay provides to public safety applications as specified in 3GPP TS 23.303 [6].

NOTE: This element is common for all MC services.

6.2.30 `<x>/<x>/OffNetwork/MCPTTGroupParameter/<x>/IPVersions`

**Table 6.2.30.1: `<x>/<x>/OffNetwork/MCPTTGroupParameter/<x>/IPVersions`**

`<x>/OffNetwork/MCPTTGroupParameter/<x>/IPVersions`

Status	Occurrence	Format	Min. Access Types
Required	One	chr	Get, Replace

This leaf node indicates whether IPv4 or IPv6 is used for the MCS group as specified in 3GPP TS 23.303 [6].

The value is "IPv4" or "IPv6".

NOTE: This element is common for all MC services.

6.2.31 `<x>/<x>/OffNetwork/EmergencyCallCancel`

**Table 6.2.31.1: `<x>/<x>/OffNetwork/EmergencyCallCancel`**

`<x>/OffNetwork/EmergencyCallCancel`

Status	Occurrence	Format	Min. Access Types
Required	One	int	Get, Replace

This leaf node indicates the timeout value for the cancellation of an in progress emergency group call for MCPTT.

- Values: 0-65535

The EmergencyCallCancel time is in seconds.

NOTE: This element is specific for MCPTT.

## 6.2.32 /<x>/<x>/OffNetwork/ImminentPerilCallCancel

**Table 6.2.32.1: /<x>/<x>/OffNetwork/ImminentPerilCallCancel**

<x>/OffNetwork/ImminentPerilCallCancel

Status	Occurrence	Format	Min. Access Types
Required	One	int	Get, Replace

This leaf node indicates the timeout value for the cancellation of an in progress MCPTT imminent peril group call.

- Values: 0-65535

The ImminentPerilCallCancel time is in seconds.

NOTE: This element is specific for MCPTT.

## 6.2.33 /<x>/<x>/OffNetwork/HangTime

**Table 6.2.33.1: /<x>/<x>/OffNetwork/HangTime**

<x>/OffNetwork/HangTime

Status	Occurrence	Format	Min. Access Types
Required	One	int	Get, Replace

This leaf node indicates the group call hang timer.

- Values: 0-65535

The HangTime is in seconds.

NOTE: This element is specific for MCPTT.

## 6.2.34 /<x>/<x>/OffNetwork/MaxDuration

**Table 6.2.34.1: /<x>/<x>/OffNetwork/MaxDuration**

<x>/OffNetwork/MaxDuration

Status	Occurrence	Format	Min. Access Types
Required	One	int	Get, Replace

This leaf node indicates the max duration of group calls.

- Values: 0-65535

The MaxDuration time is in seconds.

NOTE: This element is specific for MCPTT.

## 6.2.34A /<x>/<x>/OffNetwork/QueueUsage

**Table 6.2.34A.1: /<x>/<x>/OffNetwork/QueueUsage**

<x>/OffNetwork/QueueUsage

Status	Occurrence	Format	Min. Access Types
Required	One	bool	Get, Replace

This leaf node indicates if queuing is enabled or not.

When set to "true" queuing floor requests is enabled on the group.

When set to "false" queuing floor requests is not enabled on the group.

The default value is set to "true".

NOTE: This element is specific for MCPTT.

## 6.2.35 /<x>/<x>/OffNetwork/DefaultPPPP

**Table 6.2.35.1: /<x>/<x>/OffNetwork/DefaultPPPP**

<x>/OffNetwork/DefaultPPPP

Status	Occurrence	Format	Min. Access Types
Required	One	node	Get, Replace

This interior node is a placeholder for the default ProSe Per-Packet Priority (PPPP) configuration.

## 6.2.36 /<x>/<x>/OffNetwork/DefaultPPPP/MCPTTGroupCallSignalling

**Table 6.2.36.1: /<x>/<x>/OffNetwork/DefaultPPPP/MCPTTGroupCallSignalling**

<x>/OffNetwork/DefaultPPPP/MCPTTGroupCallSignalling

Status	Occurrence	Format	Min. Access Types
Required	One	int	Get, Replace

This leaf node indicates the default ProSe Per-Packet Priority (PPPP) value (as specified in 3GPP TS 23.303 [6]) for the group call signalling for MCPTT.

- Values: 1-8

The MCPTT user data with the lowest ProSe Per-Packet Priority value shall be considered as the MCPTT user data having the highest priority among the MCPTT user data.

NOTE: This element is specific for MCPTT.

## 6.2.37 /<x>/<x>/OffNetwork/DefaultPPPP/MCPTTGroupCallMedia

**Table 6.2.37.1: /<x>/<x>/OffNetwork/DefaultPPPP/MCPTTGroupCallMedia**

<x>/OffNetwork/DefaultPPPP/MCPTTGroupCallMedia

Status	Occurrence	Format	Min. Access Types
Required	One	int	Get, Replace

This leaf node indicates the default ProSe Per-Packet Priority (PPPP) value (as specified in 3GPP TS 23.303 [6]) for the group call media for MCPTT.

- Values: 1-8

The MCPTT user data with the lowest ProSe Per-Packet Priority value shall be considered as the MCPTT user data having the highest priority among the MCPTT user data.

NOTE: This element is specific for MCPTT.

## 6.2.38

### /<x>/<x>/OffNetwork/DefaultPPPP/MCPTTEmergencyGroupCallSignalling

**Table 6.2.38.1: /<x>/<x>/OffNetwork/DefaultPPPP/MCPTTEmergencyGroupCallSignalling**

<x>/OffNetwork/DefaultPPPP/MCPTTEmergencyGroupCallSignalling

Status	Occurrence	Format	Min. Access Types
Required	One	int	Get, Replace

This leaf node indicates the default ProSe Per-Packet Priority (PPPP) value (as specified in 3GPP TS 23.303 [6]) for the MCPTT emergency group call signalling.

- Values: 1-8

The MCPTT user data with the lowest ProSe Per-Packet Priority value shall be considered as the MCPTT user data having the highest priority among the MCPTT user data.

NOTE: This element is specific for MCPTT.

## 6.2.39

`<x>/<x>/OffNetwork/DefaultPPPP/MCPTTEmergencyGroupCallMedia`

**Table 6.2.39.1: `<x>/<x>/OffNetwork/DefaultPPPP/MCPTTEmergencyGroupCallMedia`**

`<x>/OffNetwork/DefaultPPPP/MCPTTEmergencyGroupCallMedia`

Status	Occurrence	Format	Min. Access Types
Required	One	int	Get, Replace

This leaf node indicates the default ProSe Per-Packet Priority (PPPP) value (as specified in 3GPP TS 23.303 [6]) for the MCPTT emergency group call media.

- Values: 1-8

The MCPTT user data with the lowest ProSe Per-Packet Priority value shall be considered as the MCPTT user data having the highest priority among the MCPTT user data.

NOTE: This element is specific for MCPTT.

## 6.2.40

`<x>/<x>/OffNetwork/DefaultPPPP/MCPTTImminentPerilGroupCallSignalling`

**Table 6.2.40.1: `<x>/<x>/OffNetwork/DefaultPPPP/MCPTTImminentPerilGroupCallSignalling`**

`<x>/OffNetwork/DefaultPPPP/MCPTTImminentPerilGroupCallSignalling`

Status	Occurrence	Format	Min. Access Types
Required	One	int	Get, Replace

This leaf node indicates the default ProSe Per-Packet Priority (PPPP) value (as specified in 3GPP TS 23.303 [6]) for the MCPTT imminent peril group call signalling.

- Values: 1-8

The MCPTT user data with the lowest ProSe Per-Packet Priority value shall be considered as the MCPTT user data having the highest priority among the MCPTT user data.

NOTE: This element is specific for MCPTT.

## 6.2.41

`<x>/<x>/OffNetwork/DefaultPPPP/MCPTTImminentPerilGroupCallMedia`

**Table 6.2.41.1: `<x>/<x>/OffNetwork/DefaultPPPP/MCPTTImminentPerilGroupCallMedia`**

`<x>/OffNetwork/DefaultPPPP/MCPTTImminentPerilGroupCallMedia`

Status	Occurrence	Format	Min. Access Types
Required	One	int	Get, Replace

This leaf node indicates the default ProSe Per-Packet Priority (PPPP) value (as specified in 3GPP TS 23.303 [6]) for the MCPTT imminent peril group call media.

- Values: 1-8

The MCPTT user data with the lowest ProSe Per-Packet Priority value shall be considered as the MCPTT user data having the highest priority among the MCPTT user data.

NOTE: This element is specific for MCPTT.

## 6.2.42 /<x>/<x>/OffNetwork/MCData

**Table 6.2.42.1: /<x>/<x>/OffNetwork/MCData**

<x>/OffNetwork/MCData

Status	Occurrence	Format	Min. Access Types
Required	One	node	Get, Replace

This interior node is a placeholder for off-network MCData configuration.

## 6.2.43 /<x>/<x>/OffNetwork/MCData/DefaultPPPP

**Table 6.2.43.1: /<x>/<x>/OffNetwork/MCData/DefaultPPPP**

<x>/OffNetwork/MCData/DefaultPPPP

Status	Occurrence	Format	Min. Access Types
Required	One	node	Get, Replace

This interior node is a placeholder for the default ProSe Per-Packet Priority (PPPP) configuration.

## 6.2.44

### /<x>/<x>/OffNetwork/MCData/DefaultPPPP/MCDataGroupCallSignalling

**Table 6.2.44.1: /<x>/<x>/OffNetwork/MCData/DefaultPPPP/MCDataGroupCallSignalling**

<x>/OffNetwork/MCData/DefaultPPPP/MCDataGroupCallSignalling

Status	Occurrence	Format	Min. Access Types
Required	One	int	Get, Replace

This leaf node indicates the default ProSe Per-Packet Priority (PPPP) value (as specified in 3GPP TS 23.303 [6]) for the group call signalling for MCData..

- Values: 1-8

The MCData user data with the lowest ProSe Per-Packet Priority value shall be considered as the MCData user data having the highest priority among the MCData user data.

## 6.2.45

### /<x>/<x>/OffNetwork/MCData/DefaultPPPP/MCDataGroupCallMedia

**Table 6.2.45.1: /<x>/<x>/OffNetwork/MCData/DefaultPPPP/MCDataGroupCallMedia**

<x>/OffNetwork/MCData/DefaultPPPP/MCDataGroupCallMedia

Status	Occurrence	Format	Min. Access Types
Required	One	int	Get, Replace

This leaf node indicates the default ProSe Per-Packet Priority (PPPP) value (as specified in 3GPP TS 23.303 [6]) for the group call media for MCDData.

- Values: 1-8

The MCDData user data with the lowest ProSe Per-Packet Priority value shall be considered as the MCDData user data having the highest priority among the MCDData user data.

## 6.2.46 /<x>/<x>/OffNetwork/MCVideo

**Table 6.2.46.1: /<x>/<x>/OffNetwork/MCVideo**

<x>/OffNetwork/MCVideo

Status	Occurrence	Format	Min. Access Types
Required	One	node	Get, Replace

This interior node is a placeholder for off-network MCVideo group configuration.

## 6.2.47 /<x>/<x>/OffNetwork/MCVideo/ArbitrationApproach

**Table 6.2.47.1: /<x>/<x>/OffNetwork/MCVideo/ArbitrationApproach**

<x>/OffNetwork/MCVideo/ArbitrationApproach

Status	Occurrence	Format	Min. Access Types
Required	One	chr	Get, Replace

This leaf node indicates the arbitration approach used for off-network video transmissions on the group

The valid values are:

- "single" which indicates transmission participants rely on a single participant designated as transmission arbitrator for the arbitration of transmission requests; and
- "self" which indicates each transmission participant arbitrates its own transmission based on its view of the topology;

## 6.2.48 /<x>/<x>/OffNetwork/MCVideo/MaxTransmissions

**Table 6.2.48.1: /<x>/<x>/ OffNetwork/MCVideo/MaxTransmissions**

<x>/OffNetwork/MCVideo/MaxTransmissions

Status	Occurrence	Format	Min. Access Types
Required	One	int	Get, Replace

This leaf node indicates maximum number of simultaneous transmissions for off-network MCVideo procedures.

- Values: 0-65535

## 6.2.49 /<x>/<x>/OffNetwork/MCVideo/DefaultPPPP

**Table 6.2.49.1: /<x>/<x>/OffNetwork/MCVideo/DefaultPPPP**

<x>/OffNetwork/MCVideo/DefaultPPPP

Status	Occurrence	Format	Min. Access Types
Required	One	node	Get, Replace

This interior node is a placeholder for the default ProSe Per-Packet Priority (PPPP) configuration.



## 6.2.50

### /<x>/<x>/OffNetwork/MCVideo/DefaultPPPP/MCVideoGroupCallSignalling

**Table 6.2.50.1: /<x>/<x>/OffNetwork/MCVideo/DefaultPPPP/MCVideoGroupCallSignalling**

<x>/OffNetwork/MCVideo/DefaultPPPP/MCVideoGroupCallSignalling

Status	Occurrence	Format	Min. Access Types
Required	One	int	Get, Replace

This leaf node indicates the default ProSe Per-Packet Priority (PPPP) value (as specified in 3GPP TS 23.303 [6]) for the group call signalling for MCVideo..

- Values: 1-8

The MCVideo user data with the lowest ProSe Per-Packet Priority value shall be considered as the MCVideo user data having the highest priority among the MCVideo user data.

## 6.2.51

### /<x>/<x>/OffNetwork/MCVideo/DefaultPPPP/MCVideoGroupCallMedia

**Table 6.2.51.1: /<x>/<x>/OffNetwork/MCVideo/DefaultPPPP/MCVideoGroupCallMedia**

<x>/OffNetwork/MCVideo/DefaultPPPP/MCVideoGroupCallMedia

Status	Occurrence	Format	Min. Access Types
Required	One	int	Get, Replace

This leaf node indicates the default ProSe Per-Packet Priority (PPPP) value (as specified in 3GPP TS 23.303 [6]) for the group call media for MCVideo.

- Values: 1-8

The MCVideo user data with the lowest ProSe Per-Packet Priority value shall be considered as the MCVideo user data having the highest priority among the MCVideo user data.

## 6.2.52

### /<x>/<x>/OffNetwork/MCVideo/DefaultPPPP/MCVideoEmergencyGroupCallSignalling

**Table 6.2.52.1: /<x>/<x>/OffNetwork/MCVideo/DefaultPPPP/MCVideoEmergencyGroupCallSignalling**

<x>/OffNetwork/MCVideo/DefaultPPPP/MCVideoEmergencyGroupCallSignalling

Status	Occurrence	Format	Min. Access Types
Required	One	int	Get, Replace

This leaf node indicates the default ProSe Per-Packet Priority (PPPP) value (as specified in 3GPP TS 23.303 [6]) for the MCVideo emergency group call signalling.

- Values: 1-8

The MCVideo user data with the lowest ProSe Per-Packet Priority value shall be considered as the MCVideo user data having the highest priority among the MCVideo user data.

## 6.2.53

### /<x>/<x>/OffNetwork/MCVideo/DefaultPPPP/MCVideoEmergencyGroupCallMedia

**Table 6.2.53.1: /<x>/<x>/OffNetwork/MCVideo/DefaultPPPP/MCVideoEmergencyGroupCallMedia**

<x>/OffNetwork/MCVideo/DefaultPPPP/MCVideoEmergencyGroupCallMedia

Status	Occurrence	Format	Min. Access Types
Required	One	int	Get, Replace

This leaf node indicates the default ProSe Per-Packet Priority (PPPP) value (as specified in 3GPP TS 23.303 [6]) for the MCVideo emergency group call media.

- Values: 1-8

The MCVideo user data with the lowest ProSe Per-Packet Priority value shall be considered as the MCVideo user data having the highest priority among the MCVideo user data.

## 6.2.54

### /<x>/<x>/OffNetwork/MCVideo/DefaultPPPP/MCVideoImminentPerilGroupCallSignalling

**Table 6.2.54.1:**

**/<x>/<x>/OffNetwork/MCVideo/DefaultPPPP/MCVideoImminentPerilGroupCallSignalling**

<x>/OffNetwork/MCVideo/DefaultPPPP/MCVideoImminentPerilGroupCallSignalling

Status	Occurrence	Format	Min. Access Types
Required	One	int	Get, Replace

This leaf node indicates the default ProSe Per-Packet Priority (PPPP) value (as specified in 3GPP TS 23.303 [6]) for the MCVideo imminent peril group call signalling.

- Values: 1-8

The MCVideo user data with the lowest ProSe Per-Packet Priority value shall be considered as the MCVideo user data having the highest priority among the MCVideo user data.

## 6.2.55

### /<x>/<x>/OffNetwork/MCVideo/DefaultPPPP/MCVideoImminentPerilGroupCallMedia

**Table 6.2.55.1: /<x>/<x>/OffNetwork/MCVideo/DefaultPPPP/MCVideoImminentPerilGroupCallMedia**

<x>/OffNetwork/MCVideo/DefaultPPPP/MCVideoImminentPerilGroupCallMedia

Status	Occurrence	Format	Min. Access Types
Required	One	int	Get, Replace

This leaf node indicates the default ProSe Per-Packet Priority (PPPP) value (as specified in 3GPP TS 23.303 [6]) for the MCVideo imminent peril group call media.

- Values: 1-8

The MCVideo user data with the lowest ProSe Per-Packet Priority value shall be considered as the MCVideo user data having the highest priority among the MCVideo user data.

# 7 MCPTT service configuration MO

## 7.1 General

The MCPTT service configuration Management Object (MO) is used to configure MCPTT Client behaviour for the on-network or off-network MCPTT Service. The MCPTT service configuration parameters may be stored in the ME, or in the USIM as specified in 3GPP TS 31.102 [10], or in both the ME and the USIM. If both the ME and the USIM contain the same parameters, the values stored in the USIM shall take precedence.

The Management Object Identifier is: urn:oma:mo:ext-3gpp-MCPTT-service-configuration:1.0.

Protocol compatibility: This MO is compatible with OMA OMA DM 1.2 [3].

The OMA DM ACL property mechanism (see OMA OMA-ERELED-DM-V1\_2 [2]) may be used to grant or deny access rights to OMA DM servers in order to modify nodes and leaf objects of the MCPTT service configuration MO.

The following nodes and leaf objects are possible under the MCPTT service configuration node as described in figure 7.1.1:

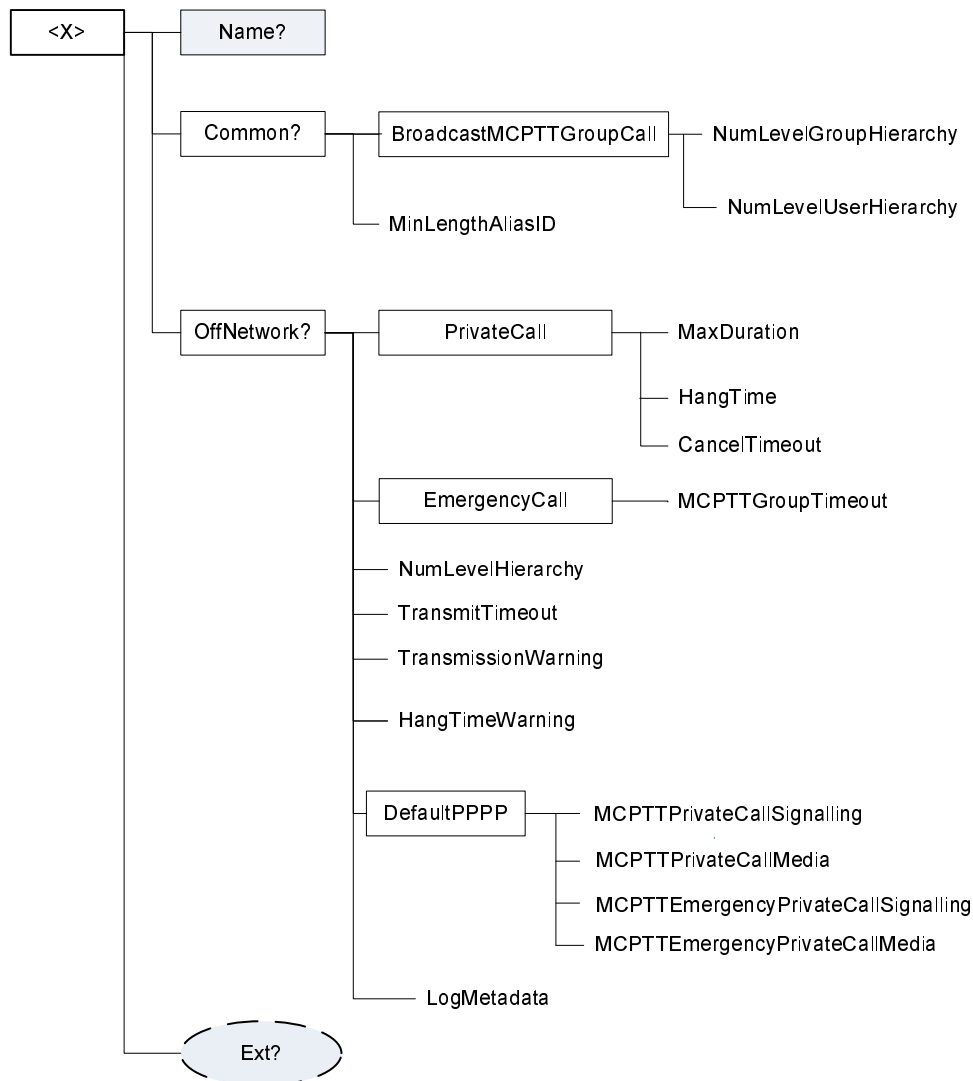

Figure 7.1.1: The MCPTT service configuration MO

## 7.2 MCPTT service configuration MO parameters

### 7.2.1 General

This clause describes the parameters for the MCPTT service configuration Management Object (MO).

### 7.2.2 Node: <x>

**Table 7.2.2.1: Node: <x>**

<x>

Status	Occurrence	Format	Min. Access Types
Required	OneOrMore	node	Get

This interior node acts as a placeholder for the MCPTT service configuration Management Object (MO).

For the MCPTT service configuration MO, the namespace specific string is: "urn:oma:mo:oma-dm-mcptt-service-configuration:1.0"

- Values: N/A

### 7.2.3 /<x>/Name

**Table 7.2.3.1: /<x>/Name**

Name

Status	Occurrence	Format	Min. Access Types
Required	ZeroOrOne	chr	Get

The Name leaf is a name for the MCPTT service configuration settings.

- Values: <User displayable name>

### 7.2.4 /<x>/Ext/

**Table 7.2.4.1: /<x>/Ext/**

Ext

Status	Occurrence	Format	Min. Access Types
Optional	ZeroOrOne	node	Get, Replace

The Ext is an interior node for where the vendor specific information about the MCPTT service configuration MO is being placed.

Usually the vendor extension is identified by vendor specific name under the ext node and contains the vendor meaning application vendor, device vendor etc. The tree structure under the vendor identified is not defined and can therefore include one or more un-standardized sub-trees.

- Values: N/A

### 7.2.5 /<x>/Common

**Table 7.2.5.1: /<x>/Common**

Common

Status	Occurrence	Format	Min. Access Types
Required	ZeroOrOne	node	Get, Replace

This interior node represents a container for the common network operation which means both on-network operation and off-network operation.

## 7.2.6 /<x>/Common/BroadcastMCPTTGroupCall

**Table 7.2.6.1: /<x>/Common/BroadcastMCPTTGroupCall**

Common/BroadcastMCPTTGroupCall

Status	Occurrence	Format	Min. Access Types
Required	One	node	Get, Replace

This interior node is a placeholder for Broadcast MCPTT Group Call configuration.

## 7.2.7

### /<x>/Common/BroadcastMCPTTGroupCall/NumLevelGroupHierarchy

**Table 7.2.7.1: /<x>/Common/BroadcastMCPTTGroupCall/NumLevelGroupHierarchy**

Common/BroadcastMCPTTGroupCall/NumLevelGroupHierarchy

Status	Occurrence	Format	Min. Access Types
Required	One	int	Get, Replace

This leaf node indicates the number of levels of group hierarchy for group-broadcast groups.

- Values: 0-255

The group-broadcast group with the lowest NumLevelGroupHierarchy value shall be considered as the group-broadcast group having the lowest level among the groups.

## 7.2.8 /<x>/Common/BroadcastMCPTTGroupCall/NumLevelUserHierarchy

**Table 7.2.8.1: /<x>/Common/BroadcastMCPTTGroupCall/NumLevelUserHierarchy**

Common/BroadcastMCPTTGroupCall/NumLevelUserHierarchy

Status	Occurrence	Format	Min. Access Types
Required	One	int	Get, Replace

This leaf node indicates the number of levels of user hierarchy for user-broadcast groups.

- Values: 0-255

The user-broadcast group with the lowest NumLevelUserHierarchy value shall be considered as the user-broadcast group the lowest level among the groups.

## 7.2.9 /<x>/Common/MinLengthAliasID

**Table 7.2.9.1: /<x>/Common/MinLengthAliasID**

Common/MinLengthAliasID

Status	Occurrence	Format	Min. Access Types
Required	One	int	Get, Replace

This leaf node indicates minimum length of an alphanumeric identifier (i.e., alias) assigned by an MCPTT administrator.

- Values: 0-255

## 7.2.10 /<x>/OffNetwork

**Table 7.2.10.1: /<x>/OffNetwork**

OffNetwork

Status	Occurrence	Format	Min. Access Types
Required	ZeroOrOne	node	Get, Replace

This interior node represents a container for off-network operation.

## 7.2.11 /<x>/OffNetwork/PrivateCall

**Table 7.2.11.1: /<x>/OffNetwork/PrivateCall**

OffNetwork/PrivateCall

Status	Occurrence	Format	Min. Access Types
Required	One	node	Get, Replace

This interior node is a placeholder for private call configuration.

## 7.2.12 /<x>/OffNetwork/PrivateCall/MaxDuration

**Table 7.2.12.1: /<x>/OffNetwork/PrivateCall/MaxDuration**

OffNetwork/PrivateCall/MaxDuration

Status	Occurrence	Format	Min. Access Types
Required	One	int	Get, Replace

This leaf node indicates max private call (with floor control) duration.

- Values: 0-65535

The MaxDuration time is in seconds.

## 7.2.13 /<x>/OffNetwork/PrivateCall/HangTime

**Table 7.2.13.1: /<x>/OffNetwork/PrivateCall/HangTime**

OffNetwork/PrivateCall/HangTime

Status	Occurrence	Format	Min. Access Types
Required	One	int	Get, Replace

This leaf node indicates hang timer for private calls (with floor control).

- Values: 0-65535

The HangTime is in seconds.

## 7.2.14 /<x>/OffNetwork/PrivateCall/CancelTimeout

**Table 7.2.14.1: /<x>/OffNetwork/PrivateCall/CancelTimeout**

OffNetwork/PrivateCall/CancelTimeout

Status	Occurrence	Format	Min. Access Types
Required	One	int	Get, Replace

This leaf node indicates timeout value for the cancellation of an in progress emergency for an MCPTT private call.

- Values: 0-65535

The CancelTimeout is in seconds.

## 7.2.15 /<x>/OffNetwork/EmergencyCall

**Table 7.2.15.1: /<x>/OffNetwork/EmergencyCall**

OffNetwork/EmergencyCall

Status	Occurrence	Format	Min. Access Types
Required	One	node	Get, Replace

This interior node indicates a placeholder for the MCPTT emergency call policy.

## 7.2.16 /<x>/OffNetwork/EmergencyCall/MCPTTGroupTimeout

**Table 7.2.16.1: /<x>/OffNetwork/EmergencyCall/MCPTTGroupTimeout**

OffNetwork/EmergencyCall/MCPTTGroupTimeout

Status	Occurrence	Format	Min. Access Types
Required	One	int	Get, Replace

This leaf node indicates time limit for an in progress MCPTT emergency call related to an MCPTT group.

- Values: 0-65535

The GroupTimeout is in seconds.

## 7.2.17 /<x>/OffNetwork/NumLevelHierarchy

**Table 7.2.17.1: /<x>/OffNetwork/NumLevelHierarchy**

OffNetwork/NumLevelHierarchy

Status	Occurrence	Format	Min. Access Types
Required	One	int	Get, Replace

This leaf node indicates the number of levels of hierarchy for floor control override in off-network.

- Values: 4-256

The request with the lowest NumLevelHierarchy value shall be considered as the request having the lowest priority level given to override an active transmission among the requests.

## 7.2.18 /<x>/OffNetwork/TransmitTimeout

**Table 7.2.18.1: /<x>/OffNetwork/TransmitTimeout**

OffNetwork/TransmitTimeout

Status	Occurrence	Format	Min. Access Types
Required	One	int	Get, Replace

This leaf node indicates transmit time limit from a single request to transmit in a group or private call.

- Values: 0-65535

The TransmitTimeout is in seconds.

## 7.2.19 /<x>/OffNetwork/TransmissionWarning

**Table 7.2.19.1: /<x>/OffNetwork/TransmissionWarning**

OffNetwork/TransmissionWarning

Status	Occurrence	Format	Min. Access Types
Required	One	int	Get, Replace

This leaf node indicates configuration of warning time before time limit of transmission is reached (off-network).

- Values: 0-255

The TransmissionWarning time is in seconds.

## 7.2.20 /<x>/OffNetwork/HangTimeWarning

**Table 7.2.20.1: /<x>/OffNetwork/HangTimeWarning**

OffNetwork/HangTimeWarning

Status	Occurrence	Format	Min. Access Types
Required	One	int	Get, Replace

This leaf node indicates configuration of warning time before hang time is reached (off-network).

- Values: 0-255

The HangTimeWarning time is in seconds.

## 7.2.21 /<x>/OffNetwork/DefaultPPPP

**Table 7.2.21.1: /<x>/OffNetwork/DefaultPPPP**

OffNetwork/DefaultPPPP

Status	Occurrence	Format	Min. Access Types
Required	One	node	Get, Replace

This interior node is a placeholder for the default ProSe Per-Packet Priority (PPPP) configuration.

## 7.2.22 /<x>/OffNetwork/DefaultPPPP/MCPTTPrivateCallSignalling

**Table 7.2.22.1: /<x>/OffNetwork/DefaultPPPP/MCPTTPrivateCallSignalling**

OffNetwork/DefaultPPPP/MCPTTPrivateCallSignalling

Status	Occurrence	Format	Min. Access Types
Required	One	int	Get, Replace

This leaf node indicates the default ProSe Per-Packet Priority (PPPP) value (as specified in 3GPP TS 23.303 [6]) for the MCPTT private call signalling.

- Values: 1-8

The MCPTT user data with the lowest ProSe Per-Packet Priority value shall be considered as the MCPTT user data having the highest priority among the MCPTT user data.

## 7.2.23 /<x>/OffNetwork/DefaultPPPP/MCPTTPrivateCallMedia

**Table 7.2.23.1: /<x>/OffNetwork/DefaultPPPP/MCPTTPrivateCallMedia**

OffNetwork/DefaultPPPP/MCPTTPrivateCallMedia

Status	Occurrence	Format	Min. Access Types
Required	One	int	Get, Replace

This leaf node indicates the default ProSe Per-Packet Priority (PPPP) value (as specified in 3GPP TS 23.303 [6]) for the MCPTT private call media.

- Values: 1-8

The MCPTT user data with the lowest ProSe Per-Packet Priority value shall be considered as the MCPTT user data having the highest priority among the MCPTT user data.



## 7.2.24

### /<x>/OffNetwork/DefaultPPPP/MCPTTEmergencyPrivateCallSignalling

**Table 7.2.24.1: /<x>/OffNetwork/DefaultPPPP/MCPTTEmergencyPrivateCallSignalling**

OffNetwork/DefaultPPPP/MCPTTEmergencyPrivateCallSignalling

Status	Occurrence	Format	Min. Access Types
Required	One	int	Get, Replace

This leaf node indicates the default ProSe Per-Packet Priority (PPPP) value (as specified in 3GPP TS 23.303 [6]) for the MCPTT emergency private call signalling.

- Values: 1-8

The MCPTT user data with the lowest ProSe Per-Packet Priority value shall be considered as the MCPTT user data having the highest priority among the MCPTT user data.

## 7.2.25 /<x>/OffNetwork/DefaultPPPP/MCPTTEmergencyPrivateCallMedia

**Table 7.2.25.1: /<x>/OffNetwork/DefaultPPPP/MCPTTEmergencyPrivateCallMedia**

OffNetwork/DefaultPPPP/MCPTTEmergencyPrivateCallMedia

Status	Occurrence	Format	Min. Access Types
Required	One	int	Get, Replace

This leaf node indicates the default ProSe Per-Packet Priority (PPPP) value (as specified in 3GPP TS 23.303 [6]) for the MCPTT emergency private call media.

- Values: 1-8

The MCPTT user data with the lowest ProSe Per-Packet Priority value shall be considered as the MCPTT user data having the highest priority among the MCPTT user data.

## 7.2.26 /<x>/OffNetwork/LogMetadata

**Table 7.2.26.1: /<x>/OffNetwork/LogMetadata**

OffNetwork/LogMetadata

Status	Occurrence	Format	Min. Access Types
Required	One	bool	Get, Replace

This leaf node indicates whether logging of metadata for MCPTT group calls, MCPTT private calls and non-call activities is permitted.

When set to "true" logging of metadata for MCPTT group calls, MCPTT private calls and non-call activities, is enabled.

When set to "false" logging of metadata for MCPTT group calls, MCPTT private calls and non-call activities, is not enabled.

# 8 MCS UE initial configuration MO

## 8.1 General

The MCS UE initial configuration Management Object (MO) is used to configure the MCS Client behaviour for the on-network or off-network MCS Service. The MCS UE initial configuration parameters may be stored in the ME, or in the USIM as specified in 3GPP TS 31.102 [10], or in both the ME and the USIM. If both the ME and the USIM contain the same parameters, the values stored in the USIM shall take precedence.

NOTE: For historical reasons some of the elements in the MCS UE initial MO uses the terminology "MCPTT", however this MO is common to all MCS with some MCPTT specific elements, some MCDATA specific elements and some MCVideo specific elements. Not all elements that contain the terminology "MCPTT" are just MCPTT specific.

The Management Object Identifier is: urn:oma:mo:ext-3gpp-MCPTT-UE-initial-configuration:1.0.

Protocol compatibility: This MO is compatible with OMA OMA DM 1.2 [3].

The OMA DM ACL property mechanism (see OMA OMA-ERELD-DM-V1\_2 [2]) may be used to grant or deny access rights to OMA DM servers in order to modify nodes and leaf objects of the MCPTT user profile MO.

The following nodes and leaf objects are possible under the MCPTT node as described in figure 8.1.1, figure 8.1.2, figure 8.1.3 and figure 8.1.4:

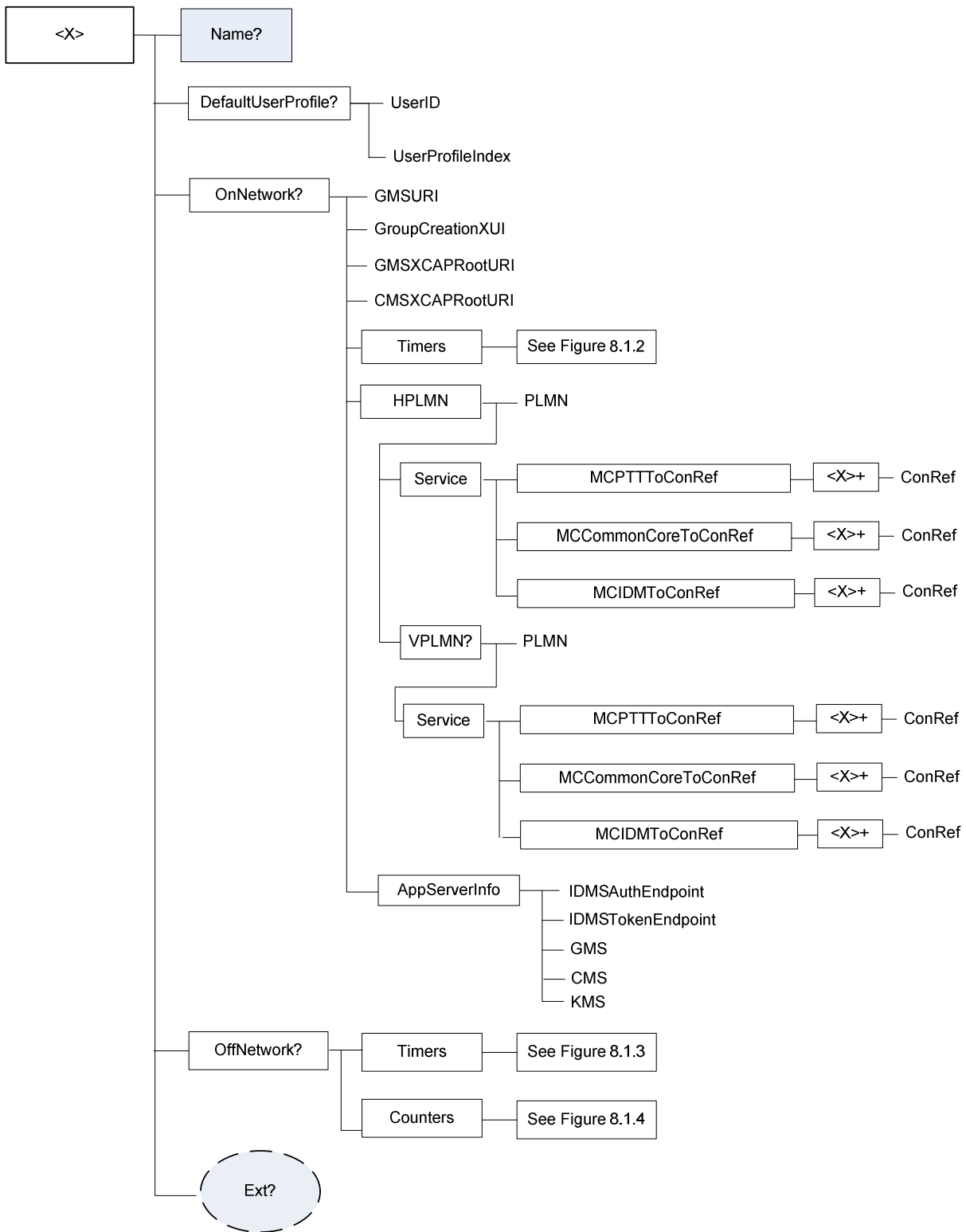
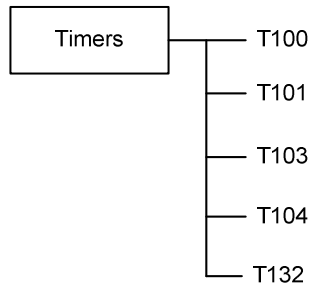

Figure 8.1.1: The MCS UE initial configuration MO (1 of 4)



**Figure 8.1.2: The MCS UE initial configuration MO (2 of 4)**

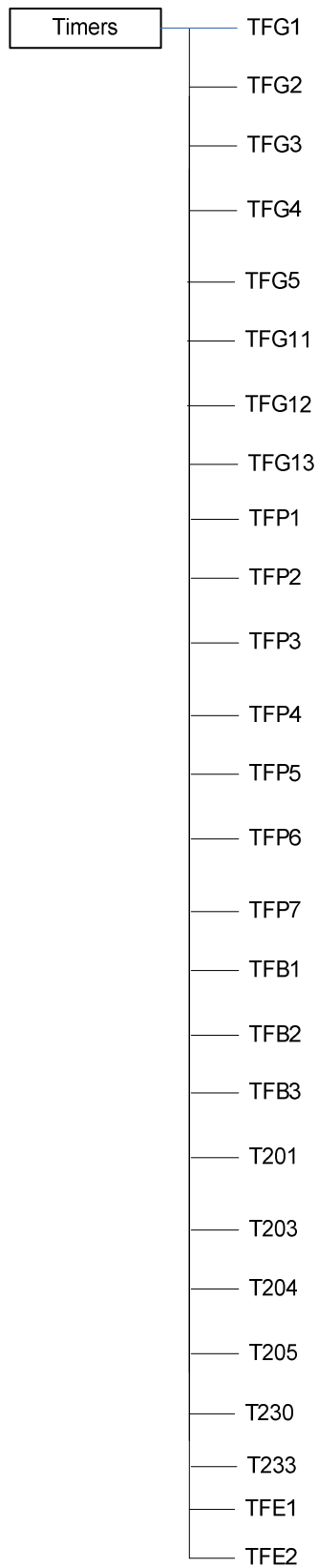

Figure 8.1.3: The MCS UE initial configuration MO (3 of 4)

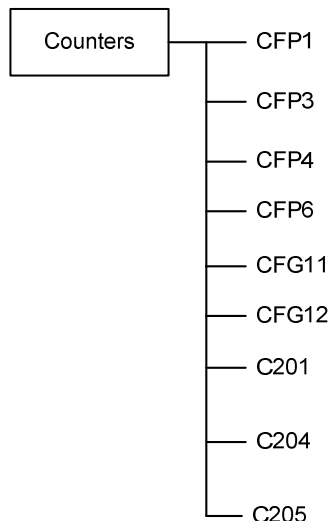

Figure 8.1.4: The MCS UE initial configuration MO (4 of 4)

## 8.2 MCS UE initial configuration MO parameters

### 8.2.1 General

This clause describes the parameters for the MCS UE initial configuration Management Object (MO).

### 8.2.2 Node: <x>

Table 8.2.2.1: Node: <x>

<x>

Status	Occurrence	Format	Min. Access Types
Required	OneOrMore	node	Get

This interior node acts as a placeholder for the MCS UE initial configuration Management Object (MO).

For the MCS UE initial configuration MO, the namespace specific string is: "urn:oma:mo:oma-dm-mcptt-ue-initial-configuration:1.0"

- Values: N/A

### 8.2.3 /<x>/Name

Table 8.2.3.1: /<x>/Name

Name

Status	Occurrence	Format	Min. Access Types
Required	ZeroOrOne	chr	Get

The Name leaf is a name for the MCPTT UE initial configuration settings.

- Values: <User displayable name>

### 8.2.4 /<x>/Ext/

Table 8.2.4.1: /<x>/Ext/

Ext

Status	Occurrence	Format	Min. Access Types
Optional	ZeroOrOne	node	Get, Replace

The Ext is an interior node for where the vendor specific information about the MCPTT UE initial configuration MO is being placed.

Usually the vendor extension is identified by vendor specific name under the ext node and contains the vendor meaning application vendor, device vendor etc. The tree structure under the vendor identified is not defined and can therefore include one or more un-standardized sub-trees.

- Values: N/A

## 8.2.5 /<x>/DefaultUserProfile

**Table 8.2.5.1: /<x>/Ext/DefaultUserProfile**

DefaultUserProfile

Status	Occurrence	Format	Min. Access Types
Required	ZeroOrOne	node	Get, Replace

This interior node represents a container for the default user profile.

The DefaultUserProfile nodes are:

- the same MCPTT user profile nodes defined in MCPTT user profile MO with a default MCPTT user ID;
- the same MCDData user profile nodes defined in MCDData user profile MO with a default MCDData user ID; or
- the same MCVideo user profile nodes defined in MCVideo user profile MO with a default MCVideo user ID;

## 8.2.6 /<x>/DefaultUserProfile/UserID

**Table 8.2.6.1: /<x>/Ext/DefaultUserProfile/UserID**

DefaultUserProfile/UserID

Status	Occurrence	Format	Min. Access Types
Required	One	chr	Get, Replace

This leaf node indicates a default MCS user identity.

## 8.2.7 /<x>/DefaultUserProfile/UserProfileIndex

**Table 8.2.7.1: /<x>/Ext/DefaultUserProfile/UserProfileIndex**

DefaultUserProfile/UserProfileIndex

Status	Occurrence	Format	Min. Access Types
Required	One	int	Get, Replace

This leaf node represents an indicator for the particular user profile.

- Values: 0-255

## 8.2.8 /<x>/OnNetwork

**Table 8.2.8.1: /<x>/OnNetwork**

OnNetwork

Status	Occurrence	Format	Min. Access Types
Required	ZeroOrOne	node	Get, Replace

This interior node represents a container for on-network operation.

## 8.2.9 /<x>/OnNetwork/GMSURI

**Table 8.2.9.1: <x>/OnNetwork/GMSURI**

OnNetwork/GMSURI

Status	Occurrence	Format	Min. Access Types
Required	One	chr	Get, Replace

This leaf node indicates the group management service URI information which contains the public service identity for performing subscription proxy function of the GMS.

The value is a URI as specified in 3GPP TS 23.003 [5].

## 8.2.9A /<x>/OnNetwork/GroupCreationXUI

**Table 8.2.9A.1: <x>/OnNetwork/GroupCreationXUI**

OnNetwork/GroupCreationXUI

Status	Occurrence	Format	Min. Access Types
Required	One	chr	Get, Replace

This leaf node indicates the group creation XUI information for creation of groups.

The value is a URI as specified in 3GPP TS 23.003 [5].

## 8.2.9B /<x>/OnNetwork/GMSXCAPRootURI

**Table 8.2.9B.1: <x>/OnNetwork/GMSXCAPRootURI**

OnNetwork/GMSXCAPRootURI

Status	Occurrence	Format	Min. Access Types
Required	One	chr	Get, Replace

This leaf node indicates the group management server XCAP Root URI information.

The value is a URI as specified in 3GPP TS 23.003 [5].

## 8.2.9C /<x>/OnNetwork/CMSXCAPRootURI

**Table 8.2.9C.1: <x>/OnNetwork/CMSXCAPRootURI**

OnNetwork/CMSXCAPRootURI

Status	Occurrence	Format	Min. Access Types
Required	One	chr	Get, Replace

This leaf node indicates the configuration management server XCAP Root URI information.

The value is a URI as specified in 3GPP TS 23.003 [5].

## 8.2.10 /<x>/OnNetwork/Timers

**Table 8.2.10.1: /<x>/OnNetwork/Timers**

OnNetwork/Timers

Status	Occurrence	Format	Min. Access Types
Required	One	node	Get, Replace

This interior node is a placeholder for timer configuration.



## 8.2.11 /<x>/OnNetwork/Timers/T100

**Table 8.2.11.1: /<x>/OnNetwork/Timers/T100**

OnNetwork/Timers/T100

Status	Occurrence	Format	Min. Access Types
Required	One	int	Get, Replace

This leaf node indicates the MCPTT timer for floor release as specified in 3GPP TS 24.380 [8].

- Values: 0-255

The T100 is in seconds.

## 8.2.12 /<x>/OnNetwork/Timers/T101

**Table 8.2.12.1: /<x>/OnNetwork/Timers/T101**

OnNetwork/Timers/T101

Status	Occurrence	Format	Min. Access Types
Required	One	int	Get, Replace

This leaf node indicates the MCPTT timer for floor request as specified in 3GPP TS 24.380 [8].

- Values: 0-255

The timer T101 is in seconds.

## 8.2.13 /<x>/OnNetwork/Timers/T103

**Table 8.2.13.1: /<x>/OnNetwork/Timers/T103**

OnNetwork/Timers/T103

Status	Occurrence	Format	Min. Access Types
Required	One	int	Get, Replace

This leaf node indicates the MCPTT timer for end of RTP media as specified in 3GPP TS 24.380 [8].

- Values: 0-255

The timer T103 is in seconds.

## 8.2.14 /<x>/OnNetwork/Timers/T104

**Table 8.2.14.1: /<x>/OnNetwork/Timers/T104**

OnNetwork/Timers/T104

Status	Occurrence	Format	Min. Access Types
Required	One	int	Get, Replace

This leaf node indicates the MCPTT timer for floor queue position request as specified in 3GPP TS 24.380 [8].

- Values: 0-255

The timer T104 is in seconds.

## 8.2.15 /<x>/OnNetwork/Timers/T132

**Table 8.2.15.1: /<x>/OnNetwork/Timers/T132**

OnNetwork/Timers/T132

Status	Occurrence	Format	Min. Access Types
Required	One	int	Get, Replace

This leaf node indicates the MCPTT timer for queued request granted MCPTT user action as specified in 3GPP TS 24.380 [8].

- Values: 0-255

The timer T132 is in seconds.

## 8.2.16 /<x>/OnNetwork/HPLMN

**Table 8.2.16.1: /<x>/OnNetwork/HPLMN**

OnNetwork/HPLMN

Status	Occurrence	Format	Min. Access Types
Required	One	node	Get, Replace

This interior node is a placeholder for the HPLMN configuration.

## 8.2.17 /<x>/OnNetwork/HPLMN/PLMN

**Table 8.2.17.1: /<x>/OnNetwork/HPLMN/PLMN**

OnNetwork/HPLMN/PLMN

Status	Occurrence	Format	Min. Access Types
Required	One	chr	Get, Replace

This leaf node indicates the HPLMN code.

- Values: <PLMN>

The format of the PLMN is defined by 3GPP TS 23.003 [5].

## 8.2.18 /<x>/OnNetwork/HPLMN/Service

**Table 8.2.18.1: /<x>/OnNetwork/HPLMN/Service**

OnNetwork/HPLMN/Service

Status	Occurrence	Format	Min. Access Types
Required	One	node	Get, Replace

This interior node indicates the MCS related services on a per HPLMN basis.

## 8.2.19 /<x>/OnNetwork/HPLMN/Service/MCPTTTtoConRef

**Table 8.2.19.1: /<x>/OnNetwork/HPLMN/Service/MCPTTTtoConRef**

OnNetwork/HPLMN/Service/MCPTTTtoConRef

Status	Occurrence	Format	Min. Access Types
Required	One	node	Get, Replace

This interior node contains the configuration parameters for establishment of the PDN connection for the MCS service on a per HPLMN basis.

## 8.2.20 /<x>/OnNetwork/HPLMN/Service/MCPTTTtoConRef/<x>

**Table 8.2.20.1: /<x>/OnNetwork/HPLMN/Service/MCPTTTtoConRef/<x>**

OnNetwork/HPLMN/Service/MCPTTTtoConRef/<x>

Status	Occurrence	Format	Min. Access Types

Required	OneorMore	node	Get, Replace
----------	-----------	------	--------------

This run-time node acts as a placeholder for each reference to the connectivity parameters on a per HPLMN basis.

## 8.2.21 /<x>/OnNetwork/HPLMN/Service/MCPTTToConRef/<x>/ConRef

**Table 8.2.21.1: /<x>/OnNetwork/HPLMN/Service/MCPTTToConRef/<x>/ConRef**

OnNetwork/HPLMN/Service/MCPTTToConRef/<x>/ConRef

Status	Occurrence	Format	Min. Access Types
Required	One	chr	Get, Replace

The ConRef specifies a specific linkage to the connectivity parameters on a per HPLMN basis.

- Values: <A network access point object>

## 8.2.22 /<x>/OnNetwork/HPLMN/Service/MCCommonCoreToConRef

**Table 8.2.22.1: /<x>/OnNetwork/HPLMN/Service/MCCommonCoreToConRef**

OnNetwork/HPLMN/Service/MCCommonCoreToConRef

Status	Occurrence	Format	Min. Access Types
Required	One	node	Get, Replace

This interior node contains the configuration parameters for establishment of the PDN connection for the MC common core service on a per HPLMN basis.

## 8.2.23 /<x>/OnNetwork/HPLMN/Service/MCCommonCoreToConRef/<x>

**Table 8.2.23.1: /<x>/OnNetwork/HPLMN/Service/MCCommonCoreToConRef/<x>**

OnNetwork/HPLMN/Service/MCCommonCoreToConRef/<x>

Status	Occurrence	Format	Min. Access Types
Required	OneorMore	node	Get, Replace

This run-time node acts as a placeholder for each reference to the connectivity parameters on a per HPLMN basis.

## 8.2.24

### /<x>/OnNetwork/HPLMN/Service/MCCommonCoreToConRef/<x>/ConRef

**Table 8.2.24.1: /<x>/OnNetwork/HPLMN/Service/MCCommonCoreToConRef/<x>/ConRef**

OnNetwork/HPLMN/Service/MCCommonCoreToConRef/<x>/ConRef

Status	Occurrence	Format	Min. Access Types
Required	One	chr	Get, Replace

The ConRef specifies a specific linkage to the connectivity parameters on a per HPLMN basis.

- Values: <A network access point object>

## 8.2.25 /<x>/OnNetwork/HPLMN/Service/MCIDMTToConRef

**Table 8.2.25.1: /<x>/OnNetwork/HPLMN/Service/MCIDMTToConRef**

OnNetwork/HPLMN/Service/MCIDMTToConRef

Status	Occurrence	Format	Min. Access Types
Required	One	node	Get, Replace

This interior node contains the configuration parameters for establishment of the PDN connection for the MC identity management service on a per HPLMN basis.

## 8.2.26 /<x>/OnNetwork/HPLMN/Service/MCIDMTtoConRef/<x>

**Table 8.2.26.1: /<x>/OnNetwork/HPLMN/Service/MCIDMTtoConRef/<x>**

OnNetwork/HPLMN/Service/MCIDMTtoConRef/<x>

Status	Occurrence	Format	Min. Access Types
Required	OneorMore	node	Get, Replace

This run-time node acts as a placeholder for each reference to the connectivity parameters on a per HPLMN basis.

## 8.2.27 /<x>/OnNetwork/HPLMN/Service/MCIDMTtoConRef/<x>/ConRef

**Table 8.2.27.1: /<x>/OnNetwork/HPLMN/Service/MCIDMTtoConRef/<x>/ConRef**

OnNetwork/HPLMN/Service/MCIDMTtoConRef/<x>/ConRef

Status	Occurrence	Format	Min. Access Types
Required	One	chr	Get, Replace

The ConRef specifies a specific linkage to the connectivity parameters on a per HPLMN basis.

- Values: <A network access point object>

## 8.2.28 /<x>/OnNetwork/HPLMN/VPLMN

**Table 8.2.28.1: /<x>/OnNetwork/HPLMN/VPLMN**

OnNetwork/HPLMN/VPLMN

Status	Occurrence	Format	Min. Access Types
Optional	ZeroOrOne	chr	Get, Replace

This interior node is a placeholder for the VPLMN configuration.

## 8.2.29 /<x>/OnNetwork/HPLMN/VPLMN/PLMN

**Table 8.2.29.1: /<x>/OnNetwork/HPLMN/VPLMN/PLMN**

OnNetwork/HPLMN/VPLMN/PLMN

Status	Occurrence	Format	Min. Access Types
Required	One	chr	Get, Replace

This leaf node indicates the VPLMN code.

- Values: <PLMN>

The format of the PLMN is defined by 3GPP TS 23.003 [5].

## 8.2.30 /<x>/OnNetwork/HPLMN/VPLMN/Service

**Table 8.2.30.1: /<x>/OnNetwork/HPLMN/VPLMN/Service**

OnNetwork/HPLMN/VPLMN/Service

Status	Occurrence	Format	Min. Access Types
Required	One	node	Get, Replace

This interior node indicates the MCS related services on a per VPLMN and HPLMN basis.

## 8.2.31 /&lt;x&gt;/OnNetwork/HPLMN/VPLMN/Service/MCPTTTToConRef

**Table 8.2.31.1: /<x>/OnNetwork/HPLMN/VPLMN/Service/MCPTTTToConRef**

OnNetwork/HPLMN/VPLMN/Service/MCPTTTToConRef

Status	Occurrence	Format	Min. Access Types
Required	One	node	Get, Replace

This interior node contains the configuration parameters for establishment of the PDN connection for the MCS service on a per VPLMN and HPLMN basis.

## 8.2.32 /&lt;x&gt;/OnNetwork/HPLMN/VPLMN/Service/MCPTTTToConRef/&lt;x&gt;

**Table 8.2.32.1: /<x>/OnNetwork/HPLMN/Service/MCPTTTToConRef/<x>**

OnNetwork/HPLMN/VPLMN/Service/MCPTTTToConRef/&lt;x&gt;

Status	Occurrence	Format	Min. Access Types
Required	OneorMore	node	Get, Replace

This run-time node acts as a placeholder for each reference to the connectivity parameters on a per VPLMN and HPLMN basis.

## 8.2.33

## /&lt;x&gt;/OnNetwork/HPLMN/VPLMN/Service/MCPTTTToConRef/&lt;x&gt;/ConRef

**Table 8.2.33.1: /<x>/OnNetwork/HPLMN/VPLMN/Service/MCPTTTToConRef/<x>/ConRef**

OnNetwork/HPLMN/VPLMN/Service/MCPTTTToConRef/&lt;x&gt;/ConRef

Status	Occurrence	Format	Min. Access Types
Required	One	chr	Get, Replace

The ConRef specifies a specific linkage to the connectivity parameters on a per VPLMN and HPLMN basis.

- Values: <A network access point object>

## 8.2.34

## /&lt;x&gt;/OnNetwork/HPLMN/VPLMN/Service/MCCommonCoreToConRef

**Table 8.2.34.1: /<x>/OnNetwork/HPLMN/VPLMN/Service/MCCommonCoreToConRef**

OnNetwork/HPLMN/VPLMN/Service/MCCommonCoreToConRef

Status	Occurrence	Format	Min. Access Types
Required	One	node	Get, Replace

This interior node contains the configuration parameters for establishment of the PDN connection for the MC common core service on a per VPLMN and HPLMN basis.

## 8.2.35

## /&lt;x&gt;/OnNetwork/HPLMN/VPLMN/Service/MCCommonCoreToConRef/&lt;x&gt;

**Table 8.2.35.1: /<x>/OnNetwork/HPLMN/VPLMN/Service/MCCommonCoreToConRef/<x>**

OnNetwork/HPLMN/VPLMN/Service/MCCommonCoreToConRef/&lt;x&gt;

Status	Occurrence	Format	Min. Access Types

Required	OneorMore	node	Get, Replace
----------	-----------	------	--------------

This run-time node acts as a placeholder for each reference to the connectivity parameters on a per VPLMN and HPLMN basis.

## 8.2.36

**`/<x>/OnNetwork/HPLMN/VPLMN/Service/MCCommonCoreToConRef/<x>/ConRef`**

**Table 8.2.36.1: `/<x>/OnNetwork/HPLMN/VPLMN/Service/MCCommonCoreToConRef/<x>/ConRef`**

`OnNetwork/HPLMN/VPLMN/Service/MCCommonCoreToConRef/<x>/ConRef`

Status	Occurrence	Format	Min. Access Types
Required	One	chr	Get, Replace

The ConRef specifies a specific linkage to the connectivity parameters on a per VPLMN and HPLMN basis.

- Values: <A network access point object>

## 8.2.37 `/<x>/OnNetwork/HPLMN/VPLMN/Service/MCIDMTToConRef`

**Table 8.2.37.1: `/<x>/OnNetwork/HPLMN/VPLMN/Service/MCIDMTToConRef`**

`OnNetwork/HPLMN/VPLMN/Service/MCIDMTToConRef`

Status	Occurrence	Format	Min. Access Types
Required	One	node	Get, Replace

This interior node contains the configuration parameters for establishment of the PDN connection for the MC identity management service on a per VPLMN and HPLMN basis.

## 8.2.38 `/<x>/OnNetwork/HPLMN/VPLMN/Service/MCIDMTToConRef/<x>`

**Table 8.2.38.1: `/<x>/OnNetwork/HPLMN/VPLMN/Service/MCIDMTToConRef/<x>`**

`OnNetwork/HPLMN/VPLMN/Service/MCIDMTToConRef/<x>`

Status	Occurrence	Format	Min. Access Types
Required	OneorMore	node	Get, Replace

This run-time node acts as a placeholder for each reference to the connectivity parameters on a per VPLMN and HPLMN basis.

## 8.2.39

**`/<x>/OnNetwork/HPLMN/VPLMN/Service/MCIDMTToConRef/<x>/ConRef`**

**Table 8.2.39.1: `/<x>/OnNetwork/HPLMN/VPLMN/Service/MCIDMTToConRef/<x>/ConRef`**

`OnNetwork/HPLMN/VPLMN/Service/MCIDMTToConRef/<x>/ConRef`

Status	Occurrence	Format	Min. Access Types
Required	One	chr	Get, Replace

The ConRef specifies a specific linkage to the connectivity parameters on a per VPLMN and HPLMN basis.

- Values: <A network access point object>

## 8.2.40 /<x>/OnNetwork/AppServerInfo

**Table 8.2.40.1: /<x>/OnNetwork/AppServerInfo**

OnNetwork/AppServerInfo

Status	Occurrence	Format	Min. Access Types
Required	One	node	Get, Replace

This interior node is a placeholder for the application plane server identity information configuration.

## 8.2.41 /<x>/OnNetwork/AppServerInfo/IDMSAuthEndpoint

**Table 8.2.41.1: /<x>/OnNetwork/AppServerInfo/IDMSAuthEndpoint**

OnNetwork/AppServerInfo/IDMSAuthEndpoint

Status	Occurrence	Format	Min. Access Types
Required	One	chr	Get, Replace

This leaf node indicates the identity management server authorisation endpoint identity information.

The value is a URI as specified in 3GPP TS 23.003 [5].

## 8.2.41A /<x>/OnNetwork/AppServerInfo/IDMSTokenEndpoint

**Table 8.2.41A.1: /<x>/OnNetwork/AppServerInfo/IDMSTokenEndpoint**

OnNetwork/AppServerInfo/IDMSTokenEndpoint

Status	Occurrence	Format	Min. Access Types
Required	One	chr	Get, Replace

This leaf node indicates the identity management server token endpoint identity information.

The value is a URI as specified in 3GPP TS 23.003 [5].

## 8.2.42 /<x>/OnNetwork/AppServerInfo/GMS

**Table 8.2.42.1: /<x>/OnNetwork/AppServerInfo/GMS**

OnNetwork/AppServerInfo/GMS

Status	Occurrence	Format	Min. Access Types
Required	One	chr	Get, Replace

This leaf node indicates the group management server identity information.

The value is a URI as specified in 3GPP TS 23.003 [5].

## 8.2.43 /<x>/OnNetwork/AppServerInfo/CMS

**Table 8.2.43.1: /<x>/OnNetwork/AppServerInfo/CMS**

OnNetwork/AppServerInfo/CMS

Status	Occurrence	Format	Min. Access Types
Required	One	chr	Get, Replace

This leaf node indicates the configuration management server identity information.

The value is a URI as specified in 3GPP TS 23.003 [5].

## 8.2.44 /<x>/OnNetwork/AppServerInfo/KMS

**Table 8.2.44.1: /<x>/OnNetwork/AppServerInfo/KMS**

OnNetwork/AppServerInfo/KMS

Status	Occurrence	Format	Min. Access Types
Required	One	chr	Get, Replace

This leaf node indicates key management server identity information.

The value is a URI as specified in 3GPP TS 23.003 [5].

## 8.2.45 /<x>/OffNetwork

**Table 8.2.45.1: /<x>/OffNetwork**

OffNetwork

Status	Occurrence	Format	Min. Access Types
Required	ZeroOrOne	node	Get, Replace

This interior node represents a container for the off-network operation.

## 8.2.46 /<x>/OffNetwork/Timers

**Table 8.2.46.1: /<x>/OffNetwork/Timers**

OffNetwork/Timers

Status	Occurrence	Format	Min. Access Types
Required	One	node	Get, Replace

This interior node is a placeholder for the timer configuration.

## 8.2.47 /<x>/OffNetwork/Timers/TFG1

**Table 8.2.47.1: /<x>/OffNetwork/Timers/TFG1**

OffNetwork/Timers/TFG1

Status	Occurrence	Format	Min. Access Types
Required	One	int	Get, Replace

This leaf node indicates the MCPTT timer for wait for call announcement as specified in 3GPP TS 24.379 [7].

- Values: 0-65535

The timer TFG1 is in milliseconds.



## 8.2.48 /<x>/OffNetwork/Timers/TFG2

**Table 8.2.48.1: /<x>/OffNetwork/Timers/TFG2**

OffNetwork/Timers/TFG2

Status	Occurrence	Format	Min. Access Types
Required	One	int	Get, Replace

This leaf node indicates the MCPTT timer for call announcement as specified in 3GPP TS 24.379 [7].

- Values: 0-65535

The timer TFG2 is in milliseconds.

## 8.2.49 /<x>/OffNetwork/Timers/TFG3

**Table 8.2.49.1: /<x>/OffNetwork/Timers/TFG3**

OffNetwork/Timers/TFG3

Status	Occurrence	Format	Min. Access Types
Required	One	int	Get, Replace

This leaf node indicates the MCPTT timer for call probe retransmission as specified in 3GPP TS 24.379 [7].

- Values: 0-65535

The timer TFG3 is in milliseconds.

## 8.2.50 /<x>/OffNetwork/Timers/TFG4

**Table 8.2.50.1: /<x>/OffNetwork/Timers/TFG4**

OffNetwork/Timers/TFG4

Status	Occurrence	Format	Min. Access Types
Required	One	int	Get, Replace

This leaf node indicates the MCPTT timer for waiting for the MCPTT user as specified in 3GPP TS 24.379 [7].

- Values: 0-60

The timer TFG4 is in seconds.

## 8.2.51 /<x>/OffNetwork/Timers/TFG5

**Table 8.2.51.1: /<x>/OffNetwork/Timers/TFG5**

OffNetwork/Timers/TFG5

Status	Occurrence	Format	Min. Access Types
Required	One	int	Get, Replace

This leaf node indicates the MCPTT timer for not present incoming call announcements as specified in 3GPP TS 24.379 [7].

- Values: 0-255

The timer TFG5 is in seconds.

## 8.2.52 /<x>/OffNetwork/Timers/TFG11

**Table 8.2.52.1: /<x>/OffNetwork/Timers/TFG11**

OffNetwork/Timers/TFG11

Status	Occurrence	Format	Min. Access Types
Required	One	int	Get, Replace

This leaf node indicates the timer for MCPTT emergency end retransmission as specified in 3GPP TS 24.379 [7].

- Values: 0-65535

The timer TFG11 is in milliseconds.

## 8.2.53 /<x>/OffNetwork/Timers/TFG12

**Table 8.2.53.1: /<x>/OffNetwork/Timers/TFG12**

OffNetwork/Timers/TFG12

Status	Occurrence	Format	Min. Access Types
Required	One	int	Get, Replace

This leaf node indicates the timer for MCPTT imminent peril end retransmission as specified in 3GPP TS 24.379 [7].

- Values: 0-65535

The timer TFG12 is in milliseconds.

## 8.2.54 /<x>/OffNetwork/Timers/TFG13

**Table 8.2.54.1: /<x>/OffNetwork/Timers/TFG13**

OffNetwork/Timers/TFG13

Status	Occurrence	Format	Min. Access Types
Required	One	int	Get, Replace

This leaf node indicates the MCPTT timer for implicit priority downgrade as specified in 3GPP TS 24.379 [7].

- Values: 0-255

The timer TFG13 is in seconds.

## 8.2.55 /<x>/OffNetwork/Timers/TFP1

**Table 8.2.55.1: /<x>/OffNetwork/Timers/TFP1**

OffNetwork/Timers/TFP1

Status	Occurrence	Format	Min. Access Types
Required	One	int	Get, Replace

This leaf node indicates the MCPTT timer for private call request retransmission as specified in 3GPP TS 24.379 [7].

- Values: 0-65535

The timer TFP1 is in milliseconds.

## 8.2.56 /<x>/OffNetwork/Timers/TFP2

**Table 8.2.56.1: /<x>/OffNetwork/Timers/TFP2**

OffNetwork/Timers/TFP2

Status	Occurrence	Format	Min. Access Types
Required	One	int	Get, Replace

This leaf node indicates the MCPTT timer for waiting for call response message as specified in 3GPP TS 24.379 [7].

- Values: 0-60

The timer TFP2 is in seconds.

## 8.2.57 /<x>/OffNetwork/Timers/TFP3

**Table 8.2.57.1: /<x>/OffNetwork/Timers/TFP3**

OffNetwork/Timers/TFP3

Status	Occurrence	Format	Min. Access Types
Required	One	int	Get, Replace

This leaf node indicates the MCPTT timer for private call release retransmission as specified in 3GPP TS 24.379 [7].

- Values: 0-65535

The timer TFP3 is in milliseconds.

## 8.2.58 /<x>/OffNetwork/Timers/TFP4

**Table 8.2.58.1: /<x>/OffNetwork/Timers/TFP4**

OffNetwork/Timers/TFP4

Status	Occurrence	Format	Min. Access Types
Required	One	int	Get, Replace

This leaf node indicates the MCPTT timer for private call accept retransmission as specified in 3GPP TS 24.379 [7].

- Values: 0-65535

The timer TFP4 is in milliseconds.

## 8.2.59 /<x>/OffNetwork/Timers/TFP5

**Table 8.2.59.1: /<x>/OffNetwork/Timers/TFP5**

OffNetwork/Timers/TFP5

Status	Occurrence	Format	Min. Access Types
Required	One	int	Get, Replace

This leaf node indicates the MCPTT timer for call release as specified in 3GPP TS 24.379 [7].

- Values: 0-600

The timer TFP5 is in seconds.

## 8.2.60 /<x>/OffNetwork/Timers/TFP6

**Table 8.2.60.1: /<x>/OffNetwork/Timers/TFP6**

OffNetwork/Timers/TFP6

Status	Occurrence	Format	Min. Access Types
Required	One	int	Get, Replace

This leaf node indicates the MCPTT timer for MCPTT emergency private call cancel retransmission as specified in 3GPP TS 24.379 [7].

- Values: 0-65535

The timer TFP6 is in milliseconds.

## 8.2.61 /<x>/OffNetwork/Timers/TFP7

**Table 8.2.61.1: /<x>/OffNetwork/Timers/TFP7**

OffNetwork/Timers/TFP7

Status	Occurrence	Format	Min. Access Types
Required	One	int	Get, Replace

This leaf node indicates the MCPTT timer for waiting for any message with same call identifier as specified in 3GPP TS 24.379 [7].

- Values: 0-255

The timer TFP7 is in seconds.

## 8.2.62 /<x>/OffNetwork/Timers/TFB1

**Table 8.2.62.1: /<x>/OffNetwork/Timers/TFB1**

OffNetwork/Timers/TFB1

Status	Occurrence	Format	Min. Access Types
Required	One	int	Get, Replace

This leaf node indicates the MCPTT timer for max duration as specified in 3GPP TS 24.379 [7].

- Values: 0-600

The timer TFB1 is in seconds.

## 8.2.63 /<x>/OffNetwork/Timers/TFB2

**Table 8.2.63.1: /<x>/OffNetwork/Timers/TFB2**

OffNetwork/Timers/TFB2

Status	Occurrence	Format	Min. Access Types
Required	One	int	Get, Replace

This leaf node indicates the MCPTT timer for broadcast retransmission as specified in 3GPP TS 24.379 [7].

- Values: 0-10

The timer TFB2 is in seconds.

## 8.2.64 /<x>/OffNetwork/Timers/TFB3

**Table 8.2.64.1: /<x>/OffNetwork/Timers/TFB3**

OffNetwork/Timers/TFB3

Status	Occurrence	Format	Min. Access Types
Required	One	int	Get, Replace

This leaf node indicates the MCPTT timer for waiting for the MCPTT user as specified in 3GPP TS 24.379 [7].

- Values: 0-60

The timer TFB3 is in seconds.

## 8.2.65 /<x>/OffNetwork/Timers/T201

**Table 8.2.65.1: /<x>/OffNetwork/Timers/T201**

OffNetwork/Timers/T201

Status	Occurrence	Format	Min. Access Types
Required	One	int	Get, Replace

This leaf node indicates the MCPTT timer for floor request as specified in 3GPP TS 24.380 [8].

- Values: 0-65535

The timer T201 is in milliseconds.

## 8.2.66 /<x>/OffNetwork/Timers/T203

**Table 8.2.66.1: /<x>/OffNetwork/Timers/T203**

OffNetwork/Timers/T203

Status	Occurrence	Format	Min. Access Types
Required	One	int	Get, Replace

This leaf node indicates the MCPTT timer for end of RTP media as specified in 3GPP TS 24.380 [8].

- Values: 0-255

The timer T203 is in seconds.

## 8.2.67 /<x>/OffNetwork/Timers/T204

**Table 8.2.67.1: /<x>/OffNetwork/Timers/T204**

OffNetwork/Timers/T204

Status	Occurrence	Format	Min. Access Types
Required	One	int	Get, Replace

This leaf node indicates the MCPTT timer for floor queue position request as specified in 3GPP TS 24.380 [8].

- Values: 0-255

The timer T204 is in seconds.

## 8.2.68 /<x>/OffNetwork/Timers/T205

**Table 8.2.68.1: /<x>/OffNetwork/Timers/T205**

OffNetwork/Timers/T205

Status	Occurrence	Format	Min. Access Types
Required	One	int	Get, Replace

This leaf node indicates the MCPTT timer for floor granted request as specified in 3GPP TS 24.380 [8].

- Values: 0-255

The timer T205 is in seconds.

## 8.2.69 /<x>/OffNetwork/Timers/T230

**Table 8.2.69.1: /<x>/OffNetwork/Timers/T230**

OffNetwork/Timers/T230

Status	Occurrence	Format	Min. Access Types
Required	One	int	Get, Replace

This leaf node indicates the MCPTT timer for inactivity as specified in 3GPP TS 24.380 [8].

- Values: 0-255

The timer T230 is in seconds.

## 8.2.70 /<x>/OffNetwork/Timers/T233

**Table 8.2.70.1: /<x>/OffNetwork/Timers/T233**

OffNetwork/Timers/T233

Status	Occurrence	Format	Min. Access Types
Required	One	int	Get, Replace

This leaf node indicates the MCPTT timer for pending user action as specified in 3GPP TS 24.380 [8].

- Values: 0-255

The timer T233 is in seconds.

## 8.2.71 /<x>/OffNetwork/Timers/TFE1

**Table 8.2.71.1: /<x>/OffNetwork/Timers/TFE1**

OffNetwork/Timers/TFE1

Status	Occurrence	Format	Min. Access Types
Required	One	int	Get, Replace

This leaf node indicates the timer for MCPTT emergency alert as specified in 3GPP TS 24.379 [7].

- Values: 0-65535

The timer TFE1 is in seconds.

## 8.2.72 /<x>/OffNetwork/Timers/TFE2

**Table 8.2.72.1: /<x>/OffNetwork/Timers/TFE2**

OffNetwork/Timers/TFE2

Status	Occurrence	Format	Min. Access Types

Required	One	int	Get, Replace
----------	-----	-----	--------------

This leaf node indicates the timer for MCPTT emergency alert retransmission as specified in 3GPP TS 24.379 [7].

- Values: 0-10

The timer TFE2 is in seconds.

## 8.2.73 /<x>/OffNetwork/Counters

**Table 8.2.73.1: /<x>/OffNetwork/Counters**

OffNetwork/Counters

Status	Occurrence	Format	Min. Access Types
Required	One	node	Get, Replace

This interior node is a placeholder for the counter configuration.

## 8.2.74 /<x>/OffNetwork/Counters/CFP1

**Table 8.2.74.1: /<x>/OffNetwork/Counters/CFP1**

OffNetwork/Counters/CFP1

Status	Occurrence	Format	Min. Access Types
Required	One	int	Get, Replace

This leaf node indicates the MCPTT counter for private call request retransmission as specified in 3GPP TS 24.379 [7].

- Values: 0-255

## 8.2.75 /<x>/OffNetwork/Counters/CFP3

**Table 8.2.75.1: /<x>/OffNetwork/Counters/CFP3**

OffNetwork/Counters/CFP3

Status	Occurrence	Format	Min. Access Types
Required	One	int	Get, Replace

This leaf node indicates the MCPTT counter for private call release retransmission as specified in 3GPP TS 24.379 [7].

- Values: 0-255

## 8.2.76 /<x>/OffNetwork/Counters/CFP4

**Table 8.2.76.1: /<x>/OffNetwork/Counters/CFP4**

OffNetwork/Counters/CFP4

Status	Occurrence	Format	Min. Access Types
Required	One	int	Get, Replace

This leaf node indicates the MCPTT counter for private call accept retransmission as specified in 3GPP TS 24.379 [7].

- Values: 0-255

## 8.2.77 /&lt;x&gt;/OffNetwork/Counters/CFP6

**Table 8.2.77.1: /<x>/OffNetwork/Counters/CFP6**

OffNetwork/Counters/CFP6

Status	Occurrence	Format	Min. Access Types
Required	One	int	Get, Replace

This leaf node indicates the MCPTT counter for emergency private call cancel retransmission as specified in 3GPP TS 24.379 [7].

- Values: 0-255

## 8.2.78 /&lt;x&gt;/OffNetwork/Counters/CFP11

**Table 8.2.78.1: /<x>/OffNetwork/Counters/CFP11**

OffNetwork/Counters/CFP11

Status	Occurrence	Format	Min. Access Types
Required	One	int	Get, Replace

This leaf node indicates the counter for MCPTT group call emergency end retransmission as specified in 3GPP TS 24.379 [7].

- Values: 0-255

## 8.2.79 /&lt;x&gt;/OffNetwork/Counters/CFP12

**Table 8.2.79.1: /<x>/OffNetwork/Counters/CFP12**

OffNetwork/Counters/CFP12

Status	Occurrence	Format	Min. Access Types
Required	One	int	Get, Replace

This leaf node indicates the counter for MCPTT imminent peril call emergency end retransmission as specified in 3GPP TS 24.379 [7].

- Values: 0-255

## 8.2.80 /&lt;x&gt;/OffNetwork/Counters/C201

**Table 8.2.80.1: /<x>/OffNetwork/Counters/C201**

OffNetwork/Counters/C201

Status	Occurrence	Format	Min. Access Types
Required	One	int	Get, Replace

This leaf node indicates the MCPTT counter for floor request as specified in 3GPP TS 24.380 [8].

- Values: 0-255

## 8.2.81 /&lt;x&gt;/OffNetwork/Counters/C204

**Table 8.2.81.1: /<x>/OffNetwork/Counters/C204**

OffNetwork/Counters/C204

Status	Occurrence	Format	Min. Access Types
Required	One	int	Get, Replace

This leaf node indicates the MCPTT counter for floor queue position request as specified in 3GPP TS 24.380 [8].



- Values: 0-255

## 8.2.82 /<x>/OffNetwork/Counters/C205

**Table 8.2.82.1: /<x>/OffNetwork/Counters/C205**

OffNetwork/Counters/C205

Status	Occurrence	Format	Min. Access Types
Required	One	int	Get, Replace

This leaf node indicates the MCPTT counter for floor granted request as specified in 3GPP TS 24.380 [8].

- Values: 0-255

# 9 MCDATA UE configuration MO

## 9.1 General

The MCDATA UE configuration Management Object (MO) is used to configure MCDATA Client behaviour for the on-network or off-network MCDATA Service. The MCDATA UE configuration parameters may be stored in the ME, or in the USIM as specified in 3GPP TS 31.102 [10], or in both the ME and the USIM. If both the ME and the USIM contain the same parameters, the values stored in the USIM shall take precedence.

The Management Object Identifier is: urn:oma:mo:ext-3gpp-MCDATA-UE-configuration:1.0.

Protocol compatibility: This MO is compatible with OMA OMA DM 1.2 [3].

The OMA DM ACL property mechanism (see OMA OMA-ERELED-DM-V1\_2 [2]) may be used to grant or deny access rights to OMA DM servers in order to modify nodes and leaf objects of the MCDATA UE configuration MO.

The following nodes and leaf objects are possible under the MCDATA UE configuration node as described in figure 9.1.1 and figure 9.1.2:

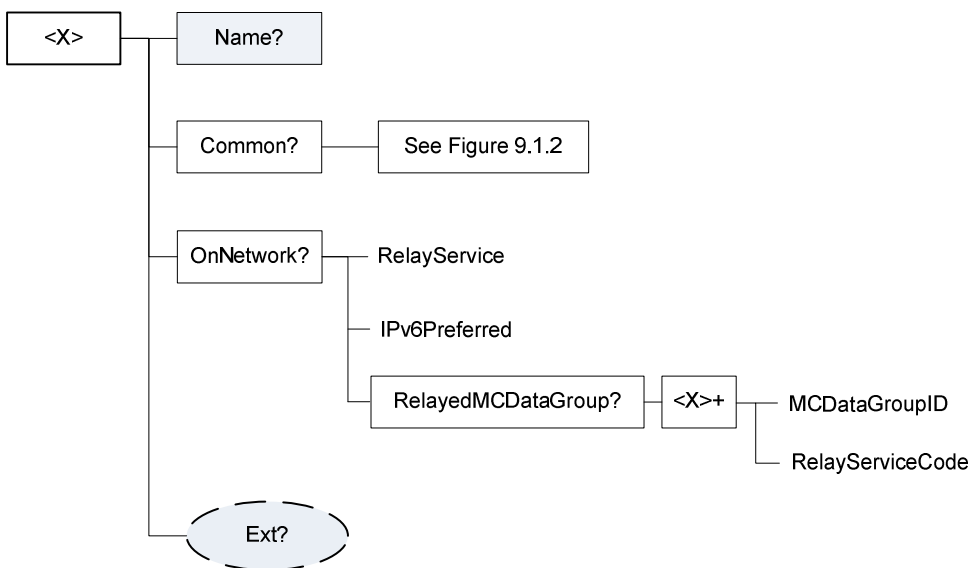

**Figure 9.1.1: The MCDATA UE configuration MO (1 of 2)**

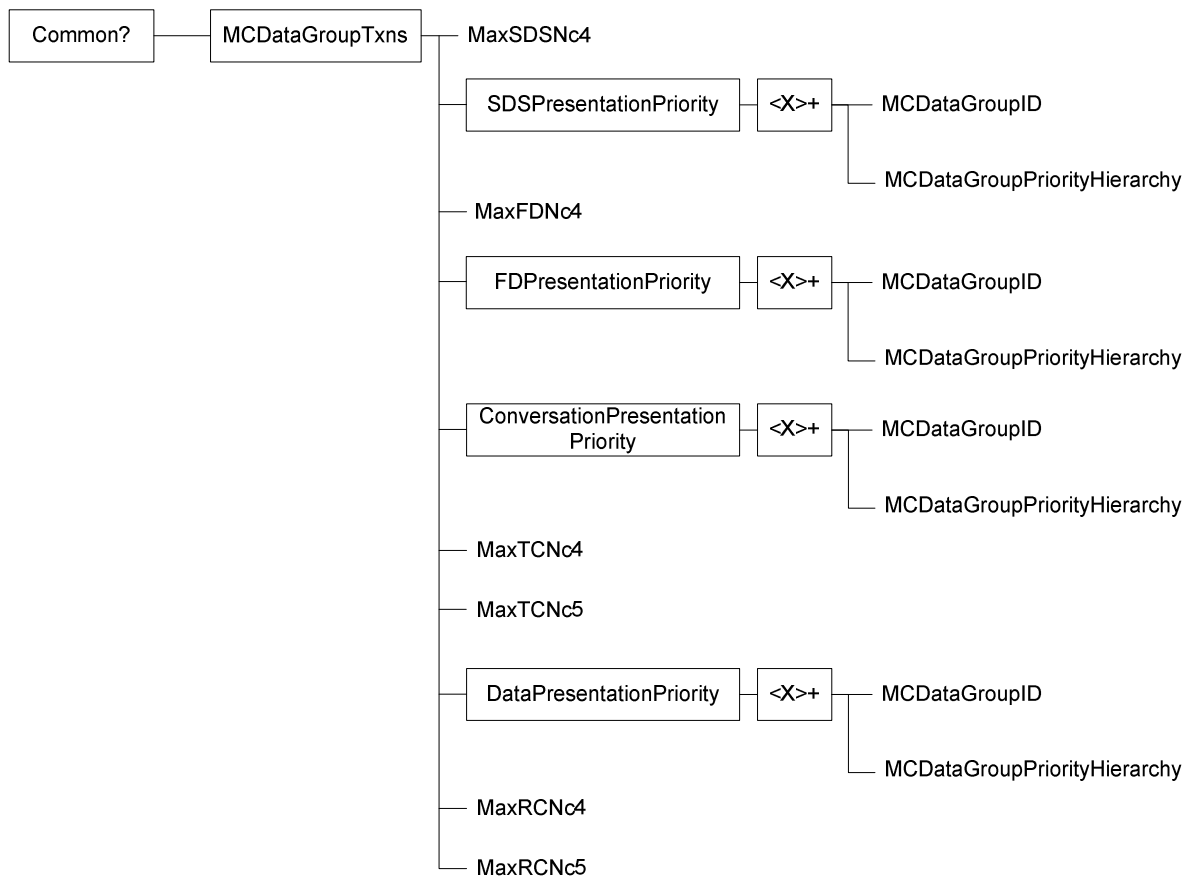

Figure 9.1.2: The MCDATA UE configuration MO (2 of 2)

## 9.2 MCDATA UE configuration MO parameters

### 9.2.1 General

This clause describes the parameters for the MCDATA UE configuration Management Object (MO).

### 9.2.2 Node: <x>

Table 9.2.2.1: Node: <x>

<x>

Status	Occurrence	Format	Min. Access Types
Required	OneOrMore	node	Get

This interior node acts as a placeholder for the MCDATA UE configuration Management Object (MO).

For the MCDATA UE configuration MO, the namespace specific string is: "urn:oma:mo:oma-dm-mcddata-ue-configuration:1.0"

- Values: N/A

### 9.2.3 /<x>/Name

Table 9.2.3.1: /<x>/Name

Name

Status	Occurrence	Format	Min. Access Types

Required	ZeroOrOne	chr	Get
----------	-----------	-----	-----

The Name leaf is a name for the MCDData UE configuration settings.

- Values: <User displayable name>

### 9.2.4 /<x>/Ext/

**Table 9.2.4.1: /<x>/Ext/**

Ext

Status	Occurrence	Format	Min. Access Types
Optional	ZeroOrOne	node	Get, Replace

The Ext is an interior node for where the vendor specific information about the MCDData UE configuration MO is being placed.

Usually the vendor extension is identified by vendor specific name under the ext node and contains the vendor meaning application vendor, device vendor etc. The tree structure under the vendor identified is not defined and can therefore include one or more un-standardized sub-trees.

- Values: N/A

### 9.2.5 /<x>/Common

**Table 9.2.5.1: /<x>/Common**

Common

Status	Occurrence	Format	Min. Access Types
Required	ZeroOrOne	node	Get, Replace

This interior node represents a container for the common network operation which means both on-network operation and off-network operation.

### 9.2.6 /<x>/Common/MCDDataGroupTxns

**Table 9.2.6.1: /<x>/Common/MCDDataGroupTxns**

Common/MCDDataGroupTxns

Status	Occurrence	Format	Min. Access Types
Required	One	node	Get, Replace

This interior node is a placeholder for the MCDData group transactions configuration.

### 9.2.7 /<x>/Common/MCDDataGroupTxns/MaxSDSNc4

**Table 9.2.7.1: /<x>/Common/MCDDataGroupTxns/MaxSDSNc4**

Common/MCDDataGroupTxns/MaxSDSNc4

Status	Occurrence	Format	Min. Access Types
Required	One	int	Get, Replace

This leaf node indicates the maximum number of simultaneous SDS transactions.

- Values: 0-255

## 9.2.8 `<x>/Common/MCDataGroupTxns/SDSPresentationPriority`

**Table 9.2.8.1: `<x>/Common/MCDataGroupTxns/SDSPresentationPriority`**

Common/MCDataGroupTxns/SDSPresentationPriority

Status	Occurrence	Format	Min. Access Types
Required	ZeroOrOne	node	Get, Replace

This interior node is a placeholder for the prioritized MCData SDS configuration.

## 9.2.9 `<x>/Common/MCDataGroupTxns/SDSPresentationPriority/<x>`

**Table 9.2.9.1: `<x>/Common/MCDataGroupTxns/SDSPresentationPriority/<x>`**

Common/MCDataGroupTxns/SDSPresentationPriority/<x>

Status	Occurrence	Format	Min. Access Types
Required	OneOrMore	node	Get, Replace

This interior node is a placeholder for one or more prioritized MCData SDS configuration.

## 9.2.10

### `<x>/Common/MCDataGroupTxns/SDSPresentationPriority/<x>/MCDataGroupID`

**Table 9.2.10.1: `<x>/Common/MCDataGroupTxns/SDSPresentationPriority/<x>/MCDataGroupID`**

Common/MCDataGroupTxns/SDSPresentationPriority/<x>/MCDataGroupID

Status	Occurrence	Format	Min. Access Types
Required	One	chr	Get, Replace

This leaf node indicates the associated MCData group ID.

The value is a "uri" attribute specified in OMA OMA-TS-XDM\_Group-V1\_1 [4].

## 9.2.11

### `<x>/Common/MCDataGroupTxns/SDSPresentationPriority/<x>/MCDataGroupPriorityHierarchy`

**Table 9.2.11.1:**

**`<x>/Common/MCDataGroupTxns/SDSPresentationPriority/<x>/MCDataGroupPriorityHierarchy`**

Common/MCDataGroupTxns/SDSPresentationPriority/<x>/MCDataGroupPriorityHierarchy

Status	Occurrence	Format	Min. Access Types
Required	One	int	Get, Replace

This leaf node indicates the requested presentation priority of SDS transactions.

- Values: 0-255

The group with the lowest MCDataGroupPriorityHierarchy value shall be considered as the group having the lowest priority among the groups.

## 9.2.12 `<x>/Common/MCDataGroupTxns/MaxFDNc4`

**Table 9.2.12.1: `<x>/Common/MCDataGroupTxns/MaxFDNc4`**

Common/MCDataGroupTxns/MaxFDNc4

Status	Occurrence	Format	Min. Access Types
Required	One	int	Get, Replace

This leaf node indicates the maximum number of simultaneous FD transactions.

- Values: 0-255

### 9.2.13 /<x>/Common/MCDataGroupTxns/FDPresentationPriority

**Table 9.2.13.1: /<x>/Common/MCDataGroupTxns/FDPresentationPriority**

Common/MCDataGroupTxns/FDPresentationPriority

Status	Occurrence	Format	Min. Access Types
Required	ZeroOrOne	node	Get, Replace

This interior node is a placeholder for the prioritized MCData FD configuration.

### 9.2.14 /<x>/Common/MCDataGroupTxns/FDPresentationPriority/<x>

**Table 9.2.14.1: /<x>/Common/MCDataGroupTxns/FDPresentationPriority/<x>**

Common/MCDataGroupTxns/FDPresentationPriority /<x>

Status	Occurrence	Format	Min. Access Types
Required	OneOrMore	node	Get, Replace

This interior node is a placeholder for one or more prioritized MCData FD configuration.

### 9.2.15

#### /<x>/Common/MCDataGroupTxns/FDPresentationPriority/<x>/MCDataGroupID

**Table 9.2.15.1: /<x>/Common/MCDataGroupTxns/FDPresentationPriority/<x>/MCDataGroupID**

Common/MCDataGroupTxns/FDPresentationPriority/<x>/MCDataGroupID

Status	Occurrence	Format	Min. Access Types
Required	One	chr	Get, Replace

This leaf node indicates the associated MCData group ID.

The value is a "uri" attribute specified in OMA OMA-TS-XDM\_Group-V1\_1 [4].

### 9.2.16

#### /<x>/Common/MCDataGroupTxns/FDPresentationPriority/<x>/MCDataGroupPriorityHierarchy

**Table 9.2.16.1:**

**/<x>/Common/MCDataGroupTxns/FDPresentationPriority/<x>/MCDataGroupPriorityHierarchy**

Common/MCDataGroupTxns/FDPresentationPriority/<x>/MCDataGroupPriorityHierarchy

Status	Occurrence	Format	Min. Access Types
Required	One	int	Get, Replace

This leaf node indicates the requested presentation priority of FD transactions.

- Values: 0-255

The group with the lowest MCDataGroupPriorityHierarchy value shall be considered as the group having the lowest priority among the groups.

## 9.2.17 /<x>/Common/MCDataGroupTxns/ConversationPresentationPriority

**Table 9.2.17.1: /<x>/Common/MCDataGroupTxns/ConversationPresentationPriority**

Common/MCDataGroupTxns/ConversationPresentationPriority

Status	Occurrence	Format	Min. Access Types
Required	ZeroOrOne	node	Get, Replace

This interior node is a placeholder for the prioritized MCData conversation management configuration.

## 9.2.18

### /<x>/Common/MCDataGroupTxns/ConversationPresentationPriority/<x>

**Table 9.2.18.1: /<x>/Common/MCDataGroupTxns/ConversationPresentationPriority/<x>**

Common/MCDataGroupTxns/ConversationPresentationPriority /<x>

Status	Occurrence	Format	Min. Access Types
Required	OneOrMore	node	Get, Replace

This interior node is a placeholder for one or more prioritized MCData conversation management configuration.

## 9.2.19

### /<x>/Common/MCDataGroupTxns/ConversationPresentationPriority/<x>/MCDataGroupID

**Table 9.2.19.1:**

#### /<x>/Common/MCDataGroupTxns/ConversationPresentationPriority/<x>/MCDataGroupID

Common/MCDataGroupTxns/ConversationPresentationPriority/<x>/MCDataGroupID

Status	Occurrence	Format	Min. Access Types
Required	One	chr	Get, Replace

This leaf node indicates the associated MCData group ID.

The value is a "uri" attribute specified in OMA OMA-TS-XDM\_Group-V1\_1 [4].

## 9.2.20

### /<x>/Common/MCDataGroupTxns/ConversationPresentationPriority/<x>/MCDataGroupPriorityHierarchy

**Table 9.2.20.1:**

#### /<x>/Common/MCDataGroupTxns/ConversationPresentationPriority/<x>/MCDataGroupPriorityHierarchy

Common/MCDataGroupTxns/ConversationPresentationPriority/<x>/MCDataGroupPriorityHierarchy

Status	Occurrence	Format	Min. Access Types
Required	One	int	Get, Replace

This leaf node indicates the requested presentation priority of conversation management transactions.

- Values: 0-255

The group with the lowest MCDataGroupPriorityHierarchy value shall be considered as the group having the lowest priority among the groups.

## 9.2.21 /<x>/Common/MCDataGroupTxns/MaxTCNc4

**Table 9.2.21.1: /<x>/Common/MCDataGroupTxns/MaxTCNc4**

Common/MCDataGroupTxns/MaxTCNc4

Status	Occurrence	Format	Min. Access Types
Required	One	int	Get, Replace

This leaf node indicates the maximum number of simultaneous data transmissions.

- Values: 0-255

## 9.2.22 /<x>/Common/MCDataGroupTxns/MaxTCNc5

**Table 9.2.22.1: /<x>/Common/MCDataGroupTxns/MaxTCNc5**

Common/MCDataGroupTxns/MaxTCN5

Status	Occurrence	Format	Min. Access Types
Required	One	int	Get, Replace

This leaf node indicates the maximum number of data transmissions in a group.

- Values: 0-255

## 9.2.23 /<x>/Common/MCDataGroupTxns/DataPresentationPriority

**Table 9.2.23.1: /<x>/Common/MCDataGroupTxns/DataPresentationPriority**

Common/MCDataGroupTxns/DataPresentationPriority

Status	Occurrence	Format	Min. Access Types
Required	ZeroOrOne	node	Get, Replace

This interior node is a placeholder for the prioritized MCData Transmission Control configuration.

## 9.2.24 /<x>/Common/MCDataGroupTxns/DataPresentationPriority/<x>

**Table 9.2.24.1: /<x>/Common/MCDataGroupTxns/DataPresentationPriority/<x>**

Common/MCDataGroupTxns/DataPresentationPriority/<x>

Status	Occurrence	Format	Min. Access Types
Required	OneOrMore	node	Get, Replace

This interior node is a placeholder for one or more prioritized MCData Transmission Control configuration.

## 9.2.25

### /<x>/Common/MCDataGroupTxns/DataPresentationPriority/<x>/MCDataGroupID

**Table 9.2.25.1: /<x>/Common/MCDataGroupTxns/DataPresentationPriority/<x>/MCDataGroupID**

Common/MCDataGroupTxns/DataPresentationPriority/<x>/MCDataGroupID

Status	Occurrence	Format	Min. Access Types
Required	One	chr	Get, Replace

This leaf node indicates the associated MCData group ID.

The value is a "uri" attribute specified in OMA OMA-TS-XDM\_Group-V1\_1 [4].

## 9.2.26

### /<x>/Common/MCDataGroupTxns/DataPresentationPriority/<x>/MCDataGroupPriorityHierarchy

**Table 9.2.26.1:**

#### /<x>/Common/MCDataGroupTxns/DataPresentationPriority/<x>/MCDataGroupPriorityHierarchy

Common/MCDataGroupTxns/DataPresentationPriority/&lt;x&gt;/MCDataGroupPriorityHierarchy

Status	Occurrence	Format	Min. Access Types
Required	One	int	Get, Replace

This leaf node indicates the requested presentation priority of data received.

- Values: 0-255

The group with the lowest MCDataGroupPriorityHierarchy value shall be considered as the group having the lowest priority among the groups.

## 9.2.27 /&lt;x&gt;/Common/MCDataGroupTxns/MaxRCNc4

**Table 9.2.27.1: /<x>/Common/MCDataGroupTxns/MaxRCNc4**

Common/MCDataGroupTxns/MaxRCNc4

Status	Occurrence	Format	Min. Access Types
Required	One	int	Get, Replace

This leaf node indicates the maximum number of simultaneous data receptions.

- Values: 0-255

## 9.2.28 /&lt;x&gt;/Common/MCDataGroupTxns/MaxRCNc5

**Table 9.2.28.1: /<x>/Common/MCDataGroupTxns/MaxRCNc5**

Common/MCDataGroupTxns/MaxRCN5

Status	Occurrence	Format	Min. Access Types
Required	One	int	Get, Replace

This leaf node indicates the maximum number of data receptions in a group.

- Values: 0-255

## 9.2.29 /&lt;x&gt;/OnNetwork

**Table 9.2.29.1: /<x>/OnNetwork**

OnNetwork

Status	Occurrence	Format	Min. Access Types
Required	ZeroOrOne	node	Get, Replace

This interior node represents a container for on-network operation.

## 9.2.30 /&lt;x&gt;/OnNetwork/RelayService

**Table 9.2.30.1: /<x>/OnNetwork/RelayService**

OnNetwork/RelayService

Status	Occurrence	Format	Min. Access Types
Required	One	bool	Get, Replace



This leaf node indicates the authorisation to use a relay service.

When set to "true" the MCDData group is allowed to use a relay service.

When set to "false" the MCDData group is not allowed to use a relay service.

### 9.2.31 /<x>/OnNetwork/IPv6Preferred

**Table 9.2.31.1: /<x>/OnNetwork/IPv6Preferred**

OnNetwork/IPv6Preferred

Status	Occurrence	Format	Min. Access Types
Required	One	bool	Get, Replace

This leaf node indicates whether IPv6 is preferred over IPv4 for on-network operation when the MCDData UE has both IPv4 and IPv6 host configuration.

If the MCDData UE has both IPv4 and IPv6 host configuration and:

- if IPv6Preferred is set to "true" then the UE uses IPv6 for all on-network signalling and media; otherwise
- if IPv6Preferred is set to "false" then the UE uses IPv4 for all on-network signalling and media.

### 9.2.32 /<x>/OnNetwork/RelayedMCDDataGroup

**Table 9.2.32.1: /<x>/OnNetwork/RelayedMCDDataGroup**

OnNetwork/RelayedMCDDataGroup

Status	Occurrence	Format	Min. Access Types
Optional	One	node	Get, Replace

This interior node is a placeholder for the allowed relayed MCDData groups.

### 9.2.33 /<x>/OnNetwork/RelayedMCDDataGroup/<x>

**Table 9.2.33.1: /<x>/OnNetwork/RelayedMCDDataGroup/<x>**

OnNetwork/RelayedMCDDataGroup/<x>

Status	Occurrence	Format	Min. Access Types
Required	OneOrMore	node	Get, Replace

This interior node is a placeholder for one or more allowed relayed MCDData groups.

### 9.2.34 /<x>/OnNetwork/RelayedMCDDataGroup/<x>/MCDDataGroupID

**Table 9.2.34.1: /<x>/OnNetwork/RelayedMCDDataGroup/<x>/MCDDataGroupID**

OnNetwork/RelayedMCDDataGroup/<x>/MCDDataGroupID

Status	Occurrence	Format	Min. Access Types
Required	One	chr	Get, Replace

This leaf node indicates the associated MCDData group ID.

The value is a "uri" attribute specified in OMA OMA-TS-XDM\_Group-V1\_1 [4].

## 9.2.35 /<x>/OnNetwork/RelayedMCDataGroup/<x>/RelayServiceCode

**Table 9.2.35.1: /<x>/OnNetwork/RelayedMCDataGroup/<x>/RelayServiceCode**

OnNetwork/RelayedMCDataGroup/<x>/RelayServiceCode

Status	Occurrence	Format	Min. Access Types
Required	One	chr	Get, Replace

This leaf node indicates the connectivity service that the ProSe UE-to-network relay provides to public safety applications as specified in 3GPP TS 23.303 [6].

# 10 MCData user profile MO

## 10.1 General

The MCData user profile configuration Management Object (MO) is used to configure the MCData Client behaviour for the on-network or off-network MCData Service. The MCData user profile configuration parameters may be stored in the ME, or in the USIM as specified in 3GPP TS 31.102 [10], or in both the ME and the USIM. If both the ME and the USIM contain the same parameters, the values stored in the USIM shall take precedence.

The Management Object Identifier is: urn:oma:mo:ext-3gpp-MCData-user-profile:1.0.

Protocol compatibility: This MO is compatible with OMA OMA DM 1.2 [3].

The OMA DM ACL property mechanism (see OMA OMA-ERELED-DM-V1\_2 [2]) may be used to grant or deny access rights to OMA DM servers in order to modify nodes and leaf objects of the MCData user profile MO.

The following nodes and leaf objects are possible under the MCData user profile node as described in figure 10.1.1, figure 10.1.2 and figure 10.1.3:

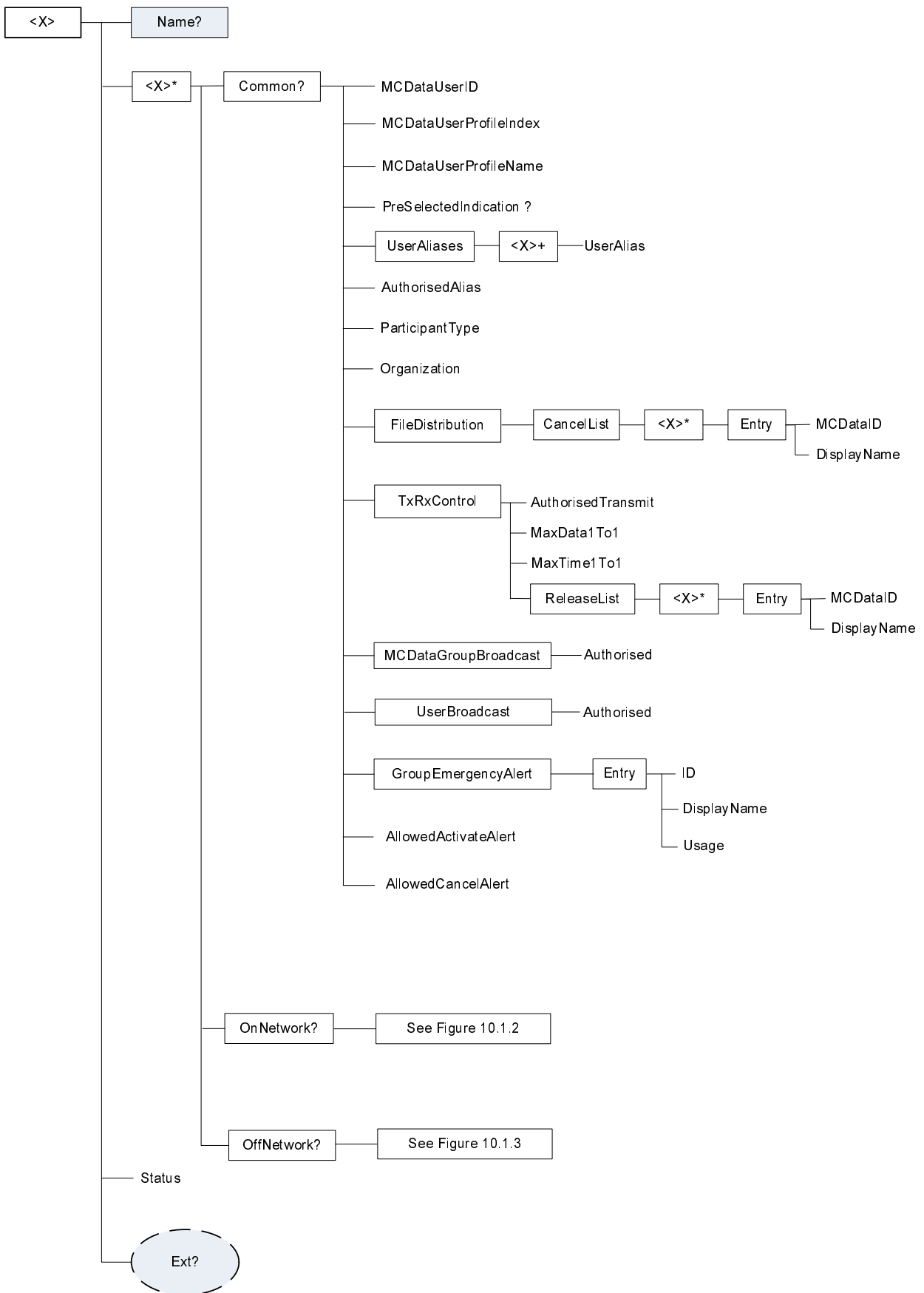

Figure 10.1.1: The MCDATA user profile MO (1 of 3)

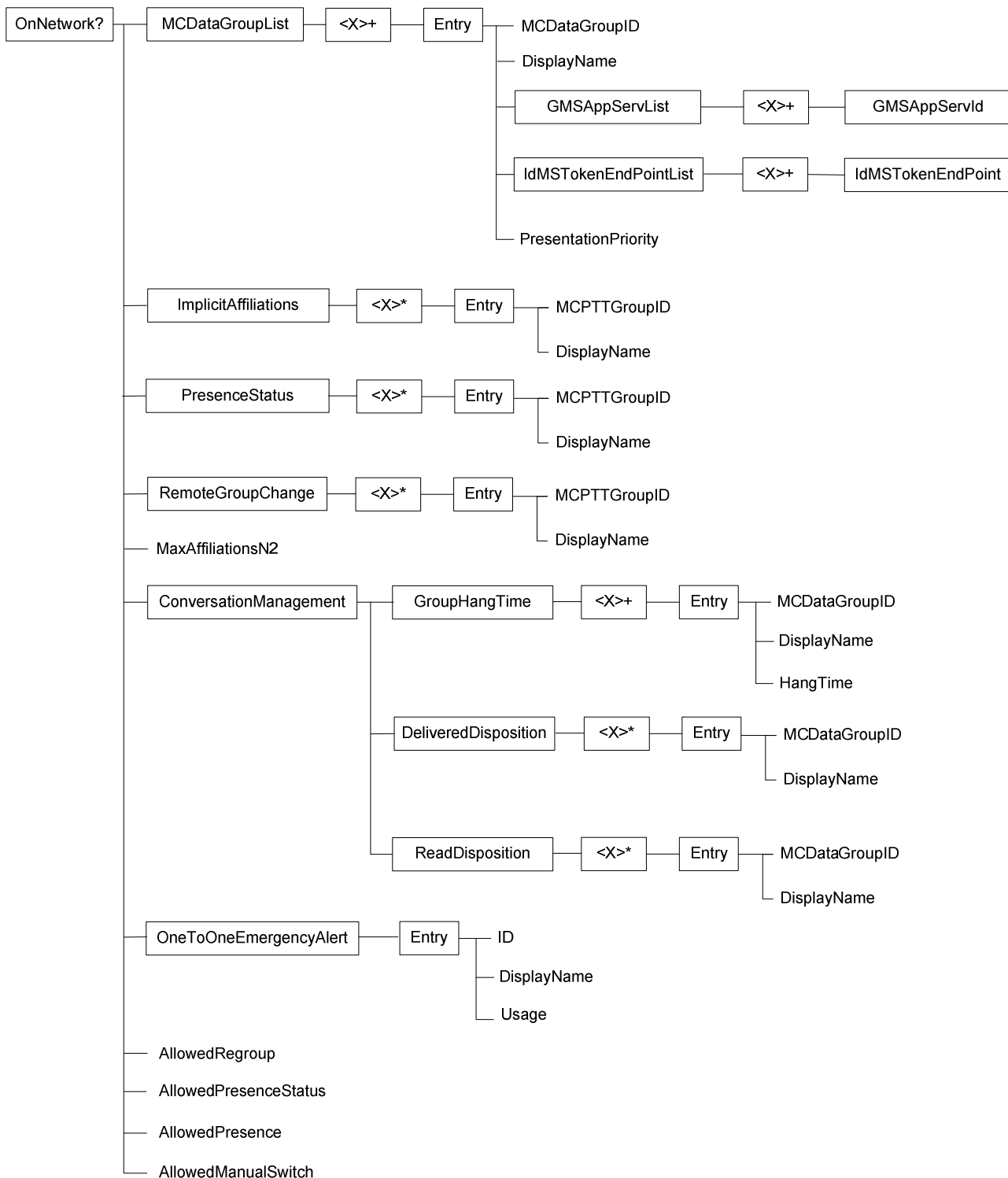

Figure 10.1.2: The MCDATA user profile MO (2 of 3)

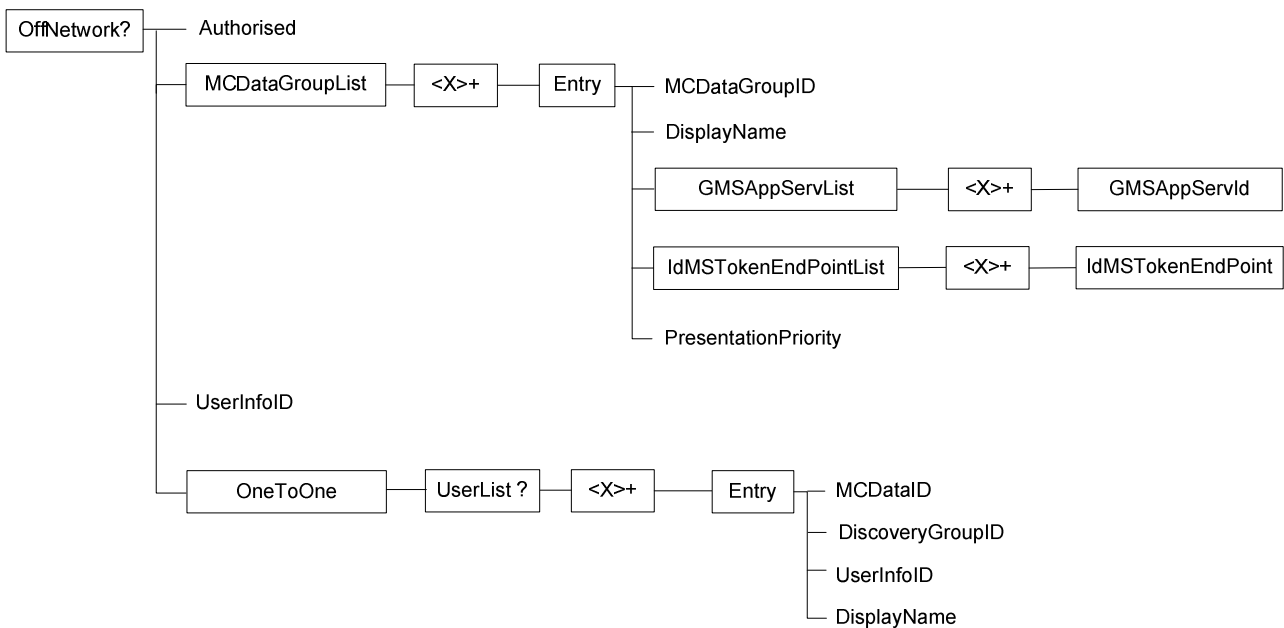

Figure 10.1.3: The MCDATA user profile MO (3 of 3)

## 10.2 MCDATA user profile MO parameters

### 10.2.1 General

This clause describes the parameters for the MCDATA user profile Management Object (MO).

### 10.2.2 Node: <x>

Table 10.2.2.1: Node: <x>

<x>

Status	Occurrence	Format	Min. Access Types
Required	OneOrMore	node	Get

This interior node acts as a placeholder for the MCDATA user profile Management Object (MO).

For the MCDATA user profile MO, the namespace specific string is: "urn:oma:mo:oma-dm-mcdata-user-profile:1.0"

- Values: N/A

### 10.2.3 /<x>/Name

Table 10.2.3.1: /<x>/Name

Name

Status	Occurrence	Format	Min. Access Types
Required	ZeroOrOne	chr	Get

The Name leaf is a name for the MCDATA user profile settings.

- Values: <User displayable name>

## 10.2.4 /<x>/Ext/

**Table 10.2.4.1: /<x>/Ext/**

Ext

Status	Occurrence	Format	Min. Access Types
Optional	ZeroOrOne	node	Get, Replace

The Ext is an interior node for where the vendor specific information about the MCDData user profile MO is being placed.

Usually the vendor extension is identified by vendor specific name under the ext node and contains the vendor meaning application vendor, device vendor etc. The tree structure under the vendor identified is not defined and can therefore include one or more un-standardized sub-trees.

- Values: N/A

## 10.2.5 /<x>/<x>

**Table 10.2.5.1: /<x>/<x>**

<x>

Status	Occurrence	Format	Min. Access Types
Required	OneOrMore	node	Get, Replace

This interior node represents a container for on-network operation and off-network operation.

## 10.2.6 /<x>/<x>/Common

**Table 10.2.6.1: /<x>/<x>/Common**

<x>/Common

Status	Occurrence	Format	Min. Access Types
Required	OneOrMore	node	Get, Replace

This interior node represents a container for the common network operation which means both on-network operation and off-network operation.

## 10.2.7 /<x>/<x>/Common/MCDDataUserID

**Table 10.2.7.1: /<x>/<x>/Common/MCDDataUserID**

<x>/Common/MCDDataUserID

Status	Occurrence	Format	Min. Access Types
Required	One	chr	Get, Replace

This leaf node indicates an MCDData user identity (MCDData ID) which is a globally unique identifier within the MCDData service that represents the MCDData user.

## 10.2.8 /<x>/<x>/Common/MCDDataUserProfileIndex

**Table 10.2.8.1: /<x>/<x>/Common/MCDDataUserProfileIndex**

<x>/Common/MCDDataUserProfileIndex

Status	Occurrence	Format	Min. Access Types
Required	One	int	Get, Replace

This leaf node indicates an index for the particular MCDData user profile.

- Values: 0-255

## 10.2.9 /<x>/<x>/Common/MCDataUserProfileName

**Table 10.2.9.1: /<x>/<x>/Common/MCDataUserProfileName**

<x>/Common/MCDataUserProfileName

Status	Occurrence	Format	Min. Access Types
Optional	One	chr	Get, Replace

This leaf node indicates a profile name for the particular MCData user profile.

## 10.2.10 /<x>/<x>/Common/PreSelectedIndication

**Table 10.2.10.1: /<x>/<x>/Common/PreSelectedIndication**

<x>/Common/PreSelectedIndication

Status	Occurrence	Format	Min. Access Types
Optional	ZeroOrOne	null	Get, Replace

This leaf node indicates that this MCData user profile MO is designated to be the pre-selected MCData user profile as defined by 3GPP TS 23.179 [15]

- Values: null

When this leaf node is present, this MCData user profile MO is designated as the pre-selected MCData user profile.

When this leaf node is absent, this MCData user profile MO is not designated as the pre-selected MCData user profile.

If more than one MCData user profile MO is specified for the MCData user, then only one MCData user profile MO for the MCData user shall contain the <x>/Common/PreSelectedIndication leaf node.

If there is only one MCData user profile MO specified for the MCData user, then it is optional to include the <x>/Common/PreSelectedIndication leaf node.

## 10.2.11 /<x>/<x>/Common/UserAliases

**Table 10.2.11.1: /<x>/<x>/Common/UserAliases**

<x>/Common/UserAliases

Status	Occurrence	Format	Min. Access Types
Required	One	node	Get, Replace

This interior node is a placeholder for a list of aliases of an MCData user.

## 10.2.12 /<x>/<x>/Common/UserAliases/<x>

**Table 10.2.12.1: /<x>/<x>/Common/UserAliases/<x>**

<x>/Common/UserAliases/<x>

Status	Occurrence	Format	Min. Access Types
Required	OneOrMore	node	Get, Replace

This interior node is a placeholder for one or more aliases of an MCData user.

## 10.2.13 /<x>/<x>/Common/UserAliases/<x>UserAlias

**Table 10.2.13.1: /<x>/<x>/Common/UserAliases/<x>/UserAlias**

<x>/Common/UserAliases/<x>/UserAlias

Status	Occurrence	Format	Min. Access Types

Required	One	chr	Get, Replace
----------	-----	-----	--------------

This leaf node indicates an alphanumeric alias of the MCDData user.

## 10.2.14 /<x>/<x>/Common/AuthorisedAlias

**Table 10.2.14.1: /<x>/<x>/Common/AuthorisedAlias**

<x>/Common/AuthorisedAlias

Status	Occurrence	Format	Min. Access Types
Optional	One	bool	Get, Replace

This leaf node indicates authorisation to create and delete aliases of other MCDData users and their associated MCDData user profiles.

When set to "true" the MCDData user is authorised to create and delete aliases of other MCDData users and their associated MCDData user profiles.

When set to "false" the MCDData user is not authorised to create and delete aliases of other MCDData user and their associated MCDData user profiles. This is the default if this leaf node is not present.

## 10.2.15 /<x>/<x>/Common/ParticipantType

**Table 10.2.15.1: /<x>/<x>/Common/ParticipantType**

<x>/Common/ParticipantType

Status	Occurrence	Format	Min. Access Types
Required	One	chr	Get, Replace

This leaf node indicates the participant type of the MCDData user.

The ParticipantType means the functional category of the participant (e.g., first responder, second responder, dispatch, dispatch supervisor), typically defined by the MCDData administrators.

## 10.2.16 /<x>/<x>/Common/Organization

**Table 10.2.16.1: /<x>/<x>/Common/Organization**

<x>/Common/Organization

Status	Occurrence	Format	Min. Access Types
Required	One	chr	Get, Replace

This leaf node indicates the organization an MCDData user belongs to.

## 10.2.17 /<x>/<x>/Common/FileDistribution

**Table 10.2.17.1: /<x>/<x>/Common/FileDistribution**

<x>/Common/FileDistribution

Status	Occurrence	Format	Min. Access Types
Required	One	node	Get, Replace

This interior node is a placeholder for the MCDData file distribution configuration.

## 10.2.18 /<x>/<x>/Common/FileDistribution/CancelList

**Table 10.2.18.1: /<x>/<x>/Common/FileDistribution/CancelList**

<x>/Common/FileDistribution/CancelList



Status	Occurrence	Format	Min. Access Types
Required	One	node	Get, Replace

This interior node is a placeholder for a list of MCDData user(s) this MCDData user is allowed to cancel distribution of files beings sent or waiting to be sent.

### 10.2.19 /<x>/<x>/Common/FileDistribution/CancelList/<x>

**Table 10.2.19.1: /<x>/<x>/Common/FileDistribution/CancelList/<x>**

<x>/Common/FileDistribution/CancelList/<x>

Status	Occurrence	Format	Min. Access Types
Optional	ZeroOrMore	node	Get, Replace

This interior node is a placeholder for zero or more list of MCDData users this MCDData user is allowed to cancel distribution of files beings sent or waiting to be sent.

### 10.2.20 /<x>/<x>/Common/FileDistribution/CancelList/<x>/Entry

**Table 10.2.20.1: /<x>/<x>/Common/FileDistribution/CancelList/<x>/Entry**

<x>/Common/FileDistribution/CancelList/<x>/Entry

Status	Occurrence	Format	Min. Access Types
Required	One	node	Get, Replace

This interior node is a placeholder for one or more MCDData users this MCDData user is allowed to cancel distribution of files beings sent or waiting to be sent.

### 10.2.21 /<x>/<x>/Common/FileDistribution/CancelList/<x>/Entry/MCDDataID

**Table 10.2.21.1: /<x>/<x>/Common/FileDistribution/CancelList/<x>/Entry/MCDDataID**

<x>/Common/FileDistribution/CancelList/<x>/Entry/MCDDataID

Status	Occurrence	Format	Min. Access Types
Optional	One	chr	Get, Replace

This leaf node indicates an MCDData user identity (MCDData ID) which is a globally unique identifier within the MCDData service that represents the MCDData user.

The value is a "uri" attribute specified in OMA OMA-TS-XDM\_Group-V1\_1 [4].

### 10.2.22

#### /<x>/<x>/Common/FileDistribution/CancelList/<x>/Entry/DisplayName

**Table 10.2.22.1: /<x>/<x>/ Common/FileDistribution/CancelList/<x>/Entry/DisplayName**

<x>/Common/FileDistribution/CancelList/<x>/Entry/DisplayName

Status	Occurrence	Format	Min. Access Types
Optional	One	chr	Get, Replace

This leaf node contains a human readable name.

### 10.2.23 /<x>/<x>/Common/TxRxControl

**Table 10.2.23.1: /<x>/<x>/Common/TxRxControl**

<x>/Common/TxRxControl

Status	Occurrence	Format	Min. Access Types

Required	One	node	Get, Replace
----------	-----	------	--------------

This interior node is a placeholder for the MCDData transmission and reception control configuration.

## 10.2.24 /<x>/<x>/Common/TxRxControl/AuthorisedTransmit

**Table 10.2.24.1: /<x>/<x>/Common/TxRxControl/AuthorisedTransmit**

<x>/Common/TxRxControl/AuthorisedTransmit

Status	Occurrence	Format	Min. Access Types
Required	One	bool	Get, Replace

This leaf node indicates the authorisation to transmit data.

When set to "true" the MCDData user is authorised to transmit data.

When set to "false" the MCDData user is not authorised to transmit data.

## 10.2.25 /<x>/<x>/Common/TxRxControl/MaxData1To1

**Table 10.2.25.1: /<x>/<x>/Common/TxRxControl/MaxData1To1**

<x>/Common/TxRxControl/MaxData1To1

Status	Occurrence	Format	Min. Access Types
Required	One	int	Get, Replace

This leaf node indicates the maximum amount of data (in megabytes) that an MCDData user can transmit in a single request during one-to-one communication.

- Values: 0-65535

The MaxData1to1 size is in megabytes..

## 10.2.26 /<x>/<x>/Common/TxRxControl/MaxTime1To1

**Table 10.2.26.1: /<x>/<x>/Common/TxRxControl/MaxTime1To1**

<x>/Common/TxRxControl/MaxTime1To1

Status	Occurrence	Format	Min. Access Types
Required	One	int	Get, Replace

This leaf node indicates the maximum amount of time that an MCDData user can transmit for in a single request during one-to-one communication.

- Values: 0-65535

The MaxTime1To1 time is in seconds.

## 10.2.27 /<x>/<x>/Common/TxRxControl/ReleaseList

**Table 10.2.27.1: /<x>/<x>/Common/TxRxControl/ReleaseList**

<x>/Common/TxRxControl/ReleaseList

Status	Occurrence	Format	Min. Access Types
Required	One	node	Get, Replace

This interior node is a placeholder for a list of MCDData users that this MCDData user is allowed to request release of an ongoing transmission.

## 10.2.28 /<x>/<x>/Common/TxRxControl/ReleaseList/<x>

**Table 10.2.28.1: /<x>/<x>/Common/TxRxControl/ReleaseList/<x>**

<x>/Common/TxRxControl/ReleaseList/<x>

Status	Occurrence	Format	Min. Access Types
Optional	ZeroOrMore	node	Get, Replace

This interior node is a placeholder for zero or more list of MCDData users this MCDData user is allowed to request release of an ongoing transmission.

## 10.2.29 /<x>/<x>/Common/TxRxControl/ReleaseList/<x>/Entry

**Table 10.2.29.1: /<x>/<x>/Common/TxRxControl/ReleaseList/<x>/Entry**

<x>/Common/TxRxControl/ReleaseList/<x>/Entry

Status	Occurrence	Format	Min. Access Types
Required	One	node	Get, Replace

This interior node is a placeholder for one or more MCDData users this MCDData user is allowed to request release of an ongoing transmission.

## 10.2.30 /<x>/<x>/Common/TxRxControl/ReleaseList/<x>/Entry/MCDDataID

**Table 10.2.30.1: /<x>/<x>/Common/TxRxControl/ReleaseList/<x>/Entry/MCDDataID**

<x>/Common/TxRxControl/ReleaseList/<x>/Entry/MCDDataID

Status	Occurrence	Format	Min. Access Types
Optional	One	chr	Get, Replace

This leaf node indicates an MCDData user identity (MCDData ID) which is a globally unique identifier within the MCDData service that represents the MCDData user.

The value is a "uri" attribute specified in OMA OMA-TS-XDM\_Group-V1\_1 [4].

## 10.2.31 /<x>/<x>/Common/TxRxControl/ReleaseList/<x>/Entry/DisplayName

**Table 10.2.31.1: /<x>/<x>/ Common/TxRxControl/ReleaseList/<x>/Entry/DisplayName**

<x>/Common/TxRxControl/ReleaseList/<x>/Entry/DisplayName

Status	Occurrence	Format	Min. Access Types
Optional	One	chr	Get, Replace

This leaf node contains a human readable name.

## 10.2.32 /<x>/<x>/Common/MCDDataGroupBroadcast

**Table 10.2.32.1: /<x>/<x>/Common/MCDDataGroupBroadcast**

<x>/Common/MCDDataGroupBroadcast

Status	Occurrence	Format	Min. Access Types
Required	One	node	Get, Replace

This interior node is a placeholder for the group-broadcast group policy.

## 10.2.33 /<x>/<x>/Common/MCDDataGroupBroadcast/Authorised

**Table 10.2.33.1: /<x>/<x>/Common/MCDDataGroupBroadcast/Authorised**

<x>/Common/MCDDataGroupBroadcast/Authorised

Status	Occurrence	Format	Min. Access Types
Required	One	bool	Get, Replace

This leaf node indicates the authorisation to create a group-broadcast group.

When set to "true" the MCDData user is authorised to create a group-broadcast group.

When set to "false" the MCDData user is not authorised to create a group-broadcast group.

### 10.2.34 /<x>/<x>/Common/UserBroadcast

**Table 10.2.34.1: /<x>/<x>/Common/UserBroadcast**

<x>/Common/UserBroadcast

Status	Occurrence	Format	Min. Access Types
Required	One	node	Get, Replace

This interior node is a placeholder for the user-broadcast group policy.

### 10.2.35 /<x>/<x>/Common/UserBroadcast/Authorised

**Table 10.2.35.1: /<x>/<x>/Common/UserBroadcast/Authorised**

<x>/Common/UserBroadcast/Authorised

Status	Occurrence	Format	Min. Access Types
Required	One	bool	Get, Replace

This leaf node indicates the authorisation to create a user-broadcast group.

When set to "true" the MCDData user is authorised to create a user-broadcast group.

When set to "false" the MCDData user is not authorised to create a user-broadcast group.

### 10.2.36 /<x>/<x>/Common/GroupEmergencyAlert

**Table 10.2.36.1: /<x>/<x>/Common/GroupEmergencyAlert**

<x>/Common/GroupEmergencyAlert

Status	Occurrence	Format	Min. Access Types
Required	One	node	Get, Replace

This interior node is a placeholder for Group Emergency Alert configuration.

### 10.2.37 /<x>/<x>/Common/GroupEmergencyAlert/Entry

**Table 10.2.37.1: /<x>/<x>/Common/GroupEmergencyAlert/Entry**

<x>/Common/GroupEmergencyAlert/Entry

Status	Occurrence	Format	Min. Access Types
Required	One	node	Get, Replace

This interior node is a placeholder for the details of the MCDData group of an MCDData emergency alert.

### 10.2.38 /<x>/<x>/Common/GroupEmergencyAlert/Entry/ID

**Table 10.2.38.1: /<x>/<x>/Common/GroupEmergencyAlert/Entry/ID**

<x>/Common/GroupEmergencyAlert/Entry/ID

Status	Occurrence	Format	Min. Access Types
Required	One	chr	Get, Replace

This leaf node indicates the MCDData group used upon certain criteria on initiation of an MCDData emergency alert.

### 10.2.39 /<x>/<x>/Common/GroupEmergencyAlert/Entry/DisplayName

**Table 10.2.39.1: /<x>/<x>/Common/GroupEmergencyAlert/Entry/DisplayName**

<x>/Common/GroupEmergencyAlert/Entry/DisplayName

Status	Occurrence	Format	Min. Access Types
Optional	One	chr	Get, Replace

This leaf node contains a human readable name that corresponds to the ID.

### 10.2.40 /<x>/<x>/Common/GroupEmergencyAlert/Entry/Usage

**Table 10.2.40.1: /<x>/<x>/Common/GroupEmergencyAlert/Entry/Usage**

<x>/Common/GroupEmergencyAlert/Entry/Usage

Status	Occurrence	Format	Min. Access Types
Required	One	chr	Get, Replace

This leaf node indicates the criteria to determine when initiation of an MCDData emergency alert uses the ID.

The valid values are 'UseCurrentlySelectedGroup' and 'DedicatedGroup'.

When set to 'UseCurrentlySelectedGroup' then if the MCDData user has currently selected an MCDData group then use that MCDData group for an on-network MCDData emergency alert, if the MCDData user does not have a currently selected MCDData group then use the MCDData group identified by the ID in subclause 10.2.30C for an MCDData emergency alert.

When set to 'DedicatedGroup' then use the MCDData group identified by the ID in subclause 10.2.30C for an MCDData emergency alert.

### 10.2.41 /<x>/<x>/Common/AllowedActivateAlert

**Table 10.2.41.1: /<x>/<x>/Common/AllowedActivateAlert**

<x>/Common/AllowedActivateAlert

Status	Occurrence	Format	Min. Access Types
Optional	One	bool	Get, Replace

This leaf node indicates whether the MCDData user is authorised to activate an emergency alert

When set to "true" the MCDData user is authorised to activate an emergency alert.

When set to "false" the MCDData user is not authorised to activate an emergency alert.

### 10.2.42 /<x>/<x>/Common/AllowedCancelAlert

**Table 10.2.42.1: /<x>/<x>/Common/AllowedCancelAlert**

<x>/Common/AllowedCancelAlert

Status	Occurrence	Format	Min. Access Types
Required	One	bool	Get, Replace

This leaf node indicates whether the MCDData user is allowed to cancel an emergency alert.

When set to "true" the MCDData user is authorised to cancel an emergency alert.

When set to "false" the MCDData user is not authorised to cancel an emergency alert.

## 10.2.43 /<x>/<x>/OnNetwork

**Table 10.2.43.1: /<x>/<x>/OnNetwork**

<x>/OnNetwork

Status	Occurrence	Format	Min. Access Types
Required	ZeroOrOne	node	Get, Replace

This interior node represents a container for on-network operation.

## 10.2.44 /<x>/<x>/OnNetwork/MCDataGroupList

**Table 10.2.44.1: /<x>/<x>/OnNetwork/MCDataGroupList**

<x>/OnNetwork/MCDataGroupList

Status	Occurrence	Format	Min. Access Types
Required	One	node	Get, Replace

This interior node is a placeholder for the list of on-network MCData groups that the MCData user is allowed to use.

## 10.2.45 /<x>/<x>/OnNetwork/MCDataGroupList/<x>

**Table 10.2.45.1: /<x>/<x>/OnNetwork/MCDataGroupList/<x>**

<x>/OnNetwork/MCDataGroupList/<x>

Status	Occurrence	Format	Min. Access Types
Required	OneOrMore	node	Get, Replace

This interior node is a placeholder for one or more list of on-network MCData groups that the MCData user is allowed to use.

## 10.2.46 /<x>/<x>/OnNetwork/MCDataGroupList/<x>/Entry

**Table 10.2.46.1: /<x>/<x>/OnNetwork/MCDataGroupList/<x>/Entry**

<x>/OnNetwork/MCDataGroupList/<x>/Entry

Status	Occurrence	Format	Min. Access Types
Optional	One	node	Get, Replace

This interior node is a placeholder for the details of the on-network MCData groups that the MCData user is allowed to use.

## 10.2.47 /<x>/<x>/OnNetwork/MCDataGroupList/<x>/Entry/MCDataGroupID

**Table 10.2.47.1: /<x>/<x>/OnNetwork/MCDataGroupList/<x>/Entry/MCDataGroupID**

<x>/OnNetwork/MCDataGroupList/<x>/Entry/MCDataGroupID

Status	Occurrence	Format	Min. Access Types
Required	One	chr	Get, Replace

This leaf node indicates the MCData group ID for the on-network MCData group that the MCData user is allowed to use.

The value is a "uri" attribute specified in OMA OMA-TS-XDM\_Group-V1\_1 [4].

## 10.2.48 /&lt;x&gt;/&lt;x&gt;/OnNetwork/MCDataGroupList/&lt;x&gt;/Entry/DisplayName

**Table 10.2.48.1: /<x>/<x>/OnNetwork/MCDataGroupList/<x>/Entry/DisplayName**

&lt;x&gt;/OnNetwork/MCDataGroupList/&lt;x&gt;/Entry/DisplayName

Status	Occurrence	Format	Min. Access Types
Optional	One	chr	Get, Replace

This leaf node contains a human readable name that corresponds to the MCData Group ID.

## 10.2.49 /&lt;x&gt;/&lt;x&gt;/OnNetwork/MCDataGroupList/&lt;x&gt;/Entry/GMSAppServList

**Table 10.2.49.1: /<x>/<x>/OnNetwork/MCDataGroupList/<x>/Entry/GMSAppServList**

&lt;x&gt;/OnNetwork/MCDataGroupList/&lt;x&gt;/Entry/GMSAppServList

Status	Occurrence	Format	Min. Access Types
Required	One	node	Get, Replace

This interior node is a placeholder for the Group Management Server application plane server identity configuration.

## 10.2.50

/<x>/<x>/OnNetwork/MCDataGroupList/<x>/Entry/GMSAppServList/  
<x>

**Table 10.2.50.1: /<x>/<x>/OnNetwork/MCDataGroupList/<x>/Entry/GMSAppServList/<x>**

&lt;x&gt;/OnNetwork/MCDataGroupList/&lt;x&gt;/Entry/GMSAppServList/&lt;x&gt;

Status	Occurrence	Format	Min. Access Types
Required	OneOrMore	node	Get, Replace

This interior node is a placeholder for one or more Group Management Server configuration.

## 10.2.51

/<x>/<x>/OnNetwork/MCDataGroupList/<x>/Entry/GMSAppServList/  
<x>/GMSAppServId

**Table 10.2.51.1:****/<x>/<x>/OnNetwork/MCDataGroupList/<x>/Entry/GMSAppServList/<x>/GMSAppServId**

&lt;x&gt;/OnNetwork/MCDataGroupList/&lt;x&gt;/Entry/GMSAppServList/&lt;x&gt;/GMSAppServId

Status	Occurrence	Format	Min. Access Types
Optional	One	chr	Get, Replace

This leaf node indicates the identity (URI) of the the group management server hosting the MCData Group ID.

## 10.2.52

/<x>/<x>/OnNetwork/MCDataGroupList/<x>/Entry/IdMSTokenEndPointList

**Table 10.2.52.1: /<x>/<x>/OnNetwork/MCDataGroupList/<x>/Entry/IdMSTokenEndPointList**

&lt;x&gt;/OnNetwork/MCDataGroupList/&lt;x&gt;/Entry/IdMSTokenEndPointList

Status	Occurrence	Format	Min. Access Types
Required	One	node	Get, Replace

This interior node is a placeholder for the Identity Management Server token endpoints configuration.

### 10.2.53

`<x>/<x>/OnNetwork/MCDataGroupList/<x>/Entry/IdMSTokenEndPointList/<x>`

**Table 10.2.53.1: `<x>/<x>/OnNetwork/MCDataGroupList/<x>/Entry/IdMSTokenEndPointList/<x>`**

`<x>/OnNetwork/MCDataGroupList/<x>/Entry/IdMSTokenEndPointList/<x>`

Status	Occurrence	Format	Min. Access Types
Required	OneOrMore	node	Get, Replace

This interior node is a placeholder for one or more IDMS token endpoints configuration.

### 10.2.54

`<x>/<x>/OnNetwork/MCDataGroupList/<x>/Entry/IdMSTokenEndPointList/<x>/IdMSTokenEndPoint`

**Table 10.2.54.1:**

`<x>/<x>/OnNetwork/MCDataGroupList/<x>/Entry/IdMSTokenEndPointList/<x>/IdMSTokenEndPoint`

`<x>/OnNetwork/MCDataGroupList/<x>/Entry/IdMSTokenEndPointList/<x>/IdMSTokenEndPoint`

Status	Occurrence	Format	Min. Access Types
Optional	One	chr	Get, Replace

This leaf node indicates the identity (URI) of the the IDMS token endpoint for the MCData Group ID in the MCDataGroupList. If the value is empty, the IDMS identities (IDMSAuthEndpoint and IDMSTokenEndpoint) present in the MCS UE initial configuration MO are used.

### 10.2.55

`<x>/<x>/OnNetwork/MCDataGroupList/<x>/Entry/PresentationPriority`

**Table 10.2.55.1: `<x>/<x>/OnNetwork/MCDataGroupList/<x>/Entry/PresentationPriority`**

`<x>/OnNetwork/MCDataGroupList/<x>/Entry/PresentationPriority`

Status	Occurrence	Format	Min. Access Types
Optional	One	int	Get, Replace

This leaf node indicates indicating the presentation priority of the on-network group for the MCData user relative to other on-network groups and on-network users.

- Values: 0-255

The lowest PresentationPriority value shall be considered as the MCData group transaction having the lowest priority for presentation among other group MCData and one-to-one user transactions.

### 10.2.56 `<x>/<x>/OnNetwork/ImplicitAffiliations`

**Table 10.2.56.1: `<x>/<x>/OnNetwork/ImplicitAffiliations`**

`<x>/OnNetwork/ImplicitAffiliations`

Status	Occurrence	Format	Min. Access Types
Required	One	chr	Get, Replace

This interior node is a placeholder for the implicit affiliation configuration.



## 10.2.57 /<x>/<x>/OnNetwork/ImplicitAffiliations/<x>

**Table 10.2.57.1: /<x>/<x>/OnNetwork/ImplicitAffiliations/<x>**

<x>/OnNetwork/ImplicitAffiliations/<x>

Status	Occurrence	Format	Min. Access Types
Required	ZeroOrMore	node	Get, Replace

This interior node is a placeholder for zero or more implicit affiliation configuration.

## 10.2.58 /<x>/<x>/OnNetwork/ImplicitAffiliations/<x>/Entry

**Table 10.2.58.1: /<x>/<x>/OnNetwork/ImplicitAffiliations/<x>/Entry**

<x>/OnNetwork/ImplicitAffiliations/<x>/Entry

Status	Occurrence	Format	Min. Access Types
Optional	One	node	Get, Replace

This interior node is a placeholder for the details of the on-network MCDData groups that the MCDData user is implicitly affiliated to.

## 10.2.59 /<x>/<x>/OnNetwork/ImplicitAffiliations/<x>/Entry/MCDDataGroupID

**Table 10.2.59.1: /<x>/<x>/OnNetwork/ImplicitAffiliations/<x>/Entry/MCDDataGroupID**

<x>/OnNetwork/ImplicitAffiliations/<x>/Entry/MCDDataGroupID

Status	Occurrence	Format	Min. Access Types
Required	One	chr	Get, Replace

This leaf node indicates a MCDData group ID to which the MCDData user is implicitly affiliated to.

The value is a "uri" attribute specified in OMA OMA-TS-XDM\_Group-V1\_1 [4].

## 10.2.60 /<x>/<x>/OnNetwork/ImplicitAffiliations/<x>/Entry/DisplayName

**Table 10.2.60.1: /<x>/<x>/OnNetwork/ImplicitAffiliations/<x>/Entry/DisplayName**

<x>/OnNetwork/ImplicitAffiliations/<x>/Entry/DisplayName

Status	Occurrence	Format	Min. Access Types
Optional	One	chr	Get, Replace

This leaf node contains a human readable name that corresponds to the MCDData Group ID.

## 10.2.61 /<x>/<x>/OnNetwork/PresenceStatus

**Table 10.2.61.1: /<x>/<x>/OnNetwork/PresenceStatus**

<x>/OnNetwork/PresenceStatus

Status	Occurrence	Format	Min. Access Types
Required	One	chr	Get, Replace

This interior node is a placeholder for the presence status configuration.

## 10.2.62 /<x>/<x>/OnNetwork/PresenceStatus/<x>

**Table 10.2.62.1: /<x>/<x>/OnNetwork/PresenceStatus/<x>**

<x>/OnNetwork/PresenceStatus/<x>

Status	Occurrence	Format	Min. Access Types
Required	ZeroOrMore	node	Get, Replace

This interior node is a placeholder for zero or more presence status configuration.

### 10.2.63 /<x>/<x>/OnNetwork/PresenceStatus/<x>/Entry

**Table 10.2.63.1: /<x>/<x>/OnNetwork/PresenceStatus/<x>/Entry**

<x>/OnNetwork/PresenceStatus/<x>/Entry

Status	Occurrence	Format	Min. Access Types
Optional	One	node	Get, Replace

This interior node is a placeholder for the details of the MCDData IDs of MCDData users that the configured MCDData user is authorised to obtain presence status;

### 10.2.64 /<x>/<x>/OnNetwork/PresenceStatus/<x>/Entry/MCDDataGroupID

**Table 10.2.64.1: /<x>/<x>/OnNetwork/PresenceStatus/<x>/Entry/MCDDataGroupID**

<x>/OnNetwork/PresenceStatus/<x>/Entry/MCDDataGroupID

Status	Occurrence	Format	Min. Access Types
Required	One	chr	Get, Replace

This leaf node indicates an MCDData ID of an MCDData user that the configured MCDData user is authorised to obtain presence status;

The value is a "uri" attribute specified in OMA OMA-TS-XDM\_Group-V1\_1 [4].

### 10.2.65 /<x>/<x>/OnNetwork/PresenceStatus/<x>/Entry/DisplayName

**Table 10.2.65.1: /<x>/<x>/OnNetwork/PresenceStatus/<x>/Entry/DisplayName**

<x>/OnNetwork/PresenceStatus/<x>/Entry/DisplayName

Status	Occurrence	Format	Min. Access Types
Optional	One	chr	Get, Replace

This leaf node contains a human readable name that corresponds to the MCDData ID.

### 10.2.66 /<x>/<x>/OnNetwork/RemoteGroupChange

**Table 10.2.66.1: /<x>/<x>/OnNetwork/RemoteGroupChange**

<x>/OnNetwork/RemoteGroupChange

Status	Occurrence	Format	Min. Access Types
Required	One	chr	Get, Replace

This interior node is a placeholder for the remote group change configuration.

### 10.2.67/<x>/<x>/OnNetwork/RemoteGroupChange/<x>

**Table 10.2.67.1: /<x>/<x>/OnNetwork/RemoteGroupChange/<x>**

<x>/OnNetwork/RemoteGroupChange/<x>

Status	Occurrence	Format	Min. Access Types
Required	ZeroOrMore	node	Get, Replace

This interior node is a placeholder for zero or more remote group change configuration.

## 10.2.68 /<x>/<x>/OnNetwork/RemoteGroupChange/<x>/Entry

**Table 10.2.68.1: /<x>/<x>/OnNetwork/RemoteGroupChange/<x>/Entry**

<x>/OnNetwork/RemoteGroupChange/<x>/Entry

Status	Occurrence	Format	Min. Access Types
Optional	One	node	Get, Replace

This interior node is a placeholder for the details of the MCDData IDs of MCDData users whose selected groups are authorised to be remotely changed by the configured MCDData user;

## 10.2.69

### /<x>/<x>/OnNetwork/RemoteGroupChange/<x>/Entry/MCDDataGroupID

**Table 10.2.69.1: /<x>/<x>/OnNetwork/RemoteGroupChange/<x>/Entry/MCDDataGroupID**

<x>/OnNetwork/RemoteGroupChange/<x>/Entry/MCDDataGroupID

Status	Occurrence	Format	Min. Access Types
Required	One	chr	Get, Replace

This leaf node indicates an MCDData ID of an MCDData user whose selected groups are authorised to be remotely changed by the configured MCDData user;

The value is a "uri" attribute specified in OMA OMA-TS-XDM\_Group-V1\_1 [4].

## 10.2.70 /<x>/<x>/OnNetwork/RemoteGroupChange/<x>/Entry/DisplayName

**Table 10.2.70.1: /<x>/<x>/OnNetwork/RemoteGroupChange/<x>/Entry/DisplayName**

<x>/OnNetwork/RemoteGroupChange/<x>/Entry/DisplayName

Status	Occurrence	Format	Min. Access Types
Optional	One	chr	Get, Replace

This leaf node contains a human readable name that corresponds to the MCDData ID.

## 10.2.71 /<x>/<x>/OnNetwork/MaxAffiliationsN2

**Table 10.2.71.1: /<x>/<x>/OnNetwork/MaxAffiliationsN2**

<x>/OnNetwork/MaxAffiliationsN2

Status	Occurrence	Format	Min. Access Types
Optional	One	int	Get, Replace

This leaf node indicates the maximum number of MCDData groups that the MCDData user is authorised to affiliate with.

- Values: 0-65535

## 10.2.72 /<x>/<x>/OnNetwork/ConversationManagement

**Table 10.2.72.1: /<x>/<x>/OnNetwork/ConversationManagement**

<x>/OnNetwork/ConversationManagement

Status	Occurrence	Format	Min. Access Types
Required	One	node	Get, Replace

This interior node is a placeholder for conversation management configuration

## 10.2.73 /<x>/<x>/OnNetwork/ConversationManagement/GroupHangTime

**Table 10.2.73.1: /<x>/<x>/OnNetwork/ConversationManagement/GroupHangTime**

<x>/OnNetwork/ConversationManagement/GroupHangTime

Status	Occurrence	Format	Min. Access Types
Required	One	node	Get, Replace

This interior node is a placeholder for group hang time configuration

## 10.2.74

/<x>/<x>/OnNetwork/ConversationManagement/GroupHangTime/<x>

**Table 10.2.74.1: /<x>/<x>/OnNetwork/ConversationManagement/GroupHangTime/<x>**

<x>/OnNetwork/ConversationManagement/GroupHangTime/<x>

Status	Occurrence	Format	Min. Access Types
Required	OneOrMore	node	Get, Replace

This interior node is a placeholder for one or more hang time configurations.

## 10.2.75

/<x>/<x>/OnNetwork/ConversationManagement/GroupHangTime/<x>/Entry

**Table 10.2.75.1: /<x>/<x>/OnNetwork/ConversationManagement/GroupHangTime/<x>/Entry**

<x>/OnNetwork/ConversationManagement/GroupHangTime/<x>/Entry

Status	Occurrence	Format	Min. Access Types
Optional	One	node	Get, Replace

This interior node is a placeholder for the conversation hang time configuration associated with the configured MCDData group, for the MCDData user.

## 10.2.76

/<x>/<x>/OnNetwork/ConversationManagement/GroupHangTime/<x>/Entry/MCDDataGroupID

**Table 10.2.76.1:**

**/<x>/<x>/OnNetwork/ConversationManagement/GroupHangTime/<x>/Entry/MCDDataGroupID**

<x>/OnNetwork/ConversationManagement/GroupHangTime/<x>/Entry/MCDDataGroupID

Status	Occurrence	Format	Min. Access Types
Required	One	chr	Get, Replace

This leaf node indicates the MCDData group ID for the on-network MCDData group.

The value is a "uri" attribute specified in OMA OMA-TS-XDM\_Group-V1\_1 [4].

## 10.2.77

`/<x>/<x>/OnNetwork/ConversationManagement/GroupHangTime/<x>/Entry/DisplayName`

Table 10.2.77.1:

`/<x>/<x>/OnNetwork/ConversationManagement/GroupHangTime/<x>/Entry/DisplayName`

`<x>/OnNetwork/ConversationManagement/GroupHangTime/<x>/Entry/DisplayName`

Status	Occurrence	Format	Min. Access Types
Optional	One	chr	Get, Replace

This leaf node contains a human readable name that corresponds to the MCDData Group ID.

## 10.2.78

`/<x>/<x>/OnNetwork/ConversationManagement/GroupHangTime/<x>/Entry/HangTime`

Table 10.2.78.1: `/<x>/<x>/OnNetwork/ConversationManagement/GroupHangTime/<x>/Entry/HangTime`

`<x>/OnNetwork/ConversationManagement/GroupHangTime/<x>/Entry/HangTime`

Status	Occurrence	Format	Min. Access Types
Required	One	int	Get, Replace

This leaf node indicates the group call hang timer of the MCDData group for conversation management, for the MCDData user.

- Values: 0-65535

The HangTime is in seconds.

## 10.2.79

`/<x>/<x>/OnNetwork/ConversationManagement/DeliveredDisposition`

Table 10.2.79.1: `/<x>/<x>/OnNetwork/ConversationManagement/DeliveredDisposition`

`<x>/OnNetwork/ConversationManagement/DeliveredDisposition`

Status	Occurrence	Format	Min. Access Types
Required	One	node	Get, Replace

This interior node is a placeholder for delivered disposition configuration

## 10.2.80

`/<x>/<x>/OnNetwork/ConversationManagement/DeliveredDisposition/<x>`

Table 10.2.80.1: `/<x>/<x>/OnNetwork/ConversationManagement/DeliveredDisposition/<x>`

`<x>/OnNetwork/ConversationManagement/DeliveredDisposition/<x>`

Status	Occurrence	Format	Min. Access Types
Required	ZeroOrMore	node	Get, Replace

This interior node is a placeholder for zero or more delivered disposition configurations.

## 10.2.81

`/<x>/<x>/OnNetwork/ConversationManagement/DeliveredDisposition/<x>/Entry`

**Table 10.2.81.1: `/<x>/<x>/OnNetwork/ConversationManagement/DeliveredDisposition/<x>/Entry`**

`<x>/OnNetwork/ConversationManagement/DeliveredDisposition/<x>/Entry`

Status	Occurrence	Format	Min. Access Types
Optional	One	node	Get, Replace

This interior node is a placeholder for the delivered disposition configuration associated with the MCDData user, indicating an MCDData ID of an MCDData user who is to be sent a message delivered disposition notification in addition to the message sender;

## 10.2.82

`/<x>/<x>/OnNetwork/ConversationManagement/DeliveredDisposition/<x>/Entry/MCDDataID`

**Table 10.2.82.1:**

**`/<x>/<x>/OnNetwork/ConversationManagement/DeliveredDisposition/<x>/Entry/MCDDataID`**

`<x>/OnNetwork/ConversationManagement/DeliveredDisposition/<x>/Entry/MCDDataID`

Status	Occurrence	Format	Min. Access Types
Required	One	chr	Get, Replace

This leaf node indicates the MCDData ID for the on-network MCDData user.

The value is a "uri" attribute specified in OMA OMA-TS-XDM\_Group-V1\_1 [4].

## 10.2.83

`/<x>/<x>/OnNetwork/ConversationManagement/DeliveredDisposition/<x>/Entry/DisplayName`

**Table 10.2.83.1:**

**`/<x>/<x>/OnNetwork/ConversationManagement/DeliveredDisposition/<x>/Entry/DisplayName`**

`<x>/OnNetwork/ConversationManagement/DeliveredDisposition/<x>/Entry/DisplayName`

Status	Occurrence	Format	Min. Access Types
Optional	One	chr	Get, Replace

This leaf node contains a human readable name that corresponds to the MCDData ID.

10.2.84 `/<x>/<x>/OnNetwork/ConversationManagement/ReadDisposition`

**Table 10.2.84.1: `/<x>/<x>/OnNetwork/ConversationManagement/ReadDisposition`**

`<x>/OnNetwork/ConversationManagement/ReadDisposition`

Status	Occurrence	Format	Min. Access Types
Required	One	node	Get, Replace

This interior node is a placeholder for read disposition configuration

## 10.2.85

`<x>/<x>/OnNetwork/ConversationManagement/ReadDisposition/<x>`

**Table 10.2.85.1: `<x>/<x>/OnNetwork/ConversationManagement/ReadDisposition/<x>`**

`<x>/OnNetwork/ConversationManagement/ReadDisposition/<x>`

Status	Occurrence	Format	Min. Access Types
Required	ZeroOrMore	node	Get, Replace

This interior node is a placeholder for zero or more read disposition configurations.

## 10.2.86

`<x>/<x>/OnNetwork/ConversationManagement/ReadDisposition/<x>/Entry`

**Table 10.2.86.1: `<x>/<x>/OnNetwork/ConversationManagement/ReadDisposition/<x>/Entry`**

`<x>/OnNetwork/ConversationManagement/ReadDisposition/<x>/Entry`

Status	Occurrence	Format	Min. Access Types
Optional	One	node	Get, Replace

This interior node is a placeholder for the read disposition configuration associated with the MCDData user, indicating an MCDData ID of an MCDData user who is to be sent a message read disposition notification in addition to the message sender;

## 10.2.87

`<x>/<x>/OnNetwork/ConversationManagement/ReadDisposition/<x>/Entry/MCDDataID`

**Table 10.2.87.1: `<x>/<x>/OnNetwork/ConversationManagement/ReadDisposition/<x>/Entry/MCDDataID`**

`<x>/OnNetwork/ConversationManagement/ReadDisposition/<x>/Entry/MCDDataID`

Status	Occurrence	Format	Min. Access Types
Required	One	chr	Get, Replace

This leaf node indicates the MCDData ID for the on-network MCDData user.

The value is a "uri" attribute specified in OMA OMA-TS-XDM\_Group-V1\_1 [4].

## 10.2.88

`<x>/<x>/OnNetwork/ConversationManagement/ReadDisposition/<x>/Entry/DisplayName`

**Table 10.2.88.1:**

**`<x>/<x>/OnNetwork/ConversationManagement/ReadDisposition/<x>/Entry/DisplayName`**

`<x>/OnNetwork/ConversationManagement/ReadDisposition/<x>/Entry/DisplayName`

Status	Occurrence	Format	Min. Access Types
Optional	One	chr	Get, Replace

This leaf node contains a human readable name that corresponds to the MCDData ID.

## 10.2.89 /<x>/<x>/OnNetwork/OneToOneEmergencyAlert

**Table 10.2.89.1: /<x>/<x>/OnNetwork/OneToOneEmergencyAlert**

<x>/OnNetwork/OneToOneEmergencyAlert

Status	Occurrence	Format	Min. Access Types
Required	One	node	Get, Replace

This interior node is a placeholder for on-network one-to-one emergency alert configuration.

## 10.2.90 /<x>/<x>/OnNetwork/OneToOneEmergencyAlert/Entry

**Table 10.2.90.1: /<x>/<x>/OnNetwork/OneToOneEmergencyAlert/Entry**

<x>/OnNetwork/OneToOneEmergencyAlert/Entry

Status	Occurrence	Format	Min. Access Types
Required	One	node	Get, Replace

This interior node is a placeholder for the details of the MCDData ID of an MCDData emergency alert.

## 10.2.91 /<x>/<x>/OnNetwork/OneToOneEmergencyAlert/Entry/ID

**Table 10.2.91.1: /<x>/<x>/OnNetwork/OneToOneEmergencyAlert/Entry/ID**

<x>/OnNetwork/OneToOneEmergencyAlert/Entry/ID

Status	Occurrence	Format	Min. Access Types
Required	One	chr	Get, Replace

This leaf node indicates the MCDData user ID used upon certain criteria on initiation of a one-to-one MCDData emergency alert.

## 10.2.92 /<x>/<x>/OnNetwork/OneToOneEmergencyAlert/Entry/DisplayName

**Table 10.2.92.1: /<x>/<x>/OnNetwork/OneToOneEmergencyAlert/Entry/DisplayName**

<x>/OnNetwork/OneToOneEmergencyAlert/Entry/DisplayName

Status	Occurrence	Format	Min. Access Types
Optional	One	chr	Get, Replace

This leaf node contains a human readable name that corresponds to the ID.

## 10.2.93 /<x>/<x>/OnNetwork/OneToOneEmergencyAlert/Entry/Usage

**Table 10.2.93.1: /<x>/<x>/OnNetwork/OneToOneEmergencyAlert/Entry/Usage**

<x>/OnNetwork/OneToOneEmergencyAlert/Entry/Usage

Status	Occurrence	Format	Min. Access Types
Required	One	chr	Get, Replace

This leaf node indicates the criteria to determine when initiation of an MCDData emergency alert uses the ID.

The valid values are 'LocallyDetermined' and 'UsePreConfigured'.

When set to 'LocallyDetermined' then if the MCDData user selects an MCDData ID then use that MCDData ID for an on-network MCDData emergency alert, if the MCDData user does not select a MCDData ID then use the MCDData ID identified by the ID in subclause 10.2.90C for an on-network MCDData emergency alert.

When set to 'UsePreConfigured' then use the ID identified by the ID in subclause 10.2.90C for an on-network MCDData emergency alert.



## 10.2.94 /<x>/<x>/OnNetwork/AllowedRegroup

**Table 10.2.94.1: /<x>/<x>/OnNetwork/AllowedRegroup**

<x>/OnNetwork/AllowedRegroup

Status	Occurrence	Format	Min. Access Types
Required	One	bool	Get, Replace

This leaf node indicates whether the MCDData user is authorised to perform dynamic regrouping operations.

When set to "true" the MCDData user is authorised to perform dynamic regrouping operations.

When set to "false" the MCDData user is not authorised to perform dynamic regrouping operations.

## 10.2.95 /<x>/<x>/OnNetwork/AllowedPresenceStatus

**Table 10.2.95.1: /<x>/<x>/OnNetwork/AllowedPresenceStatus**

<x>/OnNetwork/AllowedPresenceStatus

Status	Occurrence	Format	Min. Access Types
Optional	One	bool	Get, Replace

This leaf node indicates the presence status on the network of this MCDData user is available.

When set to "true" the presence status on the network of this MCDData user is available.

When set to "false" the presence status on the network of this MCDData user is not available. This is the default if this leaf node is not present.

## 10.2.96 /<x>/<x>/OnNetwork/AllowedPresence

**Table 10.2.96.1: /<x>/<x>/OnNetwork/AllowedPresence**

<x>/OnNetwork/AllowedPresence

Status	Occurrence	Format	Min. Access Types
Optional	One	bool	Get, Replace

This leaf node indicates whether the MCDData user is authorised to obtain whether a particular MCDData User is present on the network.

When set to "true" the MCDData user is authorised to obtain whether a particular MCDData User is present on the network.

When set to "false" the MCDData user is not authorised to obtain whether a particular MCDData User is present on the network.

## 10.2.97 /<x>/<x>/OnNetwork/AllowedManualSwitch

**Table 10.2.97.1: /<x>/<x>/OnNetwork/AllowedManualSwitch**

<x>/OnNetwork/AllowedManualSwitch

Status	Occurrence	Format	Min. Access Types
Required	One	bool	Get, Replace

This leaf node indicates whether the MCDData user is authorised to manually switch to off-network operation while in on-network operation.

When set to "true" the MCDData user is authorised to manually switch to off-network operation while in on-network operation.

When set to "false" the MCDData user is not authorised to manually switch to off-network operation while in on-network operation.

## 10.2.98 /<x>/<x>/OffNetwork

**Table 10.2.98.1: /<x>/<x>/OffNetwork**

<x>/OffNetwork

Status	Occurrence	Format	Min. Access Types
Required	ZeroOrOne	node	Get, Replace

This interior node represents a container for off-network operation.

## 10.2.99 /<x>/<x>/OffNetwork/Authorised

**Table 10.2.99.1: /<x>/<x>/OffNetwork/Authorised**

<x>/OffNetwork/Authorised

Status	Occurrence	Format	Min. Access Types
Required	One	bool	Get, Replace

This leaf node indicates the authorisation for off-network services.

When set to "true" the MCDData user is authorised for off-network.

When set to "false" the MCDData user is not authorised for off-network operation.

## 10.2.100 /<x>/<x>/OffNetwork/MCDDataGroupList

**Table 10.2.100.1: /<x>/<x>/OffNetwork/MCDDataGroupList**

<x>/OffNetwork/MCDDataGroupList

Status	Occurrence	Format	Min. Access Types
Required	One	node	Get, Replace

This interior node is a placeholder for the list of off-network MCDData groups that the MCDData user is allowed to use.

## 10.2.101 /<x>/<x>/OffNetwork/MCDDataGroupList/<x>

**Table 10.2.101.1: /<x>/<x>/OffNetwork/MCDDataGroupList/<x>**

<x>/OffNetwork/MCDDataGroupList/<x>

Status	Occurrence	Format	Min. Access Types
Required	OneOrMore	node	Get, Replace

This interior node is a placeholder for one or more list of off-network MCDData groups that the MCDData user is allowed to use.

## 10.2.102 /<x>/<x>/OffNetwork/MCDDataGroupList/<x>/Entry

**Table 10.2.102.1: /<x>/<x>/OffNetwork/MCDDataGroupList/<x>/Entry**

<x>/OffNetwork/MCDDataGroupList/<x>/Entry

Status	Occurrence	Format	Min. Access Types
Optional	One	node	Get, Replace

This interior node is a placeholder for the details of the off-network MCDData groups that the MCDData user is allowed to use.

## 10.2.103 /&lt;x&gt;/&lt;x&gt;/OffNetwork/MCDataGroupList/&lt;x&gt;/Entry/MCDataGroupID

**Table 10.2.103.1: /<x>/<x>/OffNetwork/MCDataGroupList/<x>/Entry/MCDataGroupID**

&lt;x&gt;/OffNetwork/MCDataGroupList/&lt;x&gt;/Entry/MCDataGroupID

Status	Occurrence	Format	Min. Access Types
Required	One	chr	Get, Replace

This leaf node indicates the MCData group ID for the off-network MCData group that the MCData user is allowed to use.

The value is a "uri" attribute specified in OMA OMA-TS-XDM\_Group-V1\_1 [4].

## 10.2.104 /&lt;x&gt;/&lt;x&gt;/OffNetwork/MCDataGroupList/&lt;x&gt;/Entry/DisplayName

**Table 10.2.104.1: /<x>/<x>/OffNetwork/MCDataGroupList/<x>/Entry/DisplayName**

&lt;x&gt;/OffNetwork/MCDataGroupList/&lt;x&gt;/Entry/DisplayName

Status	Occurrence	Format	Min. Access Types
Optional	One	chr	Get, Replace

This leaf node contains a human readable name that corresponds to the MCData Group ID.

## 10.2.105 /&lt;x&gt;/&lt;x&gt;/OffNetwork/MCDataGroupList/&lt;x&gt;/Entry/GMSAppServList

**Table 10.2.105.1: /<x>/<x>/OffNetwork/MCDataGroupList/<x>/Entry/GMSAppServList**

&lt;x&gt;/OffNetwork/MCDataGroupList/&lt;x&gt;/Entry/GMSAppServList

Status	Occurrence	Format	Min. Access Types
Required	One	node	Get, Replace

This interior node is a placeholder for the Group Management Server application plane server identity configuration.

## 10.2.106

/<x>/<x>/OffNetwork/MCDataGroupList/<x>/>/Entry/GMSAppServList/<x>

**Table 10.2.106.1: /<x>/<x>/OffNetwork/MCDataGroupList/<x>/Entry/GMSAppServList/<x>**

&lt;x&gt;/OffNetwork/MCDataGroupList/&lt;x&gt;/Entry/GMSAppServList/&lt;x&gt;

Status	Occurrence	Format	Min. Access Types
Required	OneOrMore	node	Get, Replace

This interior node is a placeholder for one or more Group Management Server configuration.

## 10.2.107

/<x>/<x>/OffNetwork/MCDataGroupList/<x>/Entry/GMSAppServList/<x>/GMSAppServId

**Table 10.2.107.1:****/<x>/<x>/OffNetwork/MCDataGroupList/<x>/Entry/GMSAppServList/<x>/GMSAppServId**

&lt;x&gt;/OffNetwork/MCDataGroupList/&lt;x&gt;/Entry/GMSAppServList/&lt;x&gt;/GMSAppServId

Status	Occurrence	Format	Min. Access Types
Optional	One	chr	Get, Replace

This leaf node indicates the identity (URI) of the the group management server hosting the MCDData Group ID.

10.2.108

`/<x>/<x>/OffNetwork/MCDDataGroupList/<x>/Entry/IdMSTokenEndPointList`

**Table 10.2.108.1: `/<x>/<x>/OffNetwork/MCDDataGroupList/<x>/Entry/IdMSTokenEndPointList`**

`<x>/OffNetwork/MCDDataGroupList/<x>/Entry/IdMSTokenEndPointList`

Status	Occurrence	Format	Min. Access Types
Required	One	node	Get, Replace

This interior node is a placeholder for the Identity Management Server token endpoints configuration..

10.2.109

`/<x>/<x>/OffNetwork/MCDDataGroupList/<x>/Entry/IdMSTokenEndPointList/<x>`

**Table 10.2.109.1: `/<x>/<x>/OffNetwork/MCDDataGroupList/<x>/Entry/IdMSTokenEndPointList/<x>`**

`<x>/OffNetwork/MCDDataGroupList/<x>/Entry/IdMSTokenEndPointList/<x>`

Status	Occurrence	Format	Min. Access Types
Required	OneOrMore	node	Get, Replace

This interior node is a placeholder for one or more IDMS token endpoints configuration.

10.2.110

`/<x>/<x>/OffNetwork/MCDDataGroupList/<x>/Entry/IdMSTokenEndPointList/<x>/IdMSTokenEndPoint`

**Table 10.2.110.1:**

`/<x>/<x>/OffNetwork/MCDDataGroupList/<x>/Entry/IdMSTokenEndPointList/<x>/IdMSTokenEndPoint`

`<x>/OffNetwork/MCDDataGroupList/<x>/Entry/IdMSTokenEndPointList/<x>/IdMSTokenEndPoint`

Status	Occurrence	Format	Min. Access Types
Optional	One	chr	Get, Replace

This leaf node indicates the identity (URI) of the the IDMS token endpoint for the MCDData Group ID in the MCDDataGroupList. If the value is empty, the IDMS identities (IDMSAuthEndpoint and IDMSTokenEndpoint) present in the MCS UE initial configuration MO are used.

10.2.111

`/<x>/<x>/OffNetwork/MCDDataGroupList/<x>/Entry/PresentationPriority`

**Table 10.2.111.1: `/<x>/<x>/OffNetwork/MCDDataGroupList/<x>/Entry/PresentationPriority`**

`<x>/OffNetwork/MCDDataGroupList/<x>/Entry/PresentationPriority`

Status	Occurrence	Format	Min. Access Types
Optional	One	int	Get, Replace

This leaf node indicates indicating the presentation priority of the off-network group for the MCDData user relative to other off-network groups and off-network users.

- Values: 0-255

The lowest PresentationPriority value shall be considered as the MCDATA group transaction having the lowest priority for presentation among other group MCDATA and one-to-one user transactions.

## 10.2.112 /<x>/<x>/OffNetwork/UserInfoID

**Table 10.2.112.1: /<x>/<x>/OffNetwork/UserInfoID**

<x>/OffNetwork/UserInfoID

Status	Occurrence	Format	Min. Access Types
Required	One	chr	Get, Replace

This leaf node indicates the ProSe user info ID as specified in 3GPP TS 23.303 [6].

## 10.2.113 /<x>/<x>/OffNetwork/OnetoOne

**Table 10.2.113.1: /<x>/<x>/OffNetwork/OnetoOne**

<x>/OffNetwork/OnetoOne

Status	Occurrence	Format	Min. Access Types
Required	One	node	Get, Replace

This interior node is a placeholder for the MCDATA off-network one-to-one communication configuration.

## 10.2.114 /<x>/<x>/OffNetwork/OnetoOne/UserList

**Table 10.2.114.1: /<x>/<x>/OffNetwork/OnetoOne/UserList**

<x>/OffNetwork/OnetoOne/UserList

Status	Occurrence	Format	Min. Access Types
Required	ZeroOrOne	node	Get, Replace

This interior node is a placeholder for a list of MCDATA users who can be involved in an off-network MCDATA one-to-one transaction.

## 10.2.115 /<x>/<x>/OffNetwork/OnetoOne/UserList/<x>

**Table 10.2.115.1: /<x>/<x>/OffNetwork/OnetoOne/UserList/<x>**

<x>/OffNetwork/OnetoOne/UserList/<x>

Status	Occurrence	Format	Min. Access Types
Optional	OneOrMore	node	Get, Replace

This interior node is a placeholder for one or more list of MCDATA users who can be involved in an off-network MCDATA one-to-one transaction.

## 10.2.116 /<x>/<x>/OffNetwork/OnetoOne/UserList/<x>/Entry

**Table 10.2.116.1: /<x>/<x>/OffNetwork/OnetoOne/UserList/<x>/Entry**

<x>/OffNetwork/OnetoOne/UserList/<x>/Entry

Status	Occurrence	Format	Min. Access Types
Required	One	node	Get, Replace

This interior node is a placeholder for one or more MCDATA users who can be involved in an off-network MCDATA one-to-one transaction.

## 10.2.117 /<x>/<x>/OffNetwork/OnetoOne/UserList/<x>/Entry/MCDataID

**Table 10.2.117.1: /<x>/<x>/OffNetwork/OnetoOne/UserList/<x>/Entry/MCDataID**

<x>/OffNetwork/OnetoOne/UserList/<x>/Entry/MCDataID

Status	Occurrence	Format	Min. Access Types
Optional	One	chr	Get, Replace

This leaf node indicates an MCData user identity (MCData ID) which is a globally unique identifier within the MCData service that represents the MCData user.

The value is a "uri" attribute specified in OMA OMA-TS-XDM\_Group-V1\_1 [4].

## 10.2.118

### /<x>/<x>/OffNetwork/OnetoOne/UserList/<x>/Entry/DiscoveryGroupID

**Table 10.2.118.1: /<x>/<x>/OffNetwork/OnetoOne/UserList/<x>/Entry/DiscoveryGroupID**

<x>/OffNetwork/OnetoOne/UserList/<x>/Entry/DiscoveryGroupID

Status	Occurrence	Format	Min. Access Types
Optional	One	int	Get, Replace

This leaf node indicates a discovery group ID as specified in 3GPP TS 23.303 [6].

The value is used as the discovery group ID in the ProSe discovery procedures as specified in 3GPP TS 23.303 [6].

## 10.2.119 /<x>/<x>/OffNetwork/OnetoOne/UserList/<x>/Entry/UserInfoID

**Table 10.2.119.1: /<x>/<x>/OffNetwork/OnetoOne/UserList/<x>/Entry/UserInfoID**

<x>/OffNetwork/OnetoOne/UserList/<x>/Entry/UserInfoID

Status	Occurrence	Format	Min. Access Types
Optional	One	int	Get, Replace

This leaf node indicates a ProSe user info ID as specified in 3GPP TS 23.303 [6].

## 10.2.120 /<x>/<x>/OffNetwork/OnetoOne/UserList/<x>/Entry/DisplayName

**Table 10.2.120.1: /<x>/<x>/OffNetwork/OnetoOne/UserList/<x>/Entry/DisplayName**

<x>/OffNetwork/OnetoOne/UserList/<x>/Entry/DisplayName

Status	Occurrence	Format	Min. Access Types
Optional	One	chr	Get, Replace

This leaf node contains a human readable name.

## 10.2.121 /<x>/Status

**Table 10.2.121.1: /<x>/Status**

Status

Status	Occurrence	Format	Min. Access Types
Optional	One	bool	Get, Replace

This leaf node indicates whether this MCData user profile is enabled or disabled.

When set to "true" this MCData user profile is enabled.

When set to "false" this MCData user profile is disabled.

# 11 MCDATA service configuration MO

## 11.1 General

The MCDATA service configuration Management Object (MO) is used to configure MCDATA Client behaviour for the on-network or off-network MCDATA Service. The MCDATA service configuration parameters may be stored in the ME, or in the USIM as specified in 3GPP TS 31.102 [10], or in both the ME and the USIM. If both the ME and the USIM contain the same parameters, the values stored in the USIM shall take precedence.

The Management Object Identifier is: urn:oma:mo:ext-3gpp-MCDATA-service-configuration:1.0.

Protocol compatibility: This MO is compatible with OMA OMA DM 1.2 [3].

The OMA DM ACL property mechanism (see OMA OMA-ERELED-DM-V1\_2 [2]) may be used to grant or deny access rights to OMA DM servers in order to modify nodes and leaf objects of the MCDATA service configuration MO.

The following nodes and leaf objects are possible under the MCDATA service configuration node as described in figure 11.1.1:

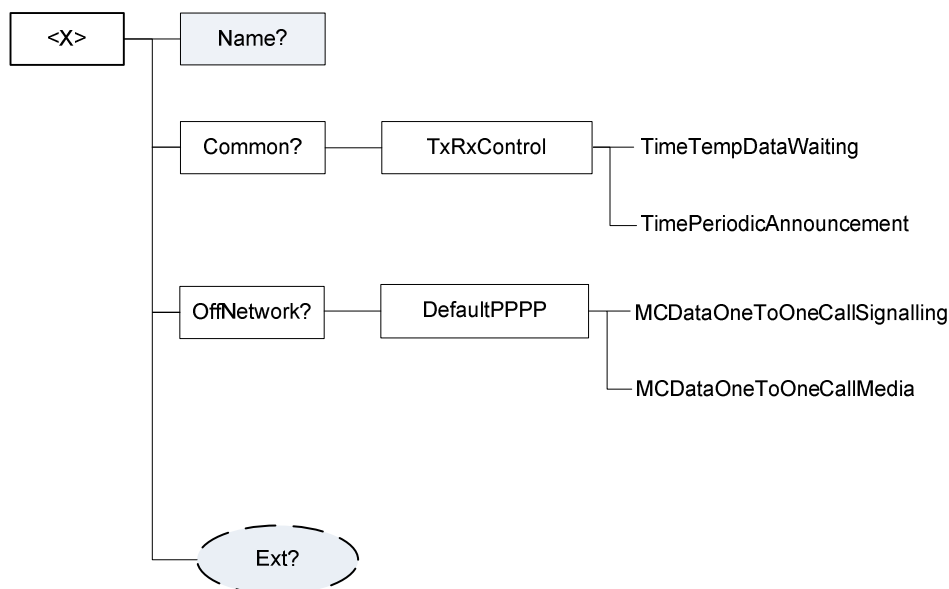

Figure 11.1.1: The MCDATA service configuration MO

## 11.2 MCDATA service configuration MO parameters

### 11.2.1 General

This clause describes the parameters for the MCDATA service configuration Management Object (MO).

### 11.2.2 Node: <x>

Table 11.2.2.1: Node: <x>

<x>

Status	Occurrence	Format	Min. Access Types
Required	OneOrMore	node	Get

This interior node acts as a placeholder for the MCDData service configuration Management Object (MO).

For the MCDData service configuration MO, the namespace specific string is: "urn:oma:mo:oma-dm-mcdata-service configuration:1.0"

- Values: N/A

### 11.2.3 /<x>/Name

**Table 11.2.3.1: /<x>/Name**

Name

Status	Occurrence	Format	Min. Access Types
Required	ZeroOrOne	chr	Get

The Name leaf is a name for the MCDData service configuration settings.

- Values: <User displayable name>

### 11.2.4 /<x>/Ext/

**Table 11.2.4.1: /<x>/Ext/**

Ext

Status	Occurrence	Format	Min. Access Types
Optional	ZeroOrOne	node	Get, Replace

The Ext is an interior node for where the vendor specific information about the MCDData service configuration MO is being placed.

Usually the vendor extension is identified by vendor specific name under the ext node and contains the vendor meaning application vendor, device vendor etc. The tree structure under the vendor identified is not defined and can therefore include one or more un-standardized sub-trees.

- Values: N/A

### 11.2.5 /<x>/Common

**Table 11.2.5.1: /<x>/Common**

Common

Status	Occurrence	Format	Min. Access Types
Required	ZeroOrOne	node	Get, Replace

This interior node represents a container for the common network operation which means both on-network operation and off-network operation.

### 11.2.6 /<x>/Common/TxRxControl

**Table 11.2.6.1: /<x>/Common/TxRxControl**

Common/TxRxControl

Status	Occurrence	Format	Min. Access Types
Required	One	node	Get, Replace

This interior node is a placeholder for transmission and reception control configuration.



## 11.2.7 /<x>/Common/TxRxControl/TimeTempDataWaiting

**Table 11.2.7.1: /<x>/Common/TxRxControl/TimeTempDataWaiting**

Common/TxRxControl/TimeTempDataWaiting

Status	Occurrence	Format	Min. Access Types
Required	One	int	Get, Replace

This leaf node indicates the time limit for the temporarily stored data that is waiting to be delivered to a receiving user.

- Values: 0-65535

The TimeTempDataWaiting is in minutes.

## 11.2.8 /<x>/Common/TxRxControl/TimePeriodicAnnouncement

**Table 11.2.8.1: /<x>/Common/TxRxControl/TimePeriodicAnnouncement**

Common/TxRxControl/TimePeriodicAnnouncement

Status	Occurrence	Format	Min. Access Types
Required	One	int	Get, Replace

This leaf node indicates the timer for the periodic announcement which contains a list of available recently invited data group communications.

- Values: 0-65535

The TimePeriodicAnnouncement is in minutes.

## 11.2.9 /<x>/OffNetwork

**Table 11.2.9.1: /<x>/OffNetwork**

OffNetwork

Status	Occurrence	Format	Min. Access Types
Required	ZeroOrOne	node	Get, Replace

This interior node represents a container for off-network operation.

## 11.2.10 /<x>/OffNetwork/DefaultPPPP

**Table 11.2.10.1: /<x>/OffNetwork/DefaultPPPP**

OffNetwork/DefaultPPPP

Status	Occurrence	Format	Min. Access Types
Required	One	node	Get, Replace

This interior node is a placeholder for the default ProSe Per-Packet Priority (PPPP) configuration.

## 11.2.11 /<x>/OffNetwork/DefaultPPPP/MCDataOneToOneCallSignalling

**Table 11.2.11.1: /<x>/OffNetwork/DefaultPPPP/MCDataOneToOneCallSignalling**

OffNetwork/DefaultPPPP/MCDataOneToOneCallSignalling

Status	Occurrence	Format	Min. Access Types
Required	One	int	Get, Replace

This leaf node indicates the default ProSe Per-Packet Priority (PPPP) value (as specified in 3GPP TS 23.303 [6]) for the MCData one-to-one call signalling.

- Values: 1-8

The MCDData user data with the lowest ProSe Per-Packet Priority value shall be considered as the MCDData user data having the highest priority among the MCDData user data.

## 11.2.12 /<x>/OffNetwork/DefaultPPPP/MCDDataOneToOneCallMedia

**Table 11.2.12.1: /<x>/OffNetwork/DefaultPPPP/MCDDataOneToOneCallMedia**

OffNetwork/DefaultPPPP/MCDDataOneToOneCallMedia

Status	Occurrence	Format	Min. Access Types
Required	One	int	Get, Replace

This leaf node indicates the default ProSe Per-Packet Priority (PPPP) value (as specified in 3GPP TS 23.303 [6]) for the MCDData private call media.

- Values: 1-8

The MCDData user data with the lowest ProSe Per-Packet Priority value shall be considered as the MCDData user data having the highest priority among the MCDData user data.

---

# 12 MCVideo UE configuration MO

## 12.1 General

The MCVideo UE configuration Management Object (MO) is used to configure MCVideo Client behaviour for the on-network or off-network MCVideo Service. The MCVideo UE configuration parameters may be stored in the ME, or in the USIM as specified in 3GPP TS 31.102 [10], or in both the ME and the USIM. If both the ME and the USIM contain the same parameters, the values stored in the USIM shall take precedence.

The Management Object Identifier is: urn:oma:mo:ext-3gpp-MCVideo-UE-configuration:1.0.

Protocol compatibility: This MO is compatible with OMA OMA DM 1.2 [3].

The OMA DM ACL property mechanism (see OMA OMA-ERELD-DM-V1\_2 [2]) may be used to grant or deny access rights to OMA DM servers in order to modify nodes and leaf objects of the MCVideo UE configuration MO.

The following nodes and leaf objects are possible under the MCVideo UE configuration node as described in figure 12.1.1:

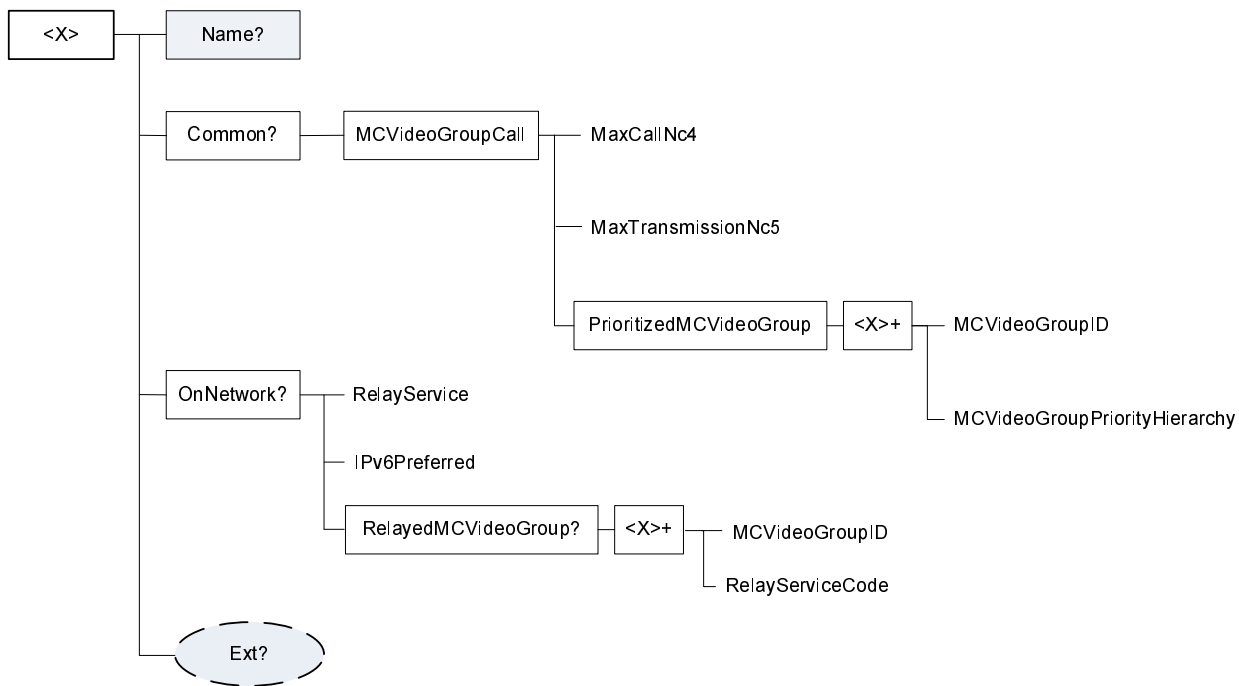

Figure 12.1.1: The MCVideo UE configuration MO

## 12.2 MCVideo UE configuration MO parameters

### 12.2.1 General

This clause describes the parameters for the MCVideo UE configuration Management Object (MO).

### 12.2.2 Node: <x>

Table 12.2.2.1: Node: <x>

<x>

Status	Occurrence	Format	Min. Access Types
Required	OneOrMore	node	Get

This interior node acts as a placeholder for the MCVideo UE configuration Management Object (MO).

For the MCVideo UE configuration MO, the namespace specific string is: "urn:oma:mo:oma-dm-mcvideo-ue-configuration:1.0"

- Values: N/A

### 12.2.3 /<x>/Name

Table 12.2.3.1: /<x>/Name

Name

Status	Occurrence	Format	Min. Access Types
Required	ZeroOrOne	chr	Get

The Name leaf is a name for the MCVideo UE configuration settings.

- Values: <User displayable name>

## 12.2.4 /<x>/Ext/

**Table 12.2.4.1: /<x>/Ext/**

Ext

Status	Occurrence	Format	Min. Access Types
Optional	ZeroOrOne	node	Get, Replace

The Ext is an interior node for where the vendor specific information about the MCVideo UE configuration MO is being placed.

Usually the vendor extension is identified by vendor specific name under the ext node and contains the vendor meaning application vendor, device vendor etc. The tree structure under the vendor identified is not defined and can therefore include one or more un-standardized sub-trees.

- Values: N/A

## 12.2.5 /<x>/Common

**Table 12.2.5.1: /<x>/Common**

Common

Status	Occurrence	Format	Min. Access Types
Required	ZeroOrOne	node	Get, Replace

This interior node represents a container for the common network operation which means both on-network operation and off-network operation.

## 12.2.6 /<x>/Common/MCVideoGroupCall

**Table 12.2.6.1: /<x>/Common/MCVideoGroupCall**

Common/MCVideoGroupCall

Status	Occurrence	Format	Min. Access Types
Required	One	node	Get, Replace

This interior node is a placeholder for the MCVideo group call configuration.

## 12.2.7 /<x>/Common/MCVideoGroupCall/MaxCallNc4

**Table 12.2.7.1: /<x>/Common/MCVideoGroupCall/MaxCallNc4**

Common/MCVideoGroupCall/MaxCallNc4

Status	Occurrence	Format	Min. Access Types
Required	One	int	Get, Replace

This leaf node indicates the maximum number of simultaneous MCVideo group calls.

- Values: 0-255

## 12.2.8 /<x>/Common/MCVideoGroupCall/MaxTransmissionNc5

**Table 12.2.8.1: /<x>/Common/MCVideoGroupCall/MaxTransmissionNc5**

Common/MCVideoGroupCall/MaxTransmissionNc5

Status	Occurrence	Format	Min. Access Types
Required	One	int	Get, Replace

This leaf node indicates the maximum number of video transmissions in a group.

- Values: 0-255

## 12.2.9 /<x>/Common/MCVideoGroupCall/PrioritizedMCVideoGroup

**Table 12.2.9.1: /<x>/Common/MCVideoGroupCall/PrioritizedMCVideoGroup**

Common/MCVideoGroupCall/PrioritizedMCVideoGroup

Status	Occurrence	Format	Min. Access Types
Required	ZeroOrOne	node	Get, Replace

This interior node is a placeholder for the prioritized MCVideo group call configuration.

## 12.2.10 /<x>/Common/MCVideoGroupCall/PrioritizedMCVideoGroup/<x>

**Table 12.2.10.1: /<x>/Common/MCVideoGroupCall/PrioritizedMCVideoGroup/<x>**

Common/MCVideoGroupCall/PrioritizedMCVideoGroup /<x>

Status	Occurrence	Format	Min. Access Types
Required	OneOrMore	node	Get, Replace

This interior node is a placeholder for one or more prioritized MCVideo group call configuration.

## 12.2.11

### /<x>/Common/MCVideoGroupCall/PrioritizedMCVideoGroup/<x>/MCVideoGroupID

**Table 12.2.11.1: /<x>/Common/MCVideoGroupCall/PrioritizedMCVideoGroup/<x>/MCVideoGroupID**

Common/MCVideoGroupCall/PrioritizedMCVideoGroup/<x>/MCVideoGroupID

Status	Occurrence	Format	Min. Access Types
Required	One	chr	Get, Replace

This leaf node indicates the associated MCVideo group ID.

The value is a "uri" attribute specified in OMA OMA-TS-XDM\_Group-V1\_1 [4].

## 12.2.12

### /<x>/Common/MCVideoGroupCall/PrioritizedMCVideoGroup/<x>/MCVideoGroupPriorityHierarchy

**Table 12.2.12.1:**

**/<x>/Common/MCVideoGroupCall/PrioritizedMCVideoGroup/<x>/MCVideoGroupPriorityHierarchy**

Common/MCVideoGroupCall/PrioritizedMCVideoGroup/<x>/MCVideoGroupPriorityHierarchy

Status	Occurrence	Format	Min. Access Types
Required	One	int	Get, Replace

This leaf node indicates the requested presentation priority of MCVideo group call.

- Values: 0-255

The group with the lowest MCVideoGroupPriorityHierarchy value shall be considered as the group having the lowest priority among the groups.

## 12.2.13 /<x>/OnNetwork

**Table 12.2.13.1: /<x>/OnNetwork**

OnNetwork

Status	Occurrence	Format	Min. Access Types
Required	ZeroOrOne	node	Get, Replace

This interior node represents a container for on-network operation.

## 12.2.14 /<x>/OnNetwork/RelayService

**Table 12.2.14.1: /<x>/OnNetwork/RelayService**

OnNetwork/RelayService

Status	Occurrence	Format	Min. Access Types
Required	One	bool	Get, Replace

This leaf node indicates the authorisation to use a relay service.

When set to "true" the MCVideo group is allowed to use a relay service.

When set to "false" the MCVideo group is not allowed to use a relay service.

## 12.2.15 /<x>/OnNetwork/IPv6Preferred

**Table 12.2.15.1: /<x>/OnNetwork/IPv6Preferred**

OnNetwork/IPv6Preferred

Status	Occurrence	Format	Min. Access Types
Required	One	bool	Get, Replace

This leaf node indicates whether IPv6 is preferred over IPv4 for on-network operation when the MCVideo UE has both IPv4 and IPv6 host configuration.

If the MCVideo UE has both IPv4 and IPv6 host configuration and:

- if IPv6Preferred is set to "true" then the UE uses IPv6 for all on-network signalling and media; otherwise
- if IPv6Preferred is set to "false" then the UE uses IPv4 for all on-network signalling and media.

## 12.2.16 /<x>/OnNetwork/RelayedMCVideoGroup

**Table 12.2.16.1: /<x>/OnNetwork/RelayedMCVideoGroup**

OnNetwork/RelayedMCVideoGroup

Status	Occurrence	Format	Min. Access Types
Optional	One	node	Get, Replace

This interior node is a placeholder for the allowed relayed MCVideo groups.

## 12.2.17 /<x>/OnNetwork/RelayedMCVideoGroup/<x>

**Table 12.2.17.1: /<x>/OnNetwork/RelayedMCVideoGroup/<x>**

OnNetwork/RelayedMCVideoGroup/<x>

Status	Occurrence	Format	Min. Access Types
Required	OneOrMore	node	Get, Replace

This interior node is a placeholder for one or more allowed relayed MCVideo groups.

## 12.2.18 /<x>/OnNetwork/RelayedMCVideoGroup/<x>/MCVideoGroupID

**Table 12.2.18.1: /<x>/OnNetwork/RelayedMCVideoGroup/<x>/MCVideoGroupID**

OnNetwork/RelayedMCVideoGroup/<x>/MCVideoGroupID

Status	Occurrence	Format	Min. Access Types
Required	One	chr	Get, Replace

This leaf node indicates the associated MCVideo group ID.

The value is a "uri" attribute specified in OMA OMA-TS-XDM\_Group-V1\_1 [4].

## 12.2.19 /<x>/OnNetwork/RelayedMCVideoGroup/<x>/RelayServiceCode

**Table 12.2.19.1: /<x>/OnNetwork/RelayedMCVideoGroup/<x>/RelayServiceCode**

OnNetwork/RelayedMCVideoGroup/<x>/RelayServiceCode

Status	Occurrence	Format	Min. Access Types
Required	One	chr	Get, Replace

This leaf node indicates the connectivity service that the ProSe UE-to-network relay provides to public safety applications as specified in 3GPP TS 23.303 [6].

---

# 13 MCVideo user profile MO

## 13.1 General

The MCVideo user profile configuration Management Object (MO) is used to configure the MCVideo Client behaviour for the on-network or off-network MCVideo Service. The MCVideo user profile configuration parameters may be stored in the ME, or in the USIM as specified in 3GPP TS 31.102 [10], or in both the ME and the USIM. If both the ME and the USIM contain the same parameters, the values stored in the USIM shall take precedence.

The Management Object Identifier is: urn:oma:mo:ext-3gpp-MCVideo-user-profile:1.0.

Protocol compatibility: This MO is compatible with OMA OMA DM 1.2 [3].

The OMA DM ACL property mechanism (see OMA OMA-ERELED-DM-V1\_2 [2]) may be used to grant or deny access rights to OMA DM servers in order to modify nodes and leaf objects of the MCVideo user profile MO.

The following nodes and leaf objects are possible under the MCVideo user profile node as described in figure 13.1.1, figure 13.1.2 and figure 13.1.3:

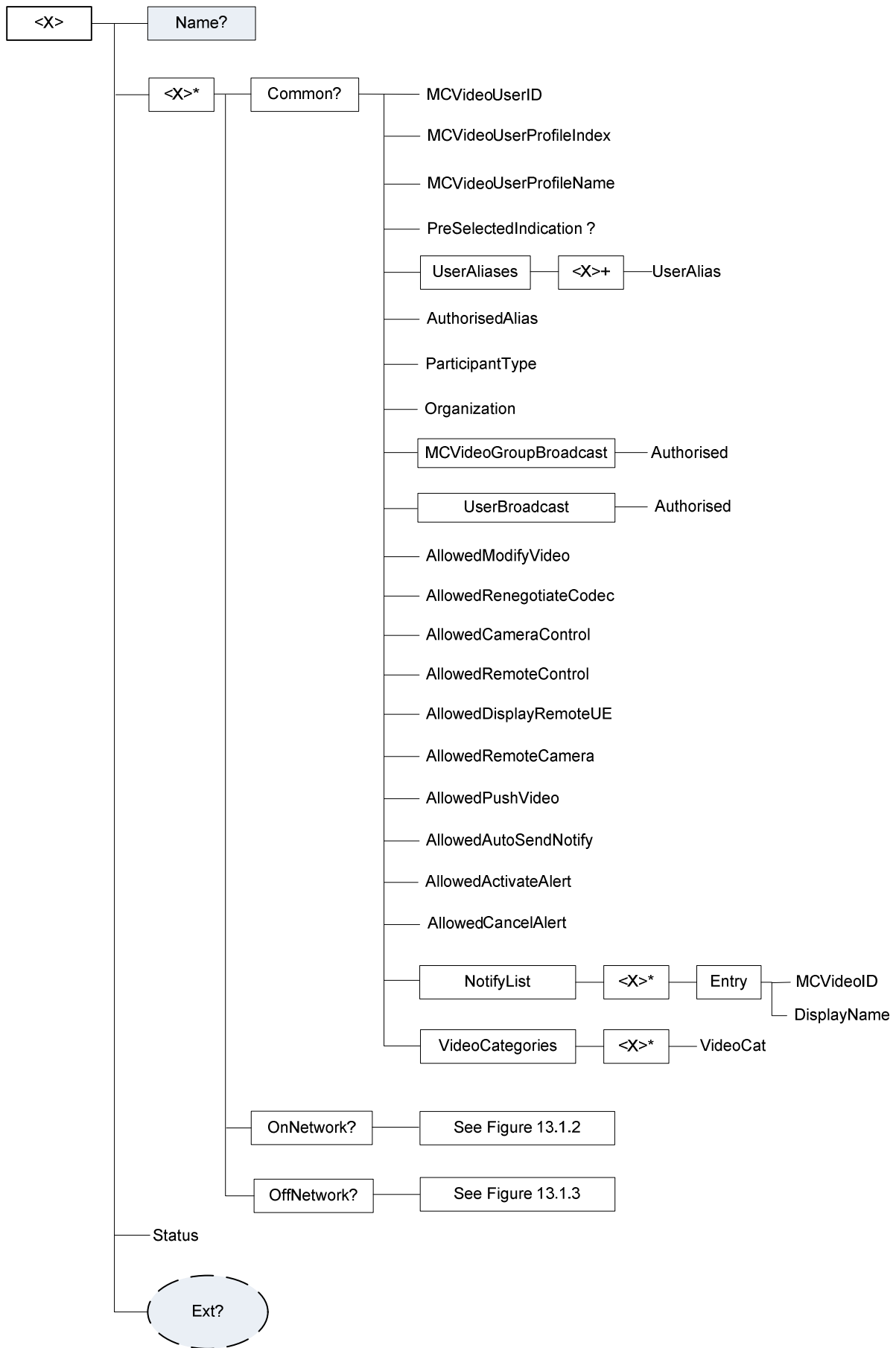

Figure 13.1.1: The MCVideo user profile MO (1 of 3)



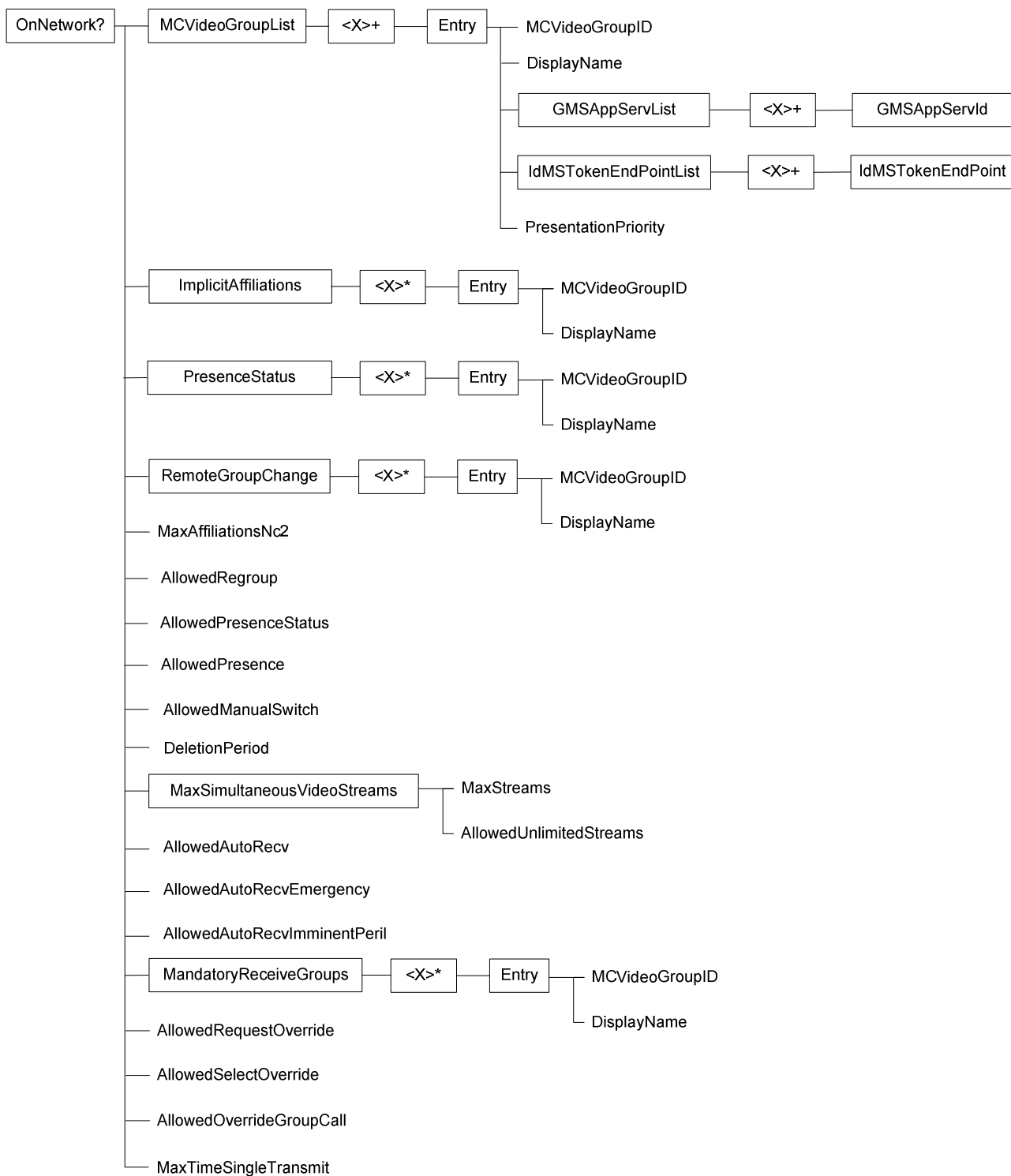

Figure 13.1.2: The MCVideo user profile MO (2 of 3)

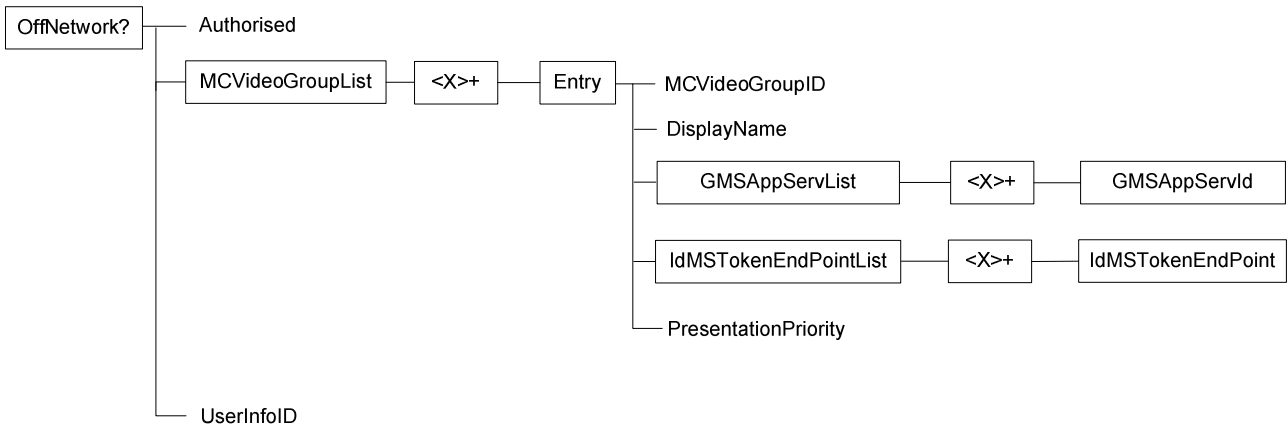

Figure 13.1.3: The MCVideo user profile MO (3 of 3)

## 13.2 MCVideo user profile MO parameters

### 13.2.1 General

This clause describes the parameters for the MCVideo user profile Management Object (MO).

### 13.2.2 Node: <x>

Table 13.2.2.1: Node: <x>

<x>

Status	Occurrence	Format	Min. Access Types
Required	OneOrMore	node	Get

This interior node acts as a placeholder for the MCVideo user profile Management Object (MO).

For the MCVideo user profile MO, the namespace specific string is: "urn:oma:mo:oma-dm-mcvideo-user-profile:1.0"

- Values: N/A

### 13.2.3 /<x>/Name

Table 13.2.3.1: /<x>/Name

Name

Status	Occurrence	Format	Min. Access Types
Required	ZeroOrOne	chr	Get

The Name leaf is a name for the MCVideo user profile settings.

- Values: <User displayable name>

### 13.2.4 /<x>/Ext/

Table 13.2.4.1: /<x>/Ext/

Ext

Status	Occurrence	Format	Min. Access Types
Optional	ZeroOrOne	node	Get, Replace

The Ext is an interior node for where the vendor specific information about the MCVideo user profile MO is being placed.

Usually the vendor extension is identified by vendor specific name under the ext node and contains the vendor meaning application vendor, device vendor etc. The tree structure under the vendor identified is not defined and can therefore include one or more un-standardized sub-trees.

- Values: N/A

### 13.2.5 /<x>/<x>

**Table 13.2.5.1: /<x>/<x>**

<x>

Status	Occurrence	Format	Min. Access Types
Required	OneOrMore	node	Get, Replace

This interior node represents a container for on-network operation and off-network operation.

### 13.2.6 /<x>/<x>/Common

**Table 13.2.6.1: /<x>/<x>/Common**

<x>/Common

Status	Occurrence	Format	Min. Access Types
Required	OneOrMore	node	Get, Replace

This interior node represents a container for the common network operation which means both on-network operation and off-network operation.

### 13.2.7 /<x>/<x>/Common/MCVideoUserID

**Table 13.2.7.1: /<x>/<x>/Common/MCVideoUserID**

<x>/Common/MCVideoUserID

Status	Occurrence	Format	Min. Access Types
Required	One	chr	Get, Replace

This leaf node indicates an MCVideo user identity (MCVideo ID) which is a globally unique identifier within the MCVideo service that represents the MCVideo user.

### 13.2.8 /<x>/<x>/Common/MCVideoUserProfileIndex

**Table 13.2.8.1: /<x>/<x>/Common/MCVideoUserProfileIndex**

<x>/Common/MCVideoUserProfileIndex

Status	Occurrence	Format	Min. Access Types
Required	One	int	Get, Replace

This leaf node indicates an index for the particular MCVideo user profile.

- Values: 0-255

### 13.2.9 /<x>/<x>/Common/MCVideoUserProfileName

**Table 13.2.9.1: /<x>/<x>/Common/MCVideoUserProfileName**

<x>/Common/MCVideoUserProfileName

Status	Occurrence	Format	Min. Access Types
Optional	One	chr	Get, Replace

This leaf node indicates a profile name for the particular MCVideo user profile.

### 13.2.10 /<x>/<x>/Common/PreSelectedIndication

**Table 13.2.10.1: /<x>/<x>/Common/PreSelectedIndication**

<x>/Common/PreSelectedIndication

Status	Occurrence	Format	Min. Access Types
Optional	ZeroOrOne	null	Get, Replace

This leaf node indicates that this MCVideo user profile MO is designated to be the pre-selected MCVideo user profile as defined by 3GPP TS 23.179 [15]

- Values: null

When this leaf node is present, this MCVideo user profile MO is designated as the pre-selected MCVideo user profile.

When this leaf node is absent, this MCVideo user profile MO is not designated as the pre-selected MCVideo user profile.

If more than one MCVideo user profile MO is specified for the MCVideo user, then only one MCVideo user profile MO for the MCVideo user shall contain the <x>/Common/PreSelectedIndication leaf node.

If there is only one MCVideo user profile MO specified for the MCVideo user, then it is optional to include the <x>/Common/PreSelectedIndication leaf node.

### 13.2.11 /<x>/<x>/Common/UserAliases

**Table 13.2.11.1: /<x>/<x>/Common/UserAliases**

<x>/Common/UserAliases

Status	Occurrence	Format	Min. Access Types
Required	One	node	Get, Replace

This interior node is a placeholder for a list of aliases of an MCVideo user.

### 13.2.12 /<x>/<x>/Common/UserAliases/<x>

**Table 13.2.12.1: /<x>/<x>/Common/UserAliases/<x>**

<x>/Common/UserAliases/<x>

Status	Occurrence	Format	Min. Access Types
Required	OneOrMore	node	Get, Replace

This interior node is a placeholder for one or more aliases of an MCVideo user.

### 13.2.13 /<x>/<x>/Common/UserAliases/<x>/UserAlias

**Table 13.2.13.1: /<x>/<x>/Common/UserAliases/<x>/UserAlias**

<x>/Common/UserAliases/<x>/UserAlias

Status	Occurrence	Format	Min. Access Types
Required	One	chr	Get, Replace

This leaf node indicates an alphanumeric alias of the MCVideo user.

### 13.2.14 /<x>/<x>/Common/AuthorisedAlias

**Table 13.2.14.1: /<x>/<x>/Common/AuthorisedAlias**

<x>/Common/AuthorisedAlias

Status	Occurrence	Format	Min. Access Types
Optional	One	bool	Get, Replace

This leaf node indicates authorisation to create and delete aliases of other MCVideo users and their associated MCVideo user profiles.

When set to "true" the MCVideo user is authorised to create and delete aliases of other MCVideo users and their associated MCVideo user profiles.

When set to "false" the MCVideo user is not authorised to create and delete aliases of other MCVideo user and their associated MCVideo user profiles. This is the default if this leaf node is not present.

### 13.2.15 /<x>/<x>/Common/ParticipantType

**Table 13.2.15.1: /<x>/<x>/Common/ParticipantType**

<x>/Common/ParticipantType

Status	Occurrence	Format	Min. Access Types
Required	One	chr	Get, Replace

This leaf node indicates the participant type of the MCVideo user.

The ParticipantType means the functional category of the participant (e.g., first responder, second responder, dispatch, dispatch supervisor), typically defined by the MCVideo administrators.

### 13.2.16 /<x>/<x>/Common/Organization

**Table 13.2.16.1: /<x>/<x>/Common/Organization**

<x>/Common/Organization

Status	Occurrence	Format	Min. Access Types
Required	One	chr	Get, Replace

This leaf node indicates the organization an MCVideo user belongs to.

### 13.2.17 /<x>/<x>/Common/MCVideoGroupBroadcast

**Table 13.2.17.1: /<x>/<x>/Common/MCVideoGroupBroadcast**

<x>/Common/MCVideoGroupBroadcast

Status	Occurrence	Format	Min. Access Types
Required	One	node	Get, Replace

This interior node is a placeholder for the group-broadcast group policy.

### 13.2.18 /<x>/<x>/Common/MCVideoGroupBroadcast/Authorised

**Table 13.2.18.1: /<x>/<x>/Common/MCVideoGroupBroadcast/Authorised**

<x>/Common/MCVideoGroupBroadcast/Authorised

Status	Occurrence	Format	Min. Access Types
Required	One	bool	Get, Replace

This leaf node indicates the authorisation to create a group-broadcast group.

When set to "true" the MCVideo user is authorised to create a group-broadcast group.

When set to "false" the MCVideo user is not authorised to create a group-broadcast group.

### 13.2.19 /<x>/<x>/Common/UserBroadcast

**Table 13.2.19.1: /<x>/<x>/Common/UserBroadcast**

<x>/Common/UserBroadcast

Status	Occurrence	Format	Min. Access Types
Required	One	node	Get, Replace

This interior node is a placeholder for the user-broadcast group policy.

### 13.2.20 /<x>/<x>/Common/UserBroadcast/Authorised

**Table 13.2.20.1: /<x>/<x>/Common/UserBroadcast/Authorised**

<x>/Common/UserBroadcast/Authorised

Status	Occurrence	Format	Min. Access Types
Required	One	bool	Get, Replace

This leaf node indicates the authorisation to create a user-broadcast group.

When set to "true" the MCVideo user is authorised to create a user-broadcast group.

When set to "false" the MCVideo user is not authorised to create a user-broadcast group.

### 13.2.21 /<x>/<x>/Common/AllowedModifyVideo

**Table 13.2.21.1: /<x>/<x>/Common/AllowedModifyVideo**

<x>/Common/AllowedModifyVideo

Status	Occurrence	Format	Min. Access Types
Required	One	bool	Get, Replace

This leaf node indicates whether the MCVideo user is authorised to modify the video settings of the transmitted video stream of another MCVideo user.

When set to "true" the MCVideo user is authorised to modify the video settings of the transmitted video stream of another MCVideo user.

When set to "false" the MCVideo user is not authorised to modify the video settings of the transmitted video stream of another MCVideo user.

### 13.2.22 /<x>/<x>/Common/AllowedRenegotiateCodec

**Table 13.2.22.1: /<x>/<x>/Common/AllowedRenegotiateCodec**

<x>/Common/AllowedRenegotiateCodec

Status	Occurrence	Format	Min. Access Types
Required	One	bool	Get, Replace

This leaf node indicates whether the MCVideo user is authorised to renegotiate a codec during a video transmission.

When set to "true" the MCVideo user is authorised to renegotiate a codec during a video transmission.

When set to "false" the MCVideo user is not authorised to renegotiate a codec during a video transmission.

### 13.2.23 /<x>/<x>/Common/AllowedCameraControl

**Table 13.2.23.1: /<x>/<x>/Common/AllowedCameraControl**

<x>/Common/AllowedCameraControl

Status	Occurrence	Format	Min. Access Types
Required	One	bool	Get, Replace

This leaf node indicates whether the MCVideo user is authorised to remotely control the video capabilities or parameters for a camera on an MCVideo UE.

When set to "true" the MCVideo user is authorised to remotely control the video capabilities or parameters for a camera on an MCVideo UE.

When set to "false" the MCVideo user is not authorised to remotely control the video capabilities or parameters for a camera on an MCVideo UE.

### 13.2.24 /<x>/<x>/Common/AllowedRemoteControl

**Table 13.2.24.1: /<x>/<x>/Common/AllowedRemoteControl**

<x>/Common/AllowedRemoteControl

Status	Occurrence	Format	Min. Access Types
Required	One	bool	Get, Replace

This leaf node indicates whether the MCVideo user is authorised to remotely control the video capabilities or parameters of a remote MCVideo UE.

When set to "true" the MCVideo user is authorised to remotely control the video capabilities or parameters of a remote MCVideo UE.

When set to "false" the MCVideo user is not authorised to remotely control the video capabilities or parameters of a remote MCVideo UE.

### 13.2.25 /<x>/<x>/Common/AllowedDisplayRemoteUE

**Table 13.2.25.1: /<x>/<x>/Common/AllowedDisplayRemoteUE**

<x>/Common/AllowedDisplayRemoteUE

Status	Occurrence	Format	Min. Access Types
Required	One	bool	Get, Replace

This leaf node indicates whether the MCVideo user is authorised to receive and display the capabilities of a remote MCVideo UE.

When set to "true" the MCVideo user is authorised to receive and display the capabilities of a remote MCVideo UE.

When set to "false" the MCVideo user is not authorised to receive and display the capabilities of a remote MCVideo UE.

### 13.2.26 /<x>/<x>/Common/AllowedRemoteCamera

**Table 13.2.26.1: /<x>/<x>/Common/AllowedRemoteCamera**

<x>/Common/AllowedRemoteCamera

Status	Occurrence	Format	Min. Access Types
Required	One	bool	Get, Replace

This leaf node indicates whether the MCVideo user is authorised to remotely activate another MCVideo user's camera.

When set to "true" the MCVideo user is authorised to remotely activate another MCVideo user's camera.

When set to "false" the MCVideo user is not authorised to remotely activate another MCVideo user's camera.

### 13.2.27 /<x>/<x>/Common/AllowedPushVideo

**Table 13.2.27.1: /<x>/<x>/Common/AllowedPushVideo**

<x>/Common/AllowedPushVideo

Status	Occurrence	Format	Min. Access Types
Required	One	bool	Get, Replace

This leaf node indicates whether the MCVideo user is authorised to push a video to another MCVideo user.

When set to "true" the MCVideo user is authorised to push a video to another MCVideo user.

When set to "false" the MCVideo user is not authorised to push a video to another MCVideo user.

### 13.2.28 /<x>/<x>/Common/AllowedAutoSendNotify

**Table 13.2.28.1: /<x>/<x>/Common/AllowedAutoSendNotify**

<x>/Common/AllowedAutoSendNotify

Status	Occurrence	Format	Min. Access Types
Required	One	bool	Get, Replace

This leaf node indicates whether the MCVideo user is authorised to enable and disable the automatic sending of a notification to a second MCVideo user that a video is being pushed to a third MCVideo user.

When set to "true" the MCVideo user is authorised to enable and disable the automatic sending of a notification to a second MCVideo user that a video is being pushed to a third MCVideo user.

When set to "false" the MCVideo user is not authorised to enable and disable the automatic sending of a notification to a second MCVideo user that a video is being pushed to a third MCVideo user.

### 13.2.29 /<x>/<x>/Common/AllowedActivateAlert

**Table 13.2.29.1: /<x>/<x>/Common/AllowedActivateAlert**

<x>/Common/AllowedActivateAlert

Status	Occurrence	Format	Min. Access Types
Required	One	bool	Get, Replace

This leaf node indicates whether the MCVideo user is authorised to activate an emergency alert.

When set to "true" the MCVideo user is authorised to activate an emergency alert.

When set to "false" the MCVideo user is not authorised to activate an emergency alert.

### 13.2.30 /<x>/<x>/Common/AllowedCancelAlert

**Table 13.2.30.1: /<x>/<x>/Common/AllowedCancelAlert**

<x>/Common/AllowedCancelAlert

Status	Occurrence	Format	Min. Access Types
Required	One	bool	Get, Replace

This leaf node indicates whether the MCVideo user is allowed to cancel an emergency alert.

When set to "true" the MCVideo user is authorised to cancel an emergency alert.

When set to "false" the MCVideo user is not authorised to cancel an emergency alert.



### 13.2.31 /<x>/<x>/Common/NotifyList

**Table 13.2.31.1: /<x>/<x>/Common/NotifyList**

<x>/Common/NotifyList

Status	Occurrence	Format	Min. Access Types
Required	One	node	Get, Replace

This interior node is a placeholder for a list of MCVideo users for whom to receive notifications about video being pushed to them.

### 13.2.32 /<x>/<x>/Common/NotifyList/<x>

**Table 13.2.32.1: /<x>/<x>/Common/NotifyList/<x>**

<x>/Common/NotifyList/<x>

Status	Occurrence	Format	Min. Access Types
Optional	ZeroOrMore	node	Get, Replace

This interior node is a placeholder for zero or more list of MCVideo users for whom to receive notifications about video being pushed to them.

### 13.2.33 /<x>/<x>/Common/NotifyList/<x>/Entry

**Table 13.2.33.1: /<x>/<x>/Common/NotifyList/<x>/Entry**

<x>/Common/NotifyList/<x>/Entry

Status	Occurrence	Format	Min. Access Types
Required	One	node	Get, Replace

This interior node is a placeholder for one or more MCVideo users for whom to receive notifications about video being pushed to them.

### 13.2.34 /<x>/<x>/Common/NotifyList/<x>/Entry/MCVideoID

**Table 13.2.34.1: /<x>/<x>/Common/NotifyList/<x>/Entry/MCVideoID**

<x>/Common/NotifyList/<x>/Entry/MCVideoID

Status	Occurrence	Format	Min. Access Types
Optional	One	chr	Get, Replace

This leaf node indicates an MCVideo user identity (MCVideo ID) which is a globally unique identifier within the MCVideo service that represents the MCVideo user.

The value is a "uri" attribute specified in OMA OMA-TS-XDM\_Group-V1\_1 [4].

### 13.2.35 /<x>/<x>/Common/NotifyList/<x>/Entry/DisplayName

**Table 13.2.35.1: /<x>/<x>/Common/NotifyList/<x>/Entry/DisplayName**

<x>/Common/NotifyList/<x>/Entry/DisplayName

Status	Occurrence	Format	Min. Access Types
Optional	One	chr	Get, Replace

This leaf node contains a human readable name.

### 13.2.36 /<x>/<x>/Common/VideoCategories

**Table 13.2.36.1: /<x>/<x>/Common/VideoCategories**

<x>/Common/VideoCategories

Status	Occurrence	Format	Min. Access Types
Required	One	node	Get, Replace

This interior node is a placeholder for a list of specific video categories to receive

### 13.2.37 /<x>/<x>/Common/VideoCategories/<x>

**Table 13.2.37.1: /<x>/<x>/Common/VideoCategories/<x>**

<x>/Common/VideoCategories/<x>

Status	Occurrence	Format	Min. Access Types
Required	ZeroOrMore	node	Get, Replace

This interior node is a placeholder for one or more specific video categories to receive.

If the list is empty, then all video categories are acceptable to the MCVideo user.

### 13.2.38 /<x>/<x>/Common/VideoCategories/<x>/VideoCat

**Table 13.2.38.1: /<x>/<x>/Common/VideoCategories/<x>/VideoCat**

<x>/Common/VideoCategories/<x>/VideoCat

Status	Occurrence	Format	Min. Access Types
Required	One	chr	Get, Replace

This leaf node indicates an alphanumeric video category

### 13.2.39 /<x>/<x>/OnNetwork

**Table 13.2.39.1: /<x>/<x>/OnNetwork**

<x>/OnNetwork

Status	Occurrence	Format	Min. Access Types
Required	ZeroOrOne	node	Get, Replace

This interior node represents a container for on-network operation.

### 13.2.40 /<x>/<x>/OnNetwork/MCVideoGroupList

**Table 13.2.40.1: /<x>/<x>/OnNetwork/MCVideoGroupList**

<x>/OnNetwork/MCVideoGroupList

Status	Occurrence	Format	Min. Access Types
Required	One	node	Get, Replace

This interior node is a placeholder for the list of on-network MCVideo groups that the MCVideo user is allowed to use.

### 13.2.41 /<x>/<x>/OnNetwork/MCVideoGroupList/<x>

**Table 13.2.41.1: /<x>/<x>/OnNetwork/MCVideoGroupList/<x>**

<x>/OnNetwork/MCVideoGroupList/<x>

Status	Occurrence	Format	Min. Access Types
Required	OneOrMore	node	Get, Replace

This interior node is a placeholder for one or more list of on-network MCVideo groups that the MCVideo user is allowed to use.

### 13.2.42 /<x>/<x>/OnNetwork/MCVideoGroupList/<x>/Entry

**Table 13.2.42.1: /<x>/<x>/OnNetwork/MCVideoGroupList/<x>/Entry**

<x>/OnNetwork/MCVideoGroupList/<x>/Entry

Status	Occurrence	Format	Min. Access Types
Optional	One	node	Get, Replace

This interior node is a placeholder for the details of the on-network MCVideo groups that the MCVideo user is allowed to use.

### 13.2.43

#### /<x>/<x>/OnNetwork/MCVideoGroupList/<x>/Entry/MCVideoGroupID

**Table 13.2.43.1: /<x>/<x>/OnNetwork/MCVideoGroupList/<x>/Entry/MCVideoGroupID**

<x>/OnNetwork/MCVideoGroupList/<x>/Entry/MCVideoGroupID

Status	Occurrence	Format	Min. Access Types
Required	One	chr	Get, Replace

This leaf node indicates the MCVideo group ID for the on-network MCVideo group that the MCVideo user is allowed to use.

The value is a "uri" attribute specified in OMA OMA-TS-XDM\_Group-V1\_1 [4].

### 13.2.44 /<x>/<x>/OnNetwork/MCVideoGroupList/<x>/Entry/DisplayName

**Table 13.2.44.1: /<x>/<x>/OnNetwork/MCVideoGroupList/<x>/Entry/DisplayName**

<x>/OnNetwork/MCVideoGroupList/<x>/Entry/DisplayName

Status	Occurrence	Format	Min. Access Types
Optional	One	chr	Get, Replace

This leaf node contains a human readable name that corresponds to the MCVideo Group ID.

### 13.2.45

#### /<x>/<x>/OnNetwork/MCVideoGroupList/<x>/Entry/GMSAppServList

**Table 13.2.45.1: /<x>/<x>/OnNetwork/MCVideoGroupList/<x>/Entry/GMSAppServList**

<x>/OnNetwork/MCVideoGroupList/<x>/Entry/GMSAppServList

Status	Occurrence	Format	Min. Access Types
Required	One	node	Get, Replace

This interior node is a placeholder for the Group Management Server application plane server identity configuration.

## 13.2.46

`<x>/<x>/OnNetwork/MCVideoGroupList/<x>/Entry/GMSAppServList/<x>`

**Table 13.2.46.1: `<x>/<x>/OnNetwork/MCVideoGroupList/<x>/Entry/GMSAppServList/<x>`**

`<x>/OnNetwork/MCVideoGroupList/<x>/Entry/GMSAppServList/<x>`

Status	Occurrence	Format	Min. Access Types
Required	OneOrMore	node	Get, Replace

This interior node is a placeholder for one or more Group Management Server configuration.

## 13.2.47

`<x>/<x>/OnNetwork/MCVideoGroupList/<x>/Entry/GMSAppServList/<x>/GMSAppServId`

**Table 13.2.47.1:**

**`<x>/<x>/OnNetwork/MCVideoGroupList/<x>/Entry/GMSAppServList/<x>/GMSAppServId`**

`<x>/OnNetwork/MCVideoGroupList/<x>/Entry/GMSAppServList/<x>/GMSAppServId`

Status	Occurrence	Format	Min. Access Types
Optional	One	chr	Get, Replace

This leaf node indicates the identity (URI) of the the group management server hosting the MCVideo Group ID.

## 13.2.48

`<x>/<x>/OnNetwork/MCVideoGroupList/<x>/Entry/IdMSTokenEndPointList`

**Table 13.2.48.1: `<x>/<x>/OnNetwork/MCVideoGroupList/<x>/Entry/IdMSTokenEndPointList`**

`<x>/OnNetwork/MCVideoGroupList/<x>/Entry/IdMSTokenEndPointList`

Status	Occurrence	Format	Min. Access Types
Required	One	node	Get, Replace

This interior node is a placeholder for the Identity Management Server application plane server identity configuration.

## 13.2.49

`<x>/<x>/OnNetwork/MCVideoGroupList/<x>/Entry/IdMSTokenEndPointList/<x>`

**Table 13.2.49.1: `<x>/<x>/OnNetwork/MCVideoGroupList/<x>/Entry/IdMSTokenEndPointList/<x>`**

`<x>/OnNetwork/MCVideoGroupList/<x>/Entry/IdMSTokenEndPointList/<x>`

Status	Occurrence	Format	Min. Access Types
Required	OneOrMore	node	Get, Replace

This interior node is a placeholder for one or more Identity Management Server configuration.

## 13.2.50

`<x>/<x>/OnNetwork/MCVideoGroupList/<x>/Entry/IdMSTokenEndPointList/<x>/IdMSTokenEndPoint`

**Table 13.2.50.1:**

`<x>/<x>/OnNetwork/MCVideoGroupList/<x>/Entry/IdMSTokenEndPointList/<x>/IdMSTokenEndPoint`

`<x>/OnNetwork/MCVideoGroupList/<x>/Entry/IdMSTokenEndPointList/<x>/IdMSTokenEndPoint`

Status	Occurrence	Format	Min. Access Types
Optional	One	chr	Get, Replace

This leaf node indicates the identity (URI) of the the identity management server hosting the MCVideo Group ID.

## 13.2.51

`<x>/<x>/OnNetwork/MCVideoGroupList/<x>/Entry/PresentationPriority`

**Table 13.2.51.1: `<x>/<x>/OnNetwork/MCVideoGroupList/<x>/Entry/PresentationPriority`**

`<x>/OnNetwork/MCVideoGroupList/<x>/Entry/PresentationPriority`

Status	Occurrence	Format	Min. Access Types
Optional	One	int	Get, Replace

This leaf node indicates indicating the presentation priority of the on-network group for the MCVideo user relative to other on-network groups and on-network users.

- Values: 0-255

The lowest PresentationPriority value shall be considered as the MCVideo group transaction having the lowest priority for presentation among other group MCVideo and one-to-one user transactions.

13.2.52 `<x>/<x>/OnNetwork/ImplicitAffiliations`**Table 13.2.52.1: `<x>/<x>/OnNetwork/ImplicitAffiliations`**

`<x>/OnNetwork/ImplicitAffiliations`

Status	Occurrence	Format	Min. Access Types
Required	One	chr	Get, Replace

This interior node is a placeholder for the implicit affiliation configuration.

13.2.53 `<x>/<x>/OnNetwork/ImplicitAffiliations/<x>`**Table 13.2.53.1: `<x>/<x>/OnNetwork/ImplicitAffiliations/<x>`**

`<x>/OnNetwork/ImplicitAffiliations/<x>`

Status	Occurrence	Format	Min. Access Types
Required	ZeroOrMore	node	Get, Replace

This interior node is a placeholder for zero or more implicit affiliation configuration.

13.2.54 `<x>/<x>/OnNetwork/ImplicitAffiliations/<x>/Entry`**Table 13.2.54.1: `<x>/<x>/OnNetwork/ImplicitAffiliations/<x>/Entry`**

`<x>/OnNetwork/ImplicitAffiliations/<x>/Entry`

Status	Occurrence	Format	Min. Access Types
Optional	One	node	Get, Replace

This interior node is a placeholder for the details of the on-network MCVideo groups that the MCVideo user is implicitly affiliated to.

### 13.2.55 `<x>/<x>/OnNetwork/ImplicitAffiliations/<x>/Entry/MCVideoGroupID`

**Table 13.2.55.1: `<x>/<x>/OnNetwork/ImplicitAffiliations/<x>/Entry/MCVideoGroupID`**

`<x>/OnNetwork/ImplicitAffiliations/<x>/Entry/MCVideoGroupID`

Status	Occurrence	Format	Min. Access Types
Required	One	chr	Get, Replace

This leaf node indicates a MCVideo group ID to which the MCVideo user is implicitly affiliated to.

The value is a "uri" attribute specified in OMA OMA-TS-XDM\_Group-V1\_1 [4].

### 13.2.56 `<x>/<x>/OnNetwork/ImplicitAffiliations/<x>/Entry/DisplayName`

**Table 13.2.56.1: `<x>/<x>/OnNetwork/ImplicitAffiliations/<x>/Entry/DisplayName`**

`<x>/OnNetwork/ImplicitAffiliations/<x>/Entry/DisplayName`

Status	Occurrence	Format	Min. Access Types
Optional	One	chr	Get, Replace

This leaf node contains a human readable name that corresponds to the MCVideo Group ID.

### 13.2.57 `<x>/<x>/OnNetwork/PresenceStatus`

**Table 13.2.57.1: `<x>/<x>/OnNetwork/PresenceStatus`**

`<x>/OnNetwork/PresenceStatus`

Status	Occurrence	Format	Min. Access Types
Required	One	chr	Get, Replace

This interior node is a placeholder for the presence status configuration.

### 13.2.58 `<x>/<x>/OnNetwork/PresenceStatus/<x>`

**Table 13.2.58.1: `<x>/<x>/OnNetwork/PresenceStatus/<x>`**

`<x>/OnNetwork/PresenceStatus/<x>`

Status	Occurrence	Format	Min. Access Types
Required	ZeroOrMore	node	Get, Replace

This interior node is a placeholder for zero or more presence status configuration.

### 13.2.59 `<x>/<x>/OnNetwork/PresenceStatus/<x>/Entry`

**Table 13.2.59.1: `<x>/<x>/OnNetwork/PresenceStatus/<x>/Entry`**

`<x>/OnNetwork/PresenceStatus/<x>/Entry`

Status	Occurrence	Format	Min. Access Types
Optional	One	node	Get, Replace

This interior node is a placeholder for the details of the MCVideo IDs of MCVideo users that the configured MCVideo user is authorised to obtain presence status;

## 13.2.60 /&lt;x&gt;/&lt;x&gt;/OnNetwork/PresenceStatus/&lt;x&gt;/Entry/MCVideoGroupID

**Table 13.2.60.1: /<x>/<x>/OnNetwork/PresenceStatus/<x>/Entry/MCVideoGroupID**

&lt;x&gt;/OnNetwork/PresenceStatus/&lt;x&gt;/Entry/MCVideoGroupID

Status	Occurrence	Format	Min. Access Types
Required	One	chr	Get, Replace

This leaf node indicates an MCVideo ID of an MCVideo user that the configured MCVideo user is authorised to obtain presence status;

The value is a "uri" attribute specified in OMA OMA-TS-XDM\_Group-V1\_1 [4].

## 13.2.61 /&lt;x&gt;/&lt;x&gt;/OnNetwork/PresenceStatus/&lt;x&gt;/Entry/DisplayName

**Table 13.2.61.1: /<x>/<x>/OnNetwork/PresenceStatus/<x>/Entry/DisplayName**

&lt;x&gt;/OnNetwork/PresenceStatus/&lt;x&gt;/Entry/DisplayName

Status	Occurrence	Format	Min. Access Types
Optional	One	chr	Get, Replace

This leaf node contains a human readable name that corresponds to the MCVideo ID.

## 13.2.62 /&lt;x&gt;/&lt;x&gt;/OnNetwork/RemoteGroupChange

**Table 13.2.62.1: /<x>/<x>/OnNetwork/RemoteGroupChange**

&lt;x&gt;/OnNetwork/RemoteGroupChange

Status	Occurrence	Format	Min. Access Types
Required	One	chr	Get, Replace

This interior node is a placeholder for the remote group change configuration.

## 13.2.63 /&lt;x&gt;/&lt;x&gt;/OnNetwork/RemoteGroupChange/&lt;x&gt;

**Table 13.2.63.1: /<x>/<x>/OnNetwork/RemoteGroupChange/<x>**

&lt;x&gt;/OnNetwork/RemoteGroupChange/&lt;x&gt;

Status	Occurrence	Format	Min. Access Types
Required	ZeroOrMore	node	Get, Replace

This interior node is a placeholder for zero or more remote group change configuration.

## 13.2.64 /&lt;x&gt;/&lt;x&gt;/OnNetwork/RemoteGroupChange/&lt;x&gt;/Entry

**Table 13.2.64.1: /<x>/<x>/OnNetwork/RemoteGroupChange/<x>/Entry**

&lt;x&gt;/OnNetwork/RemoteGroupChange/&lt;x&gt;/Entry

Status	Occurrence	Format	Min. Access Types
Optional	One	node	Get, Replace

This interior node is a placeholder for the details of the MCVideo IDs of MCVideo users whose selected groups are authorised to be remotely changed by the configured MCVideo user;

## 13.2.65

`/<x>/<x>/OnNetwork/RemoteGroupChange/<x>/Entry/MCVideoGroupID`

**Table 13.2.65.1: `/<x>/<x>/OnNetwork/RemoteGroupChange/<x>/Entry/MCVideoGroupID`**

`<x>/OnNetwork/RemoteGroupChange/<x>/Entry/MCVideoGroupID`

Status	Occurrence	Format	Min. Access Types
Required	One	chr	Get, Replace

This leaf node indicates an MCVideo ID of an MCVideo user whose selected groups are authorised to be remotely changed by the configured MCVideo user;

The value is a "uri" attribute specified in OMA OMA-TS-XDM\_Group-V1\_1 [4].

13.2.66 `/<x>/<x>/OnNetwork/RemoteGroupChange/<x>/Entry/DisplayName`

**Table 13.2.66.1: `/<x>/<x>/OnNetwork/RemoteGroupChange/<x>/Entry/DisplayName`**

`<x>/OnNetwork/RemoteGroupChange/<x>/Entry/DisplayName`

Status	Occurrence	Format	Min. Access Types
Optional	One	chr	Get, Replace

This leaf node contains a human readable name that corresponds to the MCVideo ID.

13.2.67 `/<x>/<x>/OnNetwork/MaxAffiliationsNc2`

**Table 13.2.67.1: `/<x>/<x>/OnNetwork/MaxAffiliationsNc2`**

`<x>/OnNetwork/MaxAffiliationsNc2`

Status	Occurrence	Format	Min. Access Types
Optional	One	int	Get, Replace

This leaf node indicates the maximum number of MCVideo groups that the MCVideo user is authorised to affiliate with.

- Values: 0-65535

13.2.68 `/<x>/<x>/OnNetwork/AllowedRegroup`

**Table 13.2.68.1: `/<x>/<x>/OnNetwork/AllowedRegroup`**

`<x>/OnNetwork/AllowedRegroup`

Status	Occurrence	Format	Min. Access Types
Required	One	bool	Get, Replace

This leaf node indicates whether the MCVideo user is authorised to perform dynamic regrouping operations.

When set to "true" the MCVideo user is authorised to perform dynamic regrouping operations.

When set to "false" the MCVideo user is not authorised to perform dynamic regrouping operations.

13.2.69 `/<x>/<x>/OnNetwork/AllowedPresenceStatus`

**Table 13.2.69.1: `/<x>/<x>/OnNetwork/AllowedPresenceStatus`**

`<x>/OnNetwork/AllowedPresenceStatus`

Status	Occurrence	Format	Min. Access Types
Optional	One	bool	Get, Replace



This leaf node indicates the presence status on the network of this MCVideo user is available.

When set to "true" the presence status on the network of this MCVideo user is available.

When set to "false" the presence status on the network of this MCVideo user is not available. This is the default if this leaf node is not present.

### 13.2.70 /<x>/<x>/OnNetwork/AllowedPresence

**Table 13.2.70.1: /<x>/<x>/OnNetwork/AllowedPresence**

<x>/OnNetwork/AllowedPresence

Status	Occurrence	Format	Min. Access Types
Optional	One	bool	Get, Replace

This leaf node indicates whether the MCVideo user is authorised to obtain whether a particular MCVideo User is present on the network.

When set to "true" the MCVideo user is authorised to obtain whether a particular MCVideo User is present on the network.

When set to "false" the MCVideo user is not authorised to obtain whether a particular MCVideo User is present on the network. This is the default if this leaf node is not present.

### 13.2.71 /<x>/<x>/OnNetwork/AllowedManualSwitch

**Table 13.2.71.1: /<x>/<x>/OnNetwork/AllowedManualSwitch**

<x>/OnNetwork/AllowedManualSwitch

Status	Occurrence	Format	Min. Access Types
Required	One	bool	Get, Replace

This leaf node indicates whether the MCVideo user is authorised to manually switch to off-network operation while in on-network operation.

When set to "true" the MCVideo user is authorised to manually switch to off-network operation while in on-network operation.

When set to "false" the MCVideo user is not authorised to manually switch to off-network operation while in on-network operation.

### 13.2.72 /<x>/<x>/OnNetwork/DeletionPeriod

**Table 13.2.72.1: /<x>/<x>/OnNetwork/DeletionPeriod**

<x>/OnNetwork/DeletionPeriod

Status	Occurrence	Format	Min. Access Types
Required	One	int	Get, Replace

This leaf node indicates the period (in hours) after which MCVideo data on an MCVideo UE is to be deleted if no action is taken by an authorized MCVideo user.

- Values: 0-65535

### 13.2.73 /<x>/<x>/OnNetwork/MaxSimultaneousVideoStreams

**Table 13.2.73.1: /<x>/<x>/OnNetwork/MaxSimultaneousVideoStreams**

<x>/OnNetwork/MaxSimultaneousVideoStreams

Status	Occurrence	Format	Min. Access Types
Required	One	chr	Get, Replace

This interior node is a placeholder for maximum number of simultaneous video streams that can be received.

### 13.2.74 /<x>/<x>/OnNetwork/MaxSimultaneousVideoStreams/MaxStreams

**Table 13.2.74.1: /<x>/<x>/OnNetwork/MaxSimultaneousVideoStreams/MaxStreams**

<x>/OnNetwork/MaxSimultaneousVideoStreams/MaxStreams

Status	Occurrence	Format	Min. Access Types
Optional	One	int	Get, Replace

This leaf node indicates the maximum number of simultaneous video streams that can be received.

- Values: 0-65535

### 13.2.75

#### /<x>/<x>/OnNetwork/MaxSimultaneousVideoStreams/AllowedUnlimited

**Table 13.2.75.1: /<x>/<x>/OnNetwork/MaxSimultaneousVideoStreams/AllowedUnlimited**

<x>/OnNetwork/MaxSimultaneousVideoStreams/AllowedUnlimited

Status	Occurrence	Format	Min. Access Types
Required	One	bool	Get, Replace

This leaf node indicates whether the MCVideo user can receive an unlimited number of simultaneous video streams.

When set to "true" the MCVideo user is allowed to receive an unlimited number of simultaneous video streams .

When set to "false" the MCVideo user is not allowed to receive an unlimited number of simultaneous video streams.

When set to "true", the value in the MaxStreams element (if present) is ignored.

### 13.2.76 /<x>/<x>/OnNetwork/AllowedAutoRecv

**Table 13.2.76.1: /<x>/<x>/OnNetwork/AllowedAutoRecv**

<x>/OnNetwork/AllowedAutoRecv

Status	Occurrence	Format	Min. Access Types
Required	One	bool	Get, Replace

This leaf node indicates whether the MCVideo user is authorised to automatically receive video communications.

When set to "true" the MCVideo user is authorised to automatically receive video communications.

When set to "false" the MCVideo user is not authorised to automatically receive video communications.

### 13.2.77 /<x>/<x>/OnNetwork/AllowedAutoRecvEmergency

**Table 13.2.77.1: /<x>/<x>/OnNetwork/AllowedAutoRecvEmergency**

<x>/OnNetwork/AllowedAutoRecvEmergency

Status	Occurrence	Format	Min. Access Types
Required	One	bool	Get, Replace

This leaf node indicates whether the MCVideo user is authorised to automatically receive emergency video streams.

When set to "true" the MCVideo user is authorised to automatically receive emergency video streams.

When set to "false" the MCVideo user is not authorised to automatically receive emergency video streams.

### 13.2.78 /<x>/<x>/OnNetwork/AllowedAutoRecvImminentPeril

**Table 13.2.78.1: /<x>/<x>/OnNetwork/AllowedAutoRecvImminentPeril**

<x>/OnNetwork/AllowedAutoRecvImminentPeril

Status	Occurrence	Format	Min. Access Types
Required	One	bool	Get, Replace

This leaf node indicates whether the MCVideo user is authorised to automatically receive imminent peril video streams.

When set to "true" the MCVideo user is authorised to automatically receive imminent peril video streams.

When set to "false" the MCVideo user is not authorised to automatically receive imminent peril video streams.

### 13.2.79 /<x>/<x>/OnNetwork/MandatoryReceiveGroups

**Table 13.2.79.1: /<x>/<x>/OnNetwork/MandatoryReceiveGroups**

<x>/OnNetwork/MandatoryReceiveGroups

Status	Occurrence	Format	Min. Access Types
Required	One	node	Get, Replace

This interior node is a placeholder for the list of on-network MCVideo groups for which video can be automatically/mandatorily received.

### 13.2.80 /<x>/<x>/OnNetwork/MandatoryReceiveGroups/<x>

**Table 13.2.80.1: /<x>/<x>/OnNetwork/MCVideoGroupList/<x>**

<x>/OnNetwork/MandatoryReceiveGroups/<x>

Status	Occurrence	Format	Min. Access Types
Required	ZeroOrMore	node	Get, Replace

This interior node is a placeholder for zero or more list of on-network MCVideo groups for which video can be automatically/mandatorily received.

### 13.2.81 /<x>/<x>/OnNetwork/MandatoryReceiveGroups/<x>/Entry

**Table 13.2.81.1: /<x>/<x>/OnNetwork/MCVideoGroupList/<x>/Entry**

<x>/OnNetwork/MandatoryReceiveGroups/<x>/Entry

Status	Occurrence	Format	Min. Access Types
Optional	One	node	Get, Replace

This interior node is a placeholder for the details of an on-network MCVideo group for which video can be automatically/mandatorily received.

### 13.2.82

#### /<x>/<x>/OnNetwork/MandatoryReceiveGroups/<x>/Entry/MCVideoGroupID

**Table 13.2.82.1: /<x>/<x>/OnNetwork/MandatoryReceiveGroups/<x>/Entry/MCVideoGroupID**

<x>/OnNetwork/MandatoryReceiveGroups/<x>/Entry/MCVideoGroupID

Status	Occurrence	Format	Min. Access Types
Required	One	chr	Get, Replace

This leaf node indicates the MCVideo group ID for the on-network MCVideo group for which video can be automatically/mandatorily received.

The value is a "uri" attribute specified in OMA OMA-TS-XDM\_Group-V1\_1 [4].

### 13.2.83

`<x>/<x>/OnNetwork/MandatoryReceiveGroups/<x>/Entry/DisplayName`

**Table 13.2.83.1: `<x>/<x>/OnNetwork/MCVideoGroupList/<x>/Entry/DisplayName`**

`<x>/OnNetwork/MandatoryReceiveGroups/<x>/Entry/DisplayName`

Status	Occurrence	Format	Min. Access Types
Optional	One	chr	Get, Replace

This leaf node contains a human readable name that corresponds to the MCVideo Group ID.

### 13.2.84 `<x>/<x>/OnNetwork/AllowedRequestOverride`

**Table 13.2.84.1: `<x>/<x>/OnNetwork/AllowedRequestOverride`**

`<x>/OnNetwork/AllowedRequestOverride`

Status	Occurrence	Format	Min. Access Types
Required	One	bool	Get, Replace

This leaf node indicates whether the MCVideo user is authorised to request to override an active MCVideo transmission.

When set to "true" the MCVideo user is authorised to request to override an active MCVideo transmission.

When set to "false" the MCVideo user is not authorised to request to override an active MCVideo transmission.

### 13.2.85 `<x>/<x>/OnNetwork/AllowedSelectOverride`

**Table 13.2.85.1: `<x>/<x>/OnNetwork/AllowedSelectOverride`**

`<x>/OnNetwork/AllowedSelectOverride`

Status	Occurrence	Format	Min. Access Types
Required	One	bool	Get, Replace

This leaf node indicates whether the MCVideo user is authorised to select MCVideo transmissions that can be overridden.

When set to "true" the MCVideo user is authorised to select MCVideo transmissions that can be overridden.

When set to "false" the MCVideo user is not authorised to select MCVideo transmissions that can be overridden.

### 13.2.86 `<x>/<x>/OnNetwork/AllowedOverrideGroupCall`

**Table 13.2.86.1: `<x>/<x>/OnNetwork/AllowedOverrideGroupCall`**

`<x>/OnNetwork/AllowedOverrideGroupCall`

Status	Occurrence	Format	Min. Access Types
Required	One	bool	Get, Replace

This leaf node indicates whether the MCVideo user is authorised to allow MCVideo private communications to override active MCVideo group communications

When set to "true" the MCVideo user is authorised to allow MCVideo private communications to override active MCVideo group communications.

When set to "false" the MCVideo user is not authorised to allow MCVideo private communications to override active MCVideo group communications.

### 13.2.87 /<x>/<x>/OnNetwork/MaxTimeSingleTransmit

**Table 13.2.87.1: /<x>/<x>/OnNetwork/MaxTimeSingleTransmit**

<x>/OnNetwork/MaxTimeSingleTransmit

Status	Occurrence	Format	Min. Access Types
Required	One	int	Get, Replace

This leaf node indicates the maximum length of time that an MCVideo user can transmit for a single video transmission.

- Values: 0-65535

The MaxTimeSingleTransmit time is in seconds.

### 13.2.88 /<x>/<x>/OffNetwork

**Table 13.2.88.1: /<x>/<x>/OffNetwork**

<x>/OffNetwork

Status	Occurrence	Format	Min. Access Types
Required	ZeroOrOne	node	Get, Replace

This interior node represents a container for off-network operation.

### 13.2.89 /<x>/<x>/OffNetwork/Authorised

**Table 13.2.89.1: /<x>/<x>/OffNetwork/Authorised**

<x>/OffNetwork/Authorised

Status	Occurrence	Format	Min. Access Types
Required	One	bool	Get, Replace

This leaf node indicates the authorisation for off-network services.

When set to "true" the MCVideo user is authorised for off-network operation.

When set to "false" the MCVideo user is not authorised for off-network operation.

### 13.2.90 /<x>/<x>/OffNetwork/MCVideoGroupList

**Table 13.2.90.1: /<x>/<x>/OffNetwork/MCVideoGroupList**

<x>/OffNetwork/MCVideoGroupList

Status	Occurrence	Format	Min. Access Types
Required	One	node	Get, Replace

This interior node is a placeholder for the list of off-network MCVideo groups that the MCVideo user is allowed to use.

### 13.2.91 /<x>/<x>/OffNetwork/MCVideoGroupList/<x>

**Table 13.2.91.1: /<x>/<x>/OffNetwork/MCVideoGroupList/<x>**

<x>/OffNetwork/MCVideoGroupList/<x>

Status	Occurrence	Format	Min. Access Types
Required	OneOrMore	node	Get, Replace

This interior node is a placeholder for one or more list of off-network MCVideo groups that the MCVideo user is allowed to use.

### 13.2.92 /<x>/<x>/OffNetwork/MCVideoGroupList/<x>/Entry

**Table 13.2.92.1: /<x>/<x>/OffNetwork/MCVideoGroupList/<x>/Entry**

<x>/OffNetwork/MCVideoGroupList/<x>/Entry

Status	Occurrence	Format	Min. Access Types
Optional	One	node	Get, Replace

This interior node is a placeholder for the details of the off-network MCVideo groups that the MCVideo user is allowed to use.

### 13.2.93

#### /<x>/<x>/OffNetwork/MCVideoGroupList/<x>/Entry/MCVideoGroupID

**Table 13.2.93.1: /<x>/<x>/OffNetwork/MCVideoGroupList/<x>/Entry/MCVideoGroupID**

<x>/OffNetwork/MCVideoGroupList/<x>/Entry/MCVideoGroupID

Status	Occurrence	Format	Min. Access Types
Required	One	chr	Get, Replace

This leaf node indicates the MCVideo group ID for the off-network MCVideo group that the MCVideo user is allowed to use.

The value is a "uri" attribute specified in OMA OMA-TS-XDM\_Group-V1\_1 [4].

### 13.2.94 /<x>/<x>/OffNetwork/MCVideoGroupList/<x>/Entry/DisplayName

**Table 13.2.94.1: /<x>/<x>/OffNetwork/MCVideoGroupList/<x>/Entry/DisplayName**

<x>/OffNetwork/MCVideoGroupList/<x>/Entry/DisplayName

Status	Occurrence	Format	Min. Access Types
Optional	One	chr	Get, Replace

This leaf node contains a human readable name that corresponds to the MCVideo Group ID.

### 13.2.95

#### /<x>/<x>/OffNetwork/MCVideoGroupList/<x>/Entry/GMSAppServList

**Table 13.2.95.1: /<x>/<x>/OffNetwork/MCVideoGroupList/<x>/Entry/GMSAppServList**

<x>/OffNetwork/MCVideoGroupList/<x>/Entry/GMSAppServList

Status	Occurrence	Format	Min. Access Types
Required	One	node	Get, Replace

This interior node is a placeholder for the Group Management Server application plane server identity configuration.

## 13.2.96

`<x>/<x>/OffNetwork/MCVideoGroupList/<x>/Entry/GMSAppServList/<x>`

**Table 13.2.96.1: `<x>/<x>/OffNetwork/MCVideoGroupList/<x>/Entry/GMSAppServList/<x>`**

`<x>/OffNetwork/MCVideoGroupList/<x>/Entry/GMSAppServList/<x>`

Status	Occurrence	Format	Min. Access Types
Required	OneOrMore	node	Get, Replace

This interior node is a placeholder for one or more Group Management Server configuration.

## 13.2.97

`<x>/<x>/OffNetwork/MCVideoGroupList/<x>/Entry/GMSAppServList/<x>/GMSAppServId`

**Table 13.2.97.1:**

**`<x>/<x>/OffNetwork/MCVideoGroupList/<x>/Entry/GMSAppServList/<x>/GMSAppServId`**

`<x>/OffNetwork/MCVideoGroupList/<x>/Entry/GMSAppServList/<x>/GMSAppServId`

Status	Occurrence	Format	Min. Access Types
Optional	One	chr	Get, Replace

This leaf node indicates the identity (URI) of the the group management server hosting the MCVideo Group ID.

## 13.2.98

`<x>/<x>/OffNetwork/MCVideoGroupList/<x>/Entry/IdMSTokenEndPointList`

**Table 13.2.98.1: `<x>/<x>/OffNetwork/MCVideoGroupList/<x>/Entry/IdMSTokenEndPointList`**

`<x>/OffNetwork/MCVideoGroupList/<x>/Entry/IdMSTokenEndPointList`

Status	Occurrence	Format	Min. Access Types
Required	One	node	Get, Replace

This interior node is a placeholder for the Identity Management Server application plane server identity configuration.

13.2.99 `<x>/<x>/OffNetwork/MCVideoGroupList/<x>/Entry/IdMSTokenEndPointList/<x>`

**Table 13.2.99.1: `<x>/<x>/OffNetwork/MCVideoGroupList/<x>/Entry/IdMSTokenEndPointList/<x>`**

`<x>/OffNetwork/MCVideoGroupList/<x>/Entry/IdMSTokenEndPointList/<x>`

Status	Occurrence	Format	Min. Access Types
Required	OneOrMore	node	Get, Replace

This interior node is a placeholder for one or more Identity Management Server configuration.

## 13.2.100

`/<x>/<x>/OffNetwork/MCVideoGroupList/<x>/Entry/IdMSTokenEndPointList/<x>/IdMSTokenEndPoint`

Table 13.2.100.1:

`/<x>/<x>/OffNetwork/MCVideoGroupList/<x>/Entry/IdMSTokenEndPointList/<x>/IdMSTokenEndPoint`

`<x>/OffNetwork/MCVideoGroupList/<x>/Entry/IdMSTokenEndPointList/<x>/IdMSTokenEndPoint`

Status	Occurrence	Format	Min. Access Types
Optional	One	chr	Get, Replace

This leaf node indicates the identity (URI) of the the identity management server hosting the MCVideo Group ID.

## 13.2.101

`/<x>/<x>/OffNetwork/MCVideoGroupList/<x>/>/Entry/PresentationPriority`

Table 13.2.101.1: `/<x>/<x>/OffNetwork/MCVideoGroupList/<x>/Entry/PresentationPriority`

`<x>/OffNetwork/MCVideoGroupList/<x>/Entry/PresentationPriority`

Status	Occurrence	Format	Min. Access Types
Optional	One	int	Get, Replace

This leaf node indicates indicating the presentation priority of the off-network group for the MCVideo user relative to other off-network groups and off-network users.

- Values: 0-255

The lowest PresentationPriority value shall be considered as the MCVideo group transaction having the lowest priority for presentation among other group MCVideo and one-to-one user transactions.

13.2.102 `/<x>/<x>/OffNetwork/UserInfoID`Table 13.2.102.1: `/<x>/<x>/OffNetwork/UserInfoID`

`<x>/OffNetwork/UserInfoID`

Status	Occurrence	Format	Min. Access Types
Required	One	chr	Get, Replace

This leaf node indicates the ProSe user info ID as specified in 3GPP TS 23.303 [6].

13.2.103 `/<x>/Status`Table 13.2.103.1: `/<x>/Status`

Status

Status	Occurrence	Format	Min. Access Types
Optional	One	bool	Get, Replace

This leaf node indicates whether this MCVideo user profile is enabled or disabled.

When set to "true" this MCVideo user profile is enabled.

When set to "false" this MCVideo user profile is disabled.



# 14 MCVideo service configuration MO

## 14.1 General

The MCVideo service configuration Management Object (MO) is used to configure MCVideo Client behaviour for the on-network or off-network MCVideo Service. The MCVideo service configuration parameters may be stored in the ME, or in the USIM as specified in 3GPP TS 31.102 [10], or in both the ME and the USIM. If both the ME and the USIM contain the same parameters, the values stored in the USIM shall take precedence.

The Management Object Identifier is: urn:oma:mo:ext-3gpp-MCVideo-service-configuration:1.0.

Protocol compatibility: This MO is compatible with OMA OMA DM 1.2 [3].

The OMA DM ACL property mechanism (see OMA OMA-ERELED-DM-V1\_2 [2]) may be used to grant or deny access rights to OMA DM servers in order to modify nodes and leaf objects of the MCVideo service configuration MO.

The following nodes and leaf objects are possible under the MCVideo service configuration node as described in figure 14.1.1:

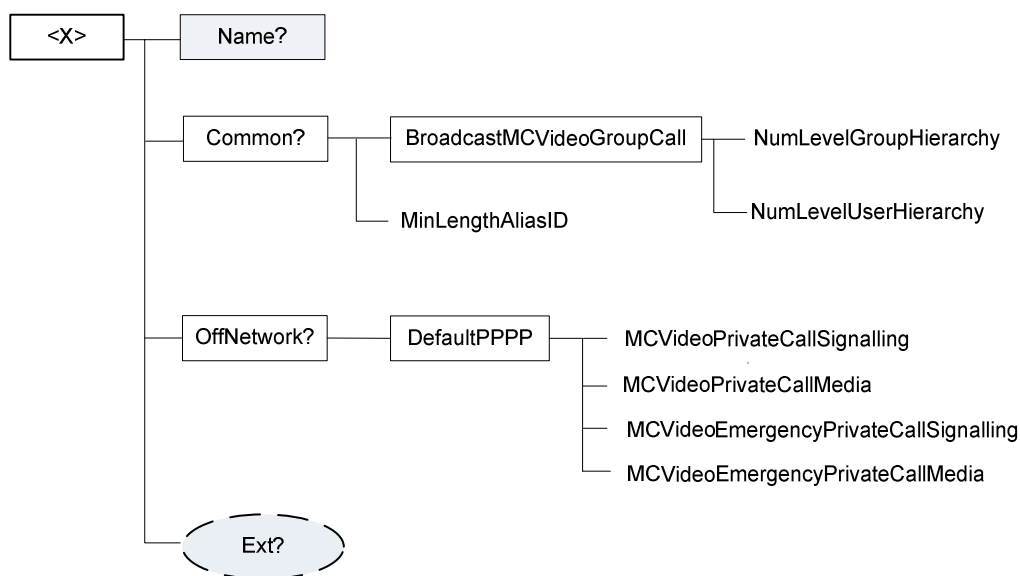

Figure 14.1.1: The MCVideo service configuration MO

## 14.2 MCVideo service configuration MO parameters

### 14.2.1 General

This clause describes the parameters for the MCVideo service configuration Management Object (MO).

### 14.2.2 Node: <x>

Table 14.2.2.1: Node: <x>

<x>

Status	Occurrence	Format	Min. Access Types
Required	OneOrMore	node	Get

This interior node acts as a placeholder for the MCVideo service configuration Management Object (MO).

For the MCVideo service configuration MO, the namespace specific string is: "urn:oma:mo:oma-dm-mcvideo-service configuration:1.0"

- Values: N/A

### 14.2.3 /<x>/Name

**Table 14.2.3.1: /<x>/Name**

Name

Status	Occurrence	Format	Min. Access Types
Required	ZeroOrOne	chr	Get

The Name leaf is a name for the MCVideo service configuration settings.

- Values: <User displayable name>

### 14.2.4 /<x>/Ext/

**Table 14.2.4.1: /<x>/Ext/**

Ext

Status	Occurrence	Format	Min. Access Types
Optional	ZeroOrOne	node	Get, Replace

The Ext is an interior node for where the vendor specific information about the MCVideo service configuration MO is being placed.

Usually the vendor extension is identified by vendor specific name under the ext node and contains the vendor meaning application vendor, device vendor etc. The tree structure under the vendor identified is not defined and can therefore include one or more un-standardized sub-trees.

- Values: N/A

### 14.2.5 /<x>/Common

**Table 14.2.5.1: /<x>/Common**

Common

Status	Occurrence	Format	Min. Access Types
Required	ZeroOrOne	node	Get, Replace

This interior node represents a container for the common network operation which means both on-network operation and off-network operation.

### 14.2.6 /<x>/Common/BroadcastMCVideoGroupCall

**Table 14.2.6.1: /<x>/Common/BroadcastMCVideoGroupCall**

Common/BroadcastMCVideoGroupCall

Status	Occurrence	Format	Min. Access Types
Required	One	node	Get, Replace

This interior node is a placeholder for Broadcast MCVideo Group Call configuration.

## 14.2.7

## /&lt;x&gt;/Common/BroadcastMCVideoGroupCall/NumLevelGroupHierarchy

**Table 14.2.7.1: /<x>/Common/BroadcastMCVideoGroupCall/NumLevelGroupHierarchy**

Common/BroadcastMCVideoGroupCall/NumLevelGroupHierarchy

Status	Occurrence	Format	Min. Access Types
Required	One	int	Get, Replace

This leaf node indicates the number of levels of group hierarchy for group-broadcast groups.

- Values: 0-255

The group-broadcast group with the lowest NumLevelGroupHierarchy value shall be considered as the group-broadcast group having the lowest level among the groups.

## 14.2.8

## /&lt;x&gt;/Common/BroadcastMCVideoGroupCall/NumLevelUserHierarchy

**Table 14.2.8.1: /<x>/Common/BroadcastMCVideoGroupCall/NumLevelUserHierarchy**

Common/BroadcastMCVideoGroupCall/NumLevelUserHierarchy

Status	Occurrence	Format	Min. Access Types
Required	One	int	Get, Replace

This leaf node indicates the number of levels of user hierarchy for user-broadcast groups.

- Values: 0-255

The user-broadcast group with the lowest NumLevelUserHierarchy value shall be considered as the user-broadcast group the lowest level among the groups.

## 14.2.9 /&lt;x&gt;/Common/MinLengthAliasID

**Table 14.2.9.1: /<x>/Common/MinLengthAliasID**

Common/MinLengthAliasID

Status	Occurrence	Format	Min. Access Types
Required	One	int	Get, Replace

This leaf node indicates minimum length of an alphanumeric identifier (i.e., alias) assigned by an MCVideo administrator.

- Values: 0-255

## 14.2.10 /&lt;x&gt;/OffNetwork

**Table 14.2.10.1: /<x>/OffNetwork**

OffNetwork

Status	Occurrence	Format	Min. Access Types
Required	ZeroOrOne	node	Get, Replace

This interior node represents a container for off-network operation.

### 14.2.11 /<x>/OffNetwork/DefaultPPPP

**Table 14.2.11.1: /<x>/OffNetwork/DefaultPPPP**

OffNetwork/DefaultPPPP

Status	Occurrence	Format	Min. Access Types
Required	One	node	Get, Replace

This interior node is a placeholder for the default ProSe Per-Packet Priority (PPPP) configuration.

### 14.2.12 /<x>/OffNetwork/DefaultPPPP/MCVideoPrivateCallSignalling

**Table 14.2.12.1: /<x>/OffNetwork/DefaultPPPP/MCVideoPrivateCallSignalling**

OffNetwork/DefaultPPPP/MCVideoPrivateCallSignalling

Status	Occurrence	Format	Min. Access Types
Required	One	int	Get, Replace

This leaf node indicates the default ProSe Per-Packet Priority (PPPP) value (as specified in 3GPP TS 23.303 [6]) for the MCVideo private call signalling.

- Values: 1-8

The MCVideo user data with the lowest ProSe Per-Packet Priority value shall be considered as the MCVideo user data having the highest priority among the MCVideo user data.

### 14.2.13 /<x>/OffNetwork/DefaultPPPP/MCVideoPrivateCallMedia

**Table 14.2.13.1: /<x>/OffNetwork/DefaultPPPP/MCVideoPrivateCallMedia**

OffNetwork/DefaultPPPP/MCVideoPrivateCallMedia

Status	Occurrence	Format	Min. Access Types
Required	One	int	Get, Replace

This leaf node indicates the default ProSe Per-Packet Priority (PPPP) value (as specified in 3GPP TS 23.303 [6]) for the MCVideo private call media.

- Values: 1-8

The MCVideo user data with the lowest ProSe Per-Packet Priority value shall be considered as the MCVideo user data having the highest priority among the MCVideo user data.

### 14.2.14

#### /<x>/OffNetwork/DefaultPPPP/MCVideoEmergencyPrivateCallSignalling

**Table 14.2.14.1: /<x>/OffNetwork/DefaultPPPP/MCVideoEmergencyPrivateCallSignalling**

OffNetwork/DefaultPPPP/MCVideoEmergencyPrivateCallSignalling

Status	Occurrence	Format	Min. Access Types
Required	One	int	Get, Replace

This leaf node indicates the default ProSe Per-Packet Priority (PPPP) value (as specified in 3GPP TS 23.303 [6]) for the MCVideo emergency private call signalling.

- Values: 1-8

The MCVideo user data with the lowest ProSe Per-Packet Priority value shall be considered as the MCVideo user data having the highest priority among the MCVideo user data.

## 14.2.15 /<x>/OffNetwork/DefaultPPPP/MCVideoEmergencyPrivateCallMedia

**Table 14.2.15.1: /<x>/OffNetwork/DefaultPPPP/MCVideoEmergencyPrivateCallMedia**

OffNetwork/DefaultPPPP/MCVideoEmergencyPrivateCallMedia

Status	Occurrence	Format	Min. Access Types
Required	One	int	Get, Replace

This leaf node indicates the default ProSe Per-Packet Priority (PPPP) value (as specified in 3GPP TS 23.303 [6]) for the MCVideo emergency private call media.

- Values: 1-8

The MCVideo user data with the lowest ProSe Per-Packet Priority value shall be considered as the MCVideo user data having the highest priority among the MCVideo user data.

---

## Annex A (informative): MCPTT UE configuration MO DDF

This DDF is the standardized minimal set. A vendor can define it's own DDF for the complete device. This DDF can include more features than this minimal standardized version. The DDF is included as an XML file.

---

## Annex B (informative): MCPTT user profile MO DDF

This DDF is the standardized minimal set. A vendor can define it's own DDF for the complete device. This DDF can include more features than this minimal standardized version. The DDF is included as an XML file.

---

## Annex C (informative): MCPTT group configuration MO DDF

This DDF is the standardized minimal set. A vendor can define it's own DDF for the complete device. This DDF can include more features than this minimal standardized version. The DDF is included as an XML file.



---

## Annex D (informative): MCPTT service configuration MO DDF

This DDF is the standardized minimal set. A vendor can define it's own DDF for the complete device. This DDF can include more features than this minimal standardized version. The DDF is included as an XML file.

---

## Annex E (informative): MCPTT UE initial configuration MO DDF

This DDF is the standardized minimal set. A vendor can define it's own DDF for the complete device. This DDF can include more features than this minimal standardized version. The DDF is included as an XML file.

---

## Annex F (informative): MCVideo UE configuration MO DDF

This DDF is the standardized minimal set. A vendor can define its own DDF for the complete device. This DDF can include more features than this minimal standardized version. The DDF is included as an XML file.

---

## Annex G (informative): MCVideo user profile configuration MO DDF

This DDF is the standardized minimal set. A vendor can define its own DDF for the complete device. This DDF can include more features than this minimal standardized version. The DDF is included as an XML file.

---

## Annex H (informative): MCVideo service configuration MO DDF

This DDF is the standardized minimal set. A vendor can define its own DDF for the complete device. This DDF can include more features than this minimal standardized version. The DDF is included as an XML file.

---

## Annex I (informative): MCData UE configuration MO DDF

This DDF is the standardized minimal set. A vendor can define its own DDF for the complete device. This DDF can include more features than this minimal standardized version. The DDF is included as an XML file.

---

## Annex J (informative): MCData user profile configuration MO DDF

This DDF is the standardized minimal set. A vendor can define its own DDF for the complete device. This DDF can include more features than this minimal standardized version. The DDF is included as an XML file.

---

## Annex K (informative): MCData service configuration MO DDF

This DDF is the standardized minimal set. A vendor can define its own DDF for the complete device. This DDF can include more features than this minimal standardized version. The DDF is included as an XML file.



## Annex L (informative): Change history

Change history							
Date	TSG #	TSG Doc.	CR	Rev	Subject/Comment	Old	New
2015-07					Initial proposal to CT1	-	0.0.0
2015-08					Included skeleton from C1ah-150016 and scope from C1ah-150038 agreed at CT1#92bis	0.0.0	0.10
2015-08					Included CRs C1-152964 and C1-152965 agreed at CT1#93	0.1.0	0.2.0
2015-08					Revision number changed due to cover sheet modifications	0.2.0	0.2.1
2015-09					Modifying the cover sheet to add the TS number. Changes by the rapporteur.	0.2.1	0.2.2
2015-10					Included CRs C1-153754, and C1-153755 agreed at CT1#94	0.2.2	0.3.0
2016-01					Included CRs C1-160352, C1-160474, C1-160475, C1-160476, C1-160477 and C1-160478 agreed at CT1#95bis	0.3.0	0.4.0
2016-01					Editorial and formatting fixes	0.4.0	0.4.1
2016-02					Included CRs C1-161077, C1-161078, C1-161231, C1-161324, C1-161326, C1-161327, C1-161509 and C1-161510 agreed at CT1#96 Editorial and formatting fixes by the rapporteur.	0.4.1	0.5.0
2016-03	CT-71	CP-160056			Version 1.0.0 created for presentation for information and approval	0.5.0	1.0.0
2016-03	CT-71				Version 13.0.0 created after approval	1.0.0	13.0.0
2016-03					An editorial change from TS rapporteur	13.0.0	13.0.10
2016-06	CT-72	CP-160322	0002	1	Corrections to the scope of MCPTT Management Object (MO)	13.0.1	13.1.0
2016-06	CT-72	CP-160322	0003	3	Correction for MCPTT UE configuration management object (MO)	13.0.1	13.1.0
2016-06	CT-72	CP-160322	0004	3	Correction for MCPTT user profile management object (MO)	13.0.1	13.1.0
2016-06	CT-72	CP-160322	0005	2	Correction for MCPTT group configuration management object (MO)	13.0.1	13.1.0
2016-06	CT-72	CP-160322	0006	1	Correction for MCPTT service configuration management object (MO)	13.0.1	13.1.0
2016-06	CT-72	CP-160322	0007	3	Correction for MCPTT UE initial configuration management object (MO)	13.0.1	13.1.0
2016-06	CT-72	CP-160322	0011		Correction for security configuration parameters in MCPTT management object (MO)	13.0.1	13.1.0

Change history							
Date	Meeting	TDoc	CR	Rev	Cat	Subject/Comment	New version
2016-09	CT#73	CP-160565	0013	3	F	Correction for configuration parameters in MCPTT user profile management object (MO)	13.2.0
2016-09	CT#73	CP-160503	0014	1	F	Correction for group related parameters in MCPTT UE initial configuration management object (MO)	13.2.0
2016-09	CT#73	CP-160503	0015	1	F	Correction for security material parameter in MCPTT group configuration management object (MO)	13.2.0
2016-09	CT#73	CP-160503	0016		F	Correction for "MCPTTGroupPriorityHierarchy" value in MCPTT UE configuration management object (MO)	24.383 13.2.0
2016-12	CT#74					Change of spec number from 24.383 to 24.483 with wider scope and changed title	24.483 13.2.1
2016-12	CT#74	CP-160733	0018	1	F	Identity management endpoint UE initial configuration MO correction (24.383 CR)	13.3.0
2016-12	CT#74	CP-160733	0019	1	F	Correction for ProSe related configuration parameters (24.383 CR)	13.3.0
2016-12	CT#74	CP-160733	0020	3	F	Correction for MCPTT Private Call and Group Call in MCPTT user profile management (MO) (24.383 CR)	13.3.0
2016-12	CT#74	CP-160733	0021		F	Modify number of levels for priority hierarchy (24.383 CR)	13.3.0
2016-12	CT#74	CP-160733	0022	1	F	Identification of pre-selected MCPTT user profile in MCPTT user profile managed object. (24.383 CR)	13.3.0
2016-12	CT#74	CP-160734	0023	2	F	Off-network configuration parameter for queue (24.383 CR)	13.3.0
2017-03	CT#75	CP-170117	0001	2	F	Scope alignment with TS 24.483 title	13.4.0
2017-03	CT#75	CP-170117	0004		F	Corrections to upper limits	13.4.0
2017-03	CT#75	CP-170127	0002	1	F	Modifying references in TS 24.483 to cater for rel-14 Stage 2 and Stage 3 mission critical restructure	14.0.0
2017-03	CT#75	CP-170127	0003	1	F	Corrections and clean-up for 24.483	14.0.0
2017-03	CT#75	CP-170125	0005	1	B	MCPTT user profile MO modifications in support of private call call-back	14.0.0
2017-06	CT#76	CP-171080	0006		B	Updating general parts of TS 24.483 for MCDData, MCVideo and the initial configuration MO	14.1.0
2017-06	CT#76	CP-171080	0007	2	B	Modifications to the Group Configuration MO for MCDData and MCVideo	14.1.0
2017-06	CT#76	CP-171081	0008	1	B	MCVideo UE configuration MO	14.1.0
2017-06	CT#76	CP-171081	0009	2	B	MCVideo user profile configuration MO	14.1.0
2017-06	CT#76	CP-171081	0010		B	MCVideo service configuration MO	14.1.0
2017-06	CT#76	CP-171080	0011	2	B	MCDData UE configuration MO	14.1.0
2017-06	CT#76	CP-171080	0012	2	B	MCDData user profile configuration MO	14.1.0
2017-06	CT#76	CP-171080	0013	1	B	MCDData service configuration MO	14.1.0
2017-06	CT#76	CP-171114	0014	1	B	eMCPTT user profile MO updates	14.1.0
2017-06	CT#76	CP-171113	0016	1	A	AllowedFloorControlProtection configuration parameter	14.1.0
2017-06	CT#76	CP-171113	0018		A	QueueUsage configuration parameter	14.1.0
2017-06	CT#76	CP-171082	0019	1	F	Correction of User Aliases configuration parameter in the MCPTT user profile MO	14.1.0

---

# History

<b>Document history</b>		
V14.0.0	April 2017	Publication
V14.1.0	July 2017	Publication