

ETSI TS 125 101 V4.0.0 (2001-03)

Technical Specification

**Universal Mobile Telecommunications System (UMTS);
UE Radio Transmission and Reception (FDD)
(3GPP TS 25.101 version 4.0.0 Release 4)**



Reference

RTS/TSGR-0425101Uv4

Keywords

UMTS

ETSI

650 Route des Lucioles
F-06921 Sophia Antipolis Cedex - FRANCE

Tel.: +33 4 92 94 42 00 Fax: +33 4 93 65 47 16

Siret N° 348 623 562 00017 - NAF 742 C
Association à but non lucratif enregistrée à la
Sous-Préfecture de Grasse (06) N° 7803/88

Important notice

Individual copies of the present document can be downloaded from:

<http://www.etsi.org>

The present document may be made available in more than one electronic version or in print. In any case of existing or perceived difference in contents between such versions, the reference version is the Portable Document Format (PDF). In case of dispute, the reference shall be the printing on ETSI printers of the PDF version kept on a specific network drive within ETSI Secretariat.

Users of the present document should be aware that the document may be subject to revision or change of status. Information on the current status of this and other ETSI documents is available at <http://www.etsi.org/tb/status/>

If you find errors in the present document, send your comment to:
editor@etsi.fr

Copyright Notification

No part may be reproduced except as authorized by written permission.
The copyright and the foregoing restriction extend to reproduction in all media.

© European Telecommunications Standards Institute 2001.

All rights reserved.

Intellectual Property Rights

IPRs essential or potentially essential to the present document may have been declared to ETSI. The information pertaining to these essential IPRs, if any, is publicly available for **ETSI members and non-members**, and can be found in ETSI SR 000 314: "*Intellectual Property Rights (IPRs); Essential, or potentially Essential, IPRs notified to ETSI in respect of ETSI standards*", which is available from the ETSI Secretariat. Latest updates are available on the ETSI Web server (<http://www.etsi.org/ipr>).

Pursuant to the ETSI IPR Policy, no investigation, including IPR searches, has been carried out by ETSI. No guarantee can be given as to the existence of other IPRs not referenced in ETSI SR 000 314 (or the updates on the ETSI Web server) which are, or may be, or may become, essential to the present document.

Foreword

This Technical Specification (TS) has been produced by the ETSI 3rd Generation Partnership Project (3GPP).

The present document may refer to technical specifications or reports using their 3GPP identities, UMTS identities or GSM identities. These should be interpreted as being references to the corresponding ETSI deliverables.

The cross reference between GSM, UMTS, 3GPP and ETSI identities can be found under www.etsi.org/key.

Contents

Foreword.....	6
1 Scope	7
2 References	7
3 Definitions, symbols and abbreviations.....	7
3.1 Definitions.....	7
3.2 Abbreviations	8
4 General	9
4.1 Relationship between Minimum Requirements and Test Requirements.....	9
4.2 Power Classes	9
5 Frequency bands and channel arrangement.....	9
5.1 General.....	9
5.2 Frequency bands.....	9
5.3 TX–RX frequency separation.....	10
5.4 Channel arrangement	10
5.4.1 Channel spacing.....	10
5.4.2 Channel raster.....	10
5.4.3 Channel number.....	10
5.4.4 UARFCN.....	10
6 Transmitter characteristics.....	11
6.1 General.....	11
6.2 Transmit power	11
6.2.1 UE maximum output power	11
6.3 Frequency Error	11
6.4 Output power dynamics	12
6.4.1 Open loop power control	12
6.4.1.1 Minimum requirement.....	12
6.4.2 Inner loop power control in the uplink	12
6.4.2.1 Power control steps.....	12
6.4.2.1.1 Minimum requirement	12
6.4.3 Minimum transmit output power	13
6.4.3.1 Minimum requirement.....	13
6.4.4 Out-of-synchronization handling of output power	13
6.4.4.1 Minimum requirement.....	13
6.5 Transmit ON/OFF power	14
6.5.1 Transmit OFF power	14
6.5.1.1 Minimum requirement.....	14
6.5.2 Transmit ON/OFF Time mask.....	14
6.5.2.1 Minimum requirement.....	15
6.5.3 Change of TFC	16
6.5.3.1 Minimum requirement.....	16
6.5.4 Power setting in uplink compressed mode	17
6.5.4.1 Minimum requirement.....	17
6.6 Output RF spectrum emissions	18
6.6.1 Occupied bandwidth.....	18
6.6.2 Out of band emission.....	18
6.6.2.1 Spectrum emission mask	18
6.6.2.1.1 Minimum requirement	19
6.6.2.2 Adjacent Channel Leakage power Ratio (ACLR)	19
6.6.2.2.1 Minimum requirement	19
6.6.3 Spurious emissions	19
6.6.3.1 Minimum requirement.....	19
6.7 Transmit intermodulation.....	20
6.7.1 Minimum requirement.....	20

6.8	Transmit modulation	20
6.8.1	Transmit pulse shape filter	20
6.8.2	Error Vector Magnitude.....	21
6.8.2.1	Minimum requirement.....	21
6.8.3	Peak code domain error	21
6.8.3.1	Minimum requirement.....	21
7	Receiver characteristics	21
7.1	General.....	21
7.2	Diversity characteristics	22
7.3	Reference sensitivity level	22
7.3.1	Minimum requirement.....	22
7.4	Maximum input level	22
7.4.1	Minimum requirement.....	22
7.5	Adjacent Channel Selectivity (ACS).....	23
7.5.1	Minimum requirement.....	23
7.6	Blocking characteristics	23
7.6.1	Minimum requirement.....	23
7.7	Spurious response.....	24
7.7.1	Minimum requirement.....	24
7.8	Intermodulation characteristics	24
7.8.1	Minimum requirement.....	25
7.9	Spurious emissions.....	25
7.9.1	Minimum requirement.....	25
8	Performance requirement	25
8.1	General.....	25
8.2	Demodulation in static propagation conditions	26
8.2.1	(void).....	26
8.2.2	Demodulation of Forward Access Channel (FACH).....	26
8.2.3	Demodulation of Dedicated Channel (DCH).....	26
8.2.3.1	Minimum requirement.....	26
8.3	Demodulation of DCH in multi-path fading propagation conditions	27
8.3.1	Single Link Performance.....	27
8.3.1.1	Minimum requirement.....	27
8.4	Demodulation of DCH in moving propagation conditions	29
8.4.1	Single link performance.....	29
8.4.1.1	Minimum requirement.....	29
8.5	Demodulation of DCH in birth-death propagation conditions	30
8.5.1	Single link performance.....	30
8.5.1.1	Minimum requirement	30
8.6	Demodulation of DCH in downlink Transmit diversity modes.....	30
8.6.1	Demodulation of DCH in open-loop transmit diversity mode.....	30
8.6.1.1	Minimum requirement.....	31
8.6.2	Demodulation of DCH in closed loop transmit diversity mode.....	31
8.6.2.1	Minimum requirement.....	31
8.6.3	Demodulation of DCH in Site Selection Diversity Transmission Power Control mode	32
8.6.3.1	Minimum requirements	32
8.7	Demodulation in Handover conditions.....	32
8.7.1	Demodulation of DCH in Inter-Cell Soft Handover.....	32
8.7.1.1	Minimum requirement.....	33
8.7.2	Combining of TPC commands from radio links of different radio link sets	33
8.7.2.1	Minimum requirement.....	33
8.8	Power control in downlink	34
8.8.1	Power control in the downlink, constant BLER target	34
8.8.1.1	Minimum requirements	34
8.8.2	Power control in the downlink, initial convergence	35
8.8.2.1	Minimum requirements	35
8.8.3	Power control in downlink, wind up effects	36
8.8.3.1	Minimum requirements	36
8.9	Downlink compressed mode	37
8.9.1	Single link performance.....	37

8.9.1.1	Minimum requirements	37
8.10	Blind transport format detection	38
8.10.1	Minimum requirement	38
8.11	Detection of Broadcast channel (BCH)	39
8.11.1	Minimum requirement	39
8.12	Demodulation of Paging Channel (PCH)	40
8.12.1	Minimum requirement	40
8.13	Detection of Acquisition Indicator (AI)	40
8.13.1	Minimum requirement	40
Annex A (normative): Measurement channels		42
A.1	General	42
A.2	UL reference measurement channel	42
A.2.1	UL reference measurement channel (12.2 kbps)	42
A.2.2	UL reference measurement channel (64 kbps)	43
A.2.3	UL reference measurement channel (144 kbps)	44
A.2.4	UL reference measurement channel (384 kbps)	45
A.2.5	UL reference measurement channel (768 kbps)	46
A.3	DL reference measurement channel	47
A.3.1	DL reference measurement channel (12.2 kbps)	47
A.3.2	DL reference measurement channel (64 kbps)	48
A.3.3	DL reference measurement channel (144 kbps)	48
A.3.4	DL reference measurement channel (384 kbps)	49
A.4	DL reference measurement channel for BTFD performance requirements	50
A.5	DL reference compressed mode parameters	53
A.6	DL reference parameters for PCH tests	53
Annex B (normative): Propagation conditions		55
B.1	General	55
B.2	Propagation Conditions	55
B.2.1	Static propagation condition	55
B.2.2	Multi-path fading propagation conditions	55
B.2.3	Moving propagation conditions	55
B.2.4	Birth-Death propagation conditions	56
Annex C (normative): Downlink Physical Channels		57
C.1	General	57
C.2	Connection Set-up	57
C.3	During connection	57
C.3.1	Measurement of Rx Characteristics	57
C.3.2	Measurement of Performance requirements	57
C.3.3	Connection with open-loop transmit diversity mode	58
C.3.4	Connection with closed loop transmit diversity mode	59
Annex D (normative): Environmental conditions		61
D.1	General	61
D.2	Environmental requirements	61
D.2.1	Temperature	61
D.2.2	Voltage	61
D.2.3	Vibration	61
Annex F (informative): UE capabilities (FDD)		63
Annex G (informative): Change history		64

Foreword

This Technical Specification (TS) has been produced by the 3rd Generation Partnership Project (3GPP).

The contents of the present document are subject to continuing work within the TSG and may change following formal TSG approval. Should the TSG modify the contents of the present document, it will be re-released by the TSG with an identifying change of release date and an increase in version number as follows:

Version x.y.z

where:

- x the first digit:
 - 1 presented to TSG for information;
 - 2 presented to TSG for approval;
 - 3 or greater indicates TSG approved document under change control.
- y the second digit is incremented for all changes of substance, i.e. technical enhancements, corrections, updates, etc.
- z the third digit is incremented when editorial only changes have been incorporated in the document.

1 Scope

The present document establishes the minimum RF characteristics of the FDD mode of UTRA for the User Equipment (UE).

2 References

The following documents contain provisions which, through reference in this text, constitute provisions of the present document.

- References are either specific (identified by date of publication, edition number, version number, etc.) or non-specific.
- For a specific reference, subsequent revisions do not apply.
- For a non-specific reference, the latest version applies. In the case of a reference to a 3GPP document (including a GSM document), a non-specific reference implicitly refers to the latest version of that document in the same Release as the present document.

- [1] (void)
- [2] ITU-R Recommendation SM.329-8: "Spurious emissions".
- [3] (void)
- [4] 3GPP TS 25.433: "UTRAN Iub Interface NBAP Signalling".
- [5] ETSI ETR 273: "Electromagnetic compatibility and Radio spectrum Matters (ERM); Improvement of radiated methods of measurement (using test sites) and evaluation of the corresponding measurement uncertainties; Part 1: Uncertainties in the measurement of mobile radio equipment characteristics; Sub-part 2: Examples and annexes".

3 Definitions, symbols and abbreviations

3.1 Definitions

For the purposes of the present document, the following definitions apply:

Power Setting: The value of the control signal, which determines the desired transmitter, output Power. Typically, the power setting would be altered in response to power control commands

Maximum Power Setting: The highest value of the Power control setting which can be used.

Maximum output Power: This refers to the measure of average power at the maximum power setting.

Average power: (for further study)

Peak Power: The instantaneous power of the RF envelope which is not expected to be exceeded for 99.9% of the time

Maximum peak power: The peak power observed when operating at a given maximum output power.

Average transmit power: The average transmitter output power obtained over any specified time interval, including periods with no transmission.

Maximum average power: The average transmitter output power obtained over any specified time interval, including periods with no transmission, when the transmit time slots are at the maximum power setting.

3.2 Abbreviations

For the purposes of the present document, the following abbreviations apply:

ACLR	Adjacent Channel Leakage power Ratio
ACS	Adjacent Channel Selectivity
AICH	Acquisition Indication Channel
BER	Bit Error Ratio
BLER	Block Error Ratio
CW	Continuous Wave (un-modulated signal)
DCH	Dedicated Channel, which is mapped into Dedicated Physical Channel.
DL	Down Link (forward link)
DTX	Discontinuous Transmission
DPCCCH	Dedicated Physical Control Channel
DPCH	Dedicated Physical Channel
$DPCH_E_c$	Average energy per PN chip for DPCH.
$\frac{DPCH_E_c}{I_{or}}$	The ratio of the transmit energy per PN chip of the DPCH to the total transmit power spectral density at the Node B antenna connector.
DPDCH	Dedicated Physical Data Channel
EIRP	Effective Isotropic Radiated Power
E_c	Average energy per PN chip.
$\frac{E_c}{I_{or}}$	The ratio of the average transmit energy per PN chip for different fields or physical channels to the total transmit power spectral density.
FACH	Forward Access Channel
FDD	Frequency Division Duplex
FDR	False transmit format Detection Ratio. A false Transport Format detection occurs when the receiver detects a different TF to that which was transmitted, and the decoded transport block(s) for this incorrect TF passes the CRC check(s).
F_{uw}	Frequency of unwanted signal. This is specified in bracket in terms of an absolute frequency(s) or a frequency offset from the assigned channel frequency.
Information Data Rate	Rate of the user information, which must be transmitted over the Air Interface. For example, output rate of the voice codec.
I_o	The total received power spectral density, including signal and interference, as measured at the UE antenna connector.
I_{oc}	The power spectral density of a band limited white noise source (simulating interference from cells, which are not defined in a test procedure) as measured at the UE antenna connector.
I_{or}	The total transmit power spectral density of the down link at the Node B antenna connector.
\hat{I}_{or}	The received power spectral density of the down link as measured at the UE antenna connector.
MER	Message Error Ratio
Node B	A logical node responsible for radio transmission / reception in one or more cells to/from the User Equipment. Terminates the Iub interface towards the RNC
OCNS	Orthogonal Channel Noise Simulator, a mechanism used to simulate the users or control signals on the other orthogonal channels of a downlink link.
$OCNS_E_c$	Average energy per PN chip for the OCNS.
$\frac{OCNS_E_c}{I_{or}}$	The ratio of the average transmit energy per PN chip for the OCNS to the total transmit power spectral density.
P-CCPCH	Primary Common Control Physical Channel
PCH	Paging Channel
$P-CCPCH \frac{E_c}{I_o}$	The ratio of the received P-CCPCH energy per chip to the total received power spectral density at the UE antenna connector.

$\frac{P-CCPCH_{-}E_c}{I_{or}}$	The ratio of the average transmit energy per PN chip for the P-CCPCH to the total transmit power spectral density.
P-CPICH	Primary Common Pilot Channel
PICH	Paging Indicator Channel
PPM	Parts Per Million
RACH	Random Access Channel
SCH	Synchronization Channel consisting of Primary and Secondary synchronization channels
S-CCPCH	Secondary Common Control Physical Channel.
S-CCPCH _{-E_c}	Average energy per PN chip for S-CCPCH.
SIR	Signal to Interference ratio
SSDT	Site Selection Diversity Transmission
STTD	Space Time Transmit Diversity
TDD	Time Division Duplexing
TFC	Transport Format Combination
TFCI	Transport Format Combination Indicator
TPC	Transmit Power Control
TSTD	Time Switched Transmit Diversity
UE	User Equipment
UL	Up Link (reverse link)
UTRA	UMTS Terrestrial Radio Access

4 General

4.1 Relationship between Minimum Requirements and Test Requirements

The Minimum Requirements given in this specification make no allowance for measurement uncertainty. The test specification 34.121 Annex F defines Test Tolerances. These Test Tolerances are individually calculated for each test. The Test Tolerances are used to relax the Minimum Requirements in this specification to create Test Requirements.

The measurement results returned by the test system are compared – without any modification - against the Test Requirements as defined by the shared risk principle.

The Shared Risk principle is defined in ETR 273 Part 1 sub-part 2 section 6.5.

4.2 Power Classes

For UE power classes 1 and 2, a number of RF parameter are not specified. It is intended that these are part of a later release.

5 Frequency bands and channel arrangement

5.1 General

The information presented in this subclause is based on a chip rate of 3.84 Mcps.

NOTE: Other chip rates may be considered in future releases.

5.2 Frequency bands

UTRA/FDD is designed to operate in either of the following paired bands:

- (a) 1920 – 1980 MHz: Up-link (UE transmit, Node B receive)
- 2110 – 2170 MHz: Down-link (Node B transmit, UE receive)

- (b)* 1850 – 1910 MHz: Up-link (UE transmit, Node B receive)
 1930 – 1990 MHz: Down-link (Node B transmit, UE receive)

* Used in Region 2.

Additional allocations in ITU region 2 are FFS.

Deployment in other frequency bands is not precluded.

5.3 TX–RX frequency separation

- (a) UTRA/FDD is designed to operate with the following TX-RX frequency separation

Frequency Band	TX-RX frequency separation
For operation in frequency band as defined in subclause 5.2 (a)	190 MHz
For operation in frequency band as defined in subclause 5.2 (b)	80 MHz.

- (b) UTRA/FDD can support both fixed and variable transmit to receive frequency separation.

- (c) The use of other transmit to receive frequency separations in existing or other frequency bands shall not be precluded.

5.4 Channel arrangement

5.4.1 Channel spacing

The nominal channel spacing is 5 MHz, but this can be adjusted to optimise performance in a particular deployment scenario.

5.4.2 Channel raster

The channel raster is 200 kHz, which means that the centre frequency must be an integer multiple of 200 kHz.

5.4.3 Channel number

The carrier frequency is designated by the UTRA Absolute Radio Frequency Channel Number (UARFCN). The values are defined as follows:

Table 5.1: UARFCN definition

Uplink	$N_u = 5 * F_{\text{uplink}}$	$0.0 \text{ MHz} \leq F_{\text{uplink}} \leq 3276.6 \text{ MHz}$ where F_{uplink} is the uplink frequency in MHz
Downlink	$N_d = 5 * F_{\text{downlink}}$	$0.0 \text{ MHz} \leq F_{\text{downlink}} \leq 3276.6 \text{ MHz}$ where F_{downlink} is the downlink frequency in MHz

5.4.4 UARFCN

The following UARFCN range shall be supported for each paired band

Table 5.2: UTRA Absolute Radio Frequency Channel Number

Frequency Band	Uplink UE transmit, Node B receive	Downlink UE receive, Node B transmit
For operation in frequency band as defined in subclause 5.2 (a)	9612 to 9888	10562 to 10838
For operation in frequency band as defined in subclause 5.2 (b)	9262 to 9538	9662 to 9938

6 Transmitter characteristics

6.1 General

Unless detailed the transmitter characteristic are specified at the antenna connector of the UE. For UE with integral antenna only, a reference antenna with a gain of 0 dBi is assumed. Transmitter characteristics for UE(s) with multiple antennas/antenna connectors are FFS.

The UE antenna performance has a significant impact on system performance, and minimum requirements on the antenna efficiency are therefore intended to be included in future versions of the present document. It is recognised that different requirements and test methods are likely to be required for the different types of UE.

All the parameters in clause 6 are defined using the UL reference measurement channel (12.2 kbps) specified in subclause A.2.1 and unless stated with the UL power control ON

6.2 Transmit power

6.2.1 UE maximum output power

The following Power Classes define the maximum output power.

Table 6.1: UE Power Classes

Power Class	Maximum output power	Tolerance
1	+33 dBm	+1/-3 dB
2	+27 dBm	+1/-3 dB
3	+24 dBm	+1/-3 dB
4	+21 dBm	± 2 dB

NOTE: The tolerance of the maximum output power is below the prescribed value even for the multi-code transmission mode.

6.3 Frequency Error

The UE modulated carrier frequency shall be accurate to within ± 0.1 PPM observed over a period of one timeslot compared to the carrier frequency received from the Node B. These signals will have an apparent error due to Node B frequency error and Doppler shift. In the later case, signals from the Node B must be averaged over sufficient time that errors due to noise or interference are allowed for within the above ± 0.1 PPM figure. The UE shall use the same frequency source for both RF frequency generation and the chip clock.

Table 6.2: Frequency Error

AFC	Frequency stability
ON	within ± 0.1 PPM

6.4 Output power dynamics

Power control is used to limit the interference level.

6.4.1 Open loop power control

Open loop power control is the ability of the UE transmitter to sets its output power to a specific value. The open loop power control tolerance is given in Table 6.3

6.4.1.1 Minimum requirement

The UE open loop power is defined as the average power in a timeslot or ON power duration, whichever is available, and they are measured with a filter that has a Root-Raised Cosine (RRC) filter response with a roll off $\alpha = 0.22$ and a bandwidth equal to the chip rate.

Table 6.3: Open loop power control tolerance

Normal conditions	± 9 dB
Extreme conditions	± 12 dB

6.4.2 Inner loop power control in the uplink

Inner loop power control in the Uplink is the ability of the UE transmitter to adjust its output power in accordance with one or more TPC commands received in the downlink.

6.4.2.1 Power control steps

The power control step is the change in the UE transmitter output power in response to a single TPC command, TPC_cmd, derived at the UE.

6.4.2.1.1 Minimum requirement

The UE transmitter shall have the capability of changing the output power with a step size of 1, 2 and 3 dB according to the value of Δ_{TPC} or $\Delta_{\text{RP-TPC}}$, in the slot immediately after the TPC_cmd can be derived

- (a) The transmitter output power step due to inner loop power control shall be within the range shown in Table 6.4.
- (b) The transmitter average output power step due to inner loop power control shall be within the range shown in Table 6.5. Here a TPC_cmd group is a set of TPC_cmd values derived from a corresponding sequence of TPC commands of the same duration.

The inner loop power step is defined as the relative power difference between the average power of the original (reference) timeslot and the average power of the target timeslot, not including the transient duration. The transient duration is from 25 μ s before the slot boundary to 25 μ s after the slot boundary. The power is measured with a filter that has a Root-Raised Cosine (RRC) filter response with a roll off $\alpha = 0.22$ and a bandwidth equal to the chip rate

Table 6.4: Transmitter power control range

TPC_cmd	Transmitter power control range					
	1 dB step size		2 dB step size		3 dB step size	
	Lower	Upper	Lower	Upper	Lower	Upper
+ 1	+0.5 dB	+1.5 dB	+1 dB	+3 dB	+1.5 dB	+4.5 dB
0	-0.5 dB	+0.5 dB	-0.5 dB	+0.5 dB	-0.5 dB	+0.5 dB
-1	-0.5 dB	-1.5 dB	-1 dB	-3 dB	-1.5 dB	-4.5 dB

Table 6.5: Transmitter average power control range

TPC_cmd group	Transmitter power control range after 10 equal TPC_cmd groups				Transmitter power control range after 7 equal TPC_cmd groups	
	1 dB step size		2 dB step size		3 dB step size	
	Lower	Upper	Lower	Upper	Lower	Upper
+1	+8 dB	+12 dB	+16 dB	+24 dB	+16 dB	+26 dB
0	-1 dB	+1 dB	-1 dB	+1 dB	-1 dB	+1 dB
-1	-8 dB	-12 dB	-16 dB	-24 dB	-16 dB	-26 dB
0,0,0,0,+1	+6 dB	+14 dB	N/A	N/A	N/A	N/A
0,0,0,0,-1	-6 dB	-14 dB	N/A	N/A	N/A	N/A

6.4.3 Minimum transmit output power

The minimum controlled output power of the UE is when the power control setting is set to a minimum value. This is when both the inner loop and open loop power control indicate a minimum transmit output power is required.

6.4.3.1 Minimum requirement

The minimum transmit power is defined as an averaged power in a time slot measured with a filter that has a Root-Raised Cosine (RRC) filter response with a roll off $\alpha = 0.22$ and a bandwidth equal to the chip rate. The minimum transmit power shall be better than -50 dBm.

6.4.4 Out-of-synchronization handling of output power

The UE shall monitor the DPCCCH quality in order to detect a loss of the signal on Layer 1, as specified in TS 25.214. The thresholds Q_{out} and Q_{in} specify at what DPCCCH quality levels the UE shall shut its power off and when it shall turn its power on respectively. The thresholds are not defined explicitly, but are defined by the conditions under which the UE shall shut its transmitter off and turn it on, as stated in this subclause.

6.4.4.1 Minimum requirement

The parameters in Table 6.6 are defined using the DL reference measurement channel (12.2) kbps specified in subclause A.3.1 and with static propagation conditions.

Table 6.6: DCH parameters for test of Out-of-synch handling

Parameter	Unit	Value
\hat{I}_{or}/I_{oc}	dB	-1
I_{oc}	dBm/3.84 MHz	-60
$\frac{DPDCH - E_c}{I_{or}}$	dB	See figure 6.1: Before point A -16.6 After point A Not defined
$\frac{DPCCCH - E_c}{I_{or}}$	dB	See figure 6.1
Information Data Rate	kbps	12.2
TFCI	-	On

The conditions for when the UE shall shut its transmitter on and when it shall turn it on are defined by the parameters in Table 6.6 together with the DPCH power level as defined in Figure 6.1.

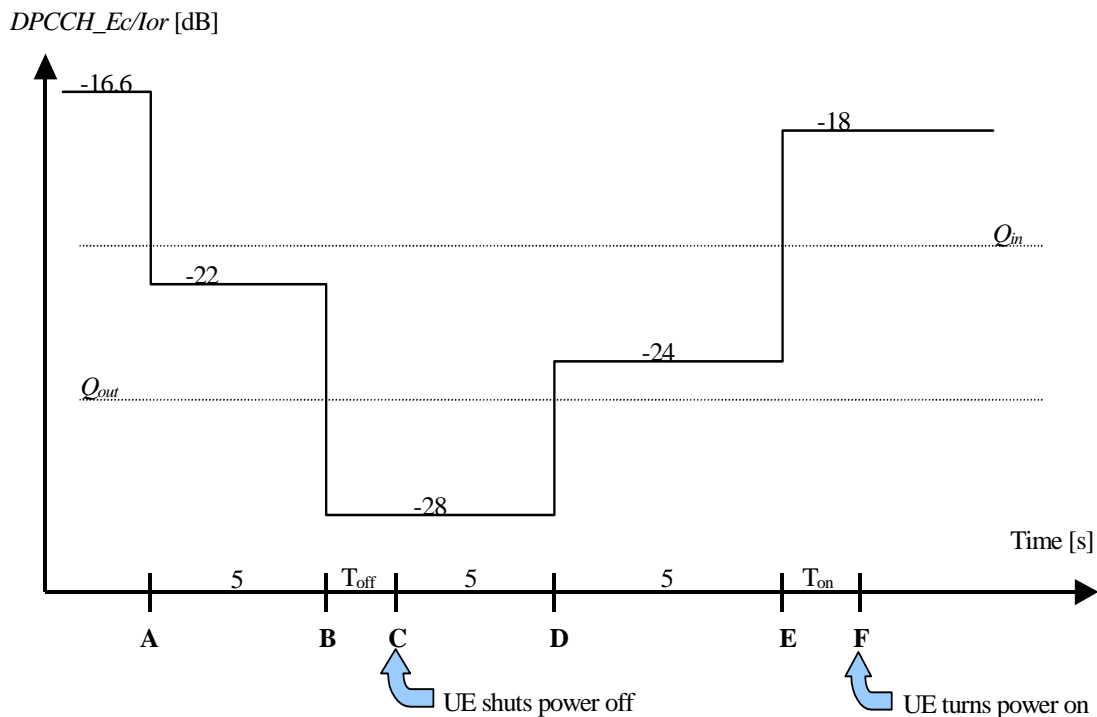

Figure 6.1: Conditions for out-of-synch handling in the UE. The indicated thresholds Q_{out} and Q_{in} are only informative

The requirements for the UE are that:

1. The UE shall not shut its transmitter off before point B.
2. The UE shall shut its transmitter off before point C, which is $T_{off} = 200$ ms after point B.
3. The UE shall not turn its transmitter on between points C and E.
4. The UE shall turn its transmitter on before point F, which is $T_{on} = 200$ ms after point E.

6.5 Transmit ON/OFF power

6.5.1 Transmit OFF power

The transmit OFF power state is when the UE does not transmit except during UL compressed mode. This parameter is defined as the maximum output transmit power within the channel bandwidth when the transmitter is OFF.

6.5.1.1 Minimum requirement

The transmit OFF power is defined as an averaged power in a duration of at least a timeslot excluding any transient periods, measured with a filter that has a Root-Raised Cosine (RRC) filter response with a roll off $\alpha = 0.22$ and a bandwidth equal to the chip rate. The requirement for the transmit OFF power shall be better than -56 dBm.

6.5.2 Transmit ON/OFF Time mask

The time mask for transmit ON/OFF defines the ramping time allowed for the UE between transmit OFF power and transmit ON power. Possible ON/OFF scenarios are RACH ,CPCH or UL compressed mode.

6.5.2.1 Minimum requirement

The transmit power levels versus time shall meet the mask specified in figure 6.2 for PRACH preambles and CPCH preambles, and the mask in figure 6.3 for all other cases. The signal is measured with a filter that has a Root-Raised Cosine (RRC) filter response with a roll off $\alpha = 0.22$ and a bandwidth equal to the chip rate.

On power is defined as either case as follows. The specification depends on each possible case.

- First preamble of RACH/CPCH: Open loop accuracy (Table 6.3).
- During preamble ramping of the RACH/CPCH, and between final RACH/CPCH preamble and RACH/CPCH message part: Accuracy depending on size of the required power difference.(Table 6.7). The step in total transmitted power between final RACH/CPCH preamble and RACH/CPCH message (control part + data part) shall be rounded to the closest integer dB value. A power step exactly half-way between two integer values shall be rounded to the closest integer of greater magnitude.
- After transmission gaps in compressed mode: Accuracy as in Table 6.9.
- Power step to Maximum Power: Maximum power accuracy (Table 6.1).

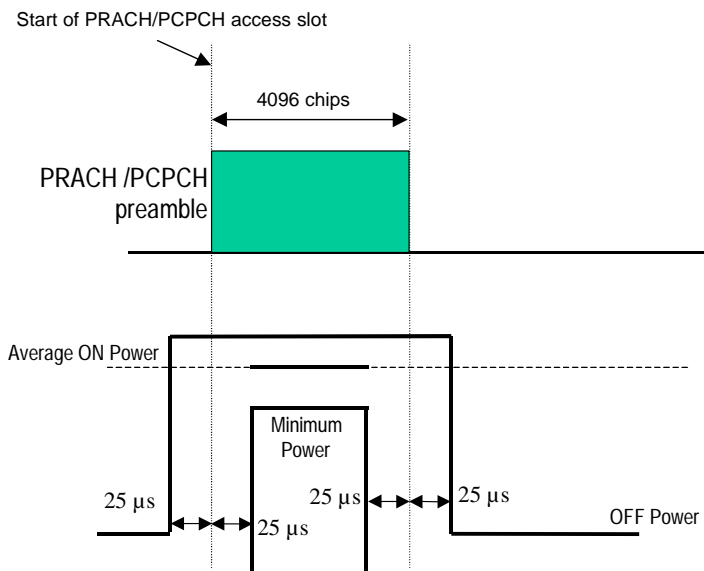

Figure 6.2: Transmit ON/OFF template for PRACH preambles and CPCH preambles

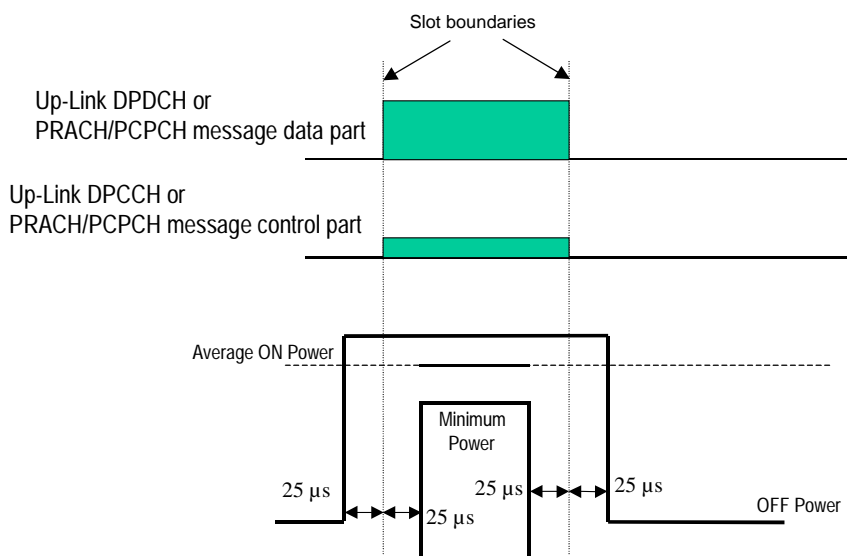

Figure 6.3: Transmit ON/OFF template for all other On/Off cases

Table 6.7: Transmitter power difference tolerance for RACH/CPCH preamble ramping, and between final RACH/CPCH preamble and RACH/CPCH message part

Power step size (Up or down)* ΔP [dB]	Transmitter power difference tolerance [dB]
0	+/- 1 dB
1	+/- 1 dB
2	+/- 1.5 dB
3	+/- 2 dB
$4 \leq \Delta P \leq 10$	+/- 2.5 dB
$11 \leq \Delta P \leq 15$	+/- 3.5 dB
$16 \leq \Delta P \leq 20$	+/- 4.5 dB
$21 \leq \Delta P$	+/- 6.5 dB

NOTE: Power step size for RACH/CPCH preamble ramping is from 1 to 8 dB with 1 dB steps.

6.5.3 Change of TFC

A change of TFC (Transport Format Combination) in uplink means that the power in the uplink varies according to the change in data rate. DTX, where the DPCH is turned off, is a special case of variable data, which is used to minimise the interference between UE(s) by reducing the UE transmit power when voice, user or control information is not present.

6.5.3.1 Minimum requirement

A change of output power is required when the TFC, and thereby the data rate, is changed. The ratio of the amplitude between the DPDCH codes and the DPCCH code will vary. The power step due to a change in TFC shall be calculated in the UE so that the power transmitted on the DPCCH shall follow the inner loop power control. The step in total transmitted power (DPCCH + DPDCH) shall then be rounded to the closest integer dB value. A power step exactly half-way between two integer values shall be rounded to the closest integer of greater magnitude. The accuracy of the power step, given the step size, is specified in Table 6.8. The power change due to a change in TFC is defined as the relative power difference between the average power of the original (reference) timeslot and the average power of the target timeslot, not including the transient duration. The transient duration is from 25 μ s before the slot boundary to 25 μ s after the slot boundary. The power is measured with a filter that has a Root-Raised Cosine (RRC) filter response with a roll off $\alpha = 0.22$ and a bandwidth equal to the chip rate.

Table 6.8: Transmitter power step tolerance

Power step size (Up or down) ΔP [dB]	Transmitter power step tolerance [dB]
0	+/- 0.5 dB
1	+/- 0.5 dB
2	+/- 1.0 dB
3	+/- 1.5 dB
$4 \leq \Delta P \leq 10$	+/- 2.0 dB
$11 \leq \Delta P \leq 15$	+/- 3.0 dB
$16 \leq \Delta P \leq 20$	+/- 4.0 dB
$21 \leq \Delta P$	+/- 6.0 dB

The transmit power levels versus time shall meet the mask specified in Figure 6.4.

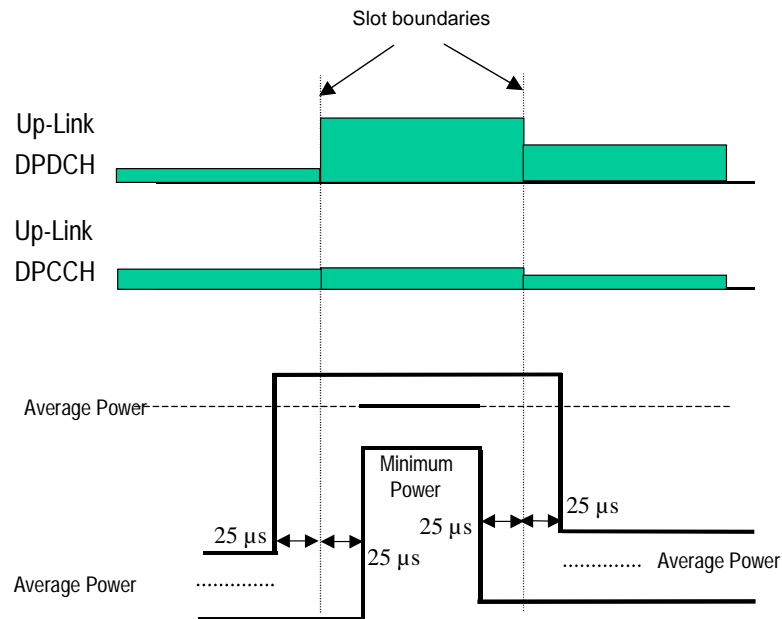

Figure 6.4: Transmit template during TFC change

6.5.4 Power setting in uplink compressed mode

Compressed mode in uplink means that the power in uplink is changed.

6.5.4.1 Minimum requirement

A change of output power is required during uplink compressed frames since the transmission of data is performed in a shorter interval. The ratio of the amplitude between the DPDCH codes and the DPCCH code will also vary. The power step due to compressed mode shall be calculated in the UE so that the energy transmitted on the pilot bits during each transmitted slot shall follow the inner loop power control.

Thereby, the power during compressed mode, and immediately afterwards, shall be such that the power on the DPCCH follows the steps due to inner loop power control combined with additional steps of $10\log_{10}(N_{\text{pilot,prev}} / N_{\text{pilot,curr}})$ dB where $N_{\text{pilot,prev}}$ is the number of pilot bits in the previously transmitted slot, and $N_{\text{pilot,curr}}$ is the current number of pilot bits per slot.

The resulting step in total transmitted power (DPCCH + DPDCH) shall then be rounded to the closest integer dB value. A power step exactly half-way between two integer values shall be rounded to the closest integer of greatest magnitude. The accuracy of the power step, given the step size, is specified in Table 6.8 in subclause 6.5.3.1. The power step is defined as the relative power difference between the average power of the original (reference) timeslot and the average power of the target timeslot, when neither the original timeslot nor the reference timeslot are in a transmission gap. The transient duration is not included, and is from 25 μs before the slot boundary to 25 μs after the slot boundary. The relative power is measured with a filter that has a Root-Raised Cosine (RRC) filter response with a roll off $\alpha = 0.22$ and a bandwidth equal to the chip rate.

In addition to any power change due to the ratio $N_{\text{pilot,prev}} / N_{\text{pilot,curr}}$, the average power of the DPCCH in the first slot after a compressed mode transmission gap shall differ from the average power in the last slot before the transmission gap by an amount Δ_{RESUME} , where Δ_{RESUME} is calculated as described in clause 5.1.2.3 of TS 25.214.

The resulting difference in the total transmitted power (DPCCH + DPDCH) shall then be rounded to the closest integer dB value. A power difference exactly half-way between two integer values shall be rounded to the closest integer of greatest magnitude. The accuracy of the resulting difference in the total transmitted power (DPCCH + DPDCH) after a transmission gap of up to 14 slots shall be as specified in Table 6.9.

Table 6.9: Transmitter power difference tolerance after a transmission gap of up to 14 slots

Tolerance on required difference in total transmitter power after a transmission gap
+/- 3 dB

The power difference is defined as the relative power difference between the average power of the original (reference) timeslot before the transmission gap and the average power of the target timeslot after the transmission gap, not including the transient durations. The transient durations at the start and end of the transmission gaps are each from 25µs before the slot boundary to 25µs after the slot boundary. The relative power is measured with a filter that has a Root-Raised Cosine (RRC) filter response with a roll off $\alpha = 0.22$ and a bandwidth equal to the chip rate.

The transmit power levels versus time shall meet the mask specified in figure 6.5

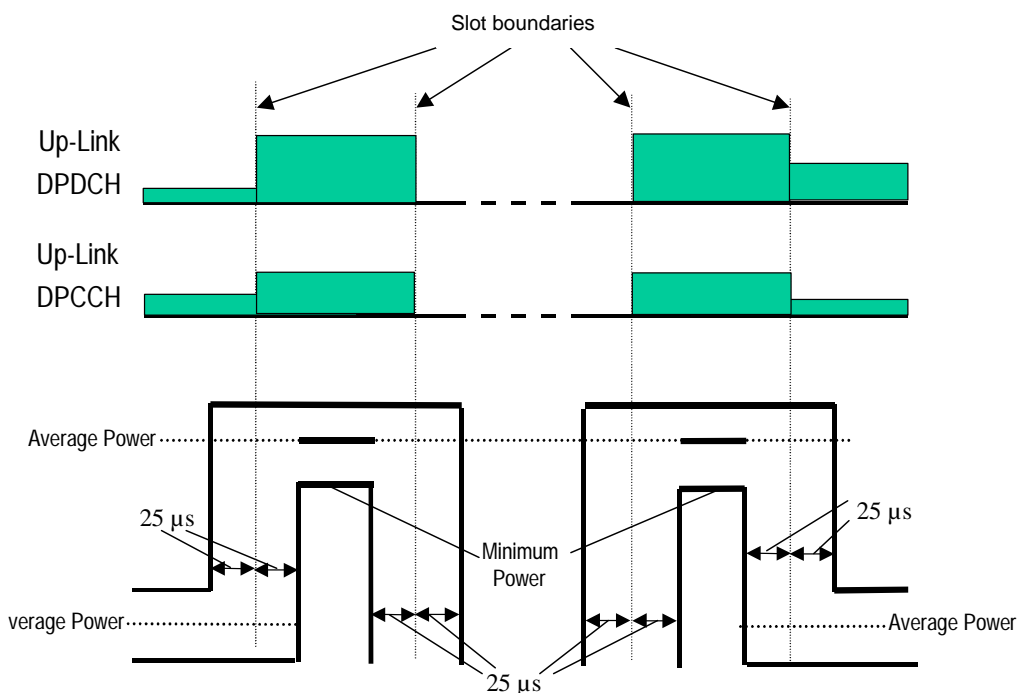

Figure 6.5: Transmit template during Compressed mode

6.6 Output RF spectrum emissions

6.6.1 Occupied bandwidth

Occupied bandwidth is a measure of the bandwidth containing 99 % of the total integrated power of the transmitted spectrum, centered on the assigned channel frequency. The occupied channel bandwidth shall be less than 5 MHz based on a chip rate of 3.84 Mcps.

6.6.2 Out of band emission

Out of band emissions are unwanted emissions immediately outside the nominal channel resulting from the modulation process and non-linearity in the transmitter but excluding spurious emissions. This out of band emission limit is specified in terms of a spectrum emission mask and Adjacent Channel Leakage power Ratio.

6.6.2.1 Spectrum emission mask

The spectrum emission mask of the UE applies to frequencies, which are between 2.5 MHz and 12.5 MHz away from the UE centre carrier frequency. The out of channel emission is specified relative to the UE output power measured in a 3.84 MHz bandwidth.

6.6.2.1.1 Minimum requirement

The power of any UE emission shall not exceed the levels specified in Table 6.10

Table 6.10: Spectrum Emission Mask Requirement

Frequency offset from carrier Δf	Minimum requirement	Measurement bandwidth
2.5 - 3.5 MHz	-35 -15*($\Delta f - 2.5$) dBc	30 kHz *
3.5 - 7.5 MHz	-35- 1*($\Delta f-3.5$) dBc	1 MHz **
7.5 - 8.5 MHz	-39 - 10*($\Delta f - 7.5$) dBc	1 MHz **
8.5 - 12.5 MHz	-49 dBc	1 MHz **
* The first and last measurement position with a 30 kHz filter is 2.515 MHz and 3.485 MHz.		
** The first and last measurement position with a 1 MHz filter is 4 MHz and 12 MHz. As a general rule, the resolution bandwidth of the measuring equipment should be equal to the measurement bandwidth. To improve measurement accuracy, sensitivity and efficiency, the resolution bandwidth can be different from the measurement bandwidth. When the resolution bandwidth is smaller than the measurement bandwidth, the result should be integrated over the measurement bandwidth.		
The lower limit shall be -50 dBm/3.84 MHz or which ever is higher.		

6.6.2.2 Adjacent Channel Leakage power Ratio (ACLR)

Adjacent Channel Leakage power Ratio (ACLR) is the ratio of the transmitted power to the power measured in an adjacent channel. Both the transmitted power and the adjacent channel power are measured with a filter that has a Root-Raised Cosine (RRC) filter response with roll-off $\alpha = 0.22$ and a bandwidth equal to the chip rate.

6.6.2.2.1 Minimum requirement

If the adjacent channel power is greater than -50dBm then the ACLR shall be higher than the value specified in Table 6.11.

Table 6.11: UE ACLR

Power Class	Adjacent channel relative to UE channel	ACLR limit
3	+ 5 MHz or - 5 MHz	33 dB
3	+ 10 MHz or - 10 MHz	43 dB
4	+ 5 MHz or - 5 MHz	33 dB
4	+ 10 MHz or -10 MHz	43 dB

NOTE 1: The requirement shall still be met in the presence of switching transients.

NOTE 2: The ACLR requirements reflect what can be achieved with present state of the art technology.

NOTE 3: Requirement on the UE shall be reconsidered when the state of the art technology progresses.

6.6.3 Spurious emissions

Spurious emissions are emissions which are caused by unwanted transmitter effects such as harmonics emission, parasitic emission, intermodulation products and frequency conversion products, but exclude out of band emissions.

The frequency boundary and the detailed transitions of the limits between the requirement for out band emissions and spectrum emissions are based on ITU-R Recommendations SM.329-8[2].

6.6.3.1 Minimum requirement

These requirements are only applicable for frequencies, which are greater than 12.5 MHz away from the UE centre carrier frequency.

Table 6.12: General spurious emissions requirements

Frequency Bandwidth	Measurement Bandwidth	Minimum requirement
$9 \text{ kHz} \leq f < 150 \text{ kHz}$	1 kHz	-36 dBm
$150 \text{ kHz} \leq f < 30 \text{ MHz}$	10 kHz	-36 dBm
$30 \text{ MHz} \leq f < 1000 \text{ MHz}$	100 kHz	-36 dBm
$1 \text{ GHz} \leq f < 12.75 \text{ GHz}$	1 MHz	-30 dBm

Table 6.13: Additional spurious emissions requirements

Paired band	Frequency Bandwidth	Measurement Bandwidth	Minimum requirement
For operation in frequency bands as defined in subclause 5.2(a)	$1893.5 \text{ MHz} < f < 1919.6 \text{ MHz}$	300 kHz	-41 dBm
	$925 \text{ MHz} \leq f \leq 935 \text{ MHz}$	100 kHz	-67 dBm *
	$935 \text{ MHz} < f \leq 960 \text{ MHz}$	100 kHz	-79 dBm *
	$1805 \text{ MHz} \leq f \leq 1880 \text{ MHz}$	100 kHz	-71 dBm *
*: The measurements are made on frequencies which are integer multiples of 200 kHz. As exceptions, up to five measurements with a level up to the applicable requirements defined in Table 6.12 are permitted for each UARFCN used in the measurement			

6.7 Transmit intermodulation

The transmit intermodulation performance is a measure of the capability of the transmitter to inhibit the generation of signals in its non linear elements caused by presence of the wanted signal and an interfering signal reaching the transmitter via the antenna.

6.7.1 Minimum requirement

User Equipment(s) transmitting in close vicinity of each other can produce intermodulation products, which can fall into the UE, or Node B receive band as an unwanted interfering signal. The UE intermodulation attenuation is defined by the ratio of the output power of the wanted signal to the output power of the intermodulation product when an interfering CW signal is added at a level below the wanted signal. Both the wanted signal power and the IM product power are measured with a filter that has a Root-Raised Cosine (RRC) filter response with roll-off $\alpha = 0.22$ and a bandwidth equal to the chip rate.

The requirement of transmitting intermodulation for a carrier spacing of 5 MHz is prescribed in Table 6.14.

Table 6.14: Transmit Intermodulation

Interference Signal Frequency Offset	5MHz	10MHz
Interference CW Signal Level	-40dBc	
Intermodulation Product	-31dBc	-41dBc

6.8 Transmit modulation

6.8.1 Transmit pulse shape filter

The transmit pulse shaping filter is a root-raised cosine (RRC) with roll-off $\alpha = 0.22$ in the frequency domain. The impulse response of the chip impulse filter $RC_0(t)$ is:

$$RC_0(t) = \frac{\sin\left(\pi \frac{t}{T_c}(1-\alpha)\right) + 4\alpha \frac{t}{T_c} \cos\left(\pi \frac{t}{T_c}(1+\alpha)\right)}{\pi \frac{t}{T_c} \left(1 - \left(4\alpha \frac{t}{T_c}\right)^2\right)}$$

Where the roll-off factor $\alpha = 0.22$ and the chip duration is

$$T = \frac{1}{\text{chiprate}} \approx 0.26042 \mu\text{s}$$

6.8.2 Error Vector Magnitude

The Error Vector Magnitude is a measure of the difference between the measured waveform and the theoretical modulated waveform (the error vector). It is the square root of the ratio of the mean error vector power to the mean reference signal power expressed as a %. The measurement interval is one power control group (timeslot).

6.8.2.1 Minimum requirement

The Error Vector Magnitude shall not exceed 17.5 % for the parameters specified in Table 6.15.

Table 6.15: Parameters for Error Vector Magnitude/Peak Code Domain Error

Parameter	Unit	Level
UE Output Power	dBm	≥ -20
Operating conditions		Normal conditions
Power control step size	dB	1

6.8.3 Peak code domain error

The Peak Code Domain Error is computed by projecting power of the error vector (as defined in 6.8.2) onto the code domain at a specific spreading factor. The Code Domain Error for every code in the domain is defined as the ratio of the mean power of the projection onto that code, to the mean power of the composite reference waveform. This ratio is expressed in dB. The Peak Code Domain Error is defined as the maximum value for the Code Domain Error for all codes. The measurement interval is one power control group (timeslot).

The requirement for peak code domain error is only applicable for multi-code transmission.

6.8.3.1 Minimum requirement

The peak code domain error shall not exceed -15 dB at spreading factor 4 for the parameters specified in Table 6.15 . The requirements are defined using the UL reference measurement channel specified in subclause A.2.5.

7 Receiver characteristics

7.1 General

Unless otherwise stated the receiver characteristics are specified at the antenna connector of the UE. For UE(s) with an integral antenna only, a reference antenna with a gain of 0 dBi is assumed. UE with an integral antenna may be taken into account by converting these power levels into field strength requirements, assuming a 0 dBi gain antenna. Receiver characteristics for UE(s) with multiple antennas/antenna connectors are FFS.

The UE antenna performance has a significant impact on system performance, and minimum requirements on the antenna efficiency are therefore intended to be included in future versions of the present document. It is recognised that different requirements and test methods are likely to be required for the different types of UE.

All the parameters in clause 7 are defined using the DL reference measurement channel (12.2 kbps) specified in subclause A.3.1 and unless stated are with DL power control OFF.

7.2 Diversity characteristics

A suitable receiver structure using coherent reception in both channel impulse response estimation and code tracking procedures is assumed. Three forms of diversity are considered to be available in UTRA/FDD.

Table 7.1: Diversity characteristics for UTRA/FDD

Time diversity	Channel coding and interleaving in both up link and down link
Multi-path diversity	Rake receiver or other suitable receiver structure with maximum combining. Additional processing elements can increase the delay-spread performance due to increased capture of signal energy.
Antenna diversity	Antenna diversity with maximum ratio combining in the Node B and optionally in the UE. Possibility for downlink transmit diversity in the Node B.

7.3 Reference sensitivity level

The reference sensitivity is the minimum receiver input power measured at the antenna port at which the Bit Error Ratio (BER) does not exceed a specific value.

7.3.1 Minimum requirement

The BER shall not exceed 0.001 for the parameters specified in Table 7.2.

Table 7.2: Test parameters for reference sensitivity

Parameter	Unit	Level
DPCH_Ec	dBm/3.84 MHz	-117
\hat{I}_{or}	dBm/3.84 MHz	-106.7
1. For Power class 3 this shall be at the maximum output power 2. For Power class 4 this shall be at the maximum output power		

7.4 Maximum input level

This is defined as the maximum receiver input power at the UE antenna port, which does not degrade the specified BER performance.

7.4.1 Minimum requirement

The BER shall not exceed 0.001 for the parameters specified in Table 7.3.

Table 7.3: Maximum input level

Parameter	Unit	Level
$\frac{DPCH_Ec}{I_{or}}$	dB	-19
\hat{I}_{or}	dBm/3.84 MHz	-25
1. For Power class 3 the average transmit output power shall be +20 dBm 2. For Power class 4 the average transmit output power shall be +18 dBm		

NOTE: Since the spreading factor is large ($10\log(SF)=21\text{dB}$), the majority of the total input signal consists of the OCNS interference. The structure of OCNS signal is defined in Annex C.3.2.

7.5 Adjacent Channel Selectivity (ACS)

Adjacent Channel Selectivity (ACS) is a measure of a receiver's ability to receive a W-CDMA signal at its assigned channel frequency in the presence of an adjacent channel signal at a given frequency offset from the centre frequency of the assigned channel. ACS is the ratio of the receive filter attenuation on the assigned channel frequency to the receive filter attenuation on the adjacent channel(s).

7.5.1 Minimum requirement

The ACS shall be better than the value indicated in Table 7.4 for the test parameters specified in Table 7.5 where the BER shall not exceed 0.001.

Table 7.4: Adjacent Channel Selectivity

Power Class	Unit	ACS
3	dB	33
4	dB	33

Table 7.5: Test parameters for Adjacent Channel Selectivity

Parameter	Unit	Level
DPCH_Ec	dBm/3.84 MHz	-103
\hat{I}_{or}	dBm/3.84 MHz	-92.7
I_{oac} (modulated)	dBm/3.84 MHz	-52
F_{uw} (offset)	MHz	+5 or -5
1. For Power class 3 the average transmit output power shall be +20 dBm		
2. For Power class 4 the average transmit output power shall be +18 dBm		

NOTE: The I_{oac} (modulated) signal consist of common channels needed for tests and 16 dedicated data channel. The channelization codes for data channels are chosen optimally to reduce peak to average ratio (PAR). All dedicated channels user data is uncorrelated to each other.

7.6 Blocking characteristics

The blocking characteristic is a measure of the receiver's ability to receive a wanted signal at its assigned channel frequency in the presence of an unwanted interferer on frequencies other than those of the spurious response or the adjacent channels, without this unwanted input signal causing a degradation of the performance of the receiver beyond a specified limit. The blocking performance shall apply at all frequencies except those at which a spurious response occur.

7.6.1 Minimum requirement

The BER shall not exceed 0.001 for the parameters specified in Table 7.6 and Table 7.7. For Table 7.7 up to 24 exceptions are allowed for spurious response frequencies in each assigned frequency channel when measured using a 1 MHz step size.

Table 7.6: In-band blocking

Parameter	Unit	Offset	Offset
DPCH_Ec	dBm/3.84 MHz	-114	-114
\hat{I}_{or}	dBm/3.84 MHz	-103.7	-103.7
$I_{blocking}$ (modulated)	dBm/3.84 MHz	-56	-44
F_{uw} (offset)	MHz	+10 or -10	+15 or -15
1. For Power class 3 the average transmit output power shall be +20 dBm			
2. For Power class 4 the average transmit output power shall be +18 dBm			

NOTE: I_{blocking} (modulated) consist of common channels and 16 dedicated data channel. The channelization codes for data channels are chosen optimally to reduce peak to average ratio (PAR). All dedicated channels user data is uncorrelated to each other.

Table 7.7: Out of band blocking

Parameter	Unit	Band 1	Band 2	Band 3
DPCH_Ec	dBm/3.84 MHz	-114	-114	-114
\hat{I}_{or}	dBm/3.84 MHz	-103.7	-103.7	-103.7
I_{blocking} (CW)	dBm	-44	-30	-15
F_{uw} For operation in frequency bands as defined in subclause 5.2(a)	MHz	2050 < f < 2095 2185 < f < 2230	2025 < f < 2050 2230 < f < 2255	1 < f < 2025 2255 < f < 12750
F_{uw} For operation in frequency bands as defined in subclause 5.2(b)	MHz	1870 < f < 1915 2005 < f < 2050	1845 < f < 1870 2050 < f < 2075	1 < f < 1845 2075 < f < 12750
1. For Power class 3 the average transmit output power shall be +20 dBm				
2. For Power class 4 the average transmit output power shall be +18 dBm				
For operation in bands referenced in 5.2(a), from 2095 < f < 2110 MHz and 2170 < f < 2185 MHz, the appropriate in-band blocking or adjacent channel selectivity in subclause 7.5.1 and table 7.6 shall be applied.				
For operation in bands referenced in 5.2(b), 1915 < f < 1930 MHz and 1990 < f < 2005 MHz, the appropriate in-band blocking or adjacent channel selectivity in subclause 7.5.1 and table 7.6 shall be applied				

7.7 Spurious response

Spurious response is a measure of the receiver's ability to receive a wanted signal on its assigned channel frequency without exceeding a given degradation due to the presence of an unwanted CW interfering signal at any other frequency at which a response is obtained i.e. for which the blocking limit is not met.

7.7.1 Minimum requirement

The BER shall not exceed 0.001 for the parameters specified in Table 7.8.

Table 7.8: Spurious Response

Parameter	Unit	Level
DPCH_Ec	dBm/3.84 MHz	-114
\hat{I}_{or}	dBm/3.84 MHz	-103.7
I_{blocking} (CW)	dBm	-44
F_{uw}	MHz	Spurious response frequencies
1. For Power class 3 the average transmit output power shall be +20 dBm		
2. For Power class 4 the average transmit output power shall be +18 dBm		

7.8 Intermodulation characteristics

Third and higher order mixing of the two interfering RF signals can produce an interfering signal in the band of the desired channel. Intermodulation response rejection is a measure of the capability of the receiver to receive a wanted signal on its assigned channel frequency in the presence of two or more interfering signals which have a specific frequency relationship to the wanted signal.

7.8.1 Minimum requirement

The BER shall not exceed 0.001 for the parameters specified in Table 7.9.

Table 7.9: Receive intermodulation characteristics

Parameter	Unit	Level	
DPCH_Ec	dBm/3.84 MHz	-114	
\hat{I}_{or}	dBm/3.84 MHz	-103.7	
I_{ouw1} (CW)	dBm	-46	
I_{ouw2} (modulated)	dBm/3.84 MHz	-46	
F_{uw1} (offset)	MHz	10	-10
F_{uw2} (offset)	MHz	20	-20
1. For Power class 3 the average transmit output power shall be +20 dBm 2. For Power class 4 the average transmit output power shall be +18 dBm			

NOTE: I_{ouw2} (modulated) consist of common channels and 16 dedicated data channel. The channelization codes for data channels are chosen optimally to reduce peak to average ratio (PAR). All dedicated channels user data is uncorrelated to each other.

7.9 Spurious emissions

The spurious emissions power is the power of emissions generated or amplified in a receiver that appear at the UE antenna connector.

7.9.1 Minimum requirement

The power of any narrow band CW spurious emission shall not exceed the maximum level specified in Table 7.10 and Table 7.11

Table 7.10: General receiver spurious emission requirements

Frequency Band	Measurement Bandwidth	Maximum level	Note
$9\text{kHz} \leq f < 1\text{GHz}$	100 kHz	-57 dBm	
$1\text{GHz} \leq f \leq 12.75\text{GHz}$	1 MHz	-47 dBm	

Table 7.11: Additional receiver spurious emission requirements

	Frequency Band	Measurement Bandwidth	Maximum level	Note
For operation in frequency bands as defined in subclause 5.2(a)	$1920\text{MHz} \leq f \leq 1980\text{MHz}$	3.84 MHz	-60 dBm	Mobile transmit band in URA_PCH, Cell_PCH and idle state
	$2110\text{MHz} \leq f \leq 2170\text{MHz}$	3.84 MHz	-60 dBm	Mobile receive band

8 Performance requirement

8.1 General

The performance requirements for the UE in this subclause are specified for the measurement channels specified in Annex A, the propagation conditions specified in Annex B and the Down link Physical channels specified in Annex C. Unless stated DL power control is OFF.

8.2 Demodulation in static propagation conditions

8.2.1 (void)

Table 8.1:(void)

Table 8.2: (void)

8.2.2 Demodulation of Forward Access Channel (FACH)

(void)

Table 8.3: (void)

Table 8.4: (void)

8.2.3 Demodulation of Dedicated Channel (DCH)

The receive characteristic of the Dedicated Channel (DCH) in the static environment is determined by the Block Error Ratio (BLER). BLER is specified for each individual data rate of the DCH. DCH is mapped into the Dedicated Physical Channel (DPCH).

8.2.3.1 Minimum requirement

For the parameters specified in Table 8.5 the average downlink $\frac{DPCH - E_c}{I_{or}}$ power shall be below the specified value for the BLER shown in Table 8.6. These requirements are applicable for TFCS size 16.

Table 8.5: DCH parameters in static propagation conditions

Parameter	Unit	Test 1	Test 2	Test 3	Test 4
Phase reference		P-CPICH			
\hat{I}_{or}/I_{oc}	dB	-1			
I_{oc}	dBm/3.84 MHz	-60			
Information Data Rate	kbps	12.2	64	144	384

Table 8.6: DCH requirements in static propagation conditions

Test Number	$\frac{DPCH - E_c}{I_{or}}$	BLER
1	-16.6 dB	10^{-2}
2	-13.1 dB	10^{-1}
	-12.8 dB	10^{-2}
3	-9.9 dB	10^{-1}
	-9.8 dB	10^{-2}
4	-5.6 dB	10^{-1}
	-5.5 dB	10^{-2}

8.3 Demodulation of DCH in multi-path fading propagation conditions

8.3.1 Single Link Performance

The receive characteristics of the Dedicated Channel (DCH) in different multi-path fading environments are determined by the Block Error Ratio (BLER) values. BLER is measured for the each of the individual data rate specified for the DPCH. DCH is mapped into in Dedicated Physical Channel (DPCH).

8.3.1.1 Minimum requirement

For the parameters specified in Table 8.7, 8.9, 8.11, 8.13 and 8.14A the average downlink $\frac{DPCH - E_c}{I_{or}}$ power shall be below the specified value for the BLER shown in Table 8.8, 8.10, 8.12, 8.14 and 8.14B. These requirements are applicable for TFCS size 16.

Table 8.7: Test Parameters for DCH in multi-path fading propagation conditions (Case 1)

Parameter	Unit	Test 1	Test 2	Test 3	Test 4
Phase reference		P-CPICH			
\hat{I}_{or}/I_{oc}	dB	9			
I_{oc}	dBm/3.84 MHz	-60			
Information Data Rate	kbps	12.2	64	144	384

Table 8.8: Test requirements for DCH in multi-path fading propagation conditions (Case 1)

Test Number	$\frac{DPCH - E_c}{I_{or}}$	BLER
1	-15.0 dB	10^{-2}
2	-13.9 dB	10^{-1}
	-10.0 dB	10^{-2}
3	-10.6 dB	10^{-1}
	-6.8 dB	10^{-2}
4	-6.3 dB	10^{-1}
	-2.2 dB	10^{-2}

Table 8.9: DCH parameters in multi-path fading propagation conditions (Case 2)

Parameter	Unit	Test 5	Test 6	Test 7	Test 8
Phase reference		P-CPICH			
\hat{I}_{or}/I_{oc}	dB	-3	-3	3	6
I_{oc}	dBm/3.84 MHz	-60			
Information Data Rate	kbps	12.2	64	144	384

Table 8.10: DCH requirements in multi-path fading propagation (Case 2)

Test Number	$\frac{DPCH_E_c}{I_{or}}$	BLER
5	-7.7 dB	10^{-2}
6	-6.4 dB	10^{-1}
	-2.7 dB	10^{-2}
7	-8.1 dB	10^{-1}
	-5.1 dB	10^{-2}
8	-5.5 dB	10^{-1}
	-3.2 dB	10^{-2}

Table 8.11: DCH parameters in multi-path fading propagation conditions (Case 3)

Parameter	Unit	Test 9	Test 10	Test 11	Test 12
Phase reference		P-CPICH			
\hat{I}_{or}/I_{oc}	dB	-3	-3	3	6
I_{oc}	dBm/3.84 MHz	-60			
Information Data Rate	kbps	12.2	64	144	384

Table 8.12: DCH requirements in multi-path fading propagation conditions (Case 3)

Test Number	$\frac{DPCH_E_c}{I_{or}}$	BLER
9	-11.8 dB	10^{-2}
10	-8.1 dB	10^{-1}
	-7.4 dB	10^{-2}
	-6.8 dB	10^{-3}
11	-9.0 dB	10^{-1}
	-8.5 dB	10^{-2}
	-8.0 dB	10^{-3}
12	-5.9 dB	10^{-1}
	-5.1 dB	10^{-2}
	-4.4 dB	10^{-3}

Table 8.13: DCH parameters in multi-path fading propagation conditions (Case 1) with S-CPICH

Parameter	Unit	Test 13	Test 14	Test 15	Test 16
Phase reference		S-CPICH			
\hat{I}_{or}/I_{oc}	dB	9			
I_{oc}	dBm/3.84 MHz	-60			
Information Data Rate	kbps	12.2	64	144	384

Table 8.14: DCH requirements in multi-path fading propagation conditions (Case 1) with S-CPICH

Test Number	$\frac{DPCH_E_c}{I_{or}}$	BLER
13	-15.0 dB	10^{-2}
14	-13.9 dB	10^{-1}
	-10.0 dB	10^{-2}
15	-10.6 dB	10^{-1}
	-6.8 dB	10^{-2}
16	-6.3 dB	10^{-1}
	-2.2 dB	10^{-2}

Table 8.14A: DCH parameters in multi-path fading propagation conditions (Case 6)

Parameter	Unit	Test 9	Test 10	Test 11	Test 12
Phase reference		P-CPICH			
\hat{I}_{or}/I_{oc}	dB	-3	-3	3	6
I_{oc}	dBm/3.84 MHz	-60			
Information Data Rate	kbps	12.2	64	144	384

Table 8.14B: DCH requirements in multi-path fading propagation conditions (Case 6)

Test Number	$\frac{DPCH_E_c}{I_{or}}$	BLER
9	-8.8 dB	10^{-2}
10	-5.1 dB	10^{-1}
	-4.4 dB	10^{-2}
	-3.8 dB	10^{-3}
11	-6.0 dB	10^{-1}
	-5.5 dB	10^{-2}
	-5.0 dB	10^{-3}
12	-2.9 dB	10^{-1}
	-2.1 dB	10^{-2}
	-1.4 dB	10^{-3}

8.4 Demodulation of DCH in moving propagation conditions

8.4.1 Single link performance

The receive single link performance of the Dedicated Channel (DCH) in dynamic moving propagation conditions are determined by the Block Error Ratio (BLER) values. BLER is measured for the each of the individual data rate specified for the DPCH. DCH is mapped into Dedicated Physical Channel (DPCH).

8.4.1.1 Minimum requirement

For the parameters specified in Table 8.15 the average downlink $\frac{DPCH_E_c}{I_{or}}$ power shall be below the specified value for the BLER shown in Table 8.16.

Table 8.15: DCH parameters in moving propagation conditions

Parameter	Unit	Test 1	Test 2
Phase reference		P-CPICH	
\hat{I}_{or}/I_{oc}	dB	-1	
I_{oc}	dBm/3.84 MHz	-60	
Information Data Rate	kbps	12.2	64

Table 8.16: DCH requirements in moving propagation conditions

Test Number	$\frac{DPCH - E_c}{I_{or}}$	BLER
1	-14.5 dB	10^{-2}
2	-10.9 dB	10^{-2}

8.5 Demodulation of DCH in birth-death propagation conditions

8.5.1 Single link performance

The receive single link performance of the Dedicated Channel (DCH) in dynamic birth-death propagation conditions are determined by the Block Error Ratio (BLER) values. BER is measured for the each of the individual data rate specified for the DPCH. DCH is mapped into Dedicated Physical Channel (DPCH).

8.5.1.1 Minimum requirement

For the parameters specified in Table 8.17 the average downlink $\frac{DPCH - E_c}{I_{or}}$ power shall be below the specified value for the BLER shown in Table 8.18.

Table 8.17: DCH parameters in birth-death propagation conditions

Parameter	Unit	Test 1	Test 2
Phase reference		P-CPICH	
\hat{I}_{or}/I_{oc}	dB	-1	
I_{oc}	dBm/3.84 MHz	-60	
Information Data Rate	kbps	12.2	64

Table 8.18: DCH requirements in birth-death propagation conditions

Test Number	$\frac{DPCH - E_c}{I_{or}}$	BLER
1	-12.6 dB	10^{-2}
2	-8.7 dB	10^{-2}

8.6 Demodulation of DCH in downlink Transmit diversity modes

8.6.1 Demodulation of DCH in open-loop transmit diversity mode

The receive characteristic of the Dedicated Channel (DCH) in open loop transmit diversity mode is determined by the Block Error Ratio (BLER). DCH is mapped into in Dedicated Physical Channel (DPCH).

8.6.1.1 Minimum requirement

For the parameters specified in Table 8.19 the average downlink $\frac{DPCH_E_c}{I_{or}}$ power shall be below the specified value for the BLER shown in Table 8.20.

Table 8.19: Test parameters for DCH reception in an open loop transmit diversity scheme. (Propagation condition: Case 1)

Parameter	Unit	Test 1
Phase reference		P-CPICH
\hat{I}_{or}/I_{oc}	dB	9
I_{oc}	dBm/3.84 MHz	-60
Information data rate	kbps	12.2

Table 8.20: Test requirements for DCH reception in open loop transmit diversity scheme

Test Number	$\frac{DPCH_E_c}{I_{or}}$ (antenna 1/2)	BLER
1	-16.8 dB	10^{-2}

8.6.2 Demodulation of DCH in closed loop transmit diversity mode

The receive characteristic of the dedicated channel (DCH) in closed loop transmit diversity mode is determined by the Block Error Ratio (BLER). DCH is mapped into in Dedicated Physical Channel (DPCH).

8.6.2.1 Minimum requirement

For the parameters specified in Table 8.21 the average downlink $\frac{DPCH_E_c}{I_{or}}$ power shall be below the specified value for the BLER shown in Table 8.22.

Table 8.21: Test Parameters for DCH Reception in closed loop transmit diversity mode (Propagation condition: Case 1)

Parameter	Unit	Test 1 (Mode 1)	Test 2 (Mode 2)
\hat{I}_{or}/I_{oc}	dB	9	9
I_{oc}	dBm/3.84 MHz	-60	-60
Information data rate	kbps	12.2	12.2
Feedback error rate	%	4	4

Table 8.22: Test requirements for DCH reception in closed loop transmit diversity mode

Test Number	$\frac{DPCH_E_c}{I_{or}}$ (see note)	BLER
1	-18.0 dB	10^{-2}
2	-18.3 dB	10^{-2}
NOTE: This is the total power from both antennas. Power sharing between antennas are feedback mode dependent as specified in TS25.214.		

8.6.3 Demodulation of DCH in Site Selection Diversity Transmission Power Control mode

The bit error characteristics of UE receiver is determined in Site Selection Diversity Transmission power control (SSDT) mode. Two Node B emulators are required for this performance test. The delay profiles of signals received from different Node Bs are assumed to be the same but time shifted by 10 chip periods (2604 ns).

8.6.3.1 Minimum requirements

The downlink physical channels and their relative power to I_{or} are the same as those specified in clause C.3.2 irrespective of Node Bs and the test cases. $DPCH_{Ec}/I_{or}$ value applies whenever DPDCH in the cell is transmitted. In Test 1 and Test 3, the received powers at UE from two Node Bs are the same, while 3dB offset is given to one that comes from one of Node Bs for Test 2 and Test 4 as specified in Table 8.23.

For the parameters specified in Table 8.23 the average downlink $\frac{DPCH_{Ec}}{I_{or}}$ power shall be below the specified value for the BLER shown in Table 8.24.

Table 8.23: DCH parameters in multi-path propagation conditions during SSDT mode (Propagation condition: Case 1)

Parameter	Unit	Test 1	Test 2	Test 3	Test 4
Phase reference		P-CPICH			
\hat{I}_{or1}/I_{oc}	dB	0	-3	0	0
\hat{I}_{or2}/I_{oc}	dB	0	0	0	-3
I_{oc}	dBm/3.84 MHz	-60			
Information Data Rate	kbps	12.2	12.2	12.2	12.2
Feedback error rate*	%	4	4	4	4
Number of FBI bits assigned to "S" Field		1	1	2	2
Code word Set		Long	Long	Short	Short

NOTE: Feedback error rate is defined as FBI bit error rate

Table 8.24: DCH requirements in multi-path propagation conditions during SSDT Mode

Test Number	$\frac{DPCH_{Ec}}{I_{or}}$	BLER
1	-7.5 dB	10^{-2}
2	-6.5 dB	10^{-2}
3	-10.5 dB	10^{-2}
4	-9.2 dB	10^{-2}

8.7 Demodulation in Handover conditions

8.7.1 Demodulation of DCH in Inter-Cell Soft Handover

The bit error rate characteristics of UE is determined during an inter-cell soft handover. During the soft handover a UE receives signals from different cells. A UE has to be able to demodulate two PCCPCH channels and to combine the energy of DCH channels. Delay profiles of signals received from different cells are assumed to be the same but time shifted by 10 chips.

The receive characteristics of the different channels during inter-cell handover are determined by the average Block Error Ratio (BLER) values.

8.7.1.1 Minimum requirement

For the parameters specified in Table 8.25 the average downlink $\frac{DPCH_E_c}{I_{or}}$ power shall be below the specified value for the BLER shown in Table 8.26.

Table 8.25: DCH parameters in multi-path propagation conditions during Soft Handoff (Case 3)

Parameter	Unit	Test 1	Test 2	Test 3	Test 4
Phase reference		P-CPICH			
\hat{I}_{or1}/I_{oc} and \hat{I}_{or2}/I_{oc}	dB	0	0	3	6
I_{oc}	dBm/3.84 MHz	-60			
Information data Rate	kbps	12.2	64	144	384

Table 8.26: DCH requirements in multi-path propagation conditions during Soft Handoff (Case 3)

Test Number	$\frac{DPCH_E_c}{I_{or}}$	BLER
1	-15.2 dB	10^{-2}
2	-11.8 dB	10^{-1}
	-11.3 dB	10^{-2}
3	-9.6 dB	10^{-1}
	-9.2 dB	10^{-2}
4	-6.0 dB	10^{-1}
	-5.5 dB	10^{-2}

8.7.2 Combining of TPC commands from radio links of different radio link sets

8.7.2.1 Minimum requirement

Test parameters are specified in Table 8.27. The delay profiles of the signals received from the different cells are the same but time-shifted by 10 chips.

For Test 1, the uplink power changes between adjacent slots shall be as shown in Table 8.28 over the 4 consecutive slots. Note that this case is without an additional noise source I_{oc} .

For Test 2, the Cell1 and Cell2 TPC patterns are repeated a number of times. If the transmitted power of a given slot is increased compared to the previous slot, then a variable "Transmitted power UP" is increased by one, otherwise a variable "Transmitted power DOWN" is increased by one. The requirements for "Transmitted power UP" and "Transmitted power DOWN" are shown in Table 8.28A.

Table 8.27: Parameters for TPC command combining

Parameter	Unit	Test 1	Test 2
Phase reference	-	P-CPICH	
DPCH_Ec/I _{or}	dB	-12	
\hat{I}_{or1} and \hat{I}_{or2}	dBm/3.84 MHz	-60	
I_{oc}	dBm/3.84 MHz	-	-60
Power-Control-Algorithm	-	Algorithm 1	
Cell 1 TPC commands over 4 slots	-	{0,0,1,1}	
Cell 2 TPC commands over 4 slots	-	{0,1,0,1}	
Information data Rate	kbps	12.2	
Propagation condition	-	Static without AWGN source I_{oc}	Multi-path fading case 3

Table 8.28: Test requirements for Test 1

Test Number	Required power changes over the 4 consecutive slots
1	Down, Down, Down, Up

Table 8.28A: Requirements for Test 2

Test Number	Ratio (Transmitted power UP) / (Total number of slots)	Ratio (Transmitted power DOWN) / (Total number of slots)
2	≥0.25	≥0.5

8.8 Power control in downlink

Power control in the downlink is the ability of the UE receiver to converge to required link quality set by the network while using as low power as possible in downlink. If a BLER target has been assigned to a DCCH (See Annex A.3), then it has to be such that outer loop is based on DTCH and not on DCCH.

8.8.1 Power control in the downlink, constant BLER target

8.8.1.1 Minimum requirements

For the parameters specified in Table 8.29 the downlink $\frac{DPCH_E_c}{I_{or}}$ power measured values, which are averaged over one slot, shall be below the specified value in Table 8.30 more than 90% of the time. BLER shall be as shown in Table 8.30. Power control in downlink is ON during the test.

Table 8.29: Test parameter for downlink power control

Parameter	Unit	Test 1	Test 2
\hat{I}_{or}/I_{oc}	dB	9	-1
I_{oc}	dBm/3.84 MHz	-60	
Information Data Rate	kbps	12.2	
Target quality value on DTCH	BLER	0.01	
Propagation condition		Case 4	
Maximum_DL_Power *	dB	7	
Minimum_DL_Power *	dB	-18	
Limited_Power_Raise_Used	-	"Not used"	

NOTE: Power is compared to P-CPICH as specified in [4].

Table 8.30: Requirements in downlink power control

Parameter	Unit	Test 1	Test 2
$\frac{DPCH_E_c}{I_{or}}$	dB	-16.0	-9.0
Measured quality on DTCH	BLER	0.01±30%	0.01±30%

8.8.2 Power control in the downlink, initial convergence

This requirement verifies that DL power control works properly during the first seconds after DPCH connection is established

8.8.2.1 Minimum requirements

For the parameters specified in Table 8.31 the downlink DPCH_Ec/Ior power measured values, which are averaged over 50 ms, shall be within the range specified in Table 8.32 more than 90% of the time. T1 equals to 500 ms and it starts 10 ms after the DPDCH connection is initiated. T2 equals to 500 ms and it starts when T1 has expired. Power control is ON during the test.

Table 8.31: Test parameters for downlink power control

Parameter	Unit	Test 1	Test 2	Test 3	Test 4
Target quality value on DTCH	BLER	0.01	0.01	0.1	0.1
Initial DPCH_Ec/lor	dB	-5.9	-25.9	-2.1	-22.1
Information Data Rate	kbps	12.2	12.2	64	64
\hat{I}_{or}/I_{oc}	dB	-1			
I_{oc}	dBm/3.84 MHz	-60			
Propagation condition		Static			
Maximum_DL_Power	dB	7			
Minimum_DL_Power	dB	-18			
Limited_Power_Raise_Used	-	"Not used"			

Table 8.32: Requirements in downlink power control

Parameter	Unit	Test 1 and Test 2	Test 3 and Test 4
$\frac{DPCH_E_c}{I_{or}}$ during T1	dB	$-18.9 \leq DPCH_Ec/lor \leq -11.9$	$-15.1 \leq DPCH_Ec/lor \leq -8.1$
$\frac{DPCH_E_c}{I_{or}}$ during T2	dB	$-18.9 \leq DPCH_Ec/lor \leq -14.9$	$-15.1 \leq DPCH_Ec/lor \leq -11.1$

8.8.3 Power control in downlink, wind up effects

8.8.3.1 Minimum requirements

This test is run in three stages where stage 1 is for convergence of the power control loop, in stage two the maximum downlink power for the dedicated channel is limited not to be higher than the parameter specified in Table 8.33. All parameters used in the three stages are specified in Table 8.33. The downlink $\frac{DPCH_E_c}{I_{or}}$ power measured values, which are averaged over one slot, during stage 3 shall be lower than the value specified in Table 8.34 more than 90% of the time.

Power control of the UE is ON during the test.

Table 8.33: Test parameter for downlink power control, wind-up effects

Parameter	Unit	Test 1		
		Stage 1	Stage 2	Stage 3
Time in each stage	s	>15	5	0.5
\hat{I}_{or}/I_{oc}	dB	5		
I_{oc}	dBm/3.84 MHz	-60		
Information Data Rate	kbps	12.2		
Quality target on DTCH	BLER	0.01		
Propagation condition		Case 4		
Maximum_DL_Power	dB	7	-6.2	7
Minimum_DL_Power	dB	-18		
Limited_Power_Raise_Used	-	"Not used"		

Table 8.34: Requirements in downlink power control, wind-up effects

Parameter	Unit	Test 1, stage 3
$\frac{DPCH_E_c}{I_{or}}$	dB	-13.3

8.9 Downlink compressed mode

Downlink compressed mode is used to create gaps in the downlink transmission, to allow the UE to make measurements on other frequencies.

8.9.1 Single link performance

The receiver single link performance of the Dedicated Traffic Channel (DCH) in compressed mode is determined by the Block Error Ratio (BLER) and transmitted $DPCH_E_c/I_{or}$ power in the downlink.

The compressed mode parameters are given in clause A.5. Tests 1 and 2 are using Set 1 compressed mode pattern parameters from Table A.21 in clause A.5 while tests 3 and 4 are using Set 2 compressed mode patterns from the same table.

8.9.1.1 Minimum requirements

For the parameters specified in Table 8.35 the downlink $\frac{DPCH_E_c}{I_{or}}$ power measured values, which are averaged over one slot, shall be below the specified value in Table 8.36 more than 90% of the time. The measured quality on DTCH shall be as required in Table 8.36.

Downlink power control is ON during the test. Uplink TPC commands shall be error free. System simulator shall increase the transmitted power during compressed frames by the same amount that UE is expected to increase its SIR target during those frames.

Table 8.35: Test parameter for downlink compressed mode

Parameter	Unit	Test 1	Test 2	Test 3	Test 4
Delta SIR1	dB	0	3	0	3
Delta SIR after1	dB	0	3	0	3
Delta SIR2	dB	0	0	0	0
Delta SIR after2	dB	0	0	0	0
\hat{I}_{or}/I_{oc}	dB	9			
I_{oc}	dBm/3.84 MHz	-60			
Information Data Rate	kbps	12.2			
Propagation condition		Case 2			
Target quality value on DTCH	BLER	0.01			
Maximum_DL_Power	dB	7			
Minimum_DL_Power	dB	-18			
Limited_Power_Raise_Used	-	"Not used"			

Table 8.36: Requirements in downlink compressed mode

Parameter	Unit	Test 1	Test 2	Test 3	Test 4
$\frac{DPCH_E_c}{I_{or}}$	dB	-14.8	No requirements	-15.4	No requirements
Measured quality of compressed and recovery frames	BLER	No requirements	<0.001	No requirements	<0.001
Measured quality on DTCH	BLER	0.01 ± 30 %			

8.10 Blind transport format detection

Performance of Blind transport format detection is determined by the Block Error Ratio (BLER) values and by the measured average transmitted $DPCH_E_c/I_{or}$ value.

8.10.1 Minimum requirement

For the parameters specified in Table 8.37 the average downlink $\frac{DPCH_E_c}{I_{or}}$ power shall be below the specified value for the BLER shown in Table 8.38.

Table 8.37: Test parameters for Blind transport format detection

Parameter	Unit	Test 1	Test 2	Test 3	Test 4	Test 5	Test 6
\hat{I}_{or}/I_{oc}	dB	-1			-3		
I_{oc}	dBm/3.84 MHz	-60					
Information Data Rate	kbps	12.2 (rate 1)	7.95 (rate 2)	1.95 (rate 3)	12.2 (rate 1)	7.95 (rate 2)	1.95 (rate 3)
propagation condition	-	static			multi-path fading case 3		
TFCI	-	off					

Table 8.38: The Requirements for DCH reception in Blind transport format detection

Test Number	$\frac{DPCH_E_c}{I_{or}}$	BLER	FDR
1	-17.7 dB	10^{-2}	10^{-4}
2	-17.8 dB	10^{-2}	10^{-4}
3	-18.4 dB	10^{-2}	10^{-4}
4	-13.0 dB	10^{-2}	10^{-4}
5	-13.2 dB	10^{-2}	10^{-4}
6	-13.8 dB	10^{-2}	10^{-4}

* The value of DPCH_Ec/Ior, Ioc, and Ior/Ioc are defined in case of DPCH is transmitted

NOTE: In this test, 9 different Transport Format Combinations (Table 8.39) are sent during the call set up procedure, so that the UE has to detect the correct transport format from these 9 candidates.

Table 8.39: Transport format combinations informed during the call set up procedure in the test

	1	2	3	4	5	6	7	8	9
DTCH	12.2k	10.2k	7.95k	7.4k	6.7k	5.9k	5.15k	4.75k	1.95k
DCCH					2.4k				

8.11 Detection of Broadcast channel (BCH)

The receiver characteristics of Broadcast Channel (BCH) are determined by the Block Error Ratio (BLER) values. BCH is mapped into the primary common control physical channel (P-CCPCH).

8.11.1 Minimum requirement

For the parameters specified in Table 8.40 the average downlink power P-CCPCH_Ec/Ior shall be below the specified value for the BLER shown in Table 8.41.

This requirement doesn't need to be tested.

Table 8.40: Parameters for BCH detection

Parameter	Unit	Test 1	Test 2
Phase reference	-	P-CPICH	
I_{oc}	dBm/3.84 MHz	-60	
\hat{I}_{or}/I_{oc}	dB	-1	-3
Propagation condition		Static	Case 3

Table 8.41: Test requirements for BCH detection

Test Number	P-CCPCH_Ec/Ior	BLER
1	-18.5 dB	0.01
2	-12.8 dB	0.01

8.12 Demodulation of Paging Channel (PCH)

The receiver characteristics of paging channel are determined by the probability of missed paging message (P_{m-p}). PCH is mapped into the S-CCPCH and it is associated with the transmission of Paging Indicators (PI) to support efficient sleep-mode procedures.

8.12.1 Minimum requirement

For the parameters specified in Table 8.42 the average probability of missed paging (P_{m-p}) shall be below the specified value in Table 8.43. Power of downlink channels other than S-CCPCH and PICH are as defined in Table C.3 of Annex C. S-CCPCH structure is as defined in Annex A.6.

Table 8.42: Parameters for PCH detection

Parameter	Unit	Test 1	Test 2
Number of paging indicators per frame (N_p)	-	72	
Phase reference	-	P-CPICH	
I_{oc}	dBm/3.84 MHz	-60	
\hat{I}_{or}/I_{oc}	dB	-1	-3
Propagation condition		Static	Case 3

Table 8.43: Test requirements for PCH detection

Test Number	S-CCPCH_Ec/Ior	PICH_Ec/Ior	P_{m-p}
1	-14.8	-19.2	0.01
2	-9.8	-12.2	0.01

8.13 Detection of Acquisition Indicator (AI)

The receiver characteristics of Acquisition Indicator (AI) are determined by the probability of false alarm P_{fa} and probability of correct detection P_d . P_{fa} is defined as a conditional probability of detection of AI signature given that a AI signature was not transmitted. P_d is defined as a conditional probability of correct detection of AI signature given that the AI signature is transmitted.

8.13.1 Minimum requirement

For the parameters specified in Table 8.44 the P_{fa} and $1-P_d$ shall not exceed the specified values in Table 8.45. Power of downlink channels other than AICH is as defined in Table C.3 of Annex C.

Table 8.44: Parameters for AI detection

Parameter	Unit	Test 1
Phase reference	-	P-CPICH
I_{oc}	dBm/3.84 MHz	-60
Number of other transmitted AI signatures on AICH	-	0
\hat{I}_{or}/I_{oc}	dB	-1
AICH_Ec/Ior	dB	-23.0
AICH Power Offset	dB	-13.0
Propagation condition	-	Static

Note that AICH_Ec/Ior can not be set. Its value is calculated from other parameters and it is given for information only.
(AICH_Ec/Ior = AICH Power Offset + CPICH_Ec/Ior)

Table 8.45: Test requirements for AI detection

Test Number	Pfa	1-Pd
1	0.01	0.01

Annex A (normative): Measurement channels

A.1 General

The measurement channels in this annex are defined to derive the requirements in clauses 6, 7 and 8. The measurement channels represent example configuration of radio access bearers for different data rates.

The measurement channel for 12.2 kbps shall be supported by any UE both in up- and downlink. Support for other measurement channels is depending on the UE Radio Access capabilities.

A.2 UL reference measurement channel

A.2.1 UL reference measurement channel (12.2 kbps)

The parameters for the 12.2 kbps UL reference measurement channel are specified in Table A.1 and Table A.2. The channel coding for information is shown in figure A.1.

Table A.1: UL reference measurement channel physical parameters (12.2 kbps)

Parameter	Unit	Level
Information bit rate	kbps	12.2
DPDCH	kbps	60
DPCCH	kbps	15
DPCCH Slot Format #i	-	0
DPCCH/DPDCH power ratio	dB	-5.46
TFCI	-	On
Repetition	%	23
NOTE:	Slot Format #2 is used for closed loop tests in subclause 8.6.2.	

Table A.2: UL reference measurement channel, transport channel parameters (12.2 kbps)

Parameters	DTCH	DCCH
Transport Channel Number	1	2
Transport Block Size	244	100
Transport Block Set Size	244	100
Transmission Time Interval	20 ms	40 ms
Type of Error Protection	Convolution Coding	Convolution Coding
Coding Rate	1/3	1/3
Rate Matching attribute	256	256
Size of CRC	16	12

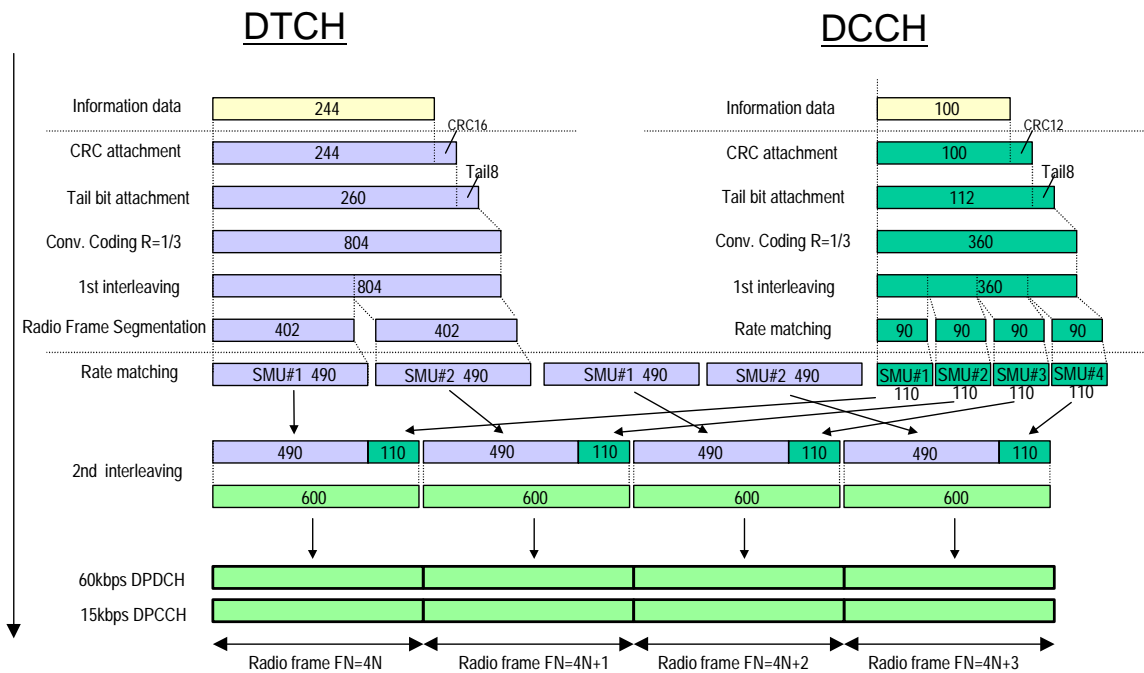

Figure A.1 (Informative): Channel coding of UL reference measurement channel (12.2 kbps)

A.2.2 UL reference measurement channel (64 kbps)

The parameters for the 64 kbps UL reference measurement channel are specified in Table A.3 and Table A.4. The channel coding for information is shown in figure A.2. This measurement channel is not currently used in TS 25.101 but can be used for future requirements.

Table A.3: UL reference measurement channel (64 kbps)

Parameter	Unit	Level
Information bit rate	kbps	64
DPDCH	kbps	240
DPCCH	kbps	15
DPCCH Slot Format #i	-	0
DPCCH/DPDCH power ratio	dB	-9.54
TFCI	-	On
Repetition	%	18

Table A.4: UL reference measurement channel, transport channel parameters (64 kbps)

Parameter	DTCH	DCCH
Transport Channel Number	1	2
Transport Block Size	1280	100
Transport Block Set Size	1280	100
Transmission Time Interval	20 ms	40 ms
Type of Error Protection	Turbo Coding	Convolution Coding
Coding Rate	1/3	1/3
Rate Matching attribute	256	256
Size of CRC	16	12

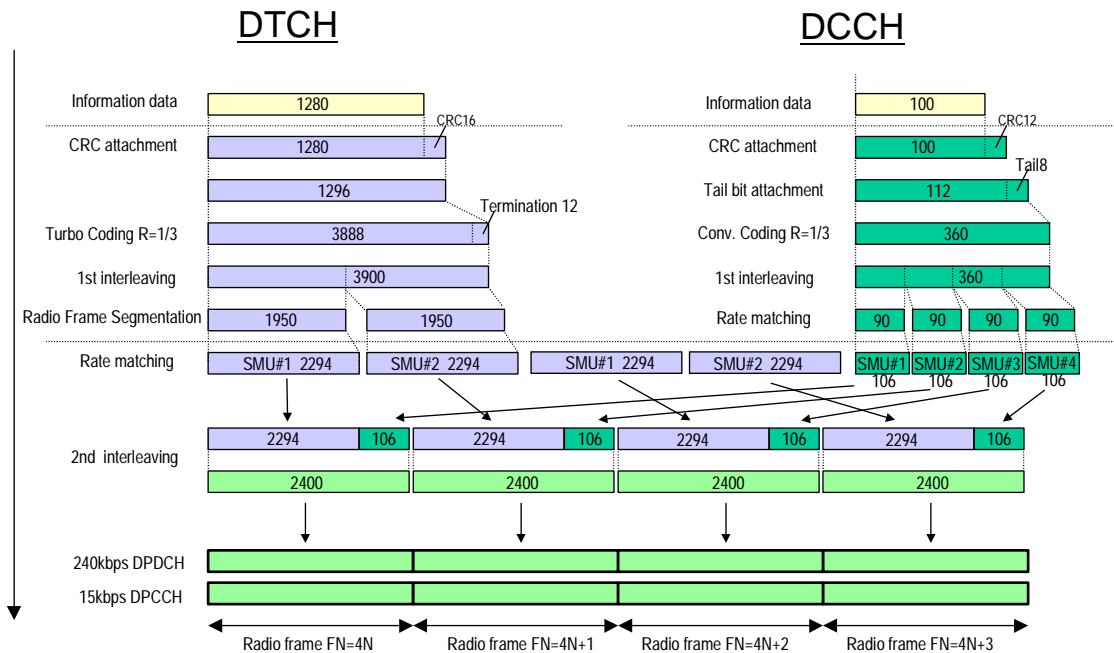

Figure A.2 (Informative): Channel coding of UL reference measurement channel (64 kbps)

A.2.3 UL reference measurement channel (144 kbps)

The parameters for the 144 kbps UL reference measurement channel are specified in Table A.5 and Table A.6. The channel coding for information is shown in Figure A.3. This measurement channel is not currently used in the present document but can be used for future requirements.

Table A.5: UL reference measurement channel (144 kbps)

Parameter	Unit	Level
Information bit rate	kbps	144
DPDCH	kbps	480
DPCCH	kbps	15
DPCCH Slot Format #i	-	0
DPCCH/DPDCH power ratio	dB	-11.48
TFCI	-	On
Repetition	%	8

Table A.6: UL reference measurement channel, transport channel parameters (144kbps)

Parameters	DTCH	DCCH
Transport Channel Number	1	2
Transport Block Size	2880	100
Transport Block Set Size	2880	100
Transmission Time Interval	20 ms	40 ms
Type of Error Protection	Turbo Coding	Convolution Coding
Coding Rate	1/3	1/3
Rate Matching attribute	256	256
Size of CRC	16	12

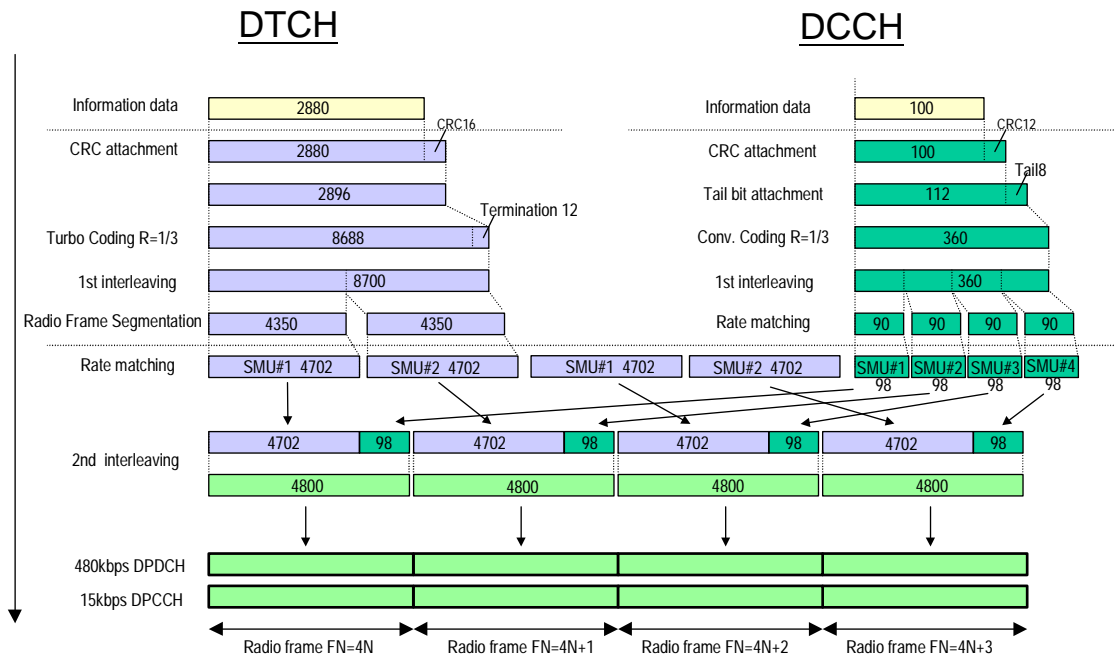

Figure A.3 (Informative): Channel coding of UL reference measurement channel (144 kbps)

A.2.4 UL reference measurement channel (384 kbps)

The parameters for the 384 kbps UL reference measurement channel are specified in Table A.7 and Table A.8. The channel coding for information is shown in Figure A.4. This measurement channel is not currently used in TS 25.101 but can be used for future requirements.

Table A.7: UL reference measurement channel (384 kbps)

Parameter	Unit	Level
Information bit rate	kbps	384
DPDCH	kbps	960
DPCCH	kbps	15
DPCCH/DPDCH power ratio	dB	-11.48
TFCI	-	On
Puncturing	%	18

Table A.8: UL reference measurement channel, transport channel parameters (384 kbps)

Parameter	DTCH	DCCH
Transport Channel Number	1	2
Transport Block Size	3840	100
Transport Block Set Size	3840	100
Transmission Time Interval	10 ms	40 ms
Type of Error Protection	Turbo Coding	Convolution Coding
Coding Rate	1/3	1/3
Rate Matching attribute	256	256
Size of CRC	16	12

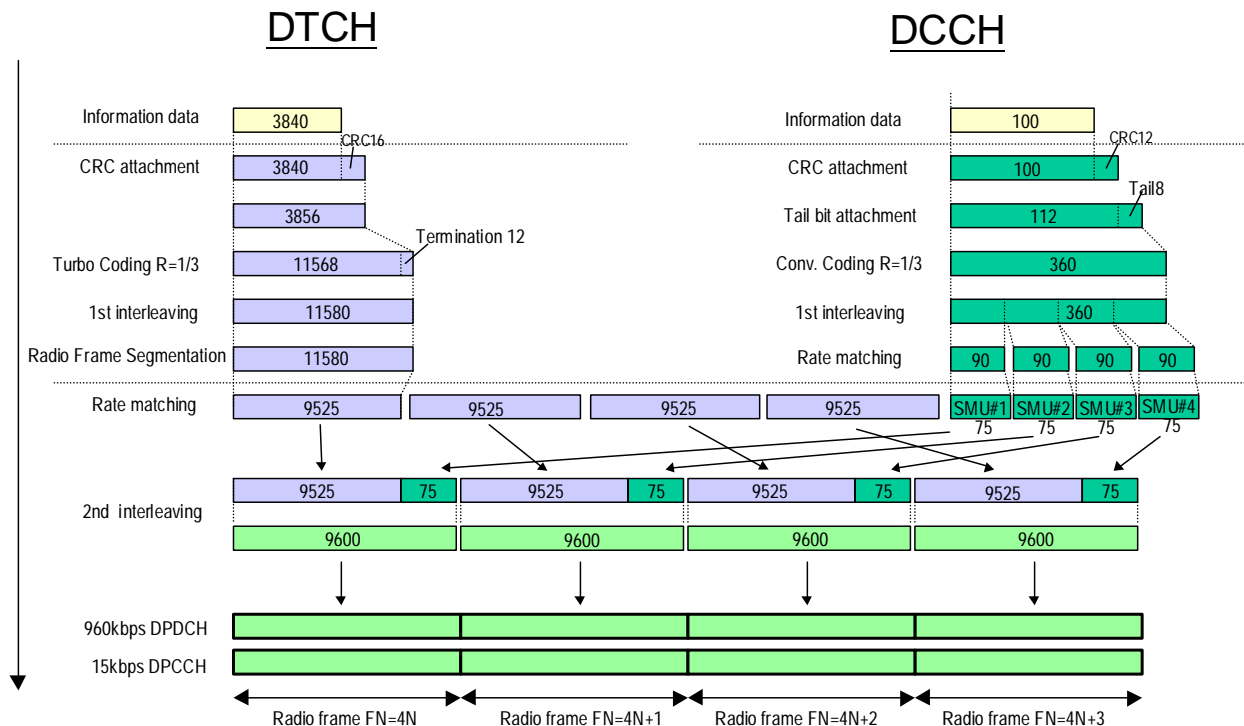

Figure A.4 (Informative): Channel coding of UL reference measurement channel (384 kbps)

A.2.5 UL reference measurement channel (768 kbps)

The parameters for the UL measurement channel for 768 kbps are specified in Table A.9 and Table A.10.

Table A.9: UL reference measurement channel, physical parameters (768 kbps)

Parameter	Unit	Level
Information bit rate	kbps	2*384
DPDCH ₁	kbps	960
DPDCH ₂	kbps	960
DPCCH	kbps	15
DPCCH/DPDCH power ratio	dB	-11.48
TFCI	-	On
Puncturing	%	18

Table A.10: UL reference measurement channel, transport channel parameters (768 kbps)

Parameter	DTCH	DCCH
Transport Channel Number	1	2
Transport Block Size	3840	100
Transport Block Set Size	7680	100
Transmission Time Interval	10 ms	40 ms
Type of Error Protection	Turbo Coding	Convolution Coding
Coding Rate	1/3	1/3
Rate Matching attribute	256	256
Size of CRC	16	12

A.3 DL reference measurement channel

A.3.1 DL reference measurement channel (12.2 kbps)

The parameters for the 12.2 Kbps DL reference measurement channel are specified in Table A.11 and Table A.12. The channel coding is shown for information in figure A.5.

Table A.11: DL reference measurement channel physical parameters (12.2 kbps)

Parameter	Unit	Level
Information bit rate	kbps	12.2
DPCH	ksps	30
Slot Format #i	-	11
TFCI	-	On
Power offsets PO1, PO2 and PO3	dB	0
Puncturing	%	14.7

Table A.12: DL reference measurement channel, transport channel parameters (12.2 kbps)

Parameter	DTCH	DCCH
Transport Channel Number	1	2
Transport Block Size	244	100
Transport Block Set Size	244	100
Transmission Time Interval	20 ms	40 ms
Type of Error Protection	Convolution Coding	Convolution Coding
Coding Rate	1/3	1/3
Rate Matching attribute	256	256
Size of CRC	16	12
Position of TrCH in radio frame	fixed	fixed

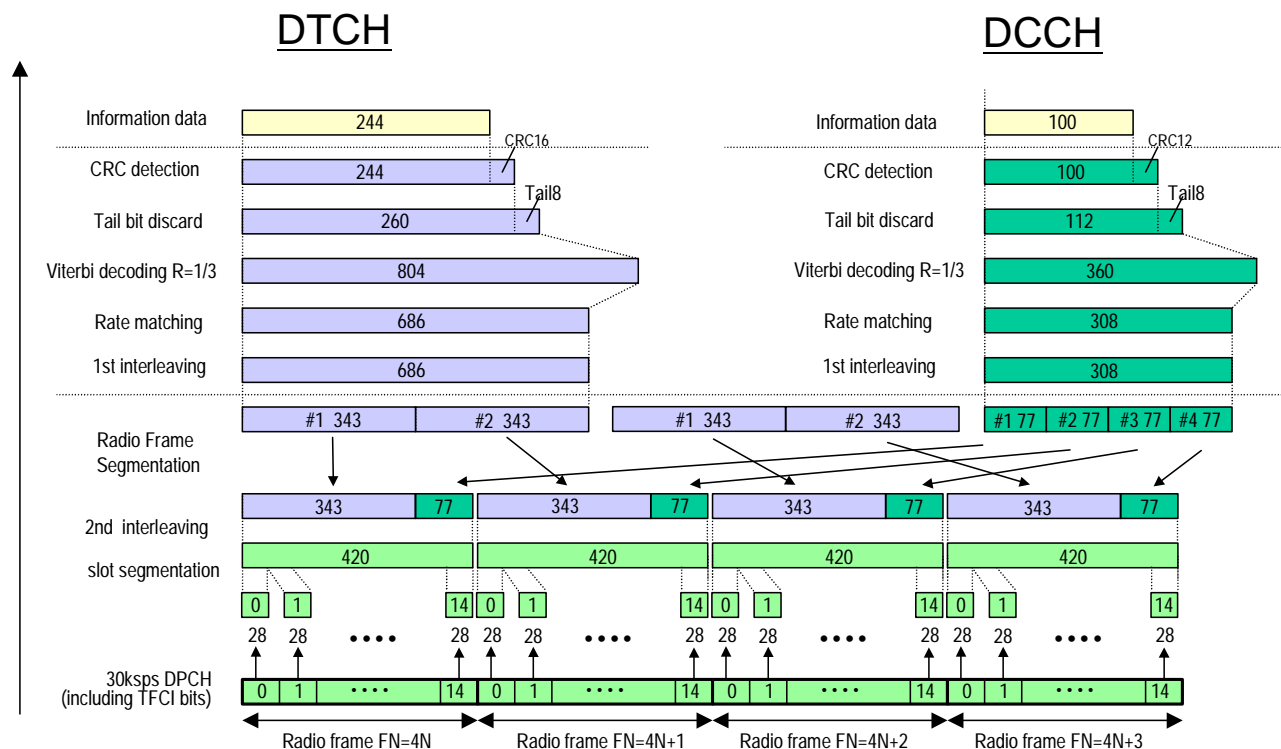

Figure A.5 (Informative): Channel coding of DL reference measurement channel (12.2 kbps)

A.3.2 DL reference measurement channel (64 kbps)

The parameters for the DL reference measurement channel for 64 kbps are specified in Table A.13 and Table A.14. The channel coding is shown for information in Figure A.6.

Table A.13: DL reference measurement channel physical parameters (64 kbps)

Parameter	Unit	Level
Information bit rate	kbps	64
DPCH	ksps	120
Slot Format #i	-	13
TFCI	-	On
Power offsets PO1, PO2 and PO3	dB	0
Repetition	%	2.9

Table A.14: DL reference measurement channel, transport channel parameters (64 kbps)

Parameter	DTCH	DCCH
Transport Channel Number	1	2
Transport Block Size	1280	100
Transport Block Set Size	1280	100
Transmission Time Interval	20 ms	40 ms
Type of Error Protection	Turbo Coding	Convolution Coding
Coding Rate	1/3	1/3
Rate Matching attribute	256	256
Size of CRC	16	12
Position of TrCH in radio frame	fixed	fixed

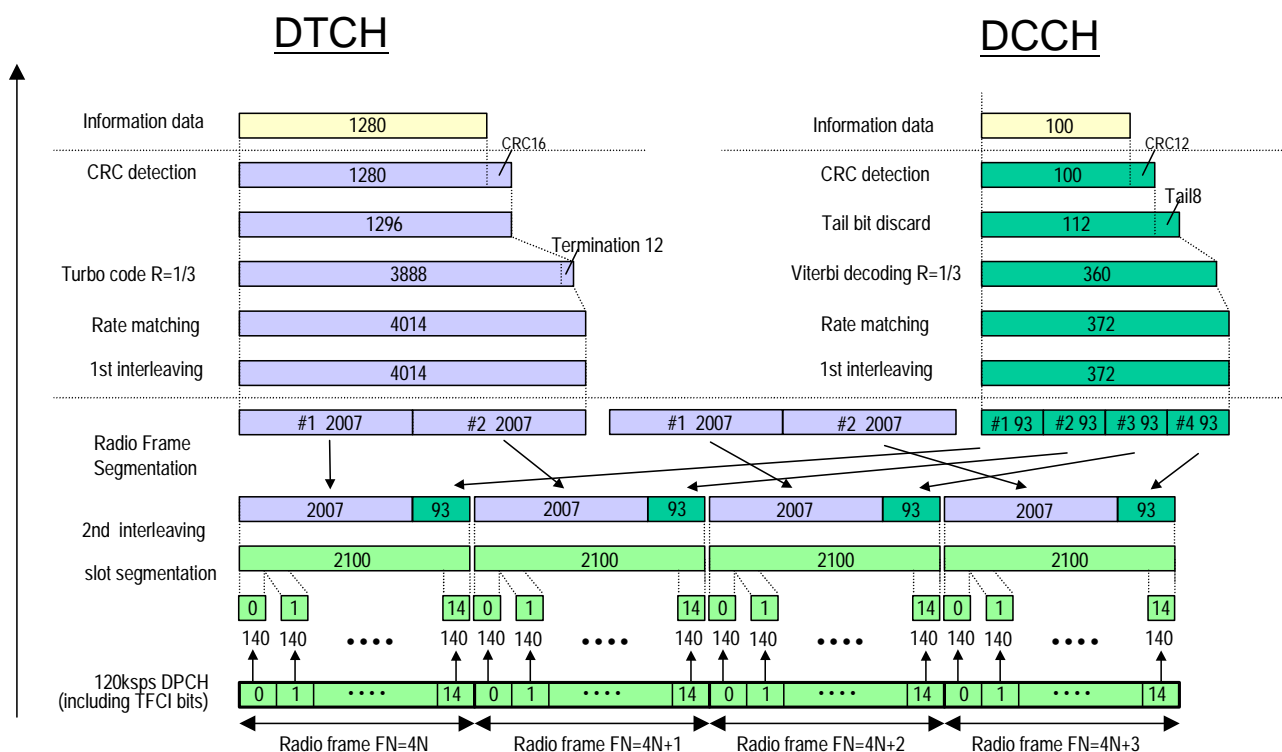

Figure A.6 (Informative): Channel coding of DL reference measurement channel (64 kbps)

A.3.3 DL reference measurement channel (144 kbps)

The parameters for the DL measurement channel for 144 kbps are specified in Table A.15 and Table A.16. The channel coding is shown for information in Figure A.7.

Table A.15: DL reference measurement channel physical parameters (144 kbps)

Parameter	Unit	Level
Information bit rate	kbps	144
DPCH	ksps	240
Slot Format #i	-	14
TFCI	-	On
Power offsets PO1, PO2 and PO3	dB	0
Puncturing	%	2.7

Table A.16: DL reference measurement channel, transport channel parameters (144 kbps)

Parameter	DTCH	DCCH
Transport Channel Number	1	2
Transport Block Size	2880	100
Transport Block Set Size	2880	100
Transmission Time Interval	20 ms	40 ms
Type of Error Protection	Turbo Coding	Convolution Coding
Coding Rate	1/3	1/3
Rate Matching attribute	256	256
Size of CRC	16	12
Position of TrCH in radio frame	fixed	fixed

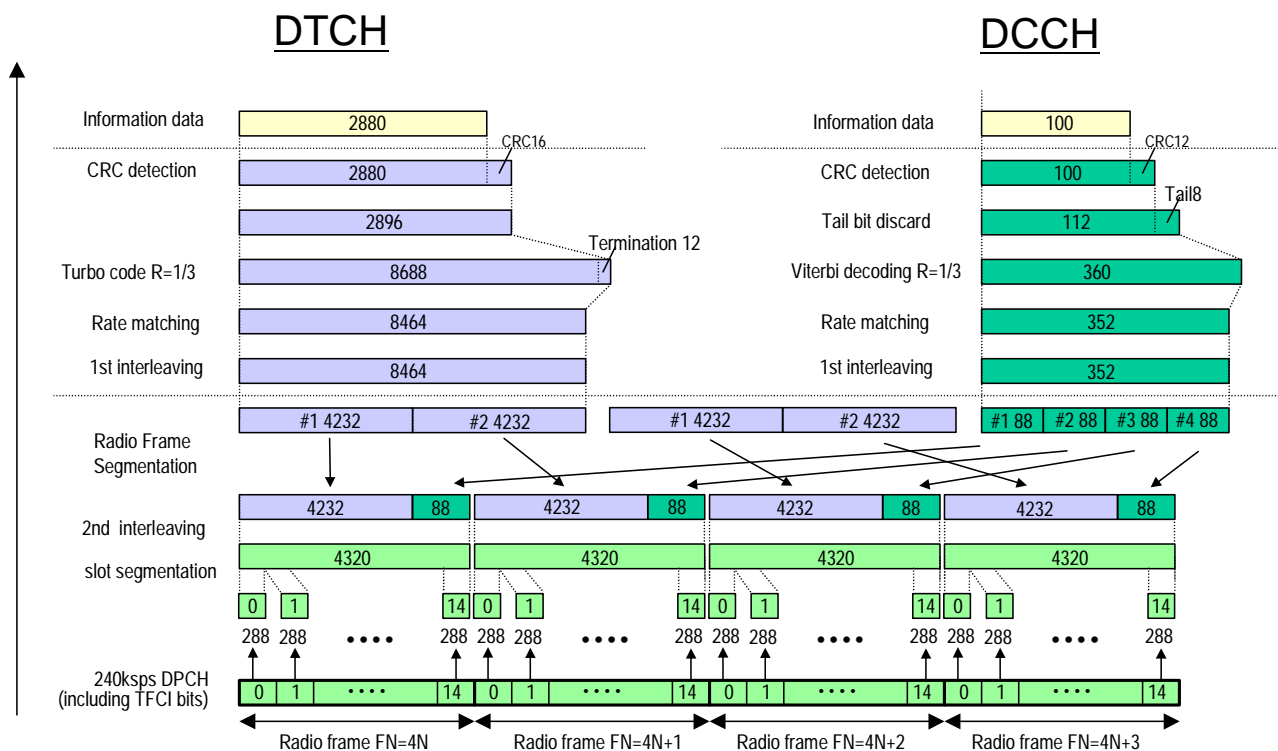

Figure A.7 (Informative): Channel coding of DL reference measurement channel (144 kbps)

A.3.4 DL reference measurement channel (384 kbps)

The parameters for the DL measurement channel for 384 kbps are specified in Table A.17 and Table A.18. The channel coding is shown for information in Figure A.8

Table A.17: DL reference measurement channel, physical parameters (384 kbps)

Parameter	Unit	Level
Information bit rate	kbps	384
DPCH	ksps	480
Slot Format # i	-	15
TFCI		On
Power offsets PO1, PO2 and PO3	dB	0
Puncturing	%	22

Table A.18: DL reference measurement channel, transport channel parameters (384 kbps)

Parameter	DTCH	DCCH
Transport Channel Number	1	2
Transport Block Size	3840	100
Transport Block Set Size	3840	100
Transmission Time Interval	10 ms	40 ms
Type of Error Protection	Turbo Coding	Convolution Coding
Coding Rate	1/3	1/3
Rate Matching attribute	256	256
Size of CRC	16	12
Position of TrCH in radio frame	fixed	Fixed

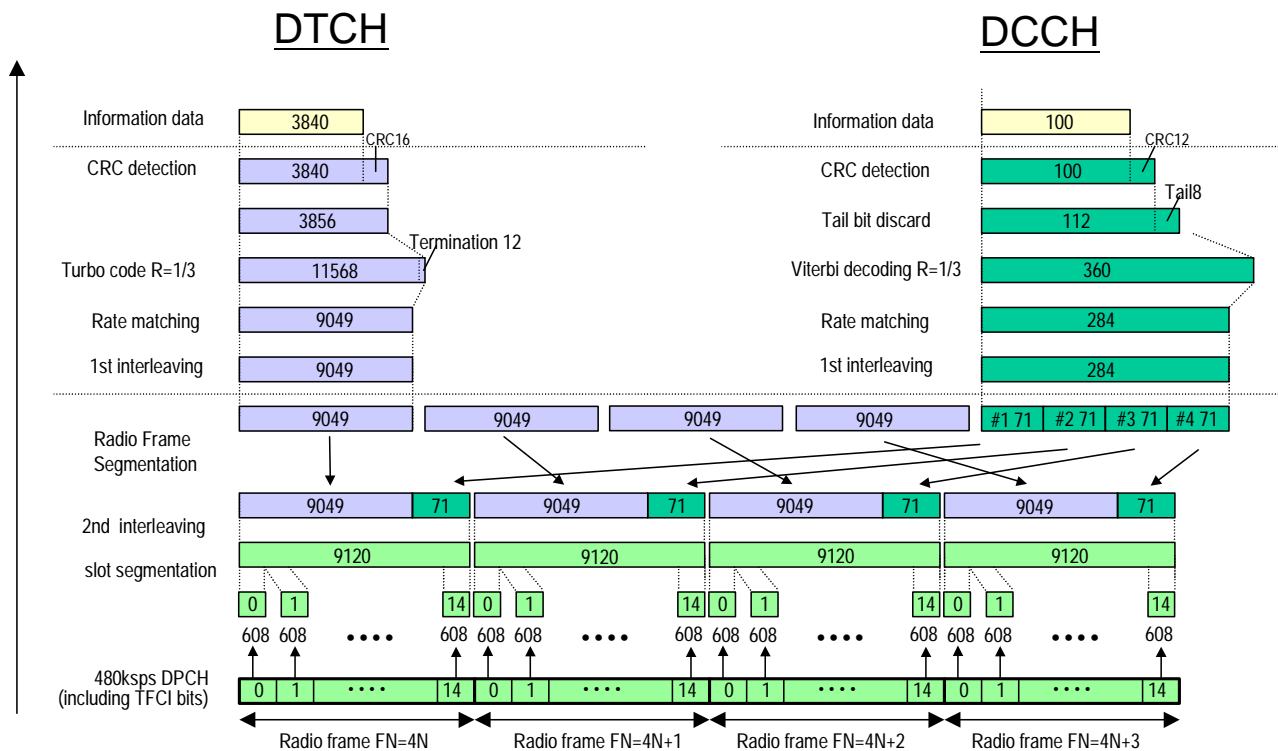

Figure A.8 (Informative): Channel coding of DL reference measurement channel (384 kbps)

A.4 DL reference measurement channel for BTFD performance requirements

The parameters for DL reference measurement channel for BTFD are specified in Table A.19 and Table A.20. The channel coding for information is shown in figures A.9, A.10, and A.11.

Table A.19: DL reference measurement channel physical parameters for BTFD

Parameter	Unit	Rate 1	Rate 2	Rate 3
Information bit rate	kbps	12.2	7.95	1.95
DPCH	kspss	30		
Slot Format # i	-	8		
TFCI	-	Off		
Power offsets PO1, PO2 and PO3	dB	0		
Repetition	%	5		

Table A.20: DL reference measurement channel, transport channel parameters for BTFD

Parameter	DTCH			DCCH
	Rate 1	Rate 2	Rate 3	
Transport Channel Number	1			2
Transport Block Size	244	159	39	100
Transport Block Set Size	244	159	39	100
Transmission Time Interval	20 ms			40 ms
Type of Error Protection	Convolution Coding			Convolution Coding
Coding Rate	1/3			1/3
Rate Matching attribute	256			256
Size of CRC	12			12
Position of TrCH in radio frame	fixed			fixed

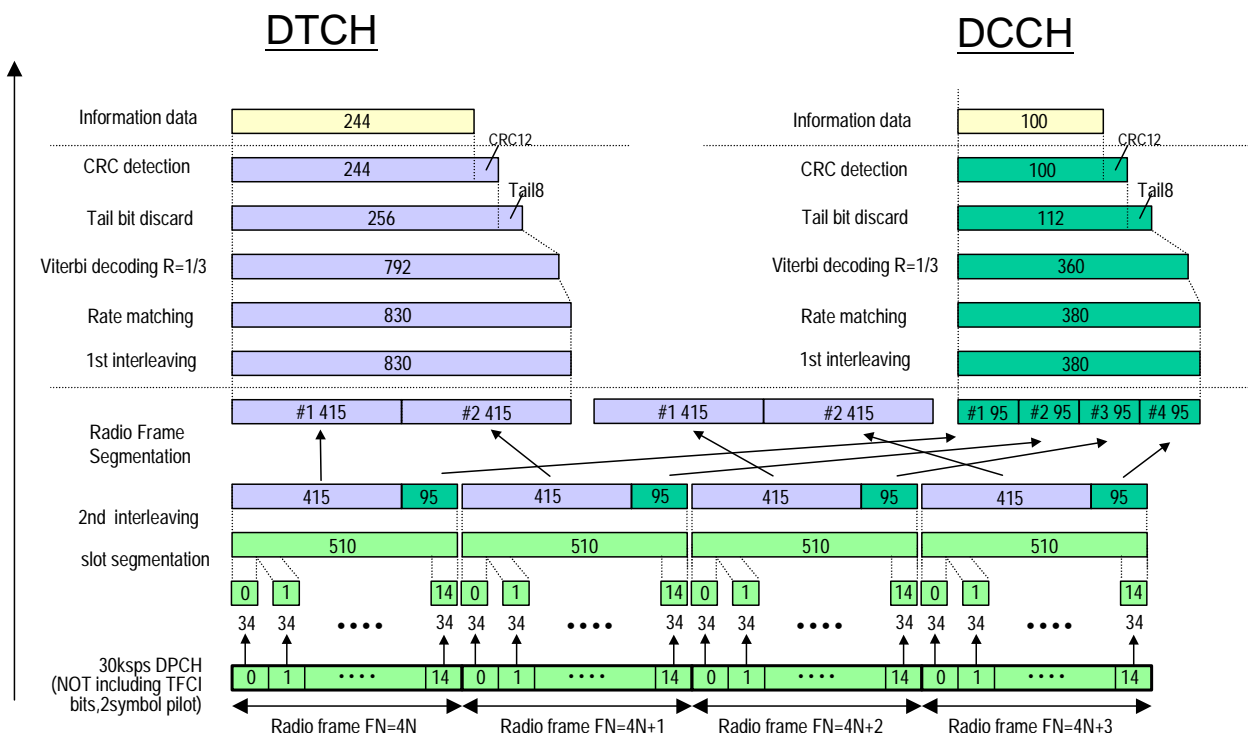

Figure A.9 (Informative): Channel coding of DL reference measurement channel for BTFD (Rate 1)

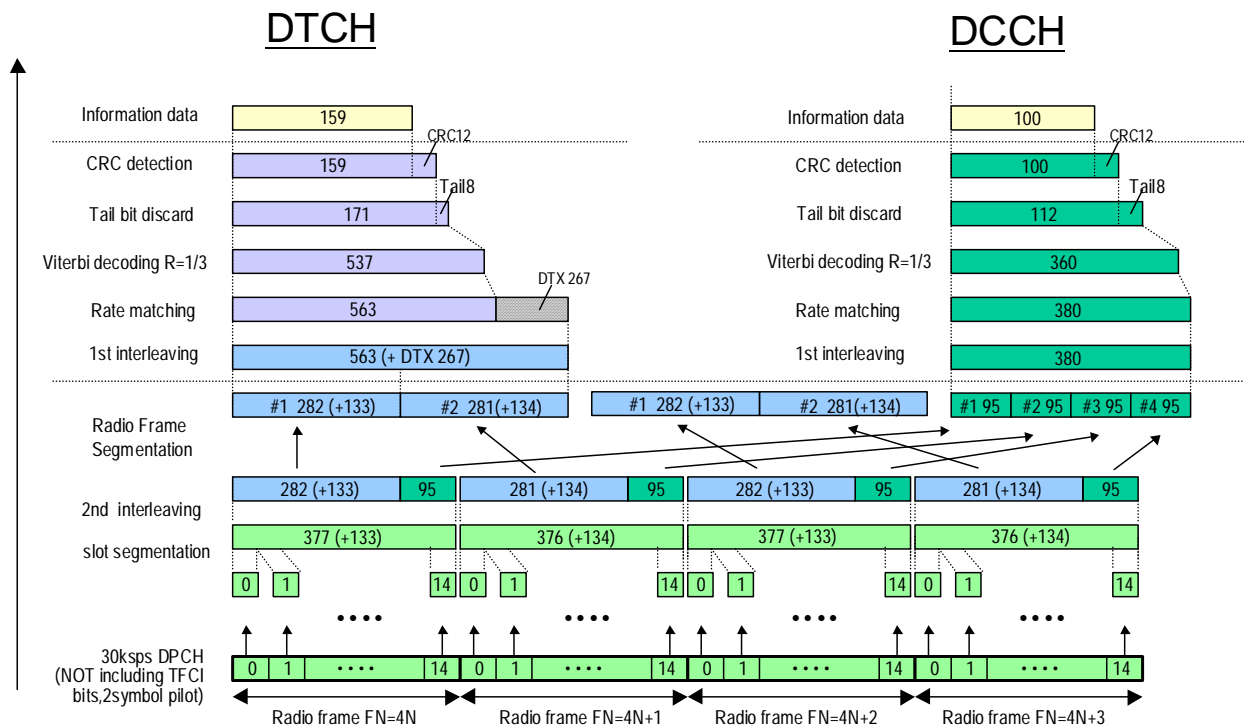

Figure A.10 (Informative): Channel coding of DL reference measurement channel for BTFD (Rate 2)

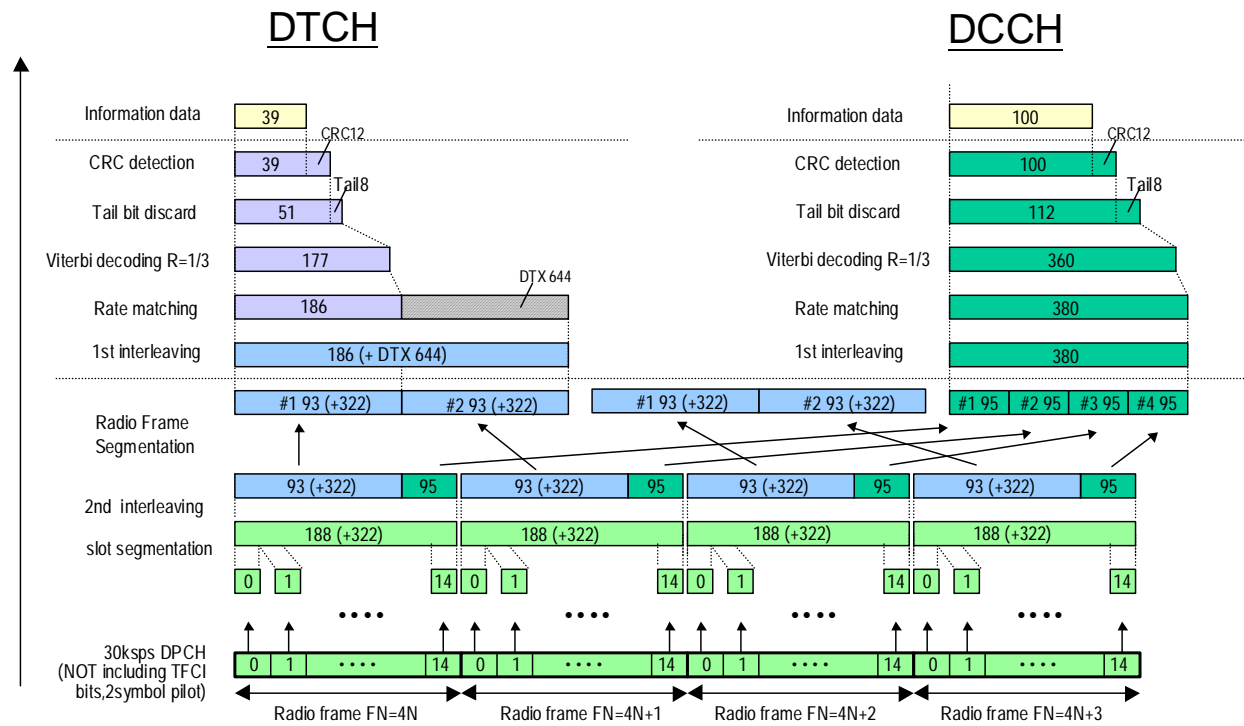

Figure A.11 (Informative): Channel coding of DL reference measurement channel for BTFD (Rate 3)

A.5 DL reference compressed mode parameters

Parameters described in Table A.21 are used in some test specified in TS 25.101 while parameters described in Table A.22 are used in some tests specified in TS 25.133.

Set 1 parameters in Table A.21 are applicable when compressed mode by spreading factor reduction is used in downlink. Set 2 parameters in Table A.21 are applicable when compressed mode by puncturing is used in downlink.

Table A.21: Compressed mode reference pattern 1 parameters

Parameter	Set 1	Set 2	Note
TGSN (Transmission Gap Starting Slot Number)	11	11	
TGL1 (Transmission Gap Length 1)	7	7	
TGL2 (Transmission Gap Length 2)	-	-	Only one gap in use.
TGD (Transmission Gap Distance)	0	0	Only one gap in use.
TGPL1 (Transmission Gap Pattern Length)	2	4	
TGPL2 (Transmission Gap Pattern Length)	-	-	Only one pattern in use.
TGPRC (Transmission Gap Pattern Repetition Count)	NA	NA	Defined by higher layers
TGCFN (Transmission Gap Connection Frame Number):	NA	NA	Defined by higher layers
UL/DL compressed mode selection	DL & UL	DL & UL	2 configurations possible DL & UL / DL
UL compressed mode method	SF/2	SF/2	
DL compressed mode method	SF/2	Puncturing	
Downlink frame type and Slot format	11B	11A	
Scrambling code change	No	No	
RPP (Recovery period power control mode)	0	0	
ITP (Initial transmission power control mode)	0	0	

Table A.22: Compressed mode reference pattern 2 parameters

Parameter	Set 1	Set 2	Note
TGSN (Transmission Gap Starting Slot Number)	4	4	
TGL1 (Transmission Gap Length 1)	7	7	
TGL2 (Transmission Gap Length 2)	-	-	Only one gap in use.
TGD (Transmission Gap Distance)	0	0	
TGPL1 (Transmission Gap Pattern Length)	3	12	
TGPL2 (Transmission Gap Pattern Length)	-	-	Only one pattern in use.
TGPRC (Transmission Gap Pattern Repetition Count)	NA	NA	Defined by higher layers
TGCFN (Transmission Gap Connection Frame Number):	NA	NA	Defined by higher layers
UL/DL compressed mode selection	DL & UL	DL & UL	2 configurations possible. DL & UL / DL
UL compressed mode method	SF/2	SF/2	
DL compressed mode method	SF/2	SF/2	
Downlink frame type and Slot format	11B	11B	
Scrambling code change	No	No	
RPP (Recovery period power control mode)	0	0	
ITP (Initial transmission power control mode)	0	0	

A.6 DL reference parameters for PCH tests

The parameters for the PCH demodulation tests are specified in Table A.23 and Table A.24.

Table A.23: Physical channel parameters for S-CCPCH.

Parameter	Unit	Level
Channel bit rate	kbps	60
Channel symbol rate	ksps	30
Slot Format #i	-	4
TFCI	-	OFF
Power offsets of TFCI and Pilot fields relative to data field	dB	0

Table A.24: Transport channel parameters for S-CCPCH

Parameter	PCH
Transport Channel Number	1
Transport Block Size	240
Transport Block Set Size	240
Transmission Time Interval	10 ms
Type of Error Protection	Convolution Coding
Coding Rate	1/2
Rate Matching attribute	256
Size of CRC	16
Position of TrCH in radio frame	fixed

Annex B (normative): Propagation conditions

B.1 General

B.2 Propagation Conditions

B.2.1 Static propagation condition

The propagation for the static performance measurement is an Additive White Gaussian Noise (AWGN) environment. No fading and multi-paths exist for this propagation model.

B.2.2 Multi-path fading propagation conditions

Table B1 shows propagation conditions that are used for the performance measurements in multi-path fading environment. All taps have classical Doppler spectrum.

Table B.1: Propagation Conditions for Multi path Fading Environments

Case 1, speed 3km/h		Case 2, speed 3 km/h		Case 3, speed 120 km/h		Case 4, speed 3 km/h		* Case 5, speed 50 km/h		Case 6, speed 250 km/h	
Relative Delay [ns]	Average Power [dB]	Relative Delay [ns]	Average Power [dB]	Relative Delay [ns]	Average Power [dB]	Relative Delay [ns]	Average Power [dB]	Relative Delay [ns]	Average Power [dB]	Relative Delay [ns]	Average Power [dB]
0	0	0	0	0	0	0	0	0	0	0	0
976	-10	976	0	260	-3	976	0	976	-10	260	-3
		20000	0	521	-6					521	-6
				781	-9					781	-9

NOTE: Case 5 is only used in TS25.133.

B.2.3 Moving propagation conditions

The dynamic propagation conditions for the test of the baseband performance are non fading channel models with two taps. The moving propagation condition has two tap, one static, Path0, and one moving, Path1. The time difference between the two paths is according Equation (B.1). The taps have equal strengths and equal phases.

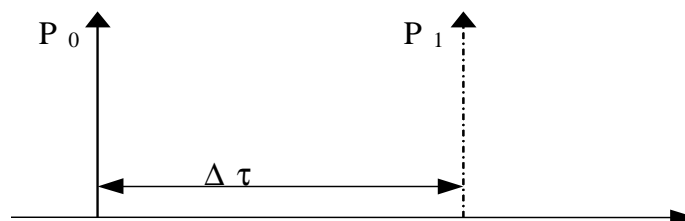

Figure B.1: The moving propagation conditions

$$\Delta\tau = B + \frac{A}{2}(1 + \sin(\Delta\omega \cdot t)) \quad (\text{B.1})$$

The parameters in the equation are shown in the following table.

Table B.2

A	5 μ s
B	1 μ s
$\Delta\omega$	$40 \cdot 10^{-3} \text{ s}^{-1}$

B.2.4 Birth-Death propagation conditions

The dynamic propagation conditions for the test of the base band performance is a non fading propagation channel with two taps. The moving propagation condition has two taps, Path1 and Path2 which alternate between 'birth' and 'death'. The positions the paths appear are randomly selected with an equal probability rate and is shown in Figure B.2.

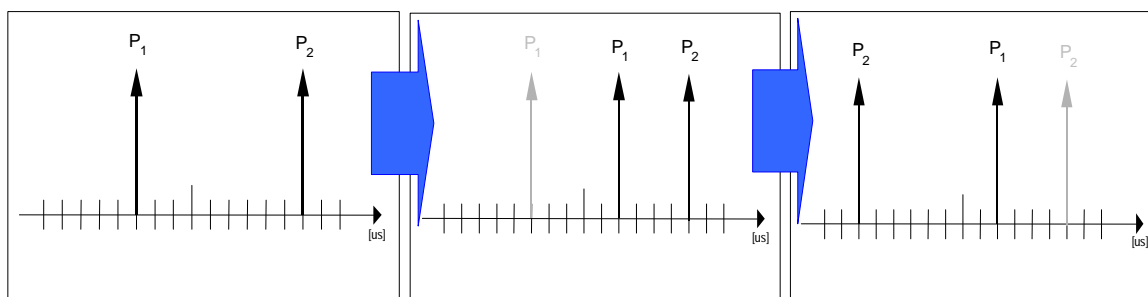

Figure B.2: Birth death propagation sequence

1. Two paths, Path1 and Path2 are randomly selected from the group[-5,-4,-3,-2,-1,0,1,2,3,4,5] μ s. The paths have equal magnitudes and equal phases.
2. After 191 ms, Path1 vanishes and reappears immediately at a new location randomly selected from the group [-5,-4,-3,-2,-1,0,1,2,3,4,5] μ s but excludes the point Path 2. The magnitudes and the phases of the tap coefficients of Path 1 and Path 2 shall remain unaltered.
3. After an additional 191 ms, Path2 vanishes and reappears immediately at a new location randomly selected from the group [-5,-4,-3,-2,-1,0,1,2,3,4,5] μ s but excludes the point Path 1. The magnitudes and the phases of the tap coefficients of Path 1 and Path 2 shall remain unaltered.
4. The sequence in 2) and 3) is repeated.

Annex C (normative): Downlink Physical Channels

C.1 General

This annex specifies the downlink physical channels that are needed for setting a connection and channels that are needed during a connection.

C.2 Connection Set-up

Table C.1 describes the downlink Physical Channels that are required for connection set up.

**Table C.1. Downlink Physical Channels required
for connection set-up**

Physical Channel
P-CPICH
P-CCPCH
SCH
S-CCPCH
PICH
AICH
DPCH

C.3 During connection

The following clauses, describes the downlink Physical Channels that are transmitted during a connection i.e., when measurements are done. For these measurements the offset between DPCH and SCH shall be zero chips at Node B meaning that SCH is overlapping with the first symbols in DPCH in the beginning of DPCH slot structure.

C.3.1 Measurement of Rx Characteristics

Table C.2 is applicable for measurements on the Receiver Characteristics (clause 7) with the exception of subclause 7.4 (Maximum input level).

Table C.2: Downlink Physical Channels transmitted during a connection

Physical Channel	Power
P-CPICH	$P\text{-CPICH_Ec} / DPCH_Ec = 7 \text{ dB}$
P-CCPCH	$P\text{-CCPCH_Ec} / DPCH_Ec = 5 \text{ dB}$
SCH	$SCH_Ec / DPCH_Ec = 5 \text{ dB}$
PICH	$PICH_Ec / DPCH_Ec = 2 \text{ dB}$
DPCH	Test dependent power

C.3.2 Measurement of Performance requirements

Table C.3 is applicable for measurements on the Performance requirements (clause 8), including subclause 7.4 (Maximum input level).

Table C.3: Downlink Physical Channels transmitted during a connection¹

Physical Channel	Power	NOTE
P-CPICH	P-CPICH_Ec/Ior = -10 dB	Use of P-CPICH or S-CPICH as phase reference is specified for each requirement and is also set by higher layer signalling.
S-CPICH	S-CPICH_Ec/Ior = -10 dB	When S-CPICH is the phase reference in a test condition, the phase of S-CPICH shall be 180 degrees offset from the phase of P-CPICH. When S-CPICH is not the phase reference, it is not transmitted.
P-CCPCH	P-CCPCH_Ec/Ior = -12 dB	
SCH	SCH_Ec/Ior = -12 dB	This power shall be divided equally between Primary and Secondary Synchronous channels
PICH	PICH_Ec/Ior = -15 dB	
DPCH	Test dependent power	When S-CPICH is the phase reference in a test condition, the phase of DPCH shall be 180 degrees offset from the phase of P-CPICH.
OCNS	Necessary power so that total transmit power spectral density of Node B (Ior) adds to one ¹	<ol style="list-style-type: none"> 1. OCNS interference consists of 16 dedicated data channels. The channelization codes, level settings and timing offsets for data channels are chosen as specified in table C.6. 2. All dedicated channels user data is uncorrelated to each other and the measurement channel during the BER/BLER measurement period.

NOTE 1 For dynamic power correction required to compensate for the presence of transient channels, e.g. control channels, a subset of the DPCH channels may be used.

C.3.3 Connection with open-loop transmit diversity mode

Table C.4 is applicable for measurements for subclause 8.6.1 (Demodulation of DCH in open loop transmit diversity mode)

Table C.4: Downlink Physical Channels transmitted during a connection¹

Physical Channel	Power	NOTE
P-CPICH (antenna 1)	P-CPICH_Ec1/lor = -13 dB	1. Total P-CPICH_Ec/lor = -10 dB
P-CPICH (antenna 2)	P-CPICH_Ec2/lor = -13 dB	
P-CCPCH (antenna 1)	P-CCPCH_Ec1/lor = -15 dB	1. STTD applied 2. Total P-CCPCH_Ec/lor = -12 dB
P-CCPCH (antenna 2)	P-CCPCH_Ec2/lor = -15 dB	
SCH (antenna 1 / 2)	SCH_Ec/lor = -12 dB	1. TSTD applied. 2. This power shall be divided equally between Primary and Secondary Synchronous channels
PICH (antenna 1)	PICH_Ec1/lor = -18 dB	1. STTD applied 2. Total PICH_Ec/lor = -15 dB
PICH (antenna 2)	PICH_Ec2/lor = -18 dB	
DPCH	Test dependent power	1. STTD applied 2. Total power from both antennas
OCNS	Necessary power so that total transmit power spectral density of Node B (lor) adds to one ¹	1. This power shall be divided equally between antennas 2. OCNS interference consists of 16 dedicated data channels. The channelization codes, level settings and timing offsets for data channels are chosen as specified in Table C.6. 3. All dedicated channels user data is uncorrelated to each other and the measurement channel during the BER/BLER measurement period.

NOTE 1 For dynamic power correction required to compensate for the presence of transient channels, e.g. control channels, a subset of the DPCH channels may be used.

C.3.4 Connection with closed loop transmit diversity mode

Table C.5 is applicable for measurements for subclause 8.6.2 (Demodulation of DCH in closed loop transmit diversity mode).

Table C.5: Downlink Physical Channels transmitted during a connection¹

Physical Channel	Power	NOTE
P-CPICH (antenna 1)	P-CPICH_Ec1/lor = -13 dB	1. Total P-CPICH_Ec/lor = -10 dB
P-CPICH (antenna 2)	P-CPICH_Ec2/lor = -13 dB	
P-CCPCH (antenna 1)	P-CCPCH_Ec1/lor = -15 dB	1. STTD applied
P-CCPCH (antenna 2)	P-CCPCH_Ec2/lor = -15 dB	1. STTD applied, 2. total P-CCPCH_Ec/lor = -12 dB
SCH (antenna 1 / 2)	SCH_Ec/lor = -12 dB	1. TSTD applied
PICH (antenna 1)	PICH_Ec1/lor = -18 dB	1. STTD applied 2. STTD applied, total PICH_Ec/lor = -15 dB
PICH (antenna 2)	PICH_Ec2/lor = -18 dB	
DPCH	Test dependent power	1. Total power from both antennas
OCNS	Necessary power so that total transmit power spectral density of Node B (lor) adds to one ¹	1. This power shall be divided equally between antennas 2. OCNS interference consists of 16 dedicated data channels. The channelization codes, level settings and timing offsets for data channels are chosen as specified in Table C.6. 3. All dedicated channels user data is uncorrelated to each other and the measurement channel during the BER/BLER measurement period.

NOTE 1 For dynamic power correction required to compensate for the presence of transient channels, e.g. control channels, a subset of the DPCH channels may be used.

Table C.6: DPCH Spreading Code, Timing offsets and relative level settings for OCNS signal.

Channelization Code	Timing offset (x256T _{chip})	Level setting (dB)
2	86	-1
11	134	-3
17	52	-3
23	45	-5
31	143	-2
38	112	-4
47	59	-8
55	23	-7
62	1	-4
69	88	-6
78	30	-5
85	18	-9
94	30	-10
102	61	-8
113	128	-6
119	143	0

Note: The DPCH Spreading Codes, Timing offsets and relative level settings are chosen for simulating a signal with realistic PAR.

Annex D (normative): Environmental conditions

D.1 General

This normative annex specifies the environmental requirements of the UE. Within these limits the requirements of the present documents shall be fulfilled.

D.2 Environmental requirements

The requirements in this clause apply to all types of UE(s).

D.2.1 Temperature

The UE shall fulfil all the requirements in the full temperature range of:

Table D.1

+15°C to +35°C	for normal conditions (with relative humidity of 25 % to 75 %)
-10°C to +55°C	for extreme conditions (see IEC publications 68-2-1 and 68-2-2)

Outside this temperature range the UE, if powered on, shall not make ineffective use of the radio frequency spectrum. In no case shall the UE exceed the transmitted levels as defined in TS 25.101 for extreme operation.

D.2.2 Voltage

The UE shall fulfil all the requirements in the full voltage range, i.e. the voltage range between the extreme voltages.

The manufacturer shall declare the lower and higher extreme voltages and the approximate shutdown voltage. For the equipment that can be operated from one or more of the power sources listed below, the lower extreme voltage shall not be higher, and the higher extreme voltage shall not be lower than that specified below.

Table D.2

Power source	Lower extreme voltage	Higher extreme voltage	Normal conditions voltage
AC mains	0,9 * nominal	1,1 * nominal	nominal
Regulated lead acid battery	0,9 * nominal	1,3 * nominal	1,1 * nominal
Non regulated batteries: Leclanché / lithium Mercury/nickel & cadmium	0,85 * nominal 0,90 * nominal	Nominal Nominal	Nominal Nominal

Outside this voltage range the UE if powered on, shall not make ineffective use of the radio frequency spectrum. In no case shall the UE exceed the transmitted levels as defined in TS 25.101 for extreme operation. In particular, the UE shall inhibit all RF transmissions when the power supply voltage is below the manufacturer declared shutdown voltage.

D.2.3 Vibration

The UE shall fulfil all the requirements when vibrated at the following frequency/amplitudes.

Table D.3

Frequency	ASD (Acceleration Spectral Density) random vibration
5 Hz to 20 Hz	0,96 m ² /s ³
20 Hz to 500 Hz	0,96 m ² /s ³ at 20 Hz, thereafter –3 dB/Octave

Outside the specified frequency range the UE, if powered on, shall not make ineffective use of the radio frequency spectrum. In no case shall the UE exceed the transmitted levels as defined in TS 25.101 for extreme operation

Annex F (informative): UE capabilities (FDD)

This annex provides the UE capabilities related to TS 25.101.

NOTES:

This annex shall be aligned with TR25.926, UE Radio Access Capabilities regarding FDD RF parameters. These RF UE Radio Access capabilities represent options in the UE, that require signalling to the network.

In addition there are options in the UE that do not require any signalling. They are designated as UE baseline capabilities, according to TR 21.904, Terminal Capability Requirements.

Table F.1 provides the list of UE radio access capability parameters and possible values for TS 25.101.

Table F.1: RF UE Radio Access Capabilities

	UE radio access capability parameter	Value range
FDD RF parameters	UE power class (TS 25.101, subclause 6.2.1)	3, 4
	Tx/Rx frequency separation for frequency band a) (TS 25.101, subclause 5.3) Not applicable if UE is not operating in frequency band a)	190 MHz, 174.8-205.2 MHz, 134.8-245.2 MHz

Table F.2 provides the UE baseline implementation capabilities for TS 25.101.

Table F.2: UE RF Baseline Implementation Capabilities

UE implementation capability	Value range
Radio frequency bands (25.101 subclause 5.2)	a), b), a+b)

Annex G (informative): Change history

Table G.1: Inclusion of CRs approved by TSG-RAN#6.

RAN Doc	Spec	CR	R	Ph	Subject	Cat	Curr	New
RP-99772	25.101	001	2	R99	Correction of UE Measurement Channels Rev.2	F	3.0.0	3.1.0
RP-99772	25.101	003		R99	Modifications for Receiver Characteristics	F	3.0.0	3.1.0
RP-99772	25.101	004		R99	Corrections to Tx Diversity testing assumptions	F	3.0.0	3.1.0
RP-99771	25.101	005		R99	UE DL performance requirements	D	3.0.0	3.1.0
RP-99772	25.101	006	1	R99	Corrections to Annex C Down link Physical Channels	F	3.0.0	3.1.0
RP-99772	25.101	007		R99	Proposal for ACLR/ACS specifications for class 3	F	3.0.0	3.1.0
RP-99773	25.101	008		R99	Addition of propagation condition to inner and outer loop PC tests in downlink	B	3.0.0	3.1.0
RP-99772	25.101	009		R99	Clarification of Uplink inner loop power control requirements	C	3.0.0	3.1.0
RP-99773	25.101	010		R99	Modifications to demodulation test parameters and requirements in inter-cell soft handover	B	3.0.0	3.1.0
RP-99772	25.101	011		R99	Power setting of DPCH	C	3.0.0	3.1.0
RP-99771	25.101	012		R99	Editorial changes to 25.101v3.0.0	D	3.0.0	3.1.0
RP-99826	25.101	013		R99	Update of UE RF capabilities	F	3.0.0	3.1.0
RP-99772	25.101	014		R99	Update of ITU Region 2 Specific Specifications and proposed universal channel numbering	C	3.0.0	3.1.0
RP-99772	25.101	015		R99	Performance requirements for demodulation of DCH in Site Selection Diversity Transmission mode for Subclause 8.6.3 of 25.101v3.0.0	F	3.0.0	3.1.0
RP-99830	25.101	016	1	R99	Change of propagation conditions	F	3.0.0	3.1.0
RP-99772	25.101	017		R99	CR for minimum requirements for UE power class 1 and 2 in 25.101	F	3.0.0	3.1.0
RP-99772	25.101	018		R99	Downlink Inner loop power control	C	3.0.0	3.1.0
RP-99773	25.101	019		R99	Performance requirements in downlink compressed mode	B	3.0.0	3.1.0

Table G.2: Inclusion of CRs approved by TSG-RAN#7.

RAN Doc	Spec	CR	R	Ph	Subject	Cat	Curr	New
RP-000015	25.101	020		R99	Clarifications to measurement channels	F	3.1.0	3.2.0
RP-000015	25.101	021		R99	Power measurement definitions for wanted signal (in-channel signal)	D	3.1.0	3.2.0
RP-000015	25.101	022		R99	Change of propagation conditions for Case 2	F	3.1.0	3.2.0
RP-000015	25.101	023		R99	Editorial corrections	D	3.1.0	3.2.0
RP-000015	25.101	024		R99	Birth-Death tap delays	F	3.1.0	3.2.0
RP-000015	25.101	025		R99	Out-of-synchronization handling of the UE	C	3.1.0	3.2.0
RP-000015	25.101	026		R99	UE Modulation performance requirements	F	3.1.0	3.2.0
RP-000015	25.101	027		R99	Measurement channel for UE PCDE test	F	3.1.0	3.2.0
RP-000015	25.101	028		R99	CR for performance requirement of BTFD	F	3.1.0	3.2.0
RP-000015	25.101	029		R99	CPCH	B	3.1.0	3.2.0
RP-000015	25.101	030		R99	Clarification of ACLR	D	3.1.0	3.2.0
RP-000015	25.101	031		R99	Correction for reference measurement channel in TS 25.101	F	3.1.0	3.2.0
RP-000015	25.101	032		R99	Modifications to requirements for power control steps in uplink	F	3.1.0	3.2.0
RP-000015	25.101	033		R99	Performance requirement	F	3.1.0	3.2.0
RP-000015	25.101	034		R99	Power Control in downlink, constant BLER target	F	3.1.0	3.2.0
RP-000015	25.101	035		R99	UE Minimum TX power change	F	3.1.0	3.2.0
RP-000015	25.101	036		R99	Performance requirements for demodulation of DCH in Site Selection Diversity Transmission mode	F	3.1.0	3.2.0
RP-000015	25.101	037		R99	Reference compressed mode patterns	F	3.1.0	3.2.0
RP-000015	25.101	038		R99	384kbps measurement channel is replaced with 10ms TTI	F	3.1.0	3.2.0
RP-000015	25.101	039		R99	Modification to the handling of measurement equipment uncertainty	F	3.1.0	3.2.0
					Correction to figure A6		3.2.0	3.2.1
					Correction to version number in title/header (April 2000)		3.2.1	3.2.2

Table G.3: Inclusion of CRs approved by TSG-RAN#8.

RAN Doc	Spec	CR	R	Ph	Subject	Cat	Curr	New
RP-000204	25.101	040	1	R99	A test for UE's SIR target setting in a call set up	F	3.2.2	3.3.0
RP-000204	25.101	041	1	R99	Reception of TPC commands in a soft handover	F	3.2.2	3.3.0
RP-000204	25.101	042		R99	DCH requirement for 64 kbps measurement channel in birth-death propagation condition	F	3.2.2	3.3.0
RP-000204	25.101	043		R99	Power control in the downlink, constant BLER target	F	3.2.2	3.3.0
RP-000204	25.101	044		R99	Value update for 384 kbps measurement channel requirements	F	3.2.2	3.3.0
RP-000204	25.101	045	1	R99	CR for demodulation of DCH	F	3.2.2	3.3.0
RP-000204	25.101	046		R99	Correction for measurement channel in TS 25.101	F	3.2.2	3.3.0
RP-000204	25.101	047		R99	Editorial CR on section 8.6.3 of TS25.101 v3.2.0	D	3.2.2	3.3.0
RP-000204	25.101	048		R99	Correction of frequency numbering scheme	F	3.2.2	3.3.0
RP-000204	25.101	049		R99	Correction - Propagation conditions	F	3.2.2	3.3.0
RP-000204	25.101	050		R99	Compressed mode tests	F	3.2.2	3.3.0
RP-000204	25.101	051		R99	Correction of Out-of-sync criteria	F	3.2.2	3.3.0
RP-000204	25.101	052		R99	Editorial corrections for TS25.101.	F	3.2.2	3.3.0
RP-000204	25.101	053		R99	Clarification of the specification on Peak Code Domain Error (PCDE)	F	3.2.2	3.3.0
RP-000204	25.101	054		R99	Transients for uplink power steps	F	3.2.2	3.3.0
RP-000204	25.101	055		R99	Power setting for uplink compressed mode and RACH preambles	F	3.2.2	3.3.0
RP-000204	25.101	056		R99	UE interfering signal definition	F	3.2.2	3.3.0
RP-000204	25.101	057		R99	Downlink Power Control, wind up effects	F	3.2.2	3.3.0
RP-000204	25.101	058		R99	Use of P-CPICH and S-CPICH for performance requirements	F	3.2.2	3.3.0
RP-000204	25.101	059		R99	Performance of Closed Loop Diversity mode 2 and Mode 1	F	3.2.2	3.3.0
RP-000204	25.101	060		R99	Removal of brackets from Inter-Cell SHO test case	F	3.2.2	3.3.0
RP-000204	25.101	061		R99	Editorial corrections on moving propagation conditions	F	3.2.2	3.3.0
					Correct page numbering problem and other minor editorials		3.3.0	3.3.1

Table G.4: Inclusion of CRs approved by TSG-RAN#9.

RAN Doc	Spec	CR	R	Ph	Subject	Cat	Curr	New
RP-000394	25.101	71		R99	Downlink power control, wind up effects	F	3.3.1	3.4.0
RP-000394	25.101	72		R99	Inclusion of OCNS definition for performance tests	F	3.3.1	3.4.0
RP-000394	25.101	63		R99	Corrections to DL compressed mode tests in TS 25.101	F	3.3.1	3.4.0
RP-000394	25.101	64		R99	Combining of TPC commands in soft handover	F	3.3.1	3.4.0
RP-000394	25.101	65		R99	Clarifications for power steps in RACH/CPCH message transmission	F	3.3.1	3.4.0
RP-000394	25.101	66		R99	Editorial corrections for TS 25.101	F	3.3.1	3.4.0
RP-000394	25.101	67		R99	Corrections to power control	F	3.3.1	3.4.0
RP-000394	25.101	68		R99	Corrections for compressed mode patterns	F	3.3.1	3.4.0
RP-000394	25.101	69		R99	Editorial modification for BTFD measurement channels	F	3.3.1	3.4.0
RP-000394	25.101	75		R99	Editorial modification to Annex A.5 of TS 25.101	F	3.3.1	3.4.0
RP-000394	25.101	76		R99	Tap magnitudes and phases for Birth-Death propagation conditions	F	3.3.1	3.4.0
RP-000394	25.101	73		R99	Removal of confidence levels	F	3.3.1	3.4.0
RP-000394	25.101	74		R99	Corrections to all tests with power control ON in TS 25.101	F	3.3.1	3.4.0
RP-000394	25.101	70		R99	Definition of period for frequency error	F	3.3.1	3.4.0
RP-000394	25.101	77		R99	UE emission mask measurement filter definition correction for TS 25.101	F	3.3.1	3.4.0
RP-000394	25.101	78		R99	Handling of measurement uncertainties in UE radio conformance testing (FDD)	F	3.3.1	3.4.0
					Re-inclusion of reference [4] which had been accidentally deleted.		3.4.0	3.4.1

Table G.5: CRs approved at RAN#10

RAN Doc	Spec	CR	R	Ph	Subject	Cat	Curr	New
R4-000885	25.101	79		R99	Proposed CR to TS 25.101 on subclause 7.8 RX Intermodulation	F	3.4.1	3.5.0
R4-000901	25.101	80		R99	Corrections to DL compressed mode tests in TS 25.101	F	3.4.1	3.5.0
R4-000902	25.101	81		R99	Correction to DL 384 kbps and BTDF measurement channels	F	3.4.1	3.5.0
R4-000917	25.101	82		R99	Compressed mode, proposal for specification	F	3.4.1	3.5.0
R4-000973	25.101	82		R99	RX spurious emissions	F	3.4.1	3.5.0
R4-000982	25.101	84		R99	Correction for 25.101 concerning the channel number calculation	F	3.4.1	3.5.0
R4-000990	25.101	85		R99	Definition of multi-code OCNS signal for receiver and performance tests	F	3.4.1	3.5.0

Table G.6: Release 1999 CRs approved at RAN#11

RAN Doc	Spec	CR	R	Ph	Subject	Cat	Curr	New
RP-010085	25.101	86		R99	CR to 25.101 for Test Tolerances	F	3.5.0	3.6.0
RP-010085	25.101	87		R99	Proposed CR to TS 25.101 on subclause 3.2 Abbreviations	F	3.5.0	3.6.0
RP-010085	25.101	88		R99	Correction of version number of the ITU-R Recommendation SM.329	F	3.5.0	3.6.0
RP-010085	25.101	89		R99	REL 99 Corrections	F	3.5.0	3.6.0
RP-010085	25.101	90		R99	Tx power during measurement on Rx characteristics	F	3.5.0	3.6.0
RP-010085	25.101	91		R99	Removal of square brackets and TBDs from TS 25.101	F	3.5.0	3.6.0
RP-010085	25.101	92		R99	Correction of Definition of multi-code OCNS signal	F	3.5.0	3.6.0
RP-010085	25.101	93		R99	Performance requirement for 250km/h	F	3.5.0	3.6.0
RP-010085	25.101	94		R99	TS25.101 Rel 99 Clarification of UARFCN (channel number)	F	3.5.0	3.6.0

Table G.7: Release 4 CRs approved at RAN#11

RAN Doc	Spec	CR	R	Ph	Subject	Cat	Curr	New
RP-010100	25.101	96		R4	Performance requirements BCH	B	3.6.0	4.0.0
RP-010100	25.101	97		R4	Performance requirements for paging channel	B	3.6.0	4.0.0
RP-010100	25.101	98		R4	Performance requirements for AI channel	B	3.6.0	4.0.0

History

Document history		
V4.0.0	March 2001	Publication