

ETSI TS 125 101 V6.7.0 (2005-03)

Technical Specification

**Universal Mobile Telecommunications System (UMTS);
User Equipment (UE) radio transmission and reception (FDD)
(3GPP TS 25.101 version 6.7.0 Release 6)**



Reference

RTS/TSGR-0425101v670

Keywords

UMTS

ETSI

650 Route des Lucioles
F-06921 Sophia Antipolis Cedex - FRANCE

Tel.: +33 4 92 94 42 00 Fax: +33 4 93 65 47 16

Siret N° 348 623 562 00017 - NAF 742 C
Association à but non lucratif enregistrée à la
Sous-Préfecture de Grasse (06) N° 7803/88

Important notice

Individual copies of the present document can be downloaded from:

<http://www.etsi.org>

The present document may be made available in more than one electronic version or in print. In any case of existing or perceived difference in contents between such versions, the reference version is the Portable Document Format (PDF). In case of dispute, the reference shall be the printing on ETSI printers of the PDF version kept on a specific network drive within ETSI Secretariat.

Users of the present document should be aware that the document may be subject to revision or change of status. Information on the current status of this and other ETSI documents is available at

<http://portal.etsi.org/tb/status/status.asp>

If you find errors in the present document, please send your comment to one of the following services:

http://portal.etsi.org/chaicor/ETSI_support.asp

Copyright Notification

No part may be reproduced except as authorized by written permission.
The copyright and the foregoing restriction extend to reproduction in all media.

© European Telecommunications Standards Institute 2005.
All rights reserved.

DECTTM, **PLUGTESTS**TM and **UMTS**TM are Trade Marks of ETSI registered for the benefit of its Members.
TIPHONTM and the **TIPHON logo** are Trade Marks currently being registered by ETSI for the benefit of its Members.
3GPPTM is a Trade Mark of ETSI registered for the benefit of its Members and of the 3GPP Organizational Partners.

Intellectual Property Rights

IPRs essential or potentially essential to the present document may have been declared to ETSI. The information pertaining to these essential IPRs, if any, is publicly available for **ETSI members and non-members**, and can be found in ETSI SR 000 314: *"Intellectual Property Rights (IPRs); Essential, or potentially Essential, IPRs notified to ETSI in respect of ETSI standards"*, which is available from the ETSI Secretariat. Latest updates are available on the ETSI Web server (<http://webapp.etsi.org/IPR/home.asp>).

Pursuant to the ETSI IPR Policy, no investigation, including IPR searches, has been carried out by ETSI. No guarantee can be given as to the existence of other IPRs not referenced in ETSI SR 000 314 (or the updates on the ETSI Web server) which are, or may be, or may become, essential to the present document.

Foreword

This Technical Specification (TS) has been produced by ETSI 3rd Generation Partnership Project (3GPP).

The present document may refer to technical specifications or reports using their 3GPP identities, UMTS identities or GSM identities. These should be interpreted as being references to the corresponding ETSI deliverables.

The cross reference between GSM, UMTS, 3GPP and ETSI identities can be found under <http://webapp.etsi.org/key/queryform.asp>.

Contents

Intellectual Property Rights	2
Foreword.....	2
Foreword.....	8
1 Scope	9
2 References	9
3 Definitions, symbols and abbreviations	9
3.1 Definitions	9
3.2 Abbreviations	10
4 General	12
4.1 Relationship between Minimum Requirements and Test Requirements	12
4.2 Power Classes.....	12
4.3 Control and monitoring functions	12
4.3.1 Minimum requirement	12
5 Frequency bands and channel arrangement.....	12
5.1 General	12
5.2 Frequency bands.....	12
5.3 TX–RX frequency separation.....	13
5.4 Channel arrangement.....	13
5.4.1 Channel spacing	13
5.4.2 Channel raster	13
5.4.3 Channel number.....	13
5.4.4 UARFCN.....	14
6 Transmitter characteristics	14
6.1 General	14
6.2 Transmit power	15
6.2.1 UE maximum output power.....	15
6.2.2 UE maximum output power with HS-DPCCH	15
6.3 Frequency Error.....	15
6.4 Output power dynamics.....	15
6.4.1 Open loop power control	16
6.4.1.1 Minimum requirement	16
6.4.2 Inner loop power control in the uplink.....	16
6.4.2.1 Power control steps	16
6.4.2.1.1 Minimum requirement.....	16
6.4.3 Minimum output power	17
6.4.3.1 Minimum requirement	17
6.4.4 Out-of-synchronization handling of output power.....	17
6.4.4.1 Minimum requirement	17
6.4.4.2 Test case.....	17
6.5 Transmit ON/OFF power	19
6.5.1 Transmit OFF power.....	19
6.5.1.1 Minimum requirement	19
6.5.2 Transmit ON/OFF Time mask.....	19
6.5.2.1 Minimum requirement	19
6.5.3 Change of TFC	21
6.5.3.1 Minimum requirement	21
6.5.4 Power setting in uplink compressed mode.....	22
6.5.4.1 Minimum requirement	23
6.5.5 HS-DPCCH.....	24
6.5.5.1 Minimum requirement	24
6.6 Output RF spectrum emissions.....	26
6.6.1 Occupied bandwidth	26

6.6.2	Out of band emission	26
6.6.2.1	Spectrum emission mask	26
6.6.2.1.1	Minimum requirement	26
6.6.2.2	Adjacent Channel Leakage power Ratio (ACLR)	27
6.6.2.2.1	Minimum requirement	27
6.6.3	Spurious emissions	27
6.6.3.1	Minimum requirement	27
6.7	Transmit intermodulation	28
6.7.1	Minimum requirement	28
6.8	Transmit modulation	28
6.8.1	Transmit pulse shape filter	29
6.8.2	Error Vector Magnitude	29
6.8.2.1	Minimum requirement	29
6.8.3	Peak code domain error	29
6.8.3.1	Minimum requirement	30
6.8.4	Phase discontinuity	30
6.8.4.1	Minimum requirement	30
7	Receiver characteristics	30
7.1	General	30
7.2	Diversity characteristics	30
7.3	Reference sensitivity level	31
7.3.1	Minimum requirement	31
7.4	Maximum input level	31
7.4.1	Minimum requirement for DPCH reception	31
7.4.2	Minimum requirement for HS-PDSCH reception	32
7.4.2.1	Minimum requirement for 16QAM	32
7.5	Adjacent Channel Selectivity (ACS)	32
7.5.1	Minimum requirement	32
7.6	Blocking characteristics	33
7.6.1	Minimum requirement (In-band blocking)	33
7.6.2	Minimum requirement (Out of-band blocking)	34
7.6.3	Minimum requirement (Narrow band blocking)	34
7.7	Spurious response	35
7.7.1	Minimum requirement	35
7.8	Intermodulation characteristics	35
7.8.1	Minimum requirement	35
7.8.2	Minimum requirement (Narrow band)	36
7.9	Spurious emissions	36
7.9.1	Minimum requirement	36
8	Performance requirement	37
8.1	General	37
8.2	Demodulation in static propagation conditions	38
8.2.1	(void)	38
8.2.2	Demodulation of Forward Access Channel (FACH)	38
8.2.3	Demodulation of Dedicated Channel (DCH)	38
8.2.3.1	Minimum requirement	38
8.3	Demodulation of DCH in multi-path fading propagation conditions	38
8.3.1	Single Link Performance	38
8.3.1.1	Minimum requirement	39
8.4	Demodulation of DCH in moving propagation conditions	42
8.4.1	Single link performance	42
8.4.1.1	Minimum requirement	42
8.5	Demodulation of DCH in birth-death propagation conditions	42
8.5.1	Single link performance	42
8.5.1.1	Minimum requirement	42
8.6	Demodulation of DCH in downlink Transmit diversity modes	43
8.6.1	Demodulation of DCH in open-loop transmit diversity mode	43
8.6.1.1	Minimum requirement	43
8.6.2	Demodulation of DCH in closed loop transmit diversity mode	43
8.6.2.1	Minimum requirement	44

8.6.3	Demodulation of DCH in Site Selection Diversity Transmission Power Control mode.....	44
8.6.3.1	Minimum requirements	44
8.7	Demodulation in Handover conditions.....	45
8.7.1	Demodulation of DCH in Inter-Cell Soft Handover	45
8.7.1.1	Minimum requirement	45
8.7.2	Combining of TPC commands from radio links of different radio link sets.....	46
8.7.2.1	Minimum requirement	46
8.7.3	Combining of reliable TPC commands from radio links of different radio link sets	47
8.7.3.1	Minimum requirement	47
8.8	Power control in downlink	47
8.8.1	Power control in the downlink, constant BLER target	47
8.8.1.1	Minimum requirements	47
8.8.2	Power control in the downlink, initial convergence.....	48
8.8.2.1	Minimum requirements	48
8.8.3	Power control in downlink, wind up effects	49
8.8.3.1	Minimum requirements	49
8.9	Downlink compressed mode	49
8.9.1	Single link performance	50
8.9.1.1	Minimum requirements	50
8.10	Blind transport format detection.....	50
8.10.1	Minimum requirement	51
8.11	Detection of Broadcast channel (BCH).....	51
8.11.1	Minimum requirement without transmit diversity	51
8.11.2	Minimum requirement with open loop transmit diversity	52
8.12	Demodulation of Paging Channel (PCH)	52
8.12.1	Minimum requirement	52
8.13	Detection of Acquisition Indicator (AI)	53
8.13.1	Minimum requirement	53
8.14	Detection of Access Preamble Acquisition Indicator Channel (AP-AICH).....	53
8.15	Detection of Collision Detection/Channel Assignment Indicator Channel (CD/CA-ICH)	54
8.16	Demodulation of CPCH Status Indicator Channel (CSICH).....	54
8.16.1	Minimum requirement when CA is not active.....	54
8.16.2	Minimum requirement when CA is active.....	55
9	Performance requirement (HSDPA)	56
9.1	Void	57
9.2	Demodulation of HS-DSCH (Fixed Reference Channel).....	57
9.2.1	Single Link performance	58
9.2.1.1	Requirement QPSK, Fixed Reference Channel (FRC) H-Set 1/2/3	58
9.2.1.2	Requirement 16QAM, Fixed Reference Channel (FRC) H-Set 1/2/3	59
9.2.1.3	Minimum requirement QPSK, Fixed Reference Channel (FRC) H-Set 4/5.....	60
9.2.1.4	Minimum requirement QPSK, Fixed Reference Channel (FRC) H-Set 6.....	61
9.2.1.5	Minimum requirement 16QAM, Fixed Reference Channel (FRC) H-Set 6.....	62
9.2.2	Open Loop Diversity performance	63
9.2.2.1	Requirement QPSK, Fixed Reference Channel (FRC) H-Set 1/2/3	63
9.2.2.2	Requirement 16QAM, Fixed Reference Channel (FRC) H-Set 1/2/3	64
9.2.2.3	Minimum requirement QPSK, Fixed Reference Channel (FRC) H-Set 4/5.....	65
9.2.3	Closed Loop Diversity Performance.....	66
9.2.3.1	Requirement QPSK, Fixed Reference Channel (FRC) H-Set 1/2/3	66
9.2.3.2	Requirement 16QAM, Fixed Reference Channel (FRC) H-Set 1/2/3	68
9.2.3.3	Minimum requirement QPSK, Fixed Reference Channel (FRC) H-Set 4/5.....	69
9.3	Reporting of Channel Quality Indicator	70
9.3.1	Single Link Performance	70
9.3.1.1	AWGN propagation conditions	70
9.3.1.1.1	Minimum Requirement – UE capability categories 1-8 and 11, 12.....	70
9.3.1.2	Fading propagation conditions	71
9.3.1.2.1	Minimum Requirement – UE capability categories 1-8 and 11, 12.....	71
9.3.2	Open Loop Diversity Performance	72
9.3.2.1	AWGN propagation conditions	72
9.3.2.1.1	Minimum Requirement - UE capability categories 1-8 and 11, 12	72
9.3.2.2	Fading propagation conditions	73
9.3.2.2.1	Minimum Requirement – UE capability categories 1-8 and 11, 12.....	73

9.3.3	Closed Loop Diversity Performance	74
9.3.3.1	AWGN propagation conditions	74
9.3.3.1.1	Minimum Requirement - UE capability categories 1-8 and 11, 12	74
9.3.3.2	Fading propagation conditions	75
9.3.3.2.1	Minimum Requirement – UE capability categories 1-8 and 11, 12.....	75
9.4	HS-SCCH Detection Performance	76
9.4.1	Single Link Performance	76
9.4.2	Open Loop Diversity Performance	77
Annex A (normative): Measurement channels		79
A.1	General	79
A.2	UL reference measurement channel	79
A.2.1	UL reference measurement channel (12.2 kbps)	79
A.2.2	UL reference measurement channel (64 kbps)	80
A.2.3	UL reference measurement channel (144 kbps)	81
A.2.4	UL reference measurement channel (384 kbps)	82
A.2.5	UL reference measurement channel (768 kbps)	83
A.3	DL reference measurement channel	84
A.3.1	DL reference measurement channel (12.2 kbps)	84
A.3.2	DL reference measurement channel (64 kbps)	85
A.3.3	DL reference measurement channel (144 kbps)	86
A.3.4	DL reference measurement channel (384 kbps)	87
A.3.5	DL reference measurement channel 2 (64 kbps)	88
A.4	DL reference measurement channel for BTFD performance requirements	89
A.4A	DL reference measurement channel for requirements using DPCCH with 4 pilot bits as phase reference	91
A.4A.1	DL reference measurement channel (12.2 kbps)	91
A.5	DL reference compressed mode parameters.....	92
A.6	DL reference parameters for PCH tests.....	93
A.7	DL reference channel parameters for HSDPA tests	94
A.7.1	Fixed Reference Channel (FRC)	94
A.7.1.1	Fixed Reference Channel Definition H-Set 1	94
A.7.1.2	Fixed Reference Channel Definition H-Set 2	95
A.7.1.3	Fixed Reference Channel Definition H-Set 3	96
A.7.1.4	Fixed Reference Channel Definition H-Set 4	97
A.7.1.5	Fixed Reference Channel Definition H-Set 5	98
A.7.1.6	Fixed Reference Channel Definition H-Set 6	98
Annex B (normative): Propagation conditions.....		100
B.1	General	100
B.2	Propagation Conditions	100
B.2.1	Static propagation condition.....	100
B.2.2	Multi-path fading propagation conditions	100
B.2.3	Moving propagation conditions.....	102
B.2.4	Birth-Death propagation conditions	102
Annex C (normative): Downlink Physical Channels.....		104
C.1	General	104
C.2	Connection Set-up	104
C.3	During connection	104
C.3.1	Measurement of Rx Characteristics.....	104
C.3.2	Measurement of Performance requirements	105
C.3.3	Connection with open-loop transmit diversity mode.....	106
C.3.4	Connection with closed loop transmit diversity mode.....	106

C.3.5	Connection with tests having DPCCCH as a phase reference	107
C.4	W-CDMA Modulated Interferer	108
C.5	HSDPA DL Physical channels	108
C.5.1	Downlink Physical Channels connection set-up.....	108
C.5.2	OCNS Definition.....	113
Annex D (normative):	Environmental conditions	114
D.1	General	114
D.2	Environmental requirements	114
D.2.1	Temperature	114
D.2.2	Voltage	114
D.2.3	Vibration.....	115
Annex E (informative):	Change history	116
History		123

Foreword

This Technical Specification (TS) has been produced by the 3rd Generation Partnership Project (3GPP).

The contents of the present document are subject to continuing work within the TSG and may change following formal TSG approval. Should the TSG modify the contents of the present document, it will be re-released by the TSG with an identifying change of release date and an increase in version number as follows:

Version x.y.z

where:

- x the first digit:
 - 1 presented to TSG for information;
 - 2 presented to TSG for approval;
 - 3 or greater indicates TSG approved document under change control.
- y the second digit is incremented for all changes of substance, i.e. technical enhancements, corrections, updates, etc.
- z the third digit is incremented when editorial only changes have been incorporated in the document.

1 Scope

The present document establishes the minimum RF characteristics of the FDD mode of UTRA for the User Equipment (UE).

2 References

The following documents contain provisions which, through reference in this text, constitute provisions of the present document.

- References are either specific (identified by date of publication, edition number, version number, etc.) or non-specific.
- For a specific reference, subsequent revisions do not apply.
- For a non-specific reference, the latest version applies. In the case of a reference to a 3GPP document (including a GSM document), a non-specific reference implicitly refers to the latest version of that document *in the same Release as the present document*.

- [1] (void)
- [2] ITU-R Recommendation SM.329: " Unwanted emissions in the spurious domain ".
- [3] (void)
- [4] 3GPP TS 25.433: "UTRAN Iub Interface NBAP Signalling".
- [5] ETSI ETR 273: "Electromagnetic compatibility and Radio spectrum Matters (ERM); Improvement of radiated methods of measurement (using test sites) and evaluation of the corresponding measurement uncertainties; Part 1: Uncertainties in the measurement of mobile radio equipment characteristics; Sub-part 2: Examples and annexes".
- [6] 3GPP TS 45.004: "Digital cellular telecommunications system (Phase 2+); Modulation".
- [7] 3GPP TS 25.331: 'Radio Resource Control (RRC); Protocol Specification'
- [8] 3GPP TS25.214: 'Physical layer procedures (FDD)

3 Definitions, symbols and abbreviations

3.1 Definitions

For the purposes of the present document, the following definitions apply:

Power Spectral Density: The units of Power Spectral Density (PSD) are extensively used in this document. PSD is a function of power versus frequency and when integrated across a given bandwidth, the function represents the mean power in such a bandwidth. When the mean power is normalised to (divided by) the chip-rate it represents the mean energy per chip. Some signals are directly defined in terms of energy per chip, (DPCH_{E_c}, E_c, OCNS_{E_c} and S-CCPCH_{E_c}) and others defined in terms of PSD (I_o, I_{oc}, I_{or} and \hat{I}_{or}). There also exist quantities that are a ratio of energy per chip to PSD (DPCH_{E_c}/I_{or}, E_c/I_{or} etc.). This is the common practice of relating energy magnitudes in communication systems.

It can be seen that if both energy magnitudes in the ratio are divided by time, the ratio is converted from an energy ratio to a power ratio, which is more useful from a measurement point of view. It follows that an energy per chip of X dBm/3.84 MHz can be expressed as a mean power per chip of X dBm. Similarly, a signal PSD of Y dBm/3.84 MHz can be expressed as a signal power of Y dBm.

Maximum Output Power: This is a measure of the maximum power the UE can transmit (i.e. the actual power as would be measured assuming no measurement error) in a bandwidth of at least $(1 + \alpha)$ times the chip rate of the radio access mode. The period of measurement shall be at least one timeslot.

Mean power: When applied to a W-CDMA modulated signal this is the power (transmitted or received) in a bandwidth of at least $(1 + \alpha)$ times the chip rate of the radio access mode. The period of measurement shall be at least one timeslot unless otherwise stated.

Nominal Maximum Output Power: This is the nominal power defined by the UE power class.

RRC filtered mean power: The mean power as measured through a root raised cosine filter with roll-off factor α and a bandwidth equal to the chip rate of the radio access mode.

NOTE 1: The RRC filtered mean power of a perfectly modulated W-CDMA signal is 0.246 dB lower than the mean power of the same signal.

NOTE 2: The roll-off factor α is defined in section 6.8.1.

Throughput: Number of information bits per second excluding CRC bits successfully received on HS-DSCH by a HSDPA capable UE.

3.2 Abbreviations

For the purposes of the present document, the following abbreviations apply:

ACLR	Adjacent Channel Leakage power Ratio
ACS	Adjacent Channel Selectivity
AICH	Acquisition Indication Channel
BER	Bit Error Ratio
BLER	Block Error Ratio
CQI	Channel Quality Indicator
CW	Continuous Wave (un-modulated signal)
DCH	Dedicated Channel, which is mapped into Dedicated Physical Channel.
DL	Down Link (forward link)
DTX	Discontinuous Transmission
DPCCCH	Dedicated Physical Control Channel
DPCH	Dedicated Physical Channel
DPCH $_E_c$	Average energy per PN chip for DPCH.
$\frac{DPCH_E_c}{I_{or}}$	The ratio of the transmit energy per PN chip of the DPCH to the total transmit power spectral density at the Node B antenna connector.
DPDCH	Dedicated Physical Data Channel
EIRP	Effective Isotropic Radiated Power
E_c	Average energy per PN chip.
$\frac{E_c}{I_{or}}$	The ratio of the average transmit energy per PN chip for different fields or physical channels to the total transmit power spectral density.
FACH	Forward Access Channel
FDD	Frequency Division Duplex
FDR	False transmit format Detection Ratio. A false Transport Format detection occurs when the receiver detects a different TF to that which was transmitted, and the decoded transport block(s) for this incorrect TF passes the CRC check(s).
F_{uw}	Frequency of unwanted signal. This is specified in bracket in terms of an absolute frequency(s) or a frequency offset from the assigned channel frequency.
HARQ	Hybrid Automatic Repeat Request
HSDPA	High Speed Downlink Packet Access
HS-DSCH	High Speed Downlink Shared Channel
HS-PDSCH	High Speed Physical Downlink Shared Channel
HS-SCCH	High Speed Shared Control Channel

Information Data Rate

	Rate of the user information, which must be transmitted over the Air Interface. For example, output rate of the voice codec.
I_o	The total received power spectral density, including signal and interference, as measured at the UE antenna connector.
I_{oc}	The power spectral density (integrated in a noise bandwidth equal to the chip rate and normalized to the chip rate) of a band limited white noise source (simulating interference from cells, which are not defined in a test procedure) as measured at the UE antenna connector.
I_{or}	The total transmit power spectral density (integrated in a bandwidth of $(1+\alpha)$ times the chip rate and normalized to the chip rate) of the downlink signal at the Node B antenna connector.
\hat{I}_{or}	The received power spectral density (integrated in a bandwidth of $(1+\alpha)$ times the chip rate and normalized to the chip rate) of the downlink signal as measured at the UE antenna connector.
MER	Message Error Ratio
Node B	A logical node responsible for radio transmission / reception in one or more cells to/from the User Equipment. Terminates the Iub interface towards the RNC
OCNS	Orthogonal Channel Noise Simulator, a mechanism used to simulate the users or control signals on the other orthogonal channels of a downlink link.
OCNS_ E_c	Average energy per PN chip for the OCNS.
$\frac{OCNS_E_c}{I_{or}}$	The ratio of the average transmit energy per PN chip for the OCNS to the total transmit power spectral density.
P-CCPCH	Primary Common Control Physical Channel
PCH	Paging Channel
$P-CCPCH \frac{E_c}{I_o}$	The ratio of the received P-CCPCH energy per chip to the total received power spectral density at the UE antenna connector.
$\frac{P-CCPCH_E_c}{I_{or}}$	The ratio of the average transmit energy per PN chip for the P-CCPCH to the total transmit power spectral density.
P-CPICH	Primary Common Pilot Channel
PICH	Paging Indicator Channel
PPM	Parts Per Million
R	Number of information bits per second excluding CRC bits successfully received on HS-DSCH by a HSDPA capable UE.
<REFSENS>	Reference sensitivity
<REF \hat{I}_{or} >	Reference \hat{I}_{or}
RACH	Random Access Channel
SCH	Synchronization Channel consisting of Primary and Secondary synchronization channels
S-CCPCH	Secondary Common Control Physical Channel.
S-CCPCH_ E_c	Average energy per PN chip for S-CCPCH.
SIR	Signal to Interference ratio
SML	Soft Metric Location (Soft channel bit)
SSDT	Site Selection Diversity Transmission
STTD	Space Time Transmit Diversity
TDD	Time Division Duplexing
TFC	Transport Format Combination
TFCI	Transport Format Combination Indicator
TPC	Transmit Power Control
TSTD	Time Switched Transmit Diversity
UE	User Equipment
UL	Up Link (reverse link)
UTRA	UMTS Terrestrial Radio Access

4 General

4.1 Relationship between Minimum Requirements and Test Requirements

The Minimum Requirements given in this specification make no allowance for measurement uncertainty. The test specification 34.121 Annex F defines Test Tolerances. These Test Tolerances are individually calculated for each test. The Test Tolerances are used to relax the Minimum Requirements in this specification to create Test Requirements.

The measurement results returned by the test system are compared – without any modification - against the Test Requirements as defined by the shared risk principle.

The Shared Risk principle is defined in ETR 273 Part 1 sub-part 2 section 6.5.

4.2 Power Classes

For UE power classes 1 and 2, a number of RF parameter are not specified. It is intended that these are part of a later release.

4.3 Control and monitoring functions

This requirement verifies that the control and monitoring functions of the UE prevent it from transmitting if no acceptable cell can be found by the UE.

4.3.1 Minimum requirement

The power of the UE, as measured with a thermal detector, shall not exceed -30dBm if no acceptable cell can be found by the UE.

5 Frequency bands and channel arrangement

5.1 General

The information presented in this subclause is based on a chip rate of 3.84 Mcps.

NOTE: Other chip rates may be considered in future releases.

5.2 Frequency bands

a) UTRA/FDD is designed to operate in the following paired bands:

Table 5.0: UTRA FDD frequency bands

Operating Band	UL Frequencies UE transmit, Node B receive	DL frequencies UE receive, Node B transmit
I	1920 – 1980 MHz	2110 –2170 MHz
II	1850 –1910 MHz	1930 –1990 MHz
III	1710-1785 MHz	1805-1880 MHz
IV	1710-1755 MHz	2110-2155 MHz
V	824 – 849 MHz	869-894 MHz
VI	830-840 MHz	875-885 MHz

Note: Band VI specifications are developed for use in Japan. The Band VI frequency ranges in the table are subject to coming regulatory decisions.

b) Deployment in other frequency bands is not precluded

5.3 TX–RX frequency separation

a) UTRA/FDD is designed to operate with the following TX-RX frequency separation

Table 5.0A: TX-RX frequency separation

Operating Band	TX-RX frequency separation
I	190 MHz
II	80 MHz.
III	95 MHz.
IV	400 MHz
V	45 MHz
VI	45 MHz

b) UTRA/FDD can support both fixed and variable transmit to receive frequency separation.

c) The use of other transmit to receive frequency separations in existing or other frequency bands shall not be precluded.

5.4 Channel arrangement

5.4.1 Channel spacing

The nominal channel spacing is 5 MHz, but this can be adjusted to optimise performance in a particular deployment scenario.

5.4.2 Channel raster

The channel raster is 200 kHz, for all bands which means that the centre frequency must be an integer multiple of 200 kHz. In addition a number of additional centre frequencies are specified according to table 5.1A, which means that the centre frequencies for these channels are shifted 100 kHz relative to the general raster.

5.4.3 Channel number

The carrier frequency is designated by the UTRA Absolute Radio Frequency Channel Number (UARFCN). The UARFCN values are defined as follows:

Table 5.1: UARFCN definition (general)

UPLINK (UL) UE transmit, Node B receive		DOWNLINK (DL) UE receive, Node B transmit	
UARFCN	Carrier frequency [MHz] (F_{UL}) (Note 1)	UARFCN	Carrier frequency [MHz] (F_{DL}) (Note 2)
$N_u = 5 * F_{UL}$	$0.0 \text{ MHz} \leq F_{UL} \leq 3276.6 \text{ MHz}$	$N_d = 5 * F_{DL}$	$0.0 \text{ MHz} \leq F_{DL} \leq 3276.6 \text{ MHz}$
Note 1: F_{UL} is the uplink frequency in MHz			
Note 2: F_{DL} is the downlink frequency in MHz			

Table 5.1A: UARFCN definition (additional channels)

Band	UPLINK (UL) UE transmit, Node B receive		DOWNLINK (DL) UE receive, Node B transmit	
	UARFCN	Carrier frequency [MHz] (F_{UL})	UARFCN	Carrier frequency [MHz] (F_{DL})
I	-	-	-	-
II	$N_u = 5 * (F_{UL} - 1850.1 \text{ MHz})$	1852.5, 1857.5, 1862.5, 1867.5, 1872.5, 1877.5, 1882.5, 1887.5, 1892.5, 1897.5, 1902.5, 1907.5	$N_d = 5 * (F_{DL} - 1850.1 \text{ MHz})$	1932.5, 1937.5, 1942.5, 1947.5, 1952.5, 1957.5, 1962.5, 1967.5, 1972.5, 1977.5, 1982.5, 1987.5
III	-	-	-	-
IV	$N_u = 5 * (F_{UL} - 1480.1 \text{ MHz})$	1712.5, 1717.5, 1722.5, 1727.5, 1732.5, 1737.5, 1742.5, 1747.5, 1752.5	$N_d = 5 * (F_{DL} - 1820.1 \text{ MHz})$	2112.5, 2117.5, 2122.5, 2127.5, 2132.5, 2137.5, 2142.5, 2147.5, 2152.5
V	$N_u = 5 * (F_{UL} - 670.1 \text{ MHz})$	826.5, 827.5, 831.5, 832.5, 837.5, 842.5	$N_d = 5 * (F_{DL} - 670.1 \text{ MHz})$	871.5, 872.5, 876.5, 877.5, 882.5, 887.5
VI	$N_u = 5 * (F_{UL} - 670.1 \text{ MHz})$	832.5, 837.5	$N_d = 5 * (F_{DL} - 670.1 \text{ MHz})$	877.5, 882.5

5.4.4 UARFCN

The following UARFCN range shall be supported for each paired band

Table 5.2: UTRA Absolute Radio Frequency Channel Number

Band	Uplink (UL) UE transmit, Node B receive		Downlink (DL) UE receive, Node B transmit	
	General	Additional	General	Additional
I	9612 to 9888	-	10562 to 10838	-
II	9262 to 9538	12, 37, 62, 87, 112, 137, 162, 187, 212, 237, 262, 287	9662 to 9938	412, 437, 462, 487, 512, 537, 562, 587, 612, 637, 662, 687
III	8562 to 8913	-	9037 to 9388	-
IV	8562 to 8763	1162, 1187, 1212, 1237, 1262, 1287, 1312, 1337, 1362	10562 to 10763	1462, 1487, 1512, 1537, 1562, 1587, 1612, 1637, 1662
V	4132 to 4233	782, 787, 807, 812, 837, 862	4357 to 4458	1007, 1012, 1032, 1037, 1062, 1087
VI	4162 to 4188	812, 837	4387 to 4413	1037, 1062

6 Transmitter characteristics

6.1 General

Unless otherwise stated, the transmitter characteristics are specified at the antenna connector of the UE. For UE with integral antenna only, a reference antenna with a gain of 0 dBi is assumed. Transmitter characteristics for UE(s) with multiple antennas/antenna connectors are FFS.

The UE antenna performance has a significant impact on system performance, and minimum requirements on the antenna efficiency are therefore intended to be included in future versions of the present document. It is recognised that different requirements and test methods are likely to be required for the different types of UE.

6.2 Transmit power

6.2.1 UE maximum output power

The following Power Classes define the nominal maximum output power. The nominal power defined is the broadband transmit power of the UE, i.e. the power in a bandwidth of at least $(1+\alpha)$ times the chip rate of the radio access mode. The period of measurement shall be at least one timeslot.

Table 6.1: UE Power Classes

Operating Band	Power Class 1		Power Class 2		Power Class 3		Power Class 4	
	Power (dBm)	Tol (dB)	Power (dBm)	Tol (dB)	Power (dBm)	Tol (dB)	Power (dBm)	Tol (dB)
Band I	+33	+1/-3	+27	+1/-3	+24	+1/-3	+21	+2/-2
Band II	-	-	-	-	+24	+1/-3	+21	+2/-2
Band III	-	-	-	-	+24	+1/-3	+21	+2/-2
Band IV	-	-	-	-	+24	+1/-3	+21	+2/-2
Band V	-	-	-	-	+24	+1/-3	+21	+2/-2
Band VI	-	-	-	-	+24	+1/-3	+21	+2/-2

NOTE: The tolerance allowed for the nominal maximum output power applies even for the multi-code DPDCH transmission mode.

6.2.2 UE maximum output power with HS-DPCCH

The applicability of this clause for UEs that support E-DCH is FFS.

For all values of β_{hs} defined in [8] the UE maximum output powers as specified in Table 6.1a are applicable in the case when the HS-DPCCH is fully or partially transmitted during a DPCCH timeslot. In DPCCH time slots, where HS-DPCCH is not transmitted, the UE maximum output power shall fulfil the requirements specified in Table 6.1.

Table 6.1a: UE maximum output powers with HS-DPCCH

Ratio of β_c to β_d for all values of β_{hs}	Power Class 3		Power Class 4	
	Power (dBm)	Tol (dB)	Power (dBm)	Tol (dB)
$1/15 \leq \beta_c/\beta_d \leq 12/15$	+24	+1/-3	+21	+2/-2
$13/15 \leq \beta_c/\beta_d \leq 15/8$	+23	+2/-3	+20	+3/-2
$15/7 \leq \beta_c/\beta_d \leq 15/0$	+22	+3/-3	+19	+4/-2

6.3 Frequency Error

The UE modulated carrier frequency shall be accurate to within ± 0.1 PPM observed over a period of one timeslot compared to the carrier frequency received from the Node B. For the PRACH and PCPCH preambles the measurement interval is lengthened to 3904 chips (being the 4096 chip nominal preamble period less a 25 μ s transient period allowance at each end of the burst). These signals will have an apparent error due to Node B frequency error and Doppler shift. In the later case, signals from the Node B must be averaged over sufficient time that errors due to noise or interference are allowed for within the above ± 0.1 PPM figure. The UE shall use the same frequency source for both RF frequency generation and the chip clock.

6.4 Output power dynamics

Power control is used to limit the interference level.

6.4.1 Open loop power control

Open loop power control is the ability of the UE transmitter to sets its output power to a specific value. The open loop power control tolerance is given in Table 6.3

6.4.1.1 Minimum requirement

The UE open loop power is defined as the mean power in a timeslot or ON power duration, whichever is available.

Table 6.3: Open loop power control tolerance

Conditions	Tolerance
Normal conditions	± 9 dB
Extreme conditions	± 12 dB

6.4.2 Inner loop power control in the uplink

Inner loop power control in the Uplink is the ability of the UE transmitter to adjust its output power in accordance with one or more TPC commands received in the downlink.

6.4.2.1 Power control steps

The power control step is the change in the UE transmitter output power in response to a single TPC command, TPC_cmd, derived at the UE.

6.4.2.1.1 Minimum requirement

The UE transmitter shall have the capability of changing the output power with a step size of 1, 2 and 3 dB according to the value of Δ_{TPC} or $\Delta_{\text{RP,TPC}}$, in the slot immediately after the TPC_cmd can be derived

- The transmitter output power step due to inner loop power control shall be within the range shown in Table 6.4.
- The transmitter average output power step due to inner loop power control shall be within the range shown in Table 6.5. Here a TPC_cmd group is a set of TPC_cmd values derived from a corresponding sequence of TPC commands of the same duration.

The inner loop power step is defined as the relative power difference between the mean power of the original (reference) timeslot and the mean power of the target timeslot, not including the transient duration. The transient duration is from 25 μ s before the slot boundary to 25 μ s after the slot boundary.

Table 6.4: Transmitter power control range

TPC_cmd	Transmitter power control range					
	1 dB step size		2 dB step size		3 dB step size	
	Lower	Upper	Lower	Upper	Lower	Upper
+ 1	+0.5 dB	+1.5 dB	+1 dB	+3 dB	+1.5 dB	+4.5 dB
0	-0.5 dB	+0.5 dB	-0.5 dB	+0.5 dB	-0.5 dB	+0.5 dB
-1	-0.5 dB	-1.5 dB	-1 dB	-3 dB	-1.5 dB	-4.5 dB

Table 6.5: Transmitter aggregate power control range

TPC_cmd group	Transmitter power control range after 10 equal TPC_cmd groups				Transmitter power control range after 7 equal TPC_cmd groups	
	1 dB step size		2 dB step size		3 dB step size	
	Lower	Upper	Lower	Upper	Lower	Upper
+1	+8 dB	+12 dB	+16 dB	+24 dB	+16 dB	+26 dB
0	-1 dB	+1 dB	-1 dB	+1 dB	-1 dB	+1 dB
-1	-8 dB	-12 dB	-16 dB	-24 dB	-16 dB	-26 dB
0,0,0,0,+1	+6 dB	+14 dB	N/A	N/A	N/A	N/A
0,0,0,0,-1	-6 dB	-14 dB	N/A	N/A	N/A	N/A

The UE shall meet the above requirements for inner loop power control over the power range bounded by the Minimum output power as defined in subclause 6.4.3, and the Maximum output power supported by the UE (i.e. the actual power as would be measured assuming no measurement error). This power shall be in the range specified for the power class of the UE in subclause 6.2.1.

6.4.3 Minimum output power

The minimum controlled output power of the UE is when the power is set to a minimum value.

6.4.3.1 Minimum requirement

The minimum output power is defined as the mean power in one time slot. The minimum output power shall be less than -50 dBm.

6.4.4 Out-of-synchronization handling of output power

The UE shall monitor the DPCCH quality in order to detect a loss of the signal on Layer 1, as specified in TS 25.214. The thresholds Q_{out} and Q_{in} specify at what DPCCH quality levels the UE shall shut its power off and when it shall turn its power on respectively. The thresholds are not defined explicitly, but are defined by the conditions under which the UE shall shut its transmitter off and turn it on, as stated in this subclause.

The DPCCH quality shall be monitored in the UE and compared to the thresholds Q_{out} and Q_{in} for the purpose of monitoring synchronization. The threshold Q_{out} should correspond to a level of DPCCH quality where no reliable detection of the TPC commands transmitted on the downlink DPCCH can be made. This can be at a TPC command error ratio level of e.g. 30%. The threshold Q_{in} should correspond to a level of DPCCH quality where detection of the TPC commands transmitted on the downlink DPCCH is significantly more reliable than at Q_{out} . This can be at a TPC command error ratio level of e.g. 20%.

6.4.4.1 Minimum requirement

When the UE estimates the DPCCH quality over the last 160 ms period to be worse than a threshold Q_{out} , the UE shall shut its transmitter off within 40 ms. The UE shall not turn its transmitter on again until the DPCCH quality exceeds an acceptable level Q_{in} . When the UE estimates the DPCCH quality over the last 160 ms period to be better than a threshold Q_{in} , the UE shall again turn its transmitter on within 40 ms.

The UE transmitter shall be considered 'off' if the transmitted power is below the level defined in subclause 6.5.1 (Transmit off power). Otherwise the transmitter shall be considered as 'on'.

6.4.4.2 Test case

This subclause specifies a test case, which provides additional information for how the minimum requirement should be interpreted for the purpose of conformance testing.

The quality levels at the thresholds Q_{out} and Q_{in} correspond to different signal levels depending on the downlink conditions DCH parameters. For the conditions in Table 6.6, a signal with the quality at the level Q_{out} can be generated by a DPCCH_Ec/Ior ratio of -25 dB, and a signal with Q_{in} by a DPCCH_Ec/Ior ratio of -21 dB. The DL reference

measurement channel (12.2) kbps specified in subclause A.3.1 and with static propagation conditions. The downlink physical channels, other than those specified in Table 6.6, are as specified in Table C.3 of Annex C.

Figure 6.1 shows an example scenario where the DPCCH_Ec/I_{or} ratio varies from a level where the DPCH is demodulated under normal conditions, down to a level below Q_{out} where the UE shall shut its power off and then back up to a level above Q_{in} where the UE shall turn the power back on.

Table 6.6: DCH parameters for the Out-of-synch handling test case

Parameter	Unit	Value
\hat{I}_{or}/I_{oc}	dB	-1
I_{oc}	dBm/3.84 MHz	-60
$\frac{DPDCH_E_c}{I_{or}}$	dB	See figure 6.1: Before point A -16.6 After point A Not defined
$\frac{DPCCH_E_c}{I_{or}}$	dB	See figure 6.1
Information Data Rate	kbps	12.2

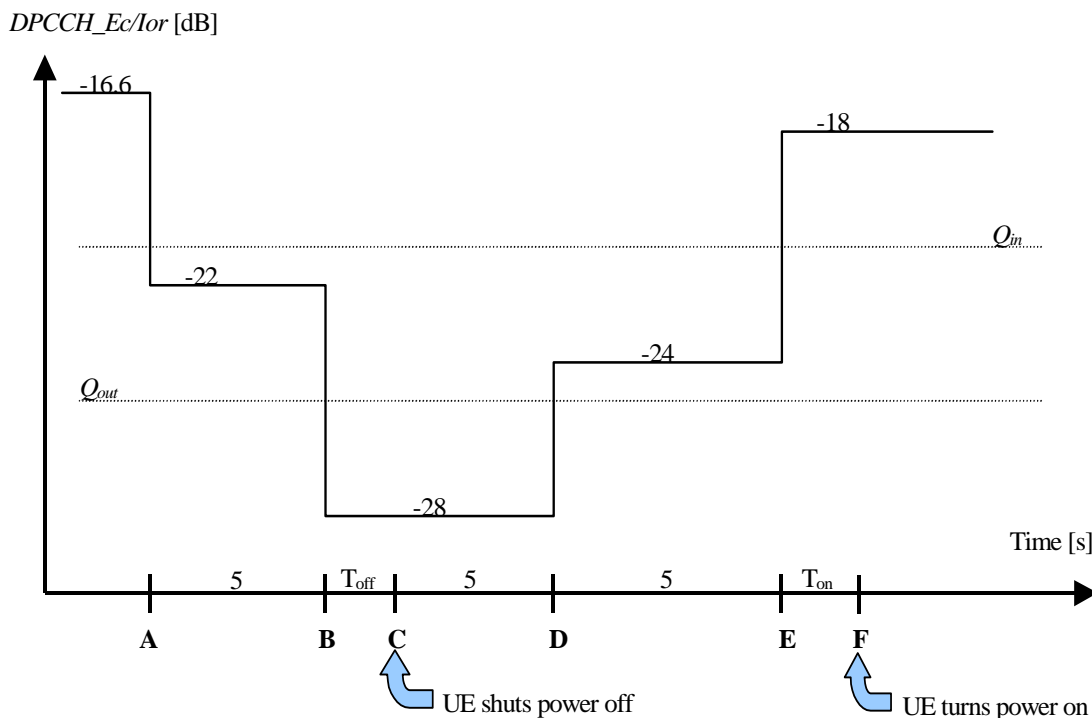

Figure 6.1: Test case for out-of-synch handling in the UE

In this test case, the requirements for the UE are that:

1. The UE shall not shut its transmitter off before point B.
2. The UE shall shut its transmitter off before point C, which is T_{off} = 200 ms after point B.
3. The UE shall not turn its transmitter on between points C and E.
4. The UE shall turn its transmitter on before point F, which is T_{on} = 200 ms after point E.

6.5 Transmit ON/OFF power

6.5.1 Transmit OFF power

Transmit OFF power is defined as the RRC filtered mean power when the transmitter is off. The transmitter is considered to be off when the UE is not allowed to transmit. During UL compressed mode gaps, the UE is not considered to be off.

6.5.1.1 Minimum requirement

The transmit OFF power is defined as the RRC filtered mean power in a duration of at least one timeslot excluding any transient periods. The requirement for the transmit OFF power shall be less than -56 dBm.

6.5.2 Transmit ON/OFF Time mask

The time mask for transmit ON/OFF defines the transient period allowed for the UE between transmit OFF power and transmit ON power. During the transient period there are no additional requirements on UE transmit power beyond what is required in subclause 6.2 maximum output power observed over a period of at least one timeslot. ON/OFF scenarios include PRACH/PCPCH preamble bursts, the beginning or end of PRACH/PCPCH message parts and the beginning or end of UL DPCH transmissions.

6.5.2.1 Minimum requirement

The transmit power levels versus time shall meet the requirements in figure 6.2 for PRACH preambles and CPCH preambles, and the requirements in figure 6.3 for all other cases. The off power observation period is defined as the RRC filtered mean power in a duration of at least one timeslot excluding any transient periods. The on power observation period is defined as the mean power over one timeslot excluding any transient periods. For PRACH/PCPCH preambles, the on power observation period is 3904 chips (4096 chips less the transient periods).

The off power specification in figures 6.2 and 6.3 is as defined in 6.5.1.1.

The average on power specification in figures 6.2 and 6.3 depends on each possible case.

- First preamble of RACH/CPCH: Open loop accuracy (Table 6.3).
- During preamble ramping of the RACH/CPCH, and between final RACH/CPCH preamble and RACH/CPCH message part: Accuracy depending on size of the required power difference.(Table 6.7). The step in total transmitted power between final RACH/CPCH preamble and RACH/CPCH message (control part + data part) shall be rounded to the closest integer dB value. A power step exactly half-way between two integer values shall be rounded to the closest integer of greater magnitude.
- After transmission gaps in compressed mode: Accuracy as in Table 6.9.
- Power step to Maximum Power: Maximum power accuracy (Table 6.1).

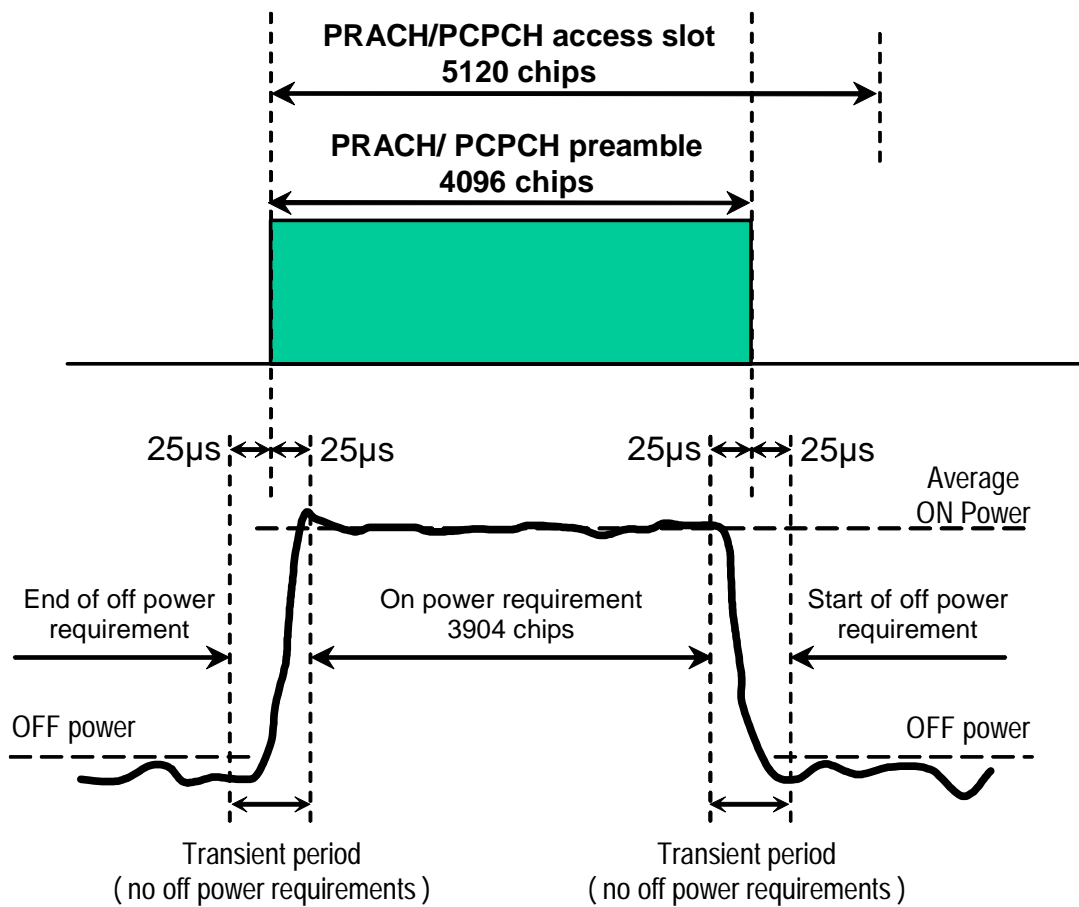

Figure 6.2: Transmit ON/OFF template for PRACH preambles and CPCH preambles

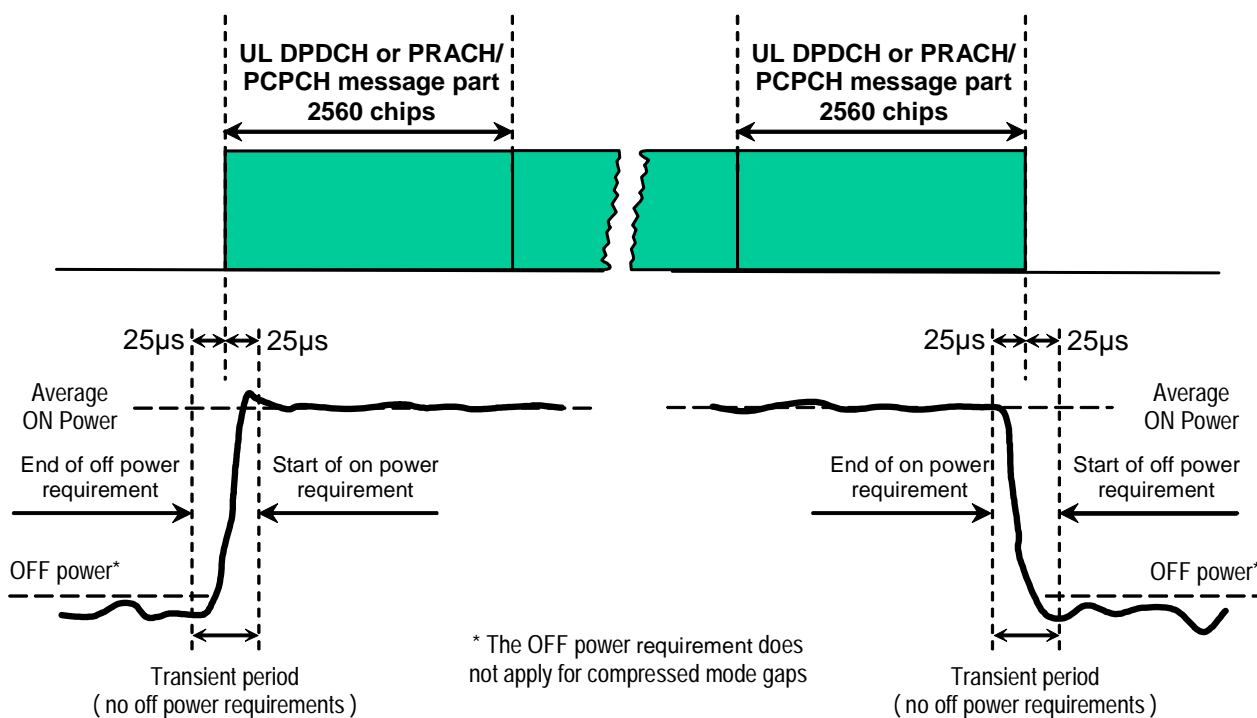

Figure 6.3: Transmit ON/OFF template for all other On/Off cases

Table 6.7: Transmitter power difference tolerance for RACH/CPCH preamble ramping, and between final RACH/CPCH preamble and RACH/CPCH message part

Power step size (Up or down)* ΔP [dB]	Transmitter power difference tolerance [dB]
0	+/- 1
1	+/- 1
2	+/- 1.5
3	+/- 2
$4 \leq \Delta P \leq 10$	+/- 2.5
$11 \leq \Delta P \leq 15$	+/- 3.5
$16 \leq \Delta P \leq 20$	+/- 4.5
$21 \leq \Delta P$	+/- 6.5

NOTE: Power step size for RACH/CPCH preamble ramping is from 1 to 8 dB with 1 dB steps.

6.5.3 Change of TFC

A change of TFC (Transport Format Combination) in uplink means that the power in the uplink varies according to the change in data rate. DTX, where the DPDCH is turned off, is a special case of variable data, which is used to minimise the interference between UE(s) by reducing the UE transmit power when voice, user or control information is not present.

6.5.3.1 Minimum requirement

A change of output power is required when the TFC, and thereby the data rate, is changed. The ratio of the amplitude between the DPDCH codes and the DPCCH code will vary. The power step due to a change in TFC shall be calculated in the UE so that the power transmitted on the DPCCH shall follow the inner loop power control. The step in total transmitted power (DPCCH + DPDCH) shall then be rounded to the closest integer dB value. A power step exactly half-way between two integer values shall be rounded to the closest integer of greater magnitude. The accuracy of the power step, given the step size, is specified in Table 6.8. The power change due to a change in TFC is defined as the relative power difference between the mean power of the original (reference) timeslot and the mean power of the target

timeslot, not including the transient duration. The transient duration is from 25µs before the slot boundary to 25µs after the slot boundary.

Table 6.8: Transmitter power step tolerance

Power step size (Up or down) ΔP [dB]	Transmitter power step tolerance [dB]
0	+/- 0.5
1	+/- 0.5
2	+/- 1.0
3	+/- 1.5
$4 \leq \Delta P \leq 10$	+/- 2.0
$11 \leq \Delta P \leq 15$	+/- 3.0
$16 \leq \Delta P \leq 20$	+/- 4.0
$21 \leq \Delta P$	+/- 6.0

The mean power of successive slots shall be calculated according to Figure 6.4.

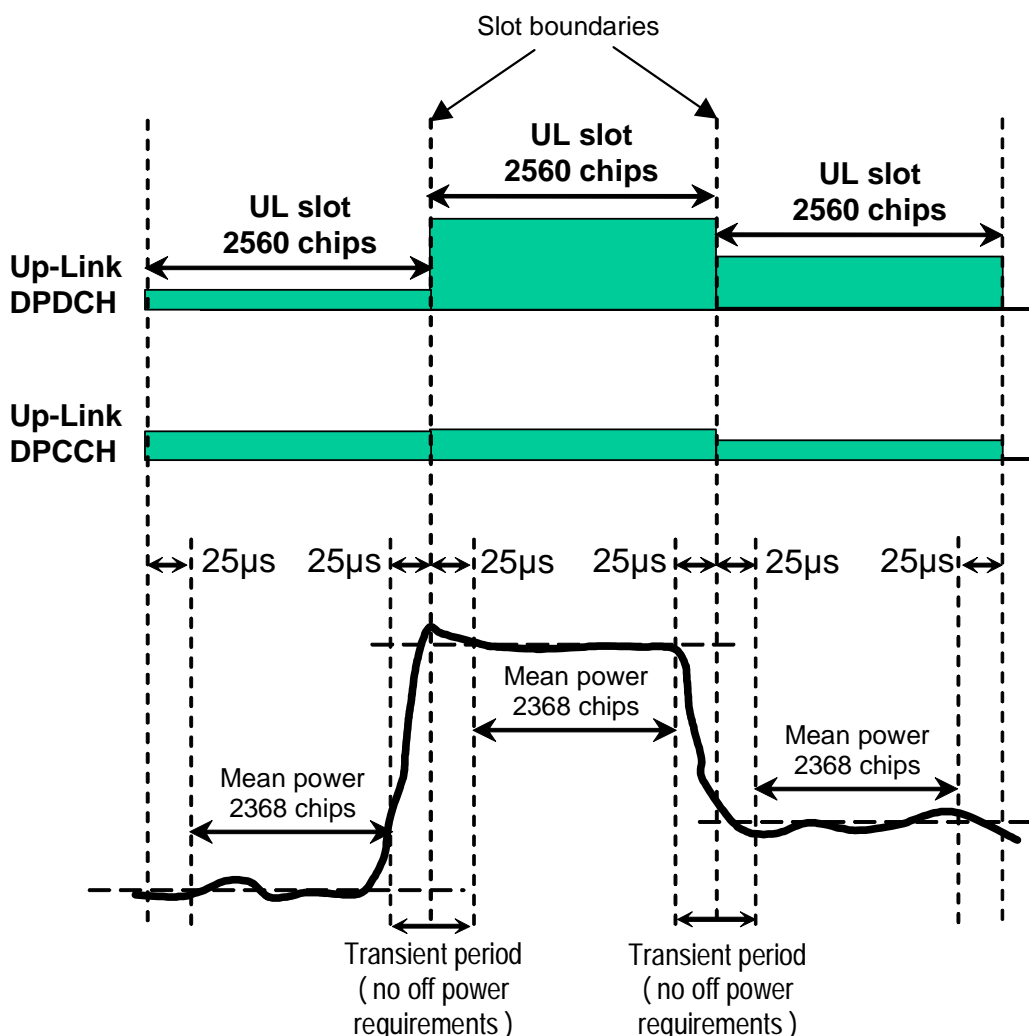

Figure 6.4: Transmit template during TFC change

6.5.4 Power setting in uplink compressed mode

Compressed mode in uplink means that the power in uplink is changed.

6.5.4.1 Minimum requirement

A change of output power is required during uplink compressed frames since the transmission of data is performed in a shorter interval. The ratio of the amplitude between the DPDCH codes and the DPCCH code will also vary. The power step due to compressed mode shall be calculated in the UE so that the energy transmitted on the pilot bits during each transmitted slot shall follow the inner loop power control.

Thereby, the power during compressed mode, and immediately afterwards, shall be such that the mean power of the DPCCH follows the steps due to inner loop power control combined with additional steps of $10\log_{10}(N_{\text{pilot,prev}} / N_{\text{pilot,curr}})$ dB where $N_{\text{pilot,prev}}$ is the number of pilot bits in the previously transmitted slot, and $N_{\text{pilot,curr}}$ is the current number of pilot bits per slot.

The resulting step in total transmitted power (DPCCH + DPDCH) shall then be rounded to the closest integer dB value. A power step exactly half-way between two integer values shall be rounded to the closest integer of greatest magnitude. The accuracy of the power step, given the step size, is specified in Table 6.8 in subclause 6.5.3.1. The power step is defined as the relative power difference between the mean power of the original (reference) timeslot and the mean power of the target timeslot, when neither the original timeslot nor the reference timeslot are in a transmission gap. The transient duration is not included, and is from 25µs before the slot boundary to 25µs after the slot boundary.

In addition to any power change due to the ratio $N_{\text{pilot,prev}} / N_{\text{pilot,curr}}$, the mean power of the DPCCH in the first slot after a compressed mode transmission gap shall differ from the mean power of the DPCCH in the last slot before the transmission gap by an amount Δ_{RESUME} , where Δ_{RESUME} is calculated as described in clause 5.1.2.3 of TS 25.214.

The resulting difference in the total transmitted power (DPCCH + DPDCH) shall then be rounded to the closest integer dB value. A power difference exactly half-way between two integer values shall be rounded to the closest integer of greatest magnitude. The accuracy of the resulting difference in the total transmitted power (DPCCH + DPDCH) after a transmission gap of up to 14 slots shall be as specified in Table 6.9.

Table 6.9: Transmitter power difference tolerance after a transmission gap of up to 14 slots

Power difference (Up or down) ΔP [dB]	Transmitter power step tolerance after a transmission gap [dB]
$\Delta P \leq 2$	+/- 3
3	+/- 3
$4 \leq \Delta P \leq 10$	+/- 3.5
$11 \leq \Delta P \leq 15$	+/- 4
$16 \leq \Delta P \leq 20$	+/- 4.5
$21 \leq \Delta P$	+/- 6.5

The power difference is defined as the difference between the mean power of the original (reference) timeslot before the transmission gap and the mean power of the target timeslot after the transmission gap, not including the transient durations. The transient durations at the start and end of the transmission gaps are each from 25µs before the slot boundary to 25µs after the slot boundary.

The mean power of successive slots shall be calculated according to figure 6.5.

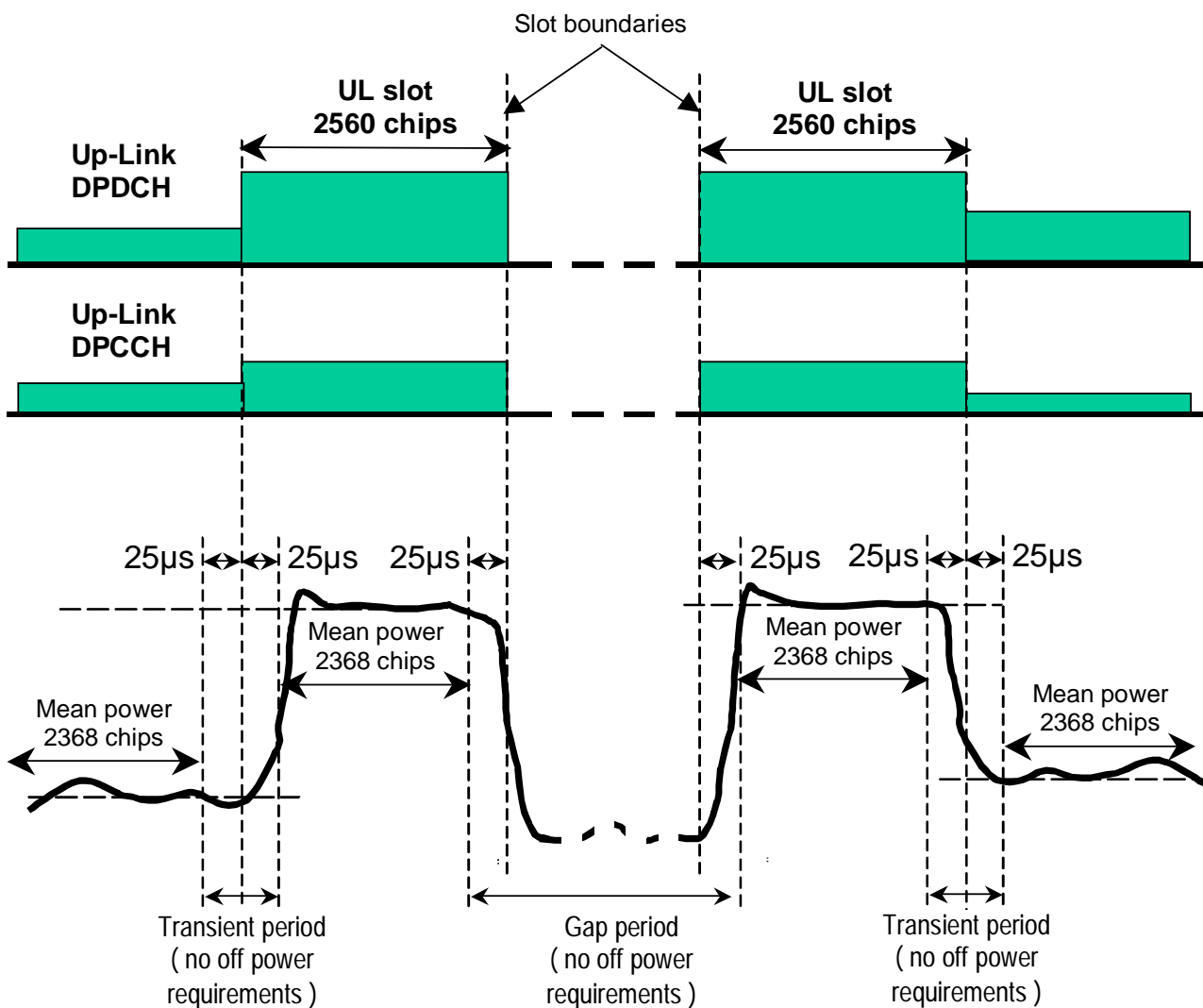

Figure 6.5: Transmit template during Compressed mode

6.5.5 HS-DPCCH

The transmission of Ack/Nack or CQI over the HS-DPCCH may cause the transmission power in the uplink to vary. The ratio of the amplitude between the DPCCH and the Ack/Nack and CQI respectively is signalled by higher layers.

6.5.5.1 Minimum requirement

The sum power on DPCCH+DPDCH is independent of the transmission of Ack/Nack and CQI unless the UE output power when Ack/Nack or CQI is transmitted would exceed the maximum value specified in Table 6.1A or fall below the value specified in 6.4.3.1, whereupon the UE shall apply additional scaling to the total transmit power as defined in section 5.1.2.6 of TS.25.214 [8].

The composite transmitted power (DPCCH + DPDCH+HS-DPCCH) shall be rounded to the closest integer dB value. When the HS-DPCCH slot timing is aligned with the DPCCH slot timing, the calculation of the power step and any subsequent change in transmitted power occurs once per DPCCH slot at the DPCCH slot boundaries. When the HS-DPCCH slot timing is not aligned with the DPCCH slot timing, this same process occurs twice per DPCCH slot, once at the DPCCH boundary and once at the HS-DPCCH boundary. A power step exactly half-way between two integer values shall be rounded to the closest integer of greater magnitude. The accuracy of the power step, given the step size, is specified in Table 6.9A.

The nominal power step due to transmission of Ack/Nack or CQI is defined as the difference between the nominal mean power of any two adjacent power evaluation periods. In the simple case where the HS-DPCCH slots are aligned with the DPCCH slots, each power evaluation period shall be one DPCCH timeslot in length. In the case where the HS-DPCCH timeslots are not aligned with the DPCCH timeslots, the power evaluation periods are shorter and start with a DPCCH slot boundary ending with the next HS-DPCCH slot boundary or start with an HS-DPCCH slot boundary and end with the next DPCCH slot boundary. In this non-aligned case, the length of any two adjacent power evaluation periods equals 2560 chips. In all cases the evaluation of mean power shall exclude a 25µs period before and after any DPCCH or HS-DPCCH slot boundary.

Table 6.9A: Transmitter power step tolerance

Nominal power step size (Up or down) ΔP [dB]	Transmitter power step tolerance [dB]
0	+/- 0.5
1	+/- 0.5
2	+/- 1.0
3	+/- 1.5
$4 \leq \Delta P \leq 7$	+/- 2.0

The transmit power levels versus time shall meet the mask specified in Figure 6.6.

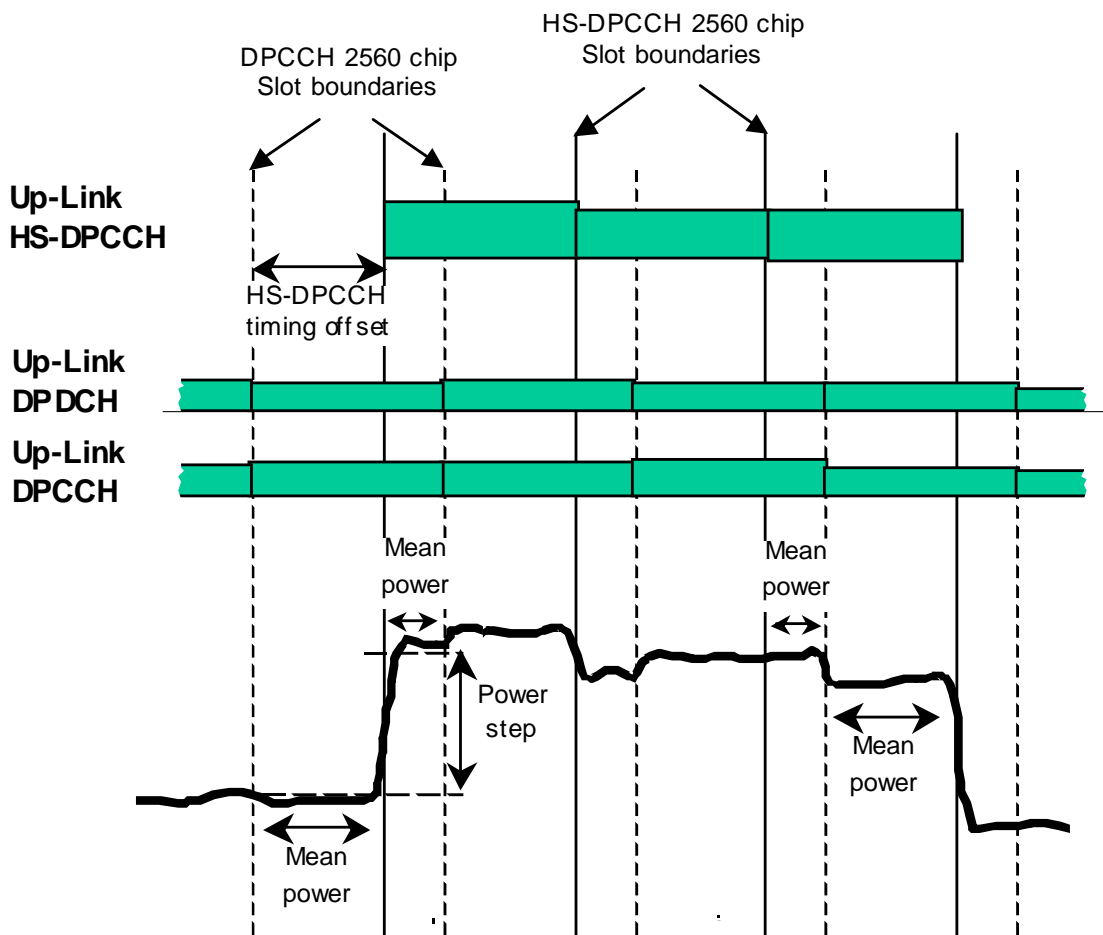

The mean power is evaluated excluding a 25µs transient period either side of any DPCCH or HS-DPCCH slot boundary

Figure 6.6: Transmit power template during HS-DPCCH transmission

6.6 Output RF spectrum emissions

6.6.1 Occupied bandwidth

Occupied bandwidth is a measure of the bandwidth containing 99 % of the total integrated power of the transmitted spectrum, centered on the assigned channel frequency. The occupied channel bandwidth shall be less than 5 MHz based on a chip rate of 3.84 Mcps.

6.6.2 Out of band emission

Out of band emissions are unwanted emissions immediately outside the nominal channel resulting from the modulation process and non-linearity in the transmitter but excluding spurious emissions. This out of band emission limit is specified in terms of a spectrum emission mask and Adjacent Channel Leakage power Ratio.

6.6.2.1 Spectrum emission mask

The spectrum emission mask of the UE applies to frequencies, which are between 2.5 MHz and 12.5 MHz away from the UE centre carrier frequency. The out of channel emission is specified relative to the RRC filtered mean power of the UE carrier.

6.6.2.1.1 Minimum requirement

The power of any UE emission shall not exceed the levels specified in Table 6.10. The absolute requirement is based on a -50 dBm/3.84 MHz minimum power threshold for the UE. This limit is expressed for the narrower measurement bandwidths as -55.8 dBm/1 MHz and -71.1 dBm/30 kHz. The requirements are applicable for all values of β_c , β_d and β_{hs} as specified in [8].

Table 6.10: Spectrum Emission Mask Requirement

Δf in MHz (Note 1)	Minimum requirement (Note 2) Band I, II, III, IV, V, VI		Additional requirements Band II, Band IV and Band V (Note 3)	Measurement bandwidth (Note 6)
	Relative requirement	Absolute requirement		
2.5 - 3.5	$\left\{ -35 - 15 \cdot \left(\frac{\Delta f}{\text{MHz}} - 2.5 \right) \right\} \text{dBc}$	-71.1 dBm	-15 dBm	30 kHz (Note 4)
3.5 - 7.5	$\left\{ -35 - 1 \cdot \left(\frac{\Delta f}{\text{MHz}} - 3.5 \right) \right\} \text{dBc}$	-55.8 dBm	-13 dBm	1 MHz (Note 5)
7.5 - 8.5	$\left\{ -39 - 10 \cdot \left(\frac{\Delta f}{\text{MHz}} - 7.5 \right) \right\} \text{dBc}$	-55.8 dBm	-13 dBm	1 MHz (Note 5)
8.5 - 12.5 MHz	-49 dBc	-55.8 dBm	-13 dBm	1 MHz (Note 5)

Note 1: Δf is the separation between the carrier frequency and the centre of the measurement bandwidth.

Note 2: The minimum requirement for bands I, II, III, IV, V & VI is calculated from the relative requirement or the absolute requirement, whichever is the higher power.

Note 3: For operation in Band II, Band IV and Band V only, the minimum requirement is calculated from the minimum requirement calculated in Note 2 or the additional requirement for band II, whichever is the lower power.

Note 4: The first and last measurement position with a 30 kHz filter is at Δf equals to 2.515 MHz and 3.485 MHz.

Note 5: The first and last measurement position with a 1 MHz filter is at Δf equals to 4 MHz and 12 MHz.

Note 6: As a general rule, the resolution bandwidth of the measuring equipment should be equal to the measurement bandwidth. However, to improve measurement accuracy, sensitivity and efficiency, the resolution bandwidth may be smaller than the measurement bandwidth. When the resolution bandwidth is smaller than the measurement bandwidth, the result should be integrated over the measurement bandwidth in order to obtain the equivalent noise bandwidth of the measurement bandwidth.

6.6.2.2 Adjacent Channel Leakage power Ratio (ACLR)

Adjacent Channel Leakage power Ratio (ACLR) is the ratio of the RRC filtered mean power centered on the assigned channel frequency to the RRC filtered mean power centered on an adjacent channel frequency.

6.6.2.2.1 Minimum requirement

If the adjacent channel power is greater than -50dBm then the ACLR shall be higher than the value specified in Table 6.11. The requirements are applicable for all values of β_c , β_d and β_{hs} as specified in [8].

Table 6.11: UE ACLR

Power Class	Adjacent channel frequency relative to assigned channel frequency	ACLR limit
3	+ 5 MHz or – 5 MHz	33 dB
3	+ 10 MHz or – 10 MHz	43 dB
4	+ 5 MHz or – 5 MHz	33 dB
4	+ 10 MHz or –10 MHz	43 dB

NOTE 1: The requirement shall still be met in the presence of switching transients.

NOTE 2: The ACLR requirements reflect what can be achieved with present state of the art technology.

NOTE 3: Requirement on the UE shall be reconsidered when the state of the art technology progresses.

6.6.3 Spurious emissions

Spurious emissions are emissions which are caused by unwanted transmitter effects such as harmonics emission, parasitic emission, intermodulation products and frequency conversion products, but exclude out of band emissions.

The frequency boundary and the detailed transitions of the limits between the requirement for out band emissions and spectrum emissions are based on ITU-R Recommendations SM.329 [2].

6.6.3.1 Minimum requirement

These requirements are only applicable for frequencies, which are greater than 12.5 MHz away from the UE centre carrier frequency.

Table 6.12: General spurious emissions requirements

Frequency Bandwidth	Measurement Bandwidth	Minimum requirement
$9\text{ kHz} \leq f < 150\text{ kHz}$	1 kHz	-36 dBm
$150\text{ kHz} \leq f < 30\text{ MHz}$	10 kHz	-36 dBm
$30\text{ MHz} \leq f < 1000\text{ MHz}$	100 kHz	-36 dBm
$1\text{ GHz} \leq f < 12.75\text{ GHz}$	1 MHz	-30 dBm

Table 6.13: Additional spurious emissions requirements

Operating Band	Frequency Bandwidth	Measurement Bandwidth	Minimum requirement
I	$875 \text{ MHz} \leq f \leq 885 \text{ MHz}$	3.84 MHz	-60 dBm
	$921 \text{ MHz} \leq f < 925 \text{ MHz}$	100 kHz	-60 dBm *
	$925 \text{ MHz} \leq f \leq 935 \text{ MHz}$	100 kHz	-67 dBm *
	$935 \text{ MHz} < f \leq 960 \text{ MHz}$	100 kHz	-79 dBm *
	$1805 \text{ MHz} \leq f \leq 1880 \text{ MHz}$	100 kHz	-71 dBm *
	$1893.5 \text{ MHz} < f < 1919.6 \text{ MHz}$	300 kHz	-41 dBm
II	$2110 \text{ MHz} \leq f \leq 2170 \text{ MHz}$	3.84 MHz	-60 dBm
	$869 \text{ MHz} \leq f \leq 894 \text{ MHz}$	3.84 MHz	-60 dBm
	$1930 \text{ MHz} \leq f \leq 1990 \text{ MHz}$	3.84 MHz	-60 dBm
III	$2110 \text{ MHz} \leq f \leq 2155 \text{ MHz}$	3.84 MHz	-60 dBm
	$921 \text{ MHz} \leq f < 925 \text{ MHz}$	100 kHz	-60 dBm *
	$925 \text{ MHz} \leq f \leq 935 \text{ MHz}$	100 kHz	-67 dBm *
	$935 \text{ MHz} < f \leq 960 \text{ MHz}$	100 kHz	-79 dBm *
	$1805 \text{ MHz} \leq f \leq 1880 \text{ MHz}$	3.84 MHz	-60 dBm
IV	$2110 \text{ MHz} \leq f \leq 2170 \text{ MHz}$	3.84 MHz	-60 dBm
	$869 \text{ MHz} \leq f \leq 894 \text{ MHz}$	3.84 MHz	-60 dBm
	$1930 \text{ MHz} \leq f \leq 1990 \text{ MHz}$	3.84 MHz	-60 dBm
V	$2110 \text{ MHz} \leq f \leq 2155 \text{ MHz}$	3.84 MHz	-60 dBm
	$869 \text{ MHz} \leq f \leq 894 \text{ MHz}$	3.84 MHz	-60 dBm
	$1930 \text{ MHz} \leq f \leq 1990 \text{ MHz}$	3.84 MHz	-60 dBm
VI	$2110 \text{ MHz} \leq f \leq 2170 \text{ MHz}$	3.84 MHz	-60 dBm
	$875 \text{ MHz} \leq f \leq 885 \text{ MHz}$	3.84 MHz	-60 dBm
	$1893.5 \text{ MHz} \leq f \leq 1919.6 \text{ MHz}$	300 kHz	-41 dBm
Note * The measurements are made on frequencies which are integer multiples of 200 kHz. As exceptions, up to five measurements with a level up to the applicable requirements defined in Table 6.12 are permitted for each UARFCN used in the measurement			

6.7 Transmit intermodulation

The transmit intermodulation performance is a measure of the capability of the transmitter to inhibit the generation of signals in its non linear elements caused by presence of the wanted signal and an interfering signal reaching the transmitter via the antenna.

6.7.1 Minimum requirement

User Equipment(s) transmitting in close vicinity of each other can produce intermodulation products, which can fall into the UE, or Node B receive band as an unwanted interfering signal. The UE intermodulation attenuation is defined by the ratio of the RRC filtered mean power of the wanted signal to the RRC filtered mean power of the intermodulation product when an interfering CW signal is added at a level below the wanted signal.

The requirement of transmitting intermodulation for a carrier spacing of 5 MHz is prescribed in Table 6.14.

Table 6.14: Transmit Intermodulation

Interference Signal Frequency Offset	5MHz	10MHz
Interference CW Signal Level	-40dBc	
Intermodulation Product	-31dBc	-41dBc

6.8 Transmit modulation

Transmit modulation defines the modulation quality for expected in-channel RF transmissions from the UE. The requirements apply to all transmissions including the PRACH/PCPCH pre-amble and message parts and all other

expected transmissions. In cases where the mean power of the RF signal is allowed to change versus time e.g. PRACH, DPCH in compressed mode, change of TFC and inner loop power control, the EVM and Peak Code Domain Error requirements do not apply during the 25 μ s period before and after the nominal time when the power is expected to change.

6.8.1 Transmit pulse shape filter

The transmit pulse shaping filter is a root-raised cosine (RRC) with roll-off $\alpha = 0.22$ in the frequency domain. The impulse response of the chip impulse filter $RC_0(t)$ is:

$$RC_0(t) = \frac{\sin\left(\pi \frac{t}{T_c}(1-\alpha)\right) + 4\alpha \frac{t}{T_c} \cos\left(\pi \frac{t}{T_c}(1+\alpha)\right)}{\pi \frac{t}{T_c} \left(1 - \left(4\alpha \frac{t}{T_c}\right)^2\right)}$$

Where the roll-off factor $\alpha = 0.22$ and the chip duration is

$$T = \frac{1}{\text{chiprate}} \approx 0.26042 \mu\text{s}$$

6.8.2 Error Vector Magnitude

The Error Vector Magnitude is a measure of the difference between the reference waveform and the measured waveform. This difference is called the error vector. Both waveforms pass through a matched Root Raised Cosine filter with bandwidth 3,84 MHz and roll-off $\alpha = 0.22$. Both waveforms are then further modified by selecting the frequency, absolute phase, absolute amplitude and chip clock timing so as to minimise the error vector. The EVM result is defined as the square root of the ratio of the mean error vector power to the mean reference power expressed as a %. The measurement interval is one timeslot except when the mean power between slots is expected to change whereupon the measurement interval is reduced by 25 μ s at each end of the slot. For the PRACH and PCPCH preambles the measurement interval is 4096 chips less 25 μ s at each end of the burst (3904 chips).

6.8.2.1 Minimum requirement

The Error Vector Magnitude shall not exceed 17.5 % for the parameters specified in Table 6.15. The requirements are applicable for all values of β_c , β_d and β_{hs} as specified in [8].

Table 6.15: Parameters for Error Vector Magnitude/Peak Code Domain Error

Parameter	Unit	Level
UE Output Power	dBm	≥ -20
Operating conditions		Normal conditions
Power control step size	dB	1

6.8.3 Peak code domain error

The Peak Code Domain Error is computed by projecting power of the error vector (as defined in 6.8.2) onto the code domain at a specific spreading factor. The Code Domain Error for every code in the domain is defined as the ratio of the mean power of the projection onto that code, to the mean power of the composite reference waveform. This ratio is expressed in dB. The Peak Code Domain Error is defined as the maximum value for the Code Domain Error for all codes. The measurement interval is one timeslot except when the mean power between slots is expected to change whereupon the measurement interval is reduced by 25 μ s at each end of the slot.

The requirement for peak code domain error is only applicable for multi-code DPDCH transmission and therefore does not apply for the PRACH and PCPCH preamble and message parts.

6.8.3.1 Minimum requirement

The peak code domain error shall not exceed -15 dB at spreading factor 4 for the parameters specified in Table 6.15 . The requirements are defined using the UL reference measurement channel specified in subclause A.2.5.

6.8.4 Phase discontinuity

Phase discontinuity is the change in phase between any two adjacent timeslots. The EVM for each timeslot (excluding the transient periods of 25 us on either side of the nominal timeslot boundaries), shall be measured according to subclause 6.8.2. The frequency, absolute phase, absolute amplitude and chip clock timing used to minimise the error vector are chosen independently for each timeslot. The phase discontinuity result is defined as the difference between the absolute phase used to calculate EVM for the preceding timeslot, and the absolute phase used to calculate EVM for the succeeding timeslot.

6.8.4.1 Minimum requirement

The rate of occurrence of any phase discontinuity on an uplink DPCH for the parameters specified in table 6.16 shall not exceed the values specified in table 6.17. Phase shifts that are caused by changes of the UL transport format combination (TFC) and compressed mode are not included. When calculating the phase discontinuity, the requirements for frequency error and EVM in subclauses 6.3 and 6.8.2 for each timeslot shall be met.

Table 6.16: Parameters for Phase discontinuity

Parameter	Unit	Level
Power control step size	dB	1

Table 6.17: Phase discontinuity minimum requirement

Phase discontinuity $\Delta\theta$ in degrees	Maximum allowed rate of occurrence in Hz
$\Delta\theta \leq 30$	1500
$30 < \Delta\theta \leq 60$	300
$\Delta\theta > 60$	0

7 Receiver characteristics

7.1 General

Unless otherwise stated the receiver characteristics are specified at the antenna connector of the UE. For UE(s) with an integral antenna only, a reference antenna with a gain of 0 dBi is assumed. UE with an integral antenna may be taken into account by converting these power levels into field strength requirements, assuming a 0 dBi gain antenna. Receiver characteristics for UE(s) with multiple antennas/antenna connectors are FFS.

The UE antenna performance has a significant impact on system performance, and minimum requirements on the antenna efficiency are therefore intended to be included in future versions of the present document. It is recognised that different requirements and test methods are likely to be required for the different types of UE.

All the parameters in clause 7 are defined using the DL reference measurement channel (12.2 kbps) specified in subclause A.3.1 and unless otherwise stated with DL power control OFF.

7.2 Diversity characteristics

A suitable receiver structure using coherent reception in both channel impulse response estimation and code tracking procedures is assumed. Three forms of diversity are considered to be available in UTRA/FDD.

Table 7.1: Diversity characteristics for UTRA/FDD

Time diversity	Channel coding and interleaving in both up link and down link
Multi-path diversity	Rake receiver or other suitable receiver structure with maximum combining. Additional processing elements can increase the delay-spread performance due to increased capture of signal energy.
Antenna diversity	Antenna diversity with maximum ratio combining in the Node B and optionally in the UE. Possibility for downlink transmit diversity in the Node B.

7.3 Reference sensitivity level

The reference sensitivity level <REFSENS> is the minimum mean power received at the UE antenna port at which the Bit Error Ratio (BER) shall not exceed a specific value.

7.3.1 Minimum requirement

The BER shall not exceed 0.001 for the parameters specified in Table 7.2.

Table 7.2: Test parameters for reference sensitivity

Operating Band	Unit	DPCH_Ec <REFSENS>	<REFI _{or} >
I, VI	dBm/3.84 MHz	-117	-106.7
II	dBm/3.84 MHz	-115	-104.7
III	dBm/3.84 MHz	-114	-103.7
IV	dBm/3.84 MHz	-117	-106.7
V	dBm/3.84 MHz	-115	-104.7

NOTE 1. For Power class 3 this shall be at the maximum output power
NOTE 2. For Power class 4 this shall be at the maximum output power

7.4 Maximum input level

This is defined as the maximum mean power received at the UE antenna port, at which the specified BER performance shall be met.

7.4.1 Minimum requirement for DPCH reception

The BER shall not exceed 0.001 for the parameters specified in Table 7.3.

Table 7.3: Maximum input level

Parameter	Unit	Level
$\frac{DPCH_Ec}{I_{or}}$	dB	-19
\hat{I}_{or}	dBm/3.84 MHz	-25
UE transmitted mean power	dBm	20 (for Power class 3) 18 (for Power class 4)

NOTE: Since the spreading factor is large ($10\log(SF)=21\text{dB}$), the majority of the total input signal consists of the OCNS interference. The structure of OCNS signal is defined in Annex C.3.2.

7.4.2 Minimum requirement for HS-PDSCH reception

7.4.2.1 Minimum requirement for 16QAM

The requirements are specified in terms of a minimum information bit throughput R for the DL reference channel H-Set 1 (16QAM version) specified in Annex A.7.1.1. with the addition of the parameters in Table 7.3A and the downlink physical channel setup according to table C.8.

Using this configuration the throughput shall meet or exceed the minimum requirements specified in table 7.3B.

Table 7.3A

Parameter	Unit	Value
Phase reference		P-CPICH
\hat{I}_{or}	dBm/3.84 MHz	-25
UE transmitted mean power	dBm	20 (for Power class 3) 18 (for Power class 4)
DPCH_Ec/I _{or}	dB	-13
HS-SCCH_1_Ec/I _{or}	dB	-13
Redundancy and constellation version		6
Maximum number of HARQ transmissions		1
Note:	The HS-SCCH and corresponding HS-PDSCH shall be transmitted continuously with constant power but the HS-SCCH shall only use the identity of the UE under test every third TTI	

Table 7.3B

HS-PDSCH E_c / I_{or} (dB)	T-put R (kbps)
-3	700

7.5 Adjacent Channel Selectivity (ACS)

Adjacent Channel Selectivity (ACS) is a measure of a receiver's ability to receive a W-CDMA signal at its assigned channel frequency in the presence of an adjacent channel signal at a given frequency offset from the centre frequency of the assigned channel. ACS is the ratio of the receive filter attenuation on the assigned channel frequency to the receive filter attenuation on the adjacent channel(s).

7.5.1 Minimum requirement

The UE shall fulfil the minimum requirement specified in Table 7.4 for all values of an adjacent channel interferer up to -25 dBm.

However it is not possible to directly measure the ACS, instead the lower and upper range of test parameters are chosen in Table 7.5 where the BER shall not exceed 0.001.

Table 7.4: Adjacent Channel Selectivity

Power Class	Unit	ACS
3	dB	33
4	dB	33

Table 7.5: Test parameters for Adjacent Channel Selectivity

Parameter	Unit	Case 1	Case 2
DPCH_Ec	dBm/3.84 MHz	<REFSENS> + 14 dB	<REFSENS> + 41 dB
\hat{I}_{or}	dBm/3.84 MHz	<REF \hat{I}_{or} > + 14 dB	REF \hat{I}_{or} > + 41 dB
I_{oac} mean power (modulated)	dBm	-52	-25
F_{uw} (offset)	MHz	+5 or -5	+5 or -5
UE transmitted mean power	dBm	20 (for Power class 3) 18 (for Power class 4)	20 (for Power class 3) 18 (for Power class 4)

NOTE: The I_{oac} (modulated) signal consists of the common channels needed for tests as specified in Table C.7 and 16 dedicated data channels as specified in Table C.6.

7.6 Blocking characteristics

The blocking characteristic is a measure of the receiver's ability to receive a wanted signal at its assigned channel frequency in the presence of an unwanted interferer on frequencies other than those of the spurious response or the adjacent channels, without this unwanted input signal causing a degradation of the performance of the receiver beyond a specified limit. The blocking performance shall apply at all frequencies except those at which a spurious response occur.

7.6.1 Minimum requirement (In-band blocking)

The BER shall not exceed 0.001 for the parameters specified in Table 7.6. In-band blocking is defined for an unwanted interfering signal falling into the UE receive band or into the first 15 MHz below or above the UE receive band.

Table 7.6: In-band blocking

Parameter	Unit	Level	
DPCH_Ec	dBm/3.84 MHz	<REFSENS>+3 dB	
\hat{I}_{or}	dBm/3.84 MHz	<REF \hat{I}_{or} > + 3 dB	
$I_{blocking}$ mean power (modulated)	dBm	-56	-44
F_{uw} offset		± 10 MHz	≤ -15 MHz & ≥ 15 MHz
F_{uw} (Band I operation)	MHz	$2102.4 \leq f \leq 2177.6$ (Note 2)	$2095 \leq f \leq 2185$
F_{uw} (Band II operation)	MHz	$1922.4 \leq f \leq 1997.6$ (Note 2)	$1915 \leq f \leq 2005$
F_{uw} (Band III operation)	MHz	$1797.4 \leq f \leq 1887.6$ (Note 2)	$1790 \leq f \leq 1895$
F_{uw} (Band IV operation)	MHz	$2102.4 \leq f \leq 2162.6$ (Note 2)	$2095 \leq f \leq 2170$
F_{uw} (Band V operation)	MHz	$861.4 \leq f \leq 901.6$ (Note 2)	$854 \leq f \leq 909$
F_{uw} (Band VI operation)	MHz	$867.4 \leq f \leq 892.6$ (Note 2 and 3)	$860 \leq f \leq 900$ (Note 3)
UE transmitted mean power	dBm	20 (for Power class 3) 18 (for Power class 4)	

Note 1: $I_{blocking}$ (modulated) consists of the common channels needed for tests as specified in Table C.7 and 16 dedicated data channels as specified in Table C.6.

Note 2: For each carrier frequency the requirement is valid for two frequencies, the carrier frequency +/- 10 MHz.

Note 3: For Band VI, the unwanted interfering signal does not fall inside the UE receive band, but within the first 15 MHz below or above the UE receive band.

7.6.2 Minimum requirement (Out of-band blocking)

The BER shall not exceed 0.001 for the parameters specified in Table 7.7. Out-of-band band blocking is defined for an unwanted interfering signal falling more than 15 MHz below or above the UE receive band.

For Table 7.7 in frequency range 1, 2 and 3, up to 24 exceptions are allowed for spurious response frequencies in each assigned frequency channel when measured using a 1 MHz step size. For these exceptions the requirements of clause 7.7 Spurious response are applicable.

For Table 7.7 in frequency range 4, up to 8 exceptions are allowed for spurious response frequencies in each assigned frequency channel when measured using a 1 MHz step size. For these exceptions the requirements of clause 7.7 Spurious response are applicable

Table 7.7: Out of band blocking

Parameter	Unit	Frequency range 1	Frequency range 2	Frequency range 3	Frequency range 4
DPCH_Ec	dBm/3.84 MHz	<REFSENS>+3 dB	<REFSENS>+3 dB	<REFSENS>+3 dB	<REFSENS> +3 dB
\hat{I}_{or}	dBm/3.84 MHz	<REF \hat{I}_{or} > + 3 dB	<REF \hat{I}_{or} > + 3 dB	<REF \hat{I}_{or} > + 3 dB	<REF \hat{I}_{or} > + 3 dB
$I_{blocking}$ (CW)	dBm	-44	-30	-15	-15
F_{uw} (Band I operation)	MHz	2050<f <2095 2185<f <2230	2025 <f ≤2050 2230 ≤f <2255	1< f ≤2025 2255≤f<12750	-
F_{uw} (Band II operation)	MHz	1870<f <1915 2005<f <2050	1845 <f ≤1870 2050 ≤f <2075	1< f ≤1845 2075≤f<12750	1850 ≤ f ≤ 1910
F_{uw} (Band III operation)	MHz	1745 <f <1790 1895<f <1940	1720 <f ≤ 1745 1940≤f < 1965	1< f ≤1720 1965≤f<12750	-
F_{uw} (Band IV operation)	MHz	2050< f <2095 2170< f <2215	2025< f ≤2050 2215≤ f < 2240	1< f ≤2025 2240≤f<12750	-
F_{uw} (Band V operation)	MHz	809< f <854 909< f <954	784< f ≤809 954≤ f < 979	1< f ≤784 979≤f<12750	824 ≤ f ≤ 849
F_{uw} (Band VI operation)	MHz	815 < f < 860 900 < f < 945	790 < f ≤ 815 945 ≤ f < 970	1 < f ≤ 790 970 ≤ f < 12750	-
UE transmitted mean power	dBm	20 (for Power class 3) 18 (for Power class 4)			
Band I operation	For 2095≤f ≤2185 MHz, the appropriate in-band blocking or adjacent channel selectivity in subclause 7.5.1 and subclause 7.6.1 shall be applied.				
Band II operation	For 1915≤f ≤2005 MHz, the appropriate in-band blocking or adjacent channel selectivity in subclause 7.5.1 and subclause 7.6.1 shall be applied				
Band III operation	For 1790≤f ≤1895 MHz, the appropriate in-band blocking or adjacent channel selectivity in subclause 7.5.1 and subclause 7.6.1 shall be applied.				
Band IV operation	For 2095≤f≤2170 MHz, the appropriate in-band blocking or adjacent channel selectivity in subclause 7.5.1 and subclause 7.6.1 shall be applied.				
Band V operation	For 854≤f≤909 MHz, the appropriate in-band blocking or adjacent channel selectivity in subclause 7.5.1 and subclause 7.6.1 shall be applied.				
Band VI operation	For 860≤f≤900 MHz, the appropriate in-band blocking or adjacent channel selectivity in subclause 7.5.1 and subclause 7.6.1 shall be applied.				

7.6.3 Minimum requirement (Narrow band blocking)

The BER shall not exceed 0.001 for the parameters specified in Table 7.7A. This requirement is measure of a receiver's ability to receive a W-CDMA signal at its assigned channel frequency in the presence of an unwanted narrow band interferer at a frequency, which is less than the nominal channel spacing

Table 7.7A: Narrow band blocking characteristics

Parameter	Unit	Band II, Band IV and Band V	Band III
DPCH_Ec	dBm/3.84 MHz	<REFSENS> + 10 dB	<REFSENS> + 10 dB
\hat{I}_{or}	dBm/3.84 MHz	<REF \hat{I}_{or} > + 10 dB	<REF \hat{I}_{or} > + 10 dB
$I_{blocking}$ (GMSK)	dBm	-57	-56
F_{uw} (offset)	MHz	2.7	2.8
UE transmitted mean power	dBm	20 (for Power class 3) 18 (for Power class 4)	

NOTE: $I_{blocking}$ (GMSK) is an interfering signal as defined in TS 45.004 [6]

7.7 Spurious response

Spurious response is a measure of the receiver's ability to receive a wanted signal on its assigned channel frequency without exceeding a given degradation due to the presence of an unwanted CW interfering signal at any other frequency at which a response is obtained i.e. for which the out of band blocking limit as specified in subclause 7.6.2 is not met.

7.7.1 Minimum requirement

The BER shall not exceed 0.001 for the parameters specified in Table 7.8.

Table 7.8: Spurious Response

Parameter	Unit	Level
DPCH_Ec	dBm/3.84 MHz	<REFSENS> +3 dB
\hat{I}_{or}	dBm/3.84 MHz	<REF \hat{I}_{or} > +3 dB
$I_{blocking}$ (CW)	dBm	-44
F_{uw}	MHz	Spurious response frequencies
UE transmitted mean power	dBm	20 (for Power class 3) 18 (for Power class 4)

7.8 Intermodulation characteristics

Third and higher order mixing of the two interfering RF signals can produce an interfering signal in the band of the desired channel. Intermodulation response rejection is a measure of the capability of the receiver to receive a wanted signal on its assigned channel frequency in the presence of two or more interfering signals which have a specific frequency relationship to the wanted signal.

7.8.1 Minimum requirement

The BER shall not exceed 0.001 for the parameters specified in Table 7.9.

Table 7.9: Receive intermodulation characteristics

Parameter	Unit	Level	
DPCH_Ec	dBm/3.84 MHz	<REFSENS> +3 dB	
\hat{I}_{or}	dBm/3.84 MHz	<REF \hat{I}_{or} > +3 dB	
I_{ouw1} (CW)	dBm	-46	
I_{ouw2} mean power (modulated)	dBm	-46	
F_{uw1} (offset)	MHz	10	-10
F_{uw2} (offset)	MHz	20	-20
UE transmitted mean power	dBm	20 (for Power class 3) 18 (for Power class 4)	

NOTE: $I_{\text{ouw}2}$ (modulated) consists of the common channels needed for tests as specified in Table C.7 and 16 dedicated data channels as specified in Table C.6.

7.8.2 Minimum requirement (Narrow band)

The BER shall not exceed 0.001 for the parameters specified in Table 7.9A.

Table 7.9A: Receive intermodulation characteristics

Parameter	Unit	Band II, Band IV and Band V		Band III	
DPCH_Ec	dBm/3.84 MHz	<REFSENS>+ 10 dB		<REFSENS>+ 10 dB	
\hat{I}_{or}	dBm/3.84 MHz	<REF \hat{I}_{or} > + 10 dB		[<REF \hat{I}_{or} > +10 dB	
$I_{\text{ouw}1}$ (CW)	dBm	-44		-43	
$I_{\text{ouw}2}$ (GMSK)	dBm	-44		-43	
$F_{\text{uw}1}$ (offset)	MHz	3.5	-3.5	3.6	-3.6
$F_{\text{uw}2}$ (offset)	MHz	5.9	-5.9	6.0	-6.0
UE transmitted mean power	dBm	20 (for Power class 3) 18 (for Power class 4)			

NOTE: $I_{\text{ouw}2}$ (GMSK) is an interfering signal as defined in TS 45.004 [6].

7.9 Spurious emissions

The spurious emissions power is the power of emissions generated or amplified in a receiver that appear at the UE antenna connector.

7.9.1 Minimum requirement

The power of any narrow band CW spurious emission shall not exceed the maximum level specified in Table 7.10 and Table 7.11

Table 7.10: General receiver spurious emission requirements

Frequency Band	Measurement Bandwidth	Maximum level	Note
$30\text{MHz} \leq f < 1\text{GHz}$	100 kHz	-57 dBm	
$1\text{GHz} \leq f \leq 12.75\text{GHz}$	1 MHz	-47 dBm	

Table 7.11: Additional receiver spurious emission requirements

Band	Frequency Band	Measurement Bandwidth	Maximum level	Note
I	$875 \text{ MHz} \leq f \leq 885 \text{ MHz}$	3.84 MHz	-60 dBm	
	$921 \text{ MHz} \leq f < 925 \text{ MHz}$	100 kHz	-60 dBm *	
	$925 \text{ MHz} \leq f \leq 935 \text{ MHz}$	100 kHz	-67 dBm *	
	$935 \text{ MHz} < f \leq 960 \text{ MHz}$	100 kHz	-79 dBm *	
	$1805 \text{ MHz} \leq f \leq 1880 \text{ MHz}$	100 kHz	-71 dBm *	
	$1920 \text{ MHz} \leq f \leq 1980 \text{ MHz}$	3.84 MHz	-60 dBm	UE transmit band in URA_PCH, Cell_PCH and idle state
II	$2110 \text{ MHz} \leq f \leq 2170 \text{ MHz}$	3.84 MHz	-60 dBm	UE receive band
	$869 \text{ MHz} \leq f \leq 894 \text{ MHz}$	3.84 MHz	-60 dBm	
	$1850 \text{ MHz} \leq f \leq 1910 \text{ MHz}$	3.84 MHz	-60 dBm	UE transmit band in URA_PCH, Cell_PCH and idle state
	$1930 \text{ MHz} \leq f \leq 1990 \text{ MHz}$	3.84 MHz	-60 dBm	UE receive band
III	$2110 \text{ MHz} \leq f \leq 2155 \text{ MHz}$	3.84 MHz	-60 dBm	
	$921 \text{ MHz} \leq f < 925 \text{ MHz}$	100 kHz	-60 dBm*	
	$925 \text{ MHz} \leq f \leq 935 \text{ MHz}$	100 kHz	-67 dBm*	
	$935 \text{ MHz} < f \leq 960 \text{ MHz}$	100 kHz	-79 dBm*	
	$1710 \text{ MHz} \leq f \leq 1785 \text{ MHz}$	3.84 MHz	-60 dBm	UE transmit band in URA_PCH, Cell_PCH and idle state
	$1805 \text{ MHz} \leq f \leq 1880 \text{ MHz}$	3.84 MHz	-60 dBm	UE receive band
IV	$2110 \text{ MHz} \leq f \leq 2170 \text{ MHz}$	3.84 MHz	-60 dBm	
	$869 \text{ MHz} \leq f < 894 \text{ MHz}$	3.84 MHz	-60 dBm	
	$1710 \text{ MHz} \leq f < 1755 \text{ MHz}$	3.84 MHz	-60 dBm	UE transmit band in URA_PCH, Cell_PCH and idle state
	$1930 \text{ MHz} \leq f \leq 1990 \text{ MHz}$	3.84 MHz	-60 dBm	
V	$2110 \text{ MHz} \leq f \leq 2155 \text{ MHz}$	3.84 MHz	-60 dBm	UE receive band
	$824 \text{ MHz} \leq f \leq 849 \text{ MHz}$	3.84 MHz	-60 dBm	UE transmit band in URA_PCH, Cell_PCH and idle state
	$869 \text{ MHz} \leq f < 894 \text{ MHz}$	3.84 MHz	-60 dBm	UE receive band
	$1930 \text{ MHz} \leq f \leq 1990 \text{ MHz}$	3.84 MHz	-60 dBm	
VI	$2110 \text{ MHz} \leq f \leq 2155 \text{ MHz}$	3.84 MHz	-60 dBm	
	$830 \text{ MHz} \leq f \leq 840 \text{ MHz}$	3.84 MHz	-60 dBm	UE transmit band in URA_PCH, Cell_PCH and idle state
	$875 \text{ MHz} \leq f \leq 885 \text{ MHz}$	3.84 MHz	-60 dBm	UE receive band
	$2110 \text{ MHz} \leq f \leq 2170 \text{ MHz}$	3.84 MHz	-60 dBm	
Note *	The measurements are made on frequencies which are integer multiples of 200 kHz. As exceptions, up to five measurements with a level up to the applicable requirements defined in Table 7.10 are permitted for each UARFCN used in the measurement			

8 Performance requirement

8.1 General

The performance requirements for the UE in this subclause are specified for the measurement channels specified in Annex A, the propagation conditions specified in Annex B and the Down link Physical channels specified in Annex C. Unless stated DL power control is OFF.

8.2 Demodulation in static propagation conditions

8.2.1 (void)

8.2.2 Demodulation of Forward Access Channel (FACH)

void

8.2.3 Demodulation of Dedicated Channel (DCH)

The receive characteristic of the Dedicated Channel (DCH) in the static environment is determined by the Block Error Ratio (BLER). BLER is specified for each individual data rate of the DCH. DCH is mapped into the Dedicated Physical Channel (DPCH).

8.2.3.1 Minimum requirement

For the parameters specified in Table 8.5 the average downlink $\frac{DPCH_E_c}{I_{or}}$ power ratio shall be below the specified value for the BLER shown in Table 8.6. These requirements are applicable for TFCS size 16.

Table 8.5: DCH parameters in static propagation conditions

Parameter	Unit	Test 1	Test 2	Test 3	Test 4
Phase reference		P-CPICH			
\hat{I}_{or}/I_{oc}	dB	-1			
I_{oc}	dBm/3.84 MHz	-60			
Information Data Rate	kbps	12.2	64	144	384

Table 8.6: DCH requirements in static propagation conditions

Test Number	$\frac{DPCH_E_c}{I_{or}}$	BLER
1	-16.6 dB	10^{-2}
2	-13.1 dB	10^{-1}
	-12.8 dB	10^{-2}
3	-9.9 dB	10^{-1}
	-9.8 dB	10^{-2}
4	-5.6 dB	10^{-1}
	-5.5 dB	10^{-2}

8.3 Demodulation of DCH in multi-path fading propagation conditions

8.3.1 Single Link Performance

The receive characteristics of the Dedicated Channel (DCH) in different multi-path fading environments are determined by the Block Error Ratio (BLER) values. BLER is measured for each of the individual data rate specified for the DPCH. DCH is mapped into in Dedicated Physical Channel (DPCH).

8.3.1.1 Minimum requirement

For the parameters specified in Table 8.7, 8.9, 8.11, 8.13 and 8.14A the average downlink $\frac{DPCH - E_c}{I_{or}}$ power ratio shall be below the specified value for the BLER shown in Table 8.8, 8.10, 8.12, 8.14 and 8.14B. For the parameters specified in Table 8.14C and 8.14 E the downlink $\frac{DPCH - E_c}{I_{or}}$ power ratio measured values, which are averaged over one slot, shall be below the specified value in Table 8.14D and 8.14F more than 90% of the time. These requirements are applicable for TFCS size 16.

Table 8.7: Test Parameters for DCH in multi-path fading propagation conditions (Case 1)

Parameter	Unit	Test 1	Test 2	Test 3	Test 4
Phase reference		P-CPICH			
\hat{I}_{or}/I_{oc}	dB	9			
I_{oc}	dBm/3.84 MHz	-60			
Information Data Rate	kbps	12.2	64	144	384

Table 8.8: Test requirements for DCH in multi-path fading propagation conditions (Case 1)

Test Number	$\frac{DPCH - E_c}{I_{or}}$	BLER
1	-15.0 dB	10^{-2}
2	-13.9 dB	10^{-1}
	-10.0 dB	10^{-2}
3	-10.6 dB	10^{-1}
	-6.8 dB	10^{-2}
4	-6.3 dB	10^{-1}
	-2.2 dB	10^{-2}

Table 8.9: DCH parameters in multi-path fading propagation conditions (Case 2)

Parameter	Unit	Test 5	Test 6	Test 7	Test 8
Phase reference		P-CPICH			
\hat{I}_{or}/I_{oc}	dB	-3	-3	3	6
I_{oc}	dBm/3.84 MHz	-60			
Information Data Rate	kbps	12.2	64	144	384

Table 8.10: DCH requirements in multi-path fading propagation (Case 2)

Test Number	$\frac{DPCH - E_c}{I_{or}}$	BLER
5	-7.7 dB	10^{-2}
6	-6.4 dB	10^{-1}
	-2.7 dB	10^{-2}
7	-8.1 dB	10^{-1}
	-5.1 dB	10^{-2}
8	-5.5 dB	10^{-1}
	-3.2 dB	10^{-2}

Table 8.11: DCH parameters in multi-path fading propagation conditions (Case 3)

Parameter	Unit	Test 9	Test 10	Test 11	Test 12
Phase reference		P-CPICH			
\hat{I}_{or}/I_{oc}	dB	-3	-3	3	6
I_{oc}	dBm/3.84 MHz	-60			
Information Data Rate	kbps	12.2	64	144	384

Table 8.12: DCH requirements in multi-path fading propagation conditions (Case 3)

Test Number	$\frac{DPCH - E_c}{I_{or}}$	BLER
9	-11.8 dB	10^{-2}
10	-8.1 dB	10^{-1}
	-7.4 dB	10^{-2}
	-6.8 dB	10^{-3}
11	-9.0 dB	10^{-1}
	-8.5 dB	10^{-2}
	-8.0 dB	10^{-3}
12	-5.9 dB	10^{-1}
	-5.1 dB	10^{-2}
	-4.4 dB	10^{-3}

Table 8.13: DCH parameters in multi-path fading propagation conditions (Case 1) with S-CPICH

Parameter	Unit	Test 13	Test 14	Test 15	Test 16
Phase reference		S-CPICH			
\hat{I}_{or}/I_{oc}	dB	9			
I_{oc}	dBm/3.84 MHz	-60			
Information Data Rate	kbps	12.2	64	144	384

Table 8.14: DCH requirements in multi-path fading propagation conditions (Case 1) with S-CPICH

Test Number	$\frac{DPCH - E_c}{I_{or}}$	BLER
13	-15.0 dB	10^{-2}
14	-13.9 dB	10^{-1}
	-10.0 dB	10^{-2}
15	-10.6 dB	10^{-1}
	-6.8 dB	10^{-2}
16	-6.3 dB	10^{-1}
	-2.2 dB	10^{-2}

Table 8.14A: DCH parameters in multi-path fading propagation conditions (Case 6)

Parameter	Unit	Test 17	Test 18	Test 19	Test 20
Phase reference		P-CPICH			
\hat{I}_{or}/I_{oc}	dB	-3	-3	3	6
I_{oc}	dBm/3.84 MHz	-60			
Information Data Rate	kbps	12.2	64	144	384

Table 8.14B: DCH requirements in multi-path fading propagation conditions (Case 6)

Test Number	$\frac{DPCH_E_c}{I_{or}}$	BLER
17	-8.8 dB	10^{-2}
18	-5.1 dB	10^{-1}
	-4.4 dB	10^{-2}
	-3.8 dB	10^{-3}
19	-6.0 dB	10^{-1}
	-5.5 dB	10^{-2}
	-5.0 dB	10^{-3}
20	-2.9 dB	10^{-1}
	-2.1 dB	10^{-2}
	-1.4 dB	10^{-3}

Table 8.14C: DCH parameters in multi-path fading propagation conditions (Case 7)

Parameter	Unit	Test 21	Test 22	Test 23	Test 24
Phase reference		DPCCH			
\hat{I}_{or}/I_{oc}	dB	0	0	6	12
I_{oc}	dBm/3.84 MHz	-60			
Information Data Rate	kbps	12.2	64	144	384
Target quality value on DTCH	BLER	0.01	0.01	0.01	0.1
Maximum_DL_Power	dB	3 (Note)			
Minimum_DL_Power	dB	-18			
DL Power Control step size, Δ_{TPC}	dB	1			
Limited Power Increase	-	'Not used'			
NOTE: The fraction of the total Node B transmit power that is transmitted in the beam used for the UE under test, is set to 20% according to Annex C.3.5					

Table 8.14D: DCH requirements in multi-path fading propagation conditions (Case 7)

Test Number	$\frac{DPCH_E_c}{I_{or}}$
21	-14.0 dB
22	-9.1 dB
23	-9.4 dB
24	-7.4 dB

Table 8.14E: DCH parameters in multi-path fading propagation conditions (Case 7)

Parameter	Unit	Test 25
Phase reference		DPCCH
\hat{I}_{or}/I_{oc}	dB	0
I_{oc}	dBm/3.84 MHz	-60
Information Data Rate	kbps	12.2
Target quality value on DTCH	BLER	0.01
Maximum_DL_Power	dB	3 (Note)
Minimum_DL_Power	dB	-18
DL Power Control step size, Δ_{TPC}	dB	1
Limited Power Increase	-	'Not used'
NOTE: The fraction of the total Node B transmit power that is transmitted in the beam used for the UE under test, is set to 20% according to Annex C.3.5		

Table 8.14F: DCH requirements in multi-path fading propagation conditions (Case 7)

Test Number	$\frac{DPCH_E_c}{I_{or}}$
25	-12.5 dB

NOTE: The reference channel used for Test Number 25 is described in section A.4A

8.4 Demodulation of DCH in moving propagation conditions

8.4.1 Single link performance

The receive single link performance of the Dedicated Channel (DCH) in dynamic moving propagation conditions are determined by the Block Error Ratio (BLER) values. BLER is measured for the each of the individual data rate specified for the DPCH. DCH is mapped into Dedicated Physical Channel (DPCH).

8.4.1.1 Minimum requirement

For the parameters specified in Table 8.15 the average downlink $\frac{DPCH_E_c}{I_{or}}$ power ratio shall be below the specified value for the BLER shown in Table 8.16.

Table 8.15: DCH parameters in moving propagation conditions

Parameter	Unit	Test 1	Test 2
Phase reference		P-CPICH	
\hat{I}_{or}/I_{oc}	dB	-1	
I_{oc}	dBm/3.84 MHz	-60	
Information Data Rate	kbps	12.2	64

Table 8.16: DCH requirements in moving propagation conditions

Test Number	$\frac{DPCH_E_c}{I_{or}}$	BLER
1	-14.5 dB	10^{-2}
2	-10.9 dB	10^{-2}

8.5 Demodulation of DCH in birth-death propagation conditions

8.5.1 Single link performance

The receive single link performance of the Dedicated Channel (DCH) in dynamic birth-death propagation conditions are determined by the Block Error Ratio (BLER) values. BER is measured for the each of the individual data rate specified for the DPCH. DCH is mapped into Dedicated Physical Channel (DPCH).

8.5.1.1 Minimum requirement

For the parameters specified in Table 8.17 the average downlink $\frac{DPCH_E_c}{I_{or}}$ power ratio shall be below the specified value for the BLER shown in Table 8.18.

Table 8.17: DCH parameters in birth-death propagation conditions

Parameter	Unit	Test 1	Test 2
Phase reference		P-CPICH	
\hat{I}_{or}/I_{oc}	dB	-1	
I_{oc}	dBm/3.84 MHz	-60	
Information Data Rate	kbps	12.2	64

Table 8.18: DCH requirements in birth-death propagation conditions

Test Number	$\frac{DPCH_E_c}{I_{or}}$	BLER
1	-12.6 dB	10^{-2}
2	-8.7 dB	10^{-2}

8.6 Demodulation of DCH in downlink Transmit diversity modes

8.6.1 Demodulation of DCH in open-loop transmit diversity mode

The receive characteristic of the Dedicated Channel (DCH) in open loop transmit diversity mode is determined by the Block Error Ratio (BLER). DCH is mapped into in Dedicated Physical Channel (DPCH).

8.6.1.1 Minimum requirement

For the parameters specified in Table 8.19 the average downlink $\frac{DPCH_E_c}{I_{or}}$ power ratio shall be below the specified value for the BLER shown in Table 8.20.

Table 8.19: Test parameters for DCH reception in an open loop transmit diversity scheme. (Propagation condition: Case 1)

Parameter	Unit	Test 1
Phase reference		P-CPICH
\hat{I}_{or}/I_{oc}	dB	9
I_{oc}	dBm/3.84 MHz	-60
Information data rate	kbps	12.2

Table 8.20: Test requirements for DCH reception in open loop transmit diversity scheme

Test Number	$\frac{DPCH_E_c}{I_{or}}$ (antenna 1/2)	BLER
1	-16.8 dB	10^{-2}

8.6.2 Demodulation of DCH in closed loop transmit diversity mode

The receive characteristic of the dedicated channel (DCH) in closed loop transmit diversity mode is determined by the Block Error Ratio (BLER). DCH is mapped into in Dedicated Physical Channel (DPCH).

8.6.2.1 Minimum requirement

For the parameters specified in Table 8.21 the average downlink $\frac{DPCH_E_c}{I_{or}}$ power ratio shall be below the specified value for the BLER shown in Table 8.22.

Table 8.21: Test Parameters for DCH Reception in closed loop transmit diversity mode (Propagation condition: Case 1)

Parameter	Unit	Test 1 (Mode 1)	Test 2 (Mode 2)
\hat{I}_{or}/I_{oc}	dB	9	9
I_{oc}	dBm/3.84 MHz	-60	-60
Information data rate	kbps	12.2	12.2
Feedback error rate	%	4	4
Closed loop timing adjustment mode	-	1	1

Table 8.22: Test requirements for DCH reception in closed loop transmit diversity mode

Test Number	$\frac{DPCH_E_c}{I_{or}}$ (see note)	BLER
1	-18.0 dB	10^{-2}
2	-18.3 dB	10^{-2}
NOTE: This is the total power from both antennas. Power sharing between antennas are feedback mode dependent as specified in TS25.214.		

8.6.3 Demodulation of DCH in Site Selection Diversity Transmission Power Control mode

The bit error characteristics of UE receiver is determined in Site Selection Diversity Transmission power control (SSDT) mode. Two Node B emulators are required for this performance test. The delay profiles of signals received from different Node Bs are assumed to be the same but time shifted by 10 chip periods (2604 ns).

8.6.3.1 Minimum requirements

The downlink physical channels and their relative power to I_{or} are the same as those specified in clause C.3.2 irrespective of Node Bs and the test cases. $DPCH_E_c/I_{or}$ value applies whenever DPDCH in the cell is transmitted. In Test 1 and Test 3, the received powers at UE from two Node Bs are the same, while 3dB offset is given to one that comes from one of Node Bs for Test 2 and Test 4 as specified in Table 8.23.

For the parameters specified in Table 8.23 the average downlink $\frac{DPCH_E_c}{I_{or}}$ power ratio shall be below the specified value for the BLER shown in Table 8.24.

Table 8.23: DCH parameters in multi-path propagation conditions during SSdT mode (Propagation condition: Case 1)

Parameter	Unit	Test 1	Test 2	Test 3	Test 4
Phase reference		P-CPICH			
\hat{I}_{or1}/I_{oc}	dB	0	-3	0	0
\hat{I}_{or2}/I_{oc}	dB	0	0	0	-3
I_{oc}	dBm/3.84 MHz	-60			
Information Data Rate	kbps	12.2	12.2	12.2	12.2
Cell ID code word error ratio in uplink	%	1	1	1	1
Number of FBI bits assigned to "S" Field		1	1	2	2
Code word Set		Long	Long	Short	Short
UL DPCCH slot Format		#2		#5	

NOTE: The code word errors are introduced independently in both uplink channels.

Table 8.24: DCH requirements in multi-path propagation conditions during SSdT Mode

Test Number	$\frac{DPCH_E_c}{I_{or}}$	BLER
1	-6.0 dB	10^{-2}
2	-5.0 dB	10^{-2}
3	-10.5 dB	10^{-2}
4	-9.2 dB	10^{-2}

8.7 Demodulation in Handover conditions

8.7.1 Demodulation of DCH in Inter-Cell Soft Handover

The bit error rate characteristics of UE is determined during an inter-cell soft handover. During the soft handover a UE receives signals from different cells. A UE has to be able to demodulate two PCCPCH channels and to combine the energy of DCH channels. Delay profiles of signals received from different cells are assumed to be the same but time shifted by 10 chips.

The receive characteristics of the different channels during inter-cell handover are determined by the average Block Error Ratio (BLER) values.

8.7.1.1 Minimum requirement

For the parameters specified in Table 8.25 the average downlink $\frac{DPCH_E_c}{I_{or}}$ power ratio shall be below the specified value for the BLER shown in Table 8.26.

Table 8.25: DCH parameters in multi-path propagation conditions during Soft Handoff (Case 3)

Parameter	Unit	Test 1	Test 2	Test 3	Test 4
Phase reference		P-CPICH			
\hat{I}_{or1}/I_{oc} and \hat{I}_{or2}/I_{oc}	dB	0	0	3	6
I_{oc}	dBm/3.84 MHz	-60			
Information data Rate	kbps	12.2	64	144	384

Table 8.26: DCH requirements in multi-path propagation conditions during Soft Handoff (Case 3)

Test Number	$\frac{DPCH_E_c}{I_{or}}$	BLER
1	-15.2 dB	10^{-2}
2	-11.8 dB	10^{-1}
	-11.3 dB	10^{-2}
3	-9.9 dB	10^{-1}
	-9.5 dB	10^{-2}
4	-6.3 dB	10^{-1}
	-5.8 dB	10^{-2}

8.7.2 Combining of TPC commands from radio links of different radio link sets

8.7.2.1 Minimum requirement

Test parameters are specified in Table 8.27. The delay profiles of the signals received from the different cells are the same but time-shifted by 10 chips.

For Test 1, the sequence of uplink power changes between adjacent slots shall be as shown in Table 8.28 over the 4 consecutive slots more than 99% of the time. Note that this case is without an additional noise source I_{oc} .

For Test 2, the Cell1 and Cell2 TPC patterns are repeated a number of times. If the transmitted power of a given slot is increased compared to the previous slot, then a variable "Transmitted power UP" is increased by one, otherwise a variable "Transmitted power DOWN" is increased by one. The requirements for "Transmitted power UP" and "Transmitted power DOWN" are shown in Table 8.28A.

Table 8.27: Parameters for TPC command combining

Parameter	Unit	Test 1	Test 2
Phase reference	-	P-CPICH	
DPCH_Ec/I _{or}	dB	-12	
\hat{I}_{or1} and \hat{I}_{or2}	dBm/3.84 MHz	-60	
I_{oc}	dBm/3.84 MHz	-	-60
Power-Control-Algorithm	-	Algorithm 1	
Cell 1 TPC commands over 4 slots	-	{0,0,1,1}	
Cell 2 TPC commands over 4 slots	-	{0,1,0,1}	
Information data Rate	kbps	12.2	
Propagation condition	-	Static without AWGN source I_{oc}	Multi-path fading case 3

Table 8.28: Test requirements for Test 1

Test Number	Required power changes over the 4 consecutive slots
1	Down, Down, Down, Up

Table 8.28A: Requirements for Test 2

Test Number	Ratio (Transmitted power UP) / (Total number of slots)	Ratio (Transmitted power DOWN) / (Total number of slots)
2	≥ 0.25	≥ 0.5

8.7.3 Combining of reliable TPC commands from radio links of different radio link sets

8.7.3.1 Minimum requirement

Test 1 verifies that the UE follows only the reliable TPC commands in soft handover. Test 2 verifies that the UE follows all the reliable TPC commands in soft handover.

Test parameters are specified in Table 8.28B. Before the start of the tests, the UE transmit power shall be initialised to -15 dBm. An actual UE transmit power may vary from the target level of -15 dBm due to inaccurate UE output power step.

During tests 1 and 2 the UE transmit power samples, which are defined as the mean power over one timeslot, shall stay 90% of the time within the range defined in Table 8.28C.

Table 8.28B: Parameters for reliable TPC command combining

Parameter	Unit	Test 1	Test 2
Phase reference	-	P-CPICH	
DPCH_Ec/Ior1	dB	Note 1	Note 1 & Note 3
DPCH_Ec/Ior2	dB	DPCH_Ec/Ior1 - 10	DPCH_Ec/Ior1 + 6
DPCH_Ec/Ior3	dB	DPCH_Ec/Ior1 - 10	-
\hat{I}_{or1}/I_{oc}	dB	-1	-1
\hat{I}_{or2}/I_{oc}	dB	-1	-1
\hat{I}_{or3}/I_{oc}	dB	-1	-
I_{oc}	dBm/3.84 MHz	-60	
Power-Control-Algorithm	-	Algorithm 1	
UL Power Control step size, Δ_{TPC}	dB	1	
Cell 1 TPC commands	-	Note 2	Note 2
Cell 2 TPC commands	-	'1'	'1'
Cell 3 TPC commands	-	'1'	-
Information data Rate	kbps	12.2	
Propagation condition	-	Static	
Note 1: The DPCH_Ec/Ior1 is set at the level corresponding to 5% TPC error rate.			
Note 2: The uplink power control from cell1 shall be such that the UE transmit power would stay at -15 dBm.			
Note 3: The maximum DPCH_Ec/Ior1 level in cell1 is -9 dB.			

Table 8.28C: Test requirements for reliable TPC command combining

Parameter	Unit	Test 1	Test 2
UE output power	dBm	-15 ± 5 dB	-15 ± 3 dB

8.8 Power control in downlink

Power control in the downlink is the ability of the UE receiver to converge to required link quality set by the network while using as low power as possible in downlink. If a BLER target has been assigned to a DCCH (See Annex A.3), then it has to be such that outer loop is based on DTCH and not on DCCH.

8.8.1 Power control in the downlink, constant BLER target

8.8.1.1 Minimum requirements

For the parameters specified in Table 8.29 the downlink $\frac{DPCH_Ec}{I_{or}}$ power ratio measured values, which are

averaged over one slot, shall be below the specified value in Table 8.30 more than 90% of the time. BLER shall be as shown in Table 8.30. Power control in downlink is ON during the test.

Table 8.29: Test parameter for downlink power control

Parameter	Unit	Test 1	Test 2	Test 3	Test 4
\hat{I}_{or}/I_{oc}	dB	9	-1	4	9
I_{oc}	dBm/3.84 MHz	-60		-60	
Information Data Rate	kbps	12.2		64	
Reference channel in Annex A		A.3.1		A.3.5	
Target quality value on DTCH	BLER	0.01		0.1	0.001
Target quality value on DCCH	BLER	-		0.1	0.1
Propagation condition		Case 4			
Maximum_DL_Power *	dB	7			
Minimum_DL_Power *	dB	-18			
DL Power Control step size, Δ_{TPC}	dB	1			
Limited Power Increase	-	"Not used"			

NOTE: Power is compared to P-CPICH as specified in [4].

Table 8.30: Requirements in downlink power control

Parameter	Unit	Test 1	Test 2	Test 3	Test 4
$\frac{DPCH_E_c}{I_{or}}$	dB	-16.0	-9.0	-9.0	-10.3
Measured quality on DTCH	BLER	0.01±30%	0.01±30%	0.1±30%	0.001±30%

8.8.2 Power control in the downlink, initial convergence

This requirement verifies that DL power control works properly during the first seconds after DPCH connection is established

8.8.2.1 Minimum requirements

For the parameters specified in Table 8.31 the downlink DPCH_Ec/Ior power ratio measured values, which are averaged over 50 ms, shall be within the range specified in Table 8.32 more than 90% of the time. T1 equals to 500 ms and it starts 10 ms after the DPDCH physical channel is considered established and the first uplink frame is transmitted. T2 equals to 500 ms and it starts when T1 has expired. Power control is ON during the test.

The first 10 ms shall not be used for averaging, ie the first sample to be input to the averaging filter is at the beginning of T1. The averaging shall be performed with a sliding rectangular window averaging filter. The window size of the averaging filter is linearly increased from 0 up to 50 ms during the first 50 ms of T1, and then kept equal to 50ms.

Table 8.31: Test parameters for downlink power control

Parameter	Unit	Test 1	Test 2	Test 3	Test 4
Target quality value on DTCH	BLER	0.01	0.01	0.1	0.1
Initial DPCH_Ec/Ior	dB	-5.9	-25.9	-3	-22.8
Information Data Rate	kbps	12.2	12.2	64	64
\hat{I}_{or}/I_{oc}	dB	-1			
I_{oc}	dBm/3.84 MHz	-60			
Propagation condition		Static			
Maximum_DL_Power	dB	7			
Minimum_DL_Power	dB	-18			
DL Power Control step size, Δ_{TPC}	dB	1			
Limited Power Increase	-	"Not used"			

Table 8.32: Requirements in downlink power control

Parameter	Unit	Test 1 and Test 2	Test 3 and Test 4
$\frac{DPCH - E_c}{I_{or}}$ during T1	dB	$-18.9 \leq DPCH_Ec/lor \leq -11.9$	$-15.1 \leq DPCH_Ec/lor \leq -8.1$
$\frac{DPCH - E_c}{I_{or}}$ during T2	dB	$-18.9 \leq DPCH_Ec/lor \leq -14.9$	$-15.1 \leq DPCH_Ec/lor \leq -11.1$

8.8.3 Power control in downlink, wind up effects

8.8.3.1 Minimum requirements

This test is run in three stages where stage 1 is for convergence of the power control loop. In stage two the maximum downlink power for the dedicated channel is limited not to be higher than the value specified in Table 8.33. All parameters used in the three stages are specified in Table 8.33. The downlink $\frac{DPCH - E_c}{I_{or}}$ power ratio measured values,

which are averaged over one slot, during stage 3 shall be lower than the value specified in Table 8.34 more than 90% of the time.

Power control of the UE is ON during the test.

Table 8.33: Test parameter for downlink power control, wind-up effects

Parameter	Unit	Test 1		
		Stage 1	Stage 2	Stage 3
Time in each stage	s	>15	5	0.5
\hat{I}_{or}/I_{oc}	dB	5		
I_{oc}	dBm/3.84 MHz	-60		
Information Data Rate	kbps	12.2		
Quality target on DTCH	BLER	0.01		
Propagation condition		Case 4		
Maximum_DL_Power	dB	7	min(-6.2,P). Note 1	7
Minimum_DL_Power	dB	-18		
DL Power Control step size, Δ_{TPC}	dB	1		
Limited Power Increase	-	'Not used'		
Note 1: P is the level corresponding to the average $\frac{DPCH - E_c}{I_{or}}$ power ratio - 2 dB compared to the P-CPICH level. The average $\frac{DPCH - E_c}{I_{or}}$ power ratio is measured during the initialisation stage after the power control loop has converged before the actual test starts.				

Table 8.34: Requirements in downlink power control, wind-up effects

Parameter	Unit	Test 1, stage 3
$\frac{DPCH - E_c}{I_{or}}$	dB	-13.3

8.9 Downlink compressed mode

Downlink compressed mode is used to create gaps in the downlink transmission, to allow the UE to make measurements on other frequencies.

8.9.1 Single link performance

The receiver single link performance of the Dedicated Traffic Channel (DCH) in compressed mode is determined by the Block Error Ratio (BLER) and transmitted DPCH_Ec/I_{or} power ratio in the downlink.

The compressed mode parameters are given in clause A.5. Tests 1 and 2 are using Set 1 compressed mode pattern parameters from Table A.21 in clause A.5 while tests 3 and 4 are using Set 2 compressed mode patterns from the same table.

8.9.1.1 Minimum requirements

For the parameters specified in Table 8.35 the downlink $\frac{DPCH_Ec}{I_{or}}$ power ratio measured values, which are averaged over one slot, shall be below the specified value in Table 8.36 more than 90% of the time. The measured quality on DTCH shall be as required in Table 8.36.

Downlink power control is ON during the test. Uplink TPC commands shall be error free.

Table 8.35: Test parameter for downlink compressed mode

Parameter	Unit	Test 1	Test 2	Test 3	Test 4
Delta SIR1	dB	0	3	0	3
Delta SIR after1	dB	0	3	0	3
Delta SIR2	dB	0	0	0	0
Delta SIR after2	dB	0	0	0	0
\hat{I}_{or}/I_{oc}	dB	9			
I_{oc}	dBm/3.84 MHz	-60			
Information Data Rate	kbps	12.2			
Propagation condition		Case 2			
Target quality value on DTCH	BLER	0.01			
Maximum_DL_Power	dB	7			
Minimum_DL_Power	dB	-18			
DL Power Control step size, Δ_{TPC}	dB	1			
Limited Power Increase	-	"Not used"			

Table 8.36: Requirements in downlink compressed mode

Parameter	Unit	Test 1	Test 2	Test 3	Test 4
$\frac{DPCH_Ec}{I_{or}}$	dB	-14.6	No requirements	-15.2	No requirements
Measured quality of compressed and recovery frames	BLER	No requirements	<0.001	No requirements	<0.001
Measured quality on DTCH	BLER	0.01 ± 30 %			

8.10 Blind transport format detection

Performance of Blind transport format detection is determined by the Block Error Ratio (BLER) values and by the measured average transmitted DPCH_Ec/I_{or} value.

8.10.1 Minimum requirement

For the parameters specified in Table 8.37 the average downlink $\frac{DPCH_Ec}{I_{or}}$ power ratio shall be below the specified value for the BLER shown in Table 8.38.

Table 8.37: Test parameters for Blind transport format detection

Parameter	Unit	Test 1	Test 2	Test 3	Test 4	Test 5	Test 6
\hat{I}_{or}/I_{oc}	dB	-1			-3		
I_{oc}	dBm/3.84 MHz	-60					
Information Data Rate	kbps	12.2 (rate 1)	7.95 (rate 2)	1.95 (rate 3)	12.2 (rate 1)	7.95 (rate 2)	1.95 (rate 3)
propagation condition	-	static			multi-path fading case 3		
TFCI	-	off					

Table 8.38: The Requirements for DCH reception in Blind transport format detection

Test Number	$\frac{DPCH_Ec}{I_{or}}$	BLER	FDR
1	-17.7 dB	10^{-2}	10^{-4}
2	-17.8 dB	10^{-2}	10^{-4}
3	-18.4 dB	10^{-2}	10^{-4}
4	-13.0 dB	10^{-2}	10^{-4}
5	-13.2 dB	10^{-2}	10^{-4}
6	-13.8 dB	10^{-2}	10^{-4}

* The value of DPCH_Ec/I_{or}, I_{oc}, and I_{or}/I_{oc} are defined in case of DPCH is transmitted

NOTE: In this test, 9 different Transport Format Combinations (Table 8.39) are sent during the call set up procedure, so that the UE has to detect the correct transport format from these 9 candidates.

Table 8.39: Transport format combinations informed during the call set up procedure in the test

	1	2	3	4	5	6	7	8	9
DTCH	12.2k	10.2k	7.95k	7.4k	6.7k	5.9k	5.15k	4.75k	1.95k
DCCH	2.4k								

8.11 Detection of Broadcast channel (BCH)

The receiver characteristics of Broadcast Channel (BCH) are determined by the Block Error Ratio (BLER) values. BCH is mapped into the primary common control physical channel (P-CCPCH).

8.11.1 Minimum requirement without transmit diversity

For the parameters specified in Table 8.40 the average downlink power P-CCPCH_Ec/I_{or} shall be below the specified value for the BLER shown in Table 8.41. (The Down link Physical channels are specified in Annex C).

This requirement doesn't need to be tested.

Table 8.40: Parameters for BCH detection

Parameter	Unit	Test 1	Test 2
Phase reference	-	P-CPICH	
I_{oc}	dBm/3.84 MHz	-60	
\hat{I}_{or}/I_{oc}	dB	-1	-3
Propagation condition		Static	Case 3

Table 8.41: Test requirements for BCH detection

Test Number	P-CCPCH_Ec/Ior	BLER
1	-18.5 dB	0.01
2	-12.8 dB	0.01

8.11.2 Minimum requirement with open loop transmit diversity

For the parameters specified in Table 8.41A the average downlink power P-CCPCH_Ec/Ior shall be below the specified value for the BLER shown in Table 8.41B. (The Down link Physical channels are specified in Annex C).

This requirement doesn't need to be tested.

Table 8.41A: Test parameters for BCH detection in an open loop transmit diversity scheme (STTD). (Propagation condition: Case 1)

Parameter	Unit	Test 3
Phase reference	-	P-CPICH
I_{oc}	dBm/3.84 MHz	-60
\hat{I}_{or}/I_{oc}	dB	9

Table 8.41B: Test requirements for BCH detection in open loop transmit diversity scheme

Test Number	P-CCPCH_Ec/Ior (Total power from antenna 1 and 2)	BLER
3	-18.5	0.01

8.12 Demodulation of Paging Channel (PCH)

The receiver characteristics of paging channel are determined by the probability of missed paging message (Pm-p). PCH is mapped into the S-CCPCH and it is associated with the transmission of Paging Indicators (PI) to support efficient sleep-mode procedures.

8.12.1 Minimum requirement

For the parameters specified in Table 8.42 the average probability of missed paging (Pm-p) shall be below the specified value in Table 8.43. Power of downlink channels other than S-CCPCH and PICH are as defined in Table C.3 of Annex C. S-CCPCH structure is as defined in Annex A.6.

Table 8.42: Parameters for PCH detection

Parameter	Unit	Test 1	Test 2
Number of paging indicators per frame (N_p)	-	72	
Phase reference	-	P-CPICH	
I_{oc}	dBm/3.84 MHz	-60	
\hat{I}_{or}/I_{oc}	dB	-1	-3
Propagation condition		Static	Case 3

Table 8.43: Test requirements for PCH detection

Test Number	S-CCPCH E_c/I_{or}	PICH E_c/I_{or}	Pm-p
1	-14.8	-19	0.01
2	-9.8	-12	0.01

8.13 Detection of Acquisition Indicator (AI)

The receiver characteristics of Acquisition Indicator (AI) are determined by the probability of false alarm P_{fa} and probability of correct detection P_d . P_{fa} is defined as a conditional probability of detection of AI signature given that a AI signature was not transmitted. P_d is defined as a conditional probability of correct detection of AI signature given that the AI signature is transmitted.

8.13.1 Minimum requirement

For the parameters specified in Table 8.44 the P_{fa} and $1-P_d$ shall not exceed the specified values in Table 8.45. Power of downlink channels other than AICH is as defined in Table C.3 of Annex C.

Table 8.44: Parameters for AI detection

Parameter	Unit	Test 1
Phase reference	-	P-CPICH
I_{oc}	dBm/3.84 MHz	-60
Number of other transmitted AI signatures on AICH	-	0
\hat{I}_{or}/I_{oc}	dB	-1
AICH E_c/I_{or}	dB	-22.0
AICH Power Offset	dB	-12.0
Propagation condition	-	Static

Note that AICH E_c/I_{or} can not be set. Its value is calculated from other parameters and it is given for information only. (AICH E_c/I_{or} = AICH Power Offset + CPICH E_c/I_{or})

Table 8.45: Test requirements for AI detection

Test Number	P_{fa}	$1-P_d$
1	0.01	0.01

8.14 Detection of Access Preamble Acquisition Indicator Channel (AP-AICH)

The requirement for detection of the AP-AICH for CPCH is the same as the requirement for detection of the AI which is described in section 8.13 of this specification.

8.15 Detection of Collision Detection/Channel Assignment Indicator Channel (CD/CA-ICH)

The requirement for detection of the CD/CA-ICH for CPCH is the same as the requirement for detection of the AI which is described in section 8.13 of this specification.

8.16 Demodulation of CPCH Status Indicator Channel (CSICH)

The receive characteristics of the CPCH Status Indicator Channel (CSICH) when CA is not active are determined by the average message error Ratio (MER). Under the test conditions described in 8.16.1, a CSICH message demodulation error will cause the UE to transmit a CPCH message when there is pending UL data to transmit. MER is measured at the message rate listed for the conditions in Table 8.46.

The receive characteristics of the CSICH when CA is active are determined by the error rate of demodulation of Minimum Available Spreading Factor (MASF). Under the test conditions described in 8.16.2, the demodulation error of MASF bits transmitted over CSICH will cause that the UE transmits wrong CPCH Access Preamble to UTRAN. MASF Error rate is measured under the condition in Table 8.50

8.16.1 Minimum requirement when CA is not active

For the parameters and conditions specified in Tables 8.46, 8.47 and 8.48 the MER shall not exceed the values listed in table 8.49.

Other downlink channels which are present in this test are P-CPICH, P-CCPCH, and PICH, and their powers are as specified in Annex C.3.2.

Table 8.46: CPCH test parameters and conditions for CSICH performance when CA is not active

Parameter	Test 1	Test 2
CPCH mode	UE Channel Selection (PCPCH availability is broadcast in CSICH)	
Number of PCPCHs in CPCH set	15	
Number of SIs per CSICH frame	15 (one SI message per PCPCH)	
Number of CSICH bits per SI message	8 (CSICH bit repeated 8 times in each SI message)	
CSICH Message Rate	750 per second (15 messages in 20 msec frame)	
AP preamble signatures	15 PCPCHs are given 1 signature each; 1 signature is unused.	
AP preamble slot subchannels	All slot subchannels are available for access without delay.	
CD preamble signatures	16 (all signatures used)	
CD preamble slot subchannels	All slot subchannels are available for access without delay.	
Persistency value for all PCPCHs	1 (full access, no delay)	
CSICH broadcast	N=15 SIs. For each PCPCH SI, SI=0 (PCPCH not available)	
AP-AICH broadcast	In each access slot, Node B transmits 15 AP-AICH-ACKs, one for each PCPCH.	
Channel Assignment (CA)	Not active	
CD/CA-ICH broadcast	In each access slot, Node B transmits 16 CD/CA-ICH ACKs, one for each possible signature.	
Power control preamble length for all PCPCHs	0 slots	
Message length for all PCPCHs	10 ms (1 TTI) (N _{fmax} = 1)	
Spreading factor for all PCPCHs	64	
Propagation condition	Static	Case 3

Table 8.47: AP-AICH test parameters for CSICH performance when CA is not active

Parameter	Unit	Test 1	Test 2
Phase reference	-	P-CPICH	
I_{oc}	dBm/3.84 MHz	-60	
Number of transmitted AI signatures on AP-AICH	-	15 (all ACK)	
\hat{I}_{or}/I_{oc}	dB	-1	-3
AP-AICH_Ec/Ior	dB	-10.0	
AP-AICH Power Offset	dB	0	
Propagation condition		Static	Case 3

Note that AP-AICH_Ec/Ior cannot be set. Its value is calculated from other parameters and it is given for information only. (AP-AICH_Ec/Ior = AP-AICH Power Offset + CPICH_Ec/Ior)

Table 8.48: CD/CA-ICH test parameters for CSICH performance when CA is not active

Parameter	Unit	Test 1	Test 2
Phase reference	-	P-CPICH	
I_{oc}	dBm/3.84 MHz	-60	
Number of transmitted CD signatures on CD/CA-ICH	-	16 (all ACK)	
\hat{I}_{or}/I_{oc}	dB	-1	-3
CD/CA-ICH_Ec/Ior	dB	-10.0	
CD/CA-ICH Power Offset	dB	0	
Propagation condition		Static	Case 3

Note that CD/CA-ICH_Ec/Ior cannot be set. Its value is calculated from other parameters and it is given for information only. (CD/CA-ICH_Ec/Ior = CD/CA-ICH Power Offset + CPICH_Ec/Ior)

Table 8.49: CSICH demodulation requirements when CA is not active

Test Number	CSICH power offset	CSICH MER
1	-10.5 dB	0.001
2	-3.0 dB	0.001

8.16.2 Minimum requirement when CA is active

For the parameters and conditions specified in Tables 8.50 and 8.51, the MASF Error rate shall not exceed the values listed in table 8.52.

Other downlink channels, which are present in this test, are P-CPICH, P-CCPCH, and PICH, and their powers are as specified in Annex C.3.2.

Table 8.50: CPCH test parameters and conditions for CSICH performance when CA is active

Parameter	Test 1	Test 2
CPCH mode	Channel Assignment is active (PCPCH availability as well as Minimum Available Spreading Factor are broadcast in CSICH)	
Number of PCPCHs in CPCH set	9	
Number of SIs per CSICH frame	15 (9 SIs for the availability of 9 PCPCH and 6 SIs for the transmission of MASF bits)	
Number of CSICH bits per SI message	8 (CSICH bit repeated 8 times in each SI message)	
CSICH Message Rate	750 per second (15 messages in 20 msec frame)	
AP preamble signatures	2 signatures are given to each data rate and 2 signatures are unused. Where: Signature number 0 and 1 correspond to MASF 256. Signature number 2 and 3 correspond to MASF 128. Signature number 4 and 5 correspond to MASF 64. Signature number 6 and 7 correspond to MASF 32. Signature number 8 and 9 correspond to MASF 16. Signature number 10 and 11 correspond to MASF 8. Signature number 12 and 13 correspond to MASF 4.	
AP preamble slot subchannels	All slot subchannels are available for access without delay.	
CSICH broadcast	The pattern of SIs is '000000000000000' Where: MASF bits value is '000' For each PCPCH SI, SI=0 (All PCPCH are not available)	
PCPCH data rate expected by the UE	More than 15 kbps	
AP-AICH broadcast	In each access slot, Node B transmits 14 AP-AICH-NACKs	
Propagation condition	Static	Case 3

Table 8.51: AP-AICH test parameters for CSICH performance when CA is active

Parameter	Unit	Test 1	Test 2
Phase reference	-	P-CPICH	
I_{oc}	dBm/3.84 MHz	-60	
Number of transmitted AI signatures on AP-AICH	-	14	
\hat{I}_{or}/I_{oc}	DB	-1	-3
AP-AICH_Ec/Ior	DB	-10.0	
AP-AICH Power Offset	DB	0	
Propagation condition		Static	Case 3

Note that AP-AICH_Ec/Ior cannot be set. Its value is calculated from other parameters and it is given for information only. (AP-AICH_Ec/Ior = AP-AICH Power Offset + CPICH_Ec/Ior)

Table 8.52: CSICH demodulation requirements when CA is active

Test Number	CSICH power offset	CSICH MER
1	-12.55 db	0.001
2	-6.15 db	0.001

Note that CSICH_Ec/Ior = CSICH power_Offset + CPICH_Ec/Ior

9 Performance requirement (HSDPA)

The performance requirements for the UE in this clause apply for the reference measurement channels specified in Annex A.7, the propagation conditions specified in Annex B.2.2 and the Down link Physical channels specified in Annex C.5. The specific references are provided separately for each requirement.

9.1 Void

9.2 Demodulation of HS-DSCH (Fixed Reference Channel)

The minimum performance requirement for a particular UE belonging to certain HS-DSCH category are determined according to Table 9.1. The performance requirements for a particular UE belonging to certain HS-DSCH category and supporting the optional enhanced performance requirements type 1 are determined according to Table 9.1AA.

The propagation conditions for this subclause are defined in table B.1B.

Table 9.1: FRC for minimum performance requirements for different HS-DSCH categories

HS-DSCH category	Corresponding requirement		
	Single Link	Open Loop Diversity	Closed Loop Diversity
Category 1	H-Set 1	H-Set 1	H-Set 1
Category 2	H-Set 1	H-Set 1	H-Set 1
Category 3	H-Set 2	H-Set 2	H-Set 2
Category 4	H-Set 2	H-Set 2	H-Set 2
Category 5	H-Set 3	H-Set 3	H-Set 3
Category 6	H-Set 3	H-Set 3	H-Set 3
Category 7 (Note 1)	H-Set 6, H-Set 3	H-Set 3	H-Set 3
Category 8 (Note 1)	H-Set 6, H-Set 3	H-Set 3	H-Set 3
Category 11	H-Set 4	H-Set 4	H-Set 4
Category 12	H-Set 5	H-Set 5	H-Set 5

Note 1 Single link minimum performance requirements for Categories 7 and 8 in Pedestrian A with $\hat{I}_{or}/I_{oc}=10\text{dB}$ are set according to H-Set 6. Requirements in other conditions are according to H-Set 3.

Table 9.1AA: FRC for enhanced performance requirements type 1 for different HS-DSCH categories

HS-DSCH category	Corresponding requirement		
	Single Link	Open Loop Diversity	Closed Loop Diversity
Category 1	H-Set 1	H-Set 1	H-Set 1
Category 2	H-Set 1	H-Set 1	H-Set 1
Category 3	H-Set 2	H-Set 2	H-Set 2
Category 4	H-Set 2	H-Set 2	H-Set 2
Category 5	H-Set 3	H-Set 3	H-Set 3
Category 6	H-Set 3	H-Set 3	H-Set 3
Category 7 (Note 1)	H-Set 6, H-Set 3	H-Set 3	H-Set 3
Category 8 (Note 1)	H-Set 6, H-Set 3	H-Set 3	H-Set 3

Note 1 Single link enhanced performance requirements type 1 for Categories 7 and 8 in Pedestrian A with $\hat{I}_{or}/I_{oc}=10\text{dB}$ are set according to H-Set 6. Requirements in other conditions are according to H-Set 3.

During the Fixed Reference Channel tests the behaviour of the Node-B emulator in response to the ACK/NACK signalling field of the HS-DPCCH is specified in Table 9.1A:

Table 9.1A: Node-B Emulator Behaviour in response to ACK/NACK/DTX

HS-DPCCH ACK/NACK Field State	Node-B Emulator Behaviour
ACK	ACK: new transmission using 1 st redundancy and constellation version (RV)
NACK	NACK: retransmission using the next RV (up to the maximum permitted number or RV's)
DTX	DTX: retransmission using the RV previously transmitted to the same H-ARQ process

NOTE: Performance requirements in this section assume a sufficient power allocation to HS-SCCH_1 so that probability of reporting DTX is very low.

9.2.1 Single Link performance

The receiver single link performance of the High Speed Physical Downlink Shared Channel (HS-DSCH) in different multi-path fading environments are determined by the information bit throughput R

9.2.1.1 Requirement QPSK, Fixed Reference Channel (FRC) H-Set 1/2/3

The requirements are specified in terms of a minimum information bit throughput R for the DL reference channels H-set 1/2/3 (QPSK version) specified in Annex A.7.1.1, A.7.1.2 and A.7.1.3 respectively, with the addition of the parameters in Table 9.2 and the downlink physical channel setup according to table C.8.

Using this configuration the throughput shall meet or exceed the minimum requirements specified in table 9.3. Enhanced performance requirements type 1 specified in Table 9.3A are based on receiver diversity.

Table 9.2: Test Parameters for Testing QPSK FRCs H-Set 1/H-Set 2/H-Set 3

Parameter	Unit	Test 1	Test 2	Test 3	Test 4
Phase reference		P-CPICH			
I_{oc}	dBm/3.84 MHz	-60			
Redundancy and constellation version coding sequence		{0,2,5,6}			
Maximum number of HARQ transmission		4			
Note:	The HS-SCCH-1 and HS-PDSCH shall be transmitted continuously with constant power. HS-SCCH-1 shall only use the identity of the UE under test for those TTI intended for the UE.				

Table 9.3: Minimum requirement QPSK, Fixed Reference Channel (FRC) H-Set 1/2/3

Test Number	Propagation Conditions	Reference value		
		HS-PDSCH E_c / I_{or} (dB)	T-put R (kbps) * $\hat{I}_{or} / I_{oc} = 0$ dB	T-put R (kbps) * $\hat{I}_{or} / I_{oc} = 10$ dB
1	PA3	-6	65	309
		-3	N/A	423
2	PB3	-6	23	181
		-3	138	287
3	VA30	-6	22	190
		-3	142	295
4	VA120	-6	13	181
		-3	140	275

* Notes: 1) The reference value R is for the Fixed Reference Channel (FRC) H-Set 1
2) For Fixed Reference Channel (FRC) H-Set 2 the reference values for R should be scaled (multiplied by 1.5 and rounding to the nearest integer t-put in kbps, where values of $i+1/2$ are rounded up to $i+1$, i integer)
3) For Fixed Reference Channel (FRC) H-Set 3 the reference values for R should be scaled (multiplied by 3 and rounding to the nearest integer t-put in kbps, where values of $i+1/2$ are rounded up to $i+1$, i integer)

Table 9.3A: Enhanced requirement type 1 QPSK, Fixed Reference Channel (FRC) H-Set 1/2/3

Test Number	Propagation Conditions	Reference value		
		HS-PDSCH E_c/I_{or} (dB)	T-put R (kbps) * $\hat{I}_{or}/I_{oc} = 0$ dB	T-put R (kbps) * $\hat{I}_{or}/I_{oc} = 10$ dB
1	PA3	-12	N/A	247
		-9	N/A	379
		-6	195	N/A
		-3	329	N/A
2	PB3	-9	N/A	195
		-6	156	316
		-3	263	N/A
3	VA30	-9	N/A	212
		-6	171	329
		-3	273	N/A
4	VA120	-9	N/A	191
		-6	168	293
		-3	263	N/A

* Notes: 1) The reference value R is for the Fixed Reference Channel (FRC) H-Set 1
2) For Fixed Reference Channel (FRC) H-Set 2 the reference values for R should be scaled (multiplied by 1.5 and rounding to the nearest integer t-put in kbps, where values of $i+1/2$ are rounded up to $i+1$, i integer)
3) For Fixed Reference Channel (FRC) H-Set 3 the reference values for R should be scaled (multiplied by 3 and rounding to the nearest integer t-put in kbps, where values of $i+1/2$ are rounded up to $i+1$, i integer)

9.2.1.2 Requirement 16QAM, Fixed Reference Channel (FRC) H-Set 1/2/3

The requirements are specified in terms of a minimum information bit throughput R for the DL reference channels H-set 1/2/3 (16QAM version) specified in Annex A.7.1.1, A.7.1.2 and A.7.1.3 respectively, with the addition of the parameters in Table 9.4 and the downlink physical channel setup according to table C.8.

Using this configuration the throughput shall meet or exceed the minimum requirements specified in table 9.5. Enhanced performance requirements type 1 specified in Table 9.5A are based on receiver diversity.

Table 9.4: Test Parameters for Testing 16QAM FRCs H-Set 1/H-Set 2/H-Set 3

Parameter	Unit	Test 1	Test 2	Test 3	Test 4
Phase reference		P-CPICH			
I_{oc}	dBm/3.84 MHz	-60			
Redundancy and constellation version coding sequence		{6,2,1,5}			
Maximum number of HARQ transmission		4			
Note:	The HS-SCCH-1 and HS-PDSCH shall be transmitted continuously with constant power. HS-SCCH-1 shall only use the identity of the UE under test for those TTI intended for the UE.				

Table 9.5: Minimum requirement 16QAM, Fixed Reference Channel (FRC) H-Set 1/2/3

Test Number	Propagation Conditions	Reference value	
		HS-PDSCH E_c / I_{or} (dB)	T-put R (kbps) * $\hat{I}_{or} / I_{oc} = 10$ dB
1	PA3	-6	198
		-3	368
2	PB3	-6	34
		-3	219
3	VA30	-6	47
		-3	214
4	VA120	-6	28
		-3	167
* Notes: 1)The reference value R is for the Fixed Reference Channel (FRC) H-Set 1 2) For Fixed Reference Channel (FRC) H-Set 2 the reference values for R should be scaled (multiplied by 1.5 and rounding to the nearest integer t-put in kbps, where values of i+1/2 are rounded up to i+1, i integer) 3) For Fixed Reference Channel (FRC) H-Set 3 the reference values for R should be scaled (multiplied by 3 and rounding to the nearest integer t-put in kbps, where values of i+1/2 are rounded up to i+1, i integer)			

Table 9.5A: Enhanced requirement type 1 16QAM, Fixed Reference Channel (FRC) H-Set 1/2/3

Test Number	Propagation Conditions	Reference value	
		HS-PDSCH E_c / I_{or} (dB)	T-put R (kbps) * $\hat{I}_{or} / I_{oc} = 10$ dB
1	PA3	-9	312
		-6	487
2	PB3	-6	275
		-3	408
3	VA30	-6	296
		-3	430
4	VA120	-6	271
		-3	392
* Notes: 1)The reference value R is for the Fixed Reference Channel (FRC) H-Set 1 2) For Fixed Reference Channel (FRC) H-Set 2 the reference values for R should be scaled (multiplied by 1.5 and rounding to the nearest integer t-put in kbps, where values of i+1/2 are rounded up to i+1, i integer) 3) For Fixed Reference Channel (FRC) H-Set 3 the reference values for R should be scaled (multiplied by 3 and rounding to the nearest integer t-put in kbps, where values of i+1/2 are rounded up to i+1, i integer)			

9.2.1.3 Minimum requirement QPSK, Fixed Reference Channel (FRC) H-Set 4/5

The requirements are specified in terms of a minimum information bit throughput R for the DL reference channels H-set 4/5 specified in Annex A.7.1.4 and A.7.1.5 respectively, with the addition of the parameters in Table 9.6 and the downlink physical channel setup according to table C.8.

Using this configuration the throughput shall meet or exceed the minimum requirements specified in table 9.7 for H-Set 4 and table 9.8 for H-Set 5.

Table 9.6: Test Parameters for Testing QPSK FRCs H-Set 4/H-Set 5

Parameter	Unit	Test 1	Test 2	Test 3	Test 4
Phase reference		P-CPICH			
I_{oc}	dBm/3.84 MHz	-60			
Redundancy and constellation version coding sequence		{0,2,5,6}			
Maximum number of HARQ transmission		4			
Note:	The HS-SCCH-1 and HS-PDSCH shall be transmitted continuously with constant power. HS-SCCH-1 shall only use the identity of the UE under test for those TTI intended for the UE.				

Table 9.7: Minimum requirement QPSK, Fixed Reference Channel (FRC) H-Set 4

Test Number	Propagation Conditions	Reference value		
		HS-PDSCH E_c/I_{or} (dB)	T-put R (kbps) * $\hat{I}_{or}/I_{oc} = 0$ dB	T-put R (kbps) * $\hat{I}_{or}/I_{oc} = 10$ dB
1	PA3	-6	72	340
		-3	N/A	439
2	PB3	-6	24	186
		-3	142	299
3	VA30	-6	19	183
		-3	148	306
4	VA120	-6	11	170
		-3	144	284
* Note: The reference value R is for the Fixed Reference Channel (FRC) H-Set 4				

Table 9.8: Minimum requirement QPSK, Fixed Reference Channel (FRC) H-Set 5

Test Number	Propagation Conditions	Reference value		
		HS-PDSCH E_c/I_{or} (dB)	T-put R (kbps) * $\hat{I}_{or}/I_{oc} = 0$ dB	T-put R (kbps) * $\hat{I}_{or}/I_{oc} = 10$ dB
1	PA3	-6	98	464
		-3	N/A	635
2	PB3	-6	35	272
		-3	207	431
3	VA30	-6	33	285
		-3	213	443
4	VA120	-6	20	272
		-3	210	413
* Note: The reference value R is for the Fixed Reference Channel (FRC) H-Set 5				

9.2.1.4 Minimum requirement QPSK, Fixed Reference Channel (FRC) H-Set 6

The requirements are specified in terms of a minimum information bit throughput R for the DL reference channel H-Set 6 specified in Annex A.7.1.6 with the addition of the parameters in Table 9.8A and the downlink physical channel setup according to table C.8.

Using this configuration the throughput shall meet or exceed the minimum requirements specified in table 9.8B. Enhanced performance requirements type 1 as specified in Table 9.8B1 are based on receiver diversity.

Table 9.8A: Test Parameters for Testing QPSK FRCs H-Set 6

Parameter	Unit	Test 1
Phase reference		P-CPICH
I_{oc}	dBm/3.84 MHz	-60
Redundancy and constellation version coding sequence		{0,2,5,6}
Maximum number of HARQ transmission		4
Note:	The HS-SCCH-1 and HS-PDSCH shall be transmitted continuously with constant power. HS-SCCH-1 shall only use the identity of the UE under test for those TTI intended for the UE.	

Table 9.8B: Minimum requirement QPSK, Fixed Reference Channel (FRC) H-Set 6

Test Number	Propagation Conditions	Reference value	
		HS-PDSCH E_c / I_{or} (dB)	T-put R (kbps) * $\hat{I}_{or} / I_{oc} = 10$ dB
1	PA3	-6	1407
		-3	2090

Table 9.8B1: Enhanced requirements type 1 QPSK, Fixed Reference Channel (FRC) H-Set 6

Test Number	Propagation Conditions	Reference value	
		HS-PDSCH E_c / I_{or} (dB)	T-put R (kbps) * $\hat{I}_{or} / I_{oc} = 10$ dB
1	PA3	-12	672
		-9	1305

9.2.1.5 Minimum requirement 16QAM, Fixed Reference Channel (FRC) H-Set 6

The requirements are specified in terms of a minimum information bit throughput R for the DL reference channel H Set-6 specified in Annex A.7.1.6 with the addition of the parameters in Table 9.8C and the downlink physical channel setup according to table C.8.

Using this configuration the throughput shall meet or exceed the minimum requirements specified in table 9.8D. Enhanced performance requirements type 1 as specified in Table 9.8D1 are based on receiver diversity.

Table 9.8C: Test Parameters for Testing 16-QAM FRCs H-Set 6

Parameter	Unit	Test 1
Phase reference		P-CPICH
I_{oc}	dBm/3.84 MHz	-60
Redundancy and constellation version coding sequence		{6,2,1,5}
Maximum number of HARQ transmission		4
Note:	The HS-SCCH-1 and HS-PDSCH shall be transmitted continuously with constant power. HS-SCCH-1 shall only use the identity of the UE under test for those TTI intended for the UE.	

Table 9.8D: Minimum requirement 16QAM, Fixed Reference Channel (FRC) H-Set 6

Test Number	Propagation Conditions	Reference value	
		HS-PDSCH E_c / I_{or} (dB)	T-put R (kbps) * $\hat{I}_{or} / I_{oc} = 10$ dB
1	PA3	-6	887
		-3	1664

Table 9.8D1: Enhanced requirements type 1 16QAM, Fixed Reference Channel (FRC) H-Set 6

Test Number	Propagation Conditions	Reference value	
		HS-PDSCH E_c / I_{or} (dB)	T-put R (kbps) * $\hat{I}_{or} / I_{oc} = 10$ dB
1	PA3	-9	912

9.2.2 Open Loop Diversity performance

The receiver single open loop transmit diversity performance of the High Speed Physical Downlink Shared Channel (HS-DSCH) in multi-path fading environments are determined by the information bit throughput R .

9.2.2.1 Requirement QPSK, Fixed Reference Channel (FRC) H-Set 1/2/3

The requirements are specified in terms of a minimum information bit throughput R for the DL reference channels H-Set 1/2/3 (QPSK version) specified in Annex A.7.1.1, A.7.1.2 and A.7.1.3 respectively, with the addition of the parameters in Table 9.9 and the downlink physical channel setup according to table C.9.

Using this configuration the throughput shall meet or exceed the minimum requirements specified in table 9.10. Enhanced performance requirements type 1 specified in Table 9.10A are based on receiver diversity.

Table 9.9: Test Parameters for Testing QPSK FRCs H-Set 1/H-Set 2/H-Set 3

Parameter	Unit	Test 1	Test 2	Test 3
Phase reference		P-CPICH		
I_{oc}	dBm/3.84 MHz	-60		
Redundancy and constellation version coding sequence		{0,2,5,6}		
Maximum number of HARQ transmission		4		
Note:	The HS-SCCH-1 and HS-PDSCH shall be transmitted continuously with constant power. HS-SCCH-1 shall only use the identity of the UE under test for those TTI intended for the UE.			

Table 9.10: Minimum requirement QPSK, Fixed Reference Channel (FRC) H-Set 1/2/3

Test Number	Propagation Conditions	Reference value		
		HS-PDSCH E_c/I_{or} (dB)	T-put R (kbps) * $\hat{I}_{or}/I_{oc} = 0$ dB	T-put R (kbps) * $\hat{I}_{or}/I_{oc} = 10$ dB
1	PA3	-6	77	375
		-3	180	475
2	PB3	-6	20	183
		-3	154	274
3	VA30	-6	15	187
		-3	162	284

* Notes: 1) The reference value R is for the Fixed Reference Channel (FRC) H-Set 1
2) For Fixed Reference Channel (FRC) H-Set 2 the reference values for R should be scaled (multiplied by 1.5 and rounding to the nearest integer t-put in kbps, where values of $i+1/2$ are rounded up to $i+1$, i integer)
3) For Fixed Reference Channel (FRC) H-Set 3 the reference values for R should be scaled (multiplied by 3 and rounding to the nearest integer t-put in kbps, where values of $i+1/2$ are rounded up to $i+1$, i integer)

Table 9.10A: Enhanced requirement type 1 QPSK, Fixed Reference Channel (FRC) H-Set 1/2/3

Test Number	Propagation Conditions	Reference value		
		HS-PDSCH E_c/I_{or} (dB)	T-put R (kbps) * $\hat{I}_{or}/I_{oc} = 0$ dB	T-put R (kbps) * $\hat{I}_{or}/I_{oc} = 10$ dB
1	PA3	-12	N/A	268
		-9	N/A	407
		-6	197	N/A
		-3	333	N/A
2	PB3	-9	N/A	183
		-6	152	288
		-3	251	N/A
3	VA30	-9	N/A	197
		-6	164	307
		-3	261	N/A

* Notes: 1) The reference value R is for the Fixed Reference Channel (FRC) H-Set 1
2) For Fixed Reference Channel (FRC) H-Set 2 the reference values for R should be scaled (multiplied by 1.5 and rounding to the nearest integer t-put in kbps, where values of $i+1/2$ are rounded up to $i+1$, i integer)
3) For Fixed Reference Channel (FRC) H-Set 3 the reference values for R should be scaled (multiplied by 3 and rounding to the nearest integer t-put in kbps, where values of $i+1/2$ are rounded up to $i+1$, i integer)

9.2.2.2 Requirement 16QAM, Fixed Reference Channel (FRC) H-Set 1/2/3

The requirements are specified in terms of a minimum information bit throughput R for the DL reference channels H-Set 1/2/3 (16QAM version) specified in Annex A.7.1.1, A.7.1.2 and A.7.1.3 respectively, with the addition of the parameters in Table 9.11 and the downlink physical channel setup according to table C.9.

Using this configuration the throughput shall meet or exceed the minimum requirements specified in table 9.12. Enhanced performance requirements type 1 specified in Table 9.12A are based on receiver diversity.

Table 9.11: Test Parameters for Testing 16QAM FRCs H-Set 1/H-Set 2/H-Set 3

Parameter	Unit	Test 1	Test 2	Test 3
Phase reference		P-CPICH		
I_{oc}	dBm/3.84 MHz	-60		
Redundancy and constellation version coding sequence		{6,2,1,5}		
Maximum number of HARQ transmission		4		
Note:	The HS-SCCH-1 and HS-PDSCH shall be transmitted continuously with constant power. HS-SCCH-1 shall only use the identity of the UE under test for those TTI intended for the UE.			

Table 9.12: Minimum requirement 16QAM, Fixed Reference Channel (FRC) H-Set 1/2/3

Test Number	Propagation Conditions	Reference value	
		HS-PDSCH E_c/I_{or} (dB)	T-put R (kbps) * $\hat{I}_{or}/I_{oc} = 10$ dB
1	PA3	-6	295
		-3	463
2	PB3	-6	24
		-3	243
3	VA30	-6	35
		-3	251
* Notes: 1)The reference value R is for the Fixed Reference Channel (FRC) H-Set 1 2) For Fixed Reference Channel (FRC) H-Set 2 the reference values for R should be scaled (multiplied by 1.5 and rounding to the nearest integer t-put in kbps, where values of $i+1/2$ are rounded up to $i+1$, i integer) 3) For Fixed Reference Channel (FRC) H-Set 3 the reference values for R should be scaled (multiplied by 3 and rounding to the nearest integer t-put in kbps, where values of $i+1/2$ are rounded up to $i+1$, i integer)			

Table 9.12A: Enhanced requirement type 1 16QAM, Fixed Reference Channel (FRC) H-Set 1/2/3

Test Number	Propagation Conditions	Reference value	
		HS-PDSCH E_c/I_{or} (dB)	T-put R (kbps) * $\hat{I}_{or}/I_{oc} = 10$ dB
1	PA3	-9	340
		-6	513
2	PB3	-6	251
		-3	374
3	VA30	-6	280
		-3	398
* Notes: 1)The reference value R is for the Fixed Reference Channel (FRC) H-Set 1 2) For Fixed Reference Channel (FRC) H-Set 2 the reference values for R should be scaled (multiplied by 1.5 and rounding to the nearest integer t-put in kbps, where values of $i+1/2$ are rounded up to $i+1$, i integer) 3) For Fixed Reference Channel (FRC) H-Set 3 the reference values for R should be scaled (multiplied by 3 and rounding to the nearest integer t-put in kbps, where values of $i+1/2$ are rounded up to $i+1$, i integer)			

9.2.2.3 Minimum requirement QPSK, Fixed Reference Channel (FRC) H-Set 4/5

The requirements are specified in terms of a minimum information bit throughput R for the DL reference channels H-Set 4/5 specified in Annex A.7.1.4 and A.7.1.5 respectively, with the addition of the parameters in Table 9.13 and the downlink physical channel setup according to table C.9.

Using this configuration the throughput shall meet or exceed the minimum requirements specified in table 9.14 for H-Set 4 and table 9.15 for H-Set 5.

Table 9.13: Test Parameters for Testing QPSK FRCs H-Set 4/H-Set 5

Parameter	Unit	Test 1	Test 2	Test 3	Test 4
Phase reference		P-CPICH			
I_{oc}	dBm/3.84 MHz	-60			
Redundancy and constellation version coding sequence		{0,2,5,6}			
Maximum number of HARQ transmission		4			
Note:	The HS-SCCH-1 and HS-PDSCH shall be transmitted continuously with constant power. HS-SCCH-1 shall only use the identity of the UE under test for those TTI intended for the UE.				

Table 9.14: Minimum requirement QPSK, Fixed Reference Channel (FRC) H-Set 4

Test Number	Propagation Conditions	Reference value		
		HS-PDSCH E_c/I_{or} (dB)	T-put R (kbps) * $\hat{I}_{or}/I_{oc} = 0$ dB	T-put R (kbps) * $\hat{I}_{or}/I_{oc} = 10$ dB
1	PA3	-6	70	369
		-3	171	471
2	PB3	-6	14	180
		-3	150	276
3	VA30	-6	11	184
		-3	156	285

* Note: The reference value R is for the Fixed Reference Channel (FRC) H-Set 4

Table 9.15: Minimum requirement QPSK, Fixed Reference Channel (FRC) H-Set 5

Test Number	Propagation Conditions	Reference value		
		HS-PDSCH E_c/I_{or} (dB)	T-put R (kbps) * $\hat{I}_{or}/I_{oc} = 0$ dB	T-put R (kbps) * $\hat{I}_{or}/I_{oc} = 10$ dB
1	PA3	-6	116	563
		-3	270	713
2	PB3	-6	30	275
		-3	231	411
3	VA30	-6	23	281
		-3	243	426

* Note: The reference value R is for the Fixed Reference Channel (FRC) H-Set 5

9.2.3 Closed Loop Diversity Performance

The closed loop transmit diversity (Mode 1) performance of the High Speed Physical Downlink Shared Channel (HS-DSCH) in multi-path fading environments are determined by the information bit throughput R.

9.2.3.1 Requirement QPSK, Fixed Reference Channel (FRC) H-Set 1/2/3

The requirements are specified in terms of a minimum information bit throughput R for the DL reference channels H-Set 1/2/3 (QPSK version) specified in Annex A.7.1.1, A.7.1.2 and A.7.1.3 respectively, with the addition of the parameters in Table 9.16 and the downlink physical channel setup according to table C.10.

Using this configuration the throughput shall meet or exceed the minimum requirements specified in table 9.17. Enhanced performance requirements type 1 specified in Table 9.17A are based on receiver diversity.

Table 9.16: Test Parameters for Testing QPSK FRCs H-Set 1/H-Set 2/H-Set 3

Parameter	Unit	Test 1	Test 2	Test 3
Phase reference		P-CPICH		
I_{oc}	dBm/3.84 MHz	-60		
DPCH frame offset ($\tau_{DPCH,n}$)	Chip	0		
Redundancy and constellation version coding sequence		{0,2,5,6}		
Maximum number of HARQ transmission		4		
Feedback Error Rate	%	4		
Closed loop timing adjustment mode		1		
Note:	The HS-SCCH-1 and HS-PDSCH shall be transmitted continuously with constant power. HS-SCCH-1 shall only use the identity of the UE under test for those TTI intended for the UE.			

Table 9.17: Minimum requirement QPSK, Fixed Reference Channel (FRC) H-Set 1/2/3

Test Number	Propagation Conditions	Reference value		
		HS-PDSCH E_c / I_{or} (dB)	T-put R (kbps) * $\hat{I}_{or} / I_{oc} = 0$ dB	T-put R (kbps) * $\hat{I}_{or} / I_{oc} = 10$ dB
1	PA3	-6	118	399
		-3	225	458
2	PB3	-6	50	199
		-3	173	301
3	VA30	-6	47	204
		-3	172	305
* Notes: 1) The reference value R is for the Fixed Reference Channel (FRC) H-Set 1 2) For Fixed Reference Channel (FRC) H-Set 2 the reference values for R should be scaled (multiplied by 1.5 and rounding to the nearest integer t-put in kbps, where values of $i+1/2$ are rounded up to $i+1$, i integer) 3) For Fixed Reference Channel (FRC) H-Set 3 the reference values for R should be scaled (multiplied by 3 and rounding to the nearest integer t-put in kbps, where values of $i+1/2$ are rounded up to $i+1$, i integer)				

Table 9.17A: Enhanced requirement type 1 QPSK, Fixed Reference Channel (FRC) H-Set 1/2/3

Test Number	Propagation Conditions	Reference value		
		HS-PDSCH E_c / I_{or} (dB)	T-put R (kbps) * $\hat{I}_{or} / I_{oc} = 0$ dB	T-put R (kbps) * $\hat{I}_{or} / I_{oc} = 10$ dB
1	PA3	-12	N/A	297
		-9	N/A	410
		-6	242	N/A
		-3	369	N/A
2	PB3	-9	N/A	194
		-6	170	308
		-3	272	N/A
3	VA30	-9	N/A	204
		-6	172	315
		-3	270	N/A
* Notes: 1) The reference value R is for the Fixed Reference Channel (FRC) H-Set 1 2) For Fixed Reference Channel (FRC) H-Set 2 the reference values for R should be scaled (multiplied by 1.5 and rounding to the nearest integer t-put in kbps, where values of $i+1/2$ are rounded up to $i+1$, i integer) 3) For Fixed Reference Channel (FRC) H-Set 3 the reference values for R should be scaled (multiplied by 3 and rounding to the nearest integer t-put in kbps, where values of $i+1/2$ are rounded up to $i+1$, i integer)				

9.2.3.2 Requirement 16QAM, Fixed Reference Channel (FRC) H-Set 1/2/3

The requirements are specified in terms of a minimum information bit throughput R for the DL reference channels H-set 1/2/3 (16QAM version) specified in Annex A.7.1.1, A.7.1.2 and A.7.1.3 respectively, with the addition of the parameters in Table 9.18 and the downlink physical channel setup according to table C.10.

Using this configuration the throughput shall meet or exceed the minimum requirements specified in table 9.19. Enhanced performance requirements type 1 specified in Table 9.19A are based on receiver diversity.

Table 9.18: Test Parameters for Testing 16-QAM FRCs H-Set 1/H-Set 2/H-Set 3

Parameter	Unit	Test 1	Test 2	Test 3
Phase reference		P-CPICH		
I_{oc}	dBm/3.84 MHz	-60		
DPCH frame offset ($\tau_{DPCH,n}$)	Chip	0		
Redundancy and constellation version coding sequence		{6,2,1,5}		
Maximum number of HARQ transmission		4		
Feedback Error Rate	%	4		
Closed loop timing adjustment mode		1		
Note:	The HS-SCCH-1 and HS-PDSCH shall be transmitted continuously with constant power. HS-SCCH-1 shall only use the identity of the UE under test for those TTI intended for the UE.			

Table 9.19: Minimum requirement 16QAM, Fixed Reference Channel (FRC) H-Set 1/2/3

Test Number	Propagation Conditions	Reference value	
		HS-PDSCH E_c / I_{or} (dB)	T-put R (kbps) * $\hat{I}_{or} / I_{oc} = 10$ dB
1	PA3	-6	361
		-3	500
2	PB3	-6	74
		-3	255
3	VA30	-6	84
		-3	254
* Notes: 1)The reference value R is for the Fixed Reference Channel (FRC) H-Set 1 2) For Fixed Reference Channel (FRC) H-Set 2 the reference values for R should be scaled (multiplied by 1.5 and rounding to the nearest integer t-put in kbps, where values of $i+1/2$ are rounded up to $i+1$, i integer) 3) For Fixed Reference Channel (FRC) H-Set 3 the reference values for R should be scaled (multiplied by 3 and rounding to the nearest integer t-put in kbps, where values of $i+1/2$ are rounded up to $i+1$, i integer)			

Table 9.19A: Enhanced requirement type 1 16QAM, Fixed Reference Channel (FRC) H-Set 1/2/3

Test Number	Propagation Conditions	Reference value	
		HS-PDSCH E_c/I_{or} (dB)	T-put R (kbps) * $\hat{I}_{or}/I_{oc} = 10$ dB
1	PA3	-9	376
		-6	532
2	PB3	-6	267
		-3	393
3	VA30	-6	279
		-3	404

* Notes: 1)The reference value R is for the Fixed Reference Channel (FRC) H-Set 1
2) For Fixed Reference Channel (FRC) H-Set 2 the reference values for R should be scaled (multiplied by 1.5 and rounding to the nearest integer t-put in kbps, where values of $i+1/2$ are rounded up to $i+1$, i integer)
3) For Fixed Reference Channel (FRC) H-Set 3 the reference values for R should be scaled (multiplied by 3 and rounding to the nearest integer t-put in kbps, where values of $i+1/2$ are rounded up to $i+1$, i integer)

9.2.3.3 Minimum requirement QPSK, Fixed Reference Channel (FRC) H-Set 4/5

The requirements are specified in terms of a minimum information bit throughput R for the DL reference channels H-set 4/5 specified in Annex A.7.1.4 and A.7.1.5 respectively, with the addition of the parameters in Table 9.20 and the downlink physical channel setup according to table C.10.

Using this configuration the throughput shall meet or exceed the minimum requirements specified in table 9.21 for H-Set 4 and table 9.22 for H-Set 5.

Table 9.20: Test Parameters for Testing QPSK FRCs H-Set 4/H-Set 5

Parameter	Unit	Test 1	Test 2	Test 3
Phase reference		P-CPICH		
I_{oc}	dBm/3.84 MHz	-60		
DPCH frame offset ($\tau_{DPCH,n}$)	Chip	0		
Redundancy and constellation version coding sequence		{0,2,5,6}		
Maximum number of HARQ transmission		4		
Feedback Error Rate	%	4		
Closed loop timing adjustment mode		1		

Note: The HS-SCCH-1 and HS-PDSCH shall be transmitted continuously with constant power. HS-SCCH-1 shall only use the identity of the UE under test for those TTI intended for the UE.

Table 9.21: Minimum requirement QPSK, Fixed Reference Channel (FRC) H-Set 4

Test Number	Propagation Conditions	Reference value		
		HS-PDSCH E_c/I_{or} (dB)	T-put R (kbps) * $\hat{I}_{or}/I_{oc} = 0$ dB	T-put R (kbps) * $\hat{I}_{or}/I_{oc} = 10$ dB
1	PA3	-6	114	398
		-3	223	457
2	PB3	-6	43	196
		-3	167	292
3	VA30	-6	40	199
		-3	170	305

* Notes: 1) The reference value R is for the Fixed Reference Channel (FRC) H-Set 4

Table 9.22: Minimum requirement QPSK, Fixed Reference Channel (FRC) H-Set 5

Test Number	Propagation Conditions	Reference value		
		HS-PDSCH E_c/I_{or} (dB)	T-put R (kbps) * $\hat{I}_{or}/I_{oc} = 0$ dB	T-put R (kbps) * $\hat{I}_{or}/I_{oc} = 10$ dB
1	PA3	-6	177	599
		-3	338	687
2	PB3	-6	75	299
		-3	260	452
3	VA30	-6	71	306
		-3	258	458

* Note: The reference value R is for the Fixed Reference Channel (FRC) H-Set 5

9.3 Reporting of Channel Quality Indicator

The propagation conditions for this subclause are defined in table B.1C.

9.3.1 Single Link Performance

9.3.1.1 AWGN propagation conditions

The reporting accuracy of channel quality indicator (CQI) under AWGN environments is determined by the reporting variance and the BLER performance using the transport format indicated by the reported CQI median.

9.3.1.1.1 Minimum Requirement – UE capability categories 1-8 and 11, 12

For the parameters specified in Table 9.23, and using the downlink physical channels specified in table C.8, the reported CQI value shall be in the range of +/-2 of the reported median more than 90% of the time. If the HS-PDSCH BLER using the transport format indicated by median CQI is less than or equal to 0.1, the BLER using the transport format indicated by the (median CQI +2) shall be greater than 0.1. If the HS-PDSCH BLER using the transport format indicated by the median CQI is greater than 0.1, the BLER using transport format indicated by (median CQI -1) shall be less than or equal to 0.1.

Table 9.23: Test Parameter for CQI test in AWGN – single link

Parameter	Unit	Test 1	Test 2	Test 3
\hat{I}_{or}/I_{oc}	dB	0	5	10
I_{oc}	dBm/3.84 MHz	-60		
Phase reference	-	P-CPICH		
HS-PDSCH E_c/I_{or}	dB	-3		
HS-SCCH_1 E_c/I_{or}	dB	-10		
DPCH E_c/I_{or}	dB	-10		
Maximum number of H-ARQ transmission	-	1		
Number of HS-SCCH set to be monitored	-	1		
CQI feedback cycle	ms	2		
CQI repetition factor	-	1		
HS-SCCH-1 signalling pattern	-	To incorporate inter-TTI=3 the six sub-frame HS-SCCH-1 signalling pattern shall be '...XOOXOO...', where 'X' indicates TTI in which the HS-SCCH-1 uses the identity of the UE under test, and 'O' indicates TTI in which the HS-SCCH-1 uses a different UE identity.		
Note1:	Measurement power offset 'I' is configured by RRC accordingly and as defined in [7]			
Note2:	TF for HS-PDSCH is configured according to the reported CQI statistics. TF based on median CQI, median CQI -1, median CQI+2 are used. Other physical channel parameters are configured according to the CQI mapping table described in TS25.214			
Note3:	HS-PDSCH E_c/I_{or} is decreased according to reference power adjustment Δ described in TS 25.214			
Note 4:	For any given transport format the power of the HS-SCCH and HS-PDSCH shall be transmitted continuously with constant power.			

9.3.1.2 Fading propagation conditions

The reporting accuracy of the channel quality indicator (CQI) under fading environments is determined by the BLER performance using the transport format indicated by the reported CQI median.

In calculating BLER, for an HARQ process, if an odd number of consecutive DTXs are reported, the corresponding packets and one subsequent packet shall be discarded from BLER calculation. If an even number of consecutive DTXs are reported, the corresponding packets shall be discarded from BLER calculation.

The specified requirements may be subject to further simulations to verify assumptions.

9.3.1.2.1 Minimum Requirement – UE capability categories 1-8 and 11, 12

For the parameters specified in Table 9.26, and using the downlink physical channels specified in table C.8, the requirements are specified in terms of maximum BLERs at particular reported CQIs when transmitting a fixed transport format given by the CQI median as shown in Table 9.27. The BLER at a particular reported CQI is obtained by associating a particular CQI reference measurement period with the HS-PDSCH subframe overlapping with the end of this CQI reference measurement period and calculating the fraction of erroneous HS-PDSCH subframes.

Table 9.26: Test Parameters for CQI test in fading – single link

Parameter	Unit	Test 1	Test 2
HS-PDSCH E_c/I_{or}	dB	-8	-4
\hat{I}_{or}/I_{oc}	dB	0	5
I_{oc}	dBm/3.84 MHz	-60	
Phase reference	-	P-CPICH	
HS-SCCH_1 E_c/I_{or}	dB	-8.5	
DPCH E_c/I_{or}	dB	-6	
Maximum number of H-ARQ transmission	-	1	
Number of HS-SCCH set to be monitored	-	1	
CQI feedback cycle	ms	2	
CQI repetition factor	-	1	
HS-SCCH-1 signalling pattern	-	To incorporate inter-TTI=3 the six sub-frame HS-SCCH-1 signalling pattern shall be '...XOOXOO...', where 'X' indicates TTI in which the HS-SCCH-1 uses the identity of the UE under test, and 'O' indicates TTI in which the HS-SCCH-1 uses a different UE identity.	
Propagation Channel		Case 8	
Note1:	Measurement power offset 'T' is configured by RRC accordingly and as defined in [7]		
Note2:	TF for HS-PDSCH is configured according to the reported CQI statistics. TF based on median CQI is used. Other physical channel parameters are configured according to the CQI mapping table described in TS25.214		
Note3:	HS-PDSCH E_c/I_{or} is decreased according to reference power adjustment Δ described in TS 25.214		
Note 4:	For any given transport format the power of the HS-SCCH and HS-PDSCH shall be transmitted continuously with constant power.		

Table 9.27: Minimum requirement for CQI test in fading – single link

Reported CQI	Maximum BLER	
	Test 1	Test2
CQI median	60%	60%
CQI median + 3	15%	15%

9.3.2 Open Loop Diversity Performance

9.3.2.1 AWGN propagation conditions

The reporting accuracy of channel quality indicator (CQI) under AWGN environments is determined by the reporting variance and the BLER performance using the transport format indicated by the reported CQI median.

9.3.2.1.1 Minimum Requirement - UE capability categories 1-8 and 11, 12

For the parameters specified in Table 9.32, and using the downlink physical channels specified in table C.9, the reported CQI value shall be in the range of +/-2 of the reported median more than 90% of the time. If the HS-PDSCH (BLER) using the transport format indicated by median CQI is less than or equal to 0.1, the BLER using the transport format indicated by the (median CQI +2) shall be greater than 0.1. If the HS-PDSCH (BLER) using the transport format indicated by the median CQI is greater than 0.1, the BLER using transport format indicated by (median CQI -1) shall be less than or equal to 0.1.

Table 9.32: Test Parameter for CQI test in AWGN – open loop diversity

Parameter	Unit	Test 1	Test 2	Test 3
\hat{I}_{or}/I_{oc}	dB	0	5	10
I_{oc}	dBm/3.84 MHz	-60		
Phase reference	-	P-CPICH		
HS-PDSCH E_c/I_{or}	dB	-3		
HS-SCCH_1 E_c/I_{or}	dB	-10		
DPCH E_c/I_{or}	dB	-10		
Maximum number of H-ARQ transmission	-	1		
Number of HS-SCCH set to be monitored	-	1		
CQI feedback cycle	ms	2		
CQI repetition factor	-	1		
HS-SCCH-1 signalling pattern	-	To incorporate inter-TTI=3 the six sub-frame HS-SCCH-1 signalling pattern shall be '...XOOXOO...', where 'X' indicates TTI in which the HS-SCCH-1 uses the identity of the UE under test, and 'O' indicates TTI in which the HS-SCCH-1 uses a different UE identity.		
Note1:	Measurement power offset 'I' is configured by RRC accordingly and as defined in [7]			
Note2:	TF for HS-PDSCH is configured according to the reported CQI statistics. TF based on median CQI, median CQI -1, median CQI+2 are used. Other physical channel parameters are configured according to the CQI mapping table described in TS25.214			
Note3:	HS-PDSCH E_c/I_{or} is decreased according to reference power adjustment Δ described in TS 25.214			
Note 4:	For any given transport format the power of the HS-SCCH and HS-PDSCH shall be transmitted continuously with constant power.			

9.3.2.2 Fading propagation conditions

The reporting accuracy of the channel quality indicator (CQI) under fading environments is determined by the BLER performance using the transport format indicated by the reported CQI median.

The specified requirements may be subject to further simulations to verify assumptions.

9.3.2.2.1 Minimum Requirement – UE capability categories 1-8 and 11, 12

For the parameters specified in Table 9.35, and using the downlink physical channels specified in table C.9, the requirements are specified in terms of maximum BLERs at particular reported CQIs when transmitting a fixed transport format given by the CQI median as shown in Table 9.36. The BLER at a particular reported CQI is obtained by associating a particular CQI reference measurement period with the HS-PDSCH subframe overlapping with the end of this CQI reference measurement period and calculating the fraction of erroneous HS-PDSCH subframes.

Table 9.35: Test Parameters for CQI test in fading – open loop diversity

Parameter	Unit	Test 1	Test 2
HS-PDSCH E_c/I_{or}	dB	-8	-4
\hat{I}_{or}/I_{oc}	dB	0	5
I_{oc}	dBm/3.84 MHz	-60	
Phase reference	-	P-CPICH	
HS-SCCH_1 E_c/I_{or}	dB	-8.5	
DPCH E_c/I_{or}	dB	-6	
Maximum number of H-ARQ transmission	-	1	
Number of HS-SCCH set to be monitored	-	1	
CQI feedback cycle	ms	2	
CQI repetition factor	-	1	
HS-SCCH-1 signalling pattern	-	To incorporate inter-TTI=3 the six sub-frame HS-SCCH-1 signalling pattern shall be '...XOOXOO...', where 'X' indicates TTI in which the HS-SCCH-1 uses the identity of the UE under test, and 'O' indicates TTI in which the HS-SCCH-1 uses a different UE identity.	
Propagation Channel		Case 8	
Note1:	Measurement power offset 'T' is configured by RRC accordingly and as defined in [7]		
Note2:	TF for HS-PDSCH is configured according to the reported CQI statistics. TF based on median CQI is used. Other physical channel parameters are configured according to the CQI mapping table described in TS25.214		
Note3:	HS-PDSCH E_c/I_{or} is decreased according to reference power adjustment Δ described in TS 25.214		
Note 4:	For any given transport format the power of the HS-SCCH and HS-PDSCH shall be transmitted continuously with constant power.		

Table 9.36: Minimum requirement for CQI test in fading – open loop diversity

Reported CQI	Maximum BLER	
	Test 1	Test2
CQI median	60%	60%
CQI median + 3	15%	15%

9.3.3 Closed Loop Diversity Performance

9.3.3.1 AWGN propagation conditions

The reporting accuracy of channel quality indicator (CQI) under AWGN environments is determined by the reporting variance and the BLER performance using the transport format indicated by the reported CQI median.

9.3.3.1.1 Minimum Requirement - UE capability categories 1-8 and 11, 12

For the parameters specified in Table 9.41, and using the downlink physical channels specified in table C.10, the reported CQI value shall be in the range of ± 2 of the reported median more than 90% of the time. If the HS-PDSCH (BLER) using the transport format indicated by median CQI is less than or equal to 0.1, the BLER using the transport format indicated by the (median CQI +2) shall be greater than 0.1. If the HS-PDSCH (BLER) using transport format indicated by the median CQI is greater than 0.1, the BLER using the transport format indicated by (median CQI -1) shall be less than or equal to 0.1.

Table 9.41: Test Parameters for CQI in AWGN – closed loop diversity

Parameter	Unit	Test 1	Test 2	Test 3
\hat{I}_{or}/I_{oc}	dB	0	5	10
I_{oc}	dBm/3.84 MHz	-60		
Phase reference	-	P-CPICH		
HS-PDSCH E_c/I_{or}	dB	-3		
HS-SCCH_1 E_c/I_{or}	dB	-10		
DPCH E_c/I_{or}	dB	-10		
Maximum number of H-ARQ transmission	-	1		
Number of HS-SCCH set to be monitored	-	1		
CQI feedback cycle	ms	2		
CQI repetition factor	-	1		
Feedback Error Rate	%	0		
Closed loop timing adjustment mode	-	1		
HS-SCCH-1 signalling pattern	-	To incorporate inter-TTI=3 the six sub-frame HS-SCCH-1 signalling pattern shall be '...XOOXOO...', where 'X' indicates TTI in which the HS-SCCH-1 uses the identity of the UE under test, and 'O' indicates TTI in which the HS-SCCH-1 uses a different UE identity.		
Note1:	Measurement power offset 'T' is configured by RRC accordingly and as defined in [7]			
Note2:	TF for HS-PDSCH is configured according to the reported CQI statistics. TF based on median CQI, median CQI -1, median CQI+2 are used. Other physical channel parameters are configured according to the CQI mapping table described in TS25.214			
Note3:	HS-PDSCH E_c/I_{or} is decreased according to reference power adjustment Δ described in TS 25.214			
Note 4:	For any given transport format the power of the HS-SCCH and HS-PDSCH shall be transmitted continuously with constant power.			

9.3.3.2 Fading propagation conditions

The reporting accuracy of the channel quality indicator (CQI) under fading environments is determined by the BLER performance using the transport format indicated by the reported CQI median.

The specified requirements may be subject to further simulations to verify assumptions.

9.3.3.2.1 Minimum Requirement – UE capability categories 1-8 and 11, 12

For the parameters specified in Table 9.44, and using the downlink physical channels specified in table C.10, the requirements are specified in terms of maximum BLERs at particular reported CQIs when transmitting a fixed transport format given by the CQI median as shown in Table 9.45. The BLER at a particular reported CQI is obtained by associating a particular CQI reference measurement period with the HS-PDSCH subframe overlapping with the end of this CQI reference measurement period and calculating the fraction of erroneous HS-PDSCH subframes.

Table 9.44: Test Parameters for CQI test in fading– closed loop diversity

Parameter	Unit	Test 1	Test 2
HS-PDSCH E_c/I_{or}	dB	-8	-4
\hat{I}_{or}/I_{oc}	dB	0	5
I_{oc}	dBm/3.84 MHz	-60	
Phase reference	-	P-CPICH	
HS-SCCH_1 E_c/I_{or}	dB	-8.5	
DPCH E_c/I_{or}	dB	-6	
Maximum number of H-ARQ transmission	-	1	
Number of HS-SCCH set to be monitored	-	1	
CQI feedback cycle	ms	2	
CQI repetition factor	-	1	
Feedback Error Rate	%	0	
Closed loop timing adjustment mode		1	
HS-SCCH-1 signalling pattern	-	To incorporate inter-TTI=3 the six sub-frame HS-SCCH-1 signalling pattern shall be '...XOOXOO...', where 'X' indicates TTI in which the HS-SCCH-1 uses the identity of the UE under test, and 'O' indicates TTI in which the HS-SCCH-1 uses a different UE identity.	
Propagation Channel		Case 8	
Note1:	Measurement power offset 'Γ' is configured by RRC accordingly and as defined in [7]		
Note2:	TF for HS-PDSCH is configured according to the reported CQI statistics. TF based on median CQI is used. Other physical channel parameters are configured according to the CQI mapping table described in TS25.214		
Note3:	HS-PDSCH E_c/I_{or} is decreased according to reference power adjustment Δ described in TS 25.214		
Note 4:	For any given transport format the power of the HS-SCCH and HS-PDSCH shall be transmitted continuously with constant power.		

Table 9.45: Minimum requirement for CQI test in fading – closed loop diversity

Reported CQI	Maximum BLER	
	Test 1	Test2
CQI median	60%	60%
CQI median + 3	15%	15%

9.4 HS-SCCH Detection Performance

The detection performance of the HS-SCCH is determined by the probability of event E_m , which is declared when the UE is signaled on HS-SCCH-1, but DTX is observed in the corresponding HS-DPCCH ACK/NACK field. The probability of event E_m is denoted $P(E_m)$.

9.4.1 Single Link Performance

For the test parameters specified in Table 9.50, for each value of HS-SCCH-1 E_c/I_{or} specified in Table 9.51 and Table 9.51A the measured $P(E_m)$ shall be less than or equal to the corresponding specified value of $P(E_m)$. Enhanced performance requirements type 1 specified in Table 9.51A are based on receiver diversity.

Table 9.50: Test parameters for HS-SCCH detection – single link

Parameter	Unit	Test 1	Test 2	Test 3
I_{oc}	dBm/3.84 MHz	-60		
Phase reference	-	P-CPICH		
P-CPICH E_c/I_{or} (*)	dB	-10		
HS-SCCH UE Identity ($x_{ue,1}, x_{ue,2}, \dots, x_{ue,16}$)		HS-SCCH-1: 1010101010101010 (every third TTI only, UE under test addressed solely via HS-SCCH-1) HS-SCCH-2: 0001001010101010 HS-SCCH-3: 0001101010101010 HS-SCCH-4: 0001111110101010		
HS-DSCH TF of UE1		TF corresponding to CQI1		
HS-SCCH-1 transmission pattern		The HS-SCCH-1 shall be transmitted continuously with constant power.		
HS-PDSCH transmission pattern		The HS-PDSCH shall be transmitted continuously with constant power.		
HS-SCCH-1 TTI Signalling Pattern	-	The six sub-frame HS-SCCH-1 signalling pattern shall be '...XOOXOO...', where 'X' indicates TTI in which the HS-SCCH-1 uses the identity of the UE under test, and 'O' indicates TTI in which the HS-SCCH-1 uses a different UE identity.		

Table 9.51: Minimum requirement for HS-SCCH detection – single link

Test Number	Propagation Conditions	Reference value		
		HS-SCCH-1 E_c/I_{or} (dB)	\hat{I}_{or}/I_{oc} (dB)	$P(E_m)$
1	PA3	-9	0	0.05
2	PA3	-9.9	5	0.01
3	VA30	-10	0	0.01

Table 9.51A: Enhanced requirement type 1 for HS-SCCH detection – single link

Test Number	Propagation Conditions	Reference value		
		HS-SCCH-1 E_c/I_{or} (dB)	\hat{I}_{or}/I_{oc} (dB)	$P(E_m)$
1	PA3	-12.0	0	0.01
2	VA30	-15.6	0	0.01

9.4.2 Open Loop Diversity Performance

For the test parameters specified in Table 9.52, for each value of HS-SCCH-1 E_c/I_{or} specified in Table 9.53 and Table 9.54 the measured $P(E_m)$ shall be less than or equal to the corresponding specified value of $P(E_m)$. Enhanced performance requirements type 1 specified in Table 9.54 are based on receiver diversity.

Table 9.52: Test parameters for HS-SCCH detection – open loop diversity

Parameter	Unit	Test 1	Test 2	Test 3
I_{oc}	dBm/3.84 MHz	-60		
Phase reference	-	P-CPICH		
P-CPICH E_c/I_{or} (*)	dB	-10		
HS-SCCH UE Identity ($x_{ue,1}, x_{ue,2}, \dots, x_{ue,16}$)		HS-SCCH-1: 1010101010101010 (every third TTI only, UE under test addressed solely via HS-SCCH-1) HS-SCCH-2: 0001001010101010 HS-SCCH-3: 0001101010101010 HS-SCCH-4: 0001111110101010		
HS-DSCH TF of UE1		TF corresponding to CQI1		
HS-SCCH-1 transmission pattern		The HS-SCCH-1 shall be transmitted continuously with constant power.		
HS-PDSCH transmission pattern		The HS-PDSCH shall be transmitted continuously with constant power.		
HS-SCCH-1 TTI Signalling Pattern	-	The six sub-frame HS-SCCH-1 signalling pattern shall be '...XOOXOO...', where 'X' indicates TTI in which the HS-SCCH-1 uses the identity of the UE under test, and 'O' indicates TTI in which the HS-SCCH-1 uses a different UE identity.		

Table 9.53: Minimum requirement for HS-SCCH detection – open loop diversity

Test Number	Propagation Conditions	Reference value		
		HS-SCCH-1 E_c/I_{or} (dB)	\hat{I}_{or}/I_{oc} (dB)	$P(E_m)$
1	PA3	-11.6	0	0.05
2	PA3	-13.4	5	0.01
3	VA30	-11.5	0	0.01

Table 9.54: Enhanced requirement type 1 for HS-SCCH detection – open loop diversity

Test Number	Propagation Conditions	Reference value		
		HS-SCCH-1 E_c/I_{or} (dB)	\hat{I}_{or}/I_{oc} (dB)	$P(E_m)$
1	PA3	-15.2	0	0.01
2	VA30	-16.4	0	0.01

Annex A (normative): Measurement channels

A.1 General

The measurement channels in this annex are defined to derive the requirements in clauses 6, 7 and 8. The measurement channels represent example configuration of radio access bearers for different data rates.

The measurement channel for 12.2 kbps shall be supported by any UE both in up- and downlink. Support for other measurement channels is depending on the UE Radio Access capabilities.

A.2 UL reference measurement channel

A.2.1 UL reference measurement channel (12.2 kbps)

The parameters for the 12.2 kbps UL reference measurement channel are specified in Table A.1 and Table A.2. The channel coding for information is shown in figure A.1.

Table A.1: UL reference measurement channel physical parameters (12.2 kbps)

Parameter	Unit	Level
Information bit rate	kbps	12.2
DPDCH	kbps	60
DPCCH	kbps	15
DPCCH Slot Format #i	-	0
DPCCH/DPDCH power ratio	dB	-5.46
TFCI	-	On
Repetition	%	23
NOTE:	Slot Format #2 is used for closed loop tests in subclause 8.6.2. Slot Format #2 and #5 are used for site selection diversity transmission tests in subclause 8.6.3	

Table A.2: UL reference measurement channel, transport channel parameters (12.2 kbps)

Parameters	DTCH	DCCH
Transport Channel Number	1	2
Transport Block Size	244	100
Transport Block Set Size	244	100
Transmission Time Interval	20 ms	40 ms
Type of Error Protection	Convolution Coding	Convolution Coding
Coding Rate	1/3	1/3
Rate Matching attribute	256	256
Size of CRC	16	12

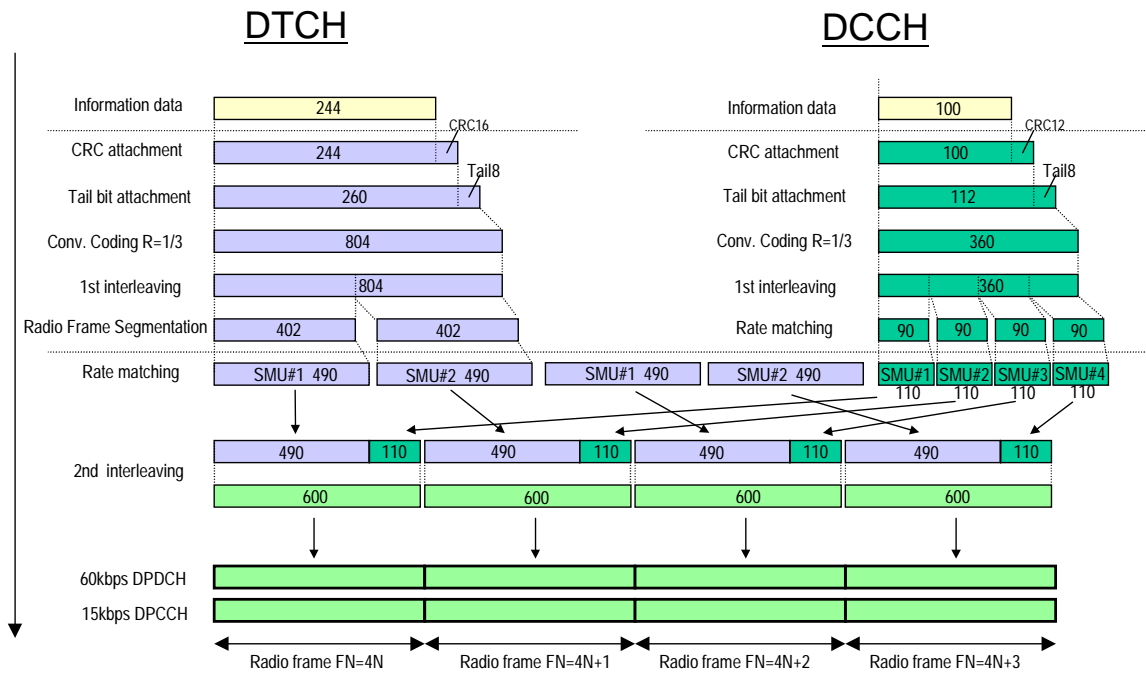

Figure A.1 (Informative): Channel coding of UL reference measurement channel (12.2 kbps)

A.2.2 UL reference measurement channel (64 kbps)

The parameters for the 64 kbps UL reference measurement channel are specified in Table A.3 and Table A.4. The channel coding for information is shown in figure A.2. This measurement channel is not currently used in TS 25.101 but can be used for future requirements.

Table A.3: UL reference measurement channel (64 kbps)

Parameter	Unit	Level
Information bit rate	kbps	64
DPDCH	kbps	240
DPCCH	kbps	15
DPCCH Slot Format #i	-	0
DPCCH/DPDCH power ratio	dB	-9.54
TFCI	-	On
Repetition	%	18

Table A.4: UL reference measurement channel, transport channel parameters (64 kbps)

Parameter	DTCH	DCCH
Transport Channel Number	1	2
Transport Block Size	1280	100
Transport Block Set Size	1280	100
Transmission Time Interval	20 ms	40 ms
Type of Error Protection	Turbo Coding	Convolution Coding
Coding Rate	1/3	1/3
Rate Matching attribute	256	256
Size of CRC	16	12

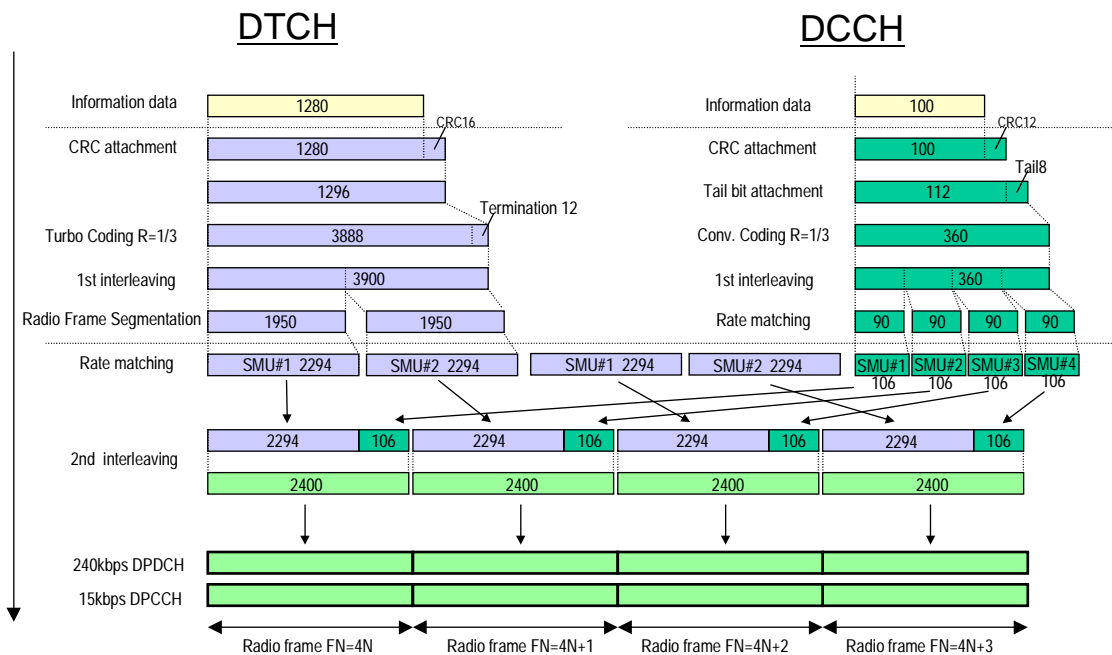

Figure A.2 (Informative): Channel coding of UL reference measurement channel (64 kbps)

A.2.3 UL reference measurement channel (144 kbps)

The parameters for the 144 kbps UL reference measurement channel are specified in Table A.5 and Table A.6. The channel coding for information is shown in Figure A.3. This measurement channel is not currently used in the present document but can be used for future requirements.

Table A.5: UL reference measurement channel (144 kbps)

Parameter	Unit	Level
Information bit rate	kbps	144
DPDCH	kbps	480
DPCCH	kbps	15
DPCCH Slot Format #i	-	0
DPCCH/DPDCH power ratio	dB	-11.48
TFCI	-	On
Repetition	%	8

Table A.6: UL reference measurement channel, transport channel parameters (144kbps)

Parameters	DTCH	DCCH
Transport Channel Number	1	2
Transport Block Size	2880	100
Transport Block Set Size	2880	100
Transmission Time Interval	20 ms	40 ms
Type of Error Protection	Turbo Coding	Convolution Coding
Coding Rate	1/3	1/3
Rate Matching attribute	256	256
Size of CRC	16	12

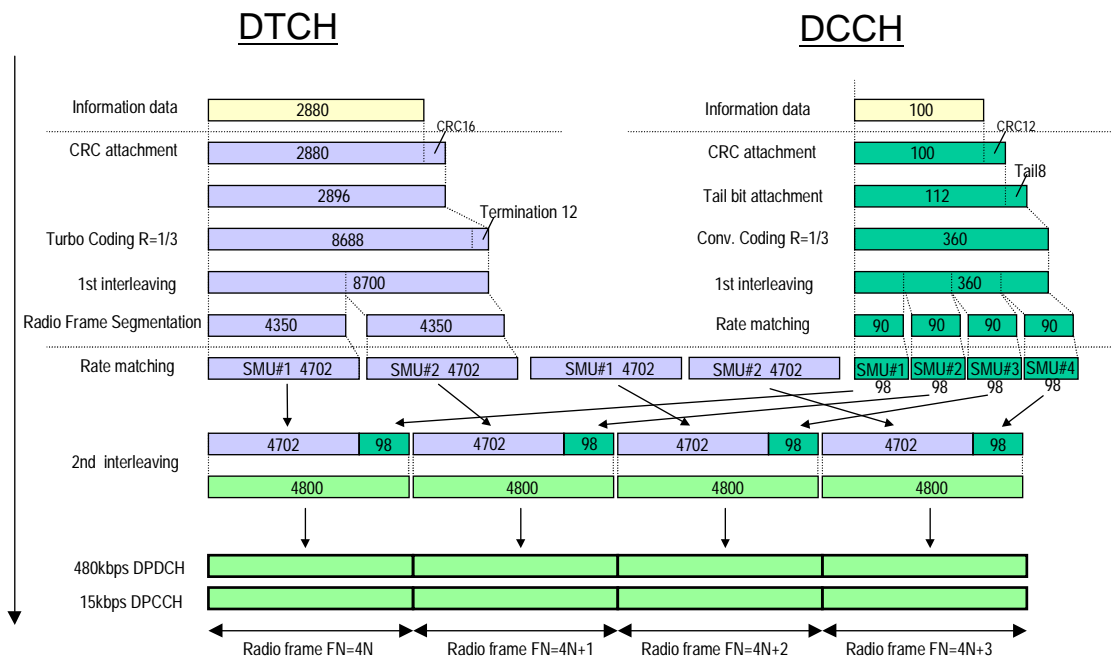

Figure A.3 (Informative): Channel coding of UL reference measurement channel (144 kbps)

A.2.4 UL reference measurement channel (384 kbps)

The parameters for the 384 kbps UL reference measurement channel are specified in Table A.7 and Table A.8. The channel coding for information is shown in Figure A.4. This measurement channel is not currently used in TS 25.101 but can be used for future requirements.

Table A.7: UL reference measurement channel (384 kbps)

Parameter	Unit	Level
Information bit rate	kbps	384
DPDCH	kbps	960
DPCCH	kbps	15
DPCCH Slot Format #1	-	0
DPCCH/DPDCH power ratio	dB	-11.48
TFCI	-	On
Puncturing	%	18

Table A.8: UL reference measurement channel, transport channel parameters (384 kbps)

Parameter	DTCH	DCCH
Transport Channel Number	1	2
Transport Block Size	3840	100
Transport Block Set Size	3840	100
Transmission Time Interval	10 ms	40 ms
Type of Error Protection	Turbo Coding	Convolution Coding
Coding Rate	1/3	1/3
Rate Matching attribute	256	256
Size of CRC	16	12

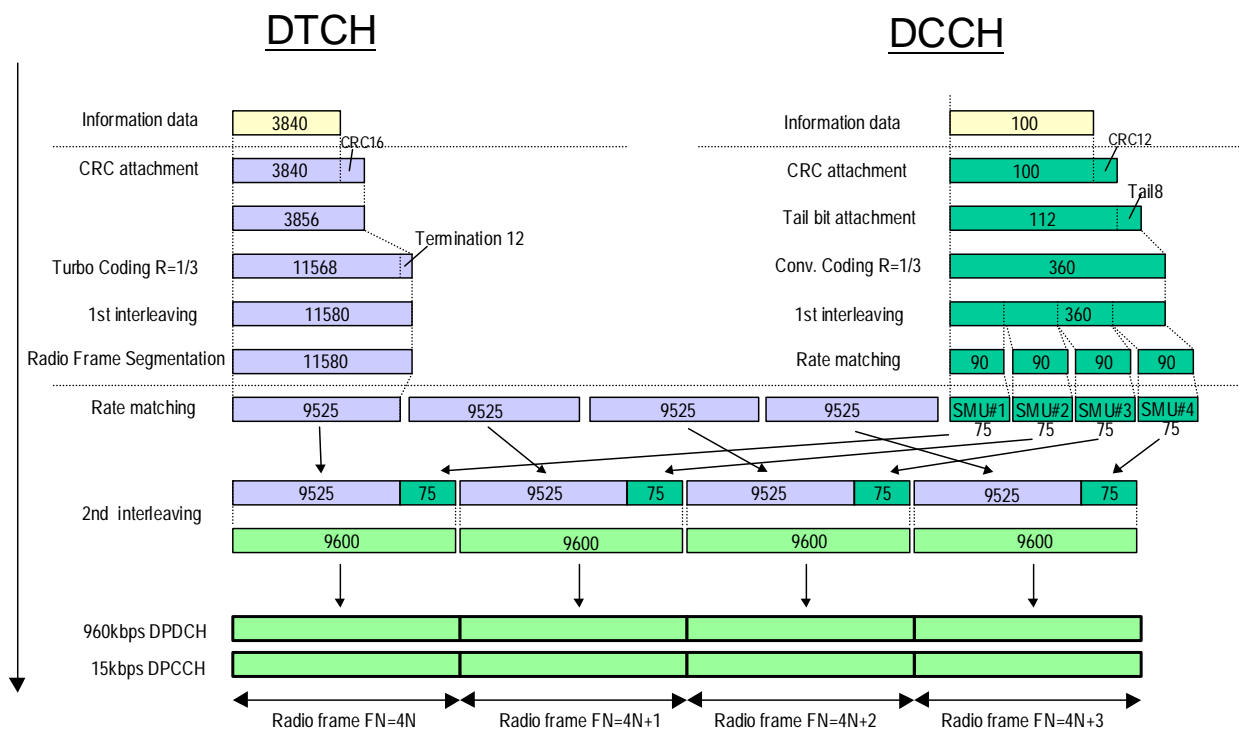

Figure A.4 (Informative): Channel coding of UL reference measurement channel (384 kbps)

A.2.5 UL reference measurement channel (768 kbps)

The parameters for the UL measurement channel for 768 kbps are specified in Table A.9 and Table A.10.

Table A.9: UL reference measurement channel, physical parameters (768 kbps)

Parameter	Unit	Level
Information bit rate	kbps	2*384
DPDCH ₁	kbps	960
DPDCH ₂	kbps	960
DPCCH	kbps	15
DPCCH Slot Format #i	-	0
DPCCH/DPDCH power ratio	dB	-11.48
TFCI	-	On
Puncturing	%	18

Table A.10: UL reference measurement channel, transport channel parameters (768 kbps)

Parameter	DTCH	DCCH
Transport Channel Number	1	2
Transport Block Size	3840	100
Transport Block Set Size	7680	100
Transmission Time Interval	10 ms	40 ms
Type of Error Protection	Turbo Coding	Convolution Coding
Coding Rate	1/3	1/3
Rate Matching attribute	256	256
Size of CRC	16	12

A.3 DL reference measurement channel

A.3.1 DL reference measurement channel (12.2 kbps)

The parameters for the 12.2 Kbps DL reference measurement channel are specified in Table A.11 and Table A.12. The channel coding is shown for information in figure A.5.

Table A.11: DL reference measurement channel physical parameters (12.2 kbps)

Parameter	Unit	Level
Information bit rate	kbps	12.2
DPCH	ksps	30
Slot Format #1	-	11
TFCI	-	On
Power offsets PO1, PO2 and PO3	dB	0
Puncturing	%	14.7

Table A.12: DL reference measurement channel, transport channel parameters (12.2 kbps)

Parameter	DTCH	DCCH
Transport Channel Number	1	2
Transport Block Size	244	100
Transport Block Set Size	244	100
Transmission Time Interval	20 ms	40 ms
Type of Error Protection	Convolution Coding	Convolution Coding
Coding Rate	1/3	1/3
Rate Matching attribute	256	256
Size of CRC	16	12
Position of TrCH in radio frame	fixed	fixed

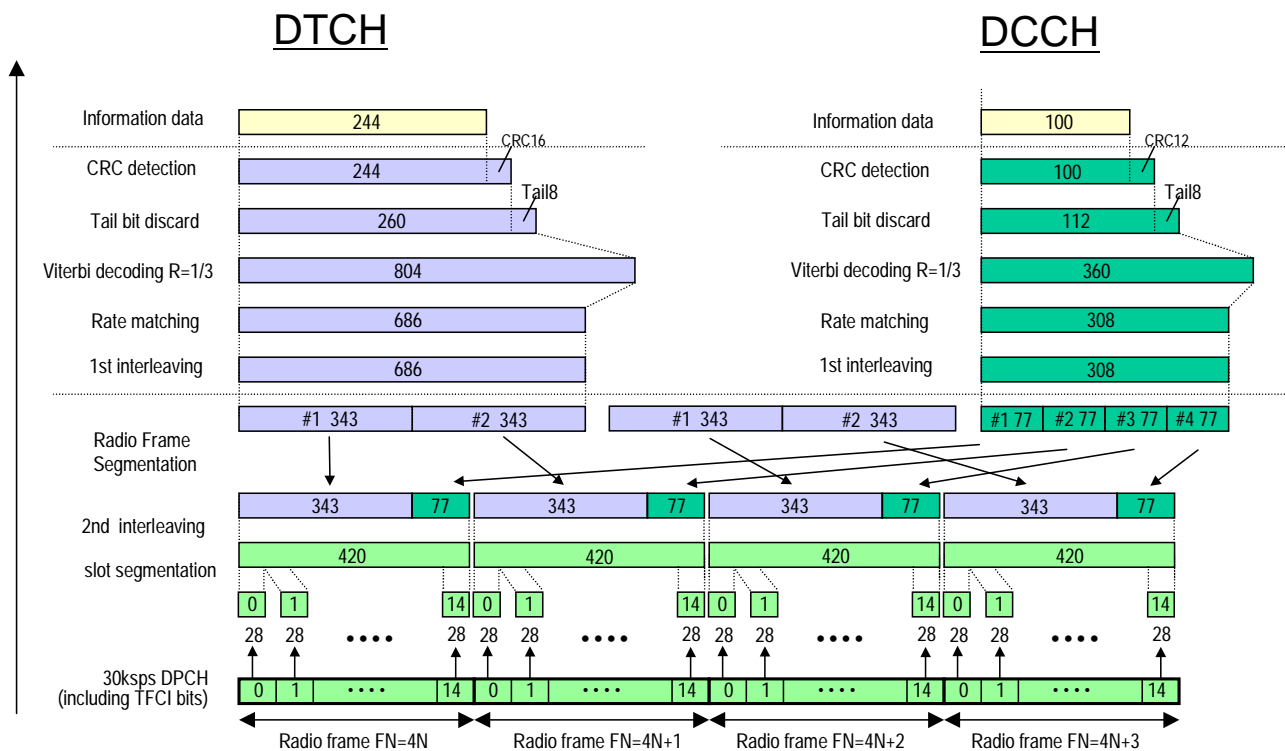

Figure A.5 (Informative): Channel coding of DL reference measurement channel (12.2 kbps)

A.3.2 DL reference measurement channel (64 kbps)

The parameters for the DL reference measurement channel for 64 kbps are specified in Table A.13 and Table A.14. The channel coding is shown for information in Figure A.6.

Table A.13: DL reference measurement channel physical parameters (64 kbps)

Parameter	Unit	Level
Information bit rate	kbps	64
DPCH	ksps	120
Slot Format #i	-	13
TFCI	-	On
Power offsets PO1, PO2 and PO3	dB	0
Repetition	%	2.9

Table A.14: DL reference measurement channel, transport channel parameters (64 kbps)

Parameter	DTCH	DCCH
Transport Channel Number	1	2
Transport Block Size	1280	100
Transport Block Set Size	1280	100
Transmission Time Interval	20 ms	40 ms
Type of Error Protection	Turbo Coding	Convolution Coding
Coding Rate	1/3	1/3
Rate Matching attribute	256	256
Size of CRC	16	12
Position of TrCH in radio frame	fixed	fixed

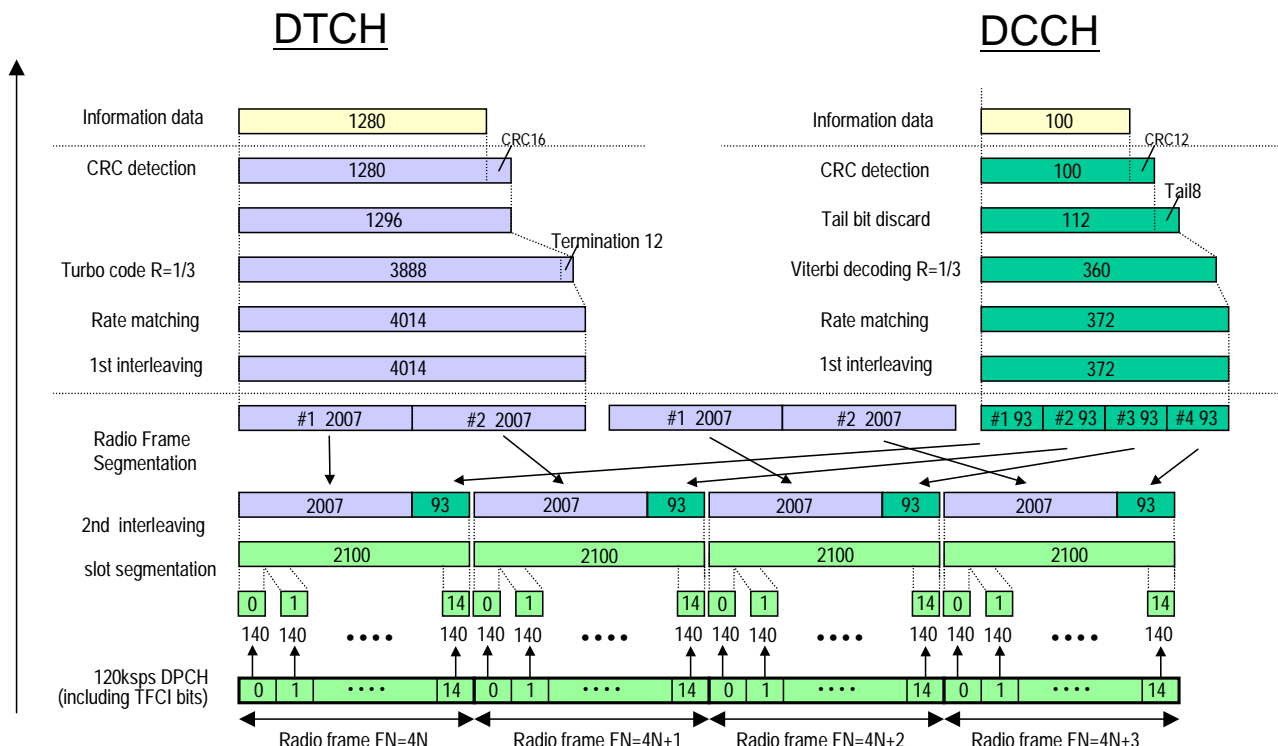

Figure A.6 (Informative): Channel coding of DL reference measurement channel (64 kbps)

A.3.3 DL reference measurement channel (144 kbps)

The parameters for the DL measurement channel for 144 kbps are specified in Table A.15 and Table A.16. The channel coding is shown for information in Figure A.7.

Table A.15: DL reference measurement channel physical parameters (144 kbps)

Parameter	Unit	Level
Information bit rate	kbps	144
DPCH	kspcs	240
Slot Format #i	-	14
TFCI	-	On
Power offsets PO1, PO2 and PO3	dB	0
Puncturing	%	2.7

Table A.16: DL reference measurement channel, transport channel parameters (144 kbps)

Parameter	DTCH	DCCH
Transport Channel Number	1	2
Transport Block Size	2880	100
Transport Block Set Size	2880	100
Transmission Time Interval	20 ms	40 ms
Type of Error Protection	Turbo Coding	Convolution Coding
Coding Rate	1/3	1/3
Rate Matching attribute	256	256
Size of CRC	16	12
Position of TrCH in radio frame	fixed	fixed

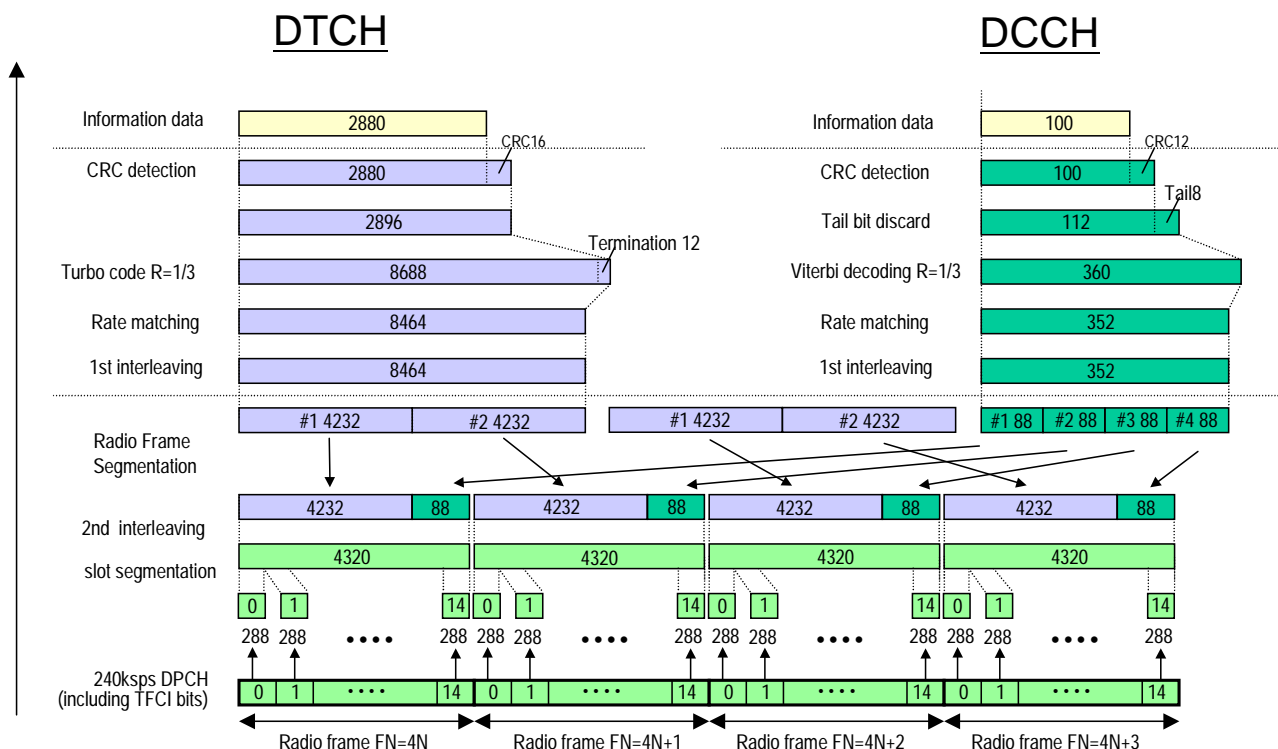

Figure A.7 (Informative): Channel coding of DL reference measurement channel (144 kbps)

A.3.4 DL reference measurement channel (384 kbps)

The parameters for the DL measurement channel for 384 kbps are specified in Table A.17 and Table A.18. The channel coding is shown for information in Figure A.8

Table A.17: DL reference measurement channel, physical parameters (384 kbps)

Parameter	Unit	Level
Information bit rate	kbps	384
DPCH	ksps	480
Slot Format # i	-	15
TFCI		On
Power offsets PO1, PO2 and PO3	dB	0
Puncturing	%	22

Table A.18: DL reference measurement channel, transport channel parameters (384 kbps)

Parameter	DTCH	DCCH
Transport Channel Number	1	2
Transport Block Size	3840	100
Transport Block Set Size	3840	100
Transmission Time Interval	10 ms	40 ms
Type of Error Protection	Turbo Coding	Convolution Coding
Coding Rate	1/3	1/3
Rate Matching attribute	256	256
Size of CRC	16	12
Position of TrCH in radio frame	fixed	Fixed

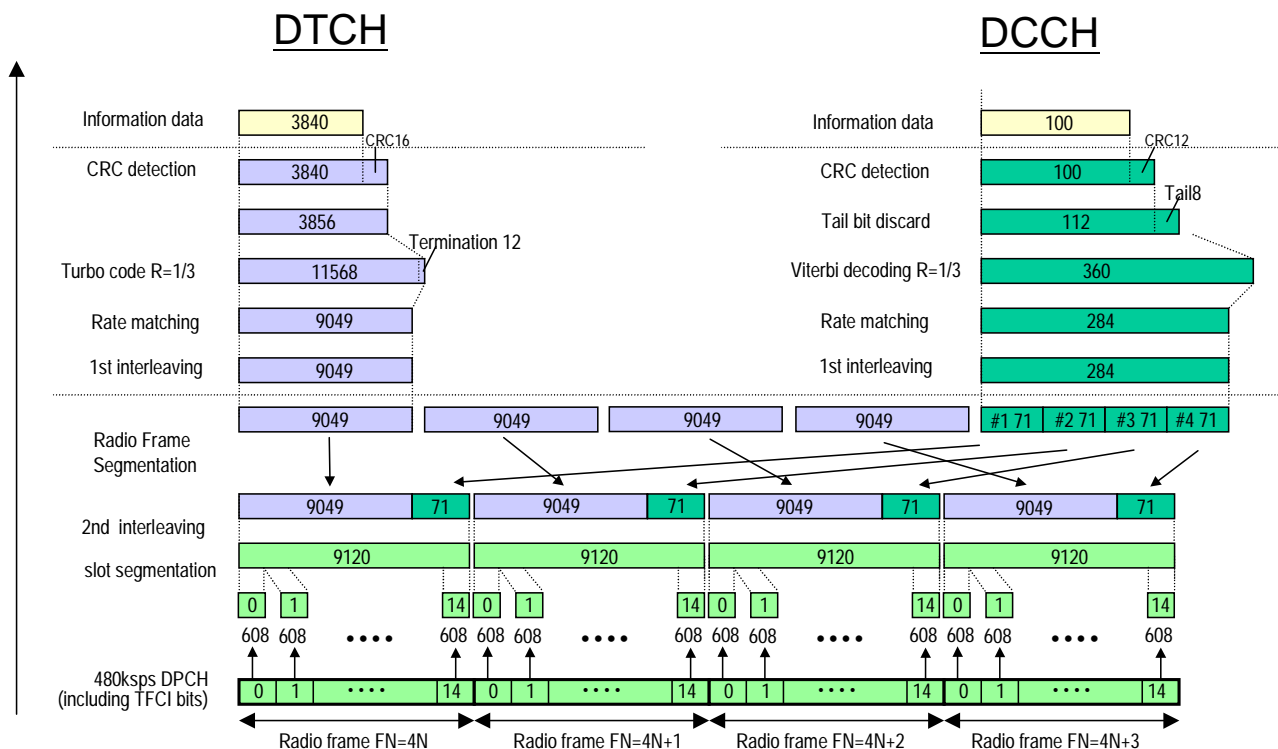

Figure A.8 (Informative): Channel coding of DL reference measurement channel (384 kbps)

A.3.5 DL reference measurement channel 2 (64 kbps)

The parameters for the DL reference measurement channel for 64 kbps are specified in Table A.18A and Table A.18B. The channel coding is shown for information in Figure A.8A.

Table A.18A: DL reference measurement channel physical parameters (64 kbps)

Parameter	Unit	Level
Information bit rate (DTCH)	kbps	64
Information bit rate (DCCH)	kbps	3.4
DPCH	ksps	120
Slot Format #i	-	13
TFCI	-	On
Puncturing (DTCH)	%	8.6
Repetition (DCCH)	%	27.9

Table A.18B: DL reference measurement channel, transport channel parameters (64 kbps)

Parameter	DTCH	DCCH
Transport Channel Number	1	2
Transport Block Size	336	148
Transport Block Set Size	1344	148
Transport blocks per TTI	4	1
Transmission Time Interval	20 ms	40 ms
Type of Error Protection	Turbo Coding	Convolution Coding
Coding Rate	1/3	1/3
Rate Matching attribute	143	200
Size of CRC	16	16
Position of TrCH in radio frame	fixed	fixed

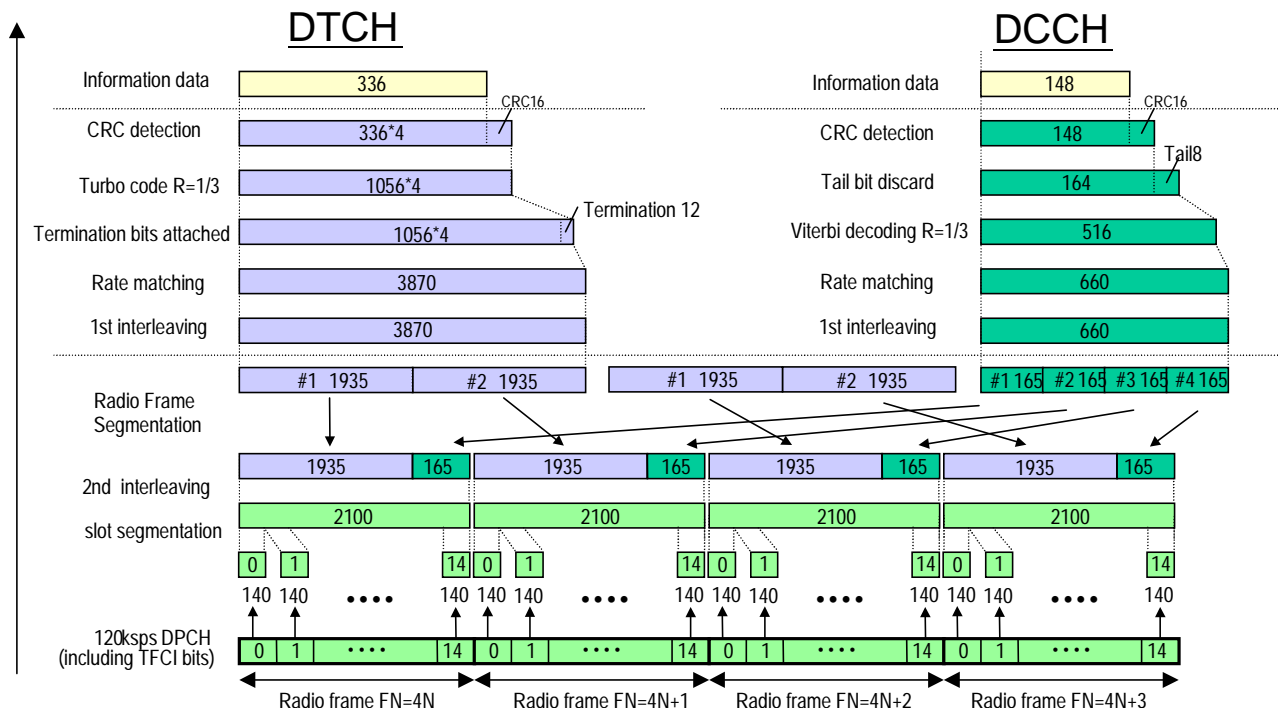

Figure A.8A (Informative): Channel coding of DL reference measurement channel 2 (64 kbps)

A.4 DL reference measurement channel for BTFD performance requirements

The parameters for DL reference measurement channel for BTFD are specified in Table A.19 and Table A.20. The channel coding for information is shown in figures A.9, A.10, and A11.

Table A.19: DL reference measurement channel physical parameters for BTFD

Parameter	Unit	Rate 1	Rate 2	Rate 3
Information bit rate	kbps	12.2	7.95	1.95
DPCH	ksps	30		
Slot Format # i	-	8		
TFCI	-	Off		
Power offsets PO1, PO2 and PO3	dB	0		
Repetition	%	5		

Table A.20: DL reference measurement channel, transport channel parameters for BTFD

Parameter	DTCH			DCCH
	Rate 1	Rate 2	Rate 3	
Transport Channel Number	1			2
Transport Block Size	244	159	39	100
Transport Block Set Size	244	159	39	100
Transmission Time Interval	20 ms			40 ms
Type of Error Protection	Convolution Coding			Convolution Coding
Coding Rate	1/3			1/3
Rate Matching attribute	256			256
Size of CRC	12			12
Position of TrCH in radio frame	fixed			fixed

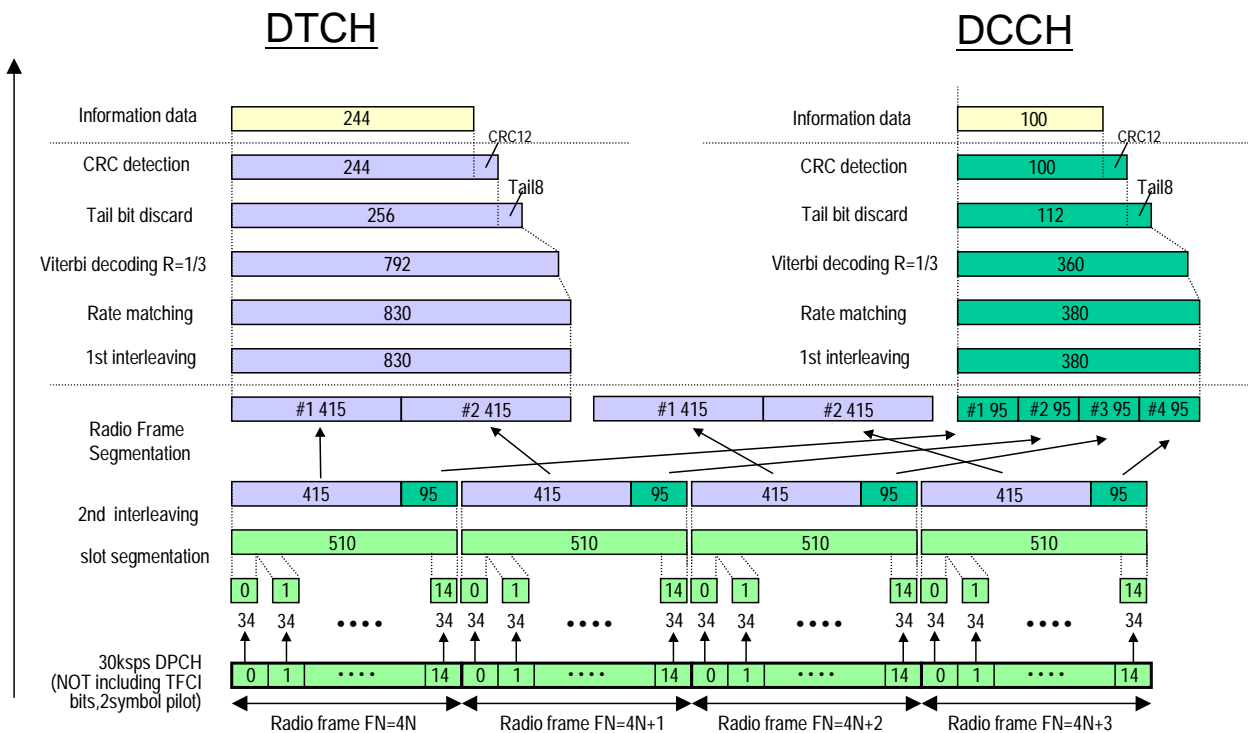

Figure A.9 (Informative): Channel coding of DL reference measurement channel for BTFD (Rate 1)

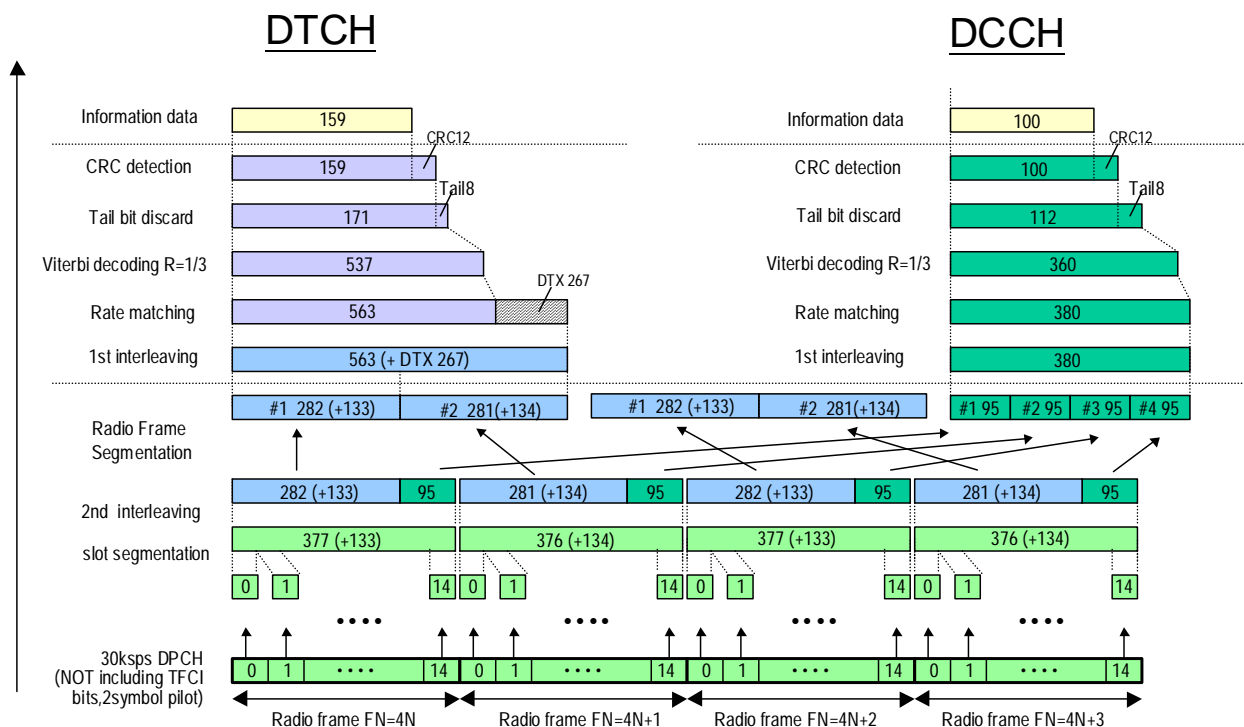

Figure A.10 (Informative): Channel coding of DL reference measurement channel for BTFD (Rate 2)

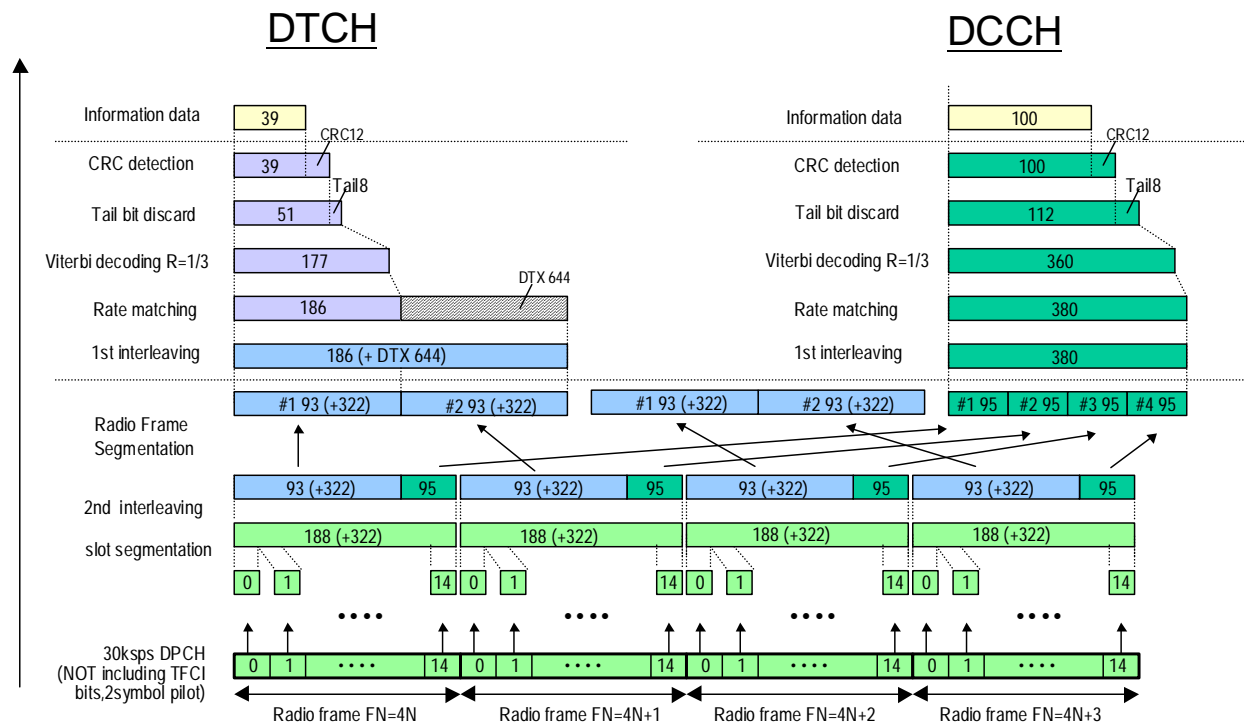

Figure A.11 (Informative): Channel coding of DL reference measurement channel for BTFD (Rate 3)

A.4A DL reference measurement channel for requirements using DPCCH with 4 pilot bits as phase reference

A.4A.1 DL reference measurement channel (12.2 kbps)

The parameters for the 12.2 Kbps DL reference measurement channel are specified in Table A.20A and Table A.20B. The channel coding is shown for information in figure A.11A.

Table A.20A: DL reference measurement channel physical parameters for DPCCH used as phase reference

Parameter	Unit	Level
Information bit rate	kbps	12.2
DPCH	ksps	30
Slot Format #i	-	9
TFCI	-	On
Power offsets PO1, PO2 and PO3	dB	0
Puncturing	%	2.5

Table A.20B: DL reference measurement channel, transport channel parameters for DPCCH used as phase reference

Parameter	DTCH	DCCH
Transport Channel Number	1	2
Transport Block Size	244	100
Transport Block Set Size	244	100
Transmission Time Interval	20 ms	40 ms
Type of Error Protection	Convolution Coding	Convolution Coding
Coding Rate	1/3	1/3
Rate Matching attribute	256	256
Size of CR C	16	12
Position of TrCH in radio frame	fixed	fixed

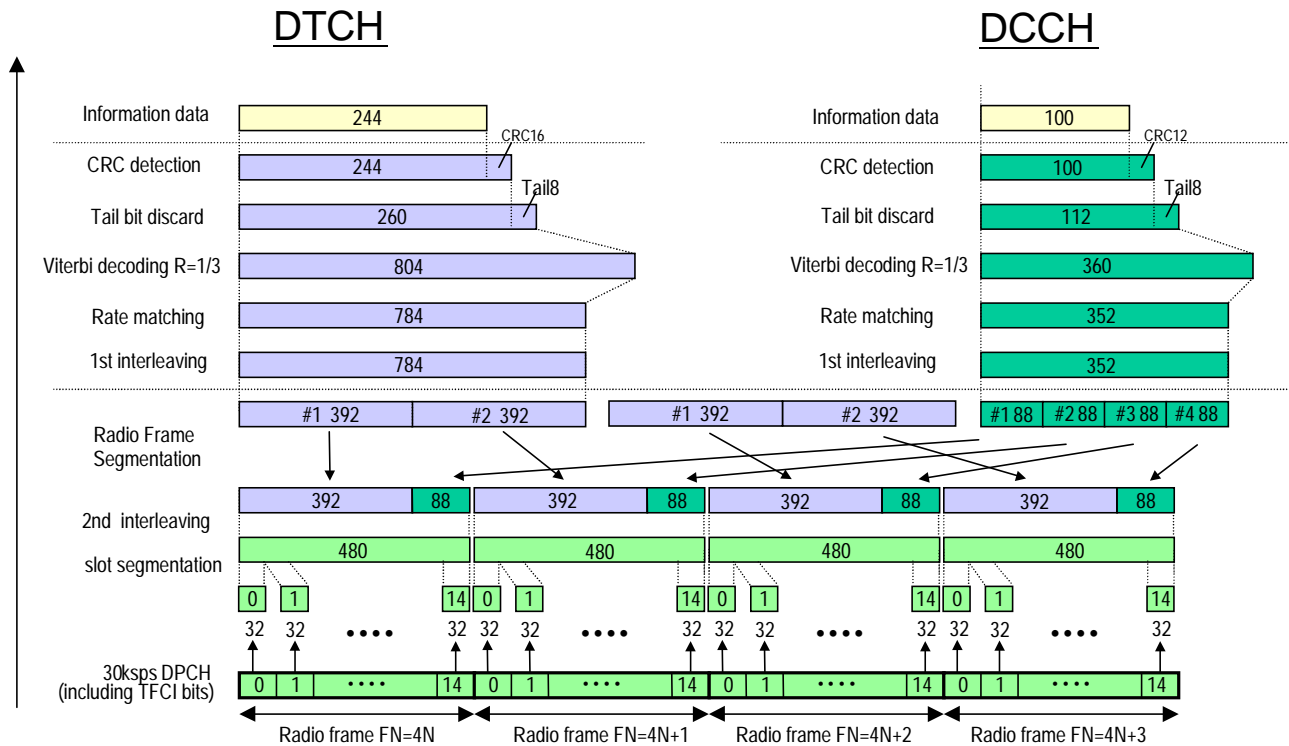

Figure A.11A (Informative): Channel coding of DL reference measurement channel for requirements using DPCCH with 4 channel bits (12.2 kbps)

A.5 DL reference compressed mode parameters

Parameters described in Table A.21 are used in some test specified in TS 25.101 while parameters described in Table A.22 are used in some tests specified in TS 25.133.

Set 1 parameters in Table A.21 are applicable when compressed mode by spreading factor reduction is used in downlink. Set 2 parameters in Table A.21 are applicable when compressed mode by puncturing is used in downlink.

Table A.21: Compressed mode reference pattern 1 parameters

Parameter	Set 1	Set 2	Note
TGSN (Transmission Gap Starting Slot Number)	11	11	
TGL1 (Transmission Gap Length 1)	7	7	
TGL2 (Transmission Gap Length 2)	-	-	Only one gap in use.
TGD (Transmission Gap Distance)	0	0	Only one gap in use.
TGPL1 (Transmission Gap Pattern Length)	4	4	
TGPRC (Transmission Gap Pattern Repetition Count)	NA	NA	Defined by higher layers
TGCFN (Transmission Gap Connection Frame Number):	NA	NA	Defined by higher layers
UL/DL compressed mode selection	DL & UL	DL & UL	2 configurations possible DL & UL / DL
UL compressed mode method	SF/2	SF/2	
DL compressed mode method	SF/2	Puncturing	
Downlink frame type and Slot format	11B	11A	
Scrambling code change	No	No	
RPP (Recovery period power control mode)	0	0	
ITP (Initial transmission power control mode)	0	0	

Table A.22: Compressed mode reference pattern 2 parameters

Parameter	Set 1	Set 2	Set 3	Set 4	Note
TGSN (Transmission Gap Starting Slot Number)	4	4	10	8	
TGL1 (Transmission Gap Length 1)	7	7	10	14	
TGL2 (Transmission Gap Length 2)	-	-	-	-	Only one gap in use.
TGD (Transmission Gap Distance)	0	0	0	0	
TGPL1 (Transmission Gap Pattern Length)	3	12	11	4	
TGPRC (Transmission Gap Pattern Repetition Count)	NA	NA	NA	NA	Defined by higher layers
TGCFN (Transmission Gap Connection Frame Number):	NA	NA	NA	NA	Defined by higher layers
UL/DL compressed mode selection	DL & UL	DL & UL	DL & UL	DL & UL	2 configurations possible. DL & UL / DL
UL compressed mode method	SF/2	SF/2	SF/2	SF/2	
DL compressed mode method	SF/2	SF/2	Puncturing	SF/2	
Downlink frame type and Slot format	11B	11B	11A	11B	
Scrambling code change	No	No	No	No	
RPP (Recovery period power control mode)	0	0	0	0	
ITP (Initial transmission power control mode)	0	0	0	0	

A.6 DL reference parameters for PCH tests

The parameters for the PCH demodulation tests are specified in Table A.23 and Table A.24.

Table A.23: Physical channel parameters for S-CCPCH

Parameter	Unit	Level
Channel bit rate	kbps	60
Channel symbol rate	ksps	30
Slot Format #i	-	4
TFCI	-	OFF
Power offsets of TFCI and Pilot fields relative to data field	dB	0

Table A.24: Transport channel parameters for S-CCPCH

Parameter	PCH
Transport Channel Number	1
Transport Block Size	240
Transport Block Set Size	240
Transmission Time Interval	10 ms
Type of Error Protection	Convolution Coding
Coding Rate	1/2
Rate Matching attribute	256
Size of CRC	16
Position of TrCH in radio frame	fixed

A.7 DL reference channel parameters for HSDPA tests

A.7.1 Fixed Reference Channel (FRC)

A.7.1.1 Fixed Reference Channel Definition H-Set 1

Table A.25: Fixed Reference Channel H-Set 1

Parameter	Unit	Value	
Nominal Avg. Inf. Bit Rate	kbps	534	777
Inter-TTI Distance	TTI"s	3	3
Number of HARQ Processes	Processes	2	2
Information Bit Payload (N_{INF})	Bits	3202	4664
Number Code Blocks	Blocks	1	1
Binary Channel Bits Per TTI	Bits	4800	7680
Total Available SML"s in UE	SML"s	19200	19200
Number of SML"s per HARQ Proc.	SML"s	9600	9600
Coding Rate		0.67	0.61
Number of Physical Channel Codes	Codes	5	4
Modulation		QPSK	16QAM
Note: The HS-DSCH shall be transmitted continuously with constant power but only every third TTI shall be allocated to the UE under test.			

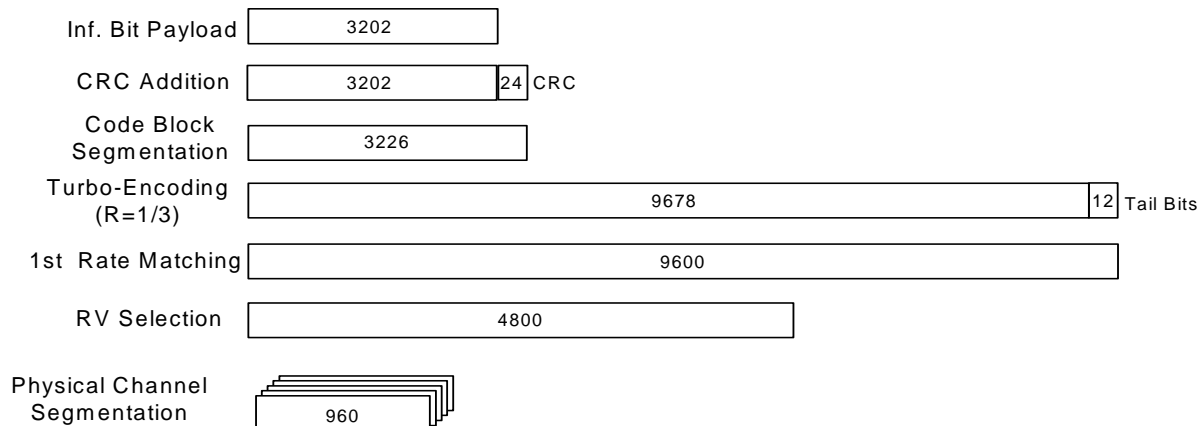

Figure A.12: Coding rate for Fixed reference Channel H-Set 1 (QPSK)

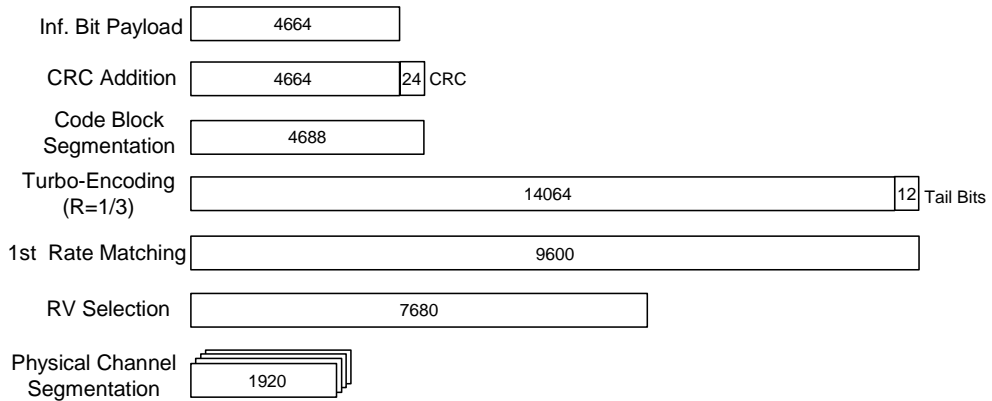

Figure A.13: Coding rate for Fixed reference Channel H-Set 1 (16 QAM)

A.7.1.2 Fixed Reference Channel Definition H-Set 2

Table A.26: Fixed Reference Channel H-Set 2

Parameter	Unit	Value	
Nominal Avg. Inf. Bit Rate	kbps	801	1166
Inter-TTI Distance	TTI"s	2	2
Number of HARQ Processes	Processes	3	3
Information Bit Payload (N_{INF})	Bits	3202	4664
Number Code Blocks	Blocks	1	1
Binary Channel Bits Per TTI	Bits	4800	7680
Total Available SML"s in UE	SML"s	28800	28800
Number of SML"s per HARQ Proc.	SML"s	9600	9600
Coding Rate		0.67	0.61
Number of Physical Channel Codes	Codes	5	4
Modulation		QPSK	16QAM
Note:	The HS-DSCH shall be transmitted continuously with constant power but only every second TTI shall be allocated to the UE under test.		

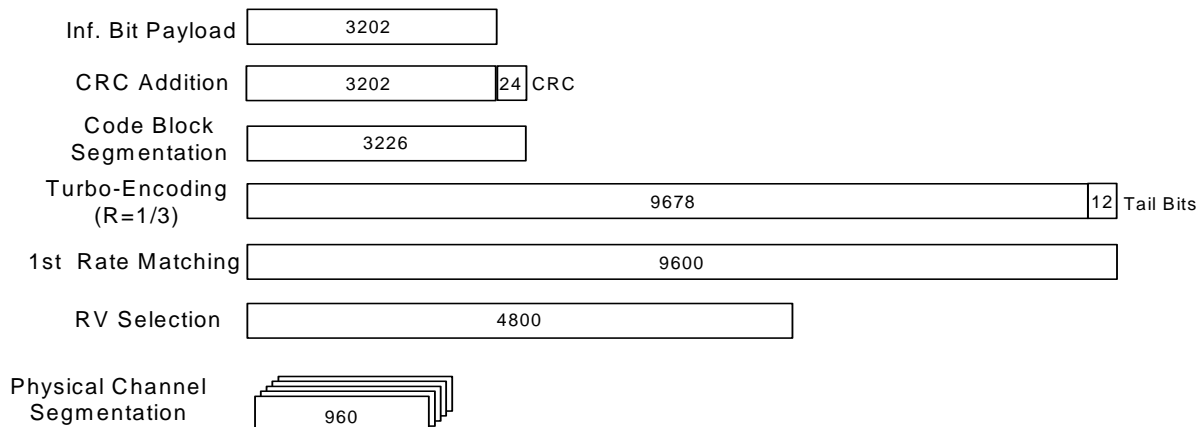

Figure A.14: Coding rate for Fixed Reference Channel H-Set 2 (QPSK)

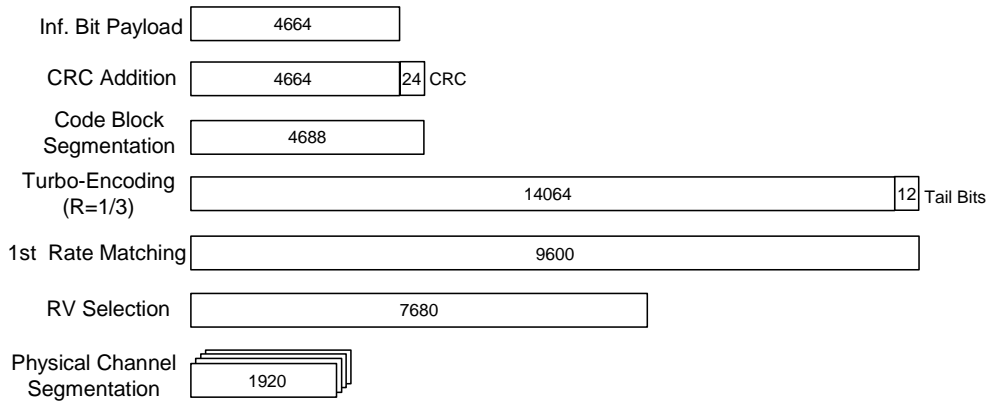

Figure A.15: Coding rate for Fixed Reference Channel H-Set 2 (16QAM)

A.7.1.3 Fixed Reference Channel Definition H-Set 3

Table A.27: Fixed Reference Channel H-Set 3

Parameter	Unit	Value	
Nominal Avg. Inf. Bit Rate	kbps	1601	2332
Inter-TTI Distance	TTI"s	1	1
Number of HARQ Processes	Processes	6	6
Information Bit Payload (N_{INF})	Bits	3202	4664
Number Code Blocks	Blocks	1	1
Binary Channel Bits Per TTI	Bits	4800	7680
Total Available SML"s, in UE	SML"s	57600	57600
Number of SML"s per HARQ Proc.	SML"s	9600	9600
Coding Rate		0.67	0.61
Number of Physical Channel Codes	Codes	5	4
Modulation		QPSK	16QAM

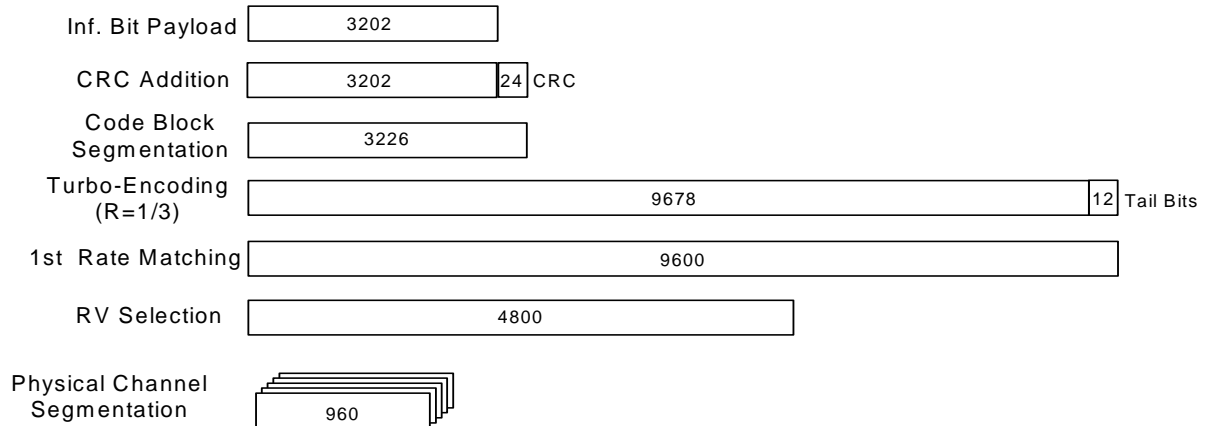

Figure A.16: Coding rate for Fixed reference Channel H-Set 3 (QPSK)

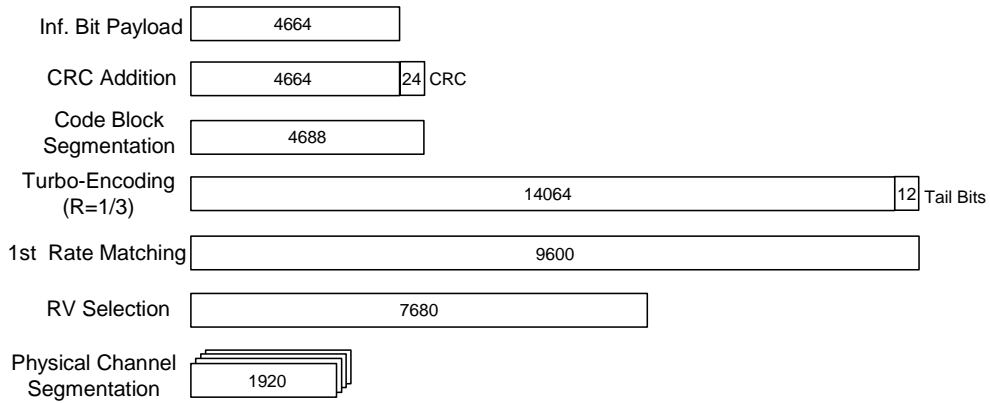

Figure A.17: Coding rate for Fixed reference Channel H-Set 3 (16QAM)

A.7.1.4 Fixed Reference Channel Definition H-Set 4

Table A.28: Fixed Reference Channel H-Set 4

Parameter	Unit	Value
Nominal Avg. Inf. Bit Rate	kbps	534
Inter-TTI Distance	TTI"s	2
Number of HARQ Processes	Processes	2
Information Bit Payload (N_{INF})	Bits	3202
Number Code Blocks	Blocks	1
Binary Channel Bits Per TTI	Bits	4800
Total Available SML"s in UE	SML"s	14400
Number of SML"s per HARQ Proc.	SML"s	7200
Coding Rate		0.67
Number of Physical Channel Codes	Codes	5
Modulation		QPSK
Note:	This FRC is used to verify the minimum inter-TTI distance for UE category 11. The HS-PDSCH shall be transmitted continuously with constant power. The six sub-frame HS-SCCH signalling pattern shall repeat as follows: ...OOXOXOOXOXO..., where "X" marks TTI in which HS-SCCH uses the identity of the UE under test and "O" marks TTI, in which HS-SCCH uses a different identity.	

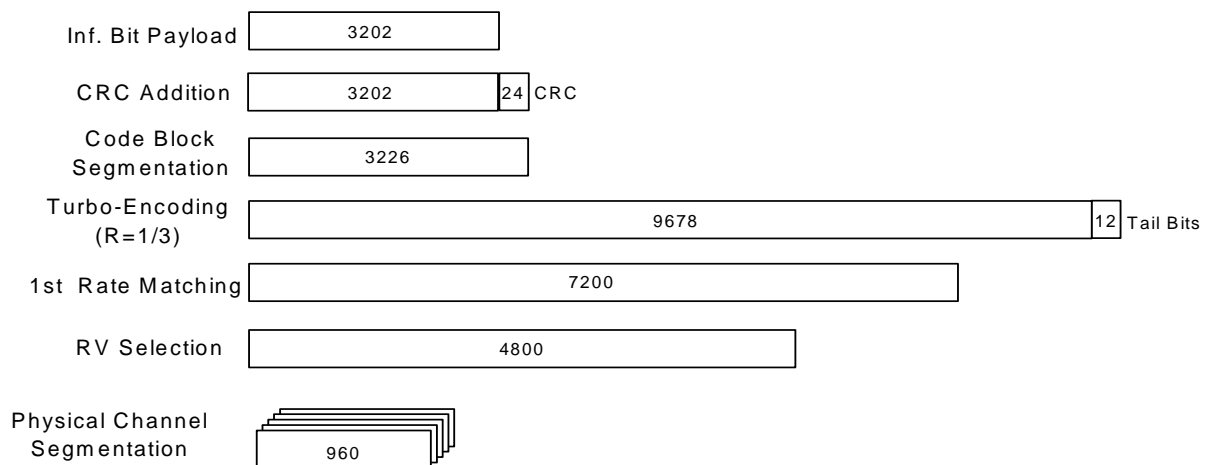

Figure A.18: Coding rate for Fixed Reference Channel H-Set 4

A.7.1.5 Fixed Reference Channel Definition H-Set 5

Table A.29: Fixed Reference Channel H-Set 5

Parameter	Unit	Value
Nominal Avg. Inf. Bit Rate	kbps	801
Inter-TTI Distance	TTI"s	1
Number of HARQ Processes	Processes	3
Information Bit Payload (N_{INF})	Bits	3202
Number Code Blocks	Blocks	1
Binary Channel Bits Per TTI	Bits	4800
Total Available SML"s in UE	SML"s	28800
Number of SML"s per HARQ Proc.	SML"s	9600
Coding Rate		0.67
Number of Physical Channel Codes	Codes	5
Modulation		QPSK
Note:	This FRC is used to verify the minimum inter-TTI distance for UE category 12. The HS-PDSCH shall be transmitted continuously with constant power. The six sub-frame HS-SCCH signalling pattern shall repeat as follows: ...OOXXXOOOXXXO..., where "X" marks TTI in which HS-SCCH uses the identity of the UE under test and "O" marks TTI, in which HS-SCCH uses a different identity.	

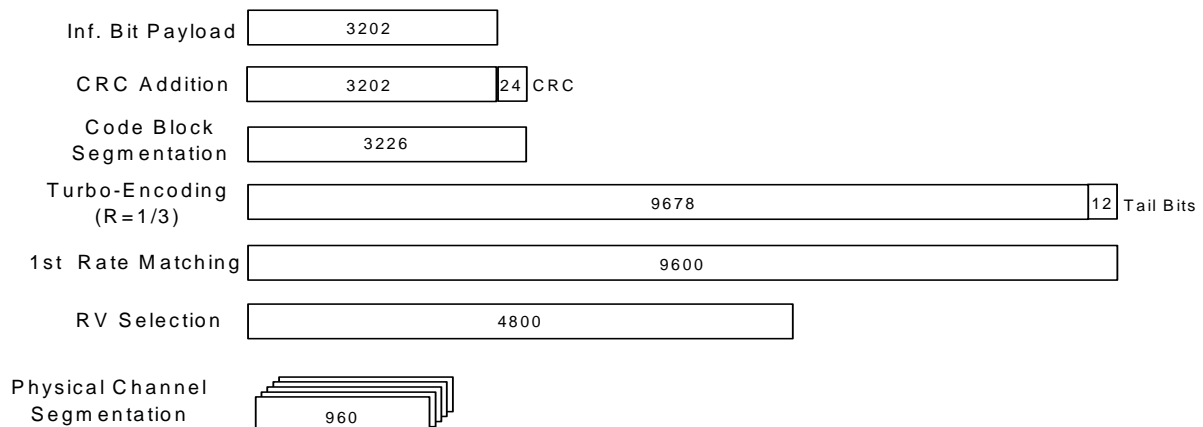

Figure A.19: Coding rate for Fixed Reference Channel H-Set 5

A.7.1.6 Fixed Reference Channel Definition H-Set 6

Table A.30: Fixed Reference Channel H-Set 6

Parameter	Unit	Value	
Nominal Avg. Inf. Bit Rate	kbps	3219	4689
Inter-TTI Distance	TTI"s	1	1
Number of HARQ Processes	Processes	6	6
Information Bit Payload (N_{INF})	Bits	6438	9377
Number Code Blocks	Blocks	2	2
Binary Channel Bits Per TTI	Bits	9600	15360
Total Available SML"s in UE	SML"s	115200	115200
Number of SML"s per HARQ Proc.	SML"s	19200	19200
Coding Rate		0.67	0.61
Number of Physical Channel Codes	Codes	10	8
Modulation		QPSK	16QAM

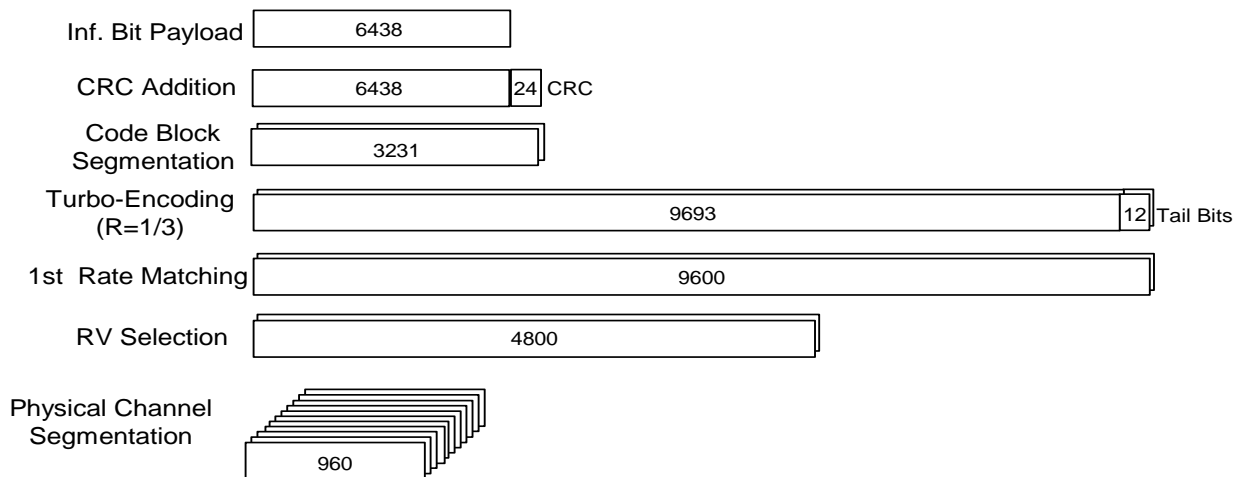

Figure A.20: Coding rate for Fixed reference Channel H-Set 6 (QPSK)

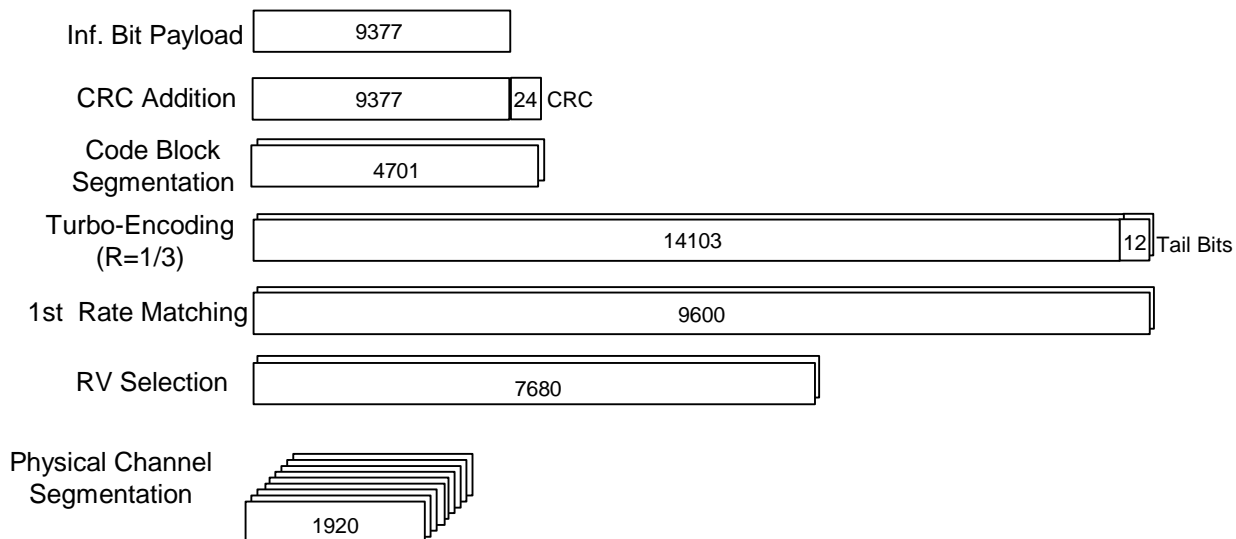

Figure A.21: Coding rate for Fixed reference Channel H-Set 6 (16 QAM)

Annex B (normative): Propagation conditions

B.1 General

Void

B.2 Propagation Conditions

B.2.1 Static propagation condition

The propagation for the static performance measurement is an Additive White Gaussian Noise (AWGN) environment. No fading and multi-paths exist for this propagation model.

B.2.2 Multi-path fading propagation conditions

Table B1 shows propagation conditions that are used for the performance measurements in multi-path fading environment. All taps have classical Doppler spectrum.

Table B.1: Propagation Conditions for Multi path Fading Environments (Cases 1 to 6)

Case 1		Case 2		Case 3		Case 4		Case 5 (Note 1)		Case 6	
Speed for Band I, II, III and IV: 3 km/h		Speed for Band I, II, III and IV: 3 km/h		Speed for Band I, II, III and IV: 120 km/h		Speed for Band I, II, III and IV: 3 km/h		Speed for Band I, II, III and IV: 50 km/h		Speed for Band I, II, III and IV: 250 km/h	
Speed for Band V and VI: 7 km/h		Speed for Band V and VI: 7 km/h		Speed for Band V and VI: 282 km/h (Note 2)		Speed for Band V and VI: 7 km/h		Speed for Band V and VI: 118 km/h		Speed for Band V and VI: 583 km/h (Note 2)	
Relative Delay [ns]	Relative mean Power [dB]	Relative Delay [ns]	Relative mean Power [dB]	Relative Delay [ns]	Relative mean Power [dB]	Relative Delay [ns]	Relative mean Power [dB]	Relative Delay [ns]	Relative mean Power [dB]	Relative Delay [ns]	Relative mean Power [dB]
0	0	0	0	0	0	0	0	0	0	0	0
976	-10	976	0	260	-3	976	0	976	-10	260	-3
		20000	0	521	-6					521	-6
				781	-9					781	-9

NOTE 1: Case 5 is only used in TS25.133.

NOTE 2: Speed above 250km/h is applicable to demodulation performance requirements only.

Table B.1A shows propagation conditions that are used for the performance measurements in multi-path environment when UE is informed by higher layer signalling that only DPCCCH exists for channel estimation. All taps have classical Doppler spectrum. Taps are normalized to the strongest tap in the beam/sector. The actual power relation between the sector and the beam is determined by the test case.

Table B.1A: Propagation Conditions for Multi path Fading Environments (Case 7)

Case 7		
Speed for Band I, II, III and IV: 50 km/h		
Speed for Band V, VI: 118 km/h		
Relative Delay [ns]	Average Power [dB]	
	Sector	Beam
0	0.0	-
260	-4.3	-
1040	-6.6	-
4690	-2.0	0.0
7290	-7.0	-0.3
14580	-7.5	-0.9

Table B.1B shows propagation conditions that are used for HSDPA performance measurements in multi-path fading environment. For HSDPA enhanced performance requirements, the fading of the signals and the AWGN signals provided in each receiver antenna port shall be independent.

Table B.1B: Propagation Conditions for Multi-Path Fading Environments for HSDPA Performance Requirements

ITU Pedestrian A Speed 3km/h (PA3)		ITU Pedestrian B Speed 3km/h (PB3)		ITU vehicular A Speed 30km/h (VA30)		ITU vehicular A Speed 120km/h (VA120)	
Speed for Band I, II, III and IV 3 km/h		Speed for Band I, II, III and IV 3 km/h		Speed for Band I, II, III and IV 30 km/h		Speed for Band I, II, III and IV 120 km/h	
Speed for Band V, VI 7 km/h		Speed for Band V, VI 7 km/h		Speed for Band V, VI 71 km/h		Speed for Band V, VI 282 km/h (Note 1)	
Relative Delay [ns]	Relative Mean Power [dB]	Relative Delay [ns]	Relative Mean Power [dB]	Relative Delay [ns]	Relative Mean Power [dB]	Relative Delay [ns]	Relative Mean Power [dB]
0	0	0	0	0	0	0	0
110	-9.7	200	-0.9	310	-1.0	310	-1.0
190	-19.2	800	-4.9	710	-9.0	710	-9.0
410	-22.8	1200	-8.0	1090	-10.0	1090	-10.0
		2300	-7.8	1730	-15.0	1730	-15.0
		3700	-23.9	2510	-20.0	2510	-20.0

NOTE 1: Speed above 120km/h is applicable to demodulation performance requirements only.

Table B.1C shows propagation conditions that are used for CQI test in multi-path fading. For HSDPA enhanced performance requirements, the fading of the signals and the AWGN signals provided in each receiver antenna port shall be independent.

Table B.1C: Propagation Conditions for CQI test in multi-path fading

Case 8, speed 30km/h	
Relative Delay [ns]	Relative mean Power [dB]
0	0
976	-10

B.2.3 Moving propagation conditions

The dynamic propagation conditions for the test of the baseband performance are non fading channel models with two taps. The moving propagation condition has two tap, one static, Path0, and one moving, Path1. The time difference between the two paths is according Equation (B.1). The taps have equal strengths and equal phases.

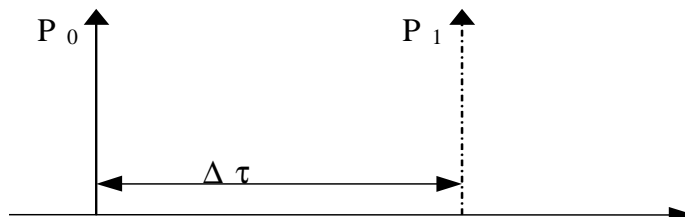

Figure B.1: The moving propagation conditions

$$\Delta\tau = B + \frac{A}{2}(1 + \sin(\Delta\omega \cdot t)) \tag{B.1}$$

The parameters in the equation are shown in the following table.

Table B.2

Parameter	Value
A	5 μs
B	1 μs
Δω	40*10 ⁻³ s ⁻¹

B.2.4 Birth-Death propagation conditions

The dynamic propagation conditions for the test of the base band performance is a non fading propagation channel with two taps. The moving propagation condition has two taps, Path1 and Path2 which alternate between 'birth' and 'death'. The positions the paths appear are randomly selected with an equal probability rate and is shown in Figure B.2.

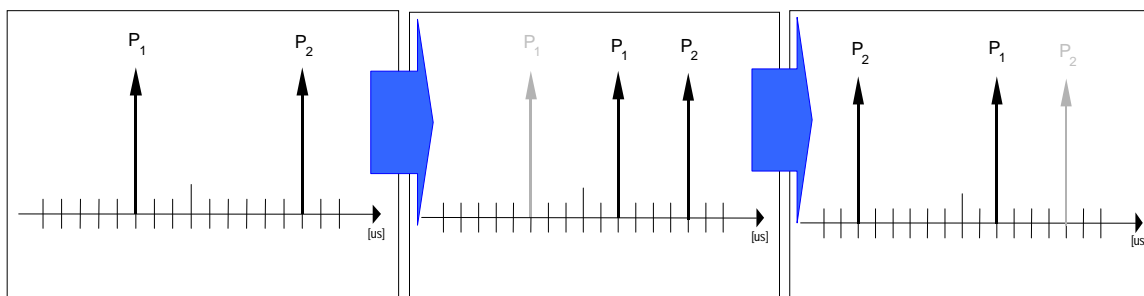

Figure B.2: Birth death propagation sequence

- Two paths, Path1 and Path2 are randomly selected from the group[-5,-4,-3,-2,-1,0,1,2,3,4,5] μs. The paths have equal magnitudes and equal phases.
- After 191 ms, Path1 vanishes and reappears immediately at a new location randomly selected from the group [-5,-4,-3,-2,-1,0,1,2,3,4,5] μs but excludes the point Path 2. The magnitudes and the phases of the tap coefficients of Path 1 and Path 2 shall remain unaltered.
- After an additional 191 ms, Path2 vanishes and reappears immediately at a new location randomly selected from the group [-5,-4,-3,-2,-1,0,1,2,3,4,5] μs but excludes the point Path 1. The magnitudes and the phases of the tap coefficients of Path 1 and Path 2 shall remain unaltered.

The sequence in 2) and 3) is repeated.

Annex C (normative): Downlink Physical Channels

C.1 General

This annex specifies the downlink physical channels that are needed for setting a connection and channels that are needed during a connection.

C.2 Connection Set-up

Table C.1 describes the downlink Physical Channels that are required for connection set up.

**Table C.1: Downlink Physical Channels required
for connection set-up**

Physical Channel
P-CPICH
P-CCPCH
SCH
S-CCPCH
PICH
AICH
DPCH

C.3 During connection

The following clauses, describes the downlink Physical Channels that are transmitted during a connection i.e., when measurements are done. For these measurements the offset between DPCH and SCH shall be zero chips at Node B meaning that SCH is overlapping with the first symbols in DPCH in the beginning of DPCH slot structure.

C.3.1 Measurement of Rx Characteristics

Table C.2 is applicable for measurements on the Receiver Characteristics (clause 7) with the exception of subclause 7.4 (Maximum input level).

Table C.2: Downlink Physical Channels transmitted during a connection

Physical Channel	Power ratio
P-CPICH	$P\text{-CPICH_Ec} / DPCH_Ec = 7 \text{ dB}$
P-CCPCH	$P\text{-CCPCH_Ec} / DPCH_Ec = 5 \text{ dB}$
SCH	$SCH_Ec / DPCH_Ec = 5 \text{ dB}$
PICH	$PICH_Ec / DPCH_Ec = 2 \text{ dB}$
DPCH	Test dependent power

C.3.2 Measurement of Performance requirements

Table C.3 is applicable for measurements on the Performance requirements (clause 8), including subclause 7.4 (Maximum input level) and subclause 6.4.4 (Out-of-synchronization handling of output power).

Table C.3: Downlink Physical Channels transmitted during a connection¹

Physical Channel	Power ratio	NOTE
P-CPICH	$P\text{-CPICH}_{Ec/Ior} = -10 \text{ dB}$	Use of P-CPICH or S-CPICH as phase reference is specified for each requirement and is also set by higher layer signalling.
S-CPICH	$S\text{-CPICH}_{Ec/Ior} = -10 \text{ dB}$	When S-CPICH is the phase reference in a test condition, the phase of S-CPICH shall be 180 degrees offset from the phase of P-CPICH. When S-CPICH is not the phase reference, it is not transmitted.
P-CCPCH	$P\text{-CCPCH}_{Ec/Ior} = -12 \text{ dB}$	When BCH performance is tested the $P\text{-CCPCH}_{Ec/Ior}$ is test dependent
SCH	$SCH_{Ec/Ior} = -12 \text{ dB}$	This power shall be divided equally between Primary and Secondary Synchronous channels
PICH	$PICH_{Ec/Ior} = -15 \text{ dB}$	
DPCH	Test dependent power	When S-CPICH is the phase reference in a test condition, the phase of DPCH shall be 180 degrees offset from the phase of P-CPICH. When BCH performance is tested the DPCH is not transmitted.
OCNS	Necessary power so that total transmit power spectral density of Node B (lor) adds to one ¹	OCNS interference consists of 16 dedicated data channels as specified in table C.6.

NOTE 1 For dynamic power correction required to compensate for the presence of transient channels, e.g. control channels, a subset of the DPCH channels may be used.

C.3.3 Connection with open-loop transmit diversity mode

Table C.4 is applicable for measurements for subclause 8.6.1 (Demodulation of DCH in open loop transmit diversity mode).

Table C.4: Downlink Physical Channels transmitted during a connection¹

Physical Channel	Power ratio	NOTE
P-CPICH (antenna 1)	P-CPICH_Ec1/lor = -13 dB	1. Total P-CPICH_Ec/lor = -10 dB
P-CPICH (antenna 2)	P-CPICH_Ec2/lor = -13 dB	
P-CCPCH (antenna 1)	P-CCPCH_Ec1/lor = -15 dB	1. STTD applied 2. Total P-CCPCH_Ec/lor = -12 dB
P-CCPCH (antenna 2)	P-CCPCH_Ec2/lor = -15 dB	
SCH (antenna 1 / 2)	SCH_Ec/lor = -12 dB	1. TSTD applied. 2. This power shall be divided equally between Primary and Secondary Synchronous channels 3. When BCH performance is tested the P-CCPCH_Ec/lor is test dependent
PICH (antenna 1)	PICH_Ec1/lor = -18 dB	1. STTD applied 2. Total PICH_Ec/lor = -15 dB
PICH (antenna 2)	PICH_Ec2/lor = -18 dB	
DPCH	Test dependent power	1. STTD applied 2. Total power from both antennas
OCNS	Necessary power so that total transmit power spectral density of Node B (lor) adds to one ¹	1.This power shall be divided equally between antennas 2.OCNS interference consists of 16 dedicated data channels as specified in Table C.6.

NOTE 1 For dynamic power correction required to compensate for the presence of transient channels, e.g. control channels, a subset of the DPCH channels may be used.

C.3.4 Connection with closed loop transmit diversity mode

Table C.5 is applicable for measurements for subclause 8.6.2 (Demodulation of DCH in closed loop transmit diversity mode).

Table C.5: Downlink Physical Channels transmitted during a connection¹

Physical Channel	Power ratio	NOTE
P-CPICH (antenna 1)	P-CPICH_Ec1/lor = -13 dB	1. Total P-CPICH_Ec/lor = -10 dB
P-CPICH (antenna 2)	P-CPICH_Ec2/lor = -13 dB	
P-CCPCH (antenna 1)	P-CCPCH_Ec1/lor = -15 dB	1. STTD applied
P-CCPCH (antenna 2)	P-CCPCH_Ec2/lor = -15 dB	1. STTD applied, 2. total P-CCPCH_Ec/lor = -12 dB
SCH (antenna 1 / 2)	SCH_Ec/lor = -12 dB	1. TSTD applied
PICH (antenna 1)	PICH_Ec1/lor = -18 dB	1. STTD applied 2. STTD applied, total PICH_Ec/lor = -15 dB
PICH (antenna 2)	PICH_Ec2/lor = -18 dB	
DPCH	Test dependent power	1. Total power from both antennas
OCNS	Necessary power so that total transmit power spectral density of Node B (lor) adds to one (Notes 1 & 2)	1.This power shall be divided equally between antennas 2. OCNS interference consists of 16 dedicated data channels. as specified in Table C.6.

Note 1 For dynamic power correction required to compensate for the presence of transient channels, e.g. control channels, a subset of the DPCH channels may be used.

Note 2 For the case of DPCH with transmit diversity, the OCNS power calculation shall be based on the addition of the power from Antenna 1 and Antenna 2, i.e. disregarding any phase relationship between the antennas.

Table C.6: DPCH Channelization Code and relative level settings for OCNS signal

Channelization Code at SF=128	Relative Level setting (dB) (Note 1)	DPCH Data
2	-1	The DPCH data for each channelization code shall be uncorrelated with each other and with any wanted signal over the period of any measurement. For OCNS with transmit diversity the DPCH data sent to each antenna shall be either STTD encoded or generated from uncorrelated sources.
11	-3	
17	-3	
23	-5	
31	-2	
38	-4	
47	-8	
55	-7	
62	-4	
69	-6	
78	-5	
85	-9	
94	-10	
125	-8	
113	-6	
119	0	

NOTE 1: The relative level setting specified in dB refers only to the relationship between the OCNS channels. The level of the OCNS channels relative to the Ior of the complete signal is a function of the power of the other channels in the signal with the intention that the power of the group of OCNS channels is used to make the total signal add up to 1.

NOTE: The DPCH Channelization Codes and relative level settings are chosen to simulate a signal with realistic Peak to Average Ratio.

C.3.5 Connection with tests having DPCH as a phase reference

Table C.6A is applicable for measurements for tests 21, 22, 23, 24 and 25 in subclause 8.3.1.

Table C.6A: Downlink Physical Channels transmitted during a connection

Physical Channel	Antenna (gain)	Power	NOTE
P-CPICH	Sector (0 dB)	P-CPICH_Ec/Ior = -10 dB	UE is informed by higher layer signalling that P-CPICH shall not be used as a phase reference
P-CCPCH		P-CCPCH_Ec/Ior = -12 dB	
SCH		SCH_Ec/Ior = -12 dB	This power shall be divided equally between Primary and Secondary Synchronous channels
PICH		PICH_Ec/Ior = -15 dB	
DPCH	Beam (6.0dB)	Test dependent power	DPCH phase shall be uncorrelated with the phase of P-CPICH (different propagation in sector and beam)
OCNS		Necessary power so that Beam total transmit power is 20 % of Node B total transmit power	<ol style="list-style-type: none"> 1) OCNS interference consists of 16 dedicated data channels as specified in Table C.6. 2) 60% of the power from Node B (Ior) is not involved in the tests, but is still counted as a part of the transmitted power.

C.4 W-CDMA Modulated Interferer

Table C.7 describes the downlink Channels that are transmitted as part of the W-CDMA modulated interferer.

Table C.7: Spreading Code, Timing offsets and relative level settings for W-CDMA Modulated Interferer signal channels

Channel Type	Spreading Factor	Channelization Code	Timing offset ($\times 256T_{\text{chip}}$)	Power	NOTE
P-CCPCH	256	1	0	P-CCPCH_Ec/Ior = -10 dB	
SCH	256	-	0	SCH_Ec/Ior = -10 dB	The SCH power shall be divided equally between Primary and Secondary Synchronous channels
P-CPICH	256	0	0	P-CPICH_Ec/Ior = -10 dB	
PICH	256	16	16	PICH_Ec/Ior = -15 dB	
OCNS	See table C.6			Necessary power so that total transmit power spectral density of Node B (Ior) adds to one	OCNS interference consists of the dedicated data channels, as specified in Table C.6.

C.5 HSDPA DL Physical channels

C.5.1 Downlink Physical Channels connection set-up

Table C.8 is applicable for the measurements for tests in subclause 7.4.2, 9.2.1 and 9.3. Table C.9 is applicable for the measurements for tests in subclause 9.2.2. Table C.10 is applicable for the measurements for tests in subclause 9.2.3. Table C.11 is applicable for the measurements for tests in subclause 9.4.1. Table C.12 is applicable for the measurements in subclause 9.4.2

Table C.8: Downlink physical channels for HSDPA receiver testing for Single Link performance.

Physical Channel	Parameter	Value	Note
P-CPICH	P-CPICH_Ec/Ior	-10dB	
P-CCPCH	P-CCPCH_Ec/Ior	-12dB	Mean power level is shared with SCH.
SCH	SCH_Ec/Ior	-12dB	Mean power level is shared with P-CCPCH – SCH includes P- and S-SCH, with power split between both. P-SCH code is S_dl,0 as per TS25.213 S-SCH pattern is scrambling code group 0
PICH	PICH_Ec/Ior	-15dB	
DPCH	DPCH_Ec/Ior	Test-specific	12.2 kbps DL reference measurement channel as defined in Annex A.3.1
HS-SCCH-1	HS-SCCH_Ec/Ior	Test-specific	Specifies fraction of Node-B radiated power transmitted when TTI is active (i.e. due to minimum inter-TTI interval).
HS-SCCH-2	HS-SCCH_Ec/Ior	DTX"d	No signalling scheduled, or power radiated, on this HS-SCCH, but signalled to the UE as present.
HS-SCCH-3	HS-SCCH_Ec/Ior	DTX"d	As HS-SCCH-2.
HS-SCCH-4	HS-SCCH_Ec/Ior	DTX"d	As HS-SCCH-2.
HS-PDSCH	HS-PDSCH_Ec/Ior	Test-specific	.
OCNS		Necessary power so that total transmit power spectral density of Node B (Ior) adds to one	OCNS interference consists of 6 dedicated data channels as specified in table C.13.

Table C.9: Downlink physical channels for HSDPA receiver testing for Open Loop Transmit Diversity performance.

Physical Channel	Parameter	Value	Note
P-CPICH (antenna 1)	P-CPICH_Ec1/lor	-13dB	1. Total P-CPICH_Ec/lor = -10dB
P-CPICH (antenna 2)	P-CPICH_Ec2/lor	-13dB	
P-CCPCH (antenna 1)	P-CCPCH_Ec1/lor	-15dB	1. STTD applied. 2. Total P-CCPCH Ec/lor is -12dB.
P-CCPCH (antenna 2)	P-CCPCH_Ec2/lor	-15dB	
SCH (antenna 1/2)	SCH_Ec/lor	-12dB	1. TSTD applied. 2. Power divided equally between primary and secondary SCH.
PICH (antenna 1)	PICH_Ec1/lor	-18dB	1. STTD applied. 2. Total PICH Ec/lor is -15dB.
PICH (antenna 2)	PICH_Ec2/lor	-18dB	
DPCH	DPCH_Ec/lor	Test-specific	1. STTD applied.
HS-SCCH-1	HS-SCCH_Ec/lor	Test-specific	1. STTD applied. 2. Specifies fraction of Node-B radiated power transmitted when TTI is active (i.e. due to minimum inter-TTI interval).
HS-SCCH-2	HS-SCCH_Ec/lor	DTX"d	1. UE assumes STTD applied. 2. No signalling scheduled, or power radiated, on this HS-SCCH, but signalled to the UE as present.
HS-SCCH-3	HS-SCCH_Ec/lor	DTX"d	1. As HS-SCCH-2.
HS-SCCH-4	HS-SCCH_Ec/lor	DTX"d	2. As HS-SCCH-2.
HS-PDSCH	HS-PDSCH_Ec/lor	Test-specific	1. STTD applied.
OCNS		Necessary power so that total transmit power spectral density of Node B (lor) adds to one (Note 1)	1. Balance of power I_{or} of the Node-B is assigned to OCNS. 2. Power divided equally between antennas. 3. OCNS interference consists of 6 dedicated data channels as specified in table C.13.

Note 1 For the case of DPCH with transmit diversity, the OCNS power calculation shall be based on the addition of the power from Antenna 1 and Antenna 2, i.e. disregarding any phase relationship between the antennas.

Table C.10: Downlink physical channels for HSDPA receiver testing for Closed Loop. Transmit Diversity (Mode-1) performance.

Physical Channel	Parameter	Value	Note
P-CPICH (antenna 1)	P-CPICH_Ec1/lor	-13dB	1. Total P-CPICH_Ec/lor = -10dB
P-CPICH (antenna 2)	P-CPICH_Ec2/lor	-13dB	
P-CCPCH (antenna 1)	P-CCPCH_Ec1/lor	-15dB	1. STTD applied. 2. Total P-CCPCH Ec/lor is -12dB.
P-CCPCH (antenna 2)	P-CCPCH_Ec2/lor	-15dB	
SCH (antenna 1/2)	SCH_Ec/lor	-12dB	1. TSTD applied. 2. Power divided equally between primary and secondary SCH.
PICH (antenna 1)	PICH_Ec1/lor	-18dB	1. STTD applied. 2. Total PICH Ec/lor is -15dB.
PICH (antenna 2)	PICH_Ec2/lor	-18dB	
DPCH	DPCH_Ec/lor	Test-specific	1. CL1 applied.
HS-SCCH-1	HS-SCCH_Ec/lor	Test-specific	1. STTD applied. 2. Specifies fraction of Node-B radiated power transmitted when TTI is active (i.e. due to minimum inter-TTI interval).
HS-SCCH-2	HS-SCCH_Ec/lor	DTX"d	1. UE assumes STDD] applied. 2. No signalling scheduled, or power radiated, on this HS-SCCH, but signalled to the UE as present.
HS-SCCH-3	HS-SCCH_Ec/lor	DTX"d	1. As HS-SCCH-2.
HS-SCCH-4	HS-SCCH_Ec/lor	DTX"d	2. As HS-SCCH-2.
HS-PDSCH	HS-PDSCH_Ec/lor	Test-specific	1. CL1 applied.
OCNS		Necessary power so that total transmit power spectral density of Node B (lor) adds to one (Note 1)	1. Balance of power I_{or} of the Node-B is assigned to OCNS. 2. Power divided equally between antennas. 3. OCNS interference consists of 6 dedicated data channels as specified in table C.13.

Note 1 For the case of DPCH with transmit diversity, the OCNS power calculation shall be based on the addition of the power from Antenna 1 and Antenna 2, i.e. disregarding any phase relationship between the antennas.

Table C.11: Downlink physical channels for HSDPA receiver testing for HS-SCCH detection performance

Parameter	Units	Value	Comment
CPICH E_c/I_{or}	dB	-10	
P-CCPCH E_c/I_{or}	dB	-12	Mean power level is shared with SCH.
SCH E_c/I_{or}	dB	-12	Mean power level is shared with P-CCPCH – SCH includes P- and S-SCH, with power split between both. P-SCH code is S_dl,0 as per TS25.213 S-SCH pattern is scrambling code group 0
PICH E_c/I_{or}	dB	-15	
HS-PDSCH-1 E_c/I_{or}	dB	-10	HS-PDSCH associated with HS-SCCH-1. The HS-PDSCH shall be transmitted continuously with constant power.
HS-PDSCH-2 E_c/I_{or}	dB	DTX	HS-PDSCH associated with HS-SCCH-2
HS-PDSCH-3 E_c/I_{or}	dB	DTX	HS-PDSCH associated with HS-SCCH-3
HS-PDSCH-4 E_c/I_{or}	dB	DTX	HS-PDSCH associated with HS-SCCH-4
DPCH E_c/I_{or}	dB	-8	12.2 kbps DL reference measurement channel as defined in Annex A.3.1
HS-SCCH-1 E_c/I_{or}	dB	Test Specific	All HS-SCCH"s allocated equal E_c/I_{or} . Specifies E_c/I_{or} when TTI is active.
HS-SCCH-2 E_c/I_{or}	dB		
HS-SCCH-3 E_c/I_{or}	dB		
HS-SCCH-4 E_c/I_{or}	dB		
OCNS E_c/I_{or}	dB	Necessary power so that total transmit power spectral density of Node B (lor) adds to one (Note 1)	1. Balance of power I_{or} of the Node-B is assigned to OCNS. 2. OCNS interference consists of 6 dedicated data channels as specified in table C.13.

Note 1 For the case of DPCH with transmit diversity, the OCNS power calculation shall be based on the addition of the power from Antenna 1 and Antenna 2, i.e. disregarding any phase relationship between the antennas.

Table C.12: Downlink physical channels for HSDPA receiver testing for HS-SCCH detection performance in Open Loop Diversity

Parameter	Units	Value	Comment
P-CPICH E_c/I_{or} (antenna 1)	dB	-13	1. Total P-CPICH $E_c/I_{or} = -10$ dB
P-CPICH E_c/I_{or} (antenna 2)	dB	-13	
P-CCPCH E_c/I_{or} (antenna 1)	dB	-15	1. STTD applied 2. Total P-CCPCH $E_c/I_{or} = -12$ dB
P-CCPCH E_c/I_{or} (antenna 2)	dB	-15	
SCH E_c/I_{or} (antenna 1/2)	dB	-12	1. TSTD applied 2. Mean power level is shared with P-CCPCH – SCH includes P- and S-SCH, with power split between both. 3. P-SCH code is S_dl,0 as per TS25.213 4. S-SCH pattern is scrambling code group 0
PICH E_c/I_{or} (antenna 1)	dB	-15	1. STTD applied 2. Total PICH $E_c/I_{or} = -12$ dB
PICH E_c/I_{or} (antenna 2)	dB	-15	
HS-PDSCH-1 E_c/I_{or}	dB	-10	1. STTD applied 2. HS-PDSCH assoc. with HS-SCCH-1
HS-PDSCH-2 E_c/I_{or}	dB	DTX	1. STTD applied 2. HS-PDSCH assoc. with HS-SCCH-2
HS-PDSCH-3 E_c/I_{or}	dB	DTX	1. STTD applied 2. HS-PDSCH assoc. with HS-SCCH-3
HS-PDSCH-4 E_c/I_{or}	dB	DTX	1. STTD applied 2. HS-PDSCH assoc. with HS-SCCH-4
DPCH E_c/I_{or}	dB	-8	1. STTD applied 2. 12.2 kbps DL reference measurement channel as defined in Annex A.3.1
HS-SCCH-1 E_c/I_{or}	dB	Test Specific	1. STTD applied 2. All HS-SCCH"s allocated equal E_c/I_{or} . 3. Specifies E_c/I_{or} when TTI is active.
HS-SCCH-2 E_c/I_{or}	dB		
HS-SCCH-3 E_c/I_{or}	dB		
HS-SCCH-4 E_c/I_{or}	dB		
OCNS E_c/I_{or}	dB	Remaining power at Node-B (including HS-SCCH power allocation when HS-SCCH"s inactive).	1. STTD applied 2. OCNS interference consists of 6 dedicated data channels as specified in table C.13. 3. Power divided equally between antennas

C.5.2 OCNS Definition

The selected channelization codes and relative power levels for OCNS transmission during for HSDPA performance assessment are defined in Table C.13. The selected codes are designed to have a single length-16 parent code.

Table C.13: OCNS definition for HSDPA receiver testing.

Channelization Code at SF=128	Relative Level setting (dB) (Note 1)	DPCH Data
122	0	The DPCH data for each channelization code shall be uncorrelated with each other and with any wanted signal over the period of any measurement. For OCNS with transmit diversity the DPCH data sent to each antenna shall be either STTD encoded or generated from uncorrelated sources.
123	-2	
124	-2	
125	-4	
126	-1	
127	-3	

Note 1 The relative level setting specified in dB refers only to the relationship between the OCNS channels. The level of the OCNS channels relative to the I_{or} of the complete signal is a function of the power of the other channels in the signal with the intention that the power of the group of OCNS channels is used to make the total signal add up to 1.

Annex D (normative): Environmental conditions

D.1 General

This normative annex specifies the environmental requirements of the UE. Within these limits the requirements of the present documents shall be fulfilled.

D.2 Environmental requirements

The requirements in this clause apply to all types of UE(s).

D.2.1 Temperature

The UE shall fulfil all the requirements in the full temperature range of:

Table D.1

+15 °C to +35 °C	for normal conditions (with relative humidity of 25 % to 75 %)
-10 °C to +55 °C	for extreme conditions (see IEC publications 68-2-1 and 68-2-2)

Outside this temperature range the UE, if powered on, shall not make ineffective use of the radio frequency spectrum. In no case shall the UE exceed the transmitted levels as defined in TS 25.101 for extreme operation.

D.2.2 Voltage

The UE shall fulfil all the requirements in the full voltage range, i.e. the voltage range between the extreme voltages.

The manufacturer shall declare the lower and higher extreme voltages and the approximate shutdown voltage. For the equipment that can be operated from one or more of the power sources listed below, the lower extreme voltage shall not be higher, and the higher extreme voltage shall not be lower than that specified below.

Table D.2

Power source	Lower extreme voltage	Higher extreme voltage	Normal conditions voltage
AC mains	0,9 * nominal	1,1 * nominal	nominal
Regulated lead acid battery	0,9 * nominal	1,3 * nominal	1,1 * nominal
Non regulated batteries: Leclanché / lithium Mercury/nickel & cadmium	0,85 * nominal 0,90 * nominal	Nominal Nominal	Nominal Nominal

Outside this voltage range the UE if powered on, shall not make ineffective use of the radio frequency spectrum. In no case shall the UE exceed the transmitted levels as defined in TS 25.101 for extreme operation. In particular, the UE shall inhibit all RF transmissions when the power supply voltage is below the manufacturer declared shutdown voltage.

D.2.3 Vibration

The UE shall fulfil all the requirements when vibrated at the following frequency/amplitudes.

Table D.3

Frequency	ASD (Acceleration Spectral Density) random vibration
5 Hz to 20 Hz	0,96 m ² /s ³
20 Hz to 500 Hz	0,96 m ² /s ³ at 20 Hz, thereafter -3 dB/Octave

Outside the specified frequency range the UE, if powered on, shall not make ineffective use of the radio frequency spectrum. In no case shall the UE exceed the transmitted levels as defined in TS 25.101 for extreme operation

Annex E (informative): Change history

Table E.1: Inclusion of CRs approved by TSG-RAN#6

RAN Doc	Spec	CR	R	Ph	Subject	Cat	Curr	New
RP-99772	25.101	001	2	R99	Correction of UE Measurement Channels Rev.2	F	3.0.0	3.1.0
RP-99772	25.101	003		R99	Modifications for Receiver Characteristics	F	3.0.0	3.1.0
RP-99772	25.101	004		R99	Corrections to Tx Diversity testing assumptions	F	3.0.0	3.1.0
RP-99771	25.101	005		R99	UE DL performance requirements	D	3.0.0	3.1.0
RP-99772	25.101	006	1	R99	Corrections to Annex C Down link Physical Channels	F	3.0.0	3.1.0
RP-99772	25.101	007		R99	Proposal for ACLR/ACS specifications for class 3	F	3.0.0	3.1.0
RP-99773	25.101	008		R99	Addition of propagation condition to inner and outer loop PC tests in downlink	B	3.0.0	3.1.0
RP-99772	25.101	009		R99	Clarification of Uplink inner loop power control requirements	C	3.0.0	3.1.0
RP-99773	25.101	010		R99	Modifications to demodulation test parameters and requirements in inter-cell soft handover	B	3.0.0	3.1.0
RP-99772	25.101	011		R99	Power setting of DPCH	C	3.0.0	3.1.0
RP-99771	25.101	012		R99	Editorial changes to 25.101v3.0.0	D	3.0.0	3.1.0
RP-99826	25.101	013		R99	Update of UE RF capabilities	F	3.0.0	3.1.0
RP-99772	25.101	014		R99	Update of ITU Region 2 Specific Specifications and proposed universal channel numbering	C	3.0.0	3.1.0
RP-99772	25.101	015		R99	Performance requirements for demodulation of DCH in Site Selection Diversity Transmission mode for Subclause 8.6.3 of 25.101v3.0.0	F	3.0.0	3.1.0
RP-99830	25.101	016	1	R99	Change of propagation conditions	F	3.0.0	3.1.0
RP-99772	25.101	017		R99	CR for minimum requirements for UE power class 1 and 2 in 25.101	F	3.0.0	3.1.0
RP-99772	25.101	018		R99	Downlink Inner loop power control	C	3.0.0	3.1.0
RP-99773	25.101	019		R99	Performance requirements in downlink compressed mode	B	3.0.0	3.1.0

Table E.2: Inclusion of CRs approved by TSG-RAN#7

RAN Doc	Spec	CR	R	Ph	Subject	Cat	Curr	New
RP-000015	25.101	020		R99	Clarifications to measurement channels	F	3.1.0	3.2.0
RP-000015	25.101	021		R99	Power measurement definitions for wanted signal (in-channel signal)	D	3.1.0	3.2.0
RP-000015	25.101	022		R99	Change of propagation conditions for Case 2	F	3.1.0	3.2.0
RP-000015	25.101	023		R99	Editorial corrections	D	3.1.0	3.2.0
RP-000015	25.101	024		R99	Birth-Death tap delays	F	3.1.0	3.2.0
RP-000015	25.101	025		R99	Out-of-synchronization handling of the UE	C	3.1.0	3.2.0
RP-000015	25.101	026		R99	UE Modulation performance requirements	F	3.1.0	3.2.0
RP-000015	25.101	027		R99	Measurement channel for UE PCDE test	F	3.1.0	3.2.0
RP-000015	25.101	028		R99	CR for performance requirement of BTFD	F	3.1.0	3.2.0
RP-000015	25.101	029		R99	CPCH	B	3.1.0	3.2.0
RP-000015	25.101	030		R99	Clarification of ACLR	D	3.1.0	3.2.0
RP-000015	25.101	031		R99	Correction for reference measurement channel in TS 25.101	F	3.1.0	3.2.0
RP-000015	25.101	032		R99	Modifications to requirements for power control steps in uplink	F	3.1.0	3.2.0
RP-000015	25.101	033		R99	Performance requirement	F	3.1.0	3.2.0
RP-000015	25.101	034		R99	Power Control in downlink, constant BLER target	F	3.1.0	3.2.0
RP-000015	25.101	035		R99	UE Minimum TX power change	F	3.1.0	3.2.0
RP-000015	25.101	036		R99	Performance requirements for demodulation of DCH in Site Selection Diversity Transmission mode	F	3.1.0	3.2.0
RP-000015	25.101	037		R99	Reference compressed mode patterns	F	3.1.0	3.2.0
RP-000015	25.101	038		R99	384kbps measurement channel is replaced with 10ms TTI	F	3.1.0	3.2.0
RP-000015	25.101	039		R99	Modification to the handling of measurement equipment uncertainty	F	3.1.0	3.2.0
					Correction to figure A6		3.2.0	3.2.1
					Correction to version number in title/header (April 2000)		3.2.1	3.2.2

Table E.3: Inclusion of CRs approved by TSG-RAN#8

RAN Doc	Spec	CR	R	Ph	Subject	Cat	Curr	New
RP-000204	25.101	040	1	R99	A test for UE's SIR target setting in a call set up	F	3.2.2	3.3.0
RP-000204	25.101	041	1	R99	Reception of TPC commands in a soft handover	F	3.2.2	3.3.0
RP-000204	25.101	042		R99	DCH requirement for 64 kbps measurement channel in birth-death propagation condition	F	3.2.2	3.3.0
RP-000204	25.101	043		R99	Power control in the downlink, constant BLER target	F	3.2.2	3.3.0
RP-000204	25.101	044		R99	Value update for 384 kbps measurement channel requirements	F	3.2.2	3.3.0
RP-000204	25.101	045	1	R99	CR for demodulation of DCH	F	3.2.2	3.3.0
RP-000204	25.101	046		R99	Correction for measurement channel in TS 25.101	F	3.2.2	3.3.0
RP-000204	25.101	047		R99	Editorial CR on section 8.6.3 of TS25.101 v3.2.0	D	3.2.2	3.3.0
RP-000204	25.101	048		R99	Correction of frequency numbering scheme	F	3.2.2	3.3.0
RP-000204	25.101	049		R99	Correction - Propagation conditions	F	3.2.2	3.3.0
RP-000204	25.101	050		R99	Compressed mode tests	F	3.2.2	3.3.0
RP-000204	25.101	051		R99	Correction of Out-of-sync criteria	F	3.2.2	3.3.0
RP-000204	25.101	052		R99	Editorial corrections for TS25.101.	F	3.2.2	3.3.0
RP-000204	25.101	053		R99	Clarification of the specification on Peak Code Domain Error (PCDE)	F	3.2.2	3.3.0
RP-000204	25.101	054		R99	Transients for uplink power steps	F	3.2.2	3.3.0
RP-000204	25.101	055		R99	Power setting for uplink compressed mode and RACH preambles	F	3.2.2	3.3.0
RP-000204	25.101	056		R99	UE interfering signal definition	F	3.2.2	3.3.0
RP-000204	25.101	057		R99	Downlink Power Control, wind up effects	F	3.2.2	3.3.0
RP-000204	25.101	058		R99	Use of P-CPICH and S-CPICH for performance requirements	F	3.2.2	3.3.0
RP-000204	25.101	059		R99	Performance of Closed Loop Diversity mode 2 and Mode 1	F	3.2.2	3.3.0
RP-000204	25.101	060		R99	Removal of brackets from Inter-Cell SHO test case	F	3.2.2	3.3.0
RP-000204	25.101	061		R99	Editorial corrections on moving propagation conditions	F	3.2.2	3.3.0
					Correct page numbering problem and other minor editorials		3.3.0	3.3.1

Table E.4: Inclusion of CRs approved by TSG-RAN#9

RAN Doc	Spec	CR	R	Ph	Subject	Cat	Curr	New
RP-000394	25.101	71		R99	Downlink power control, wind up effects	F	3.3.1	3.4.0
RP-000394	25.101	72		R99	Inclusion of OCNS definition for performance tests	F	3.3.1	3.4.0
RP-000394	25.101	63		R99	Corrections to DL compressed mode tests in TS 25.101	F	3.3.1	3.4.0
RP-000394	25.101	64		R99	Combining of TPC commands in soft handover	F	3.3.1	3.4.0
RP-000394	25.101	65		R99	Clarifications for power steps in RACH/CPCH message transmission	F	3.3.1	3.4.0
RP-000394	25.101	66		R99	Editorial corrections for TS 25.101	F	3.3.1	3.4.0
RP-000394	25.101	67		R99	Corrections to power control	F	3.3.1	3.4.0
RP-000394	25.101	68		R99	Corrections for compressed mode patterns	F	3.3.1	3.4.0
RP-000394	25.101	69		R99	Editorial modification for BTFD measurement channels	F	3.3.1	3.4.0
RP-000394	25.101	75		R99	Editorial modification to Annex A.5 of TS 25.101	F	3.3.1	3.4.0
RP-000394	25.101	76		R99	Tap magnitudes and phases for Birth-Death propagation conditions	F	3.3.1	3.4.0
RP-000394	25.101	73		R99	Removal of confidence levels	F	3.3.1	3.4.0
RP-000394	25.101	74		R99	Corrections to all tests with power control ON in TS 25.101	F	3.3.1	3.4.0
RP-000394	25.101	70		R99	Definition of period for frequency error	F	3.3.1	3.4.0
RP-000394	25.101	77		R99	UE emission mask measurement filter definition correction for TS 25.101	F	3.3.1	3.4.0
RP-000394	25.101	78		R99	Handling of measurement uncertainties in UE radio conformance testing (FDD)	F	3.3.1	3.4.0
					Re-inclusion of reference [4] which had been accidentally deleted.		3.4.0	3.4.1

Table E.5: CRs approved at RAN#10

RAN Doc	Spec	CR	R	Ph	Subject	Cat	Curr	New
R4-000885	25.101	79		R99	Proposed CR to TS 25.101 on subclause 7.8 RX Intermodulation	F	3.4.1	3.5.0
R4-000901	25.101	80		R99	Corrections to DL compressed mode tests in TS 25.101	F	3.4.1	3.5.0
R4-000902	25.101	81		R99	Correction to DL 384 kbps and BTFD measurement channels	F	3.4.1	3.5.0
R4-000917	25.101	82		R99	Compressed mode, proposal for specification	F	3.4.1	3.5.0
R4-000973	25.101	82		R99	RX spurious emissions	F	3.4.1	3.5.0
R4-000982	25.101	84		R99	Correction for 25.101 concerning the channel number calculation	F	3.4.1	3.5.0
R4-000990	25.101	85		R99	Definition of multi-code OCNS signal for receiver and performance tests	F	3.4.1	3.5.0

Table E.6: CRs approved at RAN#11

RAN Doc	Spec	CR	R	Ph	Subject	Cat	Curr	New
RP-010085	25.101	86		R99	CR to 25.101 for Test Tolerances	F	3.5.0	3.6.0
RP-010085	25.101	87		R99	Proposed CR to TS 25.101 on subclause 3.2 Abbreviations	F	3.5.0	3.6.0
RP-010085	25.101	88		R99	Correction of version number of the ITU-R Recommendation SM.329	F	3.5.0	3.6.0
RP-010085	25.101	89		R99	REL 99 Corrections	F	3.5.0	3.6.0
RP-010085	25.101	90		R99	Tx power during measurement on Rx characteristics	F	3.5.0	3.6.0
RP-010085	25.101	91		R99	Removal of square brackets and TBDs from TS 25.101	F	3.5.0	3.6.0
RP-010085	25.101	92		R99	Correction of Definition of multi-code OCNS signal	F	3.5.0	3.6.0
RP-010085	25.101	93		R99	Performance requirement for 250km/h	F	3.5.0	3.6.0
RP-010085	25.101	94		R99	TS25.101 Rel 99 Clarification of UARFCN (channel number)	F	3.5.0	3.6.0

Table E.7: Release 4 CRs approved at RAN#11

RAN Doc	Spec	CR	R	Ph	Subject	Cat	Curr	New
RP-010100	25.101	96		R4	Performance requirements BCH	B	3.6.0	4.0.0
RP-010100	25.101	97		R4	Performance requirements for paging channel	B	3.6.0	4.0.0
RP-010100	25.101	98		R4	Performance requirements for AI channel	B	3.6.0	4.0.0

Table E.8: Release 4 CRs approved at RAN#12

RAN Doc	Spec	CR	R	Ph	Title	Cat	Curr	New
RP-010347	25.101	100		Rel-4	Correction for SSDL test parameters	A	4.0.0	4.1.0
RP-010347	25.101	104		Rel-4	UL DPCCCH slot format for performance tests	A	4.0.0	4.1.0
RP-010347	25.101	108		Rel-4	Terminology for power definition	A	4.0.0	4.1.0
RP-010347	25.101	110		Rel-4	out of synchronization handling	A	4.0.0	4.1.0
RP-010347	25.101	112		Rel-4	Clarification of limits for inner loop power control	A	4.0.0	4.1.0
RP-010347	25.101	114		Rel-4	UE EVM definition	A	4.0.0	4.1.0
RP-010347	25.101	116		Rel-4	CR on the Modification to OCNS code channels to allow for 384 kbps allocation	A	4.0.0	4.1.0
RP-010358	25.101	117		Rel-4	Correction of AICH performance	F	4.0.0	4.1.0

Table E.9: Release 4 CRs approved at RAN#13

RAN Tdoc	Spec	CR	R	Ph	Title	Cat	Curr	New
RP-010614	25.101	119		Rel-4	Compressed mode, correction of reference pattern 1, Set1	A	4.1.0	4.2.0
RP-010614	25.101	121		Rel-4	DL Power Control Step Size in performance requirements	A	4.1.0	4.2.0
RP-010614	25.101	123		Rel-4	Correction for test numbers in fading propagation tests	A	4.1.0	4.2.0
RP-010614	25.101	125		Rel-4	Correction of frequency range for receiver spurious emission requirements	A	4.1.0	4.2.0
RP-010614	25.101	127		Rel-4	UE Maximum Output Power	A	4.1.0	4.2.0
RP-010614	25.101	129		Rel-4	Clarification of definition of Df	A	4.1.0	4.2.0
RP-010614	25.101	131		Rel-4	CR to TS25.101 for clarification of modulated interferer	A	4.1.0	4.2.0

Table E.10: Release 5 CR approved at RAN#13

RAN Tdoc	Spec	CR	R	Ph	Title	Cat	Curr	New	Work Item
RP-010636	25.101	132		Rel-5	Addition of UE performance requirement for CPCH	B	4.1.0	5.0.0	TEI5

Table E.11: Release 5 CRs approved at RAN#14

RAN Tdoc	Spec	CR	R	Ph	Title	Cat	Curr	New	Work Item
RP-010777	25.101	135		Rel-5	Clarification on 25.101 sec 8.8.2 averaging method.	A	5.0.0	5.1.0	TEI
RP-010777	25.101	138		Rel-5	Correction of power control in downlink, initial convergence	A	5.0.0	5.1.0	TEI
RP-010789	25.101	141		Rel-5	UMTS1800/1900 changes	B	5.0.0	5.1.0	RInImp-UMTS19, RInImp-UMTS18
RP-010790	25.101	142		Rel-5	Performance requirement for dedicated pilot	B	5.0.0	5.1.0	RANImp-BeamF

Table E.12: Release 5 CRs approved at RAN#15

RAN Tdoc	Spec	CR	R	Ph	Title	Cat	Curr	New	Work Item
RP-020039	25.101	145	1	Rel-5	Correction of Change of TFC	F	5.1.0	5.2.0	TEI5
RP-020034	25.101	148		Rel-5	Corrections to UMTS1800/1900 requirements	F	5.1.0	5.2.0	RinImp-UMTS18, RinImp-UMTS19
RP-020034	25.101	149		Rel-5	Additional spurious emission requirements for band III	B	5.1.0	5.2.0	RinImp-UMTS18
RP-020014	25.101	156	1	Rel-5	Power setting for uplink compressed mode	A	5.1.0	5.2.0	TEI
RP-020014	25.101	160		Rel-5	Correction of power terms and definitions	A	5.1.0	5.2.0	TEI
RP-020014	25.101	162		Rel-5	Correction of power spectral density	A	5.1.0	5.2.0	TEI

Table E.13: Release 5 CRs approved at RAN#16

RAN Tdoc	Spec	CR	R	Ph	Title	Cat	Curr	New	Work Item
RP-020303	25.101	164		Rel-5	Correction of ITU-R SM.329 references	F	5.2.0	5.3.0	TEI5
RP-020279	25.101	169	1	Rel-5	Control and monitoring function of UE requirement	A	5.2.0	5.3.0	TEI
RP-020279	25.101	171		Rel-5	Addition of a set of Compressed mode reference pattern 2 parameters for FDD-TDD test cases in 25.133	A	5.2.0	5.3.0	TEI
RP-020302	25.101	177		Rel-5	UE HSDPA performance requirements (fixed reference channel)	B	5.2.0	5.3.0	HSDPA-RF
RP-020279	25.101	180		Rel-5	Compressed mode performance requirements	A	5.2.0	5.3.0	TEI

Table E.14: Release 5 CRs approved at RAN#17

RAN Tdoc	Spec	CR	R	Ph	Title	Cat	Curr	New	Work Item
RP-020484	25.101	184	2	Rel-5	Requirements in case of dedicated pilot	F	5.3.0	5.4.0	RANImp-BFR-UE
RP-020495	25.101	188	2	Rel-5	Performance requirements for the HSDPA Fixed Reference Channel (FRC)	F	5.3.0	5.4.0	HSDPA-RF
RP-020484	25.101	189	1	Rel-5	Corrections to Spectrum Emission Mask	F	5.3.0	5.4.0	TEI5
RP-020484	25.101	191		Rel-5	PRACH modulation quality	F	5.3.0	5.4.0	TEI5

Table E.15: Release 5 CRs approved at RAN#18

RAN Tdoc	Spec	CR	R	Ph	Title	Cat	Curr	New	Work Item
RP-020778	25.101	195		Rel-5	Correction for TPC combining test case 1	A	5.4.0	5.5.0	TEI
RP-020803	25.101	198		Rel-5	Correction to Specified TBS for HSDPA Reference Channels	F	5.4.0	5.5.0	HSDPA-RF
RP-020803	25.101	200	1	Rel-5	Introduction of requirements for HSDPA UE categories 11 and 12	B	5.4.0	5.5.0	HSDPA-RF

Table E.16: Release 5 CRs approved at RAN#19

RAN Tdoc	Spec	CR	R	Ph	Title	Cat	Curr	New	Work Item
RP-030037	25.101	205	1	Rel-5	Phase shift due to power steps	F	5.5.0	5.6.0	TEI5
RP-030046	25.101	212	1	Rel-5	Specification of HSDPA FRC Performance for H-Sets 4 & 5	F	5.5.0	5.6.0	HSDPA-RF
RP-030046	25.101	213	1	Rel-5	Specification of HSDPA FRC Performance with Open Loop Transmit Diversity	F	5.5.0	5.6.0	HSDPA-RF
RP-030046	25.101	215	1	Rel-5	Clarification of HSDPA FRC Test Procedure on HS-SCCH Signalling Error	F	5.5.0	5.6.0	HSDPA-RF
RP-030025	25.101	219		Rel-5	The Closed Loop Timing Adjustment Mode parameter for the transmit diversity performance requirements	A	5.5.0	5.6.0	TEI
RP-030037	25.101	223		Rel-5	Correction to PRACH modulation quality	F	5.5.0	5.6.0	TEI5
RP-030025	25.101	226		Rel-5	Downlink power control during compressed mode tests	A	5.5.0	5.6.0	TEI
RP-030032	25.101	228		Rel-5	Correction to PCH demodulation test	A	5.5.0	5.6.0	TEI4

Table E.17: Release 6 CRs approved at RAN#19

RAN Tdoc	Spec	CR	R	Ph	Title	Cat	Curr	New	Work Item
RP-020300	25.101	166	1	Rel-6	FDD UE Performance Requirements	C	5.5.0	6.0.0	RInImp-UERecPerf
RP-030048	25.101	201	1	Rel-6	Addition of requirement of CSICH demodulation when CA is active.	F	5.5.0	6.0.0	TEI6

Note: CR166r1 was approved at TSG RAN #16, but put on hold until another CR to Rel-6 of this specification was produced. It was then implemented after TSG RAN #19 together with CR201r1

Table E.18: Release 6 CRs approved at RAN#20

RAN Tdoc	Spec	CR	R	Ph	Title	Cat	Curr	New	Work Item
RP-030217	25.101	232		Rel-6	Maximum input power for the UE	A	6.0.0	6.1.0	HSDPA-RF
RP-030220	25.101	234	1	Rel-6	Requirements on common channels with TX diversity	F	6.0.0	6.1.0	TEI6
RP-030207	25.101	238	1	Rel-6	Problems with "Out of sync" in Initial convergence test	A	6.0.0	6.1.0	TEI
RP-030207	25.101	243	1	Rel-6	Correction of SSDT performance requirements	A	6.0.0	6.1.0	TEI
RP-030213	25.101	245		Rel-6	Correction of TPC dynamic range in tests using DPCCH as a phase reference	A	6.0.0	6.1.0	TEI5
RP-030217	25.101	252		Rel-6	Removal of some of the FRC test cases with PA3 channel	A	6.0.0	6.1.0	HSDPA-RF
RP-030217	25.101	253		Rel-6	Specification of HSDPA CQI test	A	6.0.0	6.1.0	HSDPA-RF
RP-030217	25.101	256		Rel-6	Specification of HSDPA FRC Performance with Closed Loop Transmit Diversity	A	6.0.0	6.1.0	HSDPA-RF
RP-030217	25.101	258		Rel-6	Specification of HS-SCCH Performance	A	6.0.0	6.1.0	HSDPA-RF
RP-030217	25.101	260		Rel-6	Specification of HSDPA CQI test in fading	A	6.0.0	6.1.0	HSDPA-RF

Table E.19: Release 6 CRs approved at RAN#21

RAN Tdoc	Spec	CR	R	Ph	Title	Cat	Curr	New	Work Item
RP-030417	25.101	251	3	Rel-6	Addition of transmitter characteristics for HS-DPCCH	A	6.1.0	6.2.0	HSDPA-RF
RP-030415	25.101	264	1	Rel-6	Problems with "Out of sync" in Initial Convergence test	A	6.1.0	6.2.0	TEI
RP-030423	25.101	265	1	Rel-6	UE blocking requirements	F	6.1.0	6.2.0	TEI6
RP-030423	25.101	267	1	Rel-6	Spurious Emission in GSM bands	F	6.1.0	6.2.0	TEI6
RP-030418	25.101	270		Rel-6	Correction of CR 160 implementation for Correction of power terms and definitions	A	6.1.0	6.2.0	TEI5
RP-030515	25.101	271	1	Rel-6	Frequency bands for UMTS1.7/2.1, UMTS800 and UMTS850	B	6.1.0	6.2.0	RInImp-UMTS850, RInImp-UMTS800, RInImp-UMTS1721

Table E.20: Release 6 CRs approved at RAN#22

RAN Tdoc	Spec	CR	R	Ph	Title	Cat	Curr	New	Workitem
RP-030720	25.101	274	2	Rel-6	SML definition	F	6.2.0	6.3.0	TEI6
RP-030596	25.101	278		Rel-6	Correction of references to ITU recommendations	A	6.2.0	6.3.0	TEI5
RP-030605	25.101	280	1	Rel-6	DS-CDMA Introduction in the 800 MHz Band	B	6.2.0	6.3.0	RInImp-UMTS800
RP-030608	25.101	281		Rel-6	Specification of HSDPA FRC Performance for H-Set 6	F	6.2.0	6.3.0	HSDPA-RF
RP-030608	25.101	282	1	Rel-6	Specification of HS-SCCH Performance with Open Loop Transmit Diversity	F	6.2.0	6.3.0	HSDPA-RF
RP-030608	25.101	284	1	Rel-6	Specification of CQI Testing for UE Capability Categories 11, 12 and 1-6 in Open and Closed Loop Transmit Diversities	F	6.2.0	6.3.0	HSDPA-RF
RP-030608	25.101	285	1	Rel-6	Specification of CQI Testing for UE Capability Categories 7 and 8	F	6.2.0	6.3.0	HSDPA-RF
RP-030604	25.101	286	2	Rel-6	Introduction of UMTS 850 requirements	B	6.2.0	6.3.0	RInImp-UMTS850
RP-030607	25.101	294		Rel-6	New Compressed Mode Reference Pattern	F	6.2.0	6.3.0	TEI6
RP-030595	25.101	297	3	Rel-6	Clarification to HSDPA OCNS definition	A	6.2.0	6.3.0	HSDPA-RF
RP-030595	25.101	302		Rel-6	Power allocation for HS-SCCH in FRC test	A	6.2.0	6.3.0	HSDPA-RF
RP-030595	25.101	303		Rel-6	Corrections of CQI reporting section	A	6.2.0	6.3.0	HSDPA-RF
RP-030595	25.101	304		Rel-6	Correction for FRC test in Closed loop mode 1	A	6.2.0	6.3.0	HSDPA-RF
RP-030595	25.101	305		Rel-6	DTX handling for CQI test in fading channel	A	6.2.0	6.3.0	HSDPA-RF
RP-030590	25.101	307		Rel-6	Correction of W-CDMA modulated interferer definition	A	6.2.0	6.3.0	TEI
RP-030603	25.101	308		Rel-6	Introduction of new channel arrangement for bands IV, V and VI	B	6.2.0	6.3.0	RInImp-UMTS850, UMTS800,UMTS1721
RP-030595	25.101	309	1	Rel-6	Additional Specification of CQI Testing for UE Capability Categories 11 and 12	A	6.2.0	6.3.0	HSDPA-RF
RP-030605	25.101	314		Rel-6	DS CDMA introduction in the 800 MHz band (performance requirement in Band VI)	B	6.2.0	6.3.0	RInImp-UMTS800
RP-030605	25.101	315		Rel-6	DS CDMA introduction in the 800 MHz band (Addition of spurious emissions requirement)	B	6.2.0	6.3.0	RInImp-UMTS800
RP-030607	25.101	316		Rel-6	Additional spurious emission requirements for Band II to protect UMTS850	F	6.2.0	6.3.0	TEI6
RP-030607	25.101	317		Rel-6	Clarification of UE blocking definition	F	6.2.0	6.3.0	TEI6

Table E.21: Release 6 CRs approved at RAN#23

RAN Tdoc	Spec	CR	R	Ph	Title	Cat	Curr	New	Work Item
RP-040039	25.101	324		Rel-6	Introduction of UMTS 1.7/2.1 GHz requirements	B	6.3.0	6.4.0	RInImp-UMTS1721
RP-040042	25.101	325		Rel-6	Additional spurious emission requirements for Bands II and V to protect 1.7/2.1 GHz	F	6.3.0	6.4.0	TEI6
RP-040042	25.101	326		Rel-6	Additional spurious emission requirements for Band I to protect UMTS800	F	6.3.0	6.4.0	TEI6
RP-040036	25.101	328		Rel-6	Clarification of frequency error observation period for PRACH preambles	A	6.3.0	6.4.0	TEI5
RP-040042	25.101	329	1	Rel-6	Clarification to Power on/off time mask diagram	F	6.3.0	6.4.0	TEI6
RP-040043	25.101	331		Rel-6	Reduction of channel number for UMTS800(band VI)	F	6.3.0	6.4.0	RInImp-UMTS800
RP-040036	25.101	334		Rel-6	Minimum requirements for UE ACS	A	6.3.0	6.4.0	TEI5
RP-040044	25.101	338	1	Rel-6	Minimum requirements for TPC combining in soft Handover	A	6.3.0	6.4.0	TEI

Table E.22: Release 6 CRs approved at RAN#25

RAN Tdoc	Spec	CR	R	Ph	Title	Cat	Curr	New	Work Item
RP-040291	25.101	342	2	Rel-6	UE maximum output power with HS-DPCCH	A	6.4.0	6.5.0	HSDPA-RF
RP-040291	25.101	344	3	Rel-6	Correction of maximum allowed power and range in TFC selection with HS-DPCCH and other clarifications	F	6.4.0	6.5.0	HSDPA-RF
RP-040292	25.101	346	1	Rel-6	Correction in the Band V (850MHz) additional frequency channel - UARFCN	F	6.4.0	6.5.0	RInImp-UMTS850
RP-040288	25.101	352		Rel-6	Clarification of test parameter of reliable TPC command combining	F	6.4.0	6.5.0	TEI6
RP-040292	25.101	353		Rel-6	Frequency range correction of out-of-band blocking for Band IV	F	6.4.0	6.5.0	RInImp-UMTS1721
RP-040288	25.101	354	1	Rel-6	UE maximum input level for HS-PDSCH	F	6.4.0	6.5.0	TEI6, HSDPA-RF
RP-040288	25.101	358		Rel-6	Clarification to change of TFC and compressed mode time mask diagrams	F	6.4.0	6.5.0	TEI6
RP-040284	25.101	361		Rel-6	Clarification of HS-DSCH level	A	6.4.0	6.5.0	HSDPA-RF
RP-040284	25.101	363	1	Rel-6	Correction to OCNS code allocation for HSDPA testing	A	6.4.0	6.5.0	HSDPA-RF
RP-040287	25.101	364	1	Rel-6	Specification of enhanced performance requirements for HSDPA based on receiver diversity	B	6.4.0	6.5.0	RInImp-HSPerf-RxDiv
RP-040384	25.101	365		Rel-6	UE maximum output power for HSDPA-only terminal	B	6.4.0	6.5.0	EDCH-RF

Table E.23: Release 6 CRs approved at RAN#26

RAN Tdoc	Spec	CR	R	Ph	Title	Cat	Curr	New	Work Item
RP-040412	25.101	368	1	Rel-6	Correction to Windup testcase	F	6.5.0	6.6.0	TEI6
RP-040414	25.101	373	2	Rel-6	Corrections to 7.4.2 maximum input level for HS-PDSCH reception	F	6.5.0	6.6.0	HSDPA-RF
RP-040414	25.101	377	1	Rel-6	Corrections to 9.3 reporting of CQI	F	6.5.0	6.6.0	HSDPA-RF
RP-040414	25.101	379	2	Rel-6	Corrections to 9.4 detection of HS-SCCH	F	6.5.0	6.6.0	HSDPA-RF
RP-040414	25.101	383	3	Rel-6	H Set-4/5 pattern length	F	6.5.0	6.6.0	HSDPA-RF
RP-040406	25.101	385	1	Rel-6	Omissions in 7.6 (Blocking)	A	6.5.0	6.6.0	TEI5
RP-040534	25.101	386		Rel-6	Enhanced performance requirement on FRC throughput for PA3 cases	B	6.5.0	6.6.0	RInImp-HSPerf-RxDiv

Table E.24: Release 6 CRs approved at RAN#27

RAN Tdoc	Spec	CR	R	Ph	Title	Cat	Curr	New	Work Item
RP-050040	25.101	391		Rel-6	Specification of enhanced performance requirements for HS-SCCH with open loop diversity based on receiver diversity	B	6.6.0	6.7.0	RInImp-HSPerf-RxDiv
RP-050040	25.101	392		Rel-6	Modification of enhanced performance requirements for HS-SCCH based on receiver diversity	C	6.6.0	6.7.0	RInImp-HSPerf-RxDiv
RP-050038	25.101	396		Rel-6	Removal of TGPL2	C	6.6.0	6.7.0	TEI5
RP-050041	25.101	397		Rel-6	Minimum performance for constant BLER testcases	F	6.6.0	6.7.0	TEI6
RP-050040	25.101	400	1	Rel-6	Clarification of mapping of HS-DSCH requirements	F	6.6.0	6.7.0	RInImp-HSPerf-RxDiv
RP-050041	25.101	401	1	Rel-6	OCNS definition for transmit diversity	F	6.6.0	6.7.0	TEI6
RP-050041	25.101	402		Rel-6	Corrections to 9.2 demodulation of HS-DSCH	F	6.6.0	6.7.0	TEI6, HSDPA-RF
RP-050039	25.101	404	2	Rel-6	HS-DPCCH time mask requirements	A	6.6.0	6.7.0	HSDPA-RF
RP-050041	25.101	406		Rel-6	Update UMTS FDD Receiver Blocking Specifications	F	6.6.0	6.7.0	TEI6
RP-050040	25.101	407	1	Rel-6	Enhanced performance requirements for HSDPA cat 7 & 8 capable receivers	B	6.6.0	6.7.0	RInImp-HSPerf-RxDiv

History

Document history		
V6.3.0	December 2003	Publication
V6.4.0	May 2004	Publication
V6.5.0	September 2004	Publication
V6.6.0	December 2004	Publication
V6.7.0	March 2005	Publication