

# ETSI TS 125 102 V7.18.0 (2010-10)

---

*Technical Specification*

**Universal Mobile Telecommunications System (UMTS);  
User Equipment (UE) radio transmission and reception (TDD)  
(3GPP TS 25.102 version 7.18.0 Release 7)**



---

**Reference**RTS/TSGR-0425102v710

---

**Keywords**UMTS

---

**ETSI**

---

650 Route des Lucioles  
F-06921 Sophia Antipolis Cedex - FRANCE

---

Tel.: +33 4 92 94 42 00 Fax: +33 4 93 65 47 16

Siret N° 348 623 562 00017 - NAF 742 C  
Association à but non lucratif enregistrée à la  
Sous-Préfecture de Grasse (06) N° 7803/88

---

**Important notice**

---

Individual copies of the present document can be downloaded from:

<http://www.etsi.org>

The present document may be made available in more than one electronic version or in print. In any case of existing or perceived difference in contents between such versions, the reference version is the Portable Document Format (PDF). In case of dispute, the reference shall be the printing on ETSI printers of the PDF version kept on a specific network drive within ETSI Secretariat.

Users of the present document should be aware that the document may be subject to revision or change of status. Information on the current status of this and other ETSI documents is available at <http://portal.etsi.org/tb/status/status.asp>

If you find errors in the present document, please send your comment to one of the following services:

[http://portal.etsi.org/chaicor/ETSI\\_support.asp](http://portal.etsi.org/chaicor/ETSI_support.asp)

---

**Copyright Notification**

---

No part may be reproduced except as authorized by written permission.  
The copyright and the foregoing restriction extend to reproduction in all media.

© European Telecommunications Standards Institute 2010.  
All rights reserved.

**DECT™**, **PLUGTESTS™**, **UMTS™**, **TIPHON™**, the TIPHON logo and the ETSI logo are Trade Marks of ETSI registered for the benefit of its Members.

**3GPP™** is a Trade Mark of ETSI registered for the benefit of its Members and of the 3GPP Organizational Partners.

**LTE™** is a Trade Mark of ETSI currently being registered for the benefit of its Members and of the 3GPP Organizational Partners.

**GSM®** and the GSM logo are Trade Marks registered and owned by the GSM Association.

---

## Intellectual Property Rights

IPRs essential or potentially essential to the present document may have been declared to ETSI. The information pertaining to these essential IPRs, if any, is publicly available for **ETSI members and non-members**, and can be found in ETSI SR 000 314: *"Intellectual Property Rights (IPRs); Essential, or potentially Essential, IPRs notified to ETSI in respect of ETSI standards"*, which is available from the ETSI Secretariat. Latest updates are available on the ETSI Web server (<http://webapp.etsi.org/IPR/home.asp>).

Pursuant to the ETSI IPR Policy, no investigation, including IPR searches, has been carried out by ETSI. No guarantee can be given as to the existence of other IPRs not referenced in ETSI SR 000 314 (or the updates on the ETSI Web server) which are, or may be, or may become, essential to the present document.

---

## Foreword

This Technical Specification (TS) has been produced by ETSI 3rd Generation Partnership Project (3GPP).

The present document may refer to technical specifications or reports using their 3GPP identities, UMTS identities or GSM identities. These should be interpreted as being references to the corresponding ETSI deliverables.

The cross reference between GSM, UMTS, 3GPP and ETSI identities can be found under <http://webapp.etsi.org/key/queryform.asp>.

# Contents

Intellectual Property Rights .....	2
Foreword.....	2
Foreword.....	10
1 Scope .....	11
2 References .....	11
3 Definitions, symbols and abbreviations .....	11
3.1 Definitions .....	11
3.2 (void).....	12
3.3 Abbreviations .....	12
4 General .....	13
4.1 Relationship between Minimum Requirements and Test Requirements .....	13
4.2 Power Classes.....	14
4.3 Control and monitoring functions .....	14
4.3.1 Minimum requirement .....	14
4.3.2 RF requirements in later releases .....	14
5 Frequency bands and channel arrangement.....	14
5.1 General .....	14
5.2 Frequency bands.....	14
5.3 TX-RX frequency separation .....	15
5.3.1 3.84 Mcps TDD Option .....	15
5.3.2 1.28 Mcps TDD Option .....	15
5.3.3 7.68 Mcps TDD Option .....	15
5.4 Channel arrangement.....	15
5.4.1 Channel spacing.....	15
5.4.1.1 3.84 Mcps TDD Option.....	15
5.4.1.2 1.28 Mcps TDD Option.....	15
5.4.1.3 7.68 Mcps TDD Option.....	15
5.4.2 Channel raster .....	15
5.4.2.1 3.84 Mcps TDD Option.....	15
5.4.3 Channel number .....	15
5.4.4 UARFCN .....	16
5.4.4.1 3.84 Mcps TDD Option.....	16
5.4.4.2 1.28 Mcps TDD Option.....	16
5.4.4.3 7.68 Mcps TDD Option.....	17
6 Transmitter characteristics .....	17
6.1 General .....	17
6.2 Transmit power .....	17
6.2.1 User Equipment maximum output power .....	17
6.2.1.1 3.84 Mcps TDD option .....	17
6.2.1.2 1.28 Mcps TDD option .....	18
6.2.1.3 7.68 Mcps TDD option .....	18
6.2.2 UE maximum output power with E-DCH.....	18
6.2.2.1 3.84 Mcps TDD option .....	18
6.2.2.2 1.28 Mcps TDD option .....	18
6.2.2.3 7.68 Mcps TDD option .....	19
6.2.3 UE maximum output power with multi-code .....	19
6.2.3.1 1.28 Mcps TDD option .....	19
6.3 UE frequency stability.....	19
6.4 Output power dynamics.....	20
6.4.1 Power control.....	20
6.4.1.1 3.84 Mcps option.....	20
6.4.1.1.1 Initial Accuracy .....	20

6.4.1.1.2	Differential accuracy, controlled input .....	20
6.4.1.1.3	Differential accuracy, measured input.....	20
6.4.1.2	1.28 Mcps TDD Option.....	20
6.4.1.2.1	Open loop power control .....	20
6.4.1.2.2	Closed loop power control.....	21
6.4.1.3	7.68 Mcps option.....	21
6.4.1.3.1	Initial Accuracy .....	22
6.4.1.3.2	Differential accuracy, controlled input .....	22
6.4.1.3.3	Differential accuracy, measured input .....	22
6.4.2	Minimum output power .....	22
6.4.2.1	Minimum requirement .....	22
6.4.2.1.1	3.84 Mcps TDD Option.....	22
6.4.2.1.2	1.28 Mcps TDD Option.....	22
6.4.2.1.3	7.68 Mcps TDD Option.....	22
6.4.3	Out-of-synchronisation handling of output power .....	23
6.4.3.1	Requirement for continuous transmission .....	23
6.4.3.1.1	3.84 Mcps TDD Option.....	23
6.4.3.1.1.1	Minimum requirement .....	23
6.4.3.1.2	1.28 Mcps TDD Option.....	24
6.4.3.1.2.1	Minimum Requirement.....	24
6.4.3.1.3	7.68 Mcps TDD Option.....	26
6.4.3.1.3.1	Minimum requirement .....	26
6.4.3.2	Requirement for discontinuous transmission .....	27
6.4.3.2.1	3.84 Mcps TDD Option.....	27
6.4.3.2.1.1	Minimum Requirement.....	27
6.4.3.2.2	1.28 Mcps TDD Option.....	29
6.4.3.2.2.1	Minimum Requirement.....	29
6.4.3.2.3	7.68 Mcps TDD Option.....	31
6.4.3.2.3.1	Minimum Requirement.....	31
6.5	Transmit ON/OFF power .....	33
6.5.1	Transmit OFF power.....	33
6.5.1.1	Minimum Requirement .....	33
6.5.2	Transmit ON/OFF Time mask .....	33
6.5.2.1	Minimum Requirement .....	34
6.5.2.1.1	3.84 Mcps TDD Option.....	34
6.5.2.1.2	1.28 Mcps TDD Option.....	34
6.5.2.1.3	7.68 Mcps TDD Option.....	34
6.6	Output RF spectrum emissions.....	35
6.6.1	Occupied bandwidth .....	35
6.6.1.1	3.84 Mcps TDD Option.....	35
6.6.1.2	1.28 Mcps TDD Option.....	35
6.6.1.3	7.68 Mcps TDD Option.....	35
6.6.2	Out of band emission .....	35
6.6.2.1	Spectrum emission mask .....	35
6.6.2.1.1	3.84 Mcps TDD Option.....	35
6.6.2.1.2	1.28 Mcps TDD Option.....	36
6.6.2.1.3	7.68 Mcps TDD Option.....	37
6.6.2.2	Adjacent Channel Leakage power Ratio (ACLR).....	37
6.6.2.2.1	Minimum requirement.....	37
6.6.2.2.1.1	3.84 Mcps TDD Option .....	37
6.6.2.2.1.2	1.28 Mcps TDD Option .....	38
6.6.2.2.1.3	7.68 Mcps TDD Option .....	38
6.6.3	Spurious emissions .....	38
6.6.3.1	Minimum Requirement .....	38
6.6.3.1.1	3.84 Mcps TDD Option.....	38
6.6.3.1.2	1.28 Mcps TDD Option.....	39
6.6.3.1.3	7.68 Mcps TDD Option.....	39
6.7	Transmit intermodulation .....	40
6.7.1	Minimum requirement .....	40
6.7.1.1	3.84 Mcps TDD Option.....	40
6.7.1.2	1.28 Mcps TDD Option.....	40
6.7.1.3	7.68 Mcps TDD Option.....	41

6.8	Transmit Modulation.....	41
6.8.1	Transmit pulse shape filter.....	41
6.8.2	Error Vector Magnitude.....	41
6.8.2.1	Minimum Requirement.....	41
6.8.3	Peak Code Domain Error.....	41
6.8.3.1	Minimum Requirement.....	42
7	Receiver characteristics.....	42
7.1	General.....	42
7.2	Diversity characteristics.....	42
7.3	Reference sensitivity level.....	43
7.3.1	Minimum Requirements.....	43
7.3.1.1	3.84 Mcps TDD Option.....	43
7.3.1.2	1.28 Mcps TDD Option.....	43
7.3.1.3	7.68 Mcps TDD Option.....	43
7.3.2	Additional requirement of multi-carrier reception for 1.28Mcps TDD Option.....	43
7.4	Maximum input level.....	44
7.4.1	Minimum Requirements for DPCCH reception.....	44
7.4.1.1	3.84 Mcps TDD Option.....	44
7.4.1.2	1.28 Mcps TDD Option.....	44
7.4.1.3	7.68 Mcps TDD Option.....	44
7.4.2	Minimum Requirements for HS-PDSCH reception.....	45
7.4.2.1	3.84 Mcps TDD Option.....	45
7.4.2.2	1.28 Mcps TDD Option.....	45
7.5	Adjacent Channel Selectivity (ACS).....	45
7.5.1	Minimum Requirement.....	45
7.5.1.1	3.84 Mcps TDD Option.....	45
7.5.1.2	1.28 Mcps TDD Option.....	46
7.5.1.3	7.68 Mcps TDD Option.....	46
7.5.2	Additional requirement of multi-carrier reception for 1.28Mcps TDD Option.....	46
7.6	Blocking characteristics.....	47
7.6.1	Minimum Requirement.....	47
7.6.1.1	3.84 Mcps TDD Option.....	47
7.6.1.2	1.28 Mcps TDD Option.....	48
7.6.1.3	7.68 Mcps TDD Option.....	49
7.6.2	Additional requirement of multi-carrier reception for 1.28Mcps TDD Option.....	51
7.7	Spurious response.....	52
7.7.1	Minimum Requirement.....	52
7.7.1.1	3.84 Mcps TDD Option.....	52
7.7.1.2	1.28 Mcps TDD Option.....	52
7.7.1.3	7.68 Mcps TDD Option.....	52
7.7.2	Additional requirement of multi-carrier reception for 1.28Mcps TDD Option.....	53
7.8	Intermodulation characteristics.....	53
7.8.1	Minimum Requirements.....	53
7.8.1.1	3.84 Mcps TDD Option.....	53
7.8.1.2	1.28 Mcps TDD Option.....	54
7.8.1.3	7.68 Mcps TDD Option.....	54
7.8.2	Additional requirement of multi-carrier reception for 1.28Mcps TDD Option.....	54
7.9	Spurious emissions.....	54
7.9.1	Minimum Requirement.....	55
7.9.1.1	3.84 Mcps TDD Option.....	55
7.9.1.2	1.28 Mcps TDD Option.....	55
7.9.1.3	7.68 Mcps TDD Option.....	55
8	Performance requirement.....	56
8.1	General.....	56
8.2	Demodulation in static propagation conditions.....	56
8.2.1	Demodulation of DCH.....	56
8.2.1.1	Minimum requirement.....	56
8.2.1.1.1	3.84 Mcps TDD Option.....	56
8.2.1.1.2	1.28 Mcps TDD Option.....	57
8.2.1.1.3	7.68 Mcps TDD Option.....	58

8.3	Demodulation of DCH in multipath fading conditions .....	58
8.3.1	Multipath fading Case 1 .....	58
8.3.1.1	Minimum requirement .....	58
8.3.1.1.1	3.84 Mcps TDD Option .....	58
8.3.1.1.2	1.28 Mcps TDD Option .....	59
8.3.1.1.3	7.68 Mcps TDD Option .....	59
8.3.2	Multipath fading Case 2 .....	60
8.3.2.1	Minimum requirement .....	60
8.3.2.1.1	3.84 Mcps TDD Option .....	60
8.3.2.1.2	1.28 Mcps TDD Option .....	61
8.3.2.1.3	7.68 Mcps TDD Option .....	61
8.3.3	Multipath fading Case 3 .....	62
8.3.3.1	Minimum requirement .....	62
8.3.3.1.1	3.84 Mcps TDD Option .....	62
8.3.3.1.1	1.28 Mcps TDD Option .....	63
8.3.3.1.3	7.68 Mcps TDD Option .....	64
8.4	Base station transmit diversity mode for 3.84 Mcps TDD Option .....	64
8.4.1	Demodulation of BCH in SCTD mode .....	64
8.4.1.1	Minimum requirement .....	64
8.5	Power control in downlink .....	65
8.5.1	Power control in downlink, constant BLER target .....	65
8.5.1.1	Minimum requirements 3.84 Mcps TDD option .....	65
8.5.1.2	Minimum requirements 1.28 Mcps TDD option .....	65
8.6	Uplink Power Control for 3.84 Mcps TDD Option .....	66
8.6.1	Test Conditions .....	66
8.6.2	Performance .....	67
8.7	Demodulation of DCH in moving conditions .....	68
8.7.1	Minimum requirement .....	68
8.7.1.1	3.84 Mcps TDD Option .....	68
8.7.1.2	1.28 Mcps TDD Option .....	68
8.7.1.3	7.68 Mcps TDD Option .....	68
8.8	Demodulation of DCH in birth-death conditions .....	68
8.8.1	Minimum requirement .....	69
8.8.1.1	3.84 Mcps TDD Option .....	69
8.8.1.2	1.28 Mcps TDD Option .....	69
8.8.1.3	7.68 Mcps TDD Option .....	69
9	Performance requirements (HSDPA) .....	69
9.1	Performance requirement for 3.84 Mcps TDD option .....	69
9.1.1	HS-DSCH throughput for fixed reference channels .....	69
9.1.1.1	Minimum requirement QPSK, Fixed Reference Channel, 7,3 Mbps – Category 8 – UE .....	70
9.1.1.2	Minimum requirement 16QAM, Fixed Reference Channel, 7,3 Mbps – Category 8 – UE .....	70
9.1.2	HS-DSCH throughput for Variable Reference Channels .....	71
9.1.2.1	Minimum requirement Variable Reference Channel, 7,3 Mbps – Category 8 – UE .....	71
9.1.3	Reporting of Channel Quality Indicator .....	72
9.1.3.1	Minimum requirement Channel Quality Indicator, 7,3 Mbps – Category 8 – UE .....	72
9.1.4	HS-SCCH Detection Performance .....	73
9.1.4.1	Minimum Requirements for HS-SCCH Detection .....	73
9.2	Performance requirements for 1.28 Mcps TDD option .....	74
9.2.1	HS-DSCH throughput for fixed reference channels .....	74
9.2.1.1	Category 1, 0.5Mbps UE class .....	74
9.2.1.2	Category 4, 1.1Mbps UE class .....	75
9.2.1.3	Category 7, 1.6Mbps UE class .....	76
9.2.1.4	Category 10, 2.2Mbps UE class .....	77
9.2.1.5	Category 13, 2.8Mbps UE class .....	78
9.2.2	HS-DSCH throughput for Variable Reference Channels .....	79
9.2.2.1	Category 1, 0.5Mbps UE class .....	79
9.2.2.2	Category 4, 1.1Mbps UE class .....	80
9.2.2.3	Category 7, 1.6Mbps UE class .....	81
9.2.2.4	Category 10, 2.2 Mbps UE class .....	82
9.2.2.5	Category 13, 2.8 Mbps UE class .....	83
9.2.3	Reporting of Channel Quality Indicator .....	84

9.2.3.1	Minimum Requirement, Channel Quality Indicator.....	84
9.2.4	HS-SCCH Detection Performance.....	85
9.2.4.1	Minimum Requirements for HS-SCCH Detection.....	85
9.2.5	PLCCH Detection Performance.....	86
9.2.5.1	Minimum Requirements.....	86
9.3	Performance requirement for 7.68 Mcps TDD option.....	87
9.3.1	HS-DSCH throughput for fixed reference channels.....	87
9.3.1.1	Minimum requirement QPSK, Fixed Reference Channel, 5,3 Mbps – Category 8 – UE.....	87
9.3.1.2	Minimum requirement 16 QAM, Fixed Reference Channel, 5,3 Mbps – Category 8 – UE.....	88
9.3.2	(void).....	89
9.3.3	(void).....	89
9.3.4	HS-SCCH Detection Performance.....	89
9.3.4.1	Minimum Requirements for HS-SCCH Detection.....	89
10	Performance requirements (MBMS).....	90
10.1	Demodulation of MCCH.....	90
10.1.1	Minimum requirement.....	90
10.1.1.1	3.84 Mcps TDD Option.....	90
10.1.1.2	1.28 Mcps TDD Option.....	91
10.1.1.3	7.68 Mcps TDD Option.....	91
10.1.2	MBSFN capable UE.....	91
10.1.2.1	3.84 Mcps TDD Option.....	92
10.1.2.2	1.28 Mcps TDD Option.....	92
10.1.2.3	7.68 Mcps TDD Option.....	93
10.2	Demodulation of MTCH.....	93
10.2.1	Minimum requirement.....	93
10.2.1.1	3.84 Mcps TDD Option.....	93
10.2.1.2	1.28 Mcps TDD Option.....	94
10.2.1.3	7.68 Mcps TDD Option.....	94
10.2.2	MBSFN capable UE.....	95
10.2.2.1	3.84 Mcps TDD Option.....	95
10.2.2.2	1.28 Mcps TDD Option.....	95
10.2.2.3	7.68 Mcps TDD Option.....	96
10.2.3	MBSFN TDD & FDD same platform sharing.....	97
10.2.3.1	3.84 Mcps TDD Option.....	97
10.2.3.2	(void).....	97
10.2.3.3	7.68 Mcps TDD Option.....	97
10.3	Demodulation of MTCH and cell identification.....	98
10.3.1	Minimum requirement.....	98
10.3.1.1	(void).....	98
10.3.1.2	1.28 Mcps TDD Option.....	98
11	Performance requirement (E-DCH).....	99
11.1	Detection of E-DCH HARQ ACK Indicator Channel (E-HICH).....	99
11.1.1	Minimum requirement.....	99
11.1.1.1	3.84 Mcps TDD Option.....	99
11.1.1.2	1.28 Mcps TDD Option.....	99
11.1.1.3	7.68 Mcps TDD Option.....	100
11.2	Demodulation of E-DCH Absolute Grant Channel (E-AGCH).....	100
11.2.1	Minimum requirement.....	100
11.2.1.1	3.84 Mcps TDD Option.....	100
11.2.1.2	1.28 Mcps TDD Option.....	101
11.2.1.3	7.68 Mcps TDD Option.....	101
<b>Annex A (normative): Measurement channels.....</b>		<b>103</b>
A.1	(void).....	103
A.2	Reference measurement channel.....	103
A.2.1	UL reference measurement channel (12.2 kbps).....	103
A.2.1.1	3.84 Mcps TDD Option.....	103
A.2.1.2	1.28 Mcps TDD Option.....	104
A.2.1.3	7.68 Mcps TDD Option.....	106



A.2.2	DL reference measurement channel (12.2 kbps) .....	107
A.2.2.1	3.84 Mcps TDD Option .....	107
A.2.2.2	1.28 Mcps TDD Option .....	108
A.2.2.3	7.68 Mcps TDD Option .....	109
A.2.3	DL reference measurement channel (64 kbps) .....	110
A.2.3.1	3.84 Mcps TDD Option .....	110
A.2.3.2	1.28 Mcps TDD Option .....	111
A.2.3.3	7.68 Mcps TDD Option .....	112
A.2.4	DL reference measurement channel (144 kbps) .....	113
A.2.4.1	3.84 Mcps TDD Option .....	113
A.2.4.2	1.28 Mcps TDD Option .....	115
A.2.4.3	7.68 Mcps TDD Option .....	116
A.2.5	DL reference measurement channel (384 kbps) .....	118
A.2.5.1	3.84 Mcps TDD Option .....	118
A.2.5.2	1.28 Mcps TDD Option .....	120
A.2.5.3	7.68 Mcps TDD Option .....	121
A.2.6	BCH reference measurement channel .....	122
A.2.6.1	3.84 Mcps TDD Option .....	122
A.2.6.2	1.28 Mcps TDD Option .....	123
A.2.6.3	7.68 Mcps TDD Option .....	123
A.2.7	UL multi code reference measurement channel (12.2 kbps) .....	124
A.2.7.1	3.84 Mcps TDD Option .....	124
A.2.7.2	1.28 Mcps TDD Option .....	125
A.2.7.3	7.68 Mcps TDD Option .....	126
A.2.8	DL reference measurement channel (2 Mbps).....	128
A.2.8.1	3.84 Mcps TDD Option .....	128
A.2.8.2	1.28 Mcps TDD Option .....	130
A.2.8.3	7.68 Mcps TDD Option .....	131
A.2.9	DL reference measurement channel (12.2 kbps) for MBSFN only UEs .....	133
A.2.9.1	3.84 Mcps TDD Option .....	133
A.2.9.2	VOID .....	134
A.2.9.3	7.68 Mcps TDD Option .....	134
A.3	HSDPA reference measurement channels.....	136
A.3.1	HSDPA reference measurement channels for 3,84 Mcps TDD option .....	136
A.3.1.1	Reference measurement channels for 7,3 Mbps – Category 8 – UE.....	136
A.3.1.1.1	QPSK modulation scheme for test 1, 2, 3 .....	136
A.3.1.1.2	QPSK modulation scheme for test 4 .....	137
A.3.1.1.3	16QAM modulation scheme for test 1, 2, 3 .....	138
A.3.1.1.4	16QAM modulation scheme for test 4 .....	139
A.3.2	HSDPA reference measurement channels for 1.28 Mcps TDD option .....	140
A.3.2.1	Reference measurement channels for 0.5 Mbps UE class .....	140
A.3.2.1.1	QPSK modulation scheme .....	140
A.3.2.2	Reference measurement channels for 1.1 Mbps UE class .....	141
A.3.2.2.1	QPSK modulation scheme .....	141
A.3.2.2.2	16QAM modulation scheme .....	141
A.3.2.3	Reference measurement channels for 1.6 Mbps UE class .....	142
A.3.2.3.1	QPSK modulation scheme .....	142
A.3.2.3.2	16QAM modulation scheme .....	143
A.3.2.4	Reference measurement channels for 2.2 Mbps UE class .....	144
A.3.2.4.1	QPSK modulation scheme .....	144
A.3.2.4.2	16QAM modulation scheme .....	145
A.3.2.5	Reference measurement channels for 2.8 Mbps UE class .....	146
A.3.2.5.1	QPSK modulation scheme .....	146
A.3.2.5.2	16QAM modulation scheme .....	147
A.3.2.6	PLCCH reference measurement channel .....	148
A.3.2.7	Reference measurement channel of 48kbps.....	149
A.3.2.8	Reference Measurement Channel of HS-SICH.....	150
A.3.2A	HSDPA reference measurement channels for 7,68 Mcps TDD option .....	151
A.3.2A.1	Reference measurement channels for 5,3 Mbps – Category 8 – UE.....	151
A.3.2A.1.1	QPSK modulation scheme for test 1, 2, 3 & 4 .....	151
A.3.2A.1.2	16QAM modulation scheme for test 1, 2, 3 & 4 .....	152

A.3.3	Variable Reference Channel definition for 3,84 Mcps and 1,28 Mcps TDD options.....	152
A.4	Downlink reference parameter for MBMS tests .....	153
A.4.1	MCCH .....	153
A.4.1.1	3.84 Mcps TDD Option .....	153
A.4.1.2	1.28 Mcps TDD Option .....	153
A.4.1.3	7.68 Mcps TDD Option .....	154
A.4.2	MTCH .....	155
A.4.2.1	3.84 Mcps TDD Option .....	155
A.4.2.2	1.28 Mcps TDD Option .....	155
A.4.2.3	7.68 Mcps TDD Option .....	156
A.5	HSUPA reference measurement channels for 1.28Mcps TDD option .....	157
A.5.1	Fixed reference channel 1(FRC1) for 16QM.....	157
<b>Annex B (normative): Propagation conditions.....</b>		<b>159</b>
B.1	Static propagation condition.....	159
B.2	Multi-path fading propagation conditions .....	159
B.2.1	3.84 Mcps TDD Option.....	159
B.2.2	1.28 Mcps TDD Option.....	161
B.2.3	7.68 Mcps TDD Option.....	163
B.3	Moving propagation conditions.....	165
B.4	Birth-Death propagation conditions .....	166
<b>Annex C (normative) : Environmental conditions .....</b>		<b>167</b>
C.1	General .....	167
C.2	Environmental requirements for the UE .....	167
C.2.1	Temperature .....	167
C.2.2	Voltage .....	167
C.2.3	Vibration.....	168
<b>Annex D (informative): Terminal capabilities (TDD) .....</b>		<b>169</b>
<b>Annex E (informative): Change history .....</b>		<b>170</b>
History .....		173

---

# Foreword

This Technical Specification has been produced by the 3GPP.

The contents of the present document are subject to continuing work within the TSG and may change following formal TSG approval. Should the TSG modify the contents of this TS, it will be re-released by the TSG with an identifying change of release date and an increase in version number as follows:

Version 3.y.z

where:

x the first digit:

- 1 presented to TSG for information;
- 2 presented to TSG for approval;
- 3 Indicates TSG approved document under change control.

Y the second digit is incremented for all changes of substance, i.e. technical enhancements, corrections, updates, etc.

z the third digit is incremented when editorial only changes have been incorporated in the specification;

---

# 1 Scope

This document establishes the minimum RF characteristics of all three options of the TDD mode of UTRA. The three options are the 3.84 Mcps, 1.28 Mcps and 7.68 Mcps options respectively. The requirements are listed in different subsections only if the parameters deviate.

---

# 2 References

The following documents contain provisions, which, through reference in this text, constitute provisions of the present document.

- References are either specific (identified by date of publication, edition number, version number, etc.) or non-specific.
- For a specific reference, subsequent revisions do not apply.
- For a non-specific reference, the latest version applies. In the case of a reference to a 3GPP document (including a GSM document), a non-specific reference implicitly refers to the latest version of that document *in the same Release as the present document*.

- [1] ETSI ETR 273-1-2: 'Electromagnetic compatibility and Radio spectrum Matters (ERM); Improvement of radiated methods of measurement (using test sites) and evaluation of the corresponding measurement uncertainties; Part 1: Uncertainties in the measurement of mobile radio equipment characteristics; Sub-part 2: Examples and annexes'.
- [2] 3GPP TS 25.306: 'UE Radio Access capabilities definition'.
- [3] ITU-R Recommendation SM.329: 'Unwanted emissions in the spurious domain'.
- [4] 3GPP TS 25.307: 'Requirements on User Equipments (UEs) supporting a release-independent frequency band'.

---

# 3 Definitions, symbols and abbreviations

## 3.1 Definitions

For the purposes of the present document, the following definitions apply:

**Power Spectral Density:** The units of Power Spectral Density (PSD) are extensively used in this document. PSD is a function of power versus frequency and when integrated across a given bandwidth, the function represents the mean power in such a bandwidth. When the mean power is normalised to (divided by) the chip-rate it represents the mean energy per chip. Some signals are directly defined in terms of energy per chip, (DPCH\_Ec, Ec, and P-CCPCH\_Ec) and others defined in terms of PSD (Io, Ioc, Ior and  $\hat{I}$ or). There also exist quantities that are a ratio of energy per chip to PSD (DPCH\_Ec/Ior, Ec/Ior etc.). This is the common practice of relating energy magnitudes in communication systems.

It can be seen that if both energy magnitudes in the ratio are divided by time, the ratio is converted from an energy ratio to a power ratio, which is more useful from a measurement point of view. It follows that an energy per chip of X dBm/3.84 MHz (3.84 Mcps TDD option) or X dBm/1.28 MHz (1.28 Mcps TDD option) can be expressed as a mean power per chip of X dBm. Similarly, a signal PSD of Y dBm/3.84 MHz (3.84 Mcps TDD option) or Y dBm/1.28 MHz (1.28 Mcps TDD option) can be expressed as a signal power of Y dBm.

**Maximum Output Power:** This is a measure of the maximum power the UE can transmit (i.e. the actual power as would be measured assuming no measurement error) in a bandwidth of at least  $(1 + \alpha)$  times the chip rate of the radio

access mode. The period of measurement shall be a transmit timeslot excluding the guard period. For multi-carrier transmission of 1.28Mcps TDD Option, it refers to maximum power per carrier the UE can transmit.

**Mean Power:** When applied to a CDMA modulated signal this is the power (transmitted or received) in a bandwidth of at least  $(1 + \alpha)$  times the chip rate of the radio access mode. The period of measurement shall be a transmit timeslot excluding the guard period unless otherwise stated.

**RRC Filtered Mean Power:** The mean power as measured through a root raised cosine filter with roll-off factor  $\alpha$  and a bandwidth equal to the chip rate of the radio access mode.

**Nominal Maximum Output Power:** This is the nominal power defined by the UE power class. The period of measurement shall be a transmit timeslot excluding the guard period. For multi-carrier transmission of 1.28Mcps TDD Option, it refers to nominal power per carrier by the UE power class.

**Received Signal Code Power (RSCP):** Given only signal power is received, the RRC filtered mean power of the received signal after despreading and combining.

**Interference Signal Code Power (ISCP):** Given only interference power is received, the RRC filtered mean power of the received signal after despreading to the code and combining. Equivalent to the RSCP value but now only interference is received instead of signal

**Multi-carrier reception:** For 1.28Mcps TDD Option, it refers to the HS-DSCH reception on multiple carriers in a TTI for a UE. The assigned carriers for a UE should be contiguous.

**Multi-carrier transmission:** For 1.28Mcps TDD Option, it refers to the HS-SICH transmission on multiple carriers simultaneously for a UE. The assigned carriers for a UE should be contiguous.

NOTE 1: The RRC filtered mean power of a perfectly modulated CDMA signal is 0.246 dB lower than the mean power of the same signal.

NOTE 2: The roll-off factor  $\alpha$  is defined in section 6.8.1.

## 3.2 (void)

## 3.3 Abbreviations

For the purposes of the present document, the following abbreviations apply:

ACIR	Adjacent Channel Interference Ratio
ACLR	Adjacent Channel Leakage power Ratio
ACS	Adjacent Channel Selectivity
BS	Base Station
BER	Bit Error Ratio
BLER	Block Error Ratio
CQI	Channel Quality Indicator
CW	Continuous wave (unmodulated signal)
DL	Down link (forward link)
DTX	Discontinuous Transmission
DPCH	Dedicated physical channel
DPCH_Ec	Average energy per PN chip for DPCH
$\frac{DPCH\_Ec}{I_{or}}$	

The ratio of the average energy per PN chip of the DPCH to the total transmit power spectral density of the downlink at the BS antenna connector

$\frac{\sum DPCH\_Ec}{I_{or}}$

$I_{or}$

The ratio of the sum of DPCH\_Ec for one service in case of multicode to the total transmit power spectral density of the downlink at the BS antenna connector

E-DCH	Enhanced Dedicated Channel
E-AGCH	E-DCH Absolute Grant Channel

E-HICH	E-DCH HARQ ACK Indicator Channel
EIRP	Effective Isotropic Radiated Power
FDD	Frequency Division Duplexing
FER	Frame Error Ratio
Fuw	Frequency of unwanted signal. This is specified in bracket in terms of an absolute frequency(s) or frequency offset from the assigned channel frequency. For multi-carrier reception of 1.28Mcps TDD Option, negative offsets refer to the assigned channel frequency of the lowest carrier frequency used and positive offsets refer to the assigned channel frequency of the highest carrier frequency used.
Hybrid ARQ	Hybrid Automatic Repeat reQuest
HSDPA	High Speed Downlink Packet Access
HS-DSCH	High Speed Downlink Shared Channel
HS-PDSCH	High Speed Physical Downlink Shared Channel
HS-SCCH	High Speed Shared Control Channel
I <sub>oc</sub>	The power spectral density (integrated in a noise bandwidth equal to the chip rate and normalized to the chip rate) of a band limited white noise source (simulating interference from other cells) as measured at the UE antenna connector. For multi-carrier reception of 1.28Mcps TDD Option, I <sub>oc</sub> is defined for each of the carriers individually and is assumed to be equal for all carriers unless explicitly stated per carrier.
I <sub>or</sub>	The total transmit power spectral density (integrated in a bandwidth of (1+ $\alpha$ ) times the chip rate and normalized to the chip rate) of the downlink signal at the BS antenna connector. For multi-carrier reception of 1.28Mcps TDD Option, I <sub>or</sub> is defined for each of the carrier individually and is assumed to be equal for all carriers unless explicitly stated per carrier.
$\hat{I}_{or}$	The received power spectral density (integrated in a bandwidth of (1+ $\alpha$ ) times the chip rate and normalized to the chip rate) of the downlink signal as measured at the UE antenna connector. For multi-carrier reception of 1.28Mcps TDD Option, $\hat{I}_{or}$ is defined for each of the carrier individually and is assumed to be equal for all carriers unless explicitly stated per carrier.
MBSFN	MBMS over a Single Frequency Network
OCNS	Orthogonal Channel Noise Simulator, a mechanism used to simulate the users or control signals on the other orthogonal channels of a downlink link.
P-CCPCH	Primary Common Control Physical Channel
PCH	Paging Channel
PPM	Parts Per Million
RACH	Random Access Channel
RSSI	Received Signal Strength Indicator
R	Number of information bits per second excluding CRC bits successfully received on HS-DSCH by a HSDPA capable UE.
RU	Resource Unit
SCTD	Space Code Transmit Diversity
SIR	Signal to Interference ratio
TDD	Time Division Duplexing
TPC	Transmit Power Control
UE	User Equipment
UL	Up link (reverse link)
UTRA	UMTS Terrestrial Radio Access

---

## 4 General

### 4.1 Relationship between Minimum Requirements and Test Requirements

The Minimum Requirements given in this specification make no allowance for measurement uncertainty. The test specification 34.122 Annex F defines Test Tolerances. These Test Tolerances are individually calculated for each test. The Test Tolerances are used to relax the Minimum Requirements in this specification to create Test Requirements. The measurement results returned by the test system are compared – without any modifications – against the Test Requirements as defined by the shared risk principle.

The Shared Risk principle is defined in ETR 273 Part 1 sub-part 2 section 6.5.

## 4.2 Power Classes

For UE power classes 1 and 4, a number of RF parameter are not specified. It is intended that these are part of a later release.

## 4.3 Control and monitoring functions

*This requirement verifies that the control and monitoring functions of the UE prevent it from transmitting if no acceptable cell can be found by the UE.*

### 4.3.1 Minimum requirement

The power of the UE, as measured with a thermal detector, shall not exceed -30dBm if no acceptable cell can be found by the UE.

### 4.3.2 RF requirements in later releases

The standardisation of new frequency bands may be independent of a release. However, in order to implement a UE that conforms to a particular release but supports a band of operation that is specified in a later release, it is necessary to specify some extra requirements. TS 25.307 [4] specifies requirements on UEs supporting a frequency band that is independent of release.

NOTE: For terminals conforming to the 3GPP release of the present document, some RF requirements in later releases may be mandatory independent of whether the UE supports the bands specified in later releases or not. The set of requirements from later releases that is also mandatory for UEs conforming to the 3GPP release of the present document is determined by regional regulation.

---

# 5 Frequency bands and channel arrangement

## 5.1 General

The information presented in this section is based on the chip rates of 3.84 Mcps Option, 1.28 Mcps Option and 7.68 Mcps Option.

NOTE: Other chip rates may be considered in future releases.

## 5.2 Frequency bands

UTRA/TDD is designed to operate in the following bands;

- a) 1900 – 1920 MHz: Uplink and downlink transmission  
2010 – 2025 MHz: Uplink and downlink transmission
- b)\* 1850 – 1910 MHz: Uplink and downlink transmission  
1930 – 1990 MHz: Uplink and downlink transmission
- c)\* 1910 – 1930 MHz: Uplink and downlink transmission
- d)\*\* 2570 – 2620 MHz: Uplink and downlink transmission

\* Used in ITU Region 2

\*\*Used in ITU Region 1.

Additional allocations in ITU region 2 are FFS.

Deployment in existing or other frequency bands is not precluded.

## 5.3 TX-RX frequency separation

### 5.3.1 3.84 Mcps TDD Option

No TX-RX frequency separation is required as Time Division Duplex (TDD) is employed. Each TDMA frame consists of 15 timeslots where each timeslot can be allocated to either transmit or receive.

### 5.3.2 1.28 Mcps TDD Option

No TX-RX frequency separation is required as Time Division Duplex (TDD) is employed. Each subframe consists of 7 main timeslots where all main timeslots (at least the first one) before the single switching point are allocated DL and all main timeslots (at least the last one) after the single switching point are allocated UL.

### 5.3.3 7.68 Mcps TDD Option

No TX-RX frequency separation is required as Time Division Duplex (TDD) is employed. Each TDMA frame consists of 15 timeslots where each timeslot can be allocated to either transmit or receive.

## 5.4 Channel arrangement

### 5.4.1 Channel spacing

#### 5.4.1.1 3.84 Mcps TDD Option

The nominal channel spacing is 5 MHz, but this can be adjusted to optimise performance in a particular deployment scenario.

#### 5.4.1.2 1.28 Mcps TDD Option

The nominal channel spacing is 1.6 MHz, but this can be adjusted to optimise performance in a particular deployment scenario.

#### 5.4.1.3 7.68 Mcps TDD Option

The nominal channel spacing is 10 MHz, but this can be adjusted to optimise performance in a particular deployment scenario.

### 5.4.2 Channel raster

The channel raster is 200 kHz for all bands, which means that the carrier frequency must be a multiple of 200 kHz.

#### 5.4.2.1 3.84 Mcps TDD Option

In addition a number of additional centre frequencies are specified according to table 5.1, which means that the centre frequencies for these channels are shifted 100 kHz relative to the general raster.

### 5.4.3 Channel number

The carrier frequency is designated by the UTRA absolute radio frequency channel number (UARFCN). The value of the UARFCN in the IMT2000 band is defined in the general case as follows:

$$N_i = 5 * F$$

$$0.0 \text{ MHz} \leq F \leq 3276.6 \text{ MHz}$$



where F is the carrier frequency in MHz

Additional channels applicable to operation in the frequency band defined in sub-clause 5.2(d) are defined via the following UARFCN definition:

$$N_i = 5 * (F - 2150.1 \text{ MHz}) \quad 2572.5 \text{ MHz} \leq F \leq 2617.5 \text{ MHz}$$

## 5.4.4 UARFCN

### 5.4.4.1 3.84 Mcps TDD Option

The following UARFCN range shall be supported for each band:

**Table 5.1: UTRA Absolute Radio Frequency Channel Number 3.84 Mcps TDD Option**

Frequency Band	Frequency Range	UARFCN Uplink and Downlink transmission	Additional UARFCN Uplink and Downlink transmission
For operation in frequency band as defined in subclause 5.2 (a)	1900-1920 MHz 2010-2025 MHz	9512 to 9588 10062 to 10113	-
For operation in frequency band as defined in subclause 5.2 (b)	1850-1910 MHz 1930-1990 MHz	9262 to 9538 9662 to 9938	-
For operation in frequency band as defined in subclause 5.2 l	1910-1930 MHz	9562 to 9638	-
For operation in frequency band as defined in subclause 5.2 (d)	2570-2620 MHz	12862 to 13088	2112, 2137, 2162, 2187, 2212, 2237, 2262, 2287, 2312, 2337

### 5.4.4.2 1.28 Mcps TDD Option

The following UARFCN range shall be supported for each band:

**Table 5.2: UTRA Absolute Radio Frequency Channel Number 1.28 Mcps TDD Option**

Frequency Band	Frequency Range	UARFCN Uplink and Downlink transmission
For operation in frequency band as defined in subclause 5.2 (a)	1900-1920 MHz 2010-2025 MHz	9504 to 9596 10054 to 10121
For operation in frequency band as defined in subclause 5.2 (b)	1850-1910 MHz 1930-1990 MHz	9254 to 9546 9654 to 9946
For operation in frequency band as defined in subclause 5.2 l	1910-1930 MHz	9554 to 9646
For operation in frequency band as defined in subclause 5.2 (d)	2570-2620 MHz	12854 to 13096

### 5.4.4.3 7.68 Mcps TDD Option

The following UARFCN range shall be supported for each band:

**Table 5.3: UTRA Absolute Radio Frequency Channel Number 7.68 Mcps TDD Option**

Frequency Band	Frequency Range	UARFCN Uplink and Downlink transmission	Additional UARFCN Uplink and Downlink transmission
For operation in frequency band as defined in subclause 5.2 (a)	1900-1920 MHz 2010-2025 MHz	9512 to 9588 10062 to 10113	-
For operation in frequency band as defined in subclause 5.2 (b)	1850-1910 MHz 1930-1990 MHz	9262 to 9538 9662 to 9938	-
For operation in frequency band as defined in subclause 5.2 l	1910-1930 MHz	9562 to 9638	-
For operation in frequency band as defined in subclause 5.2 (d)	2570-2620 MHz	12874 to 13076	-

## 6 Transmitter characteristics

### 6.1 General

Unless detailed the transmitter characteristic are specified at the antenna connector of the UE. For UE with integral antenna only, a reference antenna with a gain of 0 dBi is assumed. Transmitter characteristics for UE(s) with multiple antennas/antenna connectors are FFS.

The UE antenna performance has a significant impact on system performance and minimum requirements on the antenna efficiency are therefore intended to be included in future versions of this specification. It is recognised that different requirements and test methods are likely to be required for the different types of UE.

All the parameters in section 6 are defined using the UL reference measurement channel (12.2 kbps) specified in Annex A.2.1 unless explicitly stated otherwise. For UE supporting multi-carrier transmission of 1.28Mcps TDD Option, the HS-SICH reference measurement channel is specified in Annex A.3.2.8.

### 6.2 Transmit power

#### 6.2.1 User Equipment maximum output power

The nominal maximum output power defined is the broadband transmit power of the UE, i.e. the power in a bandwidth of at least  $(1+\alpha)$  times the chip rate of the radio access mode. The period of measurement shall be a transmit timeslot excluding the guard period.

##### 6.2.1.1 3.84 Mcps TDD option

The power classes in Table 6.1 define the nominal maximum output power for 3.84 Mcps TDD options.

**Table 6.1: UE power classes**

Power Class	Nominal maximum output power	Tolerance
1	+30 dBm	+1 dB / -3 dB
2	+24 dBm	+1 dB / -3 dB
3	+21 dBm	+2 dB / -2 dB
4	+10 dBm	+4 dB / -4 dB

NOTE:

- 1) For multi-code operation the nominal maximum output power will be reduced by the difference of peak to average ratio between single and multi-code transmission.
- 2) The tolerance allowed for the nominal maximum power applies even at the multi code transmission mode.
- 3) For UE using directive antennas for transmission, a class dependent limit will be placed on the maximum EIRP (Equivalent Isotropic Radiated Power).

### 6.2.1.2 1.28 Mcps TDD option

The power classes in Table 6.2 define the nominal maximum output power for 1.28 Mcps TDD option.

**Table 6.2: UE power classes for 1.28 Mcps TDD**

Power Class	Nominal maximum output power	Tolerance
1	+33 dBm	+1 dB / -3 dB
2	+24 dBm	+1 dB / -3 dB
3	+21 dBm	+2 dB / -2 dB
4	+27 dBm	+1 dB / -3 dB

NOTE 1: The tolerance allowed for the nominal maximum power applies even at the multi code transmission mode.

NOTE 2: For UE using directive antennas for transmission, a class dependent limit will be placed on the maximum EIRP (Equivalent Isotropic Radiated Power).

### 6.2.1.3 7.68 Mcps TDD option

The power classes in Table 6.1 define the nominal maximum output power for 7.68 Mcps TDD options.

**Table 6.3: UE power classes**

Power Class	Nominal maximum output power	Tolerance
1	+30 dBm	+1 dB / -3 dB
2	+24 dBm	+1 dB / -3 dB
3	+21 dBm	+2 dB / -2 dB
4	+10 dBm	+4 dB / -4 dB

NOTE 1: For multi-code operation the nominal maximum output power will be reduced by the difference of peak to average ratio between single and multi-code transmission.

NOTE 2: The tolerance allowed for the nominal maximum power applies even at the multi code transmission mode.

NOTE 3: For UE using directive antennas for transmission, a class dependent limit will be placed on the maximum EIRP (Equivalent Isotropic Radiated Power).

## 6.2.2 UE maximum output power with E-DCH

### 6.2.2.1 3.84 Mcps TDD option

[FFS]

### 6.2.2.2 1.28 Mcps TDD option

The Maximum Power Reduction (MPR) for the nominal maximum output power defined in 6.2 is specified in table 6.4.

**Table 6.4 UE maximum output power with E-DCH**

UE transmit channel configuration	CM (dB)	MPR (dB)
E-DCH and E-UCCH	$0 \leq CM \leq 1.5$	CM

Where Cubic Metric (CM) is based on the UE transmit channel configuration and is given by

$$CM = \text{CEIL}\{[20 * \log_{10} ((v_{\text{norm}}^3)_{\text{rms}}) - 20 * \log_{10} ((v_{\text{norm\_ref}}^3)_{\text{rms}})] / k, 0.5\}$$

Where

- CEIL{X,0.5} means rounding upwards to closest 0.5dB, i.e.  $CM \in [0, 0.5, 1, 1.5]$
- $v_{\text{norm}}$  is the normalized voltage waveform of the input signal
- $v_{\text{norm\_ref}}$  is the normalized voltage waveform of the reference signal (12.2 kbps AMR Speech)
- $k$  is 1.94
- $20 * \log_{10} ((v_{\text{norm\_ref}}^3)_{\text{rms}}) = 1.22$  dB

### 6.2.1.3 7.68 Mcps TDD option

[FFS]

## 6.2.3 UE maximum output power with multi-code

### 6.2.3.1 1.28 Mcps TDD option

The Maximum Power Reduction (MPR) for the nominal maximum output power defined in 6.2 is specified in table 6.2C.

**Table 6.2C UE maximum output power with multi-code**

UE transmit channel configuration	CM (dB)	MPR (dB)
For some combinations of; DPCH and HS-SICH/DPCH	$0 \leq CM \leq 2.5$	CM

Where Cubic Metric (CM) is based on the UE transmit channel configuration and is given by

$$CM = \text{CEIL}\{[20 * \log_{10} ((v_{\text{norm}}^3)_{\text{rms}}) - 20 * \log_{10} ((v_{\text{norm\_ref}}^3)_{\text{rms}})] / k, 0.5\}$$

Where

- CEIL{X, 0.5} means rounding upwards to closest 0.5dB, i.e.  $CM \in [0, 0.5, 1, 1.5, 2, 2.5]$
- $v_{\text{norm}}$  is the normalized voltage waveform of the input signal
- $v_{\text{norm\_ref}}$  is the normalized voltage waveform of the reference signal (12.2 kbps AMR Speech)
- $k$  is 1.68
- $20 * \log_{10} ((v_{\text{norm\_ref}}^3)_{\text{rms}}) = 1.22$  dB

## 6.3 UE frequency stability

The UE modulated carrier frequency shall be accurate to within  $\pm 0.1$  PPM observed over a period of one timeslot compared to carrier frequency received from the BS. These signals will have an apparent error due to BS frequency error and Doppler shift. In the later case, signals from the BS must be averaged over sufficient time that errors due to

noise or interference are allowed for within the above  $\pm 0.1$ PPM figure. The UE shall use the same frequency source for both RF frequency generation and the chip clock.

## 6.4 Output power dynamics

Power control is used to limit the interference level.

### 6.4.1 Power control

#### 6.4.1.1 3.84 Mcps option

Uplink power control is the ability of the UE transmitter to sets its output power in accordance with measured downlink path loss, values determined by higher layer signalling and path loss weighting parameter  $\alpha$  as defined in TS 25.331. The output power is defined as the RRC filtered mean power of the transmit timeslot.

##### 6.4.1.1.1 Initial Accuracy

The UE power control initial accuracy error shall be less than  $\pm 9$ dB under normal conditions and  $\pm 12$ dB under extreme conditions.

##### 6.4.1.1.2 Differential accuracy, controlled input

The power control differential accuracy, controlled input, is defined as the error in the UE transmitter power step as a result of a step in  $SIR_{TARGET}$  when the path loss weighting parameter  $\alpha=0$ . The step in  $SIR_{TARGET}$  shall be rounded to the closest integer dB value. The power control error resulting from a change in  $I_{BTS}$  or DPCH Constant Value shall not exceed the values defined in Table 6.3.

**Table 6.3: Transmitter power step tolerance as a result of control power step**

$\Delta SIR_{TARGET}$ [dB]	Transmitter power step tolerance [dB]
$\Delta SIR_{TARGET} \leq 1$	$\pm 0.5$
$1 < \Delta SIR_{TARGET} \leq 2$	$\pm 1$
$2 < \Delta SIR_{TARGET} \leq 3$	$\pm 1.5$
$3 < \Delta SIR_{TARGET} \leq 10$	$\pm 2$
$10 < \Delta SIR_{TARGET} \leq 20$	$\pm 4$
$20 < \Delta SIR_{TARGET} \leq 30$	$\pm 6$
$30 < \Delta SIR_{TARGET}$	$\pm 9$ (note 1)
NOTE 1: Value is given for normal conditions. For extreme conditions value is $\pm 12$	

##### 6.4.1.1.3 Differential accuracy, measured input

The power control differential accuracy, measured input, is defined as the error in UE transmitter power step change as a result of a step change in path loss  $L_{PCCPCH}$ .

The error shall not exceed the sum of the following two errors:

- The power control error, resulting from a change in the path loss ( $\Delta L_{PCCPCH}$ ), the same tolerances as defined in table 6.3 shall apply,
- and the errors in the PCCPCH RSCP measurement as defined in TS 25.123.

#### 6.4.1.2 1.28 Mcps TDD Option

##### 6.4.1.2.1 Open loop power control

Open loop power control is the ability of the UE transmitter to sets its output power to a specific value. The open loop power control tolerance is given in Table 6.3A

#### 6.4.1.2.1.1 Minimum requirement

The UE open loop power is defined as the RRC filtered mean power in a timeslot or ON power duration, whichever is available.

**Table 6.3A: Open loop power control tolerance**

Normal conditions	$\pm 9$ dB
Extreme conditions	$\pm 12$ dB

#### 6.4.1.2.2 Closed loop power control

Closed loop power control in the Uplink is the ability of the UE transmitter to adjust its output power in accordance with one or more TPC commands received in the downlink.

##### 6.4.1.2.2.1 Power control steps

The power control step is the change in the UE transmitter output power in response to a single TPC command, TPC\_cmd, arrived at the UE.

##### 6.4.1.2.2.1.1 Minimum requirement

The UE transmitter shall have the capability of changing the output power with a step size of 1, 2 and 3 dB according to the value of  $\Delta_{\text{TPC}}$  or  $\Delta_{\text{RP-TPC}}$ , in the slot immediately after the TPC\_cmd can be arrived.

- The transmitter output power step due to closed loop power control shall be within the range shown in Table 6.3B.
- The transmitter average output power step due to closed loop power control shall be within the range shown in Table 6.3C. Here a TPC\_cmd group is a set of TPC\_cmd values derived from a corresponding sequence of TPC commands of the same duration.

The closed loop power is defined as the relative power differences between RRC filtered mean power of original (reference) timeslot and RRC filtered mean power of the target timeslot without transient duration.

**Table 6.3B: Transmitter power control range**

TPC_cmd	Transmitter power control range					
	1 dB step size		2 dB step size		3 dB step size	
	Lower	Upper	Lower	Upper	Lower	Upper
Up	+0.5 dB	+1.5 dB	+1 dB	+3 dB	+1.5 dB	+4.5 dB
Down	-0.5 dB	-1.5 dB	-1 dB	-3 dB	-1.5 dB	-4.5 dB

**Table 6.3C: Transmitter average power control range**

TPC_cmd group	Transmitter power control range after 10 equal TPC_cmd groups					
	1 dB step size		2 dB step size		3 dB step size	
	Lower	Upper	Lower	Upper	Lower	Upper
Up	+8 dB	+12 dB	+16 dB	+24 dB	+24 dB	+36 dB
Down	-8 dB	-12 dB	-16 dB	-24 dB	-24 dB	-36 dB

#### 6.4.1.3 7.68 Mcps option

Uplink power control is the ability of the UE transmitter to sets its output power in accordance with measured downlink path loss, values determined by higher layer signalling and path loss weighting parameter  $\alpha$  as defined in TS 25.331. The output power is defined as the RRC filtered mean power of the transmit timeslot.

### 6.4.1.3.1 Initial Accuracy

The UE power control initial accuracy error shall be less than +/-9dB under normal conditions and +/- 12dB under extreme conditions.

### 6.4.1.3.2 Differential accuracy, controlled input

The power control differential accuracy, controlled input, is defined as the error in the UE transmitter power step as a result of a step in  $SIR_{TARGET}$  when the path loss weighting parameter  $\alpha=0$ . The step in  $SIR_{TARGET}$  shall be rounded to the closest integer dB value. The power control error resulting from a change in  $I_{BTS}$  or DPCH Constant Value shall not exceed the values defined in Table 6.3D.

**Table 6.3D: Transmitter power step tolerance as a result of control power step**

$\Delta SIR_{TARGET}$ [dB]	Transmitter power step tolerance [dB]
$\Delta SIR_{TARGET} \leq 1$	$\pm 0.5$
$1 < \Delta SIR_{TARGET} \leq 2$	$\pm 1$
$2 < \Delta SIR_{TARGET} \leq 3$	$\pm 1.5$
$3 < \Delta SIR_{TARGET} \leq 10$	$\pm 2$
$10 < \Delta SIR_{TARGET} \leq 20$	$\pm 4$
$20 < \Delta SIR_{TARGET} \leq 30$	$\pm 6$
$30 < \Delta SIR_{TARGET}$	$\pm 9^{(1)}$
Note 1: Value is given for normal conditions. For extreme conditions value is $\pm 12$	

### 6.4.1.3.3 Differential accuracy, measured input

The power control differential accuracy, measured input, is defined as the error in UE transmitter power step change as a result of a step change in path loss  $L_{PCCPCH}$ .

The error shall not exceed the sum of the following two errors:

- The power control error, resulting from a change in the path loss ( $\Delta L_{PCCPCH}$ ), the same tolerances as defined in table 6.3 shall apply,
- and the errors in the PCCPCH RSCP measurement as defined in TS 25.123.

## 6.4.2 Minimum output power

The minimum controlled output power of the UE is when the power is set to a minimum value.

### 6.4.2.1 Minimum requirement

#### 6.4.2.1.1 3.84 Mcps TDD Option

The minimum output power is defined as the mean power in one time slot excluding the guard period. The minimum output power shall be less than -44 dBm.

#### 6.4.2.1.2 1.28 Mcps TDD Option

The minimum output power is defined as the mean power in one time slot excluding the guard period. The minimum output power shall be less than -49 dBm.

#### 6.4.2.1.3 7.68 Mcps TDD Option

The minimum output power is defined as the mean power in one time slot excluding the guard period. The minimum output power shall be less than -41 dBm.

### 6.4.3 Out-of-synchronisation handling of output power

The UE shall monitor the DPCH quality in order to detect a loss of the signal on Layer 1, as specified in TS 25.224. The thresholds  $Q_{out}$ ,  $Q_{in}$ ,  $Q_{sbout}$  and  $Q_{sbin}$  specify at what DPCH quality levels the UE shall shut its power off and when it shall turn its power on, respectively. The thresholds are not defined explicitly, but are defined by the conditions under which the UE shall shut its transmitter off and turn it on, as stated in this clause.

#### 6.4.3.1 Requirement for continuous transmission

##### 6.4.3.1.1 3.84 Mcps TDD Option

###### 6.4.3.1.1.1 Minimum requirement

When the UE estimates the DPCH quality over the last 160 ms period to be worse than a threshold  $Q_{out}$ , the UE shall shut its transmitter off within 40 ms. The UE shall not turn its transmitter on again until the DPCH quality exceeds an acceptable level  $Q_{in}$ . When the UE estimates the DPCH quality over the last 160 ms period to be better than a threshold  $Q_{in}$ , the UE shall again turn its transmitter on within 40 ms.

The UE transmitter shall be considered 'off' if the transmitted power is below the level defined in subclause 6.5.1 (Transmit off power). Otherwise the transmitter shall be considered as 'on'.

###### 6.4.3.1.1.2 Test case

This subclause specifies a test case, which provides additional information for how the minimum requirement should be interpreted for the purpose of conformance testing in case of continuous transmission.

The conditions for the continuous test case are as follows:

The handover triggering level shall be set very high to ensure that the beacon channel power never exceeds the value of 10dB above it. Therefore the averaging time for signal quality will always be 160 milliseconds.

The quality levels at the thresholds  $Q_{out}$  and  $Q_{in}$  correspond to different signal levels depending on the downlink conditions DCH parameters. For the conditions in Table 6.4, a signal with the quality at the level  $Q_{out}$  can be generated by a  $\Sigma DPCH\_Ec/I_{or}$  ratio of -13 dB, and a signal with  $Q_{in}$  by a  $\Sigma DPCH\_Ec/I_{or}$  ratio of -9 dB. In this test, the DL reference measurement channel (12.2) kbps specified in subclause A.2.2, where the CRC bits are replaced by data bits, and with static propagation conditions is used.

**Table 6.4: DCH parameters for the of Out-of-synch handling test case – 3.84 Mcps TDD option – continuous transmission**

Parameter	Unit	Value
$\hat{I}_{or}/I_{oc}$	dB	1.1
$I_{oc}$	dBm/3.84 MHz	-60
$\frac{\Sigma DPCH\_Ec}{I_{or}}$	dB	See figure 6.1
Information Data Rate	kbps	13
TFCI	-	On

Figure 6.1 shows an example scenario where the  $\Sigma DPCH\_Ec/I_{or}$  ratio varies from a level where the DPCH is demodulated under normal conditions, down to a level below  $Q_{out}$  where the UE shall shut its power off and then back up to a level above  $Q_{in}$  where the UE shall turn the power back on.



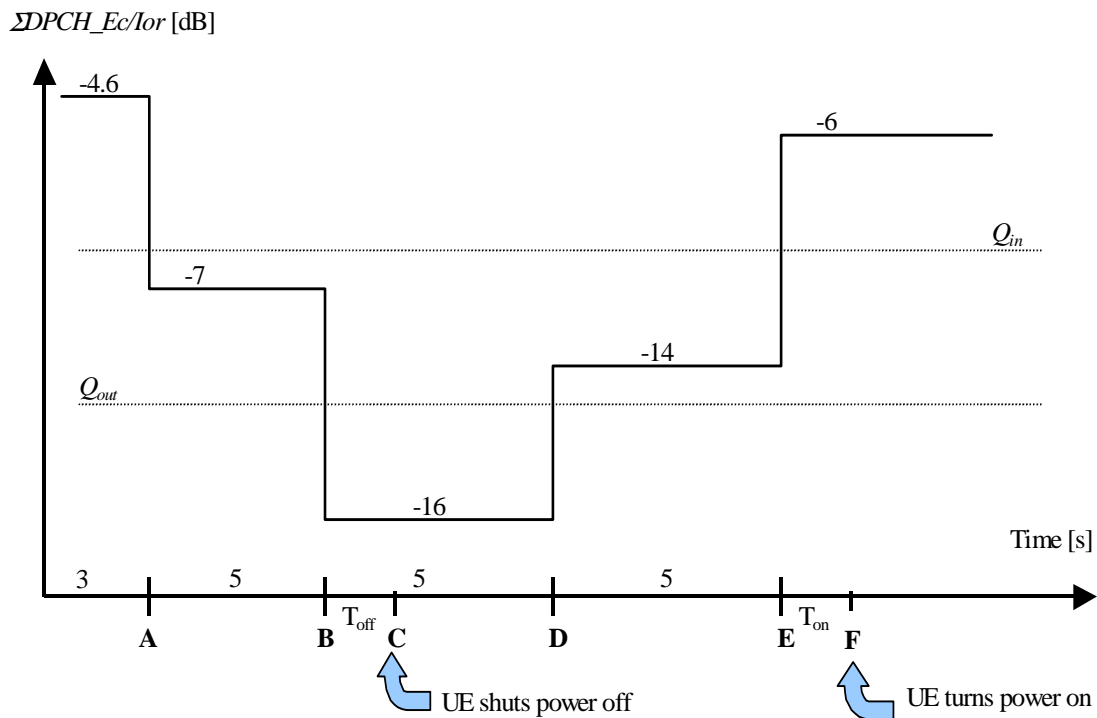

**Figure 6.1: Test case for out-of-synch handling in the UE. – 3.84 Mcps TDD option – continuous transmission**

In this test case, the requirements for the UE are that

- 1) The UE shall not shut its transmitter off before point B.
- 2) The UE shall shut its transmitter off before point C, which is  $T_{\text{off}} = 200$  ms after point B
- 3) The UE shall not turn its transmitter on between points C and E.
- 4) The UE shall turn its transmitter on before point F, which is  $T_{\text{on}} = 200$  ms after Point E.

#### 6.4.3.1.2 1.28 Mcps TDD Option

##### 6.4.3.1.2.1 Minimum Requirement

When the UE estimates the DPCH quality over the last 160 ms period to be worse than a threshold  $Q_{\text{out}}$ , the UE shall shut its transmitter off within 40 ms. The UE shall not turn its transmitter on again until the DPCH quality exceeds an acceptable level  $Q_{\text{in}}$ . When the UE estimates the DPCH quality over the last 160 ms period to be better than a threshold  $Q_{\text{in}}$ , the UE shall again turn its transmitter on within 40 ms.

The DPCH quality shall be monitored in the UE and compared to the thresholds  $Q_{\text{out}}$  and  $Q_{\text{in}}$  for the purpose of monitoring synchronisation. The threshold  $Q_{\text{out}}$  should correspond to a level of DPCH quality where no reliable detection of the TPC commands transmitted on the downlink DPCH can be made. This can be at a TPC command error ratio level of e.g. 30%. The threshold  $Q_{\text{in}}$  should correspond to a level of DPCH quality where detection of the TPC commands transmitted on the downlink DPCH is significantly more reliable than at  $Q_{\text{out}}$ . This can be at a TPC command error ratio level of e.g. 20%.

The UE transmitter shall be considered 'off' if the transmitted power is below the level defined in subclause 6.5.1 (Transmit off power). Otherwise the transmitter shall be considered as 'on'.

##### 6.4.3.1.2.2 Test case

This subclause specifies a test case, which provides additional information for how the minimum requirement should be interpreted for the purpose of conformance testing in case of continuous transmission for 1.28 Mcps TDD option.

The conditions for the continuous test case are as follows:

The handover triggering level shall be set very high to ensure that the beacon channel power never exceeds the value of 10dB above it. Therefore the averaging time for signal quality will always be 160 milliseconds.

The quality levels at the thresholds  $Q_{out}$  and  $Q_{in}$  correspond to different signal levels depending on the downlink conditions DCH parameters. For the conditions in Table 6.4, a signal with the quality at the level  $Q_{out}$  can be generated by a  $\Sigma DPCH\_Ec/I_{or}$  ratio of -15 dB, and a signal with  $Q_{in}$  by a  $\Sigma DPCH\_Ec/I_{or}$  ratio of -4.5 dB. In this test, the DL reference measurement channel (12.2) kbps specified in subclause A.2.2, where the CRC bits are replaced by data bits, and with static propagation conditions is used.

**Table 6.4AA: DCH parameters for the of Out-of-synch handling test case – 1.28 Mcps TDD option – continuous transmission**

Parameter	Unit	Value
$\hat{I}_{or}/I_{oc}$	dB	-1
$I_{oc}$	dBm/1.28 MHz	-60
$\frac{\Sigma DPCH\_Ec}{I_{or}}$	dB	See figure 6.1AA
Information Data Rate	kbps	12.2
TFCI	-	On

Figure 6.1AA shows an example scenario where the  $\Sigma DPCH\_Ec/I_{or}$  ratio varies from a level where the DPCH is demodulated under normal conditions, down to a level below  $Q_{out}$  where the UE shall shut its power off and then back up to a level above  $Q_{in}$  where the UE shall turn the power back on.

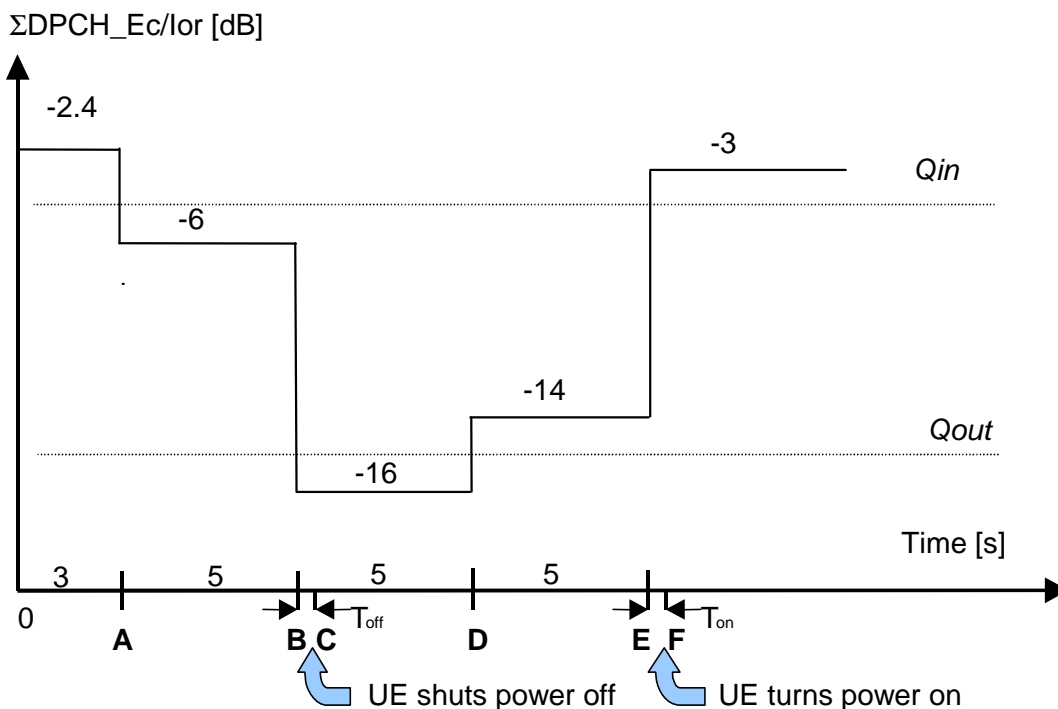

**Figure 6.1AA: Test case for out-of-synch handling in the UE – 1.28 Mcps TDD option – continuous transmission**

In this test case, the requirements for the UE are that:

- 1) The UE shall not shut its transmitter off before point B.
- 2) The UE shall shut its transmitter off before point C, which is  $T_{\text{off}} = 200$  ms after point B
- 3) The UE shall not turn its transmitter on between points C and E.
- 4) The UE shall turn its transmitter on before point F, which is  $T_{\text{on}} = 200$  ms after Point E.

### 6.4.3.1.3 7.68 Mcps TDD Option

#### 6.4.3.1.3.1 Minimum requirement

When the UE estimates the DPCH quality over the last 160 ms period to be worse than a threshold  $Q_{\text{out}}$ , the UE shall shut its transmitter off within 40 ms. The UE shall not turn its transmitter on again until the DPCH quality exceeds an acceptable level  $Q_{\text{in}}$ . When the UE estimates the DPCH quality over the last 160 ms period to be better than a threshold  $Q_{\text{in}}$ , the UE shall again turn its transmitter on within 40 ms.

The UE transmitter shall be considered 'off' if the transmitted power is below the level defined in subclause 6.5.1 (Transmit off power). Otherwise the transmitter shall be considered as 'on'.

#### 6.4.3.1.3.2 Test case

This subclause specifies a test case, which provides additional information for how the minimum requirement should be interpreted for the purpose of conformance testing in case of continuous transmission.

The conditions for the continuous test case are as follows:

The handover triggering level shall be set very high to ensure that the beacon channel power never exceeds the value of 10dB above it. Therefore the averaging time for signal quality will always be 160 milliseconds.

The quality levels at the thresholds  $Q_{\text{out}}$  and  $Q_{\text{in}}$  correspond to different signal levels depending on the downlink conditions DCH parameters. For the conditions in Table 6.4AB, a signal with the quality at the level  $Q_{\text{out}}$  can be generated by a  $\Sigma\text{DPCH\_Ec/Ior}$  ratio of -16 dB, and a signal with  $Q_{\text{in}}$  by a  $\Sigma\text{DPCH\_Ec/Ior}$  ratio of -12 dB. In this test, the DL reference measurement channel (12.2) kbps specified in subclause A.2.2, where the CRC bits are replaced by data bits, and with static propagation conditions is used.

**Table 6.4AB: DCH parameters for the of Out-of-synch handling test case – 7.68 Mcps TDD option – continuous transmission**

Parameter	Unit	Value
$\hat{I}_{or}/I_{oc}$	dB	1.1
$I_{oc}$	dBm/7.68 MHz	-60
$\frac{\Sigma\text{DPCH\_Ec}}{I_{or}}$	dB	See Figure 6.1BB
Information Data Rate	kbps	13
TFCI	-	On

Figure 6.1AB shows an example scenario where the  $\Sigma\text{DPCH\_Ec/Ior}$  ratio varies from a level where the DPCH is demodulated under normal conditions, down to a level below  $Q_{\text{out}}$  where the UE shall shut its power off and then back up to a level above  $Q_{\text{in}}$  where the UE shall turn the power back on.

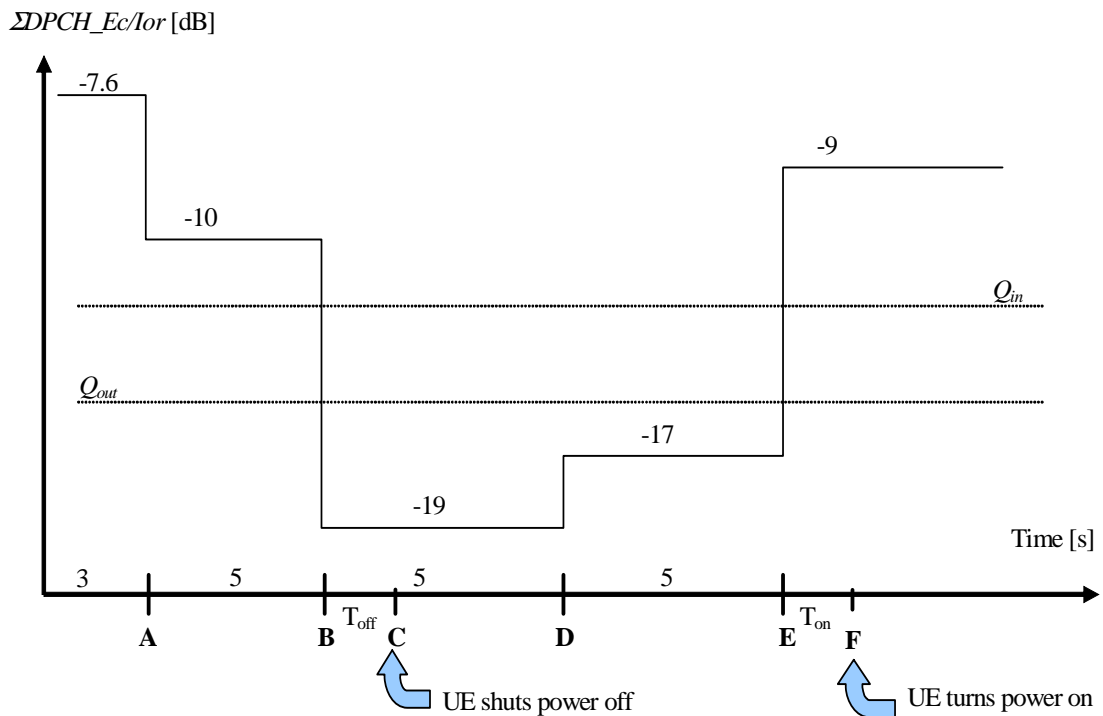

**Figure 6.1AB: Test case for out-of-synch handling in the UE. – 7.68 Mcps TDD option – continuous transmission**

In this test case, the requirements for the UE are that

- 1) The UE shall not shut its transmitter off before point B.
- 2) The UE shall shut its transmitter off before point C, which is  $T_{off} = 200$  ms after point B
- 3) The UE shall not turn its transmitter on between points C and E.
- 4) The UE shall turn its transmitter on before point F, which is  $T_{on} = 200$  ms after Point E.

### 6.4.3.2 Requirement for discontinuous transmission

#### 6.4.3.2.1 3.84 Mcps TDD Option

##### 6.4.3.2.1.1 Minimum Requirement

During DTX, there are periods when the UE will receive no data from the UTRAN. As specified in TS 25.224, in order to keep synchronization, Special Bursts shall be transmitted by the UTRAN during these periods of no data.

During these periods, the conditions for when the UE shall shut its transmitter on or off are defined by the power level of the received Special Bursts.

When the UE does not detect at least one special burst with a quality above a threshold  $Q_{s\text{b}\text{out}}$  over the last 160 ms period, the UE shall shut its transmitter off within 40 ms. The UE shall not turn its transmitter on again until the special burst quality exceeds an acceptable level  $Q_{s\text{b}\text{in}}$ . When the UE estimates the special burst quality to be better than a threshold  $Q_{s\text{b}\text{in}}$  over the last 160 ms, the UE shall again turn its transmitter on within 40 ms.

The UE transmitter shall be considered 'off' if the transmitted power is below the level defined in subclause 6.5.1 (Transmit off power). Otherwise the transmitter shall be considered as 'on'.

##### 6.4.3.2.1.2 Test case

This subclause specifies a test case, which provides additional information for how the minimum requirement should be interpreted for the purpose of conformance testing in case of discontinuous transmission.

The conditions for the discontinuous test case are as follows:

The handover triggering level shall be set very high to ensure that the beacon channel power never exceeds the value of 10dB above it. Therefore the averaging time for signal quality will always be 160 milliseconds.

The UTRAN transmits Special Bursts as specified in TS 25.224. The Special Burst Scheduling Parameter, SBSP = 4, which means that UTRAN sends a Special Burst at every fourth frame with no data. Therefore, the UTRAN sends a Special Burst in the first frame without data transmission, followed by 3 frames with no transmission; followed by a Special Burst, etc.

The DCH parameters are shown in Table 6.4A.

The quality levels at the thresholds  $Q_{sbout}$  and  $Q_{sbin}$  correspond to different signal levels depending on the downlink conditions DCH parameters. For the conditions in Table 6.4A, a signal with the quality at the level  $Q_{sbout}$  can be generated by a DPCH\_Ec/Ior ratio during received special bursts of -16 dB, and a signal with  $Q_{sbin}$  by a DPCH\_Ec/Ior ratio during received special bursts of -12 dB.

**Table 6.4A: DCH parameters for the of Out-of-synch handling test case – 3.84 Mcps TDD option – discontinuous transmission**

Parameter	Unit	Value
$\hat{I}_{or}/I_{oc}$	dB	1.1
$I_{oc}$	dBm/3.84 MHz	-60
$\frac{DPCH\_E_c}{I_{or}}$	dB	See figure 6.1A
Bits/burst (including TFCI bits)	bits	244
TFCI	-	On

Figure 6.1A shows an example scenario where the special burst quality varies from a level above  $Q_{sbin}$ , down to a level below  $Q_{sbout}$  where the UE shall shut its power off and then back up to a level above  $Q_{sbin}$  where the UE shall turn the power back on.

While the normal data is transmitted using two channelization codes, the Special Burst is transmitted with only one channelization code. Therefore the total energy per chip during Special Bursts is 3 dB lower than for continuous data transmission. The Special Bursts are represented by 'SBs' in Figure 6.1A.

During the period of 3 frames with no data, the UE will receive a very low power, which is not shown in the figure. The power shown in the figure is the power of the Special Burst.

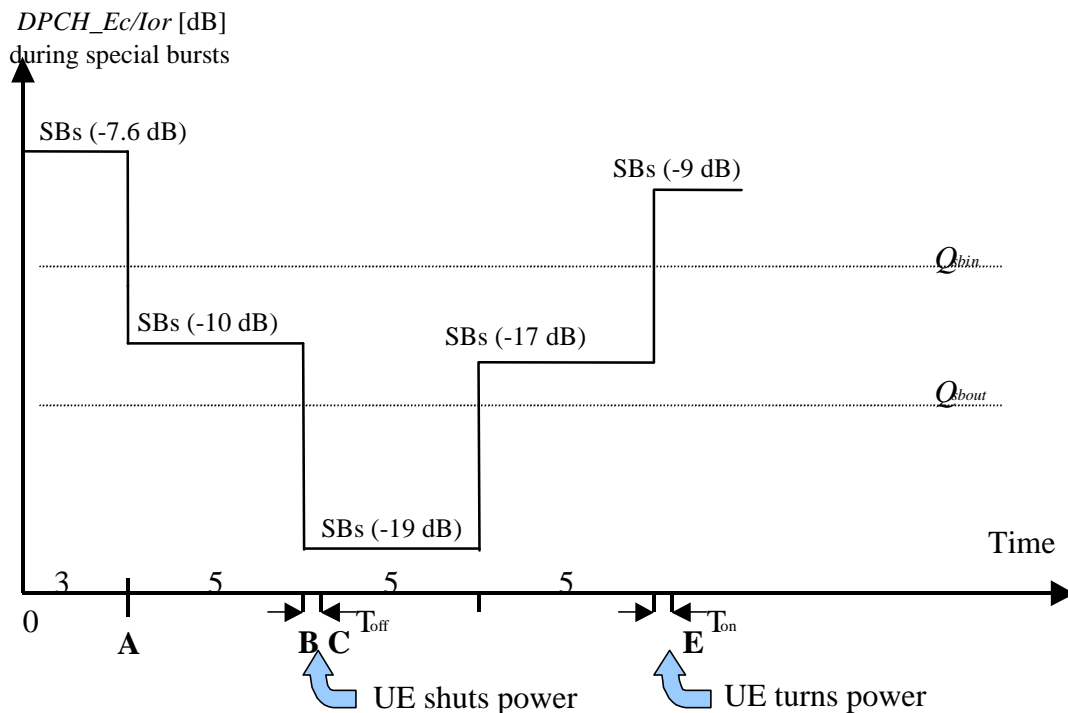

**Figure 6.1A. Test case for out-of-synch handling in the UE – 3.84 Mcps TDD option – discontinuous transmission**

In this test case, the requirements for the UE are that:

- 1) The UE shall not shut its transmitter off before point B.
- 2) The UE shall shut its transmitter off before point C, which is  $T_{\text{off}} = 200$  ms after point B.
- 3) The UE shall not turn its transmitter on between points C and E.
- 4) The UE shall turn its transmitter on before point F, which is  $T_{\text{on}} = 200$  ms after Point E.

#### 6.4.3.2.2 1.28 Mcps TDD Option

##### 6.4.3.2.2.1 Minimum Requirement

During DTX, there are periods when the UE will receive no data from the UTRAN. As specified in TS 25.224, in order to keep synchronization, Special Bursts shall be transmitted by the UTRAN during these periods of no data.

The DPCCH quality shall be monitored in the UE and compared to the thresholds  $Q_{\text{sbout}}$  and  $Q_{\text{sbin}}$  for the purpose of monitoring synchronisation during downlink DTX. The threshold  $Q_{\text{sbout}}$  should correspond to a level of DPCCH quality where no reliable detection of the TPC commands transmitted on the downlink DPCCH can be made. This can be at a TPC command error ratio level of e.g. 30. The threshold  $Q_{\text{sbin}}$  should correspond to a level of DPCCH quality where detection of the TPC commands transmitted on the downlink DPCCH is significantly more reliable than at  $Q_{\text{sbout}}$ . This can be at a TPC command error ratio level of e.g. 20%.

When the UE does not detect at least one special burst with a quality above a threshold  $Q_{\text{sbout}}$  over the last 160 ms period, the UE shall shut its transmitter off within 40 ms. The UE shall not turn its transmitter on again until the special burst quality exceeds an acceptable level  $Q_{\text{sbin}}$ . When the UE estimates the special burst quality to be better than a threshold  $Q_{\text{sbin}}$  over the last 160 ms, the UE shall again turn its transmitter on within 40 ms.

The UE transmitter shall be considered 'off' if the transmitted power is below the level defined in subclause 6.5.1 (Transmit off power). Otherwise the transmitter shall be considered as 'on'.

## 6.4.3.2.2.1 Test case

This subclause specifies a test case, which provides additional information for how the minimum requirement should be interpreted for the purpose of conformance testing in case of discontinuous transmission.

The conditions for the discontinuous test case are as follows :

The handover triggering level shall be set very high to ensure that the beacon channel power never exceeds the value of 10dB above it. Therefore the averaging time for signal quality will always be 160 milliseconds.

The UTRAN transmits Special Bursts as specified in TS 25.224. The Special Burst Scheduling Parameter, SBSP = 4, which means that UTRAN sends a Special Burst at every fourth frame with no data. Therefore, the UTRAN sends a Special Burst in the first frame without data transmission, followed by 3 frames with no transmission; followed by a Special Burst, etc. Additionally, the Special Burst will be sent in both subframes of the relevant frame designated for the Special Burst.

The DCH parameters are shown in Table 6.4B.

The quality levels at the thresholds  $Q_{sbout}$  and  $Q_{sbin}$  correspond to different signal levels depending on the downlink conditions DCH parameters. For the conditions in Table 6.4B, a signal with the quality at the level  $Q_{sbout}$  can be generated by a DPCH\_Ec/Ior ratio during received special bursts of -18 dB, and a signal with  $Q_{sbin}$  by a DPCH\_Ec/Ior ratio during received special bursts of -7,5 dB.

**Table 6.4B: DCH parameters for the of Out-of-synch handling test case – 1.28 Mcps TDD option – discontinuous transmission**

Parameter	Unit	Value
$\hat{I}_{or}/I_{oc}$	dB	-1
$I_{oc}$	dBm/1.28 MHz	-60
$\frac{\Sigma DPCH\_Ec}{I_{or}}$	dB	See figure 6.1B
Bits/burst (including TFCI bits)	bits	88 in each subframe
TFCI	-	On

Figure 6.1B shows an example scenario where the DPCH\_Ec/Ior ratio during received special bursts varies from a level where the DPCH in DTX mode is demodulated under normal conditions, down to a level below  $Q_{sbout}$  where the UE shall shut its power off and then back up to a level above  $Q_{sbin}$  where the UE shall turn the power back on.

While the normal data is transmitted using two channelization codes, the Special Burst is transmitted with only one channelization code. Therefore the total energy per chip during Special Bursts is 3 dB lower than for continuous data transmission. The Special Bursts are represented by 'SBs' in the figure.

During the period of 3 frames with no data, the UE will receive a very low power, which is not shown in the figure. In the fourth frame the Special Burst will be sent in both subframes designated to carry the Special Burst during DTX. The power shown in the figure is the power of the Special Burst.

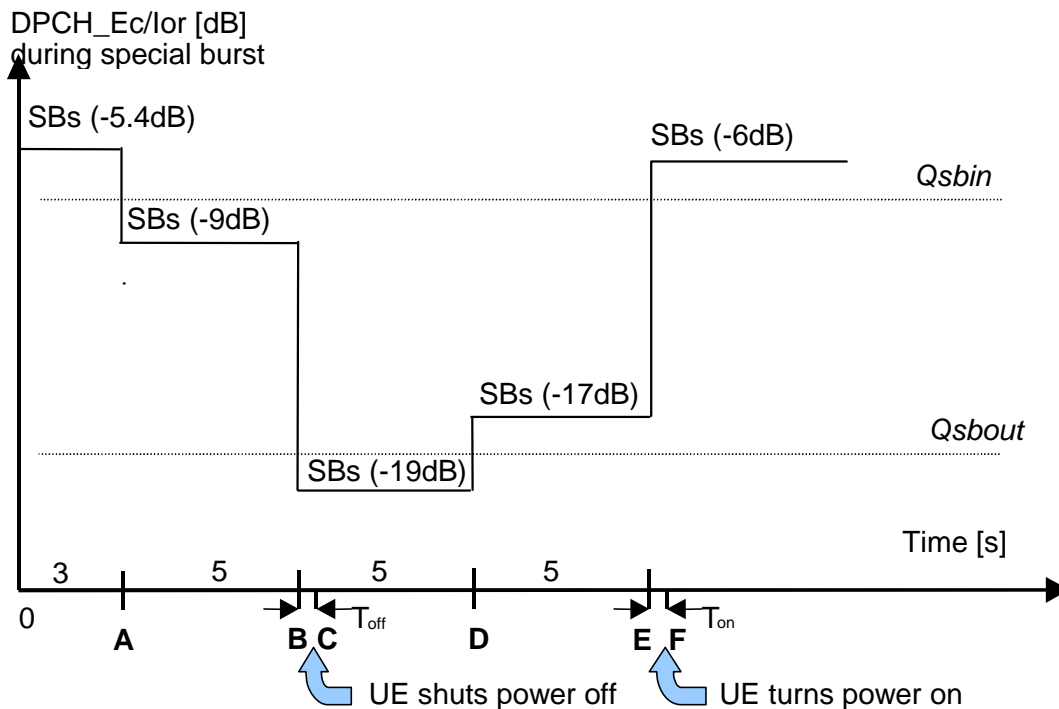

**Figure 6.1B: Test case for out-of-synch handling in the UE -1.28 Mcps TDD option – discontinuous transmission**

In this test case, the requirements for the UE are that:

- 1) The UE shall not shut its transmitter off before point B.
- 2) The UE shall shut its transmitter off before point C, which is  $T_{\text{off}} = 200$  ms after point B.
- 3) The UE shall not turn its transmitter on between points C and E.
- 4) The UE shall turn its transmitter on before point F, which is  $T_{\text{on}} = 200$  ms after Point E.

#### 6.4.3.2.3 7.68 Mcps TDD Option

##### 6.4.3.2.3.1 Minimum Requirement

During DTX, there are periods when the UE will receive no data from the UTRAN. As specified in TS 25.224, in order to keep synchronization, Special Bursts shall be transmitted by the UTRAN during these periods of no data.

During these periods, the conditions for when the UE shall shut its transmitter on or off are defined by the power level of the received Special Bursts.

When the UE does not detect at least one special burst with a quality above a threshold  $Q_{\text{sbout}}$  over the last 160 ms period, the UE shall shut its transmitter off within 40 ms. The UE shall not turn its transmitter on again until the special burst quality exceeds an acceptable level  $Q_{\text{sbin}}$ . When the UE estimates the special burst quality to be better than a threshold  $Q_{\text{sbin}}$  over the last 160 ms, the UE shall again turn its transmitter on within 40 ms.

The UE transmitter shall be considered 'off' if the transmitted power is below the level defined in subclause 6.5.1 (Transmit off power). Otherwise the transmitter shall be considered as 'on'.

##### 6.4.3.2.3.2 Test case

This subclause specifies a test case, which provides additional information for how the minimum requirement should be interpreted for the purpose of conformance testing in case of discontinuous transmission.

The conditions for the discontinuous test case are as follows:



The handover triggering level shall be set very high to ensure that the beacon channel power never exceeds the value of 10dB above it. Therefore the averaging time for signal quality will always be 160 milliseconds.

The UTRAN transmits Special Bursts as specified in TS 25.224. The Special Burst Scheduling Parameter, SBSP = 4, which means that UTRAN sends a Special Burst at every fourth frame with no data. Therefore, the UTRAN sends a Special Burst in the first frame without data transmission, followed by 3 frames with no transmission; followed by a Special Burst, etc.

The DCH parameters are shown in Table 6.4C.

The quality levels at the thresholds  $Q_{sbout}$  and  $Q_{sbin}$  correspond to different signal levels depending on the downlink conditions DCH parameters. For the conditions in Table 6.4C, a signal with the quality at the level  $Q_{sbout}$  can be generated by a DPCH\_Ec/I<sub>or</sub> ratio during received special bursts of -19 dB, and a signal with  $Q_{sbin}$  by a DPCH\_Ec/I<sub>or</sub> ratio during received special bursts of -15 dB.

**Table 6.4C: DCH parameters for the of Out-of-synch handling test case – 7.68 Mcps TDD option – discontinuous transmission**

Parameter	Unit	Value
$\hat{I}_{or}/I_{oc}$	dB	1.1
$I_{oc}$	dBm/7.68 MHz	-60
$\frac{DPCH\_Ec}{I_{or}}$	dB	See Figure 6.1C
Bits/burst (including TFCI bits)	bits	244
TFCI	-	On

Figure 6.1C shows an example scenario where the special burst quality varies from a level above  $Q_{sbin}$ , down to a level below  $Q_{sbout}$  where the UE shall shut its power off and then back up to a level above  $Q_{sbin}$  where the UE shall turn the power back on.

While the normal data is transmitted using two channelization codes, the Special Burst is transmitted with only one channelization code. Therefore the total energy per chip during Special Bursts is 3 dB lower than for continuous data transmission. The Special Bursts are represented by 'SBs' in Figure 6.1C.

During the period of 3 frames with no data, the UE will receive a very low power, which is not shown in the figure. The power shown in the figure is the power of the Special Burst.

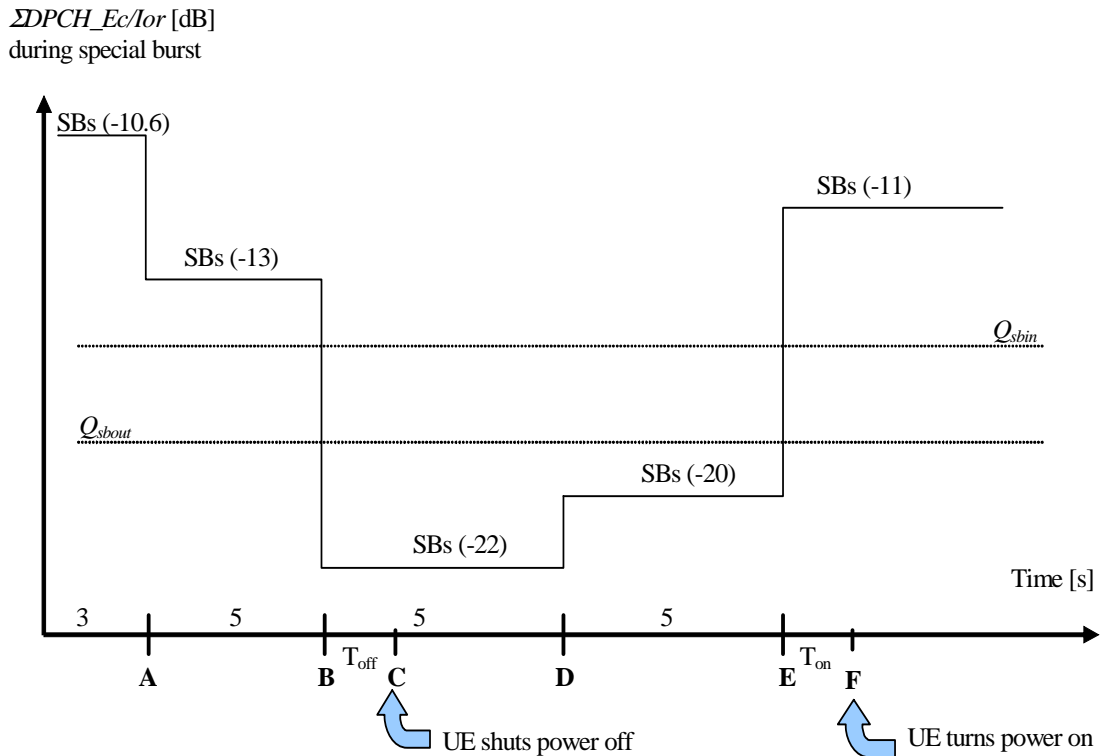

**Figure 6.1C. Test case for out-of-synch handling in the UE – 7.68 Mcps TDD option – discontinuous transmission**

In this test case, the requirements for the UE are that:

- 1) The UE shall not shut its transmitter off before point B.
- 2) The UE shall shut its transmitter off before point C, which is  $T_{off} = 200$  ms after point B.
- 3) The UE shall not turn its transmitter on between points C and E.
- 4) The UE shall turn its transmitter on before point F, which is  $T_{on} = 200$  ms after Point E.

## 6.5 Transmit ON/OFF power

### 6.5.1 Transmit OFF power

Transmit OFF power is defined as the RRC filtered mean power measured over one chip when the transmitter is off. The transmit OFF power state is when the UE does not transmit.

#### 6.5.1.1 Minimum Requirement

The requirement for transmit OFF power shall be less than  $-65$  dBm.

### 6.5.2 Transmit ON/OFF Time mask

The time mask transmit ON/OFF defines the ramping time allowed for the UE between transmit OFF power and transmit ON power.

### 6.5.2.1 Minimum Requirement

#### 6.5.2.1.1 3.84 Mcps TDD Option

The transmit power level versus time shall meet the mask specified in figure 6.2, where the transmission period refers to the burst without guard period for a single transmission slot, and to the period from the beginning of the burst in the first transmission slot to the end of the burst without guard period in the last transmission timeslot for consecutive transmission slots.

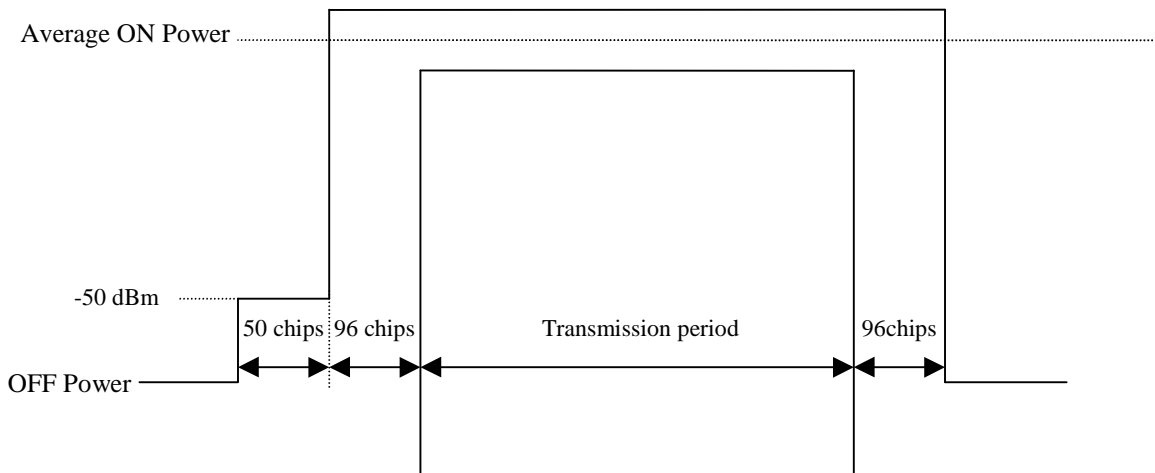

**Figure 6.2: Transmit ON/OFF template for 3.84 Mcps TDD Option**

#### 6.5.2.1.2 1.28 Mcps TDD Option

The transmit power level versus time shall meet the mask specified in figure 6.2A, where the transmission period refers to the burst without guard period for a single transmission slot, and to the period from the beginning of the burst in the first transmission slot to the end of the burst without guard period in the last transmission timeslot for consecutive transmission slots.

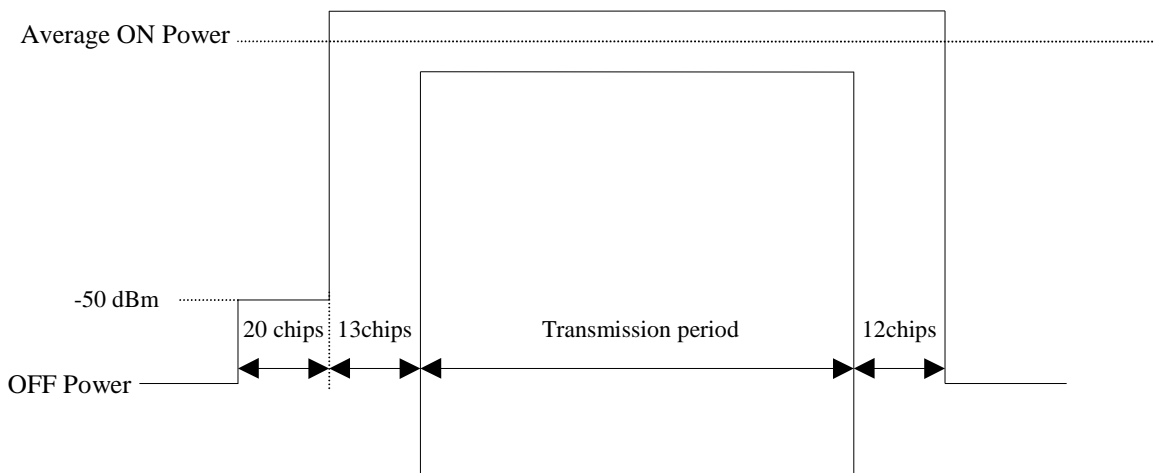

**Figure 6.2A: Transmit ON/OFF template for 1.28 Mcps TDD Option**

#### 6.5.2.1.3 7.68 Mcps TDD Option

The transmit power level versus time shall meet the mask specified in Figure 6.2B, where the transmission period refers to the burst without guard period for a single transmission slot, and to the period from the beginning of the burst in the first transmission slot to the end of the burst without guard period in the last transmission timeslot for consecutive transmission slots.

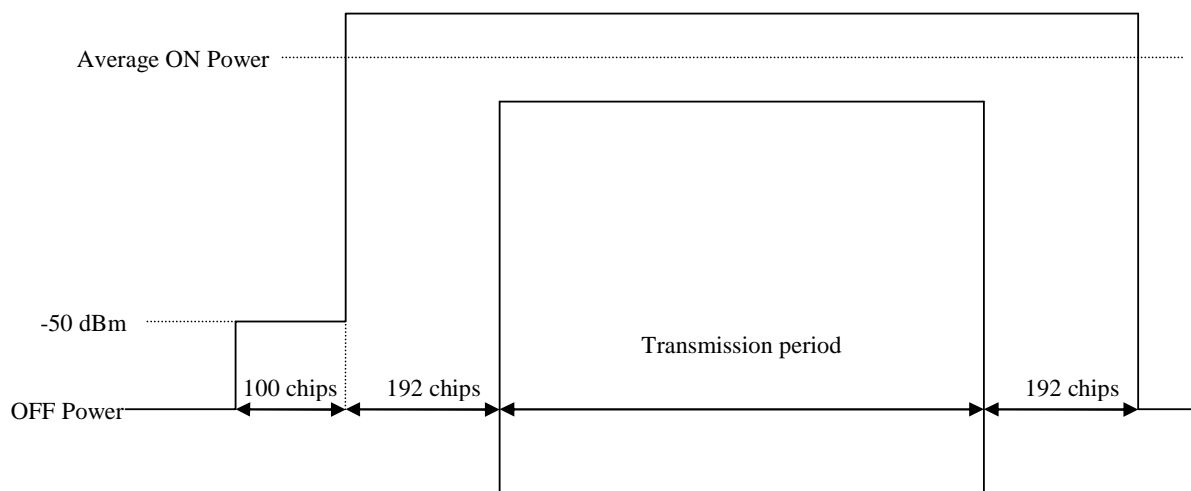

Figure 6.2B: Transmit ON/OFF template for 7.68 Mcps TDD Option

## 6.6 Output RF spectrum emissions

### 6.6.1 Occupied bandwidth

#### 6.6.1.1 3.84 Mcps TDD Option

Occupied bandwidth is a measure of the bandwidth containing 99% of the total integrated power of the transmitted spectrum, centred on the assigned channel frequency. The occupied channel bandwidth shall be less than 5 MHz based on a chip rate of 3.84 Mcps.

#### 6.6.1.2 1.28 Mcps TDD Option

Occupied bandwidth is a measure of the bandwidth containing 99% of the total integrated power of the transmitted spectrum, centred on the assigned channel frequency. The occupied channel bandwidth shall be less than 1.6 MHz based on a chip rate of 1.28 Mcps.

#### 6.6.1.3 7.68 Mcps TDD Option

Occupied bandwidth is a measure of the bandwidth containing 99% of the total integrated power of the transmitted spectrum, centred on the assigned channel frequency. The occupied channel bandwidth shall be less than 10 MHz based on a chip rate of 7.68 Mcps.

### 6.6.2 Out of band emission

Out of band emissions are unwanted emissions immediately outside the nominal channel resulting from the modulation process and non-linearity in the transmitter but excluding spurious emissions. This out of band emission limit is specified in terms of a spectrum emission mask and adjacent channel leakage power ratio (ACLR).

#### 6.6.2.1 Spectrum emission mask

##### 6.6.2.1.1 3.84 Mcps TDD Option

The spectrum emission mask of the UE applies to frequencies, which are between 2.5 MHz and 12.5MHz from the UE centre carrier frequency. The out of channel emission is specified relative to the RRC filtered mean power of the UE carrier.

## 6.6.2.1.1.1 Minimum Requirement

The power of any UE emission shall not exceed the levels specified in table 6.5.

**Table 6.5: Spectrum Emission Mask Requirement (3.84 Mcps TDD Option)**

$\Delta f^*$ in MHz	Minimum requirement	Measurement bandwidth
2.5 – 3.5	$\left\{ -35 - 15 \cdot \left( \frac{\Delta f}{\text{MHz}} - 2.5 \right) \right\} \text{dBc}$	30 kHz **
3.5 – 7.5	$\left\{ -35 - 1 \cdot \left( \frac{\Delta f}{\text{MHz}} - 3.5 \right) \right\} \text{dBc}$	1 MHz ***
7.5 – 8.5	$\left\{ -39 - 10 \cdot \left( \frac{\Delta f}{\text{MHz}} - 7.5 \right) \right\} \text{dBc}$	1 MHz ***
8.5 – 12.5	-49 dBc	1 MHz ***
*	$\Delta f$ is the separation between the carrier frequency and the centre of the measuring filter.	
**	The first and last measurement position with a 30 kHz filter is at $\Delta f$ equals to 2.515 MHz and 3.485 MHz	
***	The first and last measurement position with a 1 MHz filter is at $\Delta f$ equals to 4 MHz and 12 MHz. As a general rule, the resolution bandwidth of the measuring equipment should be equal to the measurement bandwidth. To improve measurement accuracy, sensitivity and efficiency, the resolution bandwidth can be different from the measurement bandwidth. When the resolution bandwidth is smaller than the measurement bandwidth, the result should be integrated over the measurement bandwidth in order to obtain the equivalent noise bandwidth of the measurement bandwidth.	
Note:	The lower limit shall be -50dBm/3.84 MHz or the minimum requirement presented in this table which ever is the higher.	

## 6.6.2.1.2 1.28 Mcps TDD Option

The spectrum emission mask of the UE applies to frequencies, which are between 0.8MHz and 4.0MHz from the UE centre carrier frequency. The out of channel emission is specified relative to the RRC filtered mean power of the UE carrier.

## 6.6.2.1.2.1 Minimum Requirement

The power of any UE emission shall not exceed the levels specified in table 6.5A

**Table 6.5A: Spectrum Emission Mask Requirement (1.28 Mcps TDD Option)**

$\Delta f^*$ in MHz	Minimum requirement	Measurement bandwidth
0.8-1.8	$\left\{ -35 - 14 \cdot \left( \frac{\Delta f}{\text{MHz}} - 0.8 \right) \right\} \text{dBc}$	30 kHz **
1.8-2.4	$\left( -49 - 17 \cdot \left( \frac{\Delta f}{\text{MHz}} - 1.8 \right) \right) \text{dBc}$	30 kHz **
2.4 – 4.0	-44 dBc	1MHz ***
*	$\Delta f$ is the separation between the carrier frequency and the centre of the measuring filter.	
**	The first and last measurement position with a 30 kHz filter is at $\Delta f$ equals to 0.815 MHz and 2.385 MHz.	
***	The first and last measurement position with a 1 MHz filter is at $\Delta f$ equals to 2.9MHz and 3.5MHz. As a general rule, the resolution bandwidth of the measuring equipment should be equal to the measurement bandwidth. To improve measurement accuracy, sensitivity and efficiency, the resolution bandwidth can be different from the measurement bandwidth. When the resolution bandwidth is smaller than the measurement bandwidth, the result should be integrated over the measurement bandwidth in order to obtain the equivalent noise bandwidth of the measurement bandwidth.	
Note:	The lower limit shall be -55dBm/1.28 MHz or the minimum requirement presented in this table which ever is the higher.	

### 6.6.2.1.3 7.68 Mcps TDD Option

The spectrum emission mask of the UE applies to frequencies, which are between 5 MHz and 25MHz from the UE centre carrier frequency. The out of channel emission is specified relative to the RRC filtered mean power of the UE carrier.

#### 6.6.2.1.3.1 Minimum Requirement

The power of any UE emission shall not exceed the levels specified in Table 6.5B.

**Table 6.5B: Spectrum Emission Mask of higher chip rate reference configuration**

$\Delta f^*$ in MHz	Minimum requirement	Measurement bandwidth
5.0 – 5.75	$\left\{ -38 - 10.67 \cdot \left( \frac{\Delta f}{\text{MHz}} - 5.0 \right) \right\} \text{dBc}$	30 kHz **
5.75 – 7.0	$\left\{ -46 - 5.6 \cdot \left( \frac{\Delta f}{\text{MHz}} - 5.75 \right) \right\} \text{dBc}$	30 kHz**
7.0 – 15	$\left\{ -38 - 0.5 \cdot \left( \frac{\Delta f}{\text{MHz}} - 7.0 \right) \right\} \text{dBc}$	1 MHz ***
15.0 – 17.0	$\left\{ -42 - 5.0 \cdot \left( \frac{\Delta f}{\text{MHz}} - 15.0 \right) \right\} \text{dBc}$	1 MHz ***
17.0 – 25.0	-53 dBc	1 MHz ***
*	$\Delta f$ is the separation between the carrier frequency and the centre of the measuring filter.	
**	The first and last measurement position with a 30 kHz filter is at $\Delta f$ equals to 5.015 MHz and 6.985 MHz	
***	The first and last measurement position with a 1 MHz filter is at $\Delta f$ equals to 7.5 MHz and 24.5 MHz. As a general rule, the resolution bandwidth of the measuring equipment should be equal to the measurement bandwidth. To improve measurement accuracy, sensitivity and efficiency, the resolution bandwidth can be different from the measurement bandwidth. When the resolution bandwidth is smaller than the measurement bandwidth, the result should be integrated over the measurement bandwidth in order to obtain the equivalent noise bandwidth of the measurement bandwidth.	
Note:	The lower limit shall be -47dBm/7.68 MHz or the minimum requirement presented in this table which ever is the higher.	

### 6.6.2.2 Adjacent Channel Leakage power Ratio (ACLR)

Adjacent Channel Leakage power Ratio (ACLR) is the ratio of the RRC filtered mean power centered on the assigned channel frequency to the RRC filtered mean power centered on an adjacent channel frequency.

#### 6.6.2.2.1 Minimum requirement

##### 6.6.2.2.1.1 3.84 Mcps TDD Option

If the adjacent channel RRC filtered mean power is greater than -50dBm then the ACLR shall be higher than the value specified in Table 6.6.

**Table 6.6:UE ACLR (3.84 Mcps TDD Option)**

Power Class	adjacent channel	ACLR limit
2, 3	UE channel $\pm$ 5 MHz	33 dB
2, 3	UE channel $\pm$ 10 MHz	43 dB

NOTE:

- 1) The requirement shall still be met in the presence of switching transients.
- 2) The ACLR requirements reflect what can be achieved with present state of the art technology.
- 3) Requirement on the UE shall be reconsidered when the state of the art technology progresses.

#### 6.6.2.2.1.2 1.28 Mcps TDD Option

If the adjacent channel RRC filtered mean power is greater than -55dBm then the ACLR shall be higher than the value specified in Table 6.6A.

**Table 6.6A: UE ACLR (1.28 Mcps TDD Option)**

Power Class	adjacent channel	ACLR limit
2, 3	UE channel $\pm$ 1.6 MHz	33 dB
2, 3	UE channel $\pm$ 3.2 MHz	43 dB
Note: For multi-carrier transmission, the adjacent channel is defined relative to the first or last carrier used by the UE.		

NOTE:

- 1) The requirement shall still be met in the presence of switching transients.
- 2) The ACLR requirements reflect what can be achieved with present state of the art technology.
- 3) Requirement on the UE shall be reconsidered when the state of the art technology progresses.

#### 6.6.2.2.1.3 7.68 Mcps TDD Option

If the adjacent channel RRC filtered mean power is greater than -50dBm measured with a 3.84 Mcps RRC filter then the ACLR shall be higher than the value specified in Table 6.6B.

**Table 6.6B: UE ACLR of higher chip rate reference configuration**

Power Class	adjacent channel	Chip Rate for RRC Measurement Filter	ACLR limit
2, 3	UE channel $\pm$ 7.5 MHz	3.84 MHz	33 dB
2, 3	UE channel $\pm$ 12.5 MHz	3.84 MHz	43 dB
2,3	UE channel $\pm$ 10.0 MHz	7.68 MHz	33 dB
2,3	UE channel $\pm$ 20.0 MHz	7.68 MHz	43 dB

NOTE:

- 1) The requirement shall still be met in the presence of switching transients.
- 2) The ACLR requirements reflect what can be achieved with present state of the art technology.

### 6.6.3 Spurious emissions

Spurious emissions are emissions which are caused by unwanted transmitter effects such as harmonics emission, parasitic emission, intermodulation products and frequency conversion products, but exclude out of band emissions.

The frequency boundary and the detailed transitions of the limits between the requirement for out band emissions and spectrum emissions are based on ITU-R Recommendations SM.329 [3].

#### 6.6.3.1 Minimum Requirement

##### 6.6.3.1.1 3.84 Mcps TDD Option

These requirements are only applicable for frequencies which are greater than 12.5 MHz away from the UE center carrier frequency.

**Table 6.7A: General Spurious emissions requirements (3.84 Mcps TDD Option)**

Frequency Bandwidth	Measurement Bandwidth	Minimum requirement
$9 \text{ kHz} \leq f < 150 \text{ kHz}$	1 kHz	-36 dBm
$150 \text{ kHz} \leq f < 30 \text{ MHz}$	10 kHz	-36 dBm
$30 \text{ MHz} \leq f < 1000 \text{ MHz}$	100 kHz	-36 dBm
$1 \text{ GHz} \leq f < 12.75 \text{ GHz}$	1 MHz	-30 dBm

**Table 6.7B: Additional Spurious emissions requirements (3.84 Mcps TDD Option)**

Frequency Bandwidth	Measurement Bandwidth	Minimum requirement
$921 \text{ MHz} \leq f < 925 \text{ MHz}$	100 kHz	-60 dBm (note 1)
$925 \text{ MHz} \leq f \leq 935 \text{ MHz}$	100 kHz	-67 dBm (note 1)
$935 \text{ MHz} < f \leq 960 \text{ MHz}$	100 kHz	-79 dBm (note 1)
$1805 \text{ MHz} \leq f \leq 1880 \text{ MHz}$	100 kHz	-71 dBm (note 1)
$2620 \text{ MHz} \leq f \leq 2690 \text{ MHz}$	3.84 MHz	-37 dBm (note 1)
$1884.5 \text{ MHz} \leq f \leq 1919.6 \text{ MHz}$	300 kHz	-41 dBm (note 2)

NOTE 1: The measurements are made on frequencies which are integer multiples of 200 kHz. As exceptions, up to five measurements with a level up to the applicable requirements defined in Table 6.7A are permitted for each UARFCN used in the measurement.

NOTE 2: Applicable for transmission in 2010-2025 MHz as defined in subclause 5.2 (a).

#### 6.6.3.1.2 1.28 Mcps TDD Option

These requirements are only applicable for frequencies which are greater than 4 MHz away from the UE center carrier frequency. For UE supporting multi-carrier transmission, the requirements are applicable for frequencies which are greater than 4MHz away from lowest carrier frequency or highest carrier frequency assigned for the UE.

**Table 6.7C: General Spurious emissions requirements (1.28 Mcps TDD Option)**

Frequency Bandwidth	Measurement Bandwidth	Minimum requirement
$9 \text{ kHz} \leq f < 150 \text{ kHz}$	1 kHz	-36 dBm
$150 \text{ kHz} \leq f < 30 \text{ MHz}$	10 kHz	-36 dBm
$30 \text{ MHz} \leq f < 1000 \text{ MHz}$	100 kHz	-36 dBm
$1 \text{ GHz} \leq f < 12.75 \text{ GHz}$	1 MHz	-30 dBm

**Table 6.7D: Additional Spurious emissions requirements (1.28 Mcps TDD Option)**

Frequency Bandwidth	Measurement Bandwidth	Minimum requirement
$921 \text{ MHz} \leq f < 925 \text{ MHz}$	100 kHz	-60 dBm (note)
$925 \text{ MHz} \leq f \leq 935 \text{ MHz}$	100 kHz	-67 dBm (note)
$935 \text{ MHz} < f \leq 960 \text{ MHz}$	100 kHz	-79 dBm (note)
$1805 \text{ MHz} \leq f \leq 1880 \text{ MHz}$	100 kHz	-71 dBm (note)
$2620 \text{ MHz} \leq f \leq 2690 \text{ MHz}$	3.84 MHz	-37 dBm (note)

NOTE: The measurements are made on frequencies which are integer multiples of 200 kHz. As exceptions, up to five measurements with a level up to the applicable requirements defined in Table 6.7C are permitted for each UARFCN used in the measurement.

#### 6.6.3.1.3 7.68 Mcps TDD Option

These requirements are only applicable for frequencies which are greater than 25 MHz away from the UE center carrier frequency.



**Table 6.7E: General Spurious emissions requirements (7.68 Mcps TDD Option)**

Frequency Bandwidth	Measurement Bandwidth	Minimum requirement
$9 \text{ kHz} \leq f < 150 \text{ kHz}$	1 kHz	-36 dBm
$150 \text{ kHz} \leq f < 30 \text{ MHz}$	10 kHz	-36 dBm
$30 \text{ MHz} \leq f < 1000 \text{ MHz}$	100 kHz	-36 dBm
$1 \text{ GHz} \leq f < 12.75 \text{ GHz}$	1 MHz	-30 dBm

**Table 6.7F: Additional Spurious emissions requirements (7.68 Mcps TDD Option)**

Frequency Bandwidth	Measurement Bandwidth	Minimum requirement
$921 \text{ MHz} \leq f < 925 \text{ MHz}$	100 kHz	-60 dBm (note 1)
$925 \text{ MHz} \leq f \leq 935 \text{ MHz}$	100 kHz	-67 dBm (note 1)
$935 \text{ MHz} < f \leq 960 \text{ MHz}$	100 kHz	-79 dBm (note 1)
$1805 \text{ MHz} \leq f \leq 1880 \text{ MHz}$	100 kHz	-71 dBm (note 1)
$2620 \text{ MHz} \leq f \leq 2690 \text{ MHz}$	3.84 MHz	-37 dBm (note 1)
$1884.5 \text{ MHz} \leq f \leq 1919.6 \text{ MHz}$	300 kHz	-41 dBm (note 2)

NOTE 1: The measurements are made on frequencies which are integer multiples of 200 kHz. As exceptions, up to five measurements with a level up to the applicable requirements defined in Table 6.7E are permitted for each UARFCN used in the measurement.

NOTE 2: Applicable for transmission in 2010-2025 MHz as defined in subclause 5.2 (a).

## 6.7 Transmit intermodulation

The transmit intermodulation performance is a measure of the capability of the transmitter to inhibit the generation of signals in its non linear elements caused by presence of the wanted signal and an interfering signal reaching the transmitter via the antenna.

### 6.7.1 Minimum requirement

User Equipment(s) transmitting in close vicinity of each other can produce intermodulation products, which can fall into the UE, or BS receive band as an unwanted interfering signal. The UE intermodulation attenuation is defined by the ratio of the RRC filtered mean power of the wanted signal to the RRC filtered mean power of the intermodulation product when an interfering CW signal is added at a level below the wanted signal.

#### 6.7.1.1 3.84 Mcps TDD Option

The requirement of transmitting intermodulation for carrier spacing 5 MHz is prescribed in Table 6.8.

**Table 6.8: Transmit Intermodulation (3.84 Mcps TDD Option)**

Interference Signal Frequency Offset	5MHz	10MHz
Interference Signal Level	-40 dBc	
Minimum Requirement	-31dBc	-41dBc

#### 6.7.1.2 1.28 Mcps TDD Option

The requirement of transmitting intermodulation for carrier spacing 1.6 MHz is prescribed in Table 6.8A.

**Table 6.8A: Transmit Intermodulation (1.28 Mcps TDD Option)**

Interference signal frequency offset	1.6MHz	3.2MHz
Interference signal level	-40dBc	
Minimum requirement of intermodulation products	-31 dBc	-41 dBc

### 6.7.1.3 7.68 Mcps TDD Option

The requirement of transmitting intermodulation for carrier spacing 10 MHz is prescribed in Table 6.8B.

**Table 6.8B: Transmit Intermodulation (7.68 Mcps TDD Option)**

Interference Signal Frequency Offset	10MHz	20MHz
Interference Signal Level	-40 dBc	
Minimum Requirement	-31dBc	-41dBc

## 6.8 Transmit Modulation

Transmit modulation defines the modulation quality for expected in-channel RF transmissions from the UE. The requirements apply to all transmissions.

### 6.8.1 Transmit pulse shape filter

The transmit pulse-shaping filter is a root-raised cosine (RRC) with roll-off  $\alpha = 0.22$  in the frequency domain. The impulse response of the chip impulse filter  $RC_0(t)$  is

$$RC_0(t) = \frac{\sin\left(\pi \frac{t}{T_c}(1-\alpha)\right) + 4\alpha \frac{t}{T_c} \cos\left(\pi \frac{t}{T_c}(1+\alpha)\right)}{\pi \frac{t}{T_c} \left(1 - \left(4\alpha \frac{t}{T_c}\right)^2\right)}$$

Where the roll-off factor  $\alpha = 0.22$  and  $T_c$  is the chip duration

### 6.8.2 Error Vector Magnitude

The Error Vector Magnitude is a measure of the difference between the reference waveform and the measured waveform. This difference is called the error vector. Both waveforms pass through a matched Root Raised Cosine filter with bandwidth corresponding to the considered chip rate and roll-off  $\alpha = 0.22$ . One of the waveforms is then further modified by selecting the frequency, absolute phase, absolute amplitude and chip clock timing so as to minimise the error vector. The EVM result is defined as the square root of the ratio of the mean error vector power to the mean reference power expressed as a %. The period of measurement shall be one transmit timeslot excluding the guard period. See Annex B of TS 34.122 for further details.

#### 6.8.2.1 Minimum Requirement

When 16QAM modulation is not used on any of the uplink code channels, the Error Vector Magnitude shall not exceed 17.5 % for the parameters specified in Table 6.9.

When 16QAM modulation is used on any of the uplink code channels, the modulation accuracy requirement shall not exceed 14% for the parameters specified in Table 6.9

**Table 6.9: Test parameters for Error Vector Magnitude/Peak Code Domain Error**

Parameter	Unit	Level
UE Output Power	dBm	$\geq -20$
Operating conditions		Normal conditions
Power control step size	dB	1

### 6.8.3 Peak Code Domain Error

This specification is applicable for multi-code transmission only.

The code domain error is computed by projecting the error vector power onto the code domain at a specific spreading factor. The error power for each code is defined as the ratio to the mean power of the reference waveform expressed in dB. The Peak Code Domain Error is defined as the maximum value for Code Domain Error. The period of measurement shall be one transmit timeslot excluding the guard period, and the midamble.

### 6.8.3.1 Minimum Requirement

The peak code domain error shall not exceed -21 dB at spreading factor 16 for the parameters specified in Table 6.9.

The peak code domain error for 7.68 Mcps option shall not exceed -24 dB at spreading factor 32 for the parameters specified in Table 6.9.

The requirements are defined using the UL reference measurement channel specified in subclause A.2.7.

---

## 7 Receiver characteristics

### 7.1 General

Unless detailed the receiver characteristic are specified at the antenna connector of the UE. For UE with an integral antenna only, a reference antenna with a gain of 0 dBi is assumed. UE with an integral antenna may be taken into account by converting these power levels into field strength requirements, assuming a 0 dBi gain antenna. Receiver characteristics for UE(s) with multiple antennas/antenna connectors are FFS.

The UE antenna performance has a significant impact on system performance, and minimum requirements on the antenna efficiency are therefore intended to be included in future versions of this specification. It is recognised that different requirements and test methods are likely to be required for the different types of UE.

For 3.84Mcps TDD Option and 7.68Mcps TDD Option, all the parameters in Section 7 are defined using the DL reference measurement channel specified in Annex A.2.2.

For 1.28Mcps TDD Option, UE supporting multi-carrier reception shall support both minimum requirements, as well as additional requirements for multi-carrier reception. For minimum requirements, all the parameters in Section 7 are defined using the DL reference measurement channel specified in Annex A.2.2; For UE supporting multi-carrier reception, all the parameters in Section 7 are defined using the DL reference measurement channel specified in Annex A.3.2.7. For the additional requirements for multi-carrier reception, the spacing between the two adjacent carriers shall be 1.6 MHz.

For UEs supporting only MBSFN reception, the DL reference measurement channel specified in Annex A.2.9 is used.

### 7.2 Diversity characteristics

A suitable receiver structure using coherent reception in both channel impulse response estimation, and code tracking procedures is assumed. Three forms of diversity are considered to be available in UTRA/TDD:

**Table 7.1: Diversity characteristics for UTRA/TDD**

Time diversity	Channel coding and interleaving in both up link and down link
Multi-path diversity	Rake receiver or other suitable receiver structure with maximum combining. Additional processing elements can increase the delay-spread performance due to increased capture of signal energy.
Antenna diversity	Antenna diversity with maximum ratio combining in the base station and optionally in the mobile stations. Possibility for downlink transmit diversity in the base station.

## 7.3 Reference sensitivity level

The reference sensitivity level is the minimum mean power received at the UE antenna port at which the specified minimum requirement shall be met.

### 7.3.1 Minimum Requirements

#### 7.3.1.1 3.84 Mcps TDD Option

The BER shall not exceed 0.001 for the parameters specified in Table 7.2.

**Table 7.2: Test parameters for reference sensitivity (3.84 Mcps TDD Option)**

Parameter	Level	Unit
$\frac{\Sigma DPCH_{Ec}}{I_{or}}$	0	dB
$\hat{I}_{or}$	-105	dBm/3.84 MHz

#### 7.3.1.2 1.28 Mcps TDD Option

The BER shall not exceed 0.001 for the parameters specified in Table 7.2A.

**Table 7.2A: Test parameters for reference sensitivity (1.28 Mcps TDD Option)**

Parameter	Level	Unit
$\frac{\Sigma DPCH_{Ec}}{I_{or}}$	0	dB
$\hat{I}_{or}$	-108	dBm/1.28 MHz

#### 7.3.1.3 7.68 Mcps TDD Option

The BER shall not exceed 0.001 for the parameters specified in Table 7.2B.

**Table 7.2B: Test parameters for reference sensitivity (7.68 Mcps TDD Option)**

Parameter	Level	Unit
$\frac{\Sigma DPCH_{Ec}}{I_{or}}$	0	dB
$\hat{I}_{or}$	-105	dBm/7.68 MHz

### 7.3.2 Additional requirement of multi-carrier reception for 1.28Mcps TDD Option

The BLER measured on each carrier shall not exceed 0.1 for the parameters specified in Table 7.2AA.

**Table 7.2AA: Test parameters for reference sensitivity of multi-carrier reception**

Parameter	Level	Unit
$\frac{\Sigma \text{HS - PDSCH\_Ec}}{I_{\text{or}}}$	0	dB
$\hat{I}_{\text{or}}$	-104.8	dBm/1.28 MHz

## 7.4 Maximum input level

The maximum input level is defined as the maximum mean power received at the UE antenna port which does not degrade the specified minimum requirement.

### 7.4.1 Minimum Requirements for DPCH reception

#### 7.4.1.1 3.84 Mcps TDD Option

The BER shall not exceed 0.001 for the parameters specified in Table 7.3.

**Table 7.3: Maximum input level (3.84 Mcps TDD Option)**

Parameter	Level	Unit
$\frac{\Sigma \text{DPCH\_Ec}}{I_{\text{or}}}$	-7	dB
$\hat{I}_{\text{or}}$	-25	dBm/3.84 MHz

#### 7.4.1.2 1.28 Mcps TDD Option

The BER shall not exceed 0.001 for the parameters specified in Table 7.3A

**Table 7.3A: Maximum input level (1.28 Mcps TDD Option)**

Parameter	Level	Unit
$\frac{\Sigma \text{DPCH\_Ec}}{I_{\text{or}}}$	-7	dB
$\hat{I}_{\text{or}}$	-25	dBm/1.28 MHz

#### 7.4.1.3 7.68 Mcps TDD Option

The BER shall not exceed 0.001 for the parameters specified in Table 7.3B.

**Table 7.3B: Maximum input level (7.68 Mcps TDD Option)**

Parameter	Level	Unit
$\frac{\Sigma \text{DPCH\_Ec}}{I_{\text{or}}}$	-10	dB
$\hat{I}_{\text{or}}$	-25	dBm/7.68 MHz

## 7.4.2 Minimum Requirements for HS-PDSCH reception

### 7.4.2.1 3.84 Mcps TDD Option

<Void>

### 7.4.2.2 1.28 Mcps TDD Option

The requirements are specified in terms of a minimum information bit throughput R for the DL reference channel specified in Annex A.3.2.2.2. For multi-carrier reception, DL reference channel specified in Annex A.3.2.2.2 shall be applied to each carrier simultaneously.

With the parameters specified in Table 7.3C, the throughput R shall meet or exceed 500kbps. For multi-carrier reception, the throughput R of each carrier shall meet or exceed 500kbps.

**Table 7.3C**

Parameter	Level	Unit
$\frac{\sum HS - PDSCH - Ec}{I_{or}}$	0	dB
$\hat{I}_{or}$	-25	dBm/1.28 MHz
Redundancy and constellation version	6	-
Maximum number of HARQ transmissions	1	-

## 7.5 Adjacent Channel Selectivity (ACS)

Adjacent Channel Selectivity is a measure of a receiver's ability to receive a wanted signal at its assigned channel frequency in the presence of adjacent channel signal at a given frequency offset from the centre frequency of the assigned channel. ACS is the ratio of the receive filter attenuation on the assigned channel frequency to the receiver filter attenuation on the adjacent channel(s).

### 7.5.1 Minimum Requirement

#### 7.5.1.1 3.84 Mcps TDD Option

The ACS shall be better than the value indicated in Table 7.4 for the test parameters specified in Table 7.5 where the BER shall not exceed 0.001

**Table 7.4: Adjacent Channel Selectivity (3.84 Mcps TDD Option)**

Power Class	Unit	ACS
2	dB	33
3	dB	33

**Table 7.5: Test parameters for Adjacent Channel Selectivity (3.84 Mcps TDD Option)**

Parameter	Unit	Level
$\frac{\sum DPCH - Ec}{I_{or}}$	dB	0
$\hat{I}_{or}$	dBm/3.84 MHz	-91
$I_{oac}$ mean power (modulated)	dBm	-52
$F_{uw}$ offset	MHz	+5 or -5

### 7.5.1.2 1.28 Mcps TDD Option

The ACS shall be better than the value indicated in table 7.4A for the test parameters specified in table 7.5A where the BER shall not exceed 0.001

**Table 7.4A: Adjacent Channel Selectivity (1.28 Mcps TDD Option)**

Power Class	Unit	ACS
2	dB	33
3	dB	33

**Table 7.5A: Test parameters for Adjacent Channel Selectivity (1.28 Mcps TDD Option)**

Parameter	Unit	Level
$\frac{\Sigma DPCH\_Ec}{I_{or}}$	dB	0
$\hat{I}_{or}$	dBm/1.28MHz	-91
$I_{oac}$ mean power (modulated)	dBm	-54
$F_{uw}$ offset	MHz	+1.6 or -1.6

### 7.5.1.3 7.68 Mcps TDD Option

The ACS shall be better than the value indicated in Table 7.4B for the test parameters specified in 7.5B where the BER shall not exceed 0.001

**Table 7.4B: Adjacent Channel Selectivity (7.68 Mcps TDD Option)**

Power Class	Unit	ACS
2	dB	33
3	dB	33

**Table 7.5B: Test parameters for Adjacent Channel Selectivity (7.68 Mcps TDD Option)**

Parameter	Unit	Level
$\frac{\Sigma DPCH\_Ec}{I_{or}}$	dB	0
$\hat{I}_{or}$	dBm/7.68 MHz	-91
$I_{oac}$ mean power (modulated)	dBm	-52
$F_{uw}$ offset (3.84 Mcps Modulated)	MHz	+7.5 or -7.5
$F_{uw}$ offset (7.68 Mcps Modulated)	MHz	+10 or -10

## 7.5.2 Additional requirement of multi-carrier reception for 1.28Mcps TDD Option

The ACS shall be better than the value indicated in table 7.4A for the test parameters specified in table 7.5AA where the BLER measured on each carrier shall not exceed 0.1.

**Table 7.5AA: Test parameters for Adjacent Channel Selectivity of multi-carrier reception**

Parameter	Unit	Level
$\frac{\Sigma HS - PDSCH_{Ec}}{I_{or}}$	dB	0
$\hat{I}_{or}$	dBm/1.28MHz	-87.8
$I_{oac}$ mean power (modulated)	dBm	-54
$F_{uw}$ offset(Note)	MHz	+1.6 or -1.6
Note: Negative offsets refer to the assigned channel frequency of the lowest carrier frequency used and positive offsets refer to the assigned channel frequency of the highest carrier frequency used.		

## 7.6 Blocking characteristics

The blocking characteristics is a measure of the receiver ability to receive a wanted signal at its assigned channel frequency in the presence of an unwanted interferer on frequencies other than those of the spurious response or the adjacent channels without this unwanted input signal causing a degradation of the performance of the receiver beyond a specified limit. The blocking performance shall apply at all frequencies except those at which a spurious response occur.

### 7.6.1 Minimum Requirement

#### 7.6.1.1 3.84 Mcps TDD Option

The BER shall not exceed 0.001 for the parameters specified in table 7.6, table 7.7 and table 7.7AA. For table 7.7 and 7.7AA up to 24 exceptions are allowed for spurious response frequencies in each assigned frequency channel when measured using a 1MHz step size. Additional requirement in table 7.7AA is applied for Band a) UE operating on 2010-2025MHz.

**Table 7.6: In-band blocking (3.84 Mcps TDD Option)**

Parameter	Level		Unit
$\frac{\Sigma DPCH_{Ec}}{I_{or}}$	0		dB
$\hat{I}_{or}$	-102		dBm/3.84 MHz
$I_{ouw}$ mean power (modulated)	-56 (for $F_{uw}$ offset $\pm 10$ MHz)	-44 (for $F_{uw}$ offset $\pm 15$ MHz)	dBm



**Table 7.7: Out of band blocking (3.84 Mcps TDD Option)**

Parameter	Band 1	Band 2	Band 3	Unit
$\frac{\Sigma DPCH\_Ec}{I_{or}}$	0	0	0	dB
$\hat{I}_{or}$	-102	-102	-102	dBm/3.84 MHz
$I_{ouw}$ (CW)	-44	-30	-15	dBm
$F_{uw}$ For operation in frequency bands as defined in subclause 5.2(a)	1840 <f <1885 1935 <f <1995 2040 <f <2085	1815 <f ≤1840 2085 ≤f <2110	1 < f ≤1815 2110 ≤ f <12750	MHz
$F_{uw}$ For operation in frequency bands as defined in subclause 5.2(b)	1790 < f < 1835 2005 < f < 2050	1765 < f ≤ 1790 2050 ≤ f < 2075	1 < f ≤ 1765 2075 ≤ f < 12750	MHz
$F_{uw}$ For operation in frequency bands as defined in subclause 5.2l	1850 < f < 1895 1945 < f < 1990	1825 < f ≤ 1850 1990 ≤ f < 2015	1 < f ≤ 1825 2015 ≤ f < 12750	MHz
$F_{uw}$ For operation in frequency bands as defined in subclause 5.2(d)	2510 <f < 2555 2635 <f < 2680	2485 <f ≤ 2510 2680 ≤f < 2705	1 <f ≤ 2485 2705 ≤f < 12750	MHz
1.	For operation referenced in 5.2(a), from 1885 ≤ f ≤ 1935 MHz, 1995 ≤ f ≤ 2040 MHz, the appropriate in-band blocking in table 7.6 or adjacent channel selectivity in section 7.5.1 shall be applied.			
2.	For operation referenced in 5.2(b), from 1835 ≤ f ≤ 2005 MHz, the appropriate in-band blocking in table 7.6 or adjacent channel selectivity in section 7.5.1 shall be applied.			
3.	For operation referenced in 5.2l, from 1895 ≤ f ≤ 1945 MHz, the appropriate in-band blocking in table 7.6 or adjacent channel selectivity in section 7.5.1 shall be applied.			
4.	For operation referenced in 5.2(d), from 2555 ≤ f ≤ 2635 MHz, the appropriate in-band blocking in table 7.6 or adjacent channel selectivity in section 7.5.1 shall be applied.			

**Table 7.7AA: Additional Out of band blocking (3.84 Mcps TDD Option)**

Parameter	Band 1	Band 2	Band 3	Unit
$\frac{\Sigma DPCH\_Ec}{I_{or}}$	0	0	0	dB
$\hat{I}_{or}$	-102	-102	-102	dBm/3.84 MHz
$I_{ouw}$ (CW)	-44	-30	-15	dBm
$F_{uw}$ For operation in frequency bands in 2010-2025 MHz as defined in subclause 5.2(a)	1840 <f <1995 2040 <f <2085	1815 <f ≤1840 2085 ≤f <2110	1 < f ≤1815 2110 ≤ f <12750	MHz
NOTE 1: Additional requirement is applied for Band a) UE operating on 2010-2025MHz.				

### 7.6.1.2 1.28 Mcps TDD Option

The BER shall not exceed 0.001 for the parameters specified in table 7.6A and table 7.7A. For table 7.7A up to 24 exceptions are allowed for spurious response frequencies in each assigned frequency channel when measured using a 1MHz step size.

Table 7.6A: In-band blocking (1.28 Mcps TDD Option)

Parameter	Level		Unit
$\frac{\Sigma DPCH\_Ec}{I_{or}}$	0		dB
$\hat{I}_{or}$	-105		dBm/1.28 MHz
$I_{ouw}$ mean power (modulated)	-61 (for $F_{uw}$ offset $\pm 3.2$ MHz)	-49 (for $F_{uw}$ offset $\pm 4.8$ MHz)	dBm

Table 7.7A: Out of band blocking (1.28 Mcps TDD Option)

Parameter	Band 1	Band 2	Band 3	Unit
$\frac{\Sigma DPCH\_Ec}{I_{or}}$	0	0	0	dB
$\hat{I}_{or}$	-105	-105	-105	dBm/1.28 MHz
$I_{ouw}$ (CW)	-44	-30	-15	dBm
$F_{uw}$ For operation in frequency bands as defined in subclause 5.2(a)	1840 < f < 1895.2 1924.8 < f < 2005.2 2029.8 < f < 2085	1815 < f ≤ 1840 2085 ≤ f < 2110	1 < f ≤ 1815 2110 ≤ f < 12750	MHz
$F_{uw}$ For operation in frequency bands as defined in subclause 5.2(b)	1790 < f < 1845.2 1914.8 < f < 1925.2 1994.8 < f < 2050	1765 < f ≤ 1790 2050 ≤ f < 2075	1 < f ≤ 1765 2075 ≤ f < 12750	MHz
$F_{uw}$ For operation in frequency bands as defined in subclause 5.2l	1850 < f < 1905.2 1934.8 < f < 1990	1825 < f ≤ 1850 1990 ≤ f < 2015	1 < f ≤ 1825 2015 ≤ f < 12750	MHz
$F_{uw}$ For operation in frequency bands as defined in subclause 5.2(d)	2510 < f < 2565.2 2624.8 < f < 2680	2485 < f ≤ 2510 2680 ≤ f < 2705	1 < f ≤ 2485 2705 ≤ f < 12750	MHz
1.	For operation referenced in 5.2(a), from 1895.2 ≤ f ≤ 1924.8 MHz, 2005.2 ≤ f ≤ 2029.8 MHz, the appropriate in-band blocking in table 7.6A or adjacent channel selectivity in section 7.5.1.2 shall be applied.			
2.	For operation referenced in 5.2(b), from 1845.2 ≤ f < 1914.8 MHz, and 1925.2 < f < 1994.8 MHz, the appropriate in-band blocking in table 7.6A or adjacent channel selectivity in section 7.5.1.2 shall be applied.			
3.	For operation referenced in 5.2l, from 1905.2 ≤ f ≤ 1934.8 MHz, the appropriate in-band blocking in table 7.6A or adjacent channel selectivity in section 7.5.1.2 shall be applied.			
4.	For operation referenced in 5.2(d), from 2565.2 ≤ f ≤ 2624.8 MHz, the appropriate in-band blocking in table 7.6 or adjacent channel selectivity in section 7.5.1 shall be applied.			

### 7.6.1.3 7.68 Mcps TDD Option

The BER shall not exceed 0.001 for the parameters specified in table 7.6B, 7.7B and table 7.7CC. For table 7.7B and 7.7CC up to 24 exceptions are allowed for spurious response frequencies in each assigned frequency channel when measured using a 1MHz step size. Additional requirement in table 7.7CC is applied for Band a) UE operating on 2010-2025MHz.

Table 7.6B: In-band blocking

Parameter	Level		Unit
$\frac{\Sigma DPCH\_Ec}{I_{or}}$	0		dB
$\hat{I}_{or}$	-102		dBm/7.68 MHz
$I_{ouw}$ mean power (modulated)	-53 (for $F_{uw}$ Offset $\pm 20$ MHz)	-41 (for $F_{uw}$ offset $\pm 30$ MHz)	dBm

Table 7.7B: Out of band blocking

Parameter	Band 1	Band 2	Band 3	Unit
$\frac{\Sigma DPCH\_Ec}{I_{or}}$	0	0	0	dB
$\hat{I}_{or}$	-102	-102	-102	dBm/7.68 MHz
$I_{ouw}$ (CW)	-44	-30	-15	dBm
$F_{uw}$ For operation in frequency bands as defined in subclause 5.2(a)	1840 <f <1870 1950 <f <1980 2055 <f <2085	1815 <f ≤1840 2085 ≤f <2110	1 <f ≤1815 2110 ≤f <12750	MHz
$F_{uw}$ For operation in frequency bands as defined in subclause 5.2(b)	1790 <f < 1820 2020 <f < 2050	1765 <f ≤ 1790 2050 ≤f < 2075	1 <f ≤ 1765 2075 ≤f < 12750	MHz
$F_{uw}$ For operation in frequency bands as defined in subclause 5.2l	1850 <f < 1880 1960 <f < 1990	1825 <f ≤ 1850 1990 ≤f < 2015	1 <f ≤ 1825 2015 ≤f < 12750	MHz
$F_{uw}$ For operation in frequency bands as defined in subclause 5.2(d)	2510 <f < 2540 2650 <f < 2680	2485 <f ≤ 2510 2680 ≤f < 2705	1 <f ≤ 2485 2705 ≤f < 12750	MHz
1.	For operation referenced in 5.2(a), from 1870 ≤f ≤ 1950 MHz, 1980 ≤f ≤ 2055 MHz, the appropriate in-band blocking in table 7.6B or adjacent channel selectivity in section 7.5.1.3 shall be applied.			
2.	For operation referenced in 5.2(b), from 1820 ≤f ≤ 2020 MHz, the appropriate in-band blocking in table 7.6B or adjacent channel selectivity in section 7.5.1.3 shall be applied.			
3.	For operation referenced in 5.2l, from 1880 ≤f ≤ 1960 MHz, the appropriate in-band blocking in table 7.6B or adjacent channel selectivity in section 7.5.1.3 shall be applied.			
4.	For operation referenced in 5.2(d), from 2540 ≤f ≤ 2650 MHz, the appropriate in-band blocking in table 7.6B or adjacent channel selectivity in section 7.5.1.3 shall be applied.			

Table 7.7CC: Additional Out of band blocking (7.68 Mcps TDD Option)

Parameter	Band 1	Band 2	Band 3	Unit
$\frac{\Sigma DPCH\_Ec}{I_{or}}$	0	0	0	dB
$\hat{I}_{or}$	-102	-102	-102	dBm/3.84 MHz
$I_{ouw}$ (CW)	-44	-30	-15	dBm
$F_{uw}$ For operation in frequency bands in 2010-2025 MHz as defined in subclause 5.2(a)	1840 <f <1995 2040 <f <2085	1815 <f ≤1840 2085 ≤f <2110	1 <f ≤1815 2110 ≤f <12750	MHz
NOTE 1: Additional requirement is applied for Band a) UE operating on 2010-2025MHz.				

## 7.6.2 Additional requirement of multi-carrier reception for 1.28Mcps TDD Option

The BLER measured on each carrier shall not exceed 0.1 for the parameters specified in table 7.6AA and table 7.7AAA. For table 7.7AAA up to 24 exceptions for each carrier are allowed for spurious response frequencies in each assigned frequency channel when measured using a 1MHz step size.

**Table 7.6AA: In-band blocking of multi-carrier reception**

Parameter	Level		Unit
$\frac{\Sigma HS - PDSCH\_Ec}{I_{or}}$	0		dB
$\hat{I}_{or}$	-101.8		dBm/1.28 MHz
$I_{ouw}$ mean power (modulated)	-61 (for $F_{uw}$ offset $\pm 3.2$ MHz)(Note)	-49 (for $F_{uw}$ offset $\pm 4.8$ MHz)(Note)	dBm
Note: Negative offsets refer to the assigned channel frequency of the lowest carrier frequency used and positive offsets refer to the assigned channel frequency of the highest carrier frequency used.			

**Table 7.7AAA: Out of band blocking of multi-carrier reception**

Parameter	Band 1	Band 2	Band 3	Unit
$\frac{\Sigma HS - PDSCH\_Ec}{I_{or}}$	0	0	0	dB
$\hat{I}_{or}$	-101.8	-101.8	-101.8	dBm/1.28 MHz
$I_{ouw}$ (CW)	-44	-30	-15	dBm
$F_{uw}$ For operation in frequency bands as defined in subclause 5.2(a)	1840 < f < 1895.2 1924.8 < f < 2005.2 2029.8 < f < 2085	1815 < f ≤ 1840 2085 ≤ f < 2110	1 < f ≤ 1815 2110 ≤ f < 12750	MHz
$F_{uw}$ For operation in frequency bands as defined in subclause 5.2(b)	1790 < f < 1845.2 1914.8 < f < 1925.2 1994.8 < f < 2050	1765 < f ≤ 1790 2050 ≤ f < 2075	1 < f ≤ 1765 2075 ≤ f < 12750	MHz
$F_{uw}$ For operation in frequency bands as defined in subclause 5.2(c)	1850 < f < 1905.2 1934.8 < f < 1990	1825 < f ≤ 1850 1990 ≤ f < 2015	1 < f ≤ 1825 2015 ≤ f < 12750	MHz
$F_{uw}$ For operation in frequency bands as defined in subclause 5.2(d)	2510 < f < 2565.2 2624.8 < f < 2680	2485 < f ≤ 2510 2680 ≤ f < 2705	1 < f ≤ 2485 2705 ≤ f < 12750	MHz
1.	For operation referenced in 5.2(a), from 1895.2 ≤ f ≤ 1924.8 MHz, 2005.2 ≤ f ≤ 2029.8 MHz, the appropriate in-band blocking in table 7.6AA or adjacent channel selectivity in section 7.5.2 shall be applied.			
2.	For operation referenced in 5.2(b), from 1845.2 ≤ f < 1914.8 MHz, and 1925.2 < f < 1994.8 MHz, the appropriate in-band blocking in table 7.6AA or adjacent channel selectivity in section 7.5.2 shall be applied.			
3.	For operation referenced in 5.2(c), from 1905.2 ≤ f ≤ 1934.8 MHz, the appropriate in-band blocking in table 7.6AA or adjacent channel selectivity in section 7.5.2 shall be applied.			
4.	For operation referenced in 5.2(d), from 2565.2 ≤ f ≤ 2624.8 MHz, the appropriate in-band blocking in table 7.6AA or adjacent channel selectivity in section 7.5.2 shall be applied.			

## 7.7 Spurious response

Spurious response is a measure of the receiver's ability to receive a wanted signal on its assigned channel frequency without exceeding a given degradation due to the presence of an unwanted CW interfering signal at any other frequency at which a response is obtained i.e. for which the blocking limit is not met.

### 7.7.1 Minimum Requirement

#### 7.7.1.1 3.84 Mcps TDD Option

The BER shall not exceed 0.001 for the parameters specified in Table 7.8.

**Table 7.8: Spurious Response (3.84 Mcps TDD Option)**

Parameter	Level	Unit
$\frac{\Sigma DPCH\_Ec}{I_{or}}$	0	dB
$\hat{I}_{or}$	-102	dBm/3.84 MHz
$I_{ouw}$ (CW)	-44	dBm
$F_{uw}$	Spurious response frequencies	MHz

#### 7.7.1.2 1.28 Mcps TDD Option

The BER shall not exceed 0.001 for the parameters specified in Table 7.8A.

**Table 7.8A: Spurious Response (1.28 Mcps TDD Option)**

Parameter	Level	Unit
$\frac{\Sigma DPCH\_Ec}{I_{or}}$	0	dB
$\hat{I}_{or}$	-105	dBm/1.28 MHz
$I_{ouw}$ (CW)	-44	dBm
$F_{uw}$	Spurious response frequencies	MHz

#### 7.7.1.3 7.68 Mcps TDD Option

The BER shall not exceed 0.001 for the parameters specified in Table 7.8B.

**Table 7.8B: Spurious Response**

Parameter	Level	Unit
$\frac{\Sigma DPCH\_Ec}{I_{or}}$	0	dB
$\hat{I}_{or}$	-102	dBm/7.68 MHz
$I_{ouw}$ (CW)	-44	dBm
$F_{uw}$	Spurious response frequencies	MHz

## 7.7.2 Additional requirement of multi-carrier reception for 1.28Mcps TDD Option

The BLER measured on each carrier shall not exceed 0.1 for the parameters specified in Table 7.8AA.

**Table 7.8AA: Spurious Response of multi-carrier reception**

Parameter	Level	Unit
$\frac{\Sigma HS - PDSCH\_Ec}{I_{or}}$	0	dB
$\hat{I}_{or}$	-101.8	dBm/1.28 MHz
$I_{ouw} (CW)$	-44	dBm
$F_{uw}$	Spurious response frequencies	MHz

## 7.8 Intermodulation characteristics

Third and higher order mixing of the two interfering RF signals can produce an interfering signal in the band of the desired channel. Intermodulation response rejection is a measure of the capability of the receiver to receive a wanted signal on its assigned channel frequency in the presence of two or more interfering signals which have a specific frequency relationship to the wanted signal.

### 7.8.1 Minimum Requirements

#### 7.8.1.1 3.84 Mcps TDD Option

The BER shall not exceed 0.001 for the parameters specified in table 7.9.

**Table 7.9: Receive intermodulation characteristics**

Parameter	Level	Unit
$\frac{\Sigma DPCH\_Ec}{I_{or}}$	0	dB
$\hat{I}_{or}$	-102	dBm/3.84 MHz
$I_{ouw1} (CW)$	-46	dBm
$I_{ouw2}$ mean power (modulated)	-46	dBm
$F_{uw1} (CW)$	$\pm 10$	MHz
$F_{uw2}$ (modulated)	$\pm 20$	MHz

### 7.8.1.2 1.28 Mcps TDD Option

The BER shall not exceed 0.001 for the parameters specified in table 7.9A

**Table 7.9A: Receive intermodulation characteristics (1.28 Mcps TDD Option)**

Parameter	Level	Unit
$\frac{\Sigma DPCH - Ec}{I_{or}}$	0	dB
$\hat{I}_{or}$	-105	dBm/1.28 MHz
$I_{ouw1}$ (CW)	-46	dBm
$I_{ouw2}$ mean power (modulated)	-46	dBm/1.28 MHz
$F_{uw1}$ (CW)	$\pm 3.2$	MHz
$F_{uw2}$ (modulated)	$\pm 6.4$	MHz

### 7.8.1.3 7.68 Mcps TDD Option

The BER shall not exceed 0.001 for the parameters specified in table 7.9B.

**Table 7.9B: Receive intermodulation characteristics**

Parameter	Level	Unit
$\frac{\Sigma DPCH - Ec}{I_{or}}$	0	dB
$\hat{I}_{or}$	-102	dBm/7.68 MHz
$I_{ouw1}$ (CW)	-46	dBm
$I_{ouw2}$ mean power (modulated)	-46	dBm
$F_{uw1}$ (CW)	$\pm 20$	MHz
$F_{uw2}$ (modulated)	$\pm 40$	MHz

## 7.8.2 Additional requirement of multi-carrier reception for 1.28Mcps TDD Option

The BLER measured on each carrier shall not exceed 0.1 for the parameters specified in table 7.9AA

**Table 7.9AA: Receive intermodulation characteristics of multi-carrier reception**

Parameter	Level	Unit
$\frac{\Sigma HS - PDSCH - Ec}{I_{or}}$	0	dB
$\hat{I}_{or}$	-101.8	dBm/1.28 MHz
$I_{ouw1}$ (CW)	-46	dBm
$I_{ouw2}$ mean power (modulated)	-46	dBm/1.28 MHz
$F_{uw1}$ (CW)(Note)	$\pm 3.2$	MHz
$F_{uw2}$ (modulated)	$\pm 6.4$	MHz
Note: Negative offsets refer to the assigned channel frequency of the lowest carrier frequency used and positive offsets refer to the assigned channel frequency of the highest carrier frequency used.		

## 7.9 Spurious emissions

The Spurious Emissions Power is the power of emissions generated or amplified in a receiver that appear at the UE antenna connector.

## 7.9.1 Minimum Requirement

### 7.9.1.1 3.84 Mcps TDD Option

The power of any spurious emission shall not exceed:

**Table 7.10: Receiver spurious emission requirements (3.84 Mcps TDD Option)**

Band	Maximum level	Measurement Bandwidth	Note
30 MHz – 1 GHz	-57 dBm	100 kHz	
1 GHz – 1.9 GHz and 1.92 GHz – 2.01 GHz and 2.025 GHz – 2.11 GHz and 2.17 GHz – 2.57 GHz	-47 dBm	1 MHz	
1.9 GHz – 1.92 GHz and 2.01 GHz – 2.025 GHz and 2.11 GHz – 2.170 GHz and 2.57 GHz – 2.69 GHz	-60 dBm	3.84 MHz	
2.69 GHz – 12.75 GHz	-47 dBm	1 MHz	

### 7.9.1.2 1.28 Mcps TDD Option

The power of any spurious emission shall not exceed:

**Table 7.10A: Receiver spurious emission requirements (1.28 Mcps TDD Option)**

Band	Maximum level	Measurement Bandwidth	Note
30 MHz – 1 GHz	-57 dBm	100 kHz	
1 GHz – 1.9 GHz and 1.92 GHz – 2.01 GHz and 2.025 GHz – 2.11 GHz and 2.17GHz – 2.57GHz	-47 dBm	1 MHz	
1.9 GHz – 1.92 GHz and 2.01 GHz – 2.025 GHz and 2.11 GHz – 2.170 GHz and 2.57GHz – 2.69GHz	-64 dBm	1.28 MHz	
2.69 GHz – 12.75 GHz	-47 dBm	1 MHz	

### 7.9.1.3 7.68 Mcps TDD Option

The power of any spurious emission shall not exceed:

**Table 7.10B: Receiver spurious emission requirements**

Band	Maximum level	Measurement Bandwidth	Note
30 MHz – 1 GHz	-57 dBm	100 kHz	
1 GHz – 1.9 GHz and 1.92 GHz – 2.01 GHz and 2.025 GHz – 2.11 GHz 2.17 GHz – 2.57 GHz	-47 dBm	1 MHz	
1.9 GHz – 1.92 GHz and 2.01 GHz – 2.025 GHz and 2.11 GHz – 2.170 GHz 2.57 GHz – 2.69 GHz	-57 dBm	7.68 MHz	
2.69 GHz – 12.75 GHz	-47 dBm	1 MHz	



## 8 Performance requirement

### 8.1 General

The performance requirements for the UE in this section are specified for the measurement channels specified in Annex A and the propagation condition specified in Annex B.

**Table 8.1: Summary of UE performance targets**

Test Chs.	Information Data Rate	Static	Multi-path Case 1	Multi-path Case 2	Multi-path Case 3
		Performance metric			
DCH	12.2 kbps	BLER<10 <sup>-2</sup>	BLER<10 <sup>-2</sup>	BLER<10 <sup>-2</sup>	BLER<10 <sup>-2</sup>
	64 kbps	BLER<10 <sup>-1</sup> , 10 <sup>-2</sup>	BLER<10 <sup>-1</sup> , 10 <sup>-2</sup>	BLER<10 <sup>-1</sup> , 10 <sup>-2</sup>	BLER<10 <sup>-1</sup> , 10 <sup>-2</sup> , 10 <sup>-3</sup>
	144 kbps	BLER<10 <sup>-1</sup> , 10 <sup>-2</sup>	BLER<10 <sup>-1</sup> , 10 <sup>-2</sup>	BLER<10 <sup>-1</sup> , 10 <sup>-2</sup>	BLER<10 <sup>-1</sup> , 10 <sup>-2</sup> , 10 <sup>-3</sup>
	384 kbps	BLER<10 <sup>-1</sup> , 10 <sup>-2</sup>	BLER<10 <sup>-1</sup> , 10 <sup>-2</sup>	BLER<10 <sup>-1</sup> , 10 <sup>-2</sup>	BLER<10 <sup>-1</sup> , 10 <sup>-2</sup> , 10 <sup>-3</sup>
	2048 kbps	BLER < 10 <sup>-1</sup> , 10 <sup>-2</sup>	BLER< 10 <sup>-1</sup> , 10 <sup>-2</sup>	BLER< 10 <sup>-1</sup> , 10 <sup>-2</sup>	BLER<10 <sup>-1</sup> , 10 <sup>-2</sup> , 10 <sup>-3</sup>
BCH	12.3kbps		BLER<10 <sup>-2</sup>		

### 8.2 Demodulation in static propagation conditions

#### 8.2.1 Demodulation of DCH

The performance requirement of DCH in static propagation conditions is determined by the maximum Block Error Ratio (BLER). The BLER is specified for each individual data rate of the DCH. DCH is mapped into the Dedicated Physical Channel (DPCH).

##### 8.2.1.1 Minimum requirement

###### 8.2.1.1.1 3.84 Mcps TDD Option

For the parameters specified in Table 8.2 the BLER should not exceed the piece-wise linear BLER curve specified in Table 8.3. These requirements are applicable for TFCS size 16.

**Table 8.2: DCH parameters in static propagation conditions (3.84 Mcps TDD Option)**

Parameters	Unit	Test 1	Test 2	Test 3	Test 4	Test 5
$\frac{\Sigma DPCH - E_c}{I_{or}}$	dB	-6	-3	0	0	0
$I_{oc}$	dBm/3.84 MHz	-60				
Cell Parameter*		0,1				-
DPCH Channelization Codes*	C(k,Q)	C(i,16) i=1,2	C(i,16) i=1..5	C(i,16) i=1..9	C(i,16) i=1..8	-
OCNS Channelization Code*	C(k,Q)	C(3,16)	C(6,16)	-	-	-
Information Data Rate	kbps	12.2	64	144	384	2048

\*Note: Refer to TS 25.223 for definition of channelization codes and cell parameter.

**Table 8.3: Performance requirements in AWGN channel (3.84 Mcps TDD Option)**

Test Number	$\frac{\hat{I}_{or}}{I_{oc}}$ [dB]	BLER
1	1.1	$10^{-2}$
2	3.5	$10^{-1}$
	3.8	$10^{-2}$
3	3.4	$10^{-1}$
	3.6	$10^{-2}$
4	2.7	$10^{-1}$
	3.0	$10^{-2}$
5	3.5	$10^{-1}$
	3.6	$10^{-2}$

## 8.2.1.1.2 1.28 Mcps TDD Option

For the parameters specified in Table 8.2A the BLER should not exceed the piece-wise linear BLER curve specified in Table 8.3A.

**Table 8.2A: DCH parameters in static propagation conditions (1.28 Mcps TDD Option)**

Parameters	Unit	Test 1	Test 2	Test 3	Test 4
Number of DPCH <sub>o</sub>		8	2	2	0
Scrambling code and basic midamble code number*		0	0	0	0
DPCH Channelization Codes*	C(k,Q)	C(i,16) i=1,2	C(i,16) i=1...8	C(i,16) i=1...8	C(i,16) i=1...9
DPCH <sub>o</sub> Channelization Codes*	C(k,Q)	C(i,16) 3 ≤ i ≤ 10	C(i,16) 9 ≤ i ≤ 10	C(i,16) 9 ≤ i ≤ 10	-
$\frac{DPCH_o - E_c}{I_{or}}$	dB	-10	-10	-10	0
$I_{oc}$	DBm/1.28MHz	-60			
Information Data Rate	Kbps	12.2	64	144	384

\*Note: Refer to TS 25.223 for definition of channelization codes, scrambling code and basic midamble code.

**Table 8.3A: Performance requirements in AWGN channel (1.28 Mcps TDD Option)**

Test Number	$\frac{\hat{I}_{or}}{I_{oc}}$ [dB]	BLER
1	3.6	$10^{-2}$
2	2.4	$10^{-1}$
	2.7	$10^{-2}$
3	2.8	$10^{-1}$
	3.2	$10^{-2}$
4	4.6	$10^{-1}$

8.2.1.1.3 7.68 Mcps TDD Option

For the parameters specified in Table 8.2B the BLER should not exceed the piece-wise linear BLER curve specified in Table 8.3B. These requirements are applicable for TFCS size 16.

**Table 8.2B: DCH parameters in static propagation conditions (7.68 Mcps TDD Option)**

Parameters	Unit	Test 1
$\frac{\Sigma DPCH - E_c}{I_{or}}$	dB	-9
$I_{oc}$		
Cell Parameter*		
DPCH Channelization Codes*	C(k, Q)	-60
OCNS Channelization Code*	C(k, Q)	0,1
Information Data Rate	kbps	C(i, 32), i = 1,2
		C(3, 32)
		12.2

\*Note: Refer to TS 25.223 for definition of channelization codes and cell parameter.

**Table 8.3B: Performance requirements in AWGN channel (7.68 Mcps TDD Option)**

Test Number	$\frac{\hat{I}_{or}}{I_{oc}}$ [dB]	BLER
1	1.1	$10^{-2}$

8.3 Demodulation of DCH in multipath fading conditions

8.3.1 Multipath fading Case 1

The performance requirement of DCH is determined by the maximum Block Error Ratio (BLER). The BLER is specified for each individual data rate of the DCH. DCH is mapped into the Dedicated Physical Channel (DPCH).

8.3.1.1 Minimum requirement

8.3.1.1.1 3.84 Mcps TDD Option

For the parameters specified in Table 8.4 the BLER should not exceed the piece-wise linear BLER curve specified in Table 8.5. These requirement are applicable for TFCS size 16.

**Table 8.4: DCH parameters in multipath Case 1 channel (3.84 Mcps TDD Option)**

Parameters	Unit	Test 1	Test 2	Test 3	Test 4	Test 5
$\frac{\Sigma DPCH - E_c}{I_{or}}$	DB	-6	-3	0	0	0
$I_{oc}$	dBm/3.84 MHz	-60				
Cell Parameter*		0,1				
DPCH Channelization Codes*	C(k,Q)	C(i,16) i=1,2	C(i,16) i=1..5	C(i,16) i=1..9	C(i,16) i=1..8	-
OCNS Channelization Code*	C(k,Q)	C(3,16)	C(6,16)	-	-	-
Information Data Rate	kbps	12.2	64	144	384	2048

\*Note: Refer to TS 25.223 for definition of channelization codes and cell parameter.

**Table 8.5: Performance requirements in multipath Case 1 channel (3.84 Mcps TDD Option)**

Test Number	$\frac{\hat{I}_{or}}{I_{oc}}$ [dB]	BLER
1	13.9	$10^{-2}$
2	13.7	$10^{-1}$
	19.8	$10^{-2}$
3	14.1	$10^{-1}$
	20.6	$10^{-2}$
4	13.8	$10^{-1}$
	20.0	$10^{-2}$
5	13.2	$10^{-1}$
	17.8	$10^{-2}$

## 8.3.1.1.2 1.28 Mcps TDD Option

For the parameters specified in Table 8.4A the BLER should not exceed the piece-wise linear BLER curve specified in Table 8.5A.

**Table 8.4A: DCH parameters in multipath Case 1 channel (1.28 Mcps TDD Option)**

Parameters	Unit	Test 1	Test 2	Test 3	Test 4
Number of DPCH <sub>o</sub>		8	2	2	0
Scrambling code and basic midamble code number*		0	0	0	0
DPCH Channelization Codes*	C(k,Q)	C(i,16) i=1,2	C(i,16) i=1...8	C(i,16) i=1...8	C(i,16) i=1...9
DPCH <sub>o</sub> Channelization Codes*	C(k,Q)	C(i,16) 3 ≤ i ≤ 10	C(i,16) 9 ≤ i ≤ 10	C(i,16) 9 ≤ i ≤ 10	-
$\frac{DPCH_o - E_c}{I_{or}}$	DB	-10	-10	-10	0
$I_{oc}$	dBm/1.28MHz	-60			
Information Data Rate	Kbps	12.2	64	144	384

\*Note: Refer to TS 25.223 for definition of channelization codes, scrambling code and basic midamble code.

**Table 8.5A: Performance requirements in multipath Case 1 channel (1.28 Mcps TDD Option)**

Test Number	$\frac{\hat{I}_{or}}{I_{oc}}$ [dB]	BLER
1	22.4	$10^{-2}$
2	15.8	$10^{-1}$
	22.9	$10^{-2}$
3	16.6	$10^{-1}$
	23.9	$10^{-2}$
4	15.6	$10^{-1}$
	21.4	$10^{-2}$

## 8.3.1.1.3 7.68 Mcps TDD Option

For the parameters specified in Table 8.4B the BLER should not exceed the piece-wise linear BLER curve specified in Table 8.5B. These requirement are applicable for TFCS size 16.

**Table 8.4B: DCH parameters in multipath Case 1 channel (7.68 Mcps TDD Option)**

Parameters	Unit	Test 1
$\frac{\Sigma DPCH\_E_c}{I_{or}}$	dB	-9
$I_{oc}$	dBm/7.68 MHz	-60
Cell Parameter*	-	0,1
DPCH Channelization Codes*	C(k, Q)	C(i, 32), i = 1,2
OCNS Channelization Code*	C(k, Q)	C(3, 32)
Information Data Rate	kbps	12.2
*Note: Refer to TS 25.223 for definition of channelization codes and cell parameter.		

**Table 8.5B: Performance requirements in multipath Case 1 channel (7.68 Mcps TDD Option)**

Test Number	$\frac{\hat{I}_{or}}{I_{oc}}$ [dB]	BLER
1	13.9	$10^{-2}$

## 8.3.2 Multipath fading Case 2

The performance requirement of DCH is determined by the maximum Block Error Ratio (BLER). The BLER is specified for each individual data rate of the DCH. DCH is mapped into the Dedicated Physical Channel (DPCH).

### 8.3.2.1 Minimum requirement

#### 8.3.2.1.1 3.84 Mcps TDD Option

For the parameters specified in Table 8.6 the BLER should not exceed the piece-wise linear BLER curve specified in Table 8.7. These requirements are applicable for TFCS size 16.

**Table 8.6: DCH parameters in multipath Case 2 channel (3.84 Mcps TDD Option)**

Parameters	Unit	Test 1	Test 2	Test 3	Test 4	Test 5
$\frac{\Sigma DPCH\_E_c}{I_{or}}$	DB	-3	0	0	0	0
$I_{oc}$	dBm/3.84 MHz	-60				
Cell Parameter*		0,1				-
DPCH Channelization Codes*	C(k,Q)	C(i,16) i=1,2	C(i,16) i=1..5	C(i,16) i=1..9	C(i,16) i=1..8	-
OCNS Channelization Code*	C(k,Q)	C(3,16)	-	-	-	-
Information Data Rate	kbps	12.2	64	144	384	2048
*Note: Refer to TS 25.223 for definition of channelization codes and cell parameter.						

**Table 8.7: Performance requirements in multipath Case 2 channel (3.84 Mcps TDD Option)**

Test Number	$\frac{\hat{I}_{or}}{I_{oc}}$ [dB]	BLER
1	5.8	$10^{-2}$
2	5.7	$10^{-1}$
	9.2	$10^{-2}$
3	9.3	$10^{-1}$
	12.7	$10^{-2}$
4	8.8	$10^{-1}$
	12.0	$10^{-2}$
5	10.3	$10^{-1}$
	12.7	$10^{-2}$

### 8.3.2.1.2 1.28 Mcps TDD Option

For the parameters specified in Table 8.6A the BLER should not exceed the piece-wise linear BLER curve specified in Table 8.7A.

**Table 8.6A: DCH parameters in multipath Case 2 channel (1.28 Mcps TDD Option)**

Parameters	Unit	Test 1	Test 2	Test 3	Test 4
Number of DPCH <sub>o</sub>		8	2	2	0
Scrambling code and basic midamble code number*		0	0	0	0
DPCH Channelization Codes*	C(k,Q)	C(i,16) i=1,2	C(i,16) i=1...8	C(i,16) i=1...8	C(i,16) i=1...9
DPCH <sub>o</sub> Channelization Codes*	C(k,Q)	C(i,16) 3 ≤ i ≤ 10	C(i,16) 9 ≤ i ≤ 10	C(i,16) 9 ≤ i ≤ 10	-
$\frac{DPCH_o - E_c}{I_{or}}$	dB	-10	-10	-10	0
$I_{oc}$	dBm/1.28MHz	-60			
Information Data Rate	Kbps	12.2	64	144	384

\*Note Refer to TS 25.223 for definition of channelization codes, scrambling code and basic midamble code.

**Table 8.7A: Performance requirements in multipath Case 2 channel (1.28 Mcps TDD Option)**

Test Number	$\frac{\hat{I}_{or}}{I_{oc}}$ [dB]	BLER
1	13.6	$10^{-2}$
2	9.8	$10^{-1}$
	13.9	$10^{-2}$
3	10.3	$10^{-1}$
	14.4	$10^{-2}$
4	11.4	$10^{-1}$
	15.0	$10^{-2}$

### 8.3.2.1.3 7.68 Mcps TDD Option

For the parameters specified in Table 8.6B the BLER should not exceed the piece-wise linear BLER curve specified in Table 8.7B. These requirements are applicable for TFCS size 16.

**Table 8.6B: DCH parameters in multipath Case 2 channel (7.68 Mcps TDD Option)**

Parameters	Unit	Test 1
$\frac{\Sigma DPCH\_E_c}{I_{or}}$	dB	-6
$I_{oc}$	dBm/7.68 MHz	-60
Cell Parameter (note)	-	0,1
DPCH Channelization Codes (note)	C(k, Q)	C(i, 32), i = 1,2
OCNS Channelization Code (note)	C(k, Q)	C(3, 32)
Information Data Rate	kbps	12.2
NOTE: Refer to TS 25.223 for definition of channelization codes and cell parameter.		

**Table 8.7B: Performance requirements in multipath Case 2 channel (7.68 Mcps TDD Option)**

Test Number	$\frac{\hat{I}_{or}}{I_{oc}}$ [dB]	BLER
1	5.8	$10^{-2}$

### 8.3.3 Multipath fading Case 3

The performance requirement of DCH is determined by the maximum Block Error Ratio (BLER). The BLER is specified for each individual data rate of the DCH. DCH is mapped into the Dedicated Physical Channel (DPCH).

#### 8.3.3.1 Minimum requirement

##### 8.3.3.1.1 3.84 Mcps TDD Option

For the parameters specified in Table 8.8 the BLER should not exceed the piece-wise linear BLER curve specified in Table 8.9. These requirements are applicable for TFCS size 16.

**Table 8.8: DCH parameters in multipath Case 3 channel (3.84 Mcps TDD Option)**

Parameters	Unit	Test 1	Test 2	Test 3	Test 4	Test 5
$\frac{\Sigma DPCH\_E_c}{I_{or}}$	dB	-3	0	0	0	0
$I_{oc}$	dBm/3.84 MHz	-60				
Cell Parameter*		0,1				-
DPCH Channelization Codes*	C(k,Q)	C(i,16) i=1,2	C(i,16) i=1..5	C(i,16) i=1..9	C(i,16) i=1..8	-
OCNS Channelization Code*	C(k,Q)	C(3,16)	-	-	-	-
Information Data Rate	kbps	12.2	64	144	384	2048
*Note: Refer to TS 25.223 for definition of channelization codes and cell parameter.						

**Table 8.9: Performance requirements in multipath Case 3 channel (3.84 Mcps TDD Option)**

Test Number	$\frac{\hat{I}_{or}}{I_{oc}}$ [dB]	BLER
1	4.8	$10^{-2}$
2	5.8	$10^{-1}$
	8.5	$10^{-2}$
	10.7	$10^{-3}$
3	10.3	$10^{-1}$
	13.3	$10^{-2}$
	16.0	$10^{-3}$
4	8.9	$10^{-1}$
	11.5	$10^{-2}$
	13.6	$10^{-3}$
5	9.4	$10^{-1}$
	11.5	$10^{-2}$
	13.6	$10^{-3}$

## 8.3.3.1.1 1.28 Mcps TDD Option

For the parameters specified in Table 8.8A the BLER should not exceed the piece-wise linear BLER curve specified in Table 8.9A.

**Table 8.8A: DCH parameters in multipath Case 3 channel (1.28 Mcps TDD Option)**

Parameters	Unit	Test 1	Test 2	Test 3	Test 4
Number of DPCH <sub>o</sub>		8	2	2	0
Scrambling code and basic midamble code number*		0	0	0	0
DPCH Channelization Codes*	C(k,Q)	C(i,16) i=1,2	C(i,16) i=1...8	C(i,16) i=1...8	C(i,16) i=1...9
DPCH <sub>o</sub> Channelization Codes*	C(k,Q)	C(i,16) 3 ≤ i ≤ 10	C(i,16) 9 ≤ i ≤ 10	C(i,16) 9 ≤ i ≤ 10	-
$\frac{DPCH_o - E_c}{I_{or}}$	dB	-10	-10	-10	0
$I_{oc}$	dBm/1.28MHz	-60			
Information Data Rate	Kbps	12.2	64	144	384

\*Note Refer to TS 25.223 for definition of channelization codes, scrambling code and basic midamble code.

**Table 8.9A: Performance requirements in multipath Case 3 channel (1.28 Mcps TDD Option)**

Test Number	$\frac{\hat{I}_{or}}{I_{oc}}$ [dB]	BLER
1	11.7	$10^{-2}$
2	9.0	$10^{-1}$
	11.7	$10^{-2}$
	14.3	$10^{-3}$
3	9.1	$10^{-1}$
	11.2	$10^{-2}$
	12.7	$10^{-3}$
4	9.9	$10^{-1}$
	11.2	$10^{-2}$
	12.4	$10^{-3}$



## 8.3.3.1.3 7.68 Mcps TDD Option

For the parameters specified in Table 8.8B the BLER should not exceed the piece-wise linear BLER curve specified in Table 8.9B. These requirements are applicable for TFCS size 16.

**Table 8.8B: DCH parameters in multipath Case 3 channel (7.68 Mcps TDD Option)**

Parameters	Unit	Test 1
$\frac{\Sigma DPCH - E_c}{I_{or}}$	dB	-6
$I_{oc}$	dBm/7.68 MHz	-60
Cell Parameter*	-	0,1
DPCH Channelization Codes*	C(k, Q)	C(i, 32), i = 1,2
OCNS Channelization Code*	C(k, Q)	C(3, 32)
Information Data Rate	kbps	12.2
*Note: Refer to TS 25.223 for definition of channelization codes and cell parameter.		

**Table 8.9B: Performance requirements in multipath Case 3 channel (7.68 Mcps TDD Option)**

Test Number	$\frac{\hat{I}_{or}}{I_{oc}}$ [dB]	BLER
1	4.8	$10^{-2}$

## 8.4 Base station transmit diversity mode for 3.84 Mcps TDD Option

## 8.4.1 Demodulation of BCH in SCTD mode

The performance requirement of BCH is determined by the maximum Block Error Rate (BLER). The BLER is specified for the BCH. BCH is mapped into the Primary Common Control Physical Channel (P-CCPCH).

## 8.4.1.1 Minimum requirement

For the parameters specified in Table 8.10 the BLER should not exceed the BLER specified in Table 8.11.

NOTE: This requirement doesn't need to be tested.

**Table 8.10: P-CCPCH parameters in multipath Case 1 channel**

Parameters	Unit	Test 1
$\frac{PCCPCH - E_c}{I_{or}}$	dB	-3
$I$	dBm/3.84 MHz	-60
Information Data Rate	Kbps	12.3

**Table 8.11: Performance requirements in multipath Case 1 channel**

Test Number	$\frac{\hat{I}_{or}}{I_{oc}}$ [dB]	BLER
1	8.4	$10^{-2}$

## 8.5 Power control in downlink

Power control in the downlink is the ability of the UE receiver to converge to the required link quality set by the network while using minimum downlink power.

### 8.5.1 Power control in downlink, constant BLER target

#### 8.5.1.1 Minimum requirements 3.84 Mcps TDD option

For the parameters specified in Table 8.12 the downlink  $\hat{I}_{or}/I_{oc}$  averaged over one timeslot shall be below the specified value in Table 8.13 more than 90% of the time. BLER shall be as shown in Table 8.13. Downlink power control is ON during the test.

**Table 8.12: Test parameters for downlink power control – constant BLER Target (3.84 Mcps TDD option)**

Parameter	Unit	Test 1
$\frac{DPCH - E_c}{I_{or}}$	dB	0
$I_{oc}$	dBm/3.84 MHz	-60
Information Data Rate	kbps	12.2
Target quality value on DTCH	BLER	0.01
Propagation condition		Case 1
DL Power Control step size, $\Delta_{TPC}$	dB	1
Maximum_DL_power *	dB	0
Minimum_DL_power *	dB	-27
*Note: Refer to TS 25.224 for description and definition		

**Table 8.13: Requirements for downlink power control – constant BLER Target (3.84 Mcps TDD option)**

Parameter	Unit	Test 1
$\hat{I}_{or}/I_{oc}$	dB	8.5
Measured quality on DTCH	BLER	0.01±30%

#### 8.5.1.2 Minimum requirements 1.28 Mcps TDD option

For the parameters specified in Table 8.13A the downlink  $\hat{I}_{or}/I_{oc}$  averaged over one timeslot, shall be below the specified value in Table 8.13B more than 90% of the time. BLER shall be as shown in table 8.13B. Downlink power control is ON during the test.

**Table 8.13A: Test parameters for downlink power control – constant BLER Target (1.28 Mcps TDD option)**

Parameter	Unit	Value
$\frac{\Sigma DPCH\_E_c}{I_{or}}$	dB	0
$I_{oc}$	dBm/1.28 Mhz	-60
Information data rate	kbps	12.2
Target quality on DTCH	BLER	0.01
Propagation condition		Case 1
DL Power Control step size, $\Delta_{TPC}$	dB	1
Maximum_DL_power *	dB	0
Minimum_DL_power *	dB	-27

NOTE: Power is compared to P-CCPCH power

**Table 8.13B: Requirements for downlink power control – constant BLER Target (1,28 Mcps TDD option)**

Parameter	Unit	Value
$\hat{I}_{or}/I_{oc}$	dB	7.5
Measured quality on DTCH	BLER	0.01±30%

## 8.6 Uplink Power Control for 3.84 Mcps TDD Option

Power control in the uplink is the ability of the UE to converge to the required link quality set by the network while using minimum uplink power.

### 8.6.1 Test Conditions

During period T1, the PCCPCH and a second Beacon Channel are transmitted in the DL in designated slots within each frame and at the same power level.

The UE transmits, using the channel of TS25.105, Annex A.2.1 UL reference measurement channel (12.2 kbps) in one UL slot. For different parts of the test, different UL slots will be designated.

The values of table 8.14, period T1 shall be selected. Then, with the received PCCPCH and Beacon power set at -60 dBm, the value of DPCH constant value shall be adjusted so that the mean UE output power is 5 dBm. These conditions are held steady during period T1.

Periods T1 and T2 are each 5 seconds long.

**Table 8.14: UL Power Control Test Conditions**

		Period T1	Period T2
$I_{\text{BTS}}$ all slots	dBm		-60
PCCPCH Power – Broadcast	dBm		18
PCCPCH power – Received	dBm	-60	-70
Mean UE transmit power	dBm	5	According to tables 8.15 and 8.16
$SIR_{\text{TARGET}}$	dB		6
$I_{\text{oc}}$ in PCCPCH and Beacon Slots	dBm		-60
IE (information element) Alpha	As defined in 25.331		1.0
PCCPCH slot position	Integer 0 -14		0
Beacon slot position	Integer 0-14		8

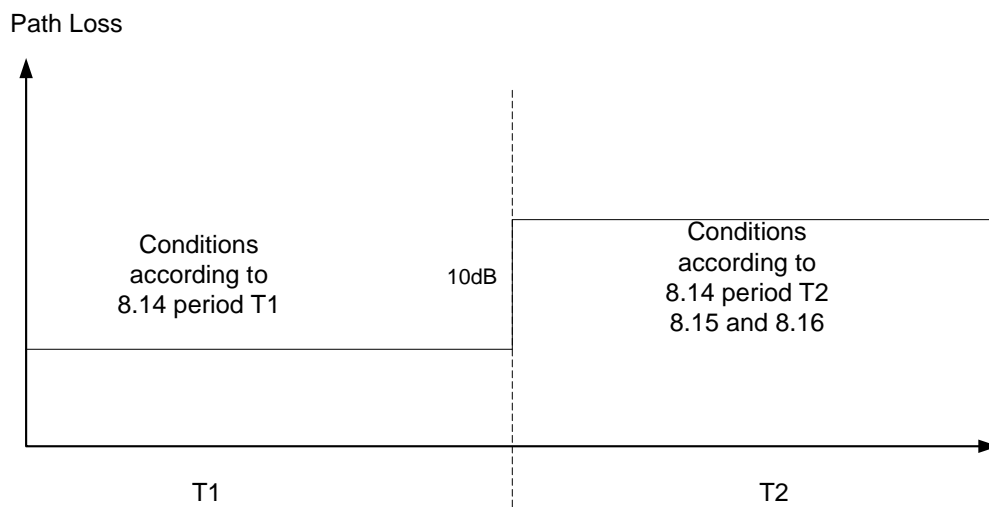

**Figure 8.1**

### 8.6.2 Performance

At the end of period T1, the PCCPCH and Beacon Received power shall be simultaneously decreased by 10 dB. These conditions are summarized in table 8.14, period T2.

For the first frame including the change in received power the UE output power shall satisfy the values in table 8.15.

For the 20<sup>th</sup> frame after the change in received power the UE output power shall satisfy the values in table 8.16.

**Table 8.15: Required UE Output Power, Frame Containing Power Level Change**

Parameter	Units	Value	
UL transmission slot position		1,9	7,14
UE output power	dBm	15 ±4.0	5 ±0.5

**Table 8.16: Required UE Output Power, 20 Frames after Power Level Change**

Parameter	Units	Value	
UL transmission slot position		1,9	7,14
UE output power	dBm	15 ±4.0	15 ±4.0

## 8.7 Demodulation of DCH in moving conditions

The receive characteristics of the Dedicated Channel (DCH) in dynamic moving propagation conditions are determined by the Block Error Ratio (BLER) values. BLER is measured for the each of the individual data rate specified for the DPCH. DCH is mapped into Dedicated Physical Channel (DPCH).

### 8.7.1 Minimum requirement

#### 8.7.1.1 3.84 Mcps TDD Option

Void

#### 8.7.1.2 1.28 Mcps TDD Option

For the parameters specified in Table 8.17 the BLER should not exceed the piece-wise linear BLER curve specified in Table 8.18.

**Table 8.17: DCH parameters in moving propagation conditions (1.28 Mcps TDD Option)**

Parameters	Unit	Test 1	Test 2
Number of DPCH <sub>o</sub>		8	2
Scrambling code and basic midamble code number*		0	0
DPCH Channelization Codes*	C(k,Q)	C(i,16) i=1,2	C(i,16) i=1...8
DPCH <sub>o</sub> Channelization Codes*	C(k,Q)	C(i,16) 3 ≤ i ≤ 10	C(i,16) 9 ≤ i ≤ 10
$\frac{DPCH_o - E_c}{I_{or}}$	dB	-10	-10
I <sub>oc</sub>	DBm/1.28MHz	-60	
Information Data Rate	Kbps	12.2	64
*Note: Refer to TS 25.223 for definition of channelization codes, scrambling code and basic midamble code.			

**Table 8.18: Performance requirements in moving propagation conditions (1.28 Mcps TDD Option)**

Test Number	$\frac{\hat{I}_{or}}{I_{oc}}$ [dB]	BLER
1	7.1	10 <sup>-2</sup>
2	6.7	10 <sup>-2</sup>

#### 8.7.1.3 7.68 Mcps TDD Option

void

## 8.8 Demodulation of DCH in birth-death conditions

The receive characteristics of the Dedicated Channel (DCH) in birth-death propagation conditions are determined by the Block Error Ratio (BLER) values. BLER is measured for the each of the individual data rate specified for the DPCH. DCH is mapped into in Dedicated Physical Channel (DPCH).

## 8.8.1 Minimum requirement

### 8.8.1.1 3.84 Mcps TDD Option

Void

### 8.8.1.2 1.28 Mcps TDD Option

For the parameters specified in Table 8.19 the BLER should not exceed the piece-wise linear BLER curve specified in Table 8.20.

**Table 8.19: DCH parameters in birth-death propagation conditions (1.28 Mcps TDD Option)**

Parameters	Unit	Test 1	Test 2
Number of DPCH <sub>o</sub>		8	2
Scrambling code and basic midamble code number*		0	0
DPCH Channelization Codes*	C(k,Q)	C(i,16) i=1,2	C(i,16) i=1...8
DPCH <sub>o</sub> Channelization Codes*	C(k,Q)	C(i,16) 3 ≤ i ≤ 10	C(i,16) 9 ≤ i ≤ 10
$\frac{DPCH_o - E_c}{I_{or}}$	dB	-10	-10
I <sub>oc</sub>	DBm/1.28MHz	-60	
Information Data Rate	Kbps	12.2	64
*Note: Refer to TS 25.223 for definition of channelization codes, scrambling code and basic midamble code.			

**Table 8.20: Performance requirements in birth-death propagation conditions (1.28 Mcps TDD Option)**

Test Number	$\frac{\hat{I}_{or}}{I_{oc}}$ [dB]	BLER
1	7.3	10 <sup>-2</sup>
2	6.5	10 <sup>-2</sup>

### 8.8.1.3 7.68 Mcps TDD Option

void

## 9 Performance requirements (HSDPA)

### 9.1 Performance requirement for 3.84 Mcps TDD option

The requirements are stated for the HSDPA UE reference combination classes specified in [2] and under the multipath propagation conditions specified in Annex B. The performance metric for HS-DSCH requirements in multi-path propagation conditions is the throughput R measured on HS-DSCH.

#### 9.1.1 HS-DSCH throughput for fixed reference channels

The performance requirements in this subclause apply for the reference measurement channels specified in Annex A.3.2.

During the Fixed Reference Channel tests the behaviour of the Node-B emulator in response to the ACK/NACK signalling field of the HS-SICH is specified in Table 9.1:

**Table 9.1: Node-B Emulator Behaviour in response to ACK/NACK/DTX**

HS-SICH ACK/NACK Field State	Node-B Emulator Behaviour
ACK	ACK: new transmission using 1 <sup>st</sup> redundancy version (RV)
NACK	NACK: retransmission using the next RV (up to the maximum permitted number or RV's)
DTX	DTX: retransmission using the RV previously transmitted to the same H-ARQ process

### 9.1.1.1 Minimum requirement QPSK, Fixed Reference Channel, 7,3 Mbps – Category 8 – UE

For the parameters specified in Table 9.2, the measured throughput R shall exceed the throughput specified in Table 9.3 for each radio condition.

**Table 9.2: Test parameters for fixed reference measurement channel requirements for 7,3 Mbps – Category 8 – UE (3,84 Mcps TDD Option) QPSK**

Parameters	Unit	Test 1	Test 2	Test 3	Test 4
HS-PDSCH Modulation	-	QPSK			
Scrambling code and basic midamble code number*	-	0, 1			
Number of TS	-	8			
HS-PDSCH Channelization Codes*	C(k,Q)	C(i,16) i=1..16			C(i,16) i=1..14
Number of Hybrid ARQ processes	-	4			
Maximum number of Hybrid ARQ transmissions	-	4			
Redundancy and constellation version coding sequence**	-	{0,0,0,0} s=1, R=0, b=0			
$\frac{HS - PDSCH - E_c}{I_{or}}$	dB	-12,04			-11,46
$\sum \frac{HS - PDSCH - E_c}{I_{or}}$	dB	0			
$I_{oc}$	dBm/3,84 MHz	-60			
Note *: Refer to TS 25.223 for definition of channelization codes, scrambling code and basic midamble code.					
Note **: This sequence implies Chase combining					

**Table 9.3: Performance requirements for fixed reference measurement channel requirement in multipath channels for 7,3 Mbps – Category 8 – UE (3,84 Mcps TDD Option) QPSK**

Test Number	Propagation conditions	$\frac{\hat{I}_{or}}{I_{oc}}$ [dB]	R (Throughput) [kbps]
1	PA3	8,5	1300
2	PB3	9,0	1300
3	VA30	9,75	1300
4	VA120	11,5	1400

### 9.1.1.2 Minimum requirement 16QAM, Fixed Reference Channel, 7,3 Mbps – Category 8 – UE

For the parameters specified in Table 9.4, the measured throughput R shall exceed the throughput specified in Table 9.5 for each radio condition.

**Table 9.4: Test parameters for fixed reference measurement channel requirements for 7,3 Mbps – Category 8 – UE (3,84 Mcps TDD Option) 16QAM**

Parameters	Unit	Test 1	Test 2	Test 3	Test 4
HS-PDSCH Modulation	-	16QAM			
Scrambling code and basic midamble code number*	-	0, 1			
Number of TS	-	8			
HS-PDSCH Channelization Codes*	C(k,Q)	C(i,16) i=1..16			C(i,16) i=1..14
Number of Hybrid ARQ processes	-	4			
Maximum number of Hybrid ARQ transmissions	-	4			
Redundancy and constellation version coding sequence**	-	{0,0,0,0} s=1, r=0			
$\frac{HS - PDSCH - E_c}{I_{or}}$	dB	-12,04			-11,46
$\frac{\sum HS - PDSCH - E_c}{I_{or}}$	dB	0			
$I_{oc}$	dBm/3,84 MHz	-60			
Note *: Refer to TS 25.223 for definition of channelization codes, scrambling code and basic midamble code.					
Note **: This sequence implies Chase combining					

**Table 9.5: Performance requirements for fixed reference measurement channel requirement in multipath channels for 7,3 Mbps – Category 8 – UE (3,84 Mcps TDD Option) 16QAM**

Test Number	Propagation conditions	$\frac{\hat{I}_{or}}{I_{oc}}$ [dB]	R (Throughput) [kbps]
1	PA3	16,0	2600
2	PB3	17,5	2600
3	VA30	18,5	2600
4	VA120	14,5	1600

## 9.1.2 HS-DSCH throughput for Variable Reference Channels

### 9.1.2.1 Minimum requirement Variable Reference Channel, 7,3 Mbps – Category 8 – UE

For the parameters specified in Table 9.6 the measured throughput R shall exceed the throughput specified in Table 9.7 for each radio condition. The Variable Reference Channel is specified in Annex A.3.3.



**Table 9.6: Test parameters for variable reference measurement channel requirements for 7,3 Mbps – Category 8 – UE (3,84 Mcps TDD Option)**

Parameters	Unit	Test 1	Test 2	Test 3	Test 4
Scrambling code and basic midamble code number*	-	0, 1			
Number of TS	-	8			
HS-PDSCH Channelization Codes*	C(k,Q)	C(i,16) i=1..16			
Number of Hybrid ARQ processes**	-	4			
Maximum number of Hybrid ARQ transmissions	-	1			
Redundancy and constellation version coding sequence	(Xrv, s, r, b)	(0, 1, 0, 0)			
HS-PDSCH <sub>i</sub> _Ec/Ior	dB	-12,04			
$\frac{\sum_{i=1}^i HS - PDSCH - Ec_i}{I_{or}}$	dB	0			
I <sub>oc</sub>	dBm/3,84MHz	-60			
Note *:	Refer to TS 25.223 for definition of channelization codes, scrambling code and basic midamble code.				
Note **:	For timing requirements, HARQ is not active				

**Table 9.7: Performance requirements for variable reference measurement channel requirement in multipath channels for 7,3 Mbps – Category 8 – UE (3,84 Mcps TDD Option)**

Test Number	Propagation conditions	$\frac{\hat{I}_{or}}{I_{oc}}$ [dB]	R (Throughput) [kbps]
1	PA3	8,8	1240
		14,8	2500
		18,8	3600
		24,8	5000
2	PB3	8,8	1220
		14,8	2430
		20,8	4030
		24,8	5080
3	VA30	10,1	1190
		16,1	2290
		20,1	3220
		24,1	4260
4	VA120	7,1	590
		11,1	1180
		15,1	1840
		19,1	2390

### 9.1.3 Reporting of Channel Quality Indicator

The reporting accuracy of channel quality indicator (CQI) under AWGN environments is determined by the reporting variance and BLER performance using the transport format indicated by the reported median CQI.

#### 9.1.3.1 Minimum requirement Channel Quality Indicator, 7,3 Mbps – Category 8 – UE

For the parameters specified in Table 9.7A the reported CQI value shall be within the range of +/- 10 of the allowable CQIs of the reported median CQI more than 90% of the time. The BLER for the reported median CQI shall be less than 10%.

**Table 9.7A: Test parameters for variable reference measurement channel requirements for 7,3 Mbps – Category 8 – UE (3,84 Mcps TDD Option)**

Parameters	Unit	Test 1	Test 2
Scrambling code and basic midamble code number*	-	0, 1	
Number of TS	-	8	
HS-PDSCH Channelization Codes*	C(k,Q)	C(i,16) i=1..16	
Number of Hybrid ARQ processes**	-	4	
Maximum number of Hybrid ARQ transmissions	-	1	
Redundancy and constellation version coding sequence	(Xrv, s, r, b)	(0, 1, 0, 0)	
HS-PDSCH <sub>i</sub> Ec/Ior	dB	-12,04	
$\frac{\sum_{i=1}^i HS - PDSCH - Ec_i}{I_{or}}$	dB	0	
$\hat{I}_{or} / I_{oc}$	dB	5	10
I <sub>oc</sub>	dBm/3,84MHz	-60	
Note*:	Refer to TS 25.223 for definition of channelization codes, scrambling code and basic midamble code.		
Note**:	For timing requirements, HARQ is not active		

## 9.1.4 HS-SCCH Detection Performance

The detection performance of the HS-SCCH is determined by the probability of event  $E_m$ , which is declared when the UE is signaled on HS-SCCH, but DTX is observed in the corresponding HS-SICH ACK/NACK field. The probability of event  $E_m$  is denoted  $P(E_m)$ .

### 9.1.4.1 Minimum Requirements for HS-SCCH Detection

For the test parameters in Table 9.7B, for each value of HS-SCCH-1  $E_c/I_{or}$  specified in Table 9.7C, the measured  $P(E_m)$  shall be less than or equal to the corresponding specified value of  $P(E_m)$ .

**Table 9.7B: Test parameters for HS-SCCH detection (3.84 Mcps TDD option)**

Parameter	Unit	Test 1	Test 2	Test 3
Number of TS under test	-	1		
Number of HS-SCCH codes per timeslot	-	4		
HS-SCCH UE Identity ( $x_{ue,1}, x_{ue,2}, \dots, x_{ue,16}$ )	-	UE1 = 0000000000000000 (UE1 under test) UE2 = 0101010101010101 UE3 = 1010101010101010 UE4 = 1111111111111111		
HS-SCCH Channelization Codes*	C(k,Q)	HS-SCCH-1 = C(1, 16), for UE1 (UE under test) HS-SCCH-2 = C(2, 16) for UE2 HS-SCCH-3 = C(3, 16) for UE3 HS-SCCH-4 = C(4, 16) for UE4		
HS-SCCH $E_c/I_{or}$	dB	HS-SCCH-2 $E_c/I_{or}$ = HS-SCCH-3 $E_c/I_{or}$ = HS-SCCH-4 $E_c/I_{or}$ , Where, $\sum HS-SCCH-X E_c/I_{or} = 1$ , where X = 1, 2, 3, 4		

**Table 9.7C: Minimum requirement for HS-SCCH detection (3.84 Mcps TDD option)**

Test Number	Propagation Conditions	Reference value		
		HS-SCCH-1 $E_c / I_{or}$ (dB)	$\hat{I}_{or} / I_{oc}$ (dB)	$P(E_m)$
1	PA3	-1.6	0	0.05
2	PA3	-3.0	5	0.01
3	VA30	-2.5	0	0.01

## 9.2 Performance requirements for 1.28 Mcps TDD option

The requirements are stated for the HSDPA UE reference combination classes specified in [2] and under the multipath propagation conditions specified in Annex B. The performance metric for HS-DSCH requirements in multi-path propagation conditions is the throughput R measured on HS-DSCH.

For multi-carrier reception, the performance metric for HS-DSCH requirements is the throughput R measured on HS-DSCH on each carrier and the spacing between the two adjacent carriers shall be 1.6 MHz.

### 9.2.1 HS-DSCH throughput for fixed reference channels

The performance requirements in this subclause apply for the reference measurement channels specified in Annex A.3.2.

During the Fixed Reference Channel tests the behaviour of the Node-B emulator in response to the ACK/NACK signalling field of the HS-SICH is specified in Table 9.8

**Table 9.8: Node-B Emulator Behaviour in response to ACK/NACK/DTX**

HS-SICH ACK/NACK Field State	Node-B Emulator Behaviour
ACK	ACK: new transmission using 1 <sup>st</sup> redundancy and constellation version (RV)
NACK	NACK: retransmission using the next RV (up to the maximum permitted number or RV"s)
DTX	DTX: retransmission using the RV previously transmitted to the same H-ARQ process

NOTE: Performance requirements in this section assume a sufficient power allocation to HS-SCCH so that probability of reporting DTX is very low.

#### 9.2.1.1 Category 1, 0.5Mbps UE class

For the parameters specified in Table 9.9, the measured throughput R shall exceed the throughput specified in Table 9.10 for each radio condition.

**Table 9.9: Test parameters for fixed reference measurement channel, QPSK**

Parameters	Unit	Test 1	Test 2	Test 3	Test 4
HS-PDSCH Modulation	-	QPSK*			
Scrambling code and basic midamble code number**	-	1			
Number of TS	-	2			
HS-PDSCH Channelization Codes*	C(k,Q)	C(i,16) i=1..10			
Number of Hybrid ARQ processes	-	4			
Maximum number of Hybrid ARQ transmissions	-	4			
Redundancy and constellation version coding sequence	-	{0,0,0,0}			
$\frac{HS - PDSCH - E_c}{I_{or}}$	dB	-10			
$I_{oc}^{***}$	dBm/1.28 MHz	-60			
*Note: Only QPSK is supported for this category UE.					
**Note: Refer to TS 25.223 for definition of channelization codes, scrambling code and basic midamble code.					
***Note: For multi-carrier reception, it refers to the interference power on each carrier.					

**Table 9.10: Performance requirements for fixed reference channel, QPSK**

Test Number	Propagation conditions	$\frac{\hat{I}_{or}}{I_{oc}}$ [dB](Note 1)	R (Throughput) [kbps] (Note 2)
1	PA3	10	160
2	PB3	10	170
3	VA30	10	161
4	VA120	10	153
Note 1: For multi-carrier reception, it refers to $\frac{\hat{I}_{or}}{I_{oc}}$ on each carrier.			
Note 2: For multi-carrier reception, R refers to throughput on each carrier.			

### 9.2.1.2 Category 4, 1.1Mbps UE class

For the parameters specified in Table 9.9-1, the measured throughput R shall exceed the throughput specified in Table 9.10-1 for each radio condition.

**Table 9.9-1: Test parameters for fixed reference measurement channel, 16QAM**

Parameters	Unit	Test 1	Test 2	Test 3	Test 4
HS-PDSCH Modulation	-	16QAM			
Scrambling code and basic midamble code number*	-	1			
Number of TS	-	2			
HS-PDSCH Channelization Codes*	C(k,Q)	C(i,16) i=1..12			
Number of Hybrid ARQ processes	-	4			
Maximum number of Hybrid ARQ transmissions	-	4			
Redundancy and constellation version coding sequence	-	{6,2,1,5}			
$\frac{HS - PDSCH - E_c}{I_{or}}$	dB	-10.8			
$I_{oc}^{**}$	dBm/1.28 MHz	-60			
*Note: Refer to TS 25.223 for definition of channelization codes, scrambling code and basic midamble code.					
**Note: For multi-carrier reception, it refers to the interference power on each carrier.					

**Table 9.10-1: Performance requirements for QPSK, fixed reference channel, 16QAM**

Test Number	Propagation conditions	$\frac{\hat{I}_{or}}{I_{oc}}$ [dB](Note 1)	R (Throughput) [kbps](Note 2)
1	PA3	15	388
2	PB3	15	347
3	VA30	15	316
4	VA120	15	274
Note 1: For multi-carrier reception, it refers to $\frac{\hat{I}_{or}}{I_{oc}}$ on each carrier.			
Note 2: For multi-carrier reception, R refers to throughput on each carrier.			

\* Note: Test case in 9.2.1.1.1 can be used to test this kind of UE in case of QPSK.

### 9.2.1.3 Category 7, 1.6Mbps UE class

For the parameters specified in Table 9.9-2, the measured throughput R shall exceed the throughput specified in Table 9.10-2 for each radio condition.

**Table 9.9-2: Test parameters for fixed reference measurement channel**

Parameters	Unit	Test 1	Test 2	Test 3	Test 4	Test 5	Test 6	Test 7	Test 8
HS-PDSCH Modulation	-	QPSK				16QAM			
Scrambling code and basic midamble code number*	-	1							
Number of TS	-	3							
Number of Hybrid ARQ processes	-	4							
Maximum number of Hybrid ARQ transmissions	-	4							
HS-PDSCH Channelization Codes*	C(k,Q)	C(i,16) i=1..10				C(i,16) i=1..12			
Redundancy and constellation version coding sequence	-	{0,0,0,0}				{6,2,1,5}			
$\frac{HS - PDSCH - E_c}{I_{or}}$	dB	-10				-10.8			
$I_{oc}^{**}$	dBm/ 1.28MHz	-60							
*Note: Refer to TS 25.223 for definition of channelization codes, scrambling code and basic midamble code.									
**Note: For multi-carrier reception, it refers to the interference power on each carrier.									

**Table 9.10-2: Performance requirements for fixed reference channel**

Test Number	Propagation conditions	$\frac{\hat{I}_{or}}{I_{oc}}$ [dB](Note 1)	R (Throughput) [kbps](Note 2)
1	PA3	10	270
2	PB3	10	278
3	VA30	10	259
4	VA120	10	242
5	PA3	15	488
6	PB3	15	471
7	VA30	15	431
8	VA120	15	377
Note 1: For multi-carrier reception, it refers to $\frac{\hat{I}_{or}}{I_{oc}}$ on each carrier.			
Note 2: For multi-carrier reception, R refers to throughput on each carrier.			

#### 9.2.1.4 Category 10, 2.2Mbps UE class

For the parameters specified in Table 9.9-3, the measured throughput R shall exceed the throughput specified in Table 9.10-3 for each radio condition.

**Table 9.9-3: Test parameters for fixed reference measurement channel**

Parameters	Unit	Test 1	Test 2	Test 3	Test 4	Test 5	Test 6	Test 7	Test 8
HS-PDSCH Modulation	-	QPSK				16QAM			
Scrambling code and basic midamble code number*	-	1							
Number of TS	-	4							
Number of Hybrid ARQ processes	-	4							
Maximum number of Hybrid ARQ transmissions	-	4							
HS-PDSCH Channelization Codes*	C(k,Q)	C(i,16) i=1..10				C(i,16) i=1..12			
Redundancy and constellation version coding sequence	-	{0,0,0,0}				{6,2,1,5}			
$\frac{HS - PDSCH - E_c}{I_{or}}$	dB	-10				-10.8			
$I_{oc}^{**}$	dBm/ 1.28MHz	-60							
*Note: Refer to TS 25.223 for definition of channelization codes, scrambling code and basic midamble code.									
**Note: For multi-carrier reception, it refers to the interference power on each carrier.									

**Table 9.10-3: Performance requirements for fixed reference channel**

Test Number	Propagation conditions	$\frac{\hat{I}_{or}}{I_{oc}}$ [dB](Note 1)	R (Throughput) [kbps](Note 2)
1	PA3	10	360
2	PB3	10	343
3	VA30	10	320
4	VA120	10	275
5	PA3	15	615
6	PB3	15	606
7	VA30	15	554
8	VA120	15	493
Note 1: For multi-carrier reception, it refers to $\frac{\hat{I}_{or}}{I_{oc}}$ on each carrier.			
Note 2: For multi-carrier reception, R refers to throughput on each carrier.			

9.2.1.5 Category 13, 2.8Mbps UE class

For the parameters specified in Table 9.9-4, the measured throughput R shall exceed the throughput specified in Table 9.10-4 for each radio condition.

Table 9.9-4: Test parameters for fixed reference measurement channel

Parameters	Unit	Test 1	Test 2	Test 3	Test 4	Test 5	Test 6	Test 7	Test 8
HS-PDSCH Modulation	-	QPSK				16QAM			
Scrambling code and basic midamble code number*	-	1							
Number of TS	-	5							
Number of Hybrid ARQ processes	-	4							
Maximum number of Hybrid ARQ transmissions	-	4							
HS-PDSCH Channelization Codes*	C(k,Q)	C(i,16) i=1..10				C(i,16) i=1..12			
Redundancy and constellation version coding sequence	-	{0,0,0,0}				{6,2,1,5}			
$\frac{HS - PDSCH - E_c}{I_{or}}$	dB	-10				-10.8			
$I_{oc}^{**}$	dBm/ 1.28MHz	-60							
*Note: Refer to TS 25.223 for definition of channelization codes, scrambling code and basic midamble code.									
**Note: For multi-carrier reception, it refers to the interference power on each carrier.									

Table 9.10-4: Performance requirements for fixed reference channel

Test Number	Propagation conditions	$\frac{\hat{I}_{or}}{I_{oc}}$ [dB](Note 1)	R (Throughput) [kbps](Note 2)
1	PA3	10	461
2	PB3	10	470
3	VA30	10	438
4	VA120	10	409
5	PA3	15	890
6	PB3	15	810
7	VA30	15	730
8	VA120	15	630
Note 1: For multi-carrier reception, it refers to $\frac{\hat{I}_{or}}{I_{oc}}$ on each carrier.			
Note 2: For multi-carrier reception, R refers to throughput on each carrier.			

## 9.2.2 HS-DSCH throughput for Variable Reference Channels

### 9.2.2.1 Category 1, 0.5Mbps UE class

For the parameters specified in Table 9.13 the measured throughput R shall exceed the throughput specified in Table 9.14 for each radio condition.



**Table 9.13: Test parameters for variable reference channel, 0.5Mbps UE class**

Parameter	Unit	Test 1	Test 2	Test 3
HS-PDSCH Modulation and TBS	-		*	
Scrambling code and basic midamble code Number **	-		1	
Number of TS	-		2	
Number of DPCH <sub>0</sub>	-		0	
Number of HARQ Process	-		4	
Number of transmission	-		1	
Redundancy and constellation version coding sequence	Xrv		0	
HS-DSCH Channelization Codes**	C(k,Q)		C(i,16) 1≤i≤10	
HS-DSCH <sub>i</sub> Ec/Ior	dB		-10	
Ioc****	dBm		-60	
<p>* Note 1 As requested by the last received CQI report</p> <p>**Note 2 Refer to TS 25.223 for definition of channelization codes, scrambling code and basic midamble code.</p> <p>***Note 3 If the indicated CQI is 0, the Node-B emulator shall format the next HS-PDSCH transmission with the transport block size and the modulation scheme that were previously used.</p> <p>****Note 4 For multi-carrier reception, it refers to the interference power on each carrier.</p>				

**Table 9.14: Performance requirements for variable reference channel, 0.5Mbps UE class**

Test Number	Propagation conditions	$\frac{\hat{I}_{or}}{I_{oc}}$ [dB] (Note1)	R (Throughput) [kbps] (Note2)
1	PA3	15	242
2	PB3	15	244
3	VA30	15	211
<p>Note 1: For multi-carrier reception, it refers to <math>\frac{\hat{I}_{or}}{I_{oc}}</math> on each carrier.</p> <p>Note 2: For multi-carrier reception, R refers to throughput on each carrier.</p>			

### 9.2.2.2 Category 4, 1.1Mbps UE class

For the parameters specified in Table 9.13-1 the measured throughput R shall exceed the throughput specified in Table 9.14-1 for each radio condition.

**Table 9.13-1: Test parameters for variable reference channel, 1.1Mbps UE class**

Parameter	Unit	Test 1	Test 2	Test 3
HS-PDSCH Modulation and TBS	-		*	
Scrambling code and basic midamble code Number **	-		1	
Number of TS	-		2	
Number of DPCH <sub>0</sub>	-		0	
Number of HARQ Process	-		4	
Number of transmission	-		1	
Redundancy and constellation version coding sequence	Xrv		0	
HS-PDSCH Channelization Codes**	C(k,Q)		C(i,16) 1≤i≤10	
HS-PDSCH <sub>i</sub> Ec/lor	dB		-10	
loc****	dBm		-60	
<p>* Note 1 As requested by the last received CQI report</p> <p>**Note 2 Refer to TS 25.223 for definition of channelization codes, scrambling code and basic midamble code.</p> <p>***Note 3 If the indicated CQI is 0, the Node-B emulator shall format the next HS-PDSCH transmission with the transport block size and the modulation scheme that were previously used.</p> <p>****Note 4 For multi-carrier reception, it refers to the interference power on each carrier.</p>				

**Table 9.14-1: Performance requirements for variable reference channel, 1.1 Mbps UE class**

Test Number	Propagation conditions	$\frac{\hat{I}_{or}}{I_{oc}}$ [dB] (Note1)	R (Throughput) [kbps] (Note2)
1	PA3	15	318
2	PB3	15	323
3	VA30	15	213
<p>Note 1: For multi-carrier reception, it refers to <math>\frac{\hat{I}_{or}}{I_{oc}}</math> on each carrier.</p> <p>Note 2: For multi-carrier reception, R refers to throughput on each carrier.</p>			

### 9.2.2.3 Category 7, 1.6Mbps UE class

For the parameters specified in Table 9.13-2 the measured throughput R shall exceed the throughput specified in Table 9.14-2 for each radio condition.

**Table 9.13-2: Test parameters for variable reference channel, 1.6Mbps UE class**

Parameter	Unit	Test 1	Test 2	Test 3
HS-PDSCH Modulation and TBS	-	*		
Scrambling code and basic midamble code Number **	-	1		
Number of TS	-	3		
Number of DPCH <sub>0</sub>	-	0		
Number of HARQ Process	-	4		
Number of transmission	-	1		
Redundancy and constellation version coding sequence	Xrv	0		
HS-PDSCH Channelization Codes**	C(k,Q)	C(i,16) 1 ≤ i ≤ 10		
HS-PDSCH <sub>i</sub> Ec/lor	dB	-10		
loc****	dBm	-60		
* Note 1 As requested by the last received CQI report **Note 2 Refer to TS 25.223 for definition of channelization codes, scrambling code and basic midamble code. ***Note 3 If the indicated CQI is 0, the Node-B emulator shall format the next HS-PDSCH transmission with the transport block size and the modulation scheme that were previously used. ****Note 4 For multi-carrier reception, it refers to the interference power on each carrier.				

**Table 9.14-2: Performance requirements for variable reference channel, 1.6Mbps UE class**

Test Number	Propagation conditions	$\frac{\hat{I}_{or}}{I_{oc}}$ [dB] (Note1)	R (Throughput) [kbps] (Note2)
1	PA3	15	480
2	PB3	15	483
3	VA30	15	323
Note 1: For multi-carrier reception, it refers to $\frac{\hat{I}_{or}}{I_{oc}}$ on each carrier. Note 2: For multi-carrier reception, R refers to throughput on each carrier.			

9.2.2.4 Category 10, 2.2 Mbps UE class

For the parameters specified in Table 9.13-3 the measured throughput R shall exceed the throughput specified in Table 9.14-3 for each radio condition.

**Table 9.13-3: Test parameters for variable reference channel, 2.2Mbps UE class**

Parameter	Unit	Test 1	Test 2	Test 3
HS-PDSCH Modulation and TBS	-		*	
Scrambling code and basic midamble code Number **	-		1	
Number of TS	-		4	
Number of DPCH <sub>0</sub>	-		0	
Number of HARQ Process	-		4	
Number of transmission	-		1	
Redundancy and constellation version coding sequence	Xrv		0	
HS-PDSCH Channelization Codes**	C(k,Q)		C(i,16) 1≤i≤10	
HS-PDSCH <sub>i</sub> Ec/lor	dB		-10	
loc****	dBm		-60	
<p>* Note 1 As requested by the last received CQI report</p> <p>**Note 2 Refer to TS 25.223 for definition of channelization codes, scrambling code and basic midamble code.</p> <p>***Note 3 If the indicated CQI is 0, the Node-B emulator shall format the next HS-PDSCH transmission with the transport block size and the modulation scheme that were previously used.</p> <p>****Note 4 For multi-carrier reception, it refers to the interference power on each carrier.</p>				

**Table 9.14-3: Performance requirements for variable reference channel, 2.2Mbps UE class**

Test Number	Propagation conditions	$\frac{\hat{I}_{or}}{I_{oc}}$ [dB] (Note1)	R (Throughput) [kbps] (Note2)
1	PA3	15	625
2	PB3	15	631
3	VA30	15	418
<p>Note 1: For multi-carrier reception, it refers to <math>\frac{\hat{I}_{or}}{I_{oc}}</math> on each carrier.</p> <p>Note 2: For multi-carrier reception, R refers to throughput on each carrier.</p>			

### 9.2.2.5 Category 13, 2.8 Mbps UE class

For the parameters specified in Table 9.13-4 the measured throughput R shall exceed the throughput specified in Table 9.14-4 for each radio condition.

**Table 9.13-4: Test parameters for variable reference channel, 2.8Mbps UE class**

Parameter	Unit	Test 1	Test 2	Test 3
HS-PDSCH Modulation and TBS	-		*	
Scrambling code and basic midamble code Number **	-		1	
Number of TS	-		5	
Number of DPCH <sub>0</sub>	-		0	
Number of HARQ Process	-		4	
Number of transmission	-		1	
Redundancy and constellation version coding sequence	Xrv		0	
HS-PDSCH Channelization Codes**	C(k,Q)		C(i,16) 1≤i≤10	
HS-PDSCH <sub>i</sub> Ec/lor	dB		-10	
loc****	dBm		-60	
<p>* Note 1 As requested by the last received CQI report</p> <p>**Note 2 Refer to TS 25.223 for definition of channelization codes, scrambling code and basic midamble code.</p> <p>***Note 3 If the indicated CQI is 0, the Node-B emulator shall format the next HS-PDSCH transmission with the transport block size and the modulation scheme that were previously used.</p> <p>****Note 4 For multi-carrier reception, it refers to the interference power on each carrier.</p>				

**Table 9.14-4: Performance requirements for variable reference channel, 2.8 Mbps UE class**

Test Number	Propagation conditions	$\frac{\hat{I}_{or}}{I_{oc}}$ [dB] (Note1)	R (Throughput) [kbps] (Note2)
1	PA3	15	783
2	PB3	15	792
3	VA30	15	544
<p>Note 1: For multi-carrier reception, it refers to <math>\frac{\hat{I}_{or}}{I_{oc}}</math> on each carrier.</p> <p>Note 2: For multi-carrier reception, R refers to throughput on each carrier.</p>			

## 9.2.3 Reporting of Channel Quality Indicator

The reporting accuracy of channel quality indicator (CQI) under AWGN environments is determined by the reporting variance and the BLER performance using the transport format indicated by the reported CQI median.

### 9.2.3.1 Minimum Requirement, Channel Quality Indicator

For the parameters specified in Table 9.15, the reported CQI value shall be within +/- x, as specified in Table 9.16, of the reported median CQI for more than Y%, also specified in Table 9.16, of the time.

**Table 9.15: Test parameters for CQI reporting measurement channel requirements (1.28 Mcps TDD Option)**

		0.5Mbps UE	1.1Mbps UE		1.6Mbps UE		2.2Mbps UE		2.8Mbps UE	
Parameter	Unit	Test 1	Test 2	Test 3	Test 4	Test 5	Test 6	Test 7	Test 8	Test 9
Number of TS	-	2	2		3		4		5	
Number of HS-PDSCH codes per TS	-	10	10		10		10		10	
HS-PDSCH <sub>i</sub> _Ec/lor	dB	-10	-10		-10		-10		-10	
HS-PDSCH Channelization Codes*	C(k, Q)	C(i,16) 1≤i≤10	C(i,16) 1≤i≤10		C(i,16) 1≤i≤10		C(i,16) 1≤i≤10		C(i,16) 1≤i≤10	
Number of DPCH <sub>o</sub>	-	0								
Number of HARQ Process	-	4								
Number of transmission	-	1								
$\hat{I}_{or}/I_{oc}$ **	dB	1	1	8	1	8	1	8	1	8
*Note 1 Refer to TS 25.223 for definition of channelization codes, scrambling code and basic midamble code.										
**Note 2 For multi-carrier reception, it refers to $\frac{\hat{I}_{or}}{I_{oc}}$ on each carrier.										

**Table 9.16: Performance requirements for CQI reporting measurement channel requirements (1.28 Mcps TDD Option)**

Test	Permitted CQI range from median (x)	% of time that CQI must be within +/- x of median (Y)	Maximum BLER for median reported CQI
Test 1	+/- 3	90	10%
Test 2	+/- 3	90	
Test 3	+/- 2	90	
Test 4	+/- 2	90	
Test 5	+/-2	90	
Test 6	+/-2	90	
Test 7	+/-2	90	
Test 8	+/-2	90	
Test 9	+/-2	90	

## 9.2.4 HS-SCCH Detection Performance

The detection performance of the HS-SCCH is determined by the probability of event  $E_m$ , which is declared when the UE is signaled on HS-SCCH, but DTX is observed in the corresponding HS-SICH ACK/NACK field. The probability of event  $E_m$  is denoted  $P(E_m)$ .

### 9.2.4.1 Minimum Requirements for HS-SCCH Detection

For the test parameters specified in Table 9.17, for each value of HS-SCCH  $\hat{I}_{or}/I_{oc}$  specified in Table 9.18 the measured  $P(E_m)$  shall be less than or equal to the corresponding specified value of  $P(E_m)$ .

**Table 9.17: Test parameters for HS-SCCH detection (1.28Mcps TDD option)**

Parameter	Unit	Test 1	Test2
Number of TS under test	-	1	
Number of HS-SCCH codes per timeslot	-	8 (4 x2)	
Scrambling code and basic midamble code number*	-	0	
Number of DPCH <sub>0</sub>	-	2	
Number of H-ARQ process	-	4	
HS-SCCH UE Identity ( $x_{ue,1}, x_{ue,2}, \dots, x_{ue,16}$ )	-	UE1 = 0000000000000000 (UE1 under test) UE2 = 0101010101010101 UE3 = 1010101010101010 UE4 = 1111111111111111	
HS-SCCH Channelization Codes*	C(k,Q)	C(i,16) 1 ≤ i ≤ 8	
HS-SCCH Channelization Codes for UE under test	C(k,Q)	C(i,16) 1 ≤ i ≤ 2	
DPCH <sub>0</sub> Channelization Codes	C(k,Q)	C(i,16) 9 ≤ i ≤ 10	
Power control for HS-SCCH of UE 1	-	OFF	
$\frac{HS-SCCH_i - E_c}{I_{or}}$	dB	-10	
$I_{oc}$	dBm/1.28MHz	-60	
Note *:	Refer to TS 25.223 for definition of channelization codes, scrambling code and basic midamble code.		
Note**:	For multi-carrier reception, it refers to the interference power on each carrier.		

**Table 9.18: Minimum requirement for HS-SCCH detection (1.28Mcps TDD option)**

Test Number	Propagation Conditions	$\frac{\hat{I}_{or}}{I_{oc}}$ (dB) (Note1)	$P(E_m)$ (Note2)
1	PA3	16	0.01
2	VA30	12	0.01
Note1: For multi-carrier reception, it refers to $\frac{\hat{I}_{or}}{I_{oc}}$ on each carrier. Note2: For multi-carrier reception, it refers to $P(E_m)$ on each carrier.			

## 9.2.5 PLCCH Detection Performance

The detection performance of the PLCCH is determined by the BER of the received PLCCH.

### 9.2.5.1 Minimum Requirements

For the test parameters in Table 9.18A, for the value of  $\hat{I}_{or}/I_{oc}$  specified in Table 9.18B, the measured BER should be equal or less than the corresponding specified BER value.

**Table 9.18A: Test parameters for PLCCH detection (1.28Mcps TDD option)**

Parameter	Unit	Test 1
Number of PLCCH	-	1
Number of interfering codes/timeslot	-	1 x SF16
Number of timeslot	-	1
PLCCH information bit pattern	-	Alternating 1 and 0 starting with 1 (101010....)
$I_{oc}$	dBm/1.28 MHz	-60
PLCCH_ $E_c/I_{or}$	dB	-3
PLCCH channelization codes	C(k, Q)	C(1, 16)
OCNS channelization code	C(k, Q)	C(2, 16)
Midamble allocation	-	Common
Power control	-	OFF
Propagation condition	-	VA30

**Table 9.18B: Minimum requirement for PLCCH detection (1.28Mcps TDD option)**

Test Number	$\frac{\hat{I}_{or}}{I_{oc}}$ (dB)	BER
1	0.3	0.04

## 9.3 Performance requirement for 7.68 Mcps TDD option

The requirements are stated for the HSDPA UE reference combination classes specified in [2] and under the multipath propagation conditions specified in Annex B. The performance metric for HS-DSCH requirements in multi-path propagation conditions is the throughput R measured on HS-DSCH.

### 9.3.1 HS-DSCH throughput for fixed reference channels

The performance requirements in this subclause apply for the reference measurement channels specified in Annex A.3.2.

During the Fixed Reference Channel tests the behaviour of the Node-B emulator in response to the ACK/NACK signalling field of the HS-SICH is specified in Table 9.19:

**Table 9.19: Node-B Emulator Behaviour in response to ACK/NACK/DTX**

HS-SICH ACK/NACK Field State	Node-B Emulator Behaviour
ACK	ACK: new transmission using 1 <sup>st</sup> redundancy version (RV)
NACK	NACK: retransmission using the next RV (up to the maximum permitted number of RV's)
DTX	DTX: retransmission using the RV previously transmitted to the same H-ARQ process

#### 9.3.1.1 Minimum requirement QPSK, Fixed Reference Channel, 5,3 Mbps – Category 8 – UE

For the parameters specified in Table 9.20, the measured throughput R shall exceed the throughput specified in Table 9.21 for each radio condition.



**Table 9.20: Test parameters for fixed reference measurement channel requirements for 5,3 Mbps – Category 8 – UE (7,68 Mcps TDD Option) QPSK**

Parameters	Unit	Test 1	Test 2	Test 3	Test 4
HS-PDSCH Modulation	-	QPSK			
Scrambling code and basic midamble code number*	-	0, 1			
Number of TS	-	4			
HS-PDSCH Channelization Codes*	C(k,Q)	C(i,32) i=1..32			
Number of Hybrid ARQ processes	-	3			
Maximum number of Hybrid ARQ transmissions	-	4			
Redundancy and constellation version coding sequence**	-	{0,0,0,0} s=1, R=0, b=0			
$\frac{HS - PDSCH - E_c}{I_{or}}$	dB	-15,05			
$\frac{\sum HS - PDSCH - E_c}{I_{or}}$	dB	0			
$I_{oc}$	dBm/7,68 MHz	-60			
Note *: Refer to TS 25.223 for definition of channelization codes, scrambling code and basic midamble code.					
Note **: This sequence implies Chase combining					

**Table 9.21: Performance requirements for fixed reference measurement channel requirement in multipath channels for 5,3 Mbps – Category 8 – UE (7,68 Mcps TDD Option) QPSK**

Test Number	Propagation conditions	$\frac{\hat{I}_{or}}{I_{oc}}$ [dB]	R (Throughput) [kbps]
1	PA3	5,2	880
2	PB3	5,5	880
3	VA30	6,2	880
4	VA120	6,2	880

### 9.3.1.2 Minimum requirement 16 QAM, Fixed Reference Channel, 5,3 Mbps – Category 8 – UE

For the parameters specified in Table 9.22, the measured throughput R shall exceed the throughput specified in Table 9.23 for each radio condition.

**Table 9.22: Test parameters for fixed reference measurement channel requirements for 5,3 Mbps – Category 8 – UE (7,68 Mcps TDD Option) 16QAM**

Parameters	Unit	Test 1	Test 2	Test 3	Test 4
HS-PDSCH Modulation	-	16QAM			
Scrambling code and basic midamble code number*	-	0, 1			
Number of TS	-	4			
HS-PDSCH Channelization Codes*	C(k,Q)	C(i,32) i=1..32			
Number of Hybrid ARQ processes	-	3			
Maximum number of Hybrid ARQ transmissions	-	4			
Redundancy and constellation version coding sequence**	-	{0,0,0,0} s=1, R=0, b=0			
$\frac{HS - PDSCH - E_c}{I_{or}}$	dB	-15,05			
$\frac{\sum HS - PDSCH - E_c}{I_{or}}$	dB	0			
$I_{oc}$	dBm/7,68 MHz	-60			
Note *: Refer to TS 25.223 for definition of channelization codes, scrambling code and basic midamble code.					
Note **: This sequence implies Chase combining					

**Table 9.23: Performance requirements for fixed reference measurement channel requirement in multipath channels for 5,3 Mbps – Category 8 – UE (7,68 Mcps TDD Option) 16QAM**

Test Number	Propagation conditions	$\frac{\hat{I}_{or}}{I_{oc}}$ [dB]	R (Throughput) [kbps]
1	PA3	11,1	1765
2	PB3	13,2	1765
3	VA30	13,7	1765
4	VA120	13,6	1765

9.3.2 (void)

9.3.3 (void)

### 9.3.4 HS-SCCH Detection Performance

The detection performance of the HS-SCCH is determined by the probability of event  $E_m$ , which is declared when the UE is signaled on HS-SCCH, but DTX is observed in the corresponding HS-SICH ACK/NACK field. The probability of event  $E_m$  is denoted  $P(E_m)$ .

#### 9.3.4.1 Minimum Requirements for HS-SCCH Detection

For the test parameters in Table 9.24, for each value of HS-SCCH-1  $E_c/I_{or}$  specified in Table 9.25, the measured  $P(E_m)$  shall be less than or equal to the corresponding specified value of  $P(E_m)$ .

**Table 9.24: Test parameters for HS-SCCH detection (7.68 Mcps TDD option)**

Parameter	Unit	Test 1	Test 2	Test 3
Number of TS under test	-	1		
Number of HS-SCCH codes per timeslot	-	4		
HS-SCCH UE Identity ( $x_{ue,1}, x_{ue,2}, \dots, x_{ue,16}$ )	-	UE1 = 0000000000000000 (UE1 under test) UE2 = 0101010101010101 UE3 = 1010101010101010 UE4 = 1111111111111111		
HS-SCCH Channelization Codes*	C(k,Q)	HS-SCCH-1 = C(1, 32), for UE1 (UE under test) HS-SCCH-2 = C(2, 32) for UE2 HS-SCCH-3 = C(3, 32) for UE3 HS-SCCH-4 = C(4, 32) for UE4		
HS-SCCH $E_c/I_{or}$	dB	HS-SCCH-2_ $E_c/I_{or}$ = HS-SCCH-3_ $E_c/I_{or}$ = HS-SCCH-4_ $E_c/I_{or}$ , Where, $\sum$ HS-SCCH-X_ $E_c/I_{or}$ = 1, where X = 1, 2, 3, 4		

**Table 9.25: Minimum requirement for HS-SCCH detection (7.68 Mcps TDD option)**

Test Number	Propagation Conditions	Reference value		
		HS-SCCH-1 $E_c/I_{or}$ (dB)	$\hat{I}_{or}/I_{oc}$ (dB)	$P(E_m)$
1	PA3	-6.0	0	0.05
2	PA3	-7.5	5	0.01
3	VA30	-6.0	0	0.01

## 10 Performance requirements (MBMS)

### 10.1 Demodulation of MCCH

The receive characteristic of the MCCH is determined by the RLC SDU error rate (RLC\_SDU\_ER). The requirement is valid for all RRC states for which the UE has capabilities.

#### 10.1.1 Minimum requirement

##### 10.1.1.1 3.84 Mcps TDD Option

For the parameters specified in Table 10.1, the measured average downlink S-CCPCH\_  $E_c/I_{or}$  power ratio shall be below the specified value for the RLC\_SDU\_ER shown in Table 10.2.

**Table 10.1: Test parameters for MCCH detection**

Parameters	Unit	Test 1
$I_{oc}$	dBm/3.84 MHz	-60
$\frac{\hat{I}_{or}}{I_{oc}}$	dB	-3
Number of Interfering codes/timeslot	-	7 × SF16
MCCH Data Rate	kbps	7.2
Propagation condition	-	VA3
Slot Format #i	-	3

**Table 10.2: Test requirements for MCCH detection**

Test Number	S-CCPCH_Ec/I <sub>or</sub> (dB)	RLC_SDU_ER
1	-1.25	0.01

### 10.1.1.2 1.28 Mcps TDD Option

For the parameters specified in Table 10.3, the measured average downlink  $\frac{\hat{I}_{or}}{I_{oc}}$  power ratio shall be below the specified value for the RLC SDU ER shown in Table 10.4.

**Table 10.3: Test parameters for MCCH detection**

Parameters	Unit	Test 1
$I_{oc}$	dBm/1.28 MHz	-60
Number of codes per timeslot	-	2xSF16
Number of interfering codes per timeslot	-	0
MCCH Data Rate	kbps	7.6
Propagation condition	-	VA3

**Table 10.4: Test requirements for MCCH detection**

Test Number	$\frac{\hat{I}_{or}}{I_{oc}}$ (dB)	RLC_SDU_ER
1	5.8	0.01

### 10.1.1.2 7.68 Mcps TDD Option

For the parameters specified in Table 10.4A, the measured average downlink S-CCPCH\_Ec/I<sub>or</sub> power ratio shall be below the specified value for the RLC\_SDU\_ER shown in Table 10.4B.

**Table 10.4A: Test parameters for MCCH detection**

Parameters	Unit	Test 1
$I_{oc}$	dBm/7.68 MHz	-60
$\frac{\hat{I}_{or}}{I_{oc}}$	dB	-3
Number of Interfering codes/timeslot	-	15 x SF32
MCCH Data Rate	kbps	7.2
Propagation condition	-	VA3
Slot Format #i	-	3

**Table 10.4B: Test requirements for MCCH detection**

Test Number	S-CCPCH_Ec/I <sub>or</sub> (dB)	RLC_SDU_ER
1	-4.7	0.01

## 10.1.2 MBSFN capable UE

This requirement is applicable for UEs that are capable of receiving MBSFN.

### 10.1.2.1 3.84 Mcps TDD Option

The test is only applicable for UEs with at least two receiver antenna connectors where the fading of the signals and the AWGN signals applied to each receiver antenna connector shall be uncorrelated.

For the parameters specified in Table 10.4C, the measured average downlink S-CCPCH\_Ec/I<sub>or</sub> power ratio shall be below the specified value for the RLC\_SDU\_ER shown in Table 10.4D.

**Table 10.4C: Test parameters for MCCH detection**

Parameters	Unit	Test 1
I <sub>oc</sub>	dBm/3.84 MHz	-60
$\frac{\hat{I}_{or}}{I_{oc}}$	dB	12
Number of Interfering codes/timeslot	-	7 × SF16
MCCH Data Rate	kbps	7.2
Propagation condition	-	Extended delay spread (see Appendix B)
Slot Format #	-	21

**Table 10.4D: Test requirements for MCCH detection (at least two receiver antennas)**

Test Number	S-CCPCH_Ec/I <sub>or</sub> (dB)	RLC_SDU_ER
1	-19.29	0.01

### 10.1.2.2 1.28 Mcps TDD Option

For the parameters specified in Table 10.4E, the measured average downlink  $\frac{\hat{I}_{or}}{I_{oc}}$  power ratio shall be below the specified value for the RLC\_SDU\_ER shown in Table 10.4F.

**Table 10.4E: Test parameters for MCCH detection**

Parameters	Unit	Test 1 <sup>1</sup>	Test 2 <sup>1</sup>
I <sub>oc</sub>	dBm/1.28 MHz	-60	-60
Rx antenna	-	1	2
Number of codes/Timeslot	-	3	3
Number of Interfering codes/timeslot	-	5XSF16	5XSF16
MCCH Data Rate	kbps	7.6	7.6
Propagation condition	-	MBSFN channel model 2 (Annex B)	MBSFN channel model 2 (Annex B)
Slot Format #	-	10 <sup>3</sup>	10 <sup>3</sup>
NOTE1: The tests are only applicable for the UE supporting extended delay spread.			
NOTE2: In the case of Rx diversity, the fading of the signal and AWGN signals applied to each receiver antenna connector shall be uncorrelated.			
NOTE3: See Table 8Ha in TS25.221.			

**Table 10.4F: Test requirements for MCCH detection**

Test Number	$\frac{\hat{I}_{or}}{I_{oc}}$ (dB)	RLC_SDU_ER
1	9.1	0.01
2	4.5	0.01

### 10.1.2.3 7.68 Mcps TDD Option

The test is only applicable for UEs with at least two receiver antenna connectors where the fading of the signals and the AWGN signals applied to each receiver antenna connector shall be uncorrelated.

For the parameters specified in Table 10.4G, the measured average downlink S-CCPCH\_Ec/I<sub>or</sub> power ratio shall be below the specified value for the RLC\_SDU\_ER shown in Table 10.4H.

**Table 10.4G: Test parameters for MCCH detection**

Parameters	Unit	Test 1
I <sub>oc</sub>	dBm/7.68 MHz	-60
$\frac{\hat{I}_{or}}{I_{oc}}$	dB	12
Number of Interfering codes/timeslot	-	15 × SF32
MCCH Data Rate	kbps	7.2
Propagation condition	-	Extended delay spread (see Appendix B)
Slot Format #i	-	21

**Table 10.4H: Test requirements for MCCH detection (at least two receiver antennas)**

Test Number	S-CCPCH_Ec/I <sub>or</sub> (dB)	RLC_SDU_ER
1	-22.71	0.01

## 10.2 Demodulation of MTCH

The receive characteristic of the MTCH is determined by RLC SDU error rate (RLC SDU ER). RLC SDU ER is specified for each individual data rate of the MTCH. The requirement is valid for all RRC states for which the UE has capabilities for MBMS.

### 10.2.1 Minimum requirement

#### 10.2.1.1 3.84 Mcps TDD Option

For the parameters specified in Table 10.5 the average downlink  $\frac{\hat{I}_{or}}{I_{oc}}$  power ratio shall be below the specified value for the RLC SDU ER shown in Table 10.6.

**Table 10.5: Parameters for MTCH detection**

Parameters	Unit	Test 1	Test 2
$\Sigma(S\text{-CCPCH\_}E_c)/I_{or}$ per active timeslot	dB	0	0
$\Sigma(S\text{-CCPCH\_}E_c)/I_{oc}$ per active timeslot	dB	0	0
MTCH Data Rate	kbps	128	256
Propagation condition	-	VA3	
Number of Radio Links	-	2	3

**Table 10.6: Test requirements for MTCH detection**

Test Number	$\frac{\hat{I}_{or}}{I_{oc}}$ (dB)	RLC SDU ER
1	5.7	0.1
2	5.5	0.1

### 10.2.1.2 1.28 Mcps TDD Option

For the parameters specified in Table 10.7 the average downlink  $\frac{\hat{I}_{or}}{I_{oc}}$  power ratio shall be below the specified value for the RLC SDU ER shown in Table 10.8.

**Table 10.7: Parameters for MTCH detection**

Parameters	Unit	Test 1	Test 2
$I_{oc}$	dBm/1.28 MHz	-60	
MTCH Data Rate	kbps	64	128
Number of codes per timeslot	-	8xSF16	14xSF16
Number of interfering codes per timeslot	-	0	0
Propagation condition	-	VA3	
Number of Radio Links	-	3	3

**Table 10.8: Test requirements for MTCH detection**

Test Number	$\frac{\hat{I}_{or}}{I_{oc}}$ (dB)	RLC SDU ER
1	4.8	0.1
2	6.0	0.1

### 10.2.1.3 7.68 Mcps TDD Option

For the parameters specified in Table 10.9 the average downlink  $\frac{\hat{I}_{or}}{I_{oc}}$  power ratio shall be below the specified value for the RLC SDU ER shown in Table 10.10.

**Table 10.9: Parameters for MTCH detection**

Parameters	Unit	Test 1	Test 2
$I_{oc}$	dBm/7.68 MHz	-60	
$\Sigma(S\text{-CCPCH\_}E_c)/I_{or}$ per active timeslot	dB	-3	-3
MTCH Data Rate	Kbps	128	256
Number of interfering codes/timeslot	-	16 x SF32	16 x SF32
Propagation condition	-	VA3	
Number of Radio Links	-	2	3

**Table 10.10: Test requirements for MTCH detection**

Test Number	$\frac{\hat{I}_{or}}{I_{oc}}$ (dB)	RLC SDU ER
1	6.1	0.1
2	5.0	0.1

## 10.2.2 MBSFN capable UE

This requirement is applicable for UEs that are capable of receiving MBSFN.

### 10.2.2.1 3.84 Mcps TDD Option

The test is only applicable for UEs with at least two receiver antenna connectors where the fading of the signals and the AWGN signals applied to each receiver antenna connector shall be uncorrelated.

For the parameters specified in Table 10.10A the average downlink power ratio shall be below the specified value for the RLC SDU ER shown in Table 10.10B.

**Table 10.10A: Parameters for MTCH detection**

Parameters	Unit	Test 1
$I_{oc}$	dBm/3.84 MHz	-60
$\Sigma(S\text{-CCPCH\_}E_c)/I_{or}$ per active timeslot	dB	0
MTCH Data Rate	kbps	512
Propagation condition	-	Extended delay spread (see Appendix B)
Number of Radio Links	-	1
S-CCPCH Modulation	-	16QAM

**Table 10.10B: Test requirements for MTCH detection (at least two receiver antennas)**

Test Number	$\frac{\hat{I}_{or}}{I_{oc}}$ (dB)	RLC SDU ER
1	14.58	0.1

### 10.2.2.2 1.28 Mcps TDD Option

For the parameters specified in Table 10.10C the average downlink power ratio shall be below the specified value for the RLC SDU ER shown in Table 10.10D.



**Table 10.10C: Parameters for MTCH detection**

Parameters	Unit	Test 1 <sup>1</sup>	Test 2 <sup>1</sup>	Test 3 <sup>2</sup>	Test 4 <sup>2</sup>
MTCH Data rate	Kbps	192	384	192	384
Rx antenna	-	1	2	1	2
Modulation	-	QPSK	16QAM	QPSK	16QAM
$I_{oc}$	dBm/1.28 MHz	-60	-60	-60	-60
$\Sigma(S\text{-CCPCH\_}E_c)/I_{or}$	dB	0	0	0	0
Propagation condition	-	MBSFN channel model 1 (Annex B)	MBSFN channel model 1 (Annex B)	MBSFN channel model 2 (Annex B)	MBSFN channel model 2 (Annex B)
Slot Format #	-	0 <sup>4</sup>	2 <sup>4</sup>	4 <sup>4</sup>	7 <sup>4</sup>

NOTE1: Test 1 and Test 2 are specified for the UE supporting normal delay spread.

NOTE2: Test 3 and Test 4 are specified for the UE supporting extended delay spread.

NOTE3: In the case of Rx diversity, the fading of the signals and the AWGN signals applied to each receiver antenna connector shall be uncorrelated.

NOTE4: See Table 8Ha in TS25.221.

**Table 10.10D: Test requirements for MTCH detection**

Test Number	$\frac{\hat{I}_{or}}{I_{oc}}$ (dB)	RLC SDU ER
1	13.3	0.1
2	14.7	0.1
3	13.3	0.1
4	15.1	0.1

### 10.2.2.3 7.68 Mcps TDD Option

The test is only applicable for UEs with at least two receiver antenna connectors where the fading of the signals and the AWGN signals applied to each receiver antenna connector shall be uncorrelated.

For the parameters specified in Table 10.10E the average downlink power ratio shall be below the specified value for the RLC SDU ER shown in Table 10.10F.

**Table 10.10E: Parameters for MTCH detection**

Parameters	Unit	Test 1
$I_{oc}$	dBm/7.68 MHz	-60
$\Sigma(S\text{-CCPCH\_}E_c)/I_{or}$ per active timeslot	dB	-3
MTCH Data Rate	kbps	512
Number of interfering codes/timeslot	-	16 x SF32
Propagation condition	-	Extended delay spread (see Appendix B)
Number of Radio Links	-	1
S-CCPCH Modulation	-	16QAM

**Table 10.10F: Test requirements for MTCH detection (at least two receiver antennas)**

Test Number	$\frac{\hat{I}_{or}}{I_{oc}}$ (dB)	RLC SDU ER
1	14.21	0.1

### 10.2.3 MBSFN TDD & FDD same platform sharing

This test case is to ensure that a simultaneous demodulation of MTCH and FDD transmission is possible for a MBSFN TDD UE sharing the same platform with a FDD UE. The test is only applicable for TDD UEs with at least two receiver antenna connectors where the fading of the signals and the AWGN signals applied to each receiver antenna connector shall be uncorrelated.

#### 10.2.3.1 3.84 Mcps TDD Option

For the parameters specified in Table 10.10G the average downlink  $\hat{I}_{or}$  power shall be below the specified value for the RLC SDU ER shown in Table 10.10H.

**Table 10.10G: Parameters for MTCH detection sharing same platform with FDD**

Parameters	Unit	Test 1	Test 2
FDD UE Tx Pwr	dBm/ 3.84 MHz	Nominal Maximum Output Power	Nominal Maximum Output Power
$I_{oc}$	dBm/ 3.84 MHz	-infinity	-infinity
$\Sigma(S\text{-CCPCH}_{E_c})/I_{or}$ per active timeslot	dB	0	0
MTCH Data Rate	kbps	512	512
Number of interfering codes/timeslot	-	0	0
Propagation condition	-	Extended Delay Spread (see Appendix B)	Extended Delay Spread (see Appendix B)
Number of Radio Links	-	1	1
S-CCPCH Modulation	-	16QAM	16QAM
TDD operating frequencies	MHz	1900-1920	2570-2620
FDD operating band	-	Band I	Band VII
TDD/FDD carrier frequencies	-	Applicable for all combinations of TDD and FDD carrier frequencies except for combinations where the carrier frequency separation is less than 15 MHz	Applicable for all combinations of TDD and FDD carrier frequencies except for combinations where the carrier frequency separation is less than 15 MHz

**Table 10.10H: Test requirements for MTCH detection sharing same platform with FDD (TDD UE has at least two receiver antennas)**

Test Number	$\hat{I}_{or}$ (dBm)	RLC SDU ER
1	-83.42	0.1
2	-83.42	0.1

#### 10.2.3.2 (void)

#### 10.2.3.3 7.68 Mcps TDD Option

For the parameters specified in Table 10.10K the average downlink  $\hat{I}_{or}$  power shall be below the specified value for the RLC SDU ER shown in Table 10.10L.

**Table 10.10K: Parameters for MTCH detection sharing same platform with FDD**

Parameters	Unit	Test 1	Test 2
FDD UE Tx Pwr	dBm/ 3.84 MHz	Nominal Maximum Output Power	Nominal Maximum Output Power
$I_{oc}$	dBm/ 7.68 MHz	-infinity	-infinity
$\Sigma(S\text{-CCPCH\_}E_c)/I_{or}$ per active timeslot	dB	-3	-3
MTCH Data Rate	kbps	512	512
Number of interfering codes/timeslot	-	16 × SF32	16 × SF32
Propagation condition	-	Extended Delay Spread (see Appendix B)	Extended Delay Spread (see Appendix B)
Number of Radio Links	-	1	1
S-CCPCH Modulation	-	16QAM	16QAM
TDD operating frequencies	MHz	1900-1920	2570-2620
FDD operating band	-	Band I	Band VII
TDD/FDD carrier frequencies	-	Applicable for all combinations of TDD and FDD carrier frequencies except for combinations where the carrier frequency separation is less than 17.5 MHz	Applicable for all combinations of TDD and FDD carrier frequencies except for combinations where the carrier frequency separation is less than 17.5 MHz

**Table 10.10L: Test requirements for MTCH detection sharing same platform with FDD (TDD UE has at least two receiver antennas)**

Test Number	$\hat{I}_{or}$ (dBm)	RLC SDU ER
1	-80.79	0.1
2	-80.79	0.1

## 10.3 Demodulation of MTCH and cell identification

MBMS combining is not controlled by a network but instead it is autonomously handled by a terminal. UE has to be able to receive MTCH and identify intra-frequency neighbour cells according to the requirements. The requirement for MBMS receiving combined with cell identification is determined by RLC SDU error rate.

### 10.3.1 Minimum requirement

#### 10.3.1.1 (void)

#### 10.3.1.2 1.28 Mcps TDD Option

For the parameters specified in Table 10.11, the average downlink  $I_{or}/I_{oc}$  power ratio shall be below the specified value for the RLC SDU error rate shown in Table 10.12. The cell reselection parameters are given in clause A.4.2.2.

**Table 10.11 parameters for MTCH demodulation requirements with cell identification**

Parameter	Unit	Test 1		
		Stage 1	Stage 2	Stage 3
Time in each stage	s	2s	800ms	2s
$I_{oc}$	dBm/1.28MHz	-60		
Propagation condition		VA 3		
MTCH Data Rate	kbps	64kbps		
Number of Radio Links		Cell 1, Cell 2	Cell 1, 2, 3	Cell 1, Cell 3

**Table 10.12: Requirements for MTCH detection**

Test Number	$\frac{\hat{I}_{or}}{I_{oc}}$	RLC SDU ER
1	6.1	0.05

## 11 Performance requirement (E-DCH)

### 11.1 Detection of E-DCH HARQ ACK Indicator Channel (E-HICH)

The performance of the E-HICH detection is determined by the false ACK probability (probability of detecting an ACK given that a NACK was sent) and the false NACK probability (probability of detecting a NACK given that an ACK was sent).

#### 11.1.1 Minimum requirement

##### 11.1.1.1 3.84 Mcps TDD Option

For the parameters specified in Table 11.1 the average downlink E-HICH  $E_c/I_{or}$  power ratio shall be below the specified value for the false ACK and false NACK probabilities shown in Table 11.2.

**Table 11.1: Test parameters for E-HICH detection (3.84 Mcps TDD option)**

Parameters	Unit	Test 1	Test 2
$I_{oc}$	dBm/3.84 MHz	-60	
$\frac{\hat{I}_{or}}{I_{oc}}$	dB	0	
Number of Interfering codes/timeslot	-	7 × SF16 (all codes have equal powers)	
E-HICH signalling pattern	-	100% NACK	100% ACK
Propagation condition	-	VA30	

**Table 11.2: Test requirements for E-HICH detection (3.84 Mcps TDD option)**

Test Number	E-HICH $E_c/I_{or}$ (dB)	Parameter	Probability
1	-18.5	False ACK	2E-3
2	-18.5	False NACK	2E-2

##### 11.1.1.2 1.28 Mcps TDD Option

For the parameters specified in Table 11.3 the average downlink E-HICH  $E_c/I_{or}$  power ratio shall be below the specified value for the false ACK and false NACK probabilities shown in Table 11.4.

**Table 11.3: Test parameters for E-HICH detection (1.28 Mcps TDD option)**

Parameters	Unit	Test 1	Test 2
$I_{oc}$	dBm/1.28 MHz	-60	
$\frac{\hat{I}_{or}}{I_{oc}}$	dB	0	
Number of Interfering codes/timeslot	-	7 × SF16 (all codes have equal powers)	
Midamble	-	Common midamble	
E-HICH signalling pattern	-	100% NACK	100% ACK
Propagation condition	-	VA30	

**Table 11.4: Test requirements for E-HICH detection (1.28 Mcps TDD option)**

Test Number	E-HICH $E_c/I_{or}$ (dB)	Parameter	Probability
1	-7.5	False ACK	2E-3
2	-7.5	False NACK	2E-2

### 11.1.1.3 7.68 Mcps TDD Option

For the parameters specified in Table 11.5 the average downlink E-HICH  $E_c/I_{or}$  power ratio shall be below the specified value for the false ACK and false NACK probabilities shown in Table 11.6.

**Table 11.5: Test parameters for E-HICH detection (7.68 Mcps TDD option)**

Parameters	Unit	Test 1	Test 2
$I_{oc}$	dBm/7.68 MHz	-60	
$\frac{\hat{I}_{or}}{I_{oc}}$	dB	0	
Number of Interfering codes/timeslot	-	15 × SF32 (all codes have equal powers)	
E-HICH signalling pattern	-	100% NACK	100% ACK
Propagation condition	-	VA30	

**Table 11.6: Test requirements for E-HICH detection (7.68 Mcps TDD option)**

Test Number	E-HICH $E_c/I_{or}$ (dB)	Parameter	Probability
1	-21.7	False ACK	2E-3
2	-21.7	False NACK	2E-2

## 11.2 Demodulation of E-DCH Absolute Grant Channel (E-AGCH)

The performance of the E-AGCH detection is determined by the missed detection probability.

### 11.2.1 Minimum requirement

#### 11.2.1.1 3.84 Mcps TDD Option

For the parameters specified in Table 11.7 the average downlink E-AGCH  $\hat{I}_{or}/I_{oc}$  power ratio shall be below the specified value for the missed detection probability shown in Table 11.8.

**Table 11.7: Test parameters for E-AGCH detection (3.84 Mcps TDD option)**

Parameters	Unit	Test 1
$I_{oc}$	dBm/3.84 MHz	-60
$\frac{E_c}{I_{or}}$	dB	-6.02
Number of Interfering codes/timeslot	-	3 × SF16
Total bits in Timeslot Resource Related Information (TRRI)	bits	6
Total bits in Resource Duration Indicator (RDI)	bits	3
Total bits in E-AGCH	bits	38
Propagation condition	-	VA30

**Table 11.8: Test requirements for E-AGCH detection (3.84 Mcps TDD option)**

Test Number	E-AGCH $\hat{I}_{or}/I_{oc}$ (dB)	Missed Detection Probability
1	1.6	0.01

### 11.2.1.2 1.28 Mcps TDD Option

For the parameters specified in Table 11.9 the average downlink E-AGCH  $\hat{I}_{or}/I_{oc}$  power ratio shall be below the specified value for the missed detection probability shown in Table 11.10.

**Table 11.9: Test parameters for E-AGCH detection (1.28 Mcps TDD option)**

Parameters	Unit	Test 1
$I_{oc}$	dBm/1.28 MHz	-60
$\frac{E_c}{I_{or}}$	dB	-3
Number of Interfering codes/timeslot	-	2 × SF16
Total bits in Timeslot Resource Related Information (TRRI)	bits	5
Total bits in Resource Duration Indicator (RDI)	bits	3
Total bits in E-AGCH	bits	26
Midamble	-	Common midamble
Propagation condition	-	VA30

**Table 11.10: Test requirements for E-AGCH detection (1.28 Mcps TDD option)**

Test Number	E-AGCH $\hat{I}_{or}/I_{oc}$ (dB)	Missed Detection Probability
1	8	0.01

### 11.2.1.3 7.68 Mcps TDD Option

For the parameters specified in Table 11.11 the average downlink E-AGCH  $\hat{I}_{or}/I_{oc}$  power ratio shall be below the specified value for the missed detection probability shown in Table 11.12.

**Table 11.11: Test parameters for E-AGCH detection (7.68 Mcps TDD option)**

Parameters	Unit	Test 1
$I_{oc}$	dBm/7.68 MHz	-60
$\frac{E_c}{I_{or}}$	dB	-9.03
Number of Interfering codes/timeslot	-	7 x SF32
Total bits in Timeslot Resource Related Information (TRRI)	bits	6
Total bits in Resource Duration Indicator (RDI)	bits	3
Total bits in E-AGCH	bits	39
Propagation condition	-	VA30

**Table 11.12: Test requirements for E-AGCH detection (7.68 Mcps TDD option)**

Test Number	E-AGCH $\hat{I}_{or}/I_{oc}$ (dB)	Missed Detection Probability
1	1.2	0.01

---

## Annex A (normative): Measurement channels

### A.1 (void)

### A.2 Reference measurement channel

#### A.2.1 UL reference measurement channel (12.2 kbps)

##### A.2.1.1 3.84 Mcps TDD Option

Table A.1

Parameter	Value
Information data rate	12.2 kbps
RU's allocated	2 RU
Midamble	512 chips
Interleaving	20 ms
Power control	2 Bit/user
TFCI	16 Bit/user
Inband signalling DCCH	2 kbps
Puncturing level at Code rate 1/3 : DCH of the DTCH / DCH of the DCCH	10% / 0%



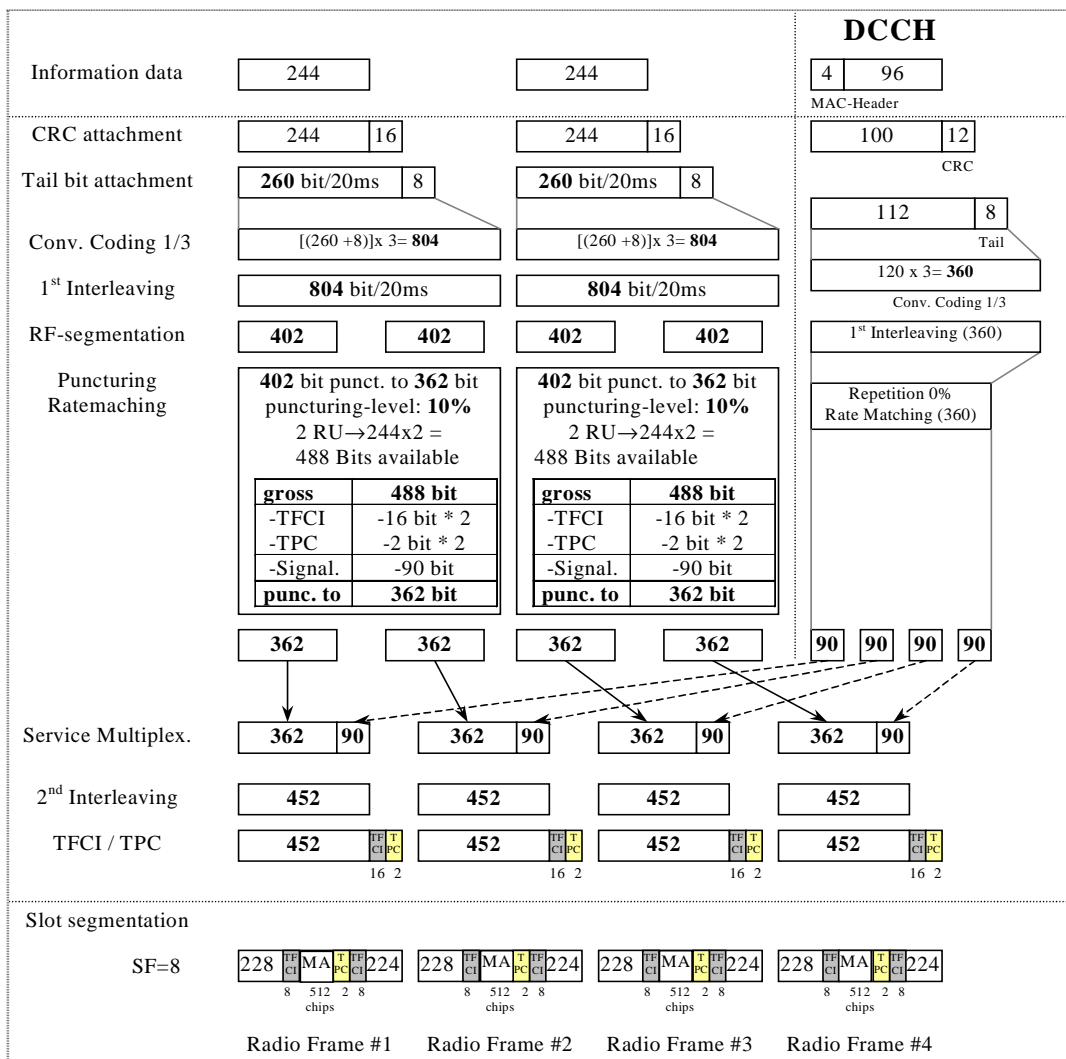

Figure A.1

A.2.1.2 1.28 Mcps TDD Option

Table A.1A

Parameter	Value
Information data rate	12.2 kbps
RU's allocated	1TS (1*SF8) = 2RU/5ms
Midamble	144
Interleaving	20 ms
Power control	4 Bit/user/10ms
TFCI	16 Bit/user/10ms
4 Bit reserved for future use (place of SS)	4 Bit/user/10ms
Inband signalling DCCH	2.4 kbps
Puncturing level at Code rate 1/3 : DCH of the DTCH / DCH of the DCCH	33% / 33%

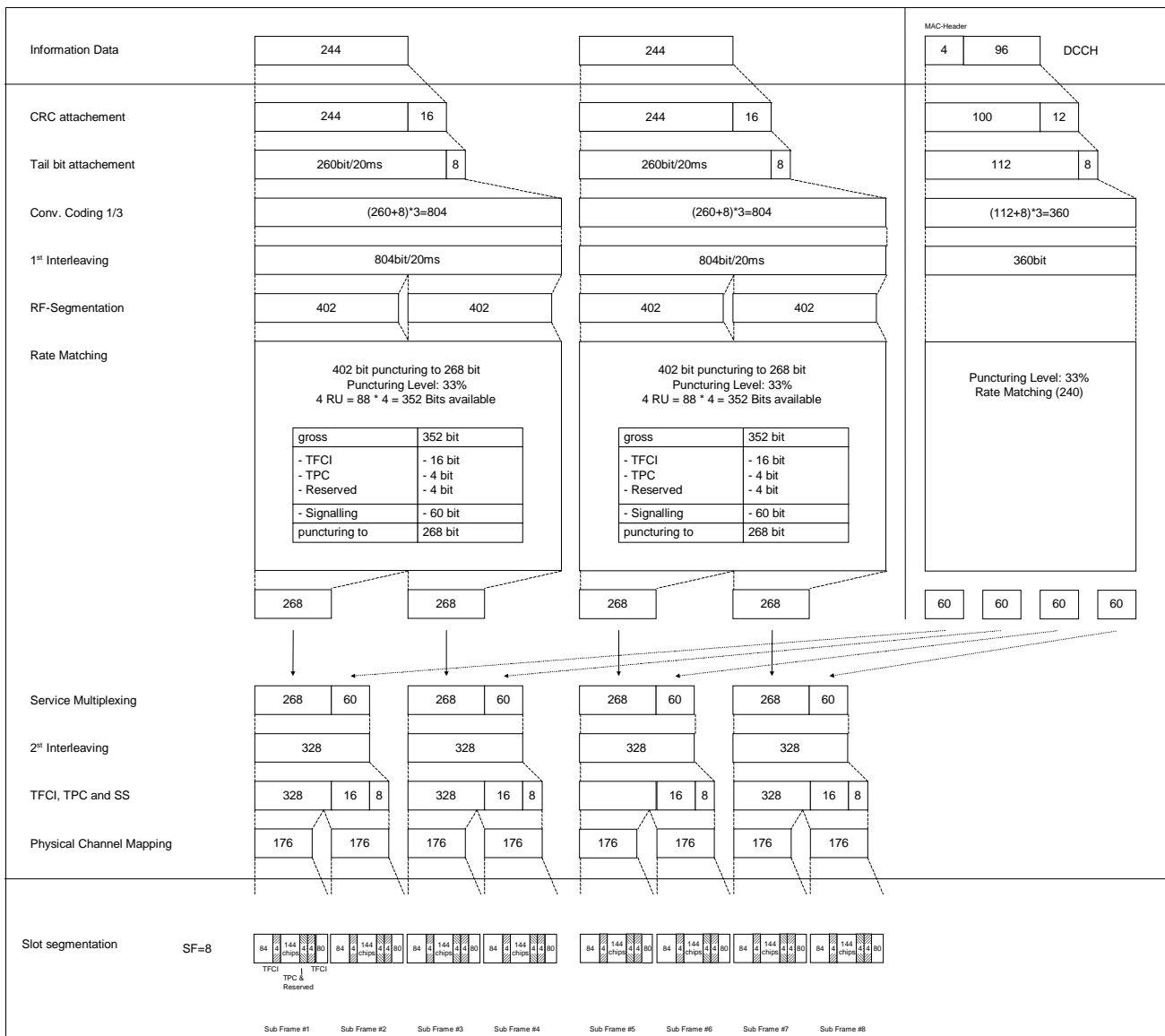

Figure A.1A

### A.2.1.3 7.68 Mcps TDD Option

Table A.1B

Parameter	Value
Information data rate	12.2 kbps
RU's allocated	2 RU
Midamble	1024 chips
Interleaving	20 ms
Power control	2 Bit/user
TFCI	16 Bit/user
Inband signalling DCCH	2 kbps
Puncturing level at Code rate 1/3 : DCH of the DTCH / DCH of the DCCH	10% / 0%

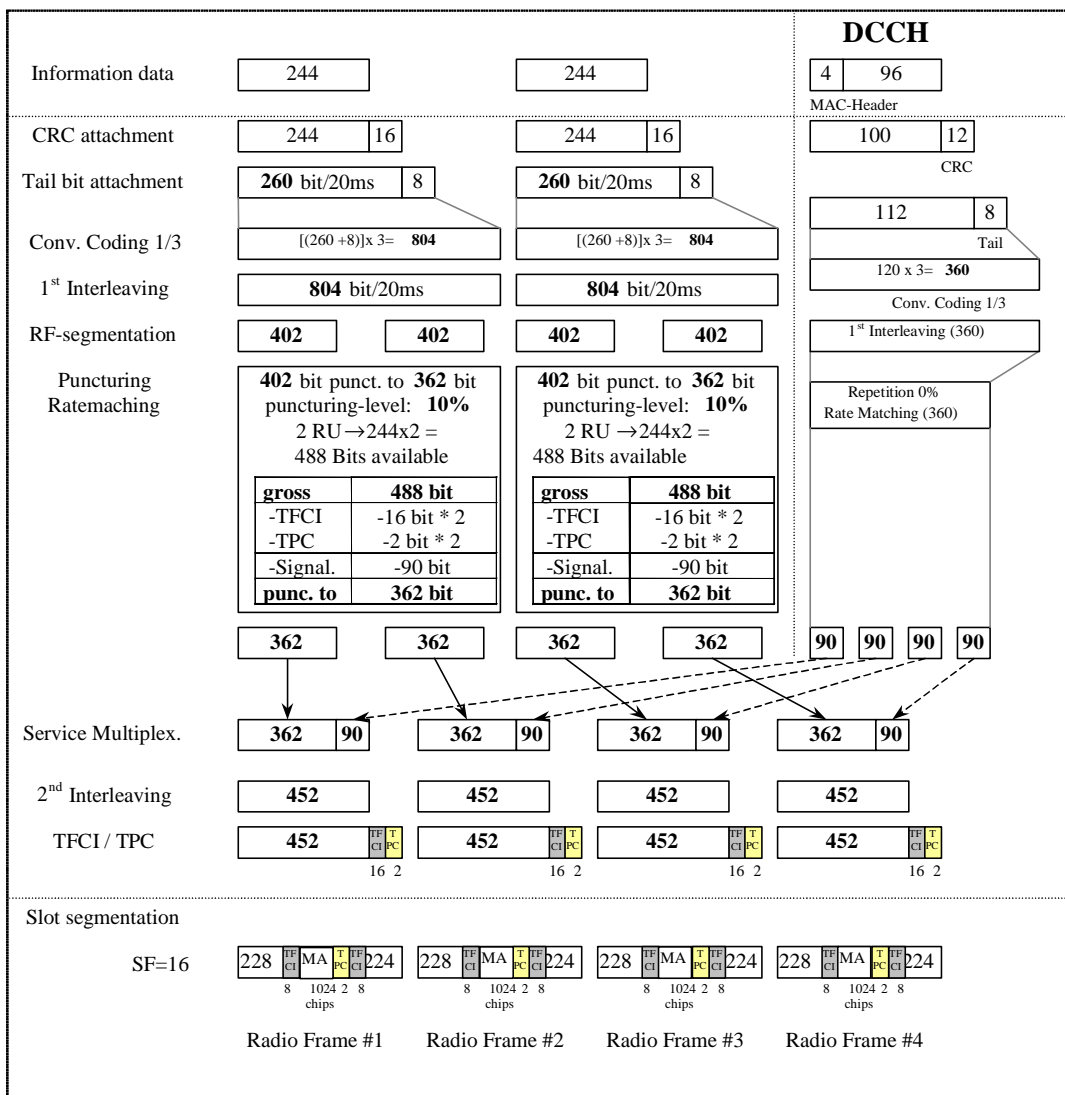

Figure A.1B

## A.2.2 DL reference measurement channel (12.2 kbps)

### A.2.2.1 3.84 Mcps TDD Option

Table A.2

Parameter	Value
Information data rate	12.2 kbps
RU's allocated	2 RU
Midamble	512 chips
Interleaving	20 ms
Power control	0 Bit/user
TFCI	16 Bit/user
Inband signalling DCCH	2 kbps
Puncturing level at Code rate 1/3 : DCH of the DTCH / DCH of the DCCH	5% / 0%

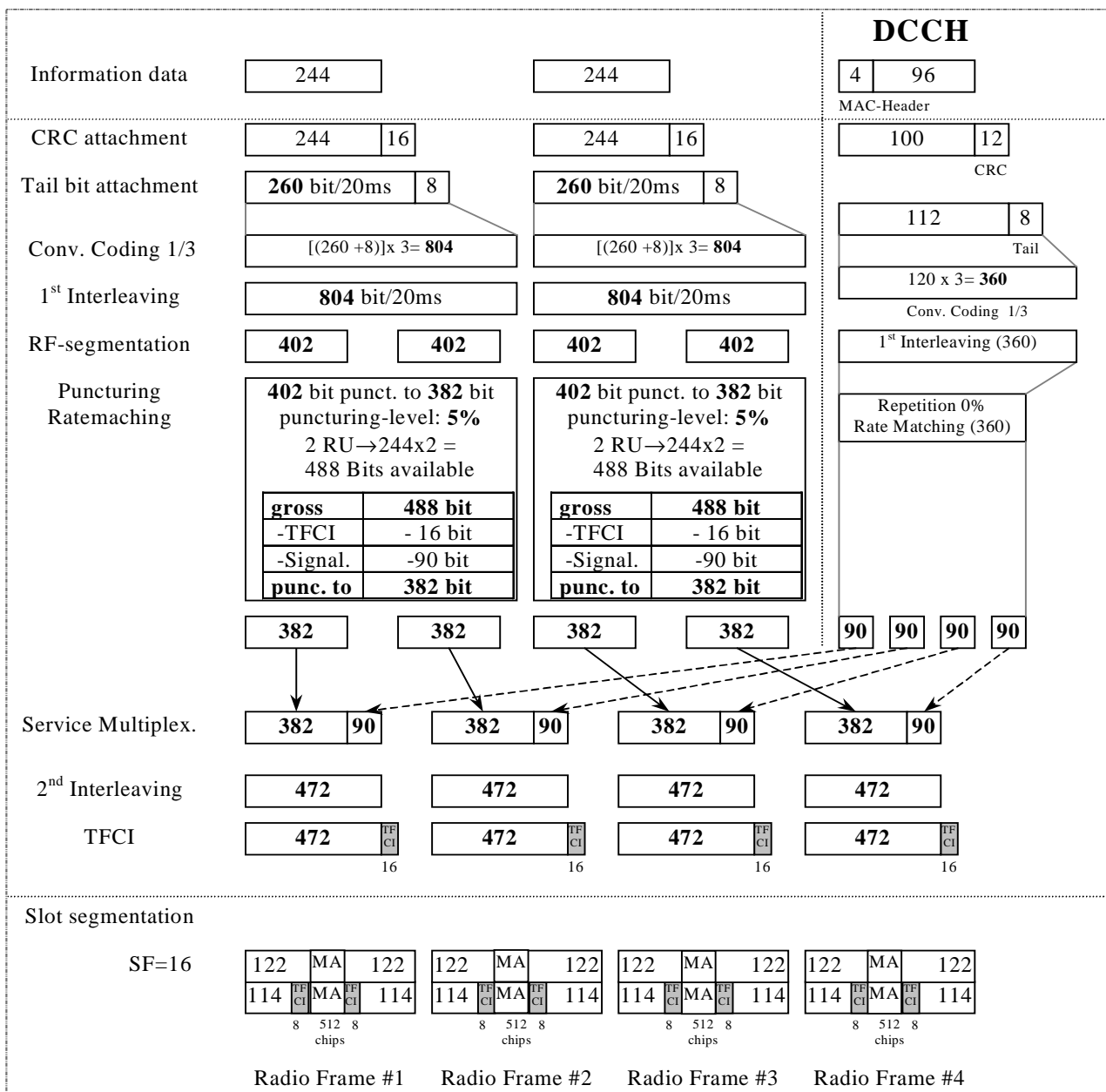

Figure A.2

A.2.2.2 1.28 Mcps TDD Option

Table A.2A

Parameter	Value
Information data rate	12.2 kbps
RU's allocated	1TS (2*SF16) = 2RU/5ms
Midamble	144
Interleaving	20 ms
Power control (TPC)	4 Bit/user/10ms
TFCI	16 Bit/user/10ms
Synchronisation Shift (SS)	4 Bit/user/10ms
Inband signalling DCCH	2.4 kbps
Puncturing level at Code rate 1/3: DCH of the DTCH / DCH of the DCCH	33% / 33%

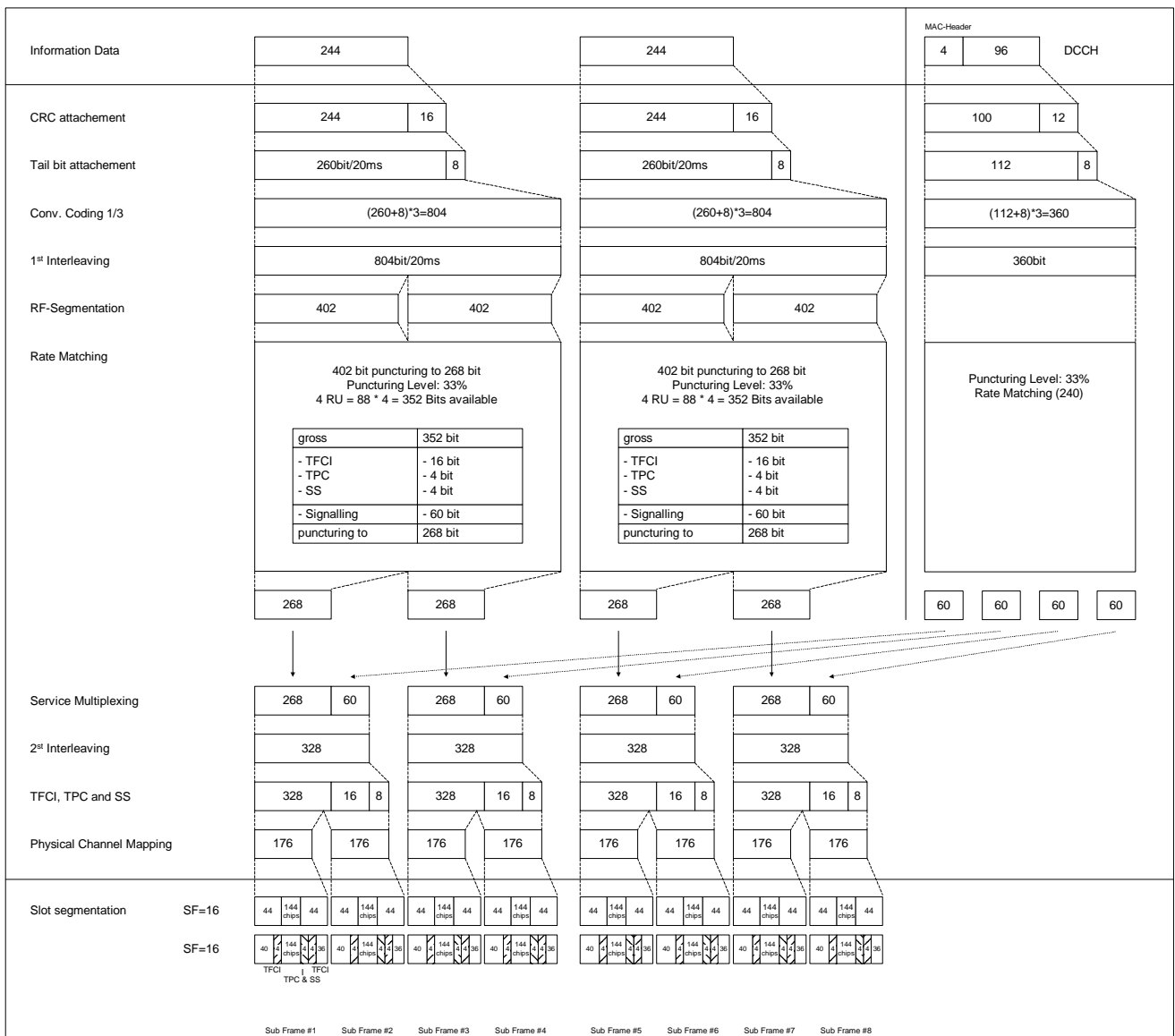

Figure A.2A

### A.2.2.3 7.68 Mcps TDD Option

TableA.2B

Parameter	Value
Information data rate	12.2 kbps
RU's allocated	2 RU
Midamble	1024 chips
Interleaving	20 ms
Power control	0 Bit/user
TFCI	16 Bit/user
Inband signalling DCCH	2 kbps
Puncturing level at Code rate 1/3 : DCH of the DTCH / DCH of the DCCH	5% / 0 %

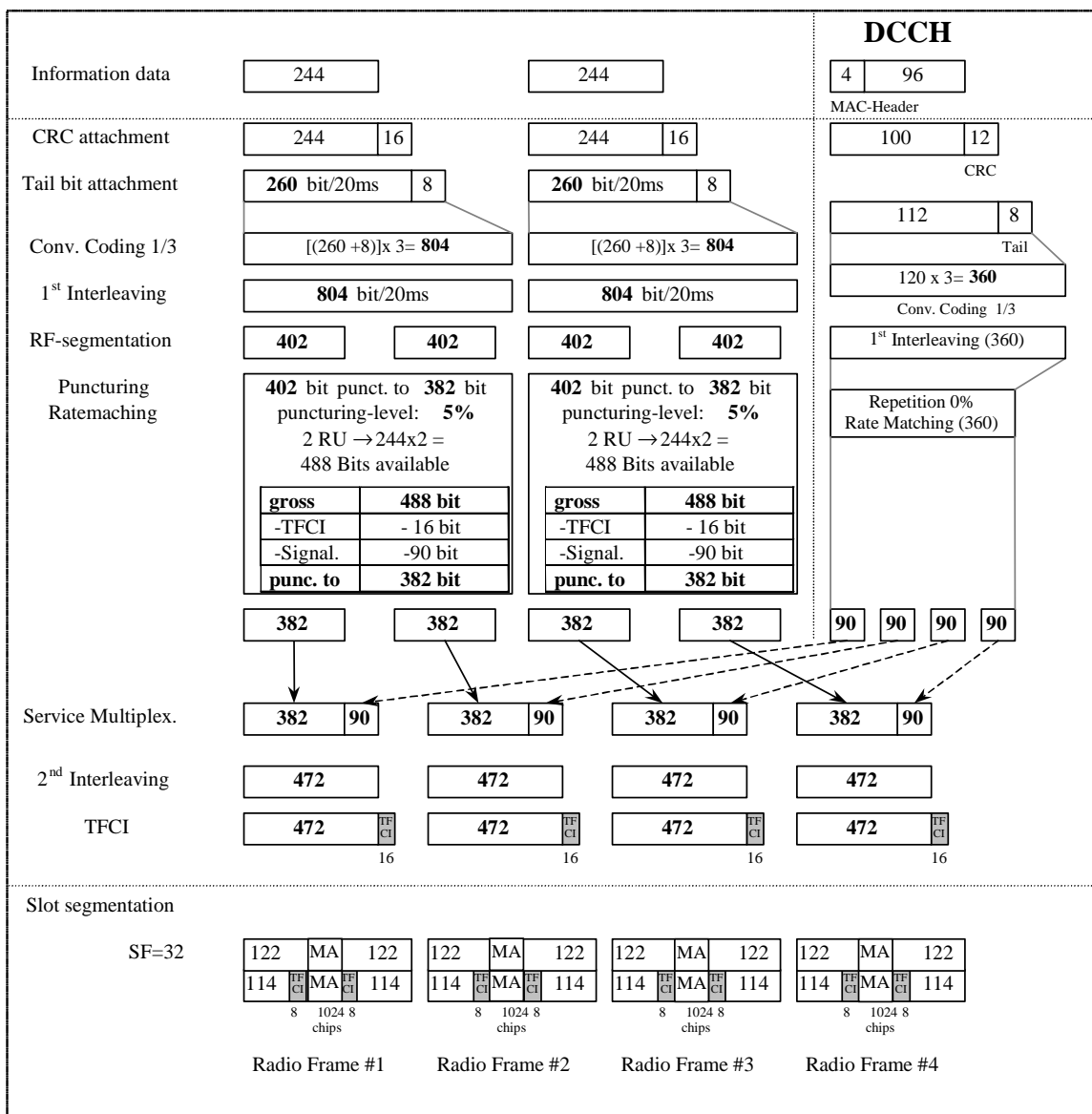

Figure A.2B

## A.2.3 DL reference measurement channel (64 kbps)

### A.2.3.1 3.84 Mcps TDD Option

Table A.3

Parameter	Value
Information data rate	64 kbps
RU's allocated	5 codes SF16 = 5RU
Midamble	512 chips
Interleaving	20 ms
Power control	0 Bit/user
TFCI	16 Bit/user
Inband signalling DCCH	2 kbps
Puncturing level at Code rate : 1/3 DCH of the DTCH / 1/2 DCH of the DCCH	41.1% / 10%

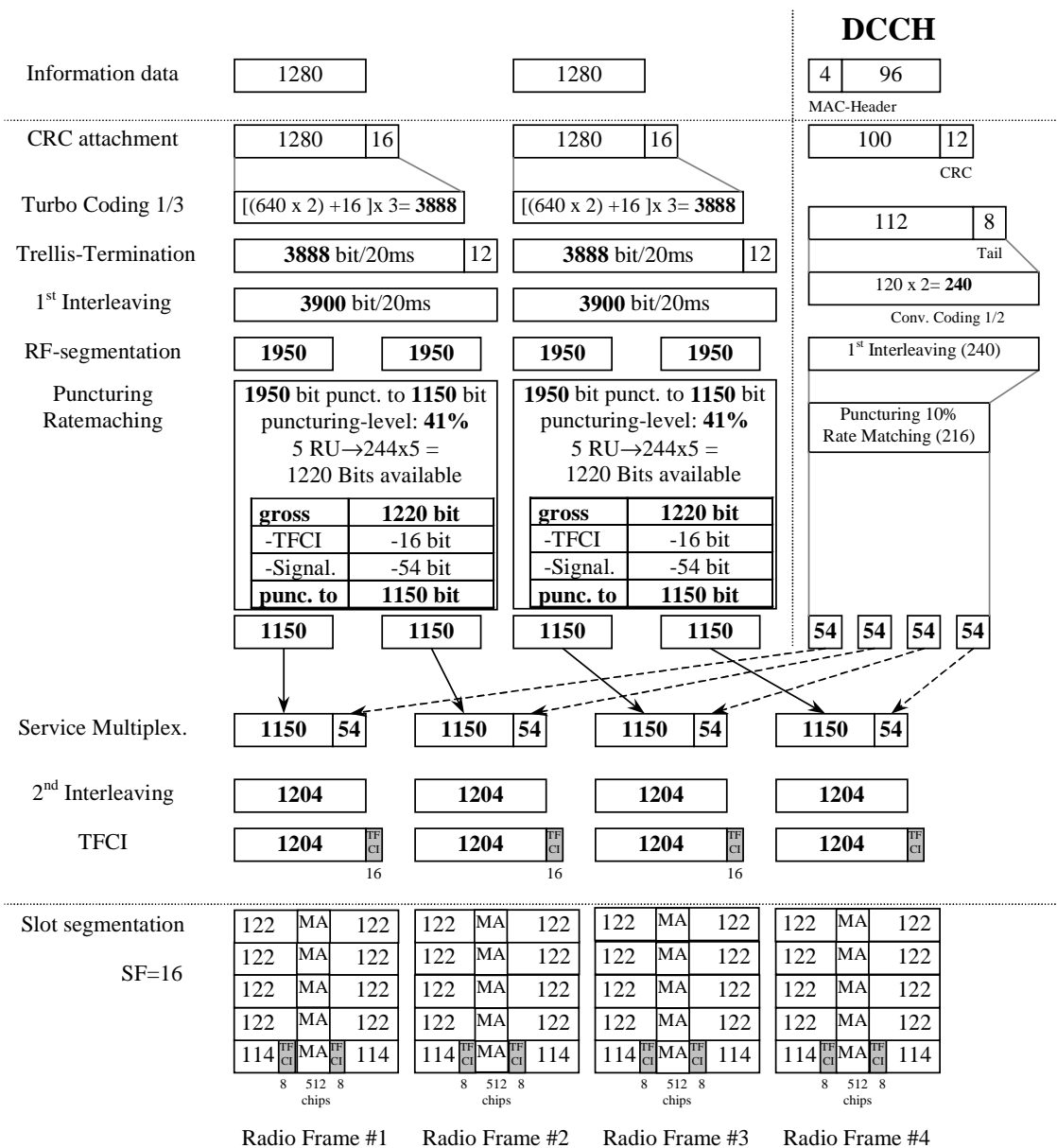

Figure A.3

A.2.3.2 1.28 Mcps TDD Option

Table A.3A

Parameter	Value
Information data rate	64 kbps
RU"s allocated	1TS (8*SF16) = 8RU/5ms
Midamble	144
Interleaving	20 ms
Power control (TPC)	4 Bit/user/10ms
TFCI	16 Bit/user/10ms
Synchronisation Shift (SS)	4 Bit/user/10ms
Inband signalling DCCH	2.4 kbps
Puncturing level at Code rate: 1/3 DCH of the DTCH / 1/2 DCH of the DCCH	32% / 0

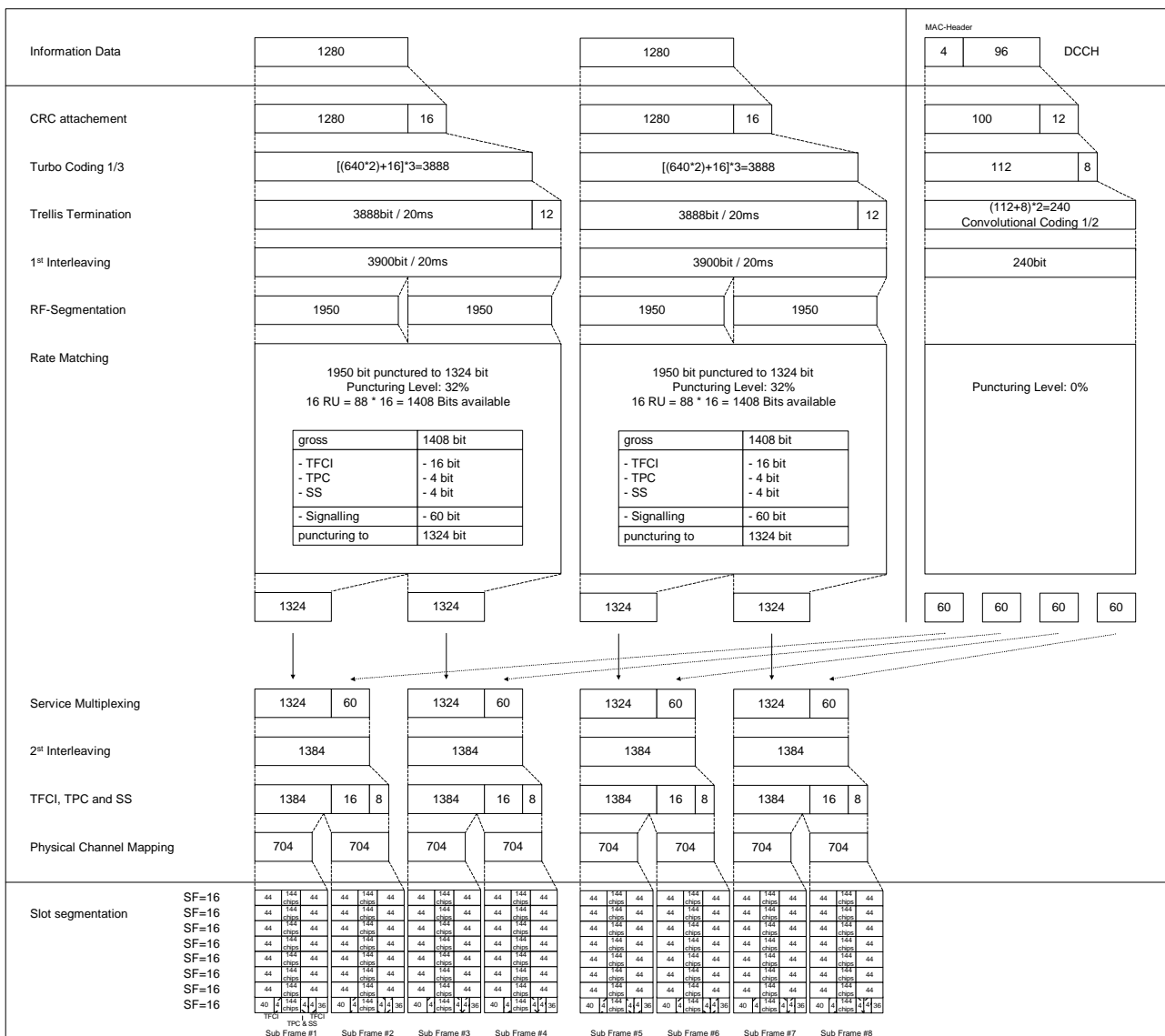

Figure A.3A



### A.2.3.3 7.68 Mcps TDD Option

Table A.3B

Parameter	Value
Information data rate	64 kbps
RU's allocated	5 codes SF32 = 5RU
Midamble	1024 chips
Interleaving	20 ms
Power control	0 Bit/user
TFCI	16 Bit/user
Inband signalling DCCH	2 kbps
Puncturing level at Code rate : 1/3 DCH of the DTCH / 1/2 DCH of the DCCH	41.1% / 10%

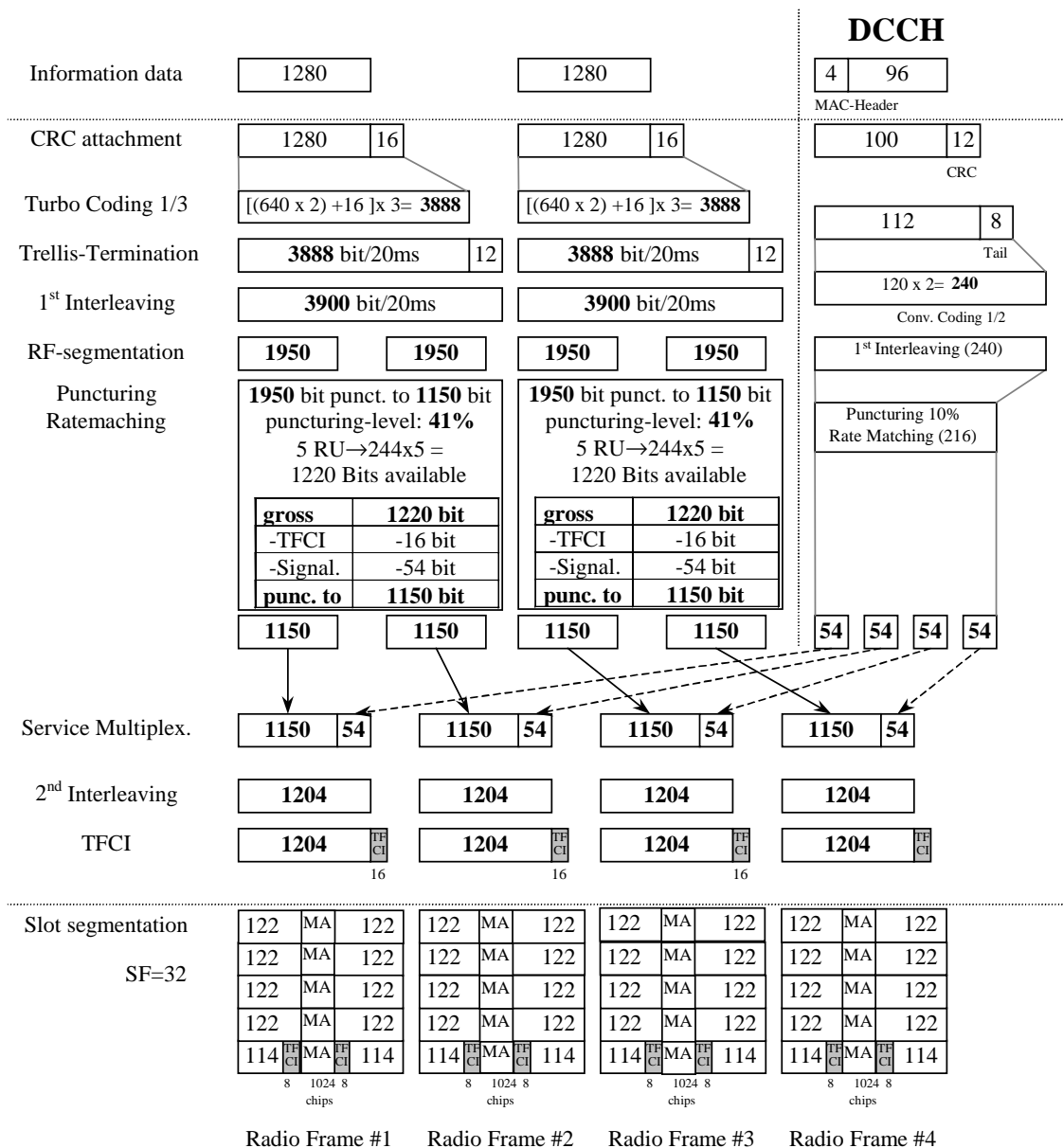

Figure A.3B

## A.2.4 DL reference measurement channel (144 kbps)

### A.2.4.1 3.84 Mcps TDD Option

Table A.4

Parameter	Value
Information data rate	144 kbps
RU's allocated	9 codes SF16 = 9RU
Midamble	256 chips
Interleaving	20 ms
Power control	0 Bit/user
TFCI	16 Bit/user
Inband signalling DCCH	2 kbps
Puncturing level at Code rate: 1/3 DCH of the DTCH / 1/2 DCH of the DCCH	44.5% / 16.6%

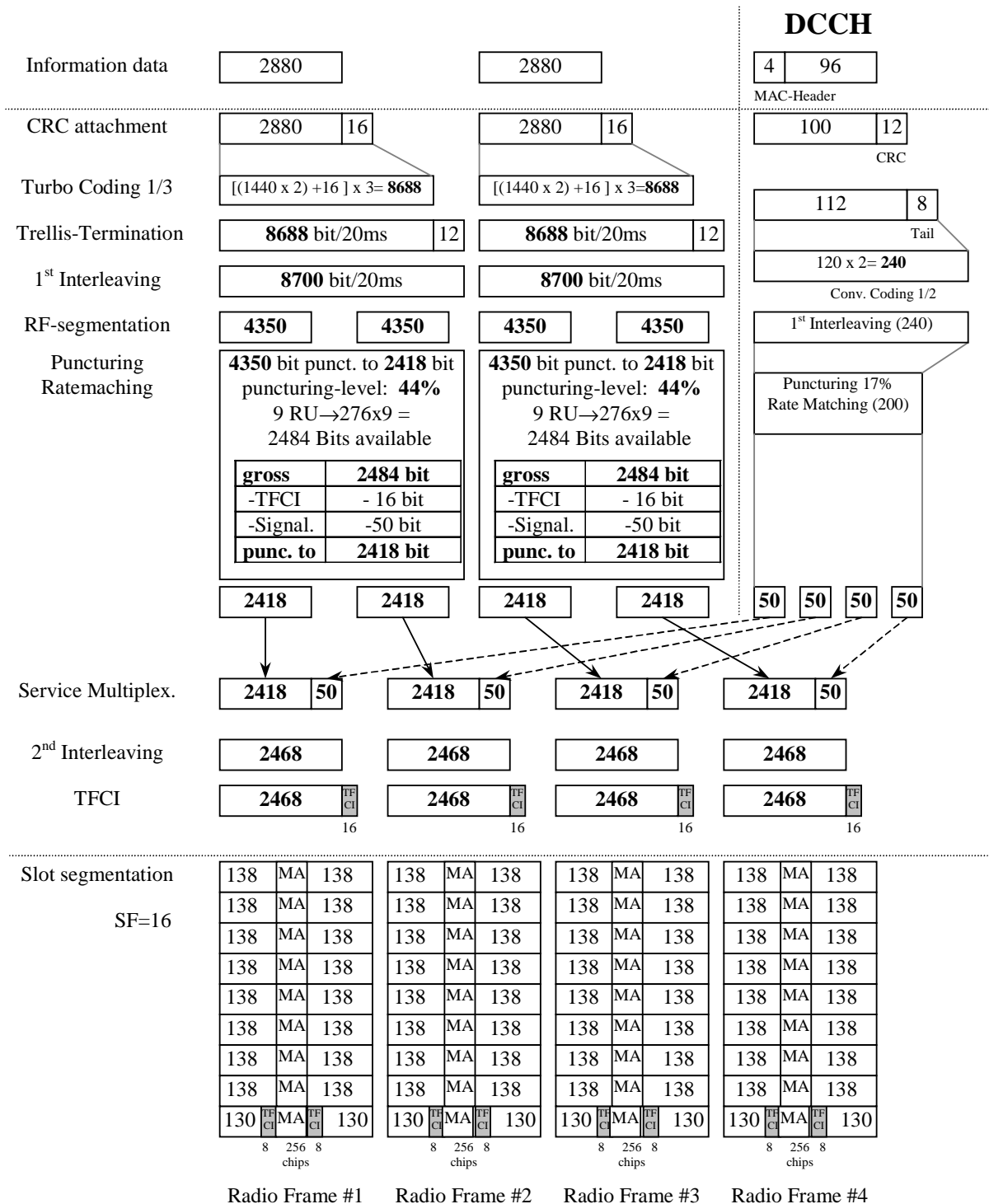

Figure A.4

### A.2.4.2 1.28 Mcps TDD Option

Table A.4A

Parameter	Value
Information data rate	144 kbps
RU's allocated	2TS (8*SF16) = 16RU/5ms
Midamble	144
Interleaving	20 ms
Power control (TPC)	8 Bit/user/10ms
TFCI	32 Bit/user/10ms
Synchronisation Shift (SS)	8 Bit/user/10ms
Inband signalling DCCH	2.4 kbps
Puncturing level at Code rate: 1/3 DCH of the DTCH / 1/2 DCH of the DCCH	38% / 7%

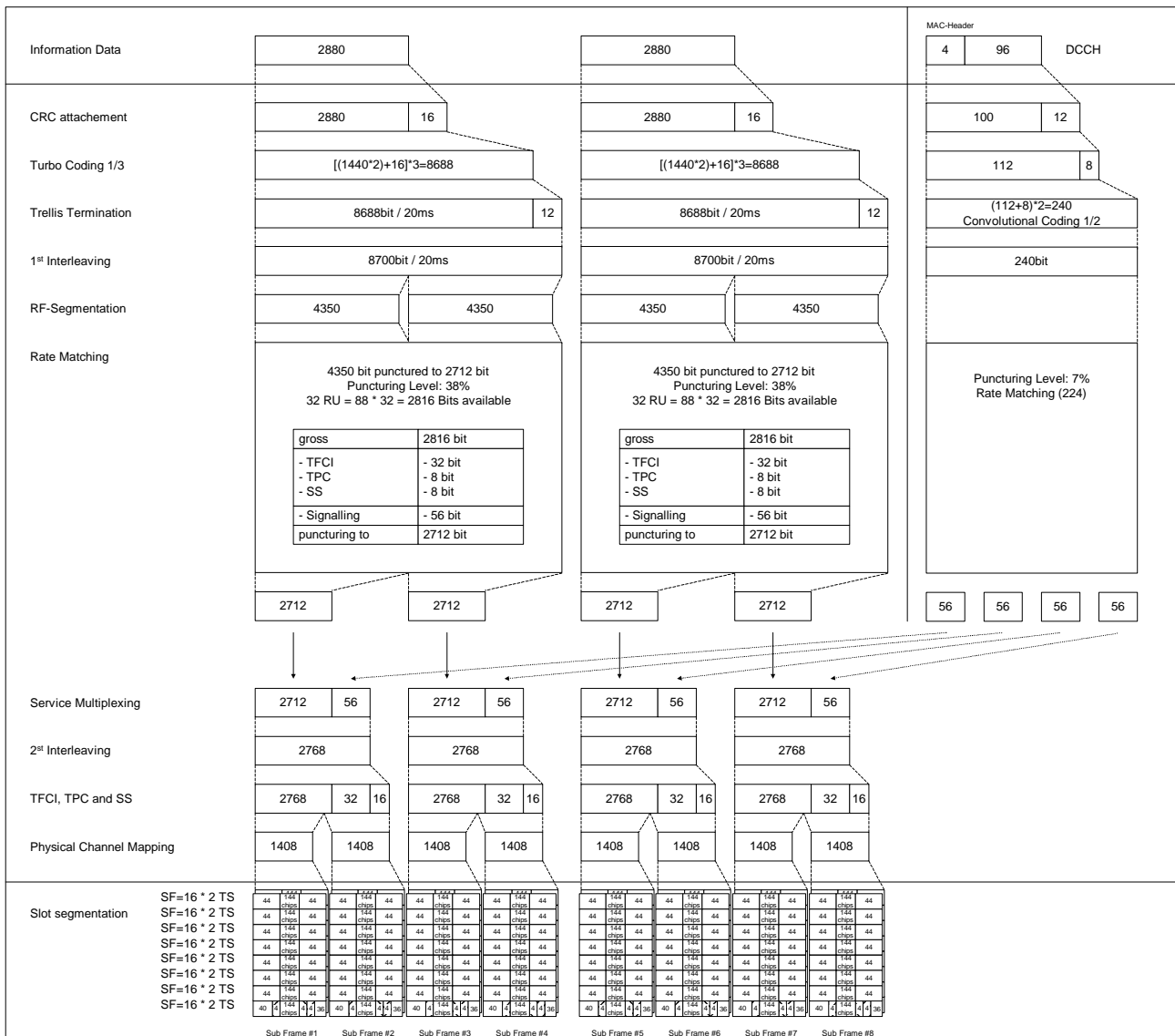

Figure A.4A

## A.2.4.3 7.68 Mcps TDD Option

Table A.4B

Parameter	Value
Information data rate	144 kbps
RU's allocated	9 codes SF32 = 9RU
Midamble	512 chips
Interleaving	20 ms
Power control	0 Bit/user
TFCI	16 Bit/user
Inband signalling DCCH	2 kbps
Puncturing level at Code rate: 1/3 DCH of the DTCH / 1/2 DCH of the DCCH	44.5% / 16.6%

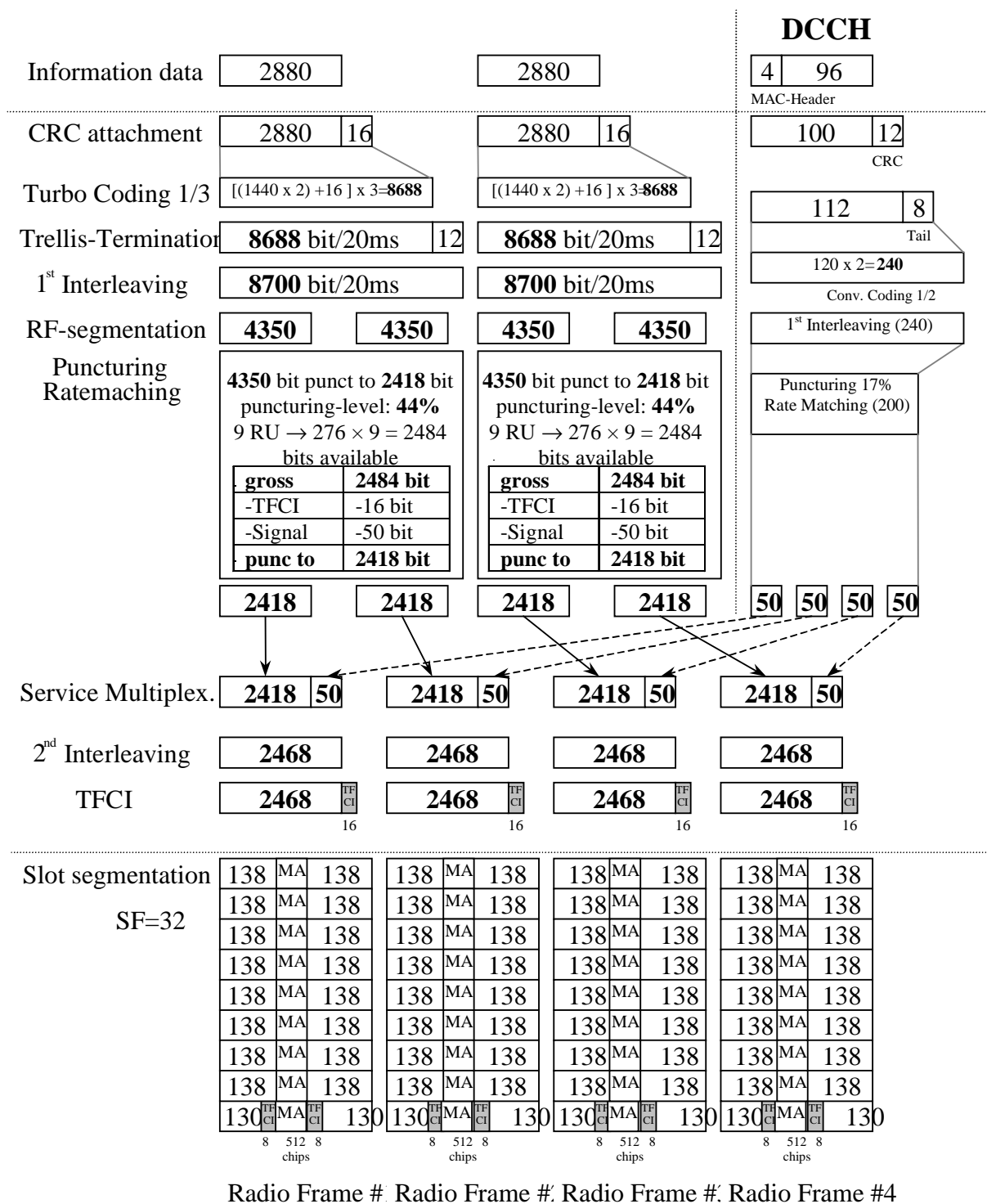

Figure A.4B

## A.2.5 DL reference measurement channel (384 kbps)

### A.2.5.1 3.84 Mcps TDD Option

Table A.5

Parameter	Value
Information data rate	384 kbps
RU's allocated	8*3TS = 24RU
Midamble	256 chips
Interleaving	20 ms
Power control	0 Bit/user
TFCI	16 Bit/user
Inband signalling DCCH	2 kbps
Puncturing level at Code rate : 1/3 DCH of the DTCH / 1/2 DCH of the DCCH	43.4% / 15.3%

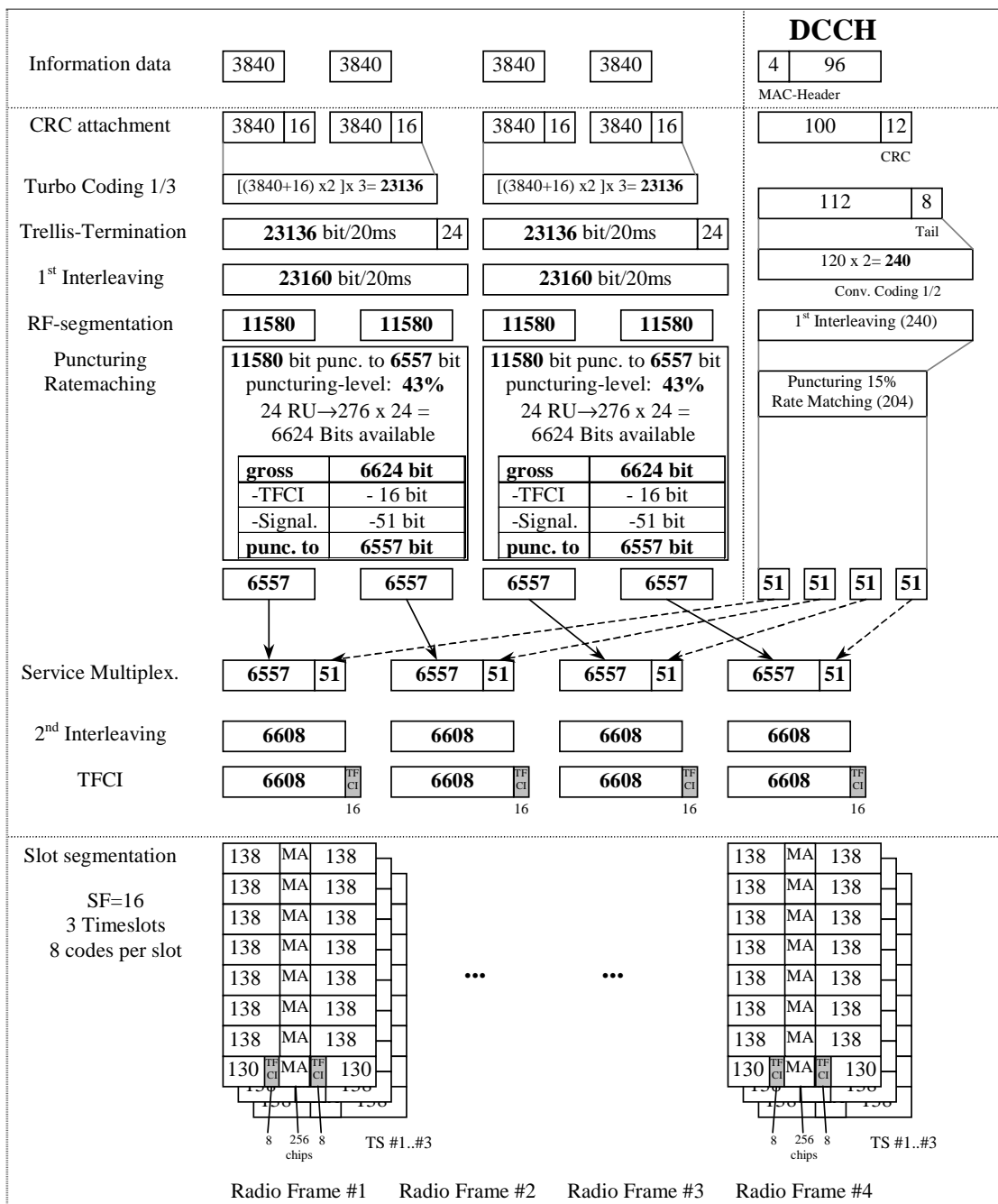

Figure A.5



A.2.5.2 1.28 Mcps TDD Option

Table A.5A

Parameter	Value
Information data rate	384 kbps
RU's allocated	4TS (9*SF16) = 36RU/5ms
Midamble	144
Interleaving	20 ms
Power control (TPC)	16 Bit/user/10ms
TFCI	64 Bit/user/10ms
Synchronisation Shift (SS)	16 Bit/user/10ms
Inband signalling DCCH	2.4 kbps
Puncturing level at Code rate: 1/3 DCH of the DTCH / 1/2 DCH of the DCCH	47% / 12%

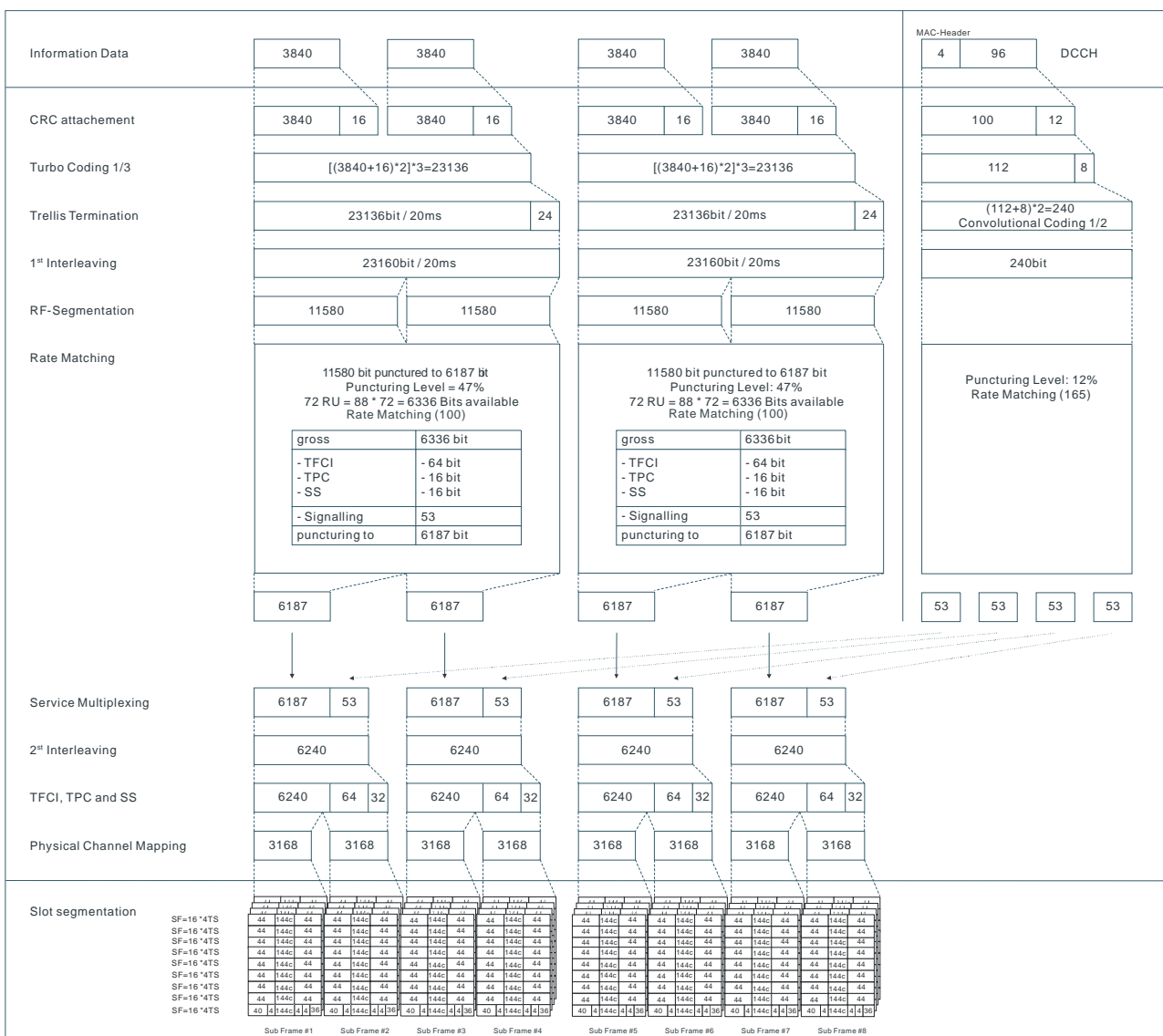

Figure A.5A

### A.2.5.3 7.68 Mcps TDD Option

Table A.5B

Parameter	Value
Information data rate	384 kbps
RU's allocated	8*3TS = 24RU
Midamble	512 chips
Interleaving	20 ms
Power control	0 Bit/user
TFCI	16 Bit/user
Inband signalling DCCH	2 kbps
Puncturing level at Code rate : 1/3 DCH of the DTCH / 1/2 DCH of the DCCH	43.4% / 15.3%

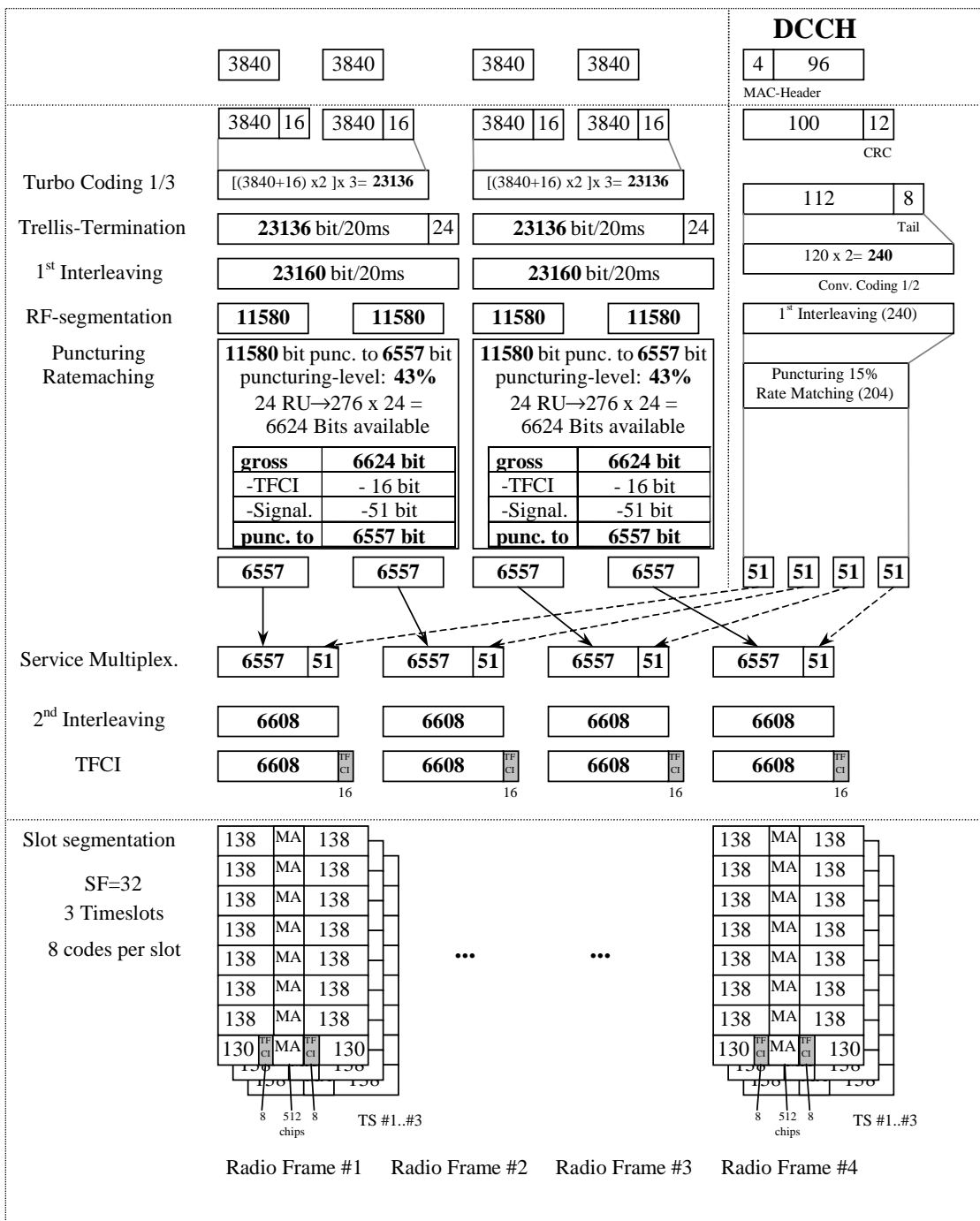

Figure A.5B

## A.2.6 BCH reference measurement channel

[mapped to 1 code SF16]

### A.2.6.1 3.84 Mcps TDD Option

Table A.6

Parameter	Value
Information data rate:	12.3 kbps
RU's allocated	1 RU
Midamble	512 chips
Interleaving	20 ms
Power control	0 bit
TFCI	0 bit
Puncturing level	10%

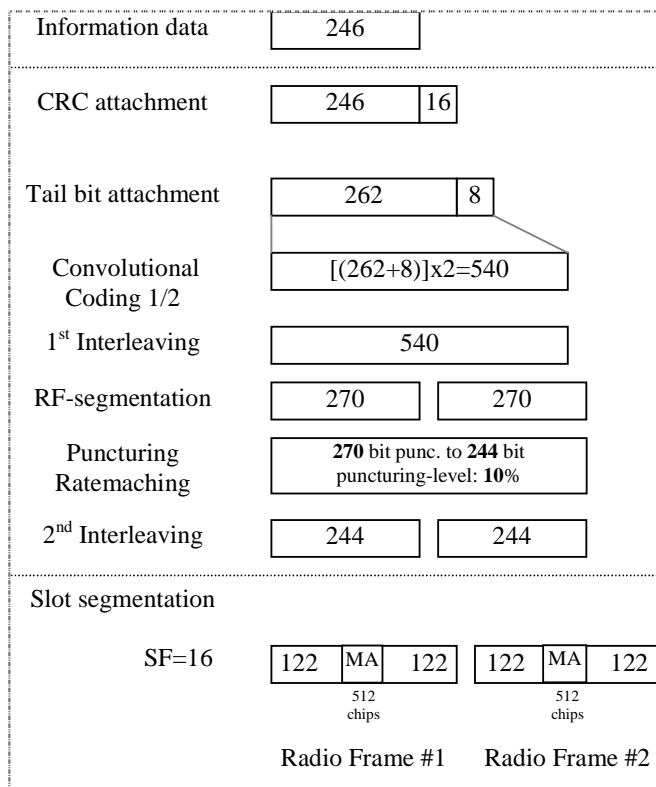
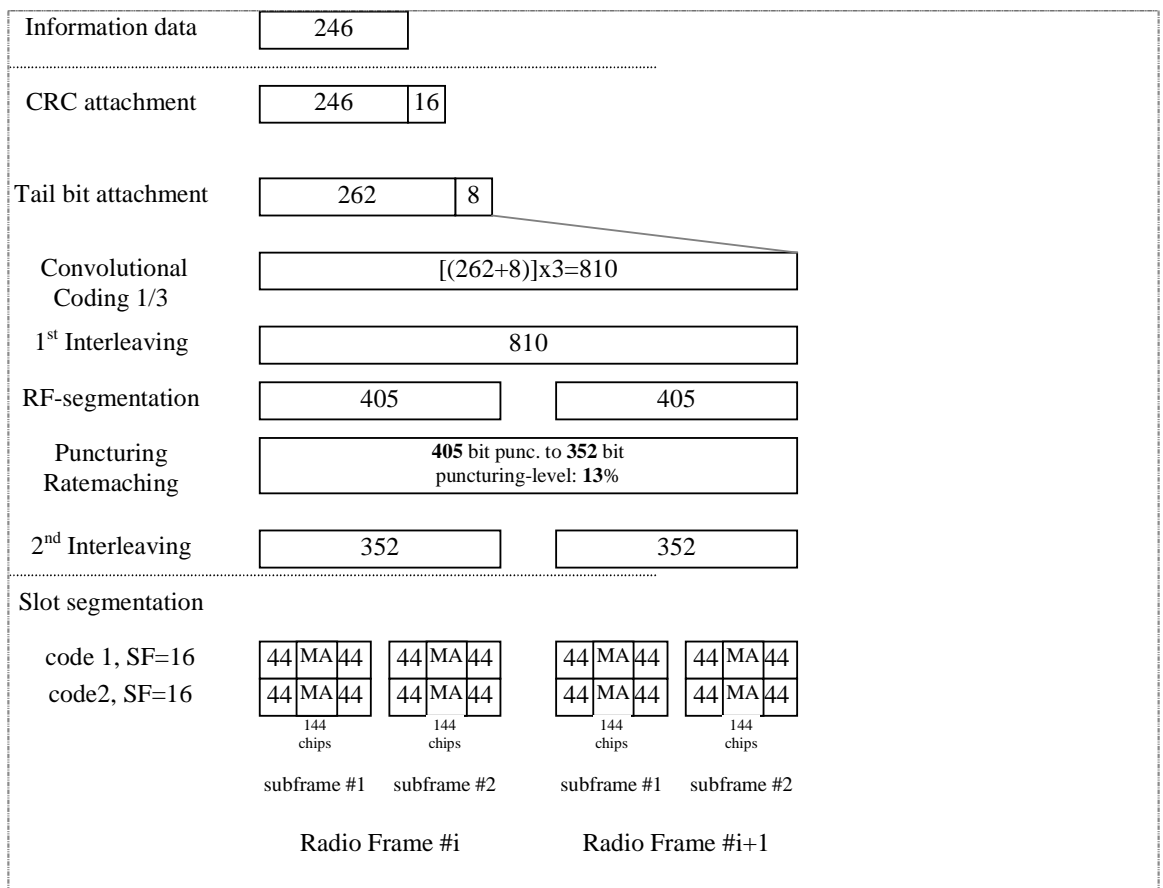

Figure A.6

### A.2.6.2 1.28 Mcps TDD Option

**Table A.6A**

Parameter	Value
Information data rate:	12.3 kbps
RU's allocated	2 RU
Midamble	144 chips
Interleaving	20 ms
Power control	0 bit
TFCI	0 bit
Puncturing level	13%



**Figure A.6A**

### A.2.6.3 7.68 Mcps TDD Option

**Table A.6**

Parameter	Value
Information data rate:	12.3 kbps
RU's allocated	1 RU
Midamble	1024 chips
Interleaving	20 ms
Power control	0 bit
TFCI	0 bit
Puncturing level	10%

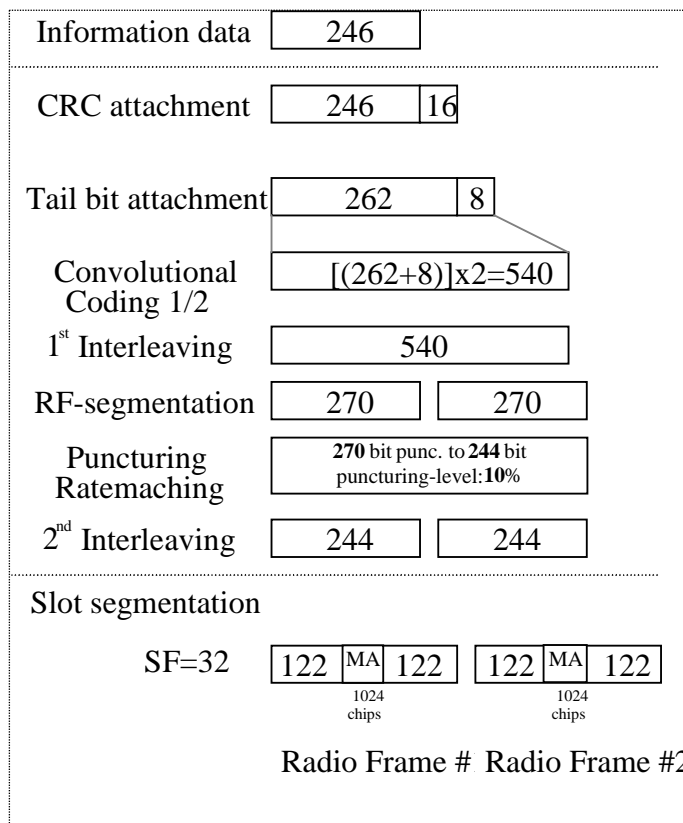

Figure A.6B

## A.2.7 UL multi code reference measurement channel (12.2 kbps)

### A.2.7.1 3.84 Mcps TDD Option

Table A.7

Parameter	Value
Information data rate	12.2 kbps
RU's allocated	2 RU
Midamble	512 chips
Interleaving	20 ms
Power control	2 Bit/user
TFCI	16 Bit/user
Inband signalling DCCH	2 kbps
Puncturing level at Code rate 1/3 : DCH of the DTCH / DCH of the DCCH	5% / 0 %

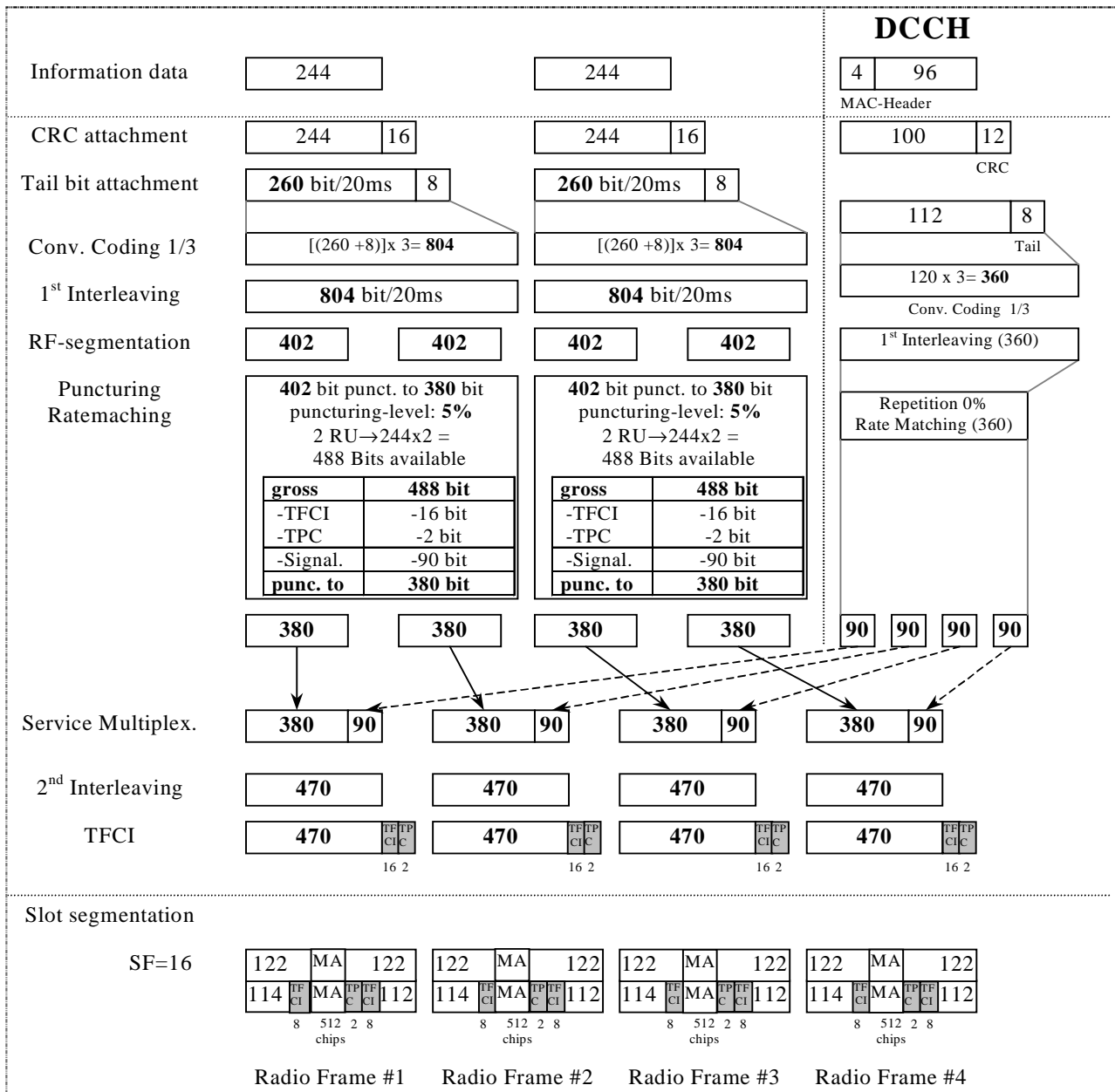

Figure A.7

A.2.7.2 1.28 Mcps TDD Option

Table A.7A

Parameter	Value
Information data rate	12.2 kbps
RU's allocated	1TS (2*SF16) = 2RU/5ms
Midamble	144
Interleaving	20 ms
Power control (TPC)	4 Bit/user/10ms
TFCI	16 Bit/user/10ms
4 Bit reserved for future use (place of SS)	4 Bit/user/10ms
Inband signalling DCCH	2.4 kbps
Puncturing level at Code rate 1/3: DCH of the DTCH / DCH of the DCCH	33% / 33%

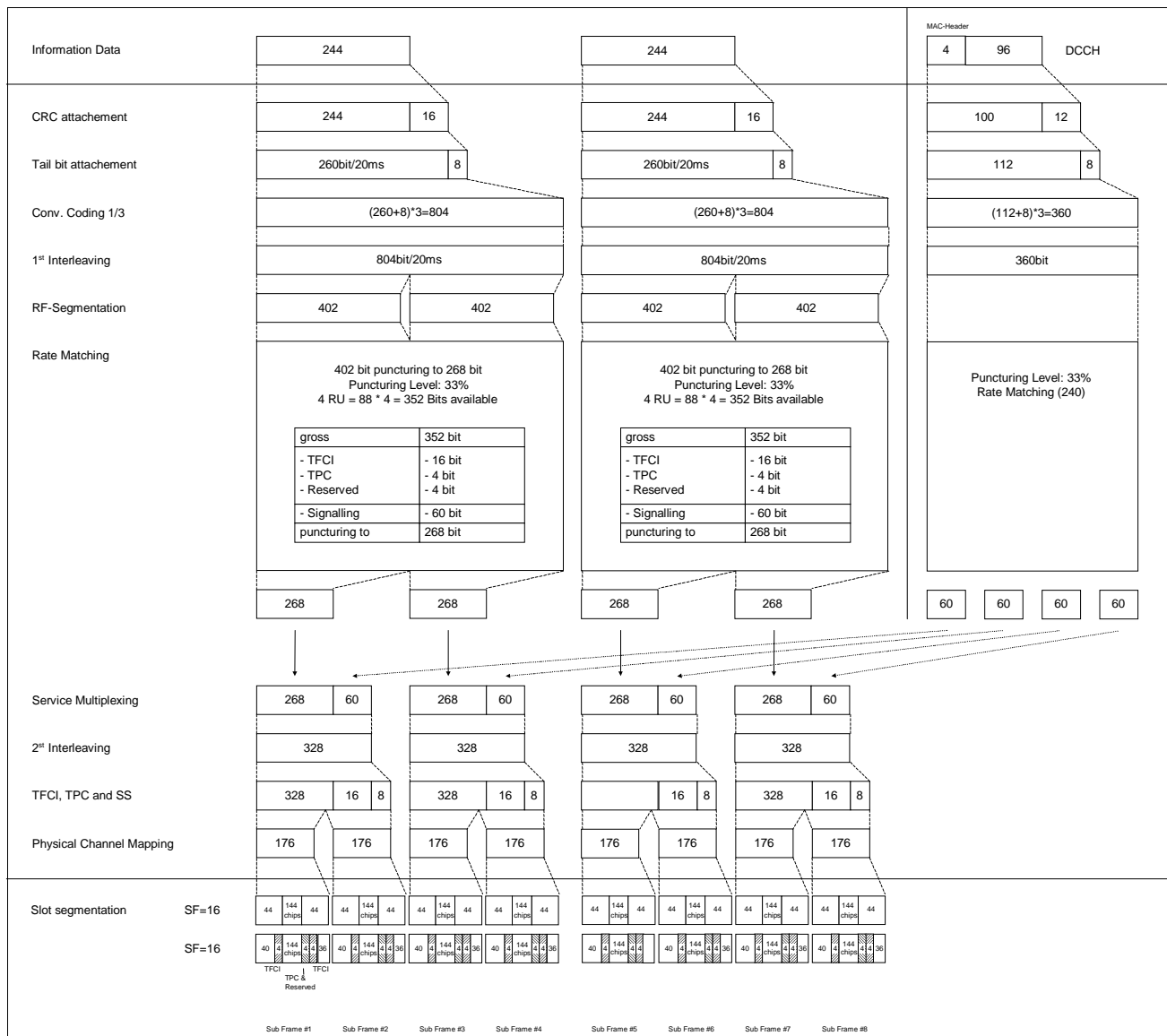

Figure A.7A

A.2.7.3 7.68 Mcps TDD Option

Table A.7B

Parameter	Value
Information data rate	12.2 kbps
RU's allocated	2 RU
Midamble	1024 chips
Interleaving	20 ms
Power control	2 Bit/user
TFCI	16 Bit/user
Inband signalling DCCH	2 kbps
Puncturing level at Code rate 1/3 : DCH of the DTCH / DCH of the DCCH	5% / 0 %

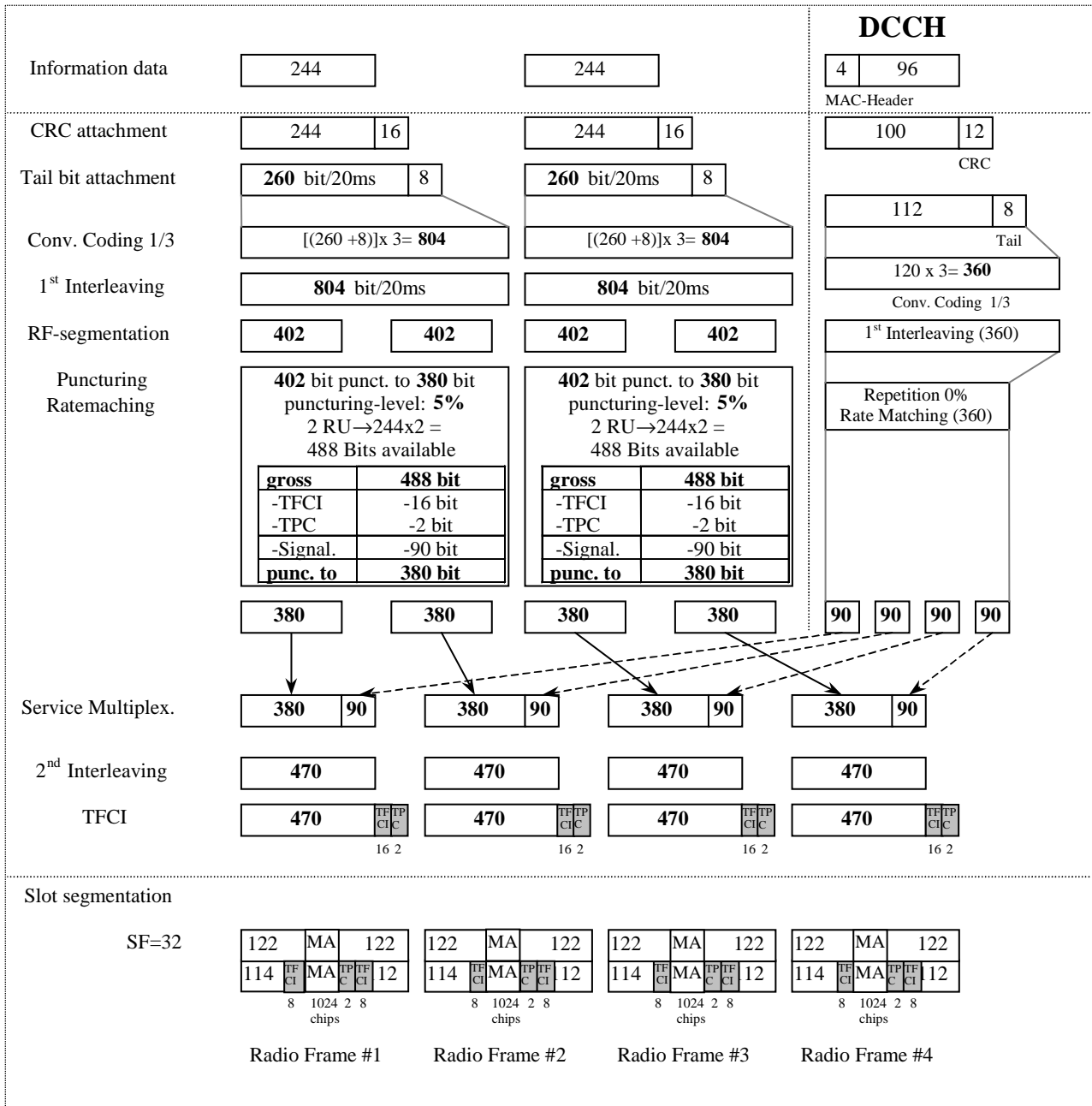

Figure A.7B



## A.2.8 DL reference measurement channel (2 Mbps)

### A.2.8.1 3.84 Mcps TDD Option

Table A.8

Parameter	Value
Information data rate	2048 kbps
RU's allocated	16*12TS = 192RU
Midamble	256 chips
Interleaving	10 ms
Power control	0 Bit/user
TFCI	16 Bit/user
Inband signalling DCCH	2 kbps
Puncturing level at Code rate 1/3 : DCH of the DTCH / DCH of the DCCH	13.9% / 0%

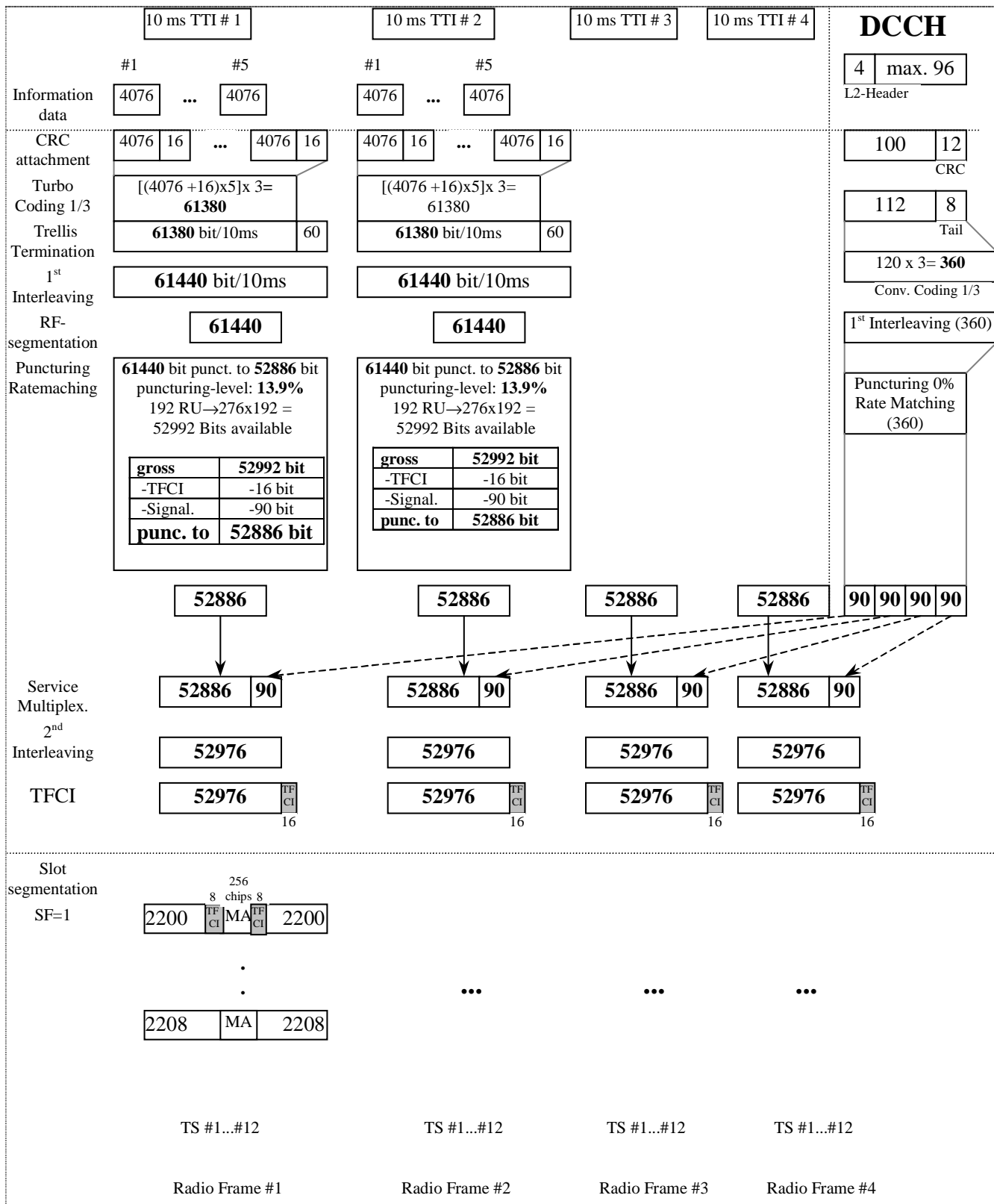

Figure A.8

### A.2.8.2 1.28 Mcps TDD Option

Table A.8A

Parameter	Value
Information data rate	2048 kbps
RU's allocated	5TS (1*SF1) = 80RU/5ms
Midamble	144
Interleaving	10 ms
Power control (TPC)	6 Bit/user/10ms
TFCI	48 Bit/user/10ms
Synchronisation Shift (SS)	6 Bit/user/10ms
Inband signalling DCCH	no
Coding	no
Modulation	8PSK

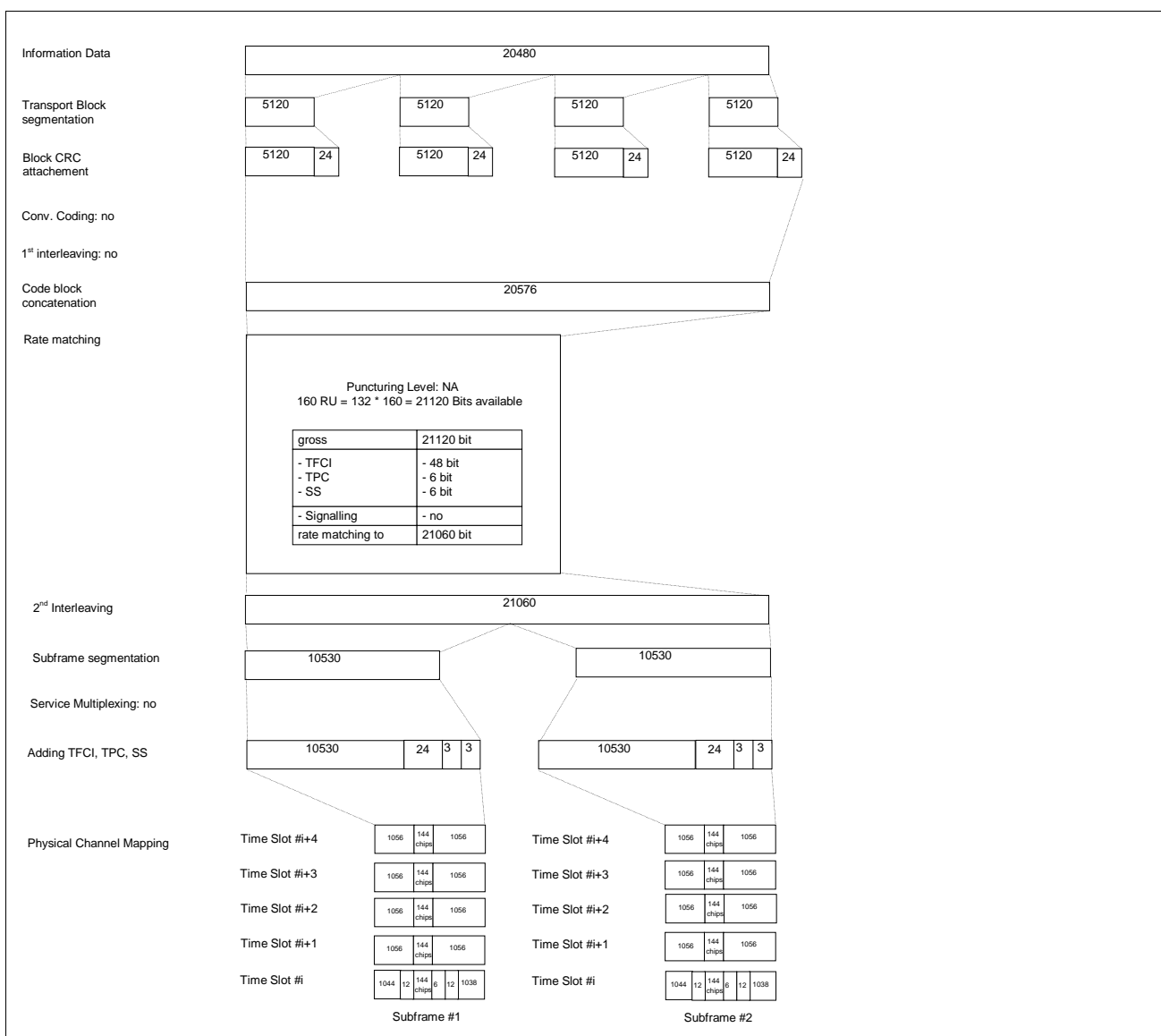

Figure A.8A

## A.2.8.3 7.68 Mcps TDD Option

Table A.8B

Parameter	Value
Information data rate	2048 kbps
RU's allocated	$16 \times 12 \text{TS} = 192 \text{RU}$
Midamble	512 chips
Interleaving	10 ms
Power control	0 Bit/user
TFCI	16 Bit/user
Inband signalling DCCH	2 kbps
Puncturing level at Code rate 1/3 : DCH of the DTCH / DCH of the DCCH	13.9% / 0%

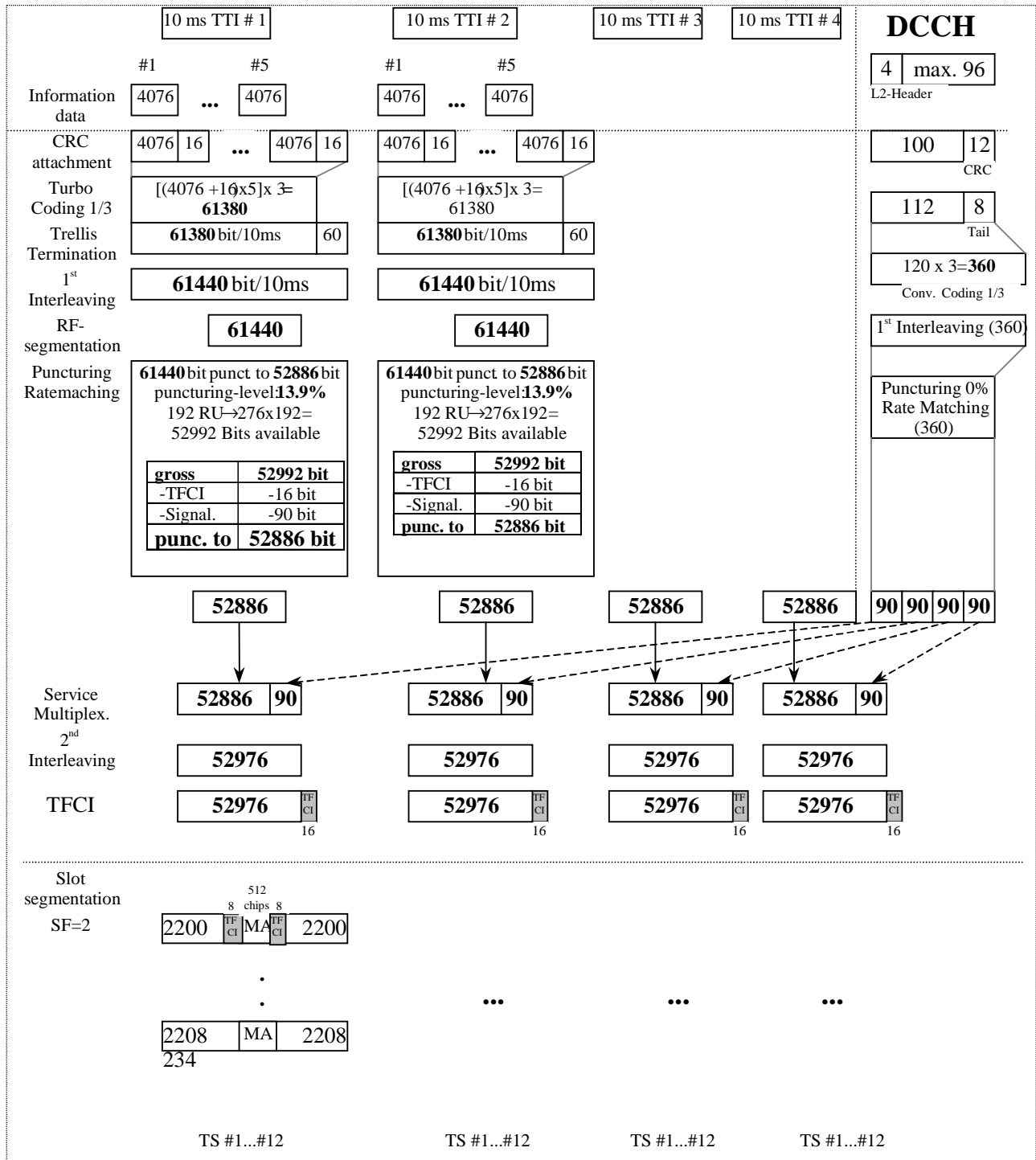

Figure A.8B

## A.2.9 DL reference measurement channel (12.2 kbps) for MBSFN only UEs

### A.2.9.1 3.84 Mcps TDD Option

**TableA.8C**

Parameter	Value
Information data rate	12.2 kbps
RU's allocated	2 RU
Midamble	320 chips
Interleaving	20 ms
Power control	0 Bit/user
TFCI	16 Bit/user
Repetition level at code rate 1/3: FACH of the MTCH	29%

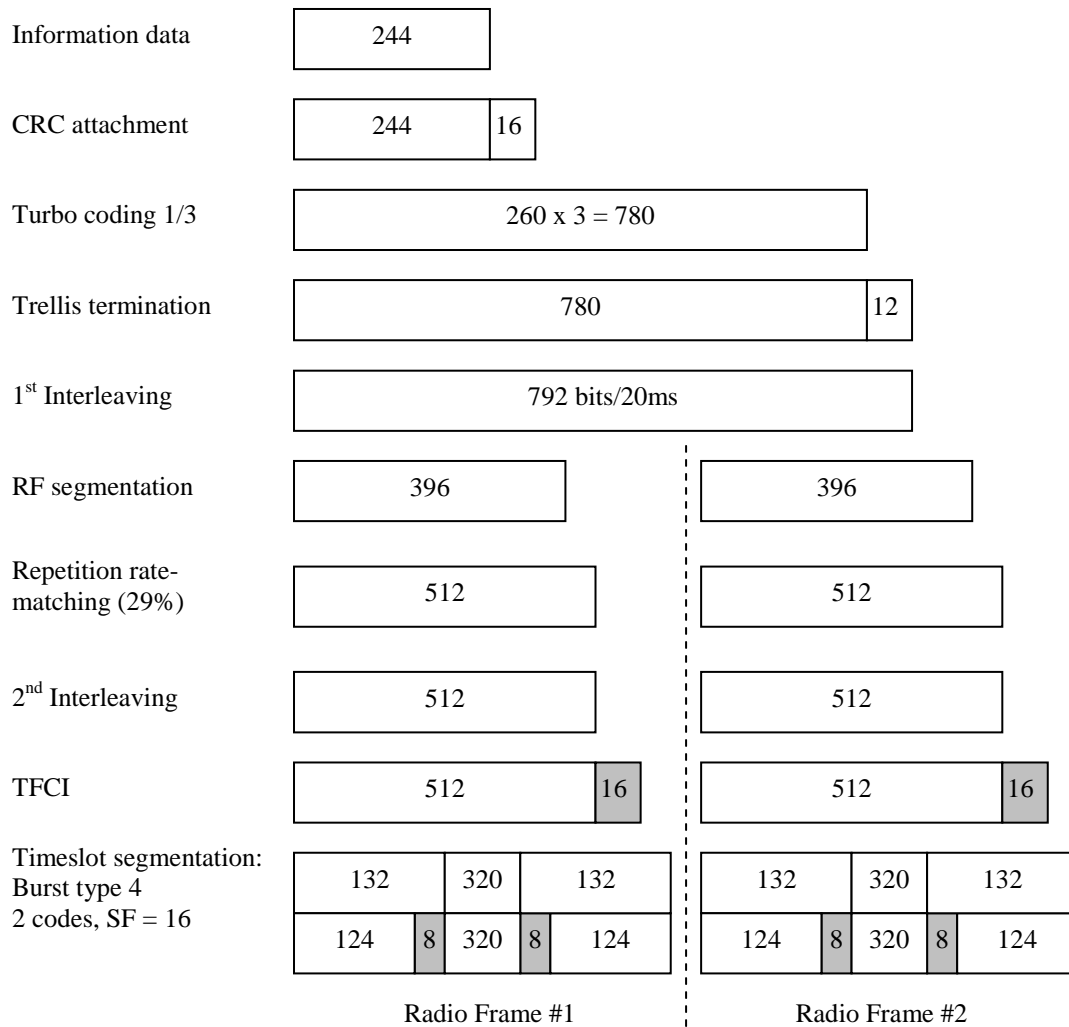

Figure A.8C

A.2.9.2 VOID

A.2.9.3 7.68 Mcps TDD Option

TableA.8D

Parameter	Value
Information data rate	12.2 kbps
RU's allocated	2 RU
Midamble	640 chips
Interleaving	20 ms
Power control	0 Bit/user
TFCI	16 Bit/user

Repetition level at code rate 1/3: FACH of the MTCH	29%
-----------------------------------------------------	-----

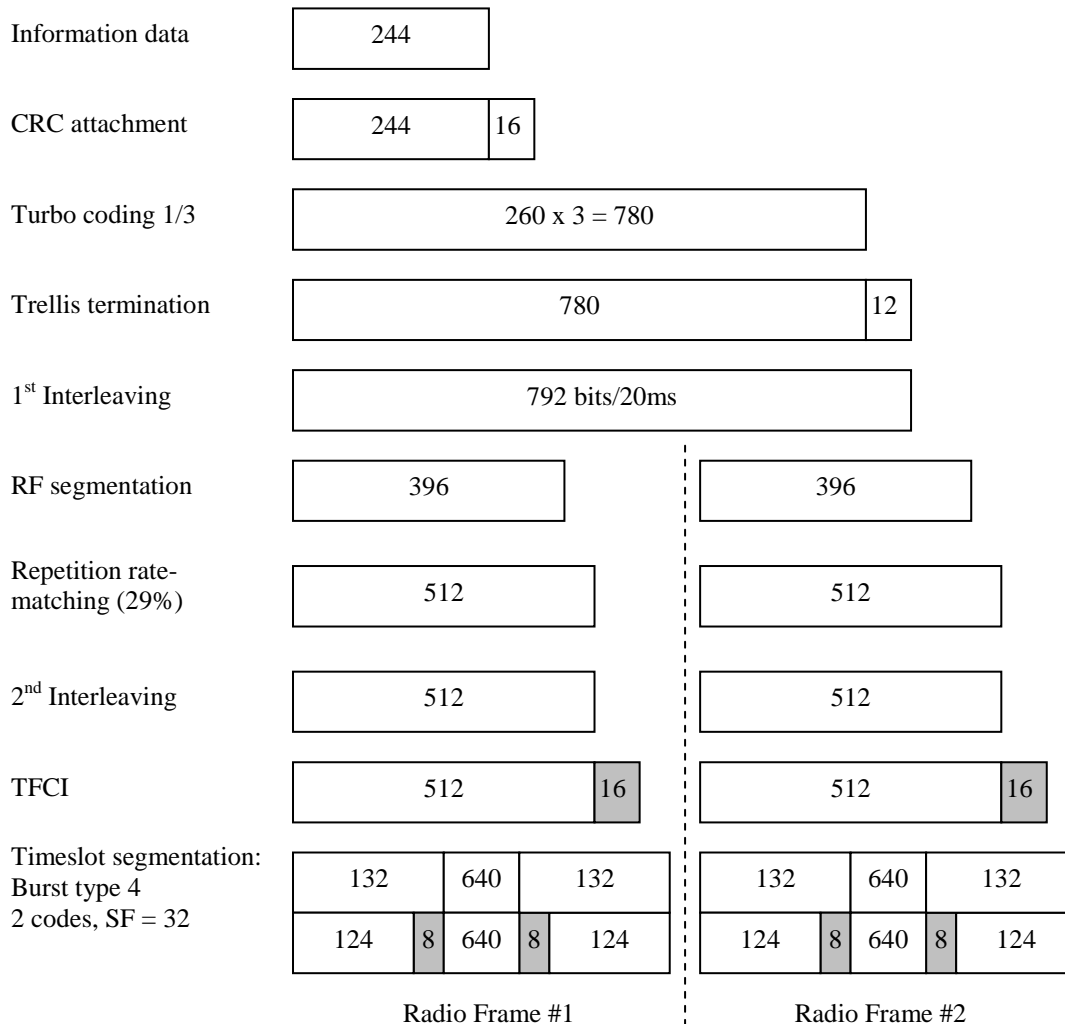

Figure A.8D



## A.3 HSDPA reference measurement channels

### A.3.1 HSDPA reference measurement channels for 3,84 Mcps TDD option

#### A.3.1.1 Reference measurement channels for 7,3 Mbps – Category 8 – UE

##### A.3.1.1.1 QPSK modulation scheme for test 1, 2, 3

**Table A.9: HS-PDSCH fixed reference channel for the PA3, PB3, and VA30 Channel models - Category 8**

Parameter	Unit	Value
Maximum information bit throughput	Mbps	2,6496
Number of HARQ Processes	Processes	4
Information Bit Payload ( $N_{INF}$ )	Bits	26496
Number Code Blocks	Blocks	6
Total Available of Soft Channel bits in UE	Bits	353280
Number of Soft Channel bit per HARQ Proc.	Bits	88320
Number of coded bits per TTI	Bits	35328
Coding Rate		3/4
Number of HS-PDSCH Timeslots	Slots	8
Number of HS-PDSCH codes per TS	Codes	16
Spreading factor	SF	16

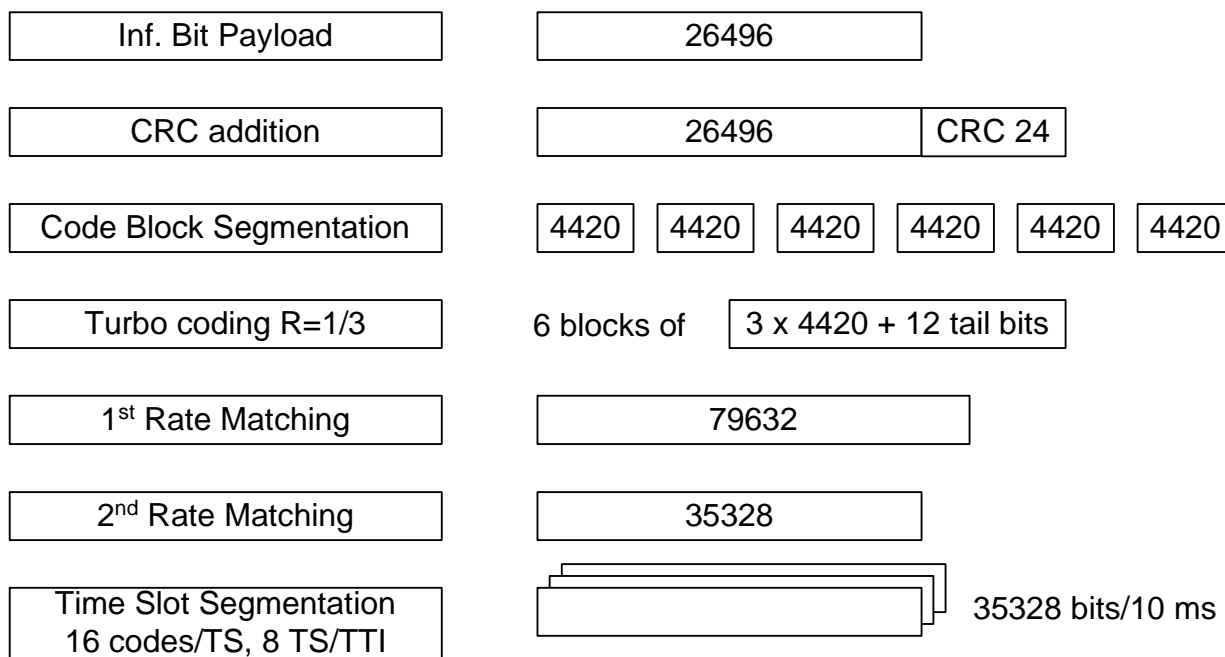
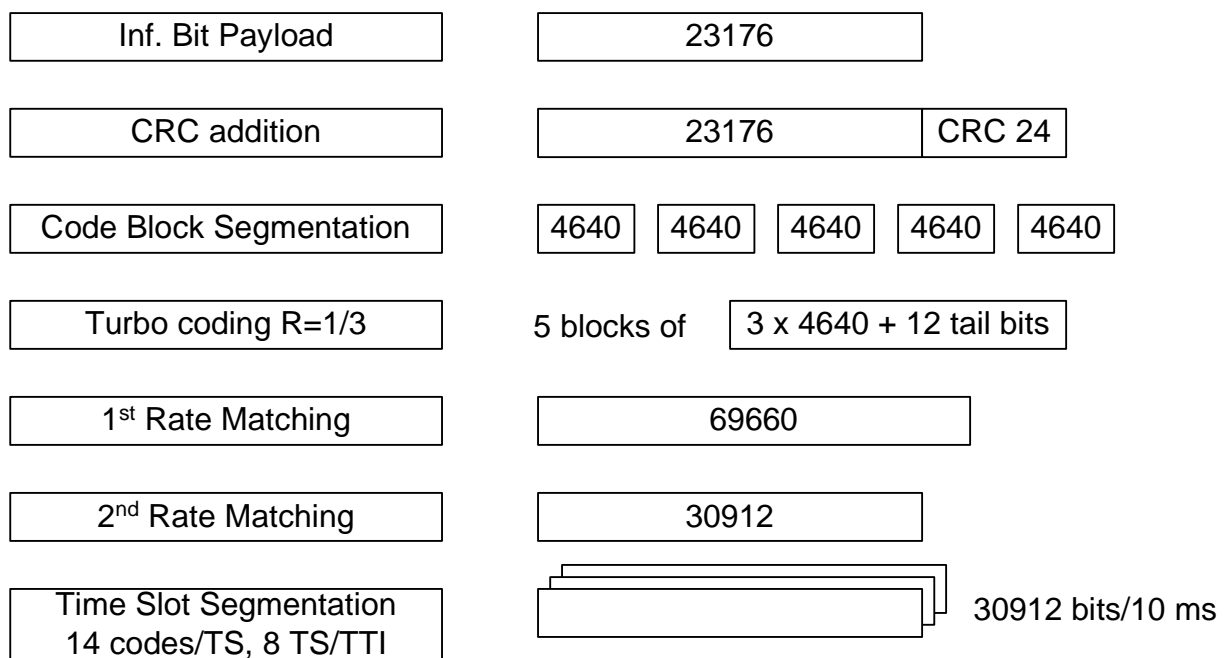

**Figure A.9: Coding for HS-PDSCH fixed reference channel with QPSK modulation for the PA3, PB3, and VA30 Channels – Category 8**

A.3.1.1.2 QPSK modulation scheme for test 4

**Table A.10: HS-PDSCH fixed reference channel for the VA120 Channel model – Category 8**

Parameter	Unit	Value
Maximum information bit throughput	Mbps	2,3176
Number of HARQ Processes	Processes	4
Information Bit Payload ( $N_{INF}$ )	Bits	23176
Number Code Blocks	Blocks	5
Total Available of Soft Channel bits in UE	Bits	353280
Number of Soft Channel bit per HARQ Proc.	Bits	88320
Number of coded bits per TTI	Bits	30912
Coding Rate		3/4
Number of HS-PDSCH Timeslots	Slots	8
Number of HS-PDSCH codes per TS	Codes	14
Spreading factor	SF	16

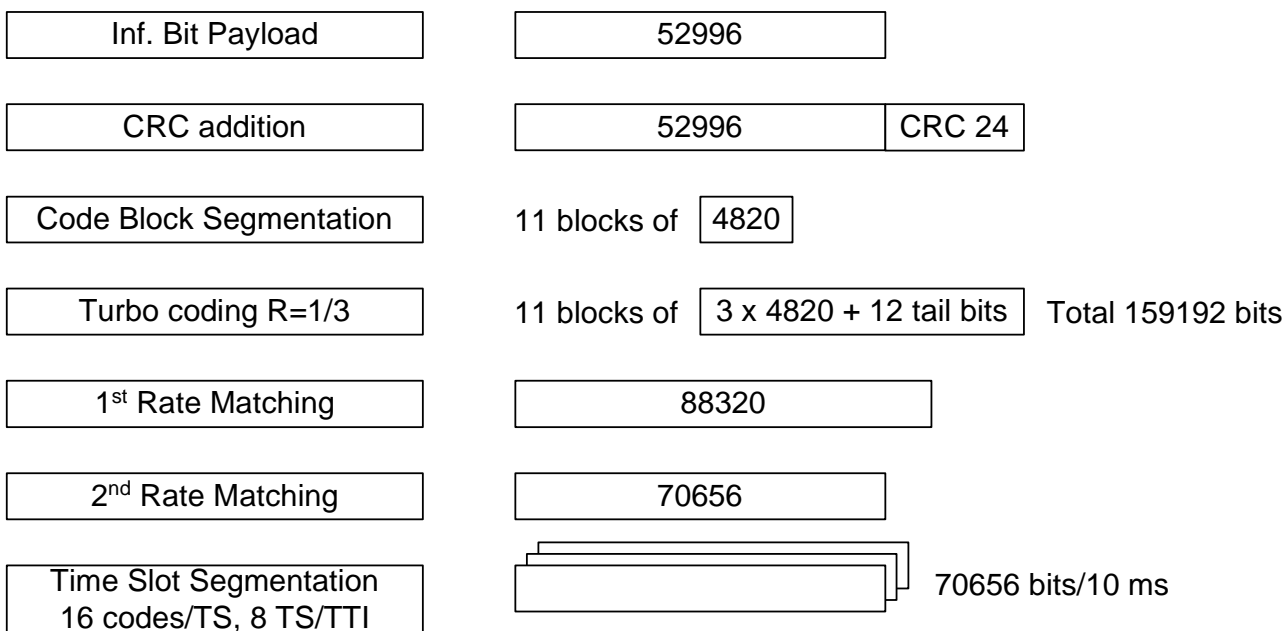

**Figure A.10: Coding for HS-PDSCH fixed reference channel with QPSK modulation for the VA120 Channel – Category 8**

A.3.1.1.3 16QAM modulation scheme for test 1, 2, 3

**Table A.11: HS-PDSCH fixed reference channel for the PA3, PB3, and VA30 Channel models – Category 8**

Parameter	Unit	Value
Modulation		<b>16-QAM</b>
Maximum information bit throughput	Mbps	5,2996
Number of HARQ Processes	Processes	4
Information Bit Payload ( $N_{INF}$ )	Bits	52996
Number Code Blocks	Blocks	11
Total Available of Soft Channel bits in UE	Bits	353280
Number of Soft Channel bit per HARQ Proc.	Bits	88320
Number of coded bits per TTI	Bits	70656
Coding Rate		3/4
Number of HS-PDSCH Timeslots	Slots	8
Number of HS-PDSCH codes per TS	Codes	16
Spreading factor	SF	16

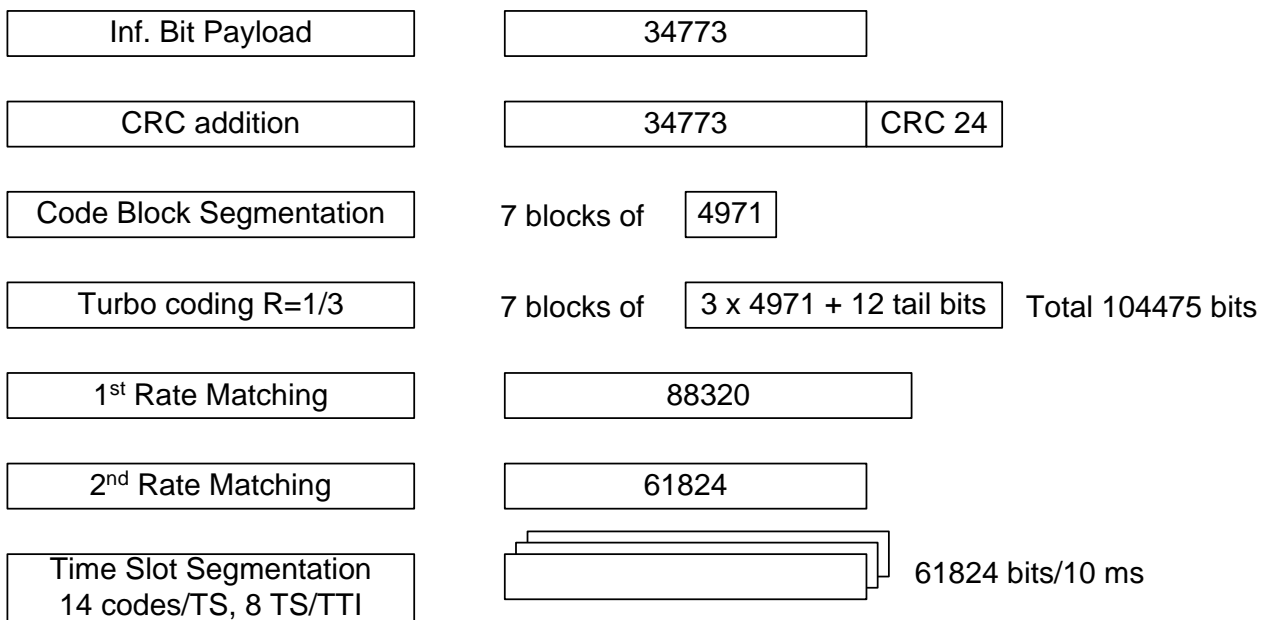

**Figure A.11: Coding for HS-PDSCH fixed reference channel with 16-QAM modulation for the PA3 PB3, and VA30 Channels – Category 8**

A.3.1.1.4 16QAM modulation scheme for test 4

**Table A.12: HS-PDSCH fixed reference channel for the PA3, PB3, and VA30 Channel models – Category 8**

Parameter	Unit	Value
Modulation		<b>16-QAM</b>
Maximum information bit throughput	Mbps	3,4773
Number of HARQ Processes	Processes	4
Information Bit Payload ( $N_{INF}$ )	Bits	34773
Number Code Blocks	Blocks	7
Total Available of Soft Channel bits in UE	Bits	353280
Number of Soft Channel bit per HARQ Proc.	Bits	88320
Number of coded bits per TTI	Bits	61824
Coding Rate		9/16
Number of HS-PDSCH Timeslots	Slots	8
Number of HS-PDSCH codes per TS	Codes	14
Spreading factor	SF	16



**Figure A.12: Coding for HS-PDSCH fixed reference channel with 16-QAM modulation for the VA120 Channel – Category 8**

### A.3.2 HSDPA reference measurement channels for 1.28 Mcps TDD option

#### A.3.2.1 Reference measurement channels for 0.5 Mbps UE class

##### A.3.2.1.1 QPSK modulation scheme

Table A.13-1

Parameter	Unit	Value
Modulation	-	QPSK
Maximum information bit throughput	Kbps	199.2
Number of HARQ Processes	Processes	4
Information Bit Payload ( $N_{INF}$ )	Bits	996
Number Code Blocks	Blocks	1
Total Available of Soft Channel bits in UE	Bits	11264
Number of Soft Channel bit per HARQ Proc.	Bits	2816
Number of coded bits per TTI	Bits	1760
Coding Rate	-	0.5795
Number of HS-DSCH Timeslots	Slots	2
Number of HS-PDSCH codes per TS	Codes	10
Spreading factor	SF	16
Note: For multi-carrier reception, the reference measurement channel is applied to each of the carriers.		

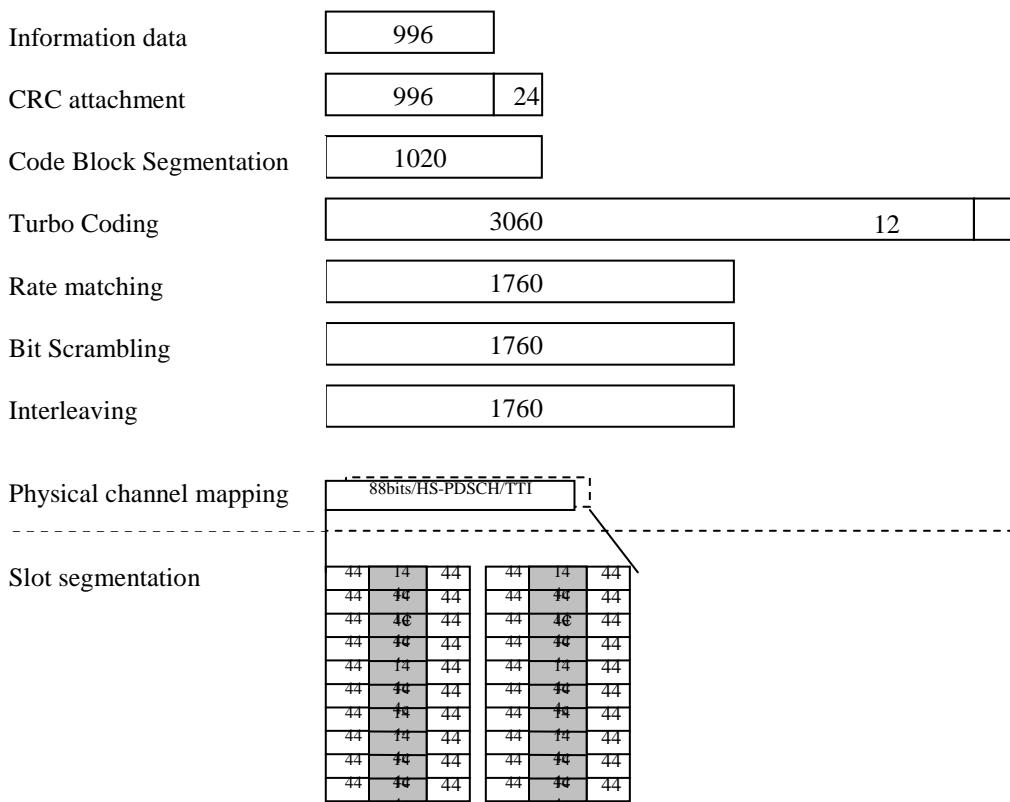

Figure 13-1

### A.3.2.2 Reference measurement channels for 1.1 Mbps UE class

#### A.3.2.2.1 QPSK modulation scheme

Reference channel in A.3.2.1.1 applies.

#### A.3.2.2.2 16QAM modulation scheme

Table A.13-2

Parameter	Unit	Value
Modulation	-	16QAM
Maximum information bit throughput	Kbps	578.6
Number of HARQ Processes	Processes	4
Information Bit Payload ( $N_{INF}$ )	Bits	2893
Number Code Blocks	Blocks	1
Total Available of Soft Channel bits in UE	Bits	22528
Number of Soft Channel bit per HARQ Proc.	Bits	5632
Number of coded bits per TTI	Bits	4224
Coding Rate	-	0.69
Number of HS-DSCH Timeslots	Slots	2
Number of HS-PDSCH codes per TS	Codes	12
Spreading factor	SF	16
Note: For multi-carrier reception, the reference measurement channel is applied to each of the carriers.		

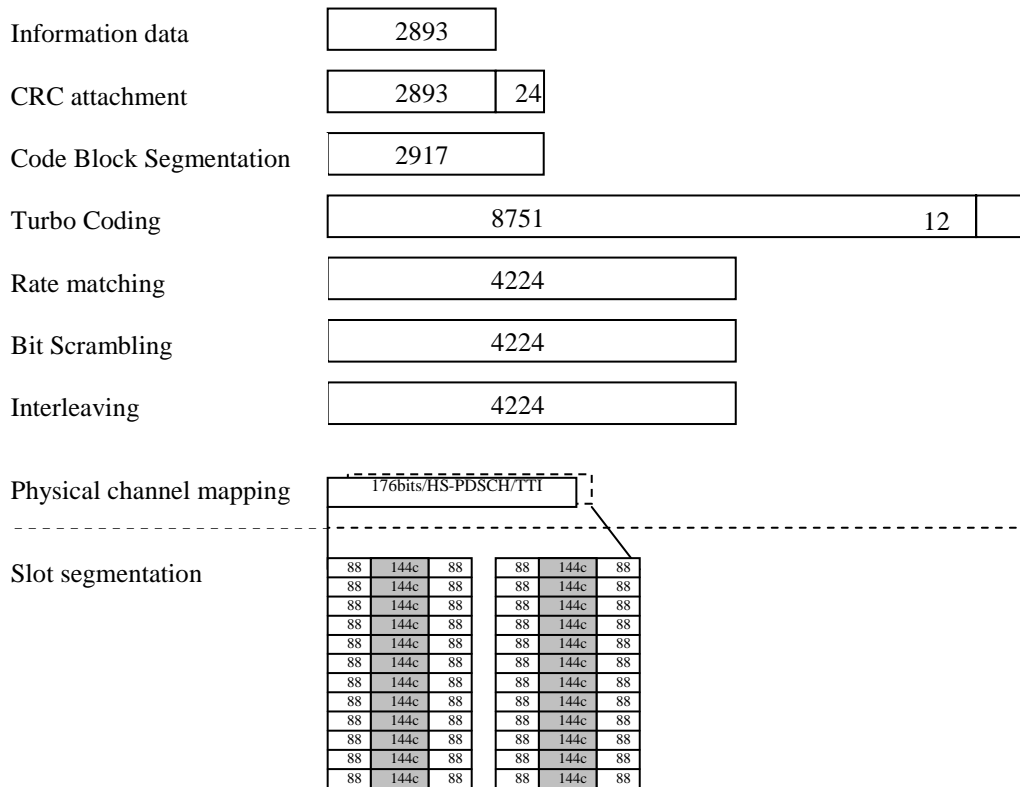

Figure 13-2

### A.3.2.3 Reference measurement channels for 1.6 Mbps UE class

#### A.3.2.3.1 QPSK modulation scheme

**Table A.13-3**

Parameter	Unit	Value
Modulation	-	QPSK
Maximum information bit throughput	Kbps	357.4
Number of HARQ Processes	Processes	4
Information Bit Payload ( $N_{INF}$ )	Bits	1787
Number Code Blocks	Blocks	1
Total Available of Soft Channel bits in UE	Bits	33792
Number of Soft Channel bit per HARQ Proc.	Bits	8448
Number of coded bits per TTI	Bits	2640
Coding Rate	-	0.686
Number of HS-DSCH Timeslots	Slots	3
Number of HS-PDSCH codes per TS	Codes	10
Spreading factor	SF	16
Note: For multi-carrier reception, the reference measurement channel is applied to each of the carriers.		

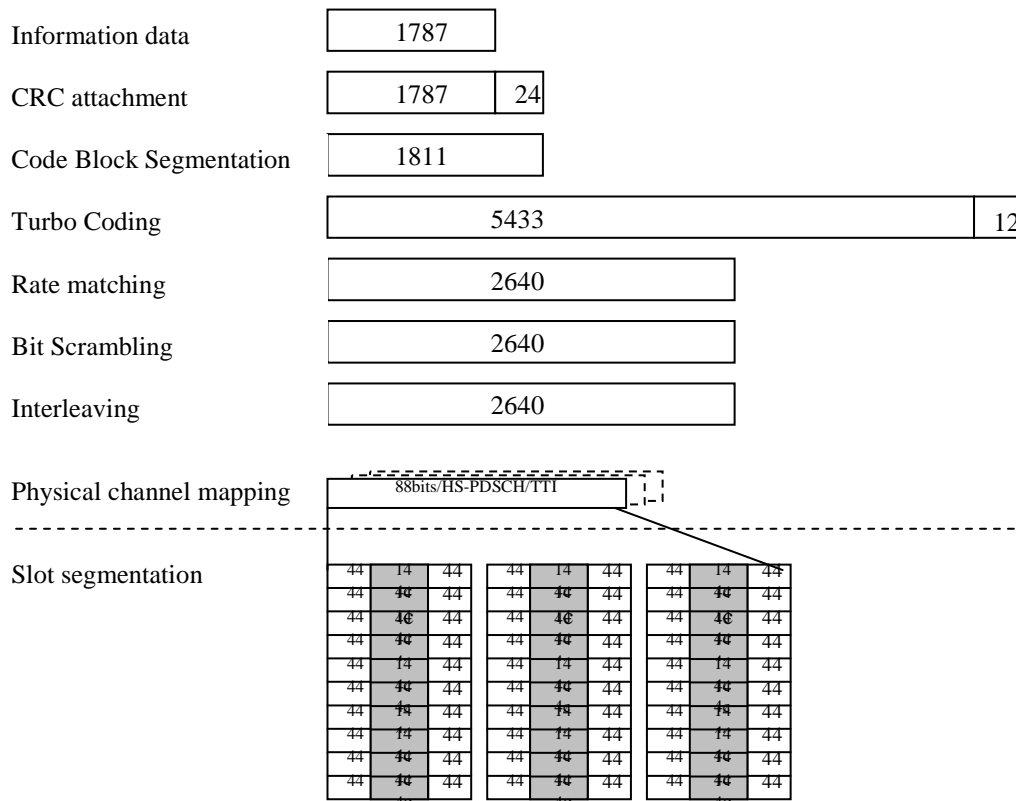

Figure 13-3

A.3.2.3.2 16QAM modulation scheme

Table A.13-4

Parameter	Unit	Value
Modulation	-	16QAM
Maximum information bit throughput	Kbps	634.6
Number of HARQ Processes	Processes	4
Information Bit Payload ( $N_{INF}$ )	Bits	3173
Number Code Blocks	Blocks	1
Total Available of Soft Channel bits in UE	Bits	33792
Number of Soft Channel bit per HARQ Proc.	Bits	8448
Number of coded bits per TTI	Bits	6336
Coding Rate	-	0.505
Number of HS-DSCH Timeslots	Slots	3
Number of HS-PDSCH codes per TS	Codes	12
Spreading factor	SF	16
Note: For multi-carrier reception, the reference measurement channel is applied to each of the carriers.		



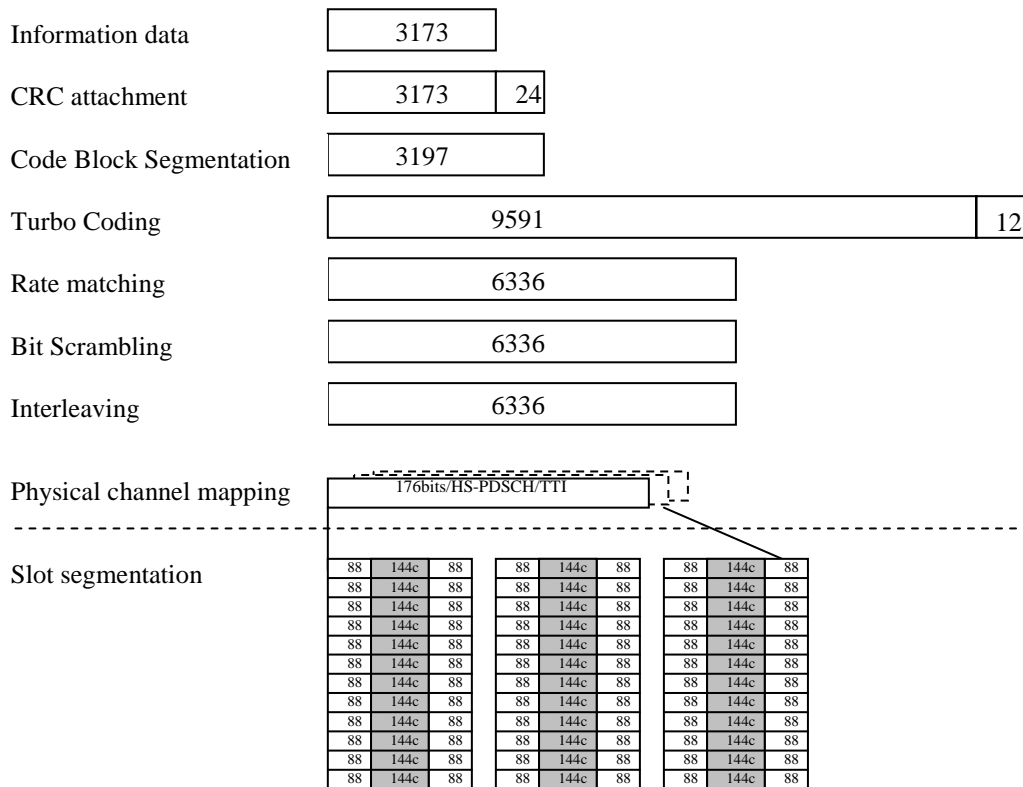

Figure A.13-4

### A.3.2.4 Reference measurement channels for 2.2 Mbps UE class

#### A.3.2.4.1 QPSK modulation scheme

Table A.13-5

Parameter	Unit	Value
Modulation	-	QPSK
Maximum information bit throughput	Kbps	539
Number of HARQ Processes	Processes	4
Information Bit Payload ( $N_{INF}$ )	Bits	2695
Number Code Blocks	Blocks	1
Total Available of Soft Channel bits in UE	Bits	45056
Number of Soft Channel bit per HARQ Proc.	Bits	11264
Number of coded bits per TTI	Bits	3520
Coding Rate	-	0.772
Number of HS-DSCH Timeslots	Slots	4
Number of HS-PDSCH codes per TS	Codes	10
Spreading factor	SF	16

Note: For multi-carrier reception, the reference measurement channel is applied to each of the carriers.

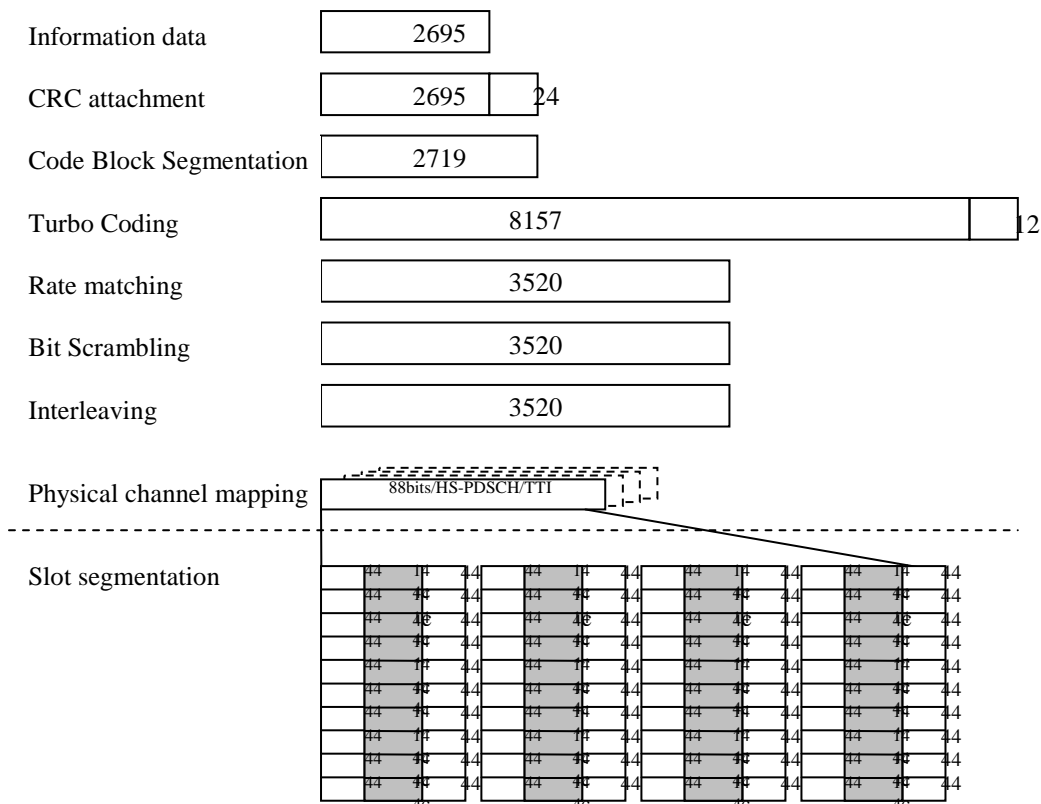

Figure 13-5

A.3.2.4.2 16QAM modulation scheme

Table A.13-6

Parameter	Unit	Value
Modulation	-	16QAM
Maximum information bit throughput	Kbps	782.2
Number of HARQ Processes	Processes	4
Information Bit Payload ( $N_{INF}$ )	Bits	3911
Number Code Blocks	Blocks	1
Total Available of Soft Channel bits in UE	Bits	45056
Number of Soft Channel bit per HARQ Proc.	Bits	11264
Number of coded bits per TTI	Bits	8448
Coding Rate	-	0.4658
Number of HS-DSCH Timeslots	Slots	4
Number of HS-PDSCH codes per TS	Codes	12

Spreading factor	SF	16
Note: For multi-carrier reception, the reference measurement channel is applied to each of the carriers.		

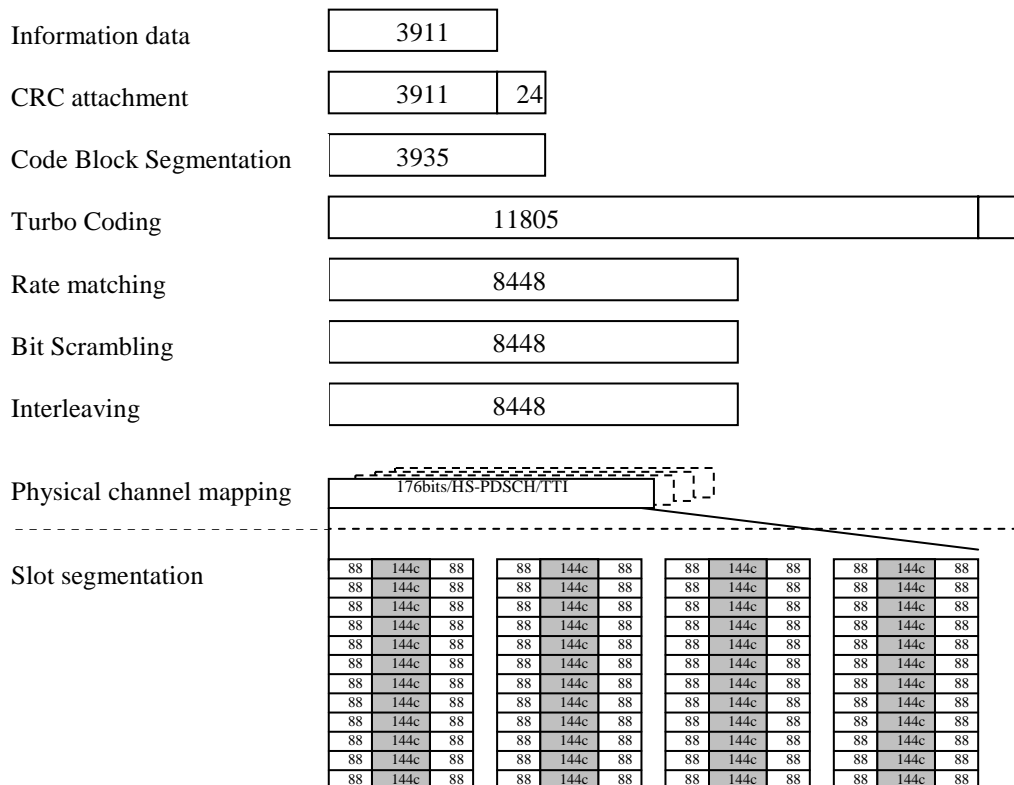

Figure 13-6

### A.3.2.5 Reference measurement channels for 2.8 Mbps UE class

#### A.3.2.5.1 QPSK modulation scheme

Table A.13-7

Parameter	Unit	Value
Modulation	-	QPSK
Maximum information bit throughput	Kbps	621
Number of HARQ Processes	Processes	4
Information Bit Payload ( $N_{INF}$ )	Bits	3105
Number Code Blocks	Blocks	1
Total Available of Soft Channel bits in UE	Bits	56320
Number of Soft Channel bit per HARQ Proc.	Bits	14080
Number of coded bits per TTI	Bits	4400
Coding Rate	-	0.711

Number of HS-DSCH Timeslots	Slots	5
Number of HS-PDSCH codes per TS	Codes	10
Spreading factor	SF	16
Note: For multi-carrier reception, the reference measurement channel is applied to each of the carriers.		

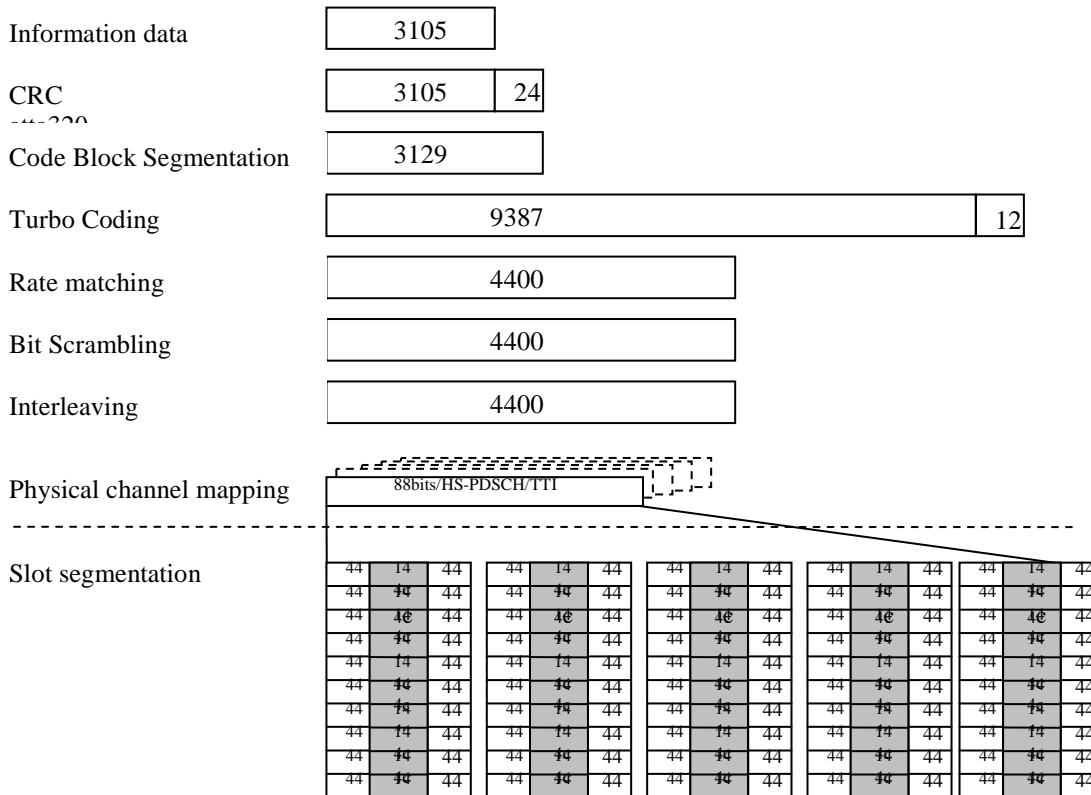

Figure 13-7

A.3.2.5.2 16QAM modulation scheme

Table A.13-8

Parameter	Unit	Value
Modulation	-	16QAM
Maximum information bit throughput	Kbps	1278.6
Number of HARQ Processes	Processes	4
Information Bit Payload ( $N_{INF}$ )	Bits	6393
Number Code Blocks	Blocks	1
Total Available of Soft Channel bits in UE	Bits	56320
Number of Soft Channel bit per HARQ Proc.	Bits	14080

Number of coded bits per TTI	Bits	10560
Coding Rate	-	0.6077
Number of HS-DSCH Timeslots	Slots	5
Number of HS-PDSCH codes per TS	Codes	12
Spreading factor	SF	16
Note: For multi-carrier reception, the reference measurement channel is applied to each of the carriers.		

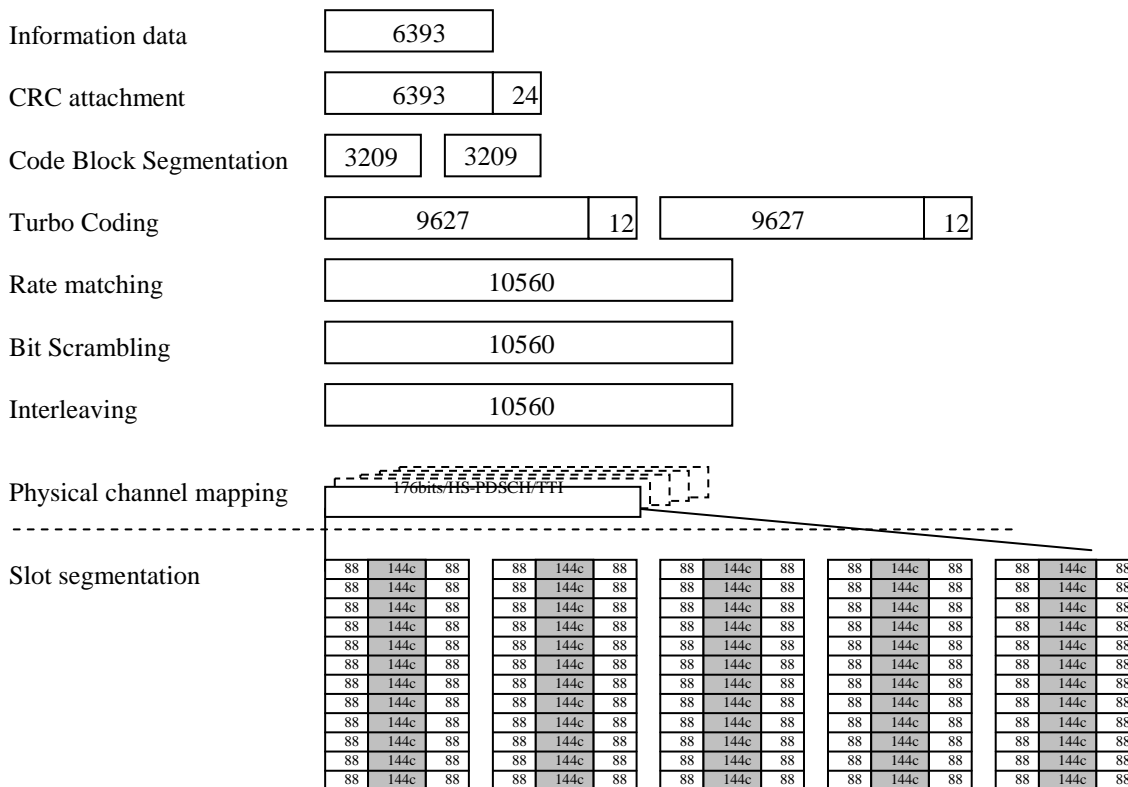

Figure 13-8

A.3.2.6 PLCCCH reference measurement channel

Table A.14A

Parameter	Unit	Value
Information bits	bits	42
Encoded bits	bits	88
Number of codes		1
Number of timeslots		1
TTI	ms	5
Spreading Factor	SF	16
Coding		Repetition encoding

### A.3.2.7 Reference measurement channel of 48kbps

Table A.15A

Parameter	Unit	Value
Modulation	-	QPSK
Maximum information bit throughput	kbps	48
Number of HARQ Processes	Processes	4
Information Bit Payload ( $N_{INF}$ )	Bits	240
Number Code Blocks	Blocks	1
Number of coded bits per TTI	Bits	804
Coding Rate	-	0.375
Number of HS-DSCH Timeslots	Slots	1
Number of HS-PDSCH codes per TS	Codes	8
Spreading factor	SF	16
HS-PDSCH <sub>i</sub> Ec/Ior	dB	-9.03
Number of DPCH <sub>o</sub>	-	0
DPCH <sub>oi</sub> Ec/Ior	dB	-

Note: For multi-carrier reception, the reference measurement channel is applied to each of the carriers.

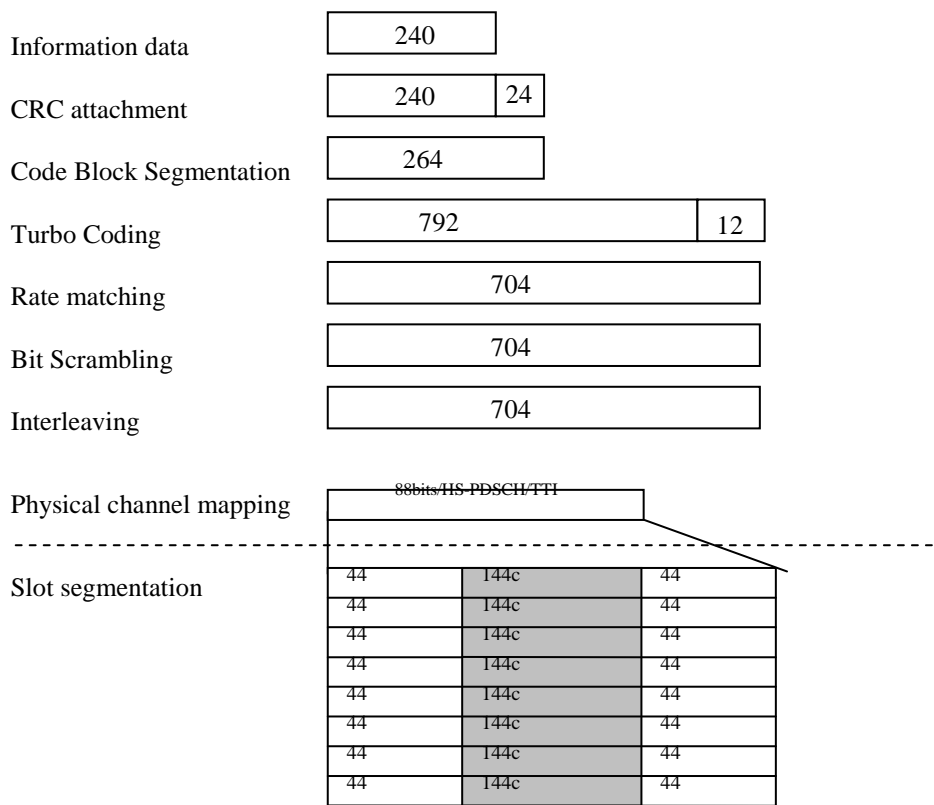
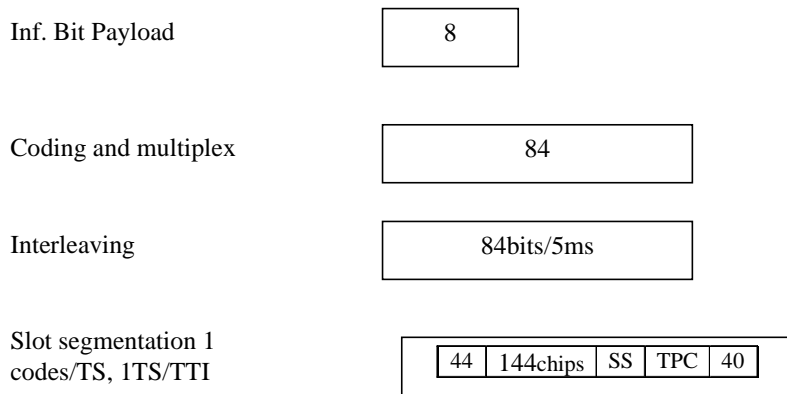

Figure A.15A

### A.3.2.8 Reference Measurement Channel of HS-SICH

**Table A.16A**

Parameter	Unit	Value
Information bits	bits	8
Encoded bits	bits	84
Number of codes	-	1
Number of timeslots	-	1
TTI	ms	5
Spreading Factor	SF	16
Note: For multi-carrier transmission, the reference measurement channel is applied to each of the carriers.		



**Figure A.16A**

### A.3.2A HSDPA reference measurement channels for 7,68 Mcps TDD option

#### A.3.2A.1 Reference measurement channels for 5,3 Mbps – Category 8 – UE

##### A.3.2A.1.1 QPSK modulation scheme for test 1, 2, 3 & 4

**Table A.15: HS-PDSCH fixed reference channel for the PA3, PB3, VA30 and VA120 Channel models - Category 8**

Parameter	Unit	Value
Maximum information bit throughput	Mbps	1.7612
Number of HARQ Processes	Processes	3
Information Bit Payload ( $N_{INF}$ )	Bits	17612
Number Code Blocks	Blocks	4
Total Available of Soft Channel bits in UE	Bits	211968
Number of Soft Channel bit per HARQ Proc.	Bits	70656
Number of coded bits per TTI	Bits	35328
Coding Rate		1/2
Number of HS-PDSCH Timeslots	Slots	4
Number of HS-PDSCH codes per TS	Codes	32
Spreading factor	SF	32

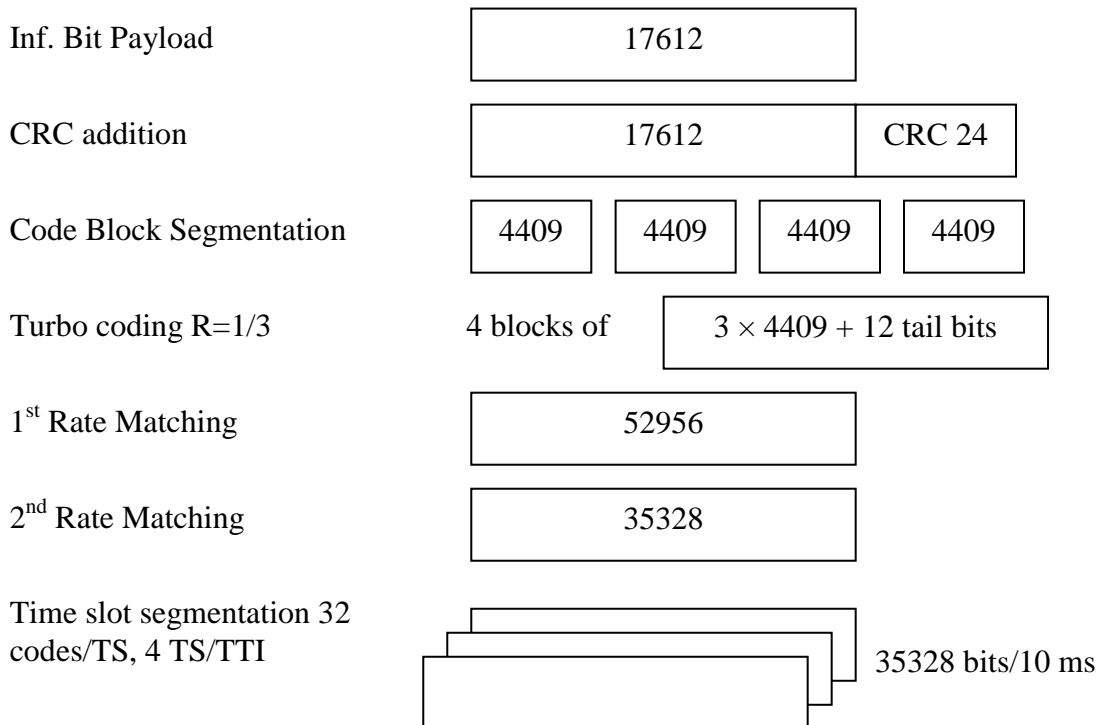

**Figure A.15: Coding for HS-PDSCH fixed reference channel with QPSK modulation for the PA3, PB3, VA30 and VA120 Channels – Category 8**



A.3.2A.1.2 16QAM modulation scheme for test 1, 2, 3 & 4

**Table A.16: HS-PDSCH fixed reference channel for the PA3, PB3, VA30 and VA120 Channel models – Category 8**

Parameter	Unit	Value
Modulation		<b>16-QAM</b>
Maximum information bit throughput	Mbps	3.5066
Number of HARQ Processes	Processes	3
Information Bit Payload ( $N_{INF}$ )	Bits	35066
Number Code Blocks	Blocks	7
Total Available of Soft Channel bits in UE	Bits	211968
Number of Soft Channel bit per HARQ Proc.	Bits	70656
Number of coded bits per TTI	Bits	70656
Coding Rate		$\frac{1}{2}$
Number of HS-PDSCH Timeslots	Slots	4
Number of HS-PDSCH codes per TS	Codes	32
Spreading factor	SF	32

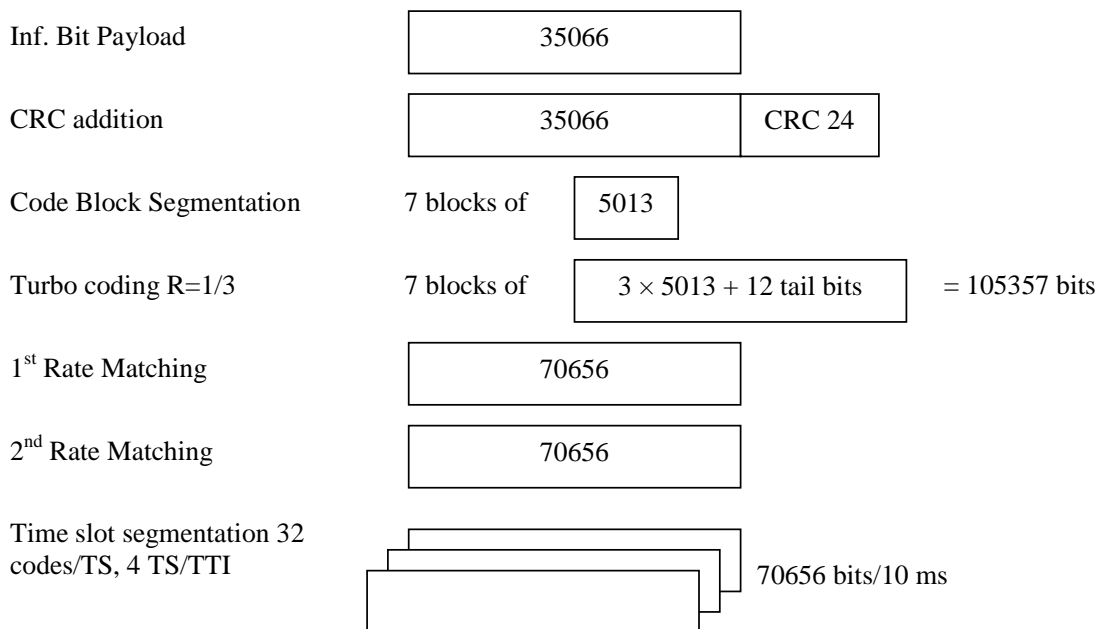

**Figure A.16: Coding for HS-PDSCH fixed reference channel with 16-QAM modulation for the PA3 PB3, VA30 and VA120 Channels – Category 8**

**A.3.3 Variable Reference Channel definition for 3,84 Mcps and 1,28 Mcps TDD options**

The variable reference measurement channels are defined by:

- a) The maximum information bit payload that is determined by the UE capability class under test and the allocated resource units (and hence implicitly by the CQI table applicable to the UE under test as derived from TS25.321).
- b) The most recently received UE CQI report.

## A.4 Downlink reference parameter for MBMS tests

### A.4.1 MCCH

#### A.4.1.1 3.84 Mcps TDD Option

The parameters for the MCCH demodulation tests are specified in Table A.41 and Table A.42.

**Table A.41: Physical channel parameters for S-CCPCH**

Parameter	Unit	Level	Level
Channel bit rate	kbps	22.8	22.8
Channel symbol rate	ksps	11.4	11.4
Slot Format #i	-	3	21
TFCI	-	ON	ON

**Table A.42: Transport channel parameters for S-CCPCH**

Parameter	MCCH
User Data Rate	7.2 kbps
Number Transport Channel	1
Transport Block Size	581
Transport Block Set Size	581
RLC SDU block size	4088
Transmission Time Interval	80 ms
Repetition period	640 ms
Modification period	1280 ms
Type of Error Protection	Turbo
Coding Rate	1/3
Rate Matching attribute	256
Size of CRC	16

#### A.4.1.2 1.28 Mcps TDD Option

The parameters for the MCCH demodulation tests are specified in Table A.43 and Table A.44.

**Table A.43: Physical channel parameters for S-CCPCH**

Parameter	Unit	Level <sup>1</sup>	Level <sup>2</sup>
Channel bit rate	kbps	17.6	<b>19.2</b>
Channel symbol rate	ksps	8.8	<b>9.6</b>
Slot Format		No TPC, SS	No TPC SS
SF	-	16	16
TFCI	-	ON	ON
NOTE1: used for MCCH test in section 10.1.1.2.			
NOTE2: used for MCCH test in section 10.1.2.2.			

**Table A.44: Transport channel parameters for S-CCPCH**

Parameter	MCCH
User Data Rate	7.6 kbps
Number Transport Channel	1
Transport Block Size	72
Transport Block Set Size	72
RLC SDU block size	4088
Transmission Time Interval	10 ms
Repetition period	640 ms
Modification period	1280 ms
Type of Error Protection	Convolutional code 1/3
Coding Rate	1/3
Rate Matching attribute	160
Size of CRC	16
TFCI	ON

### A.4.1.3 7.68 Mcps TDD Option

The parameters for the MCCH demodulation tests are specified in Table A.44A and Table A.44B.

**Table A.44A: Physical channel parameters for S-CCPCH**

Parameter	Unit	Level	Level
Channel bit rate	kbps	22.8	22.8
Channel symbol rate	ksps	11.4	11.4
Slot Format # <i>i</i>	-	3	21
TFCI	-	ON	ON

**Table A.44B: Transport channel parameters for S-CCPCH**

Parameter	MCCH
User Data Rate	7.2 kbps
Number Transport Channel	1
Transport Block Size	581
Transport Block Set Size	581
RLC SDU block size	4088
Transmission Time Interval	80 ms
Repetition period	640 ms
Modification period	1280 ms
Type of Error Protection	Turbo
Coding Rate	1/3
Rate Matching attribute	256
Size of CRC	16

## A.4.2 MTCH

### A.4.2.1 3.84 Mcps TDD Option

The parameters for the MTCH demodulation tests are specified in Table A.45 and Table A.46.

**Table A.45: Physical channel parameters for S-CCPCH**

Parameter	Unit	Level	Level	Level
User Data Rate	kpbs	512	256	128
Modulation	-	16QAM	QPSK	QPSK
Channel bit rate	kpbs	1547.8	388.8	388.8
Channel symbol rate	ksps	386.95	194.4	194.4
Slot Format #i	-	23 and 22	3 and 0	3 and 0
TFCI	-	ON	ON	ON
Physical resources	-	16 codes x SF16 1 timeslot/ frame	16 codes x SF16 1 timeslot/ frame	16 codes x SF16 1 timeslot/ frame

**Table A.46: Transport channel parameters for S-CCPCH**

Parameter	MTCH		
	512 kpbs	256 kpbs	128 kpbs
User Data Rate	512 kpbs	256 kpbs	128 kpbs
Number of Transport Channel	1	1	1
Transport Block Size	2561	2561	2561
Transport Block Set Size	40976	10244	5122
Nr of transport blocks/TTI	16	4	2
RLC SDU block size	40688	10160	5072
Transmission Time Interval	80ms	40 ms	40 ms
Type of Error Protection	Turbo	Turbo	Turbo
Coding Rate	1/3	1/3	1/3
Rate Matching attribute	256	256	256
Size of CRC	16	16	16
Puncturing limit	0.52	1.0	1.0

### A.4.2.2 1.28 Mcps TDD Option

The parameters for the MTCH demodulation tests are specified in Table A.47 and Table A.48.

**Table A.47: Physical channel parameters for S-CCPCH**

Parameter	Unit	Level	Level	Level	Level		
User Data Rate	kpbs	384	192	128	64		
Channel bit rate	kpbs	614.4 <sup>1</sup>	563.2 <sup>2</sup>	307.2 <sup>1</sup>	281.6 <sup>2</sup>	246.4	140.8
Channel symbol rate	ksps	153.6 <sup>1</sup>	140.8 <sup>2</sup>	153.6 <sup>1</sup>	140.8 <sup>2</sup>	123.2	70.4
Slot Format	-	No TPC SS	No TPC SS	No TPC, SS	No TPC, SS		
TFCI	-	ON	ON	ON	ON		

Note1 used for test 3 and test 4 in section 10.2.2.2

Note2 used for test 1 and test 2 in section 10.2.2.2

**Table A.48: Transport channel parameters for S-CCPCH**

Parameter	MTCH			
	384kbps	192kbps	128 kbps	64 kbps
User Data Rate	384kbps	192kbps	128 kbps	64 kbps
Number of Transport Channel	1	1	1	1
Transport Block Size	2561	2561	2561	1281
Transport Block Set Size	15366	7683	5122	2562
Nr of transport blocks/TTI	6	3	2	2
RLC SDU block size	15248	7616	5072	2512
Transmission Time Interval	40ms	40ms	40 ms	40 ms
Type of Error Protection	Turbo	Turbo	Turbo	Turbo
Coding Rate	1/3	1/3	1/3	1/3
Rate Matching attribute	256	256	256	256
Size of CRC	16	16	16	16

Parameters for combined MTCH demodulation and cell identification requirements are defined in Table A.49.

**Table A.49: Cell reselection parameters**

Parameter	Unit	Value
Serving cell in the initial condition	-	Cell 1
Neighbour cells	-	Cell 2 and cell 3
Cell_selection_and_reselection_quality_measure	-	P-CCPCH
Qrxlevmin	dBm	-103
UE_TXPWR_MAX_RACH	dBm	21
Treselection	seconds	4
Sintrasearch	dB	not sent
IE 'FACH Measurement occasion info'	-	not sent

### A.4.2.3 7.68 Mcps TDD Option

The parameters for the MTCH demodulation tests are specified in Table A.49a and Table A.50.

**Table A.49a: Physical channel parameters for S-CCPCH**

Parameter	Unit	Level	Level	Level
User Data Rate	kbps	512	256	128
Modulation	-	16QAM	QPSK	QPSK
Channel bit rate	kbps	1547.8	388.8	388.8
Channel symbol rate	ksps	386.95	194.4	194.4
Slot Format #i	-	23 and 22	3 and 0	3 and 0
TFCI	-	ON	ON	ON
Physical resources	-	16 codes x SF32 1 timeslot/ frame	16 codes x SF32 1 timeslot/ frame	16 codes x SF32 1 timeslot/ frame

**Table A.50: Transport channel parameters for S-CCPCH**

Parameter	MTCH		
	512 kbps	256 kbps	128 kbps
User Data Rate	512 kbps	256 kbps	128 kbps
Number of Transport Channel	1	1	1
Transport Block Size	2561	2561	2561
Transport Block Set Size	40976	10244	5122
Nr of transport blocks/TTI	16	4	2
RLC SDU block size	40688	10160	5072
Transmission Time Interval	80ms	40 ms	40 ms
Type of Error Protection	Turbo	Turbo	Turbo
Coding Rate	1/3	1/3	1/3
Rate Matching attribute	256	256	256
Size of CRC	16	16	16
Puncturing limit	0.52	1.0	1.0

## A.5 HSUPA reference measurement channels for 1.28Mcps TDD option

### A.5.1 Fixed reference channel 1(FRC1) for 16QM

**Table A.51: E-DCH Fixed reference channel 1 (1.28Mcps TDD option)**

Parameter	Unit	Value
Maximum information bit throughput	kbps	342.4
Information Bit Payload ( $N_{INF}$ )	Bits	1712
Number Code Blocks	Blocks	1
Number of coded bits per TTI	Bits	1736
Coding Rate		0.623
Modulation		16QAM
Number of E-DCH Timeslots	Slots	1
Number of E-DCH codes per TS	Codes	1
Spreading factor	SF	1
Number of E-UCCH per TTI		1

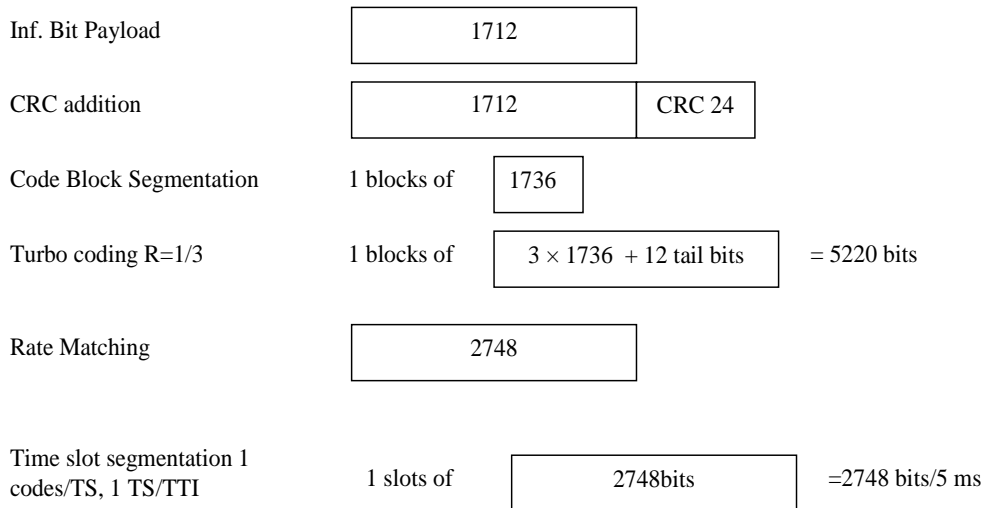

**Figure A.17: Coding for E-DCH FRC1 (1.28 Mcps TDD Option)**

## Annex B (normative): Propagation conditions

### B.1 Static propagation condition

The propagation for the static performance measurement is an Additive White Gaussian Noise (AWGN) environment. No fading and multi-paths exist for this propagation model.

### B.2 Multi-path fading propagation conditions

#### B.2.1 3.84 Mcps TDD Option

Table B.1 shows propagation conditions that are used for the performance measurements in multi-path fading environment. All taps have classical Doppler spectrum.

**Table B.1: Propagation Conditions for Multi path Fading Environments for operations referenced in 5.2 a), 5.2 b) and 5.2 c)**

Case 1 speed 3km/h		Case 2 speed 3 km/h		Case 3 speed 120 km/h		CASE 4 speed 50 km/h (note)	
Relative Delay [ns]	Relative Mean Power [dB]	Relative Delay [ns]	Relative Mean Power [dB]	Relative Delay [ns]	Relative Mean Power [dB]	Relative Delay [ns]	Relative Mean Power [dB]
0	0	0	0	0	0	0	0
976	-10	976	0	260	-3	976	-10
		12000	0	521	-6		
				781	-9		

NOTE: Case 4 is only used in TS25.123.

**Table B.1A: Propagation Conditions for Multi-Path Fading Environments for HSDPA Performance Requirements for operations referenced in 5.2 a), 5.2 b) and 5.2 c)**

ITU Pedestrian A Speed 3km/h (PA3)		ITU Pedestrian B Speed 3Km/h (PB3)		ITU vehicular A Speed 30km/h (VA30)		ITU vehicular A Speed 120km/h (VA120)	
Relative Delay [ns]	Relative Mean Power [dB]	Relative Delay [ns]	Relative Mean Power [dB]	Relative Delay [ns]	Relative Mean Power [dB]	Relative Delay [ns]	Relative Mean Power [dB]
0	0	0	0	0	0	0	0
110	-9.7	200	-0.9	310	-1.0	310	-1.0
190	-19.2	800	-4.9	710	-9.0	710	-9.0
410	-22.8	1200	-8.0	1090	-10.0	1090	-10.0
		2300	-7.8	1730	-15.0	1730	-15.0
		3700	-23.9	2510	-20	2510	-20



**Table B.1B: Propagation Conditions for Multi path Fading Environments  
for operations referenced in 5.2 d)**

Case 1 speed 2.3km/h		Case 2 speed 2.3 km/h		Case 3 speed 92 km/h		Case 4 speed 38 km/h *	
Relative Delay [ns]	Relative Mean Power [dB]	Relative Delay [ns]	Relative Mean Power [dB]	Relative Delay [ns]	Relative Mean Power [dB]	Relative Delay [ns]	Relative Mean Power [dB]
0	0	0	0	0	0	0	0
976	-10	976	0	260	-3	976	-10
		12000	0	521	-6		
				781	-9		
NOTE: Case 4 is only used in TS25.123.							

**Table B.1C: Propagation Conditions for Multi-Path Fading Environments for HSDPA Performance  
Requirements for operations referenced in 5.2 d)**

ITU Pedestrian A Speed 2.3km/h (PA3)		ITU Pedestrian B Speed 2.3Km/h (PB3)		ITU vehicular A Speed 23 km/h (VA30)		ITU vehicular A Speed 92 km/h (VA120)	
Relative Delay [ns]	Relative Mean Power [dB]	Relative Delay [ns]	Relative Mean Power [dB]	Relative Delay [ns]	Relative Mean Power [dB]	Relative Delay [ns]	Relative Mean Power [dB]
0	0	0	0	0	0	0	0
110	-9.7	200	-0.9	310	-1.0	310	-1.0
190	-19.2	800	-4.9	710	-9.0	710	-9.0
410	-22.8	1200	-8.0	1090	-10.0	1090	-10.0
		2300	-7.8	1730	-15.0	1730	-15.0
		3700	-23.9	2510	-20	2510	-20

**Table B.1D: Propagation Conditions for Multi-Path Fading Environments for Performance Requirements under an extended delay spread environment**

Extended Delay Spread			
Operations referenced in 5.2 a), 5.2 b) and 5.2 c) Speed 3km/h (EDS)		Operations referenced in 5.2 d) Speed 2.3km/h (EDS)	
Relative Delay [ns]	Relative Mean Power [dB]	Relative Delay [ns]	Relative Mean Power [dB]
0	0	0	0
310	-1	310	-1
710	-9	710	-9
1090	-10	1090	-10
1730	-15	1730	-15
2510	-20	2510	-20
12490	-10	12490	-10
12800	-11	12800	-11
13200	-19	13200	-19
13580	-20	13580	-20
14220	-25	14220	-25
15000	-30	15000	-30
27490	-20	27490	-20
27800	-21	27800	-21
28200	-29	28200	-29
28580	-30	28580	-30
29220	-35	29220	-35
30000	-40	30000	-40

## B.2.2 1.28 Mcps TDD Option

Table B.2 shows propagation conditions that are used for the general performance measurements in multi-path fading environment. Table B.3 shows propagation conditions that are used for HSDPA and multi-carrier HSDPA performance measurements in multi-path fading environments. For multi-carrier HSDPA requirements, the fading of the signals for each carrier shall be independent. All taps in both tables have classical Doppler spectrum.

**Table B.2: Propagation Conditions for Multi-Path Fading Environments operations referenced in 5.2 a), b) and c)**

Case 1, speed 3km/h		Case 2, speed 3km/h		Case 3, speed 120km/h	
Relative Delay [ns]	Relative Mean Power [dB]	Relative Delay [ns]	Relative Mean Power [dB]	Relative Delay [ns]	Relative Mean Power [dB]
0	0	0	0	0	0
2928	-10	2928	0	781	-3
		12000	0	1563	-6
				2344	-9

**Table B.2A: Propagation Conditions for Multi-Path Fading Environments operations referenced in 5.2 d)**

Case 1, speed 2.3km/h		Case 2, speed 2.3km/h		Case 3, speed 92km/h	
Relative Delay [ns]	Relative Mean Power [dB]	Relative Delay [ns]	Relative Mean Power [dB]	Relative Delay [ns]	Relative Mean Power [dB]
0	0	0	0	0	0
2928	-10	2928	0	781	-3
		12000	0	1563	-6
				2344	-9

**Table B.3: Propagation Conditions for Multi-Path Fading Environments for HSDPA Performance Requirements operations referenced in 5.2 a), b) and c)**

ITU Pedestrian A Speed 3km/h (PA3)		ITU Pedestrian B Speed 3K/h (PB3)		ITU vehicular A Speed 30km/h (VA30)		ITU vehicular A Speed 120km/h (VA120)	
Relative Delay [ns]	Relative Mean Power [dB]	Relative Delay [ns]	Relative Mean Power [dB]	Relative Delay [ns]	Relative Mean Power [dB]	Relative Delay [ns]	Relative Mean Power [dB]
0	0	0	0	0	0	0	0
110	-9.7	200	-0.9	310	-1.0	310	-1.0
190	-19.2	800	-4.9	710	-9.0	710	-9.0
410	-22.8	1200	-8.0	1090	-10.0	1090	-10.0
		2300	-7.8	1730	-15.0	1730	-15.0
		3700	-23.9	2510	-20	2510	-20

**Table B.3A: Propagation Conditions for Multi-Path Fading Environments for HSDPA Performance Requirements operations referenced in 5.2 d)**

ITU Pedestrian A Speed 2.3km/h (PA3)		ITU Pedestrian B Speed 2.3km/h (PB3)		ITU vehicular A Speed 23km/h (VA30)		ITU vehicular A Speed 92km/h (VA120)	
Relative Delay [ns]	Relative Mean Power [dB]	Relative Delay [ns]	Relative Mean Power [dB]	Relative Delay [ns]	Relative Mean Power [dB]	Relative Delay [ns]	Relative Mean Power [dB]
0	0	0	0	0	0	0	0
110	-9.7	200	-0.9	310	-1.0	310	-1.0
190	-19.2	800	-4.9	710	-9.0	710	-9.0
410	-22.8	1200	-8.0	1090	-10.0	1090	-10.0
		2300	-7.8	1730	-15.0	1730	-15.0
		3700	-23.9	2510	-20	2510	-20

Table B.3B shows propagation conditions that are used for MBSFN demodulation performance measurements in multi-path fading environment. All taps have classical Doppler spectrum.

In the case of Rx diversity, the fading of the signals and the AWGN signals provided in each receiver antenna port shall be independent.

**Table B.3B: Propagation Conditions for Multi-Path Fading Environments for MBSFN Demodulation Performance Requirements**

MBSFN channel model 1		MBSFN channel model 2	
Speed for Band a, b, c 30 km/h		Speed for Band a, b, c 30 km/h	
Speed for Band d: 23 km/h		Speed for Band d: 23 km/h	
Relative Delay [ns]	Relative Mean Power [dB]	Relative Delay [ns]	Relative Mean Power [dB]
0	0.0	0	0.0
310	-1.0	310	-1.0
710	-9.0	710	-9.0
1090	-10.0	1090	-10.0
1730	-15.0	1730	-15.0
2510	-20.0	2510	-20.0
2734	-6.6	5859	-6.8
3044	-7.6	6169	-7.8
3444	-15.6	6569	-15.8
3824	-16.6	6949	-16.8
4464	-21.6	7589	-21.8
5469	-8.5	10938	-13.3
5779	-9.5	11248	-14.3
6179	-17.5	11648	-22.3
6559	-18.5	12028	-23.3
8428	-12.6	15459	-15.0
8738	-13.6	15769	-16.0
9138	-21.6	16169	-24.0

## B.2.3 7.68 Mcps TDD Option

Table B.4 and Table B.5 show propagation conditions that are used for the performance measurements in multi-path fading environment. All taps have classical Doppler spectrum.

**Table B.4: Propagation Conditions for Multi path Fading Environments for operations referenced in 5.2 a), 5.2 b) and 5.2 c)**

Case 1 speed 3km/h		Case 2 speed 3 km/h		Case 3 speed 120 km/h		CASE 4 speed 50 km/h *	
Relative Delay [ns]	Relative Mean Power [dB]	Relative Delay [ns]	Relative Mean Power [dB]	Relative Delay [ns]	Relative Mean Power [dB]	Relative Delay [ns]	Relative Mean Power [dB]
0	0	0	0	0	0	0	0
976	-10	976	0	260	-3	976	-10
		12000	0	521	-6		
				781	-9		

\*NOTE: Case 4 is only used in TS25.123.

**Table B.5: Propagation Conditions for Multi-Path Fading Environments for HSDPA Performance Requirements for operations referenced in 5.2 a), 5.2 b) and 5.2 c)**

ITU Pedestrian A Speed 3km/h (PA3)		ITU Pedestrian B Speed 3Km/h (PB3)		ITU vehicular A Speed 30km/h (VA30)		ITU vehicular A Speed 120km/h (VA120)	
Relative Delay [ns]	Relative Mean Power [dB]	Relative Delay [ns]	Relative Mean Power [dB]	Relative Delay [ns]	Relative Mean Power [dB]	Relative Delay [ns]	Relative Mean Power [dB]
0	0	0	0	0	0	0	0
110	-9.7	200	-0.9	310	-1.0	310	-1.0
190	-19.2	800	-4.9	710	-9.0	710	-9.0
410	-22.8	1200	-8.0	1090	-10.0	1090	-10.0
		2300	-7.8	1730	-15.0	1730	-15.0
		3700	-23.9	2510	-20	2510	-20

**Table B.6: Propagation Conditions for Multi path Fading Environments for operations referenced in 5.2 d)**

Case 1 speed 2.3km/h		Case 2 speed 2.3 km/h		Case 3 speed 92 km/h		Case 4 speed 38 km/h *	
Relative Delay [ns]	Relative Mean Power [dB]	Relative Delay [ns]	Relative Mean Power [dB]	Relative Delay [ns]	Relative Mean Power [dB]	Relative Delay [ns]	Relative Mean Power [dB]
0	0	0	0	0	0	0	0
976	-10	976	0	260	-3	976	-10
		12000	0	521	-6		
				781	-9		

\*NOTE: Case 4 is only used in TS 25.123.

**Table B.7: Propagation Conditions for Multi-Path Fading Environments for HSDPA Performance Requirements for operations referenced in 5.2 d)**

ITU Pedestrian A Speed 2.3km/h (PA3)		ITU Pedestrian B Speed 2.3Km/h (PB3)		ITU vehicular A Speed 23 km/h (VA30)		ITU vehicular A Speed 92 km/h (VA120)	
Relative Delay [ns]	Relative Mean Power [dB]	Relative Delay [ns]	Relative Mean Power [dB]	Relative Delay [ns]	Relative Mean Power [dB]	Relative Delay [ns]	Relative Mean Power [dB]
0	0	0	0	0	0	0	0
110	-9.7	200	-0.9	310	-1.0	310	-1.0
190	-19.2	800	-4.9	710	-9.0	710	-9.0
410	-22.8	1200	-8.0	1090	-10.0	1090	-10.0
		2300	-7.8	1730	-15.0	1730	-15.0
		3700	-23.9	2510	-20	2510	-20

**Table B.8: Propagation Conditions for Multi-Path Fading Environments for Performance Requirements under an extended delay spread environment**

Extended Delay Spread			
Operations referenced in 5.2 a), 5.2 b) and 5.2 c) Speed 3km/h (EDS)		Operations referenced in 5.2 d) Speed 2.3km/h (EDS)	
Relative Delay [ns]	Relative Mean Power [dB]	Relative Delay [ns]	Relative Mean Power [dB]
0	0	0	0
310	-1	310	-1
710	-9	710	-9
1090	-10	1090	-10
1730	-15	1730	-15
2510	-20	2510	-20
12490	-10	12490	-10
12800	-11	12800	-11
13200	-19	13200	-19
13580	-20	13580	-20
14220	-25	14220	-25
15000	-30	15000	-30
27490	-20	27490	-20
27800	-21	27800	-21
28200	-29	28200	-29
28580	-30	28580	-30
29220	-35	29220	-35
30000	-40	30000	-40

### B.3 Moving propagation conditions

The dynamic propagation conditions for the test of the baseband performance are non fading channel models with two taps. The moving propagation condition has two taps, one static, Path0, and one moving, Path1. The time difference between the two paths is according Equation (B.1). The taps have equal strengths and equal phases.

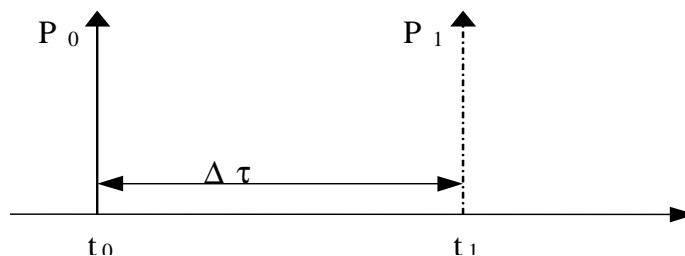

**Figure B.1: The moving propagation conditions**

$$\Delta\tau = B + \frac{A}{2}(1 + \sin(\Delta\omega \cdot t)) \tag{B.1}$$

The parameters in the equation are shown in.

A	5 $\mu$ s
B	1 $\mu$ s
$\Delta\omega$	$40 \cdot 10^{-3} \text{ s}^{-1}$

## B.4 Birth-Death propagation conditions

The dynamic propagation conditions for the test of the baseband performance is a non fading propagation channel with two taps. The moving propagation condition has two taps, Path1 and Path2 while alternate between 'birth' and 'death'. The positions the paths appear are randomly selected with an equal probability rate and are shown in figure B.2.

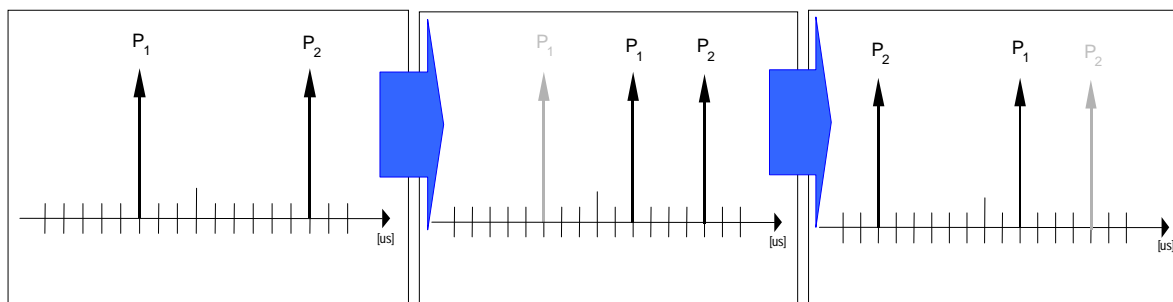

**Figure B.2: Birth death propagation sequence**

NOTE1: Two paths, Path1 and Path2 are randomly selected from the group [-3, -2, -1, 0, 1, 2, 3] chip(781.25ns). The paths have equal strengths and equal phases.

NOTE 2: After 191 ms, Path1 vanishes and reappears immediately at a new location randomly selected from the group [-3, -2, -1, 0, 1, 2, 3]chip but excludes the point Path2.

NOTE 3: After additional 191 ms, Path2 vanishes and reappears immediately at a new location randomly selected from the group [-3, -2, -1, 0, 1, 2, 3] chip but excludes the point Path1.

NOTE 4: The sequence in 2) and 3) is repeated.

## Annex C (normative) : Environmental conditions

### C.1 General

This normative annex specifies the environmental requirements of the UE. Within these limits the requirements of this specifications shall be fulfilled.

### C.2 Environmental requirements for the UE

The requirements in this clause apply to all types of UE(s)

#### C.2.1 Temperature

The UE shall fulfil all the requirements in the full temperature range of:

**Table C.1**

+15°C - +35°C	for normal conditions (with relative humidity of 25 % to 75 %);
-10°C - +55°C	for extreme conditions (see IEC publications 68-2-1 and 68-2-2)

Outside this temperature range the UE, if powered on, shall not make ineffective use of the radio frequency spectrum. In no case shall the UE exceed the transmitted levels as defined in S25.102 for extreme operation.

#### C.2.2 Voltage

The UE shall fulfil all the requirements in the full voltage range, i.e. the voltage range between the extreme voltages.

The manufacturer shall declare the lower and higher extreme voltages and the approximate shutdown voltage. For the equipment that can be operated from one or more of the power sources listed below, the lower extreme voltage shall not be higher, and the higher extreme voltage shall not be lower than that specified below.

**Table C.2**

Power source	Lower extreme voltage	Higher extreme voltage	Normal conditions voltage
AC mains	0,9 * nominal	1,1 * nominal	nominal
Regulated lead acid battery	0,9 * nominal	1,3 * nominal	1,1 * nominal
Non regulated batteries:			
Leclanché/lithium	0,85 * nominal	Nominal	Nominal
Mercury/nickel cadmium	0,90 * nominal	Nominal	Nominal

Outside this voltage range the UE if powered on, shall not make ineffective use of the radio frequency spectrum. In no case shall the UE exceed the transmitted levels as defined in S4.01A for extreme operation. In particular, the UE shall inhibit all RF transmissions when the power supply voltage is below the manufacturer declared shutdown voltage.



## C.2.3 Vibration

The UE shall fulfil all the requirements when vibrated at the following frequency/amplitudes:

**Table C.3**

<b>Frequency</b>	<b>ASD (Acceleration Spectral Density) random vibration</b>
5 Hz to 20 Hz	0,96 m <sup>2</sup> /s <sup>3</sup>
20 Hz to 500 Hz	0,96 m <sup>2</sup> /s <sup>3</sup> at 20 Hz, thereafter -3 dB/Octave

Outside the specified frequency range the UE, if powered on, shall not make ineffective use of the radio frequency spectrum. In no case shall the UE exceed the transmitted levels as defined in S4.01A for extreme operation.

## Annex D (informative): Terminal capabilities (TDD)

This section provides the UE capabilities related to 25.102.

This section shall be aligned with TS25.306, UE Radio Access Capabilities regarding TDD RF parameters. These RF UE Radio Access capabilities represent options in the UE, that require signalling to the network.

Table D.1 provides the list of UE radio access capability parameters and possible values for 25.102

**Table D.1: RF UE Radio Access Capabilities**

	<b>UE radio access capability parameter</b>	<b>Value range</b>
TDD RF parameters	UE power class (25.102 section 6.2.1)	2, 3 NOTE: Only power classes 2 and 3 are part of R99
	Radio frequency bands (25.102 section 5.2)	a), b), c), a+b), a+c), b+c, a+b+c)
	Chip rate capability (25.102)	3.84 Mcps, 1.28 Mcps respectively

## Annex E (informative): Change history

TSG	29	CR	R	Title	Cat	Curr	New	Work Item
RP-29				Rel-7 version created based on v6.2.0			7.0.0	
RP-29	RP-050501	0153		Introduction of UMTS 2.6GHz operating band for TDD	B	6.1.0	7.0.0	RinImp-UMTS2600TDD
RP-29	RP-050501	0154		UMTS 2.6 GHz TDD Propagation Conditions	B	6.1.0	7.0.0	RinImp-UMTS2600TDD
RP-29	RP-050501	0155		UMTS 2.6 GHz TDD UE Receiver Specifications	B	6.1.0	7.0.0	RinImp-UMTS2600TDD
RP-29	RP-050501	0156	2	Channel Raster and UARFCN for 3.84 Mcps TDD in UMTS 2.6 GHz	B	6.1.0	7.0.0	RinImp-UMTS2600TDD
RP-29	RP-050501	0157		Introduction of UMTS 2.6 GHz new operating band for 1.28Mcps TDD	B	6.1.0	7.0.0	RinImp-UMTS2600TDD
RP-29	RP-050501	0158		Introduction of Propagation Conditions for UMTS 2.6 GHz for 1.28Mcps TDD	B	6.1.0	7.0.0	RinImp-UMTS2600TDD
RP-29	RP-050501	0159		Introduction of UMTS 2.6 GHz requirements for blocking and spurious emission of UE receiver for 1.28Mcps TDD	B	6.1.0	7.0.0	RinImp-UMTS2600TDD
RP-30	RP-050740	0160	1	Additional UE Tx Spurious Emission for co-existence with 2.6 GHz FDD	B	7.0.0	7.1.0	RinImp-UMTS2600TDD
RP-31	RP-060104	0162	1	Modifications to HSDPA test parameters for 1.28Mcps TDD	A	7.1.0	7.2.0	TEI6
RP-31	RP-060113	0163	1	MBMS Requirements for MCCH & MTCH channels	B	7.1.0	7.2.0	MBMS-RAN-RF-TDD
RP-32	RP-060313	0165	2	1.28Mcps TDD MBMS UE performance requirements	B	7.2.0	7.3.0	MBMS-RAN-RF-TDD
RP-32	RP-060309	0166	1	7.68 Mcps Frequency Band & Channel Arrangement	B	7.2.0	7.3.0	VHCRTDD-RF
RP-32	RP-060309	0167	2	7.68 Mcps UE Transmitter Characteristics	B	7.2.0	7.3.0	VHCRTDD-RF
RP-32	RP-060309	0168		7.68 Mcps UE Receiver Characteristics	B	7.2.0	7.3.0	VHCRTDD-RF
RP-32	RP-060309	0169		7.68 Mcps – Channel Performance	B	7.2.0	7.3.0	VHCRTDD-RF
RP-32	RP-060309	0170	1	7.68 Mcps Measurement Channels & Propagation Conditions	B	7.2.0	7.3.0	VHCRTDD-RF
RP-33	RP-060522	0180		HS-SCCH performance requirement for 3.84 Mcps TDD option and 7.68 Mcps TDD option		7.3.0	7.4.0	TEI7
RP-33	RP-060516	0185	1	Out of band blocking for 3.84 Mcps and 7.68 Mcps TDD UE operating in 2010-2025 MHz of band (a) in Japan.		7.3.0	7.4.0	TEI7
RP-33	RP-060517	0190		Clarification of Tx spurious emission level from 3.84 Mcps and 7.68 Mcps TDD UE into PHS band		7.3.0	7.4.0	TEI7
RP-33	RP-060529	0192		Editorial corrections to 3.84 Mcps TDD UE performances on MBMS.		7.3.0	7.4.0	TEI7
RP-33	RP-060528	0193		Performance requirements for 3.84 Mcps E-DCH associated downlink signalling channels: E-AGCH and E-HICH		7.3.0	7.4.0	TEI7
RP-33	RP-060526	0194		7.68 Mcps Operations in 2.6 GHz band		7.3.0	7.4.0	TEI7
RP-33	RP-060530	0195		Clarification of 7.68 Mcps TDD UE ACLR at +/- 10 MHz offset.		7.3.0	7.4.0	MBMS-RAN-RF-TDD

RP-33	RP-060530	0196		Performance requirements for 3.84 Mcps E-DCH associated downlink signalling channels: E-AGCH and E-HICH		7.3.0	7.4.0	EDCHTDD-RF
RP-34	RP-060810	0200		Combined MBMS demodulation and Cell identification requirement for 1.28 Mcps TDD	A	7.4.0	7.5.0	TEI6
RP-34	RP-060818	0198		Performance requirements for 7.68 Mcps E-DCH associated downlink signalling channels: E-AGCH and E-HICH	B	7.4.0	7.5.0	TEI7
RP-34	RP-060816	0197		PLCCH Performance Requirement	B	7.4.0	7.5.0	RANimp-RABSE-CodOptLCRTDD
RP-35	RP-070081	0209		Modificaiton to SEM for 1.28Mcps TDD	A	7.5.0	7.6.0	TEI4
RP-35	RP-070082	0201		Performance requirements for 7.68 Mcps E-DCH associated downlink signalling channels: E-AGCH and E-HICH	B	7.5.0	7.6.0	TEI7
RP-35	RP-070082	0203		Corrections & clarifications on 7.68 Mcps TDD MTCH demodulation test case.	F	7.5.0	7.6.0	TEI7
RP-35	RP-070085	0202		Performance requirements for MTCH using 16QAM in an extended delay spread environment	B	7.5.0	7.6.0	MBMSE-RANPhysTDD
RP-35	RP-070085	0211		Performance requirement for MCCH in an extended delay spread environment	B	7.5.0	7.6.0	MBMSE-RANPhysTDD
RP-36	RP-070376	0225		Performance requirements for MCCH in an extended delay spread environment.	F	7.6.0	7.7.0	MBMSE-RANPhysTDD
RP-36	RP-070376	0212	1	MCCH & MTCH Channels Performances in TDD MBSFN	B	7.6.0	7.7.0	MBMSE-RANPhysTDD
RP-36	RP-070376	0224	1	Performance requirements for MTCH using 16QAM in an extended delay spread environment.	F	7.6.0	7.7.0	MBMSE-RANPhysTDD
RP-36	RP-070376	0213	1	Performance requirement for MTCH in a MBSFN TDD UE sharing the same platform with a FDD UE	B	7.6.0	7.7.0	MBMSE-RANPhysTDD
RP-36	RP-070377	0223	1	Performance requirements for 1.28 Mcps E-DCH associated downlink signalling channels: E-AGCH and E-HICH	B	7.6.0	7.7.0	LCRTDD-EDCH-RF
RP-36	RP-070373	0222	1	Updating of HSDPA demodulation performance requirements for 1.28Mcps TDD	A	7.6.0	7.7.0	TEI7
RP-36	RP-070373	0216		Updating of HSDPA demodulation performance requirements for 1.28Mcps TDD-FRC	A	7.6.0	7.7.0	TEI7
RP-36	RP-070373	0219		Updating of HSDPA demodulation performance requirements for 1.28Mcps TDD-VRC	A	7.6.0	7.7.0	TEI7
RP-37	RP-070651	0243		Change to HSDPA for 1.28 Mcps TDD	F	7.7.0	7.8.0	TEI7
RP-37	RP-070651	0240		Correction of UE maximum output power classes for 1.28 Mcps TDD option	F	7.7.0	7.8.0	TEI7
RP-37	RP-070651	0230		Inclusion of 7.68 Mcps in the scope of document	D	7.7.0	7.8.0	TEI7
RP-37	RP-070651	0232		Clarification of MBMS test for LCR TDD	A	7.7.0	7.8.0	TEI7
RP-37	RP-070652	0229		Requirements for maximum Input level for HS-PDSCH reception	A	7.7.0	7.8.0	TEI7
RP-37	RP-070654	0234		Performance Requirements for TDD MBSFN Channels	B	7.7.0	7.8.0	MBMSE-RANPhysTDD
RP-38	RP-070935	0244		LCR TDD MBSFN UE demodulation performance requirements	B	7.8.0	7.9.0	MBMSE-RANPhysLCRTDD
RP-38	RP-070937	0245		Relative delay corrections in Extended Delay Spread propagation condition	F	7.8.0	7.9.0	TEI7
RP-39	RP-080118	0250		Adding EVM requirement for UL 16QAM	F	7.9.0	7.10.0	LCRTDD-EDCH-RF
RP-39	RP-080118	0251	1	Adding requirements for MBSFN capable UE (dedicated carrier case)	F	7.9.0	7.10.0	MBMS-RANPhysLCRTDD
RP-39	RP-080119	0246		Omissions of minimum requirements for blocking characteristics	F	7.9.0	7.10.0	TEI6

RP-39	RP-080119	0249		Deleting redundant notes for receiver spurious emissions	F	7.9.0	7.10.0	TEI6
RP-40	RP-080324	0263		Clarification of MCCH Physical Channel for MBSFN	F	7.10.0	7.11.0	MBMSE-RANPhysTDD
RP-40	RP-080324	0262		Correction to MTCH parameters for demodulation test in TDD MBSFN	F	7.10.0	7.11.0	MBMSE-RANPhysTDD
RP-40	RP-080324	0257		Corrections for LCR TDD MBMS	F	7.10.0	7.11.0	MBMSE-RANPhysTDD
RP-40	RP-080324	0256		MBSFN Reference Channel	F	7.10.0	7.11.0	MBMSE-RANPhysTDD
RP-41	RP-080628	0268		RF requirements in later releases	A	7.11.0	7.12.0	RinImp8-UMTS2300TDD
RP-42	RP-080899	0278	1	UE reference measurement channel and performance requirement for 384kbps service	A	7.12.0	7.13.0	TEI4
RP-43	RP-090168	0283		Introduction of multi-carrier HSDPA RF requirement for LCR TDD	F	7.13.0	7.14.0	TEI7
RP-43	RP-090169	0287		Correction on MBSFN MCCH Slot Format	F	7.13.0	7.14.0	MBMSE-RANPhysTDD
RP-44	RP-090539	0299		Correction concerning scope of applicability for Extended Delay Spread propagation conditions	F	7.14.0	7.15.0	MBMSE-RANPhysTDD
RP-46	RP-091260	314	1	Maximum output power with E-DCH for TDD And FRC (Technically endorsed at RAN 4 52bis in R4-093559)	F	7.15.0	7.16.0	TEI7
RP-47	RP-100256	325	1	Maximum output power with multi-code for TDD	F	7.16.0	7.17.0	TEI7
RP-47	RP-100256	325	1	Maximum output power with multi-code for TDD	F	7.16.0	7.17.0	TEI7
RP-47	RP-100256	319		Demodulation of DCH in birth-death conditions for TDD	F	7.16.0	7.17.0	TEI7
RP-49	RP-100913	329		Correction of 1.28Mcps TDD spectrum emission mask requirement	F	7.17.0	7.18.0	TEI7

---

## History

<b>Document history</b>		
V7.1.0	December 2005	Publication
V7.2.0	March 2006	Publication
V7.3.0	June 2006	Publication
V7.4.0	October 2006	Publication
V7.5.0	December 2006	Publication
V7.6.0	March 2007	Publication
V7.7.0	June 2007	Publication
V7.8.0	October 2007	Publication
V7.9.0	January 2008	Publication
V7.10.0	April 2008	Publication
V7.11.0	June 2008	Publication
V7.12.0	October 2008	Publication
V7.13.0	January 2009	Publication
V7.14.0	March 2009	Publication
V7.15.0	July 2009	Publication
V7.16.0	February 2010	Publication
V7.17.0	April 2010	Publication
V7.18.0	October 2010	Publication