

ETSI TS 125 102 V8.11.0 (2011-10)



**Universal Mobile Telecommunications System (UMTS);
User Equipment (UE) radio transmission and reception (TDD)
(3GPP TS 25.102 version 8.11.0 Release 8)**



ReferenceRTS/TSGR-0425102v8b0

KeywordsUMTS

ETSI

650 Route des Lucioles
F-06921 Sophia Antipolis Cedex - FRANCE

Tel.: +33 4 92 94 42 00 Fax: +33 4 93 65 47 16

Siret N° 348 623 562 00017 - NAF 742 C
Association à but non lucratif enregistrée à la
Sous-Préfecture de Grasse (06) N° 7803/88

Important notice

Individual copies of the present document can be downloaded from:

<http://www.etsi.org>

The present document may be made available in more than one electronic version or in print. In any case of existing or perceived difference in contents between such versions, the reference version is the Portable Document Format (PDF). In case of dispute, the reference shall be the printing on ETSI printers of the PDF version kept on a specific network drive within ETSI Secretariat.

Users of the present document should be aware that the document may be subject to revision or change of status. Information on the current status of this and other ETSI documents is available at

<http://portal.etsi.org/tb/status/status.asp>

If you find errors in the present document, please send your comment to one of the following services:

http://portal.etsi.org/chaicor/ETSI_support.asp

Copyright Notification

No part may be reproduced except as authorized by written permission.
The copyright and the foregoing restriction extend to reproduction in all media.

© European Telecommunications Standards Institute 2011.
All rights reserved.

DECT[™], **PLUGTESTS**[™], **UMTS**[™] and the ETSI logo are Trade Marks of ETSI registered for the benefit of its Members.
3GPP[™] and **LTE**[™] are Trade Marks of ETSI registered for the benefit of its Members and
of the 3GPP Organizational Partners.
GSM[®] and the GSM logo are Trade Marks registered and owned by the GSM Association.

Intellectual Property Rights

IPRs essential or potentially essential to the present document may have been declared to ETSI. The information pertaining to these essential IPRs, if any, is publicly available for **ETSI members and non-members**, and can be found in ETSI SR 000 314: *"Intellectual Property Rights (IPRs); Essential, or potentially Essential, IPRs notified to ETSI in respect of ETSI standards"*, which is available from the ETSI Secretariat. Latest updates are available on the ETSI Web server (<http://ipr.etsi.org>).

Pursuant to the ETSI IPR Policy, no investigation, including IPR searches, has been carried out by ETSI. No guarantee can be given as to the existence of other IPRs not referenced in ETSI SR 000 314 (or the updates on the ETSI Web server) which are, or may be, or may become, essential to the present document.

Foreword

This Technical Specification (TS) has been produced by ETSI 3rd Generation Partnership Project (3GPP).

The present document may refer to technical specifications or reports using their 3GPP identities, UMTS identities or GSM identities. These should be interpreted as being references to the corresponding ETSI deliverables.

The cross reference between GSM, UMTS, 3GPP and ETSI identities can be found under <http://webapp.etsi.org/key/queryform.asp>.

Contents

Intellectual Property Rights	2
Foreword.....	2
Foreword.....	11
1 Scope	12
2 References	12
3 Definitions, symbols and abbreviations	12
3.1 Definitions	12
3.2 (void).....	13
3.3 Abbreviations	13
4 General	14
4.1 Relationship between Minimum Requirements and Test Requirements	14
4.2 Power Classes.....	15
4.3 Control and monitoring functions	15
4.3.1 Minimum requirement	15
4.4 RF requirements in later releases	15
4.5 Applicability of requirements for MBSFN-only UEs	15
5 Frequency bands and channel arrangement.....	15
5.1 General	15
5.2 Frequency bands.....	15
5.3 TX-RX frequency separation	16
5.3.1 3.84 Mcps TDD Option	16
5.3.2 1.28 Mcps TDD Option	16
5.3.3 7.68 Mcps TDD Option	16
5.4 Channel arrangement.....	16
5.4.1 Channel spacing.....	16
5.4.1.1 3.84 Mcps TDD Option.....	16
5.4.1.2 1.28 Mcps TDD Option.....	16
5.4.1.3 7.68 Mcps TDD Option.....	16
5.4.2 Channel raster	16
5.4.2.1 3.84 Mcps TDD Option.....	17
5.4.3 Channel number	17
5.4.4 UARFCN	17
5.4.4.1 3.84 Mcps TDD Option.....	17
5.4.4.2 1.28 Mcps TDD Option.....	17
5.4.4.3 7.68 Mcps TDD Option.....	18
6 Transmitter characteristics	18
6.1 General	18
6.2 Transmit power	18
6.2.1 User Equipment maximum output power	18
6.2.1.1 3.84 Mcps TDD option	18
6.2.1.2 1.28 Mcps TDD option	19
6.2.1.3 7.68 Mcps TDD option	19
6.2.2 UE maximum output power with E-DCH	20
6.2.2.1 3.84 Mcps TDD option	20
6.2.2.2 1.28 Mcps TDD option	20
6.2.2.3 7.68 Mcps TDD option	20
6.2.3 UE maximum output power with multi-code	20
6.2.3.1 1.28 Mcps TDD option.....	20
6.3 UE frequency stability.....	21
6.4 Output power dynamics.....	21
6.4.1 Power control.....	21
6.4.1.1 3.84 Mcps option.....	21

6.4.1.1.1	Initial Accuracy	21
6.4.1.1.2	Differential accuracy, controlled input	21
6.4.1.1.3	Differential accuracy, measured input	21
6.4.1.2	1.28 Mcps TDD Option.....	22
6.4.1.2.1	Open loop power control	22
6.4.1.2.2	Closed loop power control.....	22
6.4.1.3	7.68 Mcps option.....	23
6.4.1.3.1	Initial Accuracy	23
6.4.1.3.2	Differential accuracy, controlled input	23
6.4.1.3.3	Differential accuracy, measured input	23
6.4.2	Minimum output power	23
6.4.2.1	Minimum requirement	23
6.4.2.1.1	3.84 Mcps TDD Option.....	23
6.4.2.1.2	1.28 Mcps TDD Option.....	23
6.4.2.1.3	7.68 Mcps TDD Option.....	24
6.4.3	Out-of-synchronisation handling of output power	24
6.4.3.1	Requirement for continuous transmission	24
6.4.3.1.1	3.84 Mcps TDD Option.....	24
6.4.3.1.2	1.28 Mcps TDD Option.....	25
6.4.3.1.2.1	Minimum Requirement.....	25
6.4.3.1.3	7.68 Mcps TDD Option.....	27
6.4.3.2	Requirement for discontinuous transmission	28
6.4.3.2.1	3.84 Mcps TDD Option.....	28
6.4.3.2.2	1.28 Mcps TDD Option.....	30
6.4.3.2.3	7.68 Mcps TDD Option.....	32
6.5	Transmit ON/OFF power	34
6.5.1	Transmit OFF power.....	34
6.5.1.1	Minimum Requirement	34
6.5.2	Transmit ON/OFF Time mask.....	34
6.5.2.1	Minimum Requirement	35
6.5.2.1.1	3.84 Mcps TDD Option.....	35
6.5.2.1.2	1.28 Mcps TDD Option.....	35
6.5.2.1.3	7.68 Mcps TDD Option.....	35
6.6	Output RF spectrum emissions.....	36
6.6.1	Occupied bandwidth	36
6.6.1.1	3.84 Mcps TDD Option.....	36
6.6.1.2	1.28 Mcps TDD Option.....	36
6.6.1.3	7.68 Mcps TDD Option.....	36
6.6.2	Out of band emission	36
6.6.2.1	Spectrum emission mask	36
6.6.2.1.1	3.84 Mcps TDD Option.....	36
6.6.2.1.2	1.28 Mcps TDD Option.....	37
6.6.2.1.3	7.68 Mcps TDD Option.....	38
6.6.2.2	Adjacent Channel Leakage power Ratio (ACLR).....	38
6.6.2.2.1	Minimum requirement.....	38
6.6.3	Spurious emissions	39
6.6.3.1	Minimum Requirement	39
6.6.3.1.1	3.84 Mcps TDD Option.....	39
6.6.3.1.2	1.28 Mcps TDD Option.....	40
6.6.3.1.3	7.68 Mcps TDD Option.....	41
6.7	Transmit intermodulation	42
6.7.1	Minimum requirement	42
6.7.1.1	3.84 Mcps TDD Option.....	42
6.7.1.2	1.28 Mcps TDD Option.....	42
6.7.1.3	7.68 Mcps TDD Option.....	42
6.8	Transmit Modulation.....	43
6.8.1	Transmit pulse shape filter.....	43
6.8.2	Error Vector Magnitude.....	43
6.8.2.1	Minimum Requirement	43
6.8.3	Peak Code Domain Error.....	43
6.8.3.1	Minimum Requirement	43

7	Receiver characteristics	44
7.1	General	44
7.2	Diversity characteristics	44
7.3	Reference sensitivity level.....	44
7.3.1	Minimum Requirements	44
7.3.1.1	3.84 Mcps TDD Option.....	44
7.3.1.2	1.28 Mcps TDD Option.....	45
7.3.1.3	7.68 Mcps TDD Option.....	45
7.3.2	Additional requirement of multi-carrier reception for 1.28Mcps TDD Option	45
7.4	Maximum input level	45
7.4.1	Minimum Requirements for DPCH reception	46
7.4.1.1	3.84 Mcps TDD Option.....	46
7.4.1.2	1.28 Mcps TDD Option.....	46
7.4.1.3	7.68 Mcps TDD Option.....	46
7.4.2	Minimum Requirements for HS-PDSCH reception.....	46
7.4.2.1	3.84 Mcps TDD Option.....	46
7.4.2.2	1.28 Mcps TDD Option.....	46
7.4.2.2.1	Minimum requirement for 16QAM.....	46
7.4.2.2.2	Minimum requirement for 64QAM.....	47
7.5	Adjacent Channel Selectivity (ACS).....	48
7.5.1	Minimum Requirement	48
7.5.1.1	3.84 Mcps TDD Option.....	48
7.5.1.2	1.28 Mcps TDD Option.....	48
7.5.1.3	7.68 Mcps TDD Option.....	49
7.5.2	Additional requirement of multi-carrier reception for 1.28Mcps TDD Option	49
7.6	Blocking characteristics	49
7.6.1	Minimum Requirement.....	50
7.6.1.1	3.84 Mcps TDD Option.....	50
7.6.1.2	1.28 Mcps TDD Option.....	51
7.6.1.3	7.68 Mcps TDD Option.....	53
7.6.2	Additional requirement of multi-carrier reception for 1.28Mcps TDD Option	54
7.7	Spurious response.....	55
7.7.1	Minimum Requirement.....	55
7.7.1.1	3.84 Mcps TDD Option.....	55
7.7.1.2	1.28 Mcps TDD Option.....	56
7.7.1.3	7.68 Mcps TDD Option.....	56
7.7.2	Additional requirement of multi-carrier reception for 1.28Mcps TDD Option	56
7.8	Intermodulation characteristics	57
7.8.1	Minimum Requirements	57
7.8.1.1	3.84 Mcps TDD Option.....	57
7.8.1.2	1.28 Mcps TDD Option.....	58
7.8.1.3	7.68 Mcps TDD Option.....	58
7.8.2	Additional requirement of multi-carrier reception for 1.28Mcps TDD Option	58
7.9	Spurious emissions	58
7.9.1	Minimum Requirement.....	59
7.9.1.1	3.84 Mcps TDD Option.....	59
7.9.1.2	1.28 Mcps TDD Option.....	59
7.9.1.3	7.68 Mcps TDD Option.....	60
8	Performance requirement	60
8.1	General	60
8.2	Demodulation in static propagation conditions	61
8.2.1	Demodulation of DCH.....	61
8.2.1.1	Minimum requirement	61
8.2.1.1.1	3.84 Mcps TDD Option.....	61
8.2.1.1.2	1.28 Mcps TDD Option.....	61
8.2.1.1.3	7.68 Mcps TDD Option.....	62
8.3	Demodulation of DCH in multipath fading conditions	63
8.3.1	Multipath fading Case 1.....	63
8.3.1.1	Minimum requirement	63
8.3.1.1.1	3.84 Mcps TDD Option.....	63
8.3.1.1.2	1.28 Mcps TDD Option.....	64

8.3.1.1.3	7.68 Mcps TDD Option.....	64
8.3.2	Multipath fading Case 2.....	65
8.3.2.1	Minimum requirement	65
8.3.2.1.1	3.84 Mcps TDD Option.....	65
8.3.2.1.2	1.28 Mcps TDD Option.....	66
8.3.2.1.3	7.68 Mcps TDD Option.....	66
8.3.3	Multipath fading Case 3.....	67
8.3.3.1	Minimum requirement	67
8.3.3.1.1	3.84 Mcps TDD Option.....	67
8.3.3.1.2	1.28 Mcps TDD Option.....	68
8.3.3.1.3	7.68 Mcps TDD Option.....	68
8.4	Base station transmit diversity mode for 3.84 Mcps TDD Option	69
8.4.1	Demodulation of BCH in SCTD mode	69
8.4.1.1	Minimum requirement	69
8.5	Power control in downlink	69
8.5.1	Power control in downlink, constant BLER target	69
8.5.1.1	Minimum requirements 3.84 Mcps TDD option.....	69
8.5.1.2	Minimum requirements 1.28 Mcps TDD option.....	70
8.5.2	Power control in downlink, wind up effects	71
8.5.2.1	Minimum requirements 3.84 Mcps TDD option.....	71
8.5.2.2	Minimum requirements 1.28 Mcps TDD option.....	71
8.5.3	Power control in the downlink, initial convergence.....	71
8.5.3.1	Minimum requirements 3.84 Mcps TDD option.....	71
8.5.3.2	Minimum requirements 1.28 Mcps TDD option.....	71
8.6	Uplink Power Control for 3.84 Mcps TDD Option.....	72
8.6.1	Test Conditions	72
8.6.2	Performance.....	73
8.7	Demodulation of DCH in moving conditions.....	73
8.7.1	Minimum requirement	73
8.7.1.1	3.84 Mcps TDD Option.....	73
8.7.1.2	1.28 Mcps TDD Option.....	74
8.7.1.3	7.68 Mcps TDD Option.....	74
8.8	Demodulation of DCH in birth-death conditions	74
8.8.1	Minimum requirement	74
8.8.1.1	3.84 Mcps TDD Option.....	74
8.8.1.2	1.28 Mcps TDD Option.....	75
8.8.1.3	7.68 Mcps TDD Option.....	75
9	Performance requirements (HSDPA).....	75
9.1	Performance requirement for 3.84 Mcps TDD option.....	75
9.1.1	HS-DSCH throughput for fixed reference channels	75
9.1.1.1	Minimum requirement QPSK, Fixed Reference Channel, 7,3 Mbps - Category 8 - UE.....	76
9.1.1.2	Minimum requirement 16QAM, Fixed Reference Channel, 7,3 Mbps - Category 8 - UE.....	76
9.1.2	HS-DSCH throughput for Variable Reference Channels.....	77
9.1.2.1	Minimum requirement Variable Reference Channel, 7,3 Mbps - Category 8 - UE.....	77
9.1.3	Reporting of Channel Quality Indicator.....	78
9.1.3.1	Minimum requirement Channel Quality Indicator, 7,3 Mbps - Category 8 - UE.....	78
9.1.4	HS-SCCH Detection Performance.....	79
9.1.4.1	Minimum Requirements for HS-SCCH Detection.....	79
9.2	Performance requirements for 1.28 Mcps TDD option	80
9.2.1	HS-DSCH throughput for fixed reference channels	80
9.2.1.1	Category 1, 0.5Mbps UE class	80
9.2.1.2	Category 4, 1.1Mbps UE class	81
9.2.1.3	Category 7, 1.6Mbps UE class	82
9.2.1.4	Category 10, 2.2Mbps UE class	83
9.2.1.5	Category 13, 2.8Mbps UE class	84
9.2.1.6	Category 16-24.....	85
9.2.1.7	Category 25	86
9.2.1.8	Category 26	87
9.2.1.9	Category 27	88
9.2.1.10	Category 28	89
9.2.1.11	Category 29	90

9.2.1.12	Category 30	91
9.2.2	HS-DSCH throughput for Variable Reference Channels.....	92
9.2.2.1	Category 1, 0.5Mbps UE class	92
9.2.2.2	Category 4, 1.1Mbps UE class	93
9.2.2.3	Category 7, 1.6Mbps UE class	94
9.2.2.4	Category 10, 2.2 Mbps UE class	95
9.2.2.5	Category 13, 2.8 Mbps UE class	96
9.2.3	Reporting of Channel Quality Indicator.....	97
9.2.3.1	Minimum Requirement-UE categories 1-24	97
9.2.3.2	Minimum Requirement-UE categories 25-27	98
9.2.3.3	Minimum Requirement-UE categories 28-30	99
9.2.4	HS-SCCH Detection Performance.....	100
9.2.4.1	Minimum Requirements for HS-SCCH Type 1 Detection.....	100
9.2.4.2	Minimum Requirements for HS-SCCH Type 4/5 Detection.....	101
9.2.4.3	Minimum Requirements for HS-SCCH Type 6/7/8/9 Detection	102
9.2.5	PLCCH Detection Performance.....	103
9.2.5.1	Minimum Requirements.....	103
9.3	Performance requirement for 7.68 Mcps TDD option.....	104
9.3.1	HS-DSCH throughput for fixed reference channels	104
9.3.1.1	Minimum requirement QPSK, Fixed Reference Channel, 5,3 Mbps - Category 8 - UE.....	104
9.3.1.2	Minimum requirement 16 QAM, Fixed Reference Channel, 5,3 Mbps - Category 8 - UE.....	105
9.3.2	(void)	106
9.3.3	(void)	106
9.3.4	HS-SCCH Detection Performance.....	106
9.3.4.1	Minimum Requirements for HS-SCCH Detection.....	106
10	Performance requirements (MBMS)	107
10.1	Demodulation of MCCH	107
10.1.1	Minimum requirement	107
10.1.1.1	3.84 Mcps TDD Option.....	107
10.1.1.2	1.28 Mcps TDD Option.....	108
10.1.1.3	7.68 Mcps TDD Option.....	108
10.1.2	MBSFN capable UE	109
10.1.2.1	3.84 Mcps TDD Option.....	109
10.1.2.1.1	Non-IMB	109
10.1.2.1.2	IMB	109
10.1.2.2	1.28 Mcps TDD Option.....	110
10.1.2.3	7.68 Mcps TDD Option.....	111
10.2	Demodulation of MTCH	111
10.2.1	Minimum requirement	111
10.2.1.1	3.84 Mcps TDD Option.....	111
10.2.1.2	1.28 Mcps TDD Option.....	112
10.2.1.3	7.68 Mcps TDD Option.....	112
10.2.2	MBSFN capable UE	113
10.2.2.1	3.84 Mcps TDD Option.....	113
10.2.2.1.1	Non-IMB	113
10.2.2.1.2	IMB	113
10.2.2.2	1.28 Mcps TDD Option.....	114
10.2.2.3	7.68 Mcps TDD Option.....	114
10.2.3	MBSFN TDD & FDD same platform sharing	115
10.2.3.1	3.84 Mcps TDD Option.....	115
10.2.3.1.1	Non-IMB	115
10.2.3.1.2	IMB	116
10.2.3.2	(void).....	116
10.2.3.3	7.68 Mcps TDD Option.....	116
10.3	Demodulation of MTCH and cell identification.....	117
10.3.1	Minimum requirement	117
10.3.1.1	(void).....	117
10.3.1.2	1.28 Mcps TDD Option.....	117
11	Performance requirement (E-DCH)	118
11.1	Detection of E-DCH HARQ ACK Indicator Channel (E-HICH).....	118

11.1.1	Minimum requirement	118
11.1.1.1	3.84 Mcps TDD Option.....	118
11.1.1.2	1.28 Mcps TDD Option.....	118
11.1.1.3	7.68 Mcps TDD Option.....	119
11.2	Demodulation of E-DCH Absolute Grant Channel (E-AGCH)	119
11.2.1	Minimum requirement	119
11.2.1.1	3.84 Mcps TDD Option.....	119
11.2.1.2	1.28 Mcps TDD Option.....	120
11.2.1.3	7.68 Mcps TDD Option.....	121
Annex A (normative): Measurement channels		122
A.1	(void).....	122
A.2	Reference measurement channel	122
A.2.1	UL reference measurement channel (12.2 kbps).....	122
A.2.1.1	3.84 Mcps TDD Option	122
A.2.1.2	1.28 Mcps TDD Option	123
A.2.1.3	7.68 Mcps TDD Option	124
A.2.2	DL reference measurement channel (12.2 kbps).....	125
A.2.2.1	3.84 Mcps TDD Option	125
A.2.2.2	1.28 Mcps TDD Option	126
A.2.2.3	7.68 Mcps TDD Option	127
A.2.3	DL reference measurement channel (64 kbps).....	128
A.2.3.1	3.84 Mcps TDD Option	128
A.2.3.2	1.28 Mcps TDD Option	129
A.2.3.3	7.68 Mcps TDD Option	130
A.2.4	DL reference measurement channel (144 kbps).....	132
A.2.4.1	3.84 Mcps TDD Option	132
A.2.4.2	1.28 Mcps TDD Option	134
A.2.4.3	7.68 Mcps TDD Option	135
A.2.5	DL reference measurement channel (384 kbps).....	137
A.2.5.1	3.84 Mcps TDD Option	137
A.2.5.2	1.28 Mcps TDD Option	139
A.2.5.3	7.68 Mcps TDD Option	140
A.2.6	BCH reference measurement channel	141
A.2.6.1	3.84 Mcps TDD Option	141
A.2.6.2	1.28 Mcps TDD Option	142
A.2.6.3	7.68 Mcps TDD Option	142
A.2.7	UL multi code reference measurement channel (12.2 kbps).....	143
A.2.7.1	3.84 Mcps TDD Option	143
A.2.7.2	1.28 Mcps TDD Option	144
A.2.7.3	7.68 Mcps TDD Option	145
A.2.8	DL reference measurement channel (2 Mbps).....	147
A.2.8.1	3.84 Mcps TDD Option	147
A.2.8.2	1.28 Mcps TDD Option	149
A.2.8.3	7.68 Mcps TDD Option	150
A.2.9	DL reference measurement channel for MBSFN only UEs	151
A.2.9.1	3.84 Mcps TDD Option	151
A.2.9.1.1	Non-IMB	151
A.2.9.1.2	IMB	153
A.2.9.2	VOID	154
A.2.9.3	7.68 Mcps TDD Option	154
A.3	HSDPA reference measurement channels.....	156
A.3.1	HSDPA reference measurement channels for 3,84 Mcps TDD option	156
A.3.1.1	Reference measurement channels for 7,3 Mbps - Category 8 - UE	156
A.3.1.1.1	QPSK modulation scheme for test 1, 2, 3	156
A.3.1.1.2	QPSK modulation scheme for test 4	157
A.3.1.1.3	16QAM modulation scheme for test 1, 2, 3	158
A.3.1.1.4	16QAM modulation scheme for test 4	159
A.3.2	HSDPA reference measurement channels for 1.28 Mcps TDD option	160
A.3.2.1	Reference measurement channels for 0.5 Mbps UE class	160

A.3.2.1.1	QPSK modulation scheme	160
A.3.2.2	Reference measurement channels for 1.1 Mbps UE class	161
A.3.2.2.1	QPSK modulation scheme	161
A.3.2.2.2	16QAM modulation scheme	161
A.3.2.3	Reference measurement channels for 1.6 Mbps UE class	162
A.3.2.3.1	QPSK modulation scheme	162
A.3.2.3.2	16QAM modulation scheme	163
A.3.2.4	Reference measurement channels for 2.2 Mbps UE class	164
A.3.2.4.1	QPSK modulation scheme	164
A.3.2.4.2	16QAM modulation scheme	165
A.3.2.5	Reference measurement channels for 2.8 Mbps UE class	166
A.3.2.5.1	QPSK modulation scheme	166
A.3.2.5.2	16QAM modulation scheme	167
A.3.2.6	PLCCH reference measurement channel	168
A.3.2.7	Reference measurement channels for Category 16-24 UE	169
A.3.2.7.1	Reference measurement channel for category 16-18 UE	169
A.3.2.7.2	Reference measurement channel for category 19-21 UE	170
A.3.2.7.3	Reference measurement channel for category 22-24 UE	171
A.3.2.8	Reference measurement channel of 48kbps	172
A.3.2.9	Reference Measurement Channel of HS-SICH	173
A.3.2.10	Reference Measurement Channel for category 25 UE	174
A.3.2.10.1	QPSK modulation scheme	174
A.3.2.10.2	16QAM modulation scheme	175
A.3.2.11	Reference Measurement Channel for category 26 UE	177
A.3.2.11.1	QPSK modulation scheme	177
A.3.2.11.2	16QAM modulation scheme	179
A.3.2.12	Reference Measurement Channel for category 27 UE	181
A.3.2.12.1	QPSK modulation scheme	181
A.3.2.12.2	16QAM modulation scheme	183
A.3.2.13	Reference Measurement Channel for category 28 UE	185
A.3.2.13.1	64QAM modulation scheme	185
A.3.2.14	Reference Measurement Channel for category 29 UE	187
A.3.2.14.1	64QAM modulation scheme	187
A.3.2.15	Reference Measurement Channel for category 30 UE	189
A.3.2.15.1	64QAM modulation scheme	189
A.3.2A	HSDPA reference measurement channels for 7,68 Mcps TDD option	191
A.3.2A.1	Reference measurement channels for 5,3 Mbps - Category 8 - UE	191
A.3.2A.1.1	QPSK modulation scheme for test 1, 2, 3 & 4	191
A.3.2A.1.2	16QAM modulation scheme for test 1, 2, 3 & 4	192
A.3.3	Variable Reference Channel definition for 3,84 Mcps and 1,28 Mcps TDD options	193
A.4	Downlink reference parameter for MBMS tests	193
A.4.1	MCCH	193
A.4.1.1	3.84 Mcps TDD Option	193
A.4.1.1.1	Non-IMB	193
A.4.1.1.2	IMB	194
A.4.1.2	1.28 Mcps TDD Option	195
A.4.1.3	7.68 Mcps TDD Option	195
A.4.2	MTCH	196
A.4.2.1	3.84 Mcps TDD Option	196
A.4.2.1.1	Non-IMB	196
A.4.2.1.2	IMB	197
A.4.2.2	1.28 Mcps TDD Option	197
A.4.2.3	7.68 Mcps TDD Option	198
A.5	HSUPA reference measurement channels for 1.28Mcps TDD option	199
A.5.1	Fixed reference channel 1(FRC1) for 16QM	199
Annex B (normative):	Propagation conditions	201
B.1	Static propagation condition	201
B.2	Multi-path fading propagation conditions	201

B.2.1	3.84 Mcps TDD Option.....	201
B.2.2	1.28 Mcps TDD Option.....	203
B.2.3	7.68 Mcps TDD Option.....	205
B.3	MIMO propagation conditions.....	207
B.3.1	3.84 Mcps TDD Option.....	207
B.3.2	1.28 Mcps TDD Option.....	207
B.3.2.1	MIMO Dual Stream Static Orthogonal Conditions	207
B.3.3	7.68 Mcps TDD Option.....	208
B.4	Moving propagation conditions.....	208
B.5	Birth-Death propagation conditions	209
Annex C (normative):	Environmental conditions	210
C.1	General	210
C.2	Environmental requirements for the UE	210
C.2.1	Temperature	210
C.2.2	Voltage	210
C.2.3	Vibration.....	211
Annex D (informative):	Terminal capabilities (TDD)	212
Annex E (informative):	Change history	213
History		217

Foreword

This Technical Specification has been produced by the 3GPP.

The contents of the present document are subject to continuing work within the TSG and may change following formal TSG approval. Should the TSG modify the contents of this TS, it will be re-released by the TSG with an identifying change of release date and an increase in version number as follows:

Version 3.y.z

where:

- x the first digit:
 - 1 presented to TSG for information;
 - 2 presented to TSG for approval;
 - 3 Indicates TSG approved document under change control.
- y the second digit is incremented for all changes of substance, i.e. technical enhancements, corrections, updates, etc.
- z the third digit is incremented when editorial only changes have been incorporated in the specification;

1 Scope

This document establishes the minimum RF characteristics of all three options of the TDD mode of UTRA. The three options are the 3.84 Mcps, 1.28 Mcps and 7.68 Mcps options respectively. The requirements are listed in different subsections only if the parameters deviate.

2 References

The following documents contain provisions, which, through reference in this text, constitute provisions of the present document.

- References are either specific (identified by date of publication, edition number, version number, etc.) or non-specific.
- For a specific reference, subsequent revisions do not apply.
- For a non-specific reference, the latest version applies. In the case of a reference to a 3GPP document (including a GSM document), a non-specific reference implicitly refers to the latest version of that document *in the same Release as the present document*.

- [1] ETSI ETR 273-1-2: "Electromagnetic compatibility and Radio spectrum Matters (ERM); Improvement of radiated methods of measurement (using test sites) and evaluation of the corresponding measurement uncertainties; Part 1: Uncertainties in the measurement of mobile radio equipment characteristics; Sub-part 2: Examples and annexes".
- [2] 3GPP TS 25.306: "UE Radio Access capabilities definition".
- [3] ITU-R Recommendation SM.329: "Unwanted emissions in the spurious domain".
- [4] 3GPP TS 25.307: "Requirements on User Equipments (UEs) supporting a release-independent frequency band".
- [5] 3GPP TS 25.346: "Introduction of the Multimedia Broadcast/Multicast Service (MBMS) in the Radio Access Network (RAN)".

3 Definitions, symbols and abbreviations

3.1 Definitions

For the purposes of the present document, the following definitions apply:

Power Spectral Density: The units of Power Spectral Density (PSD) are extensively used in this document. PSD is a function of power versus frequency and when integrated across a given bandwidth, the function represents the mean power in such a bandwidth. When the mean power is normalised to (divided by) the chip-rate it represents the mean energy per chip. Some signals are directly defined in terms of energy per chip, (DPCH_Ec, Ec, and P-CCPCH_Ec) and others defined in terms of PSD (Io, Ioc, Ior and \hat{I} or). There also exist quantities that are a ratio of energy per chip to PSD (DPCH_Ec/Ior, Ec/Ior etc.). This is the common practice of relating energy magnitudes in communication systems.

It can be seen that if both energy magnitudes in the ratio are divided by time, the ratio is converted from an energy ratio to a power ratio, which is more useful from a measurement point of view. It follows that an energy per chip of X dBm/3.84 MHz (3.84 Mcps TDD option) or X dBm/1.28 MHz (1.28 Mcps TDD option) can be expressed as a mean power per chip of X dBm. Similarly, a signal PSD of Y dBm/3.84 MHz (3.84 Mcps TDD option) or Y dBm/1.28 MHz (1.28 Mcps TDD option) can be expressed as a signal power of Y dBm.

Maximum Output Power: This is a measure of the maximum power the UE can transmit (i.e. the actual power as would be measured assuming no measurement error) in a bandwidth of at least $(1 + \alpha)$ times the chip rate of the radio

access mode. The period of measurement shall be a transmit timeslot excluding the guard period. For multi-carrier transmission of 1.28Mcps TDD Option, it refers to maximum power per carrier the UE can transmit.

Mean Power: When applied to a CDMA modulated signal this is the power (transmitted or received) in a bandwidth of at least $(1 + \alpha)$ times the chip rate of the radio access mode. The period of measurement shall be a transmit timeslot excluding the guard period unless otherwise stated.

RRC Filtered Mean Power: The mean power as measured through a root raised cosine filter with roll-off factor α and a bandwidth equal to the chip rate of the radio access mode.

Nominal Maximum Output Power: This is the nominal power defined by the UE power class. The period of measurement shall be a transmit timeslot excluding the guard period. For multi-carrier transmission of 1.28Mcps TDD Option, it refers to maximum power per carrier the UE can transmit by the UE power class.

Received Signal Code Power (RSCP): Given only signal power is received, the RRC filtered mean power of the received signal after despreading and combining.

Interference Signal Code Power (ISCP): Given only interference power is received, the RRC filtered mean power of the received signal after despreading to the code and combining. Equivalent to the RSCP value but now only interference is received instead of signal.

Multi-carrier reception: For 1.28Mcps TDD Option, it refers to the HS-DSCH reception on multiple carriers in a TTI for a UE. The assigned carriers for a UE should be contiguous.

Multi-carrier transmission: For 1.28Mcps TDD Option, it refers to the HS-SICH transmission on multiple carriers simultaneously for a UE. The assigned carriers for a UE should be contiguous.

NOTE 1: The RRC filtered mean power of a perfectly modulated CDMA signal is 0.246 dB lower than the mean power of the same signal.

NOTE 2: The roll-off factor α is defined in section 6.8.1.

MBSFN-only UE: A UE operable in receive mode only (for the purpose of MBSFN reception).

3.2 (void)

3.3 Abbreviations

For the purposes of the present document, the following abbreviations apply:

ACIR	Adjacent Channel Interference Ratio
ACLR	Adjacent Channel Leakage power Ratio
ACS	Adjacent Channel Selectivity
BS	Base Station
BER	Bit Error Ratio
BLER	Block Error Ratio
CQI	Channel Quality Indicator
CW	Continuous wave (unmodulated signal)
DL	Down link (forward link)
DTX	Discontinuous Transmission
DPCH	Dedicated physical channel
DPCH_Ec	Average energy per PN chip for DPCH

$\frac{DPCH_Ec}{I_{or}}$

The ratio of the average energy per PN chip of the DPCH to the total transmit power spectral density of the downlink at the BS antenna connector

$\frac{\sum DPCH_Ec}{I_{or}}$

I_{or}

The ratio of the sum of DPCH_Ec for one service in case of multicode to the total transmit power spectral density of the downlink at the BS antenna connector

E-DCH	Enhanced Dedicated Channel
E-AGCH	E-DCH Absolute Grant Channel

E-HICH	E-DCH HARQ ACK Indicator Channel
EIRP	Effective Isotropic Radiated Power
FDD	Frequency Division Duplexing
FER	Frame Error Ratio
Fuw	Frequency of unwanted signal. This is specified in bracket in terms of an absolute frequency(s) or frequency offset from the assigned channel frequency. For multi-carrier reception of 1.28Mcps TDD Option, negative offsets refer to the assigned channel frequency of the lowest carrier frequency used and positive offsets refer to the assigned channel frequency of the highest carrier frequency used.
Hybrid ARQ	Hybrid Automatic Repeat reQuest
HSDPA	High Speed Downlink Packet Access
HS-DSCH	High Speed Downlink Shared Channel
HS-PDSCH	High Speed Physical Downlink Shared Channel
HS-SCCH	High Speed Shared Control Channel
IMB	Integrated Mobile Broadcast
Ioc	The power spectral density (integrated in a noise bandwidth equal to the chip rate and normalized to the chip rate) of a band limited white noise source (simulating interference from other cells) as measured at the UE antenna connector. For multi-carrier reception of 1.28Mcps TDD Option, Ioc is defined for each of the carrier individually and is assumed to be equal for all carriers unless explicitly stated per carrier.
Ior	The total transmit power spectral density (integrated in a bandwidth of $(1+\alpha)$ times the chip rate and normalized to the chip rate) of the downlink signal at the BS antenna connector. For multi-carrier reception of 1.28Mcps TDD Option, Ior is defined for each of the carrier individually and is assumed to be equal for all carriers unless explicitly stated per carrier.
\hat{I}_{or}	The received power spectral density (integrated in a bandwidth of $(1+\alpha)$ times the chip rate and normalized to the chip rate) of the downlink signal as measured at the UE antenna connector. For multi-carrier reception of 1.28Mcps TDD Option, \hat{I}_{or} is defined for each of the carrier individually and is assumed to be equal for all carriers unless explicitly stated per carrier.
MBMS	Multimedia Broadcast and Multicast Service
MBSFN	MBMS over a Single Frequency Network
MCCH	MBMS point-to-multipoint Control Channel
MTCH	MBMS point-to-multipoint Traffic Channel
OCNS	Orthogonal Channel Noise Simulator, a mechanism used to simulate the users or control signals on the other orthogonal channels of a downlink link.
P-CCPCH	Primary Common Control Physical Channel
PCH	Paging Channel
PPM	Parts Per Million
RACH	Random Access Channel
RSSI	Received Signal Strength Indicator
R	Number of information bits per second excluding CRC bits successfully received on HS-DSCH by a HSDPA capable UE.
RU	Resource Unit
SCTD	Space Code Transmit Diversity
SIR	Signal to Interference ratio
TDD	Time Division Duplexing
TPC	Transmit Power Control
UE	User Equipment
UL	Up link (reverse link)
UTRA	UMTS Terrestrial Radio Access

4 General

4.1 Relationship between Minimum Requirements and Test Requirements

The Minimum Requirements given in this specification make no allowance for measurement uncertainty. The test specification 34.122 Annex F defines Test Tolerances. These Test Tolerances are individually calculated for each test.

The Test Tolerances are used to relax the Minimum Requirements in this specification to create Test Requirements. The measurement results returned by the test system are compared - without any modifications - against the Test Requirements as defined by the shared risk principle.

The Shared Risk principle is defined in ETR 273 Part 1 sub-part 2 section 6.5.

4.2 Power Classes

For UE power classes 1 and 4, a number of RF parameter are not specified. It is intended that these are part of a later release.

4.3 Control and monitoring functions

This requirement verifies that the control and monitoring functions of the UE prevent it from transmitting if no acceptable cell can be found by the UE.

4.3.1 Minimum requirement

The power of the UE, as measured with a thermal detector, shall not exceed -30dBm if no acceptable cell can be found by the UE.

4.4 RF requirements in later releases

The standardisation of new frequency bands may be independent of a release. However, in order to implement a UE that conforms to a particular release but supports a band of operation that is specified in a later release, it is necessary to specify some extra requirements. TS 25.307 [4] specifies requirements on UEs supporting a frequency band that is independent of release.

NOTE: For terminals conforming to the 3GPP release of the present document, some RF requirements in later releases may be mandatory independent of whether the UE supports the bands specified in later releases or not. The set of requirements from later releases that is also mandatory for UEs conforming to the 3GPP release of the present document is determined by regional regulation.

4.5 Applicability of requirements for MBSFN-only UEs

Only relevant sections are applicable to MBSFN-only UE operation (which also includes IMB [5]). Furthermore, for the case of IMB, only the 3.84Mcps TDD option shall apply.

5 Frequency bands and channel arrangement

5.1 General

The information presented in this section is based on the chip rates of 3.84 Mcps Option, 1.28 Mcps Option and 7.68 Mcps Option.

NOTE: Other chip rates may be considered in future releases.

5.2 Frequency bands

UTRA/TDD is designed to operate in the following bands;

- a) 1900 - 1920 MHz: Uplink and downlink transmission
- 2010 - 2025 MHz: Uplink and downlink transmission

- b) 1850 - 1910 MHz: Uplink and downlink transmission
1930 - 1990 MHz: Uplink and downlink transmission
- c) 1910 - 1930 MHz: Uplink and downlink transmission
- d) 2570 - 2620 MHz: Uplink and downlink transmission
- e) 2300—2400 MHz: Uplink and downlink transmission
- f) 1880 - 1920 MHz: Uplink and downlink transmission

Note: Deployment in existing or other frequency bands is not precluded.

5.3 TX-RX frequency separation

5.3.1 3.84 Mcps TDD Option

No TX-RX frequency separation is required as Time Division Duplex (TDD) is employed. Each TDMA frame consists of 15 timeslots where each timeslot can be allocated to either transmit or receive.

5.3.2 1.28 Mcps TDD Option

No TX-RX frequency separation is required as Time Division Duplex (TDD) is employed. Each subframe consists of 7 main timeslots where all main timeslots (at least the first one) before the single switching point are allocated DL and all main timeslots (at least the last one) after the single switching point are allocated UL.

5.3.3 7.68 Mcps TDD Option

No TX-RX frequency separation is required as Time Division Duplex (TDD) is employed. Each TDMA frame consists of 15 timeslots where each timeslot can be allocated to either transmit or receive.

5.4 Channel arrangement

5.4.1 Channel spacing

5.4.1.1 3.84 Mcps TDD Option

The nominal channel spacing is 5 MHz, but this can be adjusted to optimise performance in a particular deployment scenario.

5.4.1.2 1.28 Mcps TDD Option

The nominal channel spacing is 1.6 MHz, but this can be adjusted to optimise performance in a particular deployment scenario.

5.4.1.3 7.68 Mcps TDD Option

The nominal channel spacing is 10 MHz, but this can be adjusted to optimise performance in a particular deployment scenario.

5.4.2 Channel raster

The channel raster is 200 kHz for all bands, which means that the carrier frequency must be a multiple of 200 kHz.

5.4.2.1 3.84 Mcps TDD Option

In addition a number of additional centre frequencies are specified according to table 5.1, which means that the centre frequencies for these channels are shifted 100 kHz relative to the general raster.

5.4.3 Channel number

The carrier frequency is designated by the UTRA absolute radio frequency channel number (UARFCN). The value of the UARFCN in the IMT2000 band is defined in the general case as follows:

$$N_t = 5 * F \quad 0.0 \text{ MHz} \leq F \leq 3276.6 \text{ MHz}$$

where F is the carrier frequency in MHz

Additional channels applicable to operation in the frequency band defined in sub-clause 5.2(d) are defined via the following UARFCN definition:

$$N_t = 5 * (F - 2150.1 \text{ MHz}) \quad 2572.5 \text{ MHz} \leq F \leq 2617.5 \text{ MHz}$$

5.4.4 UARFCN

5.4.4.1 3.84 Mcps TDD Option

The following UARFCN range shall be supported for each band:

Table 5.1: UTRA Absolute Radio Frequency Channel Number 3.84 Mcps TDD Option

Frequency Band	Frequency Range	UARFCN Uplink and Downlink transmission	Additional UARFCN Uplink and Downlink transmission
For operation in frequency band as defined in subclause 5.2 (a)	1900-1920 MHz 2010-2025 MHz	9512 to 9588 10062 to 10113	-
For operation in frequency band as defined in subclause 5.2 (b)	1850-1910 MHz 1930-1990 MHz	9262 to 9538 9662 to 9938	-
For operation in frequency band as defined in subclause 5.2 (c)	1910-1930 MHz	9562 to 9638	-
For operation in frequency band as defined in subclause 5.2 (d)	2570-2620 MHz	12862 to 13088	2112, 2137, 2162, 2187, 2212, 2237, 2262, 2287, 2312, 2337

5.4.4.2 1.28 Mcps TDD Option

The following UARFCN range shall be supported for each band:

Table 5.2: UTRA Absolute Radio Frequency Channel Number 1.28 Mcps TDD Option

Frequency Band	Frequency Range	UARFCN Uplink and Downlink transmission
For operation in frequency band as defined in subclause 5.2 (a)	1900-1920 MHz 2010-2025 MHz	9504 to 9596 10054 to 10121
For operation in frequency band as defined in subclause 5.2 (b)	1850-1910 MHz 1930-1990 MHz	9254 to 9546 9654 to 9946
For operation in frequency band as defined in subclause 5.2 (c)	1910-1930 MHz	9554 to 9646
For operation in frequency band as defined in subclause 5.2 (d)	2570-2620 MHz	12854 to 13096
For operation in frequency band as defined in subclause 5.2 (e)	2300-2400 MHz	11504 to 11996

For operation in frequency band as defined in subclause 5.2 (e)	1880-1920 MHz	9404 to 9596
---	---------------	--------------

5.4.4.3 7.68 Mcps TDD Option

The following UARFCN range shall be supported for each band:

Table 5.3: UTRA Absolute Radio Frequency Channel Number 7.68 Mcps TDD Option

Frequency Band	Frequency Range	UARFCN Uplink and Downlink transmission	Additional UARFCN Uplink and Downlink transmission
For operation in frequency band as defined in subclause 5.2 (a)	1900-1920 MHz 2010-2025 MHz	9512 to 9588 10062 to 10113	-
For operation in frequency band as defined in subclause 5.2 (b)	1850-1910 MHz 1930-1990 MHz	9262 to 9538 9662 to 9938	-
For operation in frequency band as defined in subclause 5.2 (c)	1910-1930 MHz	9562 to 9638	-
For operation in frequency band as defined in subclause 5.2 (d)	2570-2620 MHz	12874 to 13076	-

6 Transmitter characteristics

6.1 General

Unless detailed the transmitter characteristic are specified at the antenna connector of the UE. For UE with integral antenna only, a reference antenna with a gain of 0 dBi is assumed. Transmitter characteristics for UE(s) with multiple antennas/antenna connectors are FFS. For 1.28Mcps TDD MIMO capable UEs, transmitter characteristics are specified at each of the two antenna connectors,

The UE antenna performance has a significant impact on system performance and minimum requirements on the antenna efficiency are therefore intended to be included in future versions of this specification. It is recognised that different requirements and test methods are likely to be required for the different types of UE.

All the parameters in section 6 are defined using the UL reference measurement channel (12.2 kbps) specified in Annex A.2.1 unless explicitly stated otherwise. For UE supporting multi-carrier transmission of 1.28Mcps TDD Option, the HS-SICH reference measurement channel is specified in Annex A.3.2.9.

6.2 Transmit power

6.2.1 User Equipment maximum output power

The nominal maximum output power defined is the broadband transmit power of the UE, i.e. the power in a bandwidth of at least $(1+\alpha)$ times the chip rate of the radio access mode. The period of measurement shall be a transmit timeslot excluding the guard period.

6.2.1.1 3.84 Mcps TDD option

The power classes in Table 6.1 define the nominal maximum output power for 3.84 Mcps TDD options.

Table 6.1: UE power classes

Power Class	Nominal maximum output power	Tolerance
1	+30 dBm	+1 dB / -3 dB
2	+24 dBm	+1 dB / -3 dB
3	+21 dBm	+2 dB / -2 dB
4	+10 dBm	+4 dB / -4 dB

NOTE:

- 1) For multi-code operation the nominal maximum output power will be reduced by the difference of peak to average ratio between single and multi-code transmission.
- 2) The tolerance allowed for the nominal maximum power applies even at the multi code transmission mode.
- 3) For UE using directive antennas for transmission, a class dependent limit will be placed on the maximum EIRP (Equivalent Isotropic Radiated Power).

6.2.1.2 1.28 Mcps TDD option

The power classes in Table 6.2 define the nominal maximum output power for 1.28 Mcps TDD option.

Table 6.2: UE power classes for 1.28 Mcps TDD

Power Class	Nominal maximum output power	Tolerance
1	+33 dBm	+1 dB / -3 dB
2	+24 dBm	+1 dB / -3 dB
3	+21 dBm	+2 dB / -2 dB
4	+27 dBm	+1 dB / -3 dB

NOTE 1: The tolerance allowed for the nominal maximum power applies even at the multi code transmission mode.

NOTE 2: For UE using directive antennas for transmission, a class dependent limit will be placed on the maximum EIRP (Equivalent Isotropic Radiated Power).

6.2.1.3 7.68 Mcps TDD option

The power classes in Table 6.1 define the nominal maximum output power for 7.68 Mcps TDD options.

Table 6.3: UE power classes

Power Class	Nominal maximum output power	Tolerance
1	+30 dBm	+1 dB / -3 dB
2	+24 dBm	+1 dB / -3 dB
3	+21 dBm	+2 dB / -2 dB
4	+10 dBm	+4 dB / -4 dB

NOTE 1: For multi-code operation the nominal maximum output power will be reduced by the difference of peak to average ratio between single and multi-code transmission.

NOTE 2: The tolerance allowed for the nominal maximum power applies even at the multi code transmission mode.

NOTE 3: For UE using directive antennas for transmission, a class dependent limit will be placed on the maximum EIRP (Equivalent Isotropic Radiated Power).

6.2.2 UE maximum output power with E-DCH

6.2.2.1 3.84 Mcps TDD option

[FFS]

6.2.2.2 1.28 Mcps TDD option

The Maximum Power Reduction (MPR) for the nominal maximum output power defined in 6.2 is specified in table 6.4.

Table 6.4 UE maximum output power with E-DCH

UE transmit channel configuration	CM (dB)	MPR (dB)
E-DCH and E-UCCH	$0 \leq CM \leq 1.5$	CM

Where Cubic Metric (CM) is based on the UE transmit channel configuration and is given by

$$CM = \text{CEIL}\{[20 * \log_{10} ((v_{\text{norm}}^3)_{\text{rms}}) - 20 * \log_{10} ((v_{\text{norm_ref}}^3)_{\text{rms}})] / k, 0.5\}$$

Where

- CEIL{X,0.5} means rounding upwards to closest 0.5dB, i.e. $CM \in [0, 0.5, 1, 1.5]$
- v_{norm} is the normalized voltage waveform of the input signal
- $v_{\text{norm_ref}}$ is the normalized voltage waveform of the reference signal (12.2 kbps AMR Speech)
- k is 1.94
- $20 * \log_{10} ((v_{\text{norm_ref}}^3)_{\text{rms}}) = 1.22 \text{ dB}$

6.2.2.3 7.68 Mcps TDD option

[FFS]

6.2.3 UE maximum output power with multi-code

6.2.3.1 1.28 Mcps TDD option

The Maximum Power Reduction (MPR) for the nominal maximum output power defined in 6.2 is specified in table 6.2C.

Table 6.2C UE maximum output power with multi-code

UE transmit channel configuration	CM (dB)	MPR (dB)
For some combinations of; DPCH and HS-SICH/DPCH	$0 \leq CM \leq 2.5$	CM

Where Cubic Metric (CM) is based on the UE transmit channel configuration and is given by

$$CM = \text{CEIL}\{[20 * \log_{10} ((v_{\text{norm}}^3)_{\text{rms}}) - 20 * \log_{10} ((v_{\text{norm_ref}}^3)_{\text{rms}})] / k, 0.5\}$$

Where

- CEIL{X, 0.5} means rounding upwards to closest 0.5dB, i.e. $CM \in [0, 0.5, 1, 1.5, 2, 2.5]$
- v_{norm} is the normalized voltage waveform of the input signal
- $v_{\text{norm_ref}}$ is the normalized voltage waveform of the reference signal (12.2 kbps AMR Speech)
- k is 1.68

$$- 20 * \log_{10} ((v_{\text{norm_ref}}^3)_{\text{rms}}) = 1.22 \text{ dB}$$

6.3 UE frequency stability

The UE modulated carrier frequency shall be accurate to within ± 0.1 PPM observed over a period of one timeslot compared to carrier frequency received from the BS. These signals will have an apparent error due to BS frequency error and Doppler shift. In the later case, signals from the BS must be averaged over sufficient time that errors due to noise or interference are allowed for within the above ± 0.1 PPM figure. The UE shall use the same frequency source for both RF frequency generation and the chip clock.

6.4 Output power dynamics

Power control is used to limit the interference level.

6.4.1 Power control

6.4.1.1 3.84 Mcps option

Uplink power control is the ability of the UE transmitter to sets its output power in accordance with measured downlink path loss, values determined by higher layer signalling and path loss weighting parameter α as defined in TS 25.331. The output power is defined as the RRC filtered mean power of the transmit timeslot.

6.4.1.1.1 Initial Accuracy

The UE power control initial accuracy error shall be less than ± 9 dB under normal conditions and ± 12 dB under extreme conditions.

6.4.1.1.2 Differential accuracy, controlled input

The power control differential accuracy, controlled input, is defined as the error in the UE transmitter power step as a result of a step in SIR_{TARGET} when the path loss weighting parameter $\alpha=0$. The step in SIR_{TARGET} shall be rounded to the closest integer dB value. The power control error resulting from a change in I_{BTS} or DPCH Constant Value shall not exceed the values defined in Table 6.3.

Table 6.3: Transmitter power step tolerance as a result of control power step

$\Delta SIR_{\text{TARGET}}$ [dB]	Transmitter power step tolerance [dB]
$\Delta SIR_{\text{TARGET}} \leq 1$	± 0.5
$1 < \Delta SIR_{\text{TARGET}} \leq 2$	± 1
$2 < \Delta SIR_{\text{TARGET}} \leq 3$	± 1.5
$3 < \Delta SIR_{\text{TARGET}} \leq 10$	± 2
$10 < \Delta SIR_{\text{TARGET}} \leq 20$	± 4
$20 < \Delta SIR_{\text{TARGET}} \leq 30$	± 6
$30 < \Delta SIR_{\text{TARGET}}$	± 9 (note 1)
NOTE 1: Value is given for normal conditions. For extreme conditions value is ± 12	

6.4.1.1.3 Differential accuracy, measured input

The power control differential accuracy, measured input, is defined as the error in UE transmitter power step change as a result of a step change in path loss L_{PCCPCH} .

The error shall not exceed the sum of the following two errors:

- The power control error, resulting from a change in the path loss (ΔL_{PCCPCH}), the same tolerances as defined in table 6.3 shall apply,
- and the errors in the PCCPCH RSCP measurement as defined in TS 25.123.

6.4.1.2 1.28 Mcps TDD Option

6.4.1.2.1 Open loop power control

Open loop power control is the ability of the UE transmitter to sets its output power to a specific value. The open loop power control tolerance is given in Table 6.3A

6.4.1.2.1.1 Minimum requirement

The UE open loop power is defined as the RRC filtered mean power in a timeslot or ON power duration, whichever is available.

Table 6.3A: Open loop power control tolerance

Normal conditions	± 9 dB
Extreme conditions	± 12 dB

6.4.1.2.2 Closed loop power control

Closed loop power control in the Uplink is the ability of the UE transmitter to adjust its output power in accordance with one or more TPC commands received in the downlink.

6.4.1.2.2.1 Power control steps

The power control step is the change in the UE transmitter output power in response to a single TPC command, TPC_cmd, arrived at the UE.

6.4.1.2.2.1.1 Minimum requirement

The UE transmitter shall have the capability of changing the output power with a step size of 1, 2 and 3 dB according to the value of Δ_{TPC} or $\Delta_{\text{RP-TPC}}$ in the slot immediately after the TPC_cmd can be arrived.

- The transmitter output power step due to closed loop power control shall be within the range shown in Table 6.3B.
- The transmitter average output power step due to closed loop power control shall be within the range shown in Table 6.3C. Here a TPC_cmd group is a set of TPC_cmd values derived from a corresponding sequence of TPC commands of the same duration.

The closed loop power is defined as the relative power differences between RRC filtered mean power of original (reference) timeslot and RRC filtered mean power of the target timeslot without transient duration.

Table 6.3B: Transmitter power control range

TPC_cmd	Transmitter power control range					
	1 dB step size		2 dB step size		3 dB step size	
	Lower	Upper	Lower	Upper	Lower	Upper
Up	+0.5 dB	+1.5 dB	+1 dB	+3 dB	+1.5 dB	+4.5 dB
Down	-0.5 dB	-1.5 dB	-1 dB	-3 dB	-1.5 dB	-4.5 dB

Table 6.3C: Transmitter average power control range

TPC_cmd group	Transmitter power control range after 10 equal TPC_cmd groups					
	1 dB step size		2 dB step size		3 dB step size	
	Lower	Upper	Lower	Upper	Lower	Upper
Up	+8 dB	+12 dB	+16 dB	+24 dB	+24 dB	+36 dB
Down	-8 dB	-12 dB	-16 dB	-24 dB	-24 dB	-36 dB

6.4.1.3 7.68 Mcps option

Uplink power control is the ability of the UE transmitter to set its output power in accordance with measured downlink path loss, values determined by higher layer signalling and path loss weighting parameter α as defined in TS 25.331. The output power is defined as the RRC filtered mean power of the transmit timeslot.

6.4.1.3.1 Initial Accuracy

The UE power control initial accuracy error shall be less than +/-9dB under normal conditions and +/- 12dB under extreme conditions.

6.4.1.3.2 Differential accuracy, controlled input

The power control differential accuracy, controlled input, is defined as the error in the UE transmitter power step as a result of a step in SIR_{TARGET} when the path loss weighting parameter $\alpha=0$. The step in SIR_{TARGET} shall be rounded to the closest integer dB value. The power control error resulting from a change in I_{BTS} or DPCH Constant Value shall not exceed the values defined in Table 6.3D.

Table 6.3D: Transmitter power step tolerance as a result of control power step

ΔSIR_{TARGET} [dB]	Transmitter power step tolerance [dB]
$\Delta SIR_{TARGET} \leq 1$	± 0.5
$1 < \Delta SIR_{TARGET} \leq 2$	± 1
$2 < \Delta SIR_{TARGET} \leq 3$	± 1.5
$3 < \Delta SIR_{TARGET} \leq 10$	± 2
$10 < \Delta SIR_{TARGET} \leq 20$	± 4
$20 < \Delta SIR_{TARGET} \leq 30$	± 6
$30 < \Delta SIR_{TARGET}$	$\pm 9^{(1)}$
Note 1: Value is given for normal conditions. For extreme conditions value is ± 12	

6.4.1.3.3 Differential accuracy, measured input

The power control differential accuracy, measured input, is defined as the error in UE transmitter power step change as a result of a step change in path loss L_{PCCPCH} .

The error shall not exceed the sum of the following two errors:

- The power control error, resulting from a change in the path loss (ΔL_{PCCPCH}), the same tolerances as defined in table 6.3 shall apply,
- and the errors in the PCCPCH RSCP measurement as defined in TS 25.123.

6.4.2 Minimum output power

The minimum controlled output power of the UE is when the power is set to a minimum value.

6.4.2.1 Minimum requirement

6.4.2.1.1 3.84 Mcps TDD Option

The minimum output power is defined as the mean power in one time slot excluding the guard period. The minimum output power shall be less than -44 dBm.

6.4.2.1.2 1.28 Mcps TDD Option

The minimum output power is defined as the mean power in one time slot excluding the guard period. The minimum output power shall be less than -49 dBm.

6.4.2.1.3 7.68 Mcps TDD Option

The minimum output power is defined as the mean power in one time slot excluding the guard period. The minimum output power shall be less than -41 dBm.

6.4.3 Out-of-synchronisation handling of output power

The UE shall monitor the DPCH quality in order to detect a loss of the signal on Layer 1, as specified in TS 25.224. The thresholds Q_{out} , Q_{in} , Q_{sout} and Q_{sbin} specify at what DPCH quality levels the UE shall shut its power off and when it shall turn its power on, respectively. The thresholds are not defined explicitly, but are defined by the conditions under which the UE shall shut its transmitter off and turn it on, as stated in this clause.

6.4.3.1 Requirement for continuous transmission

6.4.3.1.1 3.84 Mcps TDD Option

6.4.3.1.1.1 Minimum requirement

When the UE estimates the DPCH quality over the last 160 ms period to be worse than a threshold Q_{out} , the UE shall shut its transmitter off within 40 ms. The UE shall not turn its transmitter on again until the DPCH quality exceeds an acceptable level Q_{in} . When the UE estimates the DPCH quality over the last 160 ms period to be better than a threshold Q_{in} , the UE shall again turn its transmitter on within 40 ms.

The UE transmitter shall be considered "off" if the transmitted power is below the level defined in subclause 6.5.1 (Transmit off power). Otherwise the transmitter shall be considered as "on".

6.4.3.1.1.2 Test case

This subclause specifies a test case, which provides additional information for how the minimum requirement should be interpreted for the purpose of conformance testing in case of continuous transmission.

The conditions for the continuous test case are as follows:

The handover triggering level shall be set very high to ensure that the beacon channel power never exceeds the value of 10dB above it. Therefore the averaging time for signal quality will always be 160 milliseconds.

The quality levels at the thresholds Q_{out} and Q_{in} correspond to different signal levels depending on the downlink conditions DCH parameters. For the conditions in Table 6.4, a signal with the quality at the level Q_{out} can be generated by a $\Sigma DPCH_Ec/I_{or}$ ratio of -13 dB, and a signal with Q_{in} by a $\Sigma DPCH_Ec/I_{or}$ ratio of -9 dB. In this test, the DL reference measurement channel (12.2) kbps specified in subclauseA.2.2, where the CRC bits are replaced by data bits, and with static propagation conditions is used.

Table 6.4: DCH parameters for the of Out-of-synch handling test case - 3.84 Mcps TDD option - continuous transmission

Parameter	Unit	Value
\hat{I}_{or}/I_{oc}	dB	1.1
I_{oc}	dBm/3.84 MHz	-60
$\frac{\Sigma DPCH_Ec}{I_{or}}$	dB	See figure 6.1
Information Data Rate	kbps	13
TFCI	-	On

Figure 6.1 shows an example scenario where the $\Sigma DPCH_Ec/I_{or}$ ratio varies from a level where the DPCH is demodulated under normal conditions, down to a level below Q_{out} where the UE shall shut its power off and then back up to a level above Q_{in} where the UE shall turn the power back on.

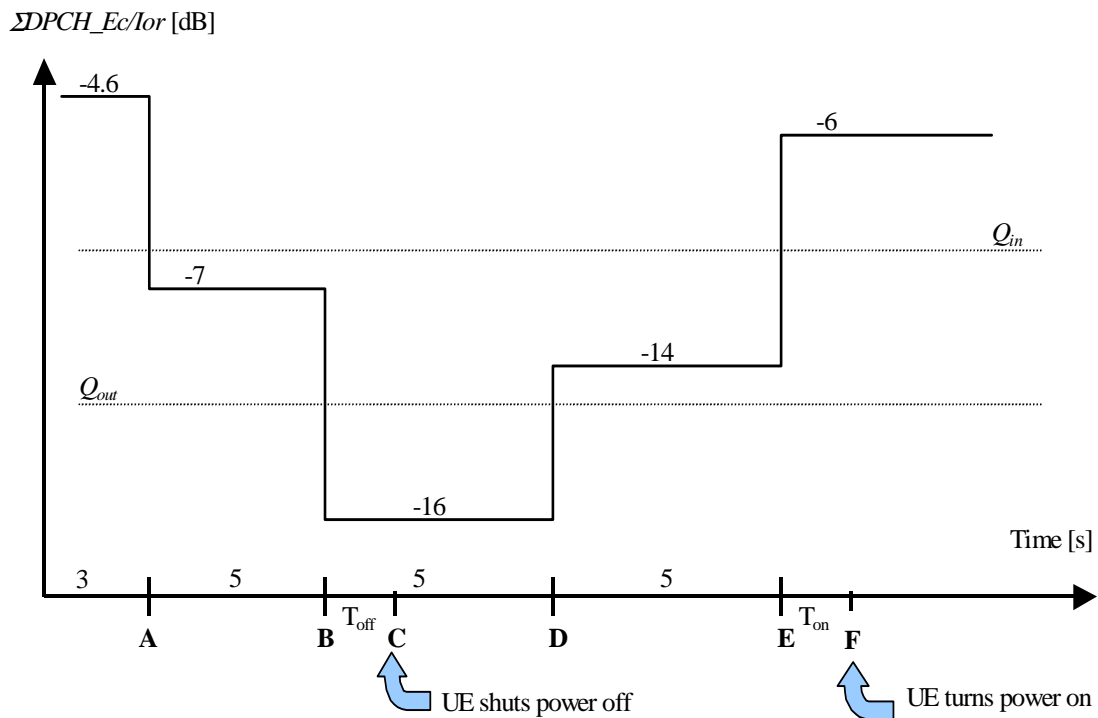

Figure 6.1: Test case for out-of-synch handling in the UE. - 3.84 Mcps TDD option - continuous transmission

In this test case, the requirements for the UE are that

- 1) The UE shall not shut its transmitter off before point B.
- 2) The UE shall shut its transmitter off before point C, which is $T_{\text{off}} = 200$ ms after point B
- 3) The UE shall not turn its transmitter on between points C and E.
- 4) The UE shall turn its transmitter on before point F, which is $T_{\text{on}} = 200$ ms after Point E.

6.4.3.1.2 1.28 Mcps TDD Option

6.4.3.1.2.1 Minimum Requirement

When the UE estimates the DPCH quality over the last 160 ms period to be worse than a threshold Q_{out} , the UE shall shut its transmitter off within 40 ms. The UE shall not turn its transmitter on again until the DPCH quality exceeds an acceptable level Q_{in} . When the UE estimates the DPCH quality over the last 160 ms period to be better than a threshold Q_{in} , the UE shall again turn its transmitter on within 40 ms.

The DPCH quality shall be monitored in the UE and compared to the thresholds Q_{out} and Q_{in} for the purpose of monitoring synchronisation. The threshold Q_{out} should correspond to a level of DPCH quality where no reliable detection of the TPC commands transmitted on the downlink DPCH can be made. This can be at a TPC command error ratio level of e.g. 30%. The threshold Q_{in} should correspond to a level of DPCH quality where detection of the TPC commands transmitted on the downlink DPCH is significantly more reliable than at Q_{out} . This can be at a TPC command error ratio level of e.g. 20%.

The UE transmitter shall be considered "off" if the transmitted power is below the level defined in subclause 6.5.1 (Transmit off power). Otherwise the transmitter shall be considered as "on".

6.4.3.1.2.2 Test case

This subclause specifies a test case, which provides additional information for how the minimum requirement should be interpreted for the purpose of conformance testing in case of continuous transmission for 1.28 Mcps TDD option.

The conditions for the continuous test case are as follows:

The handover triggering level shall be set very high to ensure that the beacon channel power never exceeds the value of 10dB above it. Therefore the averaging time for signal quality will always be 160 milliseconds.

The quality levels at the thresholds Q_{out} and Q_{in} correspond to different signal levels depending on the downlink conditions DCH parameters. For the conditions in Table 6.4, a signal with the quality at the level Q_{out} can be generated by a $\Sigma DPCH_{Ec}/I_{or}$ ratio of -15 dB, and a signal with Q_{in} by a $\Sigma DPCH_{Ec}/I_{or}$ ratio of -4.5 dB. In this test, the DL reference measurement channel (12.2) kbps specified in subclause A.2.2, where the CRC bits are replaced by data bits, and with static propagation conditions is used.

Table 6.4AA: DCH parameters for the of Out-of-synch handling test case - 1.28 Mcps TDD option - continuous transmission

Parameter	Unit	Value
\hat{I}_{or}/I_{oc}	dB	-1
I_{oc}	dBm/1.28 MHz	-60
$\frac{\Sigma DPCH_{Ec}}{I_{or}}$	dB	See figure 6.1AA
Information Data Rate	kbps	12.2
TFCI	-	On

Figure 6.1AA shows an example scenario where the $\Sigma DPCH_{Ec}/I_{or}$ ratio varies from a level where the DPCH is demodulated under normal conditions, down to a level below Q_{out} where the UE shall shut its power off and then back up to a level above Q_{in} where the UE shall turn the power back on.

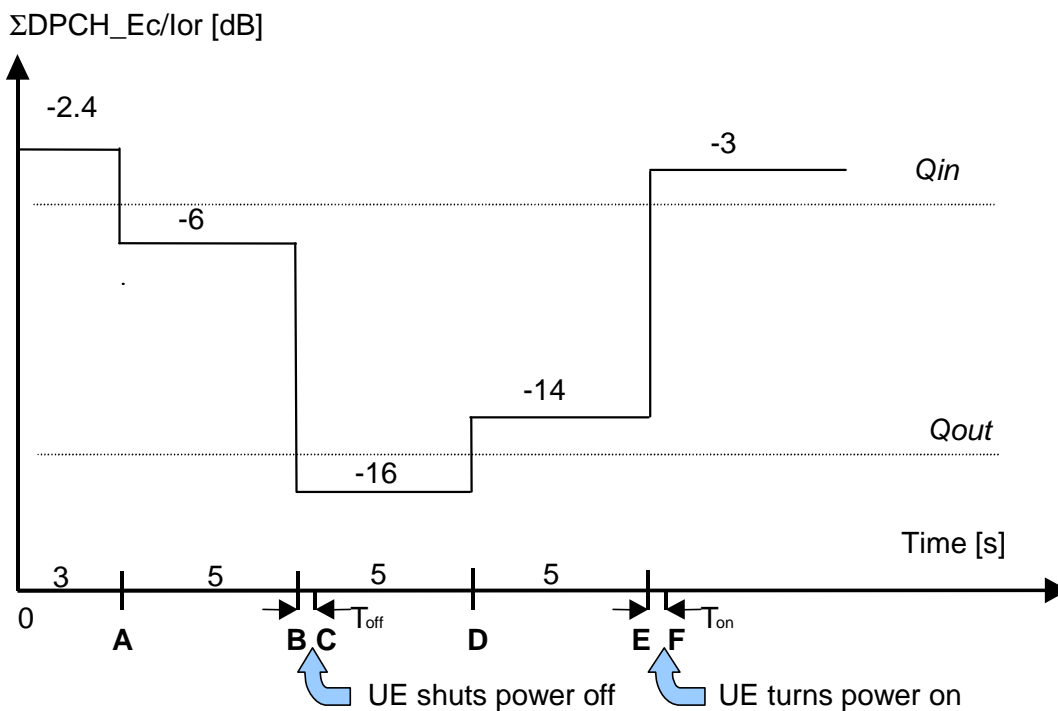

Figure 6.1AA: Test case for out-of-synch handling in the UE - 1.28 Mcps TDD option - continuous transmission

In this test case, the requirements for the UE are that:

- 1) The UE shall not shut its transmitter off before point B.
- 2) The UE shall shut its transmitter off before point C, which is $T_{\text{off}} = 200$ ms after point B
- 3) The UE shall not turn its transmitter on between points C and E.
- 4) The UE shall turn its transmitter on before point F, which is $T_{\text{on}} = 200$ ms after Point E.

6.4.3.1.3 7.68 Mcps TDD Option

6.4.3.1.3.1 Minimum requirement

When the UE estimates the DPCH quality over the last 160 ms period to be worse than a threshold Q_{out} , the UE shall shut its transmitter off within 40 ms. The UE shall not turn its transmitter on again until the DPCH quality exceeds an acceptable level Q_{in} . When the UE estimates the DPCH quality over the last 160 ms period to be better than a threshold Q_{in} , the UE shall again turn its transmitter on within 40 ms.

The UE transmitter shall be considered "off" if the transmitted power is below the level defined in subclause 6.5.1 (Transmit off power). Otherwise the transmitter shall be considered as "on".

6.4.3.1.3.2 Test case

This subclause specifies a test case, which provides additional information for how the minimum requirement should be interpreted for the purpose of conformance testing in case of continuous transmission.

The conditions for the continuous test case are as follows:

The handover triggering level shall be set very high to ensure that the beacon channel power never exceeds the value of 10dB above it. Therefore the averaging time for signal quality will always be 160 milliseconds.

The quality levels at the thresholds Q_{out} and Q_{in} correspond to different signal levels depending on the downlink conditions DCH parameters. For the conditions in Table 6.4AB, a signal with the quality at the level Q_{out} can be generated by a $\Sigma\text{DPCH_Ec/Ior}$ ratio of -16 dB, and a signal with Q_{in} by a $\Sigma\text{DPCH_Ec/Ior}$ ratio of -12 dB. In this test, the DL reference measurement channel (12.2) kbps specified in subclause A.2.2, where the CRC bits are replaced by data bits, and with static propagation conditions is used.

Table 6.4AB: DCH parameters for the of Out-of-synch handling test case - 7.68 Mcps TDD option - continuous transmission

Parameter	Unit	Value
\hat{I}_{or}/I_{oc}	dB	1.1
I_{oc}	dBm/7.68 MHz	-60
$\frac{\Sigma\text{DPCH_Ec}}{I_{or}}$	dB	See Figure 6.1BB
Information Data Rate	kbps	13
TFCI	-	On

Figure 6.1AB shows an example scenario where the $\Sigma\text{DPCH_Ec/Ior}$ ratio varies from a level where the DPCH is demodulated under normal conditions, down to a level below Q_{out} where the UE shall shut its power off and then back up to a level above Q_{in} where the UE shall turn the power back on.

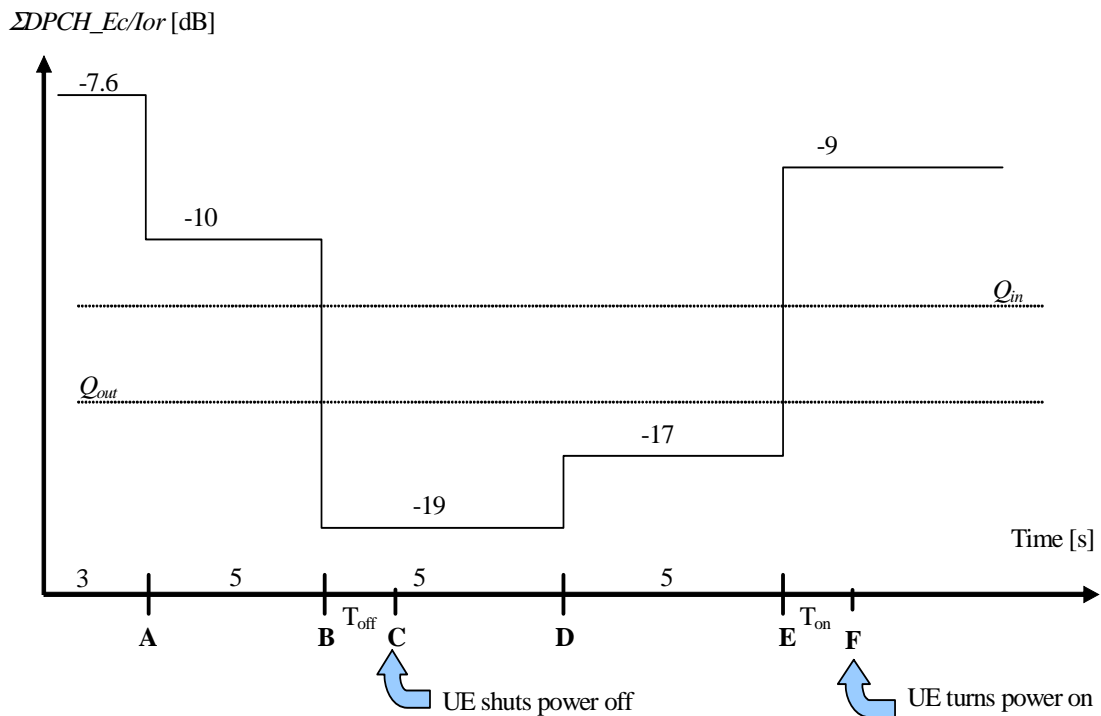

Figure 6.1AB: Test case for out-of-synch handling in the UE. - 7.68 Mcps TDD option - continuous transmission

In this test case, the requirements for the UE are that

- 1) The UE shall not shut its transmitter off before point B.
- 2) The UE shall shut its transmitter off before point C, which is $T_{\text{off}} = 200$ ms after point B
- 3) The UE shall not turn its transmitter on between points C and E.
- 4) The UE shall turn its transmitter on before point F, which is $T_{\text{on}} = 200$ ms after Point E.

6.4.3.2 Requirement for discontinuous transmission

6.4.3.2.1 3.84 Mcps TDD Option

6.4.3.2.1.1 Minimum Requirement

During DTX, there are periods when the UE will receive no data from the UTRAN. As specified in TS 25.224, in order to keep synchronization, Special Bursts shall be transmitted by the UTRAN during these periods of no data.

During these periods, the conditions for when the UE shall shut its transmitter on or off are defined by the power level of the received Special Bursts.

When the UE does not detect at least one special burst with a quality above a threshold Q_{sout} over the last 160 ms period, the UE shall shut its transmitter off within 40 ms. The UE shall not turn its transmitter on again until the special burst quality exceeds an acceptable level Q_{sbin} . When the UE estimates the special burst quality to be better than a threshold Q_{sbin} over the last 160 ms, the UE shall again turn its transmitter on within 40 ms.

The UE transmitter shall be considered "off" if the transmitted power is below the level defined in subclause 6.5.1 (Transmit off power). Otherwise the transmitter shall be considered as "on".

6.4.3.2.1.2 Test case

This subclause specifies a test case, which provides additional information for how the minimum requirement should be interpreted for the purpose of conformance testing in case of discontinuous transmission.

The conditions for the discontinuous test case are as follows:

The handover triggering level shall be set very high to ensure that the beacon channel power never exceeds the value of 10dB above it. Therefore the averaging time for signal quality will always be 160 milliseconds.

The UTRAN transmits Special Bursts as specified in TS 25.224. The Special Burst Scheduling Parameter, SBSP = 4, which means that UTRAN sends a Special Burst at every fourth frame with no data. Therefore, the UTRAN sends a Special Burst in the first frame without data transmission, followed by 3 frames with no transmission; followed by a Special Burst, etc.

The DCH parameters are shown in Table 6.4A.

The quality levels at the thresholds Q_{sbout} and Q_{sbin} correspond to different signal levels depending on the downlink conditions DCH parameters. For the conditions in Table 6.4A, a signal with the quality at the level Q_{sbout} can be generated by a DPCH_Ec/Ior ratio during received special bursts of -16 dB, and a signal with Q_{sbin} by a DPCH_Ec/Ior ratio during received special bursts of -12 dB.

Table 6.4A: DCH parameters for the of Out-of-synch handling test case - 3.84 Mcps TDD option - discontinuous transmission

Parameter	Unit	Value
\hat{I}_{or}/I_{oc}	dB	1.1
I_{oc}	dBm/3.84 MHz	-60
$\frac{DPCH_E_c}{I_{or}}$	dB	See figure 6.1A
Bits/burst (including TFCI bits)	bits	244
TFCI	-	On

Figure 6.1A shows an example scenario where the special burst quality varies from a level above Q_{sbin} , down to a level below Q_{sbout} where the UE shall shut its power off and then back up to a level above Q_{sbin} where the UE shall turn the power back on.

While the normal data is transmitted using two channelization codes, the Special Burst is transmitted with only one channelization code. Therefore the total energy per chip during Special Bursts is 3 dB lower than for continuous data transmission. The Special Bursts are represented by "SBs" in Figure 6.1A.

During the period of 3 frames with no data, the UE will receive a very low power, which is not shown in the figure. The power shown in the figure is the power of the Special Burst.

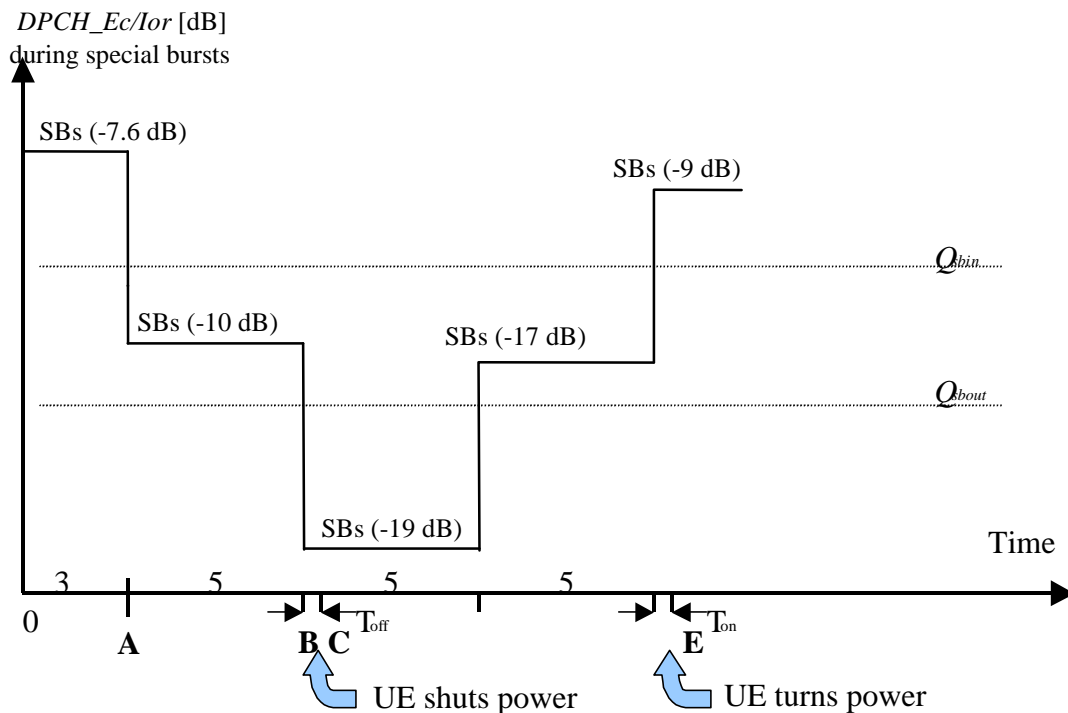

Figure 6.1A. Test case for out-of-synch handling in the UE - 3.84 Mcps TDD option - discontinuous transmission

In this test case, the requirements for the UE are that:

- 1) The UE shall not shut its transmitter off before point B.
- 2) The UE shall shut its transmitter off before point C, which is $T_{\text{off}} = 200$ ms after point B.
- 3) The UE shall not turn its transmitter on between points C and E.
- 4) The UE shall turn its transmitter on before point F, which is $T_{\text{on}} = 200$ ms after Point E.

6.4.3.2.2 1.28 Mcps TDD Option

6.4.3.2.2.1 Minimum Requirement

During DTX, there are periods when the UE will receive no data from the UTRAN. As specified in TS 25.224, in order to keep synchronization, Special Bursts shall be transmitted by the UTRAN during these periods of no data.

The DPCCH quality shall be monitored in the UE and compared to the thresholds Q_{sbout} and Q_{sbin} for the purpose of monitoring synchronisation during downlink DTX. The threshold Q_{sbout} should correspond to a level of DPCCH quality where no reliable detection of the TPC commands transmitted on the downlink DPCCH can be made. This can be at a TPC command error ratio level of e.g. 30. The threshold Q_{sbin} should correspond to a level of DPCCH quality where detection of the TPC commands transmitted on the downlink DPCCH is significantly more reliable than at Q_{sbout} . This can be at a TPC command error ratio level of e.g. 20%.

When the UE does not detect at least one special burst with a quality above a threshold Q_{sbout} over the last 160 ms period, the UE shall shut its transmitter off within 40 ms. The UE shall not turn its transmitter on again until the special burst quality exceeds an acceptable level Q_{sbin} . When the UE estimates the special burst quality to be better than a threshold Q_{sbin} over the last 160 ms, the UE shall again turn its transmitter on within 40 ms.

The UE transmitter shall be considered "off" if the transmitted power is below the level defined in subclause 6.5.1 (Transmit off power). Otherwise the transmitter shall be considered as "on".

6.4.3.2.2.2 Test case

This subclause specifies a test case, which provides additional information for how the minimum requirement should be interpreted for the purpose of conformance testing in case of discontinuous transmission.

The conditions for the discontinuous test case are as follows :

The handover triggering level shall be set very high to ensure that the beacon channel power never exceeds the value of 10dB above it. Therefore the averaging time for signal quality will always be 160 milliseconds.

The UTRAN transmits Special Bursts as specified in TS 25.224. The Special Burst Scheduling Parameter, SBSP = 4, which means that UTRAN sends a Special Burst at every fourth frame with no data. Therefore, the UTRAN sends a Special Burst in the first frame without data transmission, followed by 3 frames with no transmission; followed by a Special Burst, etc. Additionally, the Special Burst will be sent in both subframes of the relevant frame designated for the Special Burst.

The DCH parameters are shown in Table 6.4B.

The quality levels at the thresholds Q_{sbout} and Q_{sbin} correspond to different signal levels depending on the downlink conditions DCH parameters. For the conditions in Table 6.4B, a signal with the quality at the level Q_{sbout} can be generated by a DPCH_Ec/Ior ratio during received special bursts of -18 dB, and a signal with Q_{sbin} by a DPCH_Ec/Ior ratio during received special bursts of -7,5 dB.

Table 6.4B: DCH parameters for the of Out-of-synch handling test case - 1.28 Mcps TDD option - discontinuous transmission

Parameter	Unit	Value
\hat{I}_{or}/I_{oc}	dB	-1
I_{oc}	dBm/1.28 MHz	-60
$\frac{\Sigma DPCH_Ec}{I_{or}}$	dB	See figure 6.1B
Bits/burst (including TFCI bits)	bits	88 in each subframe
TFCI	-	On

Figure 6.1B shows an example scenario where the DPCH_Ec/Ior ratio during received special bursts varies from a level where the DPCH in DTX mode is demodulated under normal conditions, down to a level below Q_{sbout} where the UE shall shut its power off and then back up to a level above Q_{sbin} where the UE shall turn the power back on.

While the normal data is transmitted using two channelization codes, the Special Burst is transmitted with only one channelization code. Therefore the total energy per chip during Special Bursts is 3 dB lower than for continuous data transmission. The Special Bursts are represented by "SBs" in the figure.

During the period of 3 frames with no data, the UE will receive a very low power, which is not shown in the figure. In the fourth frame the Special Burst will be sent in both subframes designated to carry the Special Burst during DTX. The power shown in the figure is the power of the Special Burst.

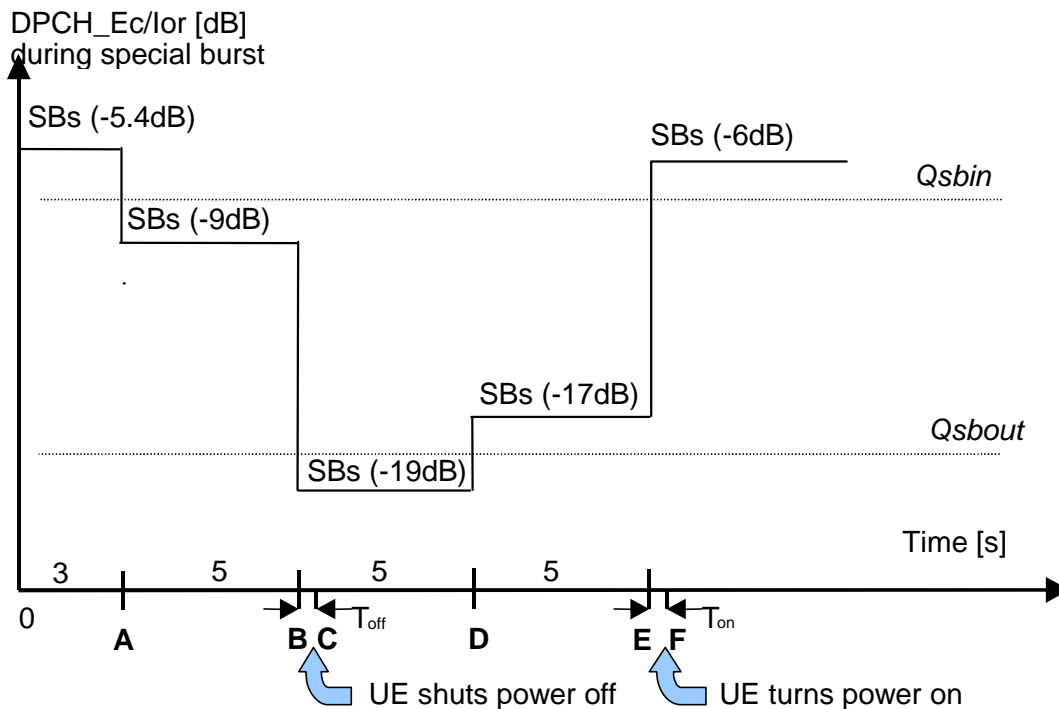

Figure 6.1B: Test case for out-of-synch handling in the UE -1.28 Mcps TDD option - discontinuous transmission

In this test case, the requirements for the UE are that:

- 1) The UE shall not shut its transmitter off before point B.
- 2) The UE shall shut its transmitter off before point C, which is $T_{\text{off}} = 200$ ms after point B.
- 3) The UE shall not turn its transmitter on between points C and E.
- 4) The UE shall turn its transmitter on before point F, which is $T_{\text{on}} = 200$ ms after Point E.

6.4.3.2.3 7.68 Mcps TDD Option

6.4.3.2.3.1 Minimum Requirement

During DTX, there are periods when the UE will receive no data from the UTRAN. As specified in TS 25.224, in order to keep synchronization, Special Bursts shall be transmitted by the UTRAN during these periods of no data.

During these periods, the conditions for when the UE shall shut its transmitter on or off are defined by the power level of the received Special Bursts.

When the UE does not detect at least one special burst with a quality above a threshold Q_{sbout} over the last 160 ms period, the UE shall shut its transmitter off within 40 ms. The UE shall not turn its transmitter on again until the special burst quality exceeds an acceptable level Q_{sbin} . When the UE estimates the special burst quality to be better than a threshold Q_{sbin} over the last 160 ms, the UE shall again turn its transmitter on within 40 ms.

The UE transmitter shall be considered "off" if the transmitted power is below the level defined in subclause 6.5.1 (Transmit off power). Otherwise the transmitter shall be considered as "on".

6.4.3.2.3.2 Test case

This subclause specifies a test case, which provides additional information for how the minimum requirement should be interpreted for the purpose of conformance testing in case of discontinuous transmission.

The conditions for the discontinuous test case are as follows:

The handover triggering level shall be set very high to ensure that the beacon channel power never exceeds the value of 10dB above it. Therefore the averaging time for signal quality will always be 160 milliseconds.

The UTRAN transmits Special Bursts as specified in TS 25.224. The Special Burst Scheduling Parameter, SBSP = 4, which means that UTRAN sends a Special Burst at every fourth frame with no data. Therefore, the UTRAN sends a Special Burst in the first frame without data transmission, followed by 3 frames with no transmission; followed by a Special Burst, etc.

The DCH parameters are shown in Table 6.4C.

The quality levels at the thresholds Q_{sbout} and Q_{sbin} correspond to different signal levels depending on the downlink conditions DCH parameters. For the conditions in Table 6.4C, a signal with the quality at the level Q_{sbout} can be generated by a DPCH_Ec/I_{or} ratio during received special bursts of -19 dB, and a signal with Q_{sbin} by a DPCH_Ec/I_{or} ratio during received special bursts of -15 dB.

Table 6.4C: DCH parameters for the of Out-of-synch handling test case - 7.68 Mcps TDD option - discontinuous transmission

Parameter	Unit	Value
\hat{I}_{or}/I_{oc}	dB	1.1
I_{oc}	dBm/7.68 MHz	-60
$\frac{DPCH_Ec}{I_{or}}$	dB	See Figure 6.1C
Bits/burst (including TFCI bits)	bits	244
TFCI	-	On

Figure 6.1C shows an example scenario where the special burst quality varies from a level above Q_{sbin} , down to a level below Q_{sbout} where the UE shall shut its power off and then back up to a level above Q_{sbin} where the UE shall turn the power back on.

While the normal data is transmitted using two channelization codes, the Special Burst is transmitted with only one channelization code. Therefore the total energy per chip during Special Bursts is 3 dB lower than for continuous data transmission. The Special Bursts are represented by "SBs" in Figure 6.1C.

During the period of 3 frames with no data, the UE will receive a very low power, which is not shown in the figure. The power shown in the figure is the power of the Special Burst.

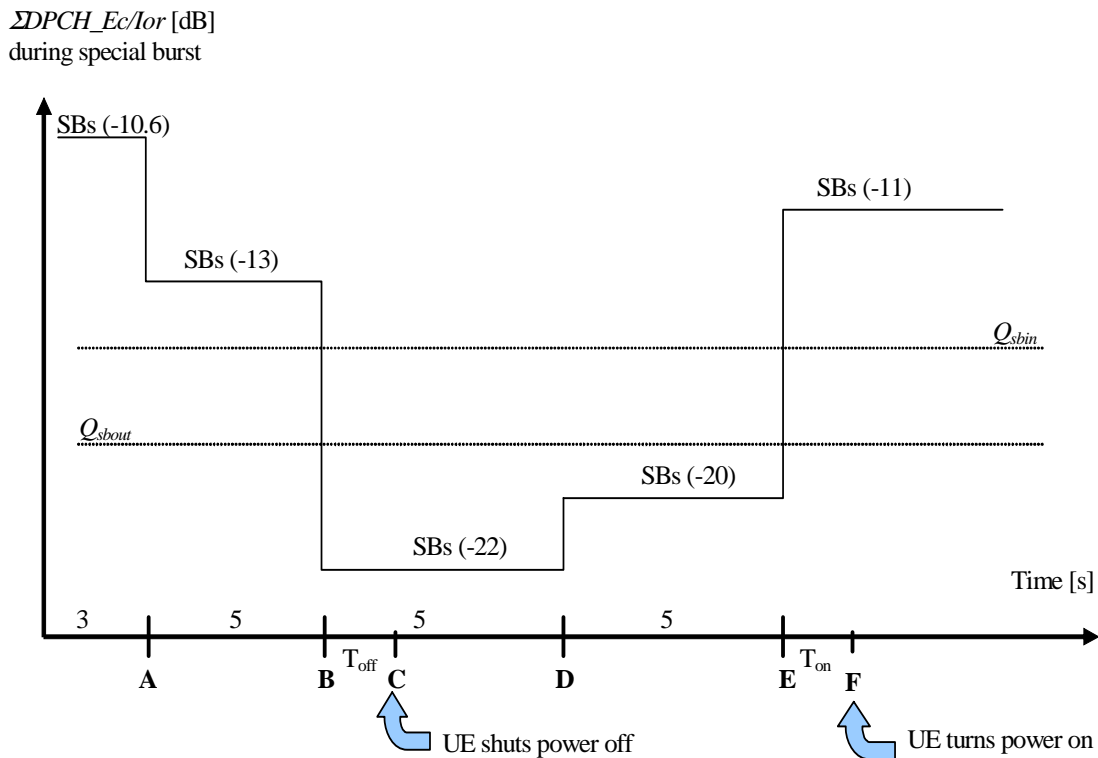

Figure 6.1C. Test case for out-of-synch handling in the UE - 7.68 Mcps TDD option - discontinuous transmission

In this test case, the requirements for the UE are that:

- 1) The UE shall not shut its transmitter off before point B.
- 2) The UE shall shut its transmitter off before point C, which is $T_{off} = 200$ ms after point B.
- 3) The UE shall not turn its transmitter on between points C and E.
- 4) The UE shall turn its transmitter on before point F, which is $T_{on} = 200$ ms after Point E.

6.5 Transmit ON/OFF power

6.5.1 Transmit OFF power

Transmit OFF power is defined as the RRC filtered mean power measured over one chip when the transmitter is off. The transmit OFF power state is when the UE does not transmit.

6.5.1.1 Minimum Requirement

The requirement for transmit OFF power shall be less than -65 dBm.

6.5.2 Transmit ON/OFF Time mask

The time mask transmit ON/OFF defines the ramping time allowed for the UE between transmit OFF power and transmit ON power.

6.5.2.1 Minimum Requirement

6.5.2.1.1 3.84 Mcps TDD Option

The transmit power level versus time shall meet the mask specified in figure 6.2, where the transmission period refers to the burst without guard period for a single transmission slot, and to the period from the beginning of the burst in the first transmission slot to the end of the burst without guard period in the last transmission timeslot for consecutive transmission slots.

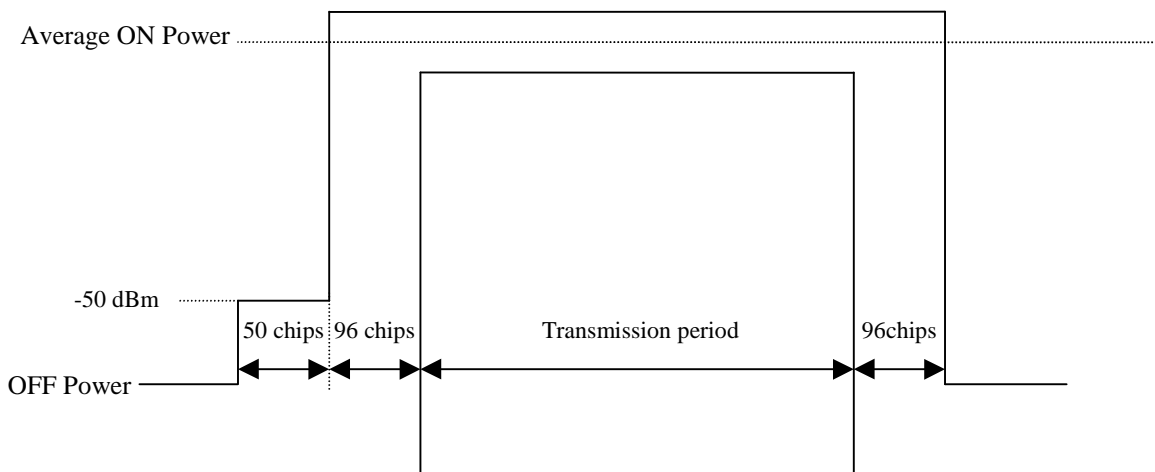

Figure 6.2: Transmit ON/OFF template for 3.84 Mcps TDD Option

6.5.2.1.2 1.28 Mcps TDD Option

The transmit power level versus time shall meet the mask specified in figure 6.2A, where the transmission period refers to the burst without guard period for a single transmission slot, and to the period from the beginning of the burst in the first transmission slot to the end of the burst without guard period in the last transmission timeslot for consecutive transmission slots.

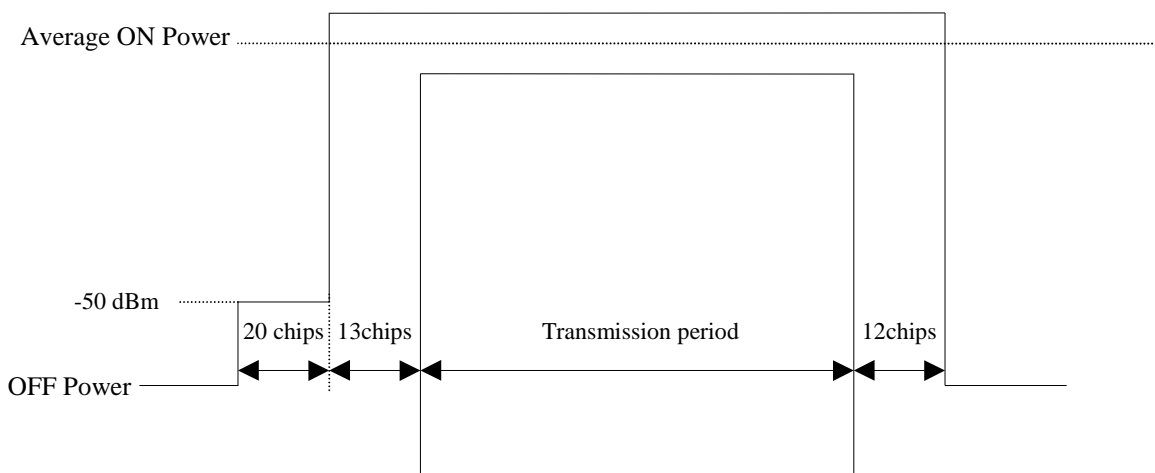

Figure 6.2A: Transmit ON/OFF template for 1.28 Mcps TDD Option

6.5.2.1.3 7.68 Mcps TDD Option

The transmit power level versus time shall meet the mask specified in Figure 6.2B, where the transmission period refers to the burst without guard period for a single transmission slot, and to the period from the beginning of the burst in the first transmission slot to the end of the burst without guard period in the last transmission timeslot for consecutive transmission slots.

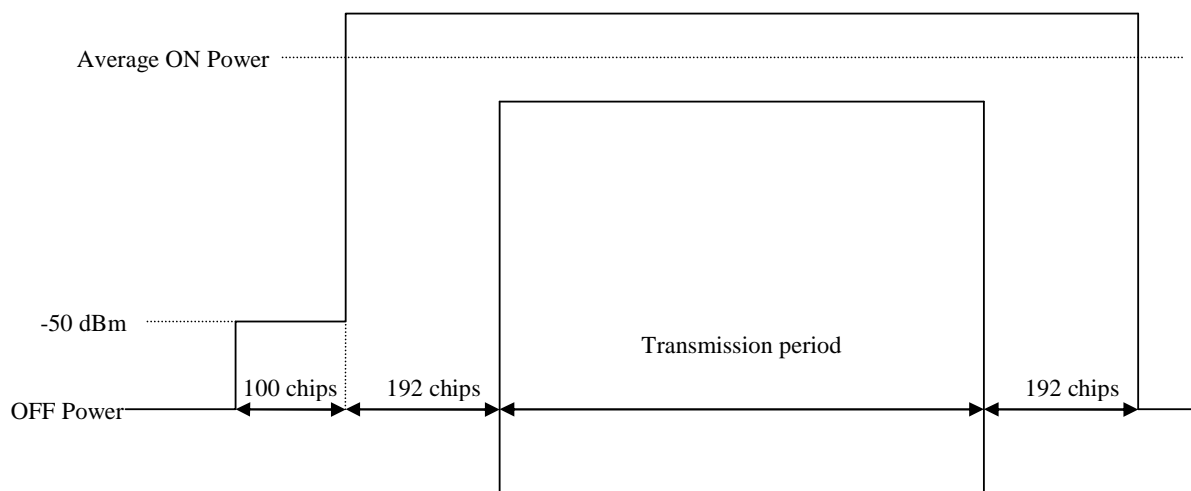

Figure 6.2B: Transmit ON/OFF template for 7.68 Mcps TDD Option

6.6 Output RF spectrum emissions

6.6.1 Occupied bandwidth

6.6.1.1 3.84 Mcps TDD Option

Occupied bandwidth is a measure of the bandwidth containing 99% of the total integrated power of the transmitted spectrum, centred on the assigned channel frequency. The occupied channel bandwidth shall be less than 5 MHz based on a chip rate of 3.84 Mcps.

6.6.1.2 1.28 Mcps TDD Option

Occupied bandwidth is a measure of the bandwidth containing 99% of the total integrated power of the transmitted spectrum, centred on the assigned channel frequency. The occupied channel bandwidth shall be less than 1.6 MHz based on a chip rate of 1.28 Mcps.

6.6.1.3 7.68 Mcps TDD Option

Occupied bandwidth is a measure of the bandwidth containing 99% of the total integrated power of the transmitted spectrum, centred on the assigned channel frequency. The occupied channel bandwidth shall be less than 10 MHz based on a chip rate of 7.68 Mcps.

6.6.2 Out of band emission

Out of band emissions are unwanted emissions immediately outside the nominal channel resulting from the modulation process and non-linearity in the transmitter but excluding spurious emissions. This out of band emission limit is specified in terms of a spectrum emission mask and adjacent channel leakage power ratio (ACLR).

6.6.2.1 Spectrum emission mask

6.6.2.1.1 3.84 Mcps TDD Option

The spectrum emission mask of the UE applies to frequencies, which are between 2.5 MHz and 12.5MHz from the UE centre carrier frequency. The out of channel emission is specified relative to the RRC filtered mean power of the UE carrier.

6.6.2.1.1.1 Minimum Requirement

The power of any UE emission shall not exceed the levels specified in table 6.5.

Table 6.5: Spectrum Emission Mask Requirement (3.84 Mcps TDD Option)

Δf^* in MHz	Minimum requirement	Measurement bandwidth
2.5 - 3.5	$\left\{ -35 - 15 \cdot \left(\frac{\Delta f}{\text{MHz}} - 2.5 \right) \right\} \text{dBc}$	30 kHz **
3.5 - 7.5	$\left\{ -35 - 1 \cdot \left(\frac{\Delta f}{\text{MHz}} - 3.5 \right) \right\} \text{dBc}$	1 MHz ***
7.5 - 8.5	$\left\{ -39 - 10 \cdot \left(\frac{\Delta f}{\text{MHz}} - 7.5 \right) \right\} \text{dBc}$	1 MHz ***
8.5 - 12.5	-49 dBc	1 MHz ***
*	Δf is the separation between the carrier frequency and the centre of the measuring filter.	
**	The first and last measurement position with a 30 kHz filter is at Δf equals to 2.515 MHz and 3.485 MHz	
***	The first and last measurement position with a 1 MHz filter is at Δf equals to 4 MHz and 12 MHz. As a general rule, the resolution bandwidth of the measuring equipment should be equal to the measurement bandwidth. To improve measurement accuracy, sensitivity and efficiency, the resolution bandwidth can be different from the measurement bandwidth. When the resolution bandwidth is smaller than the measurement bandwidth, the result should be integrated over the measurement bandwidth in order to obtain the equivalent noise bandwidth of the measurement bandwidth.	
Note:	The lower limit shall be -50dBm/3.84 MHz or the minimum requirement presented in this table which ever is the higher.	

6.6.2.1.2 1.28 Mcps TDD Option

The spectrum emission mask of the UE applies to frequencies, which are between 0.8MHz and 4.0MHz from the UE centre carrier frequency. The out of channel emission is specified relative to the RRC filtered mean power of the UE carrier.

6.6.2.1.2.1 Minimum Requirement

The power of any UE emission shall not exceed the levels specified in table 6.5A

Table 6.5A: Spectrum Emission Mask Requirement (1.28 Mcps TDD Option)

Δf^* in MHz	Minimum requirement	Measurement bandwidth
0.8-1.8	$\left\{ -35 - 14 \cdot \left(\frac{\Delta f}{\text{MHz}} - 0.8 \right) \right\} \text{dBc}$	30 kHz **
1.8-2.4	$\left(-49 - 17 \cdot \left(\frac{\Delta f}{\text{MHz}} - 1.8 \right) \right) \text{dBc}$	30 kHz **
2.4 - 4.0	-44 dBc	1MHz ***
*	Δf is the separation between the carrier frequency and the centre of the measuring filter.	
**	The first and last measurement position with a 30 kHz filter is at Δf equals to 0.815 MHz and 2.385 MHz.	
***	The first and last measurement position with a 1 MHz filter is at Δf equals to 2.9MHz and 3.5MHz. As a general rule, the resolution bandwidth of the measuring equipment should be equal to the measurement bandwidth. To improve measurement accuracy, sensitivity and efficiency, the resolution bandwidth can be different from the measurement bandwidth. When the resolution bandwidth is smaller than the measurement bandwidth, the result should be integrated over the measurement bandwidth in order to obtain the equivalent noise bandwidth of the measurement bandwidth.	
Note:	The lower limit shall be -55dBm/1.28 MHz or the minimum requirement presented in this table which ever is the higher.	

6.6.2.1.3 7.68 Mcps TDD Option

The spectrum emission mask of the UE applies to frequencies, which are between 5 MHz and 25MHz from the UE centre carrier frequency. The out of channel emission is specified relative to the RRC filtered mean power of the UE carrier.

6.6.2.1.3.1 Minimum Requirement

The power of any UE emission shall not exceed the levels specified in Table 6.5B.

Table 6.5B: Spectrum Emission Mask of higher chip rate reference configuration

Δf^* in MHz	Minimum requirement	Measurement bandwidth
5.0 - 5.75	$\left\{ -38 - 10.67 \cdot \left(\frac{\Delta f}{\text{MHz}} - 5.0 \right) \right\} \text{dBc}$	30 kHz **
5.75 - 7.0	$\left\{ -46 - 5.6 \cdot \left(\frac{\Delta f}{\text{MHz}} - 5.75 \right) \right\} \text{dBc}$	30 kHz**
7.0 - 15	$\left\{ -38 - 0.5 \cdot \left(\frac{\Delta f}{\text{MHz}} - 7.0 \right) \right\} \text{dBc}$	1 MHz ***
15.0 - 17.0	$\left\{ -42 - 5.0 \cdot \left(\frac{\Delta f}{\text{MHz}} - 15.0 \right) \right\} \text{dBc}$	1 MHz ***
17.0 - 25.0	-53 dBc	1 MHz ***
*	Δf is the separation between the carrier frequency and the centre of the measuring filter.	
**	The first and last measurement position with a 30 kHz filter is at Δf equals to 5.015 MHz and 6.985 MHz	
***	The first and last measurement position with a 1 MHz filter is at Δf equals to 7.5 MHz and 24.5 MHz. As a general rule, the resolution bandwidth of the measuring equipment should be equal to the measurement bandwidth. To improve measurement accuracy, sensitivity and efficiency, the resolution bandwidth can be different from the measurement bandwidth. When the resolution bandwidth is smaller than the measurement bandwidth, the result should be integrated over the measurement bandwidth in order to obtain the equivalent noise bandwidth of the measurement bandwidth.	
Note:	The lower limit shall be -47dBm/7.68 MHz or the minimum requirement presented in this table which ever is the higher.	

6.6.2.2 Adjacent Channel Leakage power Ratio (ACLR)

Adjacent Channel Leakage power Ratio (ACLR) is the ratio of the RRC filtered mean power centered on the assigned channel frequency to the RRC filtered mean power centered on an adjacent channel frequency.

6.6.2.2.1 Minimum requirement

6.6.2.2.1.1 3.84 Mcps TDD Option

If the adjacent channel RRC filtered mean power is greater than -50dBm then the ACLR shall be higher than the value specified in Table 6.6.

Table 6.6:UE ACLR (3.84 Mcps TDD Option)

Power Class	adjacent channel	ACLR limit
2, 3	UE channel \pm 5 MHz	33 dB
2, 3	UE channel \pm 10 MHz	43 dB

NOTE:

- 1) The requirement shall still be met in the presence of switching transients.
- 2) The ACLR requirements reflect what can be achieved with present state of the art technology.
- 3) Requirement on the UE shall be reconsidered when the state of the art technology progresses.

6.6.2.2.1.2 1.28 Mcps TDD Option

If the adjacent channel RRC filtered mean power is greater than -55dBm then the ACLR shall be higher than the value specified in Table 6.6A.

Table 6.6A: UE ACLR (1.28 Mcps TDD Option)

Power Class	adjacent channel	ACLR limit
2, 3	UE channel \pm 1.6 MHz	33 dB
2, 3	UE channel \pm 3.2 MHz	43 dB
Note: For multi-carrier transmission, the adjacent channel is defined relative to the first or last carrier used by the UE.		

NOTE:

- 1) The requirement shall still be met in the presence of switching transients.
- 2) The ACLR requirements reflect what can be achieved with present state of the art technology.
- 3) Requirement on the UE shall be reconsidered when the state of the art technology progresses.

6.6.2.2.1.3 7.68 Mcps TDD Option

If the adjacent channel RRC filtered mean power is greater than -50dBm measured with a 3.84 Mcps RRC filter then the ACLR shall be higher than the value specified in Table 6.6B.

Table 6.6B: UE ACLR of higher chip rate reference configuration

Power Class	adjacent channel	Chip Rate for RRC Measurement Filter	ACLR limit
2, 3	UE channel \pm 7.5 MHz	3.84 MHz	33 dB
2, 3	UE channel \pm 12.5 MHz	3.84 MHz	43 dB
2,3	UE channel \pm 10.0 MHz	7.68 MHz	33 dB
2,3	UE channel \pm 20.0 MHz	7.68 MHz	43 dB

NOTE:

- 1) The requirement shall still be met in the presence of switching transients.
- 2) The ACLR requirements reflect what can be achieved with present state of the art technology.

6.6.3 Spurious emissions

Spurious emissions are emissions which are caused by unwanted transmitter effects such as harmonics emission, parasitic emission, intermodulation products and frequency conversion products, but exclude out of band emissions.

The frequency boundary and the detailed transitions of the limits between the requirement for out band emissions and spectrum emissions are based on ITU-R Recommendations SM.329 [3].

6.6.3.1 Minimum Requirement

6.6.3.1.1 3.84 Mcps TDD Option

These requirements are only applicable for frequencies which are greater than 12.5 MHz away from the UE center carrier frequency.

Table 6.7A: General Spurious emissions requirements (3.84 Mcps TDD Option)

Frequency Bandwidth	Measurement Bandwidth	Minimum requirement
$9 \text{ kHz} \leq f < 150 \text{ kHz}$	1 kHz	-36 dBm
$150 \text{ kHz} \leq f < 30 \text{ MHz}$	10 kHz	-36 dBm
$30 \text{ MHz} \leq f < 1000 \text{ MHz}$	100 kHz	-36 dBm
$1 \text{ GHz} \leq f < 12.75 \text{ GHz}$	1 MHz	-30 dBm

Table 6.7B: Additional Spurious emissions requirements (3.84 Mcps TDD Option)

Frequency Bandwidth	Measurement Bandwidth	Minimum requirement
$921 \text{ MHz} \leq f < 925 \text{ MHz}$	100 kHz	-60 dBm (note 1)
$925 \text{ MHz} \leq f < 935 \text{ MHz}$	100 kHz	-67 dBm (note 1)
$935 \text{ MHz} < f \leq 960 \text{ MHz}$	100 kHz	-79 dBm (note 1)
$1805 \text{ MHz} \leq f \leq 1880 \text{ MHz}$	100 kHz	-71 dBm (note 1)
$2620 \text{ MHz} \leq f \leq 2690 \text{ MHz}$	3.84 MHz	-37 dBm (note 1)
$1884.5 \text{ MHz} \leq f \leq 1919.6 \text{ MHz}$	300 kHz	-41 dBm (note 2)

NOTE 1: The measurements are made on frequencies which are integer multiples of 200 kHz. As exceptions, up to five measurements with a level up to the applicable requirements defined in Table 6.7A are permitted for each UARFCN used in the measurement.

NOTE 2: Applicable for transmission in 2010-2025 MHz as defined in subclause 5.2 (a).

6.6.3.1.2 1.28 Mcps TDD Option

These requirements are only applicable for frequencies which are greater than 4 MHz away from the UE center carrier frequency. For UE supporting multi-carrier transmission, the requirements are applicable for frequencies which are greater than 4MHz away from lowest carrier frequency or highest carrier frequency assigned for the UE.

Table 6.7C: General Spurious emissions requirements (1.28 Mcps TDD Option)

Frequency Bandwidth	Measurement Bandwidth	Minimum requirement
$9 \text{ kHz} \leq f < 150 \text{ kHz}$	1 kHz	-36 dBm
$150 \text{ kHz} \leq f < 30 \text{ MHz}$	10 kHz	-36 dBm
$30 \text{ MHz} \leq f < 1000 \text{ MHz}$	100 kHz	-36 dBm
$1 \text{ GHz} \leq f < 12.75 \text{ GHz}$	1 MHz	-30 dBm

Table 6.7D: Additional Spurious emissions requirements (1.28 Mcps TDD Option)

Operating Band	Frequency Bandwidth	Measurement Bandwidth	Minimum requirement
a	$921 \text{ MHz} \leq f < 925 \text{ MHz}$	100 kHz	-60 dBm (note1)
	$925 \text{ MHz} \leq f \leq 935 \text{ MHz}$	100 kHz	-67 dBm (note1)
	$935 \text{ MHz} < f \leq 960 \text{ MHz}$	100 kHz	-79 dBm (note1)
	$1805 \text{ MHz} \leq f \leq 1880 \text{ MHz}$	100 kHz	-71 dBm (note1)
	$2010 \text{ MHz} \leq f \leq 2025 \text{ MHz}$	1MHz	-65 dBm (Note2)
	$1900 \text{ MHz} \leq f \leq 1920 \text{ MHz}$	1MHz	-65 dBm (Note 3)
b	$1850 \text{ MHz} \leq f \leq 1910 \text{ MHz}$	1 MHz	-65 dBm (Note 4)
	$1930 \text{ MHz} \leq f \leq 1990 \text{ MHz}$	1 MHz	-65 dBm (Note 5)
	$2010 \text{ MHz} \leq f \leq 2025 \text{ MHz}$	1MHz	-65 dBm
c	$2010 \text{ MHz} \leq f \leq 2025 \text{ MHz}$	1 MHz	-65 dBm
d	$1900 \text{ MHz} \leq f \leq 1920 \text{ MHz}$	1 MHz	-65 dBm
	$2010 \text{ MHz} \leq f \leq 2025 \text{ MHz}$	1 MHz	-65 dBm
	$2620 \text{ MHz} \leq f \leq 2690 \text{ MHz}$	3.84 MHz	-37 dBm
e	$921 \text{ MHz} \leq f < 925 \text{ MHz}$	100 kHz	-60 dBm (note1)
	$925 \text{ MHz} \leq f \leq 935 \text{ MHz}$	100 kHz	-67 dBm (note1)
	$935 \text{ MHz} < f \leq 960 \text{ MHz}$	100 kHz	-79 dBm (note1)
	$1805 \text{ MHz} \leq f \leq 1880 \text{ MHz}$	100 kHz	-71 dBm (note1)
	$1900 \text{ MHz} \leq f \leq 1920 \text{ MHz}$	1 MHz	-65 dBm
	$2010 \text{ MHz} \leq f \leq 2025 \text{ MHz}$	1 MHz	-65 dBm
f	$921 \text{ MHz} \leq f < 925 \text{ MHz}$	100 kHz	-60 dBm (note1)
	$925 \text{ MHz} < f < 935 \text{ MHz}$	100 kHz	-67 dBm (note1)
	$935 \text{ MHz} < f < 960 \text{ MHz}$	100 kHz	-79 dBm (note1)
	$1805 \text{ MHz} \leq f \leq 1850 \text{ MHz}$	100 kHz	-71 dBm (note1)
	$2010 \text{ MHz} \leq f \leq 2025 \text{ MHz}$	1MHz	-65 dBm
	$2300 \text{ MHz} \leq f \leq 2400 \text{ MHz}$	1MHz	-65 dBm
Note 1	The measurements are made on frequencies which are integer multiples of 200 kHz. As exceptions, up to five measurements with a level up to the applicable requirements defined in Table 6.7c are permitted for each UARFCN used in the measurement.		
Note 2	This requirement is only applicable when UE operating in 1900-1920MHz of band a.		
Note 3	This requirement is only applicable when UE operating in 2010-2025MHz of band a.		
Note 4	This requirement is only applicable when UE operating in 1930-1990MHz of band b.		
Note 5	This requirement is only applicable when UE operating in 1850-1910MHz of band b.		

6.6.3.1.3 7.68 Mcps TDD Option

These requirements are only applicable for frequencies which are greater than 25 MHz away from the UE center carrier frequency.

Table 6.7E: General Spurious emissions requirements (7.68 Mcps TDD Option)

Frequency Bandwidth	Measurement Bandwidth	Minimum requirement
$9 \text{ kHz} \leq f < 150 \text{ kHz}$	1 kHz	-36 dBm
$150 \text{ kHz} \leq f < 30 \text{ MHz}$	10 kHz	-36 dBm
$30 \text{ MHz} \leq f < 1000 \text{ MHz}$	100 kHz	-36 dBm
$1 \text{ GHz} \leq f < 12.75 \text{ GHz}$	1 MHz	-30 dBm

Table 6.7F: Additional Spurious emissions requirements (7.68 Mcps TDD Option)

Frequency Bandwidth	Measurement Bandwidth	Minimum requirement
$921 \text{ MHz} \leq f < 925 \text{ MHz}$	100 kHz	-60 dBm (note 1)
$925 \text{ MHz} \leq f \leq 935 \text{ MHz}$	100 kHz	-67 dBm (note 1)
$935 \text{ MHz} < f \leq 960 \text{ MHz}$	100 kHz	-79 dBm (note 1)
$1805 \text{ MHz} \leq f \leq 1880 \text{ MHz}$	100 kHz	-71 dBm (note 1)
$2620 \text{ MHz} \leq f \leq 2690 \text{ MHz}$	3.84 MHz	-37 dBm (note 1)
$1884.5 \text{ MHz} \leq f \leq 1919.6 \text{ MHz}$	300 kHz	-41 dBm (note 2)

NOTE 1: The measurements are made on frequencies which are integer multiples of 200 kHz. As exceptions, up to five measurements with a level up to the applicable requirements defined in Table 6.7E are permitted for each UARFCN used in the measurement.

NOTE 2: Applicable for transmission in 2010-2025 MHz as defined in subclause 5.2 (a).

6.7 Transmit intermodulation

The transmit intermodulation performance is a measure of the capability of the transmitter to inhibit the generation of signals in its non linear elements caused by presence of the wanted signal and an interfering signal reaching the transmitter via the antenna.

6.7.1 Minimum requirement

User Equipment(s) transmitting in close vicinity of each other can produce intermodulation products, which can fall into the UE, or BS receive band as an unwanted interfering signal. The UE intermodulation attenuation is defined by the ratio of the RRC filtered mean power of the wanted signal to the RRC filtered mean power of the intermodulation product when an interfering CW signal is added at a level below the wanted signal.

6.7.1.1 3.84 Mcps TDD Option

The requirement of transmitting intermodulation for carrier spacing 5 MHz is prescribed in Table 6.8.

Table 6.8: Transmit Intermodulation (3.84 Mcps TDD Option)

Interference Signal Frequency Offset	5MHz	10MHz
Interference Signal Level	-40 dBc	
Minimum Requirement	-31dBc	-41dBc

6.7.1.2 1.28 Mcps TDD Option

The requirement of transmitting intermodulation for carrier spacing 1.6 MHz is prescribed in Table 6.8A.

Table 6.8A: Transmit Intermodulation (1.28 Mcps TDD Option)

Interference signal frequency offset	1.6MHz	3.2MHz
Interference signal level	-40dBc	
Minimum requirement of intermodulation products	-31 dBc	-41 dBc

6.7.1.3 7.68 Mcps TDD Option

The requirement of transmitting intermodulation for carrier spacing 10 MHz is prescribed in Table 6.8B.

Table 6.8B: Transmit Intermodulation (7.68 Mcps TDD Option)

Interference Signal Frequency Offset	10MHz	20MHz
Interference Signal Level	-40 dBc	
Minimum Requirement	-31dBc	-41dBc

6.8 Transmit Modulation

Transmit modulation defines the modulation quality for expected in-channel RF transmissions from the UE. The requirements apply to all transmissions.

6.8.1 Transmit pulse shape filter

The transmit pulse-shaping filter is a root-raised cosine (RRC) with roll-off $\alpha = 0.22$ in the frequency domain. The impulse response of the chip impulse filter $RC_0(t)$ is

$$RC_0(t) = \frac{\sin\left(\pi \frac{t}{T_c}(1-\alpha)\right) + 4\alpha \frac{t}{T_c} \cos\left(\pi \frac{t}{T_c}(1+\alpha)\right)}{\pi \frac{t}{T_c} \left(1 - \left(4\alpha \frac{t}{T_c}\right)^2\right)}$$

Where the roll-off factor $\alpha = 0.22$ and T_c is the chip duration

6.8.2 Error Vector Magnitude

The Error Vector Magnitude is a measure of the difference between the reference waveform and the measured waveform. This difference is called the error vector. Both waveforms pass through a matched Root Raised Cosine filter with bandwidth corresponding to the considered chip rate and roll-off $\alpha = 0.22$. One of the waveforms is then further modified by selecting the frequency, absolute phase, absolute amplitude and chip clock timing so as to minimise the error vector. The EVM result is defined as the square root of the ratio of the mean error vector power to the mean reference power expressed as a %. The period of measurement shall be one transmit timeslot excluding the guard period. See Annex B of TS 34.122 for further details.

6.8.2.1 Minimum Requirement

When 16QAM modulation is not used on any of the uplink code channels, the Error Vector Magnitude shall not exceed 17.5 % for the parameters specified in Table 6.9.

When 16QAM modulation is used on any of the uplink code channels, the modulation accuracy requirement shall not exceed 14% for the parameters specified in Table 6.9

Table 6.9: Test parameters for Error Vector Magnitude/Peak Code Domain Error

Parameter	Unit	Level
UE Output Power	dBm	≥ -20
Operating conditions		Normal conditions
Power control step size	dB	1

6.8.3 Peak Code Domain Error

This specification is applicable for multi-code transmission only.

The code domain error is computed by projecting the error vector power onto the code domain at a specific spreading factor. The error power for each code is defined as the ratio to the mean power of the reference waveform expressed in dB. The Peak Code Domain Error is defined as the maximum value for Code Domain Error. The period of measurement shall be one transmit timeslot excluding the guard period, and the midamble.

6.8.3.1 Minimum Requirement

The peak code domain error shall not exceed -21 dB at spreading factor 16 for the parameters specified in Table 6.9.

The peak code domain error for 7.68 Mcps option shall not exceed -24 dB at spreading factor 32 for the parameters specified in Table 6.9.

The requirements are defined using the UL reference measurement channel specified in subclause A.2.7.

7 Receiver characteristics

7.1 General

Unless detailed the receiver characteristic are specified at the antenna connector of the UE. For UE with an integral antenna only, a reference antenna with a gain of 0 dBi is assumed. UE with an integral antenna may be taken into account by converting these power levels into field strength requirements, assuming a 0 dBi gain antenna. For UEs with more than one receiver antenna connector the fading of the signals and the AWGN signals applied to each receiver antenna connector shall be uncorrelated. The levels of the test signal applied to each of the antenna connectors shall be as defined in the respective sections below.

The UE antenna performance has a significant impact on system performance, and minimum requirements on the antenna efficiency are therefore intended to be included in future versions of this specification. It is recognised that different requirements and test methods are likely to be required for the different types of UE.

For 3.84Mcps TDD Option and 7.68Mcps TDD Option, all the parameters in Section 7 are defined using the DL reference measurement channel specified in Annex A.2.2

For 1.28Mcps TDD Option, UE supporting multi-carrier reception shall support both minimum requirements, as well as additional requirements for multi-carrier reception. For minimum requirements, all the parameters in Section 7 are defined using the DL reference measurement channel specified in Annex A.2.2; For UE supporting multi-carrier reception, all the parameters in Section 7 are defined using the DL reference measurement channel specified in Annex A.3.2.8. For the additional requirements for multi-carrier reception, the spacing between the two adjacent carriers shall be 1.6 MHz.

For UEs supporting only MBSFN reception, the DL reference measurement channel specified in Annex A.2.9 is used. For the purposes of clause 7, the term $\Sigma\text{DPCH_Ec}$ refers to the sum of the energy of the physical channels comprising the DL reference measurement channel in use, irrespective of its particular physical channel type (DPCH or not).

7.2 Diversity characteristics

A suitable receiver structure using coherent reception in both channel impulse response estimation, and code tracking procedures is assumed. Three forms of diversity are considered to be available in UTRA/TDD:

Table 7.1: Diversity characteristics for UTRA/TDD

Time diversity	Channel coding and interleaving in both up link and down link
Multi-path diversity	Rake receiver or other suitable receiver structure with maximum combining. Additional processing elements can increase the delay-spread performance due to increased capture of signal energy.
Antenna diversity	Antenna diversity with maximum ratio combining in the base station and optionally in the mobile stations. Possibility for downlink transmit diversity in the base station.

7.3 Reference sensitivity level

The reference sensitivity level is the minimum mean power received at the UE antenna port at which the the specified minimum requirement shall be met.

7.3.1 Minimum Requirements

7.3.1.1 3.84 Mcps TDD Option

For non-IMB operation, the BER shall not exceed 0.001 for the parameters specified in Table 7.2.

For IMB operation, the BLER shall not exceed 0.01 for the parameters specified in Table 7.2.

Table 7.2: Test parameters for reference sensitivity (3.84 Mcps TDD Option)

Parameter	Level	Unit
$\frac{\Sigma DPCH_{Ec}}{I_{or}}$	0 *	dB
\hat{I}_{or}	-105	dBm/3.84 MHz

NOTE *: Subtract 0.77dB when using the IMB DL reference measurement channel. For IMB the term $\Sigma DPCH_{Ec}$ refers to the sum of the energy of the physical channels comprising the IMB DL reference measurement channel.

7.3.1.2 1.28 Mcps TDD Option

The BER shall not exceed 0.001 for the parameters specified in Table 7.2A.

Table 7.2A: Test parameters for reference sensitivity (1.28 Mcps TDD Option)

Parameter	Level	Unit
$\frac{\Sigma DPCH_{Ec}}{I_{or}}$	0	dB
\hat{I}_{or}	-108	dBm/1.28 MHz

7.3.1.3 7.68 Mcps TDD Option

The BER shall not exceed 0.001 for the parameters specified in Table 7.2B.

Table 7.2B: Test parameters for reference sensitivity (7.68 Mcps TDD Option)

Parameter	Level	Unit
$\frac{\Sigma DPCH_{Ec}}{I_{or}}$	0	dB
\hat{I}_{or}	-105	dBm/7.68 MHz

7.3.2 Additional requirement of multi-carrier reception for 1.28Mcps TDD Option

The BLER measured on each carrier shall not exceed 0.1 for the parameters specified in Table 7.2AA.

Table 7.2AA: Test parameters for reference sensitivity of multi-carrier reception

Parameter	Level	Unit
$\frac{\Sigma HS - PDSCH_{Ec}}{I_{or}}$	0	dB
\hat{I}_{or}	-104.8	dBm/1.28 MHz

7.4 Maximum input level

The maximum input level is defined as the maximum mean power received at the UE antenna port which does not degrade the specified minimum requirement.

7.4.1 Minimum Requirements for DPCH reception

7.4.1.1 3.84 Mcps TDD Option

For non-IMB operation, the BER shall not exceed 0.001 for the parameters specified in Table 7.3.

For IMB operation, the BLER shall not exceed 0.01 for the parameters specified in Table 7.3.

Table 7.3: Maximum input level (3.84 Mcps TDD Option)

Parameter	Level	Unit
$\frac{\Sigma DPCH_Ec}{I_{or}}$	-7 *	dB
\hat{I}_{or}	-25	dBm/3.84 MHz
NOTE *: Subtract 0.77dB when using the IMB DL reference measurement channel. For IMB the term $\Sigma DPCH_Ec$ refers to the sum of the energy of the physical channels comprising the IMB DL reference measurement channel.		

7.4.1.2 1.28 Mcps TDD Option

The BER shall not exceed 0.001 for the parameters specified in Table 7.3A

Table 7.3A: Maximum input level (1.28 Mcps TDD Option)

Parameter	Level	Unit
$\frac{\Sigma DPCH_Ec}{I_{or}}$	-7	dB
\hat{I}_{or}	-25	dBm/1.28 MHz

7.4.1.3 7.68 Mcps TDD Option

The BER shall not exceed 0.001 for the parameters specified in Table 7.3B.

Table 7.3B: Maximum input level (7.68 Mcps TDD Option)

Parameter	Level	Unit
$\frac{\Sigma DPCH_Ec}{I_{or}}$	-10	dB
\hat{I}_{or}	-25	dBm/7.68 MHz

7.4.2 Minimum Requirements for HS-PDSCH reception

7.4.2.1 3.84 Mcps TDD Option

<Void>

7.4.2.2 1.28 Mcps TDD Option

7.4.2.2.1 Minimum requirement for 16QAM

The throughput shall be $\geq 90\%$ of the maximum throughput of the reference measurement channels as specified in Table 7.3CA for different UE categories with the parameters specified in Table 7.3C. For multi-carrier reception, DL

reference channel specified in Table 7.3CA and the minimum requirements shall be applied to each carrier simultaneously.

Table 7.3C

Parameter	Level	Unit
$\frac{\sum HS - PDSCH - Ec}{I_{or}}$	0	dB
\hat{I}_{or}	-25	dBm/1.28 MHz
Redundancy and constellation version	6	-
Maximum number of HARQ transmissions	1	-

Table 7.3CA

UE Category	Reference Channel
Category 4-6	A.3.2.2.2
Category 7-9	A.3.2.3.2
Category 10-12	A.3.2.4.2
Category 13-15	A.3.2.5.2

7.4.2.2.2 Minimum requirement for 64QAM

The throughput shall be $\geq 90\%$ of the maximum throughput of the reference measurement channels as specified in Table 7.3E for different UE categories with the parameters specified in Table 7.3D. For multi-carrier reception, DL reference channel specified in Table 7.3E and the minimum requirements shall be applied to each carrier simultaneously.

Table 7.3D

Parameter	Level	Unit
$\frac{\sum HS - PDSCH - Ec}{I_{or}}$	0	dB
\hat{I}_{or}	-25	dBm/1.28 MHz
Redundancy and constellation version	6	-
Maximum number of HARQ transmissions	1	-

Table 7.3E

UE Category	Reference Channel
Category 16-18	A.3.2.7.1
Category 19-21	A.3.2.7.2
Category 22-24	A.3.2.7.3
Category 25/26/27	Note1
Category 28 (Note2)	A.3.2.13.1
Category 29 (Note2)	A.3.2.14.1
Category 30 (Note2)	A.3.2.15.1
Note1: Category 25/26/27 UEs are configured to non-MIMO mode and the requirements of Category 18/21/24 UEs are applied respectively.	
Note2: The FRCs for the first stream is used.	

7.5 Adjacent Channel Selectivity (ACS)

Adjacent Channel Selectivity is a measure of a receiver's ability to receive a wanted signal at its assigned channel frequency in the presence of adjacent channel signal at a given frequency offset from the centre frequency of the assigned channel. ACS is the ratio of the receive filter attenuation on the assigned channel frequency to the receiver filter attenuation on the adjacent channel(s).

7.5.1 Minimum Requirement

7.5.1.1 3.84 Mcps TDD Option

The ACS shall be better than the value indicated in Table 7.4 for the test parameters specified in Table 7.5 where for non-IMB operation the BER shall not exceed 0.001 and for IMB operation, the BLER shall not exceed 0.01.

Table 7.4: Adjacent Channel Selectivity (3.84 Mcps TDD Option)

Power Class	Unit	ACS
2	dB	33
3	dB	33
Note: For the case of an MBSFN-only UE, no power class may be applicable. In this case the same ACS requirement of 33dB shall apply.		

Table 7.5: Test parameters for Adjacent Channel Selectivity (3.84 Mcps TDD Option)

Parameter	Unit	Level
$\frac{\Sigma DPCH_Ec}{I_{or}}$	dB	0 *
I_{or}	dBm/3.84 MHz	-91
I_{oac} mean power (modulated)	dBm	-52
F_{uw} offset	MHz	+5 or -5
NOTE *: Subtract 0.77dB when using the IMB DL reference measurement channel. For IMB the term $\Sigma DPCH_Ec$ refers to the sum of the energy of the physical channels comprising the IMB DL reference measurement channel.		

7.5.1.2 1.28 Mcps TDD Option

The UE shall fulfil the minimum requirement specified in Table 7.4A for all values of an adjacent channel interferer up to -25 dBm.

However it is not possible to directly measure the ACS, instead the lower and upper range of test parameters are chosen in Table 7.5A where the BER shall not exceed 0.001.

Table 7.4A: Adjacent Channel Selectivity (1.28 Mcps TDD Option)

Power Class	Unit	ACS
2	dB	33
3	dB	33
Note: For the case of an MBSFN-only UE, no power class may be applicable. In this case the same ACS requirement of 33dB shall apply.		

Table 7.5A: Test parameters for Adjacent Channel Selectivity (1.28 Mcps TDD Option)

Parameter	Unit	Case 1	Case 2
$\frac{\Sigma DPCH_Ec}{I_{or}}$	dB	0	0
$\frac{I_{or}}{I_{or}}$	dBm/1.28MHz	-91	-62
I_{oac} mean power (modulated)	dBm	-54	-25
F_{uw} offset	MHz	+1.6 or -1.6	+1.6 or -1.6

7.5.1.3 7.68 Mcps TDD Option

The ACS shall be better than the value indicated in Table 7.4B for the test parameters specified in 7.5B where the BER shall not exceed 0.001

Table 7.4B: Adjacent Channel Selectivity (7.68 Mcps TDD Option)

Power Class	Unit	ACS
2	dB	33
3	dB	33

Note: For the case of an MBSFN-only UE, no power class may be applicable. In this case the same ACS requirement of 33dB shall apply.

Table 7.5B: Test parameters for Adjacent Channel Selectivity (7.68 Mcps TDD Option)

Parameter	Unit	Level
$\frac{\Sigma DPCH_Ec}{I_{or}}$	dB	0
$\frac{I_{or}}{I_{or}}$	dBm/7.68 MHz	-91
I_{oac} mean power (modulated)	dBm	-52
F_{uw} Offset (3.84 Mcps Modulated)	MHz	+7.5 or -7.5
F_{uw} Offset (7.68 Mcps Modulated)	MHz	+10 or -10

7.5.2 Additional requirement of multi-carrier reception for 1.28Mcps TDD Option

The ACS shall be better than the value indicated in table 7.4A for the test parameters specified in table 7.5AA where the BLER measured on each carrier shall not exceed 0.1.

Table 7.5AA: Test parameters for Adjacent Channel Selectivity of multi-carrier reception

Parameter	Unit	Case 1	Case 2
$\frac{\Sigma HS - PDSCH_Ec}{I_{or}}$	dB	0	0
$\frac{I_{or}}{I_{or}}$	dBm/1.28MHz	-87.8	-58.8
I_{oac} mean power (modulated)	dBm	-54	-25
F_{uw} offset (Note)	MHz	+1.6 or -1.6	+1.6 or -1.6

Note: Negative offsets refer to the assigned channel frequency of the lowest carrier frequency used and positive offsets refer to the assigned channel frequency of the highest carrier frequency used.

7.6 Blocking characteristics

The blocking characteristics is a measure of the receiver ability to receive a wanted signal at its assigned channel frequency in the presence of an unwanted interferer on frequencies other than those of the spurious response or the

adjacent channels without this unwanted input signal causing a degradation of the performance of the receiver beyond a specified limit. The blocking performance shall apply at all frequencies except those at which a spurious response occur.

7.6.1 Minimum Requirement

7.6.1.1 3.84 Mcps TDD Option

For non-IMB operation, the BER shall not exceed 0.001 for the parameters specified in table 7.6, table 7.7 and table 7.7AA. For IMB operation, the BLER shall not exceed 0.01 for the parameters specified in table 7.6, table 7.7 and table 7.7AA. For table 7.7 and 7.7AA up to 24 exceptions are allowed for spurious response frequencies in each assigned frequency channel when measured using a 1MHz step size. Additional requirement in table 7.7AA is applied for Band a) UE operating on 2010-2025MHz.

Table 7.6: In-band blocking (3.84 Mcps TDD Option)

Parameter	Level		Unit
$\frac{\Sigma DPCH_Ec}{I_{or}}$	0 *		dB
\hat{I}_{or}	-102		dBm/3.84 MHz
I_{ouw} mean power (modulated)	-56 (for F_{uw} offset ± 10 MHz)	-44 (for F_{uw} offset ± 15 MHz)	dBm
NOTE *: Subtract 0.77dB when using the IMB DL reference measurement channel. For IMB the term $\Sigma DPCH_Ec$ refers to the sum of the energy of the physical channels comprising the IMB DL reference measurement channel.			

Table 7.7: Out of band blocking (3.84 Mcps TDD Option)

Parameter	Band 1	Band 2	Band 3	Unit
$\frac{\Sigma DPCH_Ec}{I_{or}}$	0 *	0 *	0 *	dB
\hat{I}_{or}	-102	-102	-102	dBm/3.84 MHz
I_{ouw} (CW)	-44	-30	-15	dBm
F_{uw} For operation in frequency bands as defined in subclause 5.2(a)	1840 <f <1885 1935 <f <1995 2040 <f <2085	1815 <f ≤1840 2085 ≤f <2110	1 <f ≤1815 2110 ≤f <12750	MHz
F_{uw} For operation in frequency bands as defined in subclause 5.2(b)	1790 <f < 1835 2005 <f < 2050	1765 <f ≤ 1790 2050 ≤f < 2075	1 <f ≤ 1765 2075 ≤f < 12750	MHz
F_{uw} For operation in frequency bands as defined in subclause 5.2(c)	1850 <f < 1895 1945 <f < 1990	1825 <f ≤ 1850 1990 ≤f < 2015	1 <f ≤ 1825 2015 ≤f < 12750	MHz
F_{uw} For operation in frequency bands as defined in subclause 5.2(d)	2510 <f < 2555 2635 <f < 2680	2485 <f ≤ 2510 2680 ≤f < 2705	1 <f ≤ 2485 2705 ≤f < 12750	MHz
1.	For operation referenced in 5.2(a), from 1885 ≤f ≤ 1935 MHz, 1995 ≤f ≤ 2040 MHz, the appropriate in-band blocking in table 7.6 or adjacent channel selectivity in section 7.5.1 shall be applied.			
2.	For operation referenced in 5.2(b), from 1835 ≤f ≤ 2005 MHz, the appropriate in-band blocking in table 7.6 or adjacent channel selectivity in section 7.5.1 shall be applied.			
3.	For operation referenced in 5.2(c), from 1895 ≤f ≤ 1945 MHz, the appropriate in-band blocking in table 7.6 or adjacent channel selectivity in section 7.5.1 shall be applied.			
4.	For operation referenced in 5.2(d), from 2555 ≤f ≤ 2635 MHz, the appropriate in-band blocking in table 7.6 or adjacent channel selectivity in section 7.5.1 shall be applied.			
NOTE *:	Subtract 0.77dB when using the IMB DL reference measurement channel. For IMB the term $\Sigma DPCH_Ec$ refers to the sum of the energy of the physical channels comprising the IMB DL reference measurement channel.			

Table 7.7AA: Additional Out of band blocking (3.84 Mcps TDD Option)

Parameter	Band 1	Band 2	Band 3	Unit
$\frac{\Sigma DPCH_Ec}{I_{or}}$	0 *	0 *	0 *	dB
\hat{I}_{or}	-102	-102	-102	dBm/3.84 MHz
I_{ouw} (CW)	-44	-30	-15	dBm
F_{uw} For operation in frequency bands in 2010-2025 MHz as defined in subclause 5.2(a)	1840 <f <1995 2040 <f <2085	1815 <f ≤1840 2085 ≤f <2110	1 <f ≤1815 2110 ≤f <12750	MHz
NOTE 1:	Additional requirement is applied for Band a) UE operating on 2010-2025MHz.			
NOTE *:	Subtract 0.77dB when using the IMB DL reference measurement channel. For IMB the term $\Sigma DPCH_Ec$ refers to the sum of the energy of the physical channels comprising the IMB DL reference measurement channel.			

7.6.1.2 1.28 Mcps TDD Option

The BER shall not exceed 0.001 for the parameters specified in table 7.6A and table 7.7A. For table 7.7A up to 24 exceptions are allowed for spurious response frequencies in each assigned frequency channel when measured using a 1MHz step size.

Table 7.6A: In-band blocking (1.28 Mcps TDD Option)

Parameter	Level		Unit
$\frac{\Sigma DPCH_Ec}{I_{or}}$	0		dB
\hat{I}_{or}	-105		dBm/1.28 MHz
I_{ouw} mean power (modulated)	-61 (for F_{uw} offset ± 3.2 MHz)	-49 (for F_{uw} offset ± 4.8 MHz)	dBm

Table 7.7A: Out of band blocking (1.28 Mcps TDD Option)

Parameter	Band 1	Band 2	Band 3	Unit
$\frac{\Sigma DPCH_Ec}{I_{or}}$	0	0	0	dB
\hat{I}_{or}	-105	-105	-105	dBm/1.28 MHz
I_{ouw} (CW)	-44	-30	-15	dBm
F_{uw} For operation in frequency bands as defined in subclause 5.2(a)	1840 < f < 1895.2 1924.8 < f < 2005.2 2029.8 < f < 2085	1815 < f ≤ 1840 2085 ≤ f < 2110	1 < f ≤ 1815 2110 ≤ f < 12750	MHz
F_{uw} For operation in frequency bands as defined in subclause 5.2(b)	1790 < f < 1845.2 1914.8 < f < 1925.2 1994.8 < f < 2050	1765 < f ≤ 1790 2050 ≤ f < 2075	1 < f ≤ 1765 2075 ≤ f < 12750	MHz
F_{uw} For operation in frequency bands as defined in subclause 5.2(c)	1850 < f < 1905.2 1934.8 < f < 1990	1825 < f ≤ 1850 1990 ≤ f < 2015	1 < f ≤ 1825 2015 ≤ f < 12750	MHz
F_{uw} For operation in frequency bands as defined in subclause 5.2(d)	2510 < f < 2565.2 2624.8 < f < 2680	2485 < f ≤ 2510 2680 ≤ f < 2705	1 < f ≤ 2485 2705 ≤ f < 12750	MHz
F_{uw} For operation in frequency bands as defined in subclause 5.2(e)	2240 < f < 2295.2 2404.8 < f < 2460	2215 < f ≤ 2240 2460 ≤ f < 2485	1 < f ≤ 2215 2485 ≤ f < 12750	MHz
F_{uw} For operation in frequency bands as defined in subclause 5.2(f)	1820 < f < 1875.2 1924.8 < f < 1980	1795 < f ≤ 1820 1980 ≤ f < 2005	1 < f ≤ 1795 2005 < f < 12750	MHz
1.	For operation referenced in 5.2(a), from 1895.2 ≤ f ≤ 1924.8 MHz, 2005.2 ≤ f ≤ 2029.8 MHz, the appropriate in-band blocking in table 7.6A or adjacent channel selectivity in section 7.5.1.2 shall be applied.			
2.	For operation referenced in 5.2(b), from 1845.2 ≤ f < 1914.8 MHz, and 1925.2 < f < 1994.8 MHz, the appropriate in-band blocking in table 7.6A or adjacent channel selectivity in section 7.5.1.2 shall be applied.			
3.	For operation referenced in 5.2(c), from 1905.2 ≤ f ≤ 1934.8 MHz, the appropriate in-band blocking in table 7.6A or adjacent channel selectivity in section 7.5.1.2 shall be applied.			
4.	For operation referenced in 5.2(d), from 2565.2 ≤ f ≤ 2624.8 MHz, the appropriate in-band blocking in table 7.6A or adjacent channel selectivity in section 7.5.1 shall be applied.			
5.	For operation referenced in 5.2(e), from 2295.2 ≤ f ≤ 2404.8 MHz, the appropriate in-band blocking in table 7.6A or adjacent channel selectivity in section 7.5.1 shall be applied.			
6.	For operation referenced in 5.2(f), from 1875.2 ≤ f ≤ 1924.8 MHz, the appropriate in-band blocking in table 7.6A or adjacent channel selectivity in section 7.5.1 shall be applied.			

7.6.1.3 7.68 Mcps TDD Option

The BER shall not exceed 0.001 for the parameters specified in table 7.6B, 7.7B and table 7.7CC. For table 7.7B and 7.7CC up to 24 exceptions are allowed for spurious response frequencies in each assigned frequency channel when measured using a 1MHz step size. Additional requirement in table 7.7CC is applied for Band a) UE operating on 2010-2025MHz.

Table 7.6B: In-band blocking

Parameter	Level		Unit
$\frac{\Sigma DPCH_Ec}{I_{or}}$	0		dB
\hat{I}_{or}	-102		dBm/7.68 MHz
I_{ouw} mean power (modulated)	-53 (for F_{uw} offset ± 20 MHz)	-41 (for F_{uw} offset ± 30 MHz)	dBm

Table 7.7B: Out of band blocking

Parameter	Band 1	Band 2	Band 3	Unit
$\frac{\Sigma DPCH_Ec}{I_{or}}$	0	0	0	dB
\hat{I}_{or}	-102	-102	-102	dBm/7.68 MHz
I_{ouw} (CW)	-44	-30	-15	dBm
F_{uw} For operation in frequency bands as defined in subclause 5.2(a)	1840 <f < 1870 1950 <f < 1980 2055 <f < 2085	1815 <f ≤ 1840 2085 ≤ f < 2110	1 < f ≤ 1815 2110 ≤ f < 12750	MHz
F_{uw} For operation in frequency bands as defined in subclause 5.2(b)	1790 < f < 1820 2020 < f < 2050	1765 < f ≤ 1790 2050 ≤ f < 2075	1 < f ≤ 1765 2075 ≤ f < 12750	MHz
F_{uw} For operation in frequency bands as defined in subclause 5.2(c)	1850 < f < 1880 1960 < f < 1990	1825 < f ≤ 1850 1990 ≤ f < 2015	1 < f ≤ 1825 2015 ≤ f < 12750	MHz
F_{uw} For operation in frequency bands as defined in subclause 5.2(d)	2510 <f < 2540 2650 <f < 2680	2485 <f ≤ 2510 2680 ≤ f < 2705	1 <f ≤ 2485 2705 ≤ f < 12750	MHz
1.	For operation referenced in 5.2(a), from 1870 ≤ f ≤ 1950 MHz, 1980 ≤ f ≤ 2055 MHz, the appropriate in-band blocking in table 7.6B or adjacent channel selectivity in section 7.5.1.3 shall be applied.			
2.	For operation referenced in 5.2(b), from 1820 ≤ f ≤ 2020 MHz, the appropriate in-band blocking in table 7.6B or adjacent channel selectivity in section 7.5.1.3 shall be applied.			
3.	For operation referenced in 5.2(c), from 1880 ≤ f ≤ 1960 MHz, the appropriate in-band blocking in table 7.6B or adjacent channel selectivity in section 7.5.1.3 shall be applied.			
4.	For operation referenced in 5.2(d), from 2540 ≤ f ≤ 2650 MHz, the appropriate in-band blocking in table 7.6B or adjacent channel selectivity in section 7.5.1.3 shall be applied.			

Table 7.7CC: Additional Out of band blocking (7.68 Mcps TDD Option)

Parameter	Band 1	Band 2	Band 3	Unit
$\frac{\Sigma DPCH_Ec}{I_{or}}$	0	0	0	dB
\hat{I}_{or}	-102	-102	-102	dBm/3.84 MHz
$I_{ouw}(CW)$	-44	-30	-15	dBm
F_{uw} For operation in frequency bands in 2010-2025 MHz as defined in subclause 5.2(a)	1840 <f <1995 2040 <f <2085	1815 <f ≤1840 2085 ≤f <2110	1 < f ≤1815 2110 ≤ f <12750	MHz
NOTE 1: Additional requirement is applied for Band a) UE operating on 2010-2025MHz.				

7.6.2 Additional requirement of multi-carrier reception for 1.28Mcps TDD Option

The BLER measured on each carrier shall not exceed 0.1 for the parameters specified in table 7.6AA and table 7.7AAA. For table 7.7AAA up to 24 exceptions for each carrier are allowed for spurious response frequencies in each assigned frequency channel when measured using a 1MHz step size.

Table 7.6AA: In-band blocking of multi-carrier reception

Parameter	Level		Unit
$\frac{\Sigma HS - PDSCH_Ec}{I_{or}}$	0		dB
\hat{I}_{or}	-101.8		dBm/1.28 MHz
I_{ouw} mean power (modulated)	-61 (for F_{uw} offset ±3.2 MHz)(Note)	-49 (for F_{uw} offset ±4.8 MHz)(Note)	dBm
Note: Negative offsets refer to the assigned channel frequency of the lowest carrier frequency used and positive offsets refer to the assigned channel frequency of the highest carrier frequency used.			

Table 7.7AAA: Out of band blocking of multi-carrier reception

Parameter	Band 1	Band 2	Band 3	Unit
$\frac{\Sigma DPCH_Ec}{I_{or}}$	0	0	0	dB
\hat{I}_{or}	-101.8	-101.8	-101.8	dBm/1.28 MHz
I_{ouw} (CW)	-44	-30	-15	dBm
F_{uw} For operation in frequency bands as defined in subclause 5.2(a)	1840 < f < 1895.2 1924.8 < f < 2005.2 2029.8 < f < 2085	1815 < f ≤ 1840 2085 ≤ f < 2110	1 < f ≤ 1815 2110 ≤ f < 12750	MHz
F_{uw} For operation in frequency bands as defined in subclause 5.2(b)	1790 < f < 1845.2 1914.8 < f < 1925.2 1994.8 < f < 2050	1765 < f ≤ 1790 2050 ≤ f < 2075	1 < f ≤ 1765 2075 ≤ f < 12750	MHz
F_{uw} For operation in frequency bands as defined in subclause 5.2(c)	1850 < f < 1905.2 1934.8 < f < 1990	1825 < f ≤ 1850 1990 ≤ f < 2015	1 < f ≤ 1825 2015 ≤ f < 12750	MHz
F_{uw} For operation in frequency bands as defined in subclause 5.2(d)	2510 < f < 2565.2 2624.8 < f < 2680	2485 < f ≤ 2510 2680 ≤ f < 2705	1 < f ≤ 2485 2705 ≤ f < 12750	MHz
F_{uw} For operation in frequency bands as defined in subclause 5.2(e)	2240 < f < 2295.2 2404.8 < f < 2460	2215 < f ≤ 2240 2460 ≤ f < 2485	1 < f ≤ 2215 2485 ≤ f < 12750	MHz
Note:				
1. For operation referenced in 5.2(a), from 1895.2 ≤ f ≤ 1924.8 MHz, 2005.2 ≤ f ≤ 2029.8 MHz, the appropriate in-band blocking in table 7.6AA or adjacent channel selectivity in section 7.5.2 shall be applied.				
2. For operation referenced in 5.2(b), from 1845.2 ≤ f < 1914.8 MHz, and 1925.2 < f < 1994.8 MHz, the appropriate in-band blocking in table 7.6AA or adjacent channel selectivity in section 7.5.2 shall be applied.				
3. For operation referenced in 5.2(c), from 1905.2 ≤ f ≤ 1934.8 MHz, the appropriate in-band blocking in table 7.6AA or adjacent channel selectivity in section 7.5.2 shall be applied.				
4. For operation referenced in 5.2(d), from 2565.2 ≤ f ≤ 2624.8 MHz, the appropriate in-band blocking in table 7.6AA or adjacent channel selectivity in section 7.5.2 shall be applied.				
5. For operation referenced in 5.2(e), from 2295.2 ≤ f ≤ 2404.8 MHz, the appropriate in-band blocking in table 7.6AA or adjacent channel selectivity in section 7.5.2 shall be applied.				

7.7 Spurious response

Spurious response is a measure of the receiver's ability to receive a wanted signal on its assigned channel frequency without exceeding a given degradation due to the presence of an unwanted CW interfering signal at any other frequency at which a response is obtained i.e. for which the blocking limit is not met.

7.7.1 Minimum Requirement

7.7.1.1 3.84 Mcps TDD Option

For non-IMB operation, the BER shall not exceed 0.001 for the parameters specified in Table 7.8.

For IMB operation, the BLER shall not exceed 0.01 for the parameters specified in Table 7.8.

Table 7.8: Spurious Response (3.84 Mcps TDD Option)

Parameter	Level	Unit
$\frac{\Sigma DPCH_Ec}{I_{or}}$	0 *	dB
\hat{I}_{or}	-102	dBm/3.84 MHz
I_{ouw} (CW)	-44	dBm
F_{uw}	Spurious response frequencies	MHz
NOTE *: Subtract 0.77dB when using the IMB DL reference measurement channel. For IMB the term $\Sigma DPCH_Ec$ refers to the sum of the energy of the physical channels comprising the IMB DL reference measurement channel.		

7.7.1.2 1.28 Mcps TDD Option

The BER shall not exceed 0.001 for the parameters specified in Table 7.8A.

Table 7.8A: Spurious Response (1.28 Mcps TDD Option)

Parameter	Level	Unit
$\frac{\Sigma DPCH_Ec}{I_{or}}$	0	dB
\hat{I}_{or}	-105	dBm/1.28 MHz
I_{ouw} (CW)	-44	dBm
F_{uw}	Spurious response frequencies	MHz

7.7.1.3 7.68 Mcps TDD Option

The BER shall not exceed 0.001 for the parameters specified in Table 7.8B.

Table 7.8B: Spurious Response

Parameter	Level	Unit
$\frac{\Sigma DPCH_Ec}{I_{or}}$	0	dB
\hat{I}_{or}	-102	dBm/7.68 MHz
I_{ouw} (CW)	-44	dBm
F_{uw}	Spurious response frequencies	MHz

7.7.2 Additional requirement of multi-carrier reception for 1.28Mcps TDD Option

The BLER measured on each carrier shall not exceed 0.1 for the parameters specified in Table 7.8AA.

Table 7.8AA: Spurious Response of multi-carrier reception

Parameter	Level	Unit
$\frac{\Sigma_{HS} - PDSCH_{Ec}}{I_{or}}$	0	dB
\hat{I}_{or}	-101.8	dBm/1.28 MHz
$I_{ouw} (CW)$	-44	dBm
F_{uw}	Spurious response frequencies	MHz

7.8 Intermodulation characteristics

Third and higher order mixing of the two interfering RF signals can produce an interfering signal in the band of the desired channel. Intermodulation response rejection is a measure of the capability of the receiver to receiver a wanted signal on its assigned channel frequency in the presence of two or more interfering signals which have a specific frequency relationship to the wanted signal.

7.8.1 Minimum Requirements

7.8.1.1 3.84 Mcps TDD Option

For non-IMB operation, the BER shall not exceed 0.001 for the parameters specified in table 7.9.

For IMB operation, the BLER shall not exceed 0.01 for the parameters specified in table 7.9.

Table 7.9: Receive intermodulation characteristics

Parameter	Level	Unit
$\frac{\Sigma_{DPCH} - Ec}{I_{or}}$	0 *	dB
\hat{I}_{or}	-102	dBm/3.84 MHz
$I_{ouw1} (CW)$	-46	dBm
I_{ouw2} mean power (modulated)	-46	dBm
$F_{uw1} (CW)$	± 10	MHz
F_{uw2} (modulated)	± 20	MHz
NOTE *: Subtract 0.77dB when using the IMB DL reference measurement channel. For IMB the term $\Sigma_{DPCH} - Ec$ refers to the sum of the energy of the physical channels comprising the IMB DL reference measurement channel.		

7.8.1.2 1.28 Mcps TDD Option

The BER shall not exceed 0.001 for the parameters specified in table 7.9A

Table 7.9A: Receive intermodulation characteristics (1.28 Mcps TDD Option)

Parameter	Level	Unit
$\frac{\Sigma DPCH - Ec}{I_{or}}$	0	dB
\hat{I}_{or}	-105	dBm/1.28 MHz
I_{ouw1} (CW)	-46	dBm
I_{ouw2} mean power (modulated)	-46	dBm/1.28 MHz
F_{uw1} (CW)	± 3.2	MHz
F_{uw2} (modulated)	± 6.4	MHz

7.8.1.3 7.68 Mcps TDD Option

The BER shall not exceed 0.001 for the parameters specified in table 7.9B.

Table 7.9B: Receive intermodulation characteristics

Parameter	Level	Unit
$\frac{\Sigma DPCH - Ec}{I_{or}}$	0	dB
\hat{I}_{or}	-102	dBm/7.68 MHz
I_{ouw1} (CW)	-46	dBm
I_{ouw2} mean power (modulated)	-46	dBm
F_{uw1} (CW)	± 20	MHz
F_{uw2} (modulated)	± 40	MHz

7.8.2 Additional requirement of multi-carrier reception for 1.28Mcps TDD Option

The BLER measured on each carrier shall not exceed 0.1 for the parameters specified in table 7.9AA

Table 7.9AA: Receive intermodulation characteristics of multi-carrier reception

Parameter	Level	Unit
$\frac{\Sigma HS - PDSCH - Ec}{I_{or}}$	0	dB
\hat{I}_{or}	-101.8	dBm/1.28 MHz
I_{ouw1} (CW)	-46	dBm
I_{ouw2} mean power (modulated)	-46	dBm/1.28 MHz
F_{uw1} (CW)(Note)	± 3.2	MHz
F_{uw2} (modulated)	± 6.4	MHz
Note: Negative offsets refer to the assigned channel frequency of the lowest carrier frequency used and positive offsets refer to the assigned channel frequency of the highest carrier frequency used.		

7.9 Spurious emissions

The Spurious Emissions Power is the power of emissions generated or amplified in a receiver that appear at the UE antenna connector.

7.9.1 Minimum Requirement

7.9.1.1 3.84 Mcps TDD Option

The power of any spurious emission shall not exceed:

Table 7.10: Receiver spurious emission requirements (3.84 Mcps TDD Option)

Band	Maximum level	Measurement Bandwidth	Note
30 MHz - 1 GHz	-57 dBm	100 kHz	
1 GHz - 1.9 GHz and 1.92 GHz - 2.01 GHz and 2.025 GHz - 2.11 GHz and 2.17 GHz - 2.57 GHz	-47 dBm	1 MHz	
1.9 GHz - 1.92 GHz and 2.01 GHz - 2.025 GHz and 2.11 GHz - 2.170 GHz and 2.57 GHz - 2.69 GHz	-60 dBm	3.84 MHz	
2.69 GHz - 12.75 GHz	-47 dBm	1 MHz	

7.9.1.2 1.28 Mcps TDD Option

The power of any spurious emission shall not exceed the maximum level specified in Table 7.10A-1 and Table 7.10A-2:

Table 7.10A-1: Receiver spurious emission requirements (1.28 Mcps TDD Option)

Frequency Band	Measurement Bandwidth	Maximum level	Note
$30\text{MHz} \leq f < 1\text{GHz}$	100 kHz	-57 dBm	
$1\text{GHz} \leq f \leq 12.75\text{GHz}$	1 MHz	-47 dBm	

Table 7.10A-2: Additional receiver spurious emission requirements (1.28 Mcps TDD Option)

Band	Frequency Band	Measurement Bandwidth	Maximum level	Note
a	$2010\text{MHz} \leq f \leq 2025\text{MHz}$	1.28MHz	-64dBm	
	$2570\text{MHz} \leq f \leq 2620\text{MHz}$	1.28MHz	-64dBm	
	$2300\text{MHz} \leq f \leq 2400\text{MHz}$	1.28MHz	-64dBm	
	$1880\text{MHz} \leq f \leq 1920\text{MHz}$	1.28MHz	-64dBm	
	$2110\text{MHz} \leq f \leq 2170\text{MHz}$	3.84MHz	-60dBm	
	$2620\text{MHz} \leq f \leq 2690\text{MHz}$	3.84MHz	-60dBm	
b	$1850\text{MHz} \leq f \leq 1910\text{MHz}$	1.28MHz	-64dBm	
	$1910\text{MHz} \leq f \leq 1990\text{MHz}$	1.28MHz	-64dBm	
c	$1910\text{MHz} \leq f \leq 1930\text{MHz}$	1.28MHz	-64dBm	
d	$2570\text{MHz} \leq f \leq 2620\text{MHz}$	1.28MHz	-64dBm	
	$2010\text{MHz} \leq f \leq 2025\text{MHz}$	1.28MHz	-64dBm	
	$2110\text{MHz} \leq f \leq 2170\text{MHz}$	3.84MHz	-60dBm	
	$2620\text{MHz} \leq f \leq 2690\text{MHz}$	3.84MHz	-60dBm	
e	$2300\text{MHz} \leq f \leq 2400\text{MHz}$	1.28MHz	-64dBm	
	$2010\text{MHz} \leq f \leq 2025\text{MHz}$	1.28MHz	-64dBm	
	$1880\text{MHz} \leq f \leq 1920\text{MHz}$	1.28MHz	-64dBm	
f	$1880\text{MHz} \leq f \leq 1920\text{MHz}$	1.28MHz	-64dBm	
	$2010\text{MHz} \leq f \leq 2025\text{MHz}$	1.28MHz	-64dBm	
	$2300\text{MHz} \leq f \leq 2400\text{MHz}$	1.28MHz	-64dBm	

7.9.1.3 7.68 Mcps TDD Option

The power of any spurious emission shall not exceed:

Table 7.10B: Receiver spurious emission requirements

Band	Maximum level	Measurement Bandwidth	Note
30 MHz - 1 GHz	-57 dBm	100 kHz	
1 GHz - 1.9 GHz and 1.92 GHz - 2.01 GHz and 2.025 GHz - 2.11 GHz 2.17 GHz - 2.57 GHz	-47 dBm	1 MHz	
1.9 GHz - 1.92 GHz and 2.01 GHz - 2.025 GHz and 2.11 GHz - 2.170 GHz 2.57 GHz - 2.69 GHz	-57 dBm	7.68 MHz	
2.69 GHz - 12.75 GHz	-47 dBm	1 MHz	

8 Performance requirement

8.1 General

The performance requirements for the UE in this section are specified for the measurement channels specified in Annex A and the propagation condition specified in Annex B. Unless otherwise stated the receiver characteristics are specified at the antenna connector of the UE. For UE(s) with an integral antenna only, a reference antenna with a gain of 0 dBi is assumed. UE with an integral antenna may be taken into account by converting these power levels into field strength requirements, assuming a 0 dBi gain antenna. For UEs with more than one receiver antenna connector the fading of the signals and the AWGN signals applied to each receiver antenna connector shall be uncorrelated. The levels of the test signal applied to each of the antenna connectors shall be as defined in the respective sections below.

Table 8.1: Summary of UE performance targets

Test Chs.	Information Data Rate	Static	Multi-path Case 1	Multi-path Case 2	Multi-path Case 3
		Performance metric			
DCH	12.2 kbps	BLER < 10 ⁻²	BLER < 10 ⁻²	BLER < 10 ⁻²	BLER < 10 ⁻²
	64 kbps	BLER < 10 ⁻¹ , 10 ⁻²	BLER < 10 ⁻¹ , 10 ⁻²	BLER < 10 ⁻¹ , 10 ⁻²	BLER < 10 ⁻¹ , 10 ⁻² , 10 ⁻³
	144 kbps	BLER < 10 ⁻¹ , 10 ⁻²	BLER < 10 ⁻¹ , 10 ⁻²	BLER < 10 ⁻¹ , 10 ⁻²	BLER < 10 ⁻¹ , 10 ⁻² , 10 ⁻³
	384 kbps	BLER < 10 ⁻¹ , 10 ⁻²	BLER < 10 ⁻¹ , 10 ⁻²	BLER < 10 ⁻¹ , 10 ⁻²	BLER < 10 ⁻¹ , 10 ⁻² , 10 ⁻³
	2048 kbps	BLER < 10 ⁻¹ , 10 ⁻²	BLER < 10 ⁻¹ , 10 ⁻²	BLER < 10 ⁻¹ , 10 ⁻²	BLER < 10 ⁻¹ , 10 ⁻² , 10 ⁻³
BCH	12.3 kbps		BLER < 10 ⁻²		

8.2 Demodulation in static propagation conditions

8.2.1 Demodulation of DCH

The performance requirement of DCH in static propagation conditions is determined by the maximum Block Error Ratio (BLER). The BLER is specified for each individual data rate of the DCH. DCH is mapped into the Dedicated Physical Channel (DPCH).

8.2.1.1 Minimum requirement

8.2.1.1.1 3.84 Mcps TDD Option

For the parameters specified in Table 8.2 the BLER should not exceed the piece-wise linear BLER curve specified in Table 8.3. These requirements are applicable for TFCS size 16.

Table 8.2: DCH parameters in static propagation conditions (3.84 Mcps TDD Option)

Parameters	Unit	Test 1	Test 2	Test 3	Test 4	Test 5
$\frac{\Sigma DPCH - E_c}{I_{or}}$	dB	-6	-3	0	0	0
I_{oc}	dBm/3.84 MHz	-60				
Cell Parameter*		0,1				-
DPCH Channelization Codes*	C(k,Q)	C(i,16) i=1,2	C(i,16) i=1..5	C(i,16) i=1..9	C(i,16) i=1..8	-
OCNS Channelization Code*	C(k,Q)	C(3,16)	C(6,16)	-	-	-
Information Data Rate	kbps	12.2	64	144	384	2048

*Note: Refer to TS 25.223 for definition of channelization codes and cell parameter.

Table 8.3: Performance requirements in AWGN channel (3.84 Mcps TDD Option)

Test Number	$\frac{\hat{I}_{or}}{I_{oc}}$ [dB]	BLER
1	1.1	10^{-2}
2	3.5	10^{-1}
	3.8	10^{-2}
3	3.4	10^{-1}
	3.6	10^{-2}
4	2.7	10^{-1}
	3.0	10^{-2}
5	3.5	10^{-1}
	3.6	10^{-2}

8.2.1.1.2 1.28 Mcps TDD Option

For the parameters specified in Table 8.2A the BLER should not exceed the piece-wise linear BLER curve specified in Table 8.3A.

Table 8.2A: DCH parameters in static propagation conditions (1.28 Mcps TDD Option)

Parameters	Unit	Test 1	Test 2	Test 3	Test 4
Number of DPCH _o		8	2	2	0
Scrambling code and basic midamble code number*		0	0	0	0
DPCH Channelization Codes*	C(k,Q)	C(i,16) i=1,2	C(i,16) i=1...8	C(i,16) i=1...8	C(i,16) i=1...9
DPCH _o Channelization Codes*	C(k,Q)	C(i,16) 3 ≤ i ≤ 10	C(i,16) 9 ≤ i ≤ 10	C(i,16) 9 ≤ i ≤ 10	-
$\frac{DPCH_o - E_c}{I_{or}}$	dB	-10	-10	-10	0
I_{oc}	DBm/1.28MHz	-60			
Information Data Rate	Kbps	12.2	64	144	384

*Note: Refer to TS 25.223 for definition of channelization codes, scrambling code and basic midamble code.

Table 8.3A: Performance requirements in AWGN channel (1.28 Mcps TDD Option)

Test Number	$\frac{\hat{I}_{or}}{I_{oc}}$ [dB]	BLER
1	3.6	10 ⁻²
2	2.4	10 ⁻¹
	2.7	10 ⁻²
3	2.8	10 ⁻¹
	3.2	10 ⁻²
4	4.6	10 ⁻¹

8.2.1.1.3 7.68 Mcps TDD Option

For the parameters specified in Table 8.2B the BLER should not exceed the piece-wise linear BLER curve specified in Table 8.3B. These requirements are applicable for TFCS size 16.

Table 8.2B: DCH parameters in static propagation conditions (7.68 Mcps TDD Option)

Parameters	Unit	Test 1
$\frac{\Sigma DPCH - E_c}{I_{or}}$	dB	-9
I_{oc}	dBm/7.68 MHz	-60
Cell Parameter*	-	0,1
DPCH Channelization Codes*	C(k, Q)	C(i, 32), i = 1,2
OCNS Channelization Code*	C(k, Q)	C(3, 32)
Information Data Rate	kbps	12.2

*Note: Refer to TS 25.223 for definition of channelization codes and cell parameter.

Table 8.3B: Performance requirements in AWGN channel (7.68 Mcps TDD Option)

Test Number	$\frac{\hat{I}_{or}}{I_{oc}}$ [dB]	BLER
1	1.1	10 ⁻²

8.3 Demodulation of DCH in multipath fading conditions

8.3.1 Multipath fading Case 1

The performance requirement of DCH is determined by the maximum Block Error Ratio (BLER). The BLER is specified for each individual data rate of the DCH. DCH is mapped into the Dedicated Physical Channel (DPCH).

8.3.1.1 Minimum requirement

8.3.1.1.1 3.84 Mcps TDD Option

For the parameters specified in Table 8.4 the BLER should not exceed the piece-wise linear BLER curve specified in Table 8.5. These requirement are applicable for TFCS size 16.

Table 8.4: DCH parameters in multipath Case 1 channel (3.84 Mcps TDD Option)

Parameters	Unit	Test 1	Test 2	Test 3	Test 4	Test 5
$\frac{\Sigma DPCH_E_c}{I_{or}}$	DB	-6	-3	0	0	0
I_{oc}	dBm/3.84 MHz	-60				
Cell Parameter*		0,1				-
DPCH Channelization Codes*	C(k,Q)	C(i,16) i=1,2	C(i,16) i=1..5	C(i,16) i=1..9	C(i,16) i=1..8	-
OCNS Channelization Code*	C(k,Q)	C(3,16)	C(6,16)	-	-	-
Information Data Rate	kbps	12.2	64	144	384	2048

*Note: Refer to TS 25.223 for definition of channelization codes and cell parameter.

Table 8.5: Performance requirements in multipath Case 1 channel (3.84 Mcps TDD Option)

Test Number	$\frac{\hat{I}_{or}}{I_{oc}}$ [dB]	BLER
1	13.9	10^{-2}
2	13.7	10^{-1}
	19.8	10^{-2}
3	14.1	10^{-1}
	20.6	10^{-2}
4	13.8	10^{-1}
	20.0	10^{-2}
5	13.2	10^{-1}
	17.8	10^{-2}

8.3.1.1.2 1.28 Mcps TDD Option

For the parameters specified in Table 8.4A the BLER should not exceed the piece-wise linear BLER curve specified in Table 8.5A.

Table 8.4A: DCH parameters in multipath Case 1 channel (1.28 Mcps TDD Option)

Parameters	Unit	Test 1	Test 2	Test 3	Test 4
Number of DPCH _o		8	2	2	0
Scrambling code and basic midamble code number*		0	0	0	0
DPCH Channelization Codes*	C(k,Q)	C(i,16) i=1,2	C(i,16) i=1...8	C(i,16) i=1...8	C(i,16) i=1...9
DPCH _o Channelization Codes*	C(k,Q)	C(i,16) 3 ≤ i ≤ 10	C(i,16) 9 ≤ i ≤ 10	C(i,16) 9 ≤ i ≤ 10	-
$\frac{DPCH_o - E_c}{I_{or}}$	DB	-10	-10	-10	0
I_{oc}	dBm/1.28MHz	-60			
Information Data Rate	Kbps	12.2	64	144	384

*Note: Refer to TS 25.223 for definition of channelization codes, scrambling code and basic midamble code.

Table 8.5A: Performance requirements in multipath Case 1 channel (1.28 Mcps TDD Option)

Test Number	$\frac{\hat{I}_{or}}{I_{oc}}$ [dB]	BLER
1	22.4	10 ⁻²
2	15.8	10 ⁻¹
	22.9	10 ⁻²
3	16.6	10 ⁻¹
	23.9	10 ⁻²
4	15.6	10 ⁻¹
	21.4	10 ⁻²

8.3.1.1.3 7.68 Mcps TDD Option

For the parameters specified in Table 8.4B the BLER should not exceed the piece-wise linear BLER curve specified in Table 8.5B. These requirement are applicable for TFCS size 16.

Table 8.4B: DCH parameters in multipath Case 1 channel (7.68 Mcps TDD Option)

Parameters	Unit	Test 1
$\frac{\Sigma DPCH - E_c}{I_{or}}$	dB	-9
I_{oc}	dBm/7.68 MHz	-60
Cell Parameter*	-	0,1
DPCH Channelization Codes*	C(k, Q)	C(i, 32), i = 1,2
OCNS Channelization Code*	C(k, Q)	C(3, 32)
Information Data Rate	kbps	12.2

*Note: Refer to TS 25.223 for definition of channelization codes and cell parameter.

Table 8.5B: Performance requirements in multipath Case 1 channel (7.68 Mcps TDD Option)

Test Number	$\frac{\hat{I}_{or}}{I_{oc}}$ [dB]	BLER
1	13.9	10 ⁻²

8.3.2 Multipath fading Case 2

The performance requirement of DCH is determined by the maximum Block Error Ratio (BLER). The BLER is specified for each individual data rate of the DCH. DCH is mapped into the Dedicated Physical Channel (DPCH).

8.3.2.1 Minimum requirement

8.3.2.1.1 3.84 Mcps TDD Option

For the parameters specified in Table 8.6 the BLER should not exceed the piece-wise linear BLER curve specified in Table 8.7. These requirements are applicable for TFCS size 16.

Table 8.6: DCH parameters in multipath Case 2 channel (3.84 Mcps TDD Option)

Parameters	Unit	Test 1	Test 2	Test 3	Test 4	Test 5
$\frac{\Sigma DPCH - E_c}{I_{or}}$	DB	-3	0	0	0	0
I_{oc}	dBm/3.84 MHz	-60				
Cell Parameter*		0,1				-
DPCH Channelization Codes*	C(k,Q)	C(i,16) i=1,2	C(i,16) i=1 . . 5	C(i,16) i=1 . . 9	C(i,16) i=1 . . 8	-
OCNS Channelization Code*	C(k,Q)	C(3,16)	-	-	-	-
Information Data Rate	kbps	12.2	64	144	384	2048

*Note: Refer to TS 25.223 for definition of channelization codes and cell parameter.

Table 8.7: Performance requirements in multipath Case 2 channel (3.84 Mcps TDD Option)

Test Number	$\frac{\hat{I}_{or}}{I_{oc}}$ [dB]	BLER
1	5.8	10^{-2}
2	5.7	10^{-1}
	9.2	10^{-2}
3	9.3	10^{-1}
	12.7	10^{-2}
4	8.8	10^{-1}
	12.0	10^{-2}
5	10.3	10^{-1}
	12.7	10^{-2}

8.3.2.1.2 1.28 Mcps TDD Option

For the parameters specified in Table 8.6A the BLER should not exceed the piece-wise linear BLER curve specified in Table 8.7A.

Table 8.6A: DCH parameters in multipath Case 2 channel (1.28 Mcps TDD Option)

Parameters	Unit	Test 1	Test 2	Test 3	Test 4
Number of DPCH _o		8	2	2	0
Scrambling code and basic midamble code number*		0	0	0	0
DPCH Channelization Codes*	C(k,Q)	C(i,16) i=1,2	C(i,16) i=1...8	C(i,16) i=1...8	C(i,16) i=1...9
DPCH _o Channelization Codes*	C(k,Q)	C(i,16) 3 ≤ i ≤ 10	C(i,16) 9 ≤ i ≤ 10	C(i,16) 9 ≤ i ≤ 10	-
$\frac{DPCH_o - E_c}{I_{or}}$	dB	-10	-10	-10	0
I_{oc}	dBm/1.28MHz	-60			
Information Data Rate	Kbps	12.2	64	144	384

*Note Refer to TS 25.223 for definition of channelization codes, scrambling code and basic midamble code.

Table 8.7A: Performance requirements in multipath Case 2 channel (1.28 Mcps TDD Option)

Test Number	$\frac{\hat{I}_{or}}{I_{oc}}$ [dB]	BLER
1	13.6	10 ⁻²
2	9.8	10 ⁻¹
	13.9	10 ⁻²
3	10.3	10 ⁻¹
	14.4	10 ⁻²
4	11.4	10 ⁻¹
	15.0	10 ⁻²

8.3.2.1.3 7.68 Mcps TDD Option

For the parameters specified in Table 8.6B the BLER should not exceed the piece-wise linear BLER curve specified in Table 8.7B. These requirements are applicable for TFCS size 16.

Table 8.6B: DCH parameters in multipath Case 2 channel (7.68 Mcps TDD Option)

Parameters	Unit	Test 1
$\frac{\Sigma DPCH - E_c}{I_{or}}$	dB	-6
I_{oc}	dBm/7.68 MHz	-60
Cell Parameter (note)	-	0,1
DPCH Channelization Codes (note)	C(k, Q)	C(i, 32), i = 1,2
OCNS Channelization Code (note)	C(k, Q)	C(3, 32)
Information Data Rate	kbps	12.2

NOTE: Refer to TS 25.223 for definition of channelization codes and cell parameter.

Table 8.7B: Performance requirements in multipath Case 2 channel (7.68 Mcps TDD Option)

Test Number	$\frac{\hat{I}_{or}}{I_{oc}}$ [dB]	BLER
1	5.8	10 ⁻²

8.3.3 Multipath fading Case 3

The performance requirement of DCH is determined by the maximum Block Error Ratio (BLER). The BLER is specified for each individual data rate of the DCH. DCH is mapped into the Dedicated Physical Channel (DPCH).

8.3.3.1 Minimum requirement

8.3.3.1.1 3.84 Mcps TDD Option

For the parameters specified in Table 8.8 the BLER should not exceed the piece-wise linear BLER curve specified in Table 8.9. These requirements are applicable for TFCS size 16.

Table 8.8: DCH parameters in multipath Case 3 channel (3.84 Mcps TDD Option)

Parameters	Unit	Test 1	Test 2	Test 3	Test 4	Test 5
$\frac{\Sigma DPCH - E_c}{I_{or}}$	dB	-3	0	0	0	0
I_{oc}	dBm/3.84 MHz	-60				
Cell Parameter*		0,1				-
DPCH Channelization Codes*	C(k,Q)	C(i,16) i=1,2	C(i,16) i=1 . . 5	C(i,16) i=1 . . 9	C(i,16) i=1 . . 8	-
OCNS Channelization Code*	C(k,Q)	C(3,16)	-	-	-	-
Information Data Rate	kbps	12.2	64	144	384	2048

*Note: Refer to TS 25.223 for definition of channelization codes and cell parameter.

Table 8.9: Performance requirements in multipath Case 3 channel (3.84 Mcps TDD Option)

Test Number	$\frac{\hat{I}_{or}}{I_{oc}}$ [dB]	BLER
1	4.8	10^{-2}
2	5.8	10^{-1}
	8.5	10^{-2}
	10.7	10^{-3}
3	10.3	10^{-1}
	13.3	10^{-2}
	16.0	10^{-3}
4	8.9	10^{-1}
	11.5	10^{-2}
	13.6	10^{-3}
5	9.4	10^{-1}
	11.5	10^{-2}
	13.6	10^{-3}

8.3.3.1.2 1.28 Mcps TDD Option

For the parameters specified in Table 8.8A the BLER should not exceed the piece-wise linear BLER curve specified in Table 8.9A.

Table 8.8A: DCH parameters in multipath Case 3 channel (1.28 Mcps TDD Option)

Parameters	Unit	Test 1	Test 2	Test 3	Test 4
Number of DPCH _o		8	2	2	0
Scrambling code and basic midamble code number*		0	0	0	0
DPCH Channelization Codes*	C(k,Q)	C(i,16) i=1,2	C(i,16) i=1...8	C(i,16) i=1...8	C(i,16) i=1...9
DPCH _o Channelization Codes*	C(k,Q)	C(i,16) 3 ≤ i ≤ 10	C(i,16) 9 ≤ i ≤ 10	C(i,16) 9 ≤ i ≤ 10	-
$\frac{DPCH_o - E_c}{I_{or}}$	dB	-10	-10	-10	0
I_{oc}	dBm/1.28MHz	-60			
Information Data Rate	Kbps	12.2	64	144	384

*Note Refer to TS 25.223 for definition of channelization codes, scrambling code and basic midamble code.

Table 8.9A: Performance requirements in multipath Case 3 channel (1.28 Mcps TDD Option)

Test Number	$\frac{\hat{I}_{or}}{I_{oc}}$ [dB]	BLER
1	11.7	10 ⁻²
2	9.0	10 ⁻¹
	11.7	10 ⁻²
	14.3	10 ⁻³
3	9.1	10 ⁻¹
	11.2	10 ⁻²
	12.7	10 ⁻³
4	9.9	10 ⁻¹
	11.2	10 ⁻²
	12.4	10 ⁻³

8.3.3.1.3 7.68 Mcps TDD Option

For the parameters specified in Table 8.8B the BLER should not exceed the piece-wise linear BLER curve specified in Table 8.9B. These requirements are applicable for TFCS size 16.

Table 8.8B: DCH parameters in multipath Case 3 channel (7.68 Mcps TDD Option)

Parameters	Unit	Test 1
$\frac{\Sigma DPCH - E_c}{I_{or}}$	dB	-6
I_{oc}	dBm/7.68 MHz	-60
Cell Parameter*	-	0,1
DPCH Channelization Codes*	C(k, Q)	C(i, 32), i = 1,2
OCNS Channelization Code*	C(k, Q)	C(3, 32)
Information Data Rate	kbps	12.2

*Note: Refer to TS 25.223 for definition of channelization codes and cell parameter.

Table 8.9B: Performance requirements in multipath Case 3 channel (7.68 Mcps TDD Option)

Test Number	$\frac{\hat{I}_{or}}{I_{oc}}$ [dB]	BLER
1	4.8	10^{-2}

8.4 Base station transmit diversity mode for 3.84 Mcps TDD Option

8.4.1 Demodulation of BCH in SCTD mode

The performance requirement of BCH is determined by the maximum Block Error Rate (BLER). The BLER is specified for the BCH. BCH is mapped into the Primary Common Control Physical Channel (P-CCPCH).

8.4.1.1 Minimum requirement

For the parameters specified in Table 8.10 the BLER should not exceed the BLER specified in Table 8.11.

NOTE: This requirement doesn't need to be tested.

Table 8.10: P-CCPCH parameters in multipath Case 1 channel

Parameters	Unit	Test 1
$\frac{PCCPCH - E_c}{I_{or}}$	dB	-3
I	dBm/3.84 MHz	-60
Information Data Rate	Kbps	12.3

Table 8.11: Performance requirements in multipath Case 1 channel

Test Number	$\frac{\hat{I}_{or}}{I_{oc}}$ [dB]	BLER
1	8.4	10^{-2}

8.5 Power control in downlink

Power control in the downlink is the ability of the UE receiver to converge to the required link quality set by the network while using minimum downlink power.

8.5.1 Power control in downlink, constant BLER target

8.5.1.1 Minimum requirements 3.84 Mcps TDD option

For the parameters specified in Table 8.12 the downlink $\frac{\hat{I}_{or}}{I_{oc}}$ averaged over one timeslot shall be below the specified value in Table 8.13 more than 90% of the time. BLER shall be as shown in Table 8.13. Downlink power control is ON during the test.

Table 8.12: Test parameters for downlink power control - constant BLER Target (3.84 Mcps TDD option)

Parameter	Unit	Test 1
$\frac{DPCH - E_c}{I_{or}}$	dB	0
I_{oc}	dBm/3.84 MHz	-60
Information Data Rate	kbps	12.2
Target quality value on DTCH	BLER	0.01
Propagation condition		Case 1
DL Power Control step size, Δ_{TPC}	dB	1
Maximum_DL_power *	dB	0
Minimum_DL_power *	dB	-27
*Note: Refer to TS 25.224 for description and definition		

Table 8.13: Requirements for downlink power control - constant BLER Target (3.84 Mcps TDD option)

Parameter	Unit	Test 1
\hat{I}_{or}/I_{oc}	dB	8.5
Measured quality on DTCH	BLER	0.01±30%

8.5.1.2 Minimum requirements 1.28 Mcps TDD option

For the parameters specified in Table 8.13A the downlink \hat{I}_{or}/I_{oc} averaged over one timeslot, shall be below the specified value in Table 8.13B more than 90% of the time. BLER shall be as shown in table 8.13B. Downlink power control is ON during the test.

Table 8.13A: Test parameters for downlink power control - constant BLER Target (1.28 Mcps TDD option)

Parameter	Unit	Test 1	Test 2	Test 3	Test 4	Test 5	Test 6
$\frac{\Sigma DPCH - E_c}{I_{or}}$	dB	0	0	0	0	0	0
I_{oc}	dBm/1.28 Mhz	-60	-60	-60	-60	-60	-60
Information data rate	kbps	12.2	12.2	64	64	64	64
Target quality on DTCH	BLER	0.01	0.01	0.1	0.1	0.001	0.001
Propagation condition		Case 1	Case 3	Case 1	Case 3	Case 1	Case 3
DL Power Control step size, Δ_{TPC}	dB	1	1	1	1	1	1
Maximum_DL_power *	dB	0	0	0	0	0	0
Minimum_DL_power *	dB	-27	-27	-27	-27	-27	-27

NOTE: Power is compared to P-CCPCH power

Table 8.13B: Requirements for downlink power control - constant BLER Target (1,28 Mcps TDD option)

Parameter	Unit	Test 1	Test 2	Test 3	Test 4	Test 5	Test 6
\hat{I}_{or}/I_{oc}	dB	7.5	4.8	9.1	8.9	17.9	13.1
Measured quality on DTCH	BLER	0.01±30%	0.01±30%	0.1±30%	0.1±30%	0.001±30%	0.001±30%

8.5.2 Power control in downlink, wind up effects

8.5.2.1 Minimum requirements 3.84 Mcps TDD option

Void

8.5.2.2 Minimum requirements 1.28 Mcps TDD option

This test is run in three stages where stage 1 is for convergence of the power control loop. In stage two the maximum downlink power for the dedicated channel is limited not to be higher than the value specified in Table 8.13C. All parameters used in the three stages are specified in Table 8.13C. The downlink I_{or}/I_{oc} power ratio measured values,

which are averaged over one timeslot, during stage 3 shall be lower than the value specified in Table 8.13D more than 90% of the time.

Power control of the UE is ON during the test.

Table 8.13C: Test parameter for downlink power control, wind-up effects

Parameter	Unit	Test 1		
		Stage 1	Stage 2	Stage 3
Time in each stage	s	5	40	5
I_{oc}	dBm/1.28 MHz	-60		
Information Data Rate	kbps	12.2		
Quality target on DTCH	BLER	0.01		
Propagation condition		Case 1		
Maximum_DL_Power	dB	0	P(Note 1)	0
Minimum_DL_Power	dB	-27		
DL Power Control step size, Δ_{TPC}	dB	1		
Note 1: P is the level corresponding to the average I_{or}/I_{oc} power ratio - 3 dB compared to the P-CCPCH level. The average I_{or}/I_{oc} power ratio is measured during the initialisation stage after the power control loop has converged before the actual test starts.				

Table 8.13D: Requirements in downlink power control, wind-up effects

Parameter	Unit	Test 1, stage 3
I_{or}/I_{oc}	dB	9.1

8.5.3 Power control in the downlink, initial convergence

This requirement verifies that DL power control works properly during the first seconds after DPCH connection is established

8.5.3.1 Minimum requirements 3.84 Mcps TDD option

Void

8.5.3.2 Minimum requirements 1.28 Mcps TDD option

For the parameters specified in Table 8.13E the downlink I_{or}/I_{oc} power ratio measured values, which are averaged over 50 ms, shall be within the range specified in Table 8.13F more than 90% of the time. T1 equals to 5 s and it starts 100 ms after the DPCH physical channel is considered established and the first uplink frame is transmitted. T2 equals to 5 s and it starts when T1 has expired. Power control is ON during the test.

The first 100 ms shall not be used for averaging, ie the first sample to be input to the averaging filter is at the beginning of T1. The averaging shall be performed with a sliding rectangular window averaging filter. The window size of the averaging filter is linearly increased from 0 up to 50 ms during the first 50 ms of T1, and then kept equal to 50ms.

Table 8.13E: Test parameters for downlink power control, initial convergence

Parameter	Unit	Test 1	Test 2	Test 3	Test 4
Target quality value on DTCH	BLER	0.01	0.01	0.1	0.1
Initial I_{or}/I_{oc}	dB	5	-15	9.4	-10.6
Information Data Rate	kbps	12.2	12.2	64	64
I_{oc}	dBm/1.28 MHz	-60			
Propagation condition		Static			
Maximum_DL_Power	dB	0			
Minimum_DL_Power	dB	-27			
DL Power Control step size, Δ_{TPC}	dB	1			

Table 8.13F: Requirements in downlink power control, initial convergence

Parameter	Unit	Test 1 and Test 2	Test 3 and Test 4
I_{or}/I_{oc} during T1	dB	$-8.5 \leq I_{or}/I_{oc} \leq 0$	$-4.1 \leq I_{or}/I_{oc} \leq 4.4$
I_{or}/I_{oc} during T2	dB	$-8.5 \leq I_{or}/I_{oc} \leq -3$	$-4.1 \leq I_{or}/I_{oc} \leq 1.4$

8.6 Uplink Power Control for 3.84 Mcps TDD Option

Power control in the uplink is the ability of the UE to converge to the required link quality set by the network while using minimum uplink power.

8.6.1 Test Conditions

During period T1, the PCCPCH and a second Beacon Channel are transmitted in the DL in designated slots within each frame and at the same power level.

The UE transmits, using the channel of TS25.105, Annex A.2.1 UL reference measurement channel (12.2 kbps) in one UL slot. For different parts of the test, different UL slots will be designated.

The values of table 8.14, period T1 shall be selected. Then, with the received PCCPCH and Beacon power set at -60 dBm, the value of DPCH constant value shall be adjusted so that the mean UE output power is 5 dBm. These conditions are held steady during period T1.

Periods T1 and T2 are each 5 seconds long.

Table 8.14: UL Power Control Test Conditions

		Period T1	Period T2
I_{BTS} all slots	dBm	-60	
PCCPCH Power -Broadcast	dBm	18	
PCCPCH power - Received	dBm	-60	-70
Mean UE transmit power	dBm	5	According to tables 8.15 and 8.16
SIR_{TARGET}	dB	6	
I_{oc} in PCCPCH and Beacon Slots	dBm	-60	
IE (information element) Alpha	As defined in 25.331	1.0	
PCCPCH slot position	Integer 0 -14	0	
Beacon slot position	Integer 0-14	8	

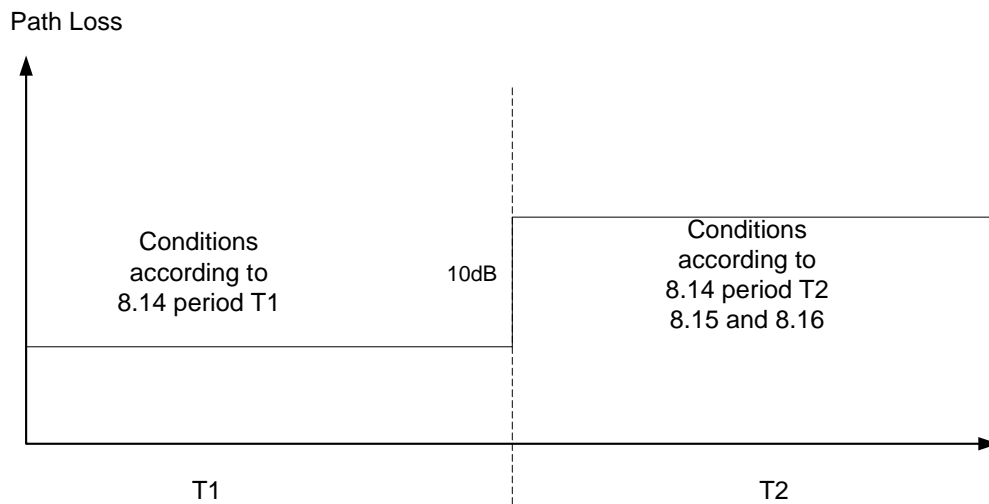

Figure 8.1

8.6.2 Performance

At the end of period T1, the PCCPCH and Beacon Received power shall be simultaneously decreased by 10 dB. These conditions are summarized in table 8.14, period T2.

For the first frame including the change in received power the UE output power shall satisfy the values in table 8.15.

For the 20th frame after the change in received power the UE output power shall satisfy the values in table 8.16.

Table 8.15: Required UE Output Power, Frame Containing Power Level Change

Parameter	Units	Value	
UL transmission slot position		1,9	7,14
UE output power	dBm	15 ±4.0	5 ±0.5

Table 8.16: Required UE Output Power, 20 Frames after Power Level Change

Parameter	Units	Value	
UL transmission slot position		1,9	7,14
UE output power	dBm	15 ±4.0	15 ±4.0

8.7 Demodulation of DCH in moving conditions

The receive characteristics of the Dedicated Channel (DCH) in dynamic moving propagation conditions are determined by the Block Error Ratio (BLER) values. BLER is measured for the each of the individual data rate specified for the DPCH. DCH is mapped into Dedicated Physical Channel (DPCH).

8.7.1 Minimum requirement

8.7.1.1 3.84 Mcps TDD Option

Void

8.7.1.2 1.28 Mcps TDD Option

For the parameters specified in Table 8.17 the BLER should not exceed the piece-wise linear BLER curve specified in Table 8.18.

Table 8.17: DCH parameters in moving propagation conditions (1.28 Mcps TDD Option)

Parameters	Unit	Test 1	Test 2
Number of DPCH _o		8	2
Scrambling code and basic midamble code number*		0	0
DPCH Channelization Codes*	C(k,Q)	C(i,16) i=1,2	C(i,16) i=1...8
DPCH _o Channelization Codes*	C(k,Q)	C(i,16) 3 ≤ i ≤ 10	C(i,16) 9 ≤ i ≤ 10
$\frac{DPCH_o - E_c}{I_{or}}$	dB	-10	-10
I_{oc}	DBm/1.28MHz	-60	
Information Data Rate	Kbps	12.2	64
*Note: Refer to TS 25.223 for definition of channelization codes, scrambling code and basic midamble code.			

Table 8.18: Performance requirements in moving propagation conditions (1.28 Mcps TDD Option)

Test Number	$\frac{\hat{I}_{or}}{I_{oc}}$ [dB]	BLER
1	7.1	10 ⁻²
2	6.7	10 ⁻²

8.7.1.3 7.68 Mcps TDD Option

Void

8.8 Demodulation of DCH in birth-death conditions

The receive characteristics of the Dedicated Channel (DCH) in birth-death propagation conditions are determined by the Block Error Ratio (BLER) values. BLER is measured for the each of the individual data rate specified for the DPCH. DCH is mapped into in Dedicated Physical Channel (DPCH).

8.8.1 Minimum requirement

8.8.1.1 3.84 Mcps TDD Option

Void

8.8.1.2 1.28 Mcps TDD Option

For the parameters specified in Table 8.19 the BLER should not exceed the piece-wise linear BLER curve specified in Table 8.20.

Table 8.19: DCH parameters in birth-death propagation conditions (1.28 Mcps TDD Option)

Parameters	Unit	Test 1	Test 2
Number of DPCH _o		8	2
Scrambling code and basic midamble code number*		0	0
DPCH Channelization Codes*	C(k,Q)	C(i,16) i=1,2	C(i,16) i=1..8
DPCH _o Channelization Codes*	C(k,Q)	C(i,16) 3 ≤ i ≤ 10	C(i,16) 9 ≤ i ≤ 10
$\frac{DPCH_o - E_c}{I_{or}}$	dB	-10	-10
I_{oc}	DBm/1.28MHz	-60	
Information Data Rate	Kbps	12.2	64
*Note: Refer to TS 25.223 for definition of channelization codes, scrambling code and basic midamble code.			

Table 8.20: Performance requirements in birth-death propagation conditions (1.28 Mcps TDD Option)

Test Number	$\frac{\hat{I}_{or}}{I_{oc}}$ [dB]	BLER
1	7.3	10 ⁻²
2	6.5	10 ⁻²

8.8.1.3 7.68 Mcps TDD Option

void

9 Performance requirements (HSDPA)

9.1 Performance requirement for 3.84 Mcps TDD option

The requirements are stated for the HSDPA UE reference combination classes specified in [2] and under the multipath propagation conditions specified in Annex B. The performance metric for HS-DSCH requirements in multi-path propagation conditions is the throughput R measured on HS-DSCH.

9.1.1 HS-DSCH throughput for fixed reference channels

The performance requirements in this subclause apply for the reference measurement channels specified in Annex A.3.2.

During the Fixed Reference Channel tests the behaviour of the Node-B emulator in response to the ACK/NACK signalling field of the HS-SICH is specified in Table 9.1:

Table 9.1: Node-B Emulator Behaviour in response to ACK/NACK/DTX

HS-SICH ACK/NACK Field State	Node-B Emulator Behaviour
ACK	ACK: new transmission using 1 st redundancy version (RV)
NACK	NACK: retransmission using the next RV (up to the maximum permitted number or RV's)
DTX	DTX: retransmission using the RV previously transmitted to the same H-ARQ process

9.1.1.1 Minimum requirement QPSK, Fixed Reference Channel, 7,3 Mbps - Category 8 - UE

For the parameters specified in Table 9.2, the measured throughput R shall exceed the throughput specified in Table 9.3 for each radio condition.

Table 9.2: Test parameters for fixed reference measurement channel requirements for 7,3 Mbps - Category 8 - UE (3,84 Mcps TDD Option) QPSK

Parameters	Unit	Test 1	Test 2	Test 3	Test 4
HS-PDSCH Modulation	-	QPSK			
Scrambling code and basic midamble code number*	-	0, 1			
Number of TS	-	8			
HS-PDSCH Channelization Codes*	C(k,Q)	C(i,16) i=1..16			C(i,16) i=1..14
Number of Hybrid ARQ processes	-	4			
Maximum number of Hybrid ARQ transmissions	-	4			
Redundancy and constellation version coding sequence**	-	{0,0,0,0} s=1, R=0, b=0			
$\frac{HS - PDSCH - E_c}{I_{or}}$	dB	-12,04			-11.46
$\sum \frac{HS - PDSCH - E_c}{I_{or}}$	dB	0			
I_{oc}	dBm/3,84 MHz	-60			
Note *: Refer to TS 25.223 for definition of channelization codes, scrambling code and basic midamble code.					
Note **: This sequence implies Chase combining					

Table 9.3: Performance requirements for fixed reference measurement channel requirement in multipath channels for 7,3 Mbps - Category 8 - UE (3,84 Mcps TDD Option) QPSK

Test Number	Propagation conditions	$\frac{\hat{I}_{or}}{I_{oc}}$ [dB]	R (Throughput) [kbps]
1	PA3	8,5	1300
2	PB3	9,0	1300
3	VA30	9,75	1300
4	VA120	11,5	1400

9.1.1.2 Minimum requirement 16QAM, Fixed Reference Channel, 7,3 Mbps - Category 8 - UE

For the parameters specified in Table 9.4, the measured throughput R shall exceed the throughput specified in Table 9.5 for each radio condition.

Table 9.4: Test parameters for fixed reference measurement channel requirements for 7,3 Mbps - Category 8 - UE (3,84 Mcps TDD Option) 16QAM

Parameters	Unit	Test 1	Test 2	Test 3	Test 4
HS-PDSCH Modulation	-	16QAM			
Scrambling code and basic midamble code number*	-	0, 1			
Number of TS	-	8			
HS-PDSCH Channelization Codes*	C(k,Q)	C(i,16) i=1..16			C(i,16) i=1..14
Number of Hybrid ARQ processes	-	4			
Maximum number of Hybrid ARQ transmissions	-	4			
Redundancy and constellation version coding sequence**	-	{0,0,0,0} s=1, r=0			
$\frac{HS - PDSCH - E_c}{I_{or}}$	dB	-12,04			-11,46
$\frac{\sum HS - PDSCH - E_c}{I_{or}}$	dB	0			
I_{oc}	dBm/3,84 MHz	-60			
Note *: Refer to TS 25.223 for definition of channelization codes, scrambling code and basic midamble code.					
Note **: This sequence implies Chase combining					

Table 9.5: Performance requirements for fixed reference measurement channel requirement in multipath channels for 7,3 Mbps - Category 8 - UE (3,84 Mcps TDD Option) 16QAM

Test Number	Propagation conditions	$\frac{\hat{I}_{or}}{I_{oc}}$ [dB]	R (Throughput) [kbps]
1	PA3	16,0	2600
2	PB3	17,5	2600
3	VA30	18,5	2600
4	VA120	14,5	1600

9.1.2 HS-DSCH throughput for Variable Reference Channels

9.1.2.1 Minimum requirement Variable Reference Channel, 7,3 Mbps - Category 8 - UE

For the parameters specified in Table 9.6 the measured throughput R shall exceed the throughput specified in Table 9.7 for each radio condition. The Variable Reference Channel is specified in Annex A.3.3.

Table 9.6: Test parameters for variable reference measurement channel requirements for 7,3 Mbps - Category 8 - UE (3,84 Mcps TDD Option)

Parameters	Unit	Test 1	Test 2	Test 3	Test 4
Scrambling code and basic midamble code number*	-	0, 1			
Number of TS	-	8			
HS-PDSCH Channelization Codes*	C(k,Q)	C(i,16) i=1..16			
Number of Hybrid ARQ processes**	-	4			
Maximum number of Hybrid ARQ transmissions	-	1			
Redundancy and constellation version coding sequence	(Xrv, s, r, b)	(0, 1, 0, 0)			
HS-PDSCH _i _Ec/Ior	dB	-12,04			
$\frac{\sum_{i=1}^i HS - PDSCH - Ec_i}{I_{or}}$	dB	0			
I _{oc}	dBm/3,84MHz	-60			
Note *:	Refer to TS 25.223 for definition of channelization codes, scrambling code and basic midamble code.				
Note **:	For timing requirements, HARQ is not active				

Table 9.7: Performance requirements for variable reference measurement channel requirement in multipath channels for 7,3 Mbps - Category 8 - UE (3,84 Mcps TDD Option)

Test Number	Propagation conditions	$\frac{\hat{I}_{or}}{I_{oc}}$ [dB]	R (Throughput) [kbps]
1	PA3	8,8	1240
		14,8	2500
		18,8	3600
		24,8	5000
		8,8	1220
2	PB3	14,8	2430
		20,8	4030
		24,8	5080
		10,1	1190
		16,1	2290
3	VA30	20,1	3220
		24,1	4260
		7,1	590
		11,1	1180
4	VA120	15,1	1840
		19,1	2390

9.1.3 Reporting of Channel Quality Indicator

The reporting accuracy of channel quality indicator (CQI) under AWGN environments is determined by the reporting variance and BLER performance using the transport format indicated by the reported median CQI.

9.1.3.1 Minimum requirement Channel Quality Indicator, 7,3 Mbps - Category 8 - UE

For the parameters specified in Table 9.7A the reported CQI value shall be within the range of +/- 10 of the allowable CQIs of the reported median CQI more than 90% of the time. The BLER for the reported median CQI shall be less than 10%.

Table 9.7A: Test parameters for variable reference measurement channel requirements for 7,3 Mbps - Category 8 - UE (3,84 Mcps TDD Option)

Parameters	Unit	Test 1	Test 2
Scrambling code and basic midamble code number*	-	0, 1	
Number of TS	-	8	
HS-PDSCH Channelization Codes*	C(k,Q)	C(i,16) i=1..16	
Number of Hybrid ARQ processes**	-	4	
Maximum number of Hybrid ARQ transmissions	-	1	
Redundancy and constellation version coding sequence	(Xrv, s, r, b)	(0, 1, 0, 0)	
HS-PDSCH _i Ec/Ior	dB	-12,04	
$\frac{\sum_{i=1}^i HS - PDSCH - Ec_i}{I_{or}}$	dB	0	
\hat{I}_{or} / I_{oc}	dB	5	10
I _{oc}	dBm/3,84MHz	-60	
Note*:	Refer to TS 25.223 for definition of channelization codes, scrambling code and basic midamble code.		
Note**:	For timing requirements, HARQ is not active		

9.1.4 HS-SCCH Detection Performance

The detection performance of the HS-SCCH is determined by the probability of event E_m , which is declared when the UE is signaled on HS-SCCH, but DTX is observed in the corresponding HS-SICH ACK/NACK field. The probability of event E_m is denoted $P(E_m)$.

9.1.4.1 Minimum Requirements for HS-SCCH Detection

For the test parameters in Table 9.7B, for each value of HS-SCCH-1 E_c/I_{or} specified in Table 9.7C, the measured $P(E_m)$ shall be less than or equal to the corresponding specified value of $P(E_m)$.

Table 9.7B: Test parameters for HS-SCCH detection (3.84 Mcps TDD option)

Parameter	Unit	Test 1	Test 2	Test 3
Number of TS under test	-	1		
Number of HS-SCCH codes per timeslot	-	4		
HS-SCCH UE Identity ($x_{ue,1}, x_{ue,2}, \dots, x_{ue,16}$)	-	UE1 = 0000000000000000 (UE1 under test) UE2 = 0101010101010101 UE3 = 1010101010101010 UE4 = 1111111111111111		
HS-SCCH Channelization Codes*	C(k,Q)	HS-SCCH-1 = C(1, 16), for UE1 (UE under test) HS-SCCH-2 = C(2, 16) for UE2 HS-SCCH-3 = C(3, 16) for UE3 HS-SCCH-4 = C(4, 16) for UE4		
HS-SCCH E_c/I_{or}	dB	HS-SCCH-2 E_c/I_{or} = HS-SCCH-3 E_c/I_{or} = HS-SCCH-4 E_c/I_{or} , Where, $\sum HS-SCCH-X E_c/I_{or} = 1$, where X = 1, 2, 3, 4		

Table 9.7C: Minimum requirement for HS-SCCH detection (3.84 Mcps TDD option)

Test Number	Propagation Conditions	Reference value		
		HS-SCCH-1 E_c / I_{or} (dB)	\hat{I}_{or} / I_{oc} (dB)	$P(E_m)$
1	PA3	-1.6	0	0.05
2	PA3	-3.0	5	0.01
3	VA30	-2.5	0	0.01

9.2 Performance requirements for 1.28 Mcps TDD option

The requirements are stated for the HSDPA UE reference combination classes specified in [2] and under the multipath propagation conditions specified in Annex B. The performance metric for HS-DSCH requirements in multi-path propagation conditions is the throughput R measured on HS-DSCH.

For multi-carrier reception, the performance metric for HS-DSCH requirements is the throughput R measured on HS-DSCH on each carrier and the spacing between the two adjacent carriers shall be 1.6 MHz.

Unless otherwise stated the performance requirements are specified at the antenna connector of the UE. For UE(s) with an integral antenna only, a reference antenna with a gain of 0 dBi is assumed. UE with an integral antenna may be taken into account by converting these power levels into field strength requirements, assuming a 0 dBi gain antenna. For UEs with more than one antenna connector testing the fading of the signals and the AWGN signals applied to each receiver antenna connector shall be uncorrelated. The levels of the test signal applied to each of the antenna connectors shall be as defined in the respective sections below.

9.2.1 HS-DSCH throughput for fixed reference channels

The performance requirements in this subclause apply for the reference measurement channels specified in Annex A.3.2.

During the Fixed Reference Channel tests the behaviour of the Node-B emulator in response to the ACK/NACK signalling field of the HS-SICH is specified in Table 9.8

Table 9.8: Node-B Emulator Behaviour in response to ACK/NACK/DTX

HS-SICH ACK/NACK Field State	Node-B Emulator Behaviour
ACK	ACK: new transmission using 1 st redundancy and constellation version (RV)
NACK	NACK: retransmission using the next RV (up to the maximum permitted number or RV"s)
DTX	DTX: retransmission using the RV previously transmitted to the same H-ARQ process

NOTE: Performance requirements in this section assume a sufficient power allocation to HS-SCCH so that probability of reporting DTX is very low.

9.2.1.1 Category 1, 0.5Mbps UE class

For the parameters specified in Table 9.9, the measured throughput R shall exceed the throughput specified in Table 9.10 for each radio condition.

Table 9.9: Test parameters for fixed reference measurement channel, QPSK

Parameters	Unit	Test 1	Test 2	Test 3	Test 4
HS-PDSCH Modulation	-	QPSK*			
Scrambling code and basic midamble code number**	-	1			
Number of TS	-	2			
HS-PDSCH Channelization Codes*	C(k,Q)	C(i,16) i=1..10			
Number of Hybrid ARQ processes	-	4			
Maximum number of Hybrid ARQ transmissions	-	4			
Redundancy and constellation version coding sequence	-	{0,0,0,0}			
$\frac{HS - PDSCH - E_c}{I_{or}}$	dB	-10			
I_{oc}^{***}	dBm/1.28 MHz	-60			
<p>* Note Only QPSK is supported for this category UE.</p> <p>**Note: Refer to TS 25.223 for definition of channelization codes, scrambling code and basic midamble code.</p> <p>***Note: For multi-carrier reception, it refers to the interference power on each carrier.</p>					

Table 9.10: Performance requirements for fixed reference channel, QPSK

Test Number	Propagation conditions	$\frac{\hat{I}_{or}}{I_{oc}}$ [dB](Note1)	R (Throughput) [kbps](Note2)
1	PA3	10	160
2	PB3	10	170
3	VA30	10	161
4	VA120	10	153
<p>Note 1: For multi-carrier reception, it refers to $\frac{\hat{I}_{or}}{I_{oc}}$ on each carrier.</p> <p>Note 2: For multi-carrier reception, R refers to throughput on each carrier.</p>			

9.2.1.2 Category 4, 1.1Mbps UE class

For the parameters specified in Table 9.9-1, the measured throughput R shall exceed the throughput specified in Table 9.10-1 for each radio condition.

Table 9.9-1: Test parameters for fixed reference measurement channel, 16QAM

Parameters	Unit	Test 1	Test 2	Test 3	Test 4
HS-PDSCH Modulation	-	16QAM			
Scrambling code and basic midamble code number*	-	1			
Number of TS	-	2			
HS-PDSCH Channelization Codes*	C(k,Q)	C(i,16) i=1..12			
Number of Hybrid ARQ processes	-	4			
Maximum number of Hybrid ARQ transmissions	-	4			
Redundancy and constellation version coding sequence	-	{6,2,1,5}			
$\frac{HS - PDSCH - E_c}{I_{or}}$	dB	-10.8			
I_{oc}^{**}	dBm/1.28 MHz	-60			
*Note: Refer to TS 25.223 for definition of channelization codes, scrambling code and basic midamble code.					
**Note: For multi-carrier reception, it refers to the interference power on each carrier.					

Table 9.10-1: Performance requirements for QPSK, fixed reference channel, 16QAM

Test Number	Propagation conditions	$\frac{\hat{I}_{or}}{I_{oc}}$ [dB](Note1)	R (Throughput) [kbps](Note2)
1	PA3	15	388
2	PB3	15	347
3	VA30	15	316
4	VA120	15	274
Note 1: For multi-carrier reception, it refers to $\frac{\hat{I}_{or}}{I_{oc}}$ on each carrier.			
Note 2: For multi-carrier reception, R refers to throughput on each carrier.			

* Note: Test case in 9.2.1.1.1 can be used to test this kind of UE in case of QPSK.

9.2.1.3 Category 7, 1.6Mbps UE class

For the parameters specified in Table 9.9-2, the measured throughput R shall exceed the throughput specified in Table 9.10-2 for each radio condition.

Table 9.9-2: Test parameters for fixed reference measurement channel

Parameters	Unit	Test 1	Test 2	Test 3	Test 4	Test 5	Test 6	Test 7	Test 8
HS-PDSCH Modulation	-	QPSK				16QAM			
Scrambling code and basic midamble code number*	-	1							
Number of TS	-	3							
Number of Hybrid ARQ processes	-	4							
Maximum number of Hybrid ARQ transmissions	-	4							
HS-PDSCH Channelization Codes*	C(k,Q)	C(i,16) i=1..10				C(i,16) i=1..12			
Redundancy and constellation version coding sequence	-	{0,0,0,0}				{6,2,1,5}			
$\frac{HS - PDSCH - E_c}{I_{or}}$	dB	-10				-10.8			
I_{oc}^{**}	dBm/ 1.28MHz	-60							
*Note: Refer to TS 25.223 for definition of channelization codes, scrambling code and basic midamble code.									
**Note: For multi-carrier reception, it refers to the interference power on each carrier.									

Table 9.10-2: Performance requirements for fixed reference channel

Test Number	Propagation conditions	$\frac{\hat{I}_{or}}{I_{oc}}$ [dB](Note1)	R (Throughput) [kbps](Note2)
1	PA3	10	270
2	PB3	10	278
3	VA30	10	259
4	VA120	10	242
5	PA3	15	488
6	PB3	15	471
7	VA30	15	431
8	VA120	15	377
Note 1: For multi-carrier reception, it refers to $\frac{\hat{I}_{or}}{I_{oc}}$ on each carrier.			
Note 2: For multi-carrier reception, R refers to throughput on each carrier.			

9.2.1.4 Category 10, 2.2Mbps UE class

For the parameters specified in Table 9.9-3, the measured throughput R shall exceed the throughput specified in Table 9.10-3 for each radio condition.

Table 9.9-3: Test parameters for fixed reference measurement channel

Parameters	Unit	Test 1	Test 2	Test 3	Test 4	Test 5	Test 6	Test 7	Test 8
HS-PDSCH Modulation	-	QPSK				16QAM			
Scrambling code and basic midamble code number*	-	1							
Number of TS	-	4							
Number of Hybrid ARQ processes	-	4							
Maximum number of Hybrid ARQ transmissions	-	4							
HS-PDSCH Channelization Codes*	C(k,Q)	C(i,16) i=1..10				C(i,16) i=1..12			
Redundancy and constellation version coding sequence	-	{0,0,0,0}				{6,2,1,5}			
$\frac{HS - PDSCH - E_c}{I_{or}}$	dB	-10				-10.8			
I_{oc}^{**}	dBm/ 1.28MHz	-60							
*Note:	Refer to TS 25.223 for definition of channelization codes, scrambling code and basic midamble code.								
**Note:	For multi-carrier reception, it refers to the interference power on each carrier.								

Table 9.10-3: Performance requirements for fixed reference channel

Test Number	Propagation conditions	$\frac{\hat{I}_{or}}{I_{oc}}$ [dB](Note1)	R (Throughput) [kbps](Note2)
1	PA3	10	360
2	PB3	10	343
3	VA30	10	320
4	VA120	10	275
5	PA3	15	615
6	PB3	15	606
7	VA30	15	554
8	VA120	15	493
Note 1:	For multi-carrier reception, it refers to $\frac{\hat{I}_{or}}{I_{oc}}$ on each carrier.		
Note 2:	For multi-carrier reception, R refers to throughput on each carrier.		

9.2.1.5 Category 13, 2.8Mbps UE class

For the parameters specified in Table 9.9-4, the measured throughput R shall exceed the throughput specified in Table 9.10-4 for each radio condition.

Table 9.9-4: Test parameters for fixed reference measurement channel

Parameters	Unit	Test 1	Test 2	Test 3	Test 4	Test 5	Test 6	Test 7	Test 8
HS-PDSCH Modulation	-	QPSK				16QAM			
Scrambling code and basic midamble code number*	-	1							
Number of TS	-	5							
Number of Hybrid ARQ processes	-	4							
Maximum number of Hybrid ARQ transmissions	-	4							
HS-PDSCH Channelization Codes*	C(k,Q)	C(i,16) i=1..10				C(i,16) i=1..12			
Redundancy and constellation version coding sequence	-	{0,0,0,0}				{6,2,1,5}			
$\frac{HS - PDSCH - E_c}{I_{or}}$	dB	-10				-10.8			
I_{oc}^{**}	dBm/ 1.28MHz	-60							
*Note:	Refer to TS 25.223 for definition of channelization codes, scrambling code and basic midamble code.								
**Note:	For multi-carrier reception, it refers to the interference power on each carrier.								

Table 9.10-4: Performance requirements for fixed reference channel

Test Number	Propagation conditions	$\frac{\hat{I}_{or}}{I_{oc}}$ [dB](Note1)	R (Throughput) [kbps](Note2)
1	PA3	10	461
2	PB3	10	470
3	VA30	10	438
4	VA120	10	409
5	PA3	15	890
6	PB3	15	810
7	VA30	15	730
8	VA120	15	630
Note 1:	For multi-carrier reception, it refers to $\frac{\hat{I}_{or}}{I_{oc}}$ on each carrier.		
Note 2:	For multi-carrier reception, R refers to throughput on each carrier.		

9.2.1.6 Category 16-24

For the parameters specified in Table 9.9-5, the measured throughput R shall exceed the throughput specified in Table 9.10-5 for each reference measurement channel in annex A.3.2.7.

Table 9.9-5: Test parameters for fixed reference measurement channels

Parameters	Unit	Test 1 (Category 16-18)	Test 2 (Category 19-21)	Test 3 (Category 22-24)
HS-PDSCH Modulation	-	64QAM		
Scrambling code and basic midamble code number*	-	1		
Number of TS	-	3	4	5
Number of Hybrid ARQ processes	-	4		
Maximum number of Hybrid ARQ transmissions	-	4		
HS-PDSCH Channelization Codes*	C(k,Q)	C(i,16) i=1..14		
Redundancy and constellation version coding sequence	-	{6,5,4,0}		
$\frac{HS - PDSCH - E_c}{I_{or}}$	dB	-11.46		
I_{oc}^{**}	dBm/ 1.28MHz	-60		
*Note: Refer to TS 25.223 for definition of channelization codes, scrambling code and basic midamble code. **Note: For multi-carrier reception, it refers to the interference power on each carrier.				

Table 9.10-5: Performance requirements for fixed reference measurement channels

Test Number	Propagation conditions	$\frac{\hat{I}_{or}}{I_{oc}}$ [dB](Note1)	R (Throughput) [kbps](Note2)
1	PA3	18	660
2	PA3	18	875
3	PA3	18	1090
Note 1: For multi-carrier reception, it refers to $\frac{\hat{I}_{or}}{I_{oc}}$ on each carrier.			
Note 2: For multi-carrier reception, R refers to throughput on each carrier.			

9.2.1.7 Category 25

The requirements in this section apply when MIMO is configured. If MIMO is not configured, a category 25 UE should have the capability of category 18 according to [2].

For the parameters specified in Table 9.9-6, the measured throughput R shall exceed the throughput specified in Table 9.10-6 for the reference measurement channels in annex A.3.2.10.

For UE supporting Spreading Factor 1 only in dual stream transmission, the number of HS-PDSCH codes per TS should be configured to 1 and the HS-PDSCH_Ec/I_{or} should be 0dB in dual stream transmission, other parameters and the performance requirements are the same.

Table 9.9-6: Test parameters for fixed reference measurement channels

Parameters	Unit	Test 1	Test 2	Test 3	Test 4
HS-PDSCH Modulation	-	QPSK		16QAM	
Scrambling code and basic midamble code number*	-	0			
Number of TS	-	3			
Number of Hybrid ARQ processes per stream	-	4			
Maximum number of Hybrid ARQ transmissions	-	4			
HS-PDSCH Channelization Codes*	C(k,Q)	C(i,16) i=1..16		C(i,16) i=1..16	
Redundancy and constellation version coding sequence	-	{0,0,0,0}		{6,2,1,5}	
$\frac{HS - PDSCH - E_c}{I_{or}}$	dB	-12.04		-12.04	
Stream Number Configuration	-	Fixed Dual Stream	Fixed Single Stream (2 nd Stream is not used)	Fixed Dual Stream	Fixed Single Stream (2 nd Stream is not used)
loc	dBm/ 1.28MH Z	-60			

*Note: Refer to TS 25.223 for definition of channelization codes, scrambling code and basic midamble code.

Table 9.10-6: Performance requirements for fixed reference channels

Test Number	Propagation conditions	$\frac{\hat{I}_{or}}{I_{oc}}$ [dB]	R (Throughput) [kbps]
1	PA3	10	390
2	PA3	6	160
3	PA3	16	860
4	PA3	12	370

9.2.1.8 Category 26

The requirements in this section apply when MIMO is configured. If MIMO is not configured, a category 26 UE should have the capability of category 21 according to [2].

For the parameters specified in Table 9.9-7, the measured throughput R shall exceed the throughput specified in Table 9.10-7 for the reference measurement channels in annex A.3.2.11.

For UE supporting Spreading Factor 1 only in dual stream transmission, the number of HS-PDSCH codes per TS should be configured to 1 and the HS-PDSCH_Ec/I_{or} should be 0dB in dual stream transmission, other parameters and the performance requirements are the same.

Table 9.9-7: Test parameters for fixed reference measurement channels

Parameters	Unit	Test 1	Test 2	Test 3	Test 4
HS-PDSCH Modulation	-	QPSK		16QAM	
Scrambling code and basic midamble code number*	-	0			
Number of TS	-	4			
Number of Hybrid ARQ processes per stream	-	4			
Maximum number of Hybrid ARQ transmissions	-	4			
HS-PDSCH Channelization Codes*	C(k,Q)	C(i,16) i=1..16		C(i,16) i=1..16	
Redundancy and constellation version coding sequence	-	{0,0,0,0}		{6,2,1,5}	
$\frac{HS - PDSCH - E_c}{I_{or}}$	dB	-12.04		-12.04	
Stream Number Configuration	-	Fixed Dual Stream	Fixed Single Stream (2 nd Stream is not used)	Fixed Dual Stream	Fixed Single Stream (2 nd Stream is not used)
loc	dBm/ 1.28MH Z	-60			

*Note: Refer to TS 25.223 for definition of channelization codes, scrambling code and basic midamble code.

Table 9.10-7: Performance requirements for fixed reference channels

Test Number	Propagation conditions	$\frac{\hat{I}_{or}}{I_{oc}}$ [dB]	R (Throughput) [kbps]
1	PA3	10	650
2	PA3	6	220
3	PA3	16	950
4	PA3	12	380

9.2.1.9 Category 27

The requirements in this section apply when MIMO is configured. If MIMO is not configured, a category 27 UE should have the capability of category 24 according to [2].

For the parameters specified in Table 9.9-8, the measured throughput R shall exceed the throughput specified in Table 9.10-8 for the reference measurement channels in annex A.3.2.12.

For UE supporting Spreading Factor 1 only in dual stream transmission, the number of HS-PDSCH codes per TS should be configured to 1 and the HS-PDSCH_Ec/I_{or} should be 0dB in dual stream transmission, other parameters and the performance requirements are the same.

Table 9.9-8: Test parameters for fixed reference measurement channels

Parameters	Unit	Test 1	Test 2	Test 3	Test 4
HS-PDSCH Modulation	-	QPSK		16QAM	
Scrambling code and basic midamble code number*	-	0			
Number of TS	-	5			
Number of Hybrid ARQ processes per stream	-	4			
Maximum number of Hybrid ARQ transmissions	-	4			
HS-PDSCH Channelization Codes*	C(k,Q)	C(i,16) i=1..16		C(i,16) i=1..16	
Redundancy and constellation version coding sequence	-	{0,0,0,0}		{6,2,1,5}	
$\frac{HS - PDSCH - E_c}{I_{or}}$	dB	-12.04		-12.04	
Stream Number Configuration	-	Fixed Dual Stream	Fixed Single Stream (2 nd Stream is not used)	Fixed Dual Stream	Fixed Single Stream (2 nd Stream is not used)
loc	dBm/ 1.28MH Z	-60			

*Note: Refer to TS 25.223 for definition of channelization codes, scrambling code and basic midamble code.

Table 9.10-8: Performance requirements for fixed reference channels

Test Number	Propagation conditions	$\frac{\hat{I}_{or}}{I_{oc}}$ [dB]	R (Throughput) [kbps]
1	PA3	10	850
2	PA3	6	280
3	PA3	16	1200
4	PA3	12	500

9.2.1.10 Category 28

For the parameters specified in Table 9.9-9, the measured throughput R shall exceed the throughput specified in Table 9.10-9 for the reference measurement channels in annex A.3.2.13.

For UE supporting Spreading Factor 1 only in dual stream transmission, the number of HS-PDSCH codes per TS should be configured to 1 and the HS-PDSCH_Ec/I_{or} should be 0dB in dual stream transmission, other parameters and the performance requirements are the same.

Table 9.9-9: Test parameters for fixed reference measurement channels

Parameters	Unit	Test 1	Test 2
HS-PDSCH Modulation	-	64QAM	
Scrambling code and basic midamble code number*	-	0	
Number of TS	-	3	
Number of Hybrid ARQ processes per stream	-	4	
Maximum number of Hybrid ARQ transmissions	-	4	
HS-PDSCH Channelization Codes*	C(k,Q)	C(i,16) i=1..16	
Redundancy and constellation version coding sequence	-	{6,5,4,0}	
$\frac{HS - PDSCH - E_c}{I_{or}}$	dB	-12.04	
Stream Number Configuration	-	Fixed Dual Stream	Fixed Single Stream (2 nd Stream is not used)
loc	dBm/ 1.28MH z	-60	

*Note: Refer to TS 25.223 for definition of channelization codes, scrambling code and basic midamble code.

Table 9.10-9: Performance requirements for fixed reference channels

Test Number	Propagation conditions	$\frac{\hat{I}_{or}}{I_{oc}}$ [dB]	R (Throughput) [kbps]
1	PA3	20	800
2	PA3	18	540

9.2.1.11 Category 29

For the parameters specified in Table 9.9-10, the measured throughput R shall exceed the throughput specified in Table 9.10-10 for the reference measurement channels in annex A.3.2.14.

For UE supporting Spreading Factor 1 only in dual stream transmission, the number of HS-PDSCH codes per TS should be configured to 1 and the HS-PDSCH_Ec/I_{or} should be 0dB in dual stream transmission, other parameters and the performance requirements are the same.

Table 9.9-10: Test parameters for fixed reference measurement channels

Parameters	Unit	Test 1	Test 2
HS-PDSCH Modulation	-	64QAM	
Scrambling code and basic midamble code number*	-	0	
Number of TS	-	4	
Number of Hybrid ARQ processes per stream	-	4	
Maximum number of Hybrid ARQ transmissions	-	4	
HS-PDSCH Channelization Codes*	C(k,Q)	C(i,16) i=1..16	
Redundancy and constellation version coding sequence	-	{6,5,4,0}	
$\frac{HS - PDSCH - E_c}{I_{or}}$	dB	-12.04	
Stream Number Configuration	-	Fixed Dual Stream	Fixed Single Stream (2 nd Stream is not used)
loc	dBm/ 1.28MH z	-60	

*Note: Refer to TS 25.223 for definition of channelization codes, scrambling code and basic midamble code.

Table 9.10-10: Performance requirements for fixed reference channels

Test Number	Propagation conditions	$\frac{\hat{I}_{or}}{I_{oc}}$ [dB]	R (Throughput) [kbps]
1	PA3	20	1200
2	PA3	18	780

9.2.1.12 Category 30

For the parameters specified in Table 9.9-11, the measured throughput R shall exceed the throughput specified in Table 9.10-11 for the reference measurement channels in annex A.3.2.15.

For UE supporting Spreading Factor 1 only in dual stream transmission, the number of HS-PDSCH codes per TS should be configured to 1 and the HS-PDSCH_Ec/I_{or} should be 0dB in dual stream transmission, other parameters and the performance requirements are the same.

Table 9.9-11: Test parameters for fixed reference measurement channels

Parameters	Unit	Test 1	Test 2
HS-PDSCH Modulation	-	64QAM	
Scrambling code and basic midamble code number*	-	0	
Number of TS	-	5	
Number of Hybrid ARQ processes per stream	-	4	
Maximum number of Hybrid ARQ transmissions	-	4	
HS-PDSCH Channelization Codes*	C(k,Q)	C(i,16) i=1..16	
Redundancy and constellation version coding sequence	-	{6,5,4,0}	
$\frac{HS - PDSCH - E_c}{I_{or}}$	dB	-12.04	
Stream Number Configuration	-	Fixed Dual Stream	Fixed Single Stream (2 nd Stream is not used)
loc	dBm/ 1.28MH z	-60	

*Note: Refer to TS 25.223 for definition of channelization codes, scrambling code and basic midamble code.

Table 9.10-11: Performance requirements for fixed reference channels

Test Number	Propagation conditions	$\frac{\hat{I}_{or}}{I_{oc}}$ [dB]	R (Throughput) [kbps]
1	PA3	20	1570
2	PA3	18	1000

9.2.2 HS-DSCH throughput for Variable Reference Channels

9.2.2.1 Category 1, 0.5Mbps UE class

For the parameters specified in Table 9.13 the measured throughput R shall exceed the throughput specified in Table 9.14 for each radio condition.

Table 9.13: Test parameters for variable reference channel, 0.5Mbps UE class

Parameter	Unit	Test 1	Test 2	Test 3
HS-PDSCH Modulation and TBS	-		*	
Scrambling code and basic midamble code Number **	-		1	
Number of TS	-		2	
Number of DPCH ₀	-		0	
Number of HARQ Process	-		4	
Number of transmission	-		1	
Redundancy and constellation version coding sequence	Xrv		0	
HS-PDSCH Channelization Codes**	C(k,Q)		C(i,16) 1≤i≤10	
HS-PDSCH _i _Ec/lor	dB		-10	
loc****	dBm		-60	
<p>* Note 1 As requested by the last received CQI report</p> <p>**Note 2 Refer to TS 25.223 for definition of channelization codes, scrambling code and basic midamble code.</p> <p>***Note 3 If the indicated CQI is 0, the Node-B emulator shall format the next HS-PDSCH transmission with the transport block size and the modulation scheme that were previously used.</p> <p>****Note 4 For multi-carrier reception, it refers to the interference power on each carrier.</p>				

Table 9.14: Performance requirements for variable reference channel, 0.5Mbps UE class

Test Number	Propagation conditions	$\frac{\hat{I}_{or}}{I_{oc}}$ [dB](Note1)	R (Throughput) [kbps](Note2)
1	PA3	15	242
2	PB3	15	244
3	VA30	15	211
<p>Note 1: For multi-carrier reception, it refers to $\frac{\hat{I}_{or}}{I_{oc}}$ on each carrier.</p> <p>Note 2 For multi-carrier reception, R refers to throughput on each carrier.</p>			

9.2.2.2 Category 4, 1.1Mbps UE class

For the parameters specified in Table 9.13-1 the measured throughput R shall exceed the throughput specified in Table 9.14-1 for each radio condition.

Table 9.13-1: Test parameters for variable reference channel, 1.1Mbps UE class

Parameter	Unit	Test 1	Test 2	Test 3
HS-PDSCH Modulation and TBS	-		*	
Scrambling code and basic midamble code Number **	-		1	
Number of TS	-		2	
Number of DPCH ₀	-		0	
Number of HARQ Process	-		4	
Number of transmission	-		1	
Redundancy and constellation version coding sequence	Xrv		0	
HS-PDSCH Channelization Codes**	C(k,Q)		C(i,16) 1≤i≤10	
HS-PDSCH _i Ec/lor	dB		-10	
loc****	dBm		-60	
<p>* Note 1 As requested by the last received CQI report</p> <p>**Note 2 Refer to TS 25.223 for definition of channelization codes, scrambling code and basic midamble code.</p> <p>***Note 3 If the indicated CQI is 0, the Node-B emulator shall format the next HS-PDSCH transmission with the transport block size and the modulation scheme that were previously used.</p> <p>****Note 4 For multi-carrier reception, it refers to the interference power on each carrier.</p>				

Table 9.14-1: Performance requirements for variable reference channel, 1.1 Mbps UE class

Test Number	Propagation conditions	$\frac{\hat{I}_{or}}{I_{oc}}$ [dB](Note1)	R (Throughput) [kbps](Note2)
1	PA3	15	318
2	PB3	15	323
3	VA30	15	213
<p>Note 1: For multi-carrier reception, it refers to $\frac{\hat{I}_{or}}{I_{oc}}$ on each carrier.</p> <p>Note 2: For multi-carrier reception, R refers to throughput on each carrier.</p>			

9.2.2.3 Category 7, 1.6Mbps UE class

For the parameters specified in Table 9.13-2 the measured throughput R shall exceed the throughput specified in Table 9.14-2 for each radio condition.

Table 9.13-2: Test parameters for variable reference channel, 1.6Mbps UE class

Parameter	Unit	Test 1	Test 2	Test 3
HS-PDSCH Modulation and TBS	-		*	
Scrambling code and basic midamble code Number **	-		1	
Number of TS	-		3	
Number of DPCH ₀	-		0	
Number of HARQ Process	-		4	
Number of transmission	-		1	
Redundancy and constellation version coding sequence	Xrv		0	
HS-PDSCH Channelization Codes**	C(k,Q)		C(i,16) 1≤i≤10	
HS-PDSCH _i Ec/Ior	dB		-10	
Ioc****	dBm		-60	
<p>* Note 1 As requested by the last received CQI report</p> <p>**Note 2 Refer to TS 25.223 for definition of channelization codes, scrambling code and basic midamble code.</p> <p>***Note 3 If the indicated CQI is 0, the Node-B emulator shall format the next HS-PDSCH transmission with the transport block size and the modulation scheme that were previously used.</p> <p>****Note 4 For multi-carrier reception, it refers to the interference power on each carrier.</p>				

Table 9.14-2: Performance requirements for variable reference channel, 1.6Mbps UE class

Test Number	Propagation conditions	$\frac{\hat{I}_{or}}{I_{oc}}$ [dB](Note1)	R (Throughput) [kbps](Note2)
1	PA3	15	480
2	PB3	15	483
3	VA30	15	323
<p>Note 1: For multi-carrier reception, it refers to $\frac{\hat{I}_{or}}{I_{oc}}$ on each carrier.</p> <p>Note 2: For multi-carrier reception, R refers to throughput on each carrier.</p>			

9.2.2.4 Category 10, 2.2 Mbps UE class

For the parameters specified in Table 9.13-3 the measured throughput R shall exceed the throughput specified in Table 9.14-3 for each radio condition.

Table 9.13-3: Test parameters for variable reference channel, 2.2Mbps UE class

Parameter	Unit	Test 1	Test 2	Test 3
HS-PDSCH Modulation and TBS	-		*	
Scrambling code and basic midamble code Number **	-		1	
Number of TS	-		4	
Number of DPCH ₀	-		0	
Number of HARQ Process	-		4	
Number of transmission	-		1	
Redundancy and constellation version coding sequence	Xrv		0	
HS-PDSCH Channelization Codes**	C(k,Q)		C(i,16) 1≤i≤10	
HS-PDSCH _i Ec/lor	dB		-10	
loc****	dBm		-60	
<p>* Note 1 As requested by the last received CQI report</p> <p>**Note 2 Refer to TS 25.223 for definition of channelization codes, scrambling code and basic midamble code.</p> <p>***Note 3 If the indicated CQI is 0, the Node-B emulator shall format the next HS-PDSCH transmission with the transport block size and the modulation scheme that were previously used.</p> <p>****Note 4 For multi-carrier reception, it refers to the interference power on each carrier.</p>				

Table 9.14-3: Performance requirements for variable reference channel, 2.2Mbps UE class

Test Number	Propagation conditions	$\frac{\hat{I}_{or}}{I_{oc}}$ [dB](Note1)	R (Throughput) [kbps](Note2)
1	PA3	15	625
2	PB3	15	631
3	VA30	15	418
<p>Note 1: For multi-carrier reception, it refers to $\frac{\hat{I}_{or}}{I_{oc}}$ on each carrier.</p> <p>Note 2: For multi-carrier reception, R refers to throughput on each carrier.</p>			

9.2.2.5 Category 13, 2.8 Mbps UE class

For the parameters specified in Table 9.13-4 the measured throughput R shall exceed the throughput specified in Table 9.14-4 for each radio condition.

Table 9.13-4: Test parameters for variable reference channel, 2.8Mbps UE class

Parameter	Unit	Test 1	Test 2	Test 3
HS-PDSCH Modulation and TBS	-		*	
Scrambling code and basic midamble code Number **	-		1	
Number of TS	-		5	
Number of DPCH ₀	-		0	
Number of HARQ Process	-		4	
Number of transmission	-		1	
Redundancy and constellation version coding sequence	Xrv		0	
HS-PDSCH Channelization Codes**	C(k,Q)		C(i,16) 1≤i≤10	
HS-PDSCH _i Ec/lor	dB		-10	
loc****	dBm		-60	
<p>* Note 1 As requested by the last received CQI report</p> <p>**Note 2 Refer to TS 25.223 for definition of channelization codes, scrambling code and basic midamble code.</p> <p>***Note 3 If the indicated CQI is 0, the Node-B emulator shall format the next HS-PDSCH transmission with the transport block size and the modulation scheme that were previously used.</p> <p>****Note 4 For multi-carrier reception, it refers to the interference power on each carrier.</p>				

Table 9.14-4: Performance requirements for variable reference channel, 2.8 Mbps UE class

Test Number	Propagation conditions	$\frac{\hat{I}_{or}}{I_{oc}}$ [dB](Note1)	R (Throughput) [kbps](Note2)
1	PA3	15	783
2	PB3	15	792
3	VA30	15	544
<p>Note 1: For multi-carrier reception, it refers to $\frac{\hat{I}_{or}}{I_{oc}}$ on each carrier.</p> <p>Note 2: For multi-carrier reception, R refers to throughput on each carrier.</p>			

9.2.3 Reporting of Channel Quality Indicator

The reporting accuracy of channel quality indicator (CQI) under AWGN and static orthogonal environments is determined by the reporting variance and the BLER performance using the transport format indicated by the reported CQI median.

9.2.3.1 Minimum Requirement-UE categories 1-24

For the parameters specified in Table 9.15, the reported CQI value shall be within +/- x, as specified in Table 9.16, of the reported median CQI for more than Y%, also specified in Table 9.16, of the time.

Table 9.15: Test parameters for CQI reporting measurement channel requirements (1.28 Mcps TDD Option)

Parameter	Unit	Category 1-3		Category 4-6		Category 7-9		Category 10-12		Category 13-15		Category 16-18	Category 19-21	Category 22-24
		Test 1	Test 2	Test 3	Test 4	Test 5	Test 6	Test 7	Test 8	Test 9	Test 10	Test 11	Test 12	
Number of TS	-	2	2		3		4		5		3	4	5	
Number of HS-PDSCH codes per TS	-	10	10		10		10		10		14	14	14	
HS-PDSCH _i Ec/lor	dB	-10	-10		-10		-10		-10		-11.46	-11.46	-11.46	
HS-PDSCH Channelization Codes*	C(k,Q)	C(i,16) 1≤i≤10	C(i,16) 1≤i≤10		C(i,16) 1≤i≤10		C(i,16) 1≤i≤10		C(i,16) 1≤i≤10		C(i,16) 1≤i≤14	C(i,16) 1≤i≤14	C(i,16) 1≤i≤14	
Number of DPCH _o	-	0												
Number of HARQ Process	-	4												
Number of transmission	-	1												
I _{oc} **	dBm/1.28MHz	-60												
\hat{I}_{or}/I_{oc}	dB	1	1	8	1	8	1	8	1	8	18	18	18	
Propagation Channel	-	AWGN												
*Note 1 Refer to TS 25.223 for definition of channelization codes, scrambling code and basic midamble code.														
**Note 2 For multi-carrier reception, it refers to $\frac{\hat{I}_{or}}{I_{oc}}$ on each carrier.														

Table 9.16: Performance requirements for CQI reporting measurement channel requirements (1.28 Mcps TDD Option)

Test	Permitted CQI range from median (x)	% of time that CQI must be within +/- x of median (Y)	Maximum BLER for median reported CQI
Test 1	+/- 3	90	10%
Test 2	+/- 3	90	
Test 3	+/- 2	90	
Test 4	+/- 2	90	
Test 5	+/-2	90	
Test 6	+/-2	90	
Test 7	+/-2	90	
Test 8	+/-2	90	
Test 9	+/-2	90	
Test 10	+/-2	90	
Test 11	+/-2	90	
Test 12	+/-2	90	

9.2.3.2 Minimum Requirement-UE categories 25-27

For the parameters specified in Table 9.16A, the reported CQI value shall be within +/- x, as specified in Table 9.16B, of the reported median CQI for more than Y%, also specified in Table 9.16B, of the time.

The MIMO dual stream static orthogonal propagation conditions are defined in subclause B.3.2.1. For UE supporting Spreading Factor 1 only in dual stream transmission, the number of HS-PDSCH codes per TS should be configured to 1 in dual stream transmission, and the HS-PDSCH_i_Ec/Ior should be 0dB.

Table 9.16A: Test parameters for CQI reporting measurement channel requirements (1.28 Mcps TDD Option)

Parameter	Unit	Category 25		Category 26		Category 27	
		Test 1	Test 2	Test 3	Test 4	Test 5	Test 6
Number of TS	-	3		4		5	
Number of HS-PDSCH codes per TS	-	16		16		16	
Number of HS-PDSCH codes per TS	-	16					
HS-PDSCH _i _Ec/Ior	dB	-12.04					
HS-PDSCH Channelization Codes	C(k,Q)	C(i,16) 1≤i≤16					
Number of DPCH _o	-	0					
Number of HARQ Process perstream	-	4					
Number of transmission loc	-	1					
loc	dBm	-60					
\hat{I}_{or} / I_{oc}	dB	8	10	8	10	8	10
Stream Number configuration	-	Single Stream	Dual Stream	Single Stream	Dual Stream	Single Stream	Dual Stream
Propagation Channel	-	AWGN	Static Orthogonal	AWGN	Static Orthogonal	AWGN	Static Orthogonal

Table 9.16B: Performance requirements for CQI reporting measurement channel requirements (1.28 Mcps TDD Option)

Test	Permitted CQI range from median (x)	% of time that CQI must be within +/- x of median (Y)	Maximum BLER for median reported CQI
Test 1	+/- 2	90	10%
Test 2	+/- 2	90	
Test 3	+/- 2	90	
Test 4	+/- 2	90	
Test 5	+/-2	90	
Test 6	+/-2	90	

9.2.3.3 Minimum Requirement-UE categories 28-30

For the parameters specified in Table 9.16C, the reported CQI value shall be within +/- x, as specified in Table 9.16D, of the reported median CQI for more than Y%, also specified in Table 9.16D, of the time.

The MIMO dual stream static orthogonal propagation conditions are defined in subclause B.3.2.1. For UE supporting Spreading Factor 1 only in dual stream transmission, the number of HS-PDSCH codes per TS should be configured to 1 in dual stream transmission, and the HS-PDSCH_i_Ec/Ior should be 0dB.

Table 9.16C: Test parameters for CQI reporting measurement channel requirements (1.28 Mcps TDD Option)

Parameter	Unit	Category 28		Category 29		Category 30	
		Test 1	Test 2	Test 3	Test 4	Test 5	Test 6
Number of TS	-	3		4		5	
Number of HS-PDSCH codes per TS	-	16		16		16	
Number of HS-PDSCH codes per TS	-	16					
HS-PDSCH _i _Ec/Ior	dB	-12.04					
HS-PDSCH Channelization Codes	C(k,Q)	C(i,16) 1≤i≤16					
Number of DPCH ₀	-	0					
Number of HARQ Process perstream	-	4					
Number of transmission	-	1					
loc	dBm	-60					
\hat{I}_{or}/I_{oc}	dB	16	18	16	18	16	18
Stream Number	-	Single Stream	Dual Stream	Single Stream	Dual Stream	Single Stream	Dual Stream
Propagation Channel	-	AWGN	Static Orthogonal	AWGN	Static Orthogonal	AWGN	Static Orthogonal

Table 9.16D: Performance requirements for CQI reporting measurement channel requirements (1.28 Mcps TDD Option)

Test	Permitted CQI range from median (x)	% of time that CQI must be within +/- x of median (Y)	Maximum BLER for median reported CQI
Test 1	+/- 2	90	10%
Test 2	+/- 2	90	
Test 3	+/- 2	90	
Test 4	+/- 2	90	
Test 5	+/- 2	90	
Test 6	+/- 2	90	

9.2.4 HS-SCCH Detection Performance

The detection performance of the HS-SCCH is determined by the probability of event E_m , which is declared when the UE is signaled on HS-SCCH, but DTX is observed in the corresponding HS-SICH ACK/NACK field. The probability of event E_m is denoted $P(E_m)$.

9.2.4.1 Minimum Requirements for HS-SCCH Type 1 Detection

For the test parameters specified in Table 9.17, for each value of HS-SCCH \hat{I}_{or}/I_{oc} specified in Table 9.18 the measured $P(E_m)$ shall be less than or equal to the corresponding specified value of $P(E_m)$.

Table 9.17: Test parameters for HS-SCCH type 1 detection (1.28Mcps TDD option)

Parameter	Unit	Test 1	Test2
Number of TS under test	-	1	
Number of HS-SCCH codes per timeslot	-	8 (4 x2)	
Scrambling code and basic midamble code number*	-	0	
Number of DPCH ₀	-	2	
Number of H-ARQ process	-	4	
HS-SCCH UE Identity ($x_{ue,1}, x_{ue,2}, \dots, x_{ue,16}$)	-	UE1 = 0000000000000000 (UE1 under test) UE2 = 0101010101010101 UE3 = 1010101010101010 UE4 = 1111111111111111	
HS-SCCH Channelization Codes*	C(k,Q)	C(i,16) 1 ≤ i ≤ 8	
HS-SCCH Channelization Codes for UE under test	C(k,Q)	C(i,16) 1 ≤ i ≤ 2	
DPCH ₀ Channelization Codes	C(k,Q)	C(i,16) 9 ≤ i ≤ 10	
Power control for HS-SCCH of UE 1	-	OFF	
$\frac{HS-SCCH_i - E_c}{I_{or}}$	dB	-10	
I_{oc}^{**}	dBm/1.28MHz	-60	
Note *:	Refer to TS 25.223 for definition of channelization codes, scrambling code and basic midamble code.		
Note **	For multi-carrier reception, it refers to $\frac{\hat{I}_{or}}{I_{oc}}$ on each carrier		

Table 9.18: Minimum requirement for HS-SCCH type 1 detection (1.28Mcps TDD option)

Test Number	Propagation Conditions	$\frac{\hat{I}_{or}}{I_{oc}}$ (dB)(Note1)	$P(E_m)$ (Note2)
1	PA3	16	0.01
2	VA30	12	0.01
Note1	For multi-carrier reception, it refers to $\frac{\hat{I}_{or}}{I_{oc}}$ on each carrier.		
Note2	For multi-carrier reception, it refers to $P(E_m)$ on each carrier.		

9.2.4.2 Minimum Requirements for HS-SCCH Type 4/5 Detection

For the test parameters specified in Table 9.18AA, for each value of HS-SCCH $\frac{\hat{I}_{or}}{I_{oc}}$ specified in Table 9.18AA the measured $P(E_m)$ shall be less than or equal to the corresponding specified value of $P(E_m)$. Minimum performance requirements specified in Table 9.18AB are based on receiver diversity.

Table 9.18AA: Test parameters for HS-SCCH Type 4/5 detection (1.28Mcps TDD option)

Parameter	Unit	Test 1	Test2
Number of TS under test	-	1	
Number of HS-SCCH codes per timeslot	-	8 (4 x2)	
Scrambling code and basic midamble code number*	-	0	
Number of DPCH _o	-	2	
Number of H-ARQ process	-	4	
HS-SCCH Channelization Codes*	C(k,Q)	C(i,16) 1≤i≤8	
HS-SCCH Channelization Codes for UE under test	C(k,Q)	C(i,16) 1≤i≤2	
DPCH _o Channelization Codes	C(k,Q)	C(i,16) 9≤i≤10	
Power control for HS-SCCH of UE 1	-	OFF	
$\frac{HS-SCCH_i - E_c}{I_{or}}$	dB	-10	
I_{oc}	dBm/1.28MHz	-60	
Note *: Refer to TS 25.223 for definition of channelization codes, scrambling code and basic midamble code.			

Table 9.18AB: Minimum requirement for HS-SCCH Type 4/5 detection (1.28Mcps TDD option)

Test Number	Propagation Conditions	$\frac{\hat{I}_{or}}{I_{oc}}$ (dB)	$P(E_m)$
1	PA3	12.3	0.01
2	VA30	9.2	0.01

9.2.4.3 Minimum Requirements for HS-SCCH Type 6/7/8/9 Detection

For the test parameters specified in Table 9.18AC, for each value of HS-SCCH \hat{I}_{or}/I_{oc} specified in Table 9.18AD the measured $P(E_m)$ shall be less than or equal to the corresponding specified value of $P(E_m)$. Minimum performance requirements specified in Table 9.18AD are based on receiver diversity.

Table 9.18AC: Test parameters for HS-SCCH Type 6/7/8/9 detection (1.28Mcps TDD option)

Parameter	Unit	Test 1	Test2
Number of TS under test	-	1	
Number of HS-SCCH codes per timeslot	-	8 (4 x2)	
Scrambling code and basic midamble code number*	-	0	
Number of DPCH _o	-	2	
Number of H-ARQ process	-	4	
HS-SCCH Channelization Codes*	C(k,Q)	C(i,16) 1≤i≤8	
HS-SCCH Channelization Codes for UE under test	C(k,Q)	C(i,16) 1≤i≤2	
DPCH _o Channelization Codes	C(k,Q)	C(i,16) 9≤i≤10	
Power control for HS-SCCH of UE 1	-	OFF	
$\frac{HS-SCCH_i - E_c}{I_{or}}$	dB	-10	
I_{oc}	dBm/1.28MHz	-60	
Note *: Refer to TS 25.223 for definition of channelization codes, scrambling code and basic midamble code.			

Table 9. 18AD: Minimum requirement for HS-SCCH Type 6/7/8/9 detection (1.28Mcps TDD option)

Test Number	Propagation Conditions	$\frac{\hat{I}_{or}}{I_{oc}}$ (dB)	$P(E_m)$
1	PA3	12.5	0.01
2	VA30	9.4	0.01

9.2.5 PLCCH Detection Performance

The detection performance of the PLCCH is determined by the BER of the received PLCCH.

9.2.5.1 Minimum Requirements

For the test parameters in Table 9.18A, for the value of \hat{I}_{or}/I_{oc} specified in Table 9.18B, the measured BER should be equal or less than the corresponding specified BER value.

Table 9.18A: Test parameters for PLCCH detection (1.28Mcps TDD option)

Parameter	Unit	Test 1
Number of PLCCH	-	1
Number of interfering codes/timeslot	-	1 x SF16
Number of timeslot	-	1
PLCCH information bit pattern	-	Alternating 1 and 0 starting with 1 (101010.....)
I_{oc}	dBm/1.28 MHz	-60
PLCCH E_c/I_{or}	dB	-3
PLCCH channelization codes	C(k, Q)	C(1, 16)
OCNS channelization code	C(k, Q)	C(2, 16)
Midamble allocation	-	Common
Power control	-	OFF
Propagation condition	-	VA30

Table 9.18B: Minimum requirement for PLCCH detection (1.28Mcps TDD option)

Test Number	$\frac{\hat{I}_{or}}{I_{oc}}$ (dB)	BER
1	0.3	0.04

9.3 Performance requirement for 7.68 Mcps TDD option

The requirements are stated for the HSDPA UE reference combination classes specified in [2] and under the multipath propagation conditions specified in Annex B. The performance metric for HS-DSCH requirements in multi-path propagation conditions is the throughput R measured on HS-DSCH.

9.3.1 HS-DSCH throughput for fixed reference channels

The performance requirements in this subclause apply for the reference measurement channels specified in Annex A.3.2.

During the Fixed Reference Channel tests the behaviour of the Node-B emulator in response to the ACK/NACK signalling field of the HS-SICH is specified in Table 9.19:

Table 9.19: Node-B Emulator Behaviour in response to ACK/NACK/DTX

HS-SICH ACK/NACK Field State	Node-B Emulator Behaviour
ACK	ACK: new transmission using 1 st redundancy version (RV)
NACK	NACK: retransmission using the next RV (up to the maximum permitted number or RV's)
DTX	DTX: retransmission using the RV previously transmitted to the same H-ARQ process

9.3.1.1 Minimum requirement QPSK, Fixed Reference Channel, 5,3 Mbps - Category 8 - UE

For the parameters specified in Table 9.20, the measured throughput R shall exceed the throughput specified in Table 9.21 for each radio condition.

Table 9.20: Test parameters for fixed reference measurement channel requirements for 5,3 Mbps - Category 8 - UE (7,68 Mcps TDD Option) QPSK

Parameters	Unit	Test 1	Test 2	Test 3	Test 4
HS-PDSCH Modulation	-	QPSK			
Scrambling code and basic midamble code number*	-	0, 1			
Number of TS	-	4			
HS-PDSCH Channelization Codes*	C(k,Q)	C(i,32) i=1..32			
Number of Hybrid ARQ processes	-	3			
Maximum number of Hybrid ARQ transmissions	-	4			
Redundancy and constellation version coding sequence**	-	{0,0,0,0} s=1, R=0, b=0			
$\frac{HS - PDSCH - E_c}{I_{or}}$	dB	-15,05			
$\frac{\sum HS - PDSCH - E_c}{I_{or}}$	dB	0			
I_{oc}	dBm/7,68 MHz	-60			
Note *: Refer to TS 25.223 for definition of channelization codes, scrambling code and basic midamble code.					
Note **: This sequence implies Chase combining					

Table 9.21: Performance requirements for fixed reference measurement channel requirement in multipath channels for 5,3 Mbps - Category 8 - UE (7,68 Mcps TDD Option) QPSK

Test Number	Propagation conditions	$\frac{\hat{I}_{or}}{I_{oc}}$ [dB]	R (Throughput) [kbps]
1	PA3	5,2	880
2	PB3	5,5	880
3	VA30	6,2	880
4	VA120	6,2	880

9.3.1.2 Minimum requirement 16 QAM, Fixed Reference Channel, 5,3 Mbps - Category 8 - UE

For the parameters specified in Table 9.22, the measured throughput R shall exceed the throughput specified in Table 9.23 for each radio condition.

Table 9.22: Test parameters for fixed reference measurement channel requirements for 5,3 Mbps - Category 8 - UE (7,68 Mcps TDD Option) 16QAM

Parameters	Unit	Test 1	Test 2	Test 3	Test 4
HS-PDSCH Modulation	-	16QAM			
Scrambling code and basic midamble code number*	-	0, 1			
Number of TS	-	4			
HS-PDSCH Channelization Codes*	C(k,Q)	C(i,32) i=1..32			
Number of Hybrid ARQ processes	-	3			
Maximum number of Hybrid ARQ transmissions	-	4			
Redundancy and constellation version coding sequence**	-	{0,0,0,0} s=1, R=0, b=0			
$\frac{HS - PDSCH - E_c}{I_{or}}$	dB	-15,05			
$\frac{\sum HS - PDSCH - E_c}{I_{or}}$	dB	0			
I_{oc}	dBm/7,68 MHz	-60			
Note *: Refer to TS 25.223 for definition of channelization codes, scrambling code and basic midamble code.					
Note **: This sequence implies Chase combining					

Table 9.23: Performance requirements for fixed reference measurement channel requirement in multipath channels for 5,3 Mbps - Category 8 - UE (7,68 Mcps TDD Option) 16QAM

Test Number	Propagation conditions	$\frac{\hat{I}_{or}}{I_{oc}}$ [dB]	R (Throughput) [kbps]
1	PA3	11,1	1765
2	PB3	13,2	1765
3	VA30	13,7	1765
4	VA120	13,6	1765

9.3.2 (void)

9.3.3 (void)

9.3.4 HS-SCCH Detection Performance

The detection performance of the HS-SCCH is determined by the probability of event E_m , which is declared when the UE is signaled on HS-SCCH, but DTX is observed in the corresponding HS-SICH ACK/NACK field. The probability of event E_m is denoted $P(E_m)$.

9.3.4.1 Minimum Requirements for HS-SCCH Detection

For the test parameters in Table 9.24, for each value of HS-SCCH-1 E_c/I_{or} specified in Table 9.25, the measured $P(E_m)$ shall be less than or equal to the corresponding specified value of $P(E_m)$.

Table 9.24: Test parameters for HS-SCCH detection (7.68 Mcps TDD option)

Parameter	Unit	Test 1	Test 2	Test 3
Number of TS under test	-	1		
Number of HS-SCCH codes per timeslot	-	4		
HS-SCCH UE Identity ($x_{ue,1}, x_{ue,2}, \dots, x_{ue,16}$)	-	UE1 = 0000000000000000 (UE1 under test) UE2 = 0101010101010101 UE3 = 1010101010101010 UE4 = 1111111111111111		
HS-SCCH Channelization Codes*	C(k,Q)	HS-SCCH-1 = C(1, 32), for UE1 (UE under test) HS-SCCH-2 = C(2, 32) for UE2 HS-SCCH-3 = C(3, 32) for UE3 HS-SCCH-4 = C(4, 32) for UE4		
HS-SCCH E_d/I_{or}	dB	HS-SCCH-2_ E_d/I_{or} = HS-SCCH-3_ E_d/I_{or} = HS-SCCH-4_ E_d/I_{or} , Where, \sum HS-SCCH-X_ E_d/I_{or} = 1, where X = 1, 2, 3, 4		

Table 9.25: Minimum requirement for HS-SCCH detection (7.68 Mcps TDD option)

Test Number	Propagation Conditions	Reference value		
		HS-SCCH-1 E_c/I_{or} (dB)	\hat{I}_{or}/I_{oc} (dB)	$P(E_m)$
1	PA3	-6.0	0	0.05
2	PA3	-7.5	5	0.01
3	VA30	-6.0	0	0.01

10 Performance requirements (MBMS)

Unless otherwise stated the receiver characteristics are specified at the antenna connector of the UE. For UE(s) with an integral antenna only, a reference antenna with a gain of 0 dBi is assumed. UE with an integral antenna may be taken into account by converting these power levels into field strength requirements, assuming a 0 dBi gain antenna. For UEs with more than one receiver antenna connector the fading of the signals and the AWGN signals applied to each receiver antenna connector shall be uncorrelated. The levels of the test signal applied to each of the antenna connectors shall be as defined in the respective sections below.

10.1 Demodulation of MCCH

The receive characteristic of the MCCH is determined by the RLC SDU error rate (RLC_SDU_ER). The requirement is valid for all RRC states for which the UE has capabilities.

10.1.1 Minimum requirement

10.1.1.1 3.84 Mcps TDD Option

For the parameters specified in Table 10.1, the measured average downlink S-CCPCH_ E_c/I_{or} power ratio shall be below the specified value for the RLC_SDU_ER shown in Table 10.2.

Table 10.1: Test parameters for MCCH detection

Parameters	Unit	Test 1
I_{oc}	dBm/3.84 MHz	-60
$\frac{\hat{I}_{or}}{I_{oc}}$	dB	-3
Number of Interfering codes/timeslot	-	7 × SF16
MCCH Data Rate	kbps	7.2
Propagation condition	-	VA3
Slot Format #i	-	3

Table 10.2: Test requirements for MCCH detection

Test Number	S-CCPCH_Ec/I _{or} (dB)	RLC_SDU_ER
1	-1.25	0.01

10.1.1.2 1.28 Mcps TDD Option

For the parameters specified in Table 10.3, the measured average downlink $\frac{\hat{I}_{or}}{I_{oc}}$ power ratio shall be below the specified value for the RLC SDU ER shown in Table 10.4.

Table 10.3: Test parameters for MCCH detection

Parameters	Unit	Test 1
I_{oc}	dBm/1.28 MHz	-60
Number of codes per timeslot	-	2xSF16
Number of interfering codes per timeslot	-	0
MCCH Data Rate	kbps	7.6
Propagation condition	-	VA3

Table 10.4: Test requirements for MCCH detection

Test Number	$\frac{\hat{I}_{or}}{I_{oc}}$ (dB)	RLC_SDU_ER
1	5.8	0.01

10.1.1.3 7.68 Mcps TDD Option

For the parameters specified in Table 10.4A, the measured average downlink S-CCPCH_Ec/I_{or} power ratio shall be below the specified value for the RLC_SDU_ER shown in Table 10.4B.

Table 10.4A: Test parameters for MCCH detection

Parameters	Unit	Test 1
I_{oc}	dBm/7.68 MHz	-60
$\frac{\hat{I}_{or}}{I_{oc}}$	dB	-3
Number of Interfering codes/timeslot	-	15 × SF32
MCCH Data Rate	kbps	7.2
Propagation condition	-	VA3
Slot Format #i	-	3

Table 10.4B: Test requirements for MCCH detection

Test Number	S-CCPCH_Ec/I _{or} (dB)	RLC_SDU_ER
1	-4.7	0.01

10.1.2 MBSFN capable UE

This requirement is applicable for UEs that are capable of receiving MBSFN.

10.1.2.1 3.84 Mcps TDD Option

10.1.2.1.1 Non-IMB

The test is only applicable for UEs with at least two receiver antenna connectors where the fading of the signals and the AWGN signals applied to each receiver antenna connector shall be uncorrelated.

For the parameters specified in Table 10.4C, the measured average downlink S-CCPCH_Ec/I_{or} power ratio shall be below the specified value for the RLC_SDU_ER shown in Table 10.4D.

Table 10.4C: Test parameters for MCCH detection

Parameters	Unit	Test 1
I_{oc}	dBm/3.84 MHz	-60
$\frac{\hat{I}_{or}}{I_{oc}}$	dB	12
Number of Interfering codes/timeslot	-	7 × SF16
MCCH Data Rate	kbps	7.2
Propagation condition	-	Extended delay spread (see Appendix B)
Slot Format #i	-	21

Table 10.4D: Test requirements for MCCH detection (at least two receiver antennas)

Test Number	S-CCPCH_Ec/I _{or} (dB)	RLC_SDU_ER
1	-19.29	0.01

10.1.2.1.2 IMB

The test is only applicable for UEs with at least two receiver antenna connectors where the fading of the signals and the AWGN signals applied to each receiver antenna connector shall be uncorrelated.

For the parameters specified in Table 10.4DA, the measured average downlink S-CCPCH_Ec/I_{or} power ratio shall be below the specified value for the RLC_SDU_ER shown in Table 10.4DB.

Table 10.4DA: Test parameters for MCCH detection

Parameters	Unit	Test 1
I _{oc}	dBm/3.84MHz	-60
$\frac{\hat{I}_{or}}{I_{oc}}$	dB	12
MCCH Data Rate	kbps	6.4 (see Annex A.4.1.1.2)
Configuration of other physical channels	-	See Annex A.4.1.1.2
Propagation condition	-	Extended Delay Spread (see Annex B.2.1, Table B.1D)

Table 10.4DB: Test requirements for MCCH detection (at least two receiver antennas)

Test Number	S-CCPCH_Ec/I _{or} (dB)	RLC_SDU_ER
1	-27	0.01

10.1.2.2 1.28 Mcps TDD Option

For the parameters specified in Table 10.4E, the measured average downlink $\frac{\hat{I}_{or}}{I_{oc}}$ power ratio shall be below the specified value for the RLC_SDU_ER shown in Table 10.4F.

Table 10.4E: Test parameters for MCCH detection

Parameters	Unit	Test 1 ¹	Test 2 ¹
I _{oc}	dBm/1.28 MHz	-60	-60
Rx antenna	-	1	2
Number of codes/Timeslot	-	3	3
Number of Interfering codes/timeslot	-	5XSF16	5XSF16
MCCH Data Rate	kbps	7.6	7.6
Propagation condition	-	MBSFN channel model 2 (Annex B)	MBSFN channel model 2 (Annex B)
Slot Format #	-	10 ³	10 ³
NOTE1: The tests are only applicable for the UE supporting extended delay spread.			
NOTE2: In the case of Rx diversity, the fading of the signal and AWGN signals applied to each receiver antenna connector shall be uncorrelated.			
NOTE3: See Table 8Ha in TS25.221.			

Table 10.4F: Test requirements for MCCH detection

Test Number	$\frac{\hat{I}_{or}}{I_{oc}}$ (dB)	RLC_SDU_ER
1	9.1	0.01
2	4.5	0.01

10.1.2.3 7.68 Mcps TDD Option

The test is only applicable for UEs with at least two receiver antenna connectors where the fading of the signals and the AWGN signals applied to each receiver antenna connector shall be uncorrelated.

For the parameters specified in Table 10.4G, the measured average downlink S-CCPCH_Ec/I_{or} power ratio shall be below the specified value for the RLC_SDU_ER shown in Table 10.4H.

Table 10.4G: Test parameters for MCCH detection

Parameters	Unit	Test 1
I _{oc}	dBm/7.68 MHz	-60
$\frac{\hat{I}_{or}}{I_{oc}}$	dB	12
Number of Interfering codes/timeslot	-	15 × SF32
MCCH Data Rate	kbps	7.2
Propagation condition	-	Extended delay spread (see Appendix B)
Slot Format #i	-	21

Table 10.4H: Test requirements for MCCH detection (at least two receiver antennas)

Test Number	S-CCPCH_Ec/I _{or} (dB)	RLC_SDU_ER
1	-22.71	0.01

10.2 Demodulation of MTCH

The receive characteristic of the MTCH is determined by RLC SDU error rate (RLC SDU ER). RLC SDU ER is specified for each individual data rate of the MTCH. The requirement is valid for all RRC states for which the UE has capabilities for MBMS.

10.2.1 Minimum requirement

10.2.1.1 3.84 Mcps TDD Option

For the parameters specified in Table 10.5 the average downlink $\frac{\hat{I}_{or}}{I_{oc}}$ power ratio shall be below the specified value for the RLC SDU ER shown in Table 10.6.

Table 10.5: Parameters for MTCH detection

Parameters	Unit	Test 1	Test 2
$\Sigma(\text{S-CCPCH_Ec})/I_{or}$ per active timeslot	dB	0	0
$\Sigma(\text{S-CCPCH_Ec})/I_{or}$ per active timeslot	dB	0	0
MTCH Data Rate	kbps	128	256
Propagation condition	-	VA3	
Number of Radio Links	-	2	3

Table 10.6: Test requirements for MTCH detection

Test Number	$\frac{\hat{I}_{or}}{I_{oc}}$ (dB)	RLC SDU ER
1	5.7	0.1
2	5.5	0.1

10.2.1.2 1.28 Mcps TDD Option

For the parameters specified in Table 10.7 the average downlink $\frac{\hat{I}_{or}}{I_{oc}}$ power ratio shall be below the specified value for the RLC SDU ER shown in Table 10.8.

Table 10.7: Parameters for MTCH detection

Parameters	Unit	Test 1	Test 2
I_{oc}	dBm/1.28 MHz	-60	
MTCH Data Rate	kbps	64	128
Number of codes per timeslot	-	8xSF16	14xSF16
Number of interfering codes per timeslot	-	0	0
Propagation condition	-	VA3	
Number of Radio Links	-	3	3

Table 10.8: Test requirements for MTCH detection

Test Number	$\frac{\hat{I}_{or}}{I_{oc}}$ (dB)	RLC SDU ER
1	4.8	0.1
2	6.0	0.1

10.2.1.3 7.68 Mcps TDD Option

For the parameters specified in Table 10.9 the average downlink $\frac{\hat{I}_{or}}{I_{oc}}$ power ratio shall be below the specified value for the RLC SDU ER shown in Table 10.10.

Table 10.9: Parameters for MTCH detection

Parameters	Unit	Test 1	Test 2
I_{oc}	dBm/7.68 MHz	-60	
$\Sigma(S\text{-CCPCH_}E_c)/I_{or}$ per active timeslot	dB	-3	-3
MTCH Data Rate	Kbps	128	256
Number of interfering codes/timeslot	-	16 x SF32	16 x SF32
Propagation condition	-	VA3	
Number of Radio Links	-	2	3

Table 10.10: Test requirements for MTCH detection

Test Number	$\frac{\hat{I}_{or}}{I_{oc}}$ (dB)	RLC SDU ER
1	6.1	0.1
2	5.0	0.1

10.2.2 MBSFN capable UE

This requirement is applicable for UEs that are capable of receiving MBSFN.

10.2.2.1 3.84 Mcps TDD Option

10.2.2.1.1 Non-IMB

The test is only applicable for UEs with at least two receiver antenna connectors where the fading of the signals and the AWGN signals applied to each receiver antenna connector shall be uncorrelated.

For the parameters specified in Table 10.10A the average downlink power ratio shall be below the specified value for the RLC SDU ER shown in Table 10.10B.

Table 10.10A: Parameters for MTCH detection

Parameters	Unit	Test 1
I_{oc}	dBm/3.84 MHz	-60
$\Sigma(S\text{-CCPCH_}E_c)/I_{or}$ per active timeslot	dB	0
MTCH Data Rate	kbps	512
Propagation condition	-	Extended delay spread (see Appendix B)
Number of Radio Links	-	1
S-CCPCH Modulation	-	16QAM

Table 10.10B: Test requirements for MTCH detection (at least two receiver antennas)

Test Number	$\frac{\hat{I}_{or}}{I_{oc}}$ (dB)	RLC SDU ER
1	14.58	0.1

10.2.2.1.2 IMB

The test is only applicable for UEs with at least two receiver antenna connectors where the fading of the signals and the AWGN signals applied to each receiver antenna connector shall be uncorrelated.

For the parameters specified in Table 10.10AA the measured average downlink S-CCPCH_ E_c/I_{or} power ratio shall be below the specified value for the RLC SDU ER shown in Table 10.10AB.

Table 10.10AA: Parameters for MTCH detection

Parameters	Unit	Test 1
I_{oc}	dBm/3.84MHz	-60
$\frac{\hat{I}_{or}}{I_{oc}}$	dB	12
MTCH Data Rate	kbps	512 (see Annex A.4.2.1.2)
Configuration of other physical channels	-	See Annex A.4.2.1.2
Propagation condition	-	Extended Delay Spread (see Annex B.2.1, Table B.1D)

Table 10.10AB: Test requirements for MTCH detection (at least two receiver antennas)

Test Number	S-CCPCH_Ec/I _{or} (dB)	RLC SDU ER
1	-3.5	0.1

10.2.2.2 1.28 Mcps TDD Option

For the parameters specified in Table 10.10C the average downlink power ratio shall be below the specified value for the RLC SDU ER shown in Table 10.10D.

Table 10.10C: Parameters for MTCH detection

Parameters	Unit	Test 1 ¹	Test 2 ¹	Test 3 ²	Test 4 ²
MTCH Data rate	Kbps	192	384	192	384
Rx antenna	-	1	2	1	2
Modulation	-	QPSK	16QAM	QPSK	16QAM
I_{oc}	dBm/1.28 MHz	-60	-60	-60	-60
$\Sigma(S\text{-CCPCH_}E_c)/I_{or}$	dB	0	0	0	0
Propagation condition	-	MBSFN channel model 1 (Annex B)	MBSFN channel model 1 (Annex B)	MBSFN channel model 2 (Annex B)	MBSFN channel model 2 (Annex B)
Slot Format #	-	0 ⁴	2 ⁴	4 ⁴	7 ⁴

NOTE1: Test 1 and Test 2 are specified for the UE supporting normal delay spread.

NOTE2: Test 3 and Test 4 are specified for the UE supporting extended delay spread.

NOTE3: In the case of Rx diversity, the fading of the signals and the AWGN signals applied to each receiver antenna connector shall be uncorrelated.

NOTE4: See Table 8Ha in TS25.221.

Table 10.10D: Test requirements for MTCH detection

Test Number	$\frac{\hat{I}_{or}}{I_{oc}}$ (dB)	RLC SDU ER
1	13.3	0.1
2	14.7	0.1
3	13.3	0.1
4	15.1	0.1

10.2.2.3 7.68 Mcps TDD Option

The test is only applicable for UEs with at least two receiver antenna connectors where the fading of the signals and the AWGN signals applied to each receiver antenna connector shall be uncorrelated.

For the parameters specified in Table 10.10E the average downlink power ratio shall be below the specified value for the RLC SDU ER shown in Table 10.10F.

Table 10.10E: Parameters for MTCH detection

Parameters	Unit	Test 1
I_{oc}	dBm/7.68 MHz	-60
$\Sigma(S\text{-CCPCH } E_c)/I_{or}$ per active timeslot	dB	-3
MTCH Data Rate	kbps	512
Number of interfering codes/timeslot	-	16 × SF32
Propagation condition	-	Extended delay spread (see Appendix B)
Number of Radio Links	-	1
S-CCPCH Modulation	-	16QAM

Table 10.10F: Test requirements for MTCH detection (at least two receiver antennas)

Test Number	$\frac{\hat{I}_{or}}{I_{oc}}$ (dB)	RLC SDU ER
1	14.21	0.1

10.2.3 MBSFN TDD & FDD same platform sharing

This test case is to ensure that a simultaneous demodulation of MTCH and FDD transmission is possible for a MBSFN TDD UE sharing the same platform with a FDD UE. The test is only applicable for TDD UEs with at least two receiver antenna connectors where the fading of the signals and the AWGN signals applied to each receiver antenna connector shall be uncorrelated.

10.2.3.1 3.84 Mcps TDD Option

10.2.3.1.1 Non-IMB

For the parameters specified in Table 10.10G the average downlink \hat{I}_{or} power shall be below the specified value for the RLC SDU ER shown in Table 10.10H.

Table 10.10G: Parameters for MTCH detection sharing same platform with FDD

Parameters	Unit	Test 1	Test 2
FDD UE Tx Pwr	dBm/ 3.84 MHz	Nominal Maximum Output Power	Nominal Maximum Output Power
I_{oc}	dBm/ 3.84 MHz	-infinity	-infinity
$\Sigma(S\text{-CCPCH_}E_c)/I_{or}$ per active timeslot	dB	0	0
MTCH Data Rate	kbps	512	512
Number of interfering codes/timeslot	-	0	0
Propagation condition	-	Extended Delay Spread (see Appendix B)	Extended Delay Spread (see Appendix B)
Number of Radio Links	-	1	1
S-CCPCH Modulation	-	16QAM	16QAM
TDD operating frequencies	MHz	1900-1920	2570-2620
FDD operating band	-	Band I	Band VII
TDD/FDD carrier frequencies	-	Applicable for all combinations of TDD and FDD carrier frequencies except for combinations where the carrier frequency separation is less than 15 MHz	Applicable for all combinations of TDD and FDD carrier frequencies except for combinations where the carrier frequency separation is less than 15 MHz

Table 10.10H: Test requirements for MTCH detection sharing same platform with FDD (TDD UE has at least two receiver antennas)

Test Number	\hat{I}_{or} (dBm)	RLC SDU ER
1	-83.42	0.1
2	-83.42	0.1

10.2.3.1.2 IMB

[Editor's note: FFS]

10.2.3.2 (void)

10.2.3.3 7.68 Mcps TDD Option

For the parameters specified in Table 10.10K the average downlink \hat{I}_{or} power shall be below the specified value for the RLC SDU ER shown in Table 10.10L.

Table 10.10K: Parameters for MTCH detection sharing same platform with FDD

Parameters	Unit	Test 1	Test 2
FDD UE Tx Pwr	dBm/ 3.84 MHz	Nominal Maximum Output Power	Nominal Maximum Output Power
I_{oc}	dBm/ 7.68 MHz	-infinity	-infinity
$\Sigma(S\text{-CCPCH_}E_c)/I_{or}$ per active timeslot	dB	-3	-3
MTCH Data Rate	kbps	512	512
Number of interfering codes/timeslot	-	16 × SF32	16 × SF32
Propagation condition	-	Extended Delay Spread (see Appendix B)	Extended Delay Spread (see Appendix B)
Number of Radio Links	-	1	1
S-CCPCH Modulation	-	16QAM	16QAM
TDD operating frequencies	MHz	1900-1920	2570-2620
FDD operating band	-	Band I	Band VII
TDD/FDD carrier frequencies	-	Applicable for all combinations of TDD and FDD carrier frequencies except for combinations where the carrier frequency separation is less than 17.5 MHz	Applicable for all combinations of TDD and FDD carrier frequencies except for combinations where the carrier frequency separation is less than 17.5 MHz

Table 10.10L: Test requirements for MTCH detection sharing same platform with FDD (TDD UE has at least two receiver antennas)

Test Number	I_{or} (dBm)	RLC SDU ER
1	-80.79	0.1
2	-80.79	0.1

10.3 Demodulation of MTCH and cell identification

MBMS combining is not controlled by a network but instead it is autonomously handled by a terminal. UE has to be able to receive MTCH and identify intra-frequency neighbour cells according to the requirements. The requirement for MBMS receiving combined with cell identification is determined by RLC SDU error rate.

10.3.1 Minimum requirement

10.3.1.1 (void)

10.3.1.2 1.28 Mcps TDD Option

For the parameters specified in Table 10.11, the average downlink I_{or}/I_{oc} power ratio shall be below the specified value for the RLC SDU error rate shown in Table 10.12. The cell reselection parameters are given in clause A.4.2.2.

Table 10.11 parameters for MTCH demodulation requirements with cell identification

Parameter	Unit	Test 1		
		Stage 1	Stage 2	Stage 3
Time in each stage	s	2s	800ms	2s
I_{oc}	dBm/1.28MHz	-60		
Propagation condition		VA 3		
MTCH Data Rate	kbps	64kbps		
Number of Radio Links		Cell 1, Cell 2	Cell 1, 2, 3	Cell 1, Cell 3

Table 10.12: Requirements for MTCH detection

Test Number	$\frac{\hat{I}_{or}}{I_{oc}}$	RLC SDU ER
1	6.1	0.05

11 Performance requirement (E-DCH)

Unless otherwise stated the receiver characteristics are specified at the antenna connector of the UE. For UE(s) with an integral antenna only, a reference antenna with a gain of 0 dBi is assumed. UE with an integral antenna may be taken into account by converting these power levels into field strength requirements, assuming a 0 dBi gain antenna. For UEs with more than one receiver antenna connector the fading of the signals and the AWGN signals applied to each receiver antenna connector shall be uncorrelated. The levels of the test signal applied to each of the antenna connectors shall be as defined in the respective sections below.

11.1 Detection of E-DCH HARQ ACK Indicator Channel (E-HICH)

The performance of the E-HICH detection is determined by the false ACK probability (probability of detecting an ACK given that a NACK was sent) and the false NACK probability (probability of detecting a NACK given that an ACK was sent).

11.1.1 Minimum requirement

11.1.1.1 3.84 Mcps TDD Option

For the parameters specified in Table 11.1 the average downlink E-HICH E_c/I_{or} power ratio shall be below the specified value for the false ACK and false NACK probabilities shown in Table 11.2.

Table 11.1: Test parameters for E-HICH detection (3.84 Mcps TDD option)

Parameters	Unit	Test 1	Test 2
I_{oc}	dBm/3.84 MHz	-60	
$\frac{\hat{I}_{or}}{I_{oc}}$	dB	0	
Number of Interfering codes/timeslot	-	7 × SF16 (all codes have equal powers)	
E-HICH signalling pattern	-	100% NACK	100% ACK
Propagation condition	-	VA30	

Table 11.2: Test requirements for E-HICH detection (3.84 Mcps TDD option)

Test Number	E-HICH E_c/I_{or} (dB)	Parameter	Probability
1	-18.5	False ACK	2E-3
2	-18.5	False NACK	2E-2

11.1.1.2 1.28 Mcps TDD Option

For the parameters specified in Table 11.3 the average downlink E-HICH E_c/I_{or} power ratio shall be below the specified value for the false ACK and false NACK probabilities shown in Table 11.4.

Table 11.3: Test parameters for E-HICH detection (1.28 Mcps TDD option)

Parameters	Unit	Test 1	Test 2
I_{oc}	dBm/1.28 MHz	-60	
$\frac{\hat{I}_{or}}{I_{oc}}$	dB	0	
Number of Interfering codes/timeslot	-	7 × SF16 (all codes have equal powers)	
Midamble	-	Common midamble	
E-HICH signalling pattern	-	100% NACK	100% ACK
Propagation condition	-	VA30	

Table 11.4: Test requirements for E-HICH detection (1.28 Mcps TDD option)

Test Number	E-HICH E_c/I_{or} (dB)	Parameter	Probability
1	-7.5	False ACK	2E-3
2	-7.5	False NACK	2E-2

11.1.1.3 7.68 Mcps TDD Option

For the parameters specified in Table 11.5 the average downlink E-HICH E_c/I_{or} power ratio shall be below the specified value for the false ACK and false NACK probabilities shown in Table 11.6.

Table 11.5: Test parameters for E-HICH detection (7.68 Mcps TDD option)

Parameters	Unit	Test 1	Test 2
I_{oc}	dBm/7.68 MHz	-60	
$\frac{\hat{I}_{or}}{I_{oc}}$	dB	0	
Number of Interfering codes/timeslot	-	15 × SF32 (all codes have equal powers)	
E-HICH signalling pattern	-	100% NACK	100% ACK
Propagation condition	-	VA30	

Table 11.6: Test requirements for E-HICH detection (7.68 Mcps TDD option)

Test Number	E-HICH E_c/I_{or} (dB)	Parameter	Probability
1	-21.7	False ACK	2E-3
2	-21.7	False NACK	2E-2

11.2 Demodulation of E-DCH Absolute Grant Channel (E-AGCH)

The performance of the E-AGCH detection is determined by the missed detection probability.

11.2.1 Minimum requirement

11.2.1.1 3.84 Mcps TDD Option

For the parameters specified in Table 11.7 the average downlink E-AGCH \hat{I}_{or}/I_{oc} power ratio shall be below the specified value for the missed detection probability shown in Table 11.8.

Table 11.7: Test parameters for E-AGCH detection (3.84 Mcps TDD option)

Parameters	Unit	Test 1
I_{oc}	dBm/3.84 MHz	-60
$\frac{E_c}{I_{or}}$	dB	-6.02
Number of Interfering codes/timeslot	-	3 × SF16
Total bits in Timeslot Resource Related Information (TRRI)	bits	6
Total bits in Resource Duration Indicator (RDI)	bits	3
Total bits in E-AGCH	bits	38
Propagation condition	-	VA30

Table 11.8: Test requirements for E-AGCH detection (3.84 Mcps TDD option)

Test Number	E-AGCH \hat{I}_{or}/I_{oc} (dB)	Missed Detection Probability
1	1.6	0.01

11.2.1.2 1.28 Mcps TDD Option

For the parameters specified in Table 11.9 the average downlink E-AGCH type 1 \hat{I}_{or}/I_{oc} power ratio shall be below the specified value for the missed detection probability shown in Table 11.10.

Table 11.9: Test parameters for E-AGCH type 1 detection (1.28 Mcps TDD option)

Parameters	Unit	Test 1
I_{oc}	dBm/1.28 MHz	-60
$\frac{E_c}{I_{or}}$	dB	-3
Number of Interfering codes/timeslot	-	2 × SF16
Total bits in Timeslot Resource Related Information (TRRI)	bits	5
Total bits in Resource Duration Indicator (RDI)	bits	3
Total bits in E-AGCH	bits	26
Midamble	-	Common midamble
Propagation condition	-	VA30

Table 11.10: Test requirements for E-AGCH type 1 detection (1.28 Mcps TDD option)

Test Number	E-AGCH \hat{I}_{or}/I_{oc} (dB)	Missed Detection Probability
1	8	0.01

For the parameters specified in Table 11.9A the average downlink E-AGCH type 2 \hat{I}_{or}/I_{oc} power ratio shall be below the specified value for the missed detection probability shown in Table 11.10A.

Table 11.9A: Test parameters for E-AGCH type 2 detection (1.28 Mcps TDD option)

Parameters	Unit	Test 1
I_{oc}	dBm/1.28 MHz	-60
$\frac{E_c}{I_{or}}$	dB	-3
Number of Interfering codes/timeslot	-	2 x SF16
Total bits in E-AGCH	bits	30
Midamble	-	Common midamble
Propagation condition	-	VA30

Table 11.10A: Test requirements for E-AGCH type 2 detection (1.28 Mcps TDD option)

Test Number	E-AGCH \hat{I}_{or}/I_{oc} (dB)	Missed Detection Probability
1	8.5	0.01

11.2.1.3 7.68 Mcps TDD Option

For the parameters specified in Table 11.11 the average downlink E-AGCH \hat{I}_{or}/I_{oc} power ratio shall be below the specified value for the missed detection probability shown in Table 11.12.

Table 11.11: Test parameters for E-AGCH detection (7.68 Mcps TDD option)

Parameters	Unit	Test 1
I_{oc}	dBm/7.68 MHz	-60
$\frac{E_c}{I_{or}}$	dB	-9.03
Number of Interfering codes/timeslot	-	7 x SF32
Total bits in Timeslot Resource Related Information (TRRI)	bits	6
Total bits in Resource Duration Indicator (RDI)	bits	3
Total bits in E-AGCH	bits	39
Propagation condition	-	VA30

Table 11.12: Test requirements for E-AGCH detection (7.68 Mcps TDD option)

Test Number	E-AGCH \hat{I}_{or}/I_{oc} (dB)	Missed Detection Probability
1	1.2	0.01

Annex A (normative): Measurement channels

A.1 (void)

A.2 Reference measurement channel

A.2.1 UL reference measurement channel (12.2 kbps)

A.2.1.1 3.84 Mcps TDD Option

Table A.1

Parameter	Value
Information data rate	12.2 kbps
RU's allocated	2 RU
Midamble	512 chips
Interleaving	20 ms
Power control	2 Bit/user
TFCI	16 Bit/user
Inband signalling DCCH	2 kbps
Puncturing level at Code rate 1/3 : DCH of the DTCH / DCH of the DCCH	10% / 0%

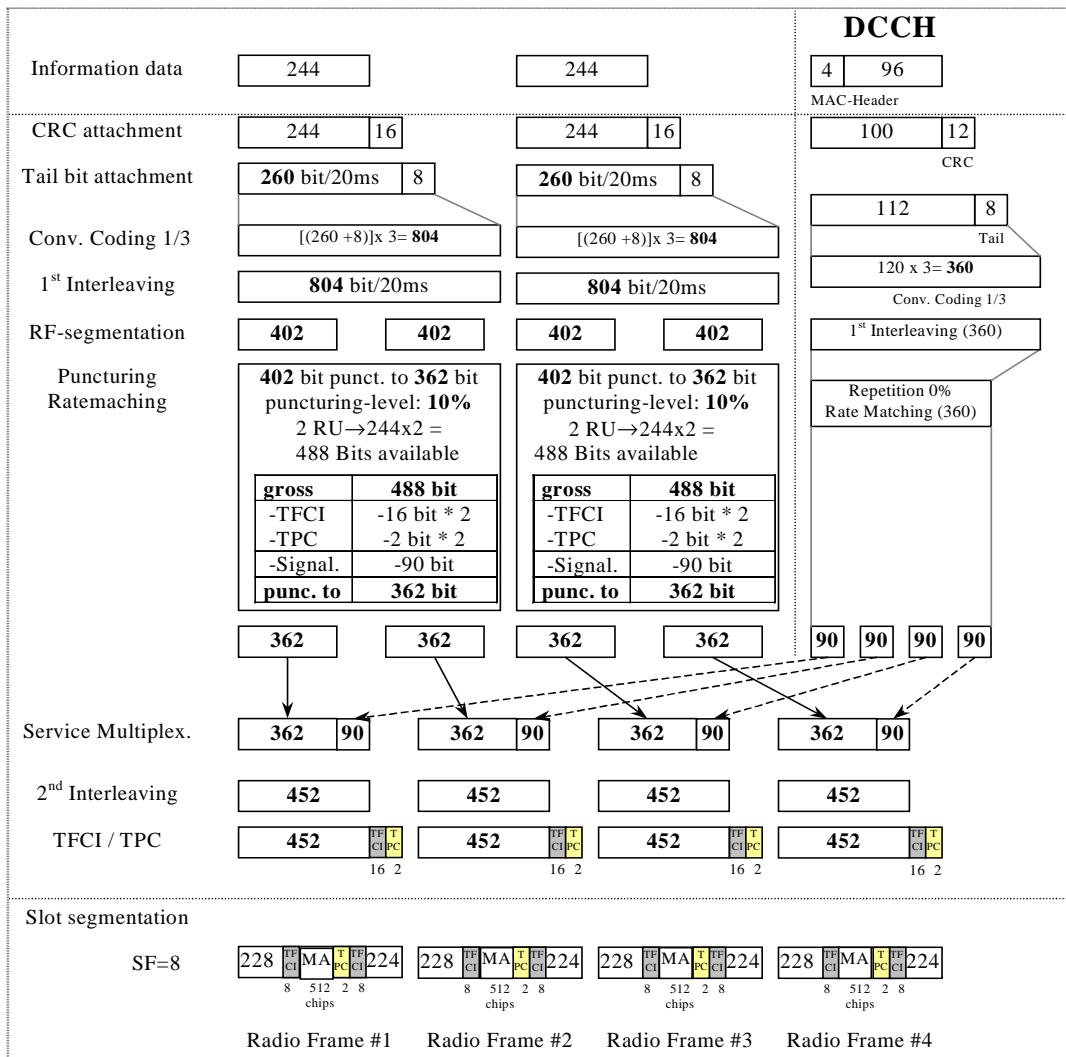

Figure A.1

A.2.1.2 1.28 Mcps TDD Option

Table A.1A

Parameter	Value
Information data rate	12.2 kbps
RU 's allocated	1TS (1*SF8) = 2RU/5ms
Midamble	144
Interleaving	20 ms
Power control	4 Bit/user/10ms
TFCI	16 Bit/user/10ms
4 Bit reserved for future use (place of SS)	4 Bit/user/10ms
Inband signalling DCCH	2.4 kbps
Puncturing level at Code rate 1/3 : DCH of the DTCH / DCCH of the DCCH	33% / 33%

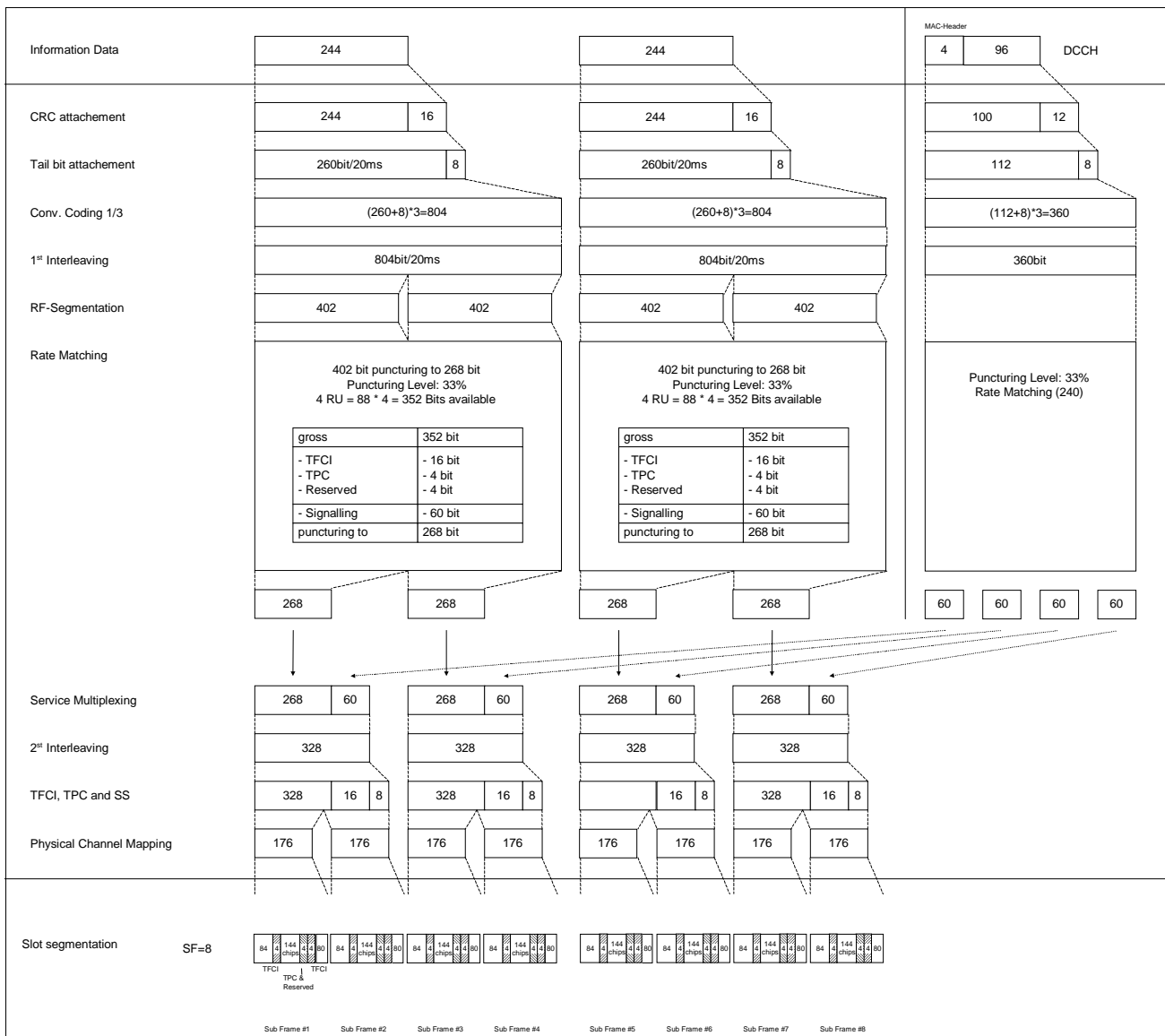

Figure A.1A

A.2.1.3 7.68 Mcps TDD Option

Table A.1B

Parameter	Value
Information data rate	12.2 kbps
RU's allocated	2 RU
Midamble	1024 chips
Interleaving	20 ms
Power control	2 Bit/user
TFCI	16 Bit/user
Inband signalling DCCH	2 kbps
Puncturing level at Code rate 1/3 : DCH of the DTCH / DCH of the DCCH	10% / 0%

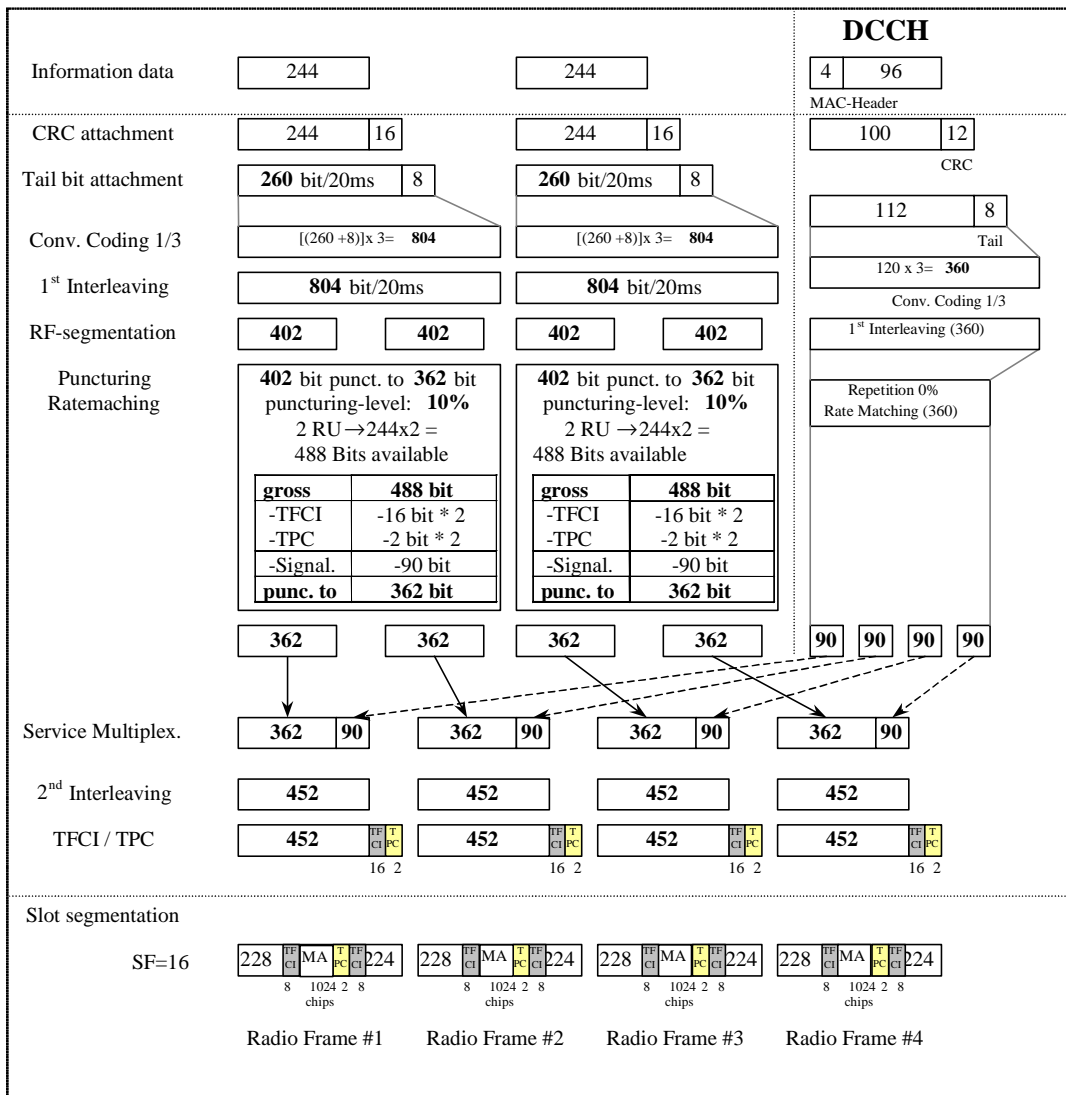

Figure A.1B

A.2.2 DL reference measurement channel (12.2 kbps)

A.2.2.1 3.84 Mcps TDD Option

Table A.2

Parameter	Value
Information data rate	12.2 kbps
RU's allocated	2 RU
Midamble	512 chips
Interleaving	20 ms
Power control	0 Bit/user
TFCI	16 Bit/user
Inband signalling DCCH	2 kbps
Puncturing level at Code rate 1/3 : DCH of the DTCH / DCH of the DCCH	5% / 0 %

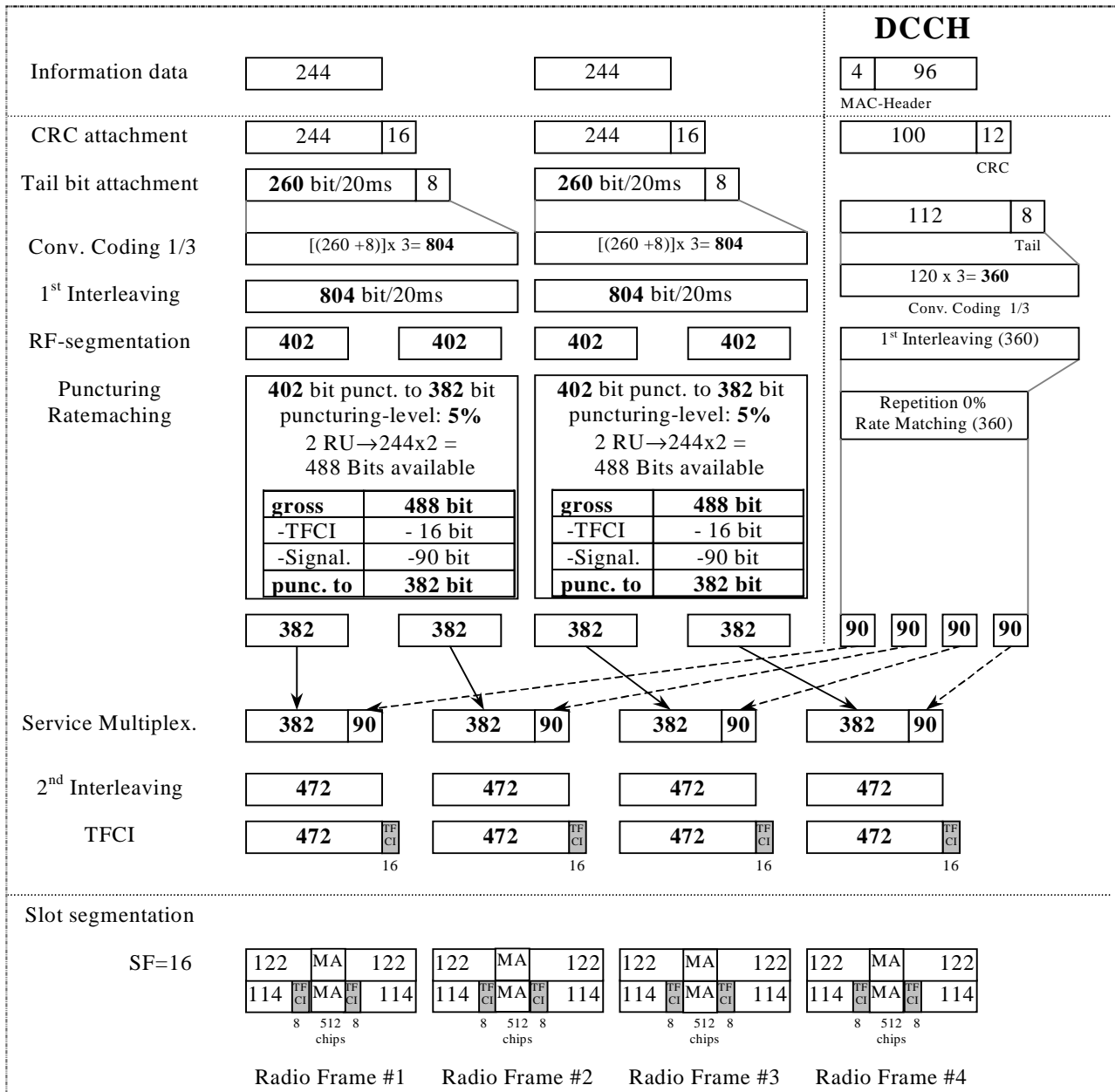

Figure A.2

A.2.2.2 1.28 Mcps TDD Option

Table A.2A

Parameter	Value
Information data rate	12.2 kbps
RU's allocated	1TS (2*SF16) = 2RU/5ms
Midamble	144
Interleaving	20 ms
Power control (TPC)	4 Bit/user/10ms
TFCI	16 Bit/user/10ms
Synchronisation Shift (SS)	4 Bit/user/10ms
Inband signalling DCCH	2.4 kbps
Puncturing level at Code rate 1/3: DCH of the DTCH / DCH of the DCCH	33% / 33%

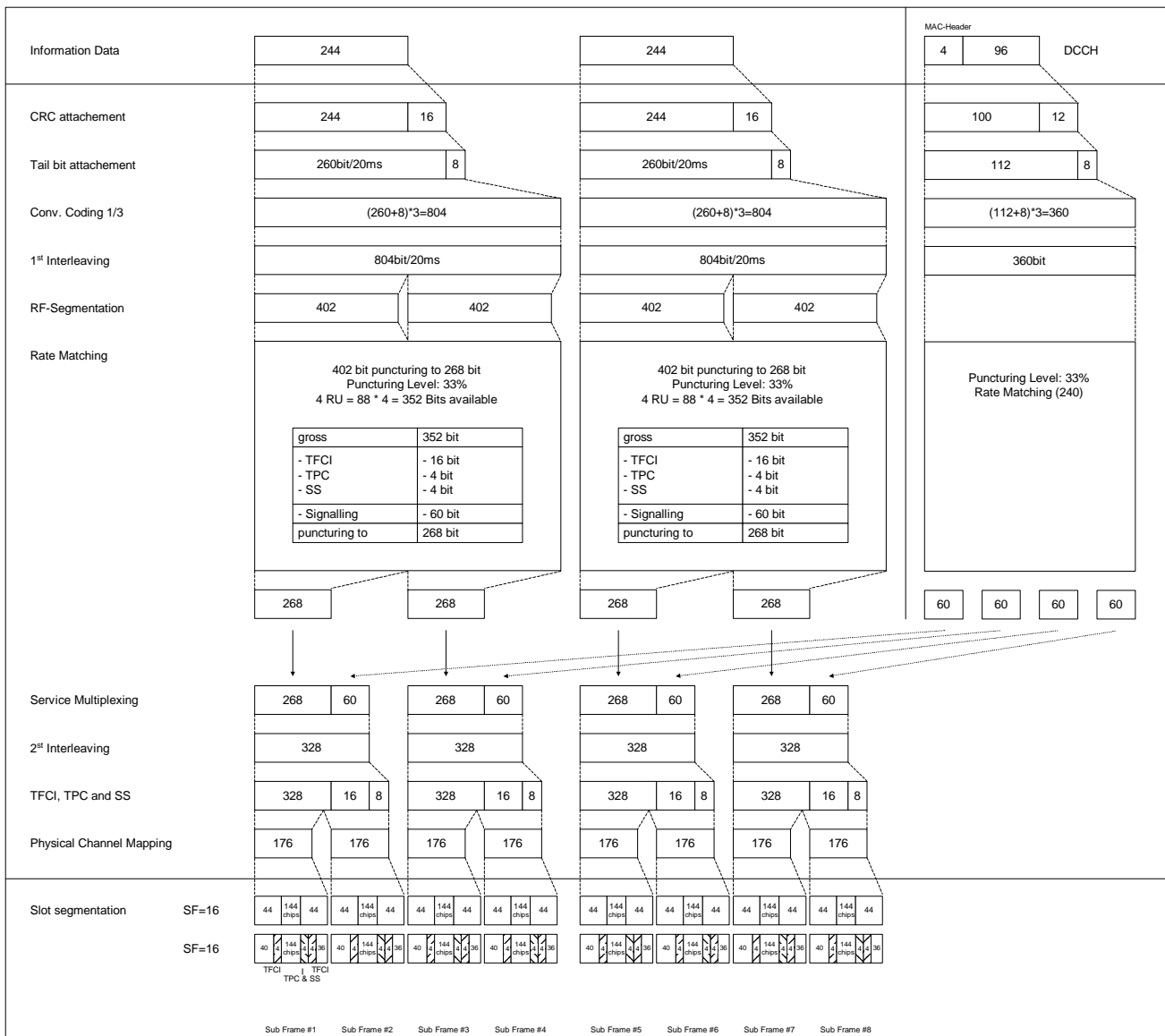

Figure A.2A

A.2.2.3 7.68 Mcps TDD Option

TableA.2B

Parameter	Value
Information data rate	12.2 kbps
RU's allocated	2 RU
Midamble	1024 chips
Interleaving	20 ms
Power control	0 Bit/user
TFCI	16 Bit/user
Inband signalling DCCH	2 kbps
Puncturing level at Code rate 1/3 : DCH of the DTCH / DCH of the DCCH	5% / 0 %

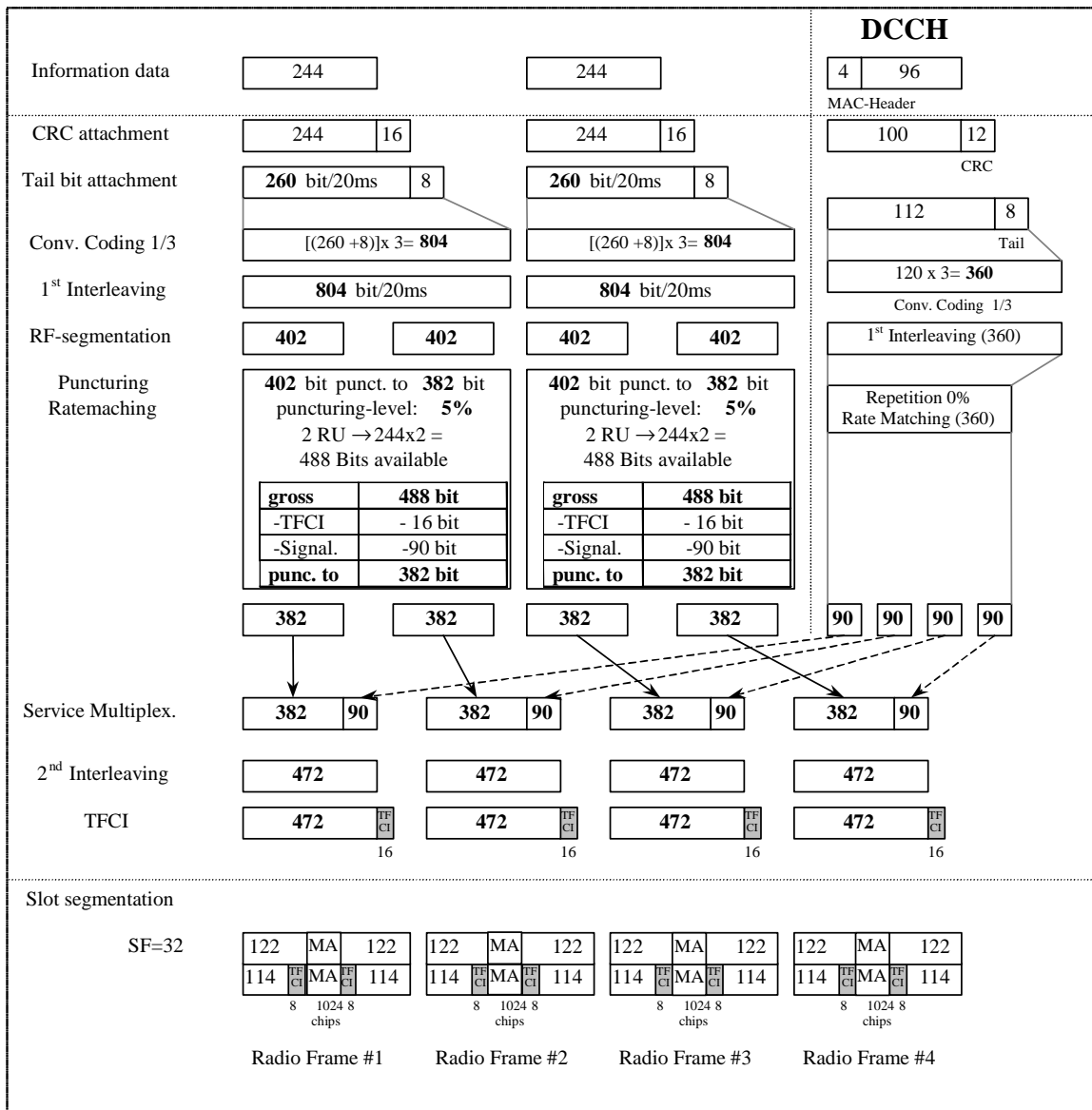

Figure A.2B

A.2.3 DL reference measurement channel (64 kbps)

A.2.3.1 3.84 Mcps TDD Option

Table A.3

Parameter	Value
Information data rate	64 kbps
RU's allocated	5 codes SF16 = 5RU
Midamble	512 chips
Interleaving	20 ms
Power control	0 Bit/user
TFCI	16 Bit/user
Inband signalling DCCH	2 kbps
Puncturing level at Code rate : 1/3 DCH of the DTCH / 1/2 DCH of the DCCH	41.1% / 10%

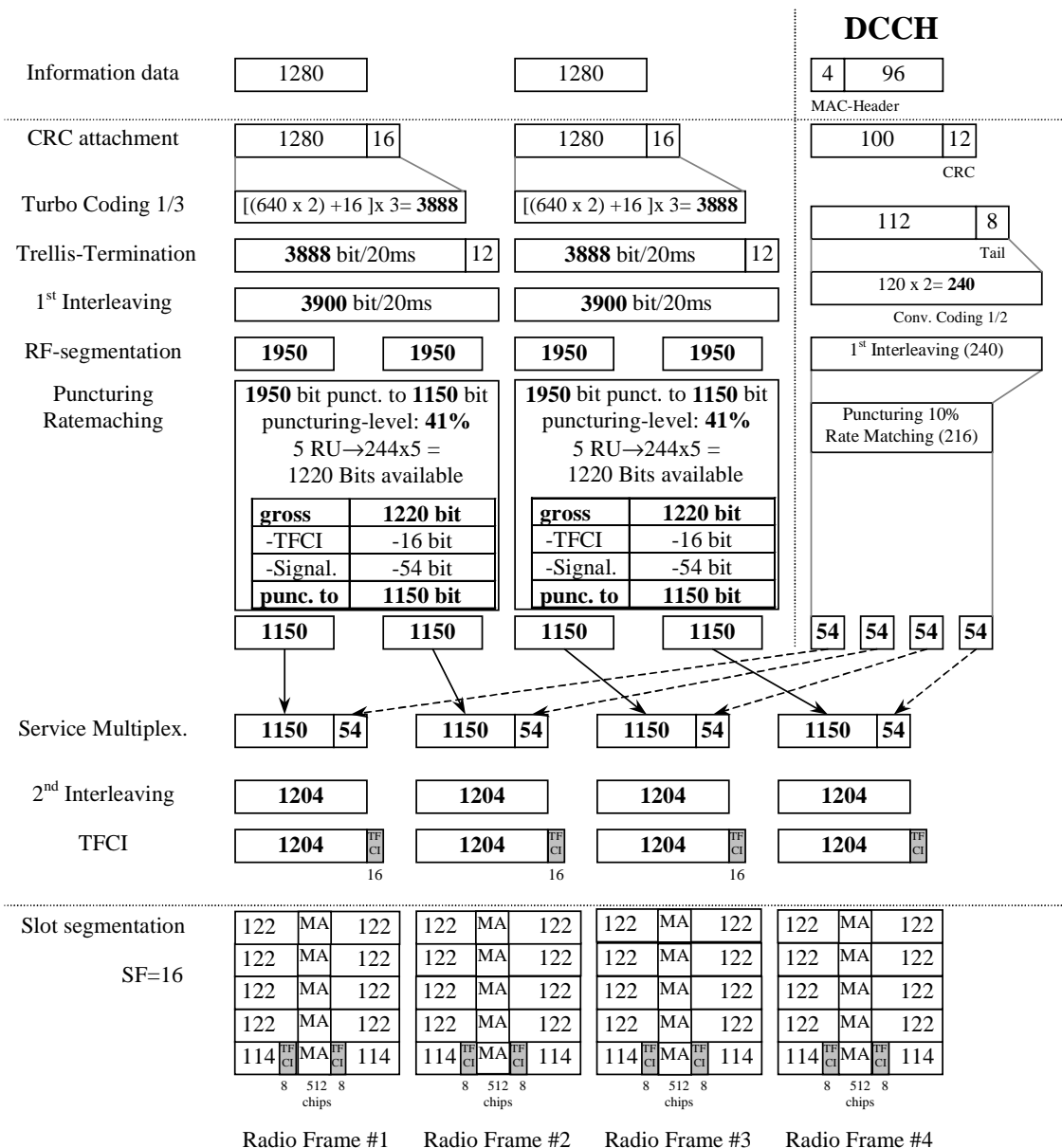

Figure A.3

A.2.3.2 1.28 Mcps TDD Option

Table A.3A

Parameter	Value
Information data rate	64 kbps
RU's allocated	1TS (8*SF16) = 8RU/5ms
Midamble	144
Interleaving	20 ms
Power control (TPC)	4 Bit/user/10ms
TFCI	16 Bit/user/10ms
Synchronisation Shift (SS)	4 Bit/user/10ms
Inband signalling DCCH	2.4 kbps
Puncturing level at Code rate: 1/3 DCH of the DTCH / 1/2 DCH of the DCCH	32% / 0

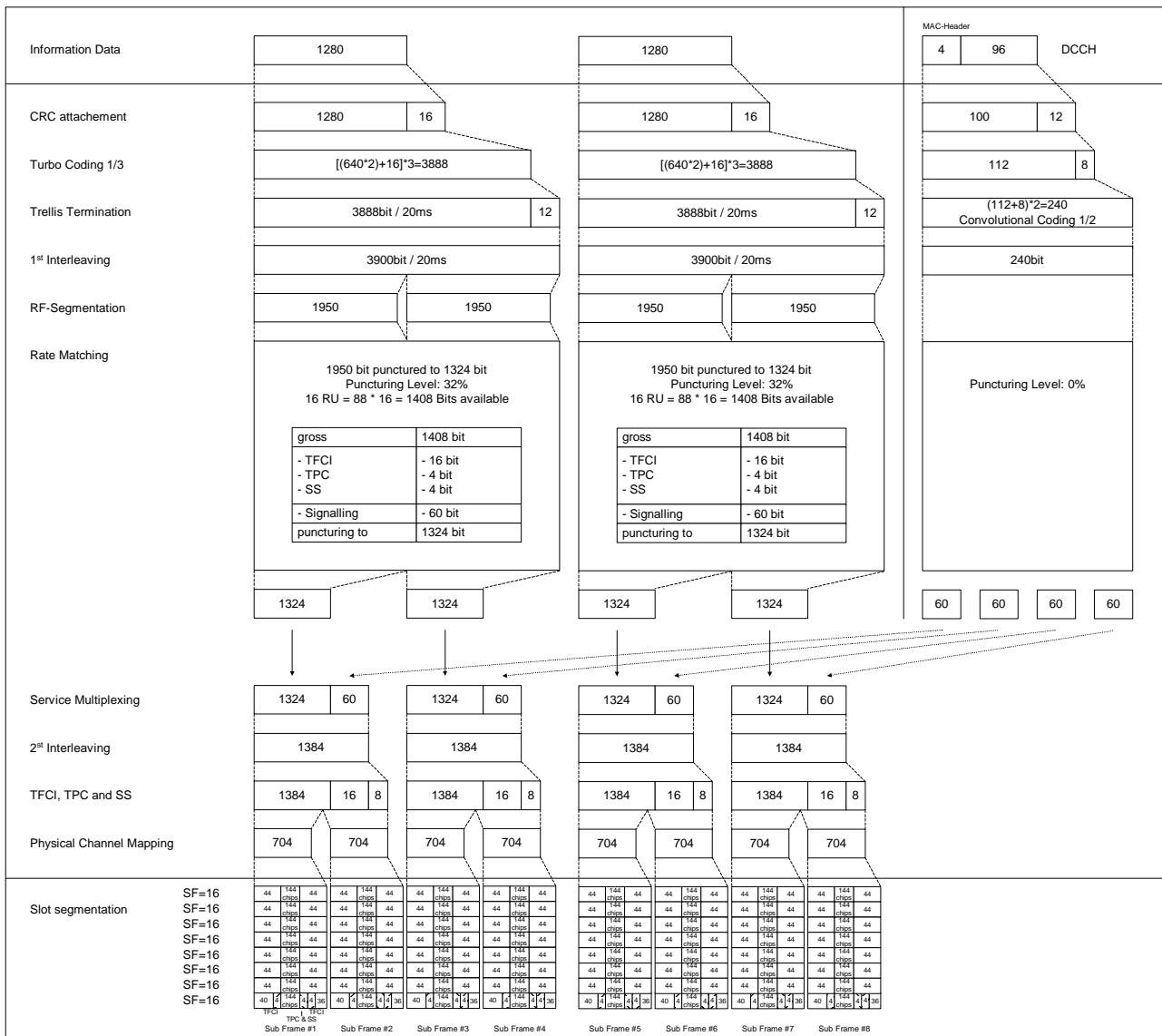

Figure A.3A

A.2.3.3 7.68 Mcps TDD Option

Table A.3B

Parameter	Value
Information data rate	64 kbps
RU's allocated	5 codes SF32 = 5RU
Midamble	1024 chips
Interleaving	20 ms
Power control	0 Bit/user
TFCI	16 Bit/user
Inband signalling DCCH	2 kbps
Puncturing level at Code rate : 1/3 DCH of the DTCH / 1/2 DCH of the DCCH	41.1% / 10%

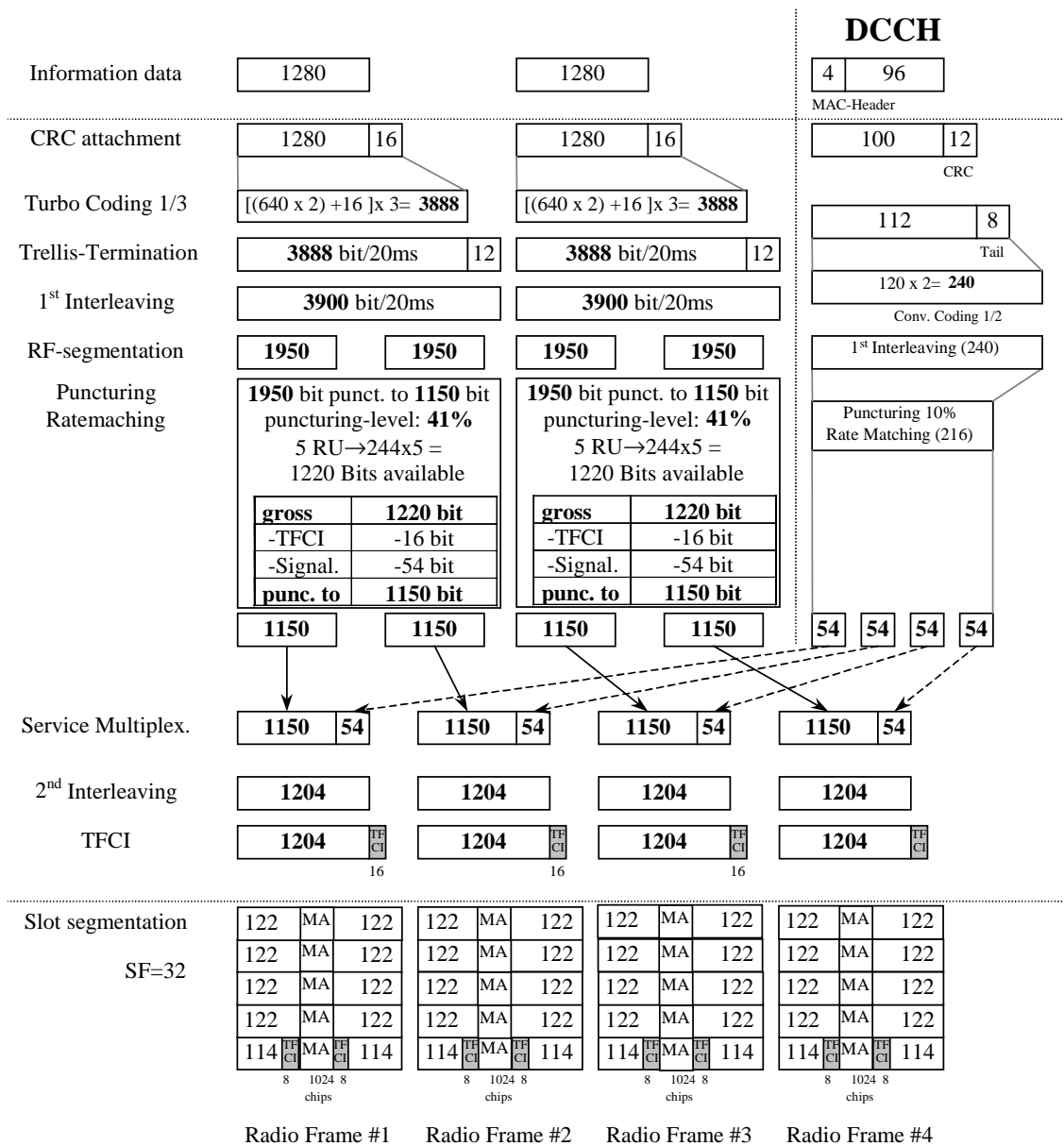

Figure A.3B

A.2.4 DL reference measurement channel (144 kbps)

A.2.4.1 3.84 Mcps TDD Option

Table A.4

Parameter	Value
Information data rate	144 kbps
RU's allocated	9 codes SF16 = 9RU
Midamble	256 chips
Interleaving	20 ms
Power control	0 Bit/user
TFCI	16 Bit/user
Inband signalling DCCH	2 kbps
Puncturing level at Code rate: 1/3 DCH of the DTCH / 1/2 DCH of the DCCH	44.5% / 16.6%

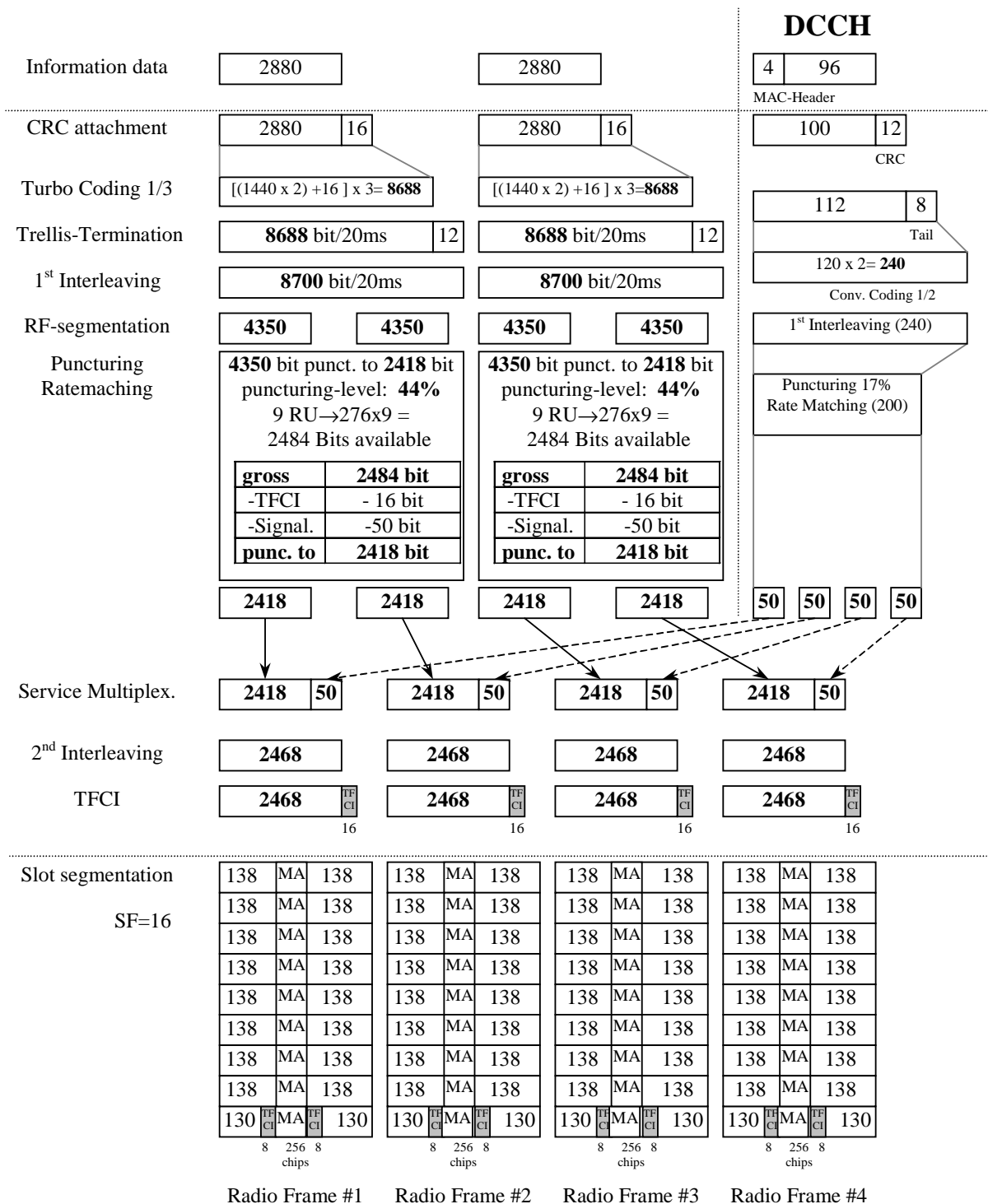

Figure A.4

A.2.4.2 1.28 Mcps TDD Option

Table A.4A

Parameter	Value
Information data rate	144 kbps
RU's allocated	2TS (8*SF16) = 16RU/5ms
Midamble	144
Interleaving	20 ms
Power control (TPC)	8 Bit/user/10ms
TFCI	32 Bit/user/10ms
Synchronisation Shift (SS)	8 Bit/user/10ms
Inband signalling DCCH	2.4 kbps
Puncturing level at Code rate: 1/3 DCH of the DTCH / 1/2 DCH of the DCCH	38% / 7%

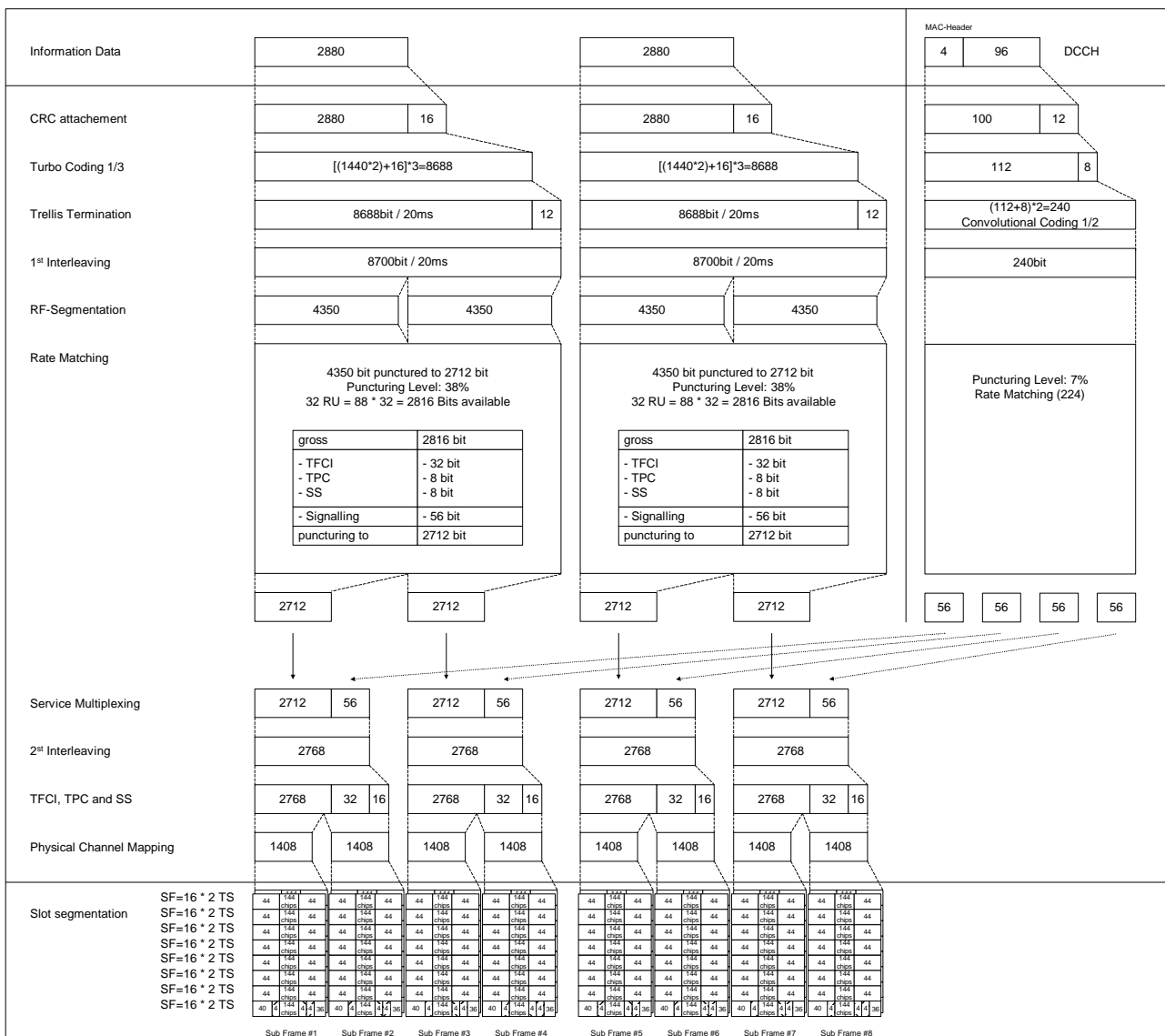

Figure A.4A

A.2.4.3 7.68 Mcps TDD Option

Table A.4B

Parameter	Value
Information data rate	144 kbps
RU's allocated	9 codes SF32 = 9RU
Midamble	512 chips
Interleaving	20 ms
Power control	0 Bit/user
TFCI	16 Bit/user
Inband signalling DCCH	2 kbps
Puncturing level at Code rate: 1/3 DCH of the DTCH / 1/2 DCH of the DCCH	44.5% / 16.6%

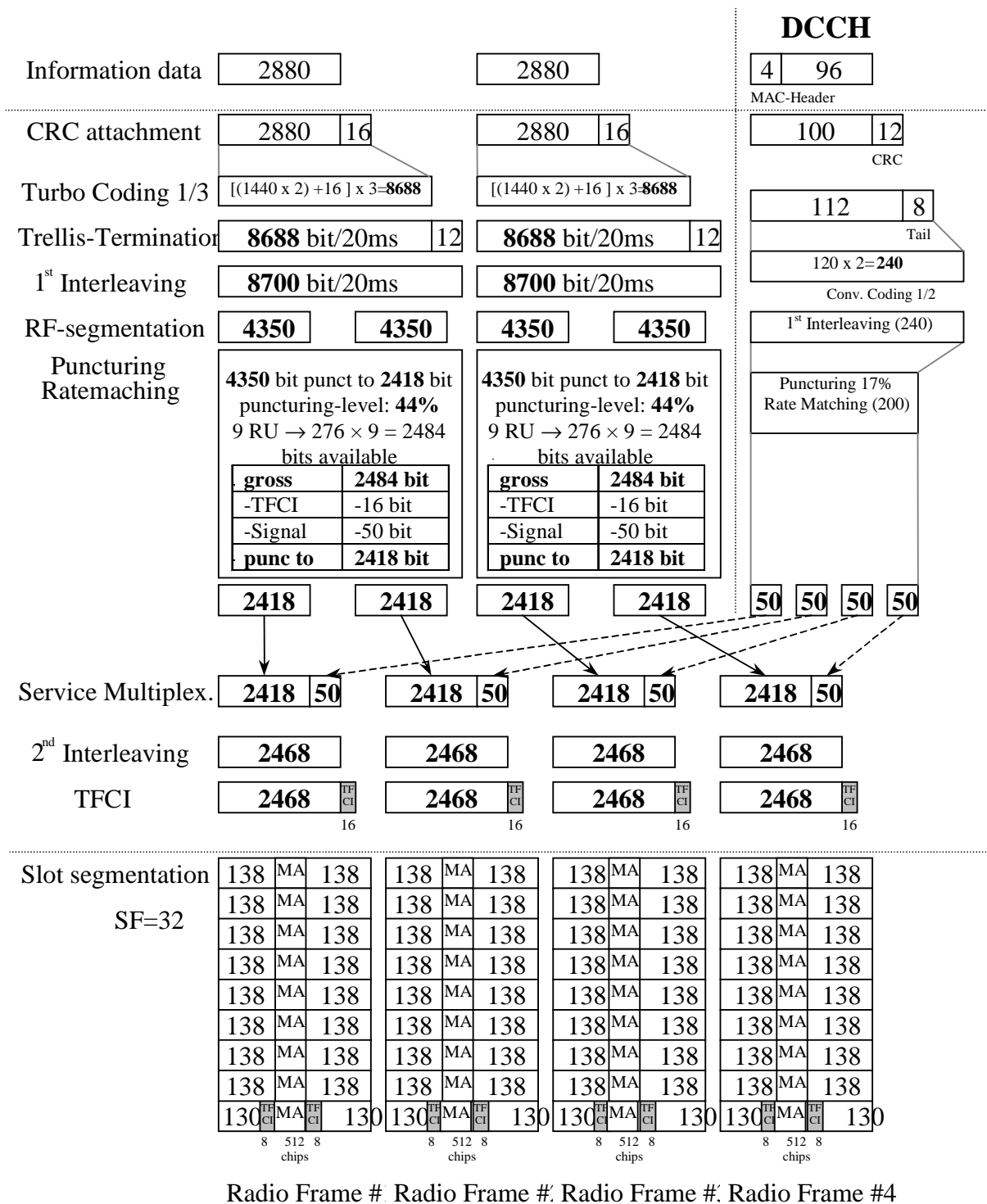

Figure A.4B

A.2.5 DL reference measurement channel (384 kbps)

A.2.5.1 3.84 Mcps TDD Option

Table A.5

Parameter	Value
Information data rate	384 kbps
RU's allocated	8*3TS = 24RU
Midamble	256 chips
Interleaving	20 ms
Power control	0 Bit/user
TFCI	16 Bit/user
Inband signalling DCCH	2 kbps
Puncturing level at Code rate : 1/3 DCH of the DTCH / 1/2 DCH of the DCCH	43.4% / 15.3%

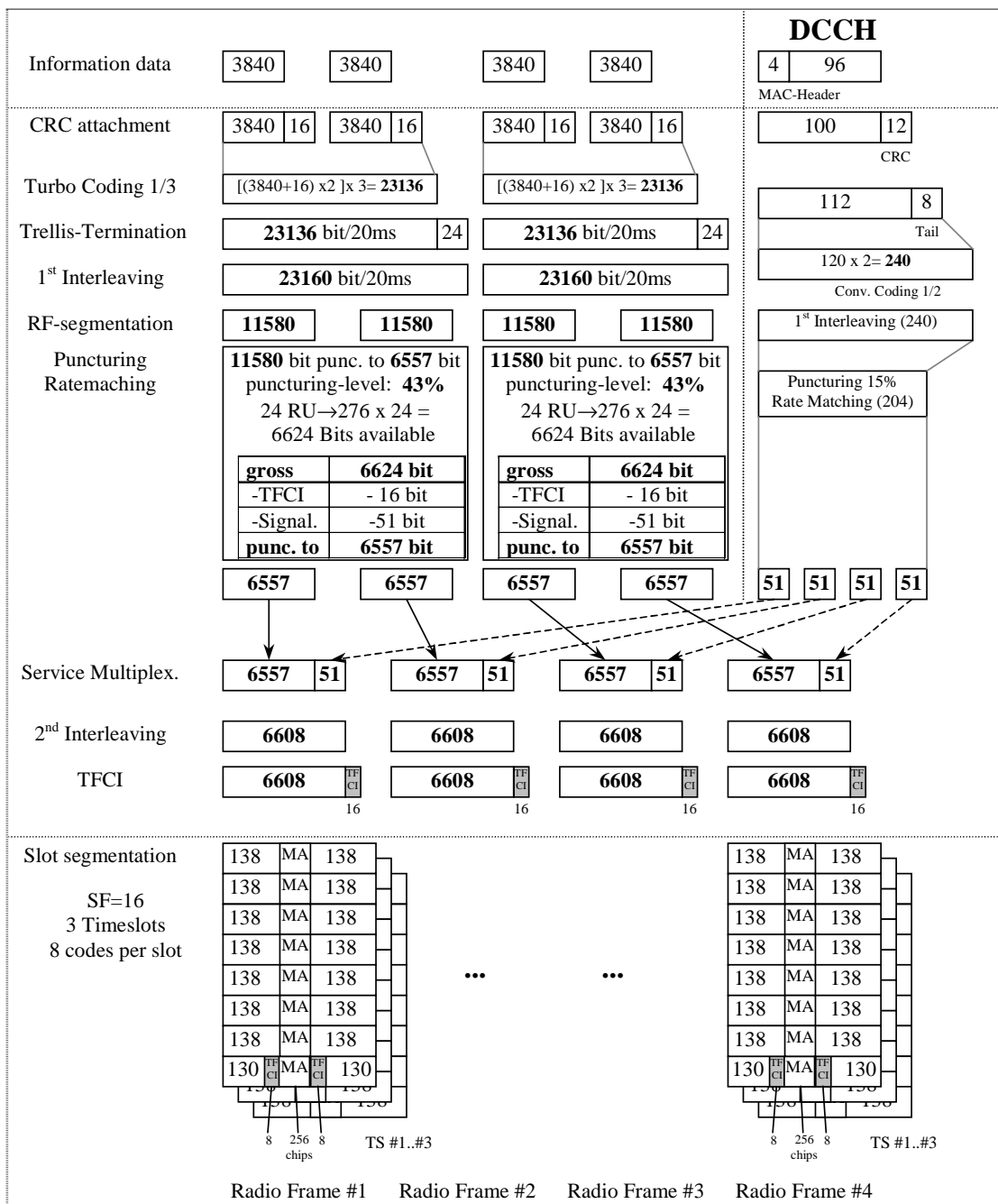

Figure A.5

A.2.5.2 1.28 Mcps TDD Option

Table A.5A

Parameter	Value
Information data rate	384 kbps
RU's allocated	4TS (9*SF16) = 36RU/5ms
Midamble	144
Interleaving	20 ms
Power control (TPC)	16 Bit/user/10ms
TFCI	64 Bit/user/10ms
Synchronisation Shift (SS)	16 Bit/user/10ms
Inband signalling DCCH	2.4 kbps
Puncturing level at Code rate: 1/3 DCH of the DTCH / 1/2 DCH of the DCCH	47% / 12%

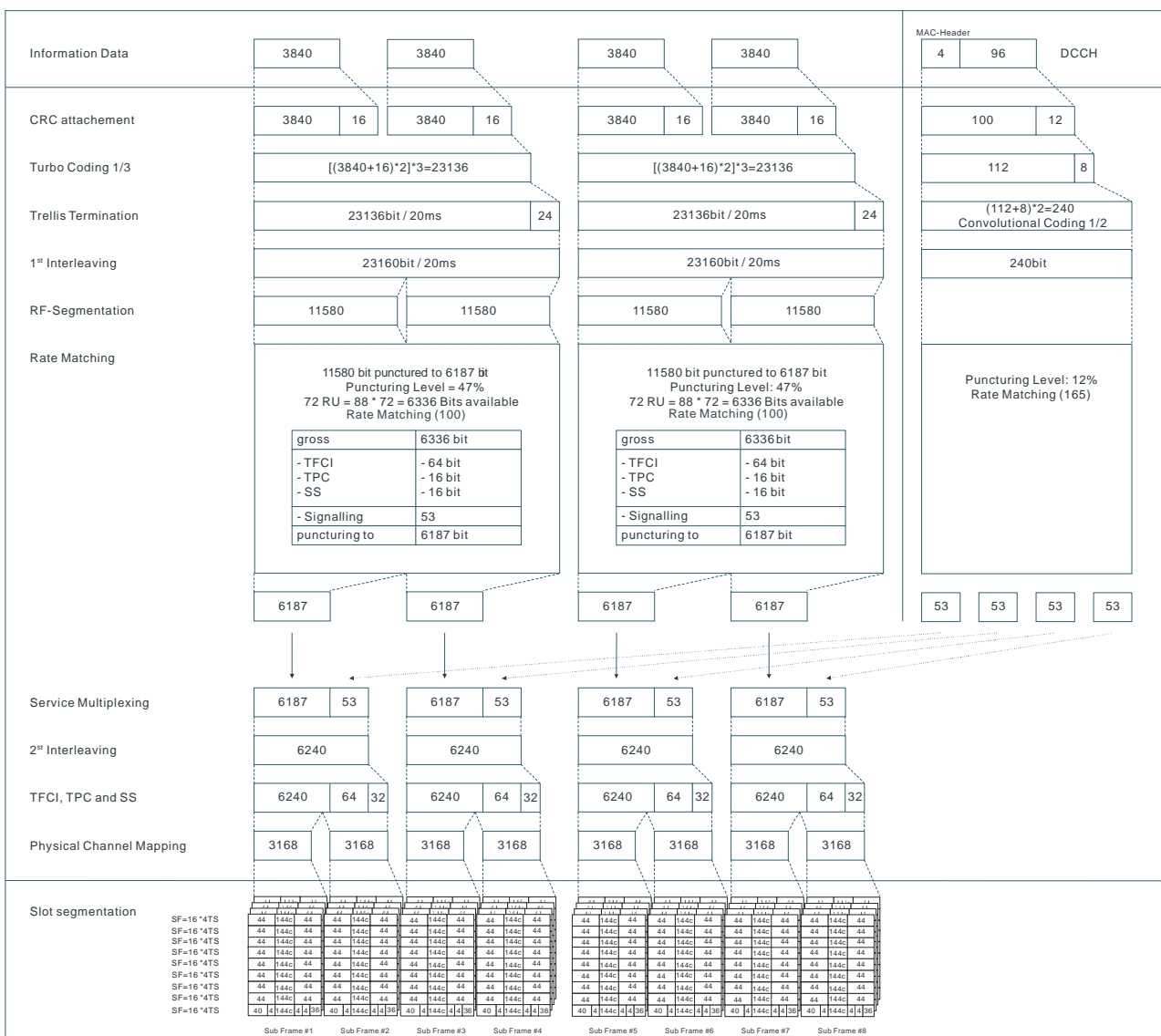

Figure A.5A

A.2.5.3 7.68 Mcps TDD Option

Table A.5B

Parameter	Value
Information data rate	384 kbps
RU's allocated	8*3TS = 24RU
Midamble	512 chips
Interleaving	20 ms
Power control	0 Bit/user
TFCI	16 Bit/user
Inband signalling DCCH	2 kbps
Puncturing level at Code rate : 1/3 DCH of the DTCH / 1/2 DCH of the DCCH	43.4% / 15.3%

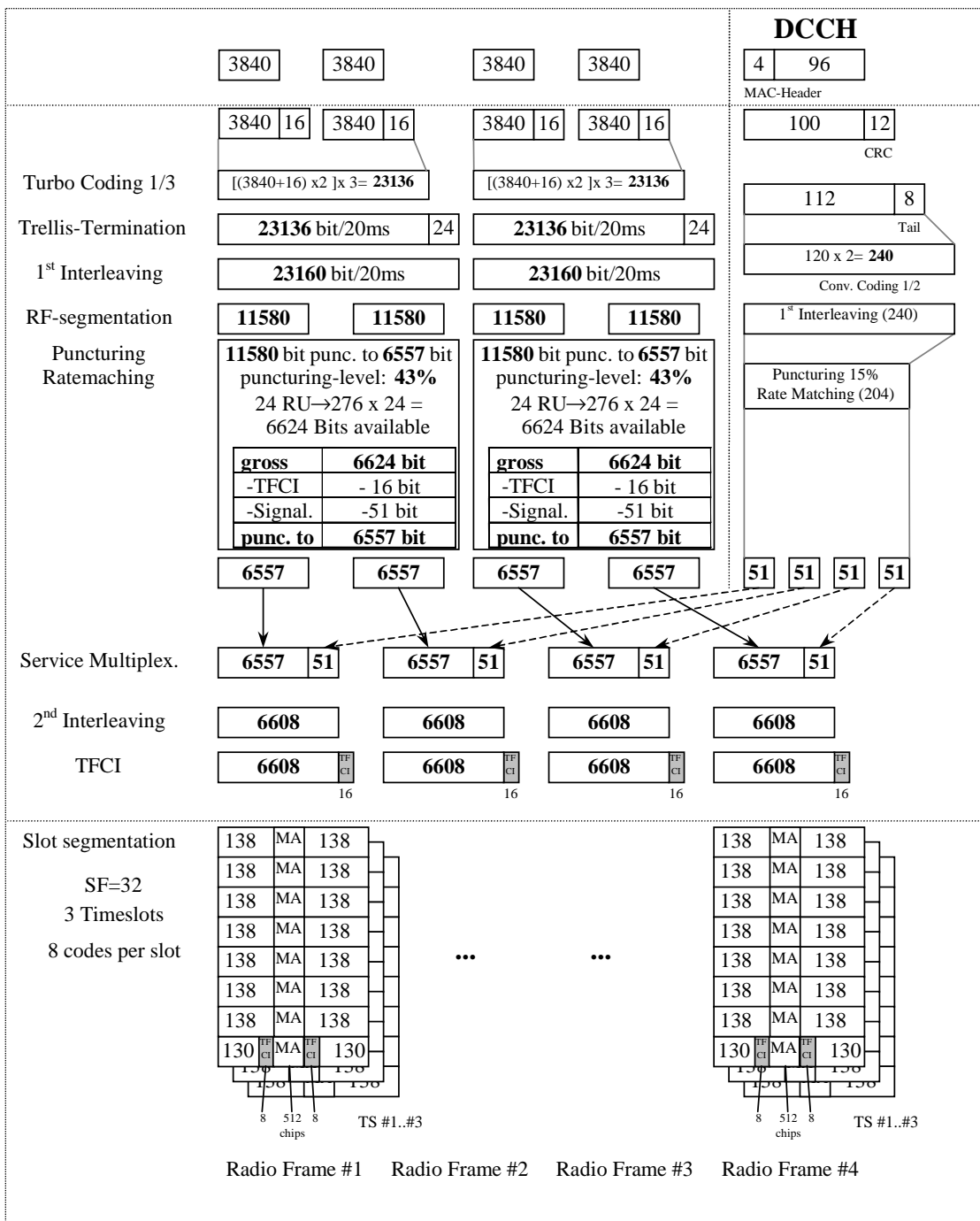

Figure A.5B

A.2.6 BCH reference measurement channel

[mapped to 1 code SF16]

A.2.6.1 3.84 Mcps TDD Option

Table A.6

Parameter	Value
Information data rate:	12.3 kbps
RU's allocated	1 RU
Midamble	512 chips
Interleaving	20 ms
Power control	0 bit
TFCI	0 bit
Puncturing level	10%

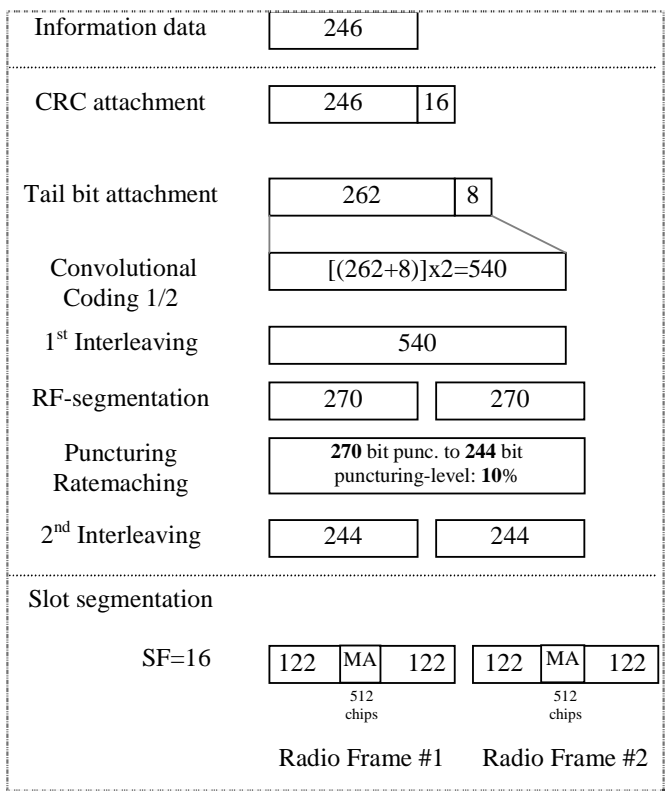

Figure A.6

A.2.6.2 1.28 Mcps TDD Option

Table A.6A

Parameter	Value
Information data rate:	12.3 kbps
RU's allocated	2 RU
Midamble	144 chips
Interleaving	20 ms
Power control	0 bit
TFCI	0 bit
Puncturing level	13%

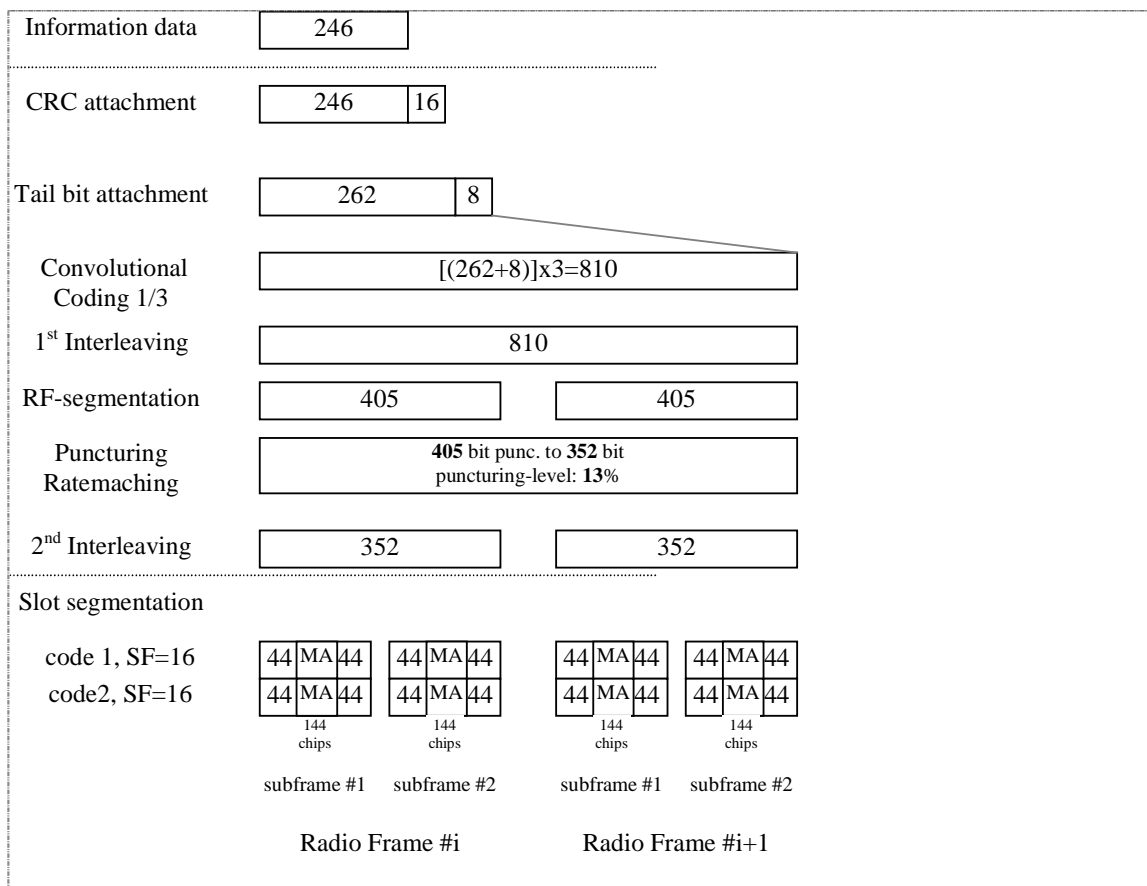

Figure A.6A

A.2.6.3 7.68 Mcps TDD Option

Table A.6

Parameter	Value
Information data rate:	12.3 kbps
RU's allocated	1 RU
Midamble	1024 chips
Interleaving	20 ms
Power control	0 bit
TFCI	0 bit
Puncturing level	10%

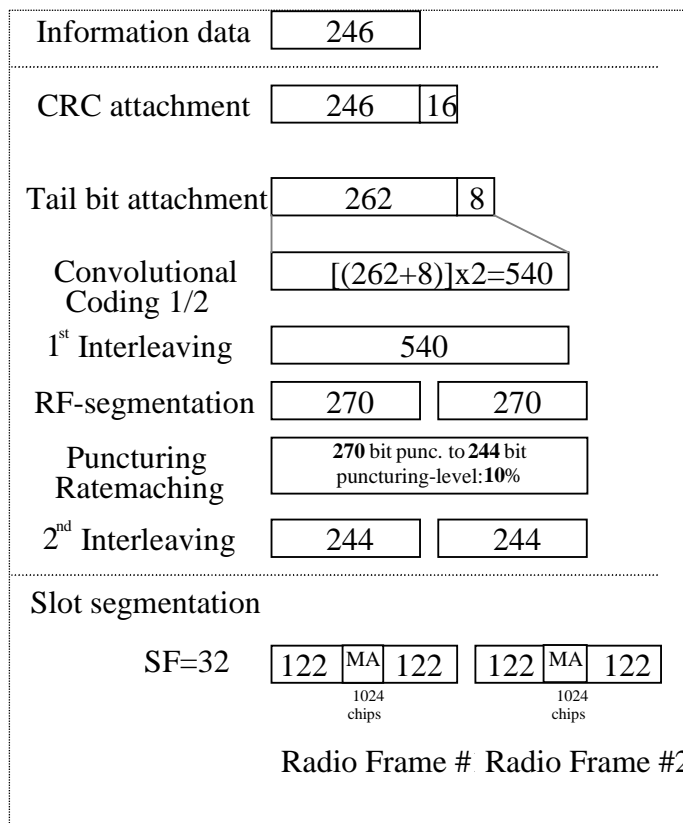

Figure A.6B

A.2.7 UL multi code reference measurement channel (12.2 kbps)

A.2.7.1 3.84 Mcps TDD Option

Table A.7

Parameter	Value
Information data rate	12.2 kbps
RU's allocated	2 RU
Midamble	512 chips
Interleaving	20 ms
Power control	2 Bit/user
TFCI	16 Bit/user
Inband signalling DCCH	2 kbps
Puncturing level at Code rate 1/3 : DCH of the DTCH / DCH of the DCCH	5% / 0 %

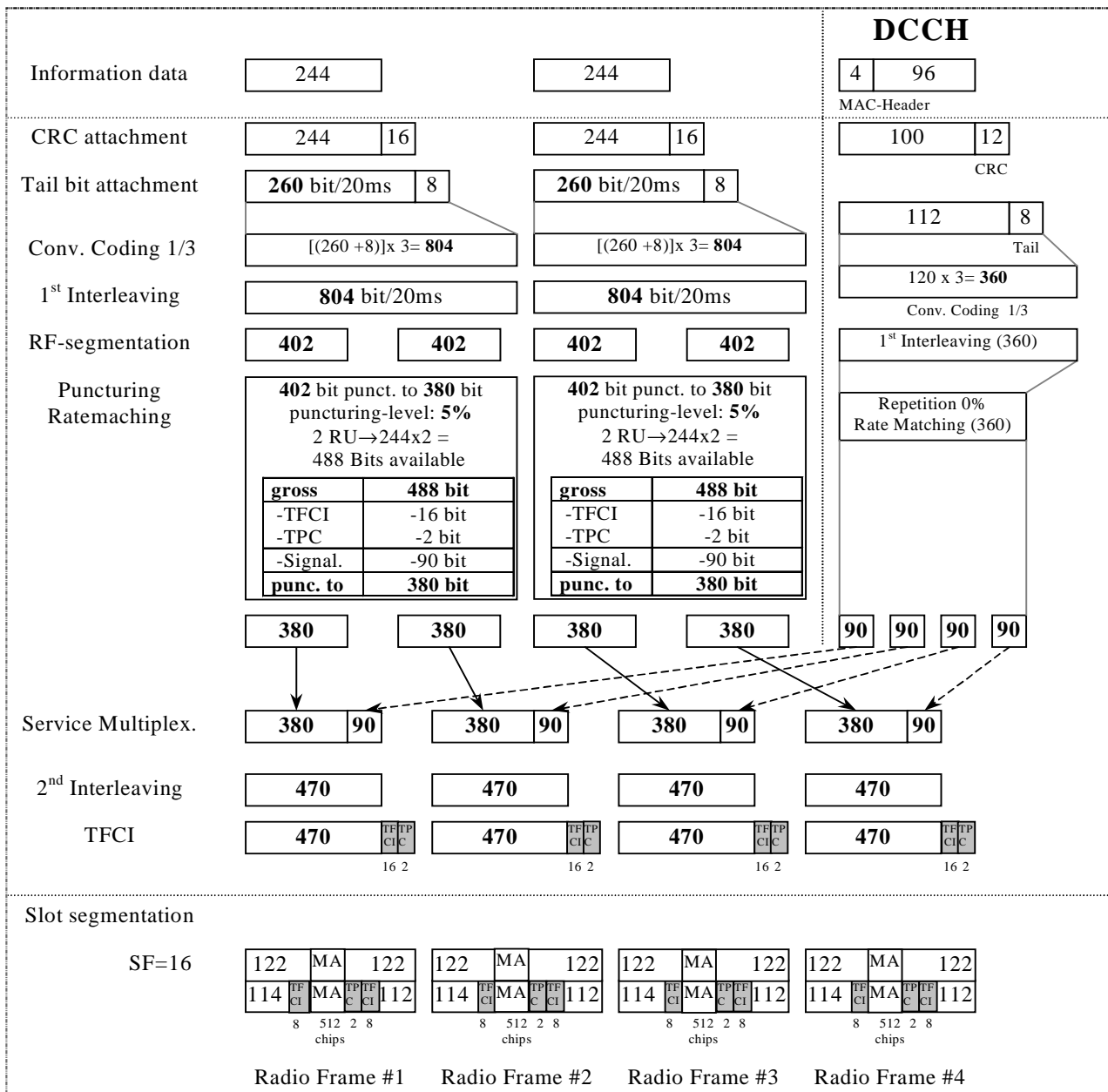

Figure A.7

A.2.7.2 1.28 Mcps TDD Option

Table A.7A

Parameter	Value
Information data rate	12.2 kbps
RU's allocated	1TS (2*SF16) = 2RU/5ms
Midamble	144
Interleaving	20 ms
Power control (TPC)	4 Bit/user/10ms
TFCI	16 Bit/user/10ms
4 Bit reserved for future use (place of SS)	4 Bit/user/10ms
Inband signalling DCCH	2.4 kbps
Puncturing level at Code rate 1/3: DCH of the DTCH / DCH of the DCCH	33% / 33%

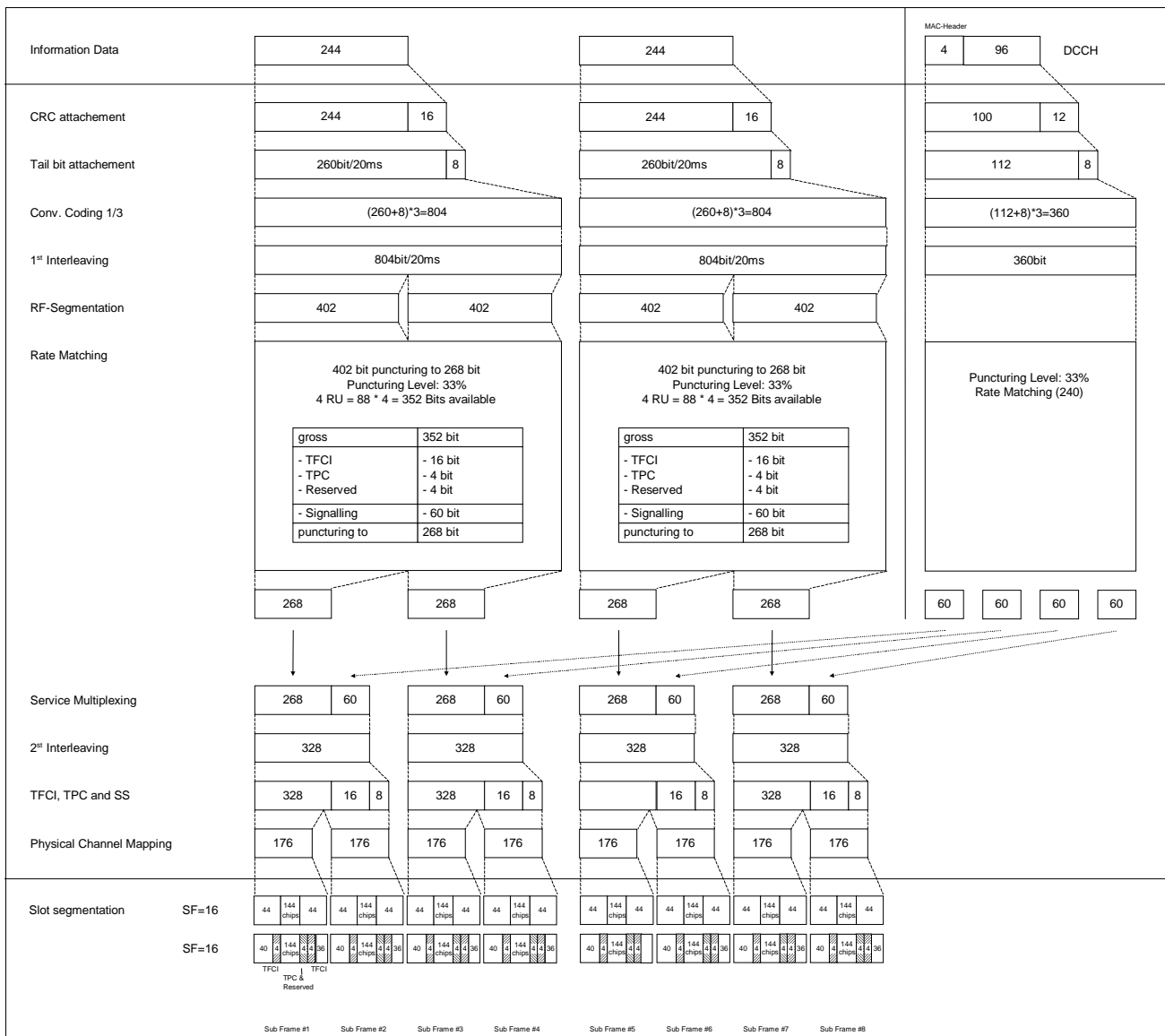

Figure A.7A

A.2.7.3 7.68 Mcps TDD Option

Table A.7B

Parameter	Value
Information data rate	12.2 kbps
RU's allocated	2 RU
Midamble	1024 chips
Interleaving	20 ms
Power control	2 Bit/user
TFCI	16 Bit/user
Inband signalling DCCH	2 kbps
Puncturing level at Code rate 1/3 : DCH of the DTCH / DCH of the DCCH	5% / 0 %

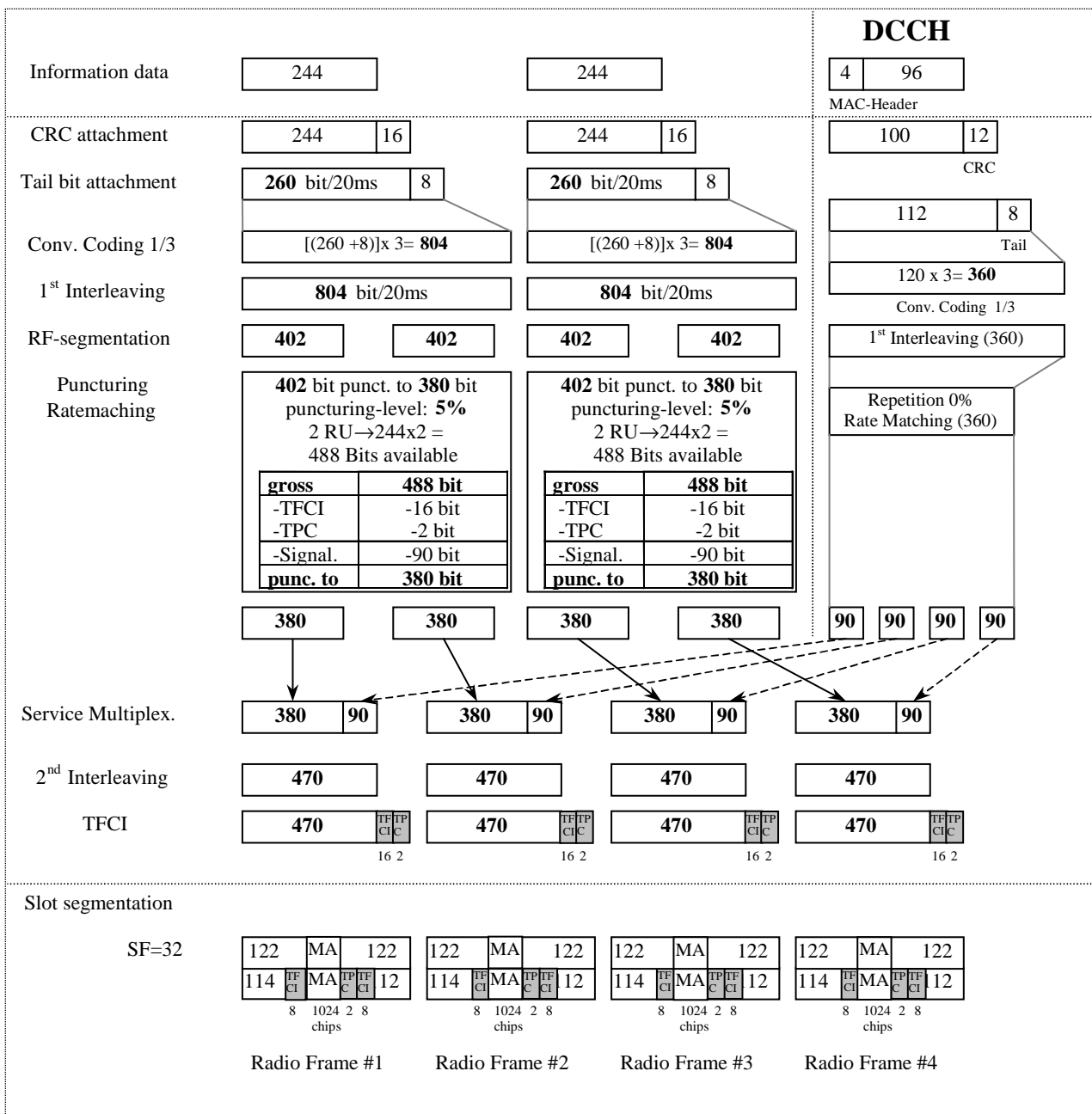

Figure A.7B

A.2.8 DL reference measurement channel (2 Mbps)

A.2.8.1 3.84 Mcps TDD Option

Table A.8

Parameter	Value
Information data rate	2048 kbps
RU's allocated	16*12TS = 192RU
Midamble	256 chips
Interleaving	10 ms
Power control	0 Bit/user
TFCI	16 Bit/user
Inband signalling DCCH	2 kbps
Puncturing level at Code rate 1/3 : DCH of the DTCH / DCH of the DCCH	13.9% / 0%

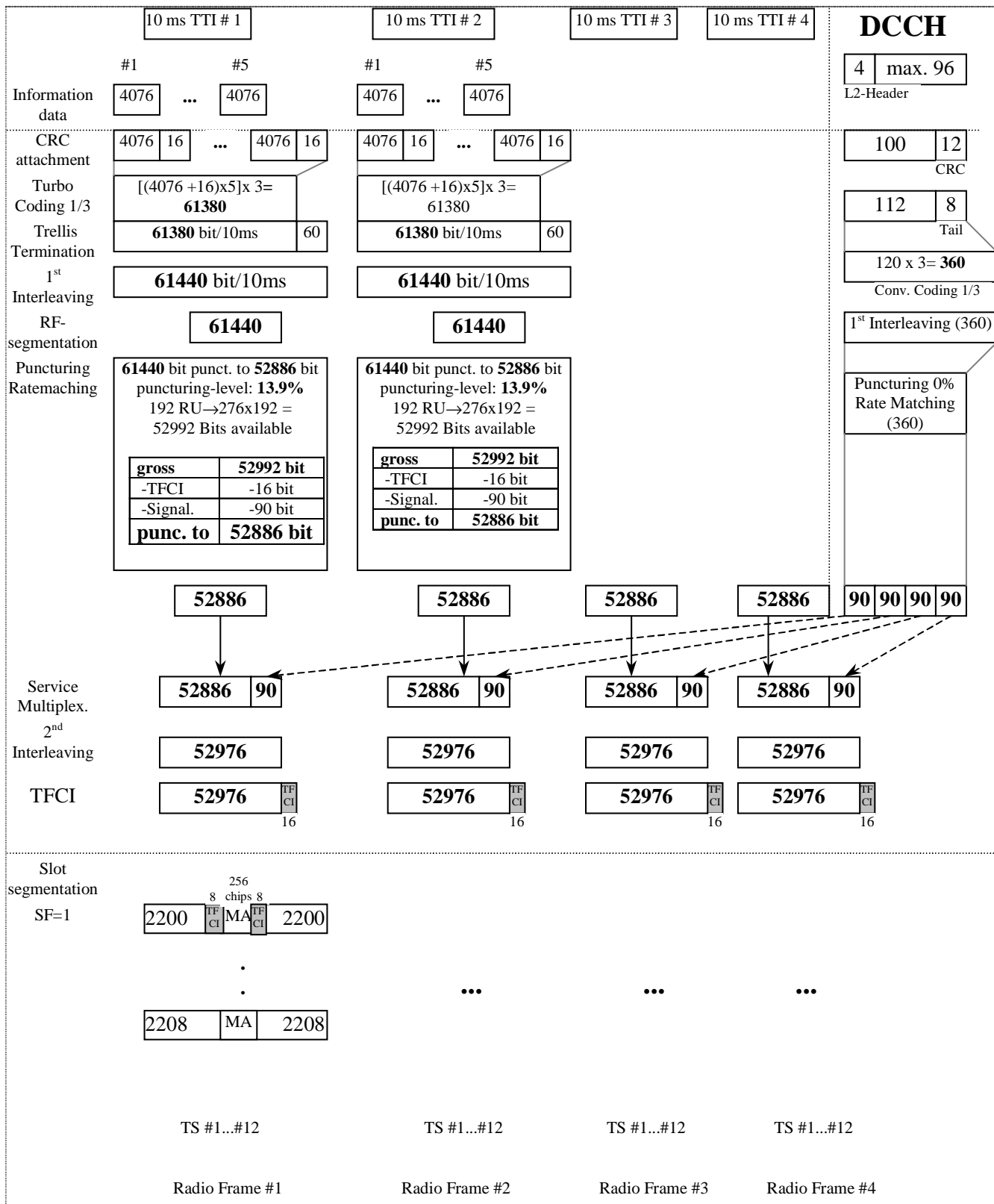

Figure A.8

A.2.8.2 1.28 Mcps TDD Option

Table A.8A

Parameter	Value
Information data rate	2048 kbps
RU's allocated	5TS (1*SF1) = 80RU/5ms
Midamble	144
Interleaving	10 ms
Power control (TPC)	6 Bit/user/10ms
TFCI	48 Bit/user/10ms
Synchronisation Shift (SS)	6 Bit/user/10ms
Inband signalling DCCH	no
Coding	no
Modulation	8PSK

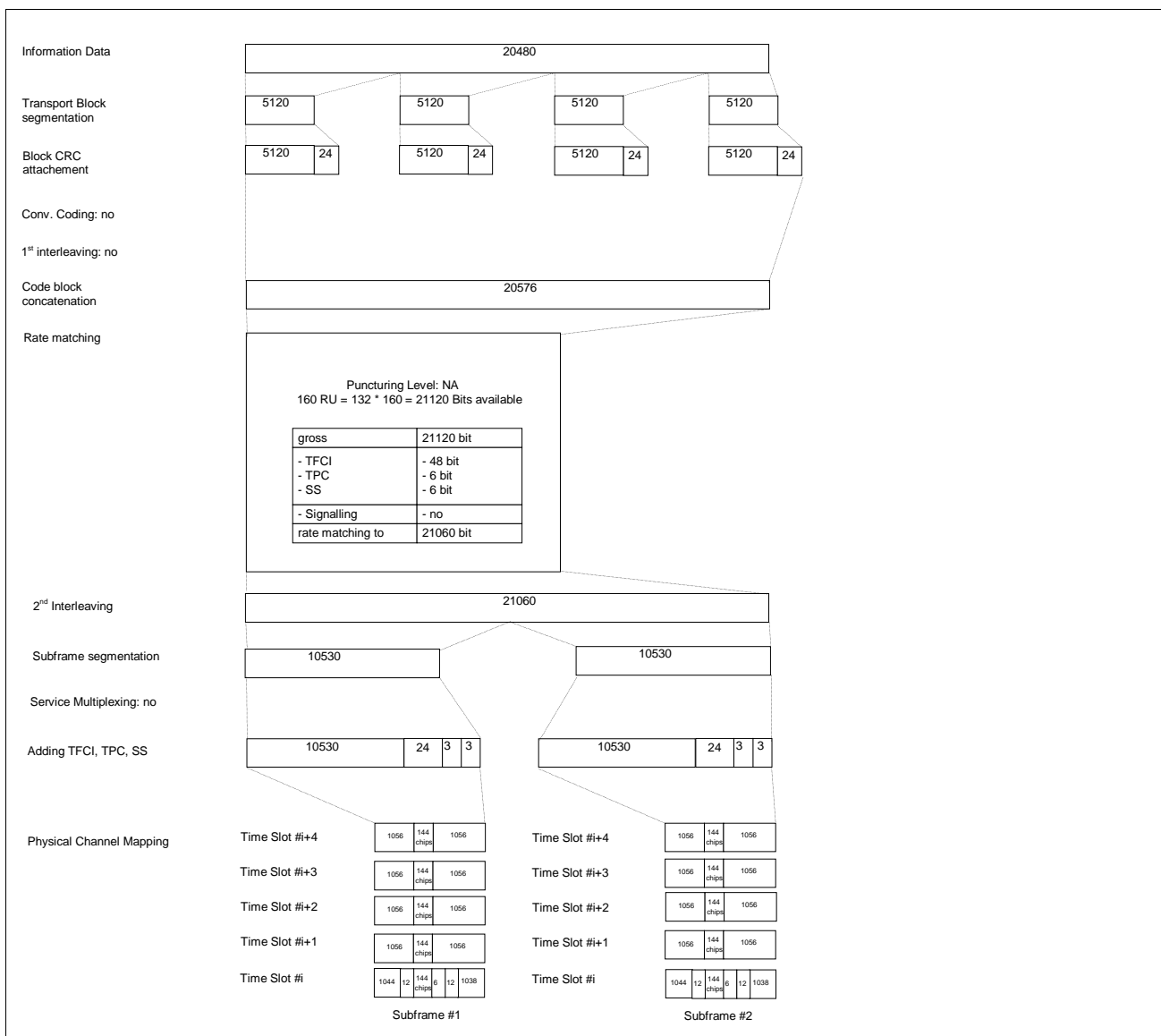

Figure A.8A

A.2.8.3 7.68 Mcps TDD Option

Table A.8B

Parameter	Value
Information data rate	2048 kbps
RU's allocated	$16 \times 12 \text{TS} = 192 \text{RU}$
Midamble	512 chips
Interleaving	10 ms
Power control	0 Bit/user
TFCI	16 Bit/user
Inband signalling DCCH	2 kbps
Puncturing level at Code rate 1/3 : DCH of the DTCH / DCH of the DCCH	13.9% / 0%

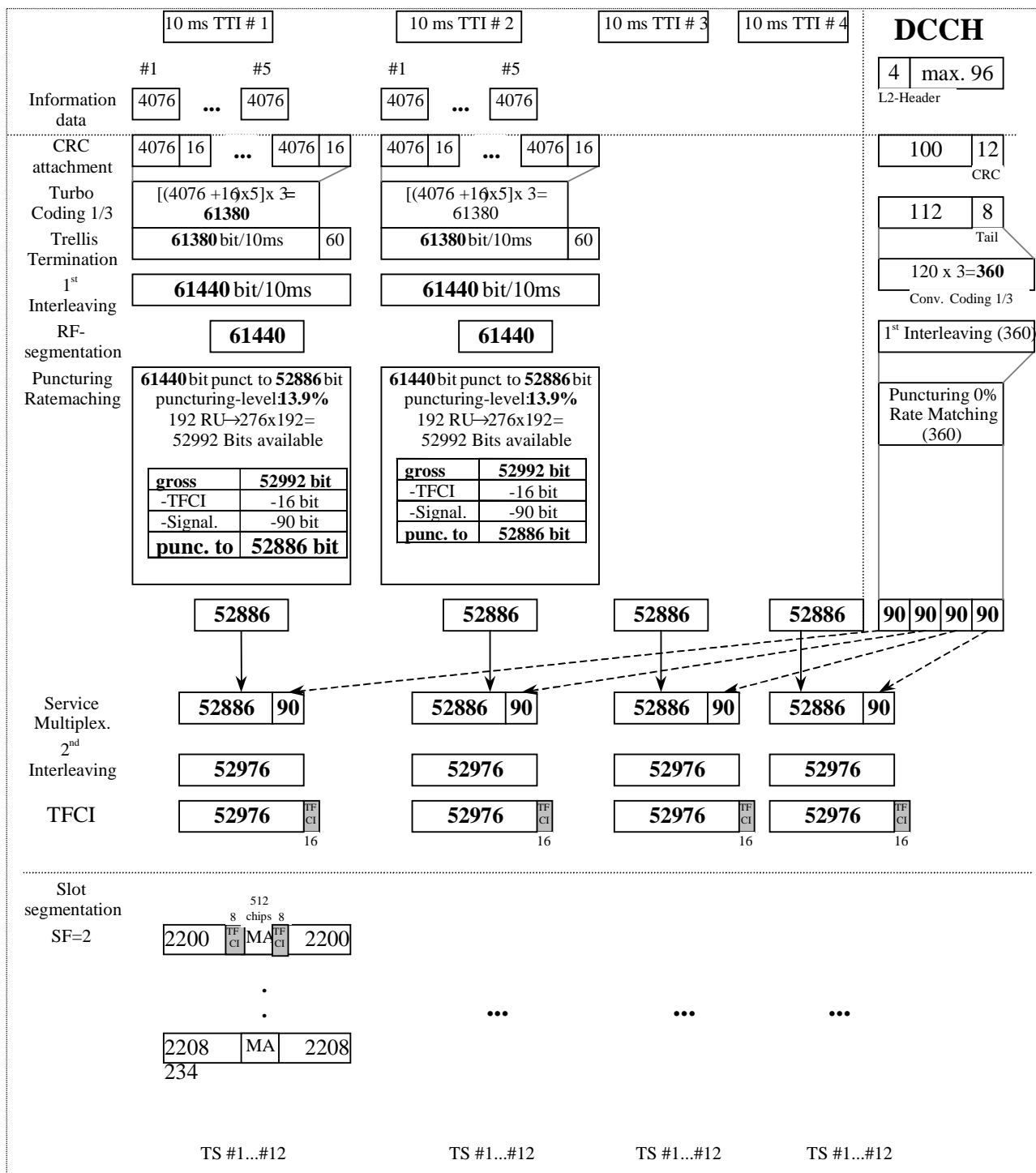

Figure A.8B

A.2.9 DL reference measurement channel for MBSFN only UEs

A.2.9.1 3.84 Mcps TDD Option

A.2.9.1.1 Non-IMB

TableA.8C

Parameter	Value
Information data rate	12.2 kbps
RU's allocated	2 RU
Midamble	320 chips
Interleaving	20 ms
Power control	0 Bit/user
TFCI	16 Bit/user
Repetition level at code rate 1/3: FACH of the MTCH	29%

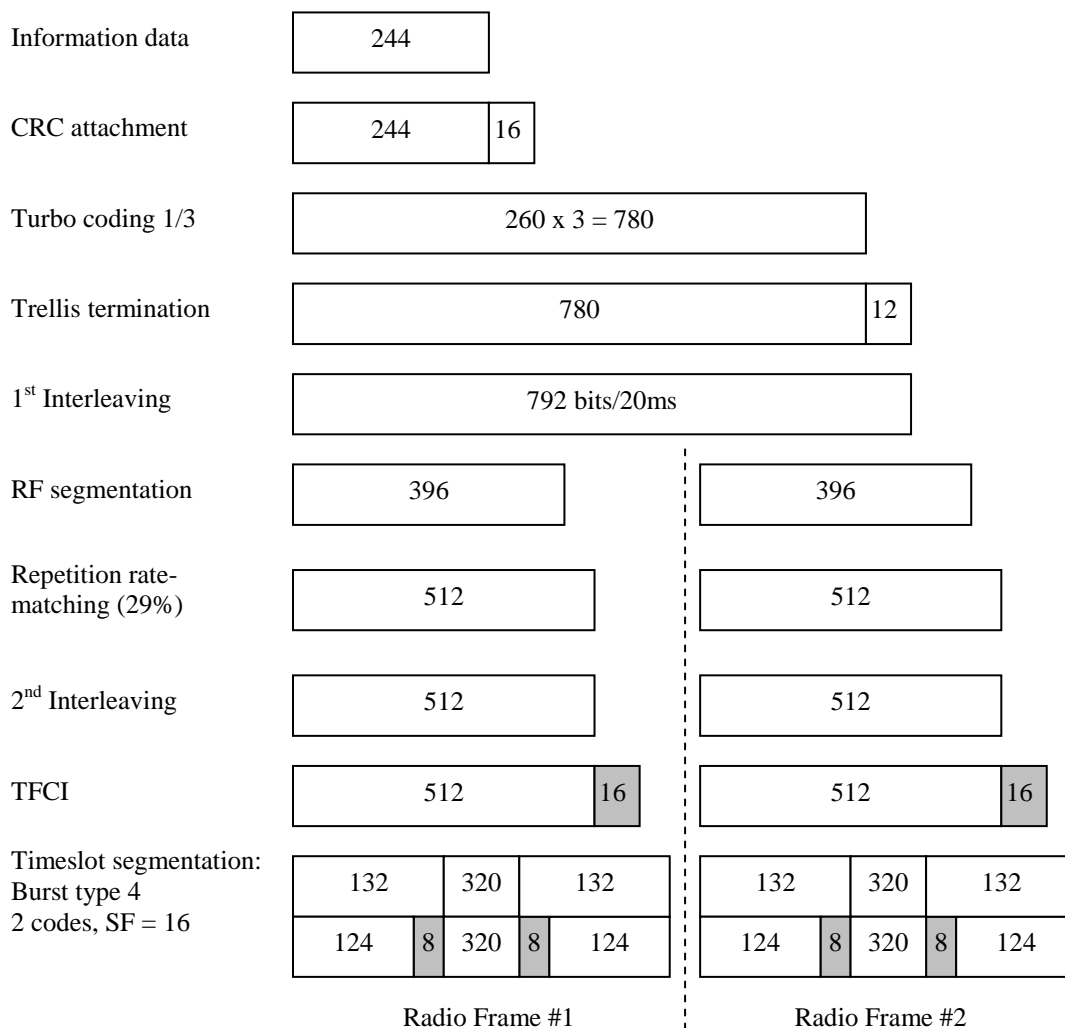

Figure A.8C

A.2.9.1.2 IMB

TableA.8CA: DL reference measurement channel, physical parameters (IMB)

Parameter	Value
Information data rate	28 kbps
Number of physical channels in the S-CCPCH type 2 sub-frame	2
Slot format #i	2 and 3
TFCI	On

TableA.8CB: DL reference measurement channel, transport parameters (IMB)

Parameter	Value
Transport channel number	1
Transport block size	552
Transport block set size	552
Transmission Time Interval	20 ms
Type of Error Protection	Turbo Coding
Coding Rate	1/3
Rate Matching Attribute	256
Size of CRC	16

Table A.8CC defines the physical channels that are transmitted simultaneously with the IMB DL reference measurement channel. Table A.8CC is applicable for all measurements on the receiver characteristics (clause 7). OCNS physical channels are applicable only in the case of subclause 7.4.

TableA.8CC: Additional downlink physical channels transmitted simultaneously with the IMB DL reference measurement channel

Physical Channel	Ec / Ior	Notes
P-CPICH	-10 dB	
T-CPICH	-0.457 dB	
P-CCPCH	-12 dB	
SCH	-12 dB	
OCNS ¹	Necessary power so that total transmit power spectral density of Node B (Ior) adds to one	OCNS consists of 8 physical channels each using SF16 and QPSK modulation. Each OCNS code has equal power.
NOTE ¹ : Applicable only in the case of sub-clause 7.4		

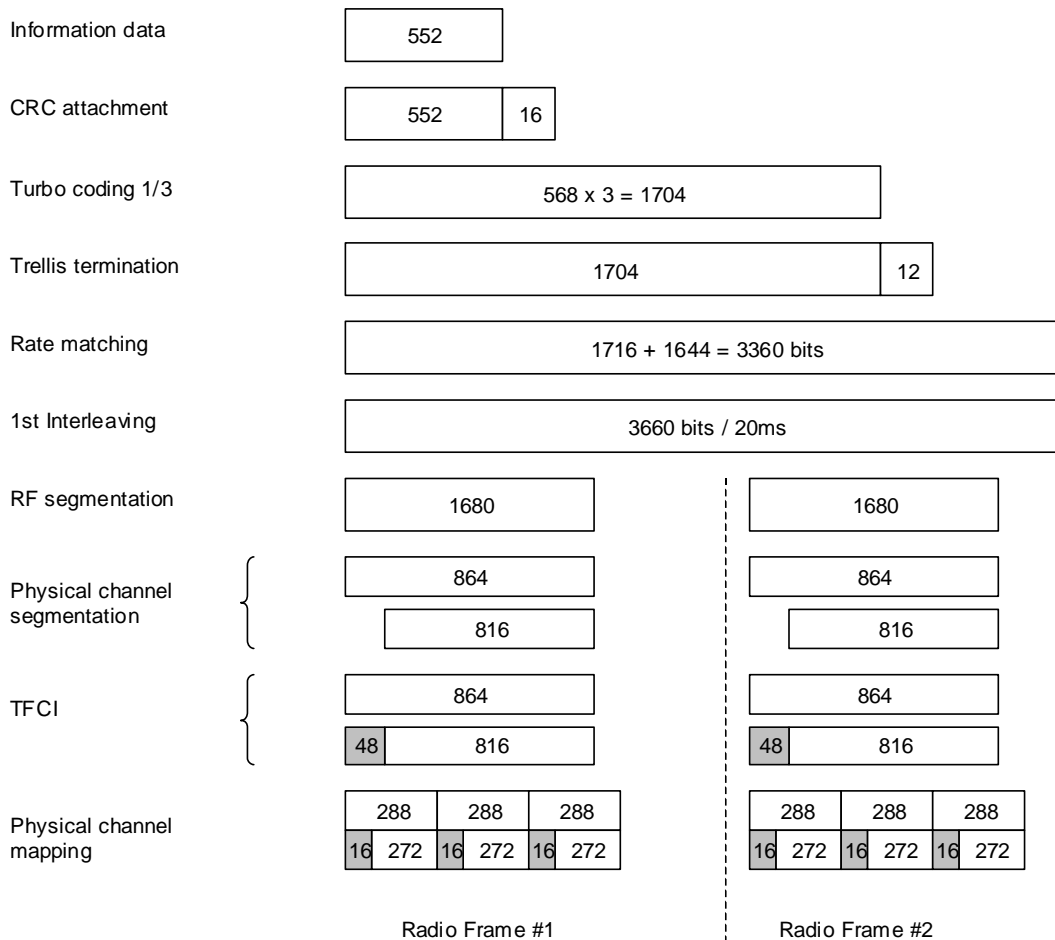

Figure A.8CA

A.2.9.2 VOID

A.2.9.3 7.68 Mcps TDD Option

TableA.8D

Parameter	Value
Information data rate	12.2 kbps
RU's allocated	2 RU
Midamble	640 chips
Interleaving	20 ms
Power control	0 Bit/user
TFCI	16 Bit/user
Repetition level at code rate 1/3: FACH of the MTCH	29%

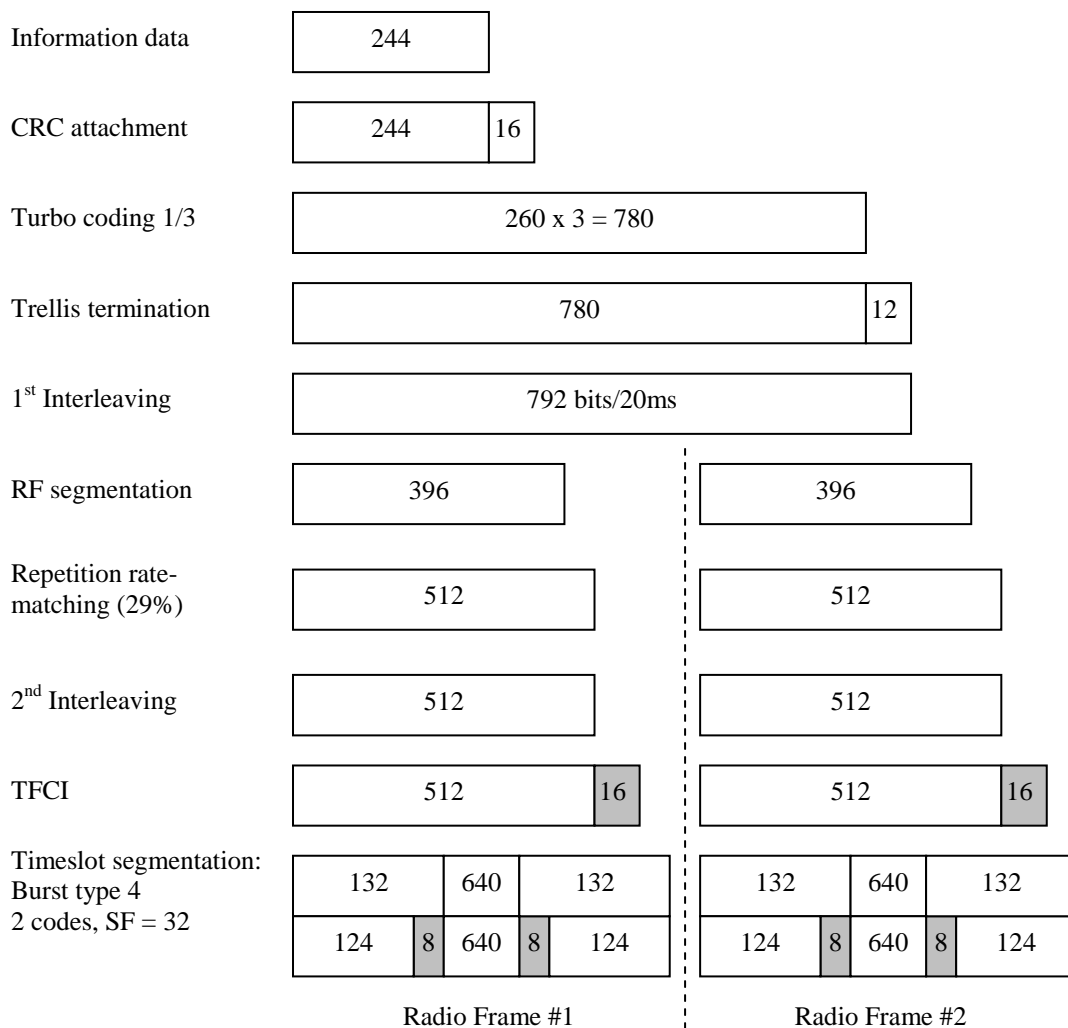

Figure A.8D

A.3 HSDPA reference measurement channels

A.3.1 HSDPA reference measurement channels for 3,84 Mcps TDD option

A.3.1.1 Reference measurement channels for 7,3 Mbps - Category 8 - UE

A.3.1.1.1 QPSK modulation scheme for test 1, 2, 3

Table A.9: HS-PDSCH fixed reference channel for the PA3, PB3, and VA30 Channel models - Category 8

Parameter	Unit	Value
Maximum information bit throughput	Mbps	2,6496
Number of HARQ Processes	Processes	4
Information Bit Payload (N_{INF})	Bits	26496
Number Code Blocks	Blocks	6
Total Available of Soft Channel bits in UE	Bits	353280
Number of Soft Channel bit per HARQ Proc.	Bits	88320
Number of coded bits per TTI	Bits	35328
Coding Rate		3/4
Number of HS-PDSCH Timeslots	Slots	8
Number of HS-PDSCH codes per TS	Codes	16
Spreading factor	SF	16

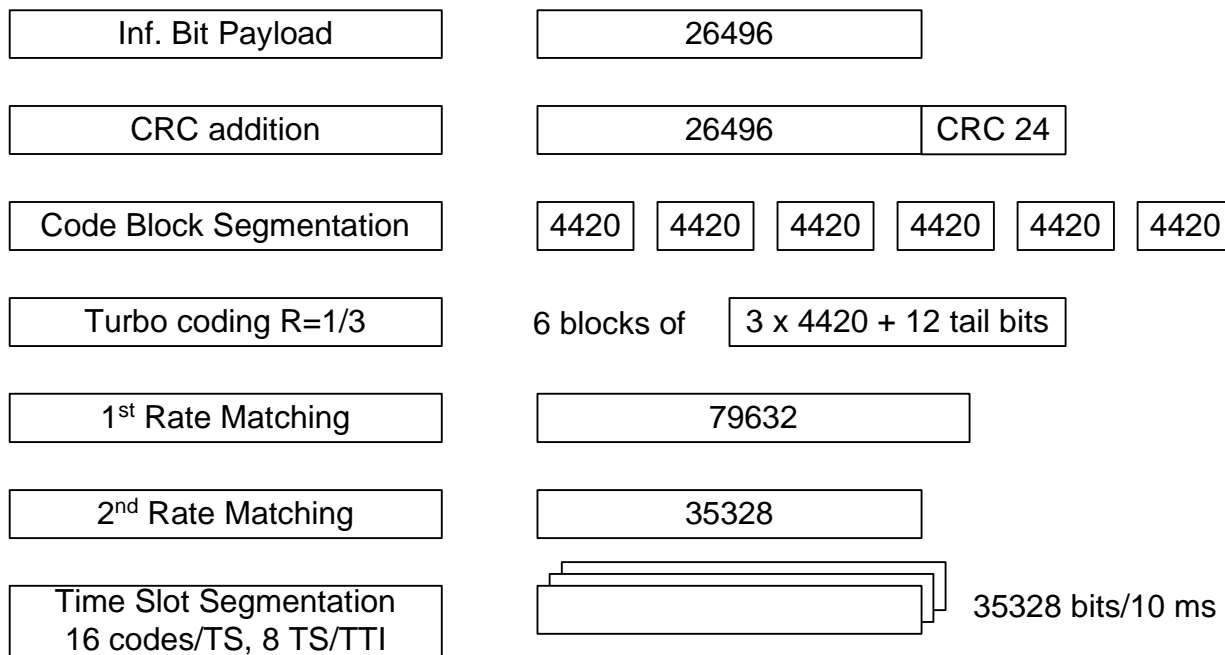

Figure A.9: Coding for HS-PDSCH fixed reference channel with QPSK modulation for the PA3, PB3, and VA30 Channels - Category 8

A.3.1.1.2 QPSK modulation scheme for test 4

Table A.10: HS-PDSCH fixed reference channel for the VA120 Channel model - Category 8

Parameter	Unit	Value
Maximum information bit throughput	Mbps	2,3176
Number of HARQ Processes	Processes	4
Information Bit Payload (N_{INF})	Bits	23176
Number Code Blocks	Blocks	5
Total Available of Soft Channel bits in UE	Bits	353280
Number of Soft Channel bit per HARQ Proc.	Bits	88320
Number of coded bits per TTI	Bits	30912
Coding Rate		3/4
Number of HS-PDSCH Timeslots	Slots	8
Number of HS-PDSCH codes per TS	Codes	14
Spreading factor	SF	16

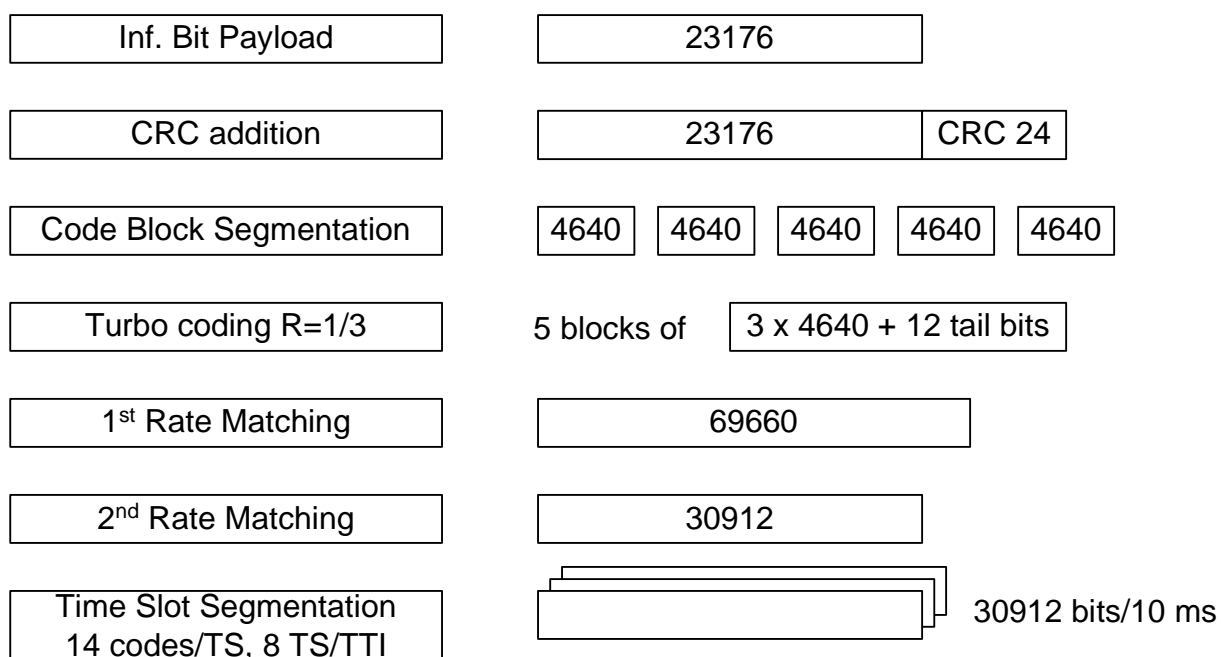

Figure A.10: Coding for HS-PDSCH fixed reference channel with QPSK modulation for the VA120 Channel - Category 8

A.3.1.1.3 16QAM modulation scheme for test 1, 2, 3

Table A.11: HS-PDSCH fixed reference channel for the PA3, PB3, and VA30 Channel models - Category 8

Parameter	Unit	Value
Modulation		16-QAM
Maximum information bit throughput	Mbps	5,2996
Number of HARQ Processes	Processes	4
Information Bit Payload (N_{INF})	Bits	52996
Number Code Blocks	Blocks	11
Total Available of Soft Channel bits in UE	Bits	353280
Number of Soft Channel bit per HARQ Proc.	Bits	88320
Number of coded bits per TTI	Bits	70656
Coding Rate		3/4
Number of HS-PDSCH Timeslots	Slots	8
Number of HS-PDSCH codes per TS	Codes	16
Spreading factor	SF	16

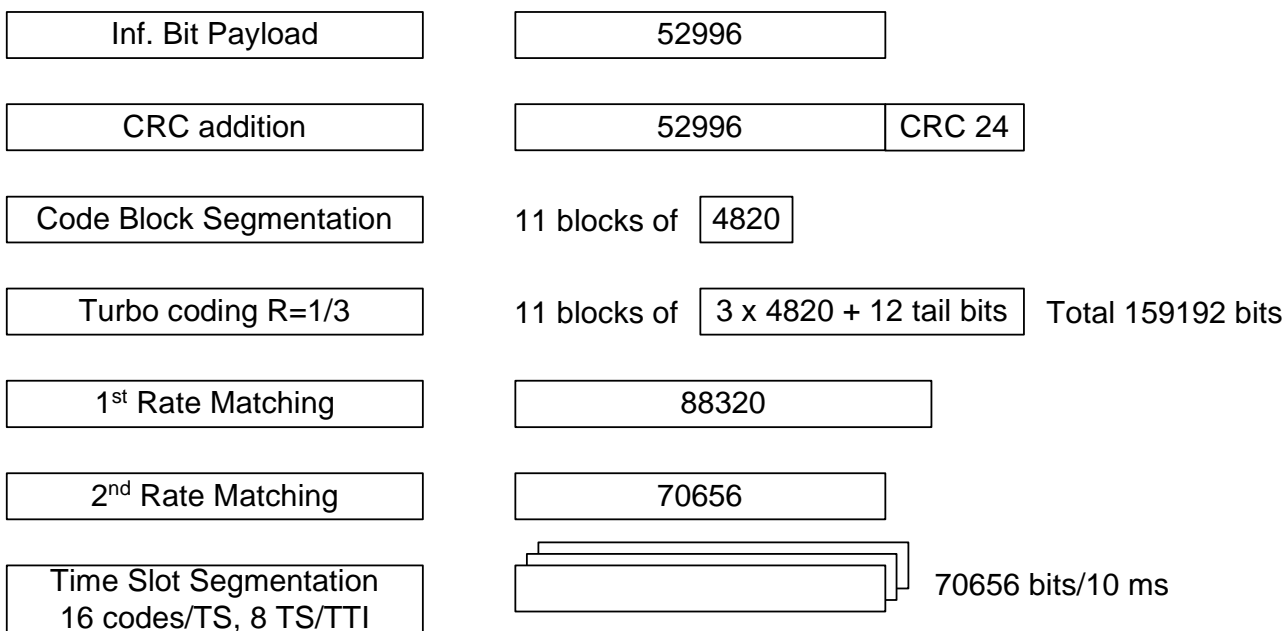

Figure A.11: Coding for HS-PDSCH fixed reference channel with 16-QAM modulation for the PA3 PB3, and VA30 Channels - Category 8

A.3.1.1.4 16QAM modulation scheme for test 4

Table A.12: HS-PDSCH fixed reference channel for the PA3, PB3, and VA30 Channel models - Category 8

Parameter	Unit	Value
Modulation		16-QAM
Maximum information bit throughput	Mbps	3,4773
Number of HARQ Processes	Processes	4
Information Bit Payload (N_{INF})	Bits	34773
Number Code Blocks	Blocks	7
Total Available of Soft Channel bits in UE	Bits	353280
Number of Soft Channel bit per HARQ Proc.	Bits	88320
Number of coded bits per TTI	Bits	61824
Coding Rate		9/16
Number of HS-PDSCH Timeslots	Slots	8
Number of HS-PDSCH codes per TS	Codes	14
Spreading factor	SF	16

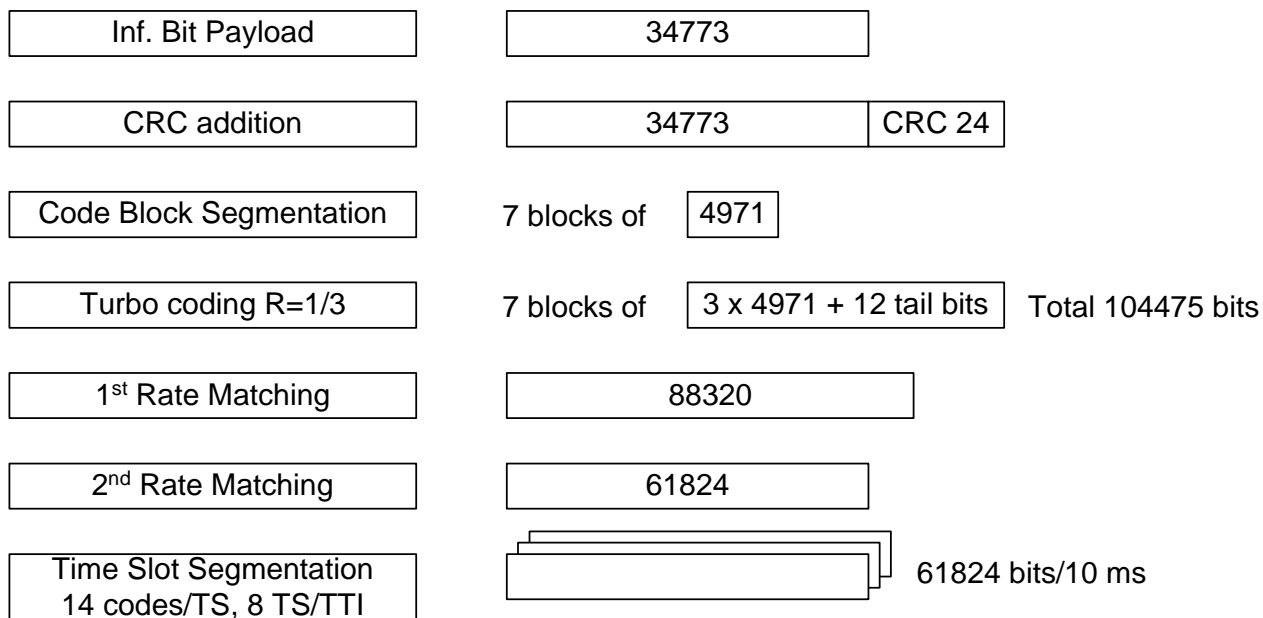

Figure A.12: Coding for HS-PDSCH fixed reference channel with 16-QAM modulation for the VA120 Channel - Category 8

A.3.2 HSDPA reference measurement channels for 1.28 Mcps TDD option

A.3.2.1 Reference measurement channels for 0.5 Mbps UE class

A.3.2.1.1 QPSK modulation scheme

Table A.13-1

Parameter	Unit	Value
Modulation	-	QPSK
Maximum information bit throughput	Kbps	199.2
Number of HARQ Processes	Processes	4
Information Bit Payload (N_{INF})	Bits	996
Number Code Blocks	Blocks	1
Total Available of Soft Channel bits in UE	Bits	11264
Number of Soft Channel bit per HARQ Proc.	Bits	2816
Number of coded bits per TTI	Bits	1760
Coding Rate	-	0.5795
Number of HS-DSCH Timeslots	Slots	2
Number of HS-PDSCH codes per TS	Codes	10
Spreading factor	SF	16
Note: For multi-carrier reception, the reference measurement channel is applied to each of the carriers.		

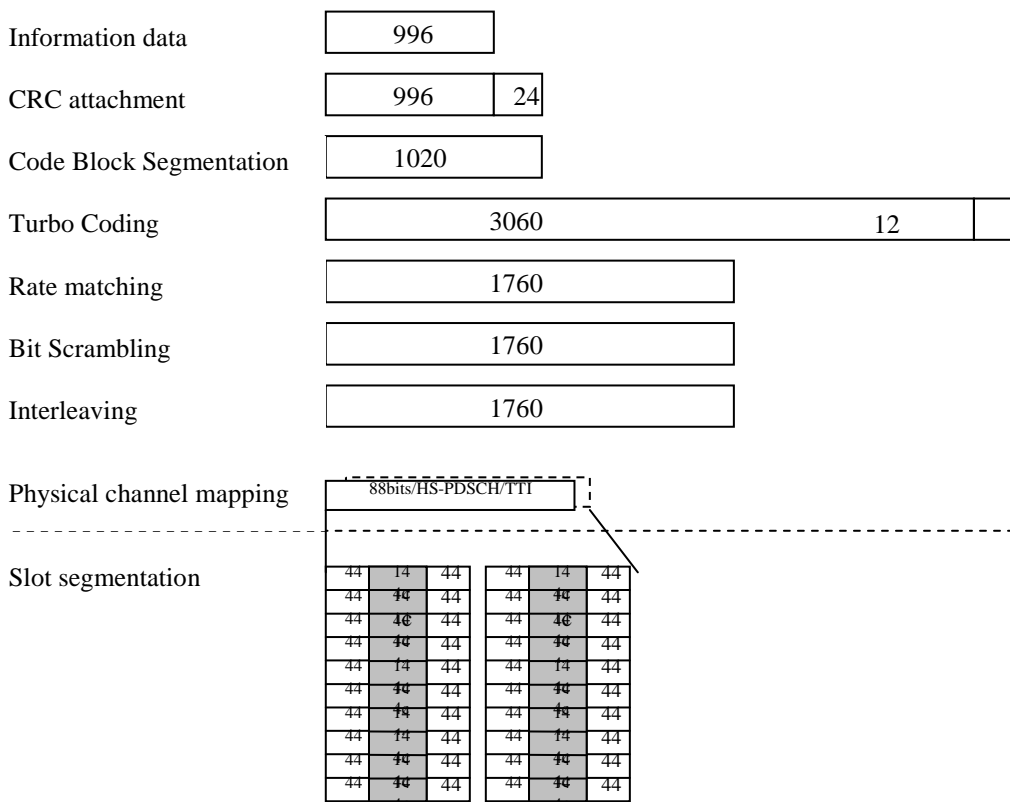

Figure 13-1

A.3.2.2 Reference measurement channels for 1.1 Mbps UE class

A.3.2.2.1 QPSK modulation scheme

Reference channel in A.3.2.1.1 applies.

A.3.2.2.2 16QAM modulation scheme

Table A.13-2

Parameter	Unit	Value
Modulation	-	16QAM
Maximum information bit throughput	Kbps	578.6
Number of HARQ Processes	Processes	4
Information Bit Payload (N_{INF})	Bits	2893
Number Code Blocks	Blocks	1
Total Available of Soft Channel bits in UE	Bits	22528
Number of Soft Channel bit per HARQ Proc.	Bits	5632
Number of coded bits per TTI	Bits	4224
Coding Rate	-	0.69
Number of HS-DSCH Timeslots	Slots	2
Number of HS-PDSCH codes per TS	Codes	12
Spreading factor	SF	16
Note: For multi-carrier reception, the reference measurement channel is applied to each of the carriers.		

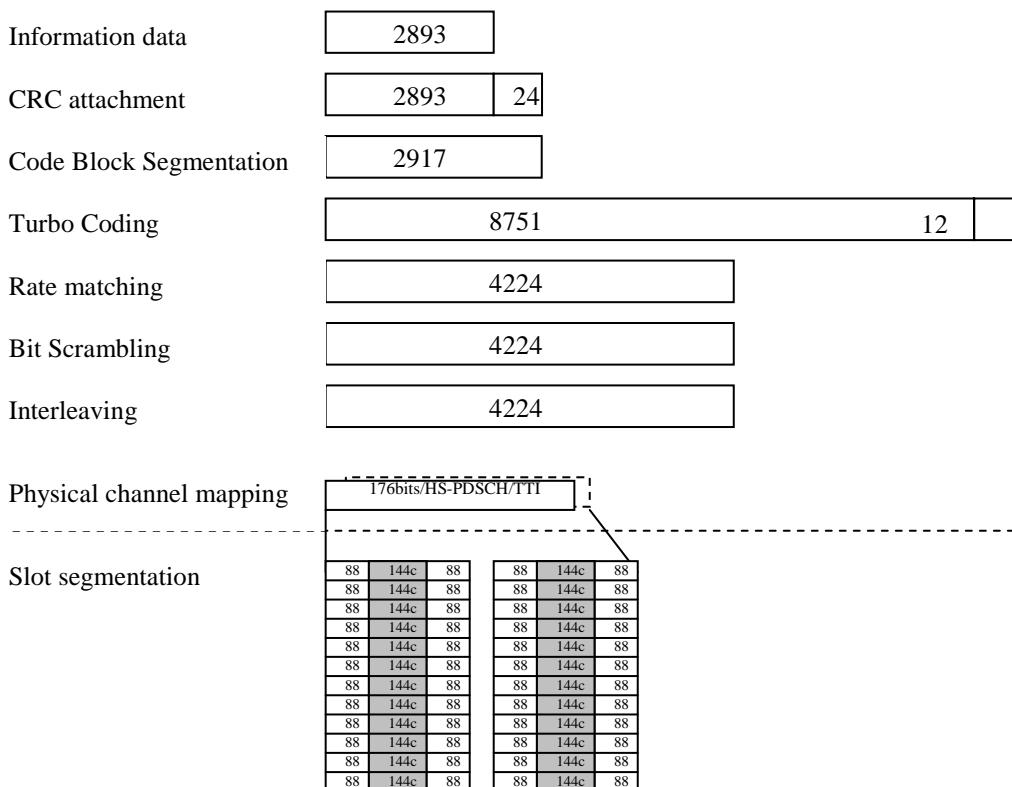

Figure 13-2

A.3.2.3 Reference measurement channels for 1.6 Mbps UE class

A.3.2.3.1 QPSK modulation scheme

Table A.13-3

Parameter	Unit	Value
Modulation	-	QPSK
Maximum information bit throughput	Kbps	357.4
Number of HARQ Processes	Processes	4
Information Bit Payload (N_{INF})	Bits	1787
Number Code Blocks	Blocks	1
Total Available of Soft Channel bits in UE	Bits	33792
Number of Soft Channel bit per HARQ Proc.	Bits	8448
Number of coded bits per TTI	Bits	2640
Coding Rate	-	0.686
Number of HS-DSCH Timeslots	Slots	3
Number of HS-PDSCH codes per TS	Codes	10
Spreading factor	SF	16
Note: For multi-carrier reception, the reference measurement channel is applied to each of the carriers.		

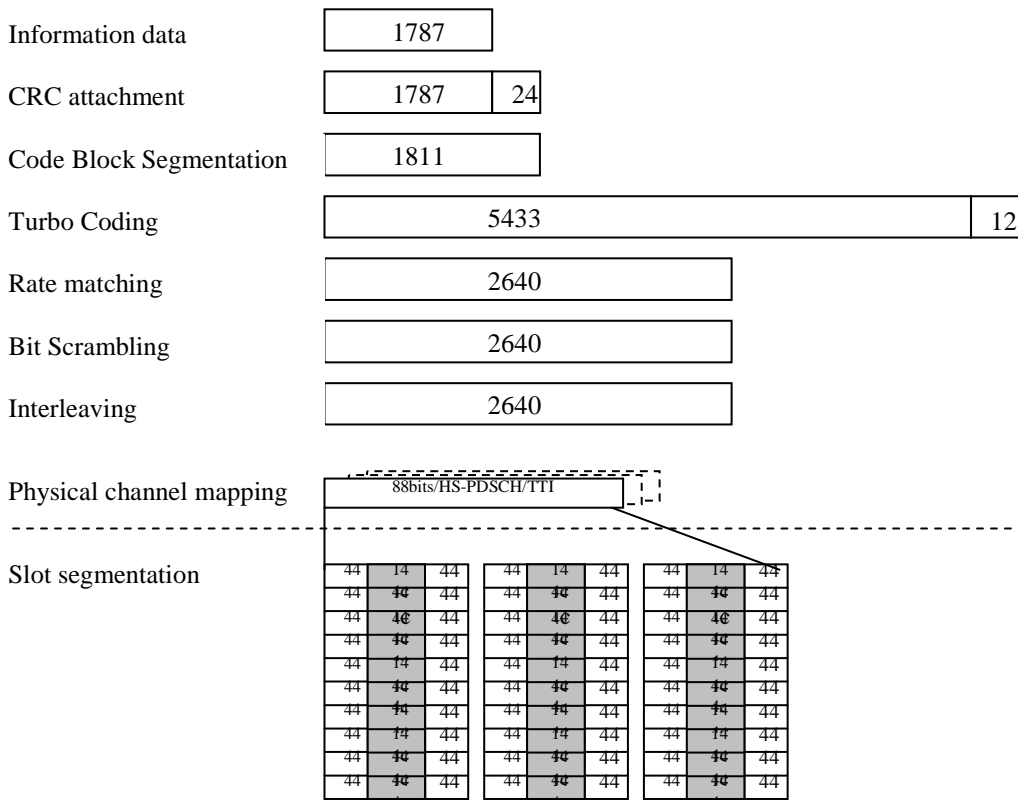

Figure 13-3

A.3.2.3.2 16QAM modulation scheme

Table A.13-4

Parameter	Unit	Value
Modulation	-	16QAM
Maximum information bit throughput	Kbps	634.6
Number of HARQ Processes	Processes	4
Information Bit Payload (N_{INF})	Bits	3173
Number Code Blocks	Blocks	1
Total Available of Soft Channel bits in UE	Bits	33792
Number of Soft Channel bit per HARQ Proc.	Bits	8448
Number of coded bits per TTI	Bits	6336
Coding Rate	-	0.505
Number of HS-DSCH Timeslots	Slots	3
Number of HS-PDSCH codes per TS	Codes	12
Spreading factor	SF	16
Note: For multi-carrier reception, the reference measurement channel is applied to each of the carriers.		

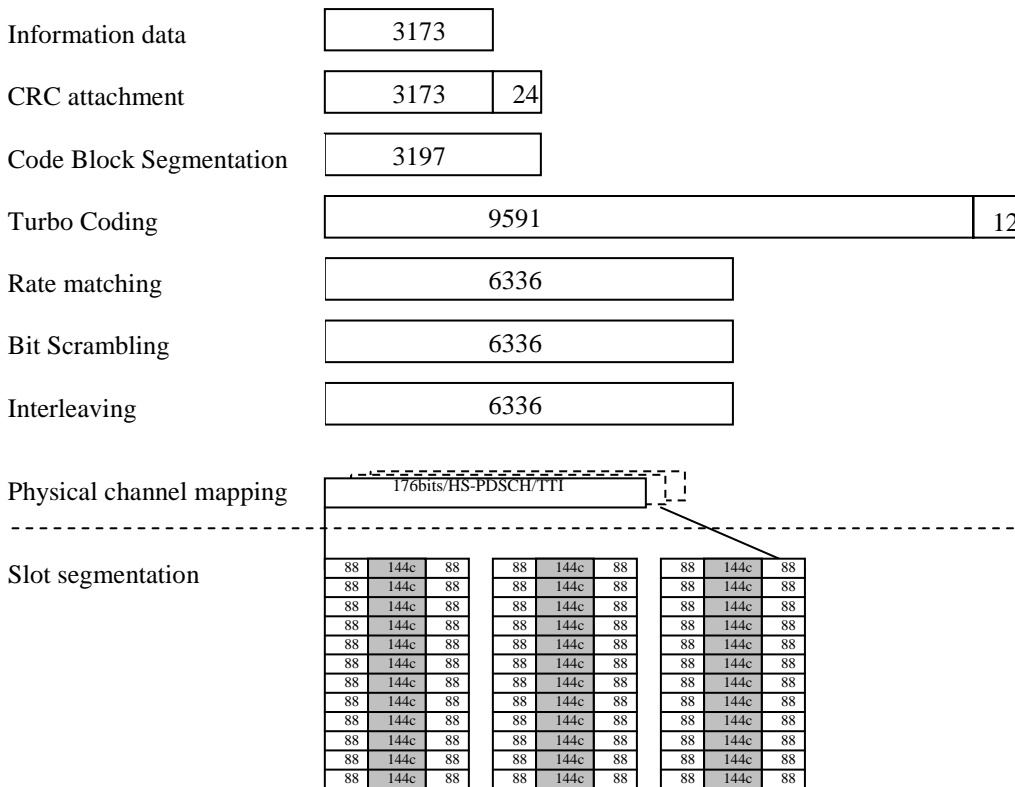

Figure A.13-4

A.3.2.4 Reference measurement channels for 2.2 Mbps UE class

A.3.2.4.1 QPSK modulation scheme

Table A.13-5

Parameter	Unit	Value
Modulation	-	QPSK
Maximum information bit throughput	Kbps	539
Number of HARQ Processes	Processes	4
Information Bit Payload (N_{INF})	Bits	2695
Number Code Blocks	Blocks	1
Total Available of Soft Channel bits in UE	Bits	45056
Number of Soft Channel bit per HARQ Proc.	Bits	11264
Number of coded bits per TTI	Bits	3520
Coding Rate	-	0.772
Number of HS-DSCH Timeslots	Slots	4
Number of HS-PDSCH codes per TS	Codes	10
Spreading factor	SF	16
Note: For multi-carrier reception, the reference measurement channel is applied to each of the carriers.		

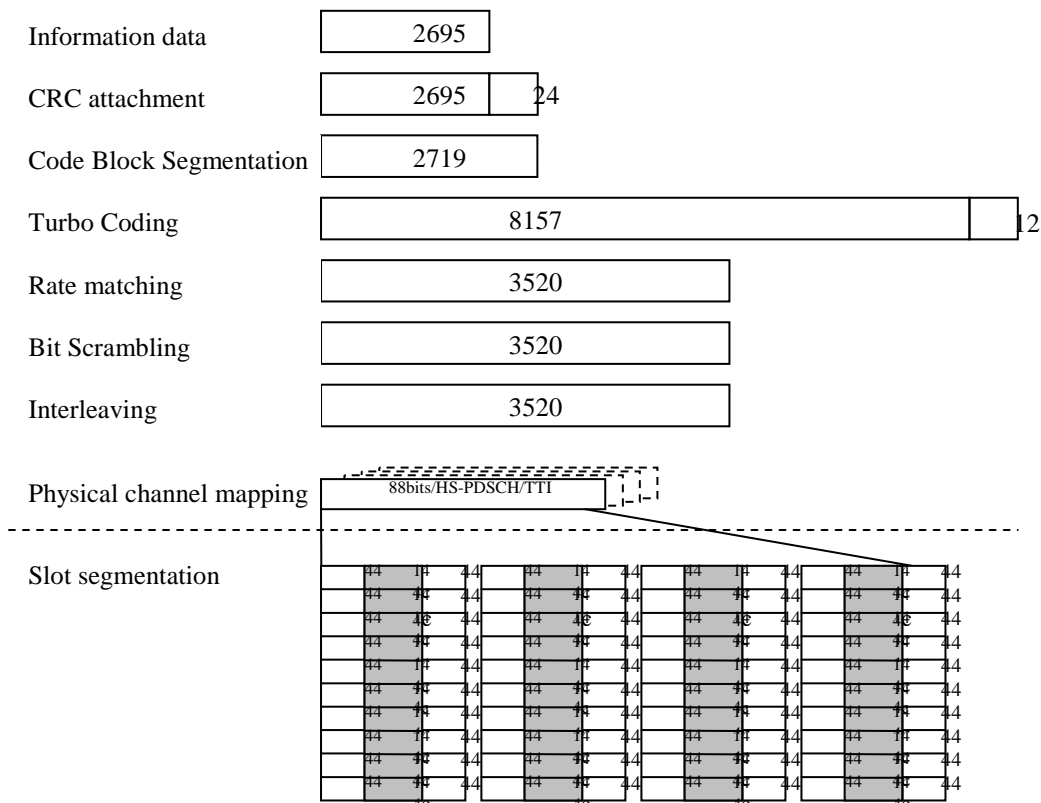

Figure 13-5

A.3.2.4.2 16QAM modulation scheme

Table A.13-6

Parameter	Unit	Value
Modulation	-	16QAM
Maximum information bit throughput	Kbps	782.2
Number of HARQ Processes	Processes	4
Information Bit Payload (N_{INF})	Bits	3911
Number Code Blocks	Blocks	1
Total Available of Soft Channel bits in UE	Bits	45056
Number of Soft Channel bit per HARQ Proc.	Bits	11264
Number of coded bits per TTI	Bits	8448
Coding Rate	-	0.4658
Number of HS-DSCH Timeslots	Slots	4
Number of HS-PDSCH codes per TS	Codes	12
Spreading factor	SF	16
Note: For multi-carrier reception, the reference measurement channel is applied to each of the carriers.		

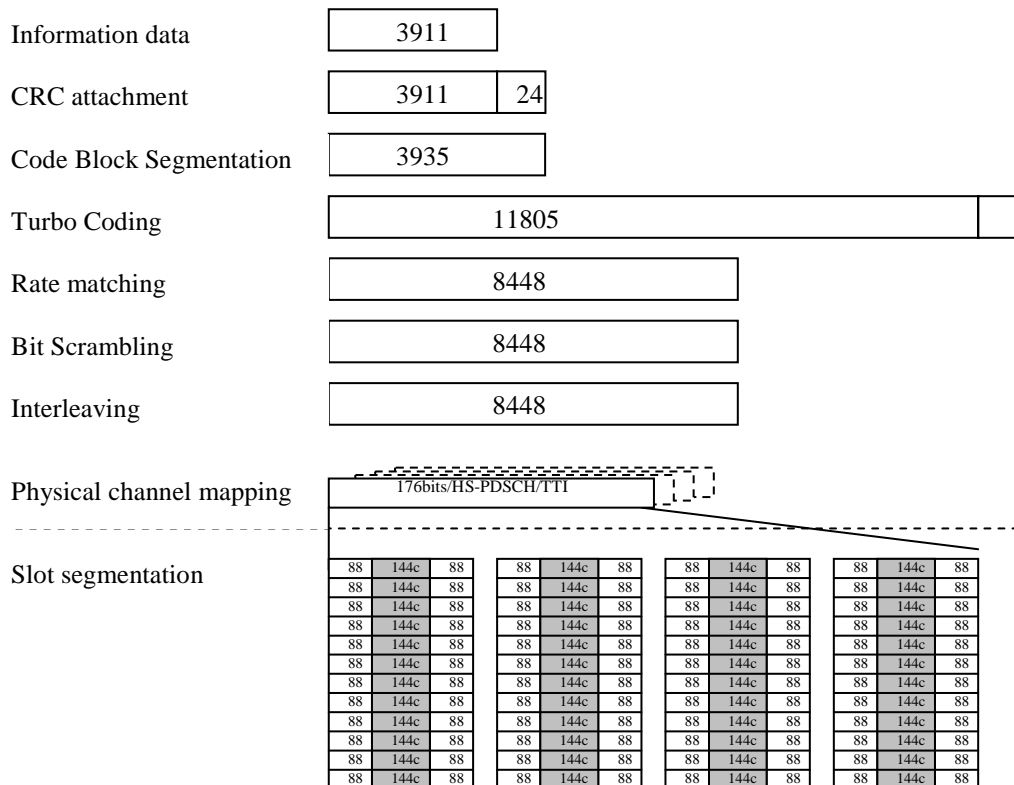

Figure 13-6

A.3.2.5 Reference measurement channels for 2.8 Mbps UE class

A.3.2.5.1 QPSK modulation scheme

Table A.13-7

Parameter	Unit	Value
Modulation	-	QPSK
Maximum information bit throughput	Kbps	621
Number of HARQ Processes	Processes	4
Information Bit Payload (N_{INF})	Bits	3105
Number Code Blocks	Blocks	1
Total Available of Soft Channel bits in UE	Bits	56320
Number of Soft Channel bit per HARQ Proc.	Bits	14080
Number of coded bits per TTI	Bits	4400
Coding Rate	-	0.711
Number of HS-DSCH Timeslots	Slots	5
Number of HS-PDSCH codes per TS	Codes	10
Spreading factor	SF	16

Note: For multi-carrier reception, the reference measurement channel is applied to each of the carriers.

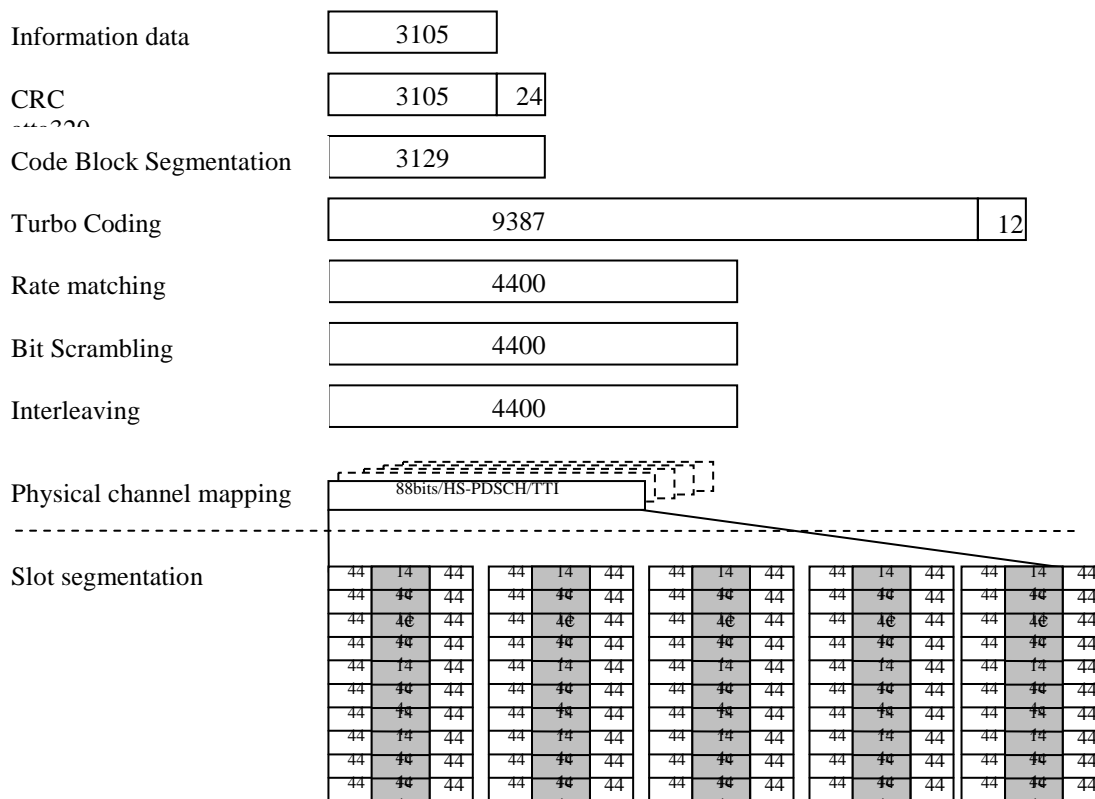

Figure 13-7

A.3.2.5.2 16QAM modulation scheme

Table A.13-8

Parameter	Unit	Value
Modulation	-	16QAM
Maximum information bit throughput	Kbps	1278.6
Number of HARQ Processes	Processes	4
Information Bit Payload (N_{INF})	Bits	6393
Number Code Blocks	Blocks	1
Total Available of Soft Channel bits in UE	Bits	56320
Number of Soft Channel bit per HARQ Proc.	Bits	14080
Number of coded bits per TTI	Bits	10560
Coding Rate	-	0.6077
Number of HS-DSCH Timeslots	Slots	5

Number of HS-PDSCH codes per TS	Codes	12
Spreading factor	SF	16
Note: For multi-carrier reception, the reference measurement channel is applied to each of the carriers.		

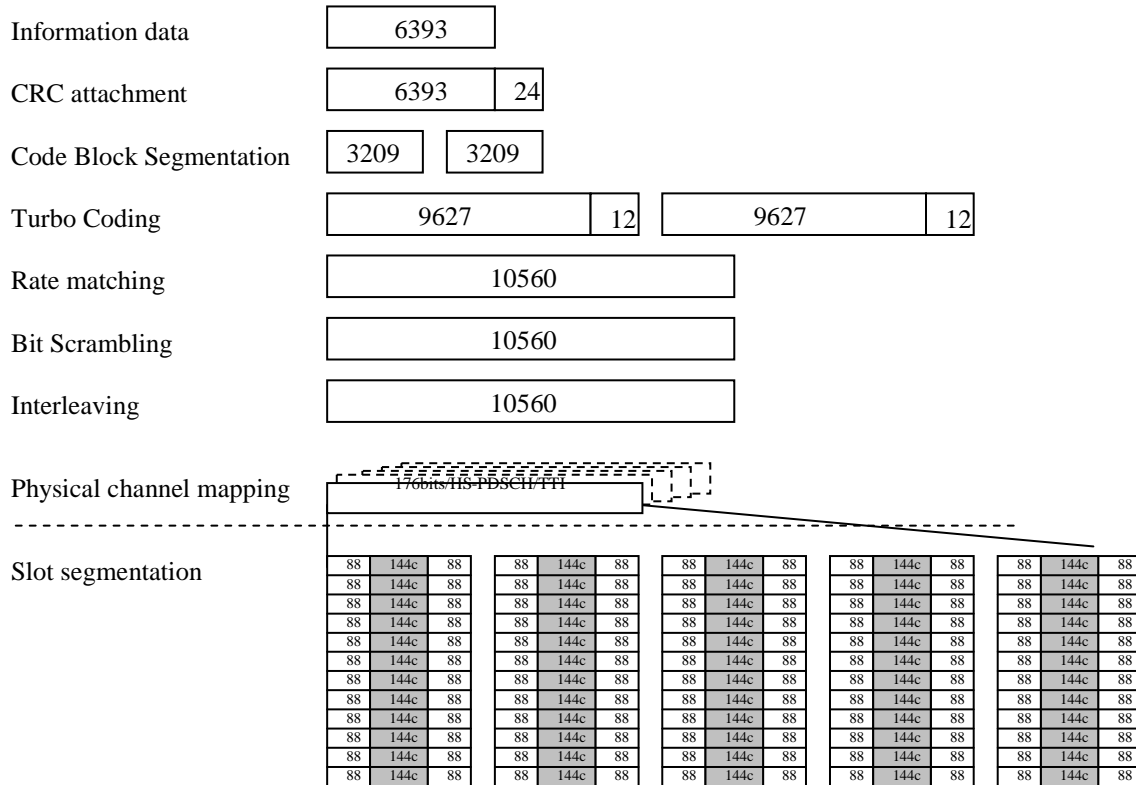

Figure 13-8

A.3.2.6 PLCCCH reference measurement channel

Table A.14A

Parameter	Unit	Value
Information bits	bits	42
Encoded bits	bits	88
Number of codes		1
Number of timeslots		1
TTI	ms	5
Spreading Factor	SF	16
Coding		Repetition encoding

A.3.2.7 Reference measurement channels for Category 16-24 UE

A.3.2.7.1 Reference measurement channel for category 16-18 UE

Table A.15A reference measurement channel for category 16-18 UE

Parameter	Unit	Value
Modulation	-	64QAM
Maximum information bit throughput	Mbps	1.2496
Number of HARQ Processes	Processes	4
Information Bit Payload (N_{INF})	Bits	6248
Number Code Blocks	Blocks	2
Total Available of Soft Channel bits in UE	Bits	50688
Number of Soft Channel bit per HARQ Proc.	Bits	12672
Number of coded bits per TTI	Bits	11088
Coding Rate	-	0.5635
Number of HS-DSCH Timeslots	Slots	3
Number of HS-PDSCH codes per TS	Codes	14
Spreading factor	SF	16
Note: For multi-carrier reception, the reference measurement channel is applied to each of the carriers.		

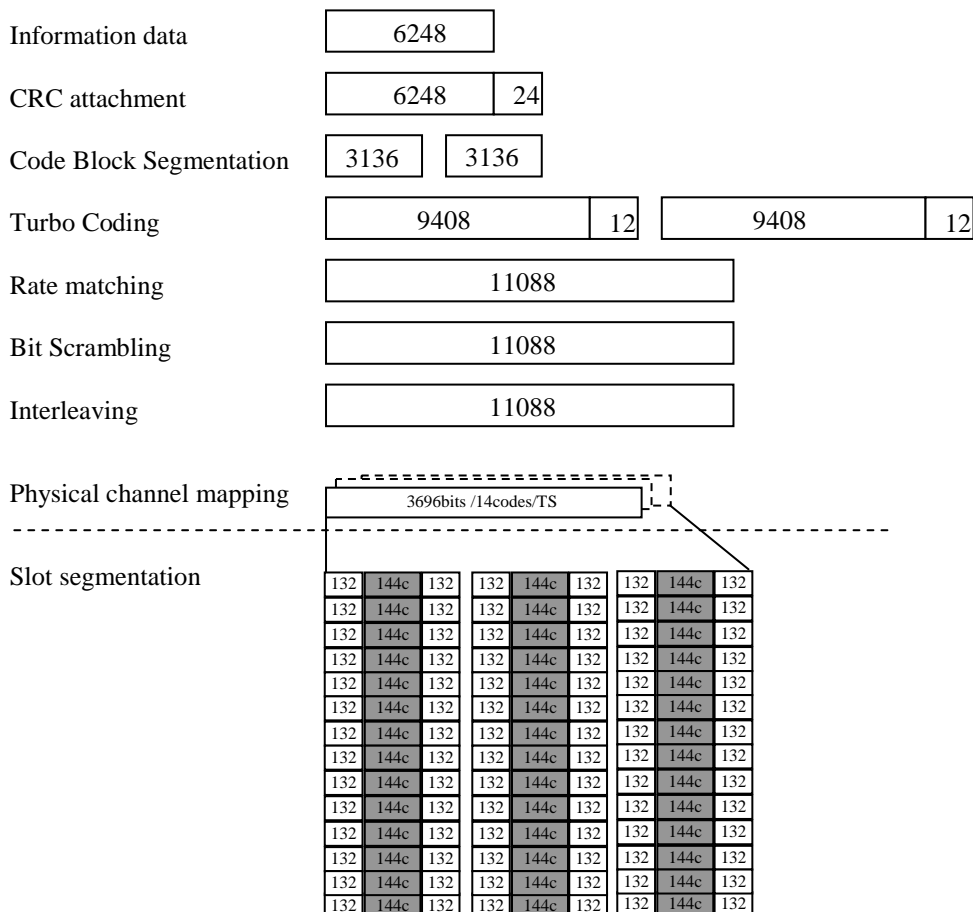

Figure A.15A Fixed reference measurement channel for category 16 UE

A.3.2.7.2 Reference measurement channel for category 19-21 UE

Table A.16A Fixed reference measurement channel for category 19-21 UE

Parameter	Unit	Value
Modulation	-	64QAM
Maximum information bit throughput	Mbps	1.6976
Number of HARQ Processes	Processes	4
Information Bit Payload (N_{INF})	Bits	8488
Number Code Blocks	Blocks	2
Total Available of Soft Channel bits in UE	Bits	67584
Number of Soft Channel bit per HARQ Proc.	Bits	16896
Number of coded bits per TTI	Bits	14784
Coding Rate	-	0.57
Number of HS-DSCH Timeslots	Slots	4
Number of HS-PDSCH codes per TS	Codes	14
Spreading factor	SF	16
Note: For multi-carrier reception, the reference measurement channel is applied to each of the carriers.		

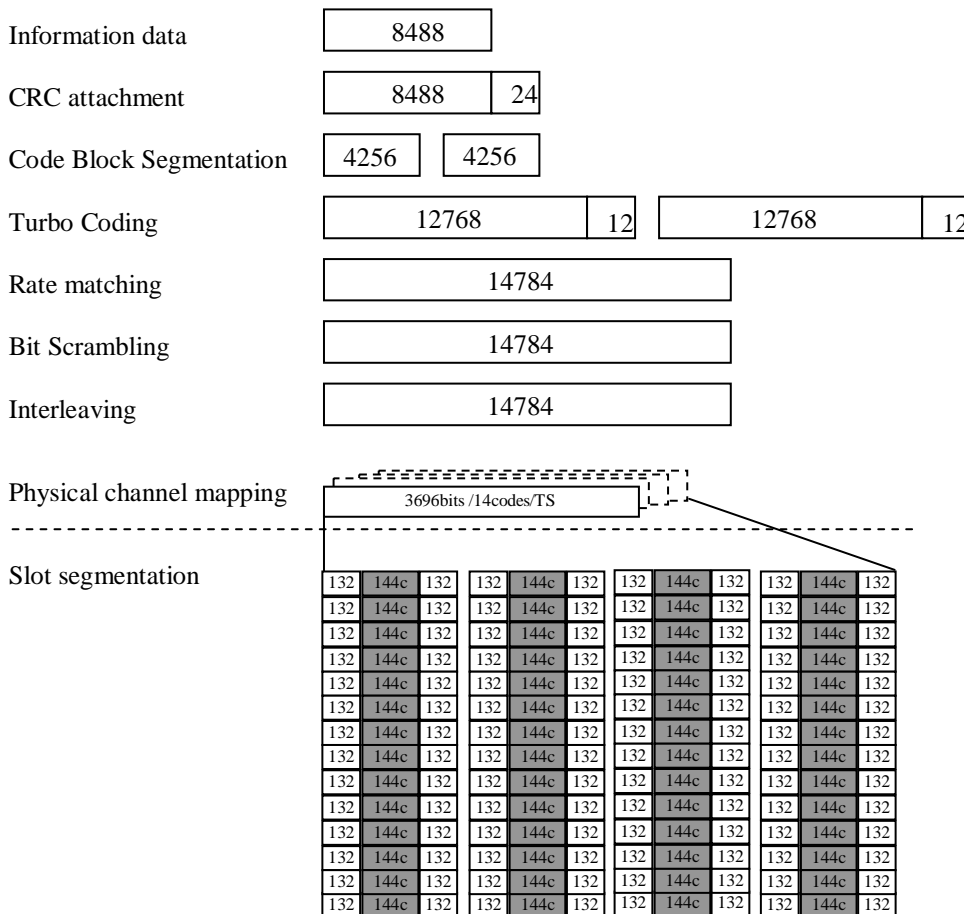

Figure A.16A Fixed reference measurement channel for category 19 UE

A.3.2.7.3 Reference measurement channel for category 22-24 UE

Table A.17A Fixed reference measurement channel for category 22-24 UE

Parameter	Unit	Value
Modulation	-	64QAM
Maximum information bit throughput	Mbps	2.0464
Number of HARQ Processes	Processes	4
Information Bit Payload (N_{INF})	Bits	10232
Number Code Blocks	Blocks	3
Total Available of Soft Channel bits in UE	Bits	84480
Number of Soft Channel bit per HARQ Proc.	Bits	21120
Number of coded bits per TTI	Bits	18480
Coding Rate	-	0.55
Number of HS-DSCH Timeslots	Slots	5
Number of HS-PDSCH codes per TS	Codes	14
Spreading factor	SF	16
Note: For multi-carrier reception, the reference measurement channel is applied to each of the carriers.		

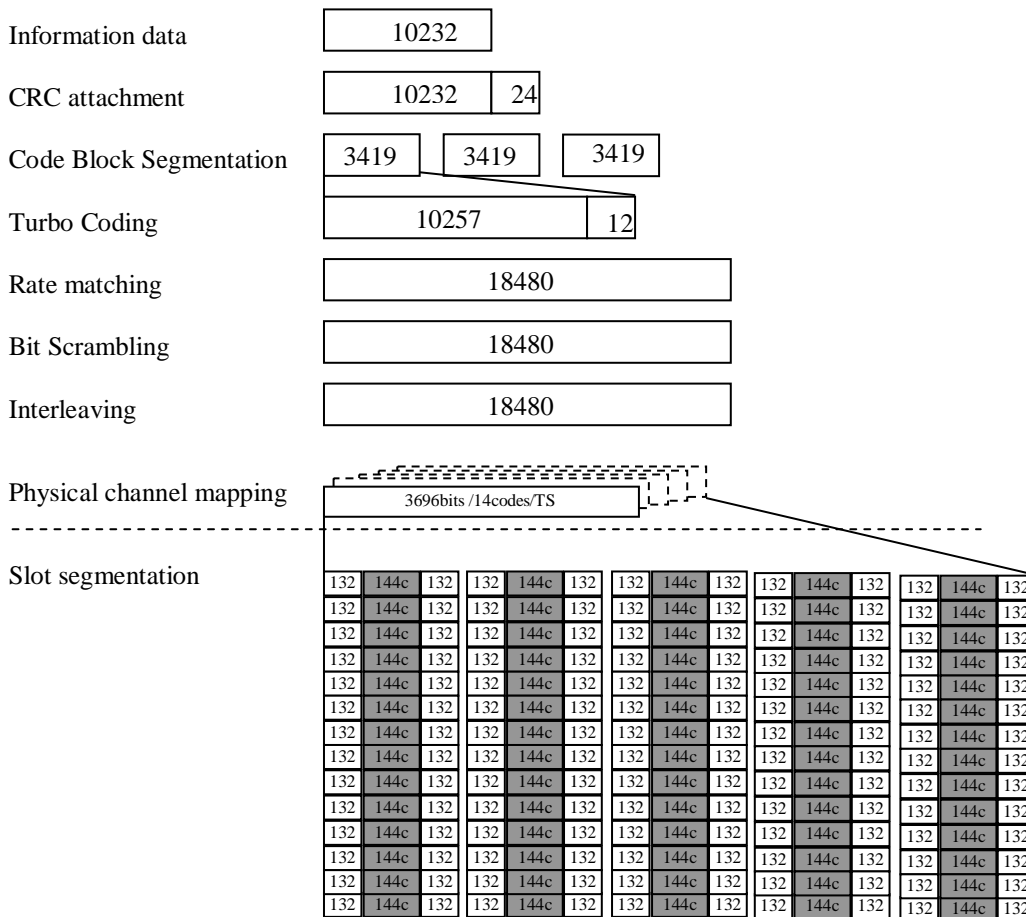

Figure A.17A Fixed reference measurement channel for category 22 UE

A.3.2.8 Reference measurement channel of 48kbps

Table A.18A

Parameter	Unit	Value
Modulation	-	QPSK
Maximum information bit throughput	kbps	48
Number of HARQ Processes	Processes	4
Information Bit Payload (N_{INF})	Bits	240
Number Code Blocks	Blocks	1
Number of coded bits per TTI	Bits	804
Coding Rate	-	0.375
Number of HS-DSCH Timeslots	Slots	1
Number of HS-PDSCH codes per TS	Codes	8
Spreading factor	SF	16
HS-PDSCH _i Ec/Ior	dB	-9.03
Number of DPCH _o	-	0
DPCH _o Ec/Ior	dB	-

Note: For multi-carrier reception, the reference measurement channel is applied to each of the carriers.

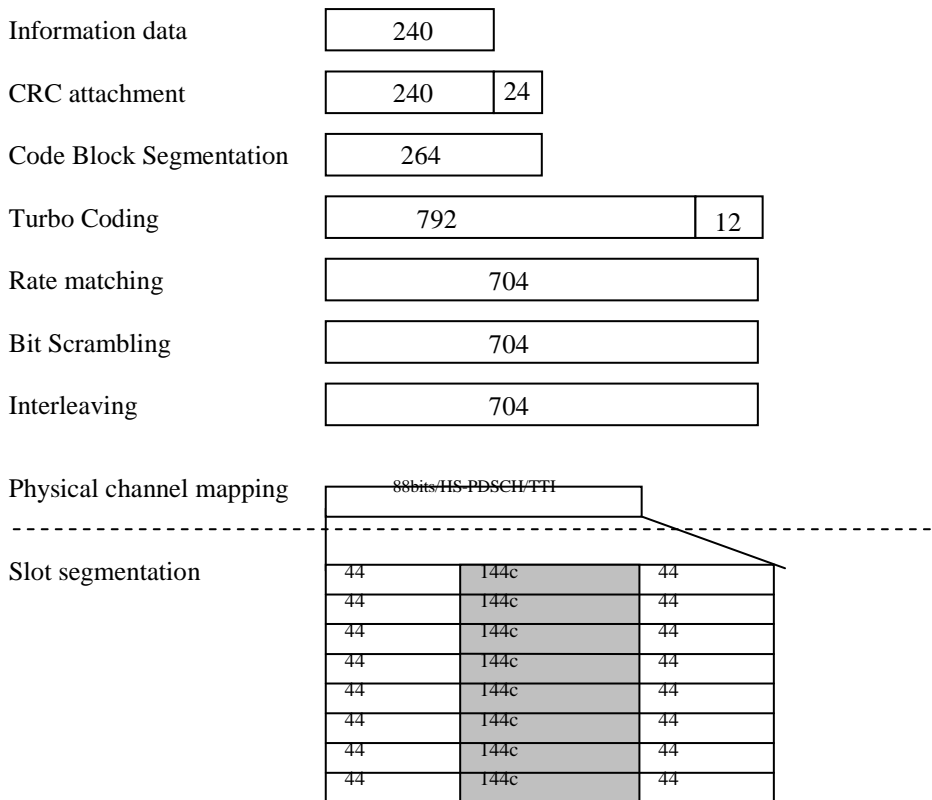

Figure A.18A

A.3.2.9 Reference Measurement Channel of HS-SICH

Table A.19A

Parameter	Unit	Value
Information bits	bits	8
Encoded bits	bits	84
Number of codes	-	1
Number of timeslots	-	1
TTI	ms	5
Spreading Factor	SF	16
Note: For multi-carrier transmission, the reference measurement channel is applied to each of the carriers.		

Inf. Bit Payload

8

Coding and multiplex

84

Interleaving

84bits/5ms

Slot segmentation 1 codes/TS, 1TS/TTI

44	144chips	SS	TPC	40
----	----------	----	-----	----

Figure A.19A

A.3.2.10 Reference Measurement Channel for category 25 UE

A.3.2.10.1 QPSK modulation scheme

Table A.20A Reference Measurement Channel for Category 25 (QPSK)

Parameter	Unit	Value	
		1 st stream	2 nd stream
Stream		1 st stream	2 nd stream
Modulation	-	QPSK	QPSK
Combined Nominal Avg. Inf. Bit Rate	Mbps	1.0976	
Nominal Avg. Inf. Bit Rate per stream	kbps	564.8	532.8
Number of HARQ Processes	Processes	4	4
Information Bit Payload (N_{INF})	Bits	2824	2664
Number Code Blocks	Blocks	1	1
Total Available of Soft Channel bits in UE	Bits	202752	
Number of Soft Channel bit per HARQ Proc.	Bits	25344	25344
Number of coded bits per TTI	Bits	4224	4224
Coding Rate	-	0.6697	0.6323
Number of HS-DSCH Timeslots	Slots	3	3
Number of HS-PDSCH codes per TS	Codes	16	16
Spreading factor	SF	16	16
Note:	For UE support SF=1 only in dual stream transmission, both the number of HS-PDSCH codes per TS and spreading factor in the FRC should be changed to 1.		

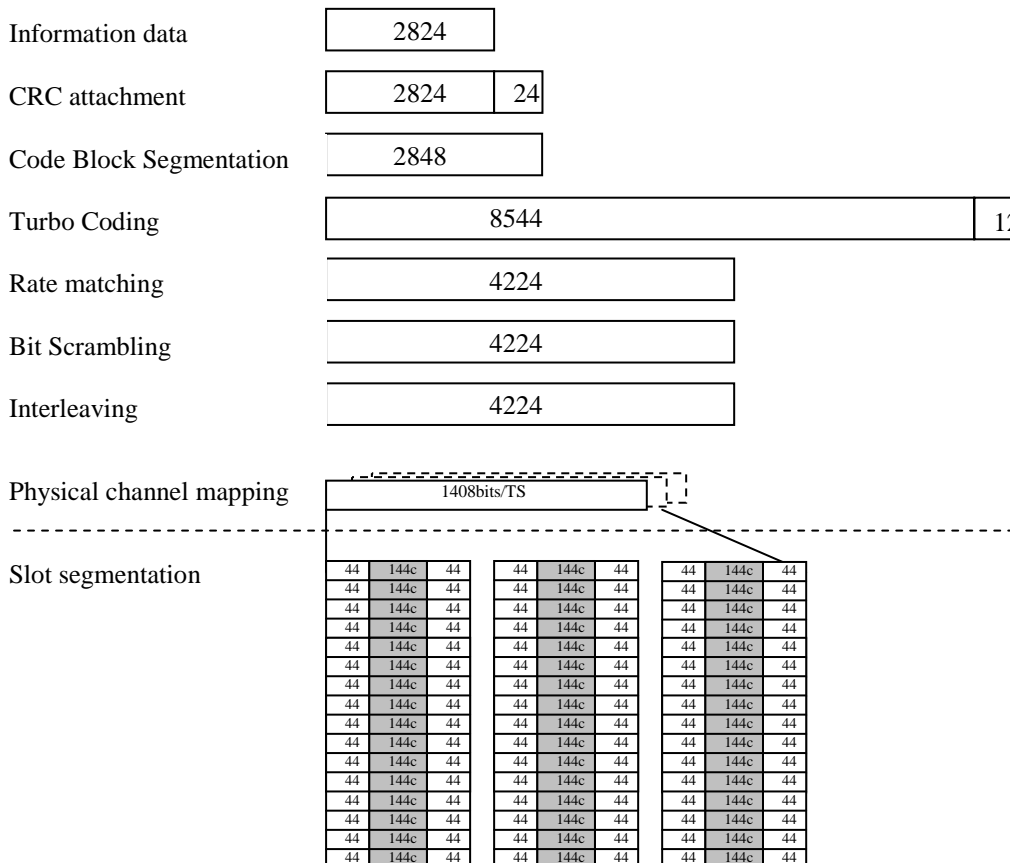

Figure A.20A Reference Measurement Channel for Category 25 (QPSK) - First Stream

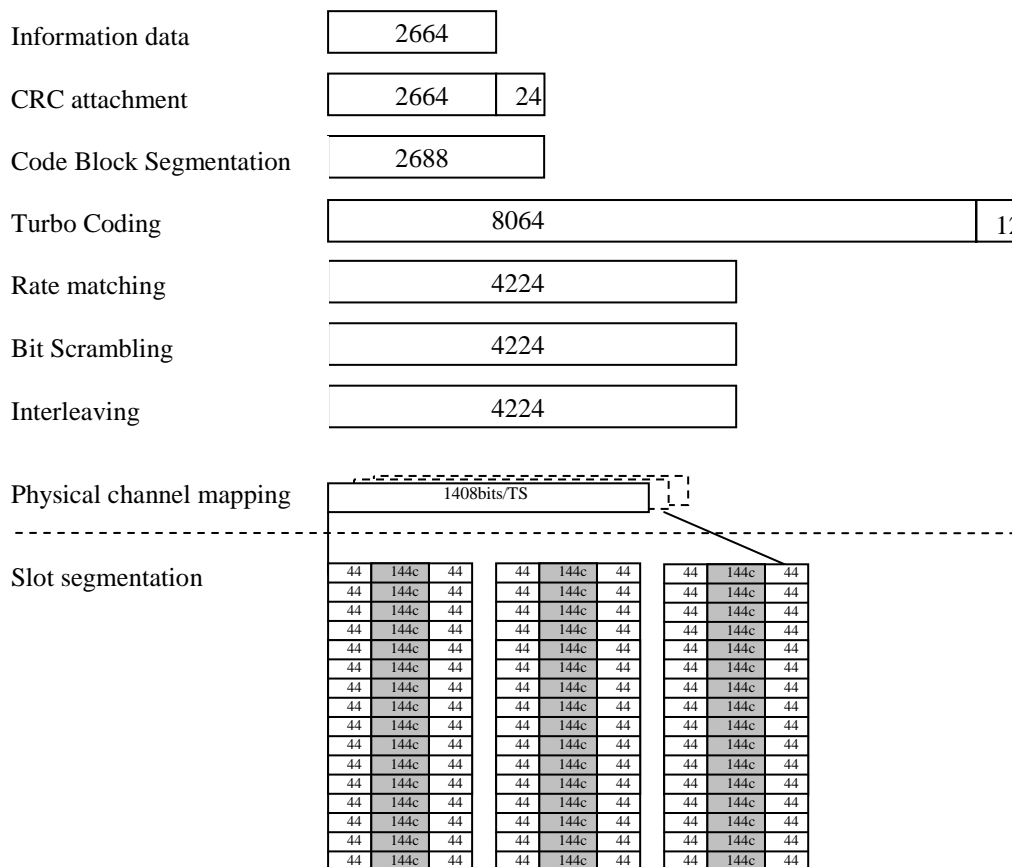

Figure A.21A Reference Measurement Channel for Category 25 (QPSK) - Second Stream

A.3.2.10.2 16QAM modulation scheme

Table A.21A Reference Measurement Channel for Category 25 (16QAM)

Parameter	Unit	Value	
		1 st stream	2 nd stream
Stream		1 st stream	2 nd stream
Modulation	-	16QAM	16QAM
Combined Nominal Avg. Inf. Bit Rate	Mbps	1.8416	
Nominal Avg. Inf. Bit Rate per stream	kbps	947.2	894.4
Number of HARQ Processes	Processes	4	4
Information Bit Payload (N_{INF})	Bits	4736	4472
Number Code Blocks	Blocks	1	1
Total Available of Soft Channel bits in UE	Bits	202752	
Number of Soft Channel bit per HARQ Proc.	Bits	25344	25344
Number of coded bits per TTI	Bits	8448	8448
Coding Rate	-	0.561	0.529
Number of HS-DSCH Timeslots	Slots	3	3
Number of HS-PDSCH codes per TS	Codes	16	16
Spreading factor	SF	16	16
Note:	For UE support SF=1 only in dual stream transmission, both the number of HS-PDSCH codes per TS and spreading factor in the FRC should be changed to 1.		

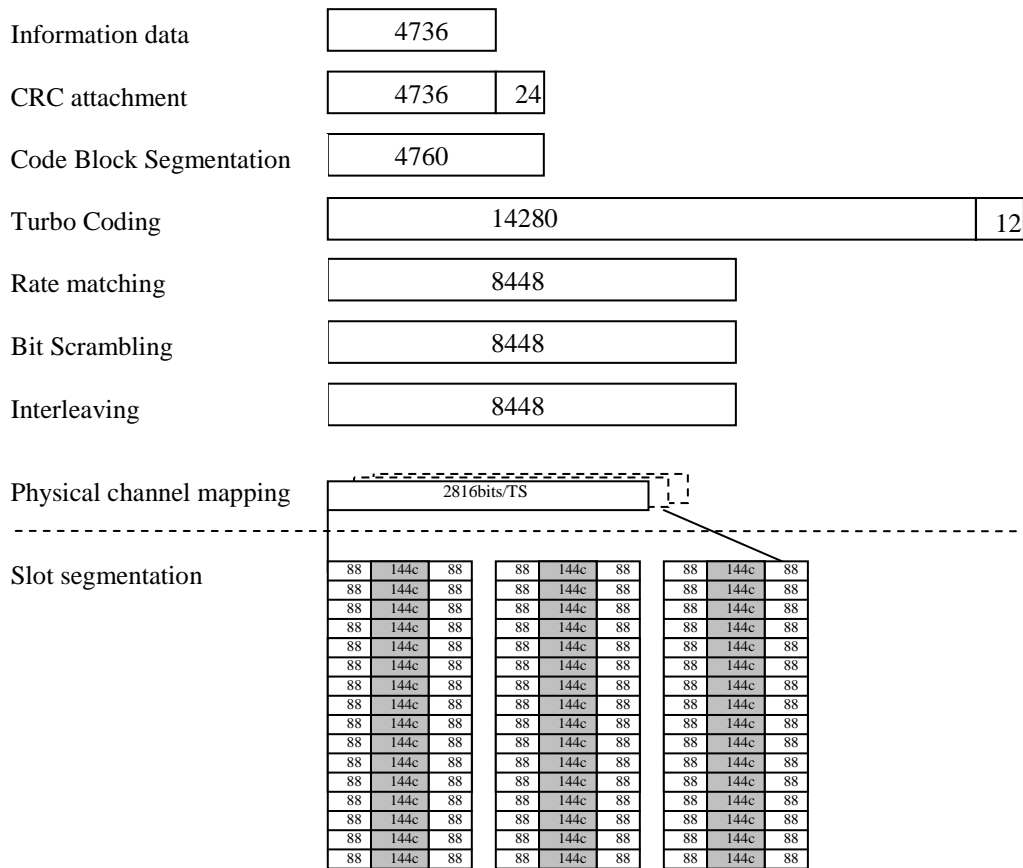

Figure A.22A Reference Measurement Channel for Category 25 (16QAM) - First Stream

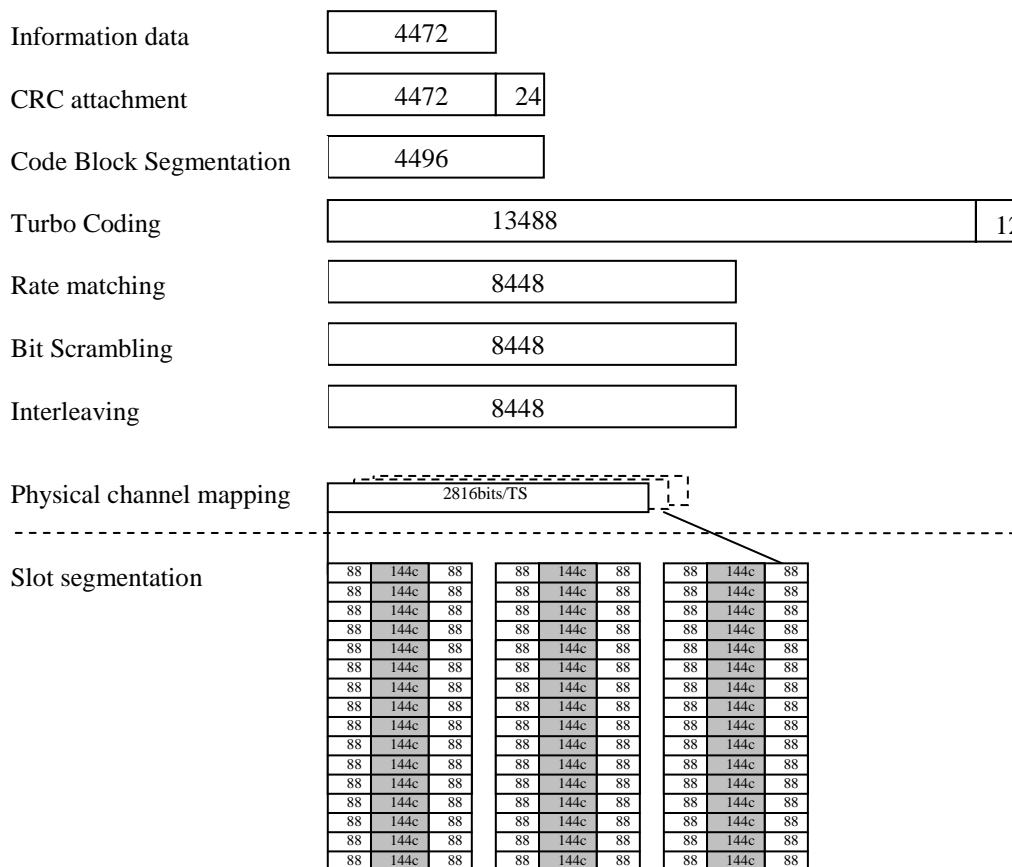

Figure A.23A Reference Measurement Channel for Category 25 (16QAM) - Second Stream

A.3.2.11 Reference Measurement Channel for category 26 UE

A.3.2.11.1 QPSK modulation scheme

Table A.22A Reference Measurement Channel for Category 26 (QPSK)

Parameter	Unit	Value	
		1 st stream	2 nd stream
Stream		1 st stream	2 nd stream
Modulation	-	QPSK	QPSK
Combined Nominal Avg. Inf. Bit Rate	Mbps	1.5152	
Nominal Avg. Inf. Bit Rate per stream	kbps	780.8	734.4
Number of HARQ Processes	Processes	4	4
Information Bit Payload (N_{INF})	Bits	3904	3672
Number Code Blocks	Blocks	1	1
Total Available of Soft Channel bits in UE	Bits	270336	
Number of Soft Channel bit per HARQ Proc.	Bits	33792	33792
Number of coded bits per TTI	Bits	5632	5632
Coding Rate	-	0.693	0.652
Number of HS-DSCH Timeslots	Slots	4	4
Number of HS-PDSCH codes per TS	Codes	16	16
Spreading factor	SF	16	16
Note:	For UE support SF=1 only in dual stream transmission, both the number of HS-PDSCH codes per TS and spreading factor in the FRC should be changed to 1.		

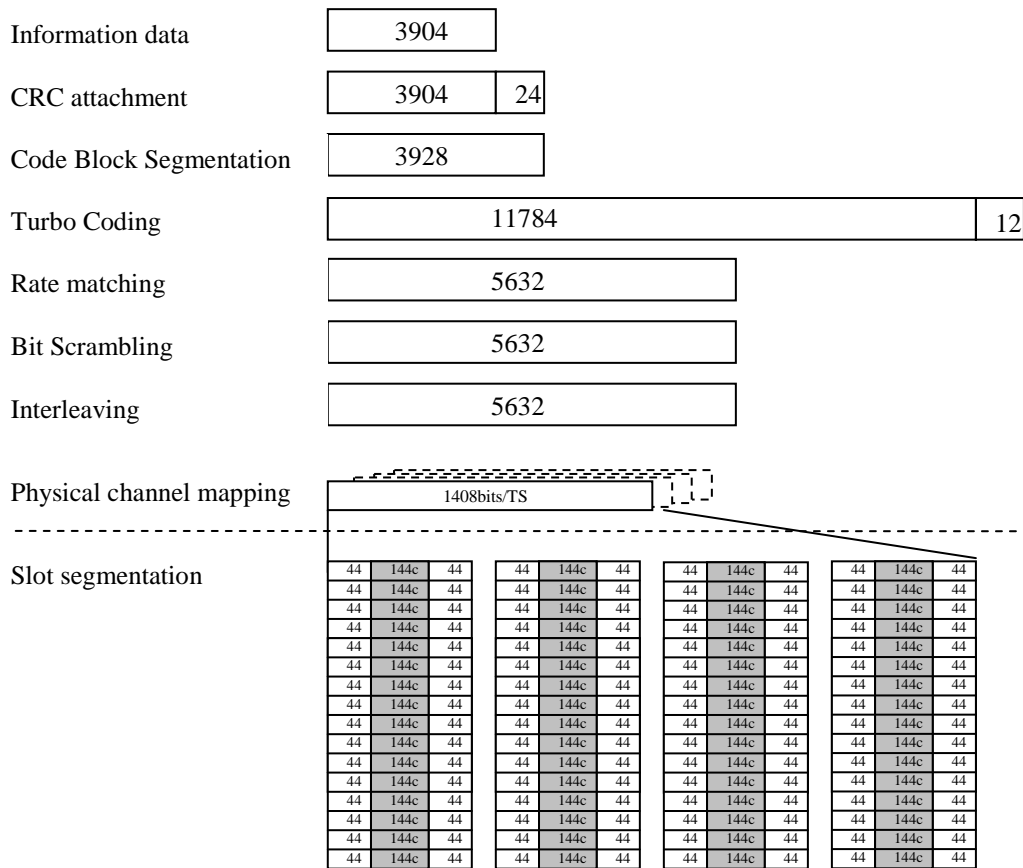

Figure A.24A Reference Measurement Channel for Category 26 (QPSK) - First Stream

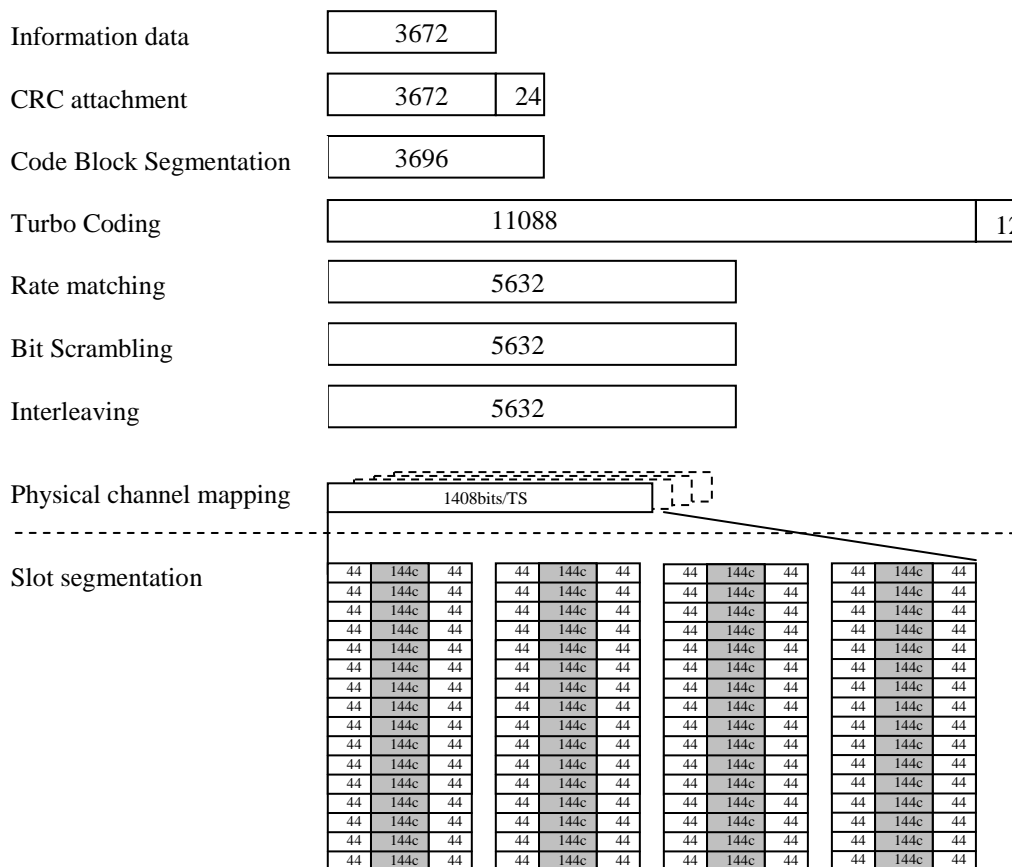

Figure A.25A Reference Measurement Channel for Category 26 (QPSK) - Second Stream

A.3.2.11.2 16QAM modulation scheme

Table A.23A Reference Measurement Channel for Category 26 (16QAM)

Parameter	Unit	Value	
		1 st stream	2 nd stream
Stream		1 st stream	2 nd stream
Modulation	-	16QAM	16QAM
Combined Nominal Avg. Inf. Bit Rate	Mbps	2.8192	
Nominal Avg. Inf. Bit Rate per stream	kbps	1452.8	1366.4
Number of HARQ Processes	Processes	4	4
Information Bit Payload (N_{INF})	Bits	7264	6832
Number Code Blocks	Blocks	2	2
Total Available of Soft Channel bits in UE	Bits	270336	
Number of Soft Channel bit per HARQ Proc.	Bits	33792	33792
Number of coded bits per TTI	Bits	11264	11264
Coding Rate	-	0.645	0.607
Number of HS-DSCH Timeslots	Slots	4	4
Number of HS-PDSCH codes per TS	Codes	16	16
Spreading factor	SF	16	16
Note:	For UE support SF=1 only in dual stream transmission, both the number of HS-PDSCH codes per TS and spreading factor in the FRC should be changed to 1.		

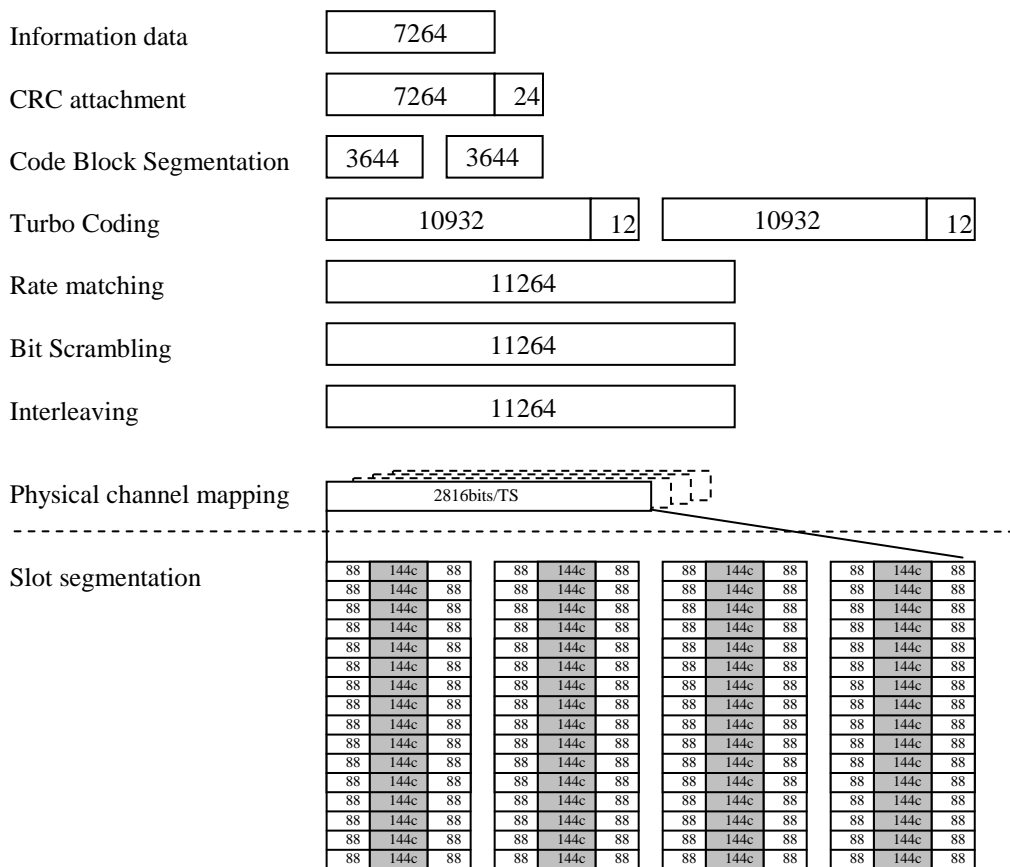

Figure A.26A Reference Measurement Channel for Category 26 (16QAM) - First Stream

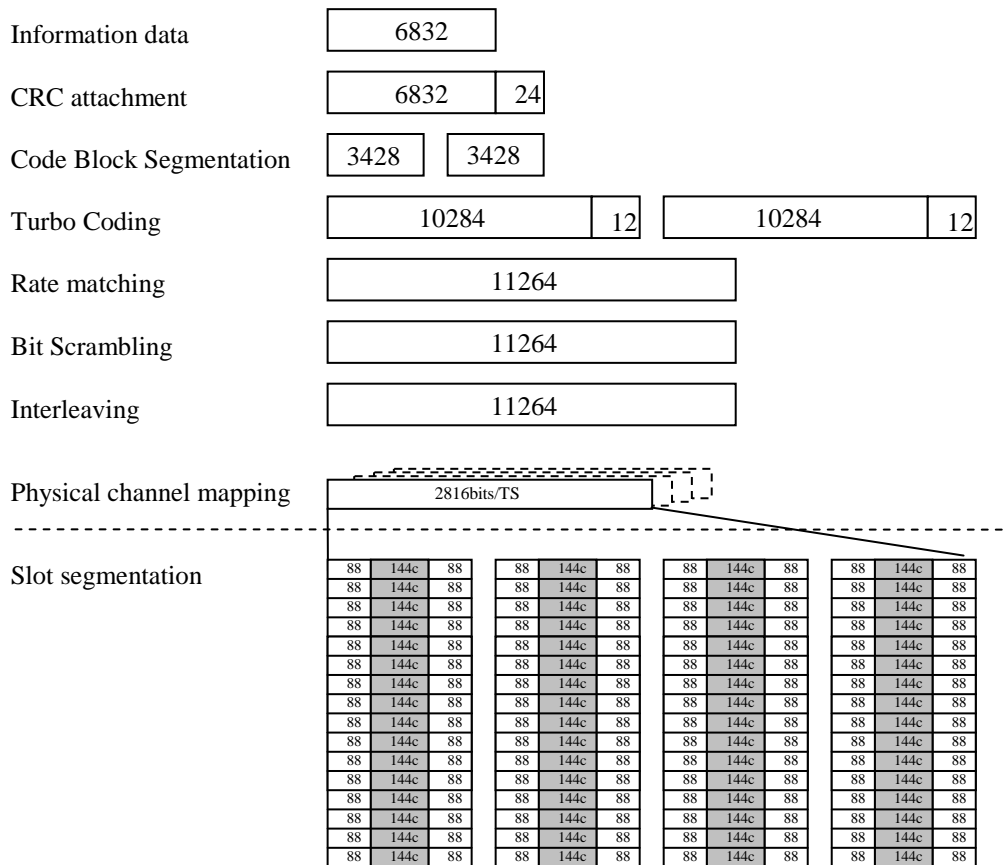

Figure A.27A Reference Measurement Channel for Category 26 (16QAM) - Second Stream

A.3.2.12 Reference Measurement Channel for category 27 UE

A.3.2.12.1 QPSK modulation scheme

Table A.24A Reference Measurement Channel for Category 27 (QPSK)

Parameter	Unit	Value	
		1 st stream	2 nd stream
Stream		QPSK	QPSK
Modulation	-	QPSK	QPSK
Combined Nominal Avg. Inf. Bit Rate	Mbps	1.7808	
Nominal Avg. Inf. Bit Rate per stream	kbps	920	860.8
Number of HARQ Processes	Processes	4	4
Information Bit Payload (N_{INF})	Bits	4600	4304
Number Code Blocks	Blocks	1	1
Total Available of Soft Channel bits in UE	Bits	337920	
Number of Soft Channel bit per HARQ Proc.	Bits	42240	42240
Number of coded bits per TTI	Bits	7040	7040
Coding Rate	-	0.653	0.611
Number of HS-DSCH Timeslots	Slots	5	5
Number of HS-PDSCH codes per TS	Codes	16	16
Spreading factor	SF	16	16
Note:	For UE support SF=1 only in dual stream transmission, both the number of HS-PDSCH codes per TS and spreading factor in the FRC should be changed to 1.		

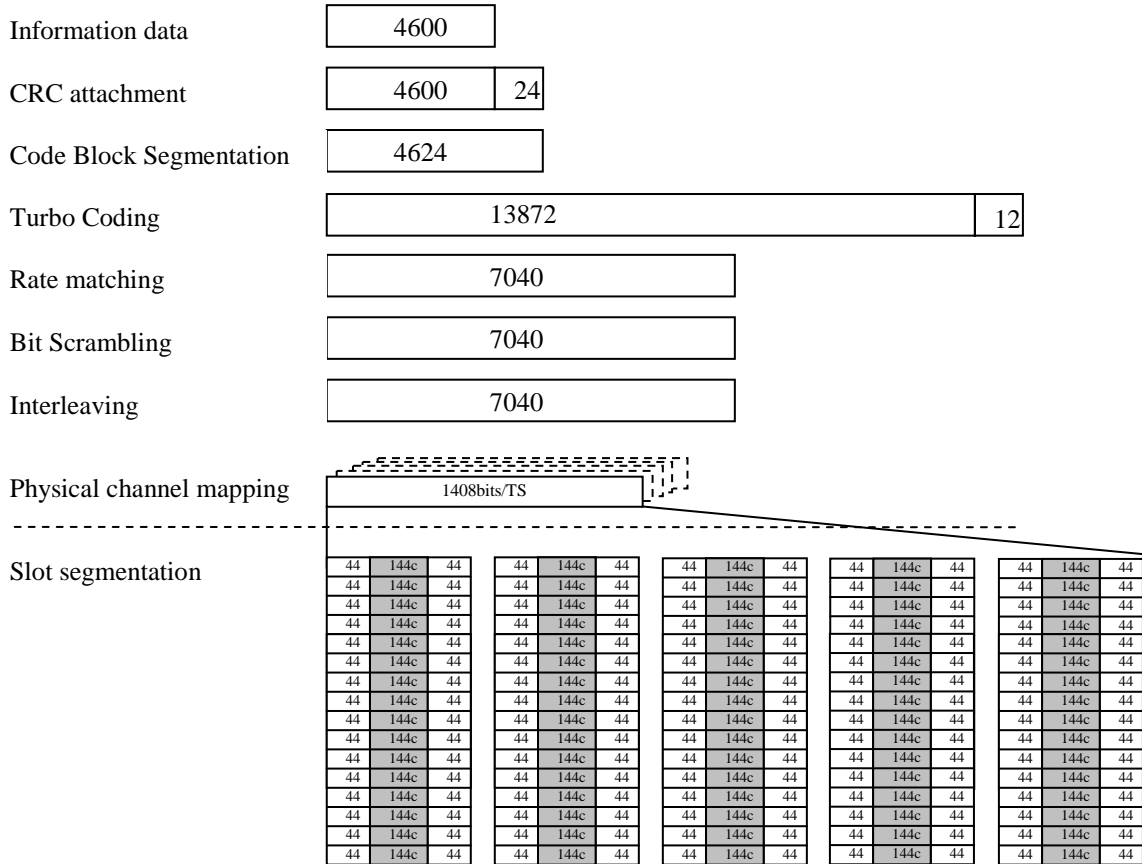

Figure A.28A Reference Measurement Channel for Category 27 (QPSK) - First Stream

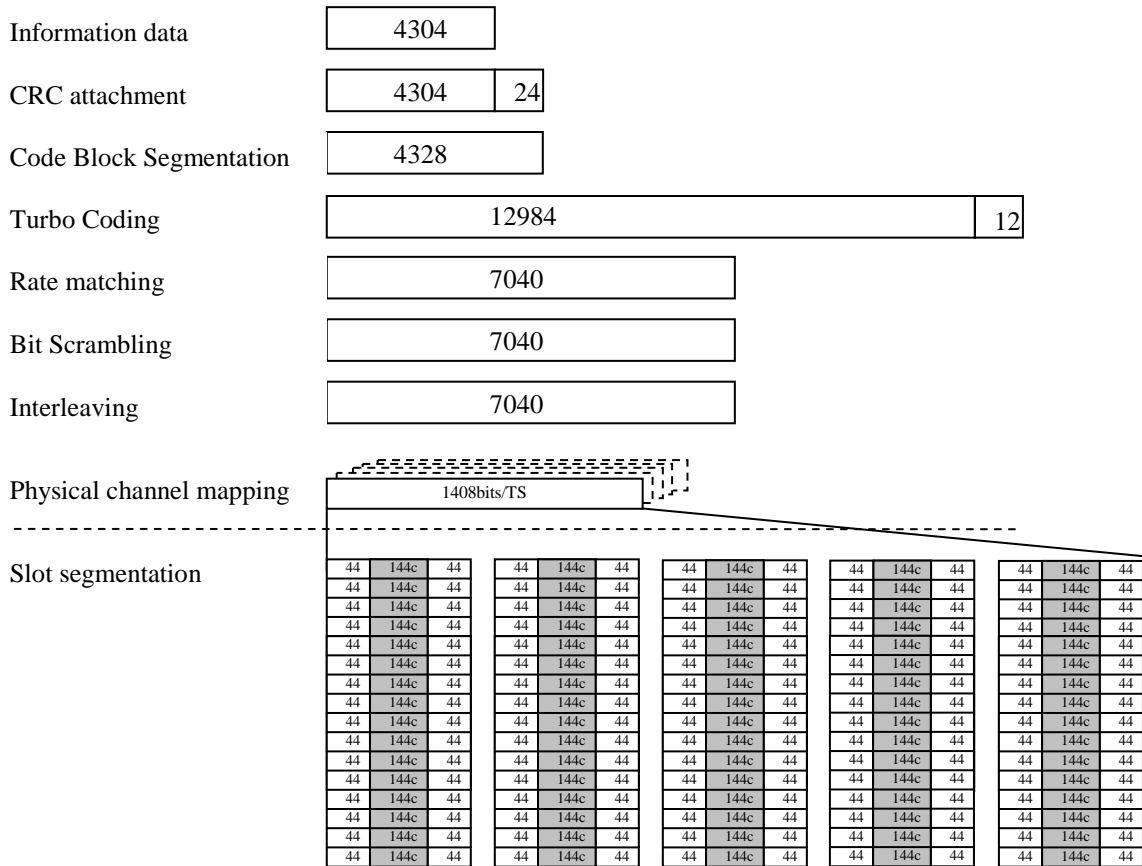

Figure A.29A Reference Measurement Channel for Category 27 (QPSK) - Second Stream

A.3.2.12.2 16QAM modulation scheme

Table A.25A Reference Measurement Channel for Category 27 (16QAM)

Parameter	Unit	Value	
		1 st stream	2 nd stream
Stream		1 st stream	2 nd stream
Modulation	-	16QAM	16QAM
Combined Nominal Avg. Inf. Bit Rate	Mbps	3.4336	
Nominal Avg. Inf. Bit Rate per stream	kbps	1772.8	1660.8
Number of HARQ Processes	Processes	4	4
Information Bit Payload (N_{INF})	Bits	8864	8304
Number Code Blocks	Blocks	2	2
Total Available of Soft Channel bits in UE	Bits	337920	
Number of Soft Channel bit per HARQ Proc.	Bits	42240	42240
Number of coded bits per TTI	Bits	14080	14080
Coding Rate	-	0.630	0.590
Number of HS-DSCH Timeslots	Slots	5	5
Number of HS-PDSCH codes per TS	Codes	16	16
Spreading factor	SF	16	16
Note:	For UE support SF=1 only in dual stream transmission, both the number of HS-PDSCH codes per TS and spreading factor in the FRC should be changed to 1.		

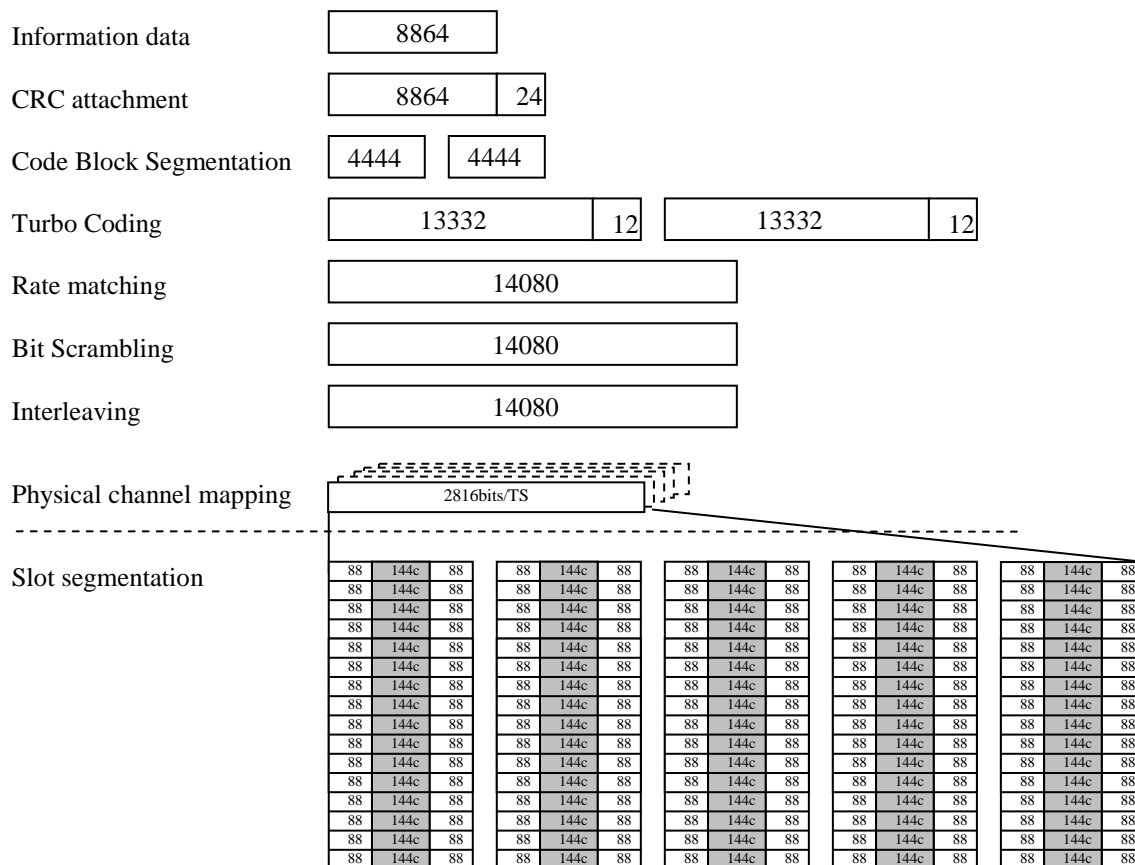

Figure A.30A Reference Measurement Channel for Category 27 (16QAM) - First Stream

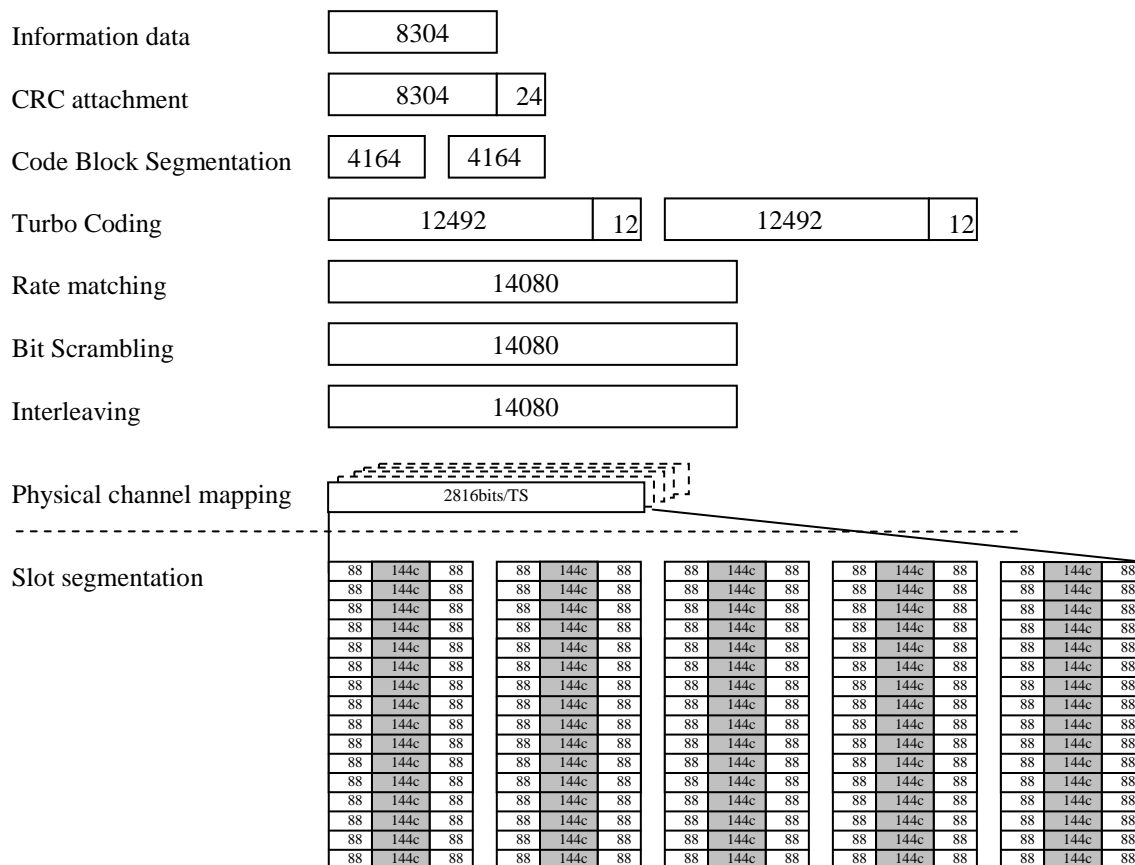

Figure A.31A Reference Measurement Channel for Category 27 (16QAM) - Second Stream

A.3.2.13 Reference Measurement Channel for category 28 UE

A.3.2.13.1 64QAM modulation scheme

Table A.26A Reference Measurement Channel for Category 28 (64QAM)

Parameter	Unit	Value	
		1 st stream	2 nd stream
Stream		1 st stream	2 nd stream
Modulation	-	64QAM	64QAM
Combined Nominal Avg. Inf. Bit Rate	Mbps	3.128	
Nominal Avg. Inf. Bit Rate per stream	kbps	1614.4	1513.6
Number of HARQ Processes	Processes	4	4
Information Bit Payload (N_{INF})	Bits	8072	7568
Number Code Blocks	Blocks	2	2
Total Available of Soft Channel bits in UE	Bits	304128	
Number of Soft Channel bit per HARQ Proc.	Bits	38016	38016
Number of coded bits per TTI	Bits	12672	12672
Coding Rate	-	0.637	0.597
Number of HS-DSCH Timeslots	Slots	3	3
Number of HS-PDSCH codes per TS	Codes	16	16
Spreading factor	SF	16	16
Note:	For UE support SF=1 only in dual stream transmission, both the number of HS-PDSCH codes per TS and spreading factor in the FRC should be changed to 1.		

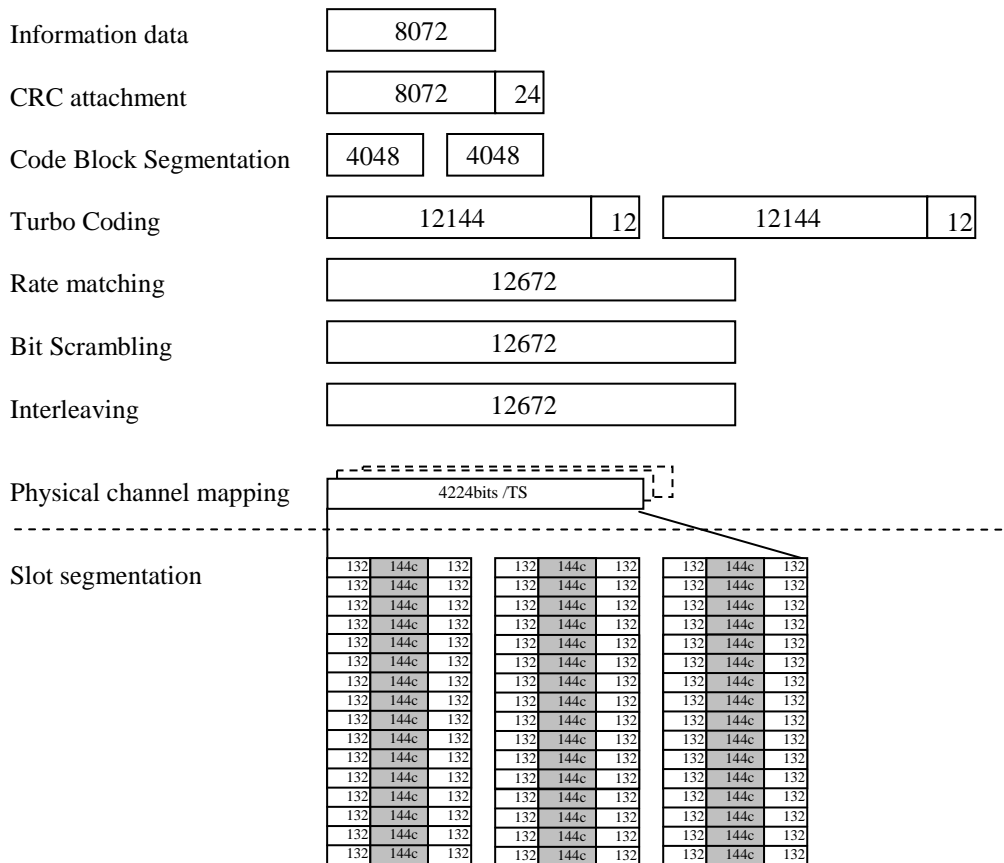

Figure A.32A Reference Measurement Channel for Category 28 (64QAM) - First Stream

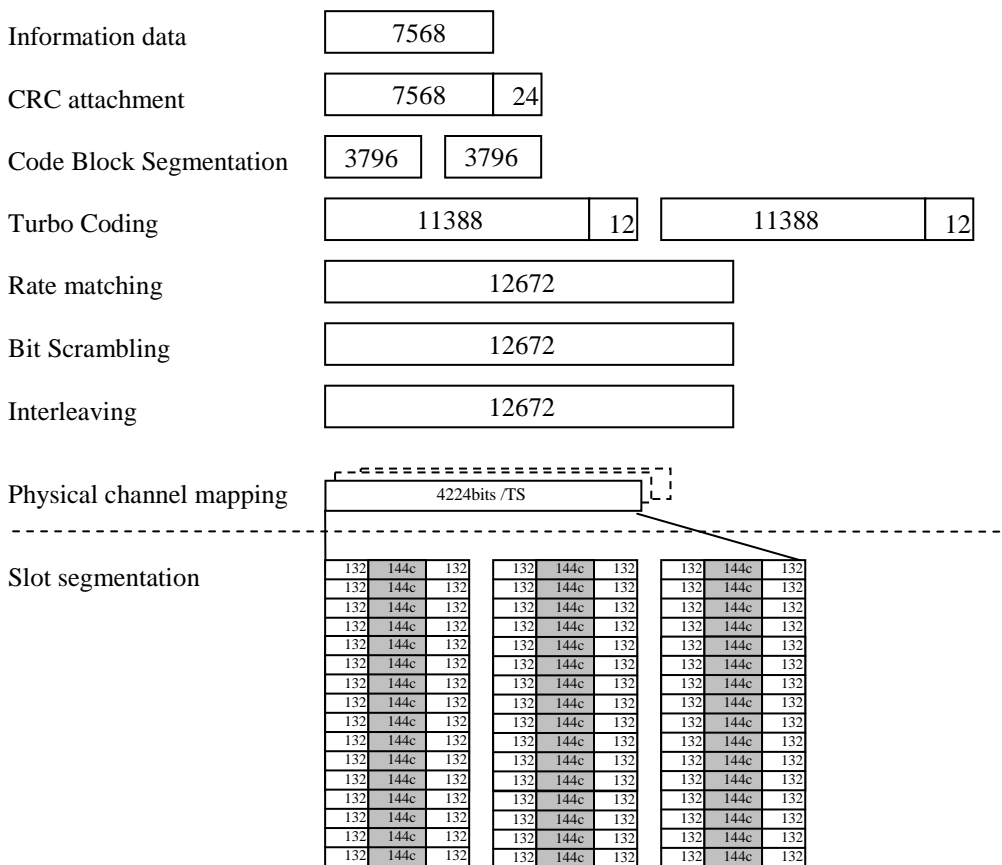

Figure A.33A Reference Measurement Channel for Category 28 (64QAM) - Second Stream

A.3.2.14 Reference Measurement Channel for category 29 UE

A.3.2.14.1 64QAM modulation scheme

Table A.27A Reference Measurement Channel for Category 29 (64QAM)

Parameter	Unit	Value	
		1 st stream	2 nd stream
Stream		1 st stream	2 nd stream
Modulation	-	64QAM	64QAM
Combined Nominal Avg. Inf. Bit Rate	Mbps	4.032	
Nominal Avg. Inf. Bit Rate per stream	kbps	2084.8	1947.2
Number of HARQ Processes	Processes	4	4
Information Bit Payload (N_{INF})	Bits	10424	9736
Number Code Blocks	Blocks	3	2
Total Available of Soft Channel bits in UE	Bits	405504	
Number of Soft Channel bit per HARQ Proc.	Bits	50688	50688
Number of coded bits per TTI	Bits	16896	16896
Coding Rate	-	0.617	0.576
Number of HS-DSCH Timeslots	Slots	4	4
Number of HS-PDSCH codes per TS	Codes	16	16
Spreading factor	SF	16	16
Note:	For UE support SF=1 only in dual stream transmission, both the number of HS-PDSCH codes per TS and spreading factor in the FRC should be changed to 1.		

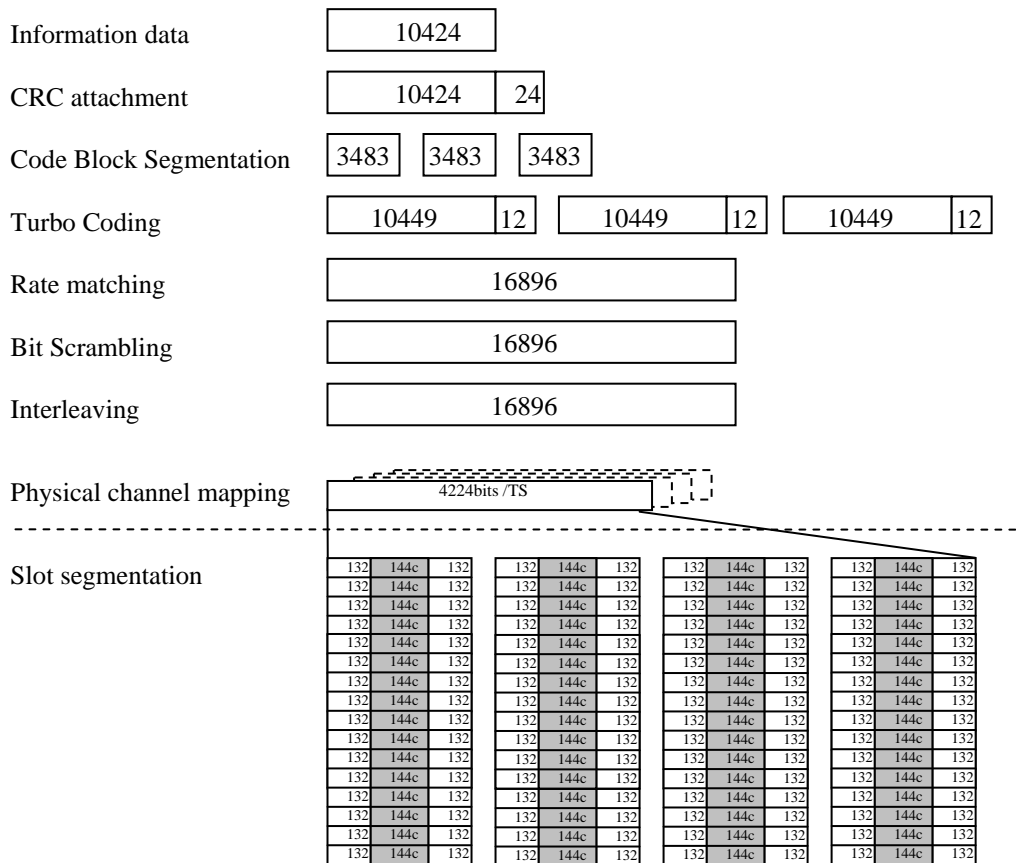

Figure A.34A Reference Measurement Channel for Category 29 (64QAM) - First Stream

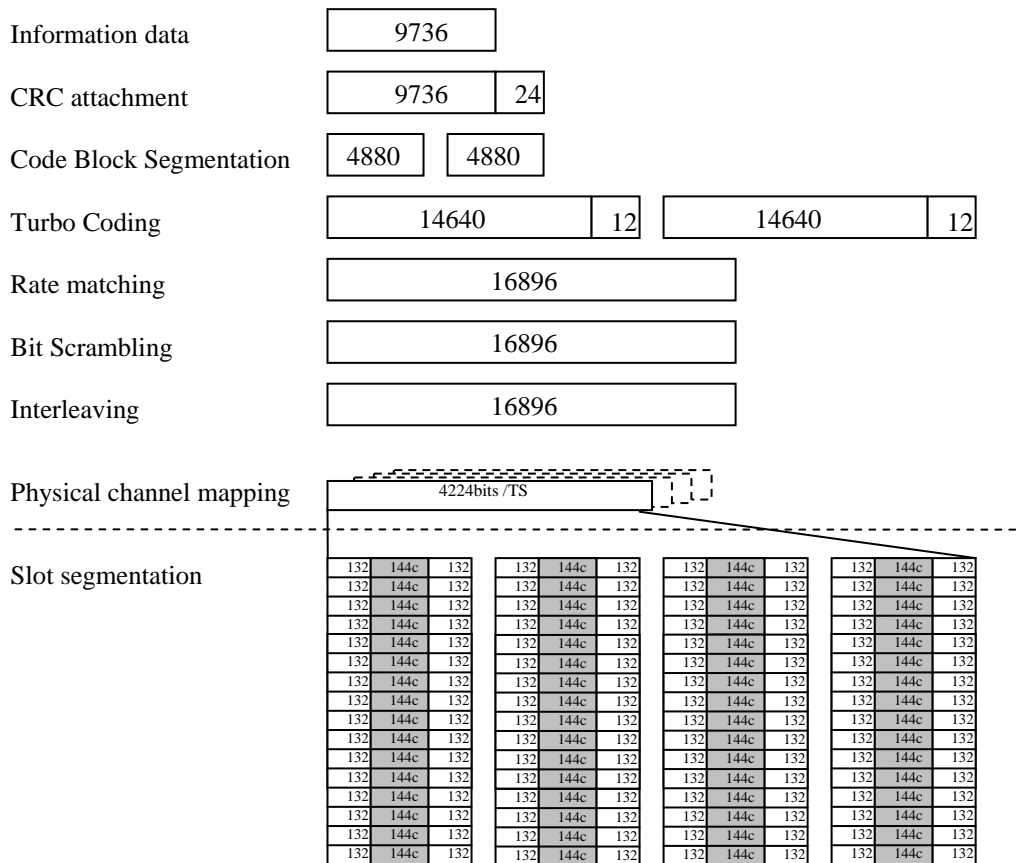

Figure A.35A Reference Measurement Channel for Category 29 (64QAM) - Second Stream

A.3.2.15 Reference Measurement Channel for category 30 UE

A.3.2.15.1 64QAM modulation scheme

Table A.28A Reference Measurement Channel for Category 30 (64QAM)

Parameter	Unit	Value	
		1 st stream	2 nd stream
Stream		1 st stream	2 nd stream
Modulation	-	64QAM	64QAM
Combined Nominal Avg. Inf. Bit Rate	Mbps	4.9072	
Nominal Avg. Inf. Bit Rate per stream	kbps	2542.4	2364.8
Number of HARQ Processes	Processes	4	4
Information Bit Payload (N_{INF})	Bits	12712	11824
Number Code Blocks	Blocks	3	3
Total Available of Soft Channel bits in UE	Bits	506880	
Number of Soft Channel bit per HARQ Proc.	Bits	63360	63360
Number of coded bits per TTI	Bits	21120	21120
Coding Rate	-	0.602	0.560
Number of HS-DSCH Timeslots	Slots	5	5
Number of HS-PDSCH codes per TS	Codes	16	16
Spreading factor	SF	16	16
Note:	For UE support SF=1 only in dual stream transmission, both the number of HS-PDSCH codes per TS and spreading factor in the FRC should be changed to 1.		

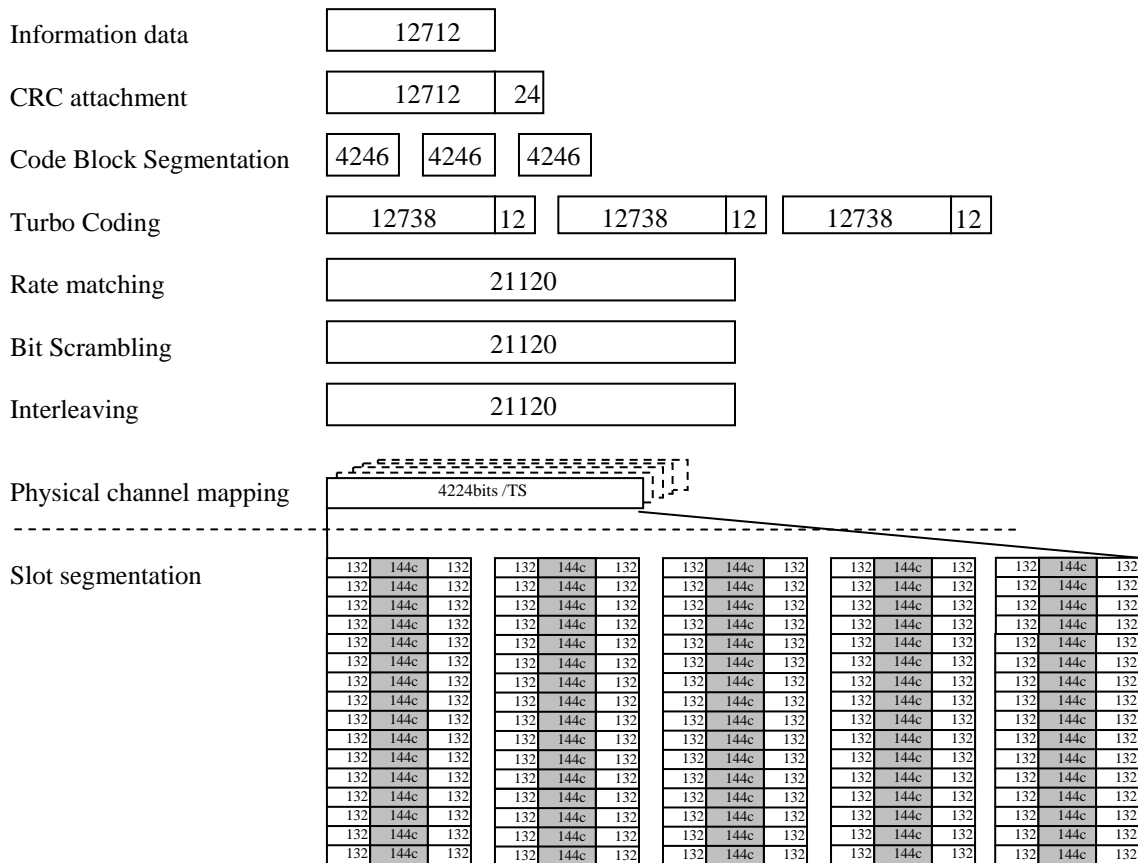

Figure A.36A Reference Measurement Channel for Category 30 (64QAM) - First Stream

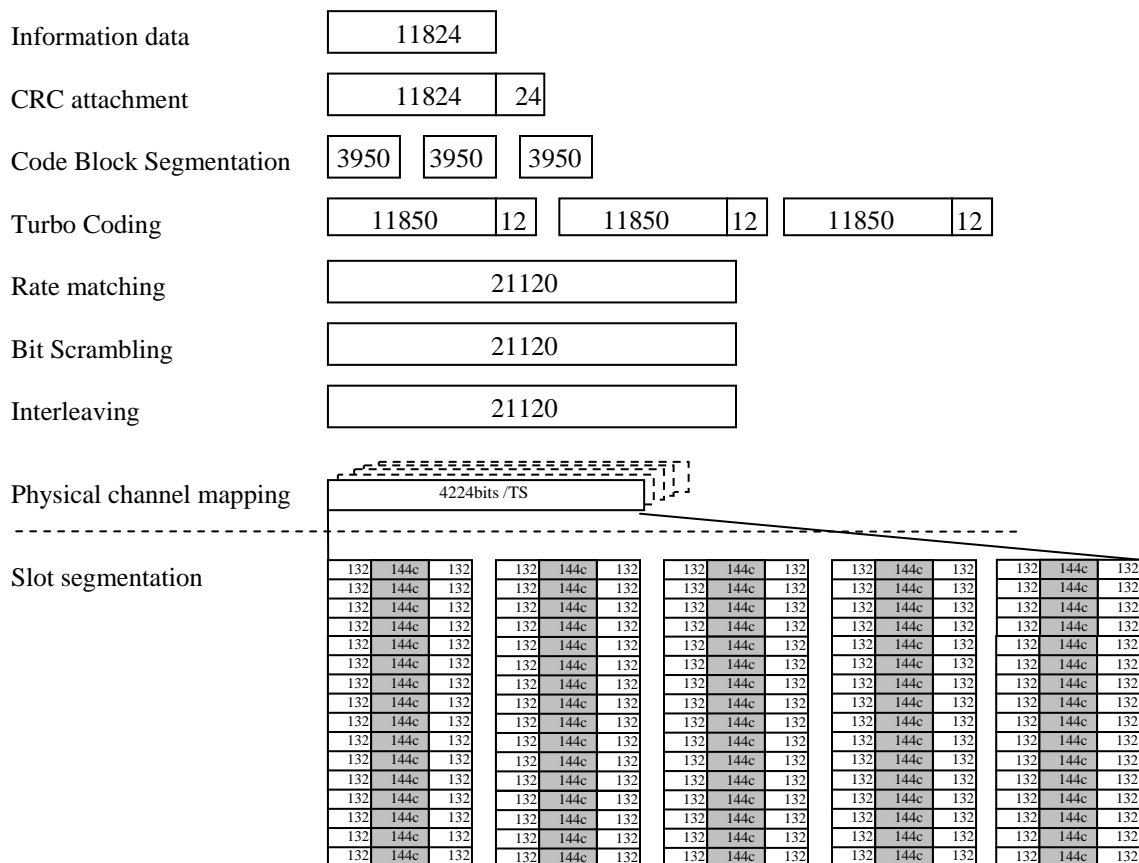

Figure A.37A Reference Measurement Channel for Category 30 (64QAM) - Second Stream

A.3.2A HSDPA reference measurement channels for 7,68 Mcps TDD option

A.3.2A.1 Reference measurement channels for 5,3 Mbps - Category 8 - UE

A.3.2A.1.1 QPSK modulation scheme for test 1, 2, 3 & 4

Table A.15: HS-PDSCH fixed reference channel for the PA3, PB3, VA30 and VA120 Channel models - Category 8

Parameter	Unit	Value
Maximum information bit throughput	Mbps	1.7612
Number of HARQ Processes	Processes	3
Information Bit Payload (N_{INF})	Bits	17612
Number Code Blocks	Blocks	4
Total Available of Soft Channel bits in UE	Bits	211968
Number of Soft Channel bit per HARQ Proc.	Bits	70656
Number of coded bits per TTI	Bits	35328
Coding Rate		1/2
Number of HS-PDSCH Timeslots	Slots	4
Number of HS-PDSCH codes per TS	Codes	32
Spreading factor	SF	32

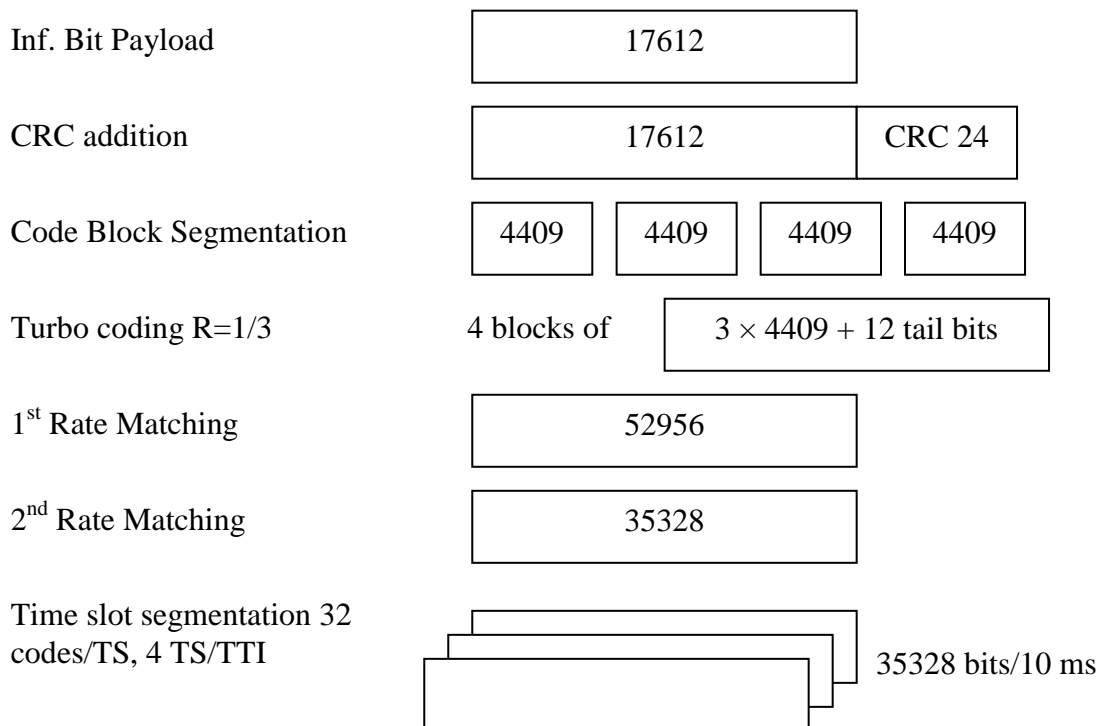

Figure A.15: Coding for HS-PDSCH fixed reference channel with QPSK modulation for the PA3, PB3, VA30 and VA120 Channels - Category 8

A.3.2A.1.2 16QAM modulation scheme for test 1, 2, 3 & 4

Table A.16: HS-PDSCH fixed reference channel for the PA3, PB3, VA30 and VA120 Channel models - Category 8

Parameter	Unit	Value
Modulation		16-QAM
Maximum information bit throughput	Mbps	3.5066
Number of HARQ Processes	Processes	3
Information Bit Payload (N_{INF})	Bits	35066
Number Code Blocks	Blocks	7
Total Available of Soft Channel bits in UE	Bits	21 1968
Number of Soft Channel bit per HARQ Proc.	Bits	70656
Number of coded bits per TTI	Bits	70656
Coding Rate		$\frac{1}{2}$
Number of HS-PDSCH Timeslots	Slots	4
Number of HS-PDSCH codes per TS	Codes	32
Spreading factor	SF	32

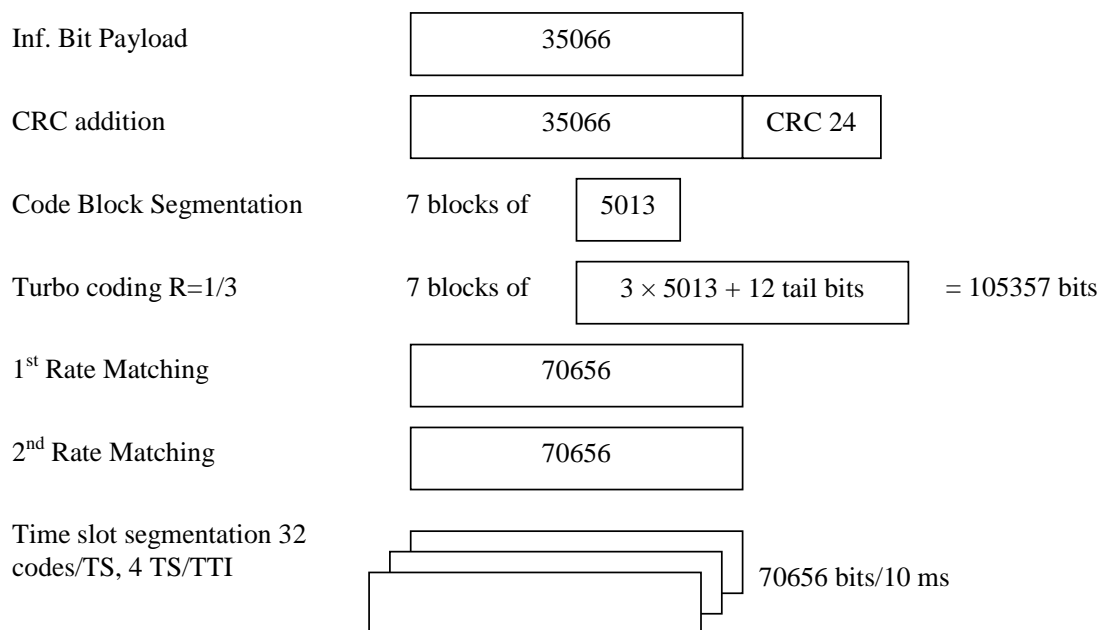

Figure A.16: Coding for HS-PDSCH fixed reference channel with 16-QAM modulation for the PA3 PB3, VA30 and VA120 Channels - Category 8

A.3.3 Variable Reference Channel definition for 3,84 Mcps and 1,28 Mcps TDD options

The variable reference measurement channels are defined by:

- The maximum information bit payload that is determined by the UE capability class under test and the allocated resource units (and hence implicitly by the CQI table applicable to the UE under test as derived from TS25.321).
- The most recently received UE CQI report.

A.4 Downlink reference parameter for MBMS tests

A.4.1 MCCH

A.4.1.1 3.84 Mcps TDD Option

A.4.1.1.1 Non-IMB

The parameters for the MCCH demodulation tests are specified in Table A.41 and Table A.42.

Table A.41: Physical channel parameters for S-CCPCH

Parameter	Unit	Level	Level
Channel bit rate	kbps	22.8	22.8
Channel symbol rate	ksps	11.4	11.4
Slot Format #i	-	3	21
TFCI	-	ON	ON

Table A.42: Transport channel parameters for S-CCPCH

Parameter	MCCH
User Data Rate	7.2 kbps
Number Transport Channel	1
Transport Block Size	581
Transport Block Set Size	581
RLC SDU block size	4088
Transmission Time Interval	80 ms
Repetition period	640 ms
Modification period	1280 ms
Type of Error Protection	Turbo
Coding Rate	1/3
Rate Matching attribute	256
Size of CRC	16

A.4.1.1.2 IMB

The parameters for the MCCH demodulation tests are specified in Table A.41A and Table A.41B and Table A.41C..

Table A.41A: Physical channel parameters for S-CCPCH frame type 1

Parameter	Unit	Level
Channel bit rate	kbps	30
Channel symbol rate	ksps	15
Slot format #i	-	1
TFCI	-	ON

Table A.41B: Transport channel parameters for S-CCPCH frame type 1

Parameter	MCCH
User Data Rate	6.4 kbps
Transport Block Size	72
Transport Block Set Size	72
RLC SDU block size	4088
Transmission Time Interval	10 ms
Repetition Period	640 ms
Modification Period	1280 ms
Type of Error Protection	Convolutional Coding
Coding Rate	1/3
Rate matching Attribute	256
Size of CRC	16

Table A.41C: Configuration of other physical channels during MCCH test

Physical Channel	Power Ratio (Ec/Ior)	NOTE
P-CPICH	-10 dB	
T-CPICH	-0.457 dB	
P-CCPCH	-12 dB	
SCH	-12 dB	This power shall be divided equally between Primary and Secondary Synchronous channels
OCNS	Necessary power so that total transmit power spectral density of Node B (Ior) adds to one	OCNS interference consists of 15 codes of equal power, each code using SF16 and QPSK modulation

A.4.1.2 1.28 Mcps TDD Option

The parameters for the MCCH demodulation tests are specified in Table A.43 and Table A.44.

Table A.43: Physical channel parameters for S-CCPCH

Parameter	Unit	Level ¹	Level ²
Channel bit rate	kbps	17.6	19.2
Channel symbol rate	ksps	8.8	9.6
Slot Format		No TPC, SS	No TPC SS
SF	-	16	16
TFCI	-	ON	ON
NOTE1: used for MCCH test in section 10.1.1.2.			
NOTE2: used for MCCH test in section 10.1.2.2.			

Table A.44: Transport channel parameters for S-CCPCH

Parameter	MCCH
User Data Rate	7.6 kbps
Number Transport Channel	1
Transport Block Size	72
Transport Block Set Size	72
RLC SDU block size	4088
Transmission Time Interval	10 ms
Repetition period	640 ms
Modification period	1280 ms
Type of Error Protection	Convolutional code 1/3
Coding Rate	1/3
Rate Matching attribute	160
Size of CRC	16
TFCI	ON

A.4.1.3 7.68 Mcps TDD Option

The parameters for the MCCH demodulation tests are specified in Table A.44A and Table A.44B.

Table A.44A: Physical channel parameters for S-CCPCH

Parameter	Unit	Level	Level
Channel bit rate	kbps	22.8	22.8
Channel symbol rate	ksps	11.4	11.4
Slot Format #i	-	3	21
TFCI	-	ON	ON

Table A.44B: Transport channel parameters for S-CCPCH

Parameter	MCCH
User Data Rate	7.2 kbps
Number Transport Channel	1
Transport Block Size	581
Transport Block Set Size	581
RLC SDU block size	4088
Transmission Time Interval	80 ms
Repetition period	640 ms
Modification period	1280 ms
Type of Error Protection	Turbo
Coding Rate	1/3
Rate Matching attribute	256
Size of CRC	16

A.4.2 MTCH

A.4.2.1 3.84 Mcps TDD Option

A.4.2.1.1 Non-IMB

The parameters for the MTCH demodulation tests are specified in Table A.45 and Table A.46.

Table A.45: Physical channel parameters for S-CCPCH

Parameter	Unit	Level	Level	Level
User Data Rate	kbps	512	256	128
Modulation	-	16QAM	QPSK	QPSK
Channel bit rate	kbps	1547.8	388.8	388.8
Channel symbol rate	ksps	386.95	194.4	194.4
Slot Format #i	-	23 and 22	3 and 0	3 and 0
TFCI	-	ON	ON	ON
Physical resources	-	16 codes x SF16 1 timeslot/ frame	16 codes x SF16 1 timeslot/ frame	16 codes x SF16 1 timeslot/ frame

Table A.46: Transport channel parameters for S-CCPCH

Parameter	MTCH		
	512 kbps	256 kbps	128 kbps
User Data Rate	512 kbps	256 kbps	128 kbps
Number of Transport Channel	1	1	1
Transport Block Size	2561	2561	2561
Transport Block Set Size	40976	10244	5122
Nr of transport blocks/TTI	16	4	2
RLC SDU block size	40688	10160	5072
Transmission Time Interval	80ms	40 ms	40 ms
Type of Error Protection	Turbo	Turbo	Turbo
Coding Rate	1/3	1/3	1/3
Rate Matching attribute	256	256	256
Size of CRC	16	16	16
Puncturing limit	0.52	1.0	1.0

A.4.2.1.2 IMB

The parameters for the MTCH demodulation tests are specified in Table A.46A, Table A.46B and Table A.46C.

Table A.46A: Physical channel parameters for S-CCPCH frame type 2

Parameter	Unit	Level
User Data Rate	kbps	512
Modulation	-	16QAM
Channel bit rate	kbps	960
Channel symbol rate	ksps	240
Slot Format #i	-	4 and 5
TFCI	-	ON
Physical resources	-	5 codes x SF16 1 x 2ms sub-frame

Table A.46B: Transport channel parameters for S-CCPCH frame type 2

Parameter	MTCH
User Data Rate	512 kbps
Number of Transport Channel	1
Transport Block Size	2536
Transport Block Set Size	40576
Nr of transport blocks/TTI	16
RLC SDU block size	40304
Transmission Time Interval	80 ms
Type of Error Protection	Turbo
Coding Rate	1/3
Rate matching Attribute	256
Size of CRC	16

Table A.46C: Configuration of other physical channels during MTCH test

Physical Channel	Power Ratio (Ec/Ior)	NOTE
P-CPICH	-10 dB	
T-CPICH	-0.457 dB	
P-CCPCH	-12 dB	
S-CCPCH frame type 1	-24 dB	
SCH	-12 dB	This power shall be divided equally between Primary and Secondary synchronous channels
OCNS	Necessary power so that total transmit power spectral density of Node B (Ior) adds to one	OCNS interference consists of 10 codes of equal power, each code using SF16 and QPSK modulation

A.4.2.2 1.28 Mcps TDD Option

The parameters for the MTCH demodulation tests are specified in Table A.47 and Table A.48.

Table A.47: Physical channel parameters for S-CCPCH

Parameter	Unit	Level		Level		Level	Level
User Data Rate	kbps	384		192		128	64
Channel bit rate	kbps	614.4 ¹	563.2 ²	307.2 ¹	281.6 ²	246.4	140.8
Channel symbol rate	ksps	153.6 ¹	140.8 ²	153.6 ¹	140.8 ²	123.2	70.4
Slot Format	-	No TPC SS		No TPC SS		No TPC, SS	No TPC, SS
TFCI	-	ON		ON		ON	ON
Note1 used for test 3 and test 4 in section 10.2.2.2							
Note2 used for test 1 and test 2 in section 10.2.2.2							

Table A.48: Transport channel parameters for S-CCPCH

Parameter	MTCH			
	384kbps	192kbps	128 kbps	64 kbps
User Data Rate	384kbps	192kbps	128 kbps	64 kbps
Number of Transport Channel	1	1	1	1
Transport Block Size	2561	2561	2561	1281
Transport Block Set Size	15366	7683	5122	2562
Nr of transport blocks/TTI	6	3	2	2
RLC SDU block size	15248	7616	5072	2512
Transmission Time Interval	40ms	40ms	40 ms	40 ms
Type of Error Protection	Turbo	Turbo	Turbo	Turbo
Coding Rate	1/3	1/3	1/3	1/3
Rate Matching attribute	256	256	256	256
Size of CRC	16	16	16	16

Parameters for combined MTCH demodulation and cell identification requirements are defined in Table A.49.

Table A.49: Cell reselection parameters

Parameter	Unit	Value
Serving cell in the initial condition	-	Cell 1
Neighbour cells	-	Cell 2 and cell 3
Cell_selection_and_reselection_quality_measure	-	P-CCPCH
Qrxlevmin	dBm	-103
UE_TXPWR_MAX_RACH	dBm	21
Treselection	seconds	4
Sintrasearch	dB	not sent
IE "FACH Measurement occasion info"	-	not sent

A.4.2.3 7.68 Mcps TDD Option

The parameters for the MTCH demodulation tests are specified in Table A.49a and Table A.50.

Table A.49a: Physical channel parameters for S-CCPCH

Parameter	Unit	Level	Level	Level
User Data Rate	kbps	512	256	128
Modulation	-	16QAM	QPSK	QPSK
Channel bit rate	kbps	1547.8	388.8	388.8
Channel symbol rate	ksps	386.95	194.4	194.4
Slot Format #i	-	23 and 22	3 and 0	3 and 0
TFCI	-	ON	ON	ON
Physical resources	-	16 codes x SF32 1 timeslot/ frame	16 codes x SF32 1 timeslot/ frame	16 codes x SF32 1 timeslot/ frame

Table A.50: Transport channel parameters for S-CCPCH

Parameter	MTCH		
	512 kbps	256 kbps	128 kbps
User Data Rate	512 kbps	256 kbps	128 kbps
Number of Transport Channel	1	1	1
Transport Block Size	2561	2561	2561
Transport Block Set Size	40976	10244	5122
Nr of transport blocks/TTI	16	4	2
RLC SDU block size	40688	10160	5072
Transmission Time Interval	80ms	40 ms	40 ms
Type of Error Protection	Turbo	Turbo	Turbo
Coding Rate	1/3	1/3	1/3
Rate Matching attribute	256	256	256
Size of CRC	16	16	16
Puncturing limit	0.52	1.0	1.0

A.5 HSUPA reference measurement channels for 1.28Mcps TDD option

A.5.1 Fixed reference channel 1(FRC1) for 16QM

Table A.51: E-DCH Fixed reference channel 1 (1.28Mcps TDD option)

Parameter	Unit	Value
Maximum information bit throughput	kbps	342.4
Information Bit Payload (N_{INF})	Bits	1712
Number Code Blocks	Blocks	1
Number of coded bits per TTI	Bits	1736
Coding Rate		0.623
Modulation		16QAM
Number of E-DCH Timeslots	Slots	1
Number of E-DCH codes per TS	Codes	1
Spreading factor	SF	1
Number of E-UCCH per TTI		1

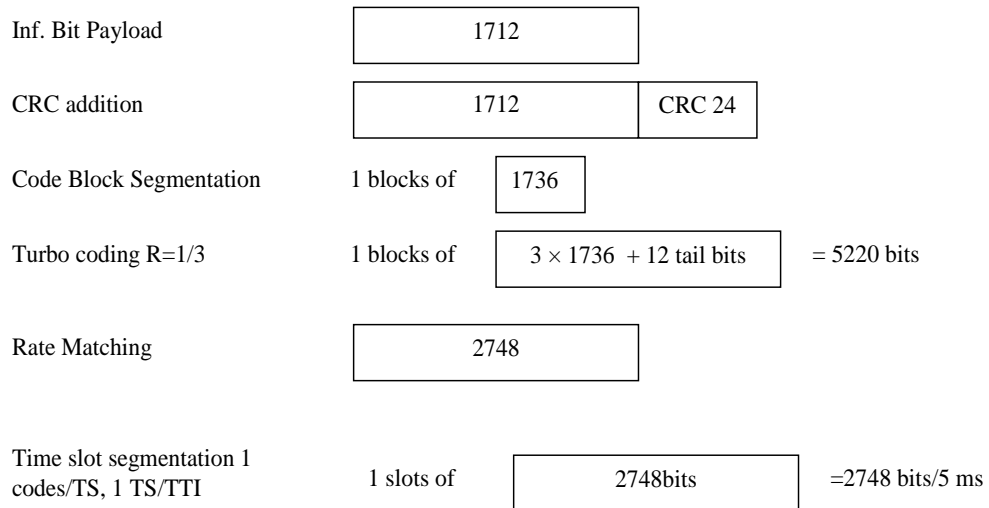

Figure A.17: Coding for E-DCH FRC1 (1.28 Mcps TDD Option)

Annex B (normative): Propagation conditions

B.1 Static propagation condition

The propagation for the static performance measurement is an Additive White Gaussian Noise (AWGN) environment. No fading and multi-paths exist for this propagation model.

B.2 Multi-path fading propagation conditions

B.2.1 3.84 Mcps TDD Option

Table B.1 shows propagation conditions that are used for the performance measurements in multi-path fading environment. All taps have classical Doppler spectrum.

Table B.1: Propagation Conditions for Multi path Fading Environments for operations referenced in 5.2 a), 5.2 b) and 5.2 c)

Case 1 speed 3km/h		Case 2 speed 3 km/h		Case 3 speed 120 km/h		CASE 4 speed 50 km/h (note)	
Relative Delay [ns]	Relative Mean Power [dB]	Relative Delay [ns]	Relative Mean Power [dB]	Relative Delay [ns]	Relative Mean Power [dB]	Relative Delay [ns]	Relative Mean Power [dB]
0	0	0	0	0	0	0	0
976	-10	976	0	260	-3	976	-10
		12000	0	521	-6		
				781	-9		

NOTE: Case 4 is only used in TS25.123.

Table B.1A: Propagation Conditions for Multi-Path Fading Environments for HSDPA Performance Requirements for operations referenced in 5.2 a), 5.2 b) and 5.2 c)

ITU Pedestrian A Speed 3km/h (PA3)		ITU Pedestrian B Speed 3Km/h (PB3)		ITU vehicular A Speed 30km/h (VA30)		ITU vehicular A Speed 120km/h (VA120)	
Relative Delay [ns]	Relative Mean Power [dB]	Relative Delay [ns]	Relative Mean Power [dB]	Relative Delay [ns]	Relative Mean Power [dB]	Relative Delay [ns]	Relative Mean Power [dB]
0	0	0	0	0	0	0	0
110	-9.7	200	-0.9	310	-1.0	310	-1.0
190	-19.2	800	-4.9	710	-9.0	710	-9.0
410	-22.8	1200	-8.0	1090	-10.0	1090	-10.0
		2300	-7.8	1730	-15.0	1730	-15.0
		3700	-23.9	2510	-20	2510	-20

**Table B.1B: Propagation Conditions for Multi path Fading Environments
for operations referenced in 5.2 d)**

Case 1 speed 2.3km/h		Case 2 speed 2.3 km/h		Case 3 speed 92 km/h		Case 4 speed 38 km/h *	
Relative Delay [ns]	Relative Mean Power [dB]	Relative Delay [ns]	Relative Mean Power [dB]	Relative Delay [ns]	Relative Mean Power [dB]	Relative Delay [ns]	Relative Mean Power [dB]
0	0	0	0	0	0	0	0
976	-10	976	0	260	-3	976	-10
		12000	0	521	-6		
				781	-9		
NOTE: Case 4 is only used in TS25.123.							

**Table B.1C: Propagation Conditions for Multi-Path Fading Environments for HSDPA Performance
Requirements for operations referenced in 5.2 d)**

ITU Pedestrian A Speed 2.3km/h (PA3)		ITU Pedestrian B Speed 2.3Km/h (PB3)		ITU vehicular A Speed 23 km/h (VA30)		ITU vehicular A Speed 92 km/h (VA120)	
Relative Delay [ns]	Relative Mean Power [dB]	Relative Delay [ns]	Relative Mean Power [dB]	Relative Delay [ns]	Relative Mean Power [dB]	Relative Delay [ns]	Relative Mean Power [dB]
0	0	0	0	0	0	0	0
110	-9.7	200	-0.9	310	-1.0	310	-1.0
190	-19.2	800	-4.9	710	-9.0	710	-9.0
410	-22.8	1200	-8.0	1090	-10.0	1090	-10.0
		2300	-7.8	1730	-15.0	1730	-15.0
		3700	-23.9	2510	-20	2510	-20

Table B.1D: Propagation Conditions for Multi-Path Fading Environments for Performance Requirements under an extended delay spread environment

Extended Delay Spread			
Operations referenced in 5.2 a), 5.2 b) and 5.2 c) Speed 3km/h (EDS)		Operations referenced in 5.2 d) Speed 2.3km/h (EDS)	
Relative Delay [ns]	Relative Mean Power [dB]	Relative Delay [ns]	Relative Mean Power [dB]
0	0	0	0
310	-1	310	-1
710	-9	710	-9
1090	-10	1090	-10
1730	-15	1730	-15
2510	-20	2510	-20
12490	-10	12490	-10
12800	-11	12800	-11
13200	-19	13200	-19
13580	-20	13580	-20
14220	-25	14220	-25
15000	-30	15000	-30
27490	-20	27490	-20
27800	-21	27800	-21
28200	-29	28200	-29
28580	-30	28580	-30
29220	-35	29220	-35
30000	-40	30000	-40

B.2.2 1.28 Mcps TDD Option

Table B.2 shows propagation conditions that are used for the general performance measurements in multi-path fading environment. Table B.3 shows propagation conditions that are used for HSDPA and multi-carrier HSDPA performance measurements in multi-path fading environments. For multi-carrier HSDPA requirements, the fading of the signals for each carrier shall be independent. All taps in both tables have classical Doppler spectrum.

Table B.2: Propagation Conditions for Multi-Path Fading Environments operations

Case 1	Case 2	Case 3
Speed for operating band a, b, c, f: 3km/h	Speed for operating band a, b, c, f: 3km/h	Speed for operating band a, b, c, f: 120km/h
Speed for operating band d: 2.3km/h	Speed for operating band d: 2.3km/h	Speed for operating band d: 92km/h
Speed for operating band e: 2.6km/h	Speed for operating band e: 2.6km/h	Speed for operating band e: 102km/h

Relative Delay [ns]	Relative Mean Power [dB]	Relative Delay [ns]	Relative Mean Power [dB]	Relative Delay [ns]	Relative Mean Power [dB]
0	0	0	0	0	0
2928	-10	2928	0	781	-3
		12000	0	1563	-6
				2344	-9

Table B.3: Propagation Conditions for Multi-Path Fading Environments for HSDPA Performance Requirements

ITU Pedestrian A		ITU Pedestrian B		ITU vehicular A		ITU vehicular A	
Speed for operating band a, b, c, f: 3km/h		Speed for operating band a, b, c, f: 3km/h		Speed for operating band a, b, c, f: 30km/h		Speed for operating band a, b, c, f: 120km/h	
Speed for operating band d: 2.3km/h		Speed for operating band d: 2.3km/h		Speed for operating band d: 23km/h		Speed for operating band d: 92km/h	
Speed for operating band e: 2.6km/h		Speed for operating band e: 2.6km/h		Speed for operating band e: 26km/h		Speed for operating band e: 102km/h	
Relative Delay [ns]	Relative Mean Power [dB]	Relative Delay [ns]	Relative Mean Power [dB]	Relative Delay [ns]	Relative Mean Power [dB]	Relative Delay [ns]	Relative Mean Power [dB]
0	0	0	0	0	0	0	0
110	-9.7	200	-0.9	310	-1.0	310	-1.0
190	-19.2	800	-4.9	710	-9.0	710	-9.0
410	-22.8	1200	-8.0	1090	-10.0	1090	-10.0
		2300	-7.8	1730	-15.0	1730	-15.0
		3700	-23.9	2510	-20	2510	-20

Table B.3B shows propagation conditions that are used for MBSFN demodulation performance measurements in multi-path fading environment. All taps have classical Doppler spectrum.

In the case of Rx diversity, the fading of the signals and the AWGN signals provided in each receiver antenna port shall be independent.

Table B.3B: Propagation Conditions for Multi-Path Fading Environments for MBSFN Demodulation Performance Requirements

MBSFN channel model 1		MBSFN channel model 2	
Speed for Band a, b, c, f: 30 km/h		Speed for Band a, b, c, f: 30 km/h	
Speed for Band d: 23 km/h		Speed for Band d: 23 km/h	
Speed for Band e: 26 km/h		Speed for Band e: 26km/h	
Relative Delay [ns]	Relative Mean Power [dB]	Relative Delay [ns]	Relative Mean Power [dB]
0	0.0	0	0.0
310	-1.0	310	-1.0
710	-9.0	710	-9.0
1090	-10.0	1090	-10.0
1730	-15.0	1730	-15.0
2510	-20.0	2510	-20.0
2734	-6.6	5859	-6.8
3044	-7.6	6169	-7.8
3444	-15.6	6569	-15.8
3824	-16.6	6949	-16.8
4464	-21.6	7589	-21.8
5469	-8.5	10938	-13.3
5779	-9.5	11248	-14.3
6179	-17.5	11648	-22.3
6559	-18.5	12028	-23.3
8428	-12.6	15459	-15.0
8738	-13.6	15769	-16.0
9138	-21.6	16169	-24.0

B.2.3 7.68 Mcps TDD Option

Table B.4 and Table B.5 show propagation conditions that are used for the performance measurements in multi-path fading environment. All taps have classical Doppler spectrum.

Table B.4: Propagation Conditions for Multi path Fading Environments for operations referenced in 5.2 a), 5.2 b) and 5.2 c)

Case 1 speed 3km/h		Case 2 speed 3 km/h		Case 3 speed 120 km/h		CASE 4 speed 50 km/h *	
Relative Delay [ns]	Relative Mean Power [dB]	Relative Delay [ns]	Relative Mean Power [dB]	Relative Delay [ns]	Relative Mean Power [dB]	Relative Delay [ns]	Relative Mean Power [dB]
0	0	0	0	0	0	0	0
976	-10	976	0	260	-3	976	-10
		12000	0	521	-6		
				781	-9		

*NOTE: Case 4 is only used in TS25.123.

Table B.5: Propagation Conditions for Multi-Path Fading Environments for HSDPA Performance Requirements for operations referenced in 5.2 a), 5.2 b) and 5.2 c)

ITU Pedestrian A Speed 3km/h (PA3)		ITU Pedestrian B Speed 3Km/h (PB3)		ITU vehicular A Speed 30km/h (VA30)		ITU vehicular A Speed 120km/h (VA120)	
Relative Delay [ns]	Relative Mean Power [dB]	Relative Delay [ns]	Relative Mean Power [dB]	Relative Delay [ns]	Relative Mean Power [dB]	Relative Delay [ns]	Relative Mean Power [dB]
0	0	0	0	0	0	0	0
110	-9.7	200	-0.9	310	-1.0	310	-1.0
190	-19.2	800	-4.9	710	-9.0	710	-9.0
410	-22.8	1200	-8.0	1090	-10.0	1090	-10.0
		2300	-7.8	1730	-15.0	1730	-15.0
		3700	-23.9	2510	-20	2510	-20

Table B.6: Propagation Conditions for Multi path Fading Environments for operations referenced in 5.2 d)

Case 1 speed 2.3km/h		Case 2 speed 2.3 km/h		Case 3 speed 92 km/h		Case 4 speed 38 km/h *	
Relative Delay [ns]	Relative Mean Power [dB]	Relative Delay [ns]	Relative Mean Power [dB]	Relative Delay [ns]	Relative Mean Power [dB]	Relative Delay [ns]	Relative Mean Power [dB]
0	0	0	0	0	0	0	0
976	-10	976	0	260	-3	976	-10
		12000	0	521	-6		
				781	-9		

*NOTE: Case 4 is only used in TS 25.123.

Table B.7: Propagation Conditions for Multi-Path Fading Environments for HSDPA Performance Requirements for operations referenced in 5.2 d)

ITU Pedestrian A Speed 2.3km/h (PA3)		ITU Pedestrian B Speed 2.3Km/h (PB3)		ITU vehicular A Speed 23 km/h (VA30)		ITU vehicular A Speed 92 km/h (VA120)	
Relative Delay [ns]	Relative Mean Power [dB]	Relative Delay [ns]	Relative Mean Power [dB]	Relative Delay [ns]	Relative Mean Power [dB]	Relative Delay [ns]	Relative Mean Power [dB]
0	0	0	0	0	0	0	0
110	-9.7	200	-0.9	310	-1.0	310	-1.0
190	-19.2	800	-4.9	710	-9.0	710	-9.0
410	-22.8	1200	-8.0	1090	-10.0	1090	-10.0
		2300	-7.8	1730	-15.0	1730	-15.0
		3700	-23.9	2510	-20	2510	-20

Table B.8: Propagation Conditions for Multi-Path Fading Environments for Performance Requirements under an extended delay spread environment

Extended Delay Spread			
Operations referenced in 5.2 a), 5.2 b) and 5.2 c) Speed 3km/h (EDS)		Operations referenced in 5.2 d) Speed 2.3km/h (EDS)	
Relative Delay [ns]	Relative Mean Power [dB]	Relative Delay [ns]	Relative Mean Power [dB]
0	0	0	0
310	-1	310	-1
710	-9	710	-9
1090	-10	1090	-10
1730	-15	1730	-15
2510	-20	2510	-20
12490	-10	12490	-10
12800	-11	12800	-11
13200	-19	13200	-19
13580	-20	13580	-20
14220	-25	14220	-25
15000	-30	15000	-30
27490	-20	27490	-20
27800	-21	27800	-21
28200	-29	28200	-29
28580	-30	28580	-30
29220	-35	29220	-35
30000	-40	30000	-40

B.3 MIMO propagation conditions

B.3.1 3.84 Mcps TDD Option

<void>

B.3.2 1.28 Mcps TDD Option

MIMO propagation conditions are defined for a 2x2 antenna configuration. The resulting propagation channel shall be characterized by a complex 2x2 matrix termed

$$\mathbf{H} = \begin{pmatrix} h_{11} & h_{12} \\ h_{21} & h_{22} \end{pmatrix}.$$

B.3.2.1 MIMO Dual Stream Static Orthogonal Conditions

The channel coefficients of the resulting propagation channel under MIMO dual stream conditions shall be given by

$$\mathbf{H} = \begin{pmatrix} h_{11} & h_{12} \\ h_{21} & h_{22} \end{pmatrix} = \begin{pmatrix} 1 & 1 \\ 1 & -1 \end{pmatrix}$$

The generation of the resulting channel coefficients for MIMO dual stream conditions and the association with the transmitter and receiver ports are depicted Figure B.1. Figure B.1 does not restrict test system implementation.

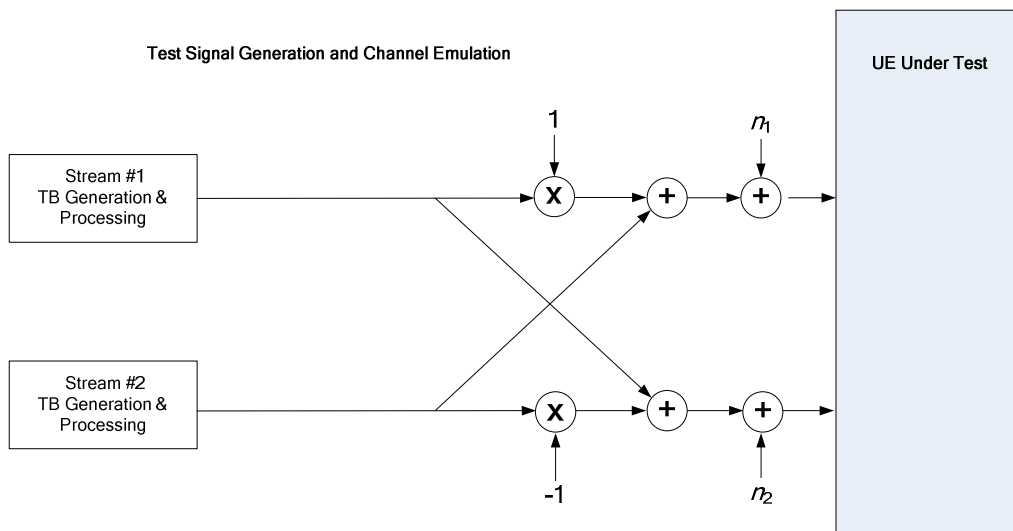

Figure B.1: Test setup under MIMO Dual Stream Static Orthogonal Conditions

B.3.3 7.68 Mcps TDD Option

<void>

B.4 Moving propagation conditions

The dynamic propagation conditions for the test of the baseband performance are non fading channel models with two taps. The moving propagation condition has two taps, one static, Path0, and one moving, Path1. The time difference between the two paths is according Equation (B.1). The taps have equal strengths and equal phases.

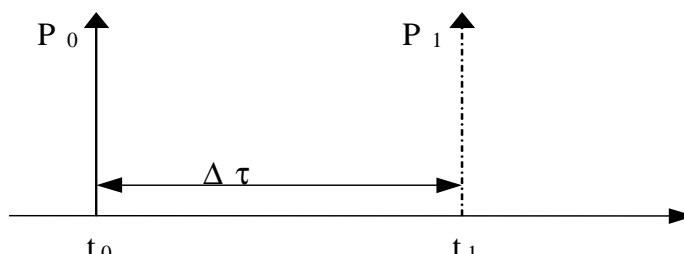

Figure B.2: The moving propagation conditions

$$\Delta\tau = B + \frac{A}{2}(1 + \sin(\Delta\omega \cdot t)) \tag{B.1}$$

The parameters in the equation are shown in.

A	5 μ s
B	1 μ s
$\Delta\omega$	$40 \cdot 10^{-3} \text{ s}^{-1}$

B.5 Birth-Death propagation conditions

The dynamic propagation conditions for the test of the baseband performance is a non fading propagation channel with two taps. The moving propagation condition has two taps, Path1 and Path2 while alternate between 'birth' and 'death'. The positions the paths appear are randomly selected with an equal probability rate and are shown in figure B.3.

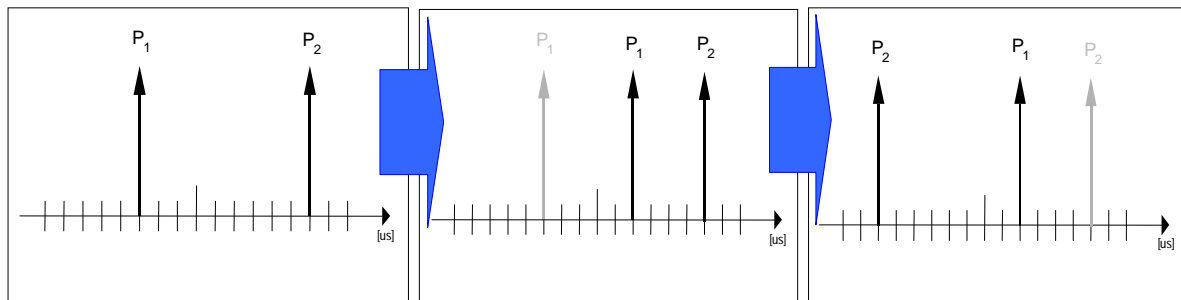

Figure B.3: Birth death propagation sequence

NOTE1: Two paths, Path1 and Path2 are randomly selected from the group [-3, -2, -1, 0, 1, 2, 3] chip(781.25ns). The paths have equal strengths and equal phases.

NOTE 2: After 191 ms, Path1 vanishes and reappears immediately at a new location randomly selected from the group [-3, -2, -1, 0, 1, 2, 3]chip but excludes the point Path2.

NOTE 3: After additional 191 ms, Path2 vanishes and reappears immediately at a new location randomly selected from the group [-3, -2, -1, 0, 1, 2, 3] chip but excludes the point Path1.

NOTE 4: The sequence in 2) and 3) is repeated.

Annex C (normative): Environmental conditions

C.1 General

This normative annex specifies the environmental requirements of the UE. Within these limits the requirements of this specifications shall be fulfilled.

C.2 Environmental requirements for the UE

The requirements in this clause apply to all types of UE(s)

C.2.1 Temperature

The UE shall fulfil all the requirements in the full temperature range of:

Table C.1

+15°C - +35°C	for normal conditions (with relative humidity of 25 % to 75 %);
-10°C - +55°C	for extreme conditions (see IEC publications 68-2-1 and 68-2-2)

Outside this temperature range the UE, if powered on, shall not make ineffective use of the radio frequency spectrum. In no case shall the UE exceed the transmitted levels as defined in S25.102 for extreme operation.

C.2.2 Voltage

The UE shall fulfil all the requirements in the full voltage range, i.e. the voltage range between the extreme voltages.

The manufacturer shall declare the lower and higher extreme voltages and the approximate shutdown voltage. For the equipment that can be operated from one or more of the power sources listed below, the lower extreme voltage shall not be higher, and the higher extreme voltage shall not be lower than that specified below.

Table C.2

Power source	Lower extreme voltage	Higher extreme voltage	Normal conditions voltage
AC mains	0,9 * nominal	1,1 * nominal	nominal
Regulated lead acid battery	0,9 * nominal	1,3 * nominal	1,1 * nominal
Non regulated batteries:			
Leclanché/lithium	0,85 * nominal	Nominal	Nominal
Mercury/nickel cadmium	0,90 * nominal	Nominal	Nominal

Outside this voltage range the UE if powered on, shall not make ineffective use of the radio frequency spectrum. In no case shall the UE exceed the transmitted levels as defined in S4.01A for extreme operation. In particular, the UE shall inhibit all RF transmissions when the power supply voltage is below the manufacturer declared shutdown voltage.

C.2.3 Vibration

The UE shall fulfil all the requirements when vibrated at the following frequency/amplitudes:

Table C.3

Frequency	ASD (Acceleration Spectral Density) random vibration
5 Hz to 20 Hz	0,96 m ² /s ³
20 Hz to 500 Hz	0,96 m ² /s ³ at 20 Hz, thereafter -3 dB/Octave

Outside the specified frequency range the UE, if powered on, shall not make ineffective use of the radio frequency spectrum. In no case shall the UE exceed the transmitted levels as defined in S4.01A for extreme operation.

Annex D (informative): Terminal capabilities (TDD)

Void

[Note: All UE capabilities can be found in 3GPP TS 25.306]

Annex E (informative): Change history

TSG	29	CR	R	Title	Cat	Curr	New	Work Item
RP-29				Rel-7 version created based on v6.2.0			7.0.0	
RP-29	RP-050501	0153		Introduction of UMTS 2.6GHz operating band for TDD	B	6.1.0	7.0.0	RInImp-UMTS2600TD
RP-29	RP-050501	0154		UMTS 2.6 GHz TDD Propagation Conditions	B	6.1.0	7.0.0	RInImp-UMTS2600TD
RP-29	RP-050501	0155		UMTS 2.6 GHz TDD UE Receiver Specifications	B	6.1.0	7.0.0	RInImp-UMTS2600TD
RP-29	RP-050501	0156	2	Channel Raster and UARFCN for 3.84 Mcps TDD in UMTS 2.6 GHz	B	6.1.0	7.0.0	RInImp-UMTS2600TD
RP-29	RP-050501	0157		Introduction of UMTS 2.6 GHz new operating band for 1.28Mcps TDD	B	6.1.0	7.0.0	RInImp-UMTS2600TD
RP-29	RP-050501	0158		Introduction of Propagation Conditions for UMTS 2.6 GHz for 1.28Mcps TDD	B	6.1.0	7.0.0	RInImp-UMTS2600TD
RP-29	RP-050501	0159		Introduction of UMTS 2.6 GHz requirements for blocking and spurious emission of UE receiver for 1.28Mcps TDD	B	6.1.0	7.0.0	RInImp-UMTS2600TD
RP-30	RP-050740	0160	1	Additional UE Tx Spurious Emission for co-existence with 2.6 GHz FDD	B	7.0.0	7.1.0	RInImp-UMTS2600TD
RP-31	RP-060104	0162	1	Modifications to HSDPA test parameters for 1.28Mcps TDD	A	7.1.0	7.2.0	TEI6
RP-31	RP-060113	0163	1	MBMS Requirements for MCCH & MTCH channels	B	7.1.0	7.2.0	MBMS-RAN-RF-TDD
RP-32	RP-060313	0165	2	1.28Mcps TDD MBMS UE performance requirements	B	7.2.0	7.3.0	MBMS-RAN-RF-TDD
RP-32	RP-060309	0166	1	7.68 Mcps Frequency Band & Channel Arrangement	B	7.2.0	7.3.0	VHCRTDD-RF
RP-32	RP-060309	0167	2	7.68 Mcps UE Transmitter Characteristics	B	7.2.0	7.3.0	VHCRTDD-RF
RP-32	RP-060309	0168		7.68 Mcps UE Receiver Characteristics	B	7.2.0	7.3.0	VHCRTDD-RF
RP-32	RP-060309	0169		7.68 Mcps - Channel Performance	B	7.2.0	7.3.0	VHCRTDD-RF
RP-32	RP-060309	0170	1	7.68 Mcps Measurement Channels & Propagation Conditions	B	7.2.0	7.3.0	VHCRTDD-RF
RP-33	RP-060522	0180		HS-SCCH performance requirement for 3.84 Mcps TDD option and 7.68 Mcps TDD option		7.3.0	7.4.0	TEI7
RP-33	RP-060516	0185	1	Out of band blocking for 3.84 Mcps and 7.68 Mcps TDD UE operating in 2010-2025 MHz of band (a) in Japan.		7.3.0	7.4.0	TEI7
RP-33	RP-060517	0190		Clarification of Tx spurious emission level from 3.84 Mcps and 7.68 MCps TDD UE into PHS band		7.3.0	7.4.0	TEI7
RP-33	RP-060529	0192		Editorial corrections to 3.84 Mcps TDD UE performances on MBMS.		7.3.0	7.4.0	TEI7
RP-33	RP-060528	0193		Performance requirements for 3.84 Mcps E-DCH associated downlink signalling channels: E-AGCH and E-HICH		7.3.0	7.4.0	TEI7
RP-33	RP-060526	0194		7.68 Mcps Operations in 2.6 GHz band		7.3.0	7.4.0	TEI7
RP-33	RP-060530	0195		Clarification of 7.68 Mcps TDD UE ACLR at +/- 10 MHz offset.		7.3.0	7.4.0	MBMS-RAN-RF-TDD
RP-33	RP-060530	0196		Performance requirements for 3.84 Mcps E-DCH associated downlink signalling channels: E-AGCH and E-HICH		7.3.0	7.4.0	EDCHTDD-RF

RP-34	RP-060810	0200		Combined MBMS demodulation and Cell identification requirement for 1.28 Mcps TDD	A	7.4.0	7.5.0	TEI6
RP-34	RP-060818	0198		Performance requirements for 7.68 Mcps E-DCH associated downlink signalling channels: E-AGCH and E-HICH	B	7.4.0	7.5.0	TEI7
RP-34	RP-060816	0197		PLCCH Performance Requirement	B	7.4.0	7.5.0	RANimp-RABSE-CodOptLCRTDD
RP-35	RP-070081	0209		Modificaiton to SEM for 1.28Mcps TDD	A	7.5.0	7.6.0	TEI4
RP-35	RP-070082	0201		Performance requirements for 7.68 Mcps E-DCH associated downlink signalling channels: E-AGCH and E-HICH	B	7.5.0	7.6.0	TEI7
RP-35	RP-070082	0203		Corrections & clarifications on 7.68 Mcps TDD MTCH demodulation test case.	F	7.5.0	7.6.0	TEI7
RP-35	RP-070085	0202		Performance requirements for MTCH using 16QAM in an extended delay spread environment	B	7.5.0	7.6.0	MBMSE-RANPhysTDD
RP-35	RP-070085	0211		Performance requirement for MCCH in an extended delay spread environment	B	7.5.0	7.6.0	MBMSE-RANPhysTDD
RP-36	RP-070376	0225		Performance requirements for MCCH in an extended delay spread environment.	F	7.6.0	7.7.0	MBMSE-RANPhysTDD
RP-36	RP-070376	0212	1	MCCH & MTCH Channels Performances in TDD MBSFN	B	7.6.0	7.7.0	MBMSE-RANPhysTDD
RP-36	RP-070376	0224	1	Performance requirements for MTCH using 16QAM in an extended delay spread environment.	F	7.6.0	7.7.0	MBMSE-RANPhysTDD
RP-36	RP-070376	0213	1	Performance requirement for MTCH in a MBSFN TDD UE sharing the same platform with a FDD UE	B	7.6.0	7.7.0	MBMSE-RANPhysTDD
RP-36	RP-070377	0223	1	Performance requirements for 1.28 Mcps E-DCH associated downlink signalling channels: E-AGCH and E-HICH	B	7.6.0	7.7.0	LCRTDD-EDCH-RF
RP-36	RP-070373	0222	1	Updating of HSDPA demodulation performance requirements for 1.28Mcps TDD	A	7.6.0	7.7.0	TEI7
RP-36	RP-070373	0216		Updating of HSDPA demodulation performance requirements for 1.28Mcps TDD-FRC	A	7.6.0	7.7.0	TEI7
RP-36	RP-070373	0219		Updating of HSDPA demodulation performance requirements for 1.28Mcps TDD-VRC	A	7.6.0	7.7.0	TEI7
RP-37	RP-070651	0243		Change to HSDPA for 1.28 Mcps TDD	F	7.7.0	7.8.0	TEI7
RP-37	RP-070651	0240		Correction of UE maximum output power classes for 1.28 Mcps TDD option	F	7.7.0	7.8.0	TEI7
RP-37	RP-070651	0230		Inclusion of 7.68 Mcps in the scope of document	D	7.7.0	7.8.0	TEI7
RP-37	RP-070651	0232		Clarification of MBMS test for LCR TDD	A	7.7.0	7.8.0	TEI7
RP-37	RP-070652	0229		Requirements for maximum Input level for HS-PDSCH reception	A	7.7.0	7.8.0	TEI7
RP-37	RP-070654	0234		Performance Requirements for TDD MBSFN Channels	B	7.7.0	7.8.0	MBMSE-RANPhysTDD
RP-38	RP-070935	0244		LCR TDD MBSFN UE demodulation performance requirements	B	7.8.0	7.9.0	MBMSE-RANPhysLCRTDD
RP-38	RP-070937	0245		Relative delay corrections in Extended Delay Spread propagation condition	F	7.8.0	7.9.0	TEI7
RP-39	RP-080118	0250		Adding EVM requirement for UL 16QAM	F	7.9.0	7.10.0	LCRTDD-EDCH-RF
RP-39	RP-080118	0251	1	Adding requirements for MBSFN capable UE (dedicated carrier case)	F	7.9.0	7.10.0	MBMS-RANPhysLCRTDD
RP-39	RP-080119	0246		Omissions of minimum requirements for blocking characteristics	F	7.9.0	7.10.0	TEI6
RP-39	RP-080119	0249		Deleting redundant notes for receiver spurious emissions	F	7.9.0	7.10.0	TEI6
RP-40	RP-080324	0263		Clarification of MCCH Physical Channel for MBSFN	F	7.10.0	7.11.0	MBMSE-RANPhysTDD
RP-40	RP-080324	0262		Correction to MTCH parameters for demodulation test in TDD MBSFN	F	7.10.0	7.11.0	MBMSE-RANPhysTDD
RP-40	RP-080324	0257		Corrections for LCR TDD MBMS	F	7.10.0	7.11.0	MBMSE-RANPhysTDD
RP-40	RP-080324	0256		MBSFN Reference Channel	F	7.10.0	7.11.0	MBMSE-RANPhysTDD

RP-40	RP-080384	0260		UMTS2.3 GHz TDD: UE receiver characteristics & propagation conditions for 1.28Mcps TDD	B	7.11.0	8.0.0	RInImp8-UMTS2300TD
RP-40	RP-080384	0259		UMTS2.3 GHz TDD: UE transmitter Characteristics for 2.3GHz LCR TDD	B	7.11.0	8.0.0	RInImp8-UMTS2300TD
RP-40	RP-080384	0258		New band introduction for 25.102	B	7.11.0	8.0.0	RInImp8-UMTS2300TD
RP-41	RP-080	270		Demodulation requirements of fixed reference channels for 1.28Mcps TDD option 64QAM DL	F	8.0.0	8.1.0	RANImp-64Qam1.28TDD
RP-41	RP-080628	0269		RF requirements in later releases	A	8.0.0	8.1.0	RInImp8-UMTS2300TD
RP-41	RP-080628	0264	1	UE RF capability information update	F	8.0.0	8.1.0	RInImp8-UMTS2300TD
RP-42	RP-080899	279	1	UE reference measurement channel and performance requirement for 384kbps service	A	8.1.0	8.2.0	TEI4
RP-42	RP-080939	280		Introduction of band 1880-1920MHz for 25.102	B	8.1.0	8.2.0	Rimp9-UMTS1880TD
RP-42	RP-080946	281		Adding the demodulation requirements for 1.28Mcps TDD Option 64QAM DL.	B	8.1.0	8.2.0	RANImp-64Qam1.28TDD
RP-42	RP-080946	282		Adding the requirement of maximum input level for 1.28Mcps TDD option 64QAM DL	B	8.1.0	8.2.0	RANImp-64Qam1.28TDD
RP-42	RP-080941	273		Additional minimum requirements for LCR TDD UE Adjacent Channel Selectivity	F	8.1.0	8.2.0	TEI8
RP-43	RP-090169	288		Correction on MBSFN MCCH Slot Format	A	8.2.0	8.3.0	MBMSE-RANPhysTDD
RP-43	RP-090169	284		Correction on MBSFN MCCH Slot Format	F	8.2.0	8.3.0	TEI7
RP-43	RP-090194	289		Introduction of 3.84Mcps TDD MBSFN IMB	B	8.2.0	8.3.0	MBSFN-DOB
RP-43	RP-090197	285		UMTS1880MHz: Transmitter spurious emission	F	8.2.0	8.3.0	RInImp9-UMTS1880TD
RP-43	RP-090197	286		UMTS1880MHz: Receiver characteristic and propagation condition for UE	F	8.2.0	8.3.0	RInImp9-UMTS1880TD
RP-44	RP-090539	300		Correction concerning scope of applicability for Extended Delay Spread propagation conditions	A	8.3.0	8.4.0	MBMSE-RANPhysTDD
RP-44	RP-090554	290		HS-DSCH performance requirements for 1.28Mcps TDD MIMO	F	8.3.0	8.4.0	RANImp-LCRMIMO
RP-44	RP-090554	291		HS-SCCH performance requirements for 1.28Mcps TDD MIMO	F	8.3.0	8.4.0	RANImp-LCRMIMO
RP-44	RP-090554	292		CQI reporting performance requirements for 1.28Mcps TDD MIMO	F	8.3.0	8.4.0	RANImp-LCRMIMO
RP-44	RP-090556	294		Correction on 64QAM Reference measurement channel for 1.28Mcps TDD. (Technically Endorsed CR in R4-50bis - R4-091184)	F	8.3.0	8.4.0	TEI8
RP-44	RP-090557	296		Definition of DL reference measurement channel for IMB	F	8.3.0	8.4.0	MBSFN-DOB
RP-44	RP-090557	295r1		Accommodation of the IMB reference bearer in the receiver characteristics of clause 7	F	8.3.0	8.4.0	MBSFN-DOB
RP-44	RP-090557	301		Addition of Performance Requirements for IMB MCCH	F	8.3.0	8.4.0	MBSFN-DOB
RP-44	RP-090557	302		Addition of Performance Requirements for IMB MTCH	F	8.3.0	8.4.0	MBSFN-DOB
RP-44	RP-090560	303		Addition of new requirement of new E-AGCH type 2	B	8.3.0	8.4.0	RANImp-LCRCPC

RP-45	RP-090818	306		Correction to TS25.102 defining the abbreviations MCCH and MTCH	F	8.4.0	8.5.0	MBSFN-DOB
		307		Addition of performance requirements for IMB MTCH	F	8.4.0	8.5.0	MBSFN-DOB
		309	1	Addition of Performance Requirements for IMB MCCH	F	8.4.0	8.5.0	MBSFN-DOB
RP-45	RP-090821	305		Correction of reference channel for category 29-30 UE	F	8.4.0	8.5.0	RANimp-MIMOLCR
		308	1	Clarification of test configuration for UE with multiple antennas	F	8.4.0	8.5.0	RANimp-MIMOLCR
RP-45	RP-090825	304		Revision of 64QAM Reference channel	F	8.4.0	8.5.0	TEI8
RP-46	RP-091260	315	1	Maximum output power with E-DCH for TDD And FRC (Technically endorsed at RAN 4 52bis in R4-093559)	A	8.5.0	8.6.0	TEI7
RP-46	RP-091281	316		Editorial corrections of 25.102.	F	8.5.0	8.6.0	MBSFN-DOB
RP-47	RP-100256	326	1	Maximum output power with multi-code for TDD	A	8.6.0	8.7.0	TEI7
RP-47	RP-100256	323		Demodulation of DCH in moving conditions for TDD	A	8.6.0	8.7.0	TEI7
RP-47	RP-100256	320		Demodulation of DCH in birth-death conditions for TDD	A	8.6.0	8.7.0	TEI7
RP-47	RP-100248	317		Modification to IMB receiver characteristic requirements	F	8.6.0	8.7.0	MBSFN-DOB
RP-49	RP-100913	330		Correction of 1.28Mcps TDD spectrum emission mask requirement	A	8.7.0	8.8.0	TEI7
RP-50	RP-101326	343		Introduction of new constant BLER test cases	A	8.8.0	8.9.0	TEI7
RP-50	RP-101339	335	1	Modification of transport block size to DL reference measurement channel for IMB MBSFN only UEs	F	8.8.0	8.9.0	MBSFN-DOB
RP-50	RP-101339	337	1	Modification of transport block size to performance requirements for demodulation of IMB MBSFN MTCH	F	8.8.0	8.9.0	MBSFN-DOB
RP-50	RP-101339	339	1	Correcting the data rate naming of performance requirements for demodulation of IMB MBSFN MCCH	F	8.8.0	8.9.0	MBSFN-DOB
RP-51	RP-110341	0348	-	Correction of Maximum Input Level Test for HS-PDSCH Transmission for 1.28Mcps TDD	F	8.9.0	8.10.0	TEI8
RP-51	RP-110335	0352	-	Introduction of new DL power control TC, wind up effects for 1.28Mcps TDD	A	8.9.0	8.10.0	TEI7
RP-53	RP-111245	357	1	Introduction of new DL power control TC, initial convergence for 1.28Mcps TDD	A	8.10.0	8.11.0	TEI7

History

Document history		
V8.0.0	October 2008	Publication
V8.1.0	October 2008	Publication
V8.2.0	January 2009	Publication
V8.3.0	March 2009	Publication
V8.4.0	July 2009	Publication
V8.5.0	October 2009	Publication
V8.6.0	February 2010	Publication
V8.7.0	April 2010	Publication
V8.8.0	October 2010	Publication
V8.9.0	January 2011	Publication
V8.10.0	May 2011	Publication
V8.11.0	October 2011	Publication