

ETSI TS 125 104 V7.3.0 (2006-03)

Technical Specification

**Universal Mobile Telecommunications System (UMTS);
Base Station (BS) radio transmission and reception (FDD)
(3GPP TS 25.104 version 7.3.0 Release 7)**



Reference

RTS/TSGR-0425104v730

Keywords

UMTS

ETSI

650 Route des Lucioles
F-06921 Sophia Antipolis Cedex - FRANCE

Tel.: +33 4 92 94 42 00 Fax: +33 4 93 65 47 16

Siret N° 348 623 562 00017 - NAF 742 C
Association à but non lucratif enregistrée à la
Sous-Préfecture de Grasse (06) N° 7803/88

Important notice

Individual copies of the present document can be downloaded from:

<http://www.etsi.org>

The present document may be made available in more than one electronic version or in print. In any case of existing or perceived difference in contents between such versions, the reference version is the Portable Document Format (PDF). In case of dispute, the reference shall be the printing on ETSI printers of the PDF version kept on a specific network drive within ETSI Secretariat.

Users of the present document should be aware that the document may be subject to revision or change of status. Information on the current status of this and other ETSI documents is available at

<http://portal.etsi.org/tb/status/status.asp>

If you find errors in the present document, please send your comment to one of the following services:

http://portal.etsi.org/chaicor/ETSI_support.asp

Copyright Notification

No part may be reproduced except as authorized by written permission.
The copyright and the foregoing restriction extend to reproduction in all media.

© European Telecommunications Standards Institute 2006.
All rights reserved.

DECT™, PLUGTESTS™ and UMTS™ are Trade Marks of ETSI registered for the benefit of its Members.
TIPHON™ and the TIPHON logo are Trade Marks currently being registered by ETSI for the benefit of its Members.
3GPP™ is a Trade Mark of ETSI registered for the benefit of its Members and of the 3GPP Organizational Partners.

Intellectual Property Rights

IPRs essential or potentially essential to the present document may have been declared to ETSI. The information pertaining to these essential IPRs, if any, is publicly available for **ETSI members and non-members**, and can be found in ETSI SR 000 314: "*Intellectual Property Rights (IPRs); Essential, or potentially Essential, IPRs notified to ETSI in respect of ETSI standards*", which is available from the ETSI Secretariat. Latest updates are available on the ETSI Web server (<http://webapp.etsi.org/IPR/home.asp>).

Pursuant to the ETSI IPR Policy, no investigation, including IPR searches, has been carried out by ETSI. No guarantee can be given as to the existence of other IPRs not referenced in ETSI SR 000 314 (or the updates on the ETSI Web server) which are, or may be, or may become, essential to the present document.

Foreword

This Technical Specification (TS) has been produced by ETSI 3rd Generation Partnership Project (3GPP).

The present document may refer to technical specifications or reports using their 3GPP identities, UMTS identities or GSM identities. These should be interpreted as being references to the corresponding ETSI deliverables.

The cross reference between GSM, UMTS, 3GPP and ETSI identities can be found under <http://webapp.etsi.org/key/queryform.asp>.

Contents

Intellectual Property Rights	2
Foreword.....	2
Foreword.....	6
1 Scope	7
2 References	7
3 Definitions and abbreviations.....	7
3.1 Definitions	7
3.2 Abbreviations	8
4 General	8
4.1 Relationship between Minimum Requirements and Test Requirements	8
4.2 Base station classes	9
4.3 Regional requirements.....	10
4.4 Environmental requirements for the BS equipment	11
5 Frequency bands and channel arrangement.....	11
5.1 General	11
5.2 Frequency bands.....	11
5.3 Tx-Rx frequency separation	12
5.4 Channel arrangement.....	12
5.4.1 Channel spacing	12
5.4.2 Channel raster	12
5.4.3 Channel number.....	12
6 Transmitter characteristics	13
6.1 General	13
6.2 Base station output power	14
6.2.1 Base station maximum output power.....	14
6.2.1.1 Minimum requirement	14
6.3 Frequency error	14
6.3.1 Minimum requirement	14
6.4 Output power dynamics.....	15
6.4.1 Inner loop power control in the downlink.....	15
6.4.1.1 Power control steps	15
6.4.1.1.1 Minimum requirement.....	15
6.4.2 Power control dynamic range	15
6.4.2.1 Minimum requirements.....	16
6.4.3 Total power dynamic range	16
6.4.3.1 Minimum requirement	16
6.4.4 Primary CPICH power.....	16
6.4.4.1 Minimum requirement	16
6.4.5 IPDL time mask.....	16
6.4.5.1 Minimum Requirement	16
6.5 Void.....	17
6.6 Output RF spectrum emissions.....	17
6.6.1 Occupied bandwidth	17
6.6.1.1 Minimum requirement	17
6.6.2 Out of band emission	17
6.6.2.1 Spectrum emission mask.....	18
6.6.2.2 Adjacent Channel Leakage power Ratio (ACLR).....	20
6.6.2.2.1 Minimum requirement.....	20
6.6.3 Spurious emissions	20
6.6.3.1 Mandatory Requirements	20
6.6.3.1.1 Spurious emissions (Category A).....	20
6.6.3.1.2 Spurious emissions (Category B).....	21

6.6.3.2	Protection of the BS receiver of own or different BS	26
6.6.3.2.1	Minimum Requirement	26
6.6.3.3	Co-existence with other systems in the same geographical area.....	27
6.6.3.4	Co-existence with co-located and co-sited base stations.....	29
6.6.3.4.1	Minimum Requirements.....	29
6.6.3.5	Co-existence with PHS	30
6.6.3.5.1	Minimum Requirement	30
6.6.3.6	Co-existence with services in adjacent frequency bands.....	31
6.6.3.6.1	Minimum requirement.....	31
6.6.3.7	Co-existence with UTRA-TDD	31
6.6.3.7.1	Operation in the same geographic area.....	31
6.6.3.7.2	Co-located base stations	31
6.7	Transmit intermodulation	32
6.7.1	Minimum requirement	32
6.8	Transmit modulation	32
6.8.1	Transmit pulse shape filter.....	32
6.8.2	Error Vector Magnitude.....	33
6.8.2.1	Minimum requirement	33
6.8.3	Peak code Domain error	33
6.8.3.1	Minimum requirement	33
6.8.4	Time alignment error in Tx Diversity	33
6.8.4.1	Minimum Requirement	33
7	Receiver characteristics.....	33
7.1	General	33
7.2	Reference sensitivity level.....	34
7.2.1	Minimum requirement	34
7.2.2	Maximum Frequency Deviation for Receiver Performance	34
7.3	Dynamic range	34
7.3.1	Minimum requirement	35
7.4	Adjacent Channel Selectivity (ACS).....	35
7.4.1	Minimum requirement	35
7.4.2	Minimum requirement – Co-location with UTRA-TDD	35
7.5	Blocking characteristics	35
7.5.1	Minimum requirement	36
7.5.2	Minimum Requirement – Co-location with GSM900, DCS 1800, PCS1900, GSM850 and/or UTRA FDD	39
7.5.3	Minimum Requirement - Co-location with UTRA-TDD	41
7.6	Intermodulation characteristics	42
7.6.1	Minimum requirement	42
7.7	Spurious emissions	43
7.7.1	Minimum requirement	43
8	Performance requirement	44
8.1	General	44
8.2	Demodulation in static propagation conditions	45
8.2.1	Demodulation of DCH.....	45
8.2.1.1	Minimum requirement	45
8.3	Demodulation of DCH in multipath fading conditions	45
8.3.1	Multipath fading Case 1	45
8.3.1.1	Minimum requirement	45
8.3.2	Multipath fading Case 2.....	46
8.3.2.1	Minimum requirement	46
8.3.3	Multipath fading Case 3.....	46
8.3.3.1	Minimum requirement	46
8.3.4	Multipath fading Case 4.....	47
8.3.4.1	Minimum requirement	47
8.4	Demodulation of DCH in moving propagation conditions.....	47
8.4.1	Minimum requirement	47
8.5	Demodulation of DCH in birth/death propagation conditions.....	47
8.5.1	Minimum requirement	48
8.6	Void.....	48

8.7	Performance requirement for RACH.....	48
8.7.1	Performance requirement for RACH preamble detection.....	48
8.7.2	Demodulation of RACH message.....	48
8.7.2.1	Minimum requirements for Static Propagation Condition	49
8.7.2.2	Minimum requirements for Multipath Fading Case 3	49
8.8	Void.....	49
8.9	Void.....	49
8.10	Performance of ACK/NACK detection for HS-DPCCH.....	50
8.10.1	ACK false alarm	50
8.10.2	ACK mis-detection	50
8.11	Demodulation of E-DPDCH in multipath fading condition	50
8.12	Performance of signaling detection for E-DPCCH in multipath fading condition	51
Annex A (normative): Measurement channels.....		53
A.1	Summary of UL reference measurement channels.....	53
A.2	UL reference measurement channel for 12.2 kbps.....	54
A.3	UL reference measurement channel for 64 kbps.....	55
A.4	UL reference measurement channel for 144 kbps.....	56
A.5	UL reference measurement channel for 384 kbps.....	57
A.6	Void.....	57
A.7	Reference measurement channels for UL RACH	58
A.8	Reference measurement channel for HS-DPCCH.....	59
A.9	Summary of E-DPDCH Fixed reference channels.....	59
A.10	E-DPDCH Fixed reference channel 1 (FRC1).....	60
A.11	E-DPDCH Fixed reference channel 2 (FRC2).....	61
A.12	E-DPDCH Fixed reference channel 3 (FRC3).....	62
A.13	E-DPDCH Fixed reference channel 4 (FRC4).....	63
A.14	E-DPDCH Fixed reference channel 5 (FRC5).....	64
A.15	E-DPDCH Fixed reference channel 6 (FRC6).....	65
A.16	E-DPDCH Fixed reference channel 7 (FRC7).....	65
Annex B (normative): Propagation conditions.....		67
B.1	Static propagation condition.....	67
B.2	Multi-path fading propagation conditions.....	67
B.3	Moving propagation conditions.....	67
B.4	Birth-Death propagation conditions	68
B.5	Multipath fading propagation conditions	68
Annex C (normative): Characteristics of the W-CDMA interference signal.....		70
Annex D (informative): Change history		71
History		78

Foreword

This Technical Specification has been produced by the 3GPP.

The contents of the present document are subject to continuing work within the TSG and may change following formal TSG approval. Should the TSG modify the contents of this TS, it will be re-released by the TSG with an identifying change of release date and an increase in version number as follows:

Version 3.y.z

where:

- x the first digit:
 - 1 presented to TSG for information;
 - 2 presented to TSG for approval;
 - 3 Indicates TSG approved document under change control.
- y the second digit is incremented for all changes of substance, i.e. technical enhancements, corrections, updates, etc.
- z the third digit is incremented when editorial only changes have been incorporated in the specification.

1 Scope

This document establishes the Base Station minimum RF characteristics of the FDD mode of UTRA.

2 References

The following documents contain provisions which, through reference in this text, constitute provisions of the present document.

- References are either specific (identified by date of publication, edition number, version number, etc.) or non-specific.
- For a specific reference, subsequent revisions do not apply.
- For a non-specific reference, the latest version applies. In the case of a reference to a 3GPP document (including a GSM document), a non-specific reference implicitly refers to the latest version of that document *in the same Release as the present document*.

- [1] ITU-R Recommendation SM.329, " Unwanted emissions in the spurious domain ".
- [2] (void)
- [3] ETSI ETR 273-1-2: "Electromagnetic compatibility and Radio spectrum Matters (ERM); Improvement of radiated methods of measurement (using test sites) and evaluation of the corresponding measurement uncertainties; Part 1: Uncertainties in the measurement of mobile radio equipment characteristics; Sub-part 2: Examples and annexes".
- [4] 3GPP TR 25.942 "RF System Scenarios".
- [5] 3GPP TS 45.004: "Digital cellular telecommunications system (Phase 2+); Modulation".
- [6] 3GPP TS 25.213: "Spreading and modulation (FDD)".
- [7] ITU-R recommendation SM.328: "Spectra and bandwidth of emissions".

3 Definitions and abbreviations

3.1 Definitions

For the purposes of the present document, the following definitions apply:

Output power: The mean power of one carrier of the base station, delivered to a load with resistance equal to the nominal load impedance of the transmitter.

Rated output power: Rated output power of the base station is the mean power level per carrier that the manufacturer has declared to be available at the antenna connector.

Maximum output Power: The mean power level per carrier of the base station measured at the antenna connector in a specified reference condition.

Mean power: When applied to a W-CDMA modulated signal this is the power (transmitted or received) in a bandwidth of at least $(1 + \alpha)$ times the chip rate of the radio access mode. The period of measurement shall be at least one timeslot unless otherwise stated.

Power control dynamic range: The difference between the maximum and the minimum transmit output power of a code channel for a specified reference condition.

RRC filtered mean power: The mean power as measured through a root raised cosine filter with roll-off factor α and a bandwidth equal to the chip rate of the radio access mode.

NOTE 1: The RRC filtered mean power of a perfectly modulated W-CDMA signal is 0.246 dB lower than the mean power of the same signal.

Code domain power: That part of the mean power which correlates with a particular (OVSF) code channel. The sum of all powers in the code domain equals the mean power in a bandwidth of $(1 + \alpha)$ times the chip rate of the radio access mode.

Total power dynamic range: The difference between the maximum and the minimum total transmit output power for a specified reference condition.

NOTE 2: The roll-off factor α is defined in section 6.8.1.

3.2 Abbreviations

For the purposes of the present document, the following abbreviations apply:

16QAM	16 Quadrature Amplitude Modulation
ACIR	Adjacent Channel Interference Ratio
ACLR	Adjacent Channel Leakage power Ratio
ACS	Adjacent Channel Selectivity
BS	Base Station
BER	Bit Error Ratio
BLER	Block Error Ratio
CW	Continuous Wave (unmodulated signal)
DL	Down Link (forward link)
FDD	Frequency Division Duplexing
GSM	Global System for Mobile Communications
P_{out}	Output Power
P_{RAT}	Rated Output Power
PHS	Personal Handyphone System
PPM	Parts Per Million
QPSK	Quadrature Phase Shift Keying
RSSI	Received Signal Strength Indicator
SIR	Signal to Interference ratio
TDD	Time Division Duplexing
TPC	Transmit Power Control
UARFCN	UTRA Absolute Radio Frequency Channel Number
UE	User Equipment
UL	Up Link (reverse link)
WCDMA	Wideband Code Division Multiple Access

4 General

4.1 Relationship between Minimum Requirements and Test Requirements

The Minimum Requirements given in this specification make no allowance for measurement uncertainty. The test specification 25.141 section 4 defines Test Tolerances. These Test Tolerances are individually calculated for each test. The Test Tolerances are used to relax the Minimum Requirements in this specification to create Test Requirements.

The measurement results returned by the Test System are compared - without any modification - against the Test Requirements as defined by the shared risk principle.

The Shared Risk principle is defined in ETR 273 Part 1 sub-part 2 section 6.5.

4.2 Base station classes

The requirements in this specification apply to Wide Area Base Stations, Medium Range Base Stations and Local Area Base Stations unless otherwise stated.

Wide Area Base Stations are characterised by requirements derived from Macro Cell scenarios with a BS to UE minimum coupling loss equals to 70 dB. The Wide Area Base Station class has the same requirements as the base station for General Purpose application in Release 99, 4 and 5.

Medium Range Base Stations are characterised by requirements derived from Micro Cell scenarios with a BS to UE minimum coupling loss equals to 53 dB.

Local Area Base Stations are characterised by requirements derived from Pico Cell scenarios with a BS to UE minimum coupling loss equals to 45 dB.

4.3 Regional requirements

Some requirements in TS 25.104 may only apply in certain regions. Table 4.1 lists all requirements that may be applied differently in different regions.

Table 4.1: List of regional requirements

Clause number	Requirement	Comments
5.2	Frequency bands	Some bands may be applied regionally.
5.3	Tx-Rx Frequency Separation	The requirement is applied according to what frequency bands in Clause 5.2 that are supported by the BS.
5.4	Channel arrangement	The requirement is applied according to what frequency bands in Clause 5.2 that are supported by the BS.
6.2.1	Base station maximum output power	In certain regions, the minimum requirement for normal conditions may apply also for some conditions outside the range of conditions defined as normal.
6.6.2.1	Spectrum emission mask	The mask specified may be mandatory in certain regions. In other regions this mask may not be applied.
6.6.3.1.1	Spurious emissions (Category A)	These requirements shall be met in cases where Category A limits for spurious emissions, as defined in ITU-R Recommendation SM.329 [1], are applied.
6.6.3.1.2	Spurious emissions (Category B)	These requirements shall be met in cases where Category B limits for spurious emissions, as defined in ITU-R Recommendation SM.329 [1], are applied.
6.6.3.3	Co-existence with other systems in the same geographical area	These requirements may apply in geographic areas in which both UTRA FDD and GSM900, DCS1800, PCS1900, GSM850 and/or UTRA FDD operating in another frequency band are deployed.
6.6.3.4	Co-existence with co-located and co-sited base stations	These requirements may be applied for the protection of other BS receivers when GSM900, DCS1800, PCS1900, GSM850 and/or FDD BS operating in another frequency band are co-located with a UTRA FDD BS.
6.6.3.5	Co-existence with PHS	This requirement may be applied for the protection of PHS in geographic areas in which both PHS and UTRA FDD are deployed.
6.6.3.6	Co-existence with services in adjacent frequency bands	This requirement may be applied for the protection in bands adjacent to the downlink bands as defined in clause 5.2 in geographic areas in which both an adjacent band service and UTRA FDD are deployed.
6.6.3.7.1	Co-existence with UTRA TDD - Operation in the same geographic area	This requirement may be applied to geographic areas in which both UTRA-TDD and UTRA-FDD are deployed.
6.6.3.7.2	Co-existence with UTRA TDD - Co-located base stations	This requirement may be applied for the protection of UTRA-TDD BS receivers when UTRA-TDD BS and UTRA FDD BS are co-located.
7.4.2	Adjacent Channel Selectivity Co-location with UTRA-TDD	This requirement may be applied for the protection of UTRA-FDD BS receivers when UTRA-FDD BS and UTRA-TDD BS are co-located.
7.5	Blocking characteristic	The requirement is applied according to what frequency bands in Clause 5.2 that are supported by the BS.
7.5.2	Blocking characteristics Co-location with GSM900, DCS 1800, PCS1900 and/or UTRA	This requirement may be applied for the protection of UTRA FDD BS receivers when UTRA FDD BS and GSM 900, DCS1800, PCS1900, GSM850 and/or UTRA BS (operating in different frequency bands) are co-located.
7.5.3	Blocking characteristics Co-location with UTRA TDD	This requirement may be applied for the protection of UTRA FDD BS receivers when UTRA FDD BS and UTRA TDD BS are co-located.

7.6	Intermodulation characteristics	The requirement is applied according to what frequency bands in Clause 5.2 that are supported by the BS.
7.7	Spurious emissions	The requirement is applied according to what frequency bands in Clause 5.2 that are supported by the BS.
7.7.1	Additional spurious emissions requirement	The requirement in Table 7.8 may be applied to geographic areas in which both UTRA-TDD and UTRA-FDD are deployed.

4.4 Environmental requirements for the BS equipment

The BS equipment shall fulfil all the requirements in the full range of environmental conditions for the relevant environmental class from the relevant IEC specifications listed below

60 721-3-3 "Stationary use at weather protected locations"

60 721-3-4 "Stationary use at non weather protected locations"

Normally it should be sufficient for all tests to be conducted using normal test conditions except where otherwise stated. For guidance on the use of test conditions to be used in order to show compliance refer to TS 25.141.

5 Frequency bands and channel arrangement

5.1 General

The information presented in this section is based on a chip rate of 3.84 Mcps.

NOTE 1: Other chip rates may be considered in future releases.

5.2 Frequency bands

a) UTRA/FDD is designed to operate in the following paired bands:

Table 5.0: Frequency bands

Operating Band	UL Frequencies UE transmit, Node B receive	DL frequencies UE receive, Node B transmit
I	1920 – 1980 MHz	2110 –2170 MHz
II	1850 –1910 MHz	1930 –1990 MHz
III	1710-1785 MHz	1805-1880 MHz
IV	1710-1755 MHz	2110-2155 MHz
V	824 – 849MHz	869-894MHz
VI	830-840 MHz	875-885 MHz
VII	2500 – 2570 MHz	2620 – 2690 MHz
VIII	880 – 915 MHz	925 – 960 MHz
IX	1749.9 – 1784.9 MHz	1844.9 – 1879.9 MHz

b) Deployment in other frequency bands is not precluded

5.3 Tx-Rx frequency separation

- a) UTRA/FDD is designed to operate with the following TX-RX frequency separation

Table 5.0A: Tx-Rx frequency separation

Operating Band	TX-RX frequency separation
I	190 MHz
II	80 MHz.
III	95 MHz.
IV	400 MHz
V	45 MHz
VI	45 MHz
VII	120 MHz
VIII	45 MHz
IX	95 MHz

- b) UTRA/FDD can support both fixed and variable transmit to receive frequency separation.
- c) The use of other transmit to receive frequency separations in existing or other frequency bands shall not be precluded.

5.4 Channel arrangement

5.4.1 Channel spacing

The nominal channel spacing is 5 MHz, but this can be adjusted to optimise performance in a particular deployment scenario.

5.4.2 Channel raster

The channel raster is 200 kHz for all bands, which means that the centre frequency must be an integer multiple of 200 kHz. In addition a number of additional centre frequencies are specified according to table 5.1A, which means that the centre frequencies for these channels are shifted 100 kHz relative to the general raster.

5.4.3 Channel number

The carrier frequency is designated by the UTRA Absolute Radio Frequency Channel Number (UARFCN). For each operating Band, the UARFCN values are defined as follows:

$$\text{Uplink: } N_U = 5 * (F_{UL} - F_{UL_Offset}), \quad \text{for the carrier frequency range } F_{UL_low} \leq F_{UL} \leq F_{UL_high}$$

$$\text{Downlink: } N_D = 5 * (F_{DL} - F_{DL_Offset}), \quad \text{for the carrier frequency range } F_{DL_low} \leq F_{DL} \leq F_{DL_high}$$

For each operating Band, F_{UL_Offset} , F_{UL_low} , F_{UL_high} , F_{DL_Offset} , F_{DL_low} and F_{DL_high} are defined in Table 5.1 for the general UARFCN. For the additional UARFCN, F_{UL_Offset} , F_{DL_Offset} and the specific F_{UL} and F_{DL} are defined in Table 5.1A.

Table 5.1: UARFCN definition (general)

Band	UPLINK (UL) UE transmit, Node B receive			DOWNLINK (DL) UE receive, Node B transmit		
	UARFCN formula offset F_{UL_Offset} [MHz]	Carrier frequency (F_{UL}) range [MHz]		UARFCN formula offset F_{DL_Offset} [MHz]	Carrier frequency (F_{DL}) range [MHz]	
		F_{UL_low}	F_{UL_high}		F_{DL_low}	F_{DL_high}
I	0	1922.4	1977.6	0	2112.4	2167.6
II	0	1852.4	1907.6	0	1932.4	1987.6
III	1525	1712.4	1782.6	1575	1807.4	1877.6
IV	1450	1712.4	1752.6	1805	2112.4	2152.6
V	0	826.4	846.6	0	871.4	891.6
VI	0	832.4	837.6	0	877.4	882.6
VII	2100	2502.4	2567.6	2175	2622.4	2687.6
VIII	340	882.4	912.6	340	927.4	957.6
IX	0	1752.4	1782.4	0	1847.4	1877.4

Table 5.1A: UARFCN definition (additional channels)

Band	UPLINK (UL) UE transmit, Node B receive		DOWNLINK (DL) UE receive, Node B transmit	
	UARFCN formula offset F_{UL_Offset} [MHz]	Carrier frequency (F_{UL}) [MHz]	UARFCN formula offset F_{DL_Offset} [MHz]	Carrier frequency (F_{DL}) [MHz]
I	-	-	-	-
II	1850.1	1852.5, 1857.5, 1862.5, 1867.5, 1872.5, 1877.5, 1882.5, 1887.5, 1892.5, 1897.5, 1902.5, 1907.5	1850.1	1932.5, 1937.5, 1942.5, 1947.5, 1952.5, 1957.5, 1962.5, 1967.5, 1972.5, 1977.5, 1982.5, 1987.5
III	-	-	-	-
IV	1380.1	1712.5, 1717.5, 1722.5, 1727.5, 1732.5, 1737.5, 1742.5, 1747.5, 1752.5	1735.1	2112.5, 2117.5, 2122.5, 2127.5, 2132.5, 2137.5, 2142.5, 2147.5, 2152.5
V	670.1	826.5, 827.5, 831.5, 832.5, 837.5, 842.5	670.1	871.5, 872.5, 876.5, 877.5, 882.5, 887.5
VI	670.1	832.5, 837.5	670.1	877.5, 882.5
VII	2030.1	2502.5, 2507.5, 2512.5, 2517.5, 2522.5, 2527.5, 2532.5, 2537.5, 2542.5, 2547.5, 2552.5, 2557.5, 2562.5, 2567.5	2105.1	2622.5, 2627.5, 2632.5, 2637.5, 2642.5, 2647.5, 2652.5, 2657.5, 2662.5, 2667.5, 2672.5, 2677.5, 2682.5, 2687.5
VIII	-	-	-	-
IX	-	-	-	-

6 Transmitter characteristics

6.1 General

Unless otherwise stated, the requirements in Section 6 assume transmission without diversity. In case of transmit diversity the requirements apply to each antenna connector separately, with the other one terminated. Unless otherwise stated, the requirements are unchanged.

Unless otherwise stated, the transmitter characteristics are specified at the BS antenna connector (test port A) with a full complement of transceivers for the configuration in normal operating conditions. If any external apparatus such as a TX amplifier, a filter or the combination of such devices is used, requirements apply at the far end antenna connector (port B).

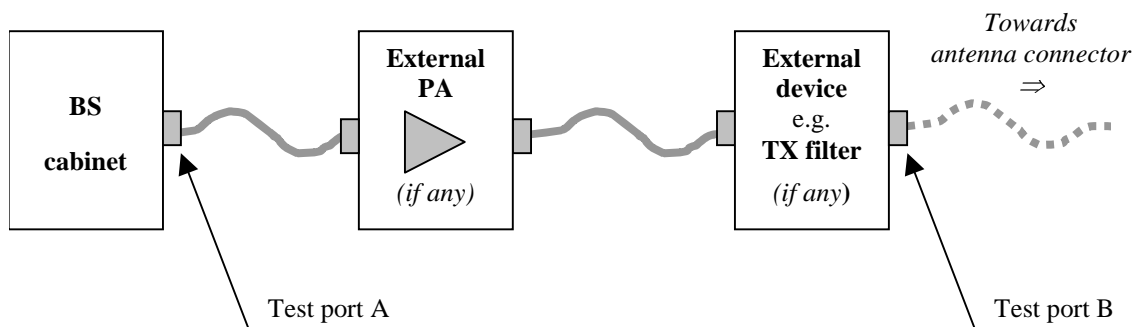

Figure 6.1: Transmitter test ports

6.2 Base station output power

Output power, P_{out} , of the base station is the mean power of one carrier delivered to a load with resistance equal to the nominal load impedance of the transmitter.

Rated output power, PRAT, of the base station is the mean power level per carrier that the manufacturer has declared to be available at the antenna connector.

6.2.1 Base station maximum output power

Maximum output power, P_{max} , of the base station is the mean power level per carrier measured at the antenna connector in specified reference condition.

The rated output power, PRAT, of the BS shall be as specified in Table 6.0A.

Table 6.0A: Base Station rated output power

BS class	PRAT
Wide Area BS	-*
Medium Range BS	$\leq +38$ dBm
Local Area BS	$\leq +24$ dBm

Note *: There is no upper limit required for the rated output power of the Wide Area Base Station like for the base station for General Purpose application in Release 99, 4, and 5.

6.2.1.1 Minimum requirement

In normal conditions, the Base station maximum output power shall remain within +2 dB and -2dB of the manufacturer's rated output power.

In extreme conditions, the Base station maximum output power shall remain within +2.5 dB and -2.5 dB of the manufacturer's rated output power.

In certain regions, the minimum requirement for normal conditions may apply also for some conditions outside the range of conditions defined as normal.

6.3 Frequency error

Frequency error is the measure of the difference between the actual BS transmit frequency and the assigned frequency. The same source shall be used for RF frequency and data clock generation.

6.3.1 Minimum requirement

The modulated carrier frequency of the BS shall be accurate to within the accuracy range given in Table 6.0 observed over a period of one timeslot.

Table 6.0: Frequency error minimum requirement

BS class	Accuracy
Wide Area BS	± 0.05 ppm
Medium Range BS	± 0.1 ppm
Local Area BS	± 0.1 ppm

6.4 Output power dynamics

Power control is used to limit the interference level. The transmitter uses a quality-based power control on the downlink.

6.4.1 Inner loop power control in the downlink

Inner loop power control in the downlink is the ability of the BS transmitter to adjust the transmitter output power of a code channel in accordance with the corresponding TPC symbols received in the uplink.

6.4.1.1 Power control steps

The power control step is the required step change in the code domain power of a code channel in response to the corresponding power control command. The combined output power change is the required total change in the DL transmitted power of a code channel in response to multiple consecutive power control commands corresponding to that code channel.

6.4.1.1.1 Minimum requirement

The BS transmitter shall have the capability of setting the inner loop code domain power with a step sizes of 1dB mandatory and 0.5, 1.5, 2.0 dB optional

- a) The tolerance of the power control step due to inner loop power control shall be within the range shown in Table 6.1.
- b) The tolerance of the combined output power change due to inner loop power control shall be within the range shown in Table 6.2.

Table 6.1: Transmitter power control step tolerance

Power control commands in the down link	Transmitter power control step tolerance							
	2 dB step size		1.5 dB step size		1 dB step size		0.5 dB step size	
	Lower	Upper	Lower	Upper	Lower	Upper	Lower	Upper
Up (TPC command "1")	+1.0 dB	+3.0 dB	+0.75 dB	+2.25 dB	+0.5 dB	+1.5 dB	+0.25 dB	+0.75 dB
Down (TPC command "0")	-1.0 dB	-3.0 dB	-0.75 dB	-2.25 dB	-0.5 dB	-1.5 dB	-0.25 dB	-0.75 dB

Table 6.2: Transmitter aggregated power control step range

Power control commands in the down link	Transmitter aggregated power control step change after 10 consecutive equal commands (up or down)							
	2 dB step size		1.5 dB step size		1 dB step size		0.5 dB step size	
	Lower	Upper	Lower	Upper	Lower	Upper	Lower	Upper
Up (TPC command "1")	+16 dB	+24 dB	+12 dB	+18 dB	+8 dB	+12 dB	+4 dB	+6 dB
Down (TPC command "0")	-16 dB	-24 dB	-12 dB	-18 dB	-8 dB	-12 dB	-4 dB	-6 dB

6.4.2 Power control dynamic range

The power control dynamic range is the difference between the maximum and the minimum code domain power of a code channel for a specified reference condition. Transmit modulation quality shall be maintained within the whole dynamic range as specified in subclause 6.8.

6.4.2.1 Minimum requirements

Down link (DL) power control dynamic range:

Maximum code domain power: BS maximum output power - 3 dB or greater

Minimum code domain power: BS maximum output power - 28 dB or less

6.4.3 Total power dynamic range

The total power dynamic range is the difference between the maximum and the minimum output power for a specified reference condition.

NOTE: The upper limit of the dynamic range is the BS maximum output power. The lower limit of the dynamic range is the lowest minimum power from the BS when no traffic channels are activated.

6.4.3.1 Minimum requirement

The downlink (DL) total power dynamic range shall be 18 dB or greater.

6.4.4 Primary CPICH power

Primary CPICH power is the code domain power of the Common Pilot Channel. Primary CPICH power is indicated on the BCH. CPICH power accuracy is defined as the maximum deviation between the Primary CPICH code domain power indicated on the BCH and the Primary CPICH code domain power measured at the TX antenna interface.

6.4.4.1 Minimum requirement

Primary CPICH code domain power shall be within ± 2.1 dB of the Primary CPICH code domain power indicated on the BCH.

In case of transmit diversity the Primary CPICH code domain power per antenna connector shall be within ± 2.1 dB of the Primary CPICH code domain power intended for that particular antenna connector.

6.4.5 IPDL time mask

To support IPDL location method, the Node B shall interrupt all transmitted signals in the downlink (i.e. common and dedicated channels).

The IPDL time mask specifies the limits of the BS output power during these idle periods.

The requirement in this section shall apply to BS supporting IPDL.

6.4.5.1 Minimum Requirement

The mean power measured over a period starting 27 chips after the beginning of the IPDL period and ending 27 chips before the expiration of the IPDL period shall be equal to or less than

$$\text{BS maximum output power} - 35 \text{ dB}$$

see also Figure 6.1A.

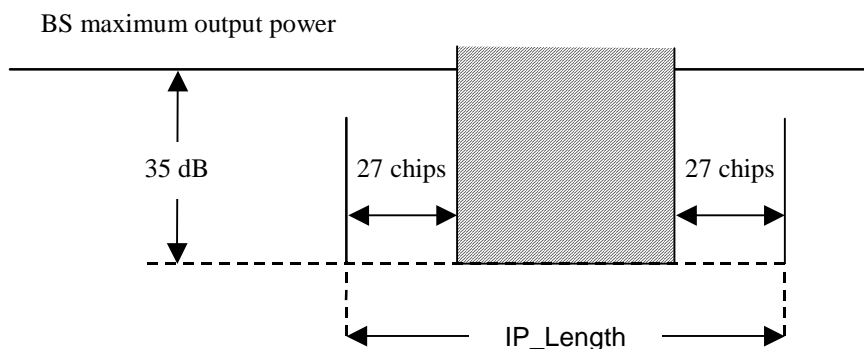

Figure 6.1A: IPDL Time Mask

The requirement applies to all output powers within the total power dynamic range as specified in subclause 6.4.3.

6.5 Void

6.6 Output RF spectrum emissions

6.6.1 Occupied bandwidth

The occupied bandwidth is the width of a frequency band such that, below the lower and above the upper frequency limits, the mean powers emitted are each equal to a specified percentage $\beta/2$ of the total mean transmitted power. See also ITU-R Recommendation SM.328 [7].

The value of $\beta/2$ shall be taken as 0,5%.

6.6.1.1 Minimum requirement

The occupied channel bandwidth shall be less than 5 MHz based on a chip rate of 3.84 Mcps.

6.6.2 Out of band emission

Out of band emissions are unwanted emissions immediately outside the channel bandwidth resulting from the modulation process and non-linearity in the transmitter but excluding spurious emissions. This out of band emission requirement is specified both in terms of a spectrum emission mask and adjacent channel power ratio for the transmitter.

6.6.2.1 Spectrum emission mask

The mask defined in Tables 6.3 to 6.6 below may be mandatory in certain regions. In other regions this mask may not be applied.

For regions where this clause applies, the requirement shall be met by a base station transmitting on a single RF carrier configured in accordance with the manufacturer's specification. Emissions shall not exceed the maximum level specified in tables 6.3 to 6.6 for the appropriate BS maximum output power, in the frequency range from $\Delta f = 2.5$ MHz to Δf_{max} from the carrier frequency, where:

- Δf is the separation between the carrier frequency and the nominal -3dB point of the measuring filter closest to the carrier frequency.
- F_{offset} is the separation between the carrier frequency and the centre of the measuring filter.
- $f_{offset_{max}}$ is either 12.5 MHz or the offset to the UMTS Tx band edge as defined in section 5.2, whichever is the greater.
- Δf_{max} is equal to $f_{offset_{max}}$ minus half of the bandwidth of the measuring filter.

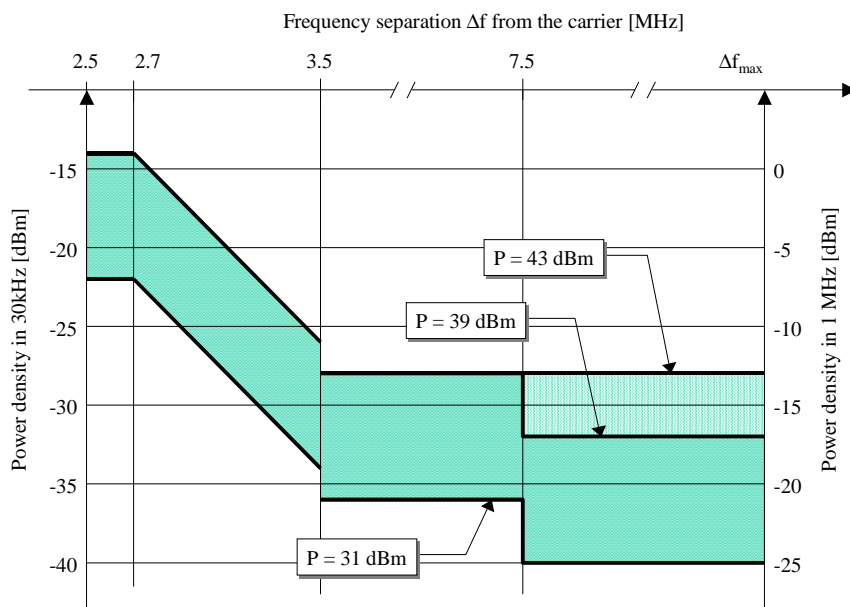

Illustrative diagram of spectrum emission mask

Figure 6.2: Spectrum emission mask

Table 6.3: Spectrum emission mask values, BS maximum output power $P \geq 43$ dBm

Frequency offset of measurement filter -3dB point, Δf	Frequency offset of measurement filter centre frequency, f_{offset}	Minimum requirement Band I, II, III, IV, V, VII, VIII	Additional requirements Band II, IV and V ¹	Measurement bandwidth ²
$2.5 \text{ MHz} \leq \Delta f < 2.7 \text{ MHz}$	$2.515\text{MHz} \leq f_{offset} < 2.715\text{MHz}$	-14 dBm	-15 dBm	30 kHz
$2.7 \text{ MHz} \leq \Delta f < 3.5 \text{ MHz}$	$2.715\text{MHz} \leq f_{offset} < 3.515\text{MHz}$	$-14\text{dBm} - 15 \cdot \left(\frac{f_{offset}}{\text{MHz}} - 2.715 \right) \text{dB}$	-15 dBm	30 kHz
(see note 3)	$3.515\text{MHz} \leq f_{offset} < 4.0\text{MHz}$	-26 dBm	NA	30 kHz
$3.5 \text{ MHz} \leq \Delta f \leq \Delta f_{max}$	$4.0\text{MHz} \leq f_{offset} < f_{offset_{max}}$	-13 dBm	-13 dBm	1 MHz

Table 6.4: Spectrum emission mask values, BS maximum output power $39 \leq P < 43$ dBm

Frequency offset of measurement filter -3dB point, Δf	Frequency offset of measurement filter centre frequency, f_{offset}	Minimum requirement Band I, II, III, IV, V, VII, VIII	Additional requirements Band II, IV and V ¹	Measurement bandwidth ²
$2.5 \text{ MHz} \leq \Delta f < 2.7 \text{ MHz}$	$2.515 \text{ MHz} \leq f_{\text{offset}} < 2.715 \text{ MHz}$	-14 dBm	-15 dBm	30 kHz
$2.7 \text{ MHz} \leq \Delta f < 3.5 \text{ MHz}$	$2.715 \text{ MHz} \leq f_{\text{offset}} < 3.515 \text{ MHz}$	$-14 \text{ dBm} - 15 \cdot \left(\frac{f_{\text{offset}}}{\text{MHz}} - 2.715 \right) \text{ dB}$	-15 dBm	30 kHz
(see note 3)	$3.515 \text{ MHz} \leq f_{\text{offset}} < 4.0 \text{ MHz}$	-26 dBm	NA	30 kHz
$3.5 \text{ MHz} \leq \Delta f < 7.5 \text{ MHz}$	$4.0 \text{ MHz} \leq f_{\text{offset}} < 8.0 \text{ MHz}$	-13 dBm	-13 dBm	1 MHz
$7.5 \text{ MHz} \leq \Delta f \leq \Delta f_{\text{max}}$	$8.0 \text{ MHz} \leq f_{\text{offset}} < f_{\text{offset}_{\text{max}}}$	$P - 56 \text{ dB}$	-13 dBm	1 MHz

Table 6.5: Spectrum emission mask values, BS maximum output power $31 \leq P < 39$ dBm

Frequency offset of measurement filter -3dB point, Δf	Frequency offset of measurement filter centre frequency, f_{offset}	Minimum requirement Band I, II, III, IV, V, VII, VIII	Additional requirements Band II, IV and V ¹	Measurement bandwidth ²
$2.5 \text{ MHz} \leq \Delta f < 2.7 \text{ MHz}$	$2.515 \text{ MHz} \leq f_{\text{offset}} < 2.715 \text{ MHz}$	$P - 53 \text{ dB}$	-15 dBm	30 kHz
$2.7 \text{ MHz} \leq \Delta f < 3.5 \text{ MHz}$	$2.715 \text{ MHz} \leq f_{\text{offset}} < 3.515 \text{ MHz}$	$P - 53 \text{ dB} - 15 \cdot \left(\frac{f_{\text{offset}}}{\text{MHz}} - 2.715 \right) \text{ dB}$	-15 dBm	30 kHz
(see note 3)	$3.515 \text{ MHz} \leq f_{\text{offset}} < 4.0 \text{ MHz}$	$P - 65 \text{ dB}$	NA	30 kHz
$3.5 \text{ MHz} \leq \Delta f < 7.5 \text{ MHz}$	$4.0 \text{ MHz} \leq f_{\text{offset}} < 8.0 \text{ MHz}$	$P - 52 \text{ dB}$	-13 dBm	1 MHz
$7.5 \text{ MHz} \leq \Delta f \leq \Delta f_{\text{max}}$	$8.0 \text{ MHz} \leq f_{\text{offset}} < f_{\text{offset}_{\text{max}}}$	$P - 56 \text{ dB}$	-13 dBm	1 MHz

Table 6.6: Spectrum emission mask values, BS maximum output power $P < 31$ dBm

Frequency offset of measurement filter -3dB point, Δf	Frequency offset of measurement filter centre frequency, f_{offset}	Minimum requirement Band I, II, III, IV, V, VII, VIII	Measurement bandwidth ²
$2.5 \text{ MHz} \leq \Delta f < 2.7 \text{ MHz}$	$2.515 \text{ MHz} \leq f_{\text{offset}} < 2.715 \text{ MHz}$	-22 dBm	30 kHz
$2.7 \text{ MHz} \leq \Delta f < 3.5 \text{ MHz}$	$2.715 \text{ MHz} \leq f_{\text{offset}} < 3.515 \text{ MHz}$	$-22 \text{ dBm} - 15 \cdot \left(\frac{f_{\text{offset}}}{\text{MHz}} - 2.715 \right) \text{ dB}$	30 kHz
(see note 3)	$3.515 \text{ MHz} \leq f_{\text{offset}} < 4.0 \text{ MHz}$	-34 dBm	30 kHz
$3.5 \text{ MHz} \leq \Delta f < 7.5 \text{ MHz}$	$4.0 \text{ MHz} \leq f_{\text{offset}} < 8.0 \text{ MHz}$	-21 dBm	1 MHz
$7.5 \text{ MHz} \leq \Delta f \leq \Delta f_{\text{max}}$	$8.0 \text{ MHz} \leq f_{\text{offset}} < f_{\text{offset}_{\text{max}}}$	-25 dBm	1 MHz

Notes for Tables 6.3, 6.4, 6.5 & 6.6

NOTE 1 The minimum requirement for operation in band II, IV and V is the lower power of the minimum requirement for band I, II, III, IV, V, VII and VIII and the additional requirement for band II, IV and V.

NOTE 2 As a general rule, the resolution bandwidth of the measuring equipment should be equal to the measurement bandwidth. However, to improve measurement accuracy, sensitivity and efficiency, the resolution bandwidth can be smaller than the measurement bandwidth. When the resolution bandwidth is smaller than the measurement bandwidth, the result should be integrated over the measurement bandwidth in order to obtain the equivalent noise bandwidth of the measurement bandwidth.

NOTE 3: This frequency range ensures that the range of values of f_{offset} is continuous.

6.6.2.2 Adjacent Channel Leakage power Ratio (ACLR)

Adjacent Channel Leakage power Ratio (ACLR) is the ratio of the RRC filtered mean power centered on the assigned channel frequency to the RRC filtered mean power centered on an adjacent channel frequency.

The requirements shall apply whatever the type of transmitter considered (single carrier or multi-carrier). It applies for all transmission modes foreseen by the manufacturer's specification.

6.6.2.2.1 Minimum requirement

The ACLR shall be higher than the value specified in Table 6.7.

Table 6.7: BS ACLR

BS adjacent channel offset below the first or above the last carrier frequency used	ACLR limit
5 MHz	45 dB
10 MHz	50 dB

6.6.3 Spurious emissions

Spurious emissions are emissions which are caused by unwanted transmitter effects such as harmonics emission, parasitic emission, intermodulation products and frequency conversion products, but exclude out of band emissions. This is measured at the base station RF output port.

The requirements shall apply whatever the type of transmitter considered (single carrier or multiple-carrier). It applies for all transmission modes foreseen by the manufacturer's specification.

The requirements (except 6.6.3.5) apply at frequencies within the specified frequency ranges, which are more than 12.5MHz below the first carrier frequency used or more than 12.5MHz above the last carrier frequency used.

Unless otherwise stated, all requirements are measured as mean power (RMS).

6.6.3.1 Mandatory Requirements

The requirements of either subclause 6.6.3.1.1 or subclause 6.6.3.1.2 shall apply.

6.6.3.1.1 Spurious emissions (Category A)

The following requirements shall be met in cases where Category A limits for spurious emissions, as defined in ITU-R Recommendation SM.329 [1], are applied.

6.6.3.1.1.1 Minimum Requirement

The power of any spurious emission shall not exceed:

Table 6.8: BS Mandatory spurious emissions limits, Category A

Band	Maximum level	Measurement Bandwidth	Note
9kHz - 150kHz	-13 dBm	1 kHz	Note 1
150kHz - 30MHz		10 kHz	Note 1
30MHz - 1GHz		100 kHz	Note 1
1GHz - 12.75 GHz		1 MHz	Note 2
NOTE 1: Bandwidth as in ITU-R SM.329 [1], s4.1			
NOTE 2: Upper frequency as in ITU-R SM.329 [1], s2.5 table 1			

6.6.3.1.2 Spurious emissions (Category B)

The following requirements shall be met in cases where Category B limits for spurious emissions, as defined in ITU-R Recommendation SM.329 [1], are applied.

6.6.3.1.2.1 Minimum Requirement

The power of any spurious emission shall not exceed:

Table 6.9: BS Mandatory spurious emissions limits, operating band I, Category B

Band	Maximum Level	Measurement Bandwidth	Note
9kHz ↔ 150kHz	-36 dBm	1 kHz	Note 1
150kHz ↔ 30MHz	- 36 dBm	10 kHz	Note 1
30MHz ↔ 1GHz	-36 dBm	100 kHz	Note 1
1GHz ↔ Fc1 - 60 MHz or 2100 MHz <i>whichever is the higher</i>	-30 dBm	1 MHz	Note 1
Fc1 - 60 MHz or 2100 MHz <i>whichever is the higher</i> ↔ Fc1 - 50 MHz or 2100 MHz <i>whichever is the higher</i>	-25 dBm	1 MHz	Note 2
Fc1 - 50 MHz or 2100 MHz <i>whichever is the higher</i> ↔ Fc2 + 50 MHz or 2180 MHz <i>whichever is the lower</i>	-15 dBm	1 MHz	Note 2
Fc2 + 50 MHz or 2180 MHz <i>whichever is the lower</i> ↔ Fc2 + 60 MHz or 2180 MHz <i>whichever is the lower</i>	-25 dBm	1 MHz	Note 2
Fc2 + 60 MHz or 2180 MHz <i>whichever is the lower</i> ↔ 12.75 GHz	-30 dBm	1 MHz	Note 3
NOTE 1: Bandwidth as in ITU-R SM.329[1], s4.1			
NOTE 2: Specification in accordance with ITU-R SM.329[1], s4.3 and Annex 7			
NOTE 3: Bandwidth as in ITU-R SM.329[1], s4.1. Upper frequency as in ITU-R SM.329[1], s2.5 table 1			

Table 6.9A: BS Mandatory spurious emissions limits, operating band II, Category B

Band	Maximum Level	Measurement Bandwidth	Note
9kHz ↔ 150kHz	-36 dBm	1 kHz	Note 1
150kHz ↔ 30MHz	- 36 dBm	10 kHz	Note 1
30MHz ↔ 1GHz	-36 dBm	100 kHz	Note 1
1GHz ↔ Fc1 - 60 MHz or 1920 MHz <i>whichever is the higher</i>	-30 dBm	1 MHz	Note 1
Fc1 - 60 MHz or 1920 MHz <i>whichever is the higher</i> ↔ Fc1 - 50 MHz or 1920 MHz <i>whichever is the higher</i>	-25 dBm	1 MHz	Note 2
Fc1 - 50 MHz or 1920 MHz <i>whichever is the higher</i> ↔ Fc2 + 50 MHz or 2000 MHz <i>whichever is the lower</i>	-15 dBm	1 MHz	Note 2
Fc2 + 50 MHz or 2000 MHz <i>whichever is the lower</i> ↔ Fc2 + 60 MHz or 2000 MHz <i>whichever is the lower</i>	-25 dBm	1 MHz	Note 2
Fc2 + 60 MHz or 2000 MHz <i>whichever is the lower</i> ↔ 12.75 GHz	-30 dBm	1 MHz	Note 3
NOTE 1: Bandwidth as in ITU-R SM.329 [1], s4.1 NOTE 2: Specification in accordance with ITU-R SM.329 [1], s4.3 and Annex 7 NOTE 3: Bandwidth as in ITU-R SM.329 [1], s4.1. Upper frequency as in ITU-R SM.329 [1], s2.5 table 16			

Table 6.9B: BS Mandatory spurious emissions limits, operating band III, Category B

Band	Maximum Level	Measurement Bandwidth	Note
9kHz ↔ 150kHz	-36 dBm	1 kHz	Note 1
150kHz ↔ 30MHz	- 36 dBm	10 kHz	Note 1
30MHz ↔ 1GHz	-36 dBm	100 kHz	Note 1
1GHz ↔ Fc1 - 60 MHz or 1795 MHz <i>whichever is the higher</i>	-30 dBm	1 MHz	Note 1
Fc1 - 60 MHz or 1795 MHz <i>whichever is the higher</i> ↔ Fc1 - 50 MHz or 1795 MHz <i>whichever is the higher</i>	-25 dBm	1 MHz	Note 2
Fc1 - 50 MHz or 1795 MHz <i>whichever is the higher</i> ↔ Fc2 + 50 MHz or 1890 MHz <i>whichever is the lower</i>	-15 dBm	1 MHz	Note 2
Fc2 + 50 MHz or 1890 MHz <i>whichever is the lower</i> ↔ Fc2 + 60 MHz or 1890 MHz <i>whichever is the lower</i>	-25 dBm	1 MHz	Note 2
Fc2 + 60 MHz or 1890 MHz <i>whichever is the lower</i> ↔ 12.75 GHz	-30 dBm	1 MHz	Note 3
NOTE 1: Bandwidth as in ITU-R SM.329 [1], s4.1 NOTE 2: Specification in accordance with ITU-R SM.329 [1], s4.3 and Annex 7 NOTE 3: Bandwidth as in ITU-R SM.329 [1], s4.1. Upper frequency as in ITU-R SM.329 [1], s2.5 table 1			

Table 6.9C: BS Mandatory spurious emissions limits, operating band V, Category B

Band	Maximum Level	Measurement Bandwidth	Note
9kHz ↔ 150kHz	-36 dBm	1 kHz	Note 1
150kHz ↔ 30MHz	- 36 dBm	10 kHz	Note 1
30MHz ↔ 859 MHz	-36 dBm	100 kHz	Note 1
859 MHz ↔ Fc1 - 20 MHz or 859 MHz <i>whichever is the higher</i>	-26 dBm	100 kHz	Note 2
Fc1 - 20 MHz or 859 MHz <i>whichever is the higher</i> ↔ Fc2 + 20 MHz or 904 MHz <i>whichever is the lower</i>	-16 dBm	100 kHz	Note 2
Fc2 + 20 MHz or 904 MHz <i>whichever is the lower</i> ↔ 904 MHz	-26 dBm	100 kHz	Note 2
904 MHz ↔ 1 GHz	-36 dBm	100 kHz	Note 3
1GHz ↔ 12.75GHz	-30 dBm	1 MHz	Note 3
NOTE 1: Bandwidth as in ITU-R SM.329 [1], s4.1			
NOTE 2: Specification in accordance with ITU-R SM.329 [1], s4.3 and Annex 7			
NOTE 3: Bandwidth as in ITU-R SM.329 [1], s4.1. Upper frequency as in ITU-R SM.329 [1], s2.5 table 1			

Table 6.9D: BS Mandatory spurious emissions limits, operating band IV, Category B

Band	Maximum Level	Measurement Bandwidth	Note
9kHz ↔ 150kHz	-36 dBm	1 kHz	Note 1
150kHz ↔ 30MHz	- 36 dBm	10 kHz	Note 1
30MHz ↔ 1GHz	-36 dBm	100 kHz	Note 1
1GHz ↔ 2100 MHz	-30 dBm	1 MHz	Note 1
2100 MHz ↔ Fc1 - 50 MHz or 2100 MHz <i>whichever is the higher</i>	-25 dBm	1 MHz	Note 2
Fc1 - 50 MHz or 2100 MHz <i>whichever is the higher</i> ↔ Fc2 + 50 MHz or 2165 MHz <i>whichever is the lower</i>	-15 dBm	1 MHz	Note 2
Fc2 + 50 MHz or 2165 MHz <i>whichever is the lower</i> ↔ 2165 MHz	-25 dBm	1 MHz	Note 2
2165 MHz ↔ 12.75 GHz	-30 dBm	1 MHz	Note 3
NOTE 1: Bandwidth as in ITU-R SM.329[1], s4.1			
NOTE 2: Specification in accordance with ITU-R SM.329[1], s4.3 and Annex 7			
NOTE 3: Bandwidth as in ITU-R SM.329[1], s4.1. Upper frequency as in ITU-R SM.329[1], s2.5 table 1			

Table 6.9E: BS Mandatory spurious emissions limits, operating band VII, Category B

Band	Maximum Level	Measurement Bandwidth	Note
9kHz ↔ 150kHz	-36 dBm	1 kHz	Note 1
150kHz ↔ 30MHz	- 36 dBm	10 kHz	Note 1
30MHz ↔ 1GHz	-36 dBm	100 kHz	Note 1
1GHz ↔ Fc1 - 60 MHz or 2610 MHz <i>whichever is the higher</i>	-30 dBm	1 MHz	Note 1
Fc1 - 60 MHz or 2610 MHz <i>whichever is the higher</i> ↔ Fc1 - 50 MHz or 2610 MHz <i>whichever is the higher</i>	-25 dBm	1 MHz	Note 2
Fc1 - 50 MHz or 2610 MHz <i>whichever is the higher</i> ↔ Fc2 + 50 MHz or 2700 MHz <i>whichever is the lower</i>	-15 dBm	1 MHz	Note 2
Fc2 + 50 MHz or 2700 MHz <i>whichever is the lower</i> ↔ Fc2 + 60 MHz or 2700 MHz <i>whichever is the lower</i>	-25 dBm	1 MHz	Note 2
Fc2 + 60 MHz or 2700 MHz <i>whichever is the lower</i> ↔ 12.75 GHz	-30 dBm	1 MHz	Note 3
NOTE 1: Bandwidth as in ITU-R SM.329[1], s4.1			
NOTE 2: Specification in accordance with ITU-R SM.329[1], s4.3 and Annex 7			
NOTE 3: Bandwidth as in ITU-R SM.329[1], s4.1. Upper frequency as in ITU-R SM.329[1], s2.5 table 1			

Table 6.9F: BS Mandatory spurious emissions limits, operating band VIII, Category B

Band	Maximum Level	Measurement Bandwidth	Note
9kHz ↔ 150kHz	-36 dBm	1 kHz	Note 1
150kHz ↔ 30MHz	- 36 dBm	10 kHz	Note 1
30MHz ↔ 915 MHz	-36 dBm	100 kHz	Note 1
915 MHz ↔ Fc1 - 20 MHz or 915 MHz <i>whichever is the higher</i>	-26 dBm	100 kHz	Note 2
Fc1 - 20 MHz or 915 MHz <i>whichever is the higher</i> ↔ Fc2 + 20 MHz or 970 MHz <i>whichever is the lower</i>	-16 dBm	100 kHz	Note 2
Fc2 + 20 MHz or 970 MHz <i>whichever is the lower</i> ↔ 970 MHz	-26 dBm	100 kHz	Note 2
970 MHz ↔ 1 GHz	-36 dBm	100 kHz	Note 3
1GHz ↔ 12.75GHz	-30 dBm	1 MHz	Note 3
NOTE 1: Bandwidth as in ITU-R SM.329 [1], s4.1			
NOTE 2: Specification in accordance with ITU-R SM.329 [1], s4.3 and Annex 7			
NOTE 3: Bandwidth as in ITU-R SM.329 [1], s4.1. Upper frequency as in ITU-R SM.329 [1], s2.5 table 1			

Fc1: Center frequency of emission of the first carrier transmitted by the BS.

Fc2: Center frequency of emission of the last carrier transmitted by the BS.

6.6.3.2 Protection of the BS receiver of own or different BS

This requirement shall be applied in order to prevent the receivers of the BSs being desensitised by emissions from a BS transmitter. This is measured at the transmit antenna port for any type of BS which has common or separate Tx/Rx antenna ports.

6.6.3.2.1 Minimum Requirement

The power of any spurious emission shall not exceed:

Table 6.10: Wide Area BS Spurious emissions limits for protection of the BS receiver

Operating Band	Band	Maximum Level	Measurement Bandwidth	Note
I	1920 - 1980MHz	-96 dBm	100 kHz	
II	1850-1910 MHz	-96 dBm	100 kHz	
III	1710-1785 MHz	-96 dBm	100 kHz	
IV	1710-1755 MHz	-96 dBm	100 kHz	
V	824-849 MHz	-96 dBm	100 kHz	
VI	815-850 MHz	-96 dBm	100 kHz	
VII	2500-2570 MHz	-96 dBm	100 kHz	
VIII	880-915 MHz	-96 dBm	100 kHz	
IX	1749.9-1784.9 MHz	-96 dBm	100 kHz	

Table 6.10A: Medium Range BS Spurious emissions limits for protection of the BS receiver

Operating Band	Band	Maximum Level	Measurement Bandwidth	Note
I	1920 - 1980MHz	-86 dBm	100 kHz	
II	1850-1910 MHz	-86 dBm	100 kHz	
III	1710-1785 MHz	-86 dBm	100 kHz	
IV	1710-1755 MHz	-86 dBm	100 kHz	
V	824-849 MHz	-86 dBm	100 kHz	
VI	815-850 MHz	-86 dBm	100 kHz	
VII	2500-2570 MHz	-86 dBm	100 kHz	
VIII	880-915 MHz	-86 dBm	100 kHz	
IX	1749.9-1784.9 MHz	-86 dBm	100 kHz	

Table 6.10B: Local Area BS Spurious emissions limits for protection of the BS receiver

Operating Band	Band	Maximum Level	Measurement Bandwidth	Note
I	1920 - 1980MHz	-82 dBm	100 kHz	
II	1850-1910 MHz	-82 dBm	100 kHz	
III	1710-1785 MHz	-82 dBm	100 kHz	
IV	1710-1755 MHz	-82 dBm	100 kHz	
V	824-849 MHz	-82 dBm	100 kHz	
VI	815-850 MHz	-82 dBm	100 kHz	
VII	2500-2570 MHz	-82 dBm	100 kHz	
VIII	880-915 MHz	-82 dBm	100 kHz	
IX	1749.9-1784.9 MHz	-82 dBm	100 kHz	

6.6.3.3 Co-existence with other systems in the same geographical area

These requirements may be applied for the protection of UE, MS and/or BS operating in other frequency bands in the same geographical area. The requirements may apply in geographic areas in which both UTRA FDD operating in frequency bands I to IX and a system operating in another frequency band than the FDD operating band are deployed. The system operating in the other frequency band may be GSM900, DCS1800, PCS1900, GSM850 and/or FDD operating in bands I to IX.

6.6.3.3.1 Minimum Requirements

The power of any spurious emission shall not exceed the limits of Table 6.11 for a BS where requirements for co-existence with the system listed in the first column apply.

Table 6.11: BS Spurious emissions limits for UTRA FDD BS in geographic coverage area of systems operating in other frequency bands

System type operating in the same geographical area	Band for co-existence requirement	Maximum Level	Measurement Bandwidth	Note
GSM900	921 - 960 MHz	-57 dBm	100 kHz	This requirement does not apply to UTRA FDD operating in band VIII
	876 – 915 MHz	-61 dBm	100 kHz	For the frequency range 880-915 MHz, this requirement does not apply to UTRA FDD operating in band VIII, since it is already covered by the requirement in sub-clause 6.6.3.2.
DCS1800	1805 - 1880 MHz	-47 dBm	100 kHz	This requirement does not apply to UTRA FDD operating in band III
	1710 – 1785 MHz	-61 dBm	100 kHz	This requirement does not apply to UTRA FDD operating in band III, since it is already covered by the requirement in sub-clause 6.6.3.2.
PCS1900	1930 - 1990 MHz	-47 dBm	100 kHz	This requirement does not apply to UTRA FDD BS operating in frequency band II
	1850 - 1910 MHz	-61 dBm	100 kHz	This requirement does not apply to UTRA FDD BS operating in frequency band II, since it is already covered by the requirement in sub-clause 6.6.3.2.
GSM850	869 – 894 MHz	-57 dBm	100 kHz	This requirement does not apply to UTRA FDD BS operating in frequency band V
	824 - 849 MHz	-61 dBm	100 kHz	This requirement does not apply to UTRA FDD BS operating in frequency band V, since it is already covered by the requirement in sub-clause 6.6.3.2.
FDD Band I	2110 – 2170 MHz	-52 dBm	1 MHz	This requirement does not apply to UTRA FDD BS operating in band I,
	1920 – 1980 MHz	-49 dBm	1 MHz	This requirement does not apply to UTRA FDD BS operating in band I, since it is already covered by the requirement in sub-clause 6.6.3.2.
FDD Band II	1930 – 1990 MHz	-52 dBm	1 MHz	This requirement does not apply to UTRA FDD BS operating in band II
	1850 – 1910 MHz	-49 dBm	1 MHz	This requirement does not apply to UTRA FDD BS operating in band II, since it is already covered by the requirement in sub-clause 6.6.3.2.
FDD Band III	1805 – 1880 MHz	-52 dBm	1 MHz	This requirement does not apply to UTRA FDD BS operating in band III
	1710 – 1785 MHz	-49 dBm	1 MHz	This requirement does not apply to UTRA FDD BS operating in band III, since it is already covered by the requirement in sub-clause 6.6.3.2.
FDD Band IV	2110 – 2155 MHz	-52 dBm	1 MHz	This requirement does not apply to UTRA FDD BS operating in band IV
	1710 – 1755 MHz	-49 dBm	1 MHz	This requirement does not apply to UTRA FDD BS operating in band IV, since it is already covered by the requirement in sub-clause 6.6.3.2.
FDD Band V	869 – 894 MHz	-52 dBm	1 MHz	This requirement does not apply to UTRA FDD BS operating in band V

	824 – 849 MHz	-49 dBm	1 MHz	This requirement does not apply to UTRA FDD BS operating in band V, since it is already covered by the requirement in sub-clause 6.6.3.2.
FDD Band VI	860 - 895 MHz	-52 dBm	1 MHz	This requirement does not apply to UTRA FDD BS operating in band VI
	815 - 850 MHz	-49 dBm	1 MHz	This requirement does not apply to UTRA FDD BS operating in band VI, since it is already covered by the requirement in sub-clause 6.6.3.2.
FDD Band VII	2620 – 2690 MHz	-52 dBm	1 MHz	This requirement does not apply to UTRA FDD BS operating in band VII,
	2500 – 2570 MHz	-49 dBm	1 MHz	This requirement does not apply to UTRA FDD BS operating in band VII, since it is already covered by the requirement in sub-clause 6.6.3.2.
FDD Band VIII	925 – 960 MHz	-52 dBm	1 MHz	This requirement does not apply to UTRA FDD BS operating in band VIII.
	880 – 915 MHz	-49 dBm	1 MHz	This requirement does not apply to UTRA FDD BS operating in band VIII, since it is already covered by the requirement in sub-clause 6.6.3.2.
FDD Band IX	1844.9 – 1879.9 MHz	-52 dBm	1 MHz	This requirement does not apply to UTRA FDD BS operating in band IX
	1749.9 – 1784.9 MHz	-49 dBm	1 MHz	This requirement does not apply to UTRA FDD BS operating in band IX, since it is already covered by the requirement in sub-clause 6.6.3.2.

6.6.3.4 Co-existence with co-located and co-sited base stations

These requirements may be applied for the protection of other BS receivers when GSM900, DCS1800, PCS1900, GSM850 and/or FDD BS operating in Bands I to IX are co-located with a UTRA FDD BS.

The requirements in this chapter assume a 30 dB coupling loss between transmitter and receiver. If BSs of different classes are co-sited, the coupling loss should be increased by the value as stated in TR 25.942 [4] chapter 10.3 in Table 10.1 and Table 10.2.

6.6.3.4.1 Minimum Requirements

The power of any spurious emission shall not exceed the limits of Table 6.12 for a Wide Area (WA) BS where requirements for co-location with a BS type listed in the first column apply.

Table 6.12: BS Spurious emissions limits for Wide Area BS co-located with another BS

Type of co-located BS	Band for co-location requirement	Maximum Level	Measurement Bandwidth	Note
Macro GSM900	876-915 MHz	-98 dBm	100 kHz	
Macro DCS1800	1710 - 1785 MHz	-98 dBm	100 kHz	
Macro PCS1900	1850 – 1910 MHz	-98 dBm	100 kHz	
Macro GSM850	824 - 849 MHz	-98 dBm	100 kHz	
WA UTRA FDD Band I	1920 - 1980 MHz	-96 dBm	100 kHz	
WA UTRA FDD Band II	1850 – 1910 MHz	-96 dBm	100 kHz	
WA UTRA FDD Band III	1710 – 1785 MHz	-96 dBm	100 kHz	
WA UTRA FDD Band IV	1710 – 1755 MHz	-96 dBm	100 kHz	
WA UTRA FDD Band V	824 – 849 MHz	-96 dBm	100 kHz	
WA UTRA FDD Band VI	815 - 850 MHz	-96 dBm	100 kHz	
WA UTRA FDD Band VII	2500 – 2570 MHz	-96 dBm	100 KHz	
WA UTRA FDD Band VIII	880 – 915 MHz	-96 dBm	100 KHz	
WA UTRA FDD Band IX	1749.9 – 1784.9 MHz	-96 dBm	100 KHz	

The power of any spurious emission shall not exceed the limits of Table 6.13 for a Medium Range (MR) BS where requirements for co-location with a BS type listed in the first column apply.

Table 6.13: BS Spurious emissions limits for Medium Range BS co-located with another BS

Type of co-located BS	Band for co-location requirement	Maximum Level	Measurement Bandwidth	Note
Micro GSM900	876-915 MHz	-91 dBm	100 kHz	
Micro DCS1800	1710 - 1785 MHz	-96 dBm	100 kHz	
Micro PCS1900	1850 – 1910 MHz	-96 dBm	100 kHz	
Micro GSM850	824 - 849 MHz	-91 dBm	100 kHz	
MR UTRA FDD Band I	1920 - 1980 MHz	-86 dBm	100 kHz	
MR UTRA FDD Band II	1850 – 1910 MHz	-86 dBm	100 kHz	
MR UTRA FDD Band III	1710 – 1785 MHz	-86 dBm	100 kHz	
MR UTRA FDD Band IV	1710 – 1755 MHz	-86 dBm	100 kHz	
MR UTRA FDD Band V	824 – 849 MHz	-86 dBm	100 kHz	
MR UTRA FDD Band VI	815 - 850 MHz	-86 dBm	100 kHz	
MR UTRA FDD Band VII	2500 – 2570 MHz	-86 dBm	100 KHz	
MR UTRA FDD Band VIII	880 – 915 MHz	-86 dBm	100 KHz	
MR UTRA FDD Band IX	1749.9 – 1784.9 MHz	-86 dBm	100 KHz	

The power of any spurious emission shall not exceed the limits of Table 6.14 for a Local Area (LA) BS where requirements for co-location with a BS type listed in the first column apply.

Table 6.14: BS Spurious emissions limits for Local Area BS co-located with another BS

Type of co-located BS	Band for co-location requirement	Maximum Level	Measurement Bandwidth	Note
Pico GSM900	876-915 MHz	-70 dBm	100 kHz	
Pico DCS1800	1710 - 1785 MHz	-80 dBm	100 kHz	
Pico PCS1900	1850 – 1910 MHz	-80 dBm	100 kHz	
Pico GSM850	824 - 849 MHz	-70 dBm	100 kHz	
LA UTRA FDD Band I	1920 - 1980 MHz	-82 dBm	100 kHz	
LA UTRA FDD Band II	1850 – 1910 MHz	-82 dBm	100 kHz	
LA UTRA FDD Band III	1710 – 1785 MHz	-82 dBm	100 kHz	
LA UTRA FDD Band IV	1710 – 1755 MHz	-82 dBm	100 kHz	
LA UTRA FDD Band V	824 – 849 MHz	-82 dBm	100 kHz	
LA UTRA FDD Band VI	815 - 850 MHz	-82 dBm	100 kHz	
LA UTRA FDD Band VII	2500 – 2570 MHz	-82 dBm	100 KHz	
LA UTRA FDD Band VIII	880 – 915 MHz	-82 dBm	100 KHz	
LA UTRA FDD Band IX	1749.9 – 1784.9 MHz	-82 dBm	100 KHz	

6.6.3.5 Co-existence with PHS

This requirement may be applied for the protection of PHS in geographic areas in which both PHS and UTRA FDD are deployed. This requirement is also applicable at specified frequencies falling between 12.5MHz below the first carrier frequency used and 12.5MHz above the last carrier frequency used.

6.6.3.5.1 Minimum Requirement

The power of any spurious emission shall not exceed:

Table 6.15: BS Spurious emissions limits for BS in geographic coverage area of PHS

Band	Maximum Level	Measurement Bandwidth	Note
1884.5 - 1919.6 MHz	-41 dBm	300 kHz	

6.6.3.6 Co-existence with services in adjacent frequency bands

This requirement may be applied for the protection in bands adjacent to bands I, II, III or VII as defined in clause 5.2 in geographic areas in which both an adjacent band service and UTRA FDD are deployed.

6.6.3.6.1 Minimum requirement

The power of any spurious emission shall not exceed:

Table 6.16: BS spurious emissions limits for protection of adjacent band services

Operating Band	Band	Maximum Level	Measurement Bandwidth	Note
I	2100-2105 MHz	$-30 + 3.4 \cdot (f - 2100 \text{ MHz}) \text{ dBm}$	1 MHz	
	2175-2180 MHz	$-30 + 3.4 \cdot (2180 \text{ MHz} - f) \text{ dBm}$	1 MHz	
II	1920-1925 MHz	$-30 + 3.4 \cdot (f - 1920 \text{ MHz}) \text{ dBm}$	1 MHz	
	1995-2000 MHz	$-30 + 3.4 \cdot (2000 \text{ MHz} - f) \text{ dBm}$	1 MHz	
III	1795-1800 MHz	$-30 + 3.4 \cdot (f - 1795 \text{ MHz}) \text{ dBm}$	1MHz	
	1885-1890 MHz	$-30 + 3.4 \cdot (1890 \text{ MHz} - f) \text{ dBm}$	1MHz	
VII	2610-2615 MHz	$-30 + 3.4 \cdot (f - 2610 \text{ MHz}) \text{ dBm}$	1 MHz	
	2695-2700 MHz	$-30 + 3.4 \cdot (2700 \text{ MHz} - f) \text{ dBm}$	1 MHz	

Note: This requirement for the frequency range 2610-2615 MHz may be applied to geographic areas in which both UTRA-TDD and UTRA-FDD are deployed.

6.6.3.7 Co-existence with UTRA-TDD

6.6.3.7.1 Operation in the same geographic area

This requirement may be applied to geographic areas in which both UTRA-TDD and UTRA-FDD are deployed.

6.6.3.7.1.1 Minimum Requirement

The power of any spurious emission shall not exceed:

Table 6.17: BS Spurious emissions limits for BS in geographic coverage area of UTRA-TDD

Band	Maximum Level	Measurement Bandwidth	Note
1900 - 1920 MHz	-52 dBm	1 MHz	
2010 - 2025 MHz	-52 dBm	1 MHz	
2570 – 2610 MHz	-52 dBm	1 MHz	

6.6.3.7.2 Co-located base stations

This requirement may be applied for the protection of UTRA-TDD BS receivers when UTRA-TDD BS and UTRA FDD BS are co-located.

6.6.3.7.2.1 Minimum Requirement

The power of any spurious emission shall not exceed:

Table 6.18: BS Spurious emissions limits for BS co-located with UTRA-TDD

BS class	Band	Maximum Level	Measurement Bandwidth	Note
Wide Area BS	1900 - 1920 MHz	-86 dBm	1 MHz	
Local Area BS	1900 - 1920 MHz	-55 dBm	1 MHz	
Wide Area BS	2010 - 2025 MHz	-86 dBm	1 MHz	
Local Area BS	2010 - 2025 MHz	-55 dBm	1 MHz	
Wide Area BS	2570 – 2610 MHz	-86 dBm	1 MHz	
Local Area BS	2570 – 2610 MHz	-55 dBm	1 MHz	

These values assume a 30 dB coupling loss between transmitter and receiver. If BSs of different classes are co-sited, the coupling loss must be increased by the difference between the corresponding values from the table above.

6.7 Transmit intermodulation

The transmit intermodulation performance is a measure of the capability of the transmitter to inhibit the generation of signals in its non linear elements caused by presence of the wanted signal and an interfering signal reaching the transmitter via the antenna.

The transmit intermodulation level is the power of the intermodulation products when a WCDMA modulated interference signal is injected into the antenna connector at a mean power level of 30 dB lower than that of the mean power of the wanted signal. The frequency of the interference signal shall be +5 MHz, -5 MHz, +10 MHz, -10 MHz, +15 MHz and -15 MHz offset from the subject signal carrier frequency, but exclude interference frequencies that are outside of the allocated frequency band for UTRA-FDD downlink specified in subclause 5.2.

6.7.1 Minimum requirement

The transmit intermodulation level shall not exceed the out of band emission or the spurious emission requirements of clauses 6.6.2 and 6.6.3 in the presence of a WCDMA modulated interference signal with a mean power level 30 dB lower than the mean power of the wanted signal.

6.8 Transmit modulation

Transmit modulation is specified in three parts, Frequency Error, Error Vector Magnitude and Peak Code Domain Error. These specifications are made with reference to a theoretical modulated waveform.

The theoretical modulated waveform is created by modulating a carrier at the assigned carrier frequency using the same data as was used to generate the measured waveform. The chip modulation rate for the theoretical waveform shall be exactly 3.84 Mcps. The code powers of the theoretical waveform shall be the same as the measured waveform, rather than the nominal code powers used to generate the test signal.

6.8.1 Transmit pulse shape filter

The transmit pulse-shaping filter is a root-raised cosine (RRC) with roll-off $\alpha = 0.22$ in the frequency domain. The impulse response of the chip impulse filter $RC_0(t)$ is

$$RC_0(t) = \frac{\sin\left(\pi \frac{t}{T_c}(1-\alpha)\right) + 4\alpha \frac{t}{T_c} \cos\left(\pi \frac{t}{T_c}(1+\alpha)\right)}{\pi \frac{t}{T_c} \left(1 - \left(4\alpha \frac{t}{T_c}\right)^2\right)}$$

Where the roll-off factor $\alpha = 0.22$ and the chip duration:

$$T_c = \frac{1}{\text{chiprate}} \approx 0.26042 \mu\text{s}$$

6.8.2 Error Vector Magnitude

The Error Vector Magnitude is a measure of the difference between the reference waveform and the measured waveform. This difference is called the error vector. Both waveforms pass through a matched Root Raised Cosine filter with bandwidth 3.84 MHz and roll-off $\alpha = 0.22$. Both waveforms are then further modified by selecting the frequency, absolute phase, absolute amplitude and chip clock timing so as to minimise the error vector. The EVM result is defined as the square root of the ratio of the mean error vector power to the mean reference power expressed as a %. The measurement interval is one timeslot as defined by the C-PICH (when present) otherwise the measurement interval is one timeslot starting with the beginning of the SCH. The requirement is valid over the total power dynamic range as specified in subclause 6.4.3.

6.8.2.1 Minimum requirement

The Error Vector Magnitude shall not be worse than 17.5 % when the base station is transmitting a composite signal using only QPSK modulation.

The Error Vector Magnitude shall not be worse than 12.5 % when the base station is transmitting a composite signal that includes 16QAM modulation.

6.8.3 Peak code Domain error

The Peak Code Domain Error is computed by projecting the error vector (as defined in 6.8.2) onto the code domain at a specified spreading factor. The Code Domain Error for every code in the domain is defined as the ratio of the mean power of the projection onto that code, to the mean power of the composite reference waveform. This ratio is expressed in dB. The Peak Code Domain Error is defined as the maximum value for the Code Domain Error for all codes. The measurement interval is one timeslot as defined by the C-PICH (when present) otherwise the measurement interval is one timeslot starting with the beginning of the SCH.

6.8.3.1 Minimum requirement

The peak code domain error shall not exceed -33 dB at spreading factor 256.

6.8.4 Time alignment error in Tx Diversity

In Tx Diversity, signals are transmitted from two antennas. These signals shall be aligned. The time alignment error in Tx Diversity is specified as the delay between the signals from the two diversity antennas at the antenna ports.

6.8.4.1 Minimum Requirement

The time alignment error in Tx Diversity shall not exceed $\frac{1}{4} T_c$.

7 Receiver characteristics

7.1 General

The requirements in Section 7 assume that the receiver is not equipped with diversity. For receivers with diversity, the requirements apply to each antenna connector separately, with the other one(s) terminated or disabled. The requirements are otherwise unchanged.

Unless otherwise stated, the receiver characteristics are specified at the BS antenna connector (test port A) with a full complement of transceivers for the configuration in normal operating conditions. If any external apparatus such as a RX

amplifier, a filter or the combination of such devices is used, requirements apply at the far end antenna connector (port B).

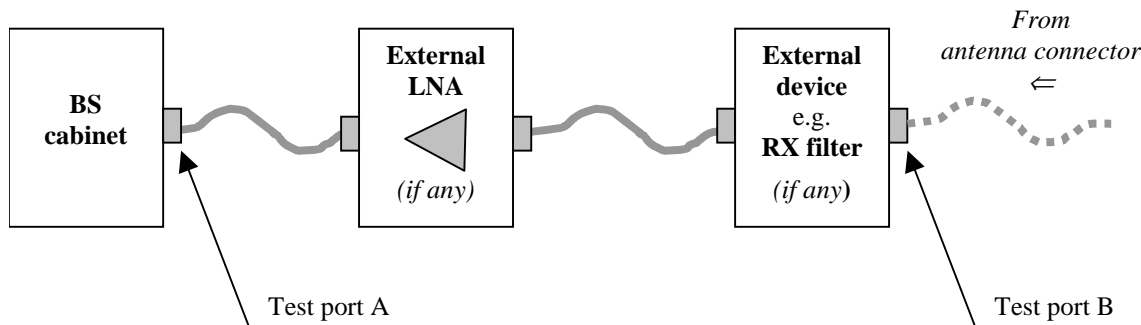

Figure 7.1: Receiver test ports

7.2 Reference sensitivity level

The reference sensitivity level is the minimum mean power received at the antenna connector at which the Bit Error Ratio (BER) shall not exceed the specific value indicated in section 7.2.1.

7.2.1 Minimum requirement

Using the reference measurement channel specification in Annex A, the reference sensitivity level and performance of the BS shall be as specified in Table 7.1.

Table 7.1: BS reference sensitivity levels

BS Class	Reference measurement channel data rate	BS reference sensitivity level (dBm)	BER
Wide Area BS	12.2 kbps	-121	BER shall not exceed 0.001
Medium Range BS	12.2 kbps	-111	BER shall not exceed 0.001
Local Area BS	12.2 kbps	-107	BER shall not exceed 0.001

7.2.2 Maximum Frequency Deviation for Receiver Performance

The need for such a requirement is for further study.

7.3 Dynamic range

Receiver dynamic range is the receiver ability to handle a rise of interference in the reception frequency channel. The receiver shall fulfil a specified BER requirement for a specified sensitivity degradation of the wanted signal in the presence of an interfering AWGN signal in the same reception frequency channel.

7.3.1 Minimum requirement

The BER shall not exceed 0.001 for the parameters specified in Table 7.2.

Table 7.2: Dynamic range

Parameter	Level Wide Area BS	Level Medium Range BS	Level Local Area BS	Unit
Reference measurement channel data rate	12.2	12.2	12.2	kbps
Wanted signal mean power	-91	-81	-77	dBm
Interfering AWGN signal	-73	-63	-59	dBm/3.84 MHz

7.4 Adjacent Channel Selectivity (ACS)

Adjacent channel selectivity (ACS) is a measure of the receiver ability to receive a wanted signal at its assigned channel frequency in the presence of an adjacent channel signal at a given frequency offset from the center frequency of the assigned channel. ACS is the ratio of the receiver filter attenuation on the assigned channel frequency to the receiver filter attenuation on the adjacent channel(s).

The interference signal is offset from the wanted signal by the frequency offset F_{uw} . The interference signal shall be a W-CDMA signal as specified in Annex C.

7.4.1 Minimum requirement

The BER shall not exceed 0.001 for the parameters specified in Table 7.3.

Table 7.3: Adjacent channel selectivity

Parameter	Level Wide Area BS	Level Medium Range BS	Level Local Area BS	Unit
Data rate	12.2	12.2	12.2	kbps
Wanted signal mean power	-115	-105	-101	dBm
Interfering signal mean power	-52	-42	-38	dBm
F_{uw} offset (Modulated)	5	5	5	MHz

7.4.2 Minimum requirement – Co-location with UTRA-TDD

The current state-of-the-art technology does not allow a single generic solution for co-location with UTRA-TDD on adjacent frequencies for 30dB BS-BS minimum coupling loss.

Further information and analysis for this scenario can be found in TR 25.942 [4].

7.5 Blocking characteristics

The blocking characteristics is a measure of the receiver ability to receive a wanted signal at its assigned channel frequency in the presence of an unwanted interferer on frequencies other than those of the adjacent channels. The blocking performance requirement applies as specified in the tables 7.4 to 7.5B below, using a 1 MHz step size.

7.5.1 Minimum requirement

The static reference performance as specified in clause 7.2.1 shall be met with a wanted and an interfering signal coupled to BS antenna input using the following parameters.

Table 7.4: Blocking performance requirement for Wide Area BS

Operating Band	Center Frequency of Interfering Signal	Interfering Signal mean power	Wanted Signal mean power	Minimum Offset of Interfering Signal	Type of Interfering Signal
I	1920 - 1980 MHz	-40 dBm	-115 dBm	10 MHz	WCDMA signal *
	1900 - 1920 MHz 1980 - 2000 MHz	-40 dBm	-115 dBm	10 MHz	WCDMA signal *
	1 MHz -1900 MHz 2000 MHz - 12750 MHz	-15 dBm	-115 dBm	—	CW carrier
II	1850 - 1910 MHz	-40 dBm	-115 dBm	10 MHz	WCDMA signal *
	1830 - 1850 MHz 1910 - 1930 MHz	-40 dBm	-115 dBm	10 MHz	WCDMA signal *
	1 MHz - 1830 MHz 1930 MHz - 12750 MHz	-15 dBm	-115 dBm	—	CW carrier
III	1710 – 1785 MHz	-40 dBm	-115 dBm	10 MHz	WCDMA signal *
	1690 - 1710 MHz 1785 – 1805 MHz	-40 dBm	-115 dBm	10 MHz	WCDMA signal *
	1 MHz - 1690 MHz 1805 MHz - 12750 MHz	-15 dBm	-115 dBm	—	CW carrier
IV	1710 – 1755 MHz	-40 dBm	-115 dBm	10 MHz	WCDMA signal *
	1690 - 1710 MHz 1755 – 1775 MHz	-40 dBm	-115 dBm	10 MHz	WCDMA signal *
	1 MHz - 1690 MHz 1775 MHz - 12750 MHz	-15 dBm	-115 dBm	—	CW carrier
V	824-849 MHz	-40 dBm	-115 dBm	10 MHz	WCDMA signal *
	804-824 MHz 849-869 MHz	-40 dBm	-115 dBm	10 MHz	WCDMA signal *
	1 MHz – 804 MHz 869 MHz - 12750 MHz	-15 dBm	-115 dBm	—	CW carrier
VI	810 – 830 MHz 840 – 860 MHz	-40 dBm	-115 dBm	10 MHz	WCDMA signal *
	1 MHz – 810 MHz 860 MHz – 12750 MHz	-15 dBm	-115 dBm	—	CW carrier
	2500 - 2570 MHz	-40 dBm	-115 dBm	10 MHz	WCDMA signal *
VII	2480 - 2500 MHz 2570 - 2590 MHz	-40 dBm	-115 dBm	10 MHz	WCDMA signal *
	1 MHz -2480 MHz 2590 MHz - 12750 MHz	-15 dBm	-115 dBm	—	CW carrier
	880 - 915 MHz	-40 dBm	-115 dBm	10 MHz	WCDMA signal *
VIII	860 - 880 MHz 915 – 925 MHz	-40 dBm	-115 dBm	10 MHz	WCDMA signal *
	1 MHz -860 MHz 925 MHz - 12750 MHz	-15 dBm	-115 dBm	—	CW carrier
	1749.9 – 1784.9 MHz	-40 dBm	-115 dBm	10 MHz	WCDMA signal *
IX	1729.9 – 1749.9 MHz 1784.9 – 1804.9 MHz	-40 dBm	-115 dBm	10 MHz	WCDMA signal *
	1 MHz – 1729.9 MHz 1804.9 MHz – 12750 MHz	-15 dBm	-115 dBm	—	CW carrier

Note*: The characteristics of the W-CDMA interference signal are specified in Annex C

Table 7.4A: Blocking performance requirement for Medium range BS

Operating Band	Center Frequency of Interfering Signal	Interfering Signal mean power	Wanted Signal mean power	Minimum Offset of Interfering Signal	Type of Interfering Signal
I	1920 - 1980 MHz	-35 dBm	-105 dBm	10 MHz	WCDMA signal *
	1900 - 1920 MHz 1980 - 2000 MHz	-35 dBm	-105 dBm	10 MHz	WCDMA signal *
	1 MHz - 1900 MHz 2000 MHz - 12750 MHz	-15 dBm	-105 dBm	—	CW carrier
II	1850 - 1910 MHz	-35 dBm	-105 dBm	10 MHz	WCDMA signal *
	1830 - 1850 MHz 1910 - 1930 MHz	-35 dBm	-105 dBm	10 MHz	WCDMA signal *
	1 MHz - 1830 MHz 1930 MHz - 12750 MHz	-15 dBm	-105 dBm	—	CW carrier
III	1710 – 1785 MHz	-35 dBm	-105 dBm	10 MHz	WCDMA signal *
	1690 - 1710 MHz 1785 – 1805 MHz	-35 dBm	-105 dBm	10 MHz	WCDMA signal *
	1 MHz - 1690 MHz 1805 MHz - 12750 MHz	-15 dBm	-105 dBm	—	CW carrier
IV	1710 – 1755 MHz	-35 dBm	-105 dBm	10 MHz	WCDMA signal *
	1690 - 1710 MHz 1755 – 1775 MHz	-35 dBm	-105 dBm	10 MHz	WCDMA signal *
	1 MHz - 1690 MHz 1775 MHz - 12750 MHz	-15 dBm	-105 dBm	—	CW carrier
V	824-849 MHz	-35 dBm	-105 dBm	10 MHz	WCDMA signal *
	804-824 MHz 849-869 MHz	-35 dBm	-105 dBm	10 MHz	WCDMA signal *
	1 MHz – 804 MHz 869 MHz - 12750 MHz	-15 dBm	-105 dBm	—	CW carrier
VI	810 – 830 MHz 840 – 860 MHz	-35 dBm	-105 dBm	10 MHz	WCDMA signal *
	1 MHz – 810 MHz 860 MHz – 12750 MHz	-15 dBm	-105 dBm	—	CW carrier
	2500 - 2570 MHz	-35 dBm	-105 dBm	10 MHz	WCDMA signal *
VII	2480 - 2500 MHz 2570 - 2590 MHz	-35 dBm	-105 dBm	10 MHz	WCDMA signal *
	1 MHz - 2480 MHz 2590 MHz - 12750 MHz	-15 dBm	-105 dBm	—	CW carrier
	880 - 915 MHz	-35 dBm	-105 dBm	10 MHz	WCDMA signal *
VIII	860 - 880 MHz 915 – 925 MHz	-35 dBm	-105 dBm	10 MHz	WCDMA signal *
	1 MHz - 860 MHz 925 MHz - 12750 MHz	-15 dBm	-105 dBm	—	CW carrier
	1749.9 – 1784.9 MHz	-35 dBm	-105 dBm	10 MHz	WCDMA signal *
IX	1729.9 – 1749.9 MHz 1784.9 – 1804.9 MHz	-35 dBm	-105 dBm	10 MHz	WCDMA signal *
	1 MHz – 1729.9 MHz 1804.9 MHz – 12750 MHz	-15 dBm	-105 dBm	—	CW carrier

Note*: The characteristics of the W-CDMA interference signal are specified in Annex C

Table 7.4B: Blocking performance requirement for Local Area BS

Operating Band	Center Frequency of Interfering Signal	Interfering Signal mean power	Wanted Signal mean power	Minimum Offset of Interfering Signal	Type of Interfering Signal
I	1920 - 1980 MHz	-30 dBm	-101 dBm	10 MHz	WCDMA signal *
	1900 - 1920 MHz 1980 - 2000 MHz	-30 dBm	-101 dBm	10 MHz	WCDMA signal *
	1 MHz - 1900 MHz 2000 MHz - 12750 MHz	-15 dBm	-101 dBm	—	CW carrier
II	1850 - 1910 MHz	-30 dBm	-101 dBm	10 MHz	WCDMA signal *
	1830 - 1850 MHz 1910 - 1930 MHz	-30 dBm	-101 dBm	10 MHz	WCDMA signal *
	1 MHz - 1830 MHz 1930 MHz - 12750 MHz	-15 dBm	-101 dBm	—	CW carrier
III	1710 - 1785 MHz	-30 dBm	-101 dBm	10 MHz	WCDMA signal *
	1690 - 1710 MHz 1785 - 1805 MHz	-30 dBm	-101 dBm	10 MHz	WCDMA signal *
	1 MHz - 1690 MHz 1805 MHz - 12750 MHz	-15 dBm	-101 dBm	—	CW carrier
IV	1710 - 1755 MHz	-30 dBm	-101 dBm	10 MHz	WCDMA signal *
	1690 - 1710 MHz 1755 - 1775 MHz	-30 dBm	-101 dBm	10 MHz	WCDMA signal *
	1 MHz - 1690 MHz 1775 MHz - 12750 MHz	-15 dBm	-101 dBm	—	CW carrier
V	824-849 MHz	-30 dBm	-101 dBm	10 MHz	WCDMA signal *
	804-824 MHz 849-869 MHz	-30 dBm	-101 dBm	10 MHz	WCDMA signal *
	1 MHz - 804 MHz 869 MHz - 12750 MHz	-15 dBm	-101 dBm	—	CW carrier
VI	810 - 830 MHz 840 - 860 MHz	-30 dBm	-101 dBm	10 MHz	WCDMA signal *
	1 MHz - 810 MHz 860 MHz - 12750 MHz	-15 dBm	-101 dBm	—	CW carrier
	2500 - 2570 MHz	-30 dBm	-101 dBm	10 MHz	WCDMA signal *
VII	2480 - 2500 MHz 2570 - 2590 MHz	-30 dBm	-101 dBm	10 MHz	WCDMA signal *
	1 MHz - 2480 MHz 2590 MHz - 12750 MHz	-15 dBm	-101 dBm	—	CW carrier
	880 - 915 MHz	-30 dBm	-101 dBm	10 MHz	WCDMA signal *
VIII	860 - 880 MHz 915 - 925 MHz	-30 dBm	-101 dBm	10 MHz	WCDMA signal *
	1 MHz - 860 MHz 925 MHz - 12750 MHz	-15 dBm	-101 dBm	—	CW carrier
	1749.9 - 1784.9 MHz	-30 dBm	-101 dBm	10 MHz	WCDMA signal *
IX	1729.9 - 1749.9 MHz 1784.9 - 1804.9 MHz	-30 dBm	-101 dBm	10 MHz	WCDMA signal *
	1 MHz - 1729.9 MHz 1804.9 MHz - 12750 MHz	-15 dBm	-101 dBm	—	CW carrier

Note*: The characteristics of the W-CDMA interference signal are specified in Annex C

Table 7.5: Blocking performance requirement (narrowband) for Wide Area BS

Operating Band	Center Frequency of Interfering Signal	Interfering Signal mean power	Wanted Signal mean power	Minimum Offset of Interfering Signal	Type of Interfering Signal
II	1850 - 1910 MHz	- 47 dBm	-115 dBm	2.7 MHz	GMSK modulated*
III	1710 – 1785 MHz	- 47 dBm	-115 dBm	2.8 MHz	GMSK modulated*
IV	1710 – 1755 MHz	- 47 dBm	-115 dBm	2.7 MHz	GMSK modulated*
V	824 – 849 MHz	- 47 dBm	-115 dBm	2.7 MHz	GMSK modulated*
VIII	880 – 915 MHz	- 47 dBm	-115 dBm	2.8 MHz	GMSK modulated*

* GMSK modulation as defined in TS 45.004 [5].

Table 7.5A: Blocking performance requirement (narrowband) for Medium Range BS

Operating Band	Center Frequency of Interfering Signal	Interfering Signal mean power	Wanted Signal mean power	Minimum Offset of Interfering Signal	Type of Interfering Signal
II	1850 - 1910 MHz	- 42 dBm	-105 dBm	2.7 MHz	GMSK modulated*
III	1710 – 1785 MHz	- 42 dBm	-105 dBm	2.8 MHz	GMSK modulated*
IV	1710 – 1755 MHz	- 42 dBm	-105 dBm	2.7 MHz	GMSK modulated*
V	824 – 849 MHz	- 42 dBm	-105 dBm	2.7 MHz	GMSK modulated*
VIII	880 – 915 MHz	- 42 dBm	-105 dBm	2.8 MHz	GMSK modulated*

* GMSK modulation as defined in TS 45.004 [5].

Table 7.5B: Blocking performance requirement (narrowband) for Local Area BS

Operating Band	Center Frequency of Interfering Signal	Interfering Signal mean power	Wanted Signal mean power	Minimum Offset of Interfering Signal	Type of Interfering Signal
II	1850 - 1910 MHz	- 37 dBm	-101 dBm	2.7 MHz	GMSK modulated*
III	1710 – 1785 MHz	- 37 dBm	-101 dBm	2.8 MHz	GMSK modulated*
IV	1710 – 1755 MHz	- 37 dBm	-101 dBm	2.7 MHz	GMSK modulated*
V	824 – 849 MHz	- 37 dBm	-101 dBm	2.7 MHz	GMSK modulated*
VIII	880 – 915 MHz	- 37 dBm	-101 dBm	2.8 MHz	GMSK modulated*

* GMSK modulation as defined in TS 45.004 [5].

7.5.2 Minimum Requirement – Co-location with GSM900, DCS 1800, PCS1900, GSM850 and/or UTRA FDD

This additional blocking requirement may be applied for the protection of FDD BS receivers when GSM900, DCS1800, PCS1900, GSM850 and/or FDD BS operating in Bands I to VIII are co-located with a UTRA FDD BS.

The requirements in this chapter assume a 30 dB coupling loss between transmitter and receiver. If BSs of different classes are co-sited, the coupling loss should be increased by the value as stated in TR 25.942 [4] chapter 10.3 in Table 10.1 and Table 10.2.

For a Wide Area (WA) FDD BS, the static reference performance as specified in clause 7.2.1 shall be met with a wanted and an interfering signal coupled to BS antenna input using the parameters in Table 7.5C.

Table 7.5C: Blocking performance requirement for Wide Area BS when co-located with BS in other bands.

Co-located BS type	Center Frequency of Interfering Signal	Interfering Signal mean power	Wanted Signal mean power	Type of Interfering Signal
Macro GSM900	921 – 960 MHz	+16 dBm	-115 dBm	CW carrier
Macro DCS1800	1805 – 1880 MHz	+16 dBm	-115 dBm	CW carrier
Macro PCS1900	1930 – 1990 MHz	+16 dBm	-115 dBm	CW carrier
Macro GSM850	869 – 894 MHz	+16 dBm	-115 dBm	CW carrier
WA UTRA-FDD Band I	2110 – 2170 MHz	+16 dBm	-115 dBm	CW carrier
WA UTRA-FDD Band II	1930 – 1990 MHz	+16 dBm	-115 dBm	CW carrier
WA UTRA-FDD Band III	1805 – 1880 MHz	+16 dBm	-115 dBm	CW carrier
WA UTRA-FDD Band IV	2110 – 2155 MHz	+16 dBm	-115 dBm	CW carrier
WA UTRA-FDD Band V	869 – 894 MHz	+16 dBm	-115 dBm	CW carrier
WA UTRA-FDD Band VI	875 – 885 MHz	+16 dBm	-115 dBm	CW carrier
WA UTRA-FDD Band VII	2620 – 2690 MHz	+16 dBm	-115 dBm	CW carrier
WA UTRA-FDD Band VIII	925 – 960 MHz	+16 dBm	-115 dBm	CW carrier
WA UTRA-FDD Band IX	1844.9 – 1879.9 MHz	+16 dBm	-115 dBm	CW carrier

For a Medium Range (MR) FDD BS, the static reference performance as specified in clause 7.2.1 shall be met with a wanted and an interfering signal coupled to BS antenna input using the parameters in Table 7.5D.

Table 7.5D: Blocking performance requirement for Medium Range BS when co-located with BS in other bands.

Co-located BS type	Center Frequency of Interfering Signal	Interfering Signal mean power	Wanted Signal mean power	Type of Interfering Signal
Micro GSM900	921 – 960 MHz	-3 dBm	-105 dBm	CW carrier
Micro DCS1800	1805 – 1880 MHz	+5 dBm	-105 dBm	CW carrier
Micro PCS1900	1930 – 1990 MHz	+5 dBm	-105 dBm	CW carrier
Micro GSM850	869 – 894 MHz	-3 dBm	-105 dBm	CW carrier
MR UTRA-FDD Band I	2110 – 2170 MHz	+8 dBm	-105 dBm	CW carrier
MR UTRA-FDD Band II	1930 – 1990 MHz	+8 dBm	-105 dBm	CW carrier
MR UTRA-FDD Band III	1805 – 1880 MHz	+8 dBm	-105 dBm	CW carrier
MR UTRA-FDD Band IV	2110 – 2155 MHz	+8 dBm	-105 dBm	CW carrier
MR UTRA-FDD Band V	869 – 894 MHz	+8 dBm	-105 dBm	CW carrier
MR UTRA-FDD Band VI	875 – 885 MHz	+8 dBm	-105 dBm	CW carrier
MR UTRA-FDD Band VII	2620 – 2690 MHz	+8 dBm	-105 dBm	CW carrier
MR UTRA-FDD Band VIII	925 – 960 MHz	+8 dBm	-105 dBm	CW carrier
MR UTRA-FDD Band IX	1844.9 – 1879.9 MHz	+8 dBm	-105 dBm	CW carrier

For a Local Area (LA) FDD BS, the static reference performance as specified in clause 7.2.1 shall be met with a wanted and an interfering signal coupled to BS antenna input using the parameters in Table 7.5E.

Table 7.5E: Blocking performance requirement for Local Area BS when co-located with BS in other bands.

Co-located BS type	Center Frequency of Interfering Signal	Interfering Signal mean power	Wanted Signal mean power	Type of Interfering Signal
Pico GSM900	921 – 960 MHz	-7 dBm	-101 dBm	CW carrier
Pico DCS1800	1805 – 1880 MHz	-4 dBm	-101 dBm	CW carrier
Pico PCS1900	1930 – 1990 MHz	-4 dBm	-101 dBm	CW carrier
Pico GSM850	869 – 894 MHz	-7dBm	-101 dBm	CW carrier
LA UTRA-FDD Band I	2110 – 2170 MHz	-6 dBm	-101 dBm	CW carrier
LA UTRA-FDD Band II	1930 – 1990 MHz	-6 dBm	-101 dBm	CW carrier
LA UTRA-FDD Band III	1805 – 1880 MHz	-6 dBm	-101 dBm	CW carrier
LA UTRA-FDD Band IV	2110 – 2155 MHz	-6 dBm	-101 dBm	CW carrier
LA UTRA-FDD Band V	869 – 894 MHz	-6 dBm	-101 dBm	CW carrier
LA UTRA-FDD Band VI	875 – 885 MHz	-6 dBm	-101 dBm	CW carrier
LA UTRA-FDD Band VII	2620 – 2690 MHz	-6 dBm	-101 dBm	CW carrier
LA UTRA-FDD Band VIII	925 – 960 MHz	-6 dBm	-101 dBm	CW carrier
LA UTRA-FDD Band IX	1844.9 – 1879.9 MHz	-6 dBm	-101 dBm	CW carrier

7.5.3 Minimum Requirement - Co-location with UTRA-TDD

An additional blocking requirement may be applied for the protection of FDD BS receivers when UTRA TDD is co-located with a UTRA FDD BS.

The requirements in this chapter assume a 30 dB coupling loss between transmitter and receiver. If BSs of different classes are co sited, the coupling loss should be increased by the value as stated in TR 25.942 [4] chapter 10.3 in Table 10.1 and Table 10.2.

The current state-of-the-art technology does not allow a single generic solution for co-location with UTRA-TDD on adjacent frequencies for 30dB BS-BS minimum coupling loss.

However, there are certain site-engineering solutions that can be used in these cases. These techniques are addressed in TR 25.942 [4].

For a Wide Area (WA) FDD BS, the static reference performance as specified in clause 7.2.1 should be met with a wanted and an interfering signal coupled to BS antenna input using the parameters in Table 7.5F.

Table 7.5F: Blocking performance requirement for Wide Area BS when co-located with UTRA TDD BS in other bands.

Co-located BS type	Center Frequency of Interfering Signal	Interfering Signal mean power	Wanted Signal mean power	Type of Interfering Signal
Wide Area TDD	2585 – 2620 MHz	+16 dBm	-115 dBm	CW carrier

For a Local Area (LA) FDD BS, the static reference performance as specified in clause 7.2.1 should be met with a wanted and an interfering signal coupled to BS antenna input using the parameters in Table 7.5G.

Table 7.5G: Blocking performance requirement for Local Area BS when co-located with UTRA TDD BS in other bands.

Co-located BS type	Center Frequency of Interfering Signal	Interfering Signal mean power	Wanted Signal mean power	Type of Interfering Signal
Local Area TDD	2585 – 2620 MHz	-4 dBm	-101 dBm	CW carrier

7.6 Intermodulation characteristics

Third and higher order mixing of the two interfering RF signals can produce an interfering signal in the band of the desired channel. Intermodulation response rejection is a measure of the capability of the receiver to receive a wanted signal on its assigned channel frequency in the presence of two or more interfering signals which have a specific frequency relationship to the wanted signal.

7.6.1 Minimum requirement

The static reference performance as specified in clause 7.2.1 shall be met for a Wide Area BS when the following signals are coupled to BS antenna input:

- A wanted signal at the assigned channel frequency with a mean power of -115 dBm.
- Two interfering signals with the following parameters.

Table 7.6: Intermodulation performance requirement (Wide Area BS)

Operating band	Interfering Signal mean power	Offset	Type of Interfering Signal
All bands	- 48 dBm	10 MHz	CW signal
	- 48 dBm	20 MHz	WCDMA signal *
Note*: The characteristics of the W-CDMA interference signal are specified in Annex C			

Table 7.6A: Narrowband intermodulation performance requirement (Wide Area BS)

Operating band	Interfering Signal mean power	Offset	Type of Interfering Signal
II, III, IV, V, VIII	- 47 dBm	3.5 MHz	CW signal
	- 47 dBm	5.9 MHz	GMSK modulated*
* GMSK as defined in TS45.004			

The static reference performance as specified in clause 7.2.1 shall be met for a Medium Range BS when the following signals are coupled to BS antenna input:

- A wanted signal at the assigned channel frequency with a mean power of -105 dBm.
- Two interfering signals with the following parameters.

Table 7.6B: Intermodulation performance requirement (Medium Range BS)

Operating band	Interfering Signal mean power	Offset	Type of Interfering Signal
All bands	- 44 dBm	10 MHz	CW signal
	- 44 dBm	20 MHz	WCDMA signal *
Note*: The characteristics of the W-CDMA interference signal are specified in Annex C			

Table 7.6C: Narrowband intermodulation performance requirement (Medium Range BS)

Operating band	Interfering Signal mean power	Offset	Type of Interfering Signal
II, III, IV, V, VIII	- 43 dBm	3.5 MHz	CW signal
	- 43 dBm	5.9 MHz	GMSK modulated*
* GMSK as defined in TS45.004			

The static reference performance as specified in clause 7.2.1 shall be met for a Local Area BS when the following signals are coupled to BS antenna input:

- A wanted signal at the assigned channel frequency with a mean power of -101 dBm.
- Two interfering signals with the following parameters.

Table 7.6D: Intermodulation performance requirement (Local Area BS)

Operating band	Interfering Signal mean power	Offset	Type of Interfering Signal
All bands	-38 dBm	10 MHz	CW signal
	-38 dBm	20 MHz	WCDMA signal *
Note*: The characteristics of the W-CDMA interference signal are specified in Annex C			

Table 7.6E: Narrowband intermodulation performance requirement (Local Area BS)

Operating band	Interfering Signal mean power	Offset	Type of Interfering Signal
II, III, IV, V, VIII	-37 dBm	3.5 MHz	CW signal
	-37 dBm	5.9 MHz	GMSK modulated*
* GMSK as defined in TS45.004			

7.7 Spurious emissions

The spurious emissions power is the power of emissions generated or amplified in a receiver that appear at the BS receiver antenna connector. The requirements apply to all BS with separate RX and TX antenna port. The test shall be performed when both TX and RX are on with the TX port terminated.

For all BS with common RX and TX antenna port the transmitter spurious emission as specified in section 6.6.3 is valid.

7.7.1 Minimum requirement

The power of any spurious emission shall not exceed:

Table 7.7: General spurious emission minimum requirement

Band	Maximum level	Measurement Bandwidth	Note
30MHz - 1 GHz	-57 dBm	100 kHz	
1 GHz - 12.75 GHz	-47 dBm	1 MHz	With the exception of frequencies between 12.5 MHz below the first carrier frequency and 12.5 MHz above the last carrier frequency used by the BS.

Table 7.7A: Additional spurious emission requirements

Operating Band	Band	Maximum level	Measurement Bandwidth	Note
I	1920 – 1980 MHz	-78 dBm	3.84 MHz	
II	1850 – 1910 MHz	-78 dBm	3.84 MHz	
III	1710 – 1785 MHz	-78 dBm	3.84 MHz	
IV	1710 – 1755 MHz	-78 dBm	3.84 MHz	
V	824 – 849 MHz	-78 dBm	3.84 MHz	
VI	815 – 850 MHz	-78 dBm	3.84 MHz	
VII	2500 – 2570 MHz	-78 dBm	3.84 MHz	
VIII	880 – 915 MHz	-78 dBm	3.84 MHz	
IX	1749.9 – 1784.9 MHz	-78 dBm	3.84 MHz	

In addition, the requirement in Table 7.8 may be applied to geographic areas in which both UTRA-TDD and UTRA-FDD are deployed.

Table 7.8: Additional spurious emission requirements for the TDD bands

Operating Band	Band	Maximum level	Measurement Bandwidth	Note
I	1900 - 1920 MHz 2010 – 2025 MHz	-78 dBm	3.84 MHz	Not applicable in Japan
	2010 – 2025 MHz	-52 dBm	1MHz	Applicable in Japan
VI, IX	2010 – 2025 MHz	-52 dBm	1MHz	

In addition to the requirements in tables 7.7, 7.7A and 7.8, the co-existence requirements for co-located base stations specified in subclause 6.6.3.4 and 6.6.3.7.2 may also be applied.

8 Performance requirement

8.1 General

Performance requirements for the BS are specified for the measurement channels defined in Annex A and the propagation conditions in Annex B. The requirements only apply to those measurement channels that are supported by the base station.

For BS with dual receiver antenna diversity, only the BS performance requirements with Rx diversity apply, the required E_b/N_0 shall be applied separately at each antenna port.

For BS without receiver antenna diversity, only the BS performance requirements without Rx diversity apply, the required E_b/N_0 shall be applied at the BS Rx antenna port.

For BS with dual receiver antenna diversity, the required E_b/N_0 shall be applied separately at each antenna port.

The E_b/N_0 used in this section is defined as:

$$E_b / N_o = \frac{E_c}{N_o} \cdot \frac{L_{chip}}{L_{inf}}$$

Where:

E_c is the received total energy of DPDCH, DPCCH, HS-DPCCH, E-DPDCH and E-DPCCH per PN chip per antenna from all paths.

N_o is the total one-sided noise power spectral density due to all noise sources

L_{chip} is the number of chips per frame

L_{inf} is the number of information bits in DTCH excluding CRC bits per frame

Table 8.1: Summary of Base Station performance targets

Physical channel	Measurement channel	Static	Multi-path Case 1	Multi-path Case 2	Multi-path Case 3	Moving	Birth / Death
		Performance metric					
DCH	12.2 kbps	BLER < 10 ⁻²	BLER < 10 ⁻²	BLER < 10 ⁻²	BLER < 10 ⁻²	BLER <	BLER <
	64 kbps	BLER < 10 ⁻¹ , 10 ⁻²	BLER < 10 ⁻¹ , 10 ⁻²	BLER < 10 ⁻¹ , 10 ⁻²	BLER < 10 ⁻¹ , 10 ⁻² , 10 ⁻³	BLER <	BLER <
	144 kbps	BLER < 10 ⁻¹ , 10 ⁻²	BLER < 10 ⁻¹ , 10 ⁻²	BLER < 10 ⁻¹ , 10 ⁻²	BLER < 10 ⁻¹ , 10 ⁻² , 10 ⁻³	-	-
	384 kbps	BLER < 10 ⁻¹ , 10 ⁻²	BLER < 10 ⁻¹ , 10 ⁻²	BLER < 10 ⁻¹ , 10 ⁻²	BLER < 10 ⁻¹ , 10 ⁻² , 10 ⁻³	-	-

8.2 Demodulation in static propagation conditions

8.2.1 Demodulation of DCH

The performance requirement of DCH in static propagation conditions is determined by the maximum Block Error Ratio (BLER) allowed when the receiver input signal is at a specified E_b/N_0 limit. The BLER is calculated for each of the measurement channels supported by the base station.

8.2.1.1 Minimum requirement

The BLER shall not exceed the limit for the E_b/N_0 specified in Table 8.2.

Table 8.2: Performance requirements in AWGN channel

Measurement channel	Received E_b/N_0 For BS with Rx diversity	Received E_b/N_0 For BS without Rx diversity	Required BLER
12.2 kbps	n.a.	n.a.	$< 10^{-1}$
	5.1 dB	8.3 dB	$< 10^{-2}$
64 kbps	1.5 dB	4.7 dB	$< 10^{-1}$
	1.7 dB	4.8 dB	$< 10^{-2}$
144 kbps	0.8 dB	3.8 dB	$< 10^{-1}$
	0.9 dB	4 dB	$< 10^{-2}$
384 kbps	0.9 dB	4 dB	$< 10^{-1}$
	1.0 dB	4.1 dB	$< 10^{-2}$

8.3 Demodulation of DCH in multipath fading conditions

8.3.1 Multipath fading Case 1

The performance requirement of DCH in multipath fading Case 1 is determined by the maximum Block Error Ratio (BLER) allowed when the receiver input signal is at a specified E_b/N_0 limit. The BLER is calculated for each of the measurement channels supported by the base station.

8.3.1.1 Minimum requirement

The BLER shall not exceed the limit for the E_b/N_0 specified in Table 8.3.

Table 8.3: Performance requirements in multipath Case 1 channel

Measurement channel	Received E_b/N_0 For BS with Rx diversity	Received E_b/N_0 For BS without Rx diversity	Required BLER
12.2 kbps	n.a.	n.a.	$< 10^{-1}$
	11.9 dB	19.1 dB	$< 10^{-2}$
64 kbps	6.2 dB	11.6 dB	$< 10^{-1}$
	9.2 dB	15.9 dB	$< 10^{-2}$
144 kbps	5.4 dB	10.8 dB	$< 10^{-1}$
	8.4 dB	15 dB	$< 10^{-2}$
384 kbps	5.8 dB	11.2 dB	$< 10^{-1}$
	8.8 dB	15.5 dB	$< 10^{-2}$

8.3.2 Multipath fading Case 2

The performance requirement of DCH in multipath fading Case 2 is determined by the maximum Block Error Ratio (BLER) allowed when the receiver input signal is at a specified E_b/N_0 limit. The BLER is calculated for each of the measurement channels supported by the base station.

8.3.2.1 Minimum requirement

The BLER shall not exceed the limit for the E_b/N_0 specified in Table 8.4.

Table 8.4: Performance requirements in multipath Case 2 channel

Measurement channel	Received E_b/N_0 For BS with Rx Diversity	Received E_b/N_0 For BS without Rx Diversity	Required BLER
12.2 kbps	n.a.	n.a.	$< 10^{-1}$
	9.0 dB	15 dB	$< 10^{-2}$
64 kbps	4.3 dB	9.2 dB	$< 10^{-1}$
	6.4 dB	12.3 dB	$< 10^{-2}$
144 kbps	3.7 dB	8.2 dB	$< 10^{-1}$
	5.6 dB	11.5 dB	$< 10^{-2}$
384 kbps	4.1 dB	8.7 dB	$< 10^{-1}$
	6.1 dB	12.1 dB	$< 10^{-2}$

8.3.3 Multipath fading Case 3

The performance requirement of DCH in multipath fading Case 3 is determined by the maximum Block Error Ratio (BLER) allowed when the receiver input signal is at a specified E_b/N_0 limit. The BLER is calculated for each of the measurement channels supported by the base station.

8.3.3.1 Minimum requirement

The BLER shall not exceed the limit for the E_b/N_0 specified in Table 8.5.

Table 8.5: Performance requirements in multipath Case 3 channel

Measurement channel	Received E_b/N_0 For BS with Rx Diversity	Received E_b/N_0 For BS without Rx Diversity	Required BLER
12.2 kbps	n.a.	n.a.	$< 10^{-1}$
	7.2 dB	10.8 dB	$< 10^{-2}$
	8.0 dB	11.7 dB	$< 10^{-3}$
64 kbps	3.4 dB	7.1 dB	$< 10^{-1}$
	3.8 dB	7.7 dB	$< 10^{-2}$
	4.1 dB	8.5 dB	$< 10^{-3}$
144 kbps	2.8 dB	6 dB	$< 10^{-1}$
	3.2 dB	6.7 dB	$< 10^{-2}$
	3.6 dB	7.2 dB	$< 10^{-3}$
384 kbps	3.2 dB	6.5 dB	$< 10^{-1}$
	3.6 dB	7.2 dB	$< 10^{-2}$
	4.2 dB	7.9 dB	$< 10^{-3}$

8.3.4 Multipath fading Case 4

The performance requirement of DCH in multipath fading Case 4 in case of a Wide Area BS is determined by the maximum Block Error Ratio (BLER) allowed when the receiver input signal is at a specified E_b/N_0 limit. The BLER is calculated for each of the measurement channels supported by the base station.

8.3.4.1 Minimum requirement

The BLER shall not exceed the limit for the E_b/N_0 specified in Table 8.5A.

Table 8.5A: Performance requirements in multipath Case 4 channel

Measurement channel	Received E_b/N_0 For BS with Rx Diversity	Received E_b/N_0 For BS without Rx Diversity	Required BLER
12.2 kbps	n.a.	n.a.	$< 10^{-1}$
	10.2 dB	13.8 dB	$< 10^{-2}$
	11.0 dB	14.7 dB	$< 10^{-3}$
64 kbps	6.4 dB	10.1 dB	$< 10^{-1}$
	6.8 dB	10.7 dB	$< 10^{-2}$
	7.1 dB	11.5 dB	$< 10^{-3}$
144 kbps	5.8 dB	9 dB	$< 10^{-1}$
	6.2 dB	9.7 dB	$< 10^{-2}$
	6.6 dB	10.2 dB	$< 10^{-3}$
384 kbps	6.2 dB	9.5 dB	$< 10^{-1}$
	6.6 dB	10.2 dB	$< 10^{-2}$
	7.2 dB	10.9 dB	$< 10^{-3}$

8.4 Demodulation of DCH in moving propagation conditions

The performance requirement of DCH in moving propagation conditions is determined by the maximum Block Error Ratio (BLER) allowed when the receiver input signal is at a specified E_b/N_0 limit. The BLER is calculated for each of the measurement channels supported by the base station.

8.4.1 Minimum requirement

The BLER shall not exceed the limit for the E_b/N_0 specified in Table 8.6.

Table 8.6: Performance requirements in moving channel

Measurement channel	Received E_b/N_0 For BS with Rx Diversity	Received E_b/N_0 For BS without Rx Diversity	Required BLER
12.2 kbps	n.a.	n.a.	$< 10^{-1}$
	5.7 dB	8.7 dB	$< 10^{-2}$
64 kbps	2.1 dB	5.3 dB	$< 10^{-1}$
	2.2 dB	5.5 dB	$< 10^{-2}$

8.5 Demodulation of DCH in birth/death propagation conditions

The performance requirement of DCH in birth/death propagation conditions is determined by the maximum Block Error Ratio (BLER) allowed when the receiver input signal is at a specified E_b/N_0 limit. The BLER is calculated for each of the measurement channels supported by the base station.

8.5.1 Minimum requirement

The BLER shall not exceed the limit for the E_b/N_0 specified in Table 8.7.

Table 8.7: Performance requirements in birth/death channel

Measurement channel	Received E_b/N_0 For BS with Rx Diversity	Received E_b/N_0 For BS without Rx Diversity	Required BLER
12.2 kbps	n.a.	n.a.	$< 10^{-1}$
	7.7 dB	10.8 dB	$< 10^{-2}$
64 kbps	4.1 dB	7.4 dB	$< 10^{-1}$
	4.2 dB	7.5 dB	$< 10^{-2}$

8.6 Void

8.7 Performance requirement for RACH

Performance requirement for RACH consists of two parts: preamble detection and message demodulation. Requirements for these are in sections 8.7.1 and 8.7.2, respectively. Requirements are defined for two propagation conditions: static and fading case 3. The propagation conditions are defined in annexes B.1 and B.2.

8.7.1 Performance requirement for RACH preamble detection

Probability of false alarm, P_{fa} (=false detection of the preamble) when the preamble was not sent, shall be 10^{-3} or less. The performance measure Required E_c/N_0 at probability of detection, P_d of 0.99 and 0.999. Only 1 signature is used and it is known by the receiver. The requirement for preamble detection, when the preamble was sent is in table 8.9 and 8.10 for static and case 3 fading.

Table 8.9: Requirements for E_c/N_0 of P_d in static propagation condition

	E_c/N_0 for required $P_d \geq 0.99$	E_c/N_0 for required $P_d \geq 0.999$
BS with Rx Diversity	-20.5 dB	-20.1 dB
BS without Rx Diversity	-17.6 dB	-16.8 dB

Table 8.10: Requirements of E_c/N_0 of P_d in case 3 fading

	E_c/N_0 for required $P_d \geq 0.99$	E_c/N_0 for required $P_d \geq 0.999$
BS with Rx Diversity	-15.5 dB	-13.4 dB
BS without Rx Diversity	-9.4 dB	-6.4 dB

8.7.2 Demodulation of RACH message

The performance measure is required E_b/N_0 for block error rate (BLER) of 10^{-1} and 10^{-2} . Both measurement channels have TTI=20 ms. Payloads are 168 and 360 bits. Channel coding is rate $\frac{1}{2}$ convolutional coding.

8.7.2.1 Minimum requirements for Static Propagation Condition

Table 8.11: Required E_b/N_0 for static propagation

Transport Block size TB and TTI in frames	168 bits, TTI = 20 ms		360 bits, TTI = 20 ms	
	E_b/N_0 for required BLER < 10^{-1}	E_b/N_0 for required BLER < 10^{-2}	E_b/N_0 for required BLER < 10^{-1}	E_b/N_0 for required BLER < 10^{-2}
BS with Rx Diversity	4.1 dB	5.0 dB	3.9 dB	4.8 dB
BS without Rx Diversity	7.2 dB	8.1 dB	6.9 dB	7.8 dB

8.7.2.2 Minimum requirements for Multipath Fading Case 3

Table 8.12: Required E_b/N_0 for case 3 fading

Transport Block size TB and TTI in frames	168 bits, TTI = 20 ms		360 bits, TTI = 20 ms	
	E_b/N_0 for required BLER < 10^{-1}	E_b/N_0 for required BLER < 10^{-2}	E_b/N_0 for required BLER < 10^{-1}	E_b/N_0 for required BLER < 10^{-2}
BS with Rx Diversity	7.4 dB	8.5 dB	7.3 dB	8.3 dB
BS without Rx Diversity	11.1 dB	12.4 dB	11.0 dB	12.1 dB

8.8 Void

Table 8.13: Void

Table 8.14: Void

8.9 Void

Table 8.15: Void

8.10 Performance of ACK/NACK detection for HS-DPCCH

Performance requirements of HS-DPCCH signaling detection consist of two parts; ACK false alarm and ACK mis-detection. Requirements for these are 8.10.1 and 8.10.2, respectively. Performance requirements are specified for the reference measurement channel of HS-DPCCH and four propagation conditions: static, multi-path fading case 1, case2 and case3. The reference measurement channel for HS-DPCCH is defined in Annex A.8. The propagation conditions are defined in Annex B.1 and B.2.

8.10.1 ACK false alarm

The probability of ACK false alarm, $P(\text{DTX} \rightarrow \text{ACK})$ (= false ACK detection when DTX is transmitted) shall not exceed the required error ratio for the E_c/N_0 specified in Table 8.16.

Table 8.16: Performance requirements for ACK false alarm

Propagation condition	Received E_c/N_0 (Test condition) For BS with Rx Diversity	Required error ratio
Static	-19.9 dB	$< 10^{-2}$
Case 1	-13.1 dB	$< 10^{-2}$
Case 2	-16.0 dB	$< 10^{-2}$
Case 3	-17.8 dB	$< 10^{-2}$

8.10.2 ACK mis-detection

The probability of ACK mis-detection, $P(\text{ACK} \rightarrow \text{NACK or DTX})$ (= mis-detected when ACK is transmitted) shall not exceed the required error ratio for the E_c/N_0 specified in Table 8.17.

Table 8.17: Performance requirements for ACK mis-detection

Propagation condition	Received E_c/N_0 For BS with Rx Diversity	Required error ratio
Static	-17.3 dB	$< 10^{-2}$
Case 1	-10.7 dB	$< 10^{-2}$
Case 2	-13.6 dB	$< 10^{-2}$
Case 3	-12.1 dB	$< 10^{-2}$

8.11 Demodulation of E-DPDCH in multipath fading condition

The performance requirement of the E-DPDCH in multi path fading condition is determined by the minimum throughput, R. For the test parameters specified in Table 8.18, the minimum requirements are specified on Table 8.19.

Table 8.18: Test parameters for testing E-DPDCH

Parameter	Unit	Test
RSN		{0, 1, 2, 3}
HARQ combining		IR
Maximum number of HARQ transmission		4
Power control		OFF
DPCCH slot format		0
E-DPCCH # code words		1024, no optimization based on prior knowledge of valid code words.
Physical channels to be turned on		DPCCH, E-DPDCH and E-DPCCH

Table 8.19 Minimum Requirement for E-DPDCH

Fixed Reference Channel		Reference value, E_c/N_0 (dB), for $R \geq 30\%$ and $R \geq 70\%$ of maximum information bit rate						
		FRC1	FRC2	FRC3	FRC4	FRC5	FRC6	FRC7
Pedestrian A without RX diversity	30%	-2.4	0.8	2.4	-7.1	-4.4	-1.4	-15.0
	70%	3.7	7.1	9.1	-0.6	2.1	5.2	-8.4
Pedestrian A with RX diversity	30%	-6.2	-3.1	-1.4	-10.6	-8.0	-5.0	-18.3
	70%	-1.0	2.2	4.1	-5.2	-2.6	0.2	-13.3
Pedestrian B without RX diversity	30%	-2.5	1.1	3.5	-7.5	-4.7	-1.3	-13.6
	70%	3.9	NA	NA	-2.1	0.9	5.3	-10.1
Pedestrian B with RX diversity	30%	-6.1	-3.1	-1.0	-10.7	-8.1	-4.9	-18.0
	70%	-0.3	3.9	8.2	-5.7	-2.9	0.7	-13.8
Vehicular 30 without RX diversity	30%	-2.5	1.0	3.2	-7.5	-4.6	-1.4	-14.3
	70%	4.9	NA	NA	-1.7	1.4	5.8	-10.1
Vehicular 30 with RX diversity	30%	-6.1	-2.9	-0.9	-10.7	-8.0	-4.9	-17.6
	70%	0.6	4.7	8.8	-5.4	-2.6	1.0	-13.7
Vehicular 120 without RX diversity	30%	-2.1	1.3	3.6	-7.3	-4.2	-1.2	-14.0
	70%	5.1	NA	NA	-1.3	1.5	6.1	-10.1
Vehicular 120 with RX diversity	30%	-5.7	-2.6	-0.5	-10.4	-7.6	-4.3	-17.0
	70%	0.7	5.0	9.5	-5.1	-2.3	1.2	-13.2

8.12 Performance of signaling detection for E-DPCCH in multipath fading condition

The performance requirement of the E-DPCCH in multi path fading condition is determined by the false alarm rate and the missed detection rate. For the test parameters specified in Table 8.20, the minimum requirements are specified in Table 8.21 and 8.22.

Table 8.20: Test parameters for testing E-DPCCH

Parameter	Unit	Test
Power control		Off
E-DPCCH # code words		1024, no optimization based on prior knowledge of valid code words.
Physical channels to be turned on for missed detection test		DPCCH, E-DPDCH and E-DPCCH
Physical channels to be turned on for false alarm test		DPCCH

Table 8.21: Performance requirements for E-DPCCH false alarm

Propagation conditions	Received E_c/N_0		Required detection probability
	FRC1	FRC4	
Pedestrian A without RX diversity	-1.6 dB	-5.0 dB	$< 10^{-2}$
Pedestrian A with RX diversity	-11.2 dB	-12.3 dB	$< 10^{-2}$
Pedestrian B without RX diversity	-13.8 dB	-15.2 dB	$< 10^{-2}$
Pedestrian B with RX diversity	-16.4 dB	-17.6 dB	$< 10^{-2}$
Vehicular 30 without RX diversity	-12.1 dB	-16.7 dB	$< 10^{-2}$
Vehicular 30 with RX diversity	-15.7 dB	-18.6 dB	$< 10^{-2}$
Vehicular 120 without RX diversity	-13.8 dB	-18.3 dB	$< 10^{-2}$
Vehicular 120 with RX diversity	-17.1 dB	-19.6 dB	$< 10^{-2}$

Table 8.22: Performance requirements for E-DPCCH missed detection

Propagation conditions	Received E_c/N_0		Required missed detection probability
	FRC1	FRC4	
Pedestrian A without RX diversity	13.7 dB	7.4 dB	$< 2 \cdot 10^{-3}$
Pedestrian A with RX diversity	1.2 dB	-2.8 dB	$< 2 \cdot 10^{-3}$
Pedestrian B without RX diversity	1.5 dB	-2.8 dB	$< 2 \cdot 10^{-3}$
Pedestrian B with RX diversity	-4.0 dB	-8.1 dB	$< 2 \cdot 10^{-3}$
Vehicular 30 without RX diversity	3.2 dB	-4.3 dB	$< 2 \cdot 10^{-3}$
Vehicular 30 with RX diversity	-3.3 dB	-9.1 dB	$< 2 \cdot 10^{-3}$
Vehicular 120 without RX diversity	1.5 dB	-5.9 dB	$< 2 \cdot 10^{-3}$
Vehicular 120 with RX diversity	-4.7 dB	-10.1 dB	$< 2 \cdot 10^{-3}$

Annex A (normative): Measurement channels

A.1 Summary of UL reference measurement channels

The parameters for the UL reference measurement channels are specified in Table A.1 and the channel coding is detailed in figure A.2 through A.6 respectively. Note that for all cases, one DPCCH shall be attached to DPDCH(s).

Table A.1: Reference measurement channels for UL DCH

Parameter		DCH for DTCH / DCH for DCCH				Unit
DPDCH	Information bit rate	12.2/2.4	64/2.4	144/2.4	384/2.4	kbps
	Physical channel	60/15	240/15	480/15	960/15	kbps
	Spreading factor	64	16	8	4	
	Repetition rate	22/22	19/19	8/9	-18/-17	%
	Interleaving	20	40	40	40	ms
	Number of DPDCHs	1	1	1	1	
DPCCH	Dedicated pilot	6				bit/slot
	Power control	2				bit/slot
	TFCI	2				bit/slot
	Spreading factor	256				
Power ratio of DPCCH/DPDCH		-2.69	-5.46	-9.54	-9.54	dB
Amplitude ratio of DPCCH/DPDCH		0.7333	0.5333	0.3333	0.3333	

A.2 UL reference measurement channel for 12.2 kbps

The parameters for the UL reference measurement channel for 12.2 kbps are specified in Table A.2 and the channel coding is detailed in Figure A.2.

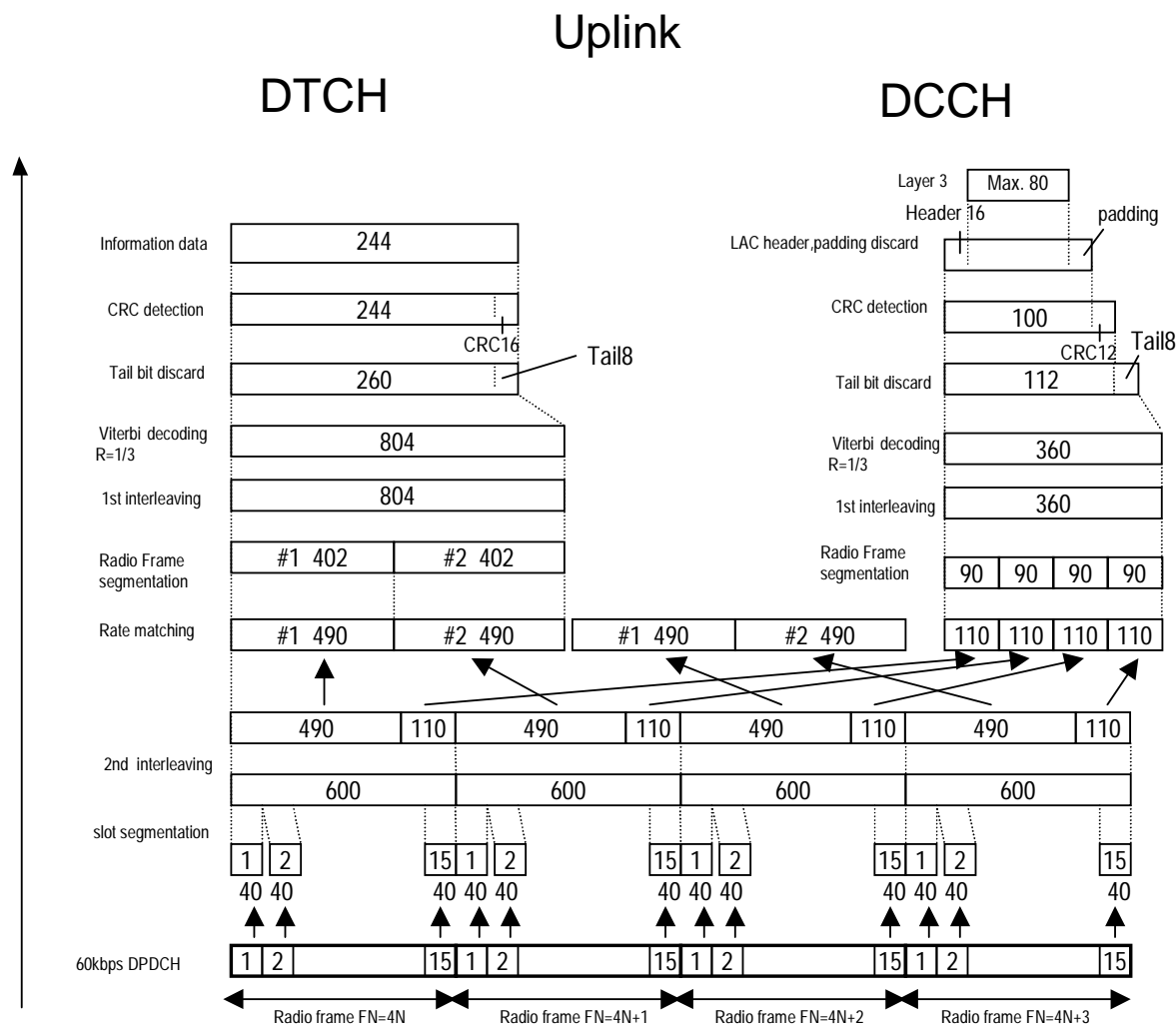

Figure A.2: Channel coding for the UL reference measurement channel (12.2 kbps)

Table A.2: UL reference measurement channel (12.2 kbps)

Parameter	Level	Unit
Information bit rate	12.2	kbps
DPCH	60	kbps
Power control	Off	
TFCI	On	
Repetition	22	%

A.3 UL reference measurement channel for 64 kbps

The parameters for the UL reference measurement channel for 64 kbps are specified in Table A.3 and the channel coding is detailed in Figure A.3.

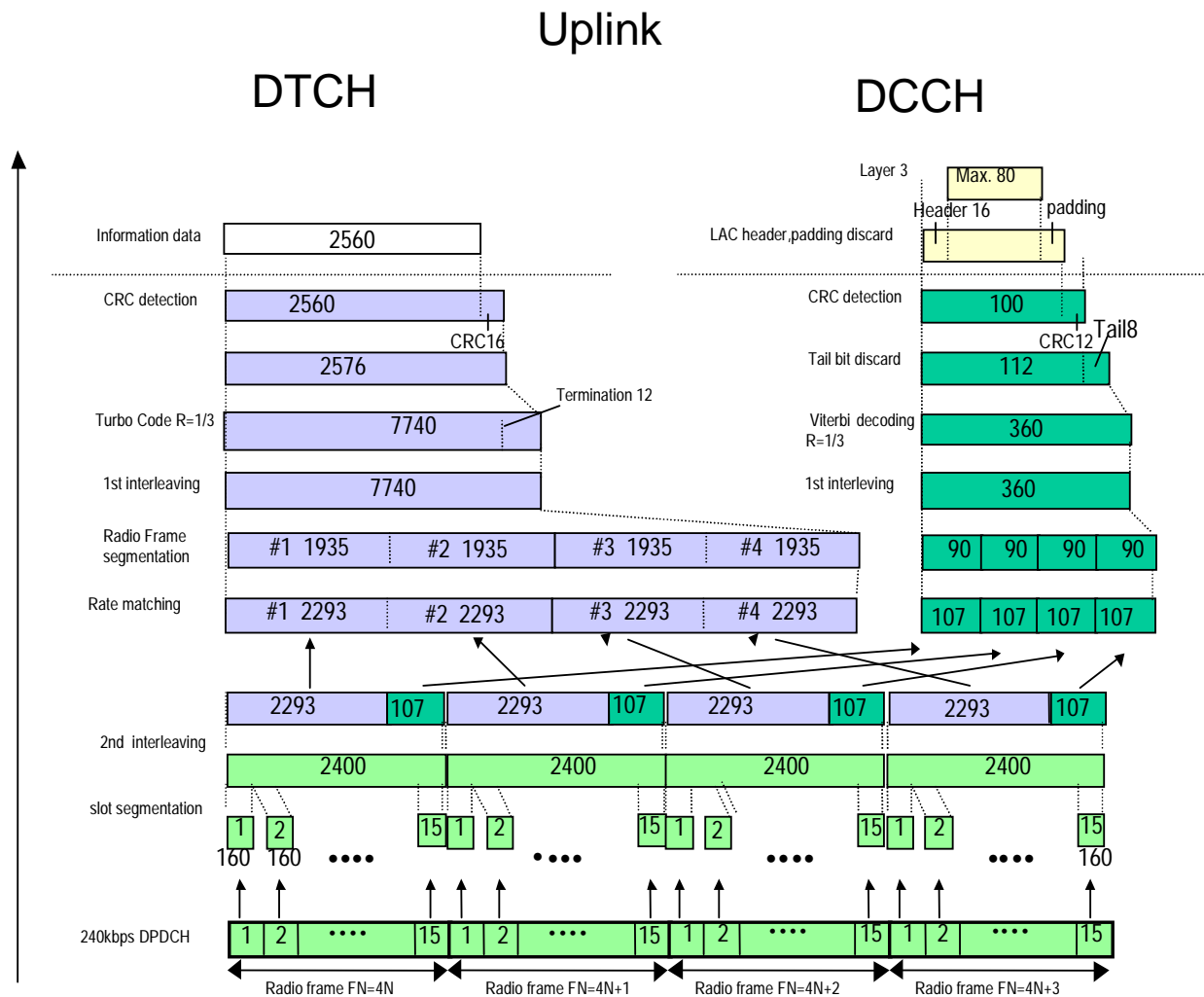

Figure A.3: Channel coding for the UL reference measurement channel (64 kbps)

Table A.3: UL reference measurement channel (64kbps)

Parameter	Level	Unit
Information bit rate	64	kbps
DPCH	240	kbps
Power control	Off	
TFCI	On	
Repetition	19	%

A.4 UL reference measurement channel for 144 kbps

The parameters for the UL reference measurement channel for 144 kbps are specified in Table A.4 and the channel coding is detailed in Figure A.4.

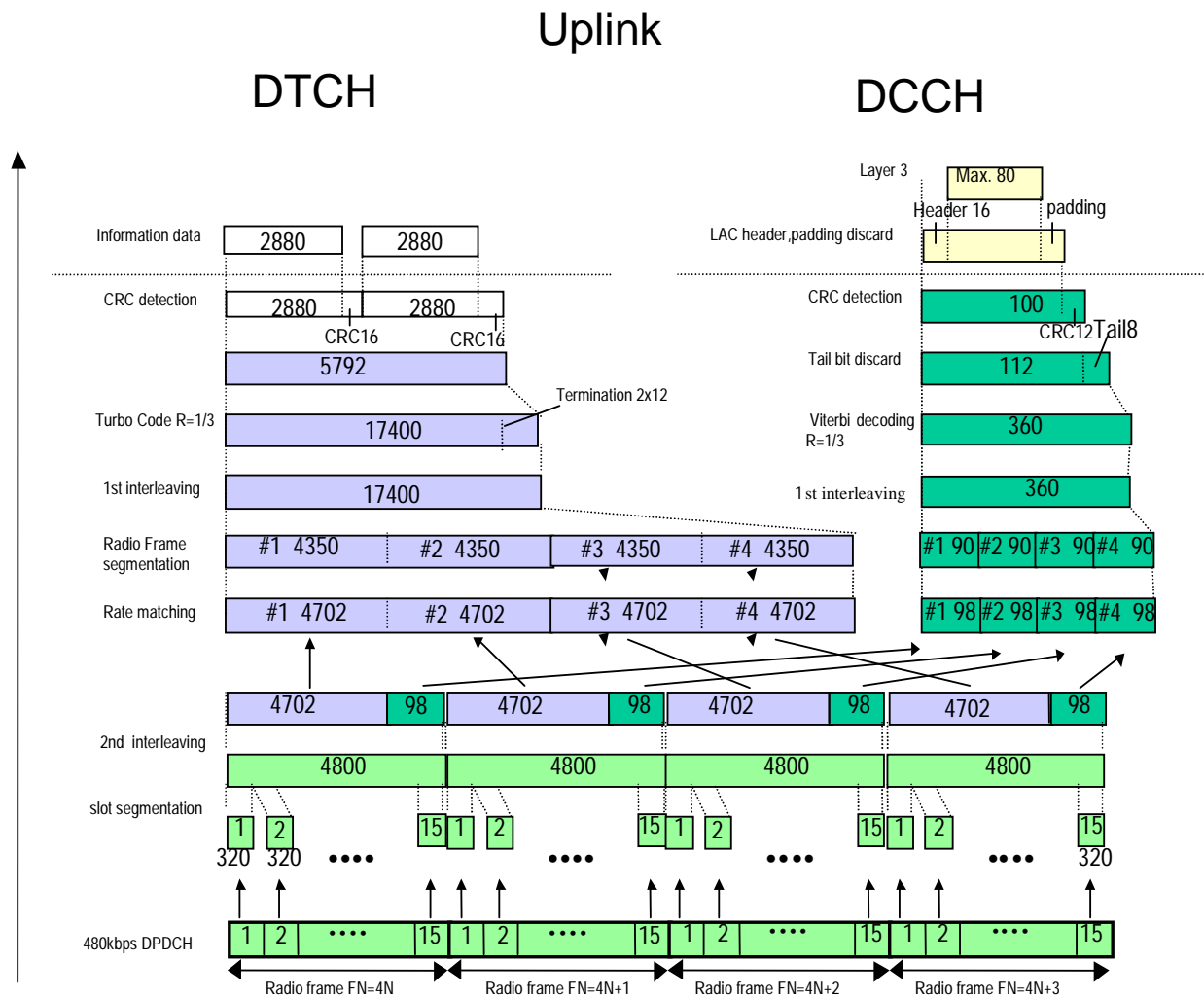

Figure A.4: Channel coding for the UL reference measurement channel (144 kbps)

Table A.4: UL reference measurement channel (144kbps)

Parameter	Level	Unit
Information bit rate	144	Kbps
DPCH	480	Kbps
Power control	Off	
TFCI	On	
Repetition	8	%

A.5 UL reference measurement channel for 384 kbps

The parameters for the UL reference measurement channel for 384 kbps are specified in Table A.5 and the channel coding is detailed in Figure A.5.

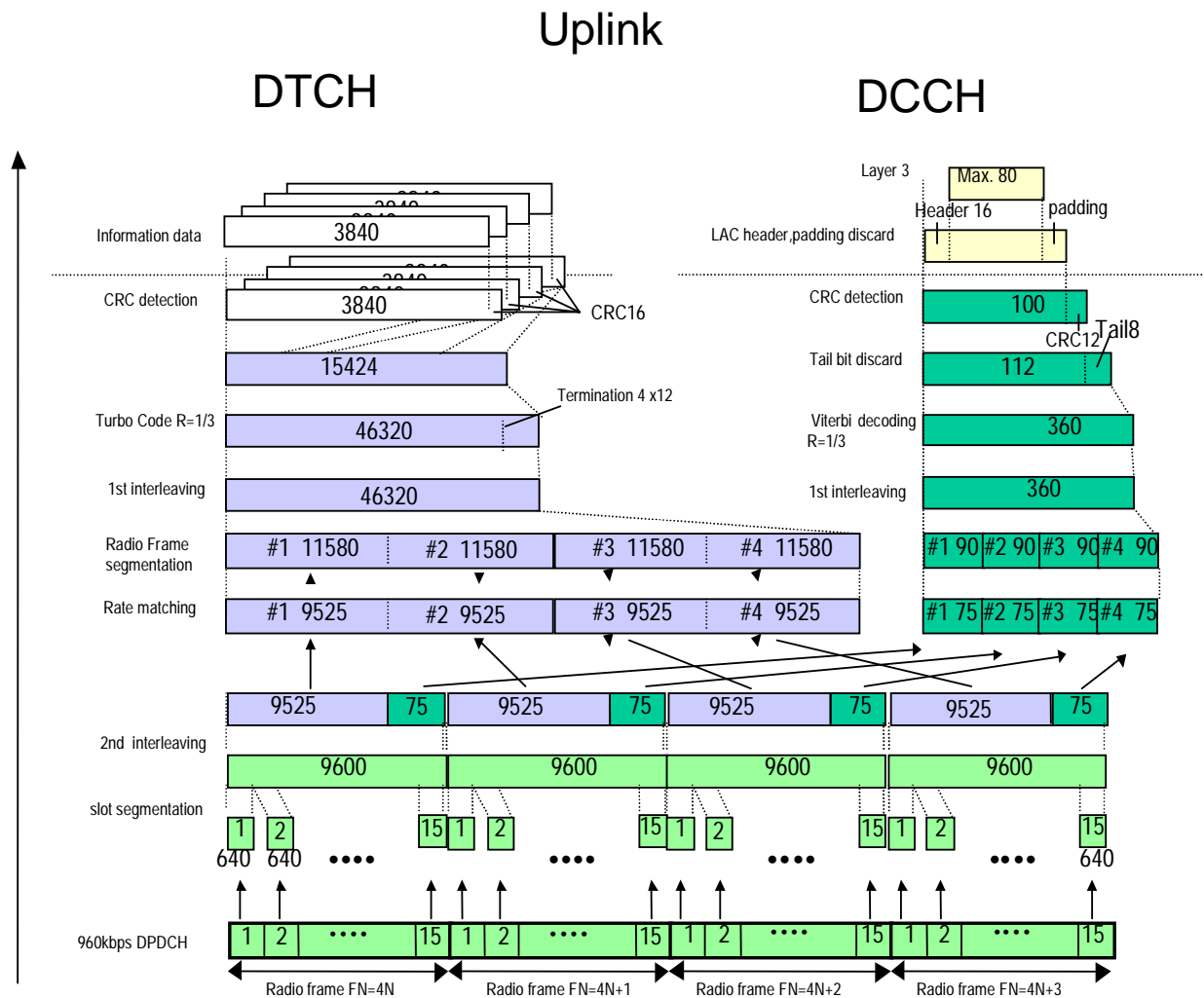

Figure A.5: Channel coding for the UL reference measurement channel (384 kbps)

Table A.5: UL reference measurement channel (384kbps)

Parameter	Level	Unit
Information bit rate	384	Kbps
DPCH	960	Kbps
Power control	Off	
TFCI	On	
Puncturing	18	%

A.6 Void

Figure A.6: Void

Table A.6: Void

A.7 Reference measurement channels for UL RACH

The parameters for the UL RACH reference measurement channels are specified in Table A.7.

Table A.7: Reference measurement channels for UL RACH

Parameter		Unit	
RACH	CRC	16	bits
	Channel Coding	Rate ½ conv. coding	
	TTI	20	ms
	TB size	168, 360	bits
	Rate Matching	Repetition	
	Number of diversity antennas	2	
	Preamble detection window size	256	chips
	Ratio of preamble power and total message power	0	dB
Power ratio of RACH Control/Data TB = 168		-2.69	dB
Power ratio of Control/Data TB = 360		-3.52	dB

A.8 Reference measurement channel for HS-DPCCH

The parameters for the UL HS-DPCCH reference measurement channel are specified in Table A.8.

Table A.8: Reference measurement channel for HS-DPCCH

		Parameter	Value	Unit
DPDCH	DTCH	Information bit rate	12.2	kbps
		Physical channel	60	kbps
		Repetition rate	22	%
	DCCH	Information bit rate	2.4	kbps
		Physical channel	15	kbps
		Repetition rate	22	%
	Spreading factor		64	
	Interleaving		20	ms
Number of DPDCHs		1		
DPCCH	Dedicated pilot		6	bits/slot
	Power control		2	bits/slot
	TFCI		2	bits/slot
	Spreading factor		256	
Power ratio of DPCCH/DPDCH			-2.69	dB
Amplitude ratio of DPCCH/DPDCH			0.7333	
Closed loop power control			OFF	
HS-DPCCH repetition			1	
HS-DPCCH power offset to DPCCH			0	dB
HS-DPCCH timing offset to DPCCH			0	symbol

DPDCH/DPCCH are same as 12.2kbps reference measurement channel specified in Annex A.2.

A.9 Summary of E-DPDCH Fixed reference channels

Table A.9

Fixed Ref Channel	TTI [ms]	N_{INF}	SF_1	SF_2	SF_3	SF_4	N_{BIN}	Coding rate	Max inf bit rate [kbps]
FRC1	2	2706	4	4	0	0	3840	0.705	1353.0
FRC2	2	5412	2	2	0	0	7680	0.705	2706.0
FRC3	2	8100	2	2	4	4	11520	0.703	4050.0
FRC4	10	5076	4	0	0	0	9600	0.529	507.6
FRC5	10	9780	4	4	0	0	19200	0.509	978.0
FRC6	10	19278	2	2	0	0	38400	0.502	1927.8
FRC7	10	690	16	0	0	0	2400	0.288	69.0

A.10 E-DPDCH Fixed reference channel 1 (FRC1)

Table A.10

Parameter	Unit	Value
Maximum. Inf. Bit Rate	kbps	1353.0
TTI	ms	2
Number of HARQ Processes	Processes	8
Information Bit Payload (N_{INF})	Bits	2706
Binary Channel Bits per TTI (N_{BIN}) (3840 / SF x TTI sum for all channels)	Bits	3840
Coding Rate (N_{INF}/ N_{BIN})		0.705
Physical Channel Codes	SF for each physical channel	{4,4}
E-DPDCH testing: E-DPDCH/DPCCH power ratio E-DPCCH/DPCCH power ratio	dB dB dB dB	Diversity: 8.94 Non-diversity: 12.04 Diversity: 2.05 Non-diversity: 6.02 E-DPDCH /DPCCH power ratio is calculated for a single E-DPDCH.
E-DPCCH missed detection testing: E-DPDCH/DPCCH power ratio E-DPCCH/DPCCH power ratio	dB dB dB dB	Diversity: 8.94 Non-diversity: 12.04 Diversity: -1.94 Non-diversity: 0.00

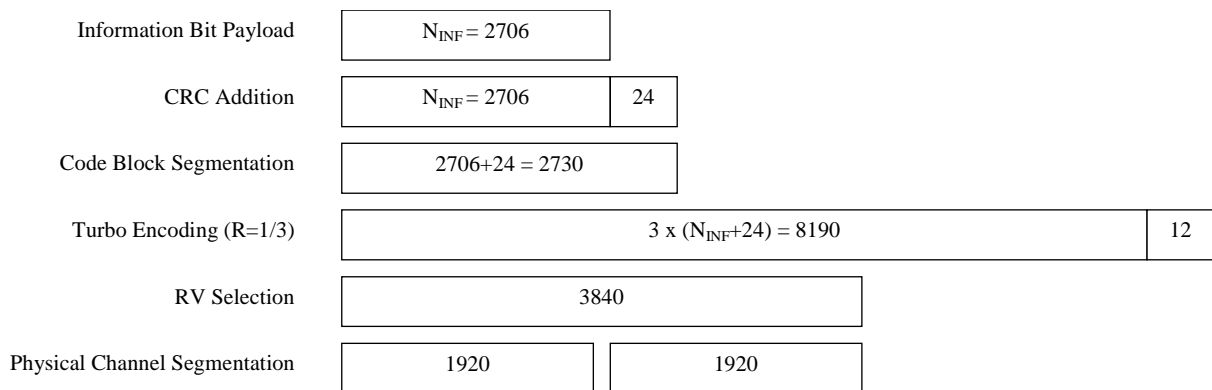

Figure A.10

A.11 E-DPDCH Fixed reference channel 2 (FRC2)

Table A.11

Parameter	Unit	Value
Maximum. Inf. Bit Rate	kbps	2706.0
TTI	ms	2
Number of HARQ Processes	Processes	8
Information Bit Payload (N_{INF})	Bits	5412
Binary Channel Bits per TTI (N_{BIN}) (3840 / SF x TTI sum for all channels)	Bits	7680
Coding Rate (N_{INF} / N_{BIN})		0.705
Physical Channel Codes	SF for each physical channel	{2,2}
E-DPDCH testing: E-DPDCH/DPCCH power ratio	dB	Diversity: 9.92 Non-diversity: 13.00
E-DPCCH/DPCCH power ratio	dB	Diversity: 4.08 Non-diversity: 6.02
		E-DPDCH /DPCCH power ratio is calculated for a single E-DPDCH.

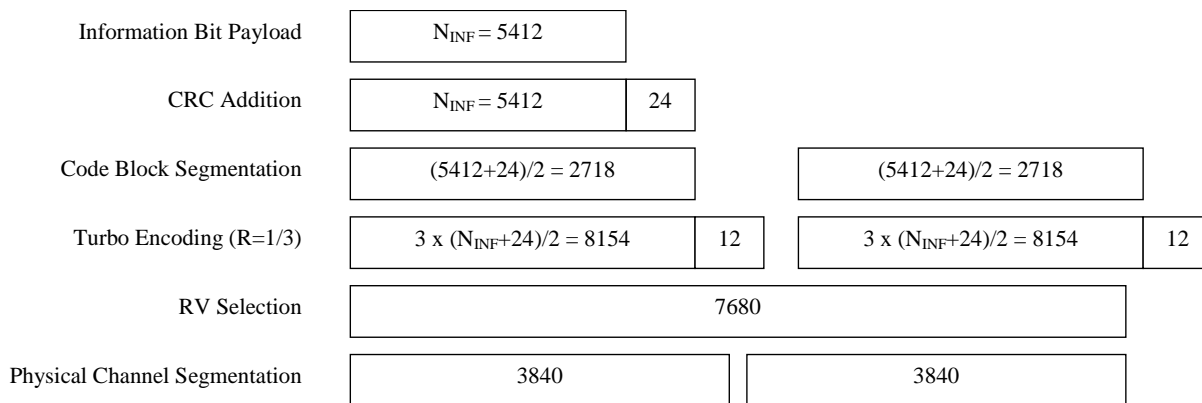

Figure A.11

A.12 E-DPDCH Fixed reference channel 3 (FRC3)

Table A.12

Parameter	Unit	Value
Maximum. Inf. Bit Rate	kbps	4050.0
TTI	ms	2
Number of HARQ Processes	Processes	8
Information Bit Payload (N_{INF})	Bits	8100
Binary Channel Bits per TTI (N_{BIN}) ($3840 / SF \times TTI$ sum for all channels)	Bits	11520
Coding Rate (N_{INF} / N_{BIN})		0.703
Physical Channel Codes	SF for each physical channel	{2,2,4,4}
E-DPDCH testing: E-DPDCH/DPCCH power ratio E-DPCCH/DPCCH power ratio	dB dB dB dB	Diversity: 6.02 Non-diversity: 8.94 Diversity: 0.0 Non-diversity: 2.05 E-DPDCH/DPCCH power ratio is calculated for a single E-DPDCH with SF 4. The power of an E-DPDCH with SF2 is twice that of an E-DPDCH with SF4.

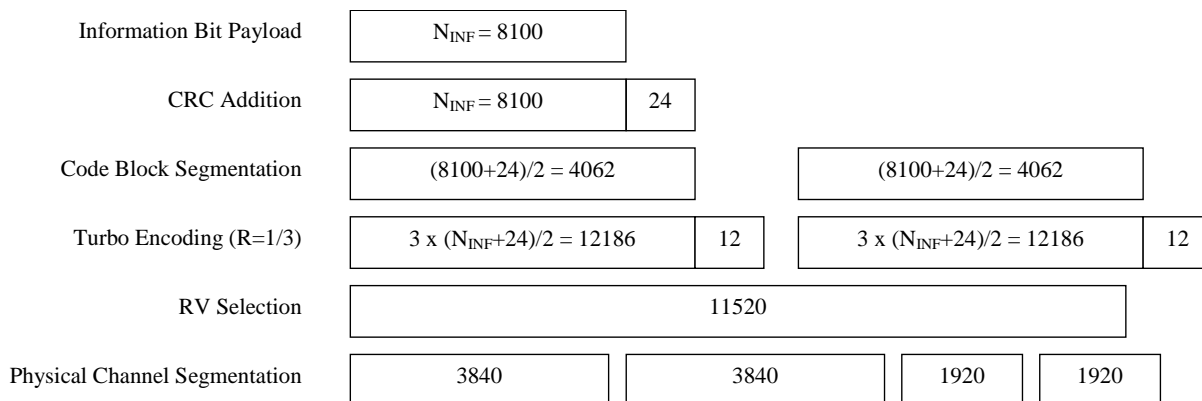

Figure A.12

A.13 E-DPDCH Fixed reference channel 4 (FRC4)

Table A.13

Parameter	Unit	Value
Maximum. Inf. Bit Rate	kbps	507.6
TTI	ms	10
Number of HARQ Processes	Processes	4
Information Bit Payload (N_{INF})	Bits	5076
Binary Channel Bits per TTI (N_{BIN}) ($3840 / SF \times TTI$ sum for all channels)	Bits	9600
Coding Rate (N_{INF} / N_{BIN})		0.529
Physical Channel Codes	SF for each physical channel	{4}
E-DPDCH testing: E-DPDCH/DPCCH power ratio	dB	Diversity: 8.94 Non-diversity: 12.04
E-DPCCH/DPCCH power ratio	dB	Diversity: -1.94 Non-diversity: 0.0
E-DPCCH missed detection testing: E-DPDCH/DPCCH power ratio	dB	Diversity: 8.94 Non-diversity: 12.04
E-DPCCH/DPCCH power ratio	dB	Diversity: -7.96 Non-diversity: -5.46

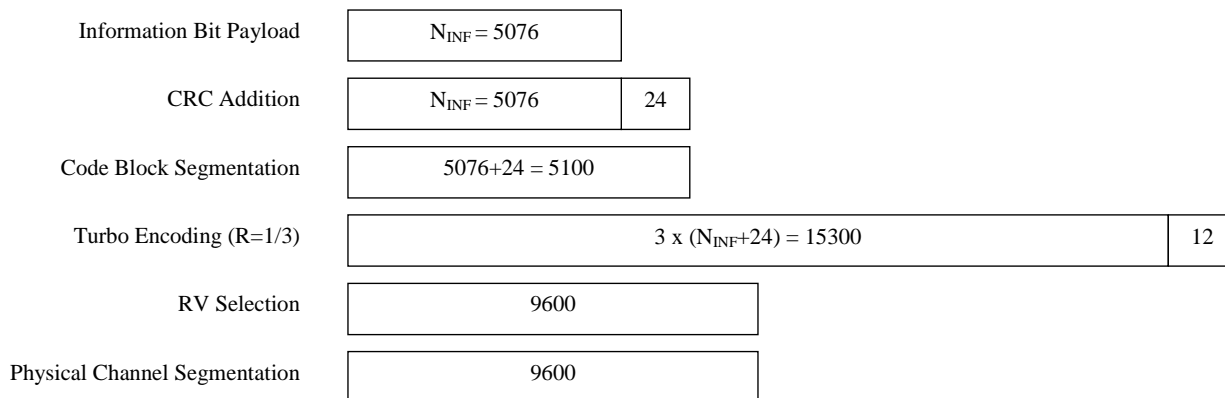

Figure A.13

A.14 E-DPDCH Fixed reference channel 5 (FRC5)

Table A.14

Parameter	Unit	Value
Maximum. Inf. Bit Rate	kbps	978.0
TTI	ms	10
Number of HARQ Processes	Processes	4
Information Bit Payload (N_{INF})	Bits	9780
Binary Channel Bits per TTI (N_{BIN}) (3840 / SF x TTI sum for all channels)	Bits	19200
Coding Rate (N_{INF} / N_{BIN})		0.509
Physical Channel Codes	SF for each physical channel	{4,4}
E-DPDCH testing: E-DPDCH/DPCCH power ratio E-DPCCH/DPCCH power ratio	dB dB dB dB	Diversity: 8.94 Non-diversity: 12.04 Diversity: -1.94 Non-diversity: 0.0 E-DPDCH /DPCCH power ratio is calculated for a single E-DPDCH.

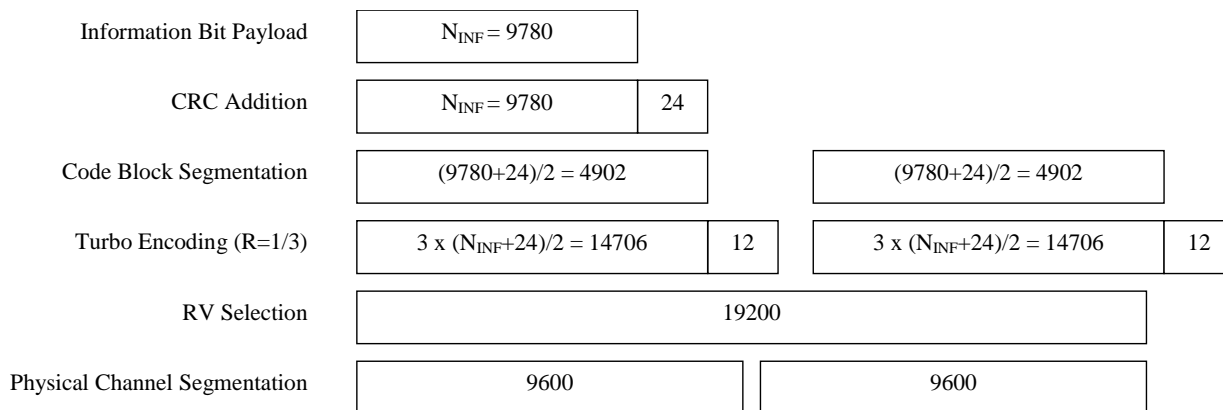

Figure A.14

A.15 E-DPDCH Fixed reference channel 6 (FRC6)

Table A.15

Parameter	Unit	Value
Maximum. Inf. Bit Rate	kbps	1927.8
TTI	ms	10
Number of HARQ Processes	Processes	4
Information Bit Payload (N_{INF})	Bits	19278
Binary Channel Bits per TTI (N_{BIN}) (3840 / SF x TTI sum for all channels)	Bits	38400
Coding Rate (N_{INF} / N_{BIN})		0.502
Physical Channel Codes	SF for each physical channel	{2,2}
E-DPDCH testing: E-DPDCH/DPCCH power ratio	dB	Diversity: 9.92 Non-diversity: 13.00
E-DPCCH/DPCCH power ratio	dB	Diversity: -5.46 Non-diversity: -1.94
		E-DPDCH /DPCCH power ratio is calculated for a single E-DPDCH.

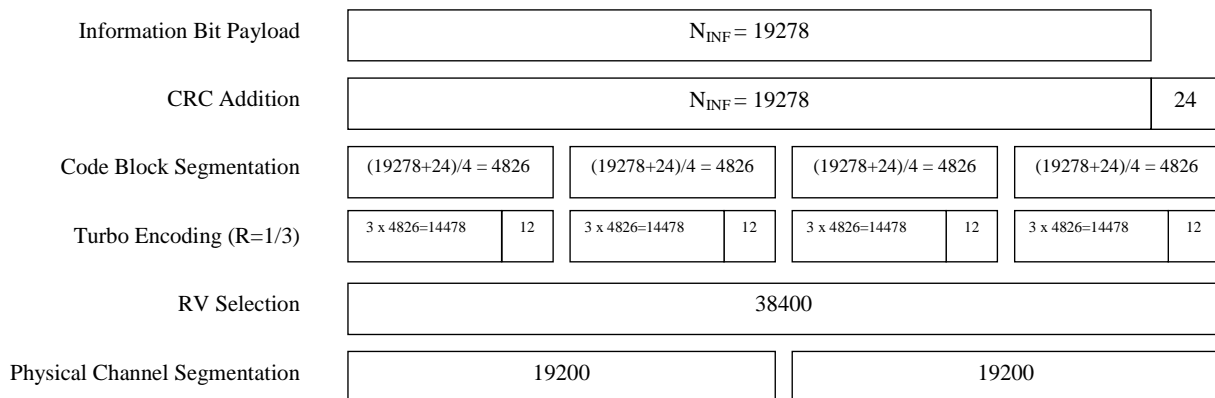

Figure A.15

A.16 E-DPDCH Fixed reference channel 7 (FRC7)

Table A.16

Parameter	Unit	Value
Maximum. Inf. Bit Rate	kbps	69.0
TTI	ms	10
Number of HARQ Processes	Processes	4
Information Bit Payload (N_{INF})	Bits	690
Binary Channel Bits per TTI (N_{BIN}) (3840 / SF x TTI sum for all channels)	Bits	2400
Coding Rate (N_{INF} / N_{BIN})		0.288
Physical Channel Codes	SF for each physical channel	{16}
E-DPDCH testing: E-DPDCH/DPCCH power ratio	dB	Diversity: 6.02 Non-diversity: 8.94
E-DPCCH/DPCCH power ratio	dB	Diversity: 0.0 Non-diversity: 4.08

Information Bit Payload	$N_{INF} = 690$	
CRC Addition	$N_{INF} = 690$	24
Code Block Segmentation	$690 + 24 = 714$	
Turbo Encoding (R=1/3)	$3 \times (N_{INF} + 24) = 2142$	12
RV Selection	2400	
Physical Channel Segmentation	2400	

Figure A.16

Annex B (normative): Propagation conditions

B.1 Static propagation condition

The propagation for the static performance measurement is an Additive White Gaussian Noise (AWGN) environment. No fading or multi-paths exist for this propagation model.

B.2 Multi-path fading propagation conditions

Table B.1 shows propagation conditions that are used for the performance measurements in multi-path fading environment. All taps have classical Doppler spectrum, defined as:

$$(CLASS) \quad S(f) \propto 1/(1 - (f / f_D)^2)^{0.5} \quad \text{for } f \in [-f_D, f_D]$$

Table B.1: Propagation Conditions for Multi path Fading Environments

Case 1		Case 2		Case 3		Case 4	
Speed for Band I, II, III, IV, IX 3 km/h		Speed for Band I, II, III, IV, IX 3 km/h		Speed for Band I, II, III, IV, IX 120 km/h		Speed for Band I, II, III, IV, IX 250 km/h	
Speed for Band V, VI, VIII 7 km/h		Speed for Band V, VI, VIII 7 km/h		Speed for Band V, VI, VIII 280 km/h		Speed for Band V, VI, VIII 583 km/h (Note 1)	
Speed for Band VII 2.3 km/h		Speed for Band VII 2.3 km/h		Speed for Band VII 92 km/h		Speed for Band VII 192 km/h	
Relative Delay [ns]	Average Power [dB]	Relative Delay [ns]	Average Power [dB]	Relative Delay [ns]	Average Power [dB]	Relative Delay [ns]	Average Power [dB]
0	0	0	0	0	0	0	0
976	-10	976	0	260	-3	260	-3
		20000	0	521	-6	521	-6
				781	-9	781	-9

NOTE 1: Speed above 250km/h is applicable to demodulation performance requirements only.

B.3 Moving propagation conditions

The dynamic propagation conditions for the test of the base band performance are non-fading channel models with two taps. The moving propagation condition has two tap, one static, Path0, and one moving, Path1. The time difference between the two paths is according Equation (B.1). The parameters for the equation are shown in Table B.2. The taps have equal strengths and equal phases.

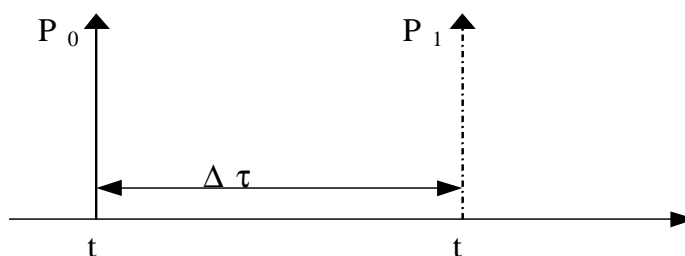

Figure B.1: The moving propagation conditions

$$\Delta\tau = B + \frac{A}{2}(1 + \sin(\Delta\omega \cdot t)) \tag{B.1}$$

Table B.2: Parameters for moving propagation

Parameter	Value
A	5 μs
B	1 μs
Δω	40·10 ⁻³ s ⁻¹

B.4 Birth-Death propagation conditions

The dynamic propagation conditions for the test of the baseband performance is a non-fading propagation channel with two taps. The birth-death propagation conditions has two taps, Path1 and Path2 which alternate between 'birth' and 'death'. The positions the paths appear are randomly selected with an equal probability rate and are shown in Figure B.2. For BS with receiver diversity, the same path positions shall be applied to both receiver antenna connectors, and the path switching times shall be synchronized on the two receiver antenna connectors, but the AWGN signals applied to the two receiver antenna connectors shall be uncorrelated.

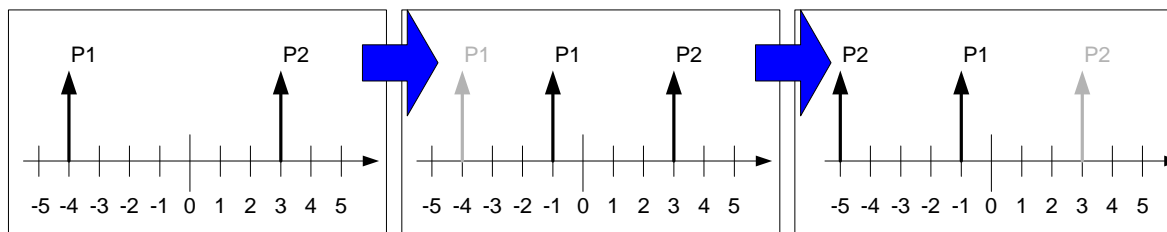

Figure B.2: Birth death propagation sequence

1. Two paths, Path1 and Path2 are randomly selected from the group [-5, -4, -3, -2, -1, 0, 1, 2, 3, 4, 5] μs. The paths have equal magnitudes and equal phases.
2. After 191 ms, Path1 vanishes and reappears immediately at a new location randomly selected from the group [-5, -4, -3, -2, -1, 0, 1, 2, 3, 4, 5] μs but excludes the point Path2. The magnitudes and the phases of the tap coefficients of Path 1 and Path 2 shall remain unaltered.
3. After an additional 191 ms, Path2 vanishes and reappears immediately at a new location randomly selected from the group [-5, -4, -3, -2, -1, 0, 1, 2, 3, 4, 5] μs but excludes the point Path1. The magnitudes and the phases of the tap coefficients of Path 1 and Path 2 shall remain unaltered.
4. The sequence in 2) and 3) is repeated.

B.5 Multipath fading propagation conditions

Table B.3 shows propagation conditions that are used for E-DPDCH and E-DPCCH performance measurements in multipath fading environment.

Table B.3: Propagation Conditions for Multipath Fading Environments for E-DPDCH and E-DPCCH Performance Requirements

ITU Pedestrian A Speed 3km/h (PA3)		ITU Pedestrian B Speed 3km/h (PB3)		ITU vehicular A Speed 30km/h (VA30)		ITU vehicular A Speed 120km/h (VA120)	
Speed for Band I, II, III, IV and IX 3 km/h		Speed for Band I, II, III, IV and IX 3 km/h		Speed for Band I, II, III, IV and IX 30 km/h		Speed for Band I, II, III, IV and IX 120 km/h	
Speed for Band V, VI, VIII 7 km/h		Speed for Band V, VI, VIII 7 km/h		Speed for Band V, VI, VIII 71 km/h		Speed for Band V, VI, VIII 282 km/h (Note 1)	
Speed for Band VII 2.3 km/h		Speed for Band VII 2.3 km/h		Speed for Band VII 23 km/h		Speed for Band VII 92 km/h	
Relative Delay [ns]	Relative Mean Power [dB]	Relative Delay [ns]	Relative Mean Power [dB]	Relative Delay [ns]	Relative Mean Power [dB]	Relative Delay [ns]	Relative Mean Power [dB]
0	0	0	0	0	0	0	0
110	-9.7	200	-0.9	310	-1.0	310	-1.0
190	-19.2	800	-4.9	710	-9.0	710	-9.0
410	-22.8	1200	-8.0	1090	-10.0	1090	-10.0
		2300	-7.8	1730	-15.0	1730	-15.0
		3700	-23.9	2510	-20.0	2510	-20.0

NOTE 1: Speed above 120km/h is applicable to demodulation performance requirements only.

Annex C (normative): Characteristics of the W-CDMA interference signal

The W-CDMA interference signal shall be a DPCH containing the DPCCH and one DPDCH. The data content for each channelization code shall be uncorrelated with each other and to the wanted signal and spread and modulated according to clause 4 of TS25.213 [6]. Further characteristics of DPDCH and DPCCH are specified in table C.1.

Table C.1.: Characteristics of the W-CDMA interference signal

Channel	Bit Rate	Spreading Factor	Channelization Code	Relative Power
DPDCH	240 kbps	16	4	0 dB
DPCCH	15 kbps	256	0	-5.46 dB

Note: The DPDCH and DPCCH settings are chosen to simulate a signal with realistic Peak to Average Ratio.

Annex D (informative): Change history

Table D.1: Document history

V3.0.0	October 1999	
V3.1.0	December 1999	CRs approved by TSG-RAN#6
V3.2.1	March 2000	CRs approved by TSG-RAN#7
V3.3.0	June 2000	CRs approved by TSG-RAN#8
V3.4.0	October 2000	CRs approved by TSG-RAN#9
V3.5.0	December 2000	CRs approved by TSG-RAN#10
V3.6.0	March 2001	CRs approved by TSG-RAN#11
V4.0.0	March 2001	CRs approved by TSG-RAN#11
V4.1.0	June 2001	CRs approved by TSG-RAN#12
V5.0.0	October 2001	CRs approved by TSG-RAN#13
V5.1.0	December 2001	CRs approved by TSG-RAN#14

Table D.2: Inclusion of CRs approved by TSG-RAN#6.

RAN Doc	Spec	CR	R	Ph	Subject	Cat	Curr	New
RP-99778	25.104	001		R99	Correction to Annex B.4 Birth-Death propagation conditions	F	3.0.0	3.1.0
RP-99778	25.104	002		R99	Base Station Modulation Code Domain Power	F	3.0.0	3.1.0
RP-99778	25.104	003		R99	Measurement channels for uplink	F	3.0.0	3.1.0
RP-99777	25.104	004		R99	Removal of Open Item List	D	3.0.0	3.1.0
RP-99778	25.104	005		R99	Clarification of ACLR requirement	F	3.0.0	3.1.0
RP-99778	25.104	006		R99	New Spurious Emission requirement for Category B	F	3.0.0	3.1.0
RP-99778	25.104	007		R99	Base Station Primary CPICH power accuracy	F	3.0.0	3.1.0
RP-99778	25.104	008		R99	Correction of Receiver sensitivity	F	3.0.0	3.1.0
RP-99778	25.104	010		R99	Correction of BS output power definition	F	3.0.0	3.1.0
RP-99778	25.104	011		R99	Clarification of power control requirements in TS 25.104	F	3.0.0	3.1.0
RP-99778	25.104	012		R99	Corrections for BS FDD Blocking Characteristics	F	3.0.0	3.1.0
RP-99778	25.104	013		R99	Output power accuracies in extreme conditions	F	3.0.0	3.1.0
RP-99778	25.104	014		R99	Clarification of Antenna Diversity receiver requirements	F	3.0.0	3.1.0
RP-99778	25.104	015		R99	Spurious Emission in 25.104	F	3.0.0	3.1.0
RP-99831	25.104	016	1	R99	Change of propagation conditions		3.0.0	3.1.0
RP-99778	25.104	017		R99	Clarification of the EVM requirement	F	3.0.0	3.1.0
RP-99778	25.104	018		R99	Introduction of requirement values in section 8	F	3.0.0	3.1.0
RP-99825	25.104	019	2	R99	Update of ITU Region 2 Specific Specifications and proposed universal channel numbering.	C	3.0.0	3.1.0
RP-99778	25.104	020		R99	Corrections for BS FDD RX spurious emission	F	3.0.0	3.1.0
RP-99778	25.104	021		R99	BS Spurious Emission Requirements for Co-Existence UTRA-FDD/ UTRA-TDD	B	3.0.0	3.1.0

Table D.3: Inclusion of CRs approved by TSG-RAN#7.

RAN Doc	Spec	CR	R	Ph	Subject	Cat	Curr	New
R4-000030	25.104	022		R99	Clarification of Receiver Dynamic Range requirement	F	3.1.0	3.2.0
R4-000096	25.104	023		R99	Change of propagation conditions for Case 2	F	3.1.0	3.2.0
R4-000019	25.104	024		R99	Removal of chapter 6.6.2.3 in 25.104	F	3.1.0	3.2.0
R4-000086	25.104	025		R99	Editorial changes to 25.104	D	3.1.0	3.2.0
R4-000101	25.104	026		R99	Corrections of spurious emissions aligning to GSM for UTRA: FDD BS	F	3.1.0	3.2.0
R4-000299	25.104	027	1	R99	Regional requirements in TS 25.104	D	3.1.0	3.2.0
R4-000137	25.104	028		R99	Specifications applicable in case of use of RF devices external to the BS	F	3.1.0	3.2.0
R4-000186	25.104	029		R99	Clarification for maximum output power and rated output power	F	3.1.0	3.2.0
R4-000215	25.104	030		R99	UL Performance requirement in multipath case 3	F	3.1.0	3.2.0
R4-000258	25.104	031		R99	ACLR	D	3.1.0	3.2.0
R4-000254	25.104	032		R99	Spectrum emission mask	F	3.1.0	3.2.0
R4-000130	25.104	033		R99	Rx spurious emissions measurement bandwidth	F	3.1.0	3.2.0
R4-000245	25.104	034		R99	Clarification for Peak code domain error	D	3.1.0	3.2.0
R4-000026	25.104	035		R99	Corrections for BS FDD Modulation Accuracy	F	3.1.0	3.2.0
R4-000291	25.104	036		R99	Modification to the handling of measurement equipment uncertainty	F	3.1.0	3.2.0
R4-000181	25.104	037		R99	Update to downlink test models	D	3.1.0	3.2.0
R4-000163	25.104	038		R99	Birth-Death tap delays	F	3.1.0	3.2.0

Table D.4: Inclusion of CRs approved by TSG-RAN#8.

RAN Doc	Spec	CR	R	Ph	Subject	Cat	Curr	New
RP-000206	25.104	040		R99	Correction of frequency numbering scheme	F	3.2.0	3.3.0
RP-000206	25.104	041		R99	Add requirements on SSDT from 5.1.1.8.	D	3.2.0	3.3.0
RP-000206	25.104	042		R99	Correction to Emission mask	F	3.2.0	3.3.0
RP-000206	25.104	043		R99	Clarification of the specification on Peak Code Domain Error (PCDE)	F	3.2.0	3.3.0
RP-000206	25.104	044		R99	Editorial changes, including definitions and abbreviations	D	3.2.0	3.3.0
RP-000206	25.104	045		R99	Reference Measurement Channels	F	3.2.0	3.3.0
RP-000206	25.104	046		R99	Editorial corrections on moving propagation conditions	F	3.2.0	3.3.0
RP-000206	25.104	047		R99	Conformance values for dynamic propagation conditions	F	3.2.0	3.3.0
RP-000206	25.104	048		R99	Alignment of measurement descriptions between 25.141 and 25.101	F	3.2.0	3.3.0

Table D.5: Inclusion of CRs approved by TSG-RAN#9.

RAN Doc	Spec	CR	R	Ph	Subject	Cat	Curr	New
RP-000396	25.104	49		R99	Correction to 25.104 ch. 6.6.3.6	F	3.3.0	3.4.0
RP-000396	25.104	50		R99	Corrections to spectrum mask	F	3.3.0	3.4.0
RP-000396	25.104	51		R99	Handling of measurement uncertainties in Base station conformance testing (FDD)	F	3.3.0	3.4.0
RP-000396	25.104	52		R99	Tap magnitudes and phases for Birth-Death propagation conditions	F	3.3.0	3.4.0

Table D.6: CRs approved by TSG RAN #10

RAN Doc	Spec	CR	R	Ph	Subject	Cat	Curr	New
R4-000982	25.104	53		R99	Correction for 25.104 concerning the channel number calculation.	F	3.4.0	3.5.0
R4-000963	25.104	54		R99	Editorial correction to uplink reference channel for 2048kbps	F	3.4.0	3.5.0

Table D.7: Rel 1999 CRs approved by TSG RAN#11

RAN Doc	Spec	CR	R	Ph	Subject	Cat	Curr	New
RP-010087	25.104	55		R99	CR to 25.104 for Test Tolerances	F	3.5.0	3.6.0
RP-010087	25.104	56		R99	Correction of reference to SM.329-8 in TS 25.104	F	3.5.0	3.6.0
RP-010087	25.104	57		R99	Receiver Blocking requirement for co-existence with GSM/DCS and co-located base stations - revised.	F	3.5.0	3.6.0
RP-010087	25.104	58		R99	UL Performance requirement in fast fading	F	3.5.0	3.6.0
RP-010087	25.104	59		R99	Performance requirement for 250km/h	F	3.5.0	3.6.0
RP-010087	25.104	60		R99	Definition of EVM / PCDE measurement period	F	3.5.0	3.6.0
RP-010087	25.104	61		R99	Inclusion of environmental requirements	F	3.5.0	3.6.0

Table D.8: Release 4 CRs approved by TSG RAN#11

RAN Doc	Spec	CR	R	Ph	Subject	Cat	Curr	New
RP-010100	25.104	63		R4	RACH implementation requirements	B	3.6.0	4.0.0

Table D.9: Release 4 CRs approved by TSG RAN#12

RAN Doc	Spec	CR	R	Ph	Title	Cat	Curr	New
RP-010349	25.104	65		Rel-4	Receiver Blocking characteristics	A	4.0.0	4.1.0
RP-010349	25.104	67		Rel-4	Receiver spurious emission for co-located base stations	A	4.0.0	4.1.0
RP-010349	25.104	69		Rel-4	Definition of Eb/No used for uplink receiver performance requirements in TS 25.104	A	4.0.0	4.1.0
RP-010349	25.104	71		Rel-4	ACLR definition	A	4.0.0	4.1.0
RP-010467	25.104	72		Rel-4	Requirements for demodulation of RACH message	F	4.0.0	4.1.0
RP-010467	25.104	75		Rel-4	RACH preamble requirements	F	4.0.0	4.1.0

Table D.10: Release 4 CRs approved by TSG RAN#13

RAN Tdoc	Spec	CR	R	Ph	Title	Cat	Curr	New
RP-010616	25.104	77		Rel-4	Correction to PCDE requirement.	A	4.1.0	4.2.0
RP-010616	25.104	79		Rel-4	Correction of frequency range for receiver spurious emission requirements	A	4.1.0	4.2.0
RP-010616	25.104	81		Rel-4	Clarification in Spectrum emission mask section	A	4.1.0	4.2.0
RP-010616	25.104	83		Rel-4	Blocking requirement for co-location of FDD and TDD base stations	A	4.1.0	4.2.0
RP-010616	25.104	85		Rel-4	Definition of "classical Doppler spectrum"	A	4.1.0	4.2.0
RP-010626	25.104	86		Rel-4	RACH measurement channel definition	F	4.1.0	4.2.0

Table D.11: Release 5 CR approved by TSG RAN#13

RAN Tdoc	Spec	CR	R	Ph	Title	Cat	Curr	New	Work Item
RP-010636	25.104	87		Rel-5	Addition of BS performance requirement for CPCH	B	4.1.0	5.0.0	TEI5

Table D.12: Release 5 CRs approved by TSG RAN#14

RAN Tdoc	Spec	CR	R	Ph	Title	Cat	Curr	New	Work Item
RP-010779	25.104	90		Rel-5	Multi and single carrier for spurious emissions	A	5.0.0	5.1.0	TEI
RP-010779	25.104	93		Rel-5	Correction to units in Spectrum emission mask	A	5.0.0	5.1.0	TEI
RP-010779	25.104	95		Rel-5	Co location with UTRA TDD	A	5.0.0	5.1.0	TEI
RP-010789	25.104	99		Rel-5	Rel 5 frequency band restructure and essential corrections for band II and III	B	5.0.0	5.1.0	RInImp-UMTS18

Table D.13: Release 5 CRs approved by TSG RAN#15

RAN Tdoc	Spec	CR	R	Ph	Title	Cat	Curr	New	Work Item
RP-020016	25.104	102	1	Rel-5	Removal of BS performance requirements in SSDD mode	A	5.1.0	5.2.0	TEI
RP-020039	25.104	105	2	Rel-5	Correction of reference measurement channel for 2048 kbps	F	5.1.0	5.2.0	TEI5
RP-020034	25.104	108		Rel-5	Corrections to UMTS1800/1900 requirements	F	5.1.0	5.2.0	RinImp-UMTS18, RinImp-UMTS19
RP-020035	25.104	109		Rel-5	Co-existence with GSM850 for band II operations	B	5.1.0	5.2.0	RinImp-UMTS19
RP-020039	25.104	113	1	Rel-5	Correction to units in spectrum emission mask	F	5.1.0	5.2.0	TEI5
RP-020016	25.104	117		Rel-5	Correction of power terms and definitions	A	5.1.0	5.2.0	TEI
RP-020038	25.104	120	1	Rel-5	Regional requirement on HSDPA	D	5.1.0	5.2.0	HSDPA-RF

Table D.14: Release 5 CRs approved by TSG RAN#16

RAN Tdoc	Spec	CR	R	Ph	Title	Cat	Curr	New	Work Item
RP-020302	25.104	122	1	Rel-5	Node B modulation accuracy requirements for HS-PDSCH	F	5.2.0	5.3.0	HSDPA-RF
RP-020301	25.104	124	1	Rel-5	BS performance requirements in SSDD (Site Selection Diversity Transmission)	F	5.2.0	5.3.0	RANimp-SSDD
RP-020290	25.104	126		Rel-5	Reference measurement channels for UL RACH Ratio of preamble power and total message power	A	5.2.0	5.3.0	TEI4
RP-020290	25.104	128		Rel-5	Correction of RACH preamble detection requirement	A	5.2.0	5.3.0	TEI4
RP-020303	25.104	129		Rel-5	Correction of ITU-R SM.329 references	F	5.2.0	5.3.0	TEI5
RP-020303	25.104	132	1	Rel-5	Corrections to Spectrum Emission Mask	F	5.2.0	5.3.0	TEI5

Table D.15: Release 5 CRs approved by TSG RAN#17

RAN Tdoc	Spec	CR	R	Ph	Title	Cat	Curr	New	Work Item
RP-020485	25.104	141	1	Rel-5	Correction to spurious emissions limits	F	5.3.0	5.4.0	RinImp-UMTS18, RinImp-UMTS19
RP-020492	25.104	142		Rel-5	Correction to CPICH measurement period	F	5.3.0	5.4.0	TEI5
RP-020485	25.104	146		Rel-5	Time alignment in TX Diversity	B	5.3.0	5.4.0	TEI5

Table D.16: Release 5 CRs approved by TSG RAN#18

RAN Tdoc	Spec	CR	R	Ph	Title	Cat	Curr	New	Work Item
RP-020781	25.104	150		Rel-5	FDD GSM 850 / PCS 1900 co-existence in the Same Geographic Area	F	5.4.0	5.5.0	TEI5
RP-020781	25.104	153		Rel-5	FDD GSM co-existence in the Same Geographic Area	A	5.4.0	5.5.0	TEI
RP-020791	25.104	160	1	Rel-5	BS IPDL requirement	A	5.4.0	5.5.0	TEI4
RP-020783	25.104	162		Rel-5	Correction to table of regional requirements	A	5.4.0	5.5.0	TEI4
RP-020796	25.104	163		Rel-5	General Release 5 corrections	F	5.4.0	5.5.0	TEI5
RP-020796	25.104	166		Rel-5	Clarification of TX diversity requirements	F	5.4.0	5.5.0	TEI5

Table D.17: Release 6 CRs approved by TSG RAN#18

RAN Tdoc	Spec	CR	R	Ph	Title	Cat	Curr	New	Work Item
RP-020802	25.104	148	1	Rel-6	Introduction of Base Station Classes	B	5.4.0	6.0.0	RinImp-BSClass-FDD
RP-020895	25.104	168		Rel-6	Regional requirements on FDD BS Classes	F	5.4.0	6.0.0	RinImp-BSClass-FDD

Table D.18: Release 6 CRs approved by TSG RAN#19

RAN Tdoc	Spec	CR	R	Ph	Title	Cat	Curr	New	Work Item
RP-030029	25.104	172	1	Rel-6	Protection of the FDD BS receiver	A	6.0.0	6.1.0	TEI
RP-030049	25.104	175		Rel-6	Co-siting requirements for different FDD BS classes	B	6.0.0	6.1.0	RInImp-BSCClass-FDD
RP-030049	25.104	177	4	Rel-6	Maximum output power for different BS class	B	6.0.0	6.1.0	RInImp-BSCClass-FDD
RP-030035	25.104	182		Rel-6	Correction to external equipment definition	A	6.0.0	6.1.0	TEI4
RP-030044	25.104	183		Rel-6	Clarification of the W-CDMA interferer definition in BS requirements for ACS and blocking characteristics	A	6.0.0	6.1.0	TEI5
RP-030049	25.104	184		Rel-6	The definition of UTRA-FDD BS classes	F	6.0.0	6.1.0	RInImp-BSCClass-FDD

Table D.19: Release 6 CRs approved by TSG RAN#20

RAN Tdoc	Spec	CR	R	Ph	Title	Cat	Curr	New	Work Item
RP-030220	25.104	185		Rel-6	Frequency error requirement correction	F	6.1.0	6.2.0	TEI6
RP-030221	25.104	186		Rel-6	Correction to DCH demodulation performance requirement in multipath fading case 4	F	6.1.0	6.2.0	RInImp-BSCClass-FDD
RP-030214	25.104	192	1	Rel-6	General corrections on co-existence and co-location requirements for UTRA-FDD BS	A	6.1.0	6.2.0	TEI5

Table D.20: Release 6 CRs approved by TSG RAN#21

RAN Tdoc	Spec	CR	R	Ph	Title	Cat	Curr	New	Work Item
RP-030423	25.104	199	1	Rel-6	Spurious emission levels for the protection of UTRA-FDD BS receiver	F	6.2.0	6.3.0	TEI6
RP-030515	25.104	200	1	Rel-6	Frequency bands for UMTS1.7/2.1, UMTS800 and UMTS850	B	6.2.0	6.3.0	RInImp-UMTS850, RInImp-UMTS800, RInImp-UMTS1721

Table D.21: Release 6 CRs approved by TSG RAN#22

RAN Tdoc	Spec	CR	R	Ph	Title	Cat	Curr	New	Workitem
RP-030597	25.104	202	1	Rel-6	Correction of the P-CPICH power accuracy requirement in case of TX-diversity	A	6.3.0	6.4.0	TEI5
RP-030596	25.104	204		Rel-6	Correction of references to ITU recommendations	A	6.3.0	6.4.0	TEI5
RP-030605	25.104	206	1	Rel-6	DS-CDMA Introduction in the 800 MHz Band	B	6.3.0	6.4.0	RInImp-UMTS800
RP-030604	25.104	207	1	Rel-6	Introduction of UMTS 850 requirements	B	6.3.0	6.4.0	RInImp-UMTS850
RP-030598	25.104	209		Rel-6	Correction of the applicability of requirements in case of TX diversity	A	6.3.0	6.4.0	TEI5
RP-030603	25.104	210		Rel-6	Introduction of new channel arrangement for bands IV, V and VI	B	6.3.0	6.4.0	RInImp-UMTS850, UMTS800,UMTS1721
RP-030607	25.104	211		Rel-6	Introduction of DCH performances for BS without RX diversity	B	6.3.0	6.4.0	TEI6
RP-030606	25.104	213		Rel-6	Co-existence with UTRA FDD in frequency band V	F	6.3.0	6.4.0	TEI6
RP-030605	25.104	214		Rel-6	DS CDMA introduction in the 800 MHz band (performance requirement in Band VI)	B	6.3.0	6.4.0	RInImp-UMTS800

Table D.22: Release 6 CRs approved by TSG RAN#23

RAN Tdoc	Spec	CR	R	Ph	Title	Cat	Curr	New	Work Item
RP-040039	25.104	216	1	Rel-6	Introduction of UMTS 1.7/2.1 GHz requirements	B	6.4.0	6.5.0	RInImp-UMTS1721
RP-040040	25.104	217		Rel-6	Co-existence with UTRA FDD in frequency band IV	F	6.4.0	6.5.0	TEI6
RP-040041	25.104	218		Rel-6	Performance requirements for HS-DPCCH signaling detection	B	6.4.0	6.5.0	HSDPA-RF
RP-040040	25.104	219		Rel-6	Co-existence with UTRA FDD in frequency band VI	F	6.4.0	6.5.0	TEI6
RP-040043	25.104	221		Rel-6	Reduction of channel number for UMTS800(band VI)	F	6.4.0	6.5.0	RInImp-UMTS800

Table D.23: Release 6 CRs approved by TSG RAN#24

RAN Tdoc	Spec	CR	R	Ph	Title	Cat	Curr	New	Work Item
RP-040228	25.104	223	2	Rel-6	Redrafting of spurious emission tables for co-existence	D	6.5.0	6.6.0	TEI6
RP-040228	25.104	224	2	Rel-6	Redrafting of blocking tables for co-location & Requirements for Medium Range BS and Local Area BS in case of co-location	F	6.5.0	6.6.0	TEI6
RP-040228	25.104	225	1	Rel-6	DCH/RACH/CPCH performance requirement for BS without Rx diversity	B	6.5.0	6.6.0	TEI6
RP-040228	25.104	226		Rel-6	Corrections on terminology	F	6.5.0	6.6.0	TEI6

Table D.24: Release 6 CRs approved by TSG RAN#25

RAN Tdoc	Spec	CR	R	Ph	Title	Cat	Curr	New	Work Item
RP-040292	25.104	227	1	Rel-6	Correction in the Band V (850MHz) additional frequency channel - UARFCN	F	6.6.0	6.7.0	RInImp-UMTS850
RP-040367	25.104	229	-	Rel-6	Regional Requirement on HSDPA	A	6.6.0	6.7.0	HSDPA-RF

Table D.25: Release 6 CRs approved by TSG RAN#26

RAN Tdoc	Spec	CR	R	Ph	Title	Cat	Curr	New	Work Item
RP-040410	25.104	230		Rel-6	Power Control step requirements for 1.5dB and 2.0dB	F	6.7.0	6.8.0	TEI6

Table D.26: Release 6 CRs approved by TSG RAN#28

RAN Tdoc	Spec	CR	R	Ph	Title	Cat	Curr	New	Work Item
RP-050216	25.104	234		Rel-6	Feature Clean Up: Removal of CPCH	C	6.8.0	6.9.0	TEI6
RP-050211	25.104	236		Rel-6	Feature Clean Up: Removal of SSDT	C	6.8.0	6.9.0	TEI6
RP-050259	25.104	240		Rel-6	Feature Clean-Up for TS25.104, 80 ms TTI	C	6.8.0	6.9.0	TEI6

Table D.27: Release 7 CRs approved by TSG RAN#28

RAN Tdoc	Spec	CR	R	Ph	Title	Cat	Curr	New	Work Item
RP-050206	25.104	231	1	Rel-7	Introduction of UMTS 2.6 GHz requirements	B	6.8.0	7.0.0	RInImp-UMTS2600
RP-050206	25.104	237		Rel-7	Introduction of UMTS 2.6 GHz adjacent band services	B	6.8.0	7.0.0	RInImp-UMTS2600
RP-050206	25.104	238		Rel-7	Introduction of UMTS 2.6 GHz blocking requirements	B	6.8.0	7.0.0	RInImp-UMTS2600

Table D.28: Release 7 CRs approved by TSG RAN#29

RAN Tdoc	Spec	CR	R	Ph	Title	Cat	Curr	New	Work Item
RP-050489	25.104	0245	1	Rel-7	Clarification of '12.5MHz rule' and modification of the protection band for PHS	A	7.0.0	7.1.0	TEI
RP-050505	25.104	0247	2	Rel-7	BS performance requirements for EDCH Uplink channels	A	7.0.0	7.1.0	EDCH-RF
RP-050496	25.104	0249	1	Rel-7	Revision of additional spurious emissions and additional receiver spurious emissions requirements on 800MHz band in Japan	A	7.0.0	7.1.0	RInImp-UMTS800
RP-050494	25.104	0252		Rel-7	Correction of additional Spectrum Emission Mask Requirements	A	7.0.0	7.1.0	TEI5

Table D.29: Release 7 CRs approved by TSG RAN#30

RAN Tdoc	Spec	CR	R	Ph	Title	Cat	Curr	New	Work Item
RP-050839	25.104	0260		Rel-7	UMTS850 Spurious emissions correction	A	7.1.0	7.2.0	RInImp-UMTS850
RP-050735	25.104	0263		Rel-7	Corrections to BS performance requirements for EDCH uplink channels	A	7.1.0	7.2.0	EDCH-RF
RP-050862	25.104	0265	2	Rel-7	Redrafted "Minimum Requirement" clauses impact in 25.104	A	7.1.0	7.2.0	TEI6
RP-050741	25.104	0267		Rel-7	Introduction of 900 MHz band (Band VIII) in UTRA-FDD BS spec TS25.104	B	7.1.0	7.2.0	RInImp-UMTS900
RP-050742	25.104	0268		Rel-7	Introduction of UMTS1700 requirements	B	7.1.0	7.2.0	RInImp-UMTS1700
RP-050732	25.104	0271	1	Rel-7	New UARFCN scheme and re-numbering	A	7.1.0	7.2.0	TEI5

Table D.30: Release 7 CRs approved by TSG RAN#31

RAN Tdoc	Spec	CR	R	Ph	Title	Cat	Curr	New	Work Item
RP-060108	25.104	0273	1	Rel-7	Clarifications on birth/death propagation channel for BS with receiver diversity	A	7.2.0	7.3.0	TEI6
RP-060105	25.104	0275	1	Rel-7	Correction of the regional requirement on BS classification	A	7.2.0	7.3.0	TEI6
RP-060110	25.104	0276	1	Rel-7	Correction of spurious emissions for coexistence with GSM900 in same geographic area	F	7.2.0	7.3.0	RInImp-UMTS900
RP-060106	25.104	0278		Rel-7	Corrections of tables and references in 25.104	A	7.2.0	7.3.0	TEI6

History

Document history		
V7.2.0	December 2005	Publication
V7.3.0	March 2006	Publication