

# ETSI TS 125 104 V8.2.0 (2008-04)

---

*Technical Specification*

**Universal Mobile Telecommunications System (UMTS);  
Base Station (BS) radio transmission and reception (FDD)  
(3GPP TS 25.104 version 8.2.0 Release 8)**



---

**Reference**

RTS/TSGR-0425104v820

---

**Keywords**

UMTS

**ETSI**

---

650 Route des Lucioles  
F-06921 Sophia Antipolis Cedex - FRANCE

Tel.: +33 4 92 94 42 00 Fax: +33 4 93 65 47 16

Siret N° 348 623 562 00017 - NAF 742 C  
Association à but non lucratif enregistrée à la  
Sous-Préfecture de Grasse (06) N° 7803/88

---

**Important notice**

Individual copies of the present document can be downloaded from:

<http://www.etsi.org>

The present document may be made available in more than one electronic version or in print. In any case of existing or perceived difference in contents between such versions, the reference version is the Portable Document Format (PDF). In case of dispute, the reference shall be the printing on ETSI printers of the PDF version kept on a specific network drive within ETSI Secretariat.

Users of the present document should be aware that the document may be subject to revision or change of status. Information on the current status of this and other ETSI documents is available at

<http://portal.etsi.org/tb/status/status.asp>

If you find errors in the present document, please send your comment to one of the following services:

[http://portal.etsi.org/chaicor/ETSI\\_support.asp](http://portal.etsi.org/chaicor/ETSI_support.asp)

---

**Copyright Notification**

No part may be reproduced except as authorized by written permission.  
The copyright and the foregoing restriction extend to reproduction in all media.

© European Telecommunications Standards Institute 2008.  
All rights reserved.

**DECT**<sup>TM</sup>, **PLUGTESTS**<sup>TM</sup>, **UMTS**<sup>TM</sup>, **TIPHON**<sup>TM</sup>, the TIPHON logo and the ETSI logo are Trade Marks of ETSI registered for the benefit of its Members.

**3GPP**<sup>TM</sup> is a Trade Mark of ETSI registered for the benefit of its Members and of the 3GPP Organizational Partners.

---

## Intellectual Property Rights

IPRs essential or potentially essential to the present document may have been declared to ETSI. The information pertaining to these essential IPRs, if any, is publicly available for **ETSI members and non-members**, and can be found in ETSI SR 000 314: "*Intellectual Property Rights (IPRs); Essential, or potentially Essential, IPRs notified to ETSI in respect of ETSI standards*", which is available from the ETSI Secretariat. Latest updates are available on the ETSI Web server (<http://webapp.etsi.org/IPR/home.asp>).

Pursuant to the ETSI IPR Policy, no investigation, including IPR searches, has been carried out by ETSI. No guarantee can be given as to the existence of other IPRs not referenced in ETSI SR 000 314 (or the updates on the ETSI Web server) which are, or may be, or may become, essential to the present document.

---

## Foreword

This Technical Specification (TS) has been produced by ETSI 3rd Generation Partnership Project (3GPP).

The present document may refer to technical specifications or reports using their 3GPP identities, UMTS identities or GSM identities. These should be interpreted as being references to the corresponding ETSI deliverables.

The cross reference between GSM, UMTS, 3GPP and ETSI identities can be found under <http://webapp.etsi.org/key/queryform.asp>.

# Contents

|   |    |
|---|----|
| Intellectual Property Rights .....  | 2  |
| Foreword.....   | 2  |
| Foreword.....   | 7  |
| 1 Scope .....   | 8  |
| 2 References .....  | 8  |
| 3 Definitions and abbreviations.....                                      | 8  |
| 3.1 Definitions .....   | 8  |
| 3.2 Abbreviations .....   | 9  |
| 4 General .....   | 9  |
| 4.1 Relationship between Minimum Requirements and Test Requirements ..... | 9  |
| 4.2 Base station classes .....  | 10 |
| 4.3 Regional requirements.....  | 11 |
| 4.4 Environmental requirements for the BS equipment .....                 | 12 |
| 5 Frequency bands and channel arrangement.....                            | 12 |
| 5.1 General .....   | 12 |
| 5.2 Frequency bands.....  | 12 |
| 5.3 Tx-Rx frequency separation .....                                      | 13 |
| 5.4 Channel arrangement.....  | 13 |
| 5.4.1 Channel spacing .....   | 13 |
| 5.4.2 Channel raster .....  | 13 |
| 5.4.3 Channel number.....   | 13 |
| 6 Transmitter characteristics .....                                       | 15 |
| 6.1 General .....   | 15 |
| 6.2 Base station output power .....                                       | 15 |
| 6.2.1 Base station maximum output power.....                              | 15 |
| 6.2.1.1 Minimum requirement .....   | 15 |
| 6.3 Frequency error .....   | 16 |
| 6.3.1 Minimum requirement .....   | 16 |
| 6.4 Output power dynamics.....  | 16 |
| 6.4.1 Inner loop power control in the downlink.....                       | 16 |
| 6.4.1.1 Power control steps .....   | 16 |
| 6.4.1.1.1 Minimum requirement.....  | 16 |
| 6.4.2 Power control dynamic range .....                                   | 17 |
| 6.4.2.1 Minimum requirements.....   | 17 |
| 6.4.3 Total power dynamic range .....                                     | 17 |
| 6.4.3.1 Minimum requirement .....   | 17 |
| 6.4.4 Primary CPICH power.....  | 17 |
| 6.4.4.1 Minimum requirement .....   | 17 |
| 6.4.5 IPDL time mask.....   | 17 |
| 6.4.5.1 Minimum Requirement .....   | 17 |
| 6.5 (void).....   | 18 |
| 6.6 Output RF spectrum emissions.....                                     | 18 |
| 6.6.1 Occupied bandwidth .....  | 18 |
| 6.6.1.1 Minimum requirement .....   | 18 |
| 6.6.2 Out of band emission .....  | 18 |
| 6.6.2.1 Spectrum emission mask.....                                       | 19 |
| 6.6.2.2 Adjacent Channel Leakage power Ratio (ACLR).....                  | 21 |
| 6.6.2.2.1 Minimum requirement.....  | 22 |
| 6.6.3 Spurious emissions .....  | 22 |
| 6.6.3.1 Mandatory Requirements .....                                      | 22 |
| 6.6.3.1.1 Spurious emissions (Category A).....                            | 22 |
| 6.6.3.1.1.1 Minimum Requirement.....                                      | 22 |

|             |   |    |
|-------------|---|----|
| 6.6.3.1.2   | Spurious emissions (Category B) .....   | 22 |
| 6.6.3.1.2.1 | Minimum Requirement .....   | 23 |
| 6.6.3.2     | Protection of the BS receiver of own or different BS .....  | 23 |
| 6.6.3.2.1   | Minimum Requirement .....   | 24 |
| 6.6.3.3     | Co-existence with other systems in the same geographical area .....                               | 25 |
| 6.6.3.3.1   | Minimum Requirements .....  | 26 |
| 6.6.3.4     | Co-existence with co-located and co-sited base stations .....                                     | 27 |
| 6.6.3.4.1   | Minimum Requirements .....  | 28 |
| 6.6.3.5     | Co-existence with PHS .....   | 29 |
| 6.6.3.5.1   | Minimum Requirement .....   | 29 |
| 6.6.3.6     | Co-existence with services in adjacent frequency bands .....                                      | 29 |
| 6.6.3.6.1   | Minimum requirement .....   | 30 |
| 6.6.3.7     | Co-existence with UTRA-TDD .....  | 30 |
| 6.6.3.7.1   | Operation in the same geographic area .....   | 30 |
| 6.6.3.7.1.1 | Minimum Requirement .....   | 30 |
| 6.6.3.7.2   | Co-located base stations .....  | 30 |
| 6.6.3.7.2.1 | Minimum Requirement .....   | 30 |
| 6.6.3.8     | Co-existence with public safety systems .....   | 31 |
| 6.6.3.8.1   | Minimum Requirement .....   | 31 |
| 6.7         | Transmit intermodulation .....  | 32 |
| 6.7.1       | Minimum requirement .....   | 32 |
| 6.8         | Transmit modulation .....   | 32 |
| 6.8.1       | Transmit pulse shape filter .....   | 32 |
| 6.8.2       | Error Vector Magnitude .....  | 32 |
| 6.8.2.1     | Minimum requirement .....   | 33 |
| 6.8.3       | Peak code Domain error .....  | 33 |
| 6.8.3.1     | Minimum requirement .....   | 33 |
| 6.8.4       | Time alignment error in Tx Diversity and MIMO transmission .....                                  | 33 |
| 6.8.4.1     | Minimum Requirement .....   | 33 |
| 6.8.5       | Relative Code Domain Error for 64QAM modulation .....   | 33 |
| 6.8.5.1     | Minimum requirement .....   | 33 |
| 7           | Receiver characteristics .....  | 33 |
| 7.1         | General .....   | 33 |
| 7.2         | Reference sensitivity level .....   | 34 |
| 7.2.1       | Minimum requirement .....   | 34 |
| 7.2.2       | Maximum Frequency Deviation for Receiver Performance .....  | 34 |
| 7.3         | Dynamic range .....   | 34 |
| 7.3.1       | Minimum requirement .....   | 34 |
| 7.4         | Adjacent Channel Selectivity (ACS) .....  | 35 |
| 7.4.1       | Minimum requirement .....   | 35 |
| 7.4.2       | Minimum requirement - Co-location with UTRA-TDD .....   | 35 |
| 7.5         | Blocking characteristics .....  | 35 |
| 7.5.1       | Minimum requirement .....   | 36 |
| 7.5.2       | Minimum Requirement - Co-location with GSM900, DCS 1800, PCS1900, GSM850 and/or UTRA<br>FDD ..... | 42 |
| 7.5.3       | Minimum Requirement - Co-location with UTRA-TDD .....   | 43 |
| 7.6         | Intermodulation characteristics .....   | 44 |
| 7.6.1       | Minimum requirement .....   | 44 |
| 7.7         | Spurious emissions .....  | 45 |
| 7.7.1       | Minimum requirement .....   | 46 |
| 8           | Performance requirement .....   | 46 |
| 8.1         | General .....   | 46 |
| 8.2         | Demodulation in static propagation conditions .....   | 47 |
| 8.2.1       | Demodulation of DCH .....   | 47 |
| 8.2.1.1     | Minimum requirement .....   | 47 |
| 8.3         | Demodulation of DCH in multipath fading conditions .....  | 48 |
| 8.3.1       | Multipath fading Case 1 .....   | 48 |
| 8.3.1.1     | Minimum requirement .....   | 48 |
| 8.3.2       | Multipath fading Case 2 .....   | 48 |
| 8.3.2.1     | Minimum requirement .....   | 49 |

|  |  |           |
|--|--|-----------|
| 8.3.3  | Multipath fading Case 3.....   | 49        |
| 8.3.3.1  | Minimum requirement .....  | 49        |
| 8.3.4  | Multipath fading Case 4.....   | 49        |
| 8.3.4.1  | Minimum requirement .....  | 50        |
| 8.4  | Demodulation of DCH in moving propagation conditions.....                          | 50        |
| 8.4.1  | Minimum requirement .....  | 50        |
| 8.5  | Demodulation of DCH in birth/death propagation conditions.....                     | 50        |
| 8.5.1  | Minimum requirement .....  | 51        |
| 8.5A   | Demodulation of DCH in high speed train conditions .....                           | 51        |
| 8.5A.1   | General.....   | 51        |
| 8.5A.2   | Minimum requirement .....  | 51        |
| 8.6  | (void).....  | 51        |
| 8.7  | Performance requirement for RACH.....  | 51        |
| 8.7.1  | Performance requirement for RACH preamble detection.....                           | 52        |
| 8.7.2  | Demodulation of RACH message.....  | 52        |
| 8.7.2.1  | Minimum requirements for Static Propagation Condition .....                        | 52        |
| 8.7.2.2  | Minimum requirements for Multipath Fading Case 3 .....                             | 53        |
| 8.7.2.3  | Minimum requirements for high speed train conditions .....                         | 53        |
| 8.8  | (void).....  | 54        |
| 8.9  | (void).....  | 54        |
| 8.10   | Performance of ACK/NACK detection for HS-DPCCH.....                                | 54        |
| 8.10.1   | ACK false alarm .....  | 54        |
| 8.10.2   | ACK mis-detection .....  | 54        |
| 8.11   | Demodulation of E-DPDCH in multipath fading condition .....                        | 54        |
| 8.12   | Performance of signaling detection for E-DPCCH in multipath fading condition ..... | 55        |
| <b>Annex A (normative):    Measurement channels.....</b>   |  | <b>57</b> |
| A.1  | Summary of UL reference measurement channels.....                                  | 57        |
| A.2  | UL reference measurement channel for 12.2 kbps.....                                | 58        |
| A.3  | UL reference measurement channel for 64 kbps.....                                  | 59        |
| A.4  | UL reference measurement channel for 144 kbps.....                                 | 60        |
| A.5  | UL reference measurement channel for 384 kbps.....                                 | 61        |
| A.6  | (void).....  | 61        |
| A.7  | Reference measurement channels for UL RACH .....                                   | 62        |
| A.8  | Reference measurement channel for HS-DPCCH.....                                    | 62        |
| A.9  | Summary of E-DPDCH Fixed reference channels.....                                   | 63        |
| A.10   | E-DPDCH Fixed reference channel 1 (FRC1).....                                      | 63        |
| A.11   | E-DPDCH Fixed reference channel 2 (FRC2).....                                      | 64        |
| A.12   | E-DPDCH Fixed reference channel 3 (FRC3).....                                      | 65        |
| A.13   | E-DPDCH Fixed reference channel 4 (FRC4).....                                      | 66        |
| A.14   | E-DPDCH Fixed reference channel 5 (FRC5).....                                      | 67        |
| A.15   | E-DPDCH Fixed reference channel 6 (FRC6).....                                      | 68        |
| A.16   | E-DPDCH Fixed reference channel 7 (FRC7).....                                      | 68        |
| A.17   | E-DPDCH Fixed reference channel 8 (FRC8).....                                      | 69        |
| <b>Annex B (normative):    Propagation conditions.....</b> |  | <b>71</b> |
| B.1  | Static propagation condition.....  | 71        |
| B.2  | Multi-path fading propagation conditions.....                                      | 71        |
| B.3  | Moving propagation conditions.....   | 71        |

|                               |   |           |
|-------------------------------|---|-----------|
| B.4                           | Birth-Death propagation conditions .....                      | 72        |
| B.4A                          | High speed train conditions .....                             | 73        |
| B.5                           | Multipath fading propagation conditions .....                 | 75        |
| <b>Annex C (normative):</b>   | <b>Characteristics of the W-CDMA interference signal.....</b> | <b>76</b> |
| <b>Annex D (informative):</b> | <b>Change History .....</b>                                   | <b>77</b> |
| History .....                 |   | 78        |

---

# Foreword

This Technical Specification has been produced by the 3GPP.

The contents of the present document are subject to continuing work within the TSG and may change following formal TSG approval. Should the TSG modify the contents of this TS, it will be re-released by the TSG with an identifying change of release date and an increase in version number as follows:

Version 3.y.z

where:

- x the first digit:
  - 1 presented to TSG for information;
  - 2 presented to TSG for approval;
  - 3 Indicates TSG approved document under change control.
- y the second digit is incremented for all changes of substance, i.e. technical enhancements, corrections, updates, etc.
- z the third digit is incremented when editorial only changes have been incorporated in the specification.



---

# 1 Scope

This document establishes the Base Station minimum RF characteristics of the FDD mode of UTRA.

---

## 2 References

The following documents contain provisions which, through reference in this text, constitute provisions of the present document.

- References are either specific (identified by date of publication, edition number, version number, etc.) or non-specific.
- For a specific reference, subsequent revisions do not apply.
- For a non-specific reference, the latest version applies. In the case of a reference to a 3GPP document (including a GSM document), a non-specific reference implicitly refers to the latest version of that document *in the same Release as the present document*.

- [1] ITU-R Recommendation SM.329, " Unwanted emissions in the spurious domain ".
- [2] (void)
- [3] ETSI ETR 273-1-2: "Electromagnetic compatibility and Radio spectrum Matters (ERM); Improvement of radiated methods of measurement (using test sites) and evaluation of the corresponding measurement uncertainties; Part 1: Uncertainties in the measurement of mobile radio equipment characteristics; Sub-part 2: Examples and annexes".
- [4] 3GPP TR 25.942 "RF System Scenarios".
- [5] 3GPP TS 45.004: "Digital cellular telecommunications system (Phase 2+); Modulation".
- [6] 3GPP TS 25.213: "Spreading and modulation (FDD)".
- [7] ITU-R recommendation SM.328: "Spectra and bandwidth of emissions".

---

## 3 Definitions and abbreviations

### 3.1 Definitions

For the purposes of the present document, the following definitions apply:

**Output power:** The mean power of one carrier of the base station, delivered to a load with resistance equal to the nominal load impedance of the transmitter.

**Rated output power:** Rated output power of the base station is the mean power level per carrier that the manufacturer has declared to be available at the antenna connector.

**Maximum output Power:** The mean power level per carrier of the base station measured at the antenna connector in a specified reference condition.

**Mean power:** When applied to a W-CDMA modulated signal this is the power (transmitted or received) in a bandwidth of at least  $(1 + \alpha)$  times the chip rate of the radio access mode. The period of measurement shall be at least one timeslot unless otherwise stated.

**Power control dynamic range:** The difference between the maximum and the minimum transmit output power of a code channel for a specified reference condition.

**RRC filtered mean power:** The mean power as measured through a root raised cosine filter with roll-off factor  $\alpha$  and a bandwidth equal to the chip rate of the radio access mode.

NOTE 1: The RRC filtered mean power of a perfectly modulated W-CDMA signal is 0.246 dB lower than the mean power of the same signal.

**Code domain power:** That part of the mean power which correlates with a particular (OVSF) code channel. The sum of all powers in the code domain equals the mean power in a bandwidth of  $(1 + \alpha)$  times the chip rate of the radio access mode.

**Total power dynamic range:** The difference between the maximum and the minimum total transmit output power for a specified reference condition.

NOTE 2: The roll-off factor  $\alpha$  is defined in section 6.8.1.

## 3.2 Abbreviations

For the purposes of the present document, the following abbreviations apply:

|           |  |
|-----------|--|
| 16QAM     | 16 Quadrature Amplitude Modulation           |
| ACIR      | Adjacent Channel Interference Ratio          |
| ACLR      | Adjacent Channel Leakage power Ratio         |
| ACS       | Adjacent Channel Selectivity                 |
| BS        | Base Station                                 |
| BER       | Bit Error Ratio                              |
| BLER      | Block Error Ratio                            |
| CW        | Continuous Wave (unmodulated signal)         |
| DL        | Down Link (forward link)                     |
| FDD       | Frequency Division Duplexing                 |
| GSM       | Global System for Mobile Communications      |
| MIMO      | Multiple Input Multiple Output               |
| $P_{out}$ | Output Power                                 |
| $P_{RAT}$ | Rated Output Power                           |
| PHS       | Personal Handyphone System                   |
| PPM       | Parts Per Million                            |
| QPSK      | Quadrature Phase Shift Keying                |
| RSSI      | Received Signal Strength Indicator           |
| SIR       | Signal to Interference ratio                 |
| TDD       | Time Division Duplexing                      |
| TPC       | Transmit Power Control                       |
| UARFCN    | UTRA Absolute Radio Frequency Channel Number |
| UE        | User Equipment                               |
| UL        | Up Link (reverse link)                       |
| WCDMA     | Wideband Code Division Multiple Access       |

---

## 4 General

### 4.1 Relationship between Minimum Requirements and Test Requirements

The Minimum Requirements given in this specification make no allowance for measurement uncertainty. The test specification 25.141 section 4 defines Test Tolerances. These Test Tolerances are individually calculated for each test. The Test Tolerances are used to relax the Minimum Requirements in this specification to create Test Requirements.

The measurement results returned by the Test System are compared - without any modification - against the Test Requirements as defined by the shared risk principle.

The Shared Risk principle is defined in ETR 273 Part 1 sub-part 2 section 6.5.

## 4.2 Base station classes

The requirements in this specification apply to Wide Area Base Stations, Medium Range Base Stations and Local Area Base Stations unless otherwise stated.

Wide Area Base Stations are characterised by requirements derived from Macro Cell scenarios with a BS to UE minimum coupling loss equals to 70 dB. The Wide Area Base Station class has the same requirements as the base station for General Purpose application in Release 99, 4 and 5.

Medium Range Base Stations are characterised by requirements derived from Micro Cell scenarios with a BS to UE minimum coupling loss equals to 53 dB.

Local Area Base Stations are characterised by requirements derived from Pico Cell scenarios with a BS to UE minimum coupling loss equals to 45 dB.

## 4.3 Regional requirements

Some requirements in TS 25.104 may only apply in certain regions. Table 4.1 lists all requirements that may be applied differently in different regions.

**Table 4.1: List of regional requirements**

| Clause number | Requirement  | Comments  |
|---------------|--|---|
| 5.2           | Frequency bands  | Some bands may be applied regionally.   |
| 5.3           | Tx-Rx Frequency Separation   | The requirement is applied according to what frequency bands in Clause 5.2 that are supported by the BS.  |
| 5.4           | Channel arrangement  | The requirement is applied according to what frequency bands in Clause 5.2 that are supported by the BS.  |
| 6.2.1         | Base station maximum output power                                  | In certain regions, the minimum requirement for normal conditions may apply also for some conditions outside the range of conditions defined as normal.   |
| 6.6.2.1       | Spectrum emission mask   | The mask specified may be mandatory in certain regions. In other regions this mask may not be applied.  |
| 6.6.2.2.1     | Adjacent Channel Leakage power Ratio                               | In Japan, the requirement depicted in the note of Table 6.7 shall be applied.   |
| 6.6.3.1.1     | Spurious emissions (Category A)                                    | These requirements shall be met in cases where Category A limits for spurious emissions, as defined in ITU-R Recommendation SM.329 [1], are applied.  |
| 6.6.3.1.2     | Spurious emissions (Category B)                                    | These requirements shall be met in cases where Category B limits for spurious emissions, as defined in ITU-R Recommendation SM.329 [1], are applied.  |
| 6.6.3.3       | Co-existence with other systems in the same geographical area      | These requirements may apply in geographic areas in which both UTRA FDD and GSM900, DCS1800, PCS1900, GSM850 and/or UTRA FDD operating in another frequency band are deployed.                            |
| 6.6.3.4       | Co-existence with co-located and co-sited base stations            | These requirements may be applied for the protection of other BS receivers when GSM900, DCS1800, PCS1900, GSM850 and/or FDD BS operating in another frequency band are co-located with a UTRA FDD BS.     |
| 6.6.3.5       | Co-existence with PHS  | This requirement may be applied for the protection of PHS in geographic areas in which both PHS and UTRA FDD are deployed.  |
| 6.6.3.6       | Co-existence with services in adjacent frequency bands             | This requirement may be applied for the protection in bands adjacent to the downlink bands as defined in clause 5.2 in geographic areas in which both an adjacent band service and UTRA FDD are deployed. |
| 6.6.3.7.1     | Co-existence with UTRA TDD - Operation in the same geographic area | This requirement may be applied to geographic areas in which both UTRA-TDD and UTRA-FDD are deployed.   |
| 6.6.3.7.2     | Co-existence with UTRA TDD - Co-located base stations              | This requirement may be applied for the protection of UTRA-TDD BS receivers when UTRA-TDD BS and UTRA FDD BS are co-located.  |
| 6.6.3.8       | Co-existence with public safety systems                            | This requirement may be applied for the protection of public safety systems in geographic areas in which both UTRA FDD and public safety systems are deployed.  |
| 7.4.2         | Adjacent Channel Selectivity Co-location with UTRA-TDD             | This requirement may be applied for the protection of UTRA-FDD BS receivers when UTRA-FDD BS and UTRA-TDD BS are co-located.  |
| 7.5           | Blocking characteristic  | The requirement is applied according to what frequency bands in Clause 5.2 that are supported by the BS.  |

|       |   |  |
|-------|---|--|
| 7.5.2 | Blocking characteristics Co-location with GSM900, DCS 1800, PCS1900 and/or UTRA | This requirement may be applied for the protection of UTRA FDD BS receivers when UTRA FDD BS and GSM 900, DCS1800, PCS1900, GSM850 and/or UTRA BS (operating in different frequency bands) are co-located. |
| 7.5.3 | Blocking characteristics Co-location with UTRA TDD                              | This requirement may be applied for the protection of UTRA FDD BS receivers when UTRA FDD BS and UTRA TDD BS are co-located.   |
| 7.6   | Intermodulation characteristics   | The requirement is applied according to what frequency bands in Clause 5.2 that are supported by the BS.   |
| 7.7   | Spurious emissions  | The requirement is applied according to what frequency bands in Clause 5.2 that are supported by the BS.   |
| 7.7.1 | Additional spurious emissions requirement                                       | The requirement in Table 7.8 may be applied to geographic areas in which both UTRA-TDD and UTRA-FDD are deployed.  |

## 4.4 Environmental requirements for the BS equipment

The BS equipment shall fulfil all the requirements in the full range of environmental conditions for the relevant environmental class from the relevant IEC specifications listed below

60 721-3-3 "Stationary use at weather protected locations"

60 721-3-4 "Stationary use at non weather protected locations"

Normally it should be sufficient for all tests to be conducted using normal test conditions except where otherwise stated. For guidance on the use of test conditions to be used in order to show compliance refer to TS 25.141.

---

## 5 Frequency bands and channel arrangement

### 5.1 General

The information presented in this section is based on a chip rate of 3.84 Mcps.

NOTE 1: Other chip rates may be considered in future releases.

### 5.2 Frequency bands

a) UTRA/FDD is designed to operate in the following paired bands:

**Table 5.0: Frequency bands**

| Operating Band | UL Frequencies<br>UE transmit, Node B receive | DL frequencies<br>UE receive, Node B transmit |
|----------------|---|---|
| I              | 1920 - 1980 MHz                               | 2110 -2170 MHz                                |
| II             | 1850 -1910 MHz                                | 1930 -1990 MHz                                |
| III            | 1710-1785 MHz                                 | 1805-1880 MHz                                 |
| IV             | 1710-1755 MHz                                 | 2110-2155 MHz                                 |
| V              | 824 - 849MHz                                  | 869-894MHz                                    |
| VI             | 830-840 MHz                                   | 875-885 MHz                                   |
| VII            | 2500 - 2570 MHz                               | 2620 - 2690 MHz                               |
| VIII           | 880 - 915 MHz                                 | 925 - 960 MHz                                 |

|      |                     |                     |
|------|---------------------|---------------------|
| IX   | 1749.9 - 1784.9 MHz | 1844.9 - 1879.9 MHz |
| X    | 1710-1770 MHz       | 2110-2170 MHz       |
| XI   | 1427.9 - 1452.9 MHz | 1475.9 - 1500.9 MHz |
| XII  | 698 - 716 MHz       | 728 - 746 MHz       |
| XIII | 777 - 787 MHz       | 746 - 756 MHz       |
| XIV  | 788 - 798 MHz       | 758 - 768 MHz       |

b) Deployment in other frequency bands is not precluded

## 5.3 Tx-Rx frequency separation

a) UTRA/FDD is designed to operate with the following TX-RX frequency separation

**Table 5.0A: Tx-Rx frequency separation**

| Operating Band | TX-RX frequency separation |
|----------------|----------------------------|
| I              | 190 MHz                    |
| II             | 80 MHz.                    |
| III            | 95 MHz.                    |
| IV             | 400 MHz                    |
| V              | 45 MHz                     |
| VI             | 45 MHz                     |
| VII            | 120 MHz                    |
| VIII           | 45 MHz                     |
| IX             | 95 MHz                     |
| X              | 400 MHz                    |
| XI             | 48 MHz                     |
| XII            | 30 MHz                     |
| XIII           | 31 MHz                     |
| XIV            | 30 MHz                     |

b) UTRA/FDD can support both fixed and variable transmit to receive frequency separation.

c) The use of other transmit to receive frequency separations in existing or other frequency bands shall not be precluded.

## 5.4 Channel arrangement

### 5.4.1 Channel spacing

The nominal channel spacing is 5 MHz, but this can be adjusted to optimise performance in a particular deployment scenario.

### 5.4.2 Channel raster

The channel raster is 200 kHz for all bands, which means that the centre frequency must be an integer multiple of 200 kHz. In addition a number of additional centre frequencies are specified according to table 5.1A, which means that the centre frequencies for these channels are shifted 100 kHz relative to the general raster.

### 5.4.3 Channel number

The carrier frequency is designated by the UTRA Absolute Radio Frequency Channel Number (UARFCN). For each operating Band, the UARFCN values are defined as follows:

Uplink:  $N_U = 5 * (F_{UL} - F_{UL\_Offset})$ , for the carrier frequency range  $F_{UL\_low} \leq F_{UL} \leq F_{UL\_high}$

Downlink:  $N_D = 5 * (F_{DL} - F_{DL\_Offset})$ , for the carrier frequency range  $F_{DL\_low} \leq F_{DL} \leq F_{DL\_high}$

For each operating Band,  $F_{UL\_Offset}$ ,  $F_{UL\_low}$ ,  $F_{UL\_high}$ ,  $F_{DL\_Offset}$ ,  $F_{DL\_low}$  and  $F_{DL\_high}$  are defined in Table 5.1 for the general UARFCN. For the additional UARFCN,  $F_{UL\_Offset}$ ,  $F_{DL\_Offset}$  and the specific  $F_{UL}$  and  $F_{DL}$  are defined in Table 5.1A.

**Table 5.1: UARFCN definition (general)**

| Band | UPLINK (UL)<br>UE transmit, Node B receive         |   |                | DOWNLINK (DL)<br>UE receive, Node B transmit       |   |                |
|------|--|---|----------------|--|---|----------------|
|      | UARFCN<br>formula offset<br>$F_{UL\_Offset}$ [MHz] | Carrier frequency ( $F_{UL}$ )<br>range [MHz] |                | UARFCN<br>formula offset<br>$F_{DL\_Offset}$ [MHz] | Carrier frequency ( $F_{DL}$ )<br>range [MHz] |                |
|      |  | $F_{UL\_low}$                                 | $F_{UL\_high}$ |  | $F_{DL\_low}$                                 | $F_{DL\_high}$ |
| I    | 0  | 1922.4  | 1977.6         | 0  | 2112.4  | 2167.6         |
| II   | 0  | 1852.4  | 1907.6         | 0  | 1932.4  | 1987.6         |
| III  | 1525   | 1712.4  | 1782.6         | 1575   | 1807.4  | 1877.6         |
| IV   | 1450   | 1712.4  | 1752.6         | 1805   | 2112.4  | 2152.6         |
| V    | 0  | 826.4   | 846.6          | 0  | 871.4   | 891.6          |
| VI   | 0  | 832.4   | 837.6          | 0  | 877.4   | 882.6          |
| VII  | 2100   | 2502.4  | 2567.6         | 2175   | 2622.4  | 2687.6         |
| VIII | 340  | 882.4   | 912.6          | 340  | 927.4   | 957.6          |
| IX   | 0  | 1752.4  | 1782.4         | 0  | 1847.4  | 1877.4         |
| X    | 1135   | 1712.4  | 1767.6         | 1490   | 2112.4  | 2167.6         |
| XI   | 733  | 1430.4  | 1450.4         | 736  | 1478.4  | 1498.4         |
| XII  | -22  | 700.4   | 713.6          | -37  | 730.4   | 743.6          |
| XIII | 21   | 779.4   | 784.6          | -55  | 748.4   | 753.6          |
| XIV  | 12   | 790.4   | 795.6          | -63  | 760.4   | 765.6          |

**Table 5.1A: UARFCN definition (additional channels)**

| Band | UPLINK (UL)<br>UE transmit, Node B receive         |  | DOWNLINK (DL)<br>UE receive, Node B transmit       |  |
|------|--|--|--|--|
|      | UARFCN<br>formula offset<br>$F_{UL\_Offset}$ [MHz] | Carrier frequency [ $F_{UL}$ ]<br>[MHz]  | UARFCN<br>formula offset<br>$F_{DL\_Offset}$ [MHz] | Carrier frequency [ $F_{DL}$ ]<br>[MHz]  |
| I    | -  | -  | -  | -  |
| II   | 1850.1   | 1852.5, 1857.5, 1862.5,<br>1867.5, 1872.5, 1877.5,<br>1882.5, 1887.5, 1892.5,<br>1897.5, 1902.5, 1907.5                    | 1850.1   | 1932.5, 1937.5, 1942.5,<br>1947.5, 1952.5, 1957.5,<br>1962.5, 1967.5, 1972.5,<br>1977.5, 1982.5, 1987.5                    |
| III  | -  | -  | -  | -  |
| IV   | 1380.1   | 1712.5, 1717.5, 1722.5,<br>1727.5, 1732.5, 1737.5,<br>1742.5, 1747.5, 1752.5   | 1735.1   | 2112.5, 2117.5, 2122.5,<br>2127.5, 2132.5, 2137.5,<br>2142.5, 2147.5, 2152.5   |
| V    | 670.1  | 826.5, 827.5, 831.5,<br>832.5, 837.5, 842.5  | 670.1  | 871.5, 872.5, 876.5,<br>877.5, 882.5, 887.5  |
| VI   | 670.1  | 832.5, 837.5   | 670.1  | 877.5, 882.5   |
| VII  | 2030.1   | 2502.5, 2507.5, 2512.5,<br>2517.5, 2522.5, 2527.5,<br>2532.5, 2537.5, 2542.5,<br>2547.5, 2552.5, 2557.5,<br>2562.5, 2567.5 | 2105.1   | 2622.5, 2627.5, 2632.5,<br>2637.5, 2642.5, 2647.5,<br>2652.5, 2657.5, 2662.5,<br>2667.5, 2672.5, 2677.5,<br>2682.5, 2687.5 |
| VIII | -  | -  | -  | -  |
| IX   | -  | -  | -  | -  |
| X    | 1075.1   | 1712.5, 1717.5, 1722.5,<br>1727.5, 1732.5, 1737.5,<br>1742.5, 1747.5, 1752.5,<br>1757.5, 1762.5, 1767.5                    | 1430.1   | 2112.5, 2117.5, 2122.5,<br>2127.5, 2132.5, 2137.5,<br>2142.5, 2147.5, 2152.5,<br>2157.5, 2162.5, 2167.5                    |
| XI   | -  | -  | -  | -  |
| XII  | -39.9  | 700.5, 701.5, 706.5,<br>707.5, 712.5, 713.5  | -54.9  | 730.5, 731.5, 736.5, 737.5,<br>742.5, 743.5  |
| XIII | 11.1   | 779.5, 784.5   | -64.9  | 748.5, 753.5   |
| XIV  | 2.1  | 790.5, 795.5   | -72.9  | 760.5, 765.5   |

## 6 Transmitter characteristics

### 6.1 General

Unless otherwise stated, the requirements in Section 6 assume transmission without diversity or MIMO. In case of transmit diversity or MIMO transmission the requirements apply to each antenna connector separately, with the other one terminated. Unless otherwise stated, the requirements are unchanged.

Unless otherwise stated, the transmitter characteristics are specified at the BS antenna connector (test port A) with a full complement of transceivers for the configuration in normal operating conditions. If any external apparatus such as a TX amplifier, a filter or the combination of such devices is used, requirements apply at the far end antenna connector (port B).

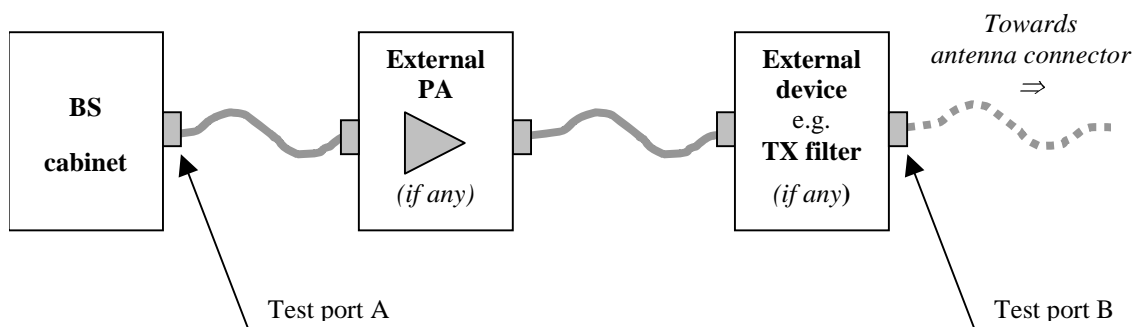

Figure 6.1: Transmitter test ports

### 6.2 Base station output power

Output power,  $P_{out}$ , of the base station is the mean power of one carrier delivered to a load with resistance equal to the nominal load impedance of the transmitter.

Rated output power, PRAT, of the base station is the mean power level per carrier that the manufacturer has declared to be available at the antenna connector.

#### 6.2.1 Base station maximum output power

Maximum output power,  $P_{max}$ , of the base station is the mean power level per carrier measured at the antenna connector in specified reference condition.

The rated output power, PRAT, of the BS shall be as specified in Table 6.0A.

Table 6.0A: Base Station rated output power

| BS class        | PRAT   |
|-----------------|--|
| Wide Area BS    | - (note)   |
| Medium Range BS | $\leq +38$ dBm   |
| Local Area BS   | $\leq +24$ dBm   |
| NOTE:           | There is no upper limit required for the rated output power of the Wide Area Base Station like for the base station for General Purpose application in Release 99, 4, and 5. |

##### 6.2.1.1 Minimum requirement

In normal conditions, the Base station maximum output power shall remain within +2 dB and -2dB of the manufacturer's rated output power.



In extreme conditions, the Base station maximum output power shall remain within +2.5 dB and -2.5 dB of the manufacturer's rated output power.

In certain regions, the minimum requirement for normal conditions may apply also for some conditions outside the range of conditions defined as normal.

## 6.3 Frequency error

Frequency error is the measure of the difference between the actual BS transmit frequency and the assigned frequency. The same source shall be used for RF frequency and data clock generation.

### 6.3.1 Minimum requirement

The modulated carrier frequency of the BS shall be accurate to within the accuracy range given in Table 6.0 observed over a period of one timeslot.

**Table 6.0: Frequency error minimum requirement**

| BS class        | Accuracy       |
|-----------------|----------------|
| Wide Area BS    | $\pm 0.05$ ppm |
| Medium Range BS | $\pm 0.1$ ppm  |
| Local Area BS   | $\pm 0.1$ ppm  |

## 6.4 Output power dynamics

Power control is used to limit the interference level. The transmitter uses a quality-based power control on the downlink.

### 6.4.1 Inner loop power control in the downlink

Inner loop power control in the downlink is the ability of the BS transmitter to adjust the transmitter output power of a code channel in accordance with the corresponding TPC symbols received in the uplink.

#### 6.4.1.1 Power control steps

The power control step is the required step change in the code domain power of a code channel in response to the corresponding power control command. The combined output power change is the required total change in the DL transmitted power of a code channel in response to multiple consecutive power control commands corresponding to that code channel.

##### 6.4.1.1.1 Minimum requirement

The BS transmitter shall have the capability of setting the inner loop code domain power with a step sizes of 1dB mandatory and 0.5, 1.5, 2.0 dB optional

- a) The tolerance of the power control step due to inner loop power control shall be within the range shown in Table 6.1.
- b) The tolerance of the combined output power change due to inner loop power control shall be within the range shown in Table 6.2.

**Table 6.1: Transmitter power control step tolerance**

| Power control commands in the down link | Transmitter power control step tolerance |         |                  |          |                |         |                  |          |
|---|--|---------|------------------|----------|----------------|---------|------------------|----------|
|   | 2 dB step size                           |         | 1.5 dB step size |          | 1 dB step size |         | 0.5 dB step size |          |
|   | Lower                                    | Upper   | Lower            | Upper    | Lower          | Upper   | Lower            | Upper    |
| Up (TPC command "1")                    | +1.0 dB                                  | +3.0 dB | +0.75 dB         | +2.25 dB | +0.5 dB        | +1.5 dB | +0.25 dB         | +0.75 dB |
| Down (TPC command "0")                  | -1.0 dB                                  | -3.0 dB | -0.75 dB         | -2.25 dB | -0.5 dB        | -1.5 dB | -0.25 dB         | -0.75 dB |

**Table 6.2: Transmitter aggregated power control step range**

| Power control commands in the down link | Transmitter aggregated power control step change after 10 consecutive equal commands (up or down) |        |                  |        |                |        |                  |       |
|---|---|--------|------------------|--------|----------------|--------|------------------|-------|
|   | 2 dB step size  |        | 1.5 dB step size |        | 1 dB step size |        | 0.5 dB step size |       |
|   | Lower   | Upper  | Lower            | Upper  | Lower          | Upper  | Lower            | Upper |
| Up (TPC command "1")                    | +16 dB  | +24 dB | +12 dB           | +18 dB | +8 dB          | +12 dB | +4 dB            | +6 dB |
| Down (TPC command "0")                  | -16 dB  | -24 dB | -12 dB           | -18 dB | -8 dB          | -12 dB | -4 dB            | -6 dB |

## 6.4.2 Power control dynamic range

The power control dynamic range is the difference between the maximum and the minimum code domain power of a code channel for a specified reference condition. Transmit modulation quality shall be maintained within the whole dynamic range as specified in subclause 6.8.

### 6.4.2.1 Minimum requirements

Down link (DL) power control dynamic range:

Maximum code domain power: BS maximum output power - 3 dB or greater

Minimum code domain power: BS maximum output power - 28 dB or less

## 6.4.3 Total power dynamic range

The total power dynamic range is the difference between the maximum and the minimum output power for a specified reference condition.

NOTE: The upper limit of the dynamic range is the BS maximum output power. The lower limit of the dynamic range is the lowest minimum power from the BS when no traffic channels are activated.

### 6.4.3.1 Minimum requirement

The downlink (DL) total power dynamic range shall be 18 dB or greater.

## 6.4.4 Primary CPICH power

Primary CPICH power is the code domain power of the Common Pilot Channel. Primary CPICH power is indicated on the BCH. CPICH power accuracy is defined as the maximum deviation between the Primary CPICH code domain power indicated on the BCH and the Primary CPICH code domain power measured at the TX antenna interface.

### 6.4.4.1 Minimum requirement

Primary CPICH code domain power shall be within  $\pm 2.1$  dB of the Primary CPICH code domain power indicated on the BCH.

## 6.4.5 IPDL time mask

To support IPDL location method, the Node B shall interrupt all transmitted signals in the downlink (i.e. common and dedicated channels).

The IPDL time mask specifies the limits of the BS output power during these idle periods.

The requirement in this section shall apply to BS supporting IPDL.

### 6.4.5.1 Minimum Requirement

The mean power measured over a period starting 27 chips after the beginning of the IPDL period and ending 27 chips before the expiration of the IPDL period shall be equal to or less than

BS maximum output power - 35 dB

see also Figure 6.1A.

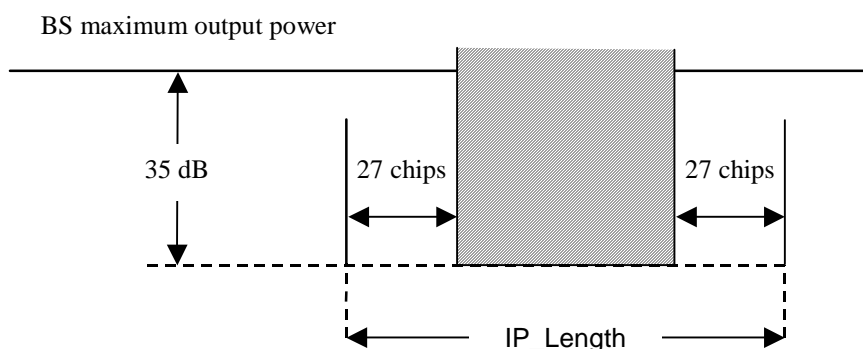

**Figure 6.1A: IPDL Time Mask**

The requirement applies to all output powers within the total power dynamic range as specified in subclause 6.4.3.

6.5 (void)

6.6 Output RF spectrum emissions

6.6.1 Occupied bandwidth

The occupied bandwidth is the width of a frequency band such that, below the lower and above the upper frequency limits, the mean powers emitted are each equal to a specified percentage  $\beta/2$  of the total mean transmitted power. See also ITU-R Recommendation SM.328 [7].

The value of  $\beta/2$  shall be taken as 0,5%.

6.6.1.1 Minimum requirement

The occupied channel bandwidth shall be less than 5 MHz based on a chip rate of 3.84 Mcps.

6.6.2 Out of band emission

Out of band emissions are unwanted emissions immediately outside the channel bandwidth resulting from the modulation process and non-linearity in the transmitter but excluding spurious emissions. This out of band emission requirement is specified both in terms of a spectrum emission mask and adjacent channel power ratio for the transmitter.

### 6.6.2.1 Spectrum emission mask

The mask defined in Tables 6.3 to 6.6 below may be mandatory in certain regions. In other regions this mask may not be applied.

For regions where this clause applies, the requirement shall be met by a base station transmitting on a single RF carrier configured in accordance with the manufacturer's specification. Emissions shall not exceed the maximum level specified in tables 6.3 to 6.6 for the appropriate BS maximum output power, in the frequency range from  $\Delta f = 2.5$  MHz to  $\Delta f_{max}$  from the carrier frequency, where:

- $\Delta f$  is the separation between the carrier frequency and the nominal -3dB point of the measuring filter closest to the carrier frequency.
- $F_{offset}$  is the separation between the carrier frequency and the centre of the measuring filter.
- $f_{offset_{max}}$  is either 12.5 MHz or the offset to the UMTS Tx band edge as defined in section 5.2, whichever is the greater.
- $\Delta f_{max}$  is equal to  $f_{offset_{max}}$  minus half of the bandwidth of the measuring filter.

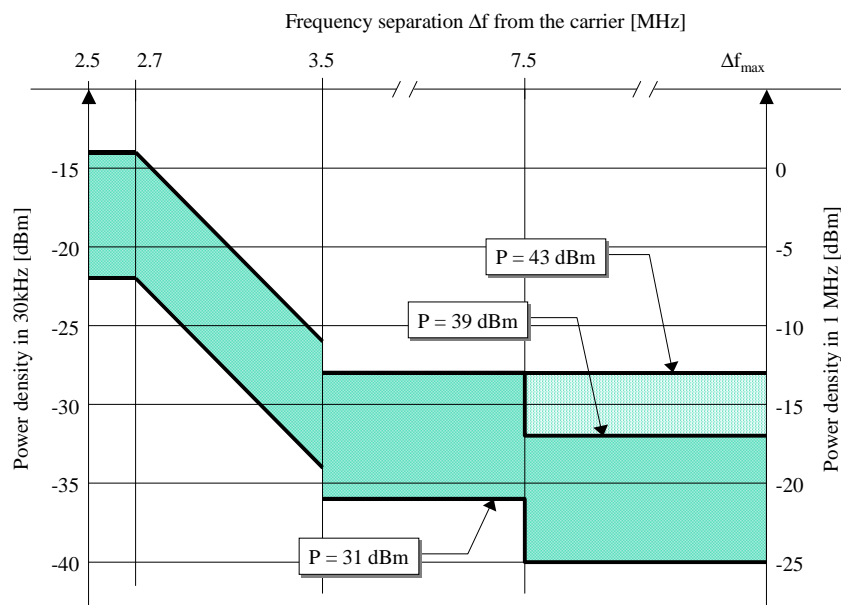

**Illustrative diagram of spectrum emission mask**

**Figure 6.2: Spectrum emission mask**

**Table 6.3: Spectrum emission mask values, BS maximum output power  $P \geq 43$  dBm**

| Frequency offset of measurement filter -3dB point, $\Delta f$ | Frequency offset of measurement filter centre frequency, $f_{offset}$ | Minimum requirement   | Measurement bandwidth (Note 2) |
|---|---|---|--------------------------------|
| $2.5 \text{ MHz} \leq \Delta f < 2.7 \text{ MHz}$             | $2.515\text{MHz} \leq f_{offset} < 2.715\text{MHz}$                   | -14 dBm   | 30 kHz                         |
| $2.7 \text{ MHz} \leq \Delta f < 3.5 \text{ MHz}$             | $2.715\text{MHz} \leq f_{offset} < 3.515\text{MHz}$                   | $-14\text{dBm} - 15 \cdot \left( \frac{f_{offset} - 2.715}{\text{MHz}} \right) \text{dB}$ | 30 kHz                         |
| (Note 1)  | $3.515\text{MHz} \leq f_{offset} < 4.0\text{MHz}$                     | -26 dBm   | 30 kHz                         |
| $3.5 \text{ MHz} \leq \Delta f \leq \Delta f_{max}$           | $4.0\text{MHz} \leq f_{offset} < f_{offset_{max}}$                    | -13 dBm   | 1 MHz                          |

**Table 6.4: Spectrum emission mask values, BS maximum output power  $39 \leq P < 43$  dBm**

| Frequency offset of measurement filter -3dB point, $\Delta f$ | Frequency offset of measurement filter centre frequency, $f_{\text{offset}}$ | Minimum requirement   | Measurement bandwidth (Note 2) |
|---|--|---|--------------------------------|
| $2.5 \text{ MHz} \leq \Delta f < 2.7 \text{ MHz}$             | $2.515 \text{ MHz} \leq f_{\text{offset}} < 2.715 \text{ MHz}$               | -14 dBm   | 30 kHz                         |
| $2.7 \text{ MHz} \leq \Delta f < 3.5 \text{ MHz}$             | $2.715 \text{ MHz} \leq f_{\text{offset}} < 3.515 \text{ MHz}$               | $-14 \text{ dBm} - 15 \cdot \left( \frac{f_{\text{offset}}}{\text{MHz}} - 2.715 \right) \text{ dB}$ | 30 kHz                         |
| (Note 1)  | $3.515 \text{ MHz} \leq f_{\text{offset}} < 4.0 \text{ MHz}$                 | -26 dBm   | 30 kHz                         |
| $3.5 \text{ MHz} \leq \Delta f < 7.5 \text{ MHz}$             | $4.0 \text{ MHz} \leq f_{\text{offset}} < 8.0 \text{ MHz}$                   | -13 dBm   | 1 MHz                          |
| $7.5 \text{ MHz} \leq \Delta f \leq \Delta f_{\text{max}}$    | $8.0 \text{ MHz} \leq f_{\text{offset}} < f_{\text{offset}_{\text{max}}}$    | $P - 56 \text{ dB}$   | 1 MHz                          |

**Table 6.5: Spectrum emission mask values, BS maximum output power  $31 \leq P < 39$  dBm**

| Frequency offset of measurement filter -3dB point, $\Delta f$ | Frequency offset of measurement filter centre frequency, $f_{\text{offset}}$ | Minimum requirement   | Measurement bandwidth (Note 2) |
|---|--|---|--------------------------------|
| $2.5 \text{ MHz} \leq \Delta f < 2.7 \text{ MHz}$             | $2.515 \text{ MHz} \leq f_{\text{offset}} < 2.715 \text{ MHz}$               | $P - 53 \text{ dB}$   | 30 kHz                         |
| $2.7 \text{ MHz} \leq \Delta f < 3.5 \text{ MHz}$             | $2.715 \text{ MHz} \leq f_{\text{offset}} < 3.515 \text{ MHz}$               | $P - 53 \text{ dB} - 15 \cdot \left( \frac{f_{\text{offset}}}{\text{MHz}} - 2.715 \right) \text{ dB}$ | 30 kHz                         |
| (Note 1)  | $3.515 \text{ MHz} \leq f_{\text{offset}} < 4.0 \text{ MHz}$                 | $P - 65 \text{ dB}$   | 30 kHz                         |
| $3.5 \text{ MHz} \leq \Delta f < 7.5 \text{ MHz}$             | $4.0 \text{ MHz} \leq f_{\text{offset}} < 8.0 \text{ MHz}$                   | $P - 52 \text{ dB}$   | 1 MHz                          |
| $7.5 \text{ MHz} \leq \Delta f \leq \Delta f_{\text{max}}$    | $8.0 \text{ MHz} \leq f_{\text{offset}} < f_{\text{offset}_{\text{max}}}$    | $P - 56 \text{ dB}$   | 1 MHz                          |

**Table 6.6: Spectrum emission mask values, BS maximum output power  $P < 31$  dBm**

| Frequency offset of measurement filter -3dB point, $\Delta f$ | Frequency offset of measurement filter centre frequency, $f_{\text{offset}}$ | Minimum requirement   | Measurement bandwidth (Note 2) |
|---|--|---|--------------------------------|
| $2.5 \text{ MHz} \leq \Delta f < 2.7 \text{ MHz}$             | $2.515 \text{ MHz} \leq f_{\text{offset}} < 2.715 \text{ MHz}$               | -22 dBm   | 30 kHz                         |
| $2.7 \text{ MHz} \leq \Delta f < 3.5 \text{ MHz}$             | $2.715 \text{ MHz} \leq f_{\text{offset}} < 3.515 \text{ MHz}$               | $-22 \text{ dBm} - 15 \cdot \left( \frac{f_{\text{offset}}}{\text{MHz}} - 2.715 \right) \text{ dB}$ | 30 kHz                         |
| (Note 1)  | $3.515 \text{ MHz} \leq f_{\text{offset}} < 4.0 \text{ MHz}$                 | -34 dBm   | 30 kHz                         |
| $3.5 \text{ MHz} \leq \Delta f < 7.5 \text{ MHz}$             | $4.0 \text{ MHz} \leq f_{\text{offset}} < 8.0 \text{ MHz}$                   | -21 dBm   | 1 MHz                          |
| $7.5 \text{ MHz} \leq \Delta f \leq \Delta f_{\text{max}}$    | $8.0 \text{ MHz} \leq f_{\text{offset}} < f_{\text{offset}_{\text{max}}}$    | -25 dBm   | 1 MHz                          |

For operation in band II, IV, V, X, XII, XIII and XIV, the applicable additional requirement in Tables 6.6A, 6.6B or 6.6C apply in addition to the minimum requirements in Tables 6.18 to 6.21.

**Table 6.6A: Additional spectrum emission limits for Bands II, IV, X**

| Frequency offset of measurement filter -3dB point, $\Delta f$ | Frequency offset of measurement filter centre frequency, $f_{\text{offset}}$ | Additional requirement | Measurement bandwidth (Note 2) |
|---|--|------------------------|--------------------------------|
| $2.5 \text{ MHz} \leq \Delta f < 3.5 \text{ MHz}$             | $2.515 \text{ MHz} \leq f_{\text{offset}} < 3.515 \text{ MHz}$               | -15 dBm                | 30 kHz                         |
| $3.5 \text{ MHz} \leq \Delta f \leq \Delta f_{\text{max}}$    | $4.0 \text{ MHz} \leq f_{\text{offset}} < f_{\text{offset}_{\text{max}}}$    | -13 dBm                | 1 MHz                          |

**Table 6.6B: Additional spectrum emission limits for Band V**

| Frequency offset of measurement filter -3dB point, $\Delta f$ | Frequency offset of measurement filter centre frequency, $f_{\text{offset}}$ | Additional requirement | Measurement bandwidth (Note 2) |
|---|--|------------------------|--------------------------------|
| $2.5 \text{ MHz} \leq \Delta f < 3.5 \text{ MHz}$             | $2.515 \text{ MHz} \leq f_{\text{offset}} < 3.515 \text{ MHz}$               | -15 dBm                | 30 kHz                         |
| $3.5 \text{ MHz} \leq \Delta f \leq \Delta f_{\text{max}}$    | $3.55 \text{ MHz} \leq f_{\text{offset}} < f_{\text{offset}_{\text{max}}}$   | -13 dBm                | 100 kHz                        |

**Table 6.6C: Additional spectrum emission limits for Bands XII, XIII, XIV**

| Frequency offset of measurement filter -3dB point, $\Delta f$ | Frequency offset of measurement filter centre frequency, $f_{\text{offset}}$ | Additional requirement | Measurement bandwidth (Note 2) |
|---|--|------------------------|--------------------------------|
| $2.5 \text{ MHz} \leq \Delta f < 3.5 \text{ MHz}$             | $2.515 \text{ MHz} \leq f_{\text{offset}} < 3.515 \text{ MHz}$               | -13 dBm                | 30 kHz                         |
| $3.5 \text{ MHz} \leq \Delta f \leq \Delta f_{\text{max}}$    | $3.55 \text{ MHz} \leq f_{\text{offset}} < f_{\text{offset}_{\text{max}}}$   | -13 dBm                | 100 kHz                        |

Notes for Tables 6.3, 6.4, 6.5 & 6.6

NOTE 1: This frequency range ensures that the range of values of  $f_{\text{offset}}$  is continuous.

NOTE 2 As a general rule, the resolution bandwidth of the measuring equipment should be equal to the measurement bandwidth. However, to improve measurement accuracy, sensitivity and efficiency, the resolution bandwidth can be smaller than the measurement bandwidth. When the resolution bandwidth is smaller than the measurement bandwidth, the result should be integrated over the measurement bandwidth in order to obtain the equivalent noise bandwidth of the measurement bandwidth.

### 6.6.2.2 Adjacent Channel Leakage power Ratio (ACLR)

Adjacent Channel Leakage power Ratio (ACLR) is the ratio of the RRC filtered mean power centered on the assigned channel frequency to the RRC filtered mean power centered on an adjacent channel frequency.

The requirements shall apply whatever the type of transmitter considered (single carrier or multi-carrier). It applies for all transmission modes foreseen by the manufacturer's specification.

### 6.6.2.2.1 Minimum requirement

The ACLR shall be higher than the value specified in Table 6.7.

**Table 6.7: BS ACLR**

| BS adjacent channel offset below the first or above the last carrier frequency used   | ACLR limit |
|---|------------|
| 5 MHz   | 45 dB      |
| 10 MHz  | 50 dB      |
| Note: In certain regions, the adjacent channel power (the RRC filtered mean power centered on an adjacent channel frequency) shall be less than or equal to -8.0 dBm/3.84 MHz (for Band I, Band IX and Band XI) or + 2.0dBm/3.84MHz (for Band VI) or as specified by the ACLR limit, whichever is the higher. |            |

## 6.6.3 Spurious emissions

Spurious emissions are emissions which are caused by unwanted transmitter effects such as harmonics emission, parasitic emission, intermodulation products and frequency conversion products, but exclude out of band emissions. This is measured at the base station RF output port.

The requirements shall apply whatever the type of transmitter considered (single carrier or multiple-carrier). It applies for all transmission modes foreseen by the manufacturer's specification.

The requirements (except 6.6.3.5 and 6.6.3.8) apply at frequencies within the specified frequency ranges, which are more than 12.5MHz below the first carrier frequency used or more than 12.5MHz above the last carrier frequency used.

Unless otherwise stated, all requirements are measured as mean power (RMS).

### 6.6.3.1 Mandatory Requirements

The requirements of either subclause 6.6.3.1.1 or subclause 6.6.3.1.2 shall apply.

#### 6.6.3.1.1 Spurious emissions (Category A)

The following requirements shall be met in cases where Category A limits for spurious emissions, as defined in ITU-R Recommendation SM.329 [1], are applied.

##### 6.6.3.1.1.1 Minimum Requirement

The power of any spurious emission shall not exceed:

**Table 6.8: BS Mandatory spurious emissions limits, Category A**

| Band   | Maximum level | Measurement Bandwidth | Note   |
|--|---------------|-----------------------|--------|
| 9kHz - 150kHz  | -13 dBm       | 1 kHz                 | Note 1 |
| 150kHz - 30MHz   |               | 10 kHz                | Note 1 |
| 30MHz - 1GHz   |               | 100 kHz               | Note 1 |
| 1GHz - 12.75 GHz   |               | 1 MHz                 | Note 2 |
| NOTE 1: Bandwidth as in ITU-R SM.329 [1], s4.1               |               |                       |        |
| NOTE 2: Upper frequency as in ITU-R SM.329 [1], s2.5 table 1 |               |                       |        |

##### 6.6.3.1.2 Spurious emissions (Category B)

The following requirements shall be met in cases where Category B limits for spurious emissions, as defined in ITU-R Recommendation SM.329 [1], are applied.

## 6.6.3.1.2.1 Minimum Requirement

The power of any spurious emission shall not exceed:

**Table 6.9: BS Mandatory spurious emissions limits, operating band I, II, III, IV, VII, X (Category B)**

| Band  | Maximum Level | Measurement Bandwidth | Note   |
|---|---------------|-----------------------|--------|
| 9 kHz ↔ 150 kHz   | -36 dBm       | 1 kHz                 | Note 1 |
| 150 kHz ↔ 30 MHz  | -36 dBm       | 10 kHz                | Note 1 |
| 30 MHz ↔ 1 GHz  | -36 dBm       | 100 kHz               | Note 1 |
| 1 GHz ↔ $F_{low} - 10$ MHz  | -30 dBm       | 1 MHz                 | Note 1 |
| $F_{low} - 10$ MHz ↔ $F_{high} + 10$ MHz  | -15 dBm       | 1 MHz                 | Note 2 |
| $F_{high} + 10$ MHz ↔ 12.75 GHz   | -30 dBm       | 1 MHz                 | Note 3 |
| NOTE 1: Bandwidth as in ITU-R Recommendation SM.329 [1], s4.1   |               |                       |        |
| NOTE 2: Limit based on ITU-R Recommendation SM.329 [1], s4.3 and Annex 7  |               |                       |        |
| NOTE 3: Bandwidth as in ITU-R Recommendation SM.329 [1], s4.1. Upper frequency as in ITU-R SM.329 [1], s2.5 table 1 |               |                       |        |
| Key:  |               |                       |        |
| $F_{low}$ : The lowest downlink frequency of the operating band as defined in Table 5.0.                            |               |                       |        |
| $F_{high}$ : The highest downlink frequency of the operating band as defined in Table 5.0.                          |               |                       |        |

**Table 6.9A: BS Mandatory spurious emissions limits, operating band V, VIII, XII, XIII, XIV (Category B)**

| Band  | Maximum Level | Measurement Bandwidth | Note   |
|---|---------------|-----------------------|--------|
| 9 kHz ↔ 150 kHz   | -36 dBm       | 1 kHz                 | Note 1 |
| 150 kHz ↔ 30 MHz  | -36 dBm       | 10 kHz                | Note 1 |
| 30 MHz ↔ $F_{low} - 10$ MHz   | -36 dBm       | 100 kHz               | Note 1 |
| $F_{low} - 10$ MHz ↔ $F_{high} + 10$ MHz  | -16 dBm       | 100 kHz               | Note 2 |
| $F_{high} + 10$ MHz ↔ 1 GHz   | -36 dBm       | 100 kHz               | Note 1 |
| 1GHz ↔ 12.75GHz   | -30 dBm       | 1 MHz                 | Note 3 |
| NOTE 1: Bandwidth as in ITU-R Recommendation SM.329 [1], s4.1   |               |                       |        |
| NOTE 2: Limit based on ITU-R Recommendation SM.329 [1], s4.3 and Annex 7  |               |                       |        |
| NOTE 3: Bandwidth as in ITU-R Recommendation SM.329 [1], s4.1. Upper frequency as in ITU-R SM.329 [1], s2.5 table 1 |               |                       |        |
| Key:  |               |                       |        |
| $F_{low}$ : The lowest downlink frequency of the operating band as defined in Table 5.0.                            |               |                       |        |
| $F_{high}$ : The highest downlink frequency of the operating band as defined in Table 5.0.                          |               |                       |        |

**Table 6.9B: (void)**

**Table 6.9C: (void)**

**Table 6.9D: (void)**

**Table 6.9E: (void)**

**Table 6.9F: (void)**

**Table 6.9G: (void)**

## 6.6.3.2 Protection of the BS receiver of own or different BS

This requirement shall be applied in order to prevent the receivers of the BSs being desensitised by emissions from a BS transmitter. This is measured at the transmit antenna port for any type of BS which has common or separate Tx/Rx antenna ports.



## 6.6.3.2.1 Minimum Requirement

The power of any spurious emission shall not exceed:

**Table 6.10: Wide Area BS Spurious emissions limits for protection of the BS receiver**

| Operating Band | Band                | Maximum Level | Measurement Bandwidth | Note |
|----------------|---------------------|---------------|-----------------------|------|
| I              | 1920 - 1980MHz      | -96 dBm       | 100 kHz               |      |
| II             | 1850-1910 MHz       | -96 dBm       | 100 kHz               |      |
| III            | 1710-1785 MHz       | -96 dBm       | 100 kHz               |      |
| IV             | 1710-1755 MHz       | -96 dBm       | 100 kHz               |      |
| V              | 824-849 MHz         | -96 dBm       | 100 kHz               |      |
| VI             | 815-850 MHz         | -96 dBm       | 100 kHz               |      |
| VII            | 2500-2570 MHz       | -96 dBm       | 100 kHz               |      |
| VIII           | 880-915 MHz         | -96 dBm       | 100 kHz               |      |
| IX             | 1749.9-1784.9 MHz   | -96 dBm       | 100 kHz               |      |
| X              | 1710-1770 MHz       | -96 dBm       | 100 kHz               |      |
| XI             | 1427.9 - 1452.9 MHz | -96 dBm       | 100 kHz               |      |
| XII            | 698 - 716 MHz       | -96 dBm       | 100 kHz               |      |
| XIII           | 777 - 787 MHz       | -96 dBm       | 100 kHz               |      |
| XIV            | 788 - 798 MHz       | -96 dBm       | 100 kHz               |      |

**Table 6.10A: Medium Range BS Spurious emissions limits for protection of the BS receiver**

| Operating Band | Band                | Maximum Level | Measurement Bandwidth | Note |
|----------------|---------------------|---------------|-----------------------|------|
| I              | 1920 - 1980MHz      | -86 dBm       | 100 kHz               |      |
| II             | 1850-1910 MHz       | -86 dBm       | 100 kHz               |      |
| III            | 1710-1785 MHz       | -86 dBm       | 100 kHz               |      |
| IV             | 1710-1755 MHz       | -86 dBm       | 100 kHz               |      |
| V              | 824-849 MHz         | -86 dBm       | 100 kHz               |      |
| VI             | 815-850 MHz         | -86 dBm       | 100 kHz               |      |
| VII            | 2500-2570 MHz       | -86 dBm       | 100 kHz               |      |
| VIII           | 880-915 MHz         | -86 dBm       | 100 kHz               |      |
| IX             | 1749.9-1784.9 MHz   | -86 dBm       | 100 kHz               |      |
| X              | 1710-1770 MHz       | -86 dBm       | 100 kHz               |      |
| XI             | 1427.9 - 1452.9 MHz | -86 dBm       | 100 kHz               |      |
| XII            | 698 - 716 MHz       | -86 dBm       | 100 kHz               |      |
| XIII           | 777 - 787 MHz       | -86 dBm       | 100 kHz               |      |
| XIV            | 788 - 798 MHz       | -86 dBm       | 100 kHz               |      |

**Table 6.10B: Local Area BS Spurious emissions limits for protection of the BS receiver**

| Operating Band | Band                | Maximum Level | Measurement Bandwidth | Note |
|----------------|---------------------|---------------|-----------------------|------|
| I              | 1920 - 1980MHz      | -82 dBm       | 100 kHz               |      |
| II             | 1850-1910 MHz       | -82 dBm       | 100 kHz               |      |
| III            | 1710-1785 MHz       | -82 dBm       | 100 kHz               |      |
| IV             | 1710-1755 MHz       | -82 dBm       | 100 kHz               |      |
| V              | 824-849 MHz         | -82 dBm       | 100 kHz               |      |
| VI             | 815-850 MHz         | -82 dBm       | 100 kHz               |      |
| VII            | 2500-2570 MHz       | -82 dBm       | 100 kHz               |      |
| VIII           | 880-915 MHz         | -82 dBm       | 100 kHz               |      |
| IX             | 1749.9-1784.9 MHz   | -82 dBm       | 100 kHz               |      |
| X              | 1710-1770 MHz       | -82 dBm       | 100 kHz               |      |
| XI             | 1427.9 - 1452.9 MHz | -82 dBm       | 100 kHz               |      |
| XII            | 698 - 716 MHz       | -82 dBm       | 100 kHz               |      |
| XIII           | 777 - 787 MHz       | -82 dBm       | 100 kHz               |      |
| XIV            | 788 - 798 MHz       | -82 dBm       | 100 kHz               |      |

### 6.6.3.3 Co-existence with other systems in the same geographical area

These requirements may be applied for the protection of UE, MS and/or BS operating in other frequency bands in the same geographical area. The requirements may apply in geographic areas in which both UTRA FDD operating in frequency bands I to XIV and a system operating in another frequency band than the FDD operating band are deployed. The system operating in the other frequency band may be GSM900, DCS1800, PCS1900, GSM850 and/or FDD operating in bands I to XIV.

## 6.6.3.3.1 Minimum Requirements

The power of any spurious emission shall not exceed the limits of Table 6.11 for a BS where requirements for co-existence with the system listed in the first column apply.

**Table 6.11: BS Spurious emissions limits for UTRA FDD BS in geographic coverage area of systems operating in other frequency bands**

| System type operating in the same geographical area | Band for co-existence requirement | Maximum Level | Measurement Bandwidth | Note   |
|---|-----------------------------------|---------------|-----------------------|--|
| GSM900  | 921 - 960 MHz                     | -57 dBm       | 100 kHz               | This requirement does not apply to UTRA FDD operating in band VIII   |
|   | 876 - 915 MHz                     | -61 dBm       | 100 kHz               | For the frequency range 880-915 MHz, this requirement does not apply to UTRA FDD operating in band VIII, since it is already covered by the requirement in sub-clause 6.6.3.2. |
| DCS1800   | 1805 - 1880 MHz                   | -47 dBm       | 100 kHz               | This requirement does not apply to UTRA FDD operating in band III  |
|   | 1710 - 1785 MHz                   | -61 dBm       | 100 kHz               | This requirement does not apply to UTRA FDD operating in band III, since it is already covered by the requirement in sub-clause 6.6.3.2.                                       |
| PCS1900   | 1930 - 1990 MHz                   | -47 dBm       | 100 kHz               | This requirement does not apply to UTRA FDD BS operating in frequency band II  |
|   | 1850 - 1910 MHz                   | -61 dBm       | 100 kHz               | This requirement does not apply to UTRA FDD BS operating in frequency band II, since it is already covered by the requirement in sub-clause 6.6.3.2.                           |
| GSM850 or CDMA850                                   | 869 - 894 MHz                     | -57 dBm       | 100 kHz               | This requirement does not apply to UTRA FDD BS operating in frequency band V   |
|   | 824 - 849 MHz                     | -61 dBm       | 100 kHz               | This requirement does not apply to UTRA FDD BS operating in frequency band V, since it is already covered by the requirement in sub-clause 6.6.3.2.                            |
| FDD Band I  | 2110 - 2170 MHz                   | -52 dBm       | 1 MHz                 | This requirement does not apply to UTRA FDD BS operating in band I,  |
|   | 1920 - 1980 MHz                   | -49 dBm       | 1 MHz                 | This requirement does not apply to UTRA FDD BS operating in band I, since it is already covered by the requirement in sub-clause 6.6.3.2.                                      |
| FDD Band II   | 1930 - 1990 MHz                   | -52 dBm       | 1 MHz                 | This requirement does not apply to UTRA FDD BS operating in band II  |
|   | 1850 - 1910 MHz                   | -49 dBm       | 1 MHz                 | This requirement does not apply to UTRA FDD BS operating in band II, since it is already covered by the requirement in sub-clause 6.6.3.2.                                     |
| FDD Band III  | 1805 - 1880 MHz                   | -52 dBm       | 1 MHz                 | This requirement does not apply to UTRA FDD BS operating in band III   |
|   | 1710 - 1785 MHz                   | -49 dBm       | 1 MHz                 | This requirement does not apply to UTRA FDD BS operating in band III, since it is already covered by the requirement in sub-clause 6.6.3.2.                                    |
| FDD Band IV   | 2110 - 2155 MHz                   | -52 dBm       | 1 MHz                 | This requirement does not apply to UTRA FDD BS operating in band IV  |
|   | 1710 - 1755 MHz                   | -49 dBm       | 1 MHz                 | This requirement does not apply to UTRA FDD BS operating in band IV, since it is already covered by the requirement in sub-clause 6.6.3.2.                                     |
| FDD Band V  | 869 - 894 MHz                     | -52 dBm       | 1 MHz                 | This requirement does not apply to UTRA FDD BS operating in band V   |
|   | 824 - 849 MHz                     | -49 dBm       | 1 MHz                 | This requirement does not apply to UTRA FDD BS operating in band V, since it is already covered by the requirement in sub-clause 6.6.3.2.                                      |
| FDD Band VI   | 860 - 895 MHz                     | -52 dBm       | 1 MHz                 | This requirement does not apply to UTRA FDD BS operating in band VI  |
|   | 815 - 850 MHz                     | -49 dBm       | 1 MHz                 | This requirement does not apply to UTRA FDD BS operating in band VI, since it is already covered by the requirement in sub-clause 6.6.3.2.                                     |
| FDD Band VII  | 2620 - 2690 MHz                   | -52 dBm       | 1 MHz                 | This requirement does not apply to UTRA FDD BS operating in band VII,  |

|               |                     |         |       |  |
|---------------|---------------------|---------|-------|--|
|               | 2500 - 2570 MHz     | -49 dBm | 1 MHz | This requirement does not apply to UTRA FDD BS operating in band VII, since it is already covered by the requirement in sub-clause 6.6.3.2.  |
| FDD Band VIII | 925 - 960 MHz       | -52 dBm | 1 MHz | This requirement does not apply to UTRA FDD BS operating in band VIII.   |
|               | 880 - 915 MHz       | -49 dBm | 1 MHz | This requirement does not apply to UTRA FDD BS operating in band VIII, since it is already covered by the requirement in sub-clause 6.6.3.2. |
| FDD Band IX   | 1844.9 - 1879.9 MHz | -52 dBm | 1 MHz | This requirement does not apply to UTRA FDD BS operating in band IX  |
|               | 1749.9 - 1784.9 MHz | -49 dBm | 1 MHz | This requirement does not apply to UTRA FDD BS operating in band IX, since it is already covered by the requirement in sub-clause 6.6.3.2.   |
| FDD Band X    | 2110 - 2170 MHz     | -52 dBm | 1 MHz | This requirement does not apply to UTRA FDD BS operating in band X   |
|               | 1710 - 1770 MHz     | -49 dBm | 1 MHz | This requirement does not apply to UTRA FDD BS operating in band X, since it is already covered by the requirement in sub-clause 6.6.3.2.    |
| FDD Band XI   | 1475.9 - 1500.9 MHz | -52 dBm | 1 MHz | This requirement does not apply to UTRA FDD BS operating in band XI  |
|               | 1427.9 - 1452.9 MHz | -49 dBm | 1 MHz | This requirement does not apply to UTRA FDD BS operating in band XI, since it is already covered by the requirement in sub-clause 6.6.3.2.   |
| FDD Band XII  | 728 - 746 MHz       | -52 dBm | 1 MHz | This requirement does not apply to UTRA FDD BS operating in band XII   |
|               | 698 - 716 MHz       | -49 dBm | 1 MHz | This requirement does not apply to UTRA FDD BS operating in band XII, since it is already covered by the requirement in sub-clause 6.6.3.2.  |
| FDD Band XIII | 746 - 756 MHz       | -52 dBm | 1 MHz | This requirement does not apply to UTRA FDD BS operating in band XIII  |
|               | 777 - 787 MHz       | -49 dBm | 1 MHz | This requirement does not apply to UTRA FDD BS operating in band XIII, since it is already covered by the requirement in sub-clause 6.6.3.2. |
| FDD Band XIV  | 758 - 768 MHz       | -52 dBm | 1 MHz | This requirement does not apply to UTRA FDD BS operating in band XIV   |
|               | 788 - 798 MHz       | -49 dBm | 1 MHz | This requirement does not apply to UTRA FDD BS operating in band XIV, since it is already covered by the requirement in sub-clause 6.6.3.2.  |

#### 6.6.3.4 Co-existence with co-located and co-sited base stations

These requirements may be applied for the protection of other BS receivers when GSM900, DCS1800, PCS1900, GSM850 and/or FDD BS operating in Bands I to XIV are co-located with a UTRA FDD BS.

The requirements in this chapter assume a 30 dB coupling loss between transmitter and receiver. If BSs of different classes are co-sited, the coupling loss should be increased by the value as stated in TR 25.942 [4] chapter 10.3 in Table 10.1 and Table 10.2.

## 6.6.3.4.1 Minimum Requirements

The power of any spurious emission shall not exceed the limits of Table 6.12 for a Wide Area (WA) BS where requirements for co-location with a BS type listed in the first column apply.

**Table 6.12: BS Spurious emissions limits for Wide Area BS co-located with another BS**

| Type of co-located BS   | Band for co-location requirement | Maximum Level | Measurement Bandwidth | Note |
|-------------------------|----------------------------------|---------------|-----------------------|------|
| Macro GSM900            | 876-915 MHz                      | -98 dBm       | 100 kHz               |      |
| Macro DCS1800           | 1710 - 1785 MHz                  | -98 dBm       | 100 kHz               |      |
| Macro PCS1900           | 1850 - 1910 MHz                  | -98 dBm       | 100 kHz               |      |
| Macro GSM850 or CDMA850 | 824 - 849 MHz                    | -98 dBm       | 100 kHz               |      |
| WA UTRA FDD Band I      | 1920 - 1980 MHz                  | -96 dBm       | 100 kHz               |      |
| WA UTRA FDD Band II     | 1850 - 1910 MHz                  | -96 dBm       | 100 kHz               |      |
| WA UTRA FDD Band III    | 1710 - 1785 MHz                  | -96 dBm       | 100 kHz               |      |
| WA UTRA FDD Band IV     | 1710 - 1755 MHz                  | -96 dBm       | 100 kHz               |      |
| WA UTRA FDD Band V      | 824 - 849 MHz                    | -96 dBm       | 100 kHz               |      |
| WA UTRA FDD Band VI     | 815 - 850 MHz                    | -96 dBm       | 100 kHz               |      |
| WA UTRA FDD Band VII    | 2500 - 2570 MHz                  | -96 dBm       | 100 KHz               |      |
| WA UTRA FDD Band VIII   | 880 - 915 MHz                    | -96 dBm       | 100 KHz               |      |
| WA UTRA FDD Band IX     | 1749.9 - 1784.9 MHz              | -96 dBm       | 100 KHz               |      |
| WA UTRA FDD Band X      | 1710 - 1770 MHz                  | -96 dBm       | 100 kHz               |      |
| WA UTRA FDD Band XI     | 1427.9 - 1452.9 MHz              | -96 dBm       | 100 kHz               |      |
| WA UTRA FDD Band XII    | 698 - 716 MHz                    | -96 dBm       | 100 KHz               |      |
| WA UTRA FDD Band XIII   | 777 - 787 MHz                    | -96 dBm       | 100 kHz               |      |
| WA UTRA FDD Band XIV    | 788 - 798 MHz                    | -96 dBm       | 100 kHz               |      |

The power of any spurious emission shall not exceed the limits of Table 6.13 for a Medium Range (MR) BS where requirements for co-location with a BS type listed in the first column apply.

**Table 6.13: BS Spurious emissions limits for Medium Range BS co-located with another BS**

| Type of co-located BS | Band for co-location requirement | Maximum Level | Measurement Bandwidth | Note |
|-----------------------|----------------------------------|---------------|-----------------------|------|
| Micro GSM900          | 876-915 MHz                      | -91 dBm       | 100 kHz               |      |
| Micro DCS1800         | 1710 - 1785 MHz                  | -96 dBm       | 100 kHz               |      |
| Micro PCS1900         | 1850 - 1910 MHz                  | -96 dBm       | 100 kHz               |      |
| Micro GSM850          | 824 - 849 MHz                    | -91 dBm       | 100 kHz               |      |
| MR UTRA FDD Band I    | 1920 - 1980 MHz                  | -86 dBm       | 100 kHz               |      |
| MR UTRA FDD Band II   | 1850 - 1910 MHz                  | -86 dBm       | 100 kHz               |      |
| MR UTRA FDD Band III  | 1710 - 1785 MHz                  | -86 dBm       | 100 kHz               |      |
| MR UTRA FDD Band IV   | 1710 - 1755 MHz                  | -86 dBm       | 100 kHz               |      |
| MR UTRA FDD Band V    | 824 - 849 MHz                    | -86 dBm       | 100 kHz               |      |
| MR UTRA FDD Band VI   | 815 - 850 MHz                    | -86 dBm       | 100 kHz               |      |
| MR UTRA FDD Band VII  | 2500 - 2570 MHz                  | -86 dBm       | 100 KHz               |      |
| MR UTRA FDD Band VIII | 880 - 915 MHz                    | -86 dBm       | 100 KHz               |      |
| MR UTRA FDD Band IX   | 1749.9 - 1784.9 MHz              | -86 dBm       | 100 KHz               |      |
| MR UTRA FDD Band X    | 1710 - 1770 MHz                  | -86 dBm       | 100 kHz               |      |
| MR UTRA FDD Band XI   | 1427.9 - 1452.9 MHz              | -86 dBm       | 100 kHz               |      |
| MR UTRA FDD Band XII  | 698 - 716 MHz                    | -86 dBm       | 100 KHz               |      |
| MR UTRA FDD Band XIII | 777 - 787 MHz                    | -86 dBm       | 100 kHz               |      |
| MR UTRA FDD Band XIV  | 788 - 798 MHz                    | -86 dBm       | 100 kHz               |      |

The power of any spurious emission shall not exceed the limits of Table 6.14 for a Local Area (LA) BS where requirements for co-location with a BS type listed in the first column apply.

**Table 6.14: BS Spurious emissions limits for Local Area BS co-located with another BS**

| Type of co-located BS | Band for co-location requirement | Maximum Level | Measurement Bandwidth | Note |
|-----------------------|----------------------------------|---------------|-----------------------|------|
| Pico GSM900           | 876-915 MHz                      | -70 dBm       | 100 kHz               |      |
| Pico DCS1800          | 1710 - 1785 MHz                  | -80 dBm       | 100 kHz               |      |
| Pico PCS1900          | 1850 - 1910 MHz                  | -80 dBm       | 100 kHz               |      |
| Pico GSM850           | 824 - 849 MHz                    | -70 dBm       | 100 kHz               |      |
| LA UTRA FDD Band I    | 1920 - 1980 MHz                  | -82 dBm       | 100 kHz               |      |
| LA UTRA FDD Band II   | 1850 - 1910 MHz                  | -82 dBm       | 100 kHz               |      |
| LA UTRA FDD Band III  | 1710 - 1785 MHz                  | -82 dBm       | 100 kHz               |      |
| LA UTRA FDD Band IV   | 1710 - 1755 MHz                  | -82 dBm       | 100 kHz               |      |
| LA UTRA FDD Band V    | 824 - 849 MHz                    | -82 dBm       | 100 kHz               |      |
| LA UTRA FDD Band VI   | 815 - 850 MHz                    | -82 dBm       | 100 kHz               |      |
| LA UTRA FDD Band VII  | 2500 - 2570 MHz                  | -82 dBm       | 100 KHz               |      |
| LA UTRA FDD Band VIII | 880 - 915 MHz                    | -82 dBm       | 100 KHz               |      |
| LA UTRA FDD Band IX   | 1749.9 - 1784.9 MHz              | -82 dBm       | 100 KHz               |      |
| LA UTRA FDD Band X    | 1710 - 1770 MHz                  | -82 dBm       | 100 kHz               |      |
| LA UTRA FDD Band XI   | 1427.9 - 1452.9 MHz              | -82 dBm       | 100 kHz               |      |
| LA UTRA FDD Band XII  | 698 - 716 MHz                    | -82 dBm       | 100 KHz               |      |
| LA UTRA FDD Band XIII | 777 - 787 MHz                    | -82 dBm       | 100 kHz               |      |
| LA UTRA FDD Band XIV  | 788 - 798 MHz                    | -82 dBm       | 100 kHz               |      |

### 6.6.3.5 Co-existence with PHS

This requirement may be applied for the protection of PHS in geographic areas in which both PHS and UTRA FDD are deployed. This requirement is also applicable at specified frequencies falling between 12.5MHz below the first carrier frequency used and 12.5MHz above the last carrier frequency used.

#### 6.6.3.5.1 Minimum Requirement

The power of any spurious emission shall not exceed:

**Table 6.15: BS Spurious emissions limits for BS in geographic coverage area of PHS**

| Band                | Maximum Level | Measurement Bandwidth | Note |
|---------------------|---------------|-----------------------|------|
| 1884.5 - 1919.6 MHz | -41 dBm       | 300 kHz               |      |

### 6.6.3.6 Co-existence with services in adjacent frequency bands

This requirement may be applied for the protection in bands adjacent to bands I, II, III or VII as defined in clause 5.2 in geographic areas in which both an adjacent band service and UTRA FDD are deployed.

### 6.6.3.6.1 Minimum requirement

The power of any spurious emission shall not exceed:

**Table 6.16: BS spurious emissions limits for protection of adjacent band services**

| Operating Band | Band          | Maximum Level  | Measurement Bandwidth | Note |
|----------------|---------------|--|-----------------------|------|
| I              | 2100-2105 MHz | $-30 + 3.4 \cdot (f - 2100 \text{ MHz}) \text{ dBm}$ | 1 MHz                 |      |
|                | 2175-2180 MHz | $-30 + 3.4 \cdot (2180 \text{ MHz} - f) \text{ dBm}$ | 1 MHz                 |      |
| II             | 1920-1925 MHz | $-30 + 3.4 \cdot (f - 1920 \text{ MHz}) \text{ dBm}$ | 1 MHz                 |      |
|                | 1995-2000 MHz | $-30 + 3.4 \cdot (2000 \text{ MHz} - f) \text{ dBm}$ | 1 MHz                 |      |
| III            | 1795-1800 MHz | $-30 + 3.4 \cdot (f - 1795 \text{ MHz}) \text{ dBm}$ | 1MHz                  |      |
|                | 1885-1890 MHz | $-30 + 3.4 \cdot (1890 \text{ MHz} - f) \text{ dBm}$ | 1MHz                  |      |
| VII            | 2610-2615 MHz | $-30 + 3.4 \cdot (f - 2610 \text{ MHz}) \text{ dBm}$ | 1 MHz                 |      |
|                | 2695-2700 MHz | $-30 + 3.4 \cdot (2700 \text{ MHz} - f) \text{ dBm}$ | 1 MHz                 |      |

NOTE: This requirement for the frequency range 2610-2615 MHz may be applied to geographic areas in which both UTRA-TDD and UTRA-FDD are deployed.

### 6.6.3.7 Co-existence with UTRA-TDD

#### 6.6.3.7.1 Operation in the same geographic area

This requirement may be applied to geographic areas in which both UTRA-TDD and UTRA-FDD are deployed.

##### 6.6.3.7.1.1 Minimum Requirement

The power of any spurious emission shall not exceed:

**Table 6.17: BS Spurious emissions limits for BS in geographic coverage area of UTRA-TDD**

| Band            | Maximum Level | Measurement Bandwidth | Note |
|-----------------|---------------|-----------------------|------|
| 1900 - 1920 MHz | -52 dBm       | 1 MHz                 |      |
| 2010 - 2025 MHz | -52 dBm       | 1 MHz                 |      |
| 2570 - 2610 MHz | -52 dBm       | 1 MHz                 |      |

#### 6.6.3.7.2 Co-located base stations

This requirement may be applied for the protection of UTRA-TDD BS receivers when UTRA-TDD BS and UTRA FDD BS are co-located.

##### 6.6.3.7.2.1 Minimum Requirement

The power of any spurious emission shall not exceed:

**Table 6.18: BS Spurious emissions limits for BS co-located with UTRA-TDD**

| BS class      | Band            | Maximum Level | Measurement Bandwidth | Note |
|---------------|-----------------|---------------|-----------------------|------|
| Wide Area BS  | 1900 - 1920 MHz | -86 dBm       | 1 MHz                 |      |
| Local Area BS | 1900 - 1920 MHz | -55 dBm       | 1 MHz                 |      |
| Wide Area BS  | 2010 - 2025 MHz | -86 dBm       | 1 MHz                 |      |
| Local Area BS | 2010 - 2025 MHz | -55 dBm       | 1 MHz                 |      |
| Wide Area BS  | 2570 - 2610 MHz | -86 dBm       | 1 MHz                 |      |
| Local Area BS | 2570 - 2610 MHz | -55 dBm       | 1 MHz                 |      |

These values assume a 30 dB coupling loss between transmitter and receiver. If BSs of different classes are co-sited, the coupling loss must be increased by the difference between the corresponding values from the table above.

### 6.6.3.8 Co-existence with public safety systems

This requirement may be applied for the protection of public safety systems in geographic areas in which both UTRA-FDD and public safety systems are deployed.

#### 6.6.3.8.1 Minimum Requirement

The power of any spurious emission shall not exceed:

**Table 6.19: BS spurious emissions limits**

| Operating Band | Band          | Maximum Level | Measurement Bandwidth | Note |
|----------------|---------------|---------------|-----------------------|------|
| XIII           | 763 - 775 MHz | -46 dBm       | 6.25 kHz              |      |
| XIII           | 793 - 805 MHz | -46 dBm       | 6.25 kHz              |      |
| XIV            | 769 - 775 MHz | -46 dBm       | 6.25 kHz              |      |
| XIV            | 799 - 805 MHz | -46 dBm       | 6.25 kHz              |      |



## 6.7 Transmit intermodulation

The transmit intermodulation performance is a measure of the capability of the transmitter to inhibit the generation of signals in its non linear elements caused by presence of the wanted signal and an interfering signal reaching the transmitter via the antenna.

The transmit intermodulation level is the power of the intermodulation products when a WCDMA modulated interference signal is injected into the antenna connector at a mean power level of 30 dB lower than that of the mean power of the wanted signal. The frequency of the interference signal shall be +5 MHz, -5 MHz, +10 MHz, -10 MHz, +15 MHz and -15 MHz offset from the subject signal carrier frequency, but exclude interference frequencies that are outside of the allocated frequency band for UTRA-FDD downlink specified in subclause 5.2.

### 6.7.1 Minimum requirement

The transmit intermodulation level shall not exceed the out of band emission or the spurious emission requirements of clauses 6.6.2 and 6.6.3 in the presence of a WCDMA modulated interference signal with a mean power level 30 dB lower than the mean power of the wanted signal.

## 6.8 Transmit modulation

Transmit modulation is specified in three parts, Frequency Error, Error Vector Magnitude and Peak Code Domain Error. These specifications are made with reference to a theoretical modulated waveform.

The theoretical modulated waveform is created by modulating a carrier at the assigned carrier frequency using the same data as was used to generate the measured waveform. The chip modulation rate for the theoretical waveform shall be exactly 3.84 Mcps. The code powers of the theoretical waveform shall be the same as the measured waveform, rather than the nominal code powers used to generate the test signal.

### 6.8.1 Transmit pulse shape filter

The transmit pulse-shaping filter is a root-raised cosine (RRC) with roll-off  $\alpha = 0.22$  in the frequency domain. The impulse response of the chip impulse filter  $RC_0(t)$  is

$$RC_0(t) = \frac{\sin\left(\pi \frac{t}{T_c}(1-\alpha)\right) + 4\alpha \frac{t}{T_c} \cos\left(\pi \frac{t}{T_c}(1+\alpha)\right)}{\pi \frac{t}{T_c} \left(1 - \left(4\alpha \frac{t}{T_c}\right)^2\right)}$$

Where the roll-off factor  $\alpha = 0.22$  and the chip duration:

$$T_c = \frac{1}{\text{chiprate}} \approx 0.26042 \mu\text{s}$$

### 6.8.2 Error Vector Magnitude

The Error Vector Magnitude is a measure of the difference between the reference waveform and the measured waveform. This difference is called the error vector. Both waveforms pass through a matched Root Raised Cosine filter with bandwidth 3.84 MHz and roll-off  $\alpha = 0.22$ . Both waveforms are then further modified by selecting the frequency, absolute phase, absolute amplitude and chip clock timing so as to minimise the error vector. The EVM result is defined as the square root of the ratio of the mean error vector power to the mean reference power expressed as a %. The measurement interval is one timeslot as defined by the C-PICH (when present) otherwise the measurement interval is one timeslot starting with the beginning of the SCH. The requirement is valid over the total power dynamic range as specified in subclause 6.4.3.

### 6.8.2.1 Minimum requirement

The Error Vector Magnitude shall not be worse than 17.5 % when the base station is transmitting a composite signal using only QPSK modulation.

The Error Vector Magnitude shall not be worse than 12.5 % when the base station is transmitting a composite signal that includes 16QAM modulation.

### 6.8.3 Peak code Domain error

The Peak Code Domain Error is computed by projecting the error vector (as defined in 6.8.2) onto the code domain at a specified spreading factor. The Code Domain Error for every code in the domain is defined as the ratio of the mean power of the projection onto that code, to the mean power of the composite reference waveform. This ratio is expressed in dB. The Peak Code Domain Error is defined as the maximum value for the Code Domain Error for all codes. The measurement interval is one timeslot as defined by the C-PICH (when present) otherwise the measurement interval is one timeslot starting with the beginning of the SCH.

#### 6.8.3.1 Minimum requirement

The peak code domain error shall not exceed -33 dB at spreading factor 256.

### 6.8.4 Time alignment error in Tx Diversity and MIMO transmission

In Tx Diversity and MIMO transmission, signals are transmitted from two antennas. These signals shall be aligned. The time alignment error in Tx Diversity and MIMO transmission is specified as the delay between the signals from the two diversity antennas at the antenna ports.

#### 6.8.4.1 Minimum Requirement

The time alignment error in Tx Diversity or MIMO transmission shall not exceed  $\frac{1}{4} T_c$ .

### 6.8.5 Relative Code Domain Error for 64QAM modulation

The Relative Code Domain Error is computed by projecting the error vector (as defined in 6.8.2) onto the code domain at a specified spreading factor. Only the active code channels in the composite reference waveform are considered for this requirement. The Relative Code Domain Error for every active code is defined as the ratio of the mean power of the error projection onto that code, to the mean power of the active code in the composite reference waveform. This ratio is expressed in dB. The measurement interval is one frame.

The requirement for Relative Code Domain Error is only applicable for 64QAM modulated codes.

#### 6.8.5.1 Minimum requirement

The average Relative Code Domain Error for 64QAM modulated codes shall not exceed -21 dB at spreading factor 16.

---

## 7 Receiver characteristics

### 7.1 General

The requirements in Section 7 assume that the receiver is not equipped with diversity. For receivers with diversity, the requirements apply to each antenna connector separately, with the other one(s) terminated or disabled. The requirements are otherwise unchanged.

Unless otherwise stated, the receiver characteristics are specified at the BS antenna connector (test port A) with a full complement of transceivers for the configuration in normal operating conditions. If any external apparatus such as a RX amplifier, a filter or the combination of such devices is used, requirements apply at the far end antenna connector (port B).

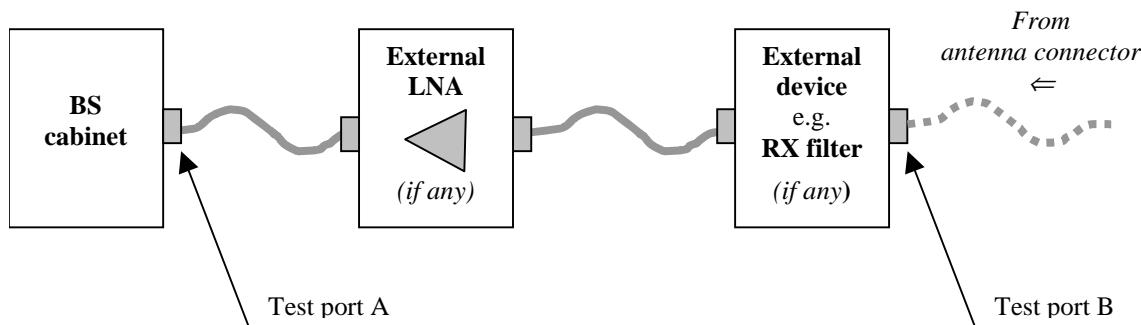

Figure 7.1: Receiver test ports

## 7.2 Reference sensitivity level

The reference sensitivity level is the minimum mean power received at the antenna connector at which the Bit Error Ratio (BER) shall not exceed the specific value indicated in section 7.2.1.

### 7.2.1 Minimum requirement

Using the reference measurement channel specification in Annex A, the reference sensitivity level and performance of the BS shall be as specified in Table 7.1.

Table 7.1: BS reference sensitivity levels

| BS Class        | Reference measurement channel data rate | BS reference sensitivity level (dBm) | BER                        |
|-----------------|---|--------------------------------------|----------------------------|
| Wide Area BS    | 12.2 kbps                               | -121                                 | BER shall not exceed 0.001 |
| Medium Range BS | 12.2 kbps                               | -111                                 | BER shall not exceed 0.001 |
| Local Area BS   | 12.2 kbps                               | -107                                 | BER shall not exceed 0.001 |

### 7.2.2 Maximum Frequency Deviation for Receiver Performance

The need for such a requirement is for further study.

## 7.3 Dynamic range

Receiver dynamic range is the receiver ability to handle a rise of interference in the reception frequency channel. The receiver shall fulfil a specified BER requirement for a specified sensitivity degradation of the wanted signal in the presence of an interfering AWGN signal in the same reception frequency channel.

### 7.3.1 Minimum requirement

The BER shall not exceed 0.001 for the parameters specified in Table 7.2.

Table 7.2: Dynamic range

| Parameter                               | Level Wide Area BS | Level Medium Range BS | Level Local Area BS | Unit         |
|---|--------------------|-----------------------|---------------------|--------------|
| Reference measurement channel data rate | 12.2               | 12.2                  | 12.2                | kbps         |
| Wanted signal mean power                | -91                | -81                   | -77                 | dBm          |
| Interfering AWGN signal                 | -73                | -63                   | -59                 | dBm/3.84 MHz |

## 7.4 Adjacent Channel Selectivity (ACS)

Adjacent channel selectivity (ACS) is a measure of the receiver ability to receive a wanted signal at its assigned channel frequency in the presence of an adjacent channel signal at a given frequency offset from the center frequency of the assigned channel. ACS is the ratio of the receiver filter attenuation on the assigned channel frequency to the receiver filter attenuation on the adjacent channel(s).

The interference signal is offset from the wanted signal by the frequency offset  $F_{uw}$ . The interference signal shall be a W-CDMA signal as specified in Annex C.

### 7.4.1 Minimum requirement

The BER shall not exceed 0.001 for the parameters specified in Table 7.3.

**Table 7.3: Adjacent channel selectivity**

| Parameter                     | Level<br>Wide Area<br>BS | Level<br>Medium<br>Range BS | Level<br>Local Area<br>BS | Unit |
|-------------------------------|--------------------------|-----------------------------|---------------------------|------|
| Data rate                     | 12.2                     | 12.2                        | 12.2                      | kbps |
| Wanted signal mean power      | -115                     | -105                        | -101                      | dBm  |
| Interfering signal mean power | -52                      | -42                         | -38                       | dBm  |
| $F_{uw}$ offset (Modulated)   | 5                        | 5                           | 5                         | MHz  |

### 7.4.2 Minimum requirement - Co-location with UTRA-TDD

The current state-of-the-art technology does not allow a single generic solution for co-location with UTRA-TDD on adjacent frequencies for 30dB BS-BS minimum coupling loss.

Further information and analysis for this scenario can be found in TR 25.942 [4].

## 7.5 Blocking characteristics

The blocking characteristics is a measure of the receiver ability to receive a wanted signal at its assigned channel frequency in the presence of an unwanted interferer on frequencies other than those of the adjacent channels. The blocking performance requirement applies as specified in the tables 7.4 to 7.5B below, using a 1 MHz step size.

## 7.5.1 Minimum requirement

The static reference performance as specified in clause 7.2.1 shall be met with a wanted and an interfering signal coupled to BS antenna input using the following parameters.

**Table 7.4: Blocking performance requirement for Wide Area BS**

| Operating Band | Center Frequency of Interfering Signal       | Interfering Signal mean power | Wanted Signal mean power | Minimum Offset of Interfering Signal | Type of Interfering Signal |
|----------------|--|-------------------------------|--------------------------|--------------------------------------|----------------------------|
| I              | 1920 - 1980 MHz                              | -40 dBm                       | -115 dBm                 | 10 MHz                               | WCDMA signal *             |
|                | 1900 - 1920 MHz<br>1980 - 2000 MHz           | -40 dBm                       | -115 dBm                 | 10 MHz                               | WCDMA signal *             |
|                | 1 MHz - 1900 MHz<br>2000 MHz - 12750 MHz     | -15 dBm                       | -115 dBm                 | —                                    | CW carrier                 |
| II             | 1850 - 1910 MHz                              | -40 dBm                       | -115 dBm                 | 10 MHz                               | WCDMA signal *             |
|                | 1830 - 1850 MHz<br>1910 - 1930 MHz           | -40 dBm                       | -115 dBm                 | 10 MHz                               | WCDMA signal *             |
|                | 1 MHz - 1830 MHz<br>1930 MHz - 12750 MHz     | -15 dBm                       | -115 dBm                 | —                                    | CW carrier                 |
| III            | 1710 - 1785 MHz                              | -40 dBm                       | -115 dBm                 | 10 MHz                               | WCDMA signal *             |
|                | 1690 - 1710 MHz<br>1785 - 1805 MHz           | -40 dBm                       | -115 dBm                 | 10 MHz                               | WCDMA signal *             |
|                | 1 MHz - 1690 MHz<br>1805 MHz - 12750 MHz     | -15 dBm                       | -115 dBm                 | —                                    | CW carrier                 |
| IV             | 1710 - 1755 MHz                              | -40 dBm                       | -115 dBm                 | 10 MHz                               | WCDMA signal *             |
|                | 1690 - 1710 MHz<br>1755 - 1775 MHz           | -40 dBm                       | -115 dBm                 | 10 MHz                               | WCDMA signal *             |
|                | 1 MHz - 1690 MHz<br>1775 MHz - 12750 MHz     | -15 dBm                       | -115 dBm                 | —                                    | CW carrier                 |
| V              | 824-849 MHz                                  | -40 dBm                       | -115 dBm                 | 10 MHz                               | WCDMA signal *             |
|                | 804-824 MHz<br>849-869 MHz                   | -40 dBm                       | -115 dBm                 | 10 MHz                               | WCDMA signal *             |
|                | 1 MHz - 804 MHz<br>869 MHz - 12750 MHz       | -15 dBm                       | -115 dBm                 | —                                    | CW carrier                 |
| VI             | 810 - 830 MHz<br>840 - 860 MHz               | -40 dBm                       | -115 dBm                 | 10 MHz                               | WCDMA signal *             |
|                | 1 MHz - 810 MHz<br>860 MHz - 12750 MHz       | -15 dBm                       | -115 dBm                 | —                                    | CW carrier                 |
| VII            | 2500 - 2570 MHz                              | -40 dBm                       | -115 dBm                 | 10 MHz                               | WCDMA signal *             |
|                | 2480 - 2500 MHz<br>2570 - 2590 MHz           | -40 dBm                       | -115 dBm                 | 10 MHz                               | WCDMA signal *             |
|                | 1 MHz - 2480 MHz<br>2590 MHz - 12750 MHz     | -15 dBm                       | -115 dBm                 | —                                    | CW carrier                 |
| VIII           | 880 - 915 MHz                                | -40 dBm                       | -115 dBm                 | 10 MHz                               | WCDMA signal *             |
|                | 860 - 880 MHz<br>915 - 925 MHz               | -40 dBm                       | -115 dBm                 | 10 MHz                               | WCDMA signal *             |
|                | 1 MHz - 860 MHz<br>925 MHz - 12750 MHz       | -15 dBm                       | -115 dBm                 | —                                    | CW carrier                 |
| IX             | 1749.9 - 1784.9 MHz                          | -40 dBm                       | -115 dBm                 | 10 MHz                               | WCDMA signal *             |
|                | 1729.9 - 1749.9 MHz<br>1784.9 - 1804.9 MHz   | -40 dBm                       | -115 dBm                 | 10 MHz                               | WCDMA signal *             |
|                | 1 MHz - 1729.9 MHz<br>1804.9 MHz - 12750 MHz | -15 dBm                       | -115 dBm                 | —                                    | CW carrier                 |
| X              | 1710 - 1770 MHz                              | -40 dBm                       | -115 dBm                 | 10 MHz                               | WCDMA signal *             |
|                | 1690 - 1710 MHz<br>1770 - 1790 MHz           | -40 dBm                       | -115 dBm                 | 10 MHz                               | WCDMA signal *             |
|                | 1 MHz - 1690 MHz<br>1790 MHz - 12750 MHz     | -15 dBm                       | -115 dBm                 | —                                    | CW carrier                 |
| XI             | 1427.9 - 1452.9 MHz                          | -40 dBm                       | -115 dBm                 | 10 MHz                               | WCDMA signal *             |
|                | 1407.9 - 1427.9 MHz<br>1452.9 - 1472.9 MHz   | -40 dBm                       | -115 dBm                 | 10 MHz                               | WCDMA signal *             |

|  |  |         |          |        |                |
|--|--|---------|----------|--------|----------------|
|  | 1 MHz - 1407.9 MHz<br>1472.9 MHz - 12750 MHz | -15 dBm | -115 dBm | —      | CW carrier     |
| XII  | 698 - 716 MHz                                | -40 dBm | -115 dBm | 10 MHz | WCDMA signal * |
|  | 678 - 698 MHz<br>716 - 728 MHz               | -40 dBm | -115 dBm | 10 MHz | WCDMA signal * |
|  | 1 MHz - 678 MHz<br>728 MHz - 12750 MHz       | -15 dBm | -115 dBm | —      | CW carrier     |
| XIII   | 777 - 787 MHz                                | -40 dBm | -115 dBm | 10 MHz | WCDMA signal * |
|  | 757 - 777 MHz<br>787 - 807 MHz               | -40 dBm | -115 dBm | 10 MHz | WCDMA signal * |
|  | 1 - 757 MHz<br>807 MHz - 12750 MHz           | -15 dBm | -115 dBm | —      | CW carrier     |
| XIV  | 788 - 798 MHz                                | -40 dBm | -115 dBm | 10 MHz | WCDMA signal * |
|  | 768 - 788 MHz<br>798 - 818 MHz               | -40 dBm | -115 dBm | 10 MHz | WCDMA signal * |
|  | 1 - 768 MHz<br>818 MHz - 12750 MHz           | -15 dBm | -115 dBm | —      | CW carrier     |
| NOTE *: The characteristics of the W-CDMA interference signal are specified in Annex C |  |         |          |        |                |

Table 7.4A: Blocking performance requirement for Medium range BS

| Operating Band | Center Frequency of Interfering Signal       | Interfering Signal mean power | Wanted Signal mean power | Minimum Offset of Interfering Signal | Type of Interfering Signal |
|----------------|--|-------------------------------|--------------------------|--------------------------------------|----------------------------|
| I              | 1920 - 1980 MHz                              | -35 dBm                       | -105 dBm                 | 10 MHz                               | WCDMA signal *             |
|                | 1900 - 1920 MHz<br>1980 - 2000 MHz           | -35 dBm                       | -105 dBm                 | 10 MHz                               | WCDMA signal *             |
|                | 1 MHz - 1900 MHz<br>2000 MHz - 12750 MHz     | -15 dBm                       | -105 dBm                 | —                                    | CW carrier                 |
| II             | 1850 - 1910 MHz                              | -35 dBm                       | -105 dBm                 | 10 MHz                               | WCDMA signal *             |
|                | 1830 - 1850 MHz<br>1910 - 1930 MHz           | -35 dBm                       | -105 dBm                 | 10 MHz                               | WCDMA signal *             |
|                | 1 MHz - 1830 MHz<br>1930 MHz - 12750 MHz     | -15 dBm                       | -105 dBm                 | —                                    | CW carrier                 |
| III            | 1710 - 1785 MHz                              | -35 dBm                       | -105 dBm                 | 10 MHz                               | WCDMA signal *             |
|                | 1690 - 1710 MHz<br>1785 - 1805 MHz           | -35 dBm                       | -105 dBm                 | 10 MHz                               | WCDMA signal *             |
|                | 1 MHz - 1690 MHz<br>1805 MHz - 12750 MHz     | -15 dBm                       | -105 dBm                 | —                                    | CW carrier                 |
| IV             | 1710 - 1755 MHz                              | -35 dBm                       | -105 dBm                 | 10 MHz                               | WCDMA signal *             |
|                | 1690 - 1710 MHz<br>1755 - 1775 MHz           | -35 dBm                       | -105 dBm                 | 10 MHz                               | WCDMA signal *             |
|                | 1 MHz - 1690 MHz<br>1775 MHz - 12750 MHz     | -15 dBm                       | -105 dBm                 | —                                    | CW carrier                 |
| V              | 824-849 MHz                                  | -35 dBm                       | -105 dBm                 | 10 MHz                               | WCDMA signal *             |
|                | 804-824 MHz<br>849-869 MHz                   | -35 dBm                       | -105 dBm                 | 10 MHz                               | WCDMA signal *             |
|                | 1 MHz - 804 MHz<br>869 MHz - 12750 MHz       | -15 dBm                       | -105 dBm                 | —                                    | CW carrier                 |
| VI             | 810 - 830 MHz<br>840 - 860 MHz               | -35 dBm                       | -105 dBm                 | 10 MHz                               | WCDMA signal *             |
|                | 1 MHz - 810 MHz<br>860 MHz - 12750 MHz       | -15 dBm                       | -105 dBm                 | —                                    | CW carrier                 |
| VII            | 2500 - 2570 MHz                              | -35 dBm                       | -105 dBm                 | 10 MHz                               | WCDMA signal *             |
|                | 2480 - 2500 MHz<br>2570 - 2590 MHz           | -35 dBm                       | -105 dBm                 | 10 MHz                               | WCDMA signal *             |
|                | 1 MHz - 2480 MHz<br>2590 MHz - 12750 MHz     | -15 dBm                       | -105 dBm                 | —                                    | CW carrier                 |
| VIII           | 880 - 915 MHz                                | -35 dBm                       | -105 dBm                 | 10 MHz                               | WCDMA signal *             |
|                | 860 - 880 MHz<br>915 - 925 MHz               | -35 dBm                       | -105 dBm                 | 10 MHz                               | WCDMA signal *             |
|                | 1 MHz - 860 MHz<br>925 MHz - 12750 MHz       | -15 dBm                       | -105 dBm                 | —                                    | CW carrier                 |
| IX             | 1749.9 - 1784.9 MHz                          | -35 dBm                       | -105 dBm                 | 10 MHz                               | WCDMA signal *             |
|                | 1729.9 - 1749.9 MHz<br>1784.9 - 1804.9 MHz   | -35 dBm                       | -105 dBm                 | 10 MHz                               | WCDMA signal *             |
|                | 1 MHz - 1729.9 MHz<br>1804.9 MHz - 12750 MHz | -15 dBm                       | -105 dBm                 | —                                    | CW carrier                 |
| X              | 1710 - 1770 MHz                              | -35 dBm                       | -105 dBm                 | 10 MHz                               | WCDMA signal *             |
|                | 1690 - 1710 MHz<br>1770 - 1790 MHz           | -35 dBm                       | -105 dBm                 | 10 MHz                               | WCDMA signal *             |
|                | 1 MHz - 1690 MHz<br>1790 MHz - 12750 MHz     | -15 dBm                       | -105 dBm                 | —                                    | CW carrier                 |
| XI             | 1427.9 - 1452.9 MHz                          | -35 dBm                       | -105 dBm                 | 10 MHz                               | WCDMA signal *             |
|                | 1407.9 - 1427.9 MHz<br>1452.9 - 1472.9 MHz   | -35 dBm                       | -105 dBm                 | 10 MHz                               | WCDMA signal *             |
|                | 1 MHz - 1407.9 MHz<br>1472.9 MHz - 12750 MHz | -15 dBm                       | -105 dBm                 | —                                    | CW carrier                 |
| XII            | 698 - 716 MHz                                | -40 dBm                       | -115 dBm                 | 10 MHz                               | WCDMA signal *             |
|                | 678 - 698 MHz<br>716 - 728 MHz               | -40 dBm                       | -115 dBm                 | 10 MHz                               | WCDMA signal *             |
|                | 1 MHz - 678 MHz<br>728 MHz - 12750 MHz       | -15 dBm                       | -115 dBm                 | —                                    | CW carrier                 |

|  |                                    |         |          |        |                |
|--|------------------------------------|---------|----------|--------|----------------|
| XIII   | 777 - 787 MHz                      | -40 dBm | -115 dBm | 10 MHz | WCDMA signal * |
|  | 757 - 777 MHz<br>787 - 807 MHz     | -40 dBm | -115 dBm | 10 MHz | WCDMA signal * |
|  | 1 - 757 MHz<br>807 MHz - 12750 MHz | -15 dBm | -115 dBm | —      | CW carrier     |
| XIV  | 788 - 798 MHz                      | -40 dBm | -115 dBm | 10 MHz | WCDMA signal * |
|  | 768 - 788 MHz<br>798 - 818 MHz     | -40 dBm | -115 dBm | 10 MHz | WCDMA signal * |
|  | 1 - 768 MHz<br>818 MHz - 12750 MHz | -15 dBm | -115 dBm | —      | CW carrier     |
| NOTE *: The characteristics of the W-CDMA interference signal are specified in Annex C |                                    |         |          |        |                |



Table 7.4B: Blocking performance requirement for Local Area BS

| Operating Band | Center Frequency of Interfering Signal       | Interfering Signal mean power | Wanted Signal mean power | Minimum Offset of Interfering Signal | Type of Interfering Signal |
|----------------|--|-------------------------------|--------------------------|--------------------------------------|----------------------------|
| I              | 1920 - 1980 MHz                              | -30 dBm                       | -101 dBm                 | 10 MHz                               | WCDMA signal *             |
|                | 1900 - 1920 MHz<br>1980 - 2000 MHz           | -30 dBm                       | -101 dBm                 | 10 MHz                               | WCDMA signal *             |
|                | 1 MHz - 1900 MHz<br>2000 MHz - 12750 MHz     | -15 dBm                       | -101 dBm                 | —                                    | CW carrier                 |
| II             | 1850 - 1910 MHz                              | -30 dBm                       | -101 dBm                 | 10 MHz                               | WCDMA signal *             |
|                | 1830 - 1850 MHz<br>1910 - 1930 MHz           | -30 dBm                       | -101 dBm                 | 10 MHz                               | WCDMA signal *             |
|                | 1 MHz - 1830 MHz<br>1930 MHz - 12750 MHz     | -15 dBm                       | -101 dBm                 | —                                    | CW carrier                 |
| III            | 1710 - 1785 MHz                              | -30 dBm                       | -101 dBm                 | 10 MHz                               | WCDMA signal *             |
|                | 1690 - 1710 MHz<br>1785 - 1805 MHz           | -30 dBm                       | -101 dBm                 | 10 MHz                               | WCDMA signal *             |
|                | 1 MHz - 1690 MHz<br>1805 MHz - 12750 MHz     | -15 dBm                       | -101 dBm                 | —                                    | CW carrier                 |
| IV             | 1710 - 1755 MHz                              | -30 dBm                       | -101 dBm                 | 10 MHz                               | WCDMA signal *             |
|                | 1690 - 1710 MHz<br>1755 - 1775 MHz           | -30 dBm                       | -101 dBm                 | 10 MHz                               | WCDMA signal *             |
|                | 1 MHz - 1690 MHz<br>1775 MHz - 12750 MHz     | -15 dBm                       | -101 dBm                 | —                                    | CW carrier                 |
| V              | 824-849 MHz                                  | -30 dBm                       | -101 dBm                 | 10 MHz                               | WCDMA signal *             |
|                | 804-824 MHz<br>849-869 MHz                   | -30 dBm                       | -101 dBm                 | 10 MHz                               | WCDMA signal *             |
|                | 1 MHz - 804 MHz<br>869 MHz - 12750 MHz       | -15 dBm                       | -101 dBm                 | —                                    | CW carrier                 |
| VI             | 810 - 830 MHz<br>840 - 860 MHz               | -30 dBm                       | -101 dBm                 | 10 MHz                               | WCDMA signal *             |
|                | 1 MHz - 810 MHz<br>860 MHz - 12750 MHz       | -15 dBm                       | -101 dBm                 | —                                    | CW carrier                 |
| VII            | 2500 - 2570 MHz                              | -30 dBm                       | -101 dBm                 | 10 MHz                               | WCDMA signal *             |
|                | 2480 - 2500 MHz<br>2570 - 2590 MHz           | -30 dBm                       | -101 dBm                 | 10 MHz                               | WCDMA signal *             |
|                | 1 MHz - 2480 MHz<br>2590 MHz - 12750 MHz     | -15 dBm                       | -101 dBm                 | —                                    | CW carrier                 |
| VIII           | 880 - 915 MHz                                | -30 dBm                       | -101 dBm                 | 10 MHz                               | WCDMA signal *             |
|                | 860 - 880 MHz<br>915 - 925 MHz               | -30 dBm                       | -101 dBm                 | 10 MHz                               | WCDMA signal *             |
|                | 1 MHz - 860 MHz<br>925 MHz - 12750 MHz       | -15 dBm                       | -101 dBm                 | —                                    | CW carrier                 |
| IX             | 1749.9 - 1784.9 MHz                          | -30 dBm                       | -101 dBm                 | 10 MHz                               | WCDMA signal *             |
|                | 1729.9 - 1749.9 MHz<br>1784.9 - 1804.9 MHz   | -30 dBm                       | -101 dBm                 | 10 MHz                               | WCDMA signal *             |
|                | 1 MHz - 1729.9 MHz<br>1804.9 MHz - 12750 MHz | -15 dBm                       | -101 dBm                 | —                                    | CW carrier                 |
| X              | 1710 - 1770 MHz                              | -30 dBm                       | -101 dBm                 | 10 MHz                               | WCDMA signal *             |
|                | 1690 - 1710 MHz<br>1770 - 1790 MHz           | -30 dBm                       | -101 dBm                 | 10 MHz                               | WCDMA signal *             |
|                | 1 MHz - 1690 MHz<br>1790 MHz - 12750 MHz     | -15 dBm                       | -101 dBm                 | —                                    | CW carrier                 |
| XI             | 1427.9 - 1452.9 MHz                          | -30 dBm                       | -101 dBm                 | 10 MHz                               | WCDMA signal *             |
|                | 1407.9 - 1427.9 MHz<br>1452.9 - 1472.9 MHz   | -30 dBm                       | -101 dBm                 | 10 MHz                               | WCDMA signal *             |
|                | 1 MHz - 1407.9 MHz<br>1472.9 MHz - 12750 MHz | -15 dBm                       | -101 dBm                 | —                                    | CW carrier                 |
| XII            | 698 - 716 MHz                                | -30 dBm                       | -101 dBm                 | 10 MHz                               | WCDMA signal *             |
|                | 678 - 698 MHz<br>716 - 728 MHz               | -30 dBm                       | -101 dBm                 | 10 MHz                               | WCDMA signal *             |
|                | 1 MHz - 678 MHz<br>728 MHz - 12750 MHz       | -15 dBm                       | -101 dBm                 | —                                    | CW carrier                 |

|      |                                    |         |          |        |                |
|------|------------------------------------|---------|----------|--------|----------------|
| XIII | 777 - 787 MHz                      | -30 dBm | -101 dBm | 10 MHz | WCDMA signal * |
|      | 757 - 777 MHz<br>787 - 807 MHz     | -30 dBm | -101 dBm | 10 MHz | WCDMA signal * |
|      | 1 - 757 MHz<br>807 MHz - 12750 MHz | -15 dBm | -101 dBm | —      | CW carrier     |
| XIV  | 788 - 798 MHz                      | -30 dBm | -101 dBm | 10 MHz | WCDMA signal * |
|      | 768 - 788 MHz<br>798 - 818 MHz     | -30 dBm | -101 dBm | 10 MHz | WCDMA signal * |
|      | 1 - 768 MHz<br>818 MHz - 12750 MHz | -15 dBm | -101 dBm | —      | CW carrier     |

NOTE \*: The characteristics of the W-CDMA interference signal are specified in Annex C

Table 7.5: Blocking performance requirement (narrowband) for Wide Area BS

| Operating Band | Center Frequency of Interfering Signal | Interfering Signal mean power | Wanted Signal mean power | Minimum Offset of Interfering Signal | Type of Interfering Signal |
|----------------|--|-------------------------------|--------------------------|--------------------------------------|----------------------------|
| II             | 1850 - 1910 MHz                        | - 47 dBm                      | -115 dBm                 | 2.7 MHz                              | GMSK modulated*            |
| III            | 1710 - 1785 MHz                        | - 47 dBm                      | -115 dBm                 | 2.8 MHz                              | GMSK modulated*            |
| IV             | 1710 - 1755 MHz                        | - 47 dBm                      | -115 dBm                 | 2.7 MHz                              | GMSK modulated*            |
| V              | 824 - 849 MHz                          | - 47 dBm                      | -115 dBm                 | 2.7 MHz                              | GMSK modulated*            |
| VIII           | 880 - 915 MHz                          | - 47 dBm                      | -115 dBm                 | 2.8 MHz                              | GMSK modulated*            |
| X              | 1710 - 1770 MHz                        | - 47 dBm                      | -115 dBm                 | 2.7 MHz                              | GMSK modulated*            |
| XII            | 698 - 716 MHz                          | - 47 dBm                      | -115 dBm                 | 2.7 MHz                              | GMSK modulated*            |
| XIII           | 777 - 787 MHz                          | - 47 dBm                      | -115 dBm                 | 2.7 MHz                              | GMSK modulated*            |
| XIV            | 788 - 798 MHz                          | - 47 dBm                      | -115 dBm                 | 2.7 MHz                              | GMSK modulated*            |

NOTE \*: GMSK modulation as defined in TS 45.004 [5].

Table 7.5A: Blocking performance requirement (narrowband) for Medium Range BS

| Operating Band | Center Frequency of Interfering Signal | Interfering Signal mean power | Wanted Signal mean power | Minimum Offset of Interfering Signal | Type of Interfering Signal |
|----------------|--|-------------------------------|--------------------------|--------------------------------------|----------------------------|
| II             | 1850 - 1910 MHz                        | - 42 dBm                      | -105 dBm                 | 2.7 MHz                              | GMSK modulated*            |
| III            | 1710 - 1785 MHz                        | - 42 dBm                      | -105 dBm                 | 2.8 MHz                              | GMSK modulated*            |
| IV             | 1710 - 1755 MHz                        | - 42 dBm                      | -105 dBm                 | 2.7 MHz                              | GMSK modulated*            |
| V              | 824 - 849 MHz                          | - 42 dBm                      | -105 dBm                 | 2.7 MHz                              | GMSK modulated*            |
| VIII           | 880 - 915 MHz                          | - 42 dBm                      | -105 dBm                 | 2.8 MHz                              | GMSK modulated*            |
| X              | 1710 - 1770 MHz                        | - 42 dBm                      | -105 dBm                 | 2.7 MHz                              | GMSK modulated*            |
| XII            | 698 - 716 MHz                          | - 42 dBm                      | -105 dBm                 | 2.7 MHz                              | GMSK modulated*            |
| XIII           | 777 - 787 MHz                          | - 42 dBm                      | -105 dBm                 | 2.7 MHz                              | GMSK modulated*            |
| XIV            | 788 - 798 MHz                          | - 42 dBm                      | -105 dBm                 | 2.7 MHz                              | GMSK modulated*            |

NOTE \*: GMSK modulation as defined in TS 45.004 [5].

Table 7.5B: Blocking performance requirement (narrowband) for Local Area BS

| Operating Band | Center Frequency of Interfering Signal | Interfering Signal mean power | Wanted Signal mean power | Minimum Offset of Interfering Signal | Type of Interfering Signal |
|----------------|--|-------------------------------|--------------------------|--------------------------------------|----------------------------|
| II             | 1850 - 1910 MHz                        | - 37 dBm                      | -101 dBm                 | 2.7 MHz                              | GMSK modulated*            |
| III            | 1710 - 1785 MHz                        | - 37 dBm                      | -101 dBm                 | 2.8 MHz                              | GMSK modulated*            |
| IV             | 1710 - 1755 MHz                        | - 37 dBm                      | -101 dBm                 | 2.7 MHz                              | GMSK modulated*            |
| V              | 824 - 849 MHz                          | - 37 dBm                      | -101 dBm                 | 2.7 MHz                              | GMSK modulated*            |
| VIII           | 880 - 915 MHz                          | - 37 dBm                      | -101 dBm                 | 2.8 MHz                              | GMSK modulated*            |
| X              | 1710 - 1770 MHz                        | - 37 dBm                      | -101 dBm                 | 2.7 MHz                              | GMSK modulated*            |
| XII            | 698 - 716 MHz                          | - 37 dBm                      | -101 dBm                 | 2.7 MHz                              | GMSK modulated*            |
| XIII           | 777 - 787 MHz                          | - 37 dBm                      | -101 dBm                 | 2.7 MHz                              | GMSK modulated*            |
| XIV            | 788 - 798 MHz                          | - 37 dBm                      | -101 dBm                 | 2.7 MHz                              | GMSK modulated*            |

NOTE \*: GMSK modulation as defined in TS 45.004 [5].

## 7.5.2 Minimum Requirement - Co-location with GSM900, DCS 1800, PCS1900, GSM850 and/or UTRA FDD

This additional blocking requirement may be applied for the protection of FDD BS receivers when GSM900, DCS1800, PCS1900, GSM850 and/or FDD BS operating in Bands I to XIV are co-located with a UTRA FDD BS.

The requirements in this chapter assume a 30 dB coupling loss between transmitter and receiver. If BSs of different classes are co-sited, the coupling loss should be increased by the value as stated in TR 25.942 [4] chapter 10.3 in Table 10.1 and Table 10.2.

For a Wide Area (WA) FDD BS, the static reference performance as specified in clause 7.2.1 shall be met with a wanted and an interfering signal coupled to BS antenna input using the parameters in Table 7.5C.

**Table 7.5C: Blocking performance requirement for Wide Area BS when co-located with BS in other bands.**

| Co-located BS type      | Center Frequency of Interfering Signal | Interfering Signal mean power | Wanted Signal mean power | Type of Interfering Signal |
|-------------------------|--|-------------------------------|--------------------------|----------------------------|
| Macro GSM900            | 921 - 960 MHz                          | +16 dBm                       | -115 dBm                 | CW carrier                 |
| Macro DCS1800           | 1805 - 1880 MHz                        | +16 dBm                       | -115 dBm                 | CW carrier                 |
| Macro PCS1900           | 1930 - 1990 MHz                        | +16 dBm                       | -115 dBm                 | CW carrier                 |
| Macro GSM850 or CDMA850 | 869 - 894 MHz                          | +16 dBm                       | -115 dBm                 | CW carrier                 |
| WA UTRA-FDD Band I      | 2110 - 2170 MHz                        | +16 dBm                       | -115 dBm                 | CW carrier                 |
| WA UTRA-FDD Band II     | 1930 - 1990 MHz                        | +16 dBm                       | -115 dBm                 | CW carrier                 |
| WA UTRA-FDD Band III    | 1805 - 1880 MHz                        | +16 dBm                       | -115 dBm                 | CW carrier                 |
| WA UTRA-FDD Band IV     | 2110 - 2155 MHz                        | +16 dBm                       | -115 dBm                 | CW carrier                 |
| WA UTRA-FDD Band V      | 869 - 894 MHz                          | +16 dBm                       | -115 dBm                 | CW carrier                 |
| WA UTRA-FDD Band VI     | 875 - 885 MHz                          | +16 dBm                       | -115 dBm                 | CW carrier                 |
| WA UTRA-FDD Band VII    | 2620 - 2690 MHz                        | +16 dBm                       | -115 dBm                 | CW carrier                 |
| WA UTRA-FDD Band VIII   | 925 - 960 MHz                          | +16 dBm                       | -115 dBm                 | CW carrier                 |
| WA UTRA-FDD Band IX     | 1844.9 - 1879.9 MHz                    | +16 dBm                       | -115 dBm                 | CW carrier                 |
| WA UTRA-FDD Band X      | 2110 - 2170 MHz                        | +16 dBm                       | -115 dBm                 | CW carrier                 |
| WA UTRA-FDD Band XI     | 1475.9 - 1500.9 MHz                    | +16 dBm                       | -115 dBm                 | CW carrier                 |
| WA UTRA-FDD Band XII    | 728 - 746 MHz                          | +16 dBm                       | -115 dBm                 | CW carrier                 |
| WA UTRA-FDD Band XIII   | 746 - 756 MHz                          | +16 dBm                       | -115 dBm                 | CW carrier                 |
| WA UTRA-FDD Band XIV    | 758 - 768 MHz                          | +16 dBm                       | -115 dBm                 | CW carrier                 |

For a Medium Range (MR) FDD BS, the static reference performance as specified in clause 7.2.1 shall be met with a wanted and an interfering signal coupled to BS antenna input using the parameters in Table 7.5D.

**Table 7.5D: Blocking performance requirement for Medium Range BS when co-located with BS in other bands.**

| Co-located BS type    | Center Frequency of Interfering Signal | Interfering Signal mean power | Wanted Signal mean power | Type of Interfering Signal |
|-----------------------|--|-------------------------------|--------------------------|----------------------------|
| Micro GSM900          | 921 - 960 MHz                          | -3 dBm                        | -105 dBm                 | CW carrier                 |
| Micro DCS1800         | 1805 - 1880 MHz                        | +5 dBm                        | -105 dBm                 | CW carrier                 |
| Micro PCS1900         | 1930 - 1990 MHz                        | +5 dBm                        | -105 dBm                 | CW carrier                 |
| Micro GSM850          | 869 - 894 MHz                          | -3 dBm                        | -105 dBm                 | CW carrier                 |
| MR UTRA-FDD Band I    | 2110 - 2170 MHz                        | +8 dBm                        | -105 dBm                 | CW carrier                 |
| MR UTRA-FDD Band II   | 1930 - 1990 MHz                        | +8 dBm                        | -105 dBm                 | CW carrier                 |
| MR UTRA-FDD Band III  | 1805 - 1880 MHz                        | +8 dBm                        | -105 dBm                 | CW carrier                 |
| MR UTRA-FDD Band IV   | 2110 - 2155 MHz                        | +8 dBm                        | -105 dBm                 | CW carrier                 |
| MR UTRA-FDD Band V    | 869 - 894 MHz                          | +8 dBm                        | -105 dBm                 | CW carrier                 |
| MR UTRA-FDD Band VI   | 875 - 885 MHz                          | +8 dBm                        | -105 dBm                 | CW carrier                 |
| MR UTRA-FDD Band VII  | 2620 - 2690 MHz                        | +8 dBm                        | -105 dBm                 | CW carrier                 |
| MR UTRA-FDD Band VIII | 925 - 960 MHz                          | +8 dBm                        | -105 dBm                 | CW carrier                 |
| MR UTRA-FDD Band IX   | 1844.9 - 1879.9 MHz                    | +8 dBm                        | -105 dBm                 | CW carrier                 |
| MR UTRA-FDD Band X    | 2110 - 2170 MHz                        | +8 dBm                        | -105 dBm                 | CW carrier                 |
| MR UTRA-FDD Band XI   | 1475.9 - 1500.9 MHz                    | +8 dBm                        | -105 dBm                 | CW carrier                 |
| MR UTRA-FDD Band XII  | 728 - 746 MHz                          | +8 dBm                        | -105 dBm                 | CW carrier                 |
| MR UTRA-FDD Band XIII | 746 - 756 MHz                          | +8 dBm                        | -105 dBm                 | CW carrier                 |
| MR UTRA-FDD Band XIV  | 758 - 768 MHz                          | +8 dBm                        | -105 dBm                 | CW carrier                 |

For a Local Area (LA) FDD BS, the static reference performance as specified in clause 7.2.1 shall be met with a wanted and an interfering signal coupled to BS antenna input using the parameters in Table 7.5E.

**Table 7.5E: Blocking performance requirement for Local Area BS when co-located with BS in other bands.**

| Co-located BS type    | Center Frequency of Interfering Signal | Interfering Signal mean power | Wanted Signal mean power | Type of Interfering Signal |
|-----------------------|--|-------------------------------|--------------------------|----------------------------|
| Pico GSM900           | 921 - 960 MHz                          | -7 dBm                        | -101 dBm                 | CW carrier                 |
| Pico DCS1800          | 1805 - 1880 MHz                        | -4 dBm                        | -101 dBm                 | CW carrier                 |
| Pico PCS1900          | 1930 - 1990 MHz                        | -4 dBm                        | -101 dBm                 | CW carrier                 |
| Pico GSM850           | 869 - 894 MHz                          | -7dBm                         | -101 dBm                 | CW carrier                 |
| LA UTRA-FDD Band I    | 2110 - 2170 MHz                        | -6 dBm                        | -101 dBm                 | CW carrier                 |
| LA UTRA-FDD Band II   | 1930 - 1990 MHz                        | -6 dBm                        | -101 dBm                 | CW carrier                 |
| LA UTRA-FDD Band III  | 1805 - 1880 MHz                        | -6 dBm                        | -101 dBm                 | CW carrier                 |
| LA UTRA-FDD Band IV   | 2110 - 2155 MHz                        | -6 dBm                        | -101 dBm                 | CW carrier                 |
| LA UTRA-FDD Band V    | 869 - 894 MHz                          | -6 dBm                        | -101 dBm                 | CW carrier                 |
| LA UTRA-FDD Band VI   | 875 - 885 MHz                          | -6 dBm                        | -101 dBm                 | CW carrier                 |
| LA UTRA-FDD Band VII  | 2620 - 2690 MHz                        | -6 dBm                        | -101 dBm                 | CW carrier                 |
| LA UTRA-FDD Band VIII | 925 - 960 MHz                          | -6 dBm                        | -101 dBm                 | CW carrier                 |
| LA UTRA-FDD Band IX   | 1844.9 - 1879.9 MHz                    | -6 dBm                        | -101 dBm                 | CW carrier                 |
| LA UTRA-FDD Band X    | 2110 - 2170 MHz                        | -6 dBm                        | -101 dBm                 | CW carrier                 |
| LA UTRA-FDD Band XI   | 1475.9 - 1500.9 MHz                    | -6 dBm                        | -101 dBm                 | CW carrier                 |
| WA UTRA-FDD Band XII  | 728 - 746 MHz                          | -6 dBm                        | -101 dBm                 | CW carrier                 |
| WA UTRA-FDD Band XIII | 746 - 756 MHz                          | -6 dBm                        | -101 dBm                 | CW carrier                 |
| WA UTRA-FDD Band XIV  | 758 - 768 MHz                          | -6 dBm                        | -101 dBm                 | CW carrier                 |

### 7.5.3 Minimum Requirement - Co-location with UTRA-TDD

An additional blocking requirement may be applied for the protection of FDD BS receivers when UTRA TDD is co-located with a UTRA FDD BS.

The requirements in this chapter assume a 30 dB coupling loss between transmitter and receiver. If BSs of different classes are co sited, the coupling loss should be increased by the value as stated in TR 25.942 [4] chapter 10.3 in Table 10.1 and Table 10.2.

The current state-of-the-art technology does not allow a single generic solution for co-location with UTRA-TDD on adjacent frequencies for 30dB BS-BS minimum coupling loss.

However, there are certain site-engineering solutions that can be used in these cases. These techniques are addressed in TR 25.942 [4].

For a Wide Area (WA) FDD BS, the static reference performance as specified in clause 7.2.1 should be met with a wanted and an interfering signal coupled to BS antenna input using the parameters in Table 7.5F.

**Table 7.5F: Blocking performance requirement for Wide Area BS when co-located with UTRA TDD BS in other bands.**

| Co-located BS type | Center Frequency of Interfering Signal | Interfering Signal mean power | Wanted Signal mean power | Type of Interfering Signal |
|--------------------|--|-------------------------------|--------------------------|----------------------------|
| Wide Area TDD      | 2585 - 2620 MHz                        | +16 dBm                       | -115 dBm                 | CW carrier                 |

For a Local Area (LA) FDD BS, the static reference performance as specified in clause 7.2.1 should be met with a wanted and an interfering signal coupled to BS antenna input using the parameters in Table 7.5G.

**Table 7.5G: Blocking performance requirement for Local Area BS when co-located with UTRA TDD BS in other bands.**

| Co-located BS type | Center Frequency of Interfering Signal | Interfering Signal mean power | Wanted Signal mean power | Type of Interfering Signal |
|--------------------|--|-------------------------------|--------------------------|----------------------------|
| Local Area TDD     | 2585 - 2620 MHz                        | -4 dBm                        | -101 dBm                 | CW carrier                 |

## 7.6 Intermodulation characteristics

Third and higher order mixing of the two interfering RF signals can produce an interfering signal in the band of the desired channel. Intermodulation response rejection is a measure of the capability of the receiver to receive a wanted signal on its assigned channel frequency in the presence of two or more interfering signals which have a specific frequency relationship to the wanted signal.

### 7.6.1 Minimum requirement

The static reference performance as specified in clause 7.2.1 shall be met for a Wide Area BS when the following signals are coupled to BS antenna input:

- A wanted signal at the assigned channel frequency with a mean power of -115 dBm.
- Two interfering signals with the following parameters.

**Table 7.6: Intermodulation performance requirement (Wide Area BS)**

| Operating band  | Interfering Signal mean power | Offset | Type of Interfering Signal |
|---|-------------------------------|--------|----------------------------|
| All bands   | - 48 dBm                      | 10 MHz | CW signal                  |
|   | - 48 dBm                      | 20 MHz | WCDMA signal *             |
| Note*: The characteristics of the W-CDMA interference signal are specified in Annex C |                               |        |                            |

**Table 7.6A: Narrowband intermodulation performance requirement (Wide Area BS)**

| Operating band                          | Interfering Signal mean power | Offset  | Type of Interfering Signal |
|---|-------------------------------|---------|----------------------------|
| II, III, IV, V, VIII, X, XII, XIII, XIV | - 47 dBm                      | 3.5 MHz | CW signal                  |
|   | - 47 dBm                      | 5.9 MHz | GMSK modulated*            |
| * GMSK as defined in TS45.004           |                               |         |                            |

The static reference performance as specified in clause 7.2.1 shall be met for a Medium Range BS when the following signals are coupled to BS antenna input:

- A wanted signal at the assigned channel frequency with a mean power of -105 dBm.
- Two interfering signals with the following parameters.

**Table 7.6B: Intermodulation performance requirement (Medium Range BS)**

| Operating band  | Interfering Signal mean power | Offset | Type of Interfering Signal |
|---|-------------------------------|--------|----------------------------|
| All bands   | - 44 dBm                      | 10 MHz | CW signal                  |
|   | - 44 dBm                      | 20 MHz | WCDMA signal *             |
| Note*: The characteristics of the W-CDMA interference signal are specified in Annex C |                               |        |                            |

**Table 7.6C: Narrowband intermodulation performance requirement (Medium Range BS)**

| Operating band                          | Interfering Signal mean power | Offset  | Type of Interfering Signal |
|---|-------------------------------|---------|----------------------------|
| II, III, IV, V, VIII, X, XII, XIII, XIV | - 43 dBm                      | 3.5 MHz | CW signal                  |
|   | - 43 dBm                      | 5.9 MHz | GMSK modulated*            |
| * GMSK as defined in TS45.004           |                               |         |                            |

The static reference performance as specified in clause 7.2.1 shall be met for a Local Area BS when the following signals are coupled to BS antenna input:

- A wanted signal at the assigned channel frequency with a mean power of -101 dBm.
- Two interfering signals with the following parameters.

**Table 7.6D: Intermodulation performance requirement (Local Area BS)**

| Operating band  | Interfering Signal mean power | Offset | Type of Interfering Signal |
|---|-------------------------------|--------|----------------------------|
| All bands   | -38 dBm                       | 10 MHz | CW signal                  |
|   | -38 dBm                       | 20 MHz | WCDMA signal *             |
| Note*: The characteristics of the W-CDMA interference signal are specified in Annex C |                               |        |                            |

**Table 7.6E: Narrowband intermodulation performance requirement (Local Area BS)**

| Operating band                          | Interfering Signal mean power | Offset  | Type of Interfering Signal |
|---|-------------------------------|---------|----------------------------|
| II, III, IV, V, VIII, X, XII, XIII, XIV | -37 dBm                       | 3.5 MHz | CW signal                  |
|   | -37 dBm                       | 5.9 MHz | GMSK modulated*            |
| * GMSK as defined in TS45.004           |                               |         |                            |

## 7.7 Spurious emissions

The spurious emissions power is the power of emissions generated or amplified in a receiver that appear at the BS receiver antenna connector. The requirements apply to all BS with separate RX and TX antenna port. The test shall be performed when both TX and RX are on with the TX port terminated.

For all BS with common RX and TX antenna port the transmitter spurious emission as specified in section 6.6.3 is valid.

## 7.7.1 Minimum requirement

The power of any spurious emission shall not exceed:

**Table 7.7: General spurious emission minimum requirement**

| Band              | Maximum level | Measurement Bandwidth | Note   |
|-------------------|---------------|-----------------------|--|
| 30MHz - 1 GHz     | -57 dBm       | 100 kHz               | With the exception of frequencies between 12.5 MHz below the first carrier frequency and 12.5 MHz above the last carrier frequency used by the BS. |
| 1 GHz - 12.75 GHz | -47 dBm       | 1 MHz                 | With the exception of frequencies between 12.5 MHz below the first carrier frequency and 12.5 MHz above the last carrier frequency used by the BS. |

**Table 7.7A: Additional spurious emission requirements**

| Operating Band | Band                | Maximum level | Measurement Bandwidth | Note |
|----------------|---------------------|---------------|-----------------------|------|
| I              | 1920 - 1980 MHz     | -78 dBm       | 3.84 MHz              |      |
| II             | 1850 - 1910 MHz     | -78 dBm       | 3.84 MHz              |      |
| III            | 1710 - 1785 MHz     | -78 dBm       | 3.84 MHz              |      |
| IV             | 1710 - 1755 MHz     | -78 dBm       | 3.84 MHz              |      |
| V              | 824 - 849 MHz       | -78 dBm       | 3.84 MHz              |      |
| VI             | 815 - 850 MHz       | -78 dBm       | 3.84 MHz              |      |
| VII            | 2500 - 2570 MHz     | -78 dBm       | 3.84 MHz              |      |
| VIII           | 880 - 915 MHz       | -78 dBm       | 3.84 MHz              |      |
| IX             | 1749.9 - 1784.9 MHz | -78 dBm       | 3.84 MHz              |      |
| X              | 1710 - 1770 MHz     | -78 dBm       | 3.84 MHz              |      |
| XI             | 1427.9 - 1452.9 MHz | -78 dBm       | 3.84 MHz              |      |
| XII            | 698 - 716 MHz       | -78 dBm       | 3.84 MHz              |      |
| XIII           | 777 - 787 MHz       | -78 dBm       | 3.84 MHz              |      |
| XIV            | 788 - 798 MHz       | -78 dBm       | 3.84 MHz              |      |

In addition, the requirement in Table 7.8 may be applied to geographic areas in which both UTRA-TDD and UTRA-FDD are deployed.

**Table 7.8: Additional spurious emission requirements for the TDD bands**

| Operating Band | Band            | Maximum level | Measurement Bandwidth | Note                    |
|----------------|-----------------|---------------|-----------------------|-------------------------|
| I              | 1900 - 1920 MHz | -78 dBm       | 3.84 MHz              | Not applicable in Japan |
|                | 2010 - 2025 MHz | -52 dBm       | 1MHz                  | Applicable in Japan     |
| VI, IX, XI     | 2010 - 2025 MHz | -52 dBm       | 1MHz                  |                         |

In addition to the requirements in tables 7.7, 7.7A and 7.8, the co-existence requirements for co-located base stations specified in subclause 6.6.3.4 and 6.6.3.7.2 may also be applied.

# 8 Performance requirement

## 8.1 General

Performance requirements for the BS are specified for the measurement channels defined in Annex A and the propagation conditions in Annex B. The requirements only apply to those measurement channels that are supported by the base station. For FRC8 in Annex 9 and Annex 17 the Non E-DPCCH boosting and E-DPCCH boosting requirement

only apply for the option supported by the base station. The performance requirements for the high speed train conditions which scenarios defined in Annex B.4A are optional.

For BS with dual receiver antenna diversity, only the BS performance requirements with Rx diversity apply, the required  $E_b/N_0$  shall be applied separately at each antenna port.

For BS without receiver antenna diversity, only the BS performance requirements without Rx diversity apply, the required  $E_b/N_0$  shall be applied at the BS Rx antenna port.

The  $E_b/N_0$  used in this section is defined as:

$$E_b / N_o = \frac{E_c}{N_o} \cdot \frac{L_{chip}}{L_{inf}}$$

Where:

$E_c$  is the received total energy of DPDCH, DPCCH, HS-DPCCH, E-DPDCH and E-DPCCH per PN chip per antenna from all paths.

$N_o$  is the total one-sided noise power spectral density due to all noise sources

$L_{chip}$  is the number of chips per frame

$L_{inf}$  is the number of information bits in DTCH excluding CRC bits per frame

**Table 8.1: Summary of Base Station performance targets**

| Physical channel | Measurement channel | Static                    | Multi-path Case 1         | Multi-path Case 2         | Multi-path Case 3                  | Moving | Birth / Death |
|------------------|---------------------|---------------------------|---------------------------|---------------------------|------------------------------------|--------|---------------|
|                  |                     | Performance metric        |                           |                           |                                    |        |               |
| DCH              | 12.2 kbps           | BLER < $10^{-2}$          | BLER < $10^{-2}$          | BLER < $10^{-2}$          | BLER < $10^{-2}$                   | BLER < | BLER <        |
|                  | 64 kbps             | BLER < $10^{-1}, 10^{-2}$ | BLER < $10^{-1}, 10^{-2}$ | BLER < $10^{-1}, 10^{-2}$ | BLER < $10^{-1}, 10^{-2}, 10^{-3}$ | BLER < | BLER <        |
|                  | 144 kbps            | BLER < $10^{-1}, 10^{-2}$ | BLER < $10^{-1}, 10^{-2}$ | BLER < $10^{-1}, 10^{-2}$ | BLER < $10^{-1}, 10^{-2}, 10^{-3}$ | -      | -             |
|                  | 384 kbps            | BLER < $10^{-1}, 10^{-2}$ | BLER < $10^{-1}, 10^{-2}$ | BLER < $10^{-1}, 10^{-2}$ | BLER < $10^{-1}, 10^{-2}, 10^{-3}$ | -      | -             |

## 8.2 Demodulation in static propagation conditions

### 8.2.1 Demodulation of DCH

The performance requirement of DCH in static propagation conditions is determined by the maximum Block Error Ratio (BLER) allowed when the receiver input signal is at a specified  $E_b/N_0$  limit. The BLER is calculated for each of the measurement channels supported by the base station.

#### 8.2.1.1 Minimum requirement

The BLER shall not exceed the limit for the  $E_b/N_0$  specified in Table 8.2.



**Table 8.2: Performance requirements in AWGN channel**

| Measurement channel | Received $E_b/N_0$<br>For BS with<br>Rx diversity | Received $E_b/N_0$<br>For BS<br>without Rx<br>diversity | Required<br>BLER |
|---------------------|---|---|------------------|
| 12.2 kbps           | n.a.  | n.a.  | $< 10^{-1}$      |
|                     | 5.1 dB  | 8.3 dB  | $< 10^{-2}$      |
| 64 kbps             | 1.5 dB  | 4.7 dB  | $< 10^{-1}$      |
|                     | 1.7 dB  | 4.8 dB  | $< 10^{-2}$      |
| 144 kbps            | 0.8 dB  | 3.8 dB  | $< 10^{-1}$      |
|                     | 0.9 dB  | 4 dB  | $< 10^{-2}$      |
| 384 kbps            | 0.9 dB  | 4 dB  | $< 10^{-1}$      |
|                     | 1.0 dB  | 4.1 dB  | $< 10^{-2}$      |

## 8.3 Demodulation of DCH in multipath fading conditions

### 8.3.1 Multipath fading Case 1

The performance requirement of DCH in multipath fading Case 1 is determined by the maximum Block Error Ratio (BLER) allowed when the receiver input signal is at a specified  $E_b/N_0$  limit. The BLER is calculated for each of the measurement channels supported by the base station.

#### 8.3.1.1 Minimum requirement

The BLER shall not exceed the limit for the  $E_b/N_0$  specified in Table 8.3.

**Table 8.3: Performance requirements in multipath Case 1 channel**

| Measurement channel | Received $E_b/N_0$<br>For BS<br>with Rx<br>diversity | Received $E_b/N_0$<br>For BS<br>without<br>Rx<br>diversity | Required<br>BLER |
|---------------------|--|--|------------------|
| 12.2 kbps           | n.a.   | n.a.   | $< 10^{-1}$      |
|                     | 11.9 dB  | 19.1 dB  | $< 10^{-2}$      |
| 64 kbps             | 6.2 dB   | 11.6 dB  | $< 10^{-1}$      |
|                     | 9.2 dB   | 15.9 dB  | $< 10^{-2}$      |
| 144 kbps            | 5.4 dB   | 10.8 dB  | $< 10^{-1}$      |
|                     | 8.4 dB   | 15 dB  | $< 10^{-2}$      |
| 384 kbps            | 5.8 dB   | 11.2 dB  | $< 10^{-1}$      |
|                     | 8.8 dB   | 15.5 dB  | $< 10^{-2}$      |

### 8.3.2 Multipath fading Case 2

The performance requirement of DCH in multipath fading Case 2 is determined by the maximum Block Error Ratio (BLER) allowed when the receiver input signal is at a specified  $E_b/N_0$  limit. The BLER is calculated for each of the measurement channels supported by the base station.

### 8.3.2.1 Minimum requirement

The BLER shall not exceed the limit for the  $E_b/N_0$  specified in Table 8.4.

**Table 8.4: Performance requirements in multipath Case 2 channel**

| Measurement channel | Received $E_b/N_0$ For BS with Rx Diversity | Received $E_b/N_0$ For BS without Rx Diversity | Required BLER |
|---------------------|---|--|---------------|
| 12.2 kbps           | n.a.  | n.a.   | $< 10^{-1}$   |
|                     | 9.0 dB                                      | 15 dB  | $< 10^{-2}$   |
| 64 kbps             | 4.3 dB                                      | 9.2 dB   | $< 10^{-1}$   |
|                     | 6.4 dB                                      | 12.3 dB  | $< 10^{-2}$   |
| 144 kbps            | 3.7 dB                                      | 8.2 dB   | $< 10^{-1}$   |
|                     | 5.6 dB                                      | 11.5 dB  | $< 10^{-2}$   |
| 384 kbps            | 4.1 dB                                      | 8.7 dB   | $< 10^{-1}$   |
|                     | 6.1 dB                                      | 12.1 dB  | $< 10^{-2}$   |

### 8.3.3 Multipath fading Case 3

The performance requirement of DCH in multipath fading Case 3 is determined by the maximum Block Error Ratio (BLER) allowed when the receiver input signal is at a specified  $E_b/N_0$  limit. The BLER is calculated for each of the measurement channels supported by the base station.

#### 8.3.3.1 Minimum requirement

The BLER shall not exceed the limit for the  $E_b/N_0$  specified in Table 8.5.

**Table 8.5: Performance requirements in multipath Case 3 channel**

| Measurement channel | Received $E_b/N_0$ For BS with Rx Diversity | Received $E_b/N_0$ For BS without Rx Diversity | Required BLER |
|---------------------|---|--|---------------|
| 12.2 kbps           | n.a.  | n.a.   | $< 10^{-1}$   |
|                     | 7.2 dB                                      | 10.8 dB  | $< 10^{-2}$   |
|                     | 8.0 dB                                      | 11.7 dB  | $< 10^{-3}$   |
| 64 kbps             | 3.4 dB                                      | 7.1 dB   | $< 10^{-1}$   |
|                     | 3.8 dB                                      | 7.7 dB   | $< 10^{-2}$   |
|                     | 4.1 dB                                      | 8.5 dB   | $< 10^{-3}$   |
| 144 kbps            | 2.8 dB                                      | 6 dB   | $< 10^{-1}$   |
|                     | 3.2 dB                                      | 6.7 dB   | $< 10^{-2}$   |
|                     | 3.6 dB                                      | 7.2 dB   | $< 10^{-3}$   |
| 384 kbps            | 3.2 dB                                      | 6.5 dB   | $< 10^{-1}$   |
|                     | 3.6 dB                                      | 7.2 dB   | $< 10^{-2}$   |
|                     | 4.2 dB                                      | 7.9 dB   | $< 10^{-3}$   |

### 8.3.4 Multipath fading Case 4

The performance requirement of DCH in multipath fading Case 4 in case of a Wide Area BS is determined by the maximum Block Error Ratio (BLER) allowed when the receiver input signal is at a specified  $E_b/N_0$  limit. The BLER is calculated for each of the measurement channels supported by the base station.

### 8.3.4.1 Minimum requirement

The BLER shall not exceed the limit for the  $E_b/N_0$  specified in Table 8.5A.

**Table 8.5A: Performance requirements in multipath Case 4 channel**

| Measurement channel | Received $E_b/N_0$ For BS with Rx Diversity | Received $E_b/N_0$ For BS without Rx Diversity | Required BLER |
|---------------------|---|--|---------------|
| 12.2 kbps           | n.a.  | n.a.   | $< 10^{-1}$   |
|                     | 10.2 dB                                     | 13.8 dB  | $< 10^{-2}$   |
|                     | 11.0 dB                                     | 14.7 dB  | $< 10^{-3}$   |
| 64 kbps             | 6.4 dB                                      | 10.1 dB  | $< 10^{-1}$   |
|                     | 6.8 dB                                      | 10.7 dB  | $< 10^{-2}$   |
|                     | 7.1 dB                                      | 11.5 dB  | $< 10^{-3}$   |
| 144 kbps            | 5.8 dB                                      | 9 dB   | $< 10^{-1}$   |
|                     | 6.2 dB                                      | 9.7 dB   | $< 10^{-2}$   |
|                     | 6.6 dB                                      | 10.2 dB  | $< 10^{-3}$   |
| 384 kbps            | 6.2 dB                                      | 9.5 dB   | $< 10^{-1}$   |
|                     | 6.6 dB                                      | 10.2 dB  | $< 10^{-2}$   |
|                     | 7.2 dB                                      | 10.9 dB  | $< 10^{-3}$   |

## 8.4 Demodulation of DCH in moving propagation conditions

The performance requirement of DCH in moving propagation conditions is determined by the maximum Block Error Ratio (BLER) allowed when the receiver input signal is at a specified  $E_b/N_0$  limit. The BLER is calculated for each of the measurement channels supported by the base station.

### 8.4.1 Minimum requirement

The BLER shall not exceed the limit for the  $E_b/N_0$  specified in Table 8.6.

**Table 8.6: Performance requirements in moving channel**

| Measurement channel | Received $E_b/N_0$ For BS with Rx Diversity | Received $E_b/N_0$ For BS without Rx Diversity | Required BLER |
|---------------------|---|--|---------------|
| 12.2 kbps           | n.a.  | n.a.   | $< 10^{-1}$   |
|                     | 5.7 dB                                      | 8.7 dB   | $< 10^{-2}$   |
| 64 kbps             | 2.1 dB                                      | 5.3 dB   | $< 10^{-1}$   |
|                     | 2.2 dB                                      | 5.5 dB   | $< 10^{-2}$   |

## 8.5 Demodulation of DCH in birth/death propagation conditions

The performance requirement of DCH in birth/death propagation conditions is determined by the maximum Block Error Ratio (BLER) allowed when the receiver input signal is at a specified  $E_b/N_0$  limit. The BLER is calculated for each of the measurement channels supported by the base station.

## 8.5.1 Minimum requirement

The BLER shall not exceed the limit for the  $E_b/N_0$  specified in Table 8.7.

**Table 8.7: Performance requirements in birth/death channel**

| Measurement channel | Received $E_b/N_0$<br>For BS with<br>Rx Diversity | Received $E_b/N_0$<br>For BS<br>without Rx<br>Diversity | Required<br>BLER |
|---------------------|---|---|------------------|
| 12.2 kbps           | n.a.  | n.a.  | $< 10^{-1}$      |
|                     | 7.7 dB  | 10.8 dB   | $< 10^{-2}$      |
| 64 kbps             | 4.1 dB  | 7.4 dB  | $< 10^{-1}$      |
|                     | 4.2 dB  | 7.5 dB  | $< 10^{-2}$      |

## 8.5A Demodulation of DCH in high speed train conditions

### 8.5A.1 General

The performance requirement of DCH in high speed train conditions is determined by the maximum BLER allowed when the receiver input signal is at a specified  $E_b/N_0$  limit. The BLER is calculated for the measurement channel supported by the base station.

### 8.5A.2 Minimum requirement

The BLER shall not exceed the limit for the  $E_b/N_0$  specified in Table 8.7A.

**Table 8.7A: Performance requirements in high speed train conditions**

| Scenario | Measurement channel | Received $E_b/N_0$<br>For BS with Rx<br>Diversity | Received $E_b/N_0$<br>For BS without<br>Rx Diversity | Required<br>BLER |
|----------|---------------------|---|--|------------------|
| 1        | 12.2 kbps           | 6.5 dB  | 9.6 dB   | $< 10^{-2}$      |
| 2        | 12.2 kbps           | n.a.  | 8.8 dB   | $< 10^{-2}$      |
| 3        | 12.2 kbps           | n.a.  | 10.1 dB  | $< 10^{-2}$      |

## 8.6 (void)

## 8.7 Performance requirement for RACH

Performance requirement for RACH consists of two parts: preamble detection and message demodulation. Requirements for these are in sections 8.7.1 and 8.7.2, respectively. Requirements are defined for three propagation conditions: static, fading case 3, and high speed train conditions. The propagation conditions are defined in annexes B.1, B.2, and B.4A.

## 8.7.1 Performance requirement for RACH preamble detection

Probability of false alarm, Pfa (=false detection of the preamble) when the preamble was not sent, shall be  $10^{-3}$  or less. The performance measure Required  $E_c/N_0$  at probability of detection, Pd of 0.99 and 0.999. Only 1 signature is used and it is known by the receiver. The requirement for preamble detection, when the preamble was sent is in table 8.9, 8.10, and 8.10A for static, case 3 fading, and high speed train conditions.

**Table 8.9: Requirements for  $E_c/N_0$  of Pd in static propagation condition**

|                                | $E_c/N_0$ for required Pd $\geq 0.99$ | $E_c/N_0$ for required Pd $\geq 0.999$ |
|--------------------------------|---------------------------------------|--|
| <b>BS with Rx Diversity</b>    | -20.5 dB                              | -20.1 dB                               |
| <b>BS without Rx Diversity</b> | -17.6 dB                              | -16.8 dB                               |

**Table 8.10: Requirements of  $E_c/N_0$  of Pd in case 3 fading**

|                                | $E_c/N_0$ for required Pd $\geq 0.99$ | $E_c/N_0$ for required Pd $\geq 0.999$ |
|--------------------------------|---------------------------------------|--|
| <b>BS with Rx Diversity</b>    | -15.5 dB                              | -13.4 dB                               |
| <b>BS without Rx Diversity</b> | -9.4 dB                               | -6.4 dB                                |

**Table 8.10A: Requirements of  $E_c/N_0$  of Pd in high speed train conditions**

| Scenario |                                | $E_c/N_0$ for required Pd $\geq 0.99$ | $E_c/N_0$ for required Pd $\geq 0.999$ |
|----------|--------------------------------|---------------------------------------|--|
| <b>1</b> | <b>BS with Rx Diversity</b>    | -18.1 dB                              | -17.9 dB                               |
|          | <b>BS without Rx Diversity</b> | -15.2 dB                              | -14.8 dB                               |
| <b>2</b> | <b>BS with Rx Diversity</b>    | n.a.                                  | n.a.                                   |
|          | <b>BS without Rx Diversity</b> | -15.6 dB                              | -14.8 dB                               |
| <b>3</b> | <b>BS with Rx Diversity</b>    | n.a.                                  | n.a.                                   |
|          | <b>BS without Rx Diversity</b> | -15.3 dB                              | -15.1 dB                               |

## 8.7.2 Demodulation of RACH message

The performance measure is required  $E_b/N_0$  for block error rate (BLER) of  $10^{-1}$  and  $10^{-2}$ . Both measurement channels have TTI=20 ms. Payloads are 168 and 360 bits. Channel coding is rate  $\frac{1}{2}$  convolutional coding.

### 8.7.2.1 Minimum requirements for Static Propagation Condition

**Table 8.11: Required  $E_b/N_0$  for static propagation**

| Transport Block size TB and TTI in frames | 168 bits, TTI = 20 ms                   |   | 360 bits, TTI = 20 ms                   |   |
|---|---|---|---|---|
|   | $E_b/N_0$ for required BLER $< 10^{-1}$ | $E_b/N_0$ for required BLER $< 10^{-2}$ | $E_b/N_0$ for required BLER $< 10^{-1}$ | $E_b/N_0$ for required BLER $< 10^{-2}$ |
| BS with Rx Diversity                      | 4.1 dB                                  | 5.0 dB                                  | 3.9 dB                                  | 4.8 dB                                  |
| BS without Rx Diversity                   | 7.2 dB                                  | 8.1 dB                                  | 6.9 dB                                  | 7.8 dB                                  |

## 8.7.2.2 Minimum requirements for Multipath Fading Case 3

Table 8.12: Required  $E_b/N_0$  for case 3 fading

| Transport Block size TB and TTI in frames | 168 bits, TTI = 20 ms                   |   | 360 bits, TTI = 20 ms                   |   |
|---|---|---|---|---|
|   | $E_b/N_0$ for required BLER < $10^{-1}$ | $E_b/N_0$ for required BLER < $10^{-2}$ | $E_b/N_0$ for required BLER < $10^{-1}$ | $E_b/N_0$ for required BLER < $10^{-2}$ |
| BS with Rx Diversity                      | 7.4 dB                                  | 8.5 dB                                  | 7.3 dB                                  | 8.3 dB                                  |
| BS without Rx Diversity                   | 11.1 dB                                 | 12.4 dB                                 | 11.0 dB                                 | 12.1 dB                                 |

## 8.7.2.3 Minimum requirements for high speed train conditions

Table 8.12A: Required  $E_b/N_0$  for high speed train conditions

| Transport Block size TB and TTI in frames |                         | 168 bits, TTI = 20 ms                   |   | 360 bits, TTI = 20 ms                   |   |
|---|-------------------------|---|---|---|---|
| Scenario                                  |                         | $E_b/N_0$ for required BLER < $10^{-1}$ | $E_b/N_0$ for required BLER < $10^{-2}$ | $E_b/N_0$ for required BLER < $10^{-1}$ | $E_b/N_0$ for required BLER < $10^{-2}$ |
| 1   | BS with Rx Diversity    | 5.1 dB                                  | 6.4 dB                                  | 5.3 dB                                  | 6.2 dB                                  |
|   | BS without Rx Diversity | 8.1 dB                                  | 9.4 dB                                  | 8.3 dB                                  | 9.2 dB                                  |
| 2   | BS with Rx Diversity    | n.a.                                    | n.a.                                    | n.a.                                    | n.a.                                    |
|   | BS without Rx Diversity | 7.7 dB                                  | 8.6 dB                                  | 7.4 dB                                  | 8.3 dB                                  |
| 3   | BS with Rx Diversity    | n.a.                                    | n.a.                                    | n.a.                                    | n.a.                                    |
|   | BS without Rx Diversity | 8.2 dB                                  | 9.6 dB                                  | 8.4 dB                                  | 9.3 dB                                  |

## 8.8 (void)

Table 8.13: (void)

Table 8.14: (void)

## 8.9 (void)

Table 8.15: (void)

## 8.10 Performance of ACK/NACK detection for HS-DPCCH

Performance requirements of HS-DPCCH signaling detection consist of two parts; ACK false alarm and ACK mis-detection. Requirements for these are 8.10.1 and 8.10.2, respectively. Performance requirements are specified for the reference measurement channel of HS-DPCCH and four propagation conditions: static, multi-path fading case 1, case2 and case3. The reference measurement channel for HS-DPCCH is defined in Annex A.8. The propagation conditions are defined in Annex B.1 and B.2.

### 8.10.1 ACK false alarm

The probability of ACK false alarm,  $P(\text{DTX} \rightarrow \text{ACK})$  (= false ACK detection when DTX is transmitted) shall not exceed the required error ratio for the  $E_c/N_0$  specified in Table 8.16.

**Table 8.16: Performance requirements for ACK false alarm**

| Propagation condition | Received $E_c/N_0$ (Test condition)<br>For BS with Rx Diversity | Required error ratio |
|-----------------------|---|----------------------|
| Static                | -19.9 dB  | $< 10^{-2}$          |
| Case 1                | -13.1 dB  | $< 10^{-2}$          |
| Case 2                | -16.0 dB  | $< 10^{-2}$          |
| Case 3                | -17.8 dB  | $< 10^{-2}$          |

### 8.10.2 ACK mis-detection

The probability of ACK mis-detection,  $P(\text{ACK} \rightarrow \text{NACK or DTX})$  (= mis-detected when ACK is transmitted) shall not exceed the required error ratio for the  $E_c/N_0$  specified in Table 8.17.

**Table 8.17: Performance requirements for ACK mis-detection**

| Propagation condition | Received $E_c/N_0$<br>For BS with Rx Diversity | Required error ratio |
|-----------------------|--|----------------------|
| Static                | -17.3 dB                                       | $< 10^{-2}$          |
| Case 1                | -10.7 dB                                       | $< 10^{-2}$          |
| Case 2                | -13.6 dB                                       | $< 10^{-2}$          |
| Case 3                | -12.1 dB                                       | $< 10^{-2}$          |

## 8.11 Demodulation of E-DPDCH in multipath fading condition

The performance requirement of the E-DPDCH in multi path fading condition is determined by the minimum throughput, R. For the test parameters specified in Table 8.18, the minimum requirements are specified on Table 8.19.

**Table 8.18: Test parameters for testing E-DPDCH**

| Parameter                           | Unit | Test  |
|-------------------------------------|------|---|
| RSN                                 |      | {0, 1, 2, 3}  |
| HARQ combining                      |      | IR  |
| Maximum number of HARQ transmission |      | 4   |
| Power control                       |      | OFF   |
| DPCCH slot format                   |      | 0   |
| E-DPCCH # code words                |      | 1024, no optimization based on prior knowledge of valid code words. |
| Physical channels to be turned on   |      | DPCCH, E-DPDCH and E-DPCCH  |

**Table 8.19 Minimum Requirement for E-DPDCH**

| Fixed Reference Channel            | Reference value, $E_c/N_0$ (dB),<br>for $R \geq 30\%$ and $R \geq 70\%$ of maximum information bit rate |                        |      |      |       |      |      |       |      |                  |
|------------------------------------|---|------------------------|------|------|-------|------|------|-------|------|------------------|
|                                    | Propagation conditions  | Propagation conditions | FRC1 | FRC2 | FRC3  | FRC4 | FRC5 | FRC6  | FRC7 | FRC8             |
| Non E-DPCCH boosting               |   |                        |      |      |       |      |      |       |      | E-DPCCH Boosting |
| Pedestrian A without RX diversity  | 30%   | -2.4                   | 0.8  | 2.4  | -7.1  | -4.4 | -1.4 | -15.0 | NA   | NA               |
|                                    | 70%   | 3.7                    | 7.1  | 9.1  | -0.6  | 2.1  | 5.2  | -8.4  | 16.2 | 16.9             |
| Pedestrian A with RX diversity     | 30%   | -6.2                   | -3.1 | -1.4 | -10.6 | -8.0 | -5.0 | -18.3 | NA   | NA               |
|                                    | 70%   | -1.0                   | 2.2  | 4.1  | -5.2  | -2.6 | 0.2  | -13.3 | 10.1 | 10.4             |
| Pedestrian B without RX diversity  | 30%   | -2.5                   | 1.1  | 3.5  | -7.5  | -4.7 | -1.3 | -13.6 | NA   | NA               |
|                                    | 70%   | 3.9                    | NA   | NA   | -2.1  | 0.9  | 5.3  | -10.1 | NA   | NA               |
| Pedestrian B with RX diversity     | 30%   | -6.1                   | -3.1 | -1.0 | -10.7 | -8.1 | -4.9 | -18.0 | NA   | NA               |
|                                    | 70%   | -0.3                   | 3.9  | 8.2  | -5.7  | -2.9 | 0.7  | -13.8 | 12.4 | 13.1             |
| Vehicular 30 without RX diversity  | 30%   | -2.5                   | 1.0  | 3.2  | -7.5  | -4.6 | -1.4 | -14.3 | NA   | NA               |
|                                    | 70%   | 4.9                    | NA   | NA   | -1.7  | 1.4  | 5.8  | -10.1 | NA   | NA               |
| Vehicular 30 with RX diversity     | 30%   | -6.1                   | -2.9 | -0.9 | -10.7 | -8.0 | -4.9 | -17.6 | NA   | NA               |
|                                    | 70%   | 0.6                    | 4.7  | 8.8  | -5.4  | -2.6 | 1.0  | -13.7 | 13.3 | 13.6             |
| Vehicular 120 without RX diversity | 30%   | -2.1                   | 1.3  | 3.6  | -7.3  | -4.2 | -1.2 | -14.0 | NA   | NA               |
|                                    | 70%   | 5.1                    | NA   | NA   | -1.3  | 1.5  | 6.1  | -10.1 | NA   | NA               |
| Vehicular 120 with RX diversity    | 30%   | -5.7                   | -2.6 | -0.5 | -10.4 | -7.6 | -4.3 | -17.0 | NA   | NA               |
|                                    | 70%   | 0.7                    | 5.0  | 9.5  | -5.1  | -2.3 | 1.2  | -13.2 | NA   | NA               |

## 8.12 Performance of signaling detection for E-DPCCH in multipath fading condition

The performance requirement of the E-DPCCH in multi path fading condition is determined by the false alarm rate and the missed detection rate. For the test parameters specified in Table 8.20, the minimum requirements are specified in Table 8.21 and 8.22.

**Table 8.20: Test parameters for testing E-DPCCH**

| Parameter   | Unit | Test  |
|---|------|---|
| Power control   |      | Off   |
| E-DPCCH # code words  |      | 1024, no optimization based on prior knowledge of valid code words. |
| Physical channels to be turned on for missed detection test |      | DPCCH, E-DPDCH and E-DPCCH  |
| Physical channels to be turned on for false alarm test      |      | DPCCH   |



**Table 8.21: Performance requirements for E-DPCCH false alarm**

| Propagation conditions             | Received $E_c/N_0$ |          | Required detection probability |
|------------------------------------|--------------------|----------|--------------------------------|
|                                    | FRC1               | FRC4     |                                |
| Pedestrian A without RX diversity  | -1.6 dB            | -5.0 dB  | $< 10^{-2}$                    |
| Pedestrian A with RX diversity     | -11.2 dB           | -12.3 dB | $< 10^{-2}$                    |
| Pedestrian B without RX diversity  | -13.8 dB           | -15.2 dB | $< 10^{-2}$                    |
| Pedestrian B with RX diversity     | -16.4 dB           | -17.6 dB | $< 10^{-2}$                    |
| Vehicular 30 without RX diversity  | -12.1 dB           | -16.7 dB | $< 10^{-2}$                    |
| Vehicular 30 with RX diversity     | -15.7 dB           | -18.6 dB | $< 10^{-2}$                    |
| Vehicular 120 without RX diversity | -13.8 dB           | -18.3 dB | $< 10^{-2}$                    |
| Vehicular 120 with RX diversity    | -17.1 dB           | -19.6 dB | $< 10^{-2}$                    |

**Table 8.22: Performance requirements for E-DPCCH missed detection**

| Propagation conditions             | Received $E_c/N_0$ |          | Required missed detection probability |
|------------------------------------|--------------------|----------|---------------------------------------|
|                                    | FRC1               | FRC4     |                                       |
| Pedestrian A without RX diversity  | 13.7 dB            | 7.4 dB   | $< 2 \cdot 10^{-3}$                   |
| Pedestrian A with RX diversity     | 1.2 dB             | -2.8 dB  | $< 2 \cdot 10^{-3}$                   |
| Pedestrian B without RX diversity  | 1.5 dB             | -2.8 dB  | $< 2 \cdot 10^{-3}$                   |
| Pedestrian B with RX diversity     | -4.0 dB            | -8.1 dB  | $< 2 \cdot 10^{-3}$                   |
| Vehicular 30 without RX diversity  | 3.2 dB             | -4.3 dB  | $< 2 \cdot 10^{-3}$                   |
| Vehicular 30 with RX diversity     | -3.3 dB            | -9.1 dB  | $< 2 \cdot 10^{-3}$                   |
| Vehicular 120 without RX diversity | 1.5 dB             | -5.9 dB  | $< 2 \cdot 10^{-3}$                   |
| Vehicular 120 with RX diversity    | -4.7 dB            | -10.1 dB | $< 2 \cdot 10^{-3}$                   |

## Annex A (normative): Measurement channels

### A.1 Summary of UL reference measurement channels

The parameters for the UL reference measurement channels are specified in Table A.1 and the channel coding is detailed in figure A.2 through A.6 respectively. Note that for all cases, one DPCCH shall be attached to DPDCH(s).

**Table A.1: Reference measurement channels for UL DCH**

| Parameter                      |                      | DCH for DTCH / DCH for DCCH |        |         |         | Unit     |
|--------------------------------|----------------------|-----------------------------|--------|---------|---------|----------|
| DPDCH                          | Information bit rate | 12.2/2.4                    | 64/2.4 | 144/2.4 | 384/2.4 | kbps     |
|                                | Physical channel     | 60/15                       | 240/15 | 480/15  | 960/15  | kbps     |
|                                | Spreading factor     | 64                          | 16     | 8       | 4       |          |
|                                | Repetition rate      | 22/22                       | 19/19  | 8/9     | -18/-17 | %        |
|                                | Interleaving         | 20                          | 40     | 40      | 40      | ms       |
|                                | Number of DPDCHs     | 1                           | 1      | 1       | 1       |          |
| DPCCH                          | Dedicated pilot      | 6                           |        |         |         | bit/slot |
|                                | Power control        | 2                           |        |         |         | bit/slot |
|                                | TFCI                 | 2                           |        |         |         | bit/slot |
|                                | Spreading factor     | 256                         |        |         |         |          |
| Power ratio of DPCCH/DPDCH     |                      | -2.69                       | -5.46  | -9.54   | -9.54   | dB       |
| Amplitude ratio of DPCCH/DPDCH |                      | 0.7333                      | 0.5333 | 0.3333  | 0.3333  |          |

## A.2 UL reference measurement channel for 12.2 kbps

The parameters for the UL reference measurement channel for 12.2 kbps are specified in Table A.2 and the channel coding is detailed in Figure A.2.

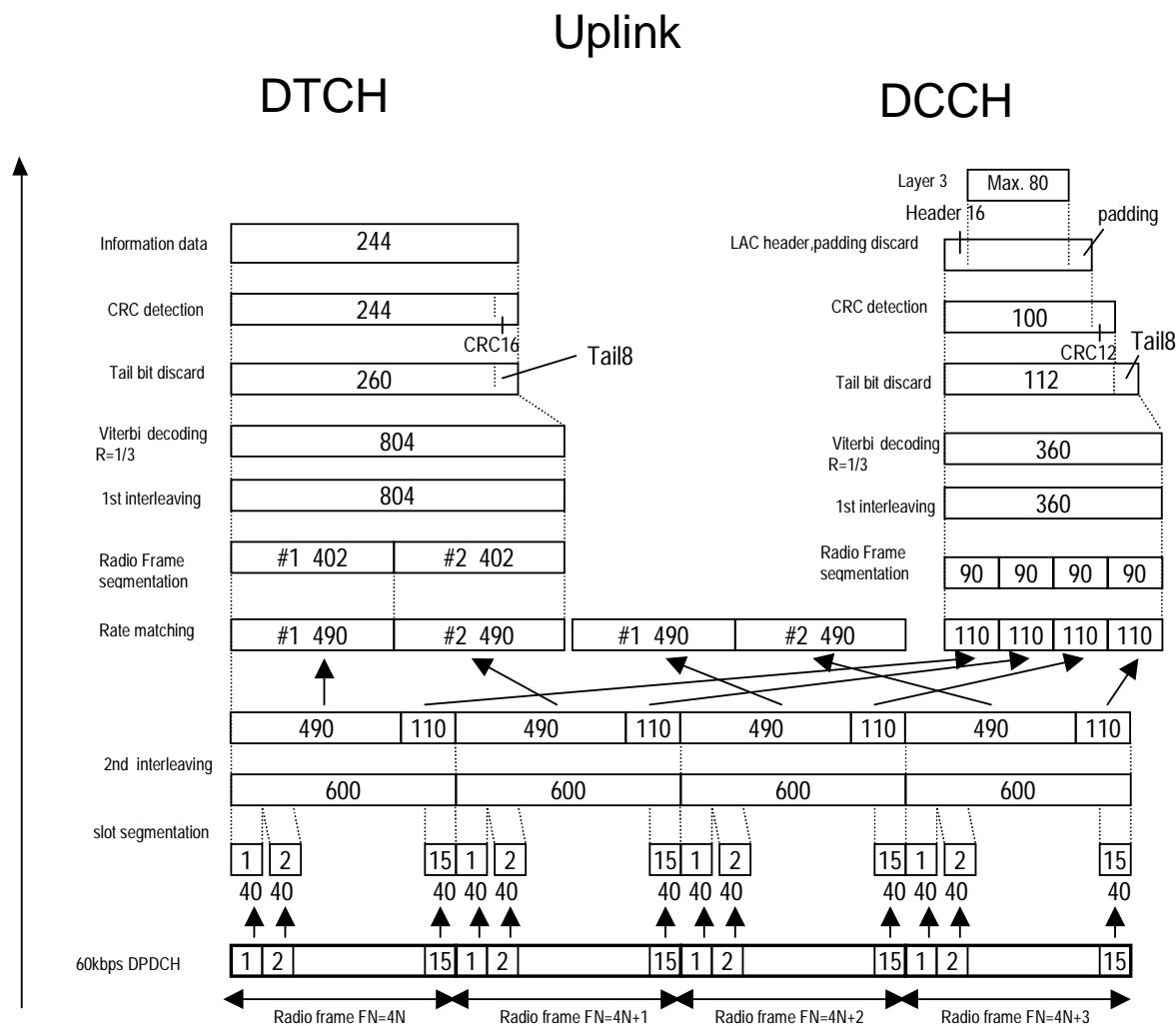

Figure A.2: Channel coding for the UL reference measurement channel (12.2 kbps)

Table A.2: UL reference measurement channel (12.2 kbps)

| Parameter            | Level | Unit |
|----------------------|-------|------|
| Information bit rate | 12.2  | kbps |
| DPCH                 | 60    | kbps |
| Power control        | Off   |      |
| TFCI                 | On    |      |
| Repetition           | 22    | %    |

# A.3 UL reference measurement channel for 64 kbps

The parameters for the UL reference measurement channel for 64 kbps are specified in Table A.3 and the channel coding is detailed in Figure A.3.

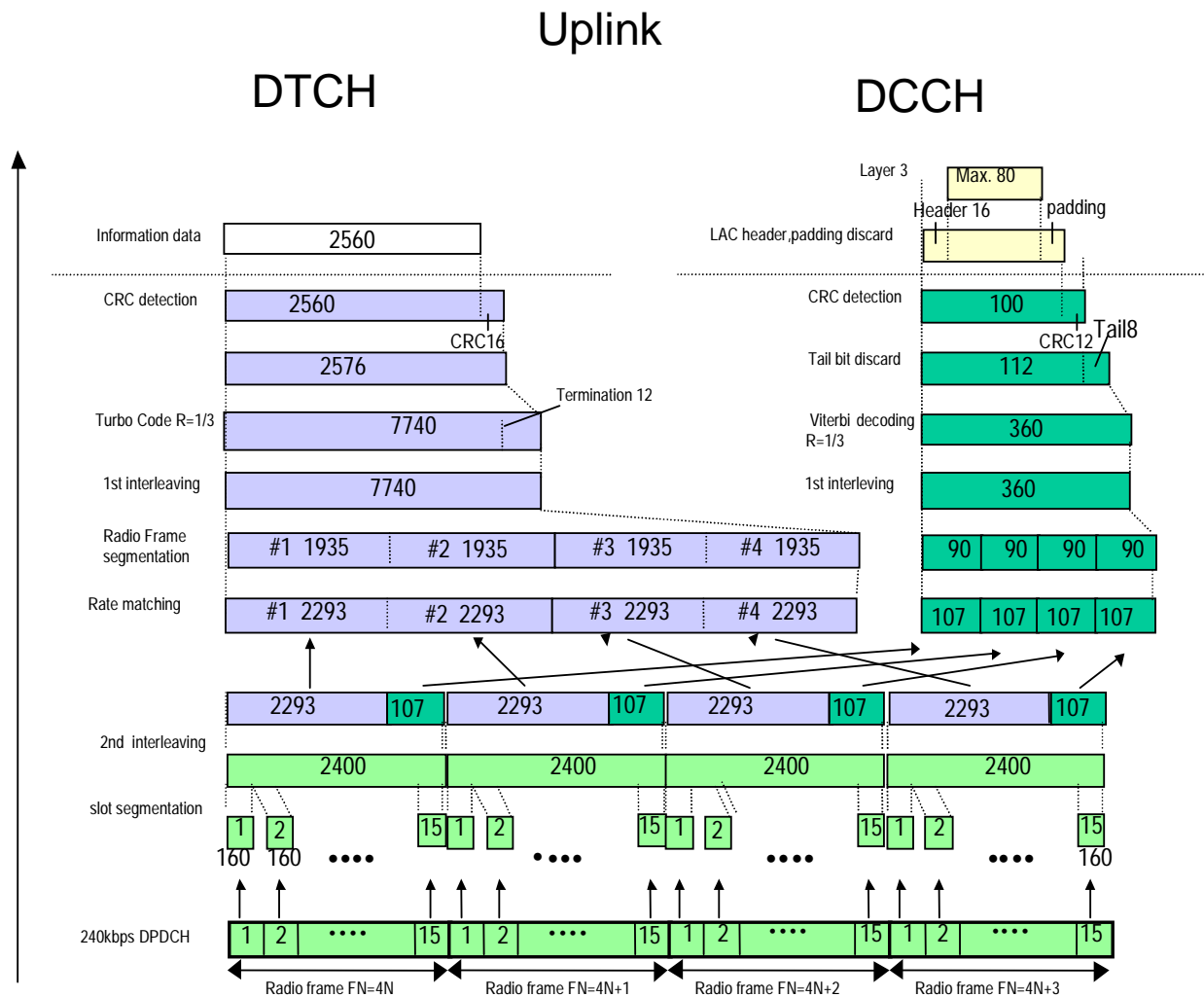

Figure A.3: Channel coding for the UL reference measurement channel (64 kbps)

Table A.3: UL reference measurement channel (64kbps)

| Parameter            | Level | Unit |
|----------------------|-------|------|
| Information bit rate | 64    | kbps |
| DPCH                 | 240   | kbps |
| Power control        | Off   |      |
| TFCI                 | On    |      |
| Repetition           | 19    | %    |

# A.4 UL reference measurement channel for 144 kbps

The parameters for the UL reference measurement channel for 144 kbps are specified in Table A.4 and the channel coding is detailed in Figure A.4.

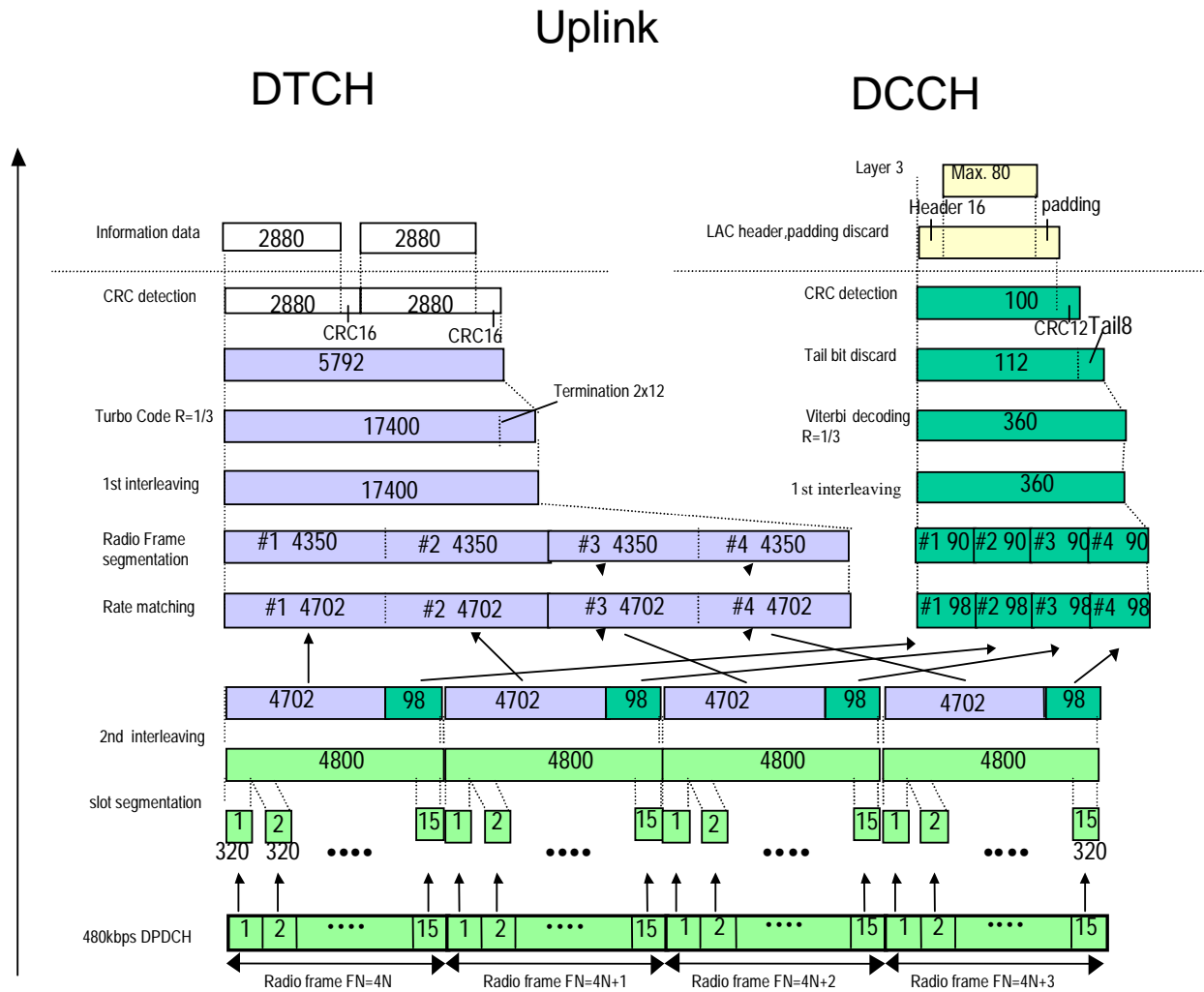

Figure A.4: Channel coding for the UL reference measurement channel (144 kbps)

Table A.4: UL reference measurement channel (144kbps)

| Parameter            | Level | Unit |
|----------------------|-------|------|
| Information bit rate | 144   | Kbps |
| DPCH                 | 480   | Kbps |
| Power control        | Off   |      |
| TFCI                 | On    |      |
| Repetition           | 8     | %    |

# A.5 UL reference measurement channel for 384 kbps

The parameters for the UL reference measurement channel for 384 kbps are specified in Table A.5 and the channel coding is detailed in Figure A.5.

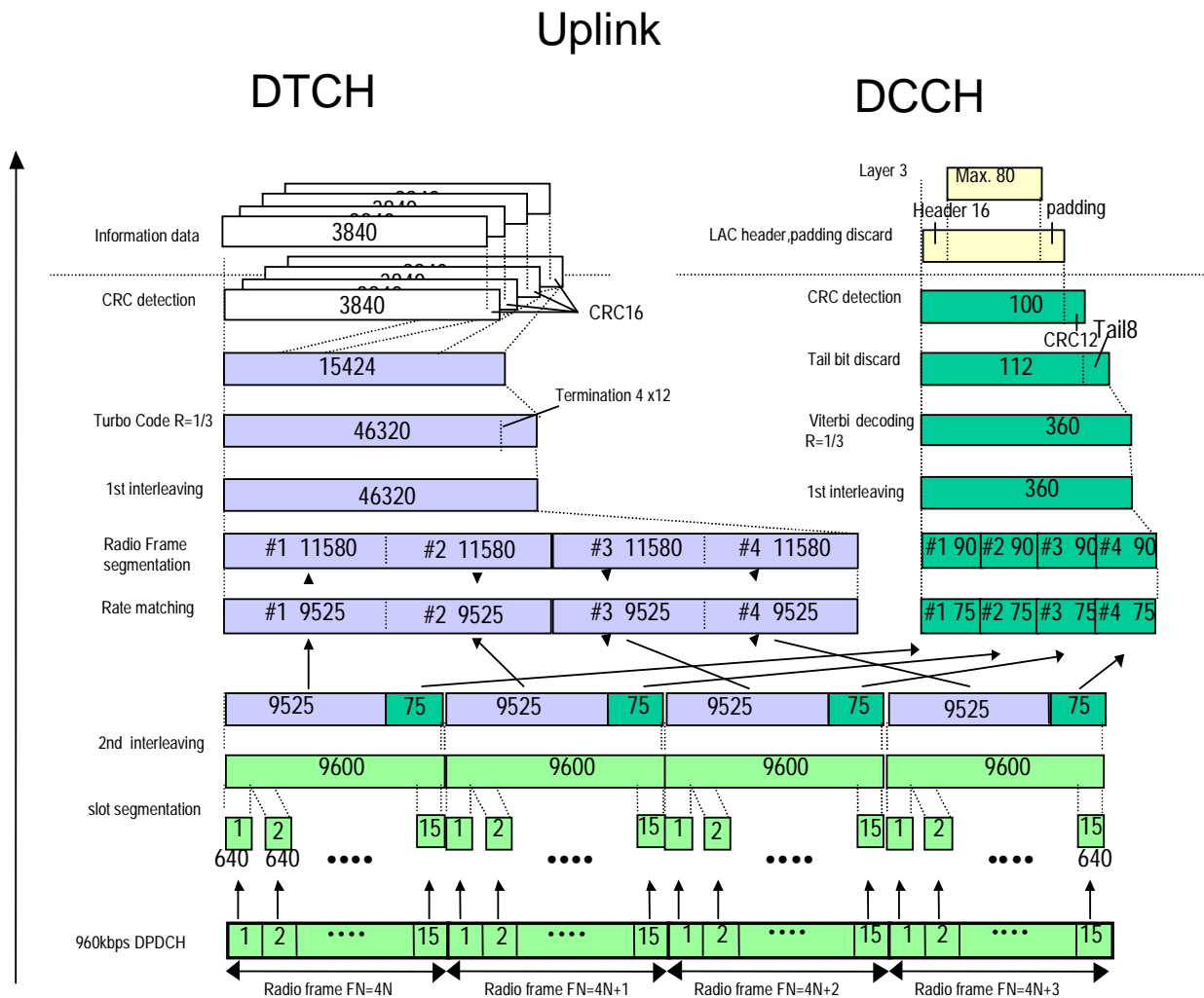

Figure A.5: Channel coding for the UL reference measurement channel (384 kbps)

Table A.5: UL reference measurement channel (384kbps)

| Parameter            | Level | Unit |
|----------------------|-------|------|
| Information bit rate | 384   | Kbps |
| DPCH                 | 960   | Kbps |
| Power control        | Off   |      |
| TFCI                 | On    |      |
| Puncturing           | 18    | %    |

# A.6 (void)

Figure A.6: (void)

Table A.6: (void)

## A.7 Reference measurement channels for UL RACH

The parameters for the UL RACH reference measurement channels are specified in Table A.7.

Table A.7: Reference measurement channels for UL RACH

| Parameter                                 |   |                     | Unit  |
|---|---|---------------------|-------|
| RACH                                      | CRC   | 16                  | bits  |
|   | Channel Coding                                  | Rate ½ conv. coding |       |
|   | TTI   | 20                  | ms    |
|   | TB size   | 168, 360            | bits  |
|   | Rate Matching                                   | Repetition          |       |
|   | Number of diversity antennas                    | 2                   |       |
|   | Preamble detection window size                  | 256                 | chips |
|   | Ratio of preamble power and total message power | 0                   | dB    |
| Power ratio of RACH Control/Data TB = 168 |   | -2.69               | dB    |
| Power ratio of Control/Data TB = 360      |   | -3.52               | dB    |

## A.8 Reference measurement channel for HS-DPCCH

The parameters for the UL HS-DPCCH reference measurement channel are specified in Table A.8.

Table A.8: Reference measurement channel for HS-DPCCH

| Parameter                       |                  |                      | Unit   |           |
|---------------------------------|------------------|----------------------|--------|-----------|
| DPDCH                           | DTCH             | Information bit rate | 12.2   | kbps      |
|                                 |                  | Physical channel     | 60     | kbps      |
|                                 |                  | Repetition rate      | 22     | %         |
|                                 | DCCH             | Information bit rate | 2.4    | kbps      |
|                                 |                  | Physical channel     | 15     | kbps      |
|                                 |                  | Repetition rate      | 22     | %         |
|                                 | Spreading factor |                      | 64     |           |
|                                 | Interleaving     |                      | 20     | ms        |
|                                 | Number of DPDCHs |                      | 1      |           |
| DPCCH                           | Dedicated pilot  |                      | 6      | bits/slot |
|                                 | Power control    |                      | 2      | bits/slot |
|                                 | TFCI             |                      | 2      | bits/slot |
|                                 | Spreading factor |                      | 256    |           |
| Power ratio of DPCCH/DPDCH      |                  |                      | -2.69  | dB        |
| Amplitude ratio of DPCCH/DPDCH  |                  |                      | 0.7333 |           |
| Closed loop power control       |                  |                      | OFF    |           |
| HS-DPCCH repetition             |                  |                      | 1      |           |
| HS-DPCCH power offset to DPCCH  |                  |                      | 0      | dB        |
| HS-DPCCH timing offset to DPCCH |                  |                      | 0      | symbol    |

DPDCH/DPCCH are same as 12.2kbps reference measurement channel specified in Annex A.2.

## A.9 Summary of E-DPDCH Fixed reference channels

Table A.9

| Fixed Ref Channel | TTI [ms] | $N_{INF}$ | $SF_1$ | $SF_2$ | $SF_3$ | $SF_4$ | $N_{BIN}$ | Coding rate | Max inf bit rate [kbps] |
|-------------------|----------|-----------|--------|--------|--------|--------|-----------|-------------|-------------------------|
| FRC1              | 2        | 2706      | 4      | 4      | 0      | 0      | 3840      | 0.705       | 1353.0                  |
| FRC2              | 2        | 5412      | 2      | 2      | 0      | 0      | 7680      | 0.705       | 2706.0                  |
| FRC3              | 2        | 8100      | 2      | 2      | 4      | 4      | 11520     | 0.703       | 4050.0                  |
| FRC4              | 10       | 5076      | 4      | 0      | 0      | 0      | 9600      | 0.529       | 507.6                   |
| FRC5              | 10       | 9780      | 4      | 4      | 0      | 0      | 19200     | 0.509       | 978.0                   |
| FRC6              | 10       | 19278     | 2      | 2      | 0      | 0      | 38400     | 0.502       | 1927.8                  |
| FRC7              | 10       | 690       | 16     | 0      | 0      | 0      | 2400      | 0.288       | 69.0                    |
| FRC8              | 2        | 16218     | 2      | 2      | 4      | 4      | 23040     | 0.704       | 8109.0                  |

## A.10 E-DPDCH Fixed reference channel 1 (FRC1)

Table A.10

| Parameter   | Unit                         | Value   |
|---|------------------------------|---|
| Maximum. Inf. Bit Rate  | kbps                         | 1353.0  |
| TTI   | ms                           | 2   |
| Number of HARQ Processes  | Processes                    | 8   |
| Information Bit Payload ( $N_{INF}$ )   | Bits                         | 2706  |
| Binary Channel Bits per TTI ( $N_{BIN}$ )<br>( $3840 / SF \times TTI$ sum for all channels)     | Bits                         | 3840  |
| Coding Rate ( $N_{INF} / N_{BIN}$ )   |                              | 0.705   |
| Physical Channel Codes  | SF for each physical channel | {4,4}   |
| E-DPDCH testing:<br>E-DPDCH/DPCCH power ratio<br><br>E-DPCCH/DPCCH power ratio                  | dB<br>dB<br>dB<br>dB         | Diversity: 8.94<br>Non-diversity: 12.04<br>Diversity: 2.05<br>Non-diversity: 6.02<br>E-DPDCH /DPCCH power ratio is calculated for a single E-DPDCH. |
| E-DPCCH missed detection testing:<br>E-DPDCH/DPCCH power ratio<br><br>E-DPCCH/DPCCH power ratio | dB<br>dB<br>dB<br>dB         | Diversity: 8.94<br>Non-diversity: 12.04<br>Diversity: -1.94<br>Non-diversity: 0.00  |



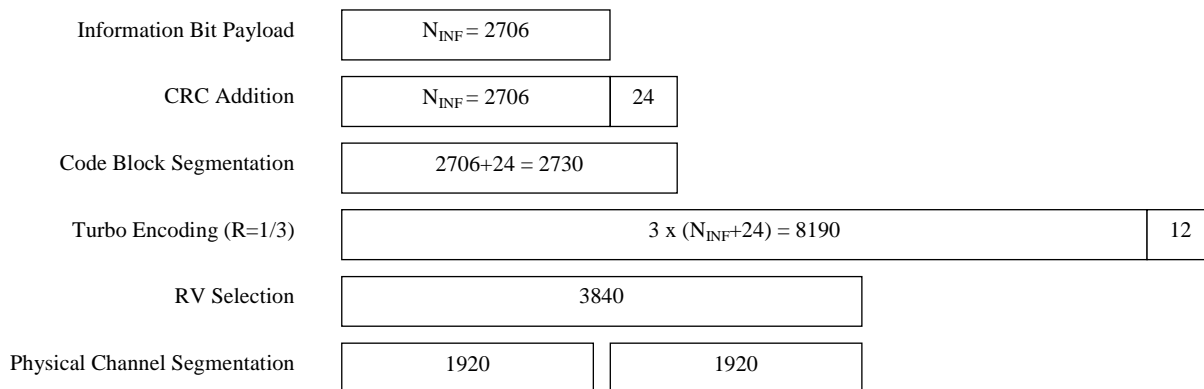

Figure A.10

## A.11 E-DPDCH Fixed reference channel 2 (FRC2)

Table A.11

| Parameter   | Unit                         | Value  |
|---|------------------------------|--|
| Maximum. Inf. Bit Rate  | kbps                         | 2706.0   |
| TTI   | ms                           | 2  |
| Number of HARQ Processes  | Processes                    | 8  |
| Information Bit Payload ( $N_{INF}$ )   | Bits                         | 5412   |
| Binary Channel Bits per TTI ( $N_{BIN}$ )<br>(3840 / SF x TTI sum for all channels) | Bits                         | 7680   |
| Coding Rate ( $N_{INF} / N_{BIN}$ )   |                              | 0.705  |
| Physical Channel Codes  | SF for each physical channel | {2,2}  |
| E-DPDCH testing:<br>E-DPDCH/DPCCH power ratio                                       | dB                           | Diversity: 9.92<br>Non-diversity: 13.00                        |
| E-DPCCH/DPCCH power ratio   | dB                           | Diversity: 4.08<br>Non-diversity: 6.02                         |
|   |                              | E-DPDCH /DPCCH power ratio is calculated for a single E-DPDCH. |

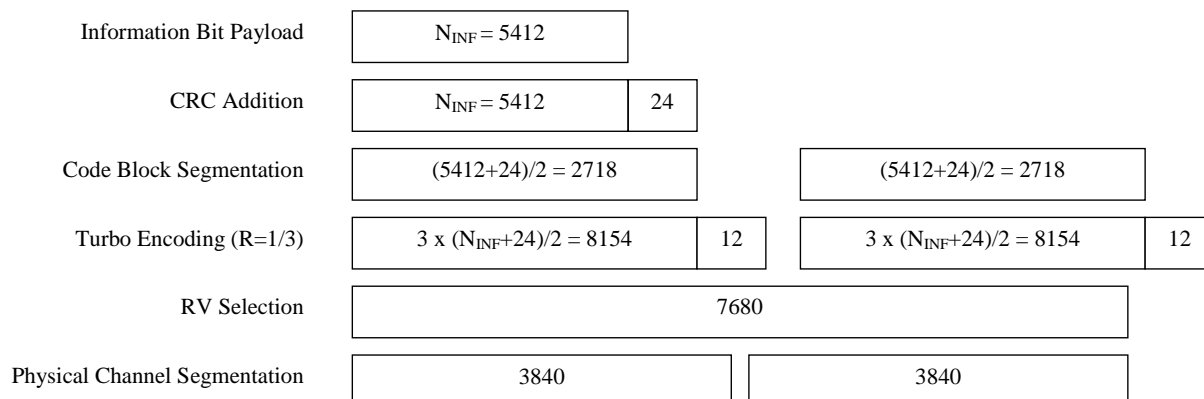

Figure A.11

# A.12 E-DPDCH Fixed reference channel 3 (FRC3)

Table A.12

| Parameter   | Unit                         | Value   |
|---|------------------------------|---|
| Maximum. Inf. Bit Rate  | kbps                         | 4050.0  |
| TTI   | ms                           | 2   |
| Number of HARQ Processes  | Processes                    | 8   |
| Information Bit Payload ( $N_{INF}$ )   | Bits                         | 8100  |
| Binary Channel Bits per TTI ( $N_{BIN}$ )<br>(3840 / SF x TTI sum for all channels) | Bits                         | 11520   |
| Coding Rate ( $N_{INF} / N_{BIN}$ )   |                              | 0.703   |
| Physical Channel Codes  | SF for each physical channel | {2,2,4,4}   |
| E-DPDCH testing:<br>E-DPDCH/DPCCH power ratio<br><br>E-DPCCH/DPCCH power ratio      | dB<br>dB<br>dB<br>dB         | Diversity: 6.02<br>Non-diversity: 8.94<br>Diversity: 0.0<br>Non-diversity: 2.05<br><br>E-DPDCH/DPCCH power ratio is calculated for a single E-DPDCH with SF 4. The power of an E-DPDCH with SF2 is twice that of an E-DPDCH with SF4. |

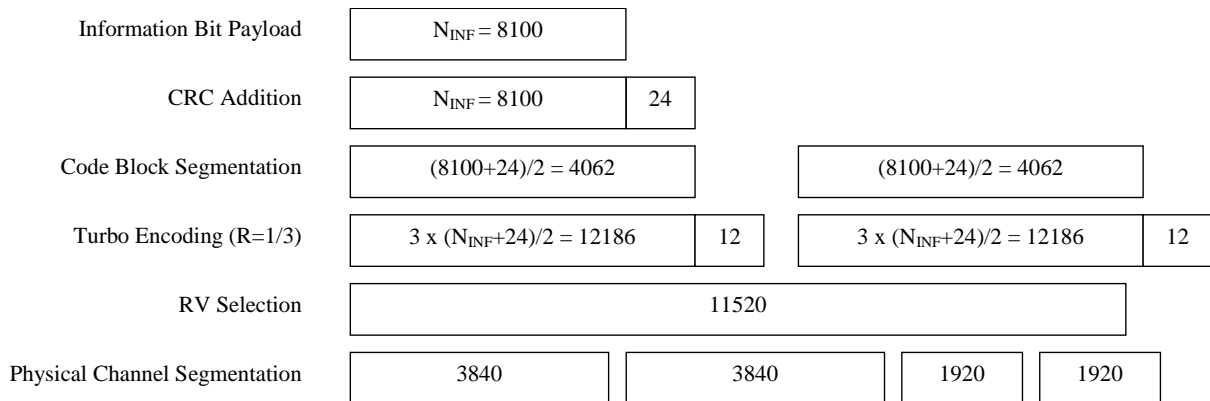

Figure A.12

# A.13 E-DPDCH Fixed reference channel 4 (FRC4)

Table A.13

| Parameter   | Unit                         | Value                                    |
|---|------------------------------|--|
| Maximum. Inf. Bit Rate  | kbps                         | 507.6                                    |
| TTI   | ms                           | 10                                       |
| Number of HARQ Processes  | Processes                    | 4  |
| Information Bit Payload ( $N_{INF}$ )   | Bits                         | 5076                                     |
| Binary Channel Bits per TTI ( $N_{BIN}$ )<br>( $3840 / SF \times TTI$ sum for all channels) | Bits                         | 9600                                     |
| Coding Rate ( $N_{INF} / N_{BIN}$ )   |                              | 0.529                                    |
| Physical Channel Codes  | SF for each physical channel | {4}                                      |
| E-DPDCH testing:<br>E-DPDCH/DPCCH power ratio   | dB                           | Diversity: 8.94<br>Non-diversity: 12.04  |
| E-DPCCH/DPCCH power ratio   | dB                           | Diversity: -1.94<br>Non-diversity: 0.0   |
| E-DPCCH missed detection testing:<br>E-DPDCH/DPCCH power ratio                              | dB                           | Diversity: 8.94<br>Non-diversity: 12.04  |
| E-DPCCH/DPCCH power ratio   | dB                           | Diversity: -7.96<br>Non-diversity: -5.46 |

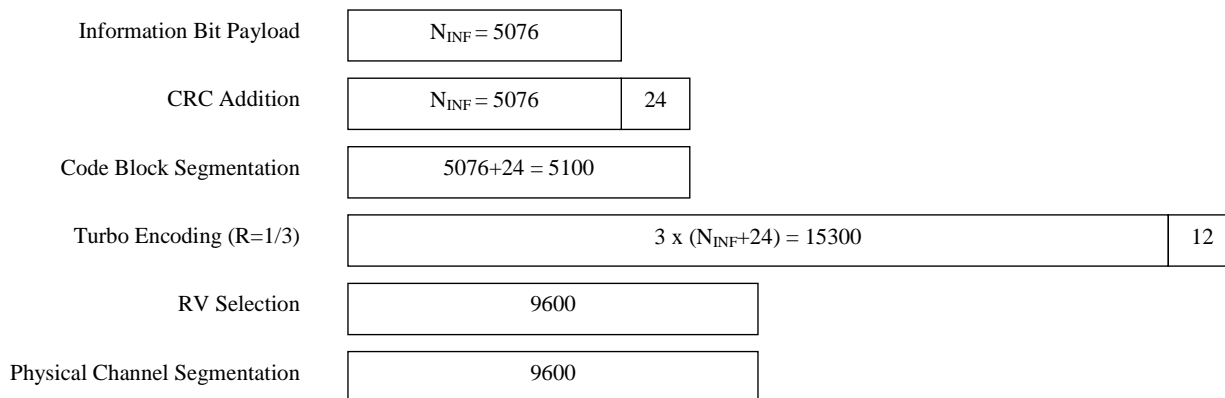

Figure A.13

# A.14 E-DPDCH Fixed reference channel 5 (FRC5)

Table A.14

| Parameter   | Unit                         | Value   |
|---|------------------------------|---|
| Maximum. Inf. Bit Rate  | kbps                         | 978.0   |
| TTI   | ms                           | 10  |
| Number of HARQ Processes  | Processes                    | 4   |
| Information Bit Payload ( $N_{INF}$ )   | Bits                         | 9780  |
| Binary Channel Bits per TTI ( $N_{BIN}$ )<br>(3840 / SF x TTI sum for all channels) | Bits                         | 19200   |
| Coding Rate ( $N_{INF} / N_{BIN}$ )   |                              | 0.509   |
| Physical Channel Codes  | SF for each physical channel | {4,4}   |
| E-DPDCH testing:<br>E-DPDCH/DPCCH power ratio<br><br>E-DPCCH/DPCCH power ratio      | dB<br>dB<br>dB<br>dB         | Diversity: 8.94<br>Non-diversity: 12.04<br>Diversity: -1.94<br>Non-diversity: 0.0<br><br>E-DPDCH /DPCCH power ratio is calculated for a single E-DPDCH. |

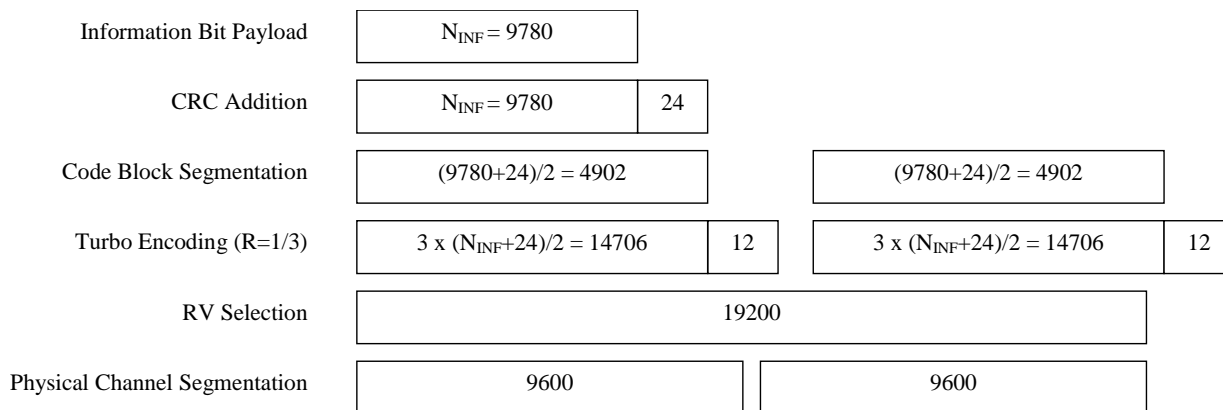

Figure A.14

## A.15 E-DPDCH Fixed reference channel 6 (FRC6)

Table A.15

| Parameter   | Unit                         | Value   |
|---|------------------------------|---|
| Maximum. Inf. Bit Rate  | kbps                         | 1927.8  |
| TTI   | ms                           | 10  |
| Number of HARQ Processes  | Processes                    | 4   |
| Information Bit Payload ( $N_{INF}$ )   | Bits                         | 19278   |
| Binary Channel Bits per TTI ( $N_{BIN}$ )<br>(3840 / SF x TTI sum for all channels) | Bits                         | 38400   |
| Coding Rate ( $N_{INF} / N_{BIN}$ )   |                              | 0.502   |
| Physical Channel Codes  | SF for each physical channel | {2,2}   |
| E-DPDCH testing:<br>E-DPDCH/DPCCH power ratio<br><br>E-DPCCH/DPCCH power ratio      | dB<br>dB<br>dB<br>dB         | Diversity: 9.92<br>Non-diversity: 13.00<br>Diversity: -5.46<br>Non-diversity: -1.94<br><br>E-DPDCH /DPCCH power ratio is calculated for a single E-DPDCH. |

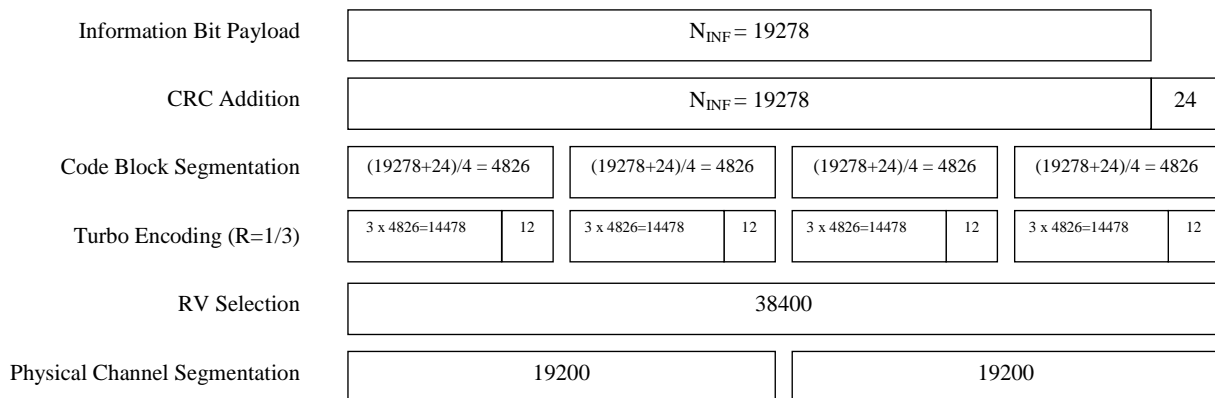

Figure A.15

## A.16 E-DPDCH Fixed reference channel 7 (FRC7)

Table A.16

| Parameter   | Unit                         | Value   |
|---|------------------------------|---|
| Maximum. Inf. Bit Rate  | kbps                         | 69.0  |
| TTI   | ms                           | 10  |
| Number of HARQ Processes  | Processes                    | 4   |
| Information Bit Payload ( $N_{INF}$ )   | Bits                         | 690   |
| Binary Channel Bits per TTI ( $N_{BIN}$ )<br>(3840 / SF x TTI sum for all channels) | Bits                         | 2400  |
| Coding Rate ( $N_{INF} / N_{BIN}$ )   |                              | 0.288   |
| Physical Channel Codes  | SF for each physical channel | {16}  |
| E-DPDCH testing:<br>E-DPDCH/DPCCH power ratio<br><br>E-DPCCH/DPCCH power ratio      | dB<br>dB<br>dB<br>dB         | Diversity: 6.02<br>Non-diversity: 8.94<br>Diversity: 0.0<br>Non-diversity: 4.08 |

|                               |                                   |    |
|-------------------------------|-----------------------------------|----|
| Information Bit Payload       | N <sub>INF</sub> = 690            |    |
| CRC Addition                  | N <sub>INF</sub> = 690            | 24 |
| Code Block Segmentation       | 690+24 = 714                      |    |
| Turbo Encoding (R=1/3)        | 3 x (N <sub>INF</sub> +24) = 2142 |    |
| RV Selection                  | 2400                              |    |
| Physical Channel Segmentation | 2400                              |    |

Figure A.16

## A.17 E-DPDCH Fixed reference channel 8 (FRC8)

Table A.17

| Parameter   | Unit                         | Value  |
|---|------------------------------|--|
| Modulation  |                              | 16QAM  |
| Maximum. Inf. Bit Rate  | kbps                         | 8109.0   |
| TTI   | ms                           | 2  |
| Number of HARQ Processes  | Processes                    | 8  |
| Information Bit Payload (N <sub>INF</sub> )   | Bits                         | 16218  |
| Binary Channel Bits per TTI (N <sub>BIN</sub> )<br>(3840 / SF x TTI sum for all channels) | Bits                         | 23040  |
| Coding Rate (N <sub>INF</sub> / N <sub>BIN</sub> )  |                              | 0.704  |
| Physical Channel Codes  | SF for each physical channel | {2,2,4,4}  |
| E-DPDCH testing:  |                              | <b>Non E-DPCCH boosting</b>  |
| E-DPDCH/DPCCH power ratio   | dB                           | Diversity: 4.09  |
| E-DPCCH/DPCCH power ratio   | dB                           | Non-diversity: 6.98  |
|   | dB                           | Diversity: -9.54   |
|   | dB                           | Non-diversity: -5.46   |
| ΔT2TP   | dB                           | <b>E-DPCCH Boosting</b>  |
| E-DPDCH/DPCCH power ratio   | dB                           | Diversity: 12  |
|   | dB                           | Non-diversity: 15  |
| E-DPCCH/DPCCH power ratio   | dB                           | Diversity: 19.99   |
|   | dB                           | Non-diversity: 22.00   |
|   | dB                           | Diversity: 16.03   |
|   | dB                           | Non-diversity: 14.09   |
|   |                              | E-DPDCH/DPCCH power ratio is calculated for a single E-DPDCH with SF 4. The power of an E-DPDCH with SF2 is twice that of an E-DPDCH with SF4. |

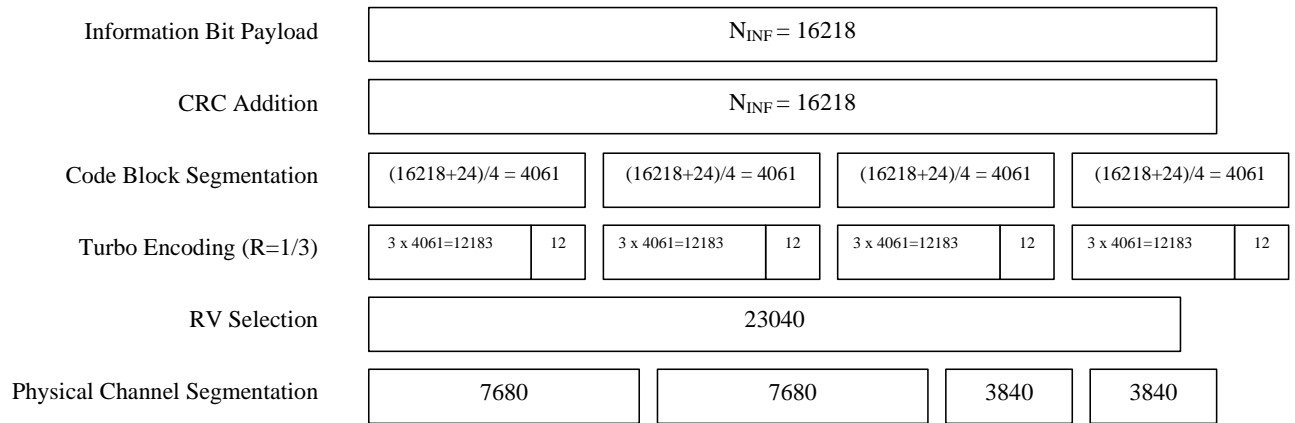

Figure A.17

## Annex B (normative): Propagation conditions

### B.1 Static propagation condition

The propagation for the static performance measurement is an Additive White Gaussian Noise (AWGN) environment. No fading or multi-paths exist for this propagation model.

### B.2 Multi-path fading propagation conditions

Table B.1 shows propagation conditions that are used for the performance measurements in multi-path fading environment. All taps have classical Doppler spectrum, defined as:

$$(CLASS) \quad S(f) \propto 1/(1 - (f / f_D)^2)^{0.5} \quad \text{for } f \in [-f_D, f_D]$$

**Table B.1: Propagation Conditions for Multi-path Fading Environments**

| Case 1   |                    | Case 2   |                    | Case 3   |                    | Case 4   |                    |
|--|--------------------|--|--------------------|--|--------------------|--|--------------------|
| Speed for Band I, II, III, IV, IX, X<br>3 km/h |                    | Speed for Band I, II, III, IV, IX, X<br>3 km/h |                    | Speed for Band I, II, III, IV, IX, X<br>120 km/h |                    | Speed for Band I, II, III, IV, IX, X<br>250 km/h |                    |
| Speed for Band V, VI, VIII<br>7 km/h           |                    | Speed for Band V, VI, VIII<br>7 km/h           |                    | Speed for Band V, VI, VIII<br>280 km/h           |                    | Speed for Band V, VI, VIII<br>583 km/h (Note 1)  |                    |
| Speed for Band VII<br>2.3 km/h                 |                    | Speed for Band VII<br>2.3 km/h                 |                    | Speed for Band VII<br>92 km/h                    |                    | Speed for Band VII<br>192 km/h                   |                    |
| Speed for Band XI<br>4.1 km/h                  |                    | Speed for Band XI<br>4.1 km/h                  |                    | Speed for Band XI<br>166 km/h                    |                    | Speed for Band XI<br>345 km/h (Note 1)           |                    |
| Speed for Band XII, XIII, XIV<br>8 km/h        |                    | Speed for Band XII, XIII, XIV<br>8 km/h        |                    | Speed for Band XII, XIII, XIV<br>320 km/h        |                    | Speed for Band XII, XIII, XIV<br>668 km/h        |                    |
| Relative Delay [ns]                            | Average Power [dB] | Relative Delay [ns]                            | Average Power [dB] | Relative Delay [ns]                              | Average Power [dB] | Relative Delay [ns]                              | Average Power [dB] |
| 0  | 0                  | 0  | 0                  | 0  | 0                  | 0  | 0                  |
| 976  | -10                | 976  | 0                  | 260  | -3                 | 260  | -3                 |
|  |                    | 20000  | 0                  | 521  | -6                 | 521  | -6                 |
|  |                    |  |                    | 781  | -9                 | 781  | -9                 |

NOTE 1: Speed above 250km/h is applicable to demodulation performance requirements only.

### B.3 Moving propagation conditions

The dynamic propagation conditions for the test of the base band performance are non-fading channel models with two taps. The moving propagation condition has two tap, one static, Path0, and one moving, Path1. The time difference between the two paths is according Equation (B.1). The parameters for the equation are shown in Table B.2. The taps have equal strengths and equal phases.



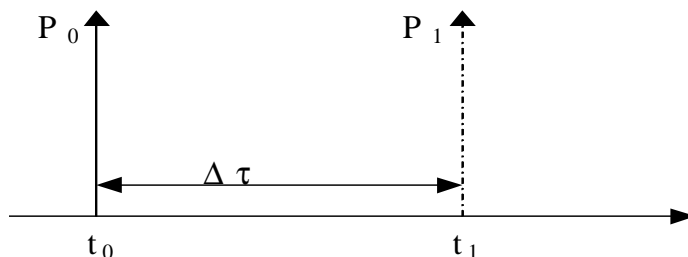

Figure B.1: The moving propagation conditions

$$\Delta\tau = B + \frac{A}{2}(1 + \sin(\Delta\omega \cdot t)) \tag{B.1}$$

Table B.2: Parameters for moving propagation

| Parameter | Value                               |
|-----------|-------------------------------------|
| A         | 5 μs                                |
| B         | 1 μs                                |
| Δω        | 40·10 <sup>-3</sup> s <sup>-1</sup> |

## B.4 Birth-Death propagation conditions

The dynamic propagation conditions for the test of the baseband performance is a non-fading propagation channel with two taps. The birth-death propagation conditions has two taps, Path1 and Path2 which alternate between 'birth' and 'death'. The positions the paths appear are randomly selected with an equal probability rate and are shown in Figure B.2. For BS with receiver diversity, the same path positions shall be applied to both receiver antenna connectors, and the path switching times shall be synchronized on the two receiver antenna connectors, but the AWGN signals applied to the two receiver antenna connectors shall be uncorrelated.

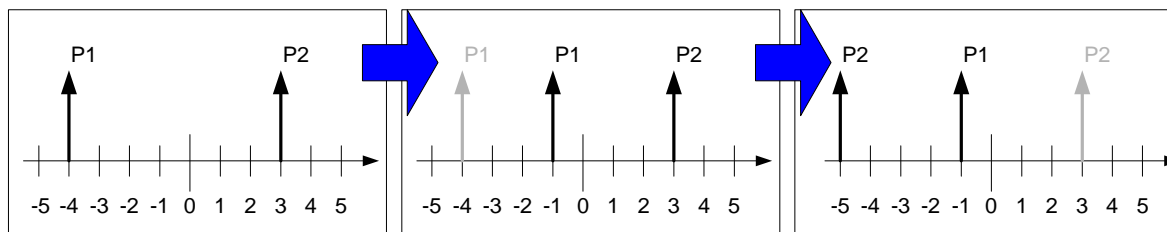

Figure B.2: Birth death propagation sequence

1. Two paths, Path1 and Path2 are randomly selected from the group [-5, -4, -3, -2, -1, 0, 1, 2, 3, 4, 5] μs. The paths have equal magnitudes and equal phases.
2. After 191 ms, Path1 vanishes and reappears immediately at a new location randomly selected from the group [-5, -4, -3, -2, -1, 0, 1, 2, 3, 4, 5] μs but excludes the point Path2. The magnitudes and the phases of the tap coefficients of Path 1 and Path 2 shall remain unaltered.
3. After an additional 191 ms, Path2 vanishes and reappears immediately at a new location randomly selected from the group [-5, -4, -3, -2, -1, 0, 1, 2, 3, 4, 5] μs but excludes the point Path1. The magnitudes and the phases of the tap coefficients of Path 1 and Path 2 shall remain unaltered.
4. The sequence in 2) and 3) is repeated.

## B.4A High speed train conditions

High speed train conditions are as follows.

Scenario 1: Open space

Scenario 2: Tunnel with leaky cable

Scenario 3: Tunnel for multi-antennas

The high speed train conditions for the test of the baseband performance are 2 non fading propagation channels (scenario 1 and 3) and 1 fading propagation channel (scenario 2) with one tap. For BS with Rx diversity defined in scenario 1, the Doppler shift variation is the same between antennas.

For scenario 1 and 3, Doppler shift is given by

$$f_s(t) = f_d \cos \theta(t) \quad (\text{B.2})$$

where  $f_s(t)$  is the Doppler shift and  $f_d$  is the maximum Doppler frequency. The cosine of angle  $\theta(t)$  is given by

$$\cos \theta(t) = \frac{D_s/2 - vt}{\sqrt{D_{\min}^2 + (D_s/2 - vt)^2}}, \quad 0 \leq t \leq D_s/v \quad (\text{B.3})$$

where  $D_s/2$  is the initial distance of the train from BS, and  $D_{\min}$  is BS-Railway track distance, both in meters;  $v$  is the velocity of the train in m/s,  $t$  is time in seconds.

For scenario 2, Rician fading is considered where Rician factor,  $K$  is defined as the ratio between the dominant signal power and the variant of the other weaker signals.

The parameters in the equation are shown in table B.2A. Accordingly, Doppler shift for scenario 1 and 3 change to the following figure B.3 and B.4, respectively.

**Table B.2A: Parameters for high speed train conditions**

| Parameter | Value      |            |            |
|-----------|------------|------------|------------|
|           | Scenario 1 | Scenario 2 | Scenario 3 |
| $D_s$     | 1000 m     | Infinity   | 300 m      |
| $D_{min}$ | 50 m       | -          | 2 m        |
| $K$       | -          | 10 dB      | -          |
| $v$       | 350 km/h   | 300 km/h   | 300 km/h   |
| $f_d$     | 1340 Hz    | 1150 Hz    | 1150 Hz    |

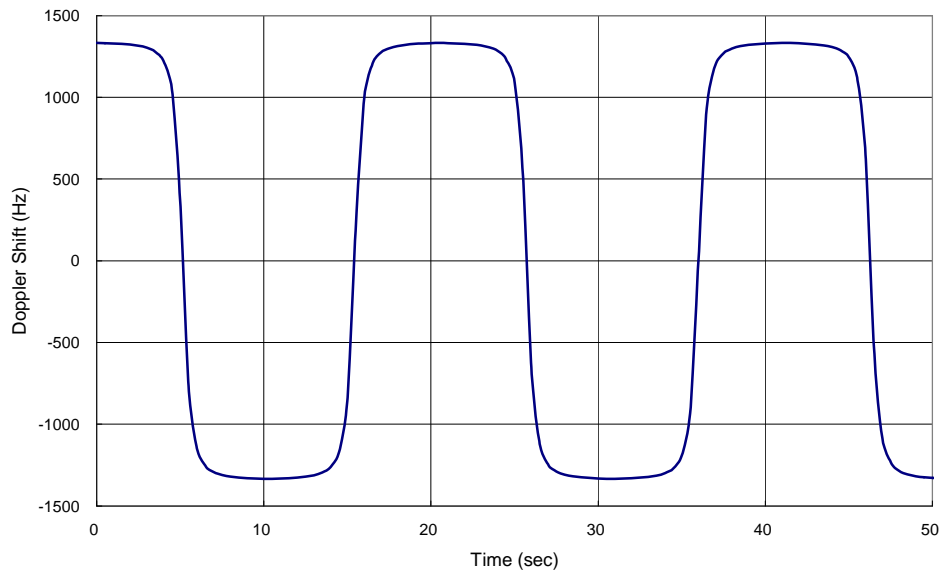

**Figure B.3: Doppler shift trajectory for scenario 1**

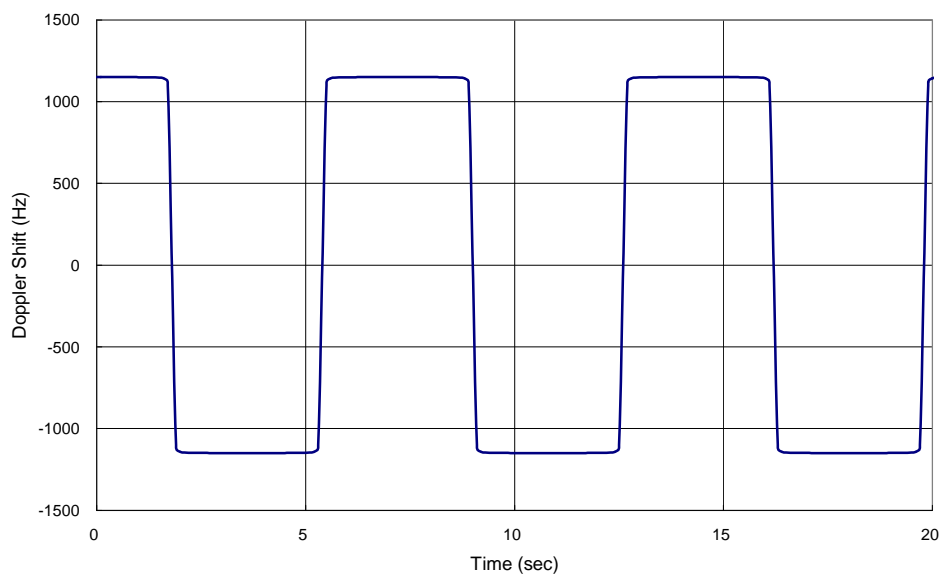

**Figure B.4: Doppler shift trajectory for scenario 3**

## B.5 Multipath fading propagation conditions

Table B.3 shows propagation conditions that are used for E-DPDCH and E-DPCCH performance measurements in multipath fading environment.

**Table B.3: Propagation Conditions for Multipath Fading Environments for E-DPDCH and E-DPCCH Performance Requirements**

| ITU Pedestrian A<br>Speed 3km/h<br>(PA3)       |                             | ITU Pedestrian B<br>Speed 3km/h<br>(PB3)       |                             | ITU vehicular A<br>Speed 30km/h<br>(VA30)       |                             | ITU vehicular A<br>Speed 120km/h<br>(VA120)      |                             |
|--|-----------------------------|--|-----------------------------|---|-----------------------------|--|-----------------------------|
| Speed for Band I, II, III, IV, IX, X<br>3 km/h |                             | Speed for Band I, II, III, IV, IX, X<br>3 km/h |                             | Speed for Band I, II, III, IV, IX, X<br>30 km/h |                             | Speed for Band I, II, III, IV, IX, X<br>120 km/h |                             |
| Speed for Band V, VI, VIII<br>7 km/h           |                             | Speed for Band V, VI, VIII<br>7 km/h           |                             | Speed for Band V, VI, VIII<br>71 km/h           |                             | Speed for Band V, VI, VIII<br>282 km/h (Note 1)  |                             |
| Speed for Band VII<br>2.3 km/h                 |                             | Speed for Band VII<br>2.3 km/h                 |                             | Speed for Band VII<br>23 km/h                   |                             | Speed for Band VII<br>92 km/h                    |                             |
| Speed for Band XI<br>4.1 km/h                  |                             | Speed for Band XI<br>4.1 km/h                  |                             | Speed for Band XI<br>41 km/h                    |                             | Speed for Band XI<br>166 km/h (Note 1)           |                             |
| Speed for Band XII, XIII, XIV<br>8 km/h        |                             | Speed for Band XII, XIII, XIV<br>8 km/h        |                             | Speed for Band XII, XIII, XIV<br>80 km/h        |                             | Speed for Band XII, XIII, XIV<br>320 km/h        |                             |
| Relative Delay<br>[ns]                         | Relative Mean Power<br>[dB] | Relative Delay<br>[ns]                         | Relative Mean Power<br>[dB] | Relative Delay<br>[ns]                          | Relative Mean Power<br>[dB] | Relative Delay<br>[ns]                           | Relative Mean Power<br>[dB] |
| 0  | 0                           | 0  | 0                           | 0   | 0                           | 0  | 0                           |
| 110  | -9.7                        | 200  | -0.9                        | 310   | -1.0                        | 310  | -1.0                        |
| 190  | -19.2                       | 800  | -4.9                        | 710   | -9.0                        | 710  | -9.0                        |
| 410  | -22.8                       | 1200   | -8.0                        | 1090  | -10.0                       | 1090   | -10.0                       |
|  |                             | 2300   | -7.8                        | 1730  | -15.0                       | 1730   | -15.0                       |
|  |                             | 3700   | -23.9                       | 2510  | -20.0                       | 2510   | -20.0                       |

NOTE 1: Speed above 120km/h is applicable to demodulation performance requirements only.

---

## Annex C (normative): Characteristics of the W-CDMA interference signal

The W-CDMA interference signal shall be a DPCH containing the DPCCH and one DPDCH. The data content for each channelization code shall be uncorrelated with each other and to the wanted signal and spread and modulated according to clause 4 of TS25.213 [6]. Further characteristics of DPDCH and DPCCH are specified in table C.1.

**Table C.1.: Characteristics of the W-CDMA interference signal**

| Channel  | Bit Rate | Spreading Factor | Channelization Code | Relative Power |
|--|----------|------------------|---------------------|----------------|
| DPDCH  | 240 kbps | 16               | 4                   | 0 dB           |
| DPCCH  | 15 kbps  | 256              | 0                   | -5.46 dB       |
| NOTE: The DPDCH and DPCCH settings are chosen to simulate a signal with realistic Peak to Average Ratio. |          |                  |                     |                |

## Annex D (informative): Change History

| TSG | Doc       | CR   | R | Title  | Cat | Curr  | New   | Work Item        |
|-----|-----------|------|---|--|-----|-------|-------|------------------|
| 37  |           |      |   | Rel-8 version created based on v7.8.0                                      |     |       | 8.0.0 |                  |
| 37  | RP-070658 | 0296 |   | Introduction of UMTS1500 requirements (Rel-8)                              | B   | 7.8.0 | 8.0.0 | RInImp8-UMTS1500 |
| 38  | RP-070936 | 0299 | 1 | Base station MIMO correction   | A   | 8.0.0 | 8.1.0 | MIMO-RF          |
| 38  | RP-070937 | 0301 |   | Spurious emission limits for coexistence with CDMA850                      | A   | 8.0.0 | 8.1.0 | TEI7             |
| 39  | RP-080120 | 0307 |   | Correction to RX spurious emissions  | A   | 8.1.0 | 8.2.0 | TEI6             |
| 39  | RP-080124 | 0302 | 1 | Introduction of UMTS700 requirements (Band XII, XIII and XIV) in TS 25.104 | B   | 8.1.0 | 8.2.0 | RInImp8-UMTS700  |

---

## History

| <b>Document history</b> |              |             |
|-------------------------|--------------|-------------|
| V8.0.0                  | January 2008 | Publication |
| V8.1.0                  | January 2008 | Publication |
| V8.2.0                  | April 2008   | Publication |
|                         |              |             |
|                         |              |             |