

# ETSI TS 125 105 V4.1.0 (2001-06)

---

*Technical Specification*

**Universal Mobile Telecommunications System (UMTS);  
UTRA (BS) TDD;  
Radio transmission and Reception  
(3GPP TS 25.105 version 4.1.0 Release 4)**

---



---

**Reference**

RTS/TSGR-0425105Uv4R1

---

**Keywords**

UMTS

**ETSI**

---

650 Route des Lucioles  
F-06921 Sophia Antipolis Cedex - FRANCE

Tel.: +33 4 92 94 42 00 Fax: +33 4 93 65 47 16

Siret N° 348 623 562 00017 - NAF 742 C  
Association à but non lucratif enregistrée à la  
Sous-Préfecture de Grasse (06) N° 7803/88

---

**Important notice**

Individual copies of the present document can be downloaded from:

<http://www.etsi.org>

The present document may be made available in more than one electronic version or in print. In any case of existing or perceived difference in contents between such versions, the reference version is the Portable Document Format (PDF). In case of dispute, the reference shall be the printing on ETSI printers of the PDF version kept on a specific network drive within ETSI Secretariat.

Users of the present document should be aware that the document may be subject to revision or change of status. Information on the current status of this and other ETSI documents is available at <http://www.etsi.org/tb/status/>

If you find errors in the present document, send your comment to:  
editor@etsi.fr

---

**Copyright Notification**

No part may be reproduced except as authorized by written permission.  
The copyright and the foregoing restriction extend to reproduction in all media.

© European Telecommunications Standards Institute 2001.

All rights reserved.

---

## Intellectual Property Rights

IPRs essential or potentially essential to the present document may have been declared to ETSI. The information pertaining to these essential IPRs, if any, is publicly available for **ETSI members and non-members**, and can be found in ETSI SR 000 314: "*Intellectual Property Rights (IPRs); Essential, or potentially Essential, IPRs notified to ETSI in respect of ETSI standards*", which is available from the ETSI Secretariat. Latest updates are available on the ETSI Web server (<http://www.etsi.org/ipr>).

Pursuant to the ETSI IPR Policy, no investigation, including IPR searches, has been carried out by ETSI. No guarantee can be given as to the existence of other IPRs not referenced in ETSI SR 000 314 (or the updates on the ETSI Web server) which are, or may be, or may become, essential to the present document.

---

## Foreword

This Technical Specification (TS) has been produced by the ETSI 3<sup>rd</sup> Generation Partnership Project (3GPP).

The present document may refer to technical specifications or reports using their 3GPP identities, UMTS identities or GSM identities. These should be interpreted as being references to the corresponding ETSI deliverables.

The cross reference between GSM, UMTS, 3GPP and ETSI identities can be found under [www.etsi.org/key](http://www.etsi.org/key).

# Contents

Contents .....	3
Foreword .....	7
1 Scope.....	8
2 References.....	8
3 Definitions, symbols and abbreviations .....	8
3.1 Definitions .....	8
3.2 Symbols .....	9
3.3 Abbreviations .....	9
4 General.....	9
4.1 Relationship between Minimum Requirements and Test Requirements .....	9
4.2 Base station classes.....	10
4.3 Regional requirements.....	10
4.4 Environmental requirements for the BS equipment .....	11
5 Frequency bands and channel arrangement .....	11
5.1 General .....	11
5.2 Frequency bands.....	11
5.3 TX–RX frequency separation.....	11
5.3.1 3,84 Mcps TDD Option .....	11
5.3.2 1,28 Mcps TDD Option .....	11
5.4 Channel arrangement.....	12
5.4.1 Channel spacing.....	12
5.4.1.1 3,84 Mcps TDD Option .....	12
5.4.1.2 1,28 Mcps TDD Option .....	12
5.4.2 Channel raster .....	12
5.4.3 Channel number.....	12
6 Transmitter characteristics .....	12
6.1 General .....	12
6.2 Base station output power .....	12
6.2.1 Base station maximum output power.....	12
6.2.1.1 Minimum Requirement.....	12
6.3 Frequency stability .....	13
6.3.1 Minimum Requirement.....	13
6.3.1.1 3,84 Mcps TDD Option .....	13
6.3.1.2 1,28 Mcps TDD Option .....	13
6.4 Output power dynamics.....	13
6.4.1 Inner loop power control.....	13
6.4.2 Power control steps.....	13
6.4.2.1 Minimum Requirement.....	13
6.4.3 Power control dynamic range .....	13
6.4.3.1 Minimum Requirement.....	14
6.4.4 Minimum transmit power .....	14
6.4.4.1 Minimum Requirement.....	14
6.4.5 Primary CCPCH power .....	14
6.4.6 Differential accuracy of Primary CCPCH power.....	14
6.4.6.1 Minimum Requirement for Differential accuracy of PCCPCH power .....	14
6.5 Transmit ON/OFF power .....	14
6.5.1 Transmit OFF power.....	14
6.5.1.1 Minimum Requirement.....	14
6.5.1.1.1 3,84 Mcps TDD Option.....	14
6.5.1.1.2 1,28 Mcps TDD Option.....	14
6.5.2 Transmit ON/OFF Time mask .....	15
6.5.2.1 Minimum Requirement.....	15
6.5.2.1.1 3,84 Mcps TDD Option.....	15

6.5.2.1.2	1,28 Mcps TDD Option.....	15
6.6	Output RF spectrum emissions.....	15
6.6.1	Occupied bandwidth.....	15
6.6.1.1	3,84 Mcps TDD Option:.....	15
6.6.1.2	1,28 Mcps TDD Option:.....	16
6.6.2	Out of band emission.....	16
6.6.2.1	Spectrum emission mask.....	16
6.6.2.1.1	3,84 Mcps TDD Option.....	16
6.6.2.1.2	1,28 Mcps TDD Option.....	17
6.6.2.2	Adjacent Channel Leakage power Ratio (ACLR).....	19
6.6.2.2.1	Minimum Requirement.....	20
6.6.2.2.1.1	3,84 Mcps TDD Option.....	20
6.6.2.2.1.2	1,28 Mcps TDD Option.....	20
6.6.2.2.2	Additional requirement in case of operation in proximity to TDD BS or FDD BS operating on an adjacent frequency.....	20
6.6.2.2.2.1	3,84 Mcps TDD Option.....	20
6.6.2.2.2.2	1,28 Mcps TDD Option.....	20
6.6.2.2.3	Additional requirement in case of co-siting with TDD BS or FDD BS operating on an adjacent frequency.....	21
6.6.2.2.3.1	3,84 Mcps TDD Option.....	21
6.6.2.2.3.2	1,28 Mcps TDD Option.....	21
6.6.3	Spurious emissions.....	22
6.6.3.1	Mandatory Requirements.....	22
6.6.3.1.1	Spurious emissions (Category A).....	22
6.6.3.1.1.1	Minimum Requirement.....	22
6.6.3.1.1.1.1	3,84 Mcps TDD Option.....	22
6.6.3.1.1.1.2	1,28 Mcps TDD Option.....	22
6.6.3.1.2	Spurious emissions (Category B).....	23
6.6.3.1.2.1	Minimum Requirement.....	23
6.6.3.1.2.1.1	3,84 Mcps TDD Option.....	23
6.6.3.1.2.1.2	1,28 Mcps TDD Option.....	24
6.6.3.2	Co-existence with GSM 900.....	24
6.6.3.2.1	Operation in the same geographic area.....	24
6.6.3.2.1.1	Minimum Requirement.....	25
6.6.3.2.2	Co-located base stations.....	25
6.6.3.2.2.1	Minimum Requirement.....	25
6.6.3.3	Co-existence with DCS 1800.....	25
6.6.3.3.1	Operation in the same geographic area.....	25
6.6.3.3.1.1	Minimum Requirement.....	25
6.6.3.3.2	Co-located basestations.....	25
6.6.3.3.2.1	Minimum Requirement.....	25
6.6.3.4	Co-existence with UTRA-FDD.....	26
6.6.3.4.1	Operation in the same geographic area.....	26
6.6.3.4.1.1	Minimum Requirement.....	26
6.6.3.4.2	Co-located base stations.....	26
6.6.3.4.2.1	Minimum Requirement.....	26
6.7	Transmit intermodulation.....	26
6.7.1	Minimum Requirement.....	26
6.7.1.1	3,84 Mcps TDD Option.....	26
6.7.1.2	1,28 Mcps TDD Option:.....	26
6.8	Transmit modulation.....	27
6.8.1	Transmit pulse shape filter.....	27
6.8.2	Modulation Accuracy.....	27
6.8.2.1	Minimum Requirement.....	27
6.8.3	Peak Code Domain Error.....	27
6.8.3.1	Minimum Requirement.....	27
7	Receiver characteristics.....	27
7.1	General.....	27
7.2	Reference sensitivity level.....	27
7.2.1	Minimum Requirement.....	28
7.2.1.1	3,84 Mcps TDD Option.....	28

7.2.1.2	1,28 Mcps TDD Option .....	28
7.3	Dynamic range .....	28
7.3.1	Minimum requirement .....	28
7.3.1.1	3,84 Mcps TDD Option .....	28
7.3.1.2	1,28 Mcps TDD Option: .....	28
7.4	Adjacent Channel Selectivity (ACS) .....	29
7.4.1	Minimum Requirement .....	29
7.4.1.1	3,84 Mcps TDD Option .....	29
7.4.1.2	1,28 Mcps TDD Option: .....	29
7.5	Blocking characteristics .....	29
7.5.0	Minimum requirement .....	29
7.5.0.1	3,84 Mcps TDD Option .....	30
7.5.0.2	1,28 Mcps TDD Option .....	30
7.5.1	Co-location with GSM900 and/or DCS 1800 .....	31
7.5.1.1	3,84 Mcps TDD Option .....	31
7.5.1.2	1,28 Mcps TDD Option .....	32
7.6	Intermodulation characteristics .....	32
7.6.1	Minimum requirement .....	32
7.6.1.1	3,84 Mcps TDD Option .....	32
7.6.1.2	1,28 Mcps TDD Option .....	32
7.7	Spurious emissions .....	33
7.7.1	Minimum Requirement .....	33
7.7.1.1	3,84 Mcps TDD Option: .....	33
7.7.1.2	1,28 Mcps TDD Option .....	33
8	Performance requirement .....	34
8.1	General .....	34
8.2	Demodulation in static propagation conditions .....	34
8.2.1	Demodulation of DCH .....	34
8.2.1.1	Minimum requirement .....	34
8.2.1.1.1	3,84 Mcps TDD Option .....	34
8.2.1.1.2	1,28 Mcps TDD Option .....	35
8.3	Demodulation of DCH in multipath fading conditions .....	35
8.3.1	Multipath fading Case 1 .....	35
8.3.1.1	Minimum requirement .....	35
8.3.1.1.1	3,84 Mcps TDD Option .....	35
8.3.1.1.2	1,28 Mcps TDD Option .....	36
8.3.2	Multipath fading Case 2 .....	37
8.3.2.1	Minimum requirement .....	37
8.3.2.1.1	3,84 Mcps TDD Option .....	37
8.3.2.1.2	1,28 Mcps TDD Option .....	37
8.3.3	Multipath fading Case 3 .....	38
8.3.3.1	Minimum requirement .....	38
8.3.3.1.1	3,84 Mcps TDD Option .....	38
8.3.3.1.2	1,28 Mcps TDD Option .....	38
<b>Annex A (normative):</b>	<b>Measurement Channels .....</b>	<b>40</b>
A.1	General .....	40
A.2	Reference measurement channel .....	40
A.2.1	UL reference measurement channel (12.2 kbps) .....	40
A.2.1.1	3,84 Mcps TDD Option .....	40
A.2.1.2	1,28 Mcps TDD Option .....	41
A.2.2	UL reference measurement channel (64 kbps) .....	42
A.2.2.1	3,84 Mcps TDD Option .....	42
A.2.2.2	1,28 Mcps TDD Option .....	44
A.2.3	UL reference measurement channel (144 kbps) .....	45
A.2.3.1	3,84 Mcps TDD Option .....	45
A.2.3.2	1,28 Mcps TDD Option .....	46
A.2.4	UL reference measurement channel (384 kbps) .....	47
A.2.4.1	3,84 Mcps TDD Option .....	47
A.2.4.2	1,28 Mcps TDD Option .....	48

A.2.5	RACH reference measurement channel.....	49
A.2.5.0	General.....	49
A.2.5.0.1	3,84 Mcps TDD Option.....	49
A.2.5.0.2	1,28 Mcps TDD Option.....	50
A.2.5.1	RACH mapped to 1 code SF16.....	51
A.2.5.1.1	3,84 Mcps TDD Option.....	51
A.2.5.1.2	1,28 Mcps TDD Option.....	51
A.2.5.2	RACH mapped to 1 code SF8.....	52
A.2.5.2.1	3,84 Mcps TDD Option.....	52
A.2.5.2.2	1,28 Mcps TDD Option.....	52
A.2.5.3	RACH mapped to 1 code SF4 (1,28 Mcps option only).....	53
<b>Annex B (normative):</b>	<b>Propagation conditions .....</b>	<b>54</b>
B.1	Static propagation condition .....	54
B.2	Multi-path fading propagation conditions .....	54
B.2.1	3,84 Mcps TDD Option .....	54
B.2.2	1,28 Mcps TDD Option .....	54
<b>Annex C (informative):</b>	<b>Change request history .....</b>	<b>55</b>

---

# Foreword

This Technical Specification has been produced by the 3GPP.

The contents of the present document are subject to continuing work within the TSG and may change following formal TSG approval. Should the TSG modify the contents of this TS, it will be re-released by the TSG with an identifying change of release date and an increase in version number as follows:

Version 3.y.z

where:

- x the first digit:
  - 1 presented to TSG for information;
  - 2 presented to TSG for approval;
  - 3 Indicates TSG approved document under change control.
- y the second digit is incremented for all changes of substance, i.e. technical enhancements, corrections, updates, etc.
- z the third digit is incremented when editorial only changes have been incorporated in the specification.



---

# 1 Scope

This document establishes the minimum RF characteristics of both options of the TDD mode of UTRA. The two options are the 3.84Mcps and 1.28Mcps options respectively. The requirements are listed in different subsections only if the parameters deviate.

---

# 2 References

The following documents contain provisions which, through reference in this text, constitute provisions of the present document.

- References are either specific (identified by date of publication, edition number, version number, etc.) or non-specific.
- For a specific reference, subsequent revisions do not apply.
- For a non-specific reference, the latest version applies. In the case of a reference to a 3GPP document (including a GSM document), a non-specific reference implicitly refers to the latest version of that document in the same Release as the present document.
- A non-specific reference to an ETS shall also be taken to refer to later versions published as an EN with the same number.

- [1] ITU-R Recommendation SM.329-8 "Spurious emissions".
- [2] ETSI ETR 273-1-2: "Electromagnetic compatibility and Radio spectrum Matters (ERM); Improvement of radiated methods of measurement (using test sites) and evaluation of the corresponding measurement uncertainties; Part 1: Uncertainties in the measurement of mobile radio equipment characteristics; Sub-part 2: Examples and annexes".
- [3] IEC 60721-3-3 (1994): "Classification of environmental conditions - Part 3: Classification of groups of environmental parameters and their severities - Section 3: Stationary use at weather protected locations".
- [4] IEC 60721-3-4 (1995): "Classification of environmental conditions - Part 3: Classification of groups of environmental parameters and their severities - Section 4: Stationary use at non-weather protected locations".
- [5] 3GPP TS 25.142: "Base station conformance testing (TDD)".

---

# 3 Definitions, symbols and abbreviations

## 3.1 Definitions

For the purposes of the present document, the definitions apply.

**Power Setting:** The value of the control signal, which determines the desired transmitter, output Power. Typically, the power setting would be altered in response to power control commands

**Maximum Power Setting:** The highest value of the Power control setting which can be used.

**Maximum output Power:** This refers to the measure of power when averaged over the transmit timeslot at the maximum power setting.

**Peak Power:** The instantaneous power of the RF envelope which is not expected to be exceeded for [99.9%] of the time.

**Maximum peak power:** The peak power observed when operating at a given maximum output power.

**Average Power:** The average transmitter output power obtained over any specified time interval, including periods with no transmission. <Editors: This definition would be relevant when considering realistic deployment scenarios where the power control setting may vary. >

**Maximum average power:** The average transmitter output power obtained over any specified time interval, including periods with no transmission, when the transmit time slots are at the maximum power setting. <Editors: The average power at the maximum power setting would also be consistent with defining a long term average power>

**Zero distance:** Connected to the antenna connector of the BS using an interconnection of negligible delay

## 3.2 Symbols

(void)

## 3.3 Abbreviations

For the purposes of the present document, the following abbreviations apply:

ACIR	Adjacent Channel Interference Ratio
ACLR	Adjacent Channel Leakage power Ratio
ACS	Adjacent Channel Selectivity
BER	Bit Error Rate
BS	Base Station
CW	Continuous wave (unmodulated signal)
DL	Down link (forward link)
DPCH <sub>o</sub>	A mechanism used to simulate an individual intracell interferer in the cell with one code and a spreading factor of 16
$\frac{DPCH_o - E_c}{I_{or}}$	The ratio of the average transmit energy per PN chip for the DPCH <sub>o</sub> to the total transmit power spectral density of all users in the cell in one timeslot as measured at the BS antenna connector
EIRP	Effective Isotropic Radiated Power
FDD	Frequency Division Duplexing
FER	Frame Error Rate
I <sub>oc</sub>	The power spectral density of a band limited white noise source (simulating interference from other cells) as measured at the BS antenna connector.
I <sub>or</sub>	The received power spectral density of all users in the cell in one timeslot as measured at the BS antenna connector
PPM	Parts Per Million
RSSI	Received Signal Strength Indicator
SIR	Signal to Interference ratio
TDD	Time Division Duplexing
TPC	Transmit Power Control
UE	User Equipment
UL	Up link (reverse link)
UTRA	UMTS Terrestrial Radio Access

---

## 4 General

### 4.1 Relationship between Minimum Requirements and Test Requirements

The Minimum Requirements given in this specification make no allowance for measurement uncertainty. The test specification 25.142 section 5.9.6 defines Test Tolerances. These Test Tolerances are individually calculated for each test. The Test Tolerances are used to relax the Minimum Requirements in this specification to create Test

Requirements. The measurement results returned by the Test System are compared -without any modification- against the Test Requirements as defined by the shared risk principle.

The Shared Risk principle is defined in ETR 273 Part 1 sub-part 2 section 6.5.

## 4.2 Base station classes

The requirements in this specification apply to base station intended for general-purpose applications in co-ordinated network operation.

In the future further classes of base stations may be defined; the requirements for these may be different than for general-purpose applications.

## 4.3 Regional requirements

Some requirements in TS 25.105 may only apply in certain regions. Table 4.1 lists all requirements that may be applied differently in different regions.

**Table 4.1: List of regional requirements.**

Clause number	Requirement	Comments
5.2	Frequency bands	Some bands may be applied regionally.
6.2.1	Base station maximum output power	In certain regions, the minimum requirement for normal conditions may apply also for some conditions outside the range of conditions defined as normal.
6.6.2.1	Spectrum emission mask	The mask specified may be mandatory in certain regions. In other regions this mask may not be applied.
6.6.3.1.1	Spurious emissions (Category A)	These requirements shall be met in cases where Category A limits for spurious emissions, as defined in ITU-R Recommendation SM.329-8 [1], are applied.
6.6.3.1.2	Spurious emissions (Category B)	These requirements shall be met in cases where Category B limits for spurious emissions, as defined in ITU-R Recommendation SM.329-8 [1], are applied.
6.6.3.2.1	Co-existence with GSM900 – Operation in the same geographic area	This requirement may be applied for the protection of GSM 900 MS in geographic areas in which both GSM 900 and UTRA are deployed.
6.6.3.2.2	Co-existence with GSM900 – Co-located base stations	This requirement may be applied for the protection of GSM 900 BTS receivers when GSM 900 BTS and UTRA BS are co-located.
6.6.3.3.1	Co-existence with DCS1800 – Operation in the same geographic area	This requirement may be applied for the protection of DCS 1800 MS in geographic areas in which both DCS 1800 and UTRA are deployed.
6.6.3.3.2	Co-existence with DCS1800 – Co-located base stations	This requirement may be applied for the protection of DCS 1800 BTS receivers when DCS 1800 BTS and UTRA BS are co-located.
6.6.3.4.1	Co-existence with UTRA FDD – Operation in the same geographic area	This requirement may be applied to geographic areas in which both UTRA-TDD and UTRA-FDD are deployed.
6.6.3.4.2	Co-existence with UTRA FDD – Co-located base stations	This requirement may be applied for the protection of UTRA-FDD BS receivers when UTRA-TDD BS and UTRA FDD BS are co-located.
7.5	Blocking characteristic	The requirement is applied according to what frequency bands in Clause 5.2 that are supported by the BS.
7.5.1	Blocking characteristic Co-location with GSM900 and/or DCS 1800	This requirement may be applied for the protection of UTRA TDD BS receivers when UTRA TDD BS and GSM 900/DCS1800 BS are co-located.

## 4.4 Environmental requirements for the BS equipment

The BS equipment shall fulfil all the requirements in the full range of environmental conditions for the relevant environmental class from the relevant IEC specifications listed below:

IEC 60 721-3-3 “Stationary use at weather protected locations” [3]

IEC 60 721-3-4 “Stationary use at non weather protected locations” [4]

Normally it should be sufficient for all tests to be conducted using normal test conditions except where otherwise stated. For guidance on the use of test conditions to be used in order to show compliance refer to TS 25.142 [5].

---

# 5 Frequency bands and channel arrangement

## 5.1 General

The information presented in this section is based on the chip rates of 3.84 Mcps and 1.28 Mcps.

Note: Other chip rates may be considered in future releases.

## 5.2 Frequency bands

UTRA/TDD is designed to operate in the following bands;

- a) 1900 – 1920 MHz: Uplink and downlink transmission  
2010 – 2025 MHz Uplink and downlink transmission
- b)\*1850 – 1910 MHz: Uplink and downlink transmission  
1930 – 1990 MHz: Uplink and downlink transmission
- c)\*1910 – 1930 MHz: Uplink and downlink transmission

\* Used in ITU Region 2

Additional allocations in ITU region 2 are FFS.

Deployment in existing and other frequency bands is not precluded.

The co-existence of TDD and FDD in the same bands is still under study in WG4.

## 5.3 TX–RX frequency separation

### 5.3.1 3,84 Mcps TDD Option

No TX-RX frequency separation is required as Time Division Duplex (TDD) is employed. Each TDMA frame consists of 15 timeslots where each timeslot can be allocated to either transmit or receive.

### 5.3.2 1,28 Mcps TDD Option

No TX-RX frequency separation is required as Time Division Duplex (TDD) is employed. Each subframe consists of 7 main timeslots where all main timeslots (at least the first one) before the single switching point are allocated DL and all main timeslots (at least the last one) after the single switching point are allocated UL.

## 5.4 Channel arrangement

### 5.4.1 Channel spacing

#### 5.4.1.1 3,84 Mcps TDD Option

The nominal channel spacing is 5 MHz, but this can be adjusted to optimise performance in a particular deployment scenario.

#### 5.4.1.2 1,28 Mcps TDD Option

The channel spacing is 1.6MHz, but this can be adjusted to optimise performance in a particular deployment scenario.

### 5.4.2 Channel raster

The channel raster is 200 kHz, which means that the carrier frequency must be a multiple of 200 kHz.

### 5.4.3 Channel number

The carrier frequency is designated by the UTRA absolute radio frequency channel number (UARFCN). The value of the UARFCN in the IMT2000 band is defined as follows:

$$N_t = 5 * F \quad 0.0 \leq F \leq 3276.6 \text{ MHz} \quad \text{where } F \text{ is the carrier frequency in MHz}$$

## 6 Transmitter characteristics

### 6.1 General

Unless detailed the transmitter characteristic are specified at the antenna connector.

### 6.2 Base station output power

Output power,  $P_{out}$ , of the base station is the mean power of one carrier delivered to a load with resistance equal to the nominal load impedance of the transmitter during one slot.

Rated output power, PRAT, of the base station is the mean power level per carrier over an active timeslot that the manufacturer has declared to be available at the antenna connector.

#### 6.2.1 Base station maximum output power

Maximum output power,  $P_{max}$ , of the base station is the mean power level per carrier over an active timeslot measured at the antenna connector for a specified reference condition.

##### 6.2.1.1 Minimum Requirement

In normal conditions, the base station maximum output power shall remain within +2 dB and -2 dB of the manufacturer's rated output power.

In extreme conditions, the Base station maximum output power shall remain within +2.5 dB and -2.5 dB of the manufacturer's rated output power.

In certain regions, the minimum requirement for normal conditions may apply also for some conditions outside the range of conditions defined as normal.

## 6.3 Frequency stability

Frequency stability is ability of the BS to transmit at the assigned carrier frequency. The BS shall use the same frequency source for both RF frequency generation and the chip clock.

### 6.3.1 Minimum Requirement

#### 6.3.1.1 3,84 Mcps TDD Option

The modulated carrier frequency of the BS shall be accurate to within  $\pm 0.05$  PPM observed over a period of one timeslot for RF frequency generation.

#### 6.3.1.2 1,28 Mcps TDD Option

The modulated carrier frequency of the BS shall be accurate to within  $\pm 0.05$  PPM observed over a period of one timeslot for RF frequency generation.

## 6.4 Output power dynamics

Power control is used to limit the interference level. The transmitter uses a quality-based power control on the downlink.

### 6.4.1 Inner loop power control

Inner loop power control is the ability of the BS transmitter to adjust its output power in response to the UL received signal.

For inner loop correction on the Downlink Channel, the base station adjusts the mean output power level of a CCTrCH in response to each valid power control bit received from the UE on the Uplink Traffic Channel based on the mapping of the TPC bits in uplink CCTrCH to downlink CCTrCH. Inner loop control is based on SIR measurements at the UE receiver and the corresponding TPC commands are generated by the UE.

### 6.4.2 Power control steps

The power control step is the step change in the DL transmitter output power in response to a TPC message from the UE.

#### 6.4.2.1 Minimum Requirement

Down link (DL) 1, 2, 3 dB

The tolerance of the transmitter output power and the greatest average rate of change in mean power due to the power control step shall be within the range shown in Table 6.1.

**Table 6.1: power control step size tolerance**

Step size	Tolerance	Range of average rate of change in mean power per 10 steps	
		minimum	maximum
1dB	+/-0.5dB	+/-8dB	+/-12dB
2dB	+/-0.75dB	+/-16dB	+/-24dB
3dB	+/-1dB	+/-24dB	+/-36dB

### 6.4.3 Power control dynamic range

The power control dynamic range is the difference between the maximum and the minimum transmit output power for a specified reference condition

### 6.4.3.1 Minimum Requirement

Down link (DL) power control dynamic range 30 dB

### 6.4.4 Minimum transmit power

The minimum controlled output power of the BS is when the power control setting is set to a minimum value. This is when the power control indicates a minimum transmit output power is required.

#### 6.4.4.1 Minimum Requirement

Down link (DL) minimum transmit power is set to: Maximum output power – 30dB

### 6.4.5 Primary CCPCH power

Primary CCPCH power is the transmission power of the primary common control physical channel averaged over the transmit timeslot. Primary CCPCH power is signalled over the BCH.

The error between the BCH-broadcast value of the Primary CCPCH power and the Primary CCPCH power averaged over the timeslot shall not exceed the values in table 6.2. The error is a function of the total power averaged over the timeslot,  $P_{out}$ , and the manufacturer's rated output power, PRAT.

**Table 6.2: Errors between Primary CCPCH power and the broadcast value**

Total power in slot, dB	PCCPCH power tolerance
$PRAT-3 < P_{out} \leq PRAT+2$	+/- 2.5 dB
$PRAT-6 < P_{out} \leq PRAT-3$	+/- 3.5 dB
$PRAT-13 < P_{out} \leq PRAT-6$	+/- 5 dB

### 6.4.6 Differential accuracy of Primary CCPCH power

The differential accuracy of the Primary CCPCH power is the relative transmitted power accuracy of PCCPCH in consecutive frames when the nominal PCCPCH power is not changed.

#### 6.4.6.1 Minimum Requirement for Differential accuracy of PCCPCH power

Differential accuracy of PCCPCH power: +/- 0.5 dB

## 6.5 Transmit ON/OFF power

### 6.5.1 Transmit OFF power

The transmit OFF power state is when the BS does not transmit. This parameter is defined as maximum output transmit power within the channel bandwidth when the transmitter is OFF.

#### 6.5.1.1 Minimum Requirement

##### 6.5.1.1.1 3,84 Mcps TDD Option

The requirement of transmit OFF power shall be better than –79 dBm measured with a filter that has a Root Raised Cosine (RRC) filter response with a roll off  $\alpha=0.22$  and a bandwidth equal to the chip rate.

##### 6.5.1.1.2 1,28 Mcps TDD Option

The requirement of transmit OFF power shall be better than –82 dBm measured with a filter that has a Root Raised Cosine (RRC) filter response with a roll off  $\alpha=0.22$  and a bandwidth equal to the chip rate.

## 6.5.2 Transmit ON/OFF Time mask

The time mask transmit ON/OFF defines the ramping time allowed for the BS between transmit OFF power and transmit ON power.

### 6.5.2.1 Minimum Requirement

#### 6.5.2.1.1 3,84 Mcps TDD Option

The transmit power level versus time should meet the mask specified in figure 6.1.

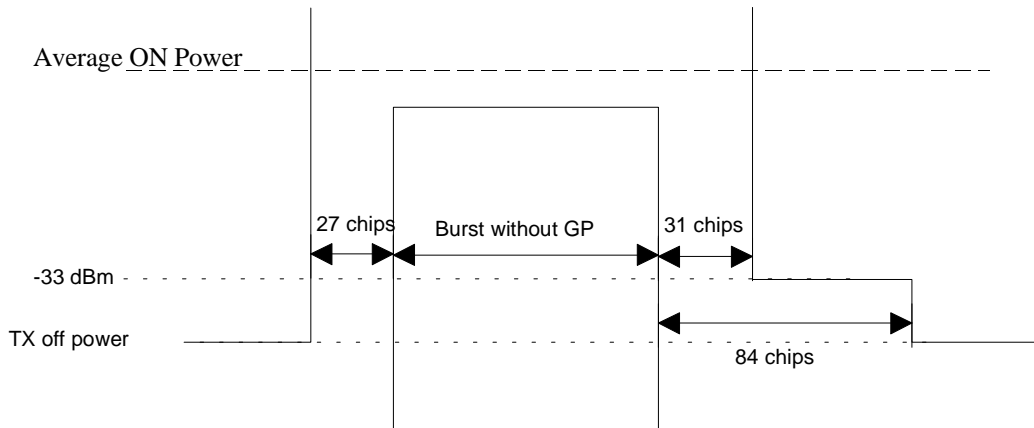

Figure 6.1: Transmit ON/OFF template

#### 6.5.2.1.2 1,28 Mcps TDD Option

The transmit power level versus time should meet the mask specified in figure 6.1A.

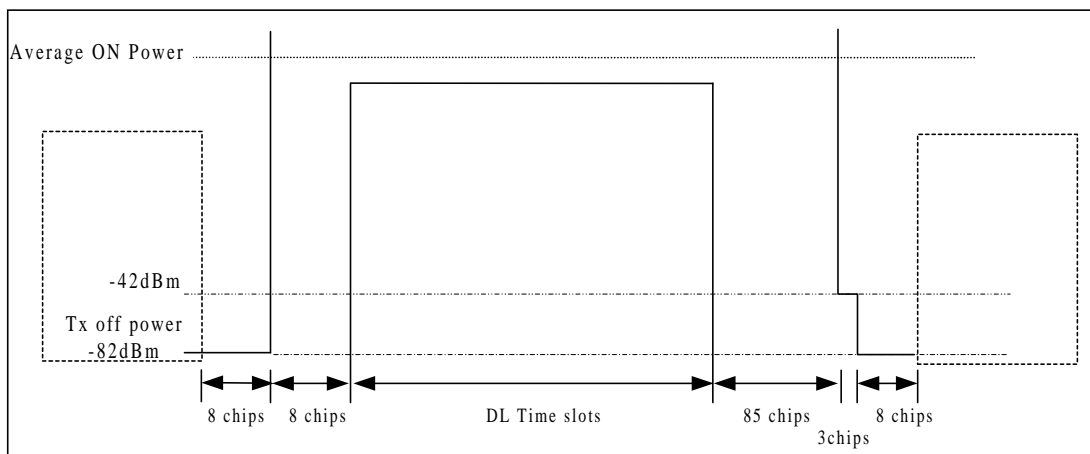

Figure 6.1A: Transmit ON/OFF template

## 6.6 Output RF spectrum emissions

### 6.6.1 Occupied bandwidth

#### 6.6.1.1 3,84 Mcps TDD Option:

Occupied bandwidth is a measure of the bandwidth containing 99% of the total integrated power for transmitted spectrum and is centered on the assigned channel frequency. The occupied channel bandwidth is less than 5 MHz based on a chip rate of 3.84 Mcps.



### 6.6.1.2 1,28 Mcps TDD Option:

Occupied bandwidth is a measure of the bandwidth containing 99% of the total integrated power for transmitted spectrum and is centered on the assigned channel frequency. The occupied channel bandwidth is about 1.6 MHz based on a chip rate of 1.28 Mcps.

## 6.6.2 Out of band emission

Out of band emissions are unwanted emissions immediately outside the channel bandwidth resulting from the modulation process and non-linearity in the transmitter but excluding spurious emissions. This out of band emission requirement is specified both in terms of a spectrum emission mask and adjacent channel power ratio for the transmitter.

### 6.6.2.1 Spectrum emission mask

#### 6.6.2.1.1 3,84 Mcps TDD Option

The mask defined in Table 6.3 to 6.6 below may be mandatory in certain regions. In other regions this mask may not be applied.

For regions where this clause applies, the requirement shall be met by a base station transmitting on a single RF carrier configured in accordance with the manufacturer’s specification. Emissions shall not exceed the maximum level specified in tables 6.3 to 6.6 for the appropriate BS maximum output power, in the frequency range from  $\Delta f = 2.5$  MHz to  $f_{\text{offset\_max}}$  from the carrier frequency, where:

- $f_{\text{offset\_max}}$  is either 12.5 MHz or the offset to the UMTS Tx band edge as defined in section 5.2, whichever is the greater.

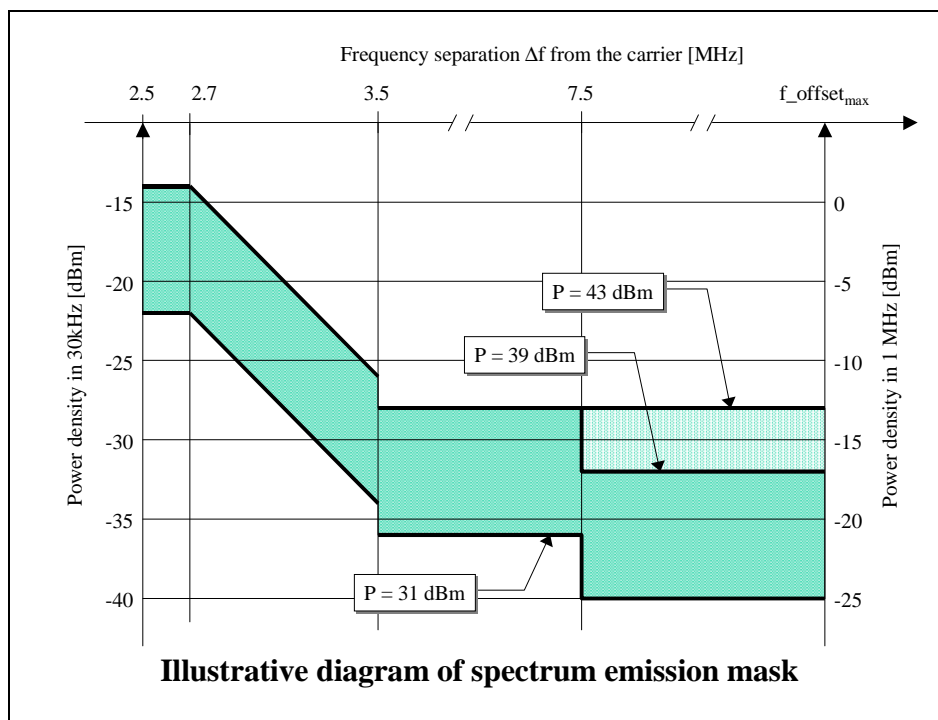

Figure 6.2

**Table 6.3: Spectrum emission mask values, BS maximum output power  $P \geq 43$  dBm**

Frequency offset of measurement filter – 3dB point, $\Delta f$	Frequency offset of measurement filter centre frequency, $f_{\text{offset}}$	Maximum level	Measurement bandwidth
$2.5 \leq \Delta f < 2.7$ MHz	$2.515\text{MHz} \leq f_{\text{offset}} < 2.715\text{MHz}$	-14 dBm	30 kHz
$2.7 \leq \Delta f < 3.5$ MHz	$2.715\text{MHz} \leq f_{\text{offset}} < 3.515\text{MHz}$	$-14 - 15 \cdot (f_{\text{offset}} - 2.715)$ dBm	30 kHz
(see note)	$3.515\text{MHz} \leq f_{\text{offset}} < 4.0\text{MHz}$	-26 dBm	30 kHz
$3.5 \leq \Delta f$ MHz	$4.0\text{MHz} \leq f_{\text{offset}} < f_{\text{offset}_{\text{max}}}$	-13 dBm	1 MHz

**Table 6.4: Spectrum emission mask values, BS maximum output power  $39 \leq P < 43$  dBm**

Frequency offset of measurement filter – 3dB point, $\Delta f$	Frequency offset of measurement filter centre frequency, $f_{\text{offset}}$	Maximum level	Measurement bandwidth
$2.5 \leq \Delta f < 2.7$ MHz	$2.515\text{MHz} \leq f_{\text{offset}} < 2.715\text{MHz}$	-14 dBm	30 kHz
$2.7 \leq \Delta f < 3.5$ MHz	$2.715\text{MHz} \leq f_{\text{offset}} < 3.515\text{MHz}$	$-14 - 15 \cdot (f_{\text{offset}} - 2.715)$ dBm	30 kHz
(see note)	$3.515\text{MHz} \leq f_{\text{offset}} < 4.0\text{MHz}$	-26 dBm	30 kHz
$3.5 \leq \Delta f < 7.5$ MHz	$4.0\text{MHz} \leq f_{\text{offset}} < 8.0\text{MHz}$	-13 dBm	1 MHz
$7.5 \leq \Delta f$ MHz	$8.0\text{MHz} \leq f_{\text{offset}} < f_{\text{offset}_{\text{max}}}$	$P - 56$ dBm	1 MHz

**Table 6.5: Spectrum emission mask values, BS maximum output power  $31 \leq P < 39$  dBm**

Frequency offset of measurement filter – 3dB point, $\Delta f$	Frequency offset of measurement filter centre frequency, $f_{\text{offset}}$	Maximum level	Measurement bandwidth
$2.5 \leq \Delta f < 2.7$ MHz	$2.515\text{MHz} \leq f_{\text{offset}} < 2.715\text{MHz}$	$P - 53$ dBm	30 kHz
$2.7 \leq \Delta f < 3.5$ MHz	$2.715\text{MHz} \leq f_{\text{offset}} < 3.515\text{MHz}$	$P - 53 - 15 \cdot (f_{\text{offset}} - 2.715)$ dBm	30 kHz
(see note)	$3.515\text{MHz} \leq f_{\text{offset}} < 4.0\text{MHz}$	$P - 65$ dBm	30 kHz
$3.5 \leq \Delta f < 7.5$ MHz	$4.0\text{MHz} \leq f_{\text{offset}} < 8.0\text{MHz}$	$P - 52$ dBm	1 MHz
$7.5 \leq \Delta f$ MHz	$8.0\text{MHz} \leq f_{\text{offset}} < f_{\text{offset}_{\text{max}}}$	$P - 56$ dBm	1 MHz

**Table 6.6: Spectrum emission mask values, BS maximum output power  $P < 31$  dBm**

Frequency offset of measurement filter – 3dB point, $\Delta f$	Frequency offset of measurement filter centre frequency, $f_{\text{offset}}$	Maximum level	Measurement bandwidth
$2.5 \leq \Delta f < 2.7$ MHz	$2.515\text{MHz} \leq f_{\text{offset}} < 2.715\text{MHz}$	-22 dBm	30 kHz
$2.7 \leq \Delta f < 3.5$ MHz	$2.715\text{MHz} \leq f_{\text{offset}} < 3.515\text{MHz}$	$-22 - 15 \cdot (f_{\text{offset}} - 2.715)$ dBm	30 kHz
(see note)	$3.515\text{MHz} \leq f_{\text{offset}} < 4.0\text{MHz}$	-34 dBm	30 kHz
$3.5 \leq \Delta f < 7.5$ MHz	$4.0\text{MHz} \leq f_{\text{offset}} < 8.0\text{MHz}$	-21 dBm	1 MHz
$7.5 \leq \Delta f$ MHz	$8.0\text{MHz} \leq f_{\text{offset}} < f_{\text{offset}_{\text{max}}}$	-25 dBm	1 MHz

NOTE: This frequency range ensures that the range of values of  $f_{\text{offset}}$  is continuous.

#### 6.6.2.1.2 1,28 Mcps TDD Option

The mask defined in Table 6.3A to 6.6A may be mandatory in certain regions. In other regions this mask may not be applied.

For regions where this clause applies, the requirement shall be met by a base station transmitting on a single RF carrier configured in accordance with the manufacturer's specification. Emissions shall not exceed the maximum level specified in table 6.3A to 6.6A for the appropriate BS maximum output power, in the frequency range from  $\Delta f = 0.8$  MHz to  $f_{\text{offset}_{\text{max}}}$  from the carrier frequency, where:

- $f_{\text{offset,max}}$  is either 4 MHz or the offset to the UMTS Tx band edge as defined in section 5.2, whichever is the greater.

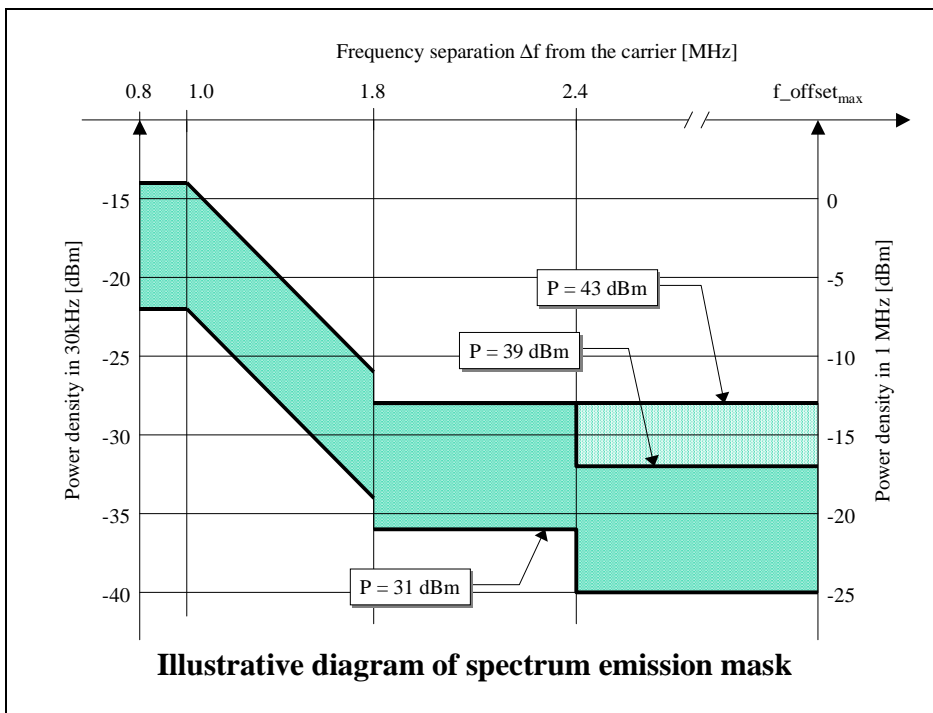

Figure 6.2A

**Table 6.3A: Spectrum emission mask values, BS maximum output power  $P \geq 43$  dBm**

Frequency offset of measurement filter – 3dB point, $\Delta f$	Frequency offset of measurement filter centre frequency, $f_{\text{offset}}$	Maximum level	Measurement bandwidth
$0.8 \leq \Delta f < 1.0$ MHz	$0.815\text{MHz} \leq f_{\text{offset}} < 1.015\text{MHz}$	-14 dBm	30 kHz
$1.0 \leq \Delta f < 1.8$ MHz	$1.015\text{MHz} \leq f_{\text{offset}} < 1.815\text{MHz}$	$-14 - 15 \cdot (f_{\text{offset}} - 1.015)$ dBm	30 kHz
See note	$1.815\text{MHz} \leq f_{\text{offset}} < 2.3\text{MHz}$	-28 dBm	30 kHz
$1.8 \leq \Delta f$ MHz	$2.3\text{MHz} \leq f_{\text{offset}} < f_{\text{offset}_{\text{max}}}$	-13 dBm	1 MHz

**Table 6.4A: Spectrum emission mask values, BS maximum output power  $39 \leq P < 43$  dBm**

Frequency offset of measurement filter – 3dB point, $\Delta f$	Frequency offset of measurement filter centre frequency, $f_{\text{offset}}$	Maximum level	Measurement bandwidth
$0.8 \leq \Delta f < 1.0$ MHz	$0.815\text{MHz} \leq f_{\text{offset}} < 1.015\text{MHz}$	-14 dBm	30 kHz
$1.0 \leq \Delta f < 1.8$ MHz	$1.015\text{MHz} \leq f_{\text{offset}} < 1.815\text{MHz}$	$-14 - 15 \cdot (f_{\text{offset}} - 1.015)$ dBm	30 kHz
$1.8 \leq \Delta f < 2.4$ MHz	$1.815\text{MHz} \leq f_{\text{offset}} < 2.415\text{MHz}$	-28 dBm	30 kHz
See note	$2.415\text{MHz} \leq f_{\text{offset}} < 2.9\text{MHz}$	P - 71 dBm	30 kHz
$2.4 \leq \Delta f$ MHz	$2.9\text{MHz} \leq f_{\text{offset}} < f_{\text{offset}_{\text{max}}}$	P - 56 dBm	1 MHz

**Table 6.5A: Spectrum emission mask values, BS maximum output power  $31 \leq P < 39$  dBm**

Frequency offset of measurement filter – 3dB point, $\Delta f$	Frequency offset of measurement filter centre frequency, $f_{\text{offset}}$	Maximum level	Measurement bandwidth
$0.8 \leq \Delta f < 1.0$ MHz	$0.815\text{MHz} \leq f_{\text{offset}} < 1.015\text{MHz}$	P - 53 dBm	30 kHz
$1.0 \leq \Delta f < 1.8$ MHz	$1.015\text{MHz} \leq f_{\text{offset}} < 1.815\text{MHz}$	$P - 53 - 15 \cdot (f_{\text{offset}} - 1.015)$ dBm	30 kHz
$1.8 \leq \Delta f < 2.4$ MHz	$1.815\text{MHz} \leq f_{\text{offset}} < 2.415\text{MHz}$	P - 67 dBm	30 kHz
See note	$2.415\text{MHz} \leq f_{\text{offset}} < 2.9\text{MHz}$	P - 71 dBm	30 kHz
$2.4 \leq \Delta f$ MHz	$2.9\text{MHz} \leq f_{\text{offset}} < f_{\text{offset}_{\text{max}}}$	P - 56 dBm	1 MHz

**Table 6.6A: Spectrum emission mask values, BS maximum output power  $P < 31$  dBm**

Frequency offset of measurement filter – 3dB point, $\Delta f$	Frequency offset of measurement filter centre frequency, $f_{\text{offset}}$	Maximum level	Measurement bandwidth
$0.8 \leq \Delta f < 1.0$ MHz	$0.815\text{MHz} \leq f_{\text{offset}} < 1.015\text{MHz}$	-22 dBm	30 kHz
$1.0 \leq \Delta f < 1.8$ MHz	$1.015\text{MHz} \leq f_{\text{offset}} < 1.815\text{MHz}$	$-22 - 15 \cdot (f_{\text{offset}} - 1.015)$ dBm	30 kHz
$1.8 \leq \Delta f < 2.4$ MHz	$1.815\text{MHz} \leq f_{\text{offset}} < 2.415\text{MHz}$	-36 dBm	30 kHz
See note	$2.415\text{MHz} \leq f_{\text{offset}} < 2.9\text{MHz}$	-40 dBm	30 kHz
$2.4 \leq \Delta f$ MHz	$2.9\text{MHz} \leq f_{\text{offset}} < f_{\text{offset}_{\text{max}}}$	-25 dBm	1 MHz

NOTE: This frequency range ensures that the range of values of  $f_{\text{offset}}$  is continuous.

### 6.6.2.2 Adjacent Channel Leakage power Ratio (ACLR)

Adjacent Channel Leakage power Ratio (ACLR) is the ratio of the transmitted power to the power measured in an adjacent channel. Both the transmitted and the adjacent channel power are measured through a matched filter (Root Raised Cosine and roll-off 0.22) with a noise power bandwidth equal to the chip rate. The requirements shall apply for all configurations of BS (single carrier or multi-carrier), and for all operating modes foreseen by the manufacturer's specification.

The requirement depends on the deployment scenario. Three different deployment scenarios have been defined as given below.

#### 6.6.2.2.1 Minimum Requirement

##### 6.6.2.2.1.1 3,84 Mcps TDD Option

The ACLR shall be higher than the value specified in Table 6.7.

**Table 6.7: BS ACLR**

BS adjacent channel offset	ACLR limit
$\pm 5$ MHz	45 dB
$\pm 10$ MHz	55 dB

##### 6.6.2.2.1.2 1,28 Mcps TDD Option

For the 1.28Mcps chip rate option, the ACLR shall be better than the value specified in Table 6.7A

**Table 6.7A: BS ACLR (1.28Mcps chip rate)**

BS adjacent channel offset	ACLR limit
$\pm 1.6$ MHz	40 dB
$\pm 3.2$ MHz	50 dB

NOTE: This requirement is valid for co-existence with frame and switching point synchronised systems, or for non-synchronised systems if the path loss between the BSs is greater than 107dB.

#### 6.6.2.2.2 Additional requirement in case of operation in proximity to TDD BS or FDD BS operating on an adjacent frequency

##### 6.6.2.2.2.1 3,84 Mcps TDD Option

In case the equipment is operated in proximity to another TDD BS or FDD BS operating on the first or second adjacent frequency, the ACLR shall be higher than the value specified in Table 6.8.

**Table 6.8: BS ACLR in case of operation in proximity**

BS adjacent channel offset	ACLR limit
$\pm 5$ MHz	70 dB
$\pm 10$ MHz	70 dB

NOTE: The requirement is based on the assumption that the coupling loss between the base stations is at least 84dB.

##### 6.6.2.2.2.2 1,28 Mcps TDD Option

In case the equipment is operated in proximity to another TDD BS or FDD BS and both BSs operating on an adjacent frequency band, the requirement is specified in terms of power level of the transmitting BS. This requirement is valid for co-existence with non-frame and non-switching point synchronised systems operating on the closest used carrier. The interference power level shall not exceed the limit in Table 6.8A.

**Table 6.8A: BS ACLR in case of operation in proximity**

Center Frequency for Measurement	Maximum Level of the interference power (in case of multiple antennas the interference powers shall be summed at all antenna connectors)	Measurement Bandwidth
Closest used carrier of the victim receiver: Either FDD carrier Or 3.84 Mcps TDD carrier Or 1.28 Mcps TDD carrier	-36 dBm	chip rate of the victim receiver: In case of FDD: 3.84 MHz In case of 3.84 Mcps TDD: 3.84 MHz In case of 1.28 Mcps TDD: 1.28 MHz

The closest used carrier with respect to the regarded carrier of one system is defined by

a minimum difference in centre frequency between the regarded carrier and the carriers used in the other system and the chip rate of the other system.

If the actual allowed interference level  $P_{\text{int, allowed, actual}}$  at the victim receiver is higher than  $-106\text{dBm}$ , this requirement may be relaxed by the amount  $P_{\text{int, allowed, actual}} - (-106\text{dBm})$ .

#### 6.6.2.2.3 Additional requirement in case of co-siting with TDD BS or FDD BS operating on an adjacent frequency

##### 6.6.2.2.3.1 3,84 Mcps TDD Option

In case the equipment is co-sited to another TDD BS or FDD BS operating on the first or second adjacent frequency, the requirement is specified in terms of the adjacent channel power level of the BS measured in the adjacent channel. The adjacent channel power shall not exceed the limit in Table 6.9.

**Table 6.9: BS ACLR in case of co-siting**

BS adjacent channel offset	Maximum Level	Measurement Bandwidth
$\pm 5$ MHz	-80 dBm	3.84 MHz
$\pm 10$ MHz	-80 dBm	3.84 MHz

##### 6.6.2.2.3.2 1,28 Mcps TDD Option

In case the equipment is co-sited to another TDD BS or FDD BS and both BSs operating on an adjacent frequency band, the requirement is specified in terms of power level of the transmitting BS. This requirement is valid for co-existence with a non-frame and non-switching point synchronised systems operating on closest used carrier. The interference power level shall not exceed the limit in Table 6.9A.

**Table 6.9A: BS ACLR in case of co-siting**

Center Frequency for Measurement	Maximum Level of the interference power (in case of multiple antennas the interference powers shall be summed at all antenna connectors)	Measurement Bandwidth
Closest used carrier of the victim receiver: Either FDD carrier Or 3.84 Mcps TDD carrier Or 1.28 Mcps TDD carrier	-76 dBm	chip rate of the victim receiver: In case of FDD: 3.84 MHz In case of 3.84 Mcps TDD: 3.84 MHz In case of 1.28 Mcps TDD: 1.28 MHz

The closest used carrier with respect to the regarded carrier of one system is defined by

a minimum difference in centre frequency between the regarded carrier and the carriers used in the other system and the chip rate of the other system.

If the actual  $MCL_{\text{actual}}$  is higher than 30dB, this requirement may be relaxed by the amount  $MCL_{\text{actual}} - 30\text{dB}$ .

If the actual allowed interference level  $P_{\text{int, allowed, actual}}$  at the victim receiver is higher than  $-106\text{dBm}$ , this requirement may be relaxed by the amount  $P_{\text{int, allowed, actual}} - (-106\text{dBm})$ .

### 6.6.3 Spurious emissions

Spurious emissions are emissions which are caused by unwanted transmitter effects such as harmonics emission, parasitic emission, intermodulation products and frequency conversion products, but exclude out of band emissions. This is measured at the base station RF output port.

Unless otherwise stated, all requirements are measured as mean power.

#### 6.6.3.1 Mandatory Requirements

The requirements of either subclause 6.6.3.1.1 or subclause 6.6.3.1.2 shall apply whatever the type of transmitter considered (single carrier or multi-carrier). It applies for all transmission modes foreseen by the manufacturer's.

##### 6.6.3.1.1 Spurious emissions (Category A)

The following requirements shall be met in cases where Category A limits for spurious emissions, as defined in ITU-R Recommendation SM.329-8 [1], are applied.

##### 6.6.3.1.1.1 Minimum Requirement

##### 6.6.3.1.1.1.1 3,84 Mcps TDD Option

Either requirement applies at frequencies within the specified frequency ranges which are more than 12.5MHz under the first carrier frequency used or more than 12.5 MHz above the last carrier frequency used. The power of any spurious emission shall not exceed:

**Table 6.10: BS Mandatory spurious emissions limits, Category A**

Band	Minimum requirement	Measurement Bandwidth	Note
9kHz – 150kHz	-13 dBm	1 kHz	Bandwidth as in ITU SM.329-8, s4.1
150kHz – 30MHz		10 kHz	Bandwidth as in ITU SM.329-8, s4.1
30MHz – 1GHz		100 kHz	Bandwidth as in ITU SM.329-8, s4.1
1GHz – 12.75 GHz		1 MHz	Upper frequency as in ITU SM.329-8, s2.5 table 1

##### 6.6.3.1.1.1.2 1,28 Mcps TDD Option

Either requirement applies at frequencies within the specified frequency ranges which are more than 4MHz under the first carrier frequency used or more than 4 MHz above the last carrier frequency used. The power of any spurious emission shall not exceed:

**Table 6.10A: BS Mandatory spurious emissions limits, Category A**

Band	Minimum requirement	Measurement Bandwidth	Note
9kHz – 150kHz	-13 dBm	1 kHz	Bandwidth as in ITU SM.329-8, s4.1
150kHz – 30MHz		10 kHz	Bandwidth as in ITU SM.329-8, s4.1
30MHz – 1GHz		100 kHz	Bandwidth as in ITU SM.329-8, s4.1
1GHz – 12.75 GHz		1 MHz	Upper frequency as in ITU SM.329-8, s2.5 table 1

NOTE: only the measurement bands are different according to the occupied bandwidth.

### 6.6.3.1.2 Spurious emissions (Category B)

The following requirements shall be met in cases where Category B limits for spurious emissions, as defined in ITU-R Recommendation SM.329-8 [1], are applied.

#### 6.6.3.1.2.1 Minimum Requirement

##### 6.6.3.1.2.1.1 3,84 Mcps TDD Option

Either requirement applies at frequencies within the specified frequency ranges which are more than 12.5MHz under the first carrier frequency used or more than 12.5 MHz above the last carrier frequency used. The power of any spurious emission shall not exceed:

**Table 6.11: BS Mandatory spurious emissions limits, Category B**

Band	Maximum Level	Measurement Bandwidth	Note
9kHz – 150kHz	-36 dBm	1 kHz	Bandwidth as in ITU SM.329-8, s4.1
150kHz – 30MHz	-36 dBm	10 kHz	Bandwidth as in ITU SM.329-8, s4.1
30MHz – 1GHz	-36 dBm	100 kHz	Bandwidth as in ITU SM.329-8, s4.1
1GHz ↔ Fc1-60 MHz or FI -10 MHz <i>whichever is the higher</i>	-30 dBm	1 MHz	Bandwidth as in ITU SM.329-8, s4.1
Fc1 - 60 MHz or FI -10 MHz <i>whichever is the higher</i> ↔ Fc1 - 50 MHz or FI -10 MHz <i>whichever is the higher</i>	-25 dBm	1 MHz	Specification in accordance with ITU-R SM.329-8, s4.3 and Annex 7
Fc1 - 50 MHz or FI -10 MHz <i>whichever is the higher</i> ↔ Fc2 + 50 MHz or Fu +10 MHz <i>whichever is the lower</i>	-15 dBm	1 MHz	Specification in accordance with ITU-R SM.329-8, s4.3 and Annex 7
Fc2 + 50 MHz or Fu + 10 MHz <i>whichever is the lower</i> ↔ Fc2 + 60 MHz or Fu + 10 MHz <i>whichever is the lower</i>	-25 dBm	1 MHz	Specification in accordance with ITU-R SM.329-8, s4.3 and Annex 7
Fc2 + 60 MHz or Fu + 10 MHz <i>whichever is the lower</i> ↔ 12,75 GHz	-30 dBm	1 MHz	Bandwidth as in ITU-R SM.329-8, s4.3 and Annex 7. Upper frequency as in ITU-R SM.329-8, s2.5 table 1

Fc1: Center frequency of emission of the first carrier transmitted by the BS



Fc2: Center frequency of emission of the last carrier transmitted by the BS

F<sub>l</sub> : Lower frequency of the band in which TDD operates

F<sub>u</sub> : Upper frequency of the band in which TDD operates

#### 6.6.3.1.2.1.2 1,28 Mcps TDD Option

either requirement applies at frequencies within the specified frequency ranges which are more than 4MHz under the first carrier frequency used or more than 4 MHz above the last carrier frequency used. The power of any spurious emission shall not exceed:

**Table 6.11A: BS Mandatory spurious emissions limits, Category B**

Band	Maximum Level	Measurement Bandwidth	Note
9kHz – 150kHz	-36 dBm	1 kHz	Bandwidth as in ITU SM.329-8, s4.1
150kHz – 30MHz	- 36 dBm	10 kHz	Bandwidth as in ITU SM.329-8, s4.1
30MHz – 1GHz	-36 dBm	100 kHz	Bandwidth as in ITU SM.329-8, s4.1
1GHz ↔ Fc1-19.2 MHz or F <sub>l</sub> -3.2 MHz <i>whichever is the higher</i>	-30 dBm	1 MHz	Bandwidth as in ITU SM.329-8, s4.1
Fc1 – 19.2 MHz or F <sub>l</sub> -3.2MHz <i>whichever is the higher</i> ↔ Fc1 - 16 MHz or F <sub>l</sub> -3.2 MHz <i>whichever is the higher</i>	-25 dBm	1 MHz	Specification in accordance with ITU-R SM.329-8, s4.1
Fc1 - 16 MHz or F <sub>l</sub> -3.2 MHz <i>whichever is the higher</i> ↔ Fc2 + 16 MHz or F <sub>u</sub> +3.2 MHz <i>whichever is the lower</i>	-15 dBm	1 MHz	Specification in accordance with ITU-R SM.329-8, s4.1
Fc2 + 16 MHz or F <sub>u</sub> + 3.2MHz <i>whichever is the lower</i> ↔ Fc2 +19.2 MHz or F <sub>u</sub> + 3.2MHz <i>whichever is the lower</i>	-25 dBm	1 MHz	Specification in accordance with ITU-R SM.329-8, s4.1
Fc2 + 19.2 MHz or F <sub>u</sub> +3.2 MHz <i>whichever is the lower</i> ↔ 12,5 GHz	-30 dBm	1 MHz	Bandwidth as in ITU-R SM.329-8, s4.1. Upper frequency as in ITU-R SM.329-8, s2.5 table 1

Fc1: Center frequency of emission of the first carrier transmitted by the BS

Fc2: Center frequency of emission of the last carrier transmitted by the BS

F<sub>l</sub> : Lower frequency of the band in which TDD operates

F<sub>u</sub> : Upper frequency of the band in which TDD operates

#### 6.6.3.2 Co-existence with GSM 900

##### 6.6.3.2.1 Operation in the same geographic area

This requirement may be applied for the protection of GSM 900 MS in geographic areas in which both GSM 900 and UTRA are deployed.

## 6.6.3.2.1.1 Minimum Requirement

The power of any spurious emission shall not exceed:

**Table 6.12: BS Spurious emissions limits for BS in geographic coverage area of GSM 900 MS receiver**

Band	Maximum Level	Measurement Bandwidth	Note
921 – 960MHz	-57 dBm	100 kHz	

## 6.6.3.2.2 Co-located base stations

This requirement may be applied for the protection of GSM 900 BTS receivers when GSM 900 BTS and UTRA BS are co-located.

## 6.6.3.2.2.1 Minimum Requirement

The power of any spurious emission shall not exceed:

**Table 6.13: BS Spurious emissions limits for protection of the GSM 900 BTS receiver**

Band	Maximum Level	Measurement Bandwidth	Note
876 – 915 MHz	-98 dBm	100 kHz	

## 6.6.3.3 Co-existence with DCS 1800

## 6.6.3.3.1 Operation in the same geographic area

This requirement may be applied for the protection of DCS 1800 MS in geographic areas in which both DCS 1800 and UTRA are deployed.

## 6.6.3.3.1.1 Minimum Requirement

The power of any spurious emission shall not exceed:

**Table 6.14: BS Spurious emissions limits for BS in geographic coverage area of DCS 1800 MS receiver**

Band	Maximum Level	Measurement Bandwidth	Note
1805 – 1880MHz	-47 dBm	100 kHz	

## 6.6.3.3.2 Co-located basestations

This requirement may be applied for the protection of DCS 1800 BTS receivers when DCS 1800 BTS and UTRA BS are co-located.

## 6.6.3.3.2.1 Minimum Requirement

The power of any spurious emission shall not exceed:

**Table 6.15: BS Spurious emissions limits for BS co-located with DCS 1800 BTS**

Band	Maximum Level	Measurement Bandwidth	Note
1710 – 1785 MHz	-98 dBm	100 kHz	

### 6.6.3.4 Co-existence with UTRA-FDD

#### 6.6.3.4.1 Operation in the same geographic area

This requirement may be applied to geographic areas in which both UTRA-TDD and UTRA-FDD are deployed.

##### 6.6.3.4.1.1 Minimum Requirement

The power of any spurious emission shall not exceed:

**Table 6.16: BS Spurious emissions limits for BS in geographic coverage area of UTRA-FDD**

Band	Maximum Level	Measurement Bandwidth	Note
1920 – 1980 MHz	-32 dBm	1 MHz	
2110 – 2170 MHz	-52 dBm	1 MHz	

#### 6.6.3.4.2 Co-located base stations

This requirement may be applied for the protection of UTRA-FDD BS receivers when UTRA-TDD BS and UTRA FDD BS are co-located.

##### 6.6.3.4.2.1 Minimum Requirement

The power of any spurious emission shall not exceed:

**Table 6.17: BS Spurious emissions limits for BS co-located with UTRA-FDD**

Band	Maximum Level	Measurement Bandwidth	Note
1920 – 1980 MHz	-86 dBm	1 MHz	
2110 – 2170 MHz	-52 dBm	1 MHz	

## 6.7 Transmit intermodulation

The transmit intermodulation performance is a measure of the capability of the transmitter to inhibit the generation of signals in its non linear elements caused by presence of the wanted signal and an interfering signal reaching the transmitter via the antenna.

The transmit intermodulation level is the power of the intermodulation products when a CDMA modulated interference signal is injected into the antenna connector at a level of 30 dB lower than that of the subject signal.

### 6.7.1 Minimum Requirement

#### 6.7.1.1 3,84 Mcps TDD Option

The frequency of the interference signal shall be  $\pm 5$  MHz,  $\pm 10$  MHz and  $\pm 15$  MHz offset from the subject signal. The Transmit intermodulation level shall not exceed the out of band or the spurious emission requirements of section 6.6.2 and 6.6.3.

#### 6.7.1.2 1,28 Mcps TDD Option:

The frequency of the interference signal shall be  $\pm 1.6$  MHz,  $\pm 3.2$  MHz and  $\pm 4.8$  MHz offset from the subject signal. The Transmit intermodulation level shall not exceed the out of band or the spurious emission requirements of section 6.6.2 and 6.6.3.

## 6.8 Transmit modulation

### 6.8.1 Transmit pulse shape filter

The transmit pulse-shaping filter is a root-raised cosine (RRC) with roll-off  $\alpha = 0.22$  in the frequency domain. The impulse response of the chip impulse filter  $RC_0(t)$  is

$$RC_0(t) = \frac{\sin\left(\pi \frac{t}{T_c}(1-\alpha)\right) + 4\alpha \frac{t}{T_c} \cos\left(\pi \frac{t}{T_c}(1+\alpha)\right)}{\pi \frac{t}{T_c} \left(1 - \left(4\alpha \frac{t}{T_c}\right)^2\right)}$$

Where the roll-off factor  $\alpha = 0.22$  and  $T_c$  is the chip duration:

### 6.8.2 Modulation Accuracy

The Error Vector Magnitude is a measure of the difference between the reference waveform and the measured waveform. This difference is called the error vector. Both waveforms pass through a matched Root Raised Cosine filter with bandwidth corresponding to the considered chip rate and roll-off  $\alpha = 0.22$ . Both waveforms are then further modified by selecting the frequency, absolute phase, absolute amplitude and chip clock timing so as to minimise the error vector. The EVM result is defined as the square root of the ratio of the mean error vector power to the mean reference power expressed as a %. The measurement interval is one timeslot. The requirement is valid over the total power dynamic range as specified in subclause 6.4.3. See Annex C of TS 25.142 for further details.

#### 6.8.2.1 Minimum Requirement

The Modulation accuracy shall not be worse than 12.5 %.

### 6.8.3 Peak Code Domain Error

The code domain error is computed by projecting the error vector power onto the code domain at a specific spreading factor. The error power for each code is defined as the ratio to the mean power of the reference waveform expressed in dB. And the Peak Code Domain Error is defined as the maximum value for Code Domain Error. The measurement interval is one timeslot.

#### 6.8.3.1 Minimum Requirement

The peak code domain error shall not exceed -28 dB at spreading factor 16.

## 7 Receiver characteristics

### 7.1 General

The requirements in this clause 7 assume that the receiver is not equipped with diversity. For receivers with diversity, the requirements apply to each antenna connector separately, with the other one(s) terminated or disabled. The requirements are otherwise unchanged.

### 7.2 Reference sensitivity level

The reference sensitivity is the minimum receiver input power measured at the antenna connector at which the FER/BER does not exceed the specific value indicated in section 7.2.1.

## 7.2.1 Minimum Requirement

### 7.2.1.1 3,84 Mcps TDD Option

For the measurement channel specified in Annex A, the reference sensitivity level and performance of the BS shall be as specified in table 7.1 below.

**Table 7.1: BS reference sensitivity levels**

Data rate	BS reference sensitivity level (dBm)	FER/BER
12.2 kbps	-109 dBm	BER shall not exceed 0.001

### 7.2.1.2 1,28 Mcps TDD Option

For the measurement channel specified in Annex A, the reference sensitivity level and performance of the BS shall be as specified in table 7.1A below.

**Table 7.1A: BS reference sensitivity levels**

Data rate	BS reference sensitivity level (dBm)	FER/BER
12.2 kbps	-110 dBm	BER shall not exceed 0.001

## 7.3 Dynamic range

Receiver dynamic range is the receiver ability to handle a rise of interference in the reception frequency channel. The receiver shall fulfil a specified BER requirement for a specified sensitivity degradation of the wanted signal in the presence of an interfering AWGN signal in the same reception frequency channel.

### 7.3.1 Minimum requirement

#### 7.3.1.1 3,84 Mcps TDD Option

The BER shall not exceed 0.001 for the parameters specified in Table 7.2.

**Table 7.2: Dynamic Range**

Parameter	Level	Unit
Data rate	12.2	kbps
Wanted signal	<REFSENS> + 30 dB	dBm
Interfering AWGN signal	-73	dBm/3.84 MHz

#### 7.3.1.2 1,28 Mcps TDD Option:

The BER shall not exceed 0.001 for the parameters specified in Table 7.2A.

**Table 7.2A: Dynamic Range**

Parameter	Level	Unit
Data rate	12.2	kbps
Wanted signal	<REFSENS> + 30 dB	dBm
Interfering AWGN signal	-76dBm	dBm/1.28 MHz

## 7.4 Adjacent Channel Selectivity (ACS)

Adjacent channel selectivity (ACS) is a measure of the receiver ability to receive a wanted signal at its assigned channel frequency in the presence of an adjacent channel signal at a given frequency offset from the center frequency of the assigned channel. ACS is the ratio of the receiver filter attenuation on the assigned channel frequency to the receive filter attenuation on the adjacent channel(s).

### 7.4.1 Minimum Requirement

#### 7.4.1.1 3,84 Mcps TDD Option

The BER shall not exceed 0.001 for the parameters specified in table 7.3.

**Table 7.3: Adjacent channel selectivity**

Parameter	Level	Unit
Data rate	12.2	kbps
Wanted signal	Reference sensitivity level + 6dB	dBm
Interfering signal	-52	dBm
F <sub>w</sub> (Modulated)	5	MHz

#### 7.4.1.2 1,28 Mcps TDD Option:

The BER shall not exceed 0.001 for the parameters specified in table 7.3A

**Table 7.3A: Adjacent channel selectivity**

Parameter	Level	Unit
Data rate	12.2	kbps
Wanted signal	Reference sensitivity level + 6dB	dBm
Interfering signal	-55	dBm
F <sub>w</sub> (Modulated)	1.6	MHz

## 7.5 Blocking characteristics

The blocking characteristics is a measure of the receiver ability to receive a wanted signal at its assigned channel frequency in the presence of an unwanted interferer on frequencies other than those of the adjacent channels. The blocking performance requirement applies to interfering signals with center frequency within the ranges specified in the tables below, using a 1MHz step size.

### 7.5.0 Minimum requirement

The static reference performance as specified in clause 7.2.1 shall be met with a wanted and an interfering signal coupled to BS antenna input using the following parameters.

## 7.5.0.1 3,84 Mcps TDD Option

Table 7.4 (a): Blocking requirements for operating bands defined in 5.2(a)

Centre Frequency of Interfering Signal	Interfering Signal Level	Wanted Signal Level	Minimum Offset of Interfering Signal	Type of Interfering Signal
1900 – 1920 MHz, 2010 – 2025 MHz	-40 dBm	<REFSENS> + 6 dB	10 MHz	WCDMA signal with one code
1880 – 1900 MHz, 1990 – 2010 MHz, 2025 – 2045 MHz	-40 dBm	<REFSENS> + 6 dB	10 MHz	WCDMA signal with one code
1920 – 1980 MHz	-40 dBm	<REFSENS> + 6 dB	10 MHz	WCDMA signal with one code
1 – 1880 MHz, 1980 – 1990 MHz, 2045 – 12750 MHz	-15 dBm	<REFSENS> + 6 dB	—	CW carrier

Table 7.4(b) : Blocking requirements for operating bands defined in 5.2(b)

Centre Frequency of Interfering Signal	Interfering Signal Level	Wanted Signal Level	Minimum Offset of Interfering Signal	Type of Interfering Signal
1850 – 1990 MHz	-40 dBm	<REFSENS> + 6 dB	10 MHz	WCDMA signal with one code
1830 – 1850 MHz, 1990 – 2010 MHz	-40 dBm	<REFSENS> + 6 dB	10 MHz	WCDMA signal with one code
1 – 1830 MHz, 2010 – 12750 MHz	-15 dBm	<REFSENS> + 6 dB	—	CW carrier

Table 7.4(c) : Blocking requirements for operating bands defined in 5.2(c)

Centre Frequency of Interfering Signal	Interfering Signal Level	Wanted Signal Level	Minimum Offset of Interfering Signal	Type of Interfering Signal
1910 – 1930 MHz	-40 dBm	<REFSENS> + 6 dB	10 MHz	WCDMA signal with one code
1890 – 1910 MHz, 1930 – 1950 MHz	-40 dBm	<REFSENS> + 6 dB	10 MHz	WCDMA signal with one code
1 – 1890 MHz, 1950 – 12750 MHz	-15 dBm	<REFSENS> + 6 dB	—	CW carrier

## 7.5.0.2 1,28 Mcps TDD Option

Table 7.4A(a): Blocking requirements for operating bands defined in 5.2(a)

Center Frequency of Interfering Signal	Interfering Signal Level	Wanted Signal Level	Minimum Offset of Interfering Signal	Type of Interfering Signal
1900 – 1920 MHz, 2010 – 2025 MHz	-40 dBm	<REFSENS> + 6 dB	3.2MHz	Narrow band CDMA signal with one code
1880 – 1900 MHz, 1990 – 2010 MHz, 2025 – 2045 MHz	-40dBm	<REFSENS> + 6 dB	3.2MHz	Narrow band CDMA signal with one code
1920 – 1980 MHz	-40dBm	<REFSENS> + 6 dB	3.2MHz	Narrow band CDMA signal with one code
1 – 1880 MHz, 1980 – 1990 MHz, 2045 – 12750 MHz	-15dBm	<REFSENS> + 6 dB	—	CW carrier

**Table 7.4A(b): Blocking requirements for operating bands defined in 5.2(b)**

Center Frequency of Interfering Signal	Interfering Signal Level	Wanted Signal Level	Minimum Offset of Interfering Signal	Type of Interfering Signal
1850 – 1990 MHz	-40dBm	<REFSENS> + 6 dB	3.2MHz	Narrow band CDMA signal with one code
1830 – 1850 MHz, 1990 – 2010 MHz	-40 dBm	<REFSENS> + 6 dB	3.2MHz	Narrow band CDMA signal with one code
1 – 1830 MHz, 2010 – 12750 MHz	-15 dBm	<REFSENS> + 6 dB	—	CW carrier

**Table 7.4A(c): Blocking requirements for operating bands defined in 5.2(c)**

Center Frequency of Interfering Signal	Interfering Signal Level	Wanted Signal Level	Minimum Offset of Interfering Signal	Type of Interfering Signal
1910 – 1930 MHz	-40dBm	<REFSENS> + 6 dB	3.2MHz	Narrow band CDMA signal with one code
1890 – 1910 MHz, 1930 – 1950 MHz	-40dBm	<REFSENS> + 6 dB	3.2 MHz	Narrow band CDMA signal with one code
1 – 1890 MHz, 1950 – 12750 MHz	-15 dBm	<REFSENS> + 6 dB	—	CW carrier

## 7.5.1 Co-location with GSM900 and/or DCS 1800

This additional blocking requirement may be applied for the protection of TDD BS receivers when GSM900 and/or DCS1800 BTS are co-located with UTRA TDD BS.

The blocking performance requirement applies to interfering signals with center frequency within the ranges specified in the tables below, using a 1MHz step size.

In case this additional blocking requirement is applied, the static reference performance as specified in clause 7.2.1 shall be met with a wanted and an interfering signal coupled to BS antenna input using the following parameters.

### 7.5.1.1 3,84 Mcps TDD Option

**Table 7.4 (d): Additional blocking requirements for operating bands defined in 5.2(a) when co-located with GSM900**

Centre Frequency of Interfering Signal	Interfering Signal Level	Wanted Signal Level	Minimum Offset of Interfering Signal	Type of Interfering Signal
921 – 960 MHz	+16 dBm	<REFSENS> + 6 dB	—	CW carrier

**Table 7.4 (e): Additional blocking requirements for operating bands defined in 5.2(a) when co-located with DCS1800**

Center Frequency of Interfering Signal	Interfering Signal Level	Wanted Signal Level	Minimum Offset of Interfering Signal	Type of Interfering Signal
1805 - 1880	+16 dBm	<REFSENS> + 6 dB	—	CW carrier



### 7.5.1.2 1,28 Mcps TDD Option

**Table 7.4A (d): Additional blocking requirements for operating bands defined in 5.2(a) when co-located with GSM900**

Centre Frequency of Interfering Signal	Interfering Signal Level	Wanted Signal Level	Minimum Offset of Interfering Signal	Type of Interfering Signal
921 – 960 MHz	+16 dBm	<REFSENS> + 6 dB	—	CW carrier

**Table 7.4A (e): Additional blocking requirements for operating bands defined in 5.2(a) when co-located with DCS1800**

Center Frequency of Interfering Signal	Interfering Signal Level	Wanted Signal Level	Minimum Offset of Interfering Signal	Type of Interfering Signal
1805 – 1880	+16 dBm	<REFSENS> + 6 dB	—	CW carrier

## 7.6 Intermodulation characteristics

Third and higher order mixing of the two interfering RF signals can produce an interfering signal in the band of the desired channel. Intermodulation response rejection is a measure of the capability of the receiver to receive a wanted signal on its assigned channel frequency in the presence of two or more interfering signals which have a specific frequency relationship to the wanted signal.

### 7.6.1 Minimum requirement

The static reference performance as specified in clause 7.2.1 should be met when the following signals are coupled to BS antenna input.

- A wanted signal at the assigned channel frequency, 6 dB above the static reference level.
- Two interfering signals with the following parameters.

#### 7.6.1.1 3,84 Mcps TDD Option

**Table 7.5 : Intermodulation requirement**

Interfering Signal Level	Offset	Type of Interfering Signal
- 48 dBm	10 MHz	CW signal
- 48 dBm	20 MHz	WCDMA signal with one code

#### 7.6.1.2 1,28 Mcps TDD Option

**Table7.5A: Intermodulation requirement**

Interfering Signal Level	Offset	Type of Interfering Signal
- 48 dBm	3.2 MHz	CW signal
- 48 dBm	6.4 MHz	1,28 Mcps TDD Option signal with one code

## 7.7 Spurious emissions

The spurious emissions power is the power of emissions generated or amplified in a receiver that appear at the BS antenna connector. The requirements apply to all BS with separate RX and TX antenna port. The test shall be performed when both TX and RX are on with the TX port terminated.

For all BS with common RX and TX antenna port the transmitter spurious emission as specified in section 6.6.3 is valid.

### 7.7.1 Minimum Requirement

#### 7.7.1.1 3,84 Mcps TDD Option:

The power of any spurious emission shall not exceed:

**Table 7.6: Receiver spurious emission requirements**

Band	Maximum level	Measurement Bandwidth	Note
9 kHz – 1 GHz	-57 dBm	100 kHz	
1 GHz – 1.9 GHz and 1.98 GHz – 2.01 GHz	-47 dBm	1 MHz	With the exception of frequencies between 12.5MHz below the first carrier frequency and 12.5MHz above the last carrier frequency used by the BS.
1.9 GHz – 1.98 GHz and 2.01 GHz – 2.025 GHz	-78 dBm	3.84 MHz	With the exception of frequencies between 12.5MHz below the first carrier frequency and 12.5MHz above the last carrier frequency used by the BS.
2.025 GHz – 12.75 GHz	-47 dBm	1 MHz	With the exception of frequencies between 12.5MHz below the first carrier frequency and 12.5MHz above the last carrier frequency used by the BS.

#### 7.7.1.2 1,28 Mcps TDD Option

The power of any spurious emission shall not exceed:

**Table 7.6A: Receiver spurious emission requirements**

Band	Maximum level	Measurement Bandwidth	Note
9 kHz – 1 GHz	-57 dBm	100 kHz	
1 GHz – 1.9 GHz and 1.98 GHz – 2.01 GHz	-47 dBm	1 MHz	With the exception of frequencies between 4MHz below the first carrier frequency and 4MHz above the last carrier frequency used by the BS.
1.9 GHz – 1.98 GHz and 2.01 GHz – 2.025 GHz	-83 dBm	1.28 MHz	With the exception of frequencies between 4MHz below the first carrier frequency and 4MHz above the last carrier frequency used by the BS.
2.025 GHz – 12.75 GHz	-47 dBm	1 MHz	With the exception of frequencies between 4MHz below the first carrier frequency and 4MHz above the last carrier frequency used by the BS.

## 8 Performance requirement

### 8.1 General

Performance requirements for the BS are specified for the measurement channels defined in Annex A and the propagation conditions in Annex B. The requirements only apply to those measurement channels that are supported by the base station.

The requirements only apply to a base station with dual receiver antenna diversity. The required  $\hat{I}_{or}/I_{oc}$  shall be applied separately at each antenna port.

**Table 8.1: Summary of Base Station performance targets**

Physical channel	Measurement channel	Static	Multi-path Case 1	Multi-path Case 2	Multi-path Case 3
		Performance metric			
DCH	12.2 kbps	BLER < $10^{-2}$	BLER < $10^{-2}$	BLER < $10^{-2}$	BLER < $10^{-2}$
	64 kbps	BLER < $10^{-1}, 10^{-2}$	BLER < $10^{-1}, 10^{-2}$	BLER < $10^{-1}, 10^{-2}$	BLER < $10^{-1}, 10^{-2}, 10^{-3}$
	144 kbps	BLER < $10^{-1}, 10^{-2}$	BLER < $10^{-1}, 10^{-2}$	BLER < $10^{-1}, 10^{-2}$	BLER < $10^{-1}, 10^{-2}, 10^{-3}$
	384 kbps	BLER < $10^{-1}, 10^{-2}$	BLER < $10^{-1}, 10^{-2}$	BLER < $10^{-1}, 10^{-2}$	BLER < $10^{-1}, 10^{-2}, 10^{-3}$

### 8.2 Demodulation in static propagation conditions

#### 8.2.1 Demodulation of DCH

The performance requirement of DCH in static propagation conditions is determined by the maximum Block Error Rate (BLER) allowed when the receiver input signal is at a specified  $\hat{I}_{or}/I_{oc}$  limit. The BLER is calculated for each of the measurement channels supported by the base station.

##### 8.2.1.1 Minimum requirement

###### 8.2.1.1.1 3,84 Mcps TDD Option

For the parameters specified in Table 8.2 the BLER should not exceed the piece-wise linear BLER curve specified in Table 8.3. These requirements are applicable for TFCS size 16.

**Table 8.2: Parameters in static propagation conditions**

Parameters	Unit	Test 1	Test 2	Test 3	Test 4
Number of DPCH <sub>o</sub>		6	4	0	0
$\frac{DPCH_o - E_c}{I_{or}}$	dB	-9	-9.5	0	0
$I_{oc}$	dBm/3.84 MHz	-89			
Cell Parameter*		0,1			
DPCH Channelization Codes*	C(k,Q)	C(1,8)	C(1,4) C(5,16)	C(1,2) C(9,16)	C(1,2)
DPCH <sub>o</sub> Channelization Codes*	C(k,Q)	C(i,16) 3 ≤ i ≤ 8	C(i,16) 6 ≤ i ≤ 9	-	-
Information Data Rate	kbps	12.2	64	144	384

\*Note: Refer to TS 25.223 for definition of channelization codes and cell parameter.

**Table 8.3: Performance requirements in AWGN channel.**

Test Number	$\frac{\hat{I}_{or}}{I_{oc}}$ [dB]	BLER Required $E_b/N_0$
1	-1.8	$10^{-2}$
2	-0.35	$10^{-1}$
	-0.05	$10^{-2}$
3	-0.2	$10^{-1}$
	0.1	$10^{-2}$
4	-0.7	$10^{-1}$
	-0.5	$10^{-2}$

### 8.2.1.1.2 1,28 Mcps TDD Option

For the parameters specified in Table 8.2A the BLER should not exceed the piece-wise linear BLER curve specified in Table 8.3A. These requirements are applicable for TFCS size 16.

**Table 8.2A: Parameters in static propagation conditions**

Parameters	Unit	Test 1	Test 2	Test 3	Test 4
Number of DPCH <sub>o</sub>		4	1	1	0
Spread factor of DPCH <sub>o</sub>		8	8	8	-
$\frac{DPCH_o - E_c}{I_{or}}$	dB	-7	-7	-7	0
$I_{oc}$	dBm/1.28MHz	-91			
Information Data Rate	Kbps	12.2	64	144	384

**Table 8.3A: Performance requirements in AWGN channel.**

Test Number	$\frac{\hat{I}_{or}}{I_{oc}}$ [dB]	BLER Required $E_b/N_0$
1	0.6	$10^{-2}$
2	-0.9	$10^{-1}$
	-0.4	$10^{-2}$
3	-0.3	$10^{-1}$
	-0.1	$10^{-2}$
4	0.5	$10^{-1}$
	0.6	$10^{-2}$

## 8.3 Demodulation of DCH in multipath fading conditions

### 8.3.1 Multipath fading Case 1

The performance requirement of DCH in multipath fading Case 1 is determined by the maximum Block Error Rate (BLER) allowed when the receiver input signal is at a specified  $\hat{I}_{or}/I_{oc}$  limit. The BLER is calculated for each of the measurement channels supported by the base station.

#### 8.3.1.1 Minimum requirement

##### 8.3.1.1.1 3,84 Mcps TDD Option

For the parameters specified in Table 8.4 the BLER should not exceed the piece-wise linear BLER curve specified in Table 8.5. These requirements are applicable for TFCS size 16.

**Table 8.4: Parameters in multipath Case 1 channel**

Parameters	Unit	Test 1	Test 2	Test 3	Test 4
Number of DPCH <sub>o</sub>		6	4	0	0
$\frac{DPCH_o - E_c}{I_{or}}$	dB	-9	-9.5	0	0
$I_{oc}$	dBm/3.84 MHz	-89			
Cell Parameter*		0,1			
DPCH Channelization Codes*	C(k,Q)	C(1,8)	C(1,4) C(5,16)	C(1,2) C(9,16)	C(1,2)
DPCH <sub>o</sub> Channelization Codes*	C(k,Q)	C(i,16) 3 ≤ i ≤ 8	C(i,16) 6 ≤ i ≤ 9	-	-
Information Data Rate	kbps	12.2	64	144	384

\*Note: Refer to TS 25.223 for definition of channelization codes and cell parameter.

**Table 8.5: Performance requirements in multipath Case 1 channel.**

Test Number	$\frac{\hat{I}_{or}}{I_{oc}}$ [dB]	BLER
1	6.7	10 <sup>-2</sup>
2	5.3	10 <sup>-1</sup>
	9.7	10 <sup>-2</sup>
3	5.5	10 <sup>-1</sup>
	9.8	10 <sup>-2</sup>
4	4.8	10 <sup>-1</sup>
	9.2	10 <sup>-2</sup>

### 8.3.1.1.2 1,28 Mcps TDD Option

For the parameters specified in Table 8.4A the BLER should not exceed the piece-wise linear BLER curve specified in Table 8.5A. These requirements are applicable for TFCS size 16.

**Table 8.4A: Parameters in multipath Case 1 channel**

Parameters	Unit	Test 1	Test 2	Test 3	Test 4
Number of DPCH <sub>o</sub>		4	1	1	0
Spread factor of DPCH <sub>o</sub>		8	8	8	-
$\frac{DPCH_o - E_c}{I_{or}}$	DB	-7	-7	-7	0
$I_{oc}$	dBm/1.28 MHz	-91			
Information Data Rate	Kbps	12.2	64	144	384

**Table 8.5A: Performance requirements in multipath Case 1 channel.**

Test Number	$\frac{\hat{I}_{or}}{I_{oc}}$ [dB]	BLER
1	10.4	10 <sup>-2</sup>
2	5.3	10 <sup>-1</sup>
	9.4	10 <sup>-2</sup>
3	5.7	10 <sup>-1</sup>
	10.1	10 <sup>-2</sup>
4	6.0	10 <sup>-1</sup>
	10.0	10 <sup>-2</sup>

## 8.3.2 Multipath fading Case 2

The performance requirement of DCH in multipath fading Case 2 is determined by the maximum Block Error Rate (BLER) allowed when the receiver input signal is at a specified  $\hat{I}_{or}/I_{oc}$  limit. The BLER is calculated for each of the measurement channels supported by the base station.

### 8.3.2.1 Minimum requirement

#### 8.3.2.1.1 3,84 Mcps TDD Option

For the parameters specified in Table 8.6 the BLER should not exceed the piece-wise linear BLER curve specified in Table 8.7. These requirements are applicable for TFCS size 16.

**Table 8.6: Parameters in multipath Case 2 channel**

Parameters	Unit	Test 1	Test 2	Test 3	Test 4
Number of DPCH <sub>o</sub>		2	0	0	0
$\frac{DPCH_o - E_c}{I_{or}}$	dB	-6	0	0	0
$I_{oc}$	dBm/3.84 MHz	-89			
Cell Parameter*		0,1			
DPCH Channelization Codes*	C(k,Q)	C(1,8)	C(1,4) C(5,16)	C(1,2) C(9,16)	C(1,2)
DPCH <sub>o</sub> Channelization Codes*	C(k,Q)	C(i,16) 3 ≤ i ≤ 4	-	-	-
Information Data Rate	kbps	12.2	64	144	384

\*Note: Refer to TS 25.223 for definition of channelization codes and cell parameter.

**Table 8.7: Performance requirements in multipath Case 2 channel.**

Test Number	$\frac{\hat{I}_{or}}{I_{oc}}$ [dB]	BLER
1	-0.2	$10^{-2}$
2	0.1	$10^{-1}$
	2.5	$10^{-2}$
3	3.5	$10^{-1}$
	5.8	$10^{-2}$
4	2.8	$10^{-1}$
	5.1	$10^{-2}$

#### 8.3.2.1.2 1,28 Mcps TDD Option

For the parameters specified in Table 8.6A the BLER should not exceed the piece-wise linear BLER curve specified in Table 8.7A. These requirements are applicable for TFCS size 16.

**Table 8.6A: Parameters in multipath Case 2 channel**

Parameters	Unit	Test 1	Test 2	Test 3	Test 4
Number of DPCH <sub>o</sub>		4	1	1	0
Spread factor of DPCH <sub>o</sub>		8	8	8	-
$\frac{DPCH_o - E_c}{I_{or}}$	DB	-7	-7	-7	0
$I_{oc}$	dBm/1.28 MHz	-91			
Information Data Rate	Kbps	12.2	64	144	384

**Table 8.7A: Performance requirements in multipath Case 2 channel.**

Test Number	$\frac{\hat{I}_{or}}{I_{oc}}$ [dB]	BLER
1	6.7	$10^{-2}$
2	3.6	$10^{-1}$
	5.9	$10^{-2}$
3	4.2	$10^{-1}$
	6.3	$10^{-2}$
4	4.6	$10^{-1}$
	6.0	$10^{-2}$

### 8.3.3 Multipath fading Case 3

The performance requirement of DCH in multipath fading Case 3 is determined by the maximum Block Error Rate (BLER) allowed when the receiver input signal is at a specified  $\hat{I}_{or}/I_{oc}$  limit. The BLER is calculated for each of the measurement channels supported by the base station.

#### 8.3.3.1 Minimum requirement

##### 8.3.3.1.1 3,84 Mcps TDD Option

For the parameters specified in Table 8.8 the BLER should not exceed the piece-wise linear BLER curve specified in Table 8.9. These requirements are applicable for TFCS size 16.

**Table 8.8: Parameters in multipath Case 3 channel**

Parameters	Unit	Test 1	Test 2	Test 3	Test 4
Number of DPCH <sub>o</sub>		2	0	0	0
$\frac{DPCH_o - E_c}{I_{or}}$	dB	-6	0	0	0
$I_{oc}$	dBm/3.84 MHz	-89			
Cell Parameter*		0,1			
DPCH Channelization Codes*	C(k,Q)	C(1,8)	C(1,4) C(5,16)	C(1,2) C(9,16)	C(1,2)
DPCH <sub>o</sub> Channelization Codes*	C(k,Q)	C(i,16) 3 ≤ i ≤ 4	-	-	-
Information Data Rate	Kbps	12.2	64	144	384

\*Note: Refer to TS 25.223 for definition of channelization codes and cell parameter.

**Table 8.9: Performance requirements in multipath Case 3 channel.**

Test Number	$\frac{\hat{I}_{or}}{I_{oc}}$ [dB]	BLER
1	-0.1	$10^{-2}$
2	0.8	$10^{-1}$
	2.7	$10^{-2}$
	4.2	$10^{-3}$
3	4.5	$10^{-1}$
	6.4	$10^{-2}$
	8.0	$10^{-3}$
4	3.6	$10^{-1}$
	5.1	$10^{-2}$
	6.5	$10^{-3}$

##### 8.3.3.1.2 1,28 Mcps TDD Option

For the parameters specified in Table 8.8A the BLER should not exceed the piece-wise linear BLER curve specified in Table 8.9A. These requirements are applicable for TFCS size 16.

**Table 8.8A: Parameters in multipath Case 3 channel**

Parameters	Unit	Test 1	Test 2	Test 3	Test 4
Number of DPCH <sub>o</sub>		4	1	1	0
Spread factor of DPCH <sub>o</sub>		8	8	8	-
$\frac{DPCH_{o-E_c}}{I_{or}}$	DB	-7	-7	-7	0
$I_{oc}$	dBm/1.28 MHz	-91			
Information Data Rate	Kbps	12.2	64	144	384

**Table 8.9A: Performance requirements in multipath Case 3 channel.**

Test Number	$\frac{\hat{I}_{or}}{I_{oc}}$ [dB]	BLER
1	5.6	10 <sup>-2</sup>
2	3.2	10 <sup>-1</sup>
	4.6	10 <sup>-2</sup>
	5.9	10 <sup>-3</sup>
3	3.7	10 <sup>-1</sup>
	4.8	10 <sup>-2</sup>
	5.9	10 <sup>-3</sup>
4	4.2	10 <sup>-1</sup>
	5.1	10 <sup>-2</sup>
	5.9	10 <sup>-3</sup>



---

## Annex A (normative): Measurement Channels

### A.1 General

(void)

---

### A.2 Reference measurement channel

#### A.2.1 UL reference measurement channel (12.2 kbps)

##### A.2.1.1 3,84 Mcps TDD Option

Table A.1

Parameter	Value
Information data rate	12.2 kbps
RU's allocated	2 RU
Midamble	512 chips
Interleaving	20 ms
Power control	2 Bit/user
TFCI	16 Bit/user
Inband signalling DCCH	2 kbps
Puncturing level at Code rate 1/3 : DCH / DCCH	5% / 0%

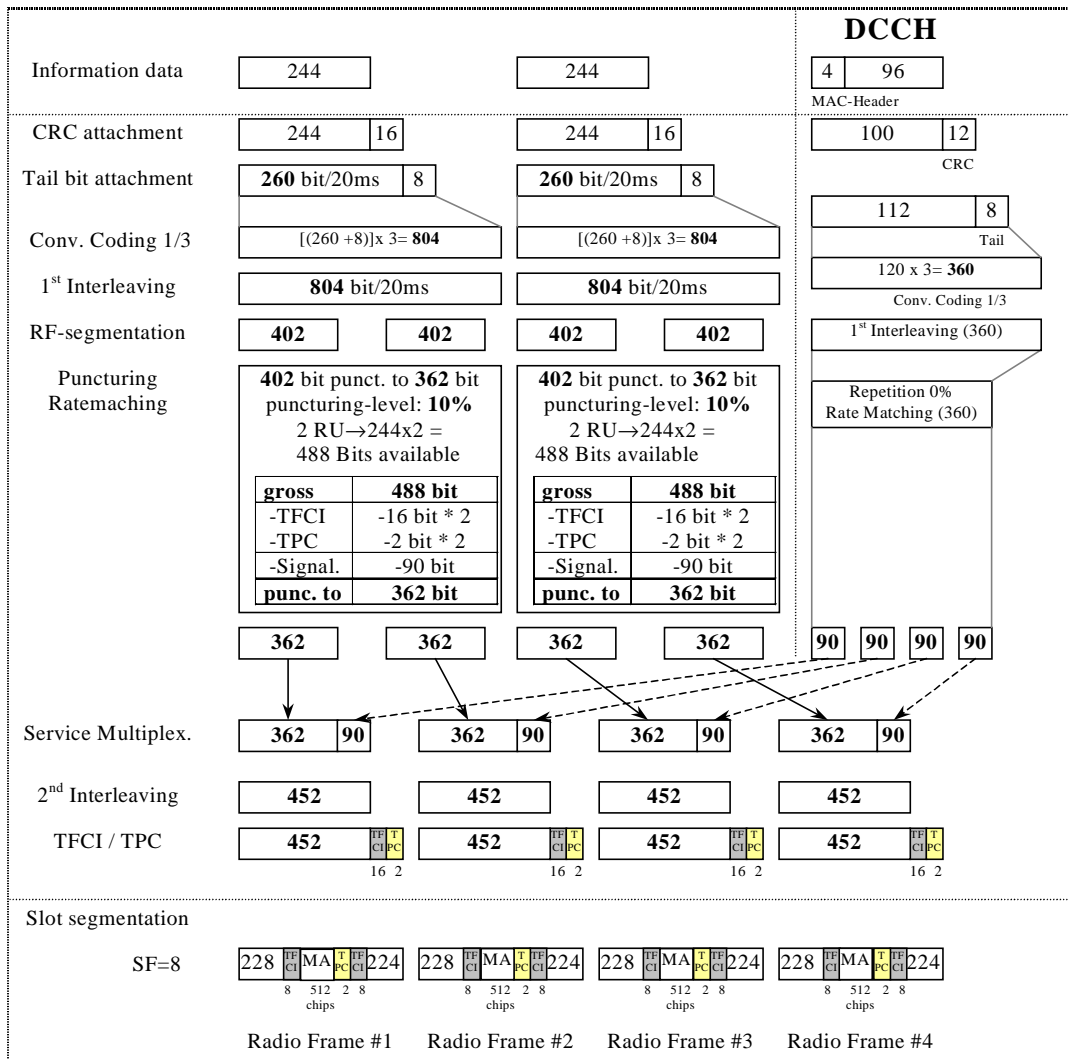

Figure A.1

### A.2.1.2 1,28 Mcps TDD Option

Table A.1A

Parameter	Value
Information data rate	12.2 kbps
RU's allocated	1TS (1*SF8) = 2RU/5ms
Midamble	144
Interleaving	20 ms
Power control (TPC)	4 Bit/user/10ms
TFCI	16 Bit/user/10ms
Synchronisation Shift (SS)	4 Bit/user/10ms
Inband signalling DCCH	2.4 kbps
Puncturing level at Code rate 1/3: DCH / DCCH	33% / 33%

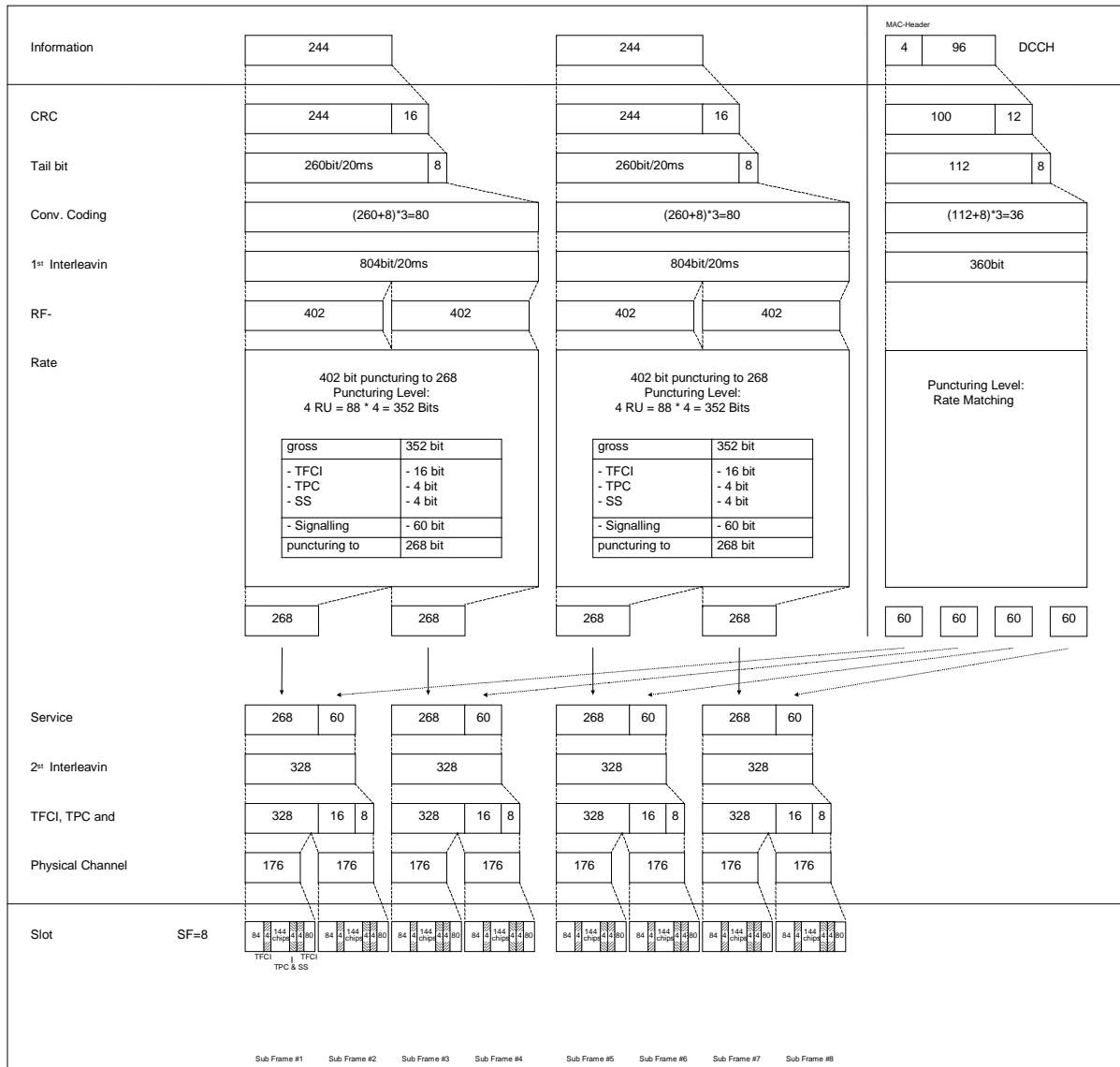

Figure A.1A

## A.2.2 UL reference measurement channel (64 kbps)

### A.2.2.1 3,84 Mcps TDD Option

Table A.2

Parameter	Value
Information data rate	64 kbps
RU's allocated	1 SF4 + 1 SF16 = 5RU
Midamble	512 chips
Interleaving	20 ms
Power control	2 Bit/user
TFCI	16 Bit/user
Inband signalling DCCH	2 kbps
Puncturing level at Code rate : 1/3 DCH / 1/2 DCCH	41.2% / 10%

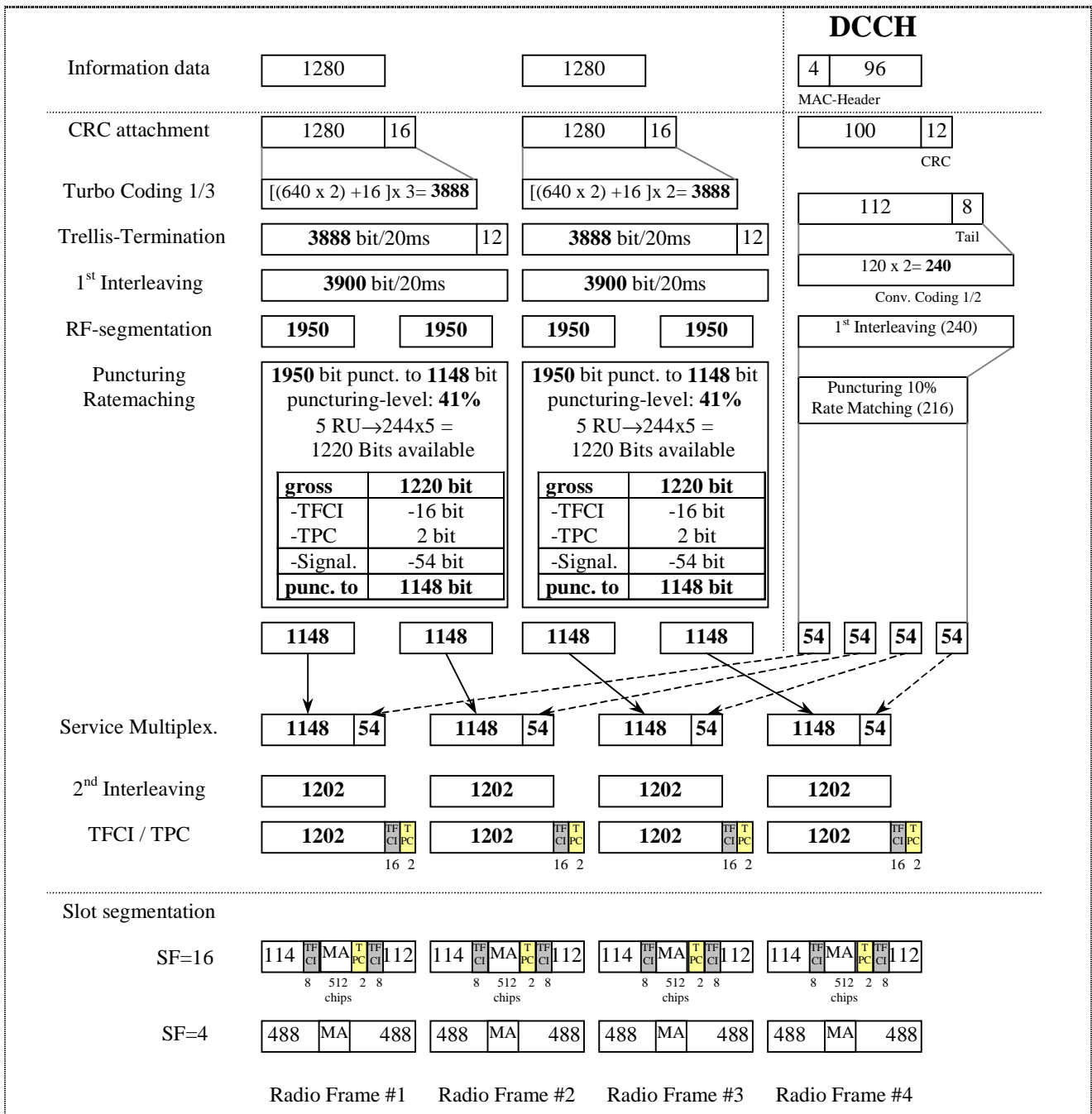

Figure A.2

### A.2.2.2 1,28 Mcps TDD Option

Table A.2A

Parameter	Value
Information data rate	64 kbps
RU's allocated	1TS (1*SF2) = 8RU/5ms
Midamble	144
Interleaving	20 ms
Power control (TPC)	4 Bit/user/10ms
TFCI	16 Bit/user/10ms
Synchronisation Shift (SS)	4 Bit/user/10ms
Inband signalling DCCH	2.4 kbps
Puncturing level at Code rate: 1/3 DCH / 1/2 DCCH	32% / 0

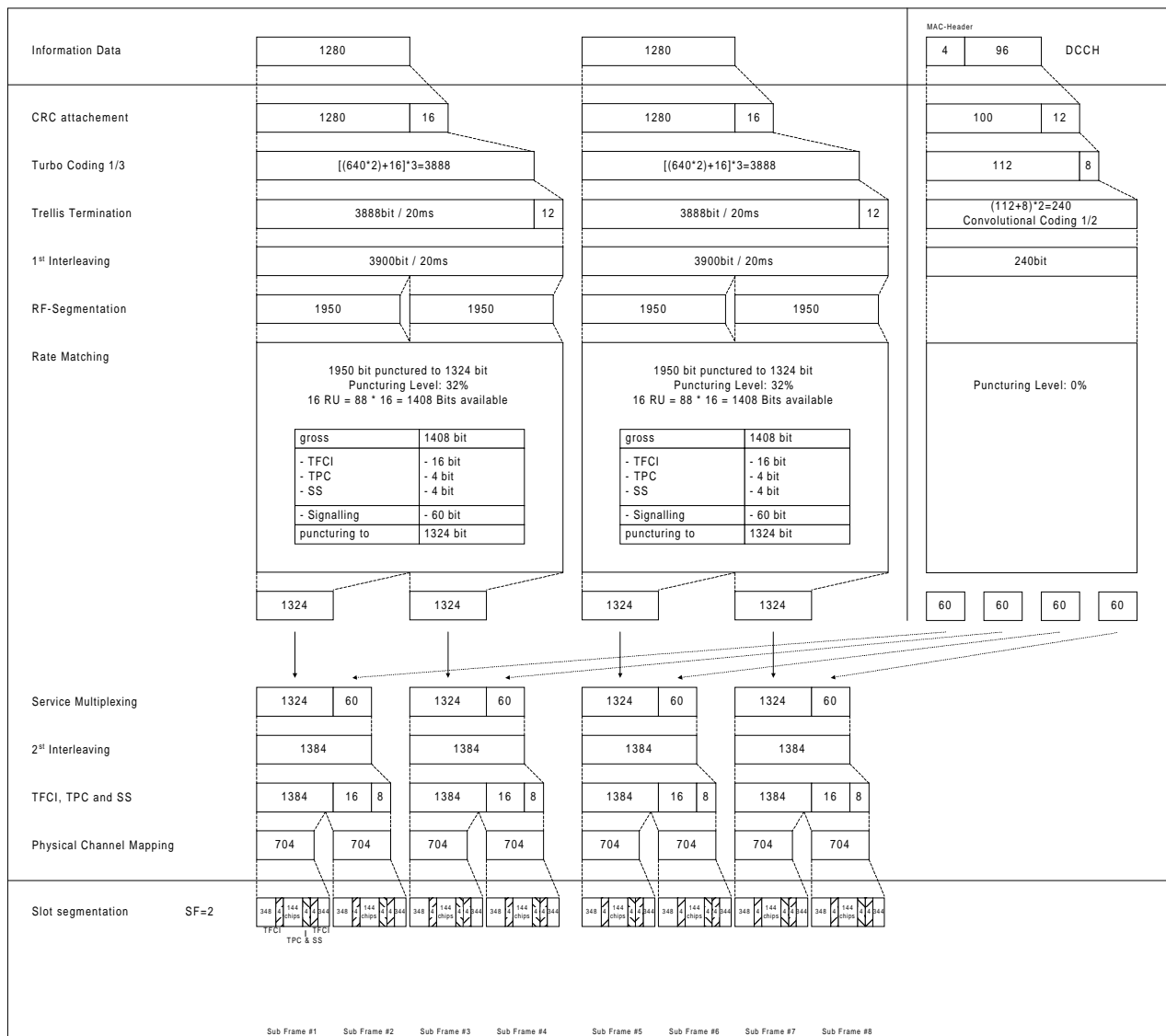

Figure A.2A

## A.2.3 UL reference measurement channel (144 kbps)

### A.2.3.1 3,84 Mcps TDD Option

Table A.3

Parameter	Value
Information data rate	144 kbps
RU's allocated	1 SF2 + 1 SF16 = 9RU
Midamble	256 chips
Interleaving	20 ms
Power control	2 Bit/user
TFCI	16 Bit/user
Inband signalling DCCH	2 kbps
Puncturing level at Code rate : 1/3 DCH / 1/2 DCCH	44.4% / 16.6%

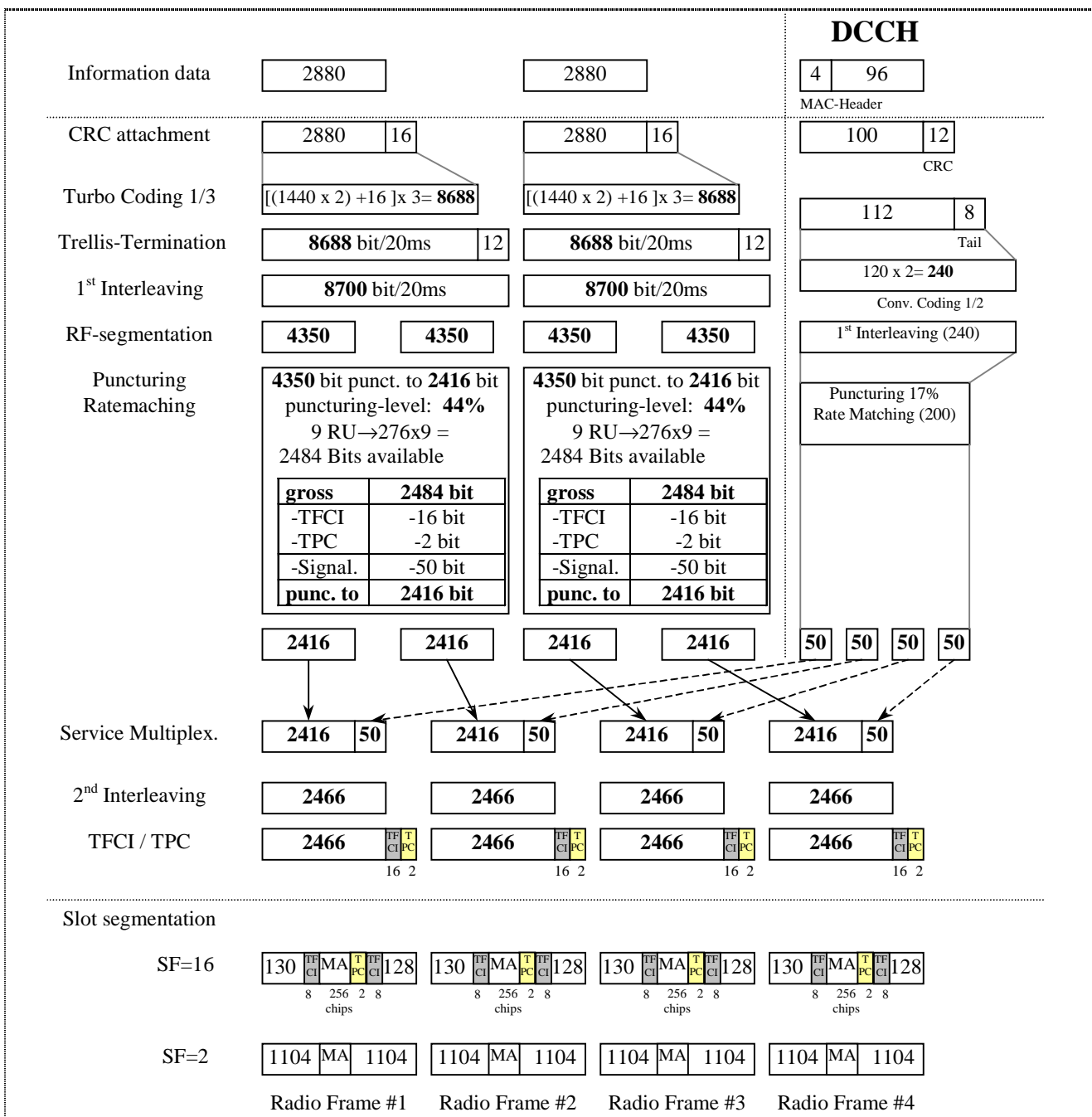

Figure A.3

A.2.3.2 1,28 Mcps TDD Option

Table A.3A

Parameter	Value
Information data rate	144 kbps
RU's allocated	2TS (1*SF2) = 16RU/5ms
Midamble	144
Interleaving	20 ms
Power control (TPC)	8 Bit/user/10ms
TFCI	32 Bit/user/10ms
Synchronisation Shift (SS)	8 Bit/user/10ms
Inband signalling DCCH	2.4 kbps
Puncturing level at Code rate: 1/3 DCH / 1/2 DCCH	38% / 7%

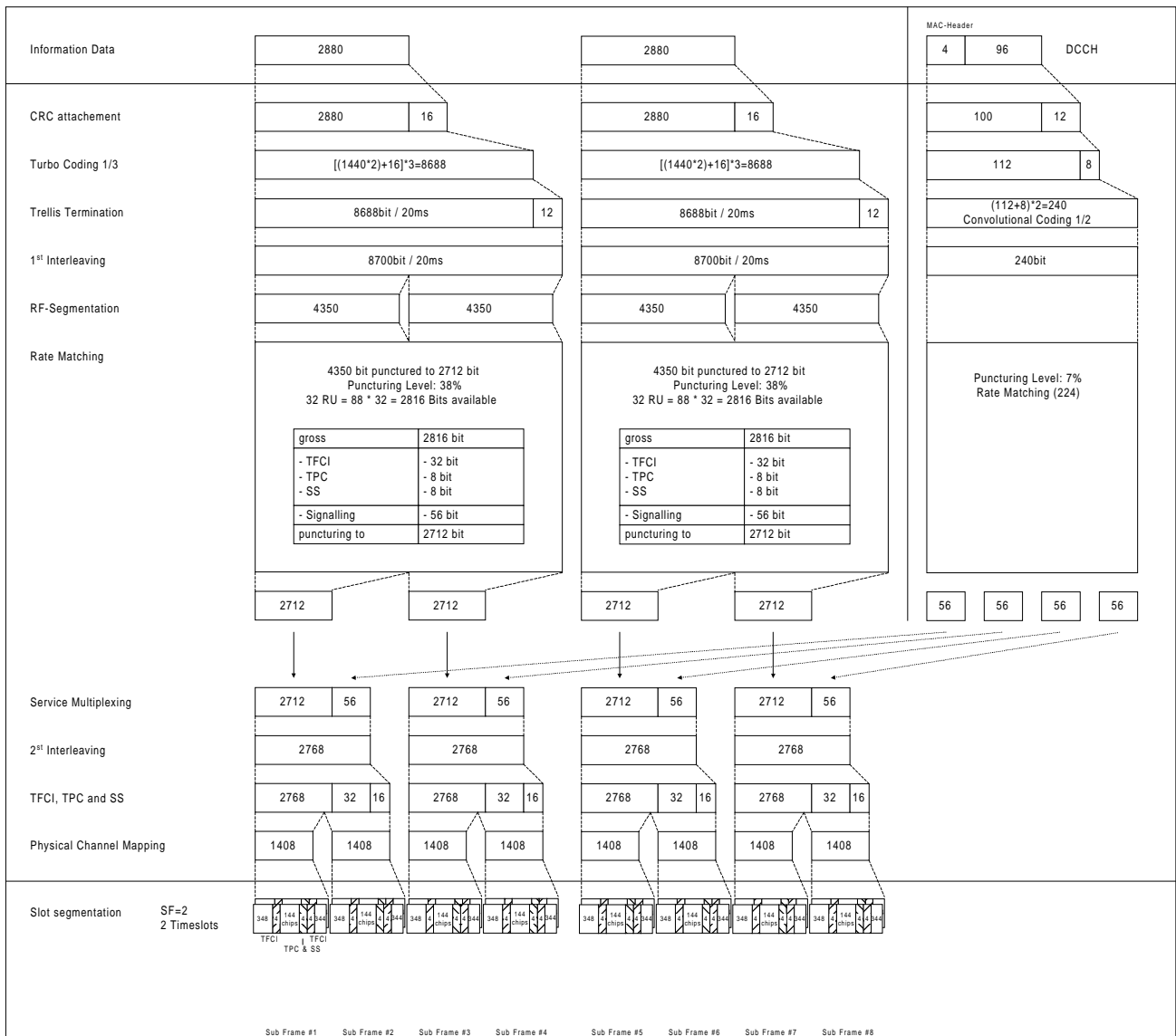

Figure A.3A

## A.2.4 UL reference measurement channel (384 kbps)

### A.2.4.1 3,84 Mcps TDD Option

Table A.4

Parameter	Value
Information data rate	384 kbps
RU's allocated	8*3TS = 24RU
Midamble	256 chips
Interleaving	20 ms
Power control	2 Bit/user
TFCI	16 Bit/user
Inband signalling DCCH	2 kbps
Puncturing level at Code rate : 1/3 DCH / 1/2 DCCH	43.4% / 15.3%

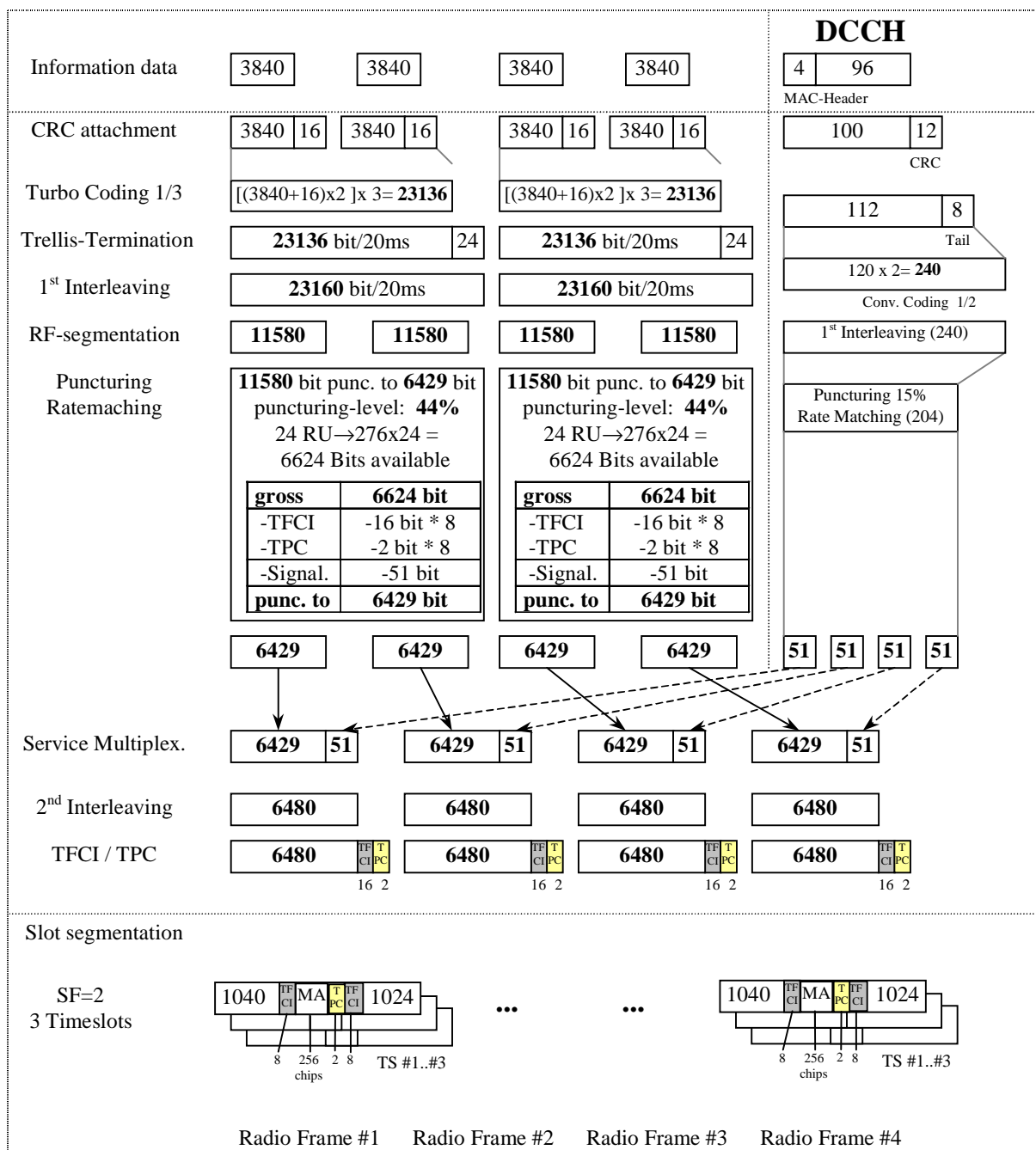



Figure A.4

## A.2.4.2 1,28 Mcps TDD Option

Table A.4A

Parameter	Value
Information data rate	384 kbps
RU's allocated	4TS (1*SF2 + 1*SF8) = 40RU/5ms
Midamble	144
Interleaving	20 ms
Power control (TPC)	16 Bit/user/10ms
TFCI	64 Bit/user/10ms
Synchronisation Shift (SS)	16 Bit/user/10ms
Inband signalling DCCH	max 2.0 kbps
Puncturing level at Code rate: 1/3 DCH / 1/2 DCCH	41% / 12%

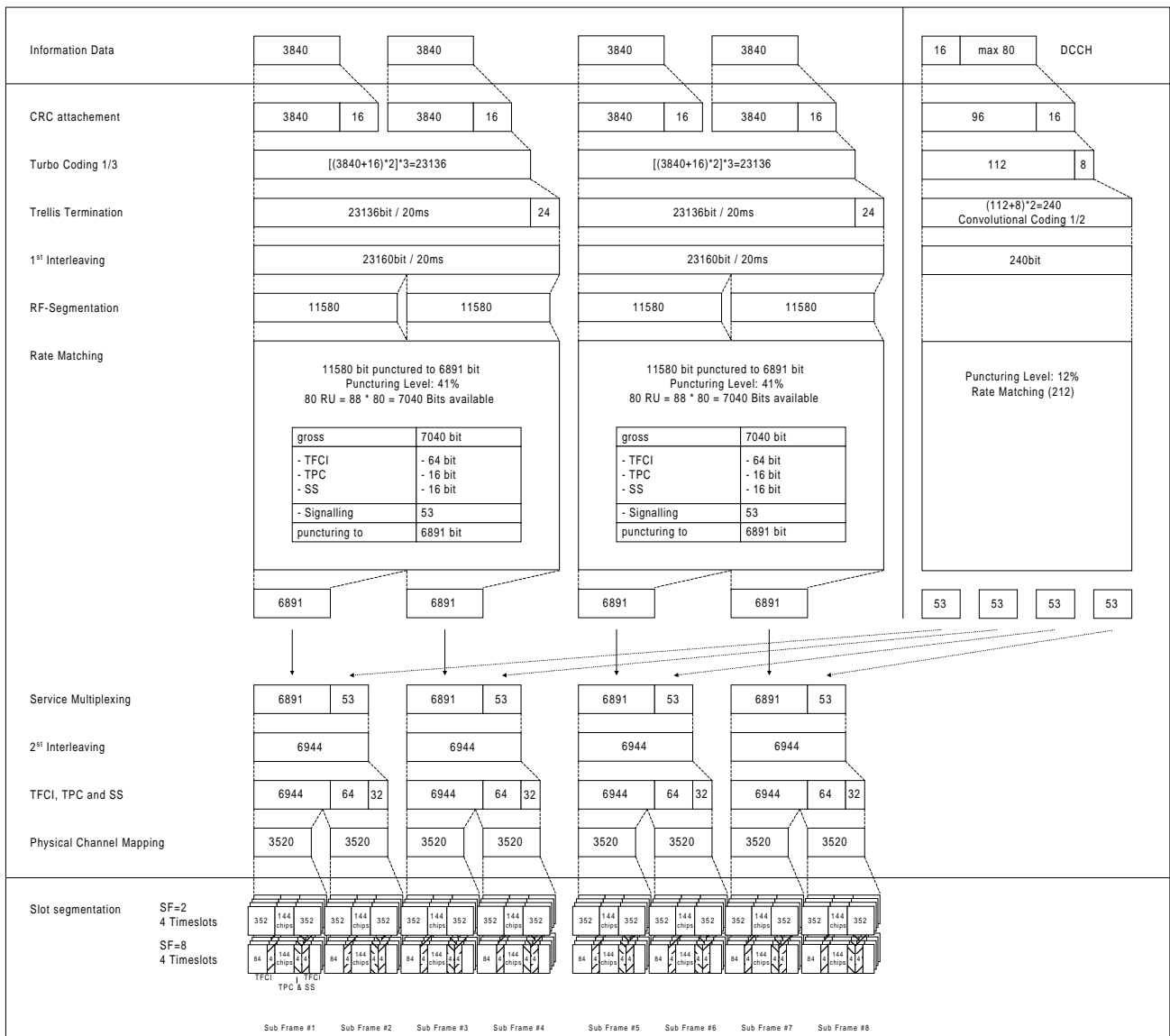

Figure A.4A

## A.2.5 RACH reference measurement channel

### A.2.5.0 General

#### A.2.5.0.1 3,84 Mcps TDD Option

Table A.5

Parameter	Value
Information data rate e.g. 2 TBs ( $B_{RACH}=2$ ): <b>SF16:</b> 0% puncturing rate at CR=1/2 10% puncturing rate at CR=1/2	46 bits per frame and TB 53 bits per frame and TB
$N_{RACH} = \frac{232 + N_{RM} - 8}{B_{RACH}} - 8$	
<b>SF8:</b>	96 bits per frame and TB 109 bits per frame and TB

0% puncturing rate at CR=1/2 10% puncturing rate at CR=1/2 $N_{RACH} = \frac{464 + N_{RM} - 8}{2} - 16$	
RU's allocated	1 RU
Midamble	512 chips
Power control	0 bit
TFCI	0 bit

$N_{RACH}$  = number of bits per TB

$B_{RACH}$  = number of TBs

A.2.5.0.2 1,28 Mcps TDD Option

Table A.5A

Parameter	Value
Information data rate: $N_{RACH} = \frac{88 * \frac{16}{SF} \left( \frac{N_{RM}}{100} + 1 \right)}{2} - 16$	$B_{RACH}=1$ CRC length = 16 Tail Bits = 8
<b>SF16</b> (RU's allocated:1): 0% puncturing rate at CR=1/2 ~10% puncturing rate at CR=1/2	20 bits per frame and TB 24 bits per frame and TB
<b>SF8</b> (RU's allocated:2): 0% puncturing rate at CR=1/2 ~10% puncturing rate at CR=1/2	64 bits per frame and TB 73 bits per frame and TB
<b>SF4</b> (RU's allocated:4): 0% puncturing rate at CR=1/2 ~10% puncturing rate at CR=1/2	152 bits per frame and TB 170 bits per frame and TB
TTI	5msec
Midamble	144 chips
Power control	0 bit
TFCI	0 bit

$N_{RACH}$  = number of bits per TB

$B_{RACH}$  = number of TBs

$N_{RM}$  = puncturing rate

### A.2.5.1 RACH mapped to 1 code SF16

#### A.2.5.1.1 3,84 Mcps TDD Option

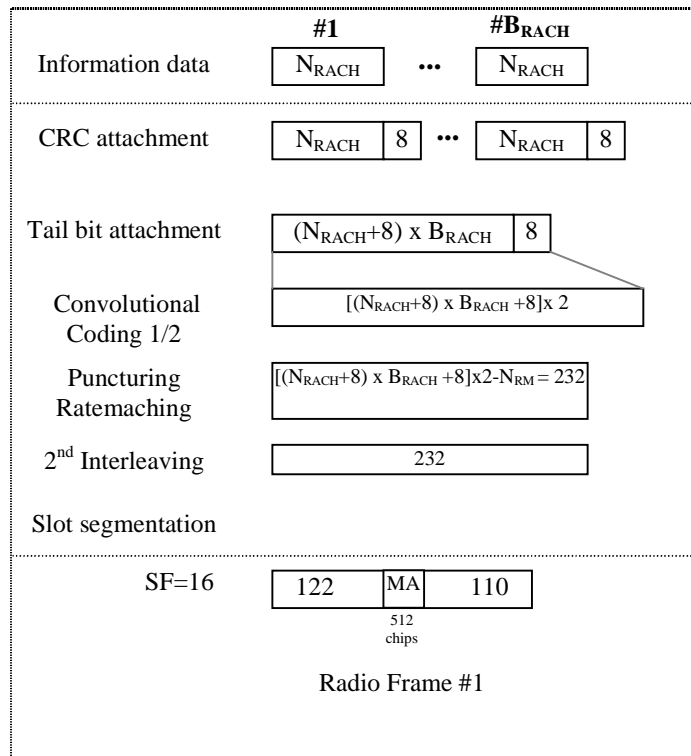

Figure A.5

#### A.2.5.1.2 1,28 Mcps TDD Option

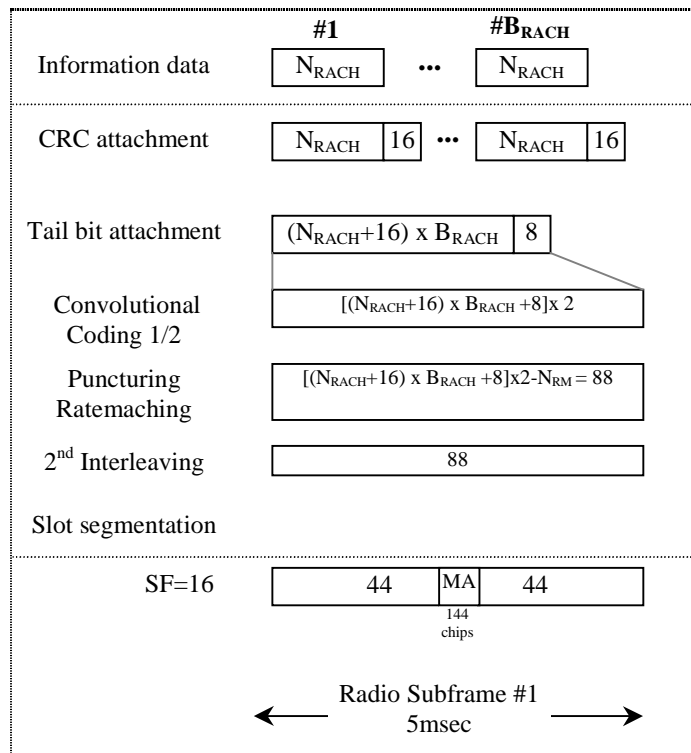

Figure A.5A

### A.2.5.2 RACH mapped to 1 code SF8

#### A.2.5.2.1 3,84 Mcps TDD Option

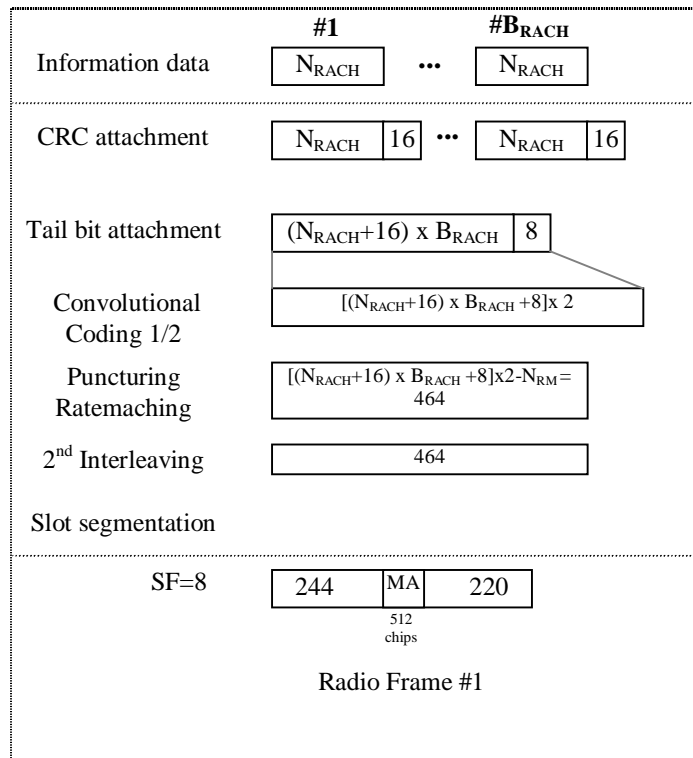

Figure A.6

#### A.2.5.2.2 1,28 Mcps TDD Option

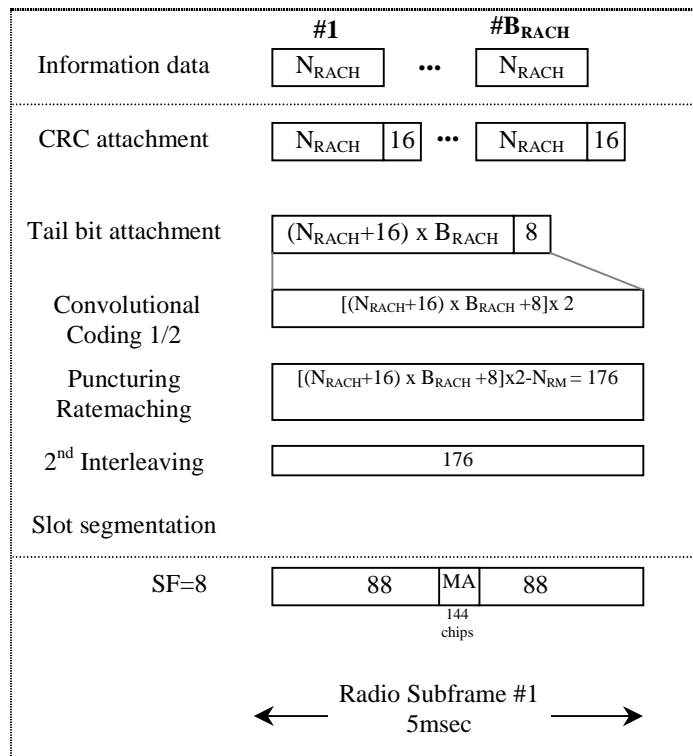
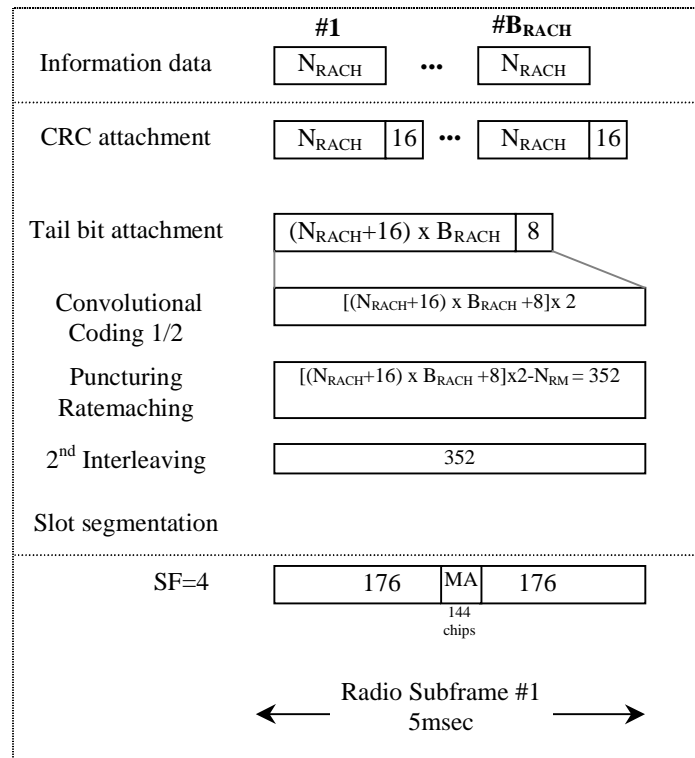

Figure A.6A

### A.2.5.3 RACH mapped to 1 code SF4 (1,28 Mcps option only)



**Figure A.7A**

## Annex B (normative): Propagation conditions

### B.1 Static propagation condition

The propagation for the static performance measurement is an Additive White Gaussian Noise (AWGN) environment. No fading and multi-paths exist for this propagation model.

### B.2 Multi-path fading propagation conditions

#### B.2.1 3,84 Mcps TDD Option

Table B1 shows propagation conditions that are used for the performance measurements in multi-path fading environment. All taps have classical Doppler spectrum.

**Table B.1: Propagation Conditions for Multi path Fading Environments**

Case 1, speed 3km/h		Case 2, speed 3 km/h		Case 3, 120 km/h	
Relative Delay [ns]	Average Power [dB]	Relative Delay [ns]	Average Power [dB]	Relative Delay [ns]	Average Power [dB]
0	0	0	0	0	0
976	-10	976	0	260	-3
		12000	0	521	-6
				781	-9

#### B.2.2 1,28 Mcps TDD Option

TableB2 shows propagation conditions that are used for the performance measurements in multi-path fading environment. All taps have classical Doppler spectrum.

**TableB2: Propagation Conditions for Multi-Path Fading Environments**

Case 1, speed 3km/h		Case 2, speed 3km/h		Case 3, speed 120km/h	
Relative Delay [ns]	Average Power [dB]	Relative Delay [ns]	Average Power [dB]	Relative Delay [ns]	Average Power [dB]
0	0	0	0	0	0
2928	-10	2928	0	781	-3
		12000	0	1563	-6
				2344	-9

## Annex C (informative): Change request history

**Table C.1: CRs approved at TSG#6**

RAN Doc	Spec	CR	R	Ph	Subject	Cat	Curr	New
RP-99780	25.105	002		R99	Primary CCPCH Power for TDD-mode	C	3.0.0	3.1.0
RP-99780	25.105	003		R99	BS Maximum input level (TDD)	C	3.0.0	3.1.0
RP-99780	25.105	001		R99	Corrections to 25.105 version 3.0.0	F	3.0.0	3.1.0
RP-99779	25.105	006		R99	Open item list in Annex D of 25.105 v3.0.0	D	3.0.0	3.1.0
RP-99780	25.105	004		R99	Receiver spurious emissions for BS TDD	C	3.0.0	3.1.0
RP-99780	25.105	005		R99	Power control in UTRA TDD	C	3.0.0	3.1.0
RP-99780	25.105	002	3	R99	TDD Base station power accuracy of PCCPCH	C	3.0.0	3.1.0
RP-99780	25.105	007	-	R99	Change of propagation conditions recommendations	C	3.0.0	3.1.0
RP-99780	25.105	008		R99	Timing Advance Requirements	F	3.0.0	3.1.0
RP-99781	25.105	009		R99	Transmit Template	B	3.0.0	3.1.0
RP-99781	25.105	010		R99	Performance Requirements	B	3.0.0	3.1.0
RP-99780	25.105	011		R99	Corrections for BS TDD Blocking Characteristics	F	3.0.0	3.1.0
RP-99780	25.105	012		R99	Corrections to 25.105 v.3.0.0 (change ME to BTS)	F	3.0.0	3.1.0
RP-99780	25.105	013		R99	Synchronization Requirement	C	3.0.0	3.1.0
RP-99780	25.105	014		R99	Update of ITU Region 2 Specific Specifications and	C	3.0.0	3.1.0
RP-99780	25.105	015		R99	Clarification of Antenna Diversity receiver	F	3.0.0	3.1.0
RP-99780	25.105	016		R99	Spurious Emission in 25.105	F	3.0.0	3.1.0
RP-99780	25.105	017		R99	ACLR	C	3.0.0	3.1.0
RP-99781	25.105	018		R99	BS TDD Spurious Emission Requirements for Co-	B	3.0.0	3.1.0

**Table C.2: CRs approved at TSG#7.**

RAN Doc	Spec	CR	R	Ph	Subject	Cat	Curr	New
R4-000283	25.105	019	1	R99	Corrections for BS TDD Blocking Requirements	F	3.1.0	3.2.0
R4-000088	25.105	020		R99	Revised Spurious Emission Requirements	F	3.1.0	3.2.0
R4-000100	25.105	021		R99	Corrections of spurious emissions aligning to GSM for	F	3.1.0	3.2.0
R4-000109	25.105	022		R99	Editorial corrections	D	3.1.0	3.2.0
R4-000111	25.105	023		R99	Spurious emission correction	F	3.1.0	3.2.0
R4-000112	25.105	024		R99	Protection outside a licensee's frequency block	F	3.1.0	3.2.0
R4-000199	25.105	025		R99	Definition of Rated Output Power and Pmax	F	3.1.0	3.2.0
R4-000200	25.105	026		R99	Primary CCPCH Power	F	3.1.0	3.2.0
R4-000216	25.105	027		R99	BS Transmit OFF power	F	3.1.0	3.2.0
R4-000223	25.105	028		R99	Corrected reference sensitivity value for the TDD BS	F	3.1.0	3.2.0
R4-000259	25.105	029		R99	ACLR	F	3.1.0	3.2.0
R4-000255	25.105	030		R99	Spectrum emission mask	F	3.1.0	3.2.0
R4-000135	25.105	031		R99	Clock Accuracy	C	3.1.0	3.2.0



**Table C.3: CRs approved at TSG#8.**

RAN Doc	Spec	CR	R	Ph	Subject	Cat	Curr	New
RP-000207	25.105	032		R99	Reference Measurement Channels	F	3.2.0	3.3.0
RP-000207	25.105	033		R99	Regional requirements in TS 25.105	F	3.2.0	3.3.0
RP-000207	25.105	034		R99	Clarification of receiver dynamic range.	F	3.2.0	3.3.0
RP-000207	25.105	035		R99	Input power level for performance requirements	F	3.2.0	3.3.0
RP-000207	25.105	036		R99	Modification to the handling of UE TDD Measurement	F	3.2.0	3.3.0
RP-000207	25.105	037		R99	Clarification of the specification on Peak Code	F	3.2.0	3.3.0
RP-000207	25.105	038		R99	Correction for emission mask measurement (TDD)	F	3.2.0	3.3.0

**Table C.4: CRs approved at TSG#9.**

RAN Doc	Spec	CR	R	Ph	Subject	Cat	Curr	New
RP-000397	25.105	39		R99	Maximum frequency deviation for receiver	F	3.3.0	3.4.0
RP-000397	25.105	40		R99	Corrections to spectrum mask	F	3.3.0	3.4.0
RP-000397	25.105	41		R99	Handling of measurement uncertainties in base	F	3.3.0	3.4.0
RP-000397	25.105	42		R99	Performance requirements with TFCI decoding	F	3.3.0	3.4.0
RP-000397	25.105	43		R99	Inner Loop Power Control	F	3.3.0	3.4.0
RP-000397	25.105	44		R99	BS Transmit ON/OFF time mask for TDD-mode	F	3.3.0	3.4.0
RP-000397	25.105	45		R99	Definition of period for frequency error	F	3.3.0	3.4.0

**Table C.5: CRs approved at TSG#10**

RAN Doc	Spec	CR	R	Ph	Subject	Cat	Curr	New
RP-000397	25.105	46		R99	Correction for 25.105 concerning the channel number	F	3.4.0	3.5.0
RP-000397	25.105	47		R99	Correction to reference measurement channels	F	3.4.0	3.5.0

**Table C.6: Release 1999 CRs approved at TSG#11**

RAN Doc	Spec	CR	R	Ph	Subject	Cat	Curr	New
RP-010088	25.105	48		R99	Receiver Blocking requirement for co-existence with GSM/DCS and co-located base stations.	F	3.5.0	3.6.0
RP-010088	25.105	49		R99	Relationship between Minimum Requirements and Test Tolerances.	F	3.5.0	3.6.0
RP-010088	25.105	50		R99	Correction of reference to SM.329-8 in TS25.105	F	3.5.0	3.6.0
RP-010088	25.105	51		R99	BS EVM definition	F	3.5.0	3.6.0

**Table C.7: Release 4 CRs approved at TSG#11**

RAN Doc	Spec	CR	R	Ph	Subject	Cat	Curr	New
RP-010097	25.105	52		R4	UTRA (BS) TDD; Radio transmission and Reception	B	3.6.0	4.0.0

**Table C.8: Release 4 CRs approved at TSG#12**

RAN Doc	Spec	CR	R	Ph	Title	Cat	Curr	New
RP-010361	25.105	53		Rel-4	Differential accuracy of P-CCPCH power	B	4.0.0	4.1.0
RP-010350	25.105	55		Rel-4	inclusion of environmental requirements	A	4.0.0	4.1.0
RP-010350	25.105	57		Rel-4	Application of blocking requirement	A	4.0.0	4.1.0
RP-010350	25.105	59		Rel-4	CR for BS Performance Requirements	A	4.0.0	4.1.0
RP-010361	25.105	60		Rel-4	Clarification of transmit intermodulation requirements	F	4.0.0	4.1.0
RP-010361	25.105	61		Rel-4	BS EVM definition correction	F	4.0.0	4.1.0
RP-010350	25.105	63		Rel-4	Correction to upper frequency of transmitter spurious	A	4.0.0	4.1.0
RP-010361	25.105	64		Rel-4	Application of blocking requirement for 1.28 Mcps	F	4.0.0	4.1.0
RP-010361	25.105	65		Rel-4	Correction to upper frequency of transmitter spurious	F	4.0.0	4.1.0

---

## History

<b>Document history</b>		
V4.0.0	March 2001	Publication
V4.1.0	June 2001	Publication