

ETSI TS 125 143 V7.2.0 (2006-12)

Technical Specification

Universal Mobile Telecommunications System (UMTS); UTRA repeater conformance testing (3GPP TS 25.143 version 7.2.0 Release 7)



Reference

RTS/TSGR-0425143v720

Keywords

UMTS

ETSI

650 Route des Lucioles
F-06921 Sophia Antipolis Cedex - FRANCE

Tel.: +33 4 92 94 42 00 Fax: +33 4 93 65 47 16

Siret N° 348 623 562 00017 - NAF 742 C
Association à but non lucratif enregistrée à la
Sous-Préfecture de Grasse (06) N° 7803/88

Important notice

Individual copies of the present document can be downloaded from:

<http://www.etsi.org>

The present document may be made available in more than one electronic version or in print. In any case of existing or perceived difference in contents between such versions, the reference version is the Portable Document Format (PDF). In case of dispute, the reference shall be the printing on ETSI printers of the PDF version kept on a specific network drive within ETSI Secretariat.

Users of the present document should be aware that the document may be subject to revision or change of status. Information on the current status of this and other ETSI documents is available at

<http://portal.etsi.org/tb/status/status.asp>

If you find errors in the present document, please send your comment to one of the following services:

http://portal.etsi.org/chaicor/ETSI_support.asp

Copyright Notification

No part may be reproduced except as authorized by written permission.
The copyright and the foregoing restriction extend to reproduction in all media.

© European Telecommunications Standards Institute 2006.
All rights reserved.

DECTTM, **PLUGTESTS**TM and **UMTS**TM are Trade Marks of ETSI registered for the benefit of its Members.
TIPHONTM and the **TIPHON logo** are Trade Marks currently being registered by ETSI for the benefit of its Members.
3GPPTM is a Trade Mark of ETSI registered for the benefit of its Members and of the 3GPP Organizational Partners.

Intellectual Property Rights

IPRs essential or potentially essential to the present document may have been declared to ETSI. The information pertaining to these essential IPRs, if any, is publicly available for **ETSI members and non-members**, and can be found in ETSI SR 000 314: "*Intellectual Property Rights (IPRs); Essential, or potentially Essential, IPRs notified to ETSI in respect of ETSI standards*", which is available from the ETSI Secretariat. Latest updates are available on the ETSI Web server (<http://webapp.etsi.org/IPR/home.asp>).

Pursuant to the ETSI IPR Policy, no investigation, including IPR searches, has been carried out by ETSI. No guarantee can be given as to the existence of other IPRs not referenced in ETSI SR 000 314 (or the updates on the ETSI Web server) which are, or may be, or may become, essential to the present document.

Foreword

This Technical Specification (TS) has been produced by ETSI 3rd Generation Partnership Project (3GPP).

The present document may refer to technical specifications or reports using their 3GPP identities, UMTS identities or GSM identities. These should be interpreted as being references to the corresponding ETSI deliverables.

The cross reference between GSM, UMTS, 3GPP and ETSI identities can be found under <http://webapp.etsi.org/key/queryform.asp>.

Contents

Intellectual Property Rights	2
Foreword.....	2
Foreword.....	6
1 Scope	7
2 References	7
3 Definitions, symbols and abbreviations	7
3.1 Definitions	7
3.2 (void).....	8
3.3 Abbreviations	8
4 Frequency bands and channel arrangement.....	8
4.1 Frequency bands.....	8
4.2 TX - RX frequency separation	9
4.3 Channel arrangement.....	9
4.3.1 Channel spacing.....	9
4.3.2 Channel raster	9
4.3.3 Channel number.....	9
5 General test conditions and declarations	10
5.1 Acceptable uncertainty of Test System	11
5.1.1 Measurements of test environments.....	11
5.1.2 Measurements of Repeater.....	12
5.2 Repeater test tolerances (informative).....	13
5.3 Interpretation of measurement results	13
5.4 Test Environment	14
5.4.1 Normal test environment	14
5.4.2 Extreme test environment	14
5.4.2.1 Extreme temperature	14
5.4.3 Vibration.....	15
5.4.4 Power supply	15
5.5 Selection of configurations for testing.....	15
5.6 Regional requirements.....	16
5.7 Test Models	17
5.8 Format and interpretation of tests	17
5.9 Repeater configurations.....	18
5.9.1 Power supply options.....	18
5.9.2 Combining of Repeaters	18
6 Output power.....	18
6.1 Maximum output power	18
6.1.1 Definition and applicability	18
6.1.2 Minimum Requirements	18
6.1.3 Test purpose.....	19
6.1.4 Method of test	19
6.1.4.1 Initial conditions	19
6.1.4.2 Procedure	19
6.1.5 Test Requirements	19
7 Frequency stability	20
7.1 Definition and applicability	20
7.2 Minimum Requirement	20
7.3 Test purpose	20
7.4 Method of test.....	20
7.4.1 Initial conditions	20
7.4.2 Procedure	21

7.5	Test requirements	21
8	Out of band gain	21
8.1	Definitions and applicability	21
8.2	Minimum Requirements	21
8.3	Test purpose	22
8.4	Method of test.....	22
8.4.1	Initial conditions	22
8.4.2	Procedure	22
8.5	Test requirements	22
9	Unwanted emission	23
9.1	Out of band emission.....	23
9.1.1	Spectrum emission mask.....	23
9.1.1.1	Definitions and applicability.....	23
9.1.1.2	Minimum Requirements	23
9.1.1.3	Test purpose.....	24
9.1.1.4	Method of test.....	25
9.1.1.4.1	Initial conditions	25
9.1.1.4.2	Procedures.....	25
9.1.1.5	Test requirements.....	25
9.2	Spurious emissions	27
9.2.1	Definition and applicability	27
9.2.2	Minimum Requirements	27
9.2.2.1	Spurious emission (Category A)	27
9.2.2.2	Spurious emission (Category B)	28
9.2.2.3	Protection of BS receiver in the operating band.....	34
9.2.2.3.1	Minimum Requirement	34
9.2.2.4	Co-existence with other systems in the same geographical area.....	34
9.2.2.4.1	Minimum Requirements	35
9.2.2.5	Co-existence with co-located and co-sited base stations.....	36
9.2.2.5.1	Minimum Requirements	37
9.2.2.6	Co-existence with PHS	38
9.2.2.6.1	Minimum requirement.....	38
9.2.2.7	Co-existence with UTRA-TDD	38
9.2.2.7.1	Operation in the same geographic area.....	38
9.2.2.7.1.1	Minimum requirement	38
9.2.2.7.2	Co-located Repeaters and UTRA-TDD base stations.....	39
9.2.2.7.2.1	Minimum requirement	39
9.2.2.8	Co-existence with services in adjacent frequency bands.....	40
9.2.2.8.1	Minimum requirement.....	40
9.2.3	Test purpose.....	41
9.2.4	Method of test	41
9.2.4.1	Initial conditions	41
9.2.4.2	Procedures.....	41
9.2.5	Test requirements.....	41
10	Modulation accuracy	42
10.1	Error vector magnitude.....	42
10.1.1	Definition and applicability	42
10.1.2	Minimum Requirements	42
10.1.3	Test purpose.....	42
10.1.4	Method of test.....	42
10.1.4.1	Initial conditions	42
10.1.4.2	Procedure	42
10.1.4.3	Stimulus EVM effect.....	42
10.1.5	Test requirements.....	42
10.2	Peak code domain error	42
10.2.1	Definition and applicability	43
10.2.2	Minimum Requirements	43
10.2.3	Test purpose.....	43
10.2.4	Method of test	43
10.2.4.1	Initial conditions	43

10.2.4.2	Procedure	43
10.2.5	Test requirements.....	43
11	Input intermodulation	43
11.1	Definition and applicability	43
11.2	Minimum Requirements	44
11.2.1	General requirement	44
11.2.2	Co-location with BS in other systems	44
11.2.3	Co-existence with other systems.....	46
11.3	Test purpose	48
11.4	Method of test.....	48
11.4.1	Initial conditions	48
11.4.2	Procedure	48
11.5	Test requirements	48
11.5.1	Mandatory requirement.....	48
11.5.2	Co-location with BS in other systems.....	48
11.5.3	Co-existence with other systems.....	50
12	Output intermodulation	51
12.1	Definition and applicability	51
12.2	Minimum requirement.....	52
12.3	Test purpose	52
12.4	Method of test.....	52
12.4.1	Initial conditions	52
12.4.2	Procedures.....	52
12.5	Test requirements	53
13	Adjacent Channel Rejection Ratio (ACRR).....	53
13.1	Definitions and applicability	53
13.2	Minimum Requirements	53
13.3	Test purpose	53
13.4	Method of test.....	53
13.4.1	Initial conditions	53
13.4.2	Procedure	54
13.4.3	Test Requirements	54
Annex A (informative):	Repeater measurement system set-up.....	55
A.1	Maximum output power	55
A.2	Frequency stability	55
A.3	Out of band gain	55
A.4	Unwanted emission: Spectrum emission mask	55
A.5	Unwanted emission: Spurious emission.....	56
A.6	Modulation Accuracy: Error Vector Magnitude	56
A.7	Modulation Accuracy: Peak Code Domain Error	56
A.8	Input inter modulation.....	57
A.9	Output Intermodulation.....	57
Annex B (informative):	Derivation of Test Requirements.....	58
Annex C (informative):	Acceptable uncertainty of Test Equipment	59
Annex D (informative):	Change History	60
History		61

Foreword

This Technical Specification has been produced by the 3rd Generation Partnership Project (3GPP).

The contents of the present document are subject to continuing work within the TSG and may change following formal TSG approval. Should the TSG modify the contents of the present document, it will be re-released by the TSG with an identifying change of release date and an increase in version number as follows:

Version x.y.z

where:

- x the first digit:
 - 1 presented to TSG for information;
 - 2 presented to TSG for approval;
 - 3 or greater indicates TSG approved document under change control.
- y the second digit is incremented for all changes of substance, i.e. technical enhancements, corrections, updates, etc.
- z the third digit is incremented when editorial only changes have been incorporated in the document.

1 Scope

The present document specifies the Radio Frequency (RF) test methods and Minimum Requirements for UTRA Repeaters. These have been derived from, and are consistent with the UTRA Repeater specifications defined in TS 25.106.

This document establishes the minimum RF characteristics of the UTRA Repeater.

2 References

The following documents contain provisions which, through reference in this text, constitute provisions of the present document.

- References are either specific (identified by date of publication, edition number, version number, etc.) or non-specific.
- For a specific reference, subsequent revisions do not apply.
- For a non-specific reference, the latest version applies. In the case of a reference to a 3GPP document (including a GSM document), a non-specific reference implicitly refers to the latest version of that document *in the same Release as the present document*.

- [1] 3GPP TS 25.104: "UTRA(BS) FDD; Radio transmission and Reception".
- [2] 3GPP TS 25.942: "RF system scenarios".
- [3] 3GPP TS 25.113: "Base station EMC".
- [4] ITU-R recommendation SM.329: "Unwanted emissions in the spurious domain".
- [5] ITU-T recommendation O.153: "Basic parameters for the measurement of error performance at bit rates below the primary rate".
- [6] IEC 60721-3-3 (1994): "Classification of environmental conditions - Part 3: Classification of groups of environmental parameters and their severities - Section 3: Stationary use at weather protected locations".
- [7] IEC 60721-3-4 (1995): "Classification of environmental conditions - Part 3: Classification of groups of environmental parameters and their severities - Section 4: Stationary use at non-weather protected locations".
- [8] IEC 60068-2-1 (1990): "Environmental testing - Part 2: Tests. Tests A: Cold".
- [9] IEC 60068-2-2 (1974): "Environmental testing - Part 2: Tests. Tests B: Dry heat".
- [10] IEC 60068-2-6 (1995): "Environmental testing - Part 2: Tests - Test Fc: Vibration (sinusoidal)".
- [11] 3GPP TS 25.141: "Base station conformance testing (FDD)".
- [12] 3GPP TS 25.106: "UTRA Repeater; Radio transmission and reception".

3 Definitions, symbols and abbreviations

3.1 Definitions

For the purposes of the present document, the following terms and definitions apply:

Donor coupling loss: is the coupling loss between the repeater and the donor base station.

Down-link: signal path where base station transmits and mobile receives

Maximum output power, P_{max}: This is the mean power level per carrier measured at the antenna connector of the Repeater in specified reference condition.

Pass band: the Repeater can have one or several pass bands. The pass band is the frequency range that the Repeater operates in with operational configuration. This frequency range can correspond to one or several consecutive nominal 5 MHz channels. If they are not consecutive each subset of channels shall be considered as an individual pass band.

Repeater: a device that receives, amplifies and transmits the radiated or conducted RF carrier both in the down-link direction (from the base station to the mobile area) and in the up-link direction (from the mobile to the base station).

Up-link: signal path where mobile transmits and base station receives.

3.2 (void)

3.3 Abbreviations

For the purposes of the present document, the following abbreviations apply:

BTS	Base Transceiver Station
CW	Continuous Wave (unmodulated signal)
EVM	Error Vector Magnitude
FDD	Frequency Division Duplex
FFS	For Further Study
IMT2000	International Mobile Telecommunication-2000
ITU	International Telecommunication Union
MS	Mobile Station
RF	Radio Frequency
TDD	Time Division Duplex
UARFCN	UTRA Absolute Radio Frequency Channel Number
UMTS	Universal Mobile Telecommunication System
UTRA	Universal Terrestrial Radio Access
WCDMA	Wide band Code Division Multiple Access

4 Frequency bands and channel arrangement

4.1 Frequency bands

- a) A UTRA/FDD Repeater is designed to operate in one or several pass bands within either of the following paired frequency bands;

Table 4.1: Frequency bands

Operating Band	UL Frequencies UE transmit, Node B receive	DL frequencies UE receive, Node B transmit
I	1920 - 1980 MHz	2110 -2170 MHz
II	1850 -1910 MHz	1930 -1990 MHz
III	1710 - 1785 MHz	1805 - 1880 MHz
IV	1710 - 1755 MHz	2110 - 2155 MHz
V	824 - 849MHz	869 - 894MHz
VI	830 - 840 MHz	875 - 885 MHz
VII	2500 - 2570 MHz	2620 - 2690 MHz
VIII	880 - 915 MHz	925 - 960 MHz
IX	1749.9 - 1784.9 MHz	1844.9 - 1879.9 MHz

- b) Deployment in other frequency bands is not precluded.

4.2 TX - RX frequency separation

- a) A UTRA/FDD repeaters is designed to operate with the following TX to RX frequency separation

Table 4.2: TX-RX frequency separation

Operating Band	TX-RX frequency separation
I	190 MHz
II	80 MHz
III	95 MHz
IV	400 MHz
V	45 MHz
VI	45 MHz
VII	120 MHz
VIII	45 MHz
IX	95 MHz

- b) A UTRA/FDD Repeater can support both fixed and variable up-link to down-link frequency separation.
- c) The use of other up-link to down-link frequency separations in existing or other frequency bands shall not be precluded.

4.3 Channel arrangement

4.3.1 Channel spacing

The nominal channel spacing is 5 MHz, but this can be adjusted to optimise performance in a particular deployment scenario.

4.3.2 Channel raster

The channel raster is 200 kHz for all bands, which means that the centre frequency must be an integer multiple of 200 kHz. In addition a number of additional centre frequencies are specified according to the table 4.4, which means that the centre frequencies for these channels are shifted 100 kHz relative to the general raster.

4.3.3 Channel number

The carrier frequency is designated by the UTRA Absolute Radio Frequency Channel Number (UARFCN).

For each operating band, the UARFCN values are defined as follows.

Uplink: $N_U = 5 * (F_{UL} - F_{UL_Offset})$, for the carrier frequency range $F_{UL_low} \leq F_{UL} \leq F_{UL_high}$

Downlink: $N_D = 5 * (F_{DL} - F_{DL_Offset})$, for the carrier frequency range $F_{DL_low} \leq F_{DL} \leq F_{DL_high}$

For each operating Band, F_{UL_Offset} , F_{UL_low} , F_{UL_high} , F_{DL_Offset} , F_{DL_low} and F_{DL_high} are defined in Table 4.3 for the general UARFCN. For the additional UARFCN, F_{UL_Offset} , F_{DL_Offset} and the specific F_{UL} and F_{DL} are defined in Table 4.4.

Table 4.3: UARFCN definition (general)

Band	UPLINK (UL) UE transmit, Node B receive			DOWNLINK (DL) UE receive, Node B transmit		
	UARFCN formula offset F_{UL_Offset} [MHz]	Carrier frequency (F_{UL}) range [MHz]		UARFCN formula offset F_{DL_Offset} [MHz]	Carrier frequency (F_{DL}) range [MHz]	
		F_{UL_low}	F_{UL_high}		F_{DL_low}	F_{DL_high}
I	0	1922.4	1977.6	0	2112.4	2167.6
II	0	1852.4	1907.6	0	1932.4	1987.6
III	1525	1712.4	1782.6	1575	1807.4	1877.6
IV	1450	1712.4	1752.6	1805	2112.4	2152.6
V	0	826.4	846.6	0	871.4	891.6
VI	0	832.4	837.6	0	877.4	882.6
VII	2100	2502.4	2567.6	2175	2622.4	2687.6
VIII	340	882.4	912.6	340	927.4	957.6
IX	0	1752.4	1782.4	0	1847.4	1877.4

Table 4.4: UARFCN definition (additional channels)

Band	UPLINK (UL) UE transmit, Node B receive		DOWNLINK (DL) UE receive, Node B transmit	
	UARFCN formula offset F_{UL_Offset} [MHz]	Carrier frequency (F_{UL}) [MHz]	UARFCN formula offset F_{DL_Offset} [MHz]	Carrier frequency (F_{DL}) [MHz]
I	-	-	-	-
II	1850.1	1852.5, 1857.5, 1862.5, 1867.5, 1872.5, 1877.5, 1882.5, 1887.5, 1892.5, 1897.5, 1902.5, 1907.5	1850.1	1932.5, 1937.5, 1942.5, 1947.5, 1952.5, 1957.5, 1962.5, 1967.5, 1972.5, 1977.5, 1982.5, 1987.5
III	-	-	-	-
IV	1380.1	1712.5, 1717.5, 1722.5, 1727.5, 1732.5, 1737.5, 1742.5, 1747.5, 1752.5	1735.1	2112.5, 2117.5, 2122.5, 2127.5, 2132.5, 2137.5, 2142.5, 2147.5, 2152.5
V	670.1	826.5, 827.5, 831.5, 832.5, 837.5, 842.5	670.1	871.5, 872.5, 876.5, 877.5, 882.5, 887.5
VI	670.1	832.5, 837.5	670.1	877.5, 882.5
VII	2030.1	2502.5, 2507.5, 2512.5, 2517.5, 2522.5, 2527.5, 2532.5, 2537.5, 2542.5, 2547.5, 2552.5, 2557.5, 2562.5, 2567.5	2105.1	2622.5, 2627.5, 2632.5, 2637.5, 2642.5, 2647.5, 2652.5, 2657.5, 2662.5, 2667.5, 2672.5, 2677.5, 2682.5, 2687.5
VIII	-	-	-	-
IX	-	-	-	-

5 General test conditions and declarations

This specification applies only to UTRA/FDD Repeater.

The requirements of this clause apply to all applicable tests in this specification. Many of the tests in this specification measure a parameter relative to a value, that is not fully specified in the UTRA specifications. For these tests, the Minimum Requirement is determined relative to a nominal value specified by the manufacturer.

Some requirements for the Repeater may be regional as listed in subclause 5.6.

When specified in a test, the manufacturer shall declare the nominal value of a parameter, or whether an option is supported.

Schematic drawings for the individual measurement set-up can be found in the Annex.

5.1 Acceptable uncertainty of Test System

The maximum acceptable uncertainty of the Test System is specified below for each test, where appropriate. The Test System shall enable the stimulus signals in the test case to be adjusted to within the specified tolerance, and the equipment under test to be measured with an uncertainty not exceeding the specified values. All tolerances and uncertainties are absolute values, and are valid for a confidence level of 95 %, unless otherwise stated.

A confidence level of 95% is the measurement uncertainty tolerance interval for a specific measurement that contains 95% of the performance of a population of test equipment.

For RF test it should be noted that the uncertainties in subclause 5.1 apply to the Test System operating into a nominal 50 ohm load and do not include system effects due to mismatch between the DUT and the Test System.

5.1.1 Measurements of test environments

The measurement accuracy of the Repeater test environments defined in Subclause 5.4, Test environments shall be.

Pressure:	± 5 kPa.
Temperature:	± 2 degrees.
Relative Humidity:	± 5 %.
DC Voltage:	$\pm 1,0$ %.
AC Voltage:	$\pm 1,5$ %.
Vibration:	10 %.
Vibration frequency:	0,1 Hz.

The above values shall apply unless the test environment is otherwise controlled and the specification for the control of the test environment specifies the uncertainty for the parameter.

5.1.2 Measurements of Repeater

Table 5.1: Maximum Test System Uncertainty

Subclause	Maximum Test System Uncertainty	Range over which Test System Uncertainty applies
6.1 Maximum output power	$\pm 0,7$ dB	
7 Frequency error	± 12 Hz	Measurement results of ± 500 Hz
8 Out of band gain	$\pm 0,5$ dB Calibration of test set-up shall be made without D.U.T. in order to achieve the accuracy	
9.1 Spectrum emission mask	$\pm 1,5$ dB Due to carrier leakage for measurements specified in a 1MHz bandwidth close to the carrier (4 MHz to 8 MHz), integration of the measurement using several narrower bandwidth measurements may be necessary in order to achieve the above accuracy. The interference from the signal generator ACLR shall be minimum 10 dB below that of a Base Station according to TS25.141	
9.2 Spurious emissions	In UTRA and coexistence receive bands: for results > -60 dBm $\pm 2,0$ dB for results < -60 dBm $\pm 3,0$ dB Outside above range: emission power $f \leq 2,2$ GHz $\pm 1,5$ dB; $2,2$ GHz $< f \leq 4$ GHz $\pm 2,0$ dB; $f > 4$ GHz $\pm 4,0$ dB. The interference from the signal generator ACLR shall be minimum 10 dB below that of a Base Station according to TS25.141	
10.1 Error vector magnitude	$\pm 2,5$ % (single code applied) ($\pm 2,5$ % measurement error for single code). 5,0 % EVM in the stimulus signal (single code) will shift the EVM maximum value 0,7% to 18,2%. (RSS repeater EVM and Stimulus EVM.)	Measurement results from 12,5% to 22,5% at signal power = $P_{\max} - 3$ dB to $P_{\max} - 18$ dB
10.2 Peak code domain error	$\pm 1,1$ dB Formula: RSS measurement error and impedance mismatch error (using $\pm 1,0$ dB measurement error and $\pm 0,5$ dB impedance mismatch error (stimulus side) assuming 14 dB return loss)	Measurement results from - 36 dB to - 30 dB, at signal power = $P_{\max} - 3$ dB to $P_{\max} - 18$ dB
11 Input intermodulation Characteristics	$\pm 1,2$ dB Formula: RSS CW1 level error, 2 x CW2 level error, and measurement error (using all errors = $\pm 0,5$ dB)	
12 Output Intermodulation	$\pm 2,1$ dB Spectrum emission Formula: RSS 2x Interference signal level error and Spectrum emission measurement level error. (1 dB interference signal level error is assumed.) Due to carrier leakage for measurements specified in a 1MHz bandwidth close to the carrier (4 MHz to 8 MHz), integration of the measurement using several narrower bandwidth measurements may be necessary in order to achieve the above accuracy. The interference from the signal generator ACLR	

	<p>shall be minimum 10 dB below that of a Base Station</p> <p>For spurious emission:</p> <p>In UTRA and coexistence receive bands: for results > -60 dBm \pm2,0 dB for results < -60 dBm \pm3,0 dB</p> <p>Outside above range: emission power f \leq 2,2 GHz \pm1,5 dB; 2,2 GHz < f \leq 4 GHz \pm2,0 dB; f > 4 GHz \pm4,0 dB.</p> <p>The interference signal must have a spurious emission level at least 10 dB below the spurious levels required in 9.2.</p>	
13 Adjacent Channel Rejection Ratio	\pm 0,7 dB	

5.2 Repeater test tolerances (informative)

The Test Tolerances defined in this subclause have been used to relax the Minimum Requirements in this specification to derive the Test Requirements.

The Test Tolerances are derived from Test System uncertainties, regulatory requirements and criticality to system performance. As a result, the Test Tolerances may sometimes be set to zero.

The test tolerances should not be modified for any reason e.g. to take account of commonly known test system errors (such as mismatch, cable loss, etc.)

Table 5.2: Test Tolerance

Subclause	Test Tolerance (Note 1)	Notes
6.1 Maximum output power	0,7 dB	
9.1 Spectrum emission mask	1,5 dB	0 dB test tolerance for the additional Band II, IV and V requirements
9.2 Spurious emissions	0 dB	
7 Frequency error	12 Hz	
10.1 Error vector magnitude	0 %	Target value is shifted due to stimulus EVM
10.2 Peak code domain error	1,1 dB	
8 Out of band gain	0,5dB	
11 Input intermodulation Characteristics	1,2dB	
12 Output intermodulation	1,5 dB for spectrum emission 0 dB for spurious emission	
13 Adjacent Channel Rejection Ratio	0,7 dB	
NOTE 1: Unless otherwise stated, The Test Tolerances are applied to the DUT Minimum Requirement. See Annex B.		

5.3 Interpretation of measurement results

The measurement results returned by the Test System are compared - without any modification - against the Test Requirements as defined by the share risk principle.

The share risk principle is defined in ETR 273 Part 1 sub-part 2 section 6.5.

The actual measurement uncertainty of the Test System for the measurement of each parameter shall be included in the test report.

The recorded value for the Test System uncertainty shall be, for each measurement, equal to or lower than the appropriate figure in subclause 5.1 of this specification.

If the Test System for a test is known to have a measurement uncertainty greater than that specified in subclause 5.1, it is still permitted to use this apparatus provided that an adjustment is made as follows.

Any additional uncertainty in the Test System over and above that specified in subclause 5.1 shall be used to tighten the Test Requirement-making the test harder to pass. (For some tests e.g. receiver test, this may require modification of stimulus signals). This procedure will ensure that a Test System not compliant with subclause 5.1 does not increase the chance of passing a device under test where that device would otherwise have failed the test if a Test System compliant with subclause 5.1 had been used.

5.4 Test Environment

For each test in the present document, the environmental conditions under which the Repeater is to be tested are defined.

5.4.1 Normal test environment

When a normal test environment is specified for a test, the test should be performed within the minimum and maximum limits of the conditions stated in Table 5.3.

Table 5.3: Limits of conditions for Normal Test Environment

Condition	Minimum	Maximum
Barometric pressure	86 kPa	106 kPa
Temperature	15°C	30°C
Relative Humidity	20 %	85 %
Power supply	Nominal, as declared by the manufacturer	
Vibration	Negligible	

The ranges of barometric pressure, temperature and humidity represent the maximum variation expected in the uncontrolled environment of a test laboratory. If it is not possible to maintain these parameters within the specified limits, the actual values shall be recorded in the test report.

NOTE: This may, for instance, be the case for measurements of radiated emissions performed on an open field test site.

5.4.2 Extreme test environment

The manufacturer shall declare one of the following:

- 1) the equipment class for the equipment under test, as defined in the IEC 60 721-3-3 [6];
- 2) the equipment class for the equipment under test, as defined in the IEC 60 721-3-4 [7];
- 3) the equipment that does not comply to the mentioned classes, the relevant classes from IEC 60 721 [6], [7] documentation for Temperature, Humidity and Vibration shall be declared.

NOTE: Reduced functionality for conditions that fall outside of the standard operational conditions are not tested in the present document. These may be stated and tested separately.

5.4.2.1 Extreme temperature

When an extreme temperature test environment is specified for a test, the test shall be performed at the standard minimum and maximum operating temperatures defined by the manufacturer's declaration for the equipment under test.

Minimum temperature:

The test shall be performed with the environment test equipment and methods including the required environmental phenomena into the equipment, conforming to the test procedure of IEC 60 068-2-1 [8].

Maximum temperature:

The test shall be performed with the environmental test equipment and methods including the required environmental phenomena into the equipment, conforming to the test procedure of IEC 60 068-2-2 [9].

NOTE: It is recommended that the equipment is made fully operational prior to the equipment being taken to its lower operating temperature.

5.4.3 Vibration

When vibration conditions are specified for a test, the test shall be performed while the equipment is subjected to a vibration sequence as defined by the manufacturer's declaration for the equipment under test. This shall use the environmental test equipment and methods of inducing the required environmental phenomena in to the equipment, conforming to the test procedure of IEC 60 068-2-6 [10]. Other environmental conditions shall be within the ranges specified in subclause 5.4.1.

NOTE: The higher levels of vibration may induce undue physical stress in to equipment after a prolonged series of tests. The testing body should only vibrate the equipment during the RF measurement process.

5.4.4. Power supply

When extreme power supply conditions are specified for a test, the test shall be performed at the standard upper and lower limits of operating voltage defined by manufacturer's declaration for the equipment under test.

Upper voltage limit:

The equipment shall be supplied with a voltage equal to the upper limit declared by the manufacturer (as measured at the input terminals to the equipment). The tests shall be carried out at the steady state minimum and maximum temperature limits declared by the manufacturer for the equipment, to the methods described in IEC 60 068-2-1 [8] Test Ab/Ad and IEC 60 068-2-2 [9] Test Bb/Bd: Dry Heat.

Lower voltage limit:

The equipment shall be supplied with a voltage equal to the lower limit declared by the manufacturer (as measured at the input terminals to the equipment). The tests shall be carried out at the steady state minimum and maximum temperature limits declared by the manufacturer for the equipment, to the methods described in IEC 60 068-2-1 [8] Test Ab/Ad and IEC 60 068-2-2 [9] Test Bb/Bd: Dry Heat.

5.5 Selection of configurations for testing

Most tests in the present document are only performed for a subset of the possible combinations of test conditions. For instance:

- only one RF channel may be specified to be tested;
- only one timeslot may be specified to be tested.

When a test is performed by a test laboratory, the choice of which combinations are to be tested shall be specified by the laboratory. The laboratory may consult with operators, the manufacturer or other bodies.

When a test is performed by a manufacturer, the choice of which combinations are to be tested may be specified by an operator.

5.6 Regional requirements

Some requirements in TS 25.143 may only apply in certain regions. Table 5.4 lists all requirements that may be applied differently in different regions.

Table 5.4: List of regional requirements

Sub-clause number	Requirement	Comments
4.1	Frequency bands	Some bands may be applied regionally.
4.2	Up-link to down-link frequency separation	The requirement is applied according to what frequency bands in clause 4.1 that are supported by the Repeater.
4.3	Channel arrangement	The requirement is applied according to what frequency bands in clause 4.1 that are supported by the Repeater.
6.1	Maximum output power	In certain regions, the minimum requirement for normal conditions may apply also for some conditions outside the ranges of conditions defined as normal.
9.1.2	Spectrum emission mask	The mask specified may be mandatory in certain regions. In other regions this mask may not be applied.
9.2.2.1	Spurious emissions (Category A)	These requirements shall be met in cases where Category A limits for spurious emissions, as defined in ITU-R Recommendation SM.329 [4], are applied.
9.2.2.2	Spurious emissions (Category B)	These requirements shall be met in cases where Category B limits for spurious emissions, as defined in ITU-R Recommendation SM.329 [4], are applied.
9.2.2.3	Protection of the BS receiver in the operating band	This requirement may be applied for the protection of UTRA FDD BS receivers in geographic areas in which both UTRA FDD BS and UTRA FDD Repeaters are deployed.
9.2.2.4	Co-existence with other systems in the same geographical area	These requirements may apply in geographic areas in which both UTRA FDD Repeater and GSM900, DCS1800, PCS1900, GSM850 and/or UTRA FDD operating in another frequency band are deployed.
9.2.2.5	Co-existence with co-located and co-sited base stations	These requirements may be applied for the protection of other BS receivers when GSM900, DCS1800, PCS1900, GSM850 and/or UTRA FDD BS operating in another frequency band are co-located with a UTRA FDD Repeater.
9.2.2.6	Spurious emissions: Co-existence with PHS	This requirement may be applied for the protection of PHS in geographic areas in which both PHS and UTRA FDD Repeaters are deployed.
9.2.2.7.1	Spurious emissions: Co-existence with UTRA TDD-Operation in the same geographic area	This requirement may be applied for the protection of UTRA UE in geographic areas in which both UTRA TDD BS and UTRA FDD Repeaters are deployed.
9.2.2.7.2	Spurious emissions: Co-existence with UTRA TDD - Co-location	This requirement may be applied for the protection of UTRA TDD BS receivers when UTRA TDD BS and UTRA FDD Repeaters are co-located.
9.2.2.8	Co-existence with services in adjacent frequency bands	This requirement may be applied for the protection in bands adjacent to the downlink band as defined in clause 4.1 in geographic areas in which both an adjacent band service and UTRA FDD Repeater are deployed.
11.2.2	Input intermodulation: Co-location with other systems	The requirement may be applied when GSM 900, DCS 1800, PCS1900, GSM850 and/or UTRA FDD BS operating in another frequency band and UTRA-FDD Repeaters are co-located.
11.2.3	Input Intermodulation: Co-existence with other systems	These requirements may apply in geographic areas in which both UTRA FDD Repeater and GSM900, DCS1800, PCS1900, GSM850 and/or UTRA FDD operating in another frequency band are deployed.

5.7 Test Models

The set-up of physical channels for the Repeater tests shall be according to one of the test models described in TS 25.141 [11]. A reference to the applicable test model in TS 25.141 is made for each test in Table 5.5 by referring to the test model number as it appears in TS 25.141.

These test models shall be used in the tests of both the up-link and the down-link directions of the Repeater unless otherwise stated.

Table 5.5: List of the applicable test models

Test model number in TS 25.141	Requirement	Comments
Test Model 1	Repeater output power	
Test Model 1	Out of band emission	
Test Model 1	Spurious emission	
Test Model 1	Error vector magnitude	
Test Model 3	Peak code domain error	

5.8 Format and interpretation of tests

Each test in the following clauses has a standard format:

X Title

All tests are applicable to all equipment within the scope of the present document, unless otherwise stated.

X.1 Definition and applicability

This subclause gives the general definition of the parameter under consideration and specifies whether the test is applicable to all equipment or only to a certain subset.

X.2 Minimum Requirements

This subclause is an informative copy of the Minimum Requirement defined by the core specification.

In addition, this subclause contains the reference to the subclause to the 3GPP reference (or core) specification which defines the Minimum Requirement.

X.3 Test purpose

This subclause defines the purpose of the test.

X.4 Method of test

X.4.1 Initial conditions

This subclause defines the initial conditions for each test, including the basic measurement set-up.

X.4.2 Procedure

This subclause describes the steps necessary to perform the test and provides further details of the test definition like point of access (e.g. antenna port), domain (e.g. frequency-span), range, weighting (e.g. bandwidth), and algorithms (e.g. averaging).

X.5 Test Requirements

This subclause defines the pass/fail criteria for the equipment under test. See subclause 5.3 Interpretation of measurement results.

5.9 Repeater configurations

5.9.1 Power supply options

If the repeater is supplied with a number of different power supply configurations, it may not be necessary to test RF parameters for each of the power supply options, provided that it can be demonstrated that the range of conditions over which the equipment is tested is at least as great as the range of conditions due to any of the power supply configurations.

5.9.2 Combining of Repeaters

If the repeater is intended for combination with additional apparatus connected to a repeater port and this combination is supplied as a system, the combination of repeater together with the additional apparatus shall also fulfil the repeater requirements. E.g. if the repeater is intended for combination such that multiple repeaters amplify the same signals into the same ports the combination shall also fulfil the repeater requirements.

An example of such a configuration is shown in figure 5.1

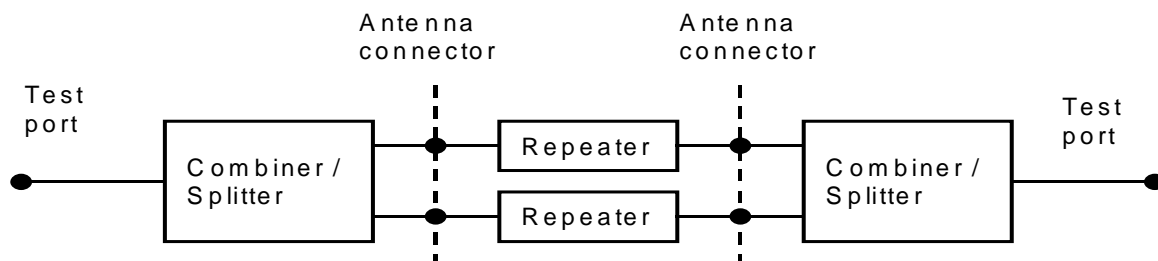

Figure 5.1: Example of repeater configuration

6 Output power

Maximum output power, P_{max} , of the Repeater is the mean power level per carrier at maximum Repeater gain that the manufacturer has declared to be available at the antenna connector.

6.1 Maximum output power

6.1.1 Definition and applicability

Maximum output power, P_{max} , of the Repeater is the mean power level per carrier measured at the antenna connector in specified reference condition.

6.1.2 Minimum Requirements

In normal conditions as specified in section 5.4.1, the Repeater maximum output power shall remain within limits specified in Table 6.1 relative to the manufacturer's rated output power.

Table 6.1: Repeater output power; normal conditions

Rated output power	Limit
$P \geq 43$ dBm	+2 dB and -2 dB
$39 \leq P < 43$ dBm	+2 dB and -2 dB
$31 \leq P < 39$ dBm	+2 dB and -2 dB
$P < 31$ dBm	+3 dB and -3 dB

In extreme conditions as specified in section 5.4.2 and 5.4.4, the Repeater maximum output power shall remain within limits specified in Table 6.2 relative to the manufacturer's rated output power.

Table 6.2: Repeater output power; extreme conditions

Rated output power	Limit
$P \geq 43$ dBm	+2,5 dB and -2,5 dB
$39 \leq P < 43$ dBm	+2,5 dB and -2,5 dB
$31 \leq P < 39$ dBm	+2,5 dB and -2,5 dB
$P < 31$ dBm	+4 dB and -4 dB

In certain regions, the minimum requirement for normal conditions may apply also for some conditions outside the ranges defined for the Normal test environment in subclause 5.4.1.

6.1.3 Test purpose

To verify that the Repeater maximum output power is within the limit specified in 6.1.2.

6.1.4 Method of test

6.1.4.1 Initial conditions

- 1) Set-up the equipment as shown in annex A.
- 2) Connect the signal generator equipment to the Repeater input port.
- 3) Connect the power measuring equipment to the Repeater output port.

6.1.4.2 Procedure

- 1) Set the signal generator to transmit a signal modulated with a combination of PCCPCH, SCCPCH and Dedicated Physical Channels specified as test model 1 in TS 25.141.
- 2) Adjust the input power to the Repeater to create the maximum nominal Repeater output power at maximum gain.
- 3) Measure the mean power at the RF output port over a certain slot.
- 4) Increase the power with 10 dB compare to the level obtained in step 2.
- 5) Measure the mean power at the RF output port over a certain slot.

In addition, on one UARFCN only, the test shall be performed under extreme power supply as defined in subclause 5.4.4

NOTE: Tests under extreme power supply also test extreme temperature.

6.1.5 Test Requirements

In normal conditions as specified in section 5.4.1, the Repeater maximum output power shall remain within limits specified in Table 6.3 relative to the manufacturer's rated output power.

Table 6.3: Repeater output power; normal conditions

Rated output power	Limit
$P \geq 43$ dBm	+2,7 dB and -2,7 dB
$39 \leq P < 43$ dBm	+2,7 dB and -2,7 dB
$31 \leq P < 39$ dBm	+2,7 dB and -2,7 dB
$P < 31$ dBm	+3,7 dB and -3,7 dB

In extreme conditions as specified in section 5.4.2 and 5.4.4, the Repeater maximum output power shall remain within limits specified in Table 6.4 relative to the manufacturer's rated output power.

Table 6.4: Repeater output power; extreme conditions

Rated output power	Limit
$P \geq 43$ dBm	+3,2 dB and -3,2 dB
$39 \leq P < 43$ dBm	+3,2 dB and -3,2 dB
$31 \leq P < 39$ dBm	+3,2 dB and -3,2 dB
$P < 31$ dBm	+4,7 dB and -4,7 dB

In certain regions, the minimum requirement for normal conditions may apply also for some conditions outside the ranges defined for the Normal test environment in subclause 5.4.1.

NOTE: If the above Test Requirement differs from the Minimum Requirement then the Test Tolerance applied for this test is non zero. The Test Tolerance for this test is defined in subclause 5.2 and the explanation of how the Minimum Requirement has been relaxed by the Test Tolerance is given in Annex B.

7 Frequency stability

Frequency error is the measure of the difference between the frequency of the received signal and the frequency of the re-transmitted signal.

7.1 Definition and applicability

The frequency stability is a measure of the frequency deviation of the output signal with respect to the input signal. The test shall address the uplink and the downlink path of the Repeater.

7.2 Minimum Requirement

In normal conditions as specified in section 5.4.1 the frequency deviation shall be within $\pm 0,01$ ppm.

7.3 Test purpose

To verify that the Frequency Error is within the limit specified in 7.2.

7.4 Method of test

7.4.1 Initial conditions

- 1) Set-up the equipment as shown in annex A.
- 2) Connect the cw signal generator equipment to the Repeater input port.
- 3) Connect the frequency counter to the Repeater output port. Both the signal generator and the frequency counter shall use the same reference frequency.

- 4) Adjust the input power to the Repeater to create the maximum nominal Repeater output power as declared by the manufacturer at maximum gain.

7.4.2 Procedure

Measure the frequency error for both paths Uplink and Downlink of the Repeater.

7.5 Test requirements

The measurement result of 7.4.2 shall not exceed:

$$|f_{IN} - f_{out}| \leq (f_{out} * 0,01 \text{ ppm}) + 12 \text{ Hz}$$

8 Out of band gain

8.1 Definitions and applicability

Out of band gain refers to the gain of the Repeater immediately outside the pass band. The measurements shall apply to both paths Uplink and Downlink of the Repeater.

8.2 Minimum Requirements

The intended use of a repeater in a system is to amplify the in band signals and not to amplify the out of band emission of the donor base station.

In the intended application of the repeater, the out of band gain is less than the donor coupling loss.

The repeater minimum donor coupling loss shall be declared by the manufacturer. This is this the minimum required attenuation between the donor BS and the repeater for proper repeater operation.

In normal conditions as specified in section 5.4.1 the gain outside the pass band shall not exceed the maximum level specified in Table 8.1, where:

- f_{offset} is the distance from the centre frequency of the first or last 5 MHz channel within the pass band.

Table 8.1: Out of band gain limits 1

Frequency offset from the carrier frequency, f_{offset}	Maximum gain
$2,7 \leq f_{offset} < 3,5 \text{ MHz}$	60 dB
$3,5 \leq f_{offset} < 7,5 \text{ MHz}$	45 dB
$7,5 \leq f_{offset} < 12,5 \text{ MHz}$	45 dB
$12,5 \text{ MHz} \leq f_{offset}$	35 dB

For $12,5 \text{ MHz} \leq f_{offset}$ the out of band gain shall not exceed the maximum gain of table 8.2 or the maximum gain stated in table 8.1 whichever is lower.

Table 8.2: Out of band gain limits 2

Repeater maximum output power as in 9.1.1.1	Maximum gain
$P < 31 \text{ dBm}$	Out of band gain \leq minimum donor coupling loss
$31 \text{ dBm} \leq P < 43 \text{ dBm}$	Out of band gain \leq minimum donor coupling loss
$P \geq 43 \text{ dBm}$	Out of band gain \leq minimum donor coupling loss - (P-43dBm)
Note:	The out of band gain is considered with $12,5 \text{ MHz} \leq f_{offset}$

8.3 Test purpose

The purpose of this test is to verify that the Repeater meets the out of band gain requirements as specified in TS 25.106.

8.4 Method of test

8.4.1 Initial conditions

Set-up the equipment as shown in annex A.

The test shall be performed with an offset between CW-signal and the first or last 5 MHz channel within the pass band of 2,7 MHz, 3 MHz, 3,5 MHz, 5 MHz, 7,5 MHz, 10 MHz, 12,5 MHz, 15 MHz and 20 MHz, excluding other pass bands. In addition the test shall also be performed for all harmonic frequencies of the repeaters pass band up to 12,75 GHz.

8.4.2 Procedure

- 1) Set the Repeater to maximum gain.
- 2) Set the signal generator to generate a CW-signal, applied to the input port of the Repeater. The power level of the RF input signal shall be at least 5 dB below the power level which, when applied within the pass band, would produce the maximum rated output power, as declared by the manufacturer. This is to ensure that the equipment is operating in the linear output range.
- 3) The average output power in each case shall be measured using a spectrum analyser connected to the output port of the Repeater and the net gain shall be recorded compared to table 8.3 or table 8.4 whichever is lower.
- 4) With the same input power as in step 1) set the repeater gain to the minimum specified by the manufacturer.
- 5) The average output power in each case shall be measured using a spectrum analyser connected to the output port of the Repeater and the net gain shall be recorded and compared to table 8.3 or table 8.4 whichever is lower.

8.5 Test requirements

Table 8.3: Out of band gain limits

Frequency offset from the carrier frequency, f_{offset}	Maximum gain
$2,7 \leq f_{\text{offset}} < 3,5$ MHz	60,5 dB
$3,5 \leq f_{\text{offset}} < 7,5$ MHz	45,5 dB
$7,5 \leq f_{\text{offset}} < 12,5$ MHz	45,5 dB
$12,5 \text{ MHz} \leq f_{\text{offset}}$	35,5 dB

Table 8.4: Out of band gain limits 2

Repeater maximum output power as in 9.1.1.1	Maximum gain
$P < 31$ dBm	Out of band gain \leq minimum donor coupling loss + 0,5 dB
$31 \text{ dBm} \leq P < 43$ dBm	Out of band gain \leq minimum donor coupling loss + 0,5 dB
$P \geq 43$ dBm	Out of band gain \leq minimum donor coupling loss - (P-43dBm) + 0,5 dB
NOTE: The donor coupling loss is considered with $12,5 \text{ MHz} \leq f_{\text{offset}}$	

9 Unwanted emission

9.1 Out of band emission

Out of band emissions are unwanted emissions immediately outside the channel bandwidth resulting from the modulation process and non-linearity in the transmitter but excluding spurious emissions. This out of band emission limit is specified in terms of a spectrum emission mask.

9.1.1 Spectrum emission mask

9.1.1.1 Definitions and applicability

The masks defined in Table 9.1, Table 9.2, Table 9.3, and Table 9.4 below may be mandatory in certain regions. In other regions this mask may not be applied.

9.1.1.2 Minimum Requirements

For regions where this clause applies, the requirement shall be met by a repeater's RF-signal output at maximum gain with WCDMA signals in the pass band of the Repeater, at levels that produce the maximum rated output power per channel. In normal conditions as specified in section 5.4.1 emissions shall not exceed the maximum level specified in Table 9.1, Table 9.2, Table 9.3, and Table 9.4 for the appropriate Repeater maximum output power, in the frequency range from $\Delta f = 2,5$ MHz to Δf_{\max} from the 5 MHz channel, where:

- Δf is the separation between the centre frequency of first or last 5 MHz channel used in the pass band and the nominal -3 dB point of the measuring filter closest to the carrier frequency.
- f_{offset} is the separation between the centre frequency of first or last 5 MHz channel in the pass band and the centre of the measuring filter.
- $f_{\text{offset}_{\max}}$ is either 12,5 MHz or the offset to the UTRA band edge at both up- and down-link as defined in section 4.1, whichever is the greater.
- Δf_{\max} is equal to $f_{\text{offset}_{\max}}$ minus half of the bandwidth of the measurement filter.

If the pass band corresponds to two or more consecutive nominal 5 MHz channels, the requirement shall be met with any combination of two WCDMA modulated signals of equal power in the repeaters pass band.

To select the table of the maximum level for the spectrum emission mask test, use the maximum output power as defined in subclause 3.1 Definition. If one channel is used for the spectrum emission mask test use this power for the selection. If two channels are used for the spectrum emission mask test use the power of one of these.

Table 9.1: Spectrum emission mask values, maximum output power $P \geq 43$ dBm

Frequency offset of measurement filter -3dB point, Δf	Frequency offset of measurement filter centre frequency, f_{offset}	Minimum requirement Band I, II, III, IV, V, VII, VIII	Additional Requirements Band II, IV and V (Note 1)	Measurement bandwidth
$2,5 \text{ MHz} \leq \Delta f < 2,7 \text{ MHz}$	$2,515\text{MHz} \leq f_{\text{offset}} < 2,715\text{MHz}$	-14 dBm	-15 dBm	30 kHz
$2,7 \text{ MHz} \leq \Delta f < 3,5 \text{ MHz}$	$2,715\text{MHz} \leq f_{\text{offset}} < 3,515\text{MHz}$	$-14\text{dBm} - 15 \cdot \left(\frac{f_{\text{offset}}}{\text{MHz}} - 2,715 \right) \text{dB}$	-15 dBm	30 kHz
	$3,515\text{MHz} \leq f_{\text{offset}} < 4,0\text{MHz}$	-26 dBm	NA	30 kHz
$3,5 \text{ MHz} \leq \Delta f < 7,5 \text{ MHz}$	$4,0 \text{ MHz} \leq f_{\text{offset}} < 8,0\text{MHz}$	-13 dBm	-13 dBm	1 MHz
$7,5 \text{ MHz} \leq \Delta f \leq f_{\max}$	$8,0 \text{ MHz} \leq f_{\text{offset}} < f_{\text{offset}_{\max}}$	-13 dBm	-13 dBm	1 MHz

Table 9.2: Spectrum emission mask values, maximum output power $39 \leq P < 43$ dBm

Frequency offset of measurement filter -3dB point, Δf	Frequency offset of measurement filter centre frequency, f_{offset}	Minimum requirement Band I, II, III, IV, V, VII, VIII	Additional Requirements Band II, IV and V (Note 1)	Measurement bandwidth
$2,5 \text{ MHz} \leq \Delta f < 2,7 \text{ MHz}$	$2,515\text{MHz} \leq f_{\text{offset}} < 2,715\text{MHz}$	-14 dBm	-15 dBm	30 kHz
$2,7 \text{ MHz} \leq \Delta f < 3,5 \text{ MHz}$	$2,715\text{MHz} \leq f_{\text{offset}} < 3,515\text{MHz}$	$-14\text{dBm} - 15 \cdot \left(\frac{f_{\text{offset}}}{\text{MHz}} - 2,715 \right) \text{dB}$	-15 dBm	30 kHz
	$3,515\text{MHz} \leq f_{\text{offset}} < 4,0\text{MHz}$	-26 dBm	NA	30 kHz
$3,5 \text{ MHz} \leq \Delta f < 7,5 \text{ MHz}$	$4,0 \text{ MHz} \leq f_{\text{offset}} < 8,0\text{MHz}$	-13 dBm	-13 dBm	1 MHz
$7,5 \text{ MHz} \leq \Delta f \leq f_{\text{max}}$	$8,0\text{MHz} \leq f_{\text{offset}} < f_{\text{offset,max}}$	$P - 56 \text{ dB}$	-13 dBm	1 MHz

Table 9.3: Spectrum emission mask values, maximum output power $31 \leq P < 39$ dBm

Frequency offset of measurement filter -3dB point, Δf	Frequency offset of measurement filter centre frequency, f_{offset}	Minimum requirement Band I, II, III, IV, V, VII, VIII	Additional Requirements Band II, IV and V (Note 1)	Measurement bandwidth
$2,5 \text{ MHz} \leq \Delta f < 2,7 \text{ MHz}$	$2,515\text{MHz} \leq f_{\text{offset}} < 2,715\text{MHz}$	$P - 53 \text{ dB}$	-15 dBm	30 kHz
$2,7 \text{ MHz} \leq \Delta f < 3,5 \text{ MHz}$	$2,715\text{MHz} \leq f_{\text{offset}} < 3,515\text{MHz}$	$P - 53\text{dB} - 15 \cdot \left(\frac{f_{\text{offset}}}{\text{MHz}} - 2,715 \right) \text{dB}$	-15 dBm	30 kHz
	$3,515\text{MHz} \leq f_{\text{offset}} < 4,0\text{MHz}$	$P - 65 \text{ dB}$	NA	30 kHz
$3,5 \text{ MHz} \leq \Delta f < 7,5 \text{ MHz}$	$4,0 \text{ MHz} \leq f_{\text{offset}} < 8,0\text{MHz}$	$P - 52 \text{ dB}$	-13 dBm	1 MHz
$7,5 \text{ MHz} \leq \Delta f \leq f_{\text{max}}$	$8,0\text{MHz} \leq f_{\text{offset}} < f_{\text{offset,max}}$	$P - 56 \text{ dB}$	-13 dBm	1 MHz

Table 9.4: Spectrum emission mask values, maximum output power $P < 31$ dBm

Frequency offset of measurement filter - 3dB point, Δf	Frequency offset of measurement filter centre frequency, f_{offset}	Minimum requirement Band I, II, III, IV, V, VII, VIII	Measurement bandwidth
$2,5 \text{ MHz} \leq \Delta f < 2,7 \text{ MHz}$	$2,515\text{MHz} \leq f_{\text{offset}} < 2,715\text{MHz}$	-22 dBm	30 kHz
$2,7 \text{ MHz} \leq \Delta f < 3,5 \text{ MHz}$	$2,715\text{MHz} \leq f_{\text{offset}} < 3,515\text{MHz}$	$-22\text{dBm} - 15 \cdot \left(\frac{f_{\text{offset}}}{\text{MHz}} - 2,715 \right) \text{dB}$	30 kHz
	$3,515\text{MHz} \leq f_{\text{offset}} < 4,0\text{MHz}$	-34 dBm	30 kHz
$3,5 \text{ MHz} \leq \Delta f < 7,5 \text{ MHz}$	$4,0 \text{ MHz} \leq f_{\text{offset}} < 8,0\text{MHz}$	-21 dBm	1 MHz
$7,5 \text{ MHz} \leq \Delta f \leq f_{\text{max}}$	$8,0\text{MHz} \leq f_{\text{offset}} < f_{\text{offset,max}}$	-25 dBm	1 MHz

Note for Tables 9.1, 9.2, 9.3 & 9.4:

NOTE 1 The minimum requirement for operation in band II, IV and V is the lower power of the minimum requirement for band I, II, III, IV and V and the additional requirement for band II, IV and V.

9.1.1.3 Test purpose

The purpose of this test is to verify that the Repeater meet the spectrum emission requirements as specified in TS 25.106.

9.1.1.4 Method of test

9.1.1.4.1 Initial conditions

- 1) Set-up the equipment as shown in annex A.
- 2) Connect a signal generator to the input port of the Repeater for tests of repeaters with a pass band corresponding to one 5 MHz channel. If the pass band corresponds to two or more 5 MHz carriers, two signal generators with a combining circuit or one signal generator with the ability to generate several WCDMA carriers is connected to the input.
- 3) Measurements with an offset from the carrier centre frequency between 2,515 MHz and 4,0 MHz shall use a 30 kHz measurement bandwidth.
- 4) Measurements with an offset from the carrier centre frequency between 4,0 MHz and (Δf_{\max} - 500 kHz) shall use a 1 MHz measurement bandwidth. The 1MHz measurement bandwidth may be calculated by integrating multiple 50 kHz or narrower filter measurements.
- 5) Detection mode: True RMS.

9.1.1.4.2 Procedures

- 1) Set the Repeater to maximum gain.
- 2) Set the signal generator(s) to generate signal(s) in accordance to test model 1, TS 25.141 subclause 6.2.1.1.1, at level(s) which produce the manufacturer specified maximum output power at maximum gain.
- 3) Measure the emission at the specified frequencies with specified measurement bandwidth and note that the measured value does not exceed the specified value.
- 4) Increase the power with 10 dB compare to the level obtained in step 2.
- 5) Measure the emission at the specified frequencies with specified measurement bandwidth and note that the measured value does not exceed the specified value.
- 6) If the pass band corresponds to two or more consecutive nominal 5 MHz channels, repeat step 1) to 5) with any combination of two WCDMA modulated signals of equal power in the repeaters pass band.
- 7) Measure the emission at the specified frequencies with specified measurement bandwidth and note that the measured value does not exceed the specified value.
- 8) Repeat the test for the opposite path of the Repeater.

9.1.1.5 Test requirements

The measurement result of step 3 and 5 of 9.1.4.2 shall not exceed the maximum level specified in tables 9.5 to 9.8 for the appropriate Repeater maximum output power.

Table 9.5: Spectrum emission mask values, maximum output power $P \geq 43$ dBm

Frequency offset of measurement filter -3dB point, Δf	Frequency offset of measurement filter centre frequency, f_{offset}	Test requirement Band I, II, III, IV, V, VII, VIII	Additional Requirements Band II, IV and V (Note 1)	Measurement bandwidth
$2,5 \text{ MHz} \leq \Delta f < 2,7 \text{ MHz}$	$2,515 \text{ MHz} \leq f_{\text{offset}} < 2,715 \text{ MHz}$	-12,5 dBm	-15 dBm	30 kHz
$2,7 \text{ MHz} \leq \Delta f < 3,5 \text{ MHz}$	$2,715 \text{ MHz} \leq f_{\text{offset}} < 3,515 \text{ MHz}$	$-12,5 \text{ dBm} - 15 \cdot \left(\frac{f_{\text{offset}}}{\text{MHz}} - 2,715 \right) \text{ dB}$	-15 dBm	30 kHz
	$3,515 \text{ MHz} \leq f_{\text{offset}} < 4,0 \text{ MHz}$	-24,5 dBm	NA	30 kHz
$3,5 \text{ MHz} \leq \Delta f < 7,5 \text{ MHz}$	$4,0 \text{ MHz} \leq f_{\text{offset}} < 8,0 \text{ MHz}$	-11,5 dBm	-13 dBm	1 MHz
$7,5 \text{ MHz} \leq \Delta f \leq f_{\text{max}}$	$8,0 \text{ MHz} \leq f_{\text{offset}} < f_{\text{offset}_{\text{max}}}$	-11,5 dBm	-13 dBm	1 MHz

Table 9.6: Spectrum emission mask values, maximum output power $39 \leq P < 43$ dBm

Frequency offset of measurement filter -3dB point, Δf	Frequency offset of measurement filter centre frequency, f_{offset}	Test requirement Band I, II, III, IV, V, VII, VIII	Additional Requirements Band II, IV and V (Note 1)	Measurement bandwidth
$2,5 \text{ MHz} \leq \Delta f < 2,7 \text{ MHz}$	$2,515 \text{ MHz} \leq f_{\text{offset}} < 2,715 \text{ MHz}$	-12,5 dBm	-15 dBm	30 kHz
$2,7 \text{ MHz} \leq \Delta f < 3,5 \text{ MHz}$	$2,715 \text{ MHz} \leq f_{\text{offset}} < 3,515 \text{ MHz}$	$-12,5 \text{ dBm} - 15 \cdot \left(\frac{f_{\text{offset}}}{\text{MHz}} - 2,715 \right) \text{ dB}$	-15 dBm	30 kHz
	$3,515 \text{ MHz} \leq f_{\text{offset}} < 4,0 \text{ MHz}$	-24,5 dBm	NA	30 kHz
$3,5 \text{ MHz} \leq \Delta f < 7,5 \text{ MHz}$	$4,0 \text{ MHz} \leq f_{\text{offset}} < 8,0 \text{ MHz}$	-11,5 dBm	-13 dBm	1 MHz
$7,5 \text{ MHz} \leq \Delta f \leq f_{\text{max}}$	$8,0 \text{ MHz} \leq f_{\text{offset}} < f_{\text{offset}_{\text{max}}}$	$P - 54,5 \text{ dB}$	-13 dBm	1 MHz

Table 9.7: Spectrum emission mask values, maximum output power $31 \leq P < 39$ dBm

Frequency offset of measurement filter -3dB point, Δf	Frequency offset of measurement filter centre frequency, f_{offset}	Test requirement Band I, II, III, IV, V, VII, VIII	Additional Requirements Band II, IV and V (Note 1)	Measurement bandwidth
$2,5 \text{ MHz} \leq \Delta f < 2,7 \text{ MHz}$	$2,515 \text{ MHz} \leq f_{\text{offset}} < 2,715 \text{ MHz}$	$P - 51,5 \text{ dB}$	-15 dBm	30 kHz
$2,7 \text{ MHz} \leq \Delta f < 3,5 \text{ MHz}$	$2,715 \text{ MHz} \leq f_{\text{offset}} < 3,515 \text{ MHz}$	$P - 51,5 \text{ dB} - 15 \cdot \left(\frac{f_{\text{offset}}}{\text{MHz}} - 2,715 \right) \text{ dB}$	-15 dBm	30 kHz
	$3,515 \text{ MHz} \leq f_{\text{offset}} < 4,0 \text{ MHz}$	$P - 63,5 \text{ dB}$	NA	30 kHz
$3,5 \text{ MHz} \leq \Delta f < 7,5 \text{ MHz}$	$4,0 \text{ MHz} \leq f_{\text{offset}} < 8,0 \text{ MHz}$	$P - 50,5 \text{ dB}$	-13 dBm	1 MHz
$7,5 \text{ MHz} \leq \Delta f \leq f_{\text{max}}$	$8,0 \text{ MHz} \leq f_{\text{offset}} < f_{\text{offset}_{\text{max}}}$	$P - 54,5 \text{ dB}$	-13 dBm	1 MHz

Table 9.8: Spectrum emission mask values, maximum output power P < 31 dBm

Frequency offset of measurement filter - 3dB point, Δf	Frequency offset of measurement filter centre frequency, f_{offset}	Test requirement Band I, II, III, IV, V, VII, VIII	Measurement bandwidth
$2,5 \text{ MHz} \leq \Delta f < 2,7 \text{ MHz}$	$2,515\text{MHz} \leq f_{\text{offset}} < 2,715\text{MHz}$	-20,5 dBm	30 kHz
$2,7 \text{ MHz} \leq \Delta f < 3,5 \text{ MHz}$	$2,715\text{MHz} \leq f_{\text{offset}} < 3,515\text{MHz}$	$-20,5\text{dBm} - 15 \cdot \left(\frac{f_{\text{offset}}}{\text{MHz}} - 2,715 \right) \text{dB}$	30 kHz
	$3,515\text{MHz} \leq f_{\text{offset}} < 4,0\text{MHz}$	-32,5 dBm	30 kHz
$3,5 \text{ MHz} \leq \Delta f < 7,5 \text{ MHz}$	$4,0 \text{ MHz} \leq f_{\text{offset}} < 8,0\text{MHz}$	-19,5 dBm	1 MHz
$7,5 \text{ MHz} \leq \Delta f \leq f_{\text{max}}$	$8,0\text{MHz} \leq f_{\text{offset}} < f_{\text{offset}_{\text{max}}}$	-23,5 dBm	1 MHz

Notes for Tables 9.5, 9.6, 9.7 & 9.8:

NOTE 1 The test requirement for operation in band II, IV and V is the lower power of the test requirement for band I, II, III, IV, and V and the additional requirement for band II, IV and V.

NOTE: If the above Test Requirement differs from the Minimum Requirement then the Test Tolerance applied for this test is non-zero. The Test Tolerance for this test is defined in subclause 5.2 and the explanation of how the Minimum Requirement has been relaxed by the Test Tolerance is given in Annex B.

9.2 Spurious emissions

9.2.1 Definition and applicability

Spurious emissions are emissions which are caused by unwanted transmitter effects such as harmonics emission, parasitic emission, intermodulation products and frequency conversion products, but exclude out of band emissions. This is measured at the Repeater output port.

The requirements of either subclause 9.2.2.1 or subclause 9.2.2.2 shall apply whatever the type of Repeater considered (one or several pass bands). It applies for all configurations foreseen by the manufacturer's specification.

Either requirement applies at frequencies within the specified frequency ranges that are more than 12,5 MHz below the centre frequency of the first 5 MHz channel or more than 12,5 MHz above the centre frequency of the last 5 MHz channel in the pass band.

Unless otherwise stated, all requirements are measured as mean power (RMS).

9.2.2 Minimum Requirements

In normal conditions as specified in section 5.4.1 the following requirements shall be met.

9.2.2.1 Spurious emission (Category A)

The following requirements shall be met in cases where Category A limits for spurious emissions, as defined in ITU-R Recommendation SM.329 [4], are applied.

At maximum Repeater gain, with WCDMA signals in the pass band of the Repeater, at levels that produce the maximum rated output power per channel, the power of any spurious emission shall not exceed the limits specified in Table 9.9.

When the power in all channels is increased by 10 dB the requirements shall still be met.

The requirement shall apply both with or without an input signal applied.

NOTE 1: If the pass band corresponds to two or more consecutive nominal 5 MHz channels, the requirement shall be met with any combination of two WCDMA modulated signals of equal power in the repeaters pass band.

Table 9.9: Up-link and down-link: General spurious emissions limits, Category A

Band	Maximum level	Measurement Bandwidth	Notes
9kHz - 150kHz	-13 dBm	1 kHz	Note 1
150kHz - 30MHz		10 kHz	Note 1
30MHz - 1GHz		100 kHz	Note 1
1GHz - 12,75 GHz		1 MHz	Note 2
NOTE 1: Bandwidth as in ITU-R SM.329 [4], s4.1			
NOTE 2: Upper frequency as in ITU-R SM.329 [4], s2.5 table 1			

9.2.2.2 Spurious emission (Category B)

The following requirements shall be met in cases where Category B limits for spurious emissions, as defined in ITU-R Recommendation SM.329 [4], are applied.

At maximum Repeater gain, with WCDMA signals in the pass band of the Repeater, at levels that produce the maximum rated power output per channel, the power of any spurious emission shall not exceed the limits specified in Tables 9.10, 9.10A, 9.10B, 9.10C, 9.10D, 9.10E and Table 9.10F depending on the declared operating band for the down- and up-link.

When the power in all channels is increased by 10 dB the requirements shall still be met.

The requirement shall apply both with or without an input signal applied.

NOTE 1: If the pass band corresponds to two or more consecutive nominal 5 MHz channels, the requirement shall be met with any combination of two WCDMA modulated signals of equal power in the repeaters pass band.

Table 9.10: General spurious emissions limits, operating band I, Category B

Up-link Band	Down-link Band	Maximum Level	Measurement Bandwidth	Notes
9kHz ↔ 150kHz	9kHz ↔ 150kHz	-36 dBm	1 kHz	Note 1
150kHz ↔ 30MHz	150kHz ↔ 30MHz	- 36 dBm	10 kHz	Note 1
30MHz ↔ 1GHz	30MHz ↔ 1GHz	-36 dBm	100 kHz	Note 1
1GHz ↔ Fc1 - 60 MHz or 1910 MHz whichever is the higher	1GHz ↔ Fc1 - 60 MHz or 2100 MHz whichever is the higher	-30 dBm	1 MHz	Note 1
Fc1 - 60 MHz or 1910 MHz whichever is the higher ↔ Fc1 - 50 MHz or 1910 MHz whichever is the higher	Fc1 - 60 MHz or 2100 MHz whichever is the higher ↔ Fc1 - 50 MHz or 2100 MHz whichever is the higher	-25 dBm	1 MHz	Note 2
Fc1 - 50 MHz or 1910 MHz whichever is the higher ↔ Fc2 + 50 MHz or 1990 MHz whichever is the lower	Fc1 - 50 MHz or 2100 MHz whichever is the higher ↔ Fc2 + 50 MHz or 2180 MHz whichever is the lower	-15 dBm	1 MHz	Note 2
Fc2 + 50 MHz or 1990 MHz whichever is the lower ↔ Fc2 + 60 MHz or 1990 MHz whichever is the lower	Fc2 + 50 MHz or 2180 MHz whichever is the lower ↔ Fc2 + 60 MHz or 2180 MHz whichever is the lower	-25 dBm	1 MHz	Note 2
Fc2 + 60 MHz or 1990 MHz whichever is the lower ↔ 12,75 GHz	Fc2 + 60 MHz or 2180 MHz whichever is the lower ↔ 12,75 GHz	-30 dBm	1 MHz	Note 3
NOTE 1: Bandwidth as in ITU-R SM.329 [4], s4.1				
NOTE 2: Specification in accordance with ITU-R SM.329 [4], s4.3 and Annex 7				
NOTE 3: Bandwidth as in ITU-R SM.329 [4], s4.1. Upper frequency as in ITU-R SM.329 [4], s2.5 table 1				

Table 9.10A: General spurious emissions limits, operating band II, Category B

Up-link Band	Down-link Band	Maximum Level	Measurement Bandwidth	Note
9kHz ↔ 150kHz	9kHz ↔ 150kHz	-36 dBm	1 kHz	Note 1
150kHz ↔ 30MHz	150kHz ↔ 30MHz	- 36 dBm	10 kHz	Note 1
30MHz ↔ 1GHz	30MHz ↔ 1GHz	-36 dBm	100 kHz	Note 1
1GHz ↔ Fc1 - 60 MHz or 1840 MHz whichever is the higher	1GHz ↔ Fc1 - 60 MHz or 1920 MHz whichever is the higher	-30 dBm	1 MHz	Note 1
Fc1 - 60 MHz or 1840 MHz whichever is the higher ↔ Fc1 - 50 MHz or 1840 MHz whichever is the higher	Fc1 - 60 MHz or 1920 MHz whichever is the higher ↔ Fc1 - 50 MHz or 1920 MHz whichever is the higher	-25 dBm	1 MHz	Note 2
Fc1 - 50 MHz or 1840 MHz whichever is the higher ↔ Fc2 + 50 MHz or 1920 MHz whichever is the lower	Fc1 - 50 MHz or 1920 MHz whichever is the higher ↔ Fc2 + 50 MHz or 2000 MHz whichever is the lower	-15 dBm	1 MHz	Note 2
Fc2 + 50 MHz or 1920 MHz whichever is the lower ↔ Fc2 + 60 MHz or 1920 MHz whichever is the lower	Fc2 + 50 MHz or 2000 MHz whichever is the lower ↔ Fc2 + 60 MHz or 2000 MHz whichever is the lower	-25 dBm	1 MHz	Note 2
Fc2 + 60 MHz or 1920 MHz whichever is the lower ↔ 12,75 GHz	Fc2 + 60 MHz or 2000 MHz whichever is the lower ↔ 12,75 GHz	-30 dBm	1 MHz	Note 3
NOTE 1: Bandwidth as in ITU-R SM.329 [4], s4.1				
NOTE 2: Specification in accordance with ITU-R SM.329 [4], s4.3 and Annex 7				
NOTE 3: Bandwidth as in ITU-R SM.329 [4], s4.1. Upper frequency as in ITU-R SM.329 [4], s2.5 table 1				

Table 9.10B: General spurious emissions limits, operating band III, Category B

Up-link Band	Down-link Band	Maximum Level	Measurement Bandwidth	Note
9kHz ↔ 150kHz	9kHz ↔ 150kHz	-36 dBm	1 kHz	Note 1
150kHz ↔ 30MHz	150kHz ↔ 30MHz	-36 dBm	10 kHz	Note 1
30MHz ↔ 1GHz	30MHz ↔ 1GHz	-36 dBm	100 kHz	Note 1
1GHz ↔ Fc1 - 60 MHz or 1700 MHz whichever is the higher	1GHz ↔ Fc1 - 60 MHz or 1795 MHz whichever is the higher	-30 dBm	1 MHz	Note 1
Fc1 - 60 MHz or 1700 MHz whichever is the higher ↔ Fc1 - 50 MHz or 1700 MHz whichever is the higher	Fc1 - 60 MHz or 1795 MHz whichever is the higher ↔ Fc1 - 50 MHz or 1795 MHz whichever is the higher	-25 dBm	1 MHz	Note 2
Fc1 - 50 MHz or 1700 MHz whichever is the higher ↔ Fc2 + 50 MHz or 1795 MHz whichever is the lower	Fc1 - 50 MHz or 1795 MHz whichever is the higher ↔ Fc2 + 50 MHz or 1890 MHz whichever is the lower	-15 dBm	1 MHz	Note 2
Fc2 + 50 MHz or 1795 MHz whichever is the lower ↔ Fc2 + 60 MHz or 1795 MHz whichever is the lower	Fc2 + 50 MHz or 1890 MHz whichever is the lower ↔ Fc2 + 60 MHz or 1890 MHz whichever is the lower	-25 dBm	1 MHz	Note 2
Fc2 + 60 MHz or 1795 MHz whichever is the lower ↔ 12,75 GHz	Fc2 + 60 MHz or 1890 MHz whichever is the lower ↔ 12,75 GHz	-30 dBm	1 MHz	Note 3
NOTE 1: Bandwidth as in ITU-R SM.329 [4], s4.1				
NOTE 2: Specification in accordance with ITU-R SM.329 [4], s4.3 and Annex 7				
NOTE 3: Bandwidth as in ITU-R SM.329 [4], s4.1. Upper frequency as in ITU-R SM.329 [4], s2.5 table 1				

Table 9.10C: General spurious emissions limits, operating band IV, Category B

Up-link Band	Down-link Band	Maximum Level	Measurement Bandwidth	Note
9kHz ↔ 150kHz	9kHz ↔ 150kHz	-36 dBm	1 kHz	Note 1
150kHz ↔ 30MHz	150kHz ↔ 30MHz	-36 dBm	10 kHz	Note 1
30MHz ↔ 1GHz	30MHz ↔ 1GHz	-36 dBm	100 kHz	Note 1
1GHz ↔ 1700 MHz	1GHz ↔ 2100 MHz	-30 dBm	1 MHz	Note 1
1700 MHz ↔ Fc1 - 50 MHz or 1700 MHz whichever is the higher	2100 MHz ↔ Fc1 - 50 MHz or 2100 MHz whichever is the higher	-25 dBm	1 MHz	Note 2
Fc1 - 50 MHz or 1700 MHz whichever is the higher ↔ Fc2 + 50 MHz or 1765 MHz whichever is the lower	Fc1 - 50 MHz or 2100 MHz whichever is the higher ↔ Fc2 + 50 MHz or 2165 MHz whichever is the lower	-15 dBm	1 MHz	Note 2
Fc2 + 50 MHz or 1765 MHz whichever is the lower ↔ 1765 MHz	Fc2 + 50 MHz or 2165 MHz whichever is the lower ↔ 2165 MHz	-25 dBm	1 MHz	Note 2
1765 MHz ↔ 12,75 GHz	2165 MHz ↔ 12,75 GHz	-30 dBm	1 MHz	Note 3
NOTE 1: Bandwidth as in ITU-R SM.329 [4], s4.1				
NOTE 2: Specification in accordance with ITU-R SM.329 [4], s4.3 and Annex 7				
NOTE 3: Bandwidth as in ITU-R SM.329 [4], s4.1. Upper frequency as in ITU-R SM.329 [4], s2.5 table 1				

Table 9.10D: General spurious emissions limits, operating band V, Category B

Up-link Band	Down-link Band	Maximum Level	Measurement Bandwidth	Note
9kHz ↔ 150kHz	9kHz ↔ 150kHz	-36 dBm	1 kHz	Note 1
150kHz ↔ 30MHz	150kHz ↔ 30MHz	-36 dBm	10 kHz	Note 1
30MHz ↔ 814MHz	30MHz ↔ 859MHz	-36 dBm	100 kHz	Note 1
814MHz ↔ Fc1 - 20 MHz or 814 MHz whichever is the higher	859MHz ↔ Fc1 - 20 MHz or 859 MHz whichever is the higher	-26 dBm	100 kHz	Note 2
Fc1 - 20 MHz or 814 MHz whichever is the higher ↔ Fc2 + 20 MHz or 859 MHz whichever is the lower	Fc1 - 20 MHz or 859 MHz whichever is the higher ↔ Fc2 + 20 MHz or 904 MHz whichever is the lower	-16 dBm	100 kHz	Note 2
Fc2 + 20 MHz or 859 MHz whichever is the lower ↔ 859 MHz	Fc2 + 20 MHz or 904 MHz whichever is the lower ↔ 904 MHz	-26 dBm	100 kHz	Note 2
859 MHz ↔ 1GHz	904 MHz ↔ 1GHz	-36 dBm	100 kHz	Note 3
1 GHz ↔ 12,75 GHz	1 GHz ↔ 12,75 GHz	-30 dBm	1 MHz	Note 3
NOTE 1: Bandwidth as in ITU-R SM.329 [4], s4.1				
NOTE 2: Specification in accordance with ITU-R SM.329 [4], s4.3 and Annex 7				
NOTE 3: Bandwidth as in ITU-R SM.329 [4], s4.1. Upper frequency as in ITU-R SM.329 [4], s2.5 table 1				

Table 9.10E: General spurious emissions limits, operating band VII, Category B

Up-link Band	Down-link Band	Maximum Level	Measurement Bandwidth	Note
9kHz ↔ 150kHz	9kHz ↔ 150kHz	-36 dBm	1 kHz	Note 1
150kHz ↔ 30MHz	150kHz ↔ 30MHz	-36 dBm	10 kHz	Note 1
30MHz ↔ 1GHz	30MHz ↔ 1GHz	-36 dBm	100 kHz	Note 1
1GHz ↔ Fc1 - 60 MHz or 2490 MHz whichever is the higher	1GHz ↔ Fc1 - 60 MHz or 2610 MHz whichever is the higher	-30 dBm	1 MHz	Note 1
Fc1 - 60 MHz or 2490 MHz whichever is the higher ↔ Fc1 - 50 MHz or 2490 MHz whichever is the higher	Fc1 - 60 MHz or 2610 MHz whichever is the higher ↔ Fc1 - 50 MHz or 2610 MHz whichever is the higher	-25 dBm	1 MHz	Note 2
Fc1 - 50 MHz or 2490 MHz whichever is the higher ↔ Fc2 + 50 MHz or 2580 MHz whichever is the lower	Fc1 - 50 MHz or 2610 MHz whichever is the higher ↔ Fc2 + 50 MHz or 2700 MHz whichever is the lower	-15 dBm	1 MHz	Note 2
Fc2 + 50 MHz or 2580 MHz whichever is the lower ↔ Fc2 + 60 MHz or 2580 MHz whichever is the lower	Fc2 + 50 MHz or 2700 MHz whichever is the lower ↔ Fc2 + 60 MHz or 2700 MHz whichever is the lower	-25 dBm	1 MHz	Note 2
Fc2 + 60 MHz or 2580 MHz whichever is the lower ↔ 12,75 GHz	Fc2 + 60 MHz or 2700 MHz whichever is the lower ↔ 12,75 GHz	-30 dBm	1 MHz	Note 3
NOTE 1: Bandwidth as in ITU-R SM.329 [4], s4.1				
NOTE 2: Specification in accordance with ITU-R SM.329 [4], s4.3 and Annex 7				
NOTE 3: Bandwidth as in ITU-R SM.329 [4], s4.1. Upper frequency as in ITU-R SM.329 [4], s2.5 table 1				

Table 9.10F: General spurious emissions limits, operating band VIII, Category B

Up-link Band	Down-link Band	Maximum Level	Measurement Bandwidth	Note
9kHz ↔ 150kHz	9kHz ↔ 150kHz	-36 dBm	1 kHz	Note 1
150kHz ↔ 30MHz	150kHz ↔ 30MHz	-36 dBm	10 kHz	Note 1
30MHz ↔ 870MHz	30MHz ↔ 915MHz	-36 dBm	100 kHz	Note 1
870MHz ↔ Fc1 - 20 MHz or 870 MHz whichever is the higher	915MHz ↔ Fc1 - 20 MHz or 915 MHz whichever is the higher	-26 dBm	100 kHz	Note 2
Fc1 - 20 MHz or 870 MHz whichever is the higher ↔ Fc2 + 20 MHz or 925 MHz whichever is the lower	Fc1 - 20 MHz or 915 MHz whichever is the higher ↔ Fc2 + 20 MHz or 970 MHz whichever is the lower	-16 dBm	100 kHz	Note 2
Fc2 + 20 MHz or 925 MHz whichever is the lower ↔ 925 MHz	Fc2 + 20 MHz or 970 MHz whichever is the lower ↔ 970 MHz	-26 dBm	100 kHz	Note 2
925 MHz ↔ 1GHz	970 MHz ↔ 1GHz	-36 dBm	100 kHz	Note 3
1 GHz ↔ 12,75 GHz	1 GHz ↔ 12,75 GHz	-30 dBm	1 MHz	Note 3
NOTE 1: Bandwidth as in ITU-R SM.329 [4], s4.1				
NOTE 2: Specification in accordance with ITU-R SM.329 [4], s4.3 and Annex 7				
NOTE 3: Bandwidth as in ITU-R SM.329 [4], s4.1. Upper frequency as in ITU-R SM.329 [4], s2.5 table 1				

Fc1: Centre frequency of emission of the first 5 MHz channel in a pass band.

Fc2: Centre frequency of emission of the last 5 MHz channel in a pass band.

9.2.2.3 Protection of BS receiver in the operating band

This requirement shall be applied for the protection of UTRA-FDD BS receivers in geographic areas in which UTRA-FDD Repeater and UTRA-FDD BS are deployed.

9.2.2.3.1 Minimum Requirement

In the up-link direction of the Repeater the power of any spurious emission shall not exceed:

Table 9.11A: UTRA Repeater up-link spurious emissions limits for protection of UTRA FDD BS receiver for the up-link direction of the Repeater

Operating band	Band	Maximum Level	Measurement Bandwidth	Note
I	1920 - 1980 MHz	-53 dBm	100 kHz	
II	1850 - 1910 MHz	-53 dBm	100 kHz	
III	1710 - 1785 MHz	-53 dBm	100 kHz	
IV	1710 - 1755 MHz	-53 dBm	100 kHz	
V	824 - 849 MHz	-53 dBm	100 kHz	
VI	815 - 850 MHz	-53 dBm	100 kHz	
VII	2500 - 2570 MHz	-53 dBm	100 kHz	
VIII	880 - 915 MHz	-53 dBm	100 kHz	
IX	1749.9 - 1784.9 MHz	-53 dBm	100 kHz	

NOTE 1: These requirements in Table 9.11A for the up link direction of the Repeater reflect what can be achieved with present state of the art technology and are based on a coupling loss of 73 dB between a Repeater and a UTRA FDD BS receiver.

NOTE 2: The requirements shall be reconsidered when the state of the art technology progresses.

9.2.2.4 Co-existence with other systems in the same geographical area

These requirements may be applied for the protection of UE, MS and/or BS operating in other frequency bands in the same geographical area. The requirements may apply in geographic areas in which both UTRA FDD Repeater operating in frequency bands I to IX and a system operating in another frequency band than the FDD operating band are deployed. The system operating in the other frequency band may be GSM900, DCS1800, PCS1900, GSM850 and/or FDD operating in bands I to IX.

9.2.2.4.1 Minimum Requirements

The power of any spurious emission shall not exceed the limits of Table 9.13 for a UTRA FDD Repeater where requirements for co-existence with the system listed in the first column apply.

Table 9.13: UTRA Repeater up-link and down-link spurious emissions limits in geographic coverage area of systems operating in other frequency bands

System type operating in the same geographical area	Band for co-existence requirement	Maximum Level	Measurement Bandwidth	Note
GSM900	921 - 960 MHz	-57 dBm	100 kHz	This requirement does not apply to UTRA FDD Repeater operating in band VIII.
	876 - 915 MHz	-61 dBm	100 kHz	For the frequency range 880-915 MHz, this requirement does not apply to the up-link of the UTRA FDD Repeater operating in band VIII, since it is already covered by the band VIII requirement in sub-clause 9.2.2.3.
DCS1800	1805 - 1880 MHz	-47 dBm	100 kHz	This requirement does not apply to UTRA FDD Repeater operating in band III.
	1710 - 1785 MHz	-61 dBm	100 kHz	This requirement does not apply to the up-link of the UTRA FDD Repeater operating in band III, since it is already covered by the band III requirement in sub-clause 9.2.2.3.
PCS1900	1930 - 1990 MHz	-47 dBm	100 kHz	This requirement does not apply to UTRA FDD Repeater operating in frequency band II.
	1850 - 1910 MHz	-61 dBm	100 kHz	This requirement does not apply to the up-link of the UTRA FDD Repeater operating in frequency band II, since it is already covered by the band II requirement in sub-clause 9.2.2.3.
GSM850	869 - 894 MHz	-57 dBm	100 kHz	This requirement does not apply to UTRA FDD Repeater operating in frequency band V.
	824 - 849 MHz	-61 dBm	100 kHz	This requirement does not apply to the up-link of the UTRA FDD Repeater operating in frequency band V, since it is already covered by the band V requirement in sub-clause 9.2.2.3.
FDD Band I	2110 - 2170 MHz	-52 dBm	1 MHz	This requirement does not apply to UTRA FDD Repeater operating in band I.
	1920 - 1980 MHz	-49 dBm	1 MHz	This requirement does not apply to the up-link of the UTRA FDD Repeater operating in band I, since it is already covered by the band I requirement in sub-clause 9.2.2.3.
FDD Band II	1930 - 1990 MHz	-52 dBm	1 MHz	This requirement does not apply to UTRA FDD Repeater operating in band II.
	1850 - 1910 MHz	-49 dBm	1 MHz	This requirement does not apply to the up-link of the UTRA FDD Repeater operating in band II, since it is already covered by the band II requirement in sub-clause 9.2.2.3.
FDD Band III	1805 - 1880 MHz	-52 dBm	1 MHz	This requirement does not apply to UTRA FDD Repeater operating in band III.
	1710 - 1785 MHz	-49 dBm	1 MHz	This requirement does not apply to the up-link of the UTRA FDD Repeater operating in band III, since it is already covered by the band III requirement in sub-clause 9.2.2.3.
FDD Band IV	2110 - 2155 MHz	-52 dBm	1 MHz	This requirement does not apply to UTRA FDD Repeater operating in band IV.
	1710 - 1755 MHz	-49 dBm	1 MHz	This requirement does not apply to the up-link of the UTRA FDD Repeater operating in band IV, since it is already covered by the band IV requirement in sub-clause 9.2.2.3.
FDD Band V	869 - 894 MHz	-52 dBm	1 MHz	This requirement does not apply to UTRA FDD Repeater operating in band V.
	824 - 849 MHz	-49 dBm	1 MHz	This requirement does not apply to the up-link of the UTRA FDD Repeater operating in band V, since it is already covered by the band V requirement in sub-clause 9.2.2.3.

FDD Band VI	860 - 895 MHz	-52 dBm	1 MHz	This requirement does not apply to UTRA FDD Repeater operating in band VI.
	815 - 850 MHz	-49 dBm	1 MHz	This requirement does not apply to the up-link of the UTRA FDD Repeater operating in band VI, since it is already covered by the band VI requirement in sub-clause 9.2.2.3.
FDD Band VII	2620 - 2690 MHz	-52 dBm	1 MHz	This requirement does not apply to UTRA FDD Repeater operating in band VII.
	2500 - 2570 MHz	-49 dBm	1 MHz	This requirement does not apply to the up-link of the UTRA FDD Repeater operating in band VII, since it is already covered by the band VII requirement in sub-clause 9.2.2.3.
FDD Band VIII	925 - 960 MHz	-52 dBm	1 MHz	This requirement does not apply to the up-link of the UTRA FDD Repeater operating in band VIII.
	880 - 915 MHz	-49 dBm	1 MHz	This requirement does not apply to the up-link of the UTRA FDD Repeater operating in band VIII, since it is already covered by the band VIII requirement in sub-clause 9.2.2.3.
FDD Band IX	1844.9 - 1879.9 MHz	-52 dBm	1 MHz	This requirement does not apply to UTRA FDD Repeater operating in band IX.
	1749.9 - 1784.9 MHz	-49 dBm	1 MHz	This requirement does not apply to the up-link of the UTRA FDD Repeater operating in band IX, since it is already covered by the band IX requirement in sub-clause 9.2.2.3.

9.2.2.5 Co-existence with co-located and co-sited base stations

These requirements may be applied for the protection of other BS receivers when GSM900 and/or DCS1800, PCS1900, GSM850 and/or FDD BS operating in Bands I to IX are co-located with a UTRA FDD Repeater.

9.2.2.5.1 Minimum Requirements

The power of any spurious emission shall not exceed the limits of Table 9.14 for a UTRA FDD Repeater where requirements for co-location with the Base Station listed in the first column apply.

Table 9.14: UTRA Repeater up-link and down-link spurious emissions limits for Repeater co-located with Base Stations

Type of co-located Base Station	Band for co-location requirement	Maximum Level	Measurement Bandwidth	Note
GSM900	876 - 915 MHz	-98 dBm	100 kHz	This requirement does not apply to the up-link of UTRA FDD Repeater operating in band VIII. The requirement of band VIII in sub-clause 9.2.2.3 applies, but requires a 75dB coupling loss between base station and the repeater UL transmit port.
DCS1800	1710 - 1785 MHz	-98 dBm	100 kHz	This requirement does not apply to the up-link of UTRA FDD Repeater operating in band III. The requirement of band III in sub-clause 9.2.2.3 applies, but requires a 75dB coupling loss between base station and the repeater UL transmit port.
PCS1900	1850 - 1910 MHz	-98 dBm	100 kHz	This requirement does not apply to the up-link of UTRA FDD Repeater operating in band II. The requirement of band II in sub-clause 9.2.2.3 applies, but requires a 75dB coupling loss between base station and the repeater UL transmit port.
GSM850	824 - 849 MHz	-98 dBm	100 kHz	This requirement does not apply to the up-link of UTRA FDD Repeater operating in band V. The requirement of band V in sub-clause 9.2.2.3 applies, but requires a 75dB coupling loss between base station and the repeater UL transmit port.
UTRA FDD Band I	1920 - 1980 MHz	-96 dBm	100 kHz	This requirement does not apply to the up-link of UTRA FDD Repeater operating in band I. The requirement of band I in sub-clause 9.2.2.3 applies, but requires a 73dB coupling loss between base station and the repeater UL transmit port.
UTRA FDD Band II	1850 - 1910 MHz	-96 dBm	100 kHz	This requirement does not apply to the up-link of UTRA FDD Repeater operating in band II. The requirement of band II in sub-clause 9.2.2.3 applies, but requires a 73dB coupling loss between base station and the repeater UL transmit port.
UTRA FDD Band III	1710 - 1785 MHz	-96 dBm	100 kHz	This requirement does not apply to the up-link of UTRA FDD Repeater operating in band III. The requirement of band III in sub-clause 9.2.2.3 applies, but requires a 73dB coupling loss between base station and the repeater UL transmit port.
UTRA FDD Band IV	1710 - 1755 MHz	-96 dBm	100 kHz	This requirement does not apply to the up-link of UTRA FDD Repeater operating in band IV. The requirement of band IV in sub-clause 9.2.2.3 applies, but requires a 73dB coupling loss between base station and the repeater UL transmit port.
UTRA FDD Band V	824 - 849 MHz	-96 dBm	100 kHz	This requirement does not apply to the up-link of UTRA FDD Repeater operating in band V. The requirement of band V in sub-clause 9.2.2.3 applies, but requires a 73dB coupling loss between base station and the repeater UL transmit port.
UTRA FDD Band VI	815 - 850 MHz	-96 dBm	100 kHz	This requirement does not apply to the up-link of UTRA FDD Repeater operating in band VI. The requirement of band VI in sub-clause 9.2.2.3 applies, but requires a 73dB coupling loss between base station and the repeater UL transmit port.
UTRA FDD Band VII	2500 - 2570 MHz	-96 dBm	100 kHz	This requirement does not apply to the up-link of UTRA FDD Repeater operating in band VII. The requirement of band VII in sub-clause 9.2.2.3 applies, but requires a 73dB coupling loss between base station and the repeater UL transmit port.

UTRA FDD Band VIII	880 - 915 MHz	-96 dBm	100 kHz	This requirement does not apply to the up-link of UTRA FDD Repeater operating in band VIII. The requirement of band VIII in sub-clause 9.2.2.3 applies, but requires a 73dB coupling loss between base station and the repeater UL transmit port.
UTRA FDD Band IX	1749.9 - 1784.9 MHz	-96 dBm	100 kHz	This requirement does not apply to the up-link of UTRA FDD Repeater operating in band IX. The requirement of band IX in sub-clause 9.2.2.3 applies, but requires a 73dB coupling loss between base station and the repeater UL transmit port.

9.2.2.6 Co-existence with PHS

This requirement may be applied for the protection of PHS in geographic areas in which both PHS and UTRA-FDD Repeaters are deployed. This requirement is also applicable at specified frequencies falling between 12,5 MHz below the centre frequency of the first 5 MHz channel or more than 12,5 MHz above the centre frequency of the last 5 MHz channel in the pass band.

9.2.2.6.1 Minimum requirement

The power of any spurious emission shall not exceed:

Table 9.17: UTRA Repeater Spurious up-link and down-link emissions limits for in geographic coverage area of PHS

Band	Maximum Level	Measurement Bandwidth	Note
1884,5 - 1919,6 MHz	-41 dBm	300 kHz	

9.2.2.7 Co-existence with UTRA-TDD

9.2.2.7.1 Operation in the same geographic area

This requirement may be applied to geographic areas in which both UTRA-TDD and UTRA-FDD Repeaters are deployed.

9.2.2.7.1.1 Minimum requirement

In the down-link direction of the Repeater the power of any spurious emission shall not exceed:

Table 9.18: UTRA Repeater down-link spurious emissions limits in geographic coverage area of UTRA-TDD

Band	Maximum Level	Measurement Bandwidth	Note
1900 - 1920 MHz	-52 dBm	1 MHz	
2010 - 2025 MHz	-52 dBm	1 MHz	
2570 - 2610 MHz	-52 dBm	1 MHz	

In the up-link direction of the Repeater the power of any spurious emission shall not exceed:

Table 9.18A: UTRA Repeater up-link spurious emissions limits in geographic coverage area of UTRA-TDD

Band	Maximum Level	Measurement Bandwidth	Note
1900 - 1920 MHz	-53 dBm	100 kHz	This requirement is applied only to UTRA FDD Repeater operating in band I or II.
1900 - 1920 MHz	-52 dBm	1 MHz	This requirement does not apply to UTRA FDD Repeater operating in band I or II.
2010 - 2025 MHz	-52 dBm	1 MHz	
2570 - 2610 MHz	-53 dBm	100 kHz	This requirement is applied only to UTRA FDD Repeater operating in band VII.
2570 - 2610 MHz	-52 dBm	1 MHz	This requirement does not apply to UTRA FDD Repeater operating in band VII.

NOTE 1: The requirements of -53dBm/100kHz in Table 9.18A for the up link direction of the Repeater reflect what can be achieved with present state of the art technology and are based on a coupling loss of 73 dB between a Repeater and a UTRA TDD BS receiver.

NOTE 2: The requirements shall be reconsidered when the state of the art technology progresses.

9.2.2.7.2 Co-located Repeaters and UTRA-TDD base stations

This requirement may be applied for the protection of UTRA-TDD BS receivers when UTRA-TDD BS and UTRA-FDD Repeater are co-located.

9.2.2.7.2.1 Minimum requirement

In the down-link direction of the Repeater the power of any spurious emission shall not exceed:

Table 9.19: UTRA Repeater down-link spurious emissions limits for protection of co-located UTRA TDD BS receiver

Band	Maximum Level	Measurement Bandwidth	Note
1900 - 1920 MHz	- 86 dBm	1 MHz	
2010 - 2025 MHz	- 86 dBm	1 MHz	
2570 - 2610 MHz	- 86 dBm	1 MHz	

In the up-link direction of the Repeater the power of any spurious emission shall not exceed:

Table 9.19A: UTRA Repeater up-link spurious emissions limits for protection of co-located UTRA TDD BS receiver

Band	Maximum Level	Measurement Bandwidth	Note
1900 - 1920 MHz	-53 dBm	100 kHz	This requirement is applied only to UTRA FDD Repeater operating in band I or II.
1900 - 1920 MHz	-86 dBm	1 MHz	This requirement does not apply to UTRA FDD Repeater operating in band I or II.
2010 - 2025 MHz	-83 dBm	100 kHz	This requirement is applied only to UTRA FDD Repeater operating in band I.
2010 - 2025 MHz	-86 dBm	1 MHz	This requirement does not apply to UTRA FDD Repeater operating in band I.
2570 - 2610 MHz	-53 dBm	100 kHz	This requirement is applied only to UTRA FDD Repeater operating in band VII.
2570 - 2610 MHz	-86 dBm	1 MHz	This requirement does not apply to UTRA FDD Repeater operating in band VII.

NOTE 1: The requirements of -53dBm/100kHz in Table 9.19A for the up link direction of the Repeater reflect what can be achieved with present state of the art technology and are based on a coupling loss of 73 dB between a Repeater and a UTRA TDD BS receiver.

NOTE 2: The requirements of -83dBm/100kHz in Table 9.19A for the up link direction of the Repeater reflect what can be achieved with present state of the art technology and are based on a coupling loss of 43 dB between a Repeater and a UTRA TDD BS receiver.

NOTE 3: The requirements shall be reconsidered when the state of the art technology progresses.

9.2.2.8 Co-existence with services in adjacent frequency bands

This requirement may be applied for the protection in bands adjacent to bands I, II, III or VII, as defined in clause 4.1 in geographic areas in which both an adjacent band service and UTRA are deployed.

The requirement applies only to the down-link direction of the repeater.

9.2.2.8.1 Minimum requirement

The power of any spurious emission shall not exceed:

Table 9.20: UTRA Repeater down-link spurious emissions limits for protection of adjacent band services

Operating Band	Band	Maximum Level	Measurement Bandwidth	Note
I	2100-2105 MHz	$-30 + 3.4 (f - 2100 \text{ MHz}) \text{ dBm}$	1 MHz	
	2175-2180 MHz	$-30 + 3.4 (2180 \text{ MHz} - f) \text{ dBm}$	1 MHz	
II	1920-1925 MHz	$-30 + 3.4 (f - 1920 \text{ MHz}) \text{ dBm}$	1 MHz	
	1995-2000 MHz	$-30 + 3.4 (2000 \text{ MHz} - f) \text{ dBm}$	1 MHz	
III	1795-1800 MHz	$-30 + 3.4 (f - 1795 \text{ MHz}) \text{ dBm}$	1 MHz	
	1885-1890 MHz	$-30 + 3.4 (1890 \text{ MHz} - f) \text{ dBm}$	1 MHz	
VII	2610-2615 MHz	$-30 + 3.4 (f - 2610 \text{ MHz}) \text{ dBm}$	1 MHz	
	2695-2700 MHz	$-30 + 3.4 (2700 \text{ MHz} - f) \text{ dBm}$	1 MHz	

9.2.3 Test purpose

This test measure conducted spurious emission from the Repeater transmitter antenna connector, while the Repeater is in operation.

9.2.4 Method of test

9.2.4.1 Initial conditions

- 1) Set-up the equipment as shown in annex A.
- 2) Connect a signal generator to the input port of the Repeater for tests of repeaters with a pass band corresponding to one 5 MHz channel. If the pass band corresponds to two or more 5 MHz carriers, two signal generators with a combining circuit or one signal generator with the ability to generate several WCDMA carriers is connected to the input.
- 3) Detection mode: True RMS.

9.2.4.2 Procedures

- 1) Set the Repeater to maximum gain.
- 2) Set the signal generator(s) to generate signal(s) in accordance to test model 1, TS 25.141 subclause 6.2.1.1.1, at level(s) which produce the manufacturer specified maximum output power at maximum gain.
- 3) The detecting device shall be configured with a measurement bandwidth as stated in the tables.
- 4) Measure the emission at the specified frequencies with specified measurement bandwidth and note that the measured value does not exceed the specified value.
- 5) Increase the input power with 10 dB compare to the level obtained in step 2.
- 6) Measure the emission at the specified frequencies with specified measurement bandwidth and note that the measured value does not exceed the specified value.
- 7) If the pass band corresponds to two or more consecutive nominal 5 MHz channels, repeat step 1) to 6) with any combination of two WCDMA modulated signals of equal power in the repeaters pass band.
- 8) Measure the emission at the specified frequencies with specified measurement bandwidth and note that the measured value does not exceed the specified value.

9.2.5 Test requirements

In all measurements, the requirements according to subclause 9.2.2 shall be fulfilled.

10 Modulation accuracy

In this section the procedure for testing the modulation accuracy of Repeaters is defined. This test includes EVM and peak code domain error.

10.1 Error vector magnitude

In this section the procedure for testing the Error Vector Magnitude (EVM) of Repeaters is defined.

10.1.1 Definition and applicability

The Error Vector Magnitude is a measure of the difference between the theoretical waveform and a modified version of the measured waveform. The modification is done according to annex E of TS25.141. This difference is called the error vector. The EVM result is defined as the square root of the ratio of the mean error vector power to the modified mean reference signal power expressed as a %. The measurement interval is one power control group (timeslot).

10.1.2 Minimum Requirements

In normal conditions as specified in section 5.4.1 the Error Vector Magnitude shall not be worse than 12,5 % as defined in TS25.106.

10.1.3 Test purpose

To verify that the EVM is within the limit specified in 10.1.2 after the signal passed through the Repeater..

10.1.4 Method of test

10.1.4.1 Initial conditions

Set-up the equipment as shown in annex A.

The test is based upon the test for the base station. Test model 1 as described in TS25.141 is used for the definition of the signal to test on. A signal generator providing the required signals is connected to the input of the Repeater. The Repeater is set to operate at full gain. The signal level is adjusted to the equivalent level to obtain the nominal output power as declared by the manufacturer. A signal analyser connected to the output is used to measure the EVM value.

10.1.4.2 Procedure

The test has to be performed in the uplink and the downlink path of the Repeater. The EVM has to be measured according to Annex E of TS25.141

10.1.4.3 Stimulus EVM effect

The stimulus signal generator EVM will RSS with the tested repeater EVM. The target for the recorded value is adjusted accordingly in the test requirements.

10.1.5 Test requirements

In normal conditions as specified in section 5.4.1, the Error Vector Magnitude, as defined in TS25.106, shall not exceed 13,2%.

10.2 Peak code domain error

In this section the procedure for testing the Peak Code Domain Error of Repeaters is defined.

10.2.1 Definition and applicability

The Peak Code Domain Error is computed by projecting the error vector onto the code domain at a specific spreading factor. The Code Domain Error for every code in the domain is defined as the ratio of the mean power of the projection onto that code, to the mean power of the composite reference waveform. This ratio is expressed in dB. The Peak Code Domain Error is defined as the maximum value for the Code Domain Error for all codes. The measurement interval is one power control group (timeslot).

10.2.2 Minimum Requirements

In normal conditions as specified in section 5.4.1 the peak code domain error shall not exceed -35 dB at spreading factor 256 as defined in TS25.106.

10.2.3 Test purpose

To verify that the peak code domain error is within the limit specified in 10.2.2 after the signal passed through the Repeater.

10.2.4 Method of test

10.2.4.1 Initial conditions

Set-up the equipment as shown in annex A.

The test is based upon the test for the base station. Test model 3 as described in TS25.141 is used for the definition of the signal to test on. A signal generator providing the required signals is connected to the input of the Repeater. The spreading factor of the signal generator is set to 256. The Repeater is set to operate at full gain. The signal level is adjusted to the equivalent level to obtain the nominal output power as declared by the manufacturer. A signal analyser connected to the output is used to measure the peak code domain error value.

10.2.4.2 Procedure

The test has to be performed in the uplink and the downlink path of the Repeater. The peak code domain error as described in TS25.141 Annex E has to be measured.

10.2.5 Test requirements

In normal conditions as specified in section 5.4.1 the peak code domain error shall not exceed -33,9 dB at spreading factor 256 as defined in TS25.106.

11 Input intermodulation

The input intermodulation is a measure of the capability of the Repeater to inhibit the generation of interference in the pass band, in the presence of interfering signals on frequencies other than the pass band.

11.1 Definition and applicability

Third and higher order mixing of the two interfering RF signals can produce an interfering signal in the band of the desired channel. Intermodulation response rejection is a measure of the capability of the Repeater to maintain the wanted frequency free of internally created interference.

The test requirements in Tables 11.2 may be applied for the protection of FDD Repeater input when GSM900, DCS1800, PCS1900, GSM850 and/or FDD BS operating in Bands I to IX are co-located with a UTRA FDD Repeater.

The additional test requirements in Tables 11.2A may be applied for the protection of FDD Repeater input when a UTRA TDD BS is co-located with a UTRA FDD Repeater.

This test applies to Uplink and Downlink path of the Repeater.

11.2 Minimum Requirements

11.2.1 General requirement

In normal conditions as specified in section 5.4.1 the intermodulation performance should be met when the following signals are applied to the Repeater:

Table 11.1: General input intermodulation requirement

f_offset	Interfering Signal Levels	Type of signals	Measurement bandwidth
3,5 MHz	-40 dBm	2 CW carriers	1 MHz

For the parameters specified in table 11.1, the power in the pass band shall not increase by more than 10 dB at the output of the Repeater as measured in the centre of the pass band, compared to the level obtained without interfering signals applied.

11.2.2 Co-location with BS in other systems

In normal conditions as specified in section 5.4.1 the intermodulation performance should be met when the following signals are applied to the Repeater:

Table 11.2: Input intermodulation requirements for interfering signals in other systems

Co-located other systems	Frequency of interfering signals	Interfering Signal Levels	Type of signals	Measurement bandwidth	Note
GSM900	921 - 960 MHz	+16 dBm	2 CW carriers	1 MHz	This requirement does not apply to UTRA FDD Repeater operating in band VIII, since it is already covered by the requirement in sub-clause 11.2.1, but requires a 86dB coupling loss between base station and the repeater DL receive port.
DCS1800	1805 - 1880 MHz	+16 dBm	2 CW carriers	1 MHz	This requirement does not apply to UTRA FDD Repeater operating in band III, since it is already covered by the requirement in sub-clause 11.2.1, but requires a 86dB coupling loss between base station and the repeater DL receive port.
PCS1900	1930 - 1990 MHz	+16 dBm	2 CW carriers	1 MHz	This requirement does not apply to UTRA FDD Repeater operating in band II, since it is already covered by the requirement in sub-clause 11.2.1, but requires a 86dB coupling loss between base station and the repeater DL receive port.
GSM850	869 - 894 MHz	+16 dBm	2 CW carriers	1 MHz	This requirement does not apply to UTRA FDD Repeater operating in band V, since it is already covered by the requirement in sub-clause 11.2.1, but requires a 86dB coupling loss between base station and the repeater DL receive port.
UTRA-FDD Band I	2110 - 2170 MHz	+16 dBm	2 CW carriers	1 MHz	This requirement does not apply to UTRA FDD Repeater operating in band I, since it is already covered by the requirement in sub-clause 11.2.1, but requires a 86dB coupling loss between base station and the repeater DL receive port.
UTRA-FDD Band II	1930 - 1990 MHz	+16 dBm	2 CW carriers	1 MHz	This requirement does not apply to UTRA FDD Repeater operating in band II, since it is already covered by the requirement in sub-clause 11.2.1, but requires a 86dB coupling loss between base station and the repeater DL receive port.
UTRA-FDD Band III	1805 - 1880 MHz	+16 dBm	2 CW carriers	1 MHz	This requirement does not apply to UTRA FDD Repeater operating in band III, since it is already covered by the requirement in sub-clause 11.2.1, but requires a 86dB coupling loss between base station and the repeater DL receive port.
UTRA-FDD Band IV	2110 - 2155 MHz	+16 dBm	2 CW carriers	1 MHz	This requirement does not apply to UTRA FDD Repeater operating in band IV, since it is already covered by the requirement in sub-clause 11.2.1, but requires a 86dB coupling loss between base station and the repeater DL receive port.
UTRA-FDD Band V	869 - 894 MHz	+16 dBm	2 CW carriers	1 MHz	This requirement does not apply to UTRA FDD Repeater operating in band V, since it is already covered by the requirement in sub-clause 11.2.1, but requires a 86dB coupling loss between base station and the repeater DL receive port.
UTRA-FDD Band VI	875 - 885 MHz	+16 dBm	2 CW carriers	1 MHz	This requirement does not apply to UTRA FDD Repeater operating in band VI, since it is already covered by the requirement in sub-clause 11.2.1, but requires a 86dB coupling loss between base station and the repeater DL receive port.
UTRA-FDD Band VII	2620 - 2690 MHz	+16 dBm	2 CW carriers	1 MHz	This requirement does not apply to UTRA FDD Repeater operating in band VII, since it is already covered by the requirement in sub-clause 11.2.1, but requires a 86dB coupling loss between base station and the repeater DL receive port.
UTRA-FDD Band VIII	925 - 960 MHz	+16 dBm	2 CW carriers	1 MHz	This requirement does not apply to UTRA FDD Repeater operating in band VIII, since it is already covered by the requirement in sub-clause 11.2.1, but requires a 86dB coupling loss between base station and the repeater DL receive port.

UTRA-FDD Band IX	1844.9 - 1879.9 MHz	+16 dBm	2 CW carriers	1 MHz	This requirement does not apply to UTRA FDD Repeater operating in band IX, since it is already covered by the requirement in sub-clause 11.2.1, but requires a 86dB coupling loss between base station and the repeater DL receive port.
---------------------	------------------------	---------	------------------	-------	--

Table 11.2AA: Input intermodulation requirements for interfering signals in UTRA TDD systems

Co-located other systems	Frequency of interfering signals	Interfering Signal Levels	Type of signals	Measurement bandwidth
UTRA-TDD	2585 - 2620 MHz	+16 dBm	2 CW carriers	1 MHz

For the parameters specified in table 11.2 and 11.2AA, the power in the pass band shall not increase with more than 10 dB at the output of the repeater as measured in the centre of the pass band, compared to the level obtained without interfering signals applied.

11.2.3 Co-existence with other systems

In normal conditions as specified in section 5.4.1 the intermodulation performance should be met when the following signals are applied to the Repeater:

Table 11.2A: Input intermodulation requirements for interfering signals in other systems

Co-existence with other systems	Frequency of interfering signals	Interfering Signal Levels	Type of signals	Measurement bandwidth	Note
GSM900	876 - 915 MHz	-15 dBm	2 CW carriers	1 MHz	This requirement does not apply to UTRA FDD Repeater operating in band VIII, since it is already covered by the requirement in sub-clause 11.2.1
DCS1800	1710 - 1785 MHz	-15 dBm	2 CW carriers	1 MHz	This requirement does not apply to UTRA FDD Repeater operating in band III, since it is already covered by the requirement in sub-clause 11.2.1
PCS1900	1850 - 1910 MHz	-15 dBm	2 CW carriers	1 MHz	This requirement does not apply to UTRA FDD Repeater operating in band II, since it is already covered by the requirement in sub-clause 11.2.1
GSM850	824 - 849 MHz	-15 dBm	2 CW carriers	1 MHz	This requirement does not apply to UTRA FDD Repeater operating in band V, since it is already covered by the requirement in sub-clause 11.2.1
UTRA-FDD Band I	1920 - 1980 MHz	-15 dBm	2 CW carriers	1 MHz	This requirement does not apply to UTRA FDD Repeater operating in band I, since it is already covered by the requirement in sub-clause 11.2.1
UTRA-FDD Band II	1850 - 1910 MHz	-15 dBm	2 CW carriers	1 MHz	This requirement does not apply to UTRA FDD Repeater operating in band II, since it is already covered by the requirement in sub-clause 11.2.1
UTRA-FDD Band III	1710 - 1785 MHz	-15 dBm	2 CW carriers	1 MHz	This requirement does not apply to UTRA FDD Repeater operating in band III, since it is already covered by the requirement in sub-clause 11.2.1
UTRA-FDD Band IV	1710 - 1755 MHz	-15 dBm	2 CW carriers	1 MHz	This requirement does not apply to UTRA FDD Repeater operating in band IV, since it is already covered by the requirement in sub-clause 11.2.1
UTRA-FDD Band V	824 - 849 MHz	-15 dBm	2 CW carriers	1 MHz	This requirement does not apply to UTRA FDD Repeater operating in band V, since it is already covered by the requirement in sub-clause 11.2.1
UTRA-FDD Band VI	830 - 840 MHz	-15 dBm	2 CW carriers	1 MHz	This requirement does not apply to UTRA FDD Repeater operating in band VI, since it is already covered by the requirement in sub-clause 11.2.1
UTRA-FDD Band VII	2500 - 2570 MHz	-15 dBm	2 CW carriers	1 MHz	This requirement does not apply to UTRA FDD Repeater operating in band VII, since it is already covered by the requirement in sub-clause 11.2.1
UTRA-FDD Band VIII	880 - 915 MHz	-15 dBm	2 CW carriers	1 MHz	This requirement does not apply to UTRA FDD Repeater operating in band VIII, since it is already covered by the requirement in sub-clause 11.2.1
UTRA-FDD Band IX	1749,9 - 1784,9 MHz	-15 dBm	2 CW carriers	1 MHz	This requirement does not apply to UTRA FDD Repeater operating in band IX, since it is already covered by the requirement in sub-clause 11.2.1

For the parameters specified in table 11.2A, the power in the pass band shall not increase with more than 10 dB at the output of the repeater as measured in the centre of the pass band, compared to the level obtained without interfering signals applied.

11.3 Test purpose

The purpose of this test is to verify that the Repeater meets the intermodulation characteristics requirements as specified in TS 25.106, subclause 11.1.

11.4 Method of test

11.4.1 Initial conditions

- 1) Set-up the equipment as shown in annex A.
- 2) Set the Repeater to maximum gain.
- 3) Connect two signal generators with a combining circuit or one signal generator with the ability to generate several CW carriers to the input.
- 4) Connect a spectrum analyser to the output of the Repeater. Set the resolution bandwidth to 1 MHz in the centre of the pass band. Set averaging to 1 second or more.

11.4.2 Procedure

- 1) Adjust the frequency of the input signals, either below or above the pass band, so that the lowest order intermodulation product is positioned in the centre of the pass band, according to subclause 11.2.
- 2) Take the measurement of the rise of the output signal.
- 3) Repeat the measurement for the opposite path of the Repeater.

11.5 Test requirements

11.5.1 Mandatory requirement

In normal conditions as specified in section 5.4.1 the intermodulation performance should be met when the following signals are applied to the Repeater:

Table 11.3: Input intermodulation requirement

f_offset	Interfering Signal Levels	Type of signals	Measurement bandwidth
3,5 MHz	-40 dBm	2 CW carriers	1 MHz

For the parameters specified in table 11.3, the power in the pass band shall not increase by more than 11,2 dB at the output of the Repeater as measured in the centre of the pass band, compared to the level obtained without interfering signals applied.

11.5.2 Co-location with BS in other systems

In normal conditions as specified in section 5.4.1 the intermodulation performance should be met when the following signals are applied to the Repeater:

Table 11.4: Input intermodulation requirements for interfering signals in other systems

Co-located other systems	Frequency of interfering signals	Interfering Signal Levels	Type of signals	Measurement bandwidth	Note
GSM900	921 - 960 MHz	+16 dBm	2 CW carriers	1 MHz	This requirement does not apply to UTRA FDD Repeater operating in band VIII, since it is already covered by the requirement in sub-clause 11.2.1, but requires a 86dB coupling loss between base station and the repeater DL receive port.
DCS1800	1805 - 1880 MHz	+16 dBm	2 CW carriers	1 MHz	This requirement does not apply to UTRA FDD Repeater operating in band III, since it is already covered by the requirement in sub-clause 11.2.1, but requires a 86dB coupling loss between base station and the repeater DL receive port.
PCS1900	1930 - 1990 MHz	+16 dBm	2 CW carriers	1 MHz	This requirement does not apply to UTRA FDD Repeater operating in band II, since it is already covered by the requirement in sub-clause 11.2.1, but requires a 86dB coupling loss between base station and the repeater DL receive port.
GSM850	869 - 894 MHz	+16 dBm	2 CW carriers	1 MHz	This requirement does not apply to UTRA FDD Repeater operating in band V, since it is already covered by the requirement in sub-clause 11.2.1, but requires a 86dB coupling loss between base station and the repeater DL receive port.
UTRA-FDD Band I	2110 - 2170 MHz	+16 dBm	2 CW carriers	1 MHz	This requirement does not apply to UTRA FDD Repeater operating in band I, since it is already covered by the requirement in sub-clause 11.2.1, but requires a 86dB coupling loss between base station and the repeater DL receive port.
UTRA-FDD Band II	1930 - 1990 MHz	+16 dBm	2 CW carriers	1 MHz	This requirement does not apply to UTRA FDD Repeater operating in band II, since it is already covered by the requirement in sub-clause 11.2.1, but requires a 86dB coupling loss between base station and the repeater DL receive port.
UTRA-FDD Band III	1805 - 1880 MHz	+16 dBm	2 CW carriers	1 MHz	This requirement does not apply to UTRA FDD Repeater operating in band III, since it is already covered by the requirement in sub-clause 11.2.1, but requires a 86dB coupling loss between base station and the repeater DL receive port.
UTRA-FDD Band IV	2110 - 2155 MHz	+16 dBm	2 CW carriers	1 MHz	This requirement does not apply to UTRA FDD Repeater operating in band IV, since it is already covered by the requirement in sub-clause 11.2.1, but requires a 86dB coupling loss between base station and the repeater DL receive port.
UTRA-FDD Band V	869 - 894 MHz	+16 dBm	2 CW carriers	1 MHz	This requirement does not apply to UTRA FDD Repeater operating in band V, since it is already covered by the requirement in sub-clause 11.2.1, but requires a 86dB coupling loss between base station and the repeater DL receive port.
UTRA-FDD Band VI	875 - 885 MHz	+16 dBm	2 CW carriers	1 MHz	This requirement does not apply to UTRA FDD Repeater operating in band VI, since it is already covered by the requirement in sub-clause 11.2.1, but requires a 86dB coupling loss between base station and the repeater DL receive port.

UTRA-FDD Band VII	2620 - 2690 MHz	+16 dBm	2 CW carriers	1 MHz	This requirement does not apply to UTRA FDD Repeater operating in band VII, since it is already covered by the requirement in sub-clause 11.2.1, but requires a 86dB coupling loss between base station and the repeater DL receive port.
UTRA-FDD Band VIII	925 - 960 MHz	+16 dBm	2 CW carriers	1 MHz	This requirement does not apply to UTRA FDD Repeater operating in band VIII, since it is already covered by the requirement in sub-clause 11.2.1, but requires a 86dB coupling loss between base station and the repeater DL receive port.
UTRA-FDD Band IX	1844.9 - 1879.9 MHz	+16 dBm	2 CW carriers	1 MHz	This requirement does not apply to UTRA FDD Repeater operating in band IX, since it is already covered by the requirement in sub-clause 11.2.1, but requires a 86dB coupling loss between base station and the repeater DL receive port.

Table 11.4AA: Input intermodulation requirements for interfering signals in UTRA TDD bands

Co-located other systems	Frequency of interfering signals	Interfering Signal Levels	Type of signals	Measurement bandwidth
UTRA-TDD	2585 - 2620 MHz	+16 dBm	2 CW carriers	1 MHz

For the parameters specified in table 11.4 and 11.4AA, the power in the pass band shall not increase with more than 11,2 dB at the output of the repeater as measured in the centre of the pass band, compared to the level obtained without interfering signals applied.

11.5.3 Co-existence with other systems

In normal conditions as specified in section 5.4.1 the intermodulation performance should be met when the following signals are applied to the Repeater:

Table 11.4A: Input intermodulation requirements for interfering signals in other systems

Co-existence with other systems	Frequency of interfering signals	Interfering Signal Levels	Type of signals	Measurement bandwidth	Note
GSM900	876 - 915 MHz	-15 dBm	2 CW carriers	1 MHz	This requirement does not apply to UTRA FDD Repeater operating in band VIII, since it is already covered by the requirement in sub-clause 11.2.1
DCS1800	1710 - 1785 MHz	-15 dBm	2 CW carriers	1 MHz	This requirement does not apply to UTRA FDD Repeater operating in band III, since it is already covered by the requirement in sub-clause 11.2.1
PCS1900	1850 - 1910 MHz	-15 dBm	2 CW carriers	1 MHz	This requirement does not apply to UTRA FDD Repeater operating in band II, since it is already covered by the requirement in sub-clause 11.2.1
GSM850	824 - 849 MHz	-15 dBm	2 CW carriers	1 MHz	This requirement does not apply to UTRA FDD Repeater operating in band V, since it is already covered by the requirement in sub-clause 11.2.1
UTRA-FDD Band I	1920 - 1980 MHz	-15 dBm	2 CW carriers	1 MHz	This requirement does not apply to UTRA FDD Repeater operating in band I, since it is already covered by the requirement in sub-clause 11.2.1
UTRA-FDD Band II	1850 - 1910 MHz	-15 dBm	2 CW carriers	1 MHz	This requirement does not apply to UTRA FDD Repeater operating in band II, since it is already covered by the requirement in sub-clause 11.2.1
UTRA-FDD Band III	1710 - 1785 MHz	-15 dBm	2 CW carriers	1 MHz	This requirement does not apply to UTRA FDD Repeater operating in band III, since it is already covered by the requirement in sub-clause 11.2.1
UTRA-FDD Band IV	1710 - 1755 MHz	-15 dBm	2 CW carriers	1 MHz	This requirement does not apply to UTRA FDD Repeater operating in band IV, since it is already covered by the requirement in sub-clause 11.2.1
UTRA-FDD Band V	824 - 849 MHz	-15 dBm	2 CW carriers	1 MHz	This requirement does not apply to UTRA FDD Repeater operating in band V, since it is already covered by the requirement in sub-clause 11.2.1
UTRA-FDD Band VI	830 - 840 MHz	-15 dBm	2 CW carriers	1 MHz	This requirement does not apply to UTRA FDD Repeater operating in band VI, since it is already covered by the requirement in sub-clause 11.2.1
UTRA-FDD Band VII	2500 - 2570 MHz	-15 dBm	2 CW carriers	1 MHz	This requirement does not apply to UTRA FDD Repeater operating in band VII, since it is already covered by the requirement in sub-clause 11.2.1
UTRA-FDD Band VIII	880 - 915 MHz	-15 dBm	2 CW carriers	1 MHz	This requirement does not apply to UTRA FDD Repeater operating in band VIII, since it is already covered by the requirement in sub-clause 11.2.1
UTRA-FDD Band IX	1749,9 - 1784,9 MHz	-15 dBm	2 CW carriers	1 MHz	This requirement does not apply to UTRA FDD Repeater operating in band IX, since it is already covered by the requirement in sub-clause 11.2.1

For the parameters specified in table 11.4A, the power in the pass band shall not increase with more than 11,2 dB at the output of the repeater as measured in the centre of the pass band, compared to the level obtained without interfering signals applied.

12 Output intermodulation

The output intermodulation requirement is a measure of the ability of the repeater to inhibit the generation of intermodulation products signals created by the presence of an interfering signal reaching the repeater via the output port.

12.1 Definition and applicability

The output intermodulation level is the power of the intermodulation products when a WCDMA modulated interference signal is injected into the output port at a level of 30 dB lower than that of the wanted signal. The frequency of the

interference signal shall be ± 5 MHz, ± 10 MHz and ± 15 MHz offset from the wanted signal, but within the frequency band allocated for UTRA FDD downlink as specified in subclause 4.1.

The requirement is applicable for downlink signals.

The normative reference for this requirement is in TS25.106 [12] section 12.

12.2 Minimum requirement

In normal conditions as specified in section 5.4.1, the output intermodulation level shall not exceed the out of band emission or the spurious emission requirements of section 9.1 and 9.2.

12.3 Test purpose

The test purpose is to verify the ability of the repeater to restrict the generation of intermodulation products in the presence of a subject signal on the repeater input and output ports, and an interfering signal applied at the repeater output port.

12.4 Method of test

12.4.1 Initial conditions

- 1) Set-up the equipment as shown in annex A.
- 2) Connect a signal generator to the input port of the Repeater for tests of repeaters with a pass band corresponding to one 5 MHz channel. Connect a signal generator to the circulator on the output port and make sure the signal generator power is directed to the repeater output port.
- 3) Measurements with an offset from the carrier centre frequency between 2,515 MHz and 4,0 MHz shall use a 30 kHz measurement bandwidth.
- 4) Measurements with an offset from the carrier centre frequency between 4,0 MHz and ($\Delta f_{\max} - 500$ kHz) shall use a 1 MHz measurement bandwidth. The 1MHz measurement bandwidth may be calculated by integrating multiple 50 kHz or narrower filter measurements
- 5) Detection mode: True RMS.

12.4.2 Procedures

- 1) Set the Repeater to maximum gain.
- 2) Set the signal generator at the repeater input port (subject signal) to generate a signal in accordance to test model 1, TS 25.141 subclause 6.1.1.1, at the level which produce the manufacturer specified maximum output power at maximum gain.
- 3) Set the signal generator at the repeater output port (interference signal) to generate a signal in accordance to test model 1, TS 25.141 subclause 6.1.1.1, at the level producing signal power corresponding to 30 dB below the manufacturer specified maximum output power at the repeater output port with the specified frequency offset from the wanted signal.
- 4) Measure the emission at the specified frequencies with specified measurement bandwidth and note that the measured value does not exceed the specified value. Measurements in the band of the interfering signal shall be excluded. The measurements can be limited to the power of all third and fifth order intermodulation products.
- 5) Repeat from clause 3 until interference signals ± 5 MHz, ± 10 MHz and ± 15 MHz frequency offset from the wanted signal has been tested. Note that interfering signals outside the UTRA-FDD allocated frequency band , as specifies in section 4.1. need not be tested.

12.5 Test requirements

In all measurements, the requirements according to sections 9.1.1.5 and the downlink requirements in section 9.2.2.1 or 9.2.2.2 shall be fulfilled.

13 Adjacent Channel Rejection Ratio (ACRR)

13.1 Definitions and applicability

Adjacent Channel Rejection Ratio (ACRR) is the ratio of the RRC weighted gain per carrier of the repeater in the pass band to the RRC weighted gain of the repeater on an adjacent channel.

The requirement shall apply to the Uplink and Downlink of Repeater where the donor link is maintained via antennas (over the air Repeater).

13.2 Minimum Requirements

In normal conditions the ACRR shall be higher than the value specified in the Table 13.1.

Table 13.1: Repeater ACRR

Repeater maximum output power as in 9.1.1	Channel offset from the centre frequency of the first or last 5 MHz channel within the pass band.	ACRR limit
$P \geq 31$ dBm	5 MHz	33dB
$P \geq 31$ dBm	10 MHz	33dB
$P < 31$ dBm	5 MHz	20dB
$P < 31$ dBm	10 MHz	20dB

13.3 Test purpose

To verify that the Repeater ACRR requirement shall be met as specified in subclause 13.1.

13.4 Method of test

13.4.1 Initial conditions

- 1) Set-up the equipment as shown in annex A.
- 2) Connect the signal generator equipment to the Repeater input port.
- 3) Connect the power measuring equipment to the Repeater output port.
- 4) The measurement device characteristics shall be:
 - measurement filter bandwidth: defined in subclause 13.1;
 - detection mode: true RMS voltage or true average power.

13.4.2 Procedure

- 1) Set the signal generator to transmit a signal modulated with a combination of PCCPCH, SCCPCH and Dedicated Physical Channels specified as test model 1 in TS 25.141 at the first or last 5 MHz channel within the pass band.
- 2) Adjust the input power to the Repeater to create the maximum nominal Repeater output power at maximum gain
- 3) Measure the RRC filtered mean power at the RF output port over a certain slot.
- 4) Set the signal generator to transmit the same signal and the same input power at one of the channel offsets according to Table 13.1.
- 5) Measure the RRC filtered mean power at the RF output port over a certain slot.
- 6) Calculate the ratio of the measured power in the pass band to the measured power at the channel offset.
- 7) Repeat step 4) to 6) until all channel offsets in Table 13.1 are measured.

13.4.3 Test Requirements

In normal conditions as specified in section 5.4.1, the ACRR shall be higher than the value specified in the Table 13.2.

Table 13.2: Repeater ACRR

Repeater maximum output power as in 9.1.1.1	Channel offset from the centre frequency of the first or last 5 MHz channel within the pass band.	ACRR limit
$P \geq 31$ dBm	5 MHz	32,3dB
$P \geq 31$ dBm	10 MHz	32,3dB
$P < 31$ dBm	5 MHz	19,3dB
$P < 31$ dBm	10 MHz	19,3dB

Annex A (informative): Repeater measurement system set-up

Example of measurement system set-ups are attached below as an informative annex.

A.1 Maximum output power

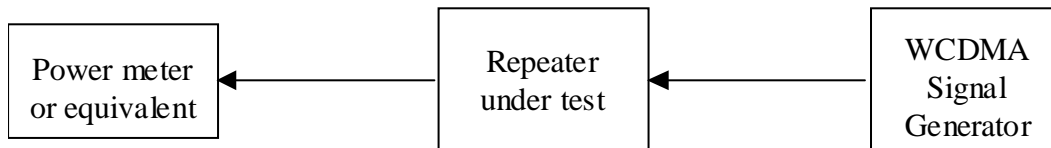

Figure A.1: Measuring system set-up for maximum output power.

Note that a repeater is a bi-directional device. The signal generator may need protection.

A.2 Frequency stability

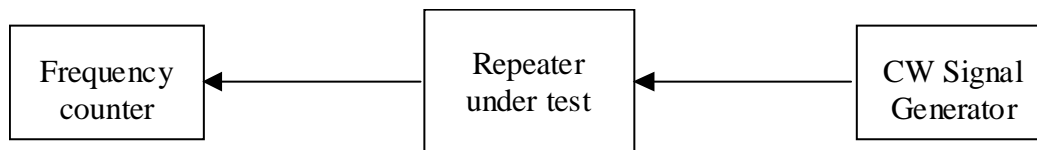

Figure A.2: Measurement system set-up for RF frequency stability.

Note that a repeater is a bi-directional device. The signal generator may need protection.

A.3 Out of band gain

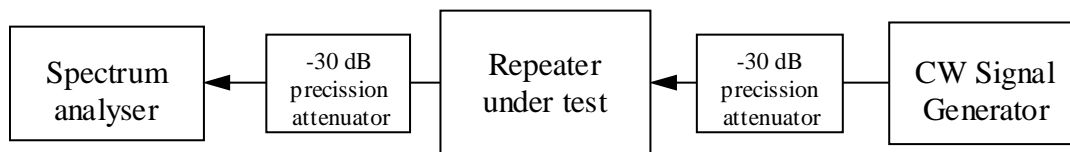

Figure A.3: Measuring system set-up for out of band gain.

Note that a repeater is a bi-directional device. The signal generator may need protection.

A.4 Unwanted emission: Spectrum emission mask

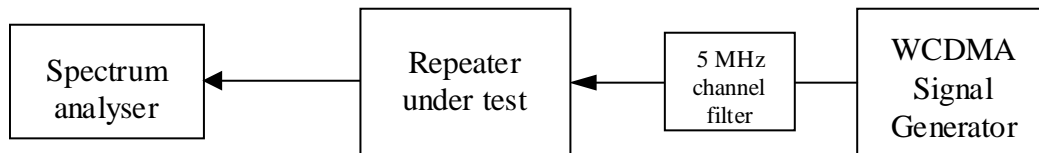

Figure A.4: Measuring system Set-up for unwanted emission: spectrum emission mask.

Note that a repeater is a bi-directional device. The signal generator may need protection.

A.5 Unwanted emission: Spurious emission

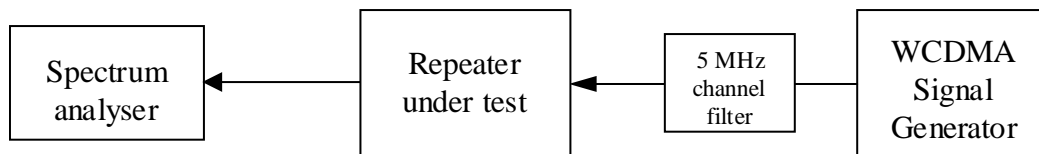

Figure A.5: Measuring system set-up for unwanted emission: spurious emission.

Note that a repeater is a bi-directional device. The signal generator may need protection.

A.6 Modulation Accuracy: Error Vector Magnitude

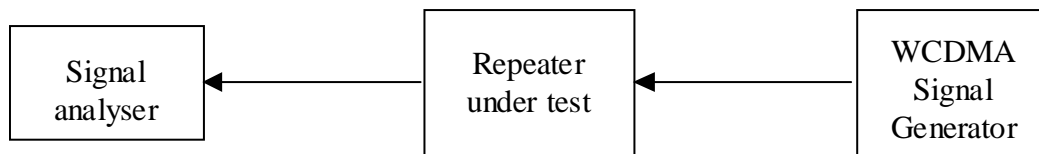

Figure A.6: Measuring system set-up for modulation accuracy: error vector magnitude.

Note that a repeater is a bi-directional device. The signal generator may need protection.

A.7 Modulation Accuracy: Peak Code Domain Error

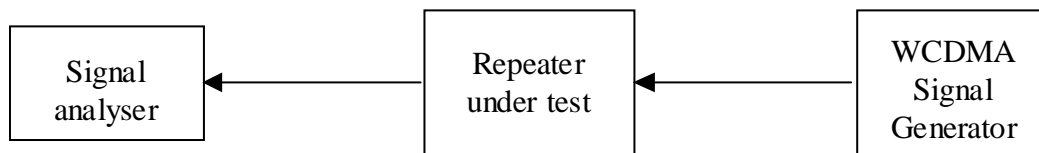

Figure A.7: Measuring system set-up for modulation accuracy: peak code domain error.

Note that a repeater is a bi-directional device. The signal generator may need protection.

A.8 Input inter modulation

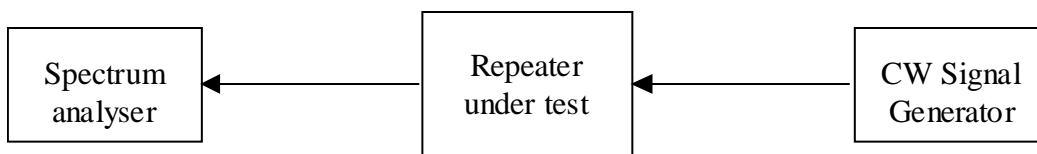

Figure A.8: Measuring system set-up for input intermodulation.

A.9 Output Intermodulation

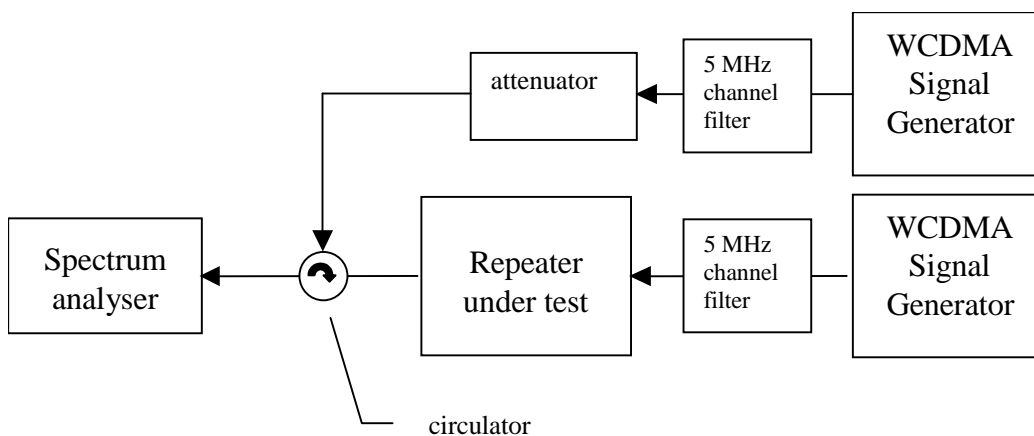

Figure A.9: Measuring system set-up for Output Intermodulation.

Note that a repeater is a bi-directional device. The signal generator may need protection.

The 5 MHz channel filter is only required if the WCDMA signal generator does not fulfil the unwanted emission requirement for base stations (TS25.141 [11], section 6.5) with at least 10 dB margin in the described set-up.

Annex B (informative): Derivation of Test Requirements

The Test Requirements in this specification have been calculated by relaxing the Minimum Requirements of the core specification using the Test Tolerances defined in subclause 5.2. When the Test Tolerance is zero, the Test Requirement will be the same as the Minimum Requirement. When the Test Tolerance is non-zero, the Test Requirements will differ from the Minimum Requirements, and the formula used for this relaxation is given in table B.1.

Table B.1: Derivation of Test Requirements

Clause number	Title	Minimum Requirement in TS 25.106	Test Tolerance (TT)	Test Requirement in TS 25.143
6.1	Maximum output power	In normal conditions Table 6.1	0,7 dB	Formula: Upper limit + TT Lower limit - TT In normal conditions refer to Table 6.3
		In extreme conditions Table 6.2		In extreme conditions refer to Table 6.4
9.1	Spectrum emission mask	Tables 9.1, 9.2, 9.3 and 9.4: "Maximum level" = X dB	1,5 dB	Formula: Maximum level + TT Refer to tables 9.5, 9.6, 9.7 and 9.8
7	Frequency stability	7.1 minimum requirement	12 Hz	Formula: Relative error + TT Refer to 7.5 Test requirements
8	Out of Band Gain	Table 8.1: Out of band gain limits	0,5 dB	Formula: Maximum level + TT Refer to table 8.2
9.2	Spurious emissions	Tables 9.5, to 9.15	0 dB	
10.1	Error Vector Magnitude	10.1.1 Minimum requirement	0 %	Formula: RSS Stimulus EVM and Repeater EVM to get target EVM Refer to 10.1.5 Test requirements
10.2	Peak code domain error	10.2.1 Minimum requirement	1,1 dB	Formula: Maximum error + TT Refer to 10.2.5 Test requirements
11	Input intermodulation	11.5 Minimum requirements, and Tables 11.1 and 11.2	1,2 dB	Maximum in-band power increase + TT Refer to 11.5 Test requirements.
12	Output intermodulation	12.1 Minimum requirements	1,5 dB for spectrum emission mask. 0 dB for spurious emissions	Maximum level + TT Refer to tables 9.5 to 9.19

Annex C (informative): Acceptable uncertainty of Test Equipment

This informative annex specifies the critical parameters of the components of an overall Test System (e.g. signal generators, signal analysers etc.) which are necessary when assembling a Test System which complies with subclause 5.1 Acceptable uncertainty of Test System. These Test Equipment parameters are fundamental to the accuracy of the overall Test System and are unlikely to be improved upon through System Calibration.

Table C.1: Equipment accuracy

Test	Equipment accuracy	Test condition
6.1 Maximum output power	Not critical	
9.1 Spectrum emission mask	Not critical	
9.2 Spurious emissions	Not critical	
11 Input intermodulation (interferer requirement)	Not critical	
7 Frequency error	± 10 Hz + timebase = 12 Hz	Range 0 to 500 Hz. (This is to allow for UE range that at 0,1 PPM is larger than BTS).
10.1 Error vector magnitude	$\pm 2,5$ % (for single code)	P_Max-3 to P_Max - 18 dB Applies for reading from 10% to 25%.
10.2 Peak code domain error		
8 Out of band gain		
11 Input intermodulation Characteristics		
12 Output intermodulation		

Annex D (informative): Change History

Table D.1: Change History

TSG	Doc	CR	R	Title	Cat	Curr	New	Work Item
RP-31				Rel-7 version created from v6.4.0			7.0.0	
RP-31	RP-060100	0053	2	Introduction of operating band III to IX requirements in 25.143	B	6.3.0	7.0.0	TEI7
RP-31	RP-060110	0054		Correction of spurious emissions for coexistence with GSM900 in same geographic area	F	6.3.0	7.0.0	RInImp-UMTS900
RP-33	RP-060520	0057	1	Clean up of Spurious emissions	A	7.0.0	7.1.0	TEI5
RP-33	RP-060521	0060	1	New UTRA Repeater up-link spurious emissions limits for co-existence/co-location with TDD	A	7.0.0	7.1.0	TEI5
RP-34	RP-060811	0063	1	Corrections to input intermodulation	A	7.1.0	7.2.0	TEI5

History

Document history		
V7.0.0	March 2006	Publication
V7.1.0	October 2006	Publication
V7.2.0	December 2006	Publication