

# ETSI TS 125 153 V14.0.0 (2017-04)



**Universal Mobile Telecommunications System (UMTS);  
UTRA repeater conformance testing (LCR TDD)  
(3GPP TS 25.153 version 14.0.0 Release 14)**



---

Reference

RTS/TSGR-0425153ve00

---

Keywords

UMTS

**ETSI**

650 Route des Lucioles  
F-06921 Sophia Antipolis Cedex - FRANCE

Tel.: +33 4 92 94 42 00 Fax: +33 4 93 65 47 16

Siret N° 348 623 562 00017 - NAF 742 C  
Association à but non lucratif enregistrée à la  
Sous-Préfecture de Grasse (06) N° 7803/88

---

**Important notice**

The present document can be downloaded from:

<http://www.etsi.org/standards-search>

The present document may be made available in electronic versions and/or in print. The content of any electronic and/or print versions of the present document shall not be modified without the prior written authorization of ETSI. In case of any existing or perceived difference in contents between such versions and/or in print, the only prevailing document is the print of the Portable Document Format (PDF) version kept on a specific network drive within ETSI Secretariat.

Users of the present document should be aware that the document may be subject to revision or change of status.

Information on the current status of this and other ETSI documents is available at

<https://portal.etsi.org/TB/ETSIDeliverableStatus.aspx>

If you find errors in the present document, please send your comment to one of the following services:

<https://portal.etsi.org/People/CommiteeSupportStaff.aspx>

---

**Copyright Notification**

No part may be reproduced or utilized in any form or by any means, electronic or mechanical, including photocopying and microfilm except as authorized by written permission of ETSI.

The content of the PDF version shall not be modified without the written authorization of ETSI.

The copyright and the foregoing restriction extend to reproduction in all media.

© European Telecommunications Standards Institute 2017.

All rights reserved.

**DECT™**, **PLUGTESTS™**, **UMTS™** and the ETSI logo are Trade Marks of ETSI registered for the benefit of its Members.

**3GPP™** and **LTE™** are Trade Marks of ETSI registered for the benefit of its Members and of the 3GPP Organizational Partners.

**oneM2M** logo is protected for the benefit of its Members

**GSM®** and the GSM logo are Trade Marks registered and owned by the GSM Association.

---

## Intellectual Property Rights

IPRs essential or potentially essential to the present document may have been declared to ETSI. The information pertaining to these essential IPRs, if any, is publicly available for **ETSI members and non-members**, and can be found in ETSI SR 000 314: "*Intellectual Property Rights (IPRs); Essential, or potentially Essential, IPRs notified to ETSI in respect of ETSI standards*", which is available from the ETSI Secretariat. Latest updates are available on the ETSI Web server (<https://ipr.etsi.org>).

Pursuant to the ETSI IPR Policy, no investigation, including IPR searches, has been carried out by ETSI. No guarantee can be given as to the existence of other IPRs not referenced in ETSI SR 000 314 (or the updates on the ETSI Web server) which are, or may be, or may become, essential to the present document.

---

## Foreword

This Technical Specification (TS) has been produced by ETSI 3rd Generation Partnership Project (3GPP).

The present document may refer to technical specifications or reports using their 3GPP identities, UMTS identities or GSM identities. These should be interpreted as being references to the corresponding ETSI deliverables.

The cross reference between GSM, UMTS, 3GPP and ETSI identities can be found under <http://webapp.etsi.org/key/queryform.asp>.

---

## Modal verbs terminology

In the present document "**shall**", "**shall not**", "**should**", "**should not**", "**may**", "**need not**", "**will**", "**will not**", "**can**" and "**cannot**" are to be interpreted as described in clause 3.2 of the [ETSI Drafting Rules](#) (Verbal forms for the expression of provisions).

"**must**" and "**must not**" are **NOT** allowed in ETSI deliverables except when used in direct citation.

# Contents

Intellectual Property Rights .....	2
Foreword.....	2
Modal verbs terminology.....	2
Foreword.....	6
1 Scope .....	7
2 References .....	7
3 Definitions, symbols and abbreviations .....	7
3.1 Definitions .....	7
3.2 Symbols.....	8
3.3 Abbreviations .....	8
4 Frequency bands and channel arrangement.....	8
4.1 Frequency bands.....	8
4.2 TX-RX frequency separation .....	9
4.3 Channel arrangement.....	9
4.3.1 Channel spacing.....	9
4.3.2 Channel raster .....	9
4.3.3 Channel number .....	9
5 General test conditions and declarations .....	9
5.1 Acceptable uncertainty of Test System .....	10
5.1.1 Measurements of test environments.....	10
5.1.2 Measurements of Repeater.....	11
5.2 Repeater test tolerances (informative).....	11
5.3 Interpretation of measurement results .....	12
5.4 Test Environment .....	12
5.4.1 Normal test environment .....	12
5.4.2 Extreme test environment .....	13
5.4.2.1 Extreme temperature .....	13
5.4.3 Vibration.....	13
5.4.4 Power supply .....	13
5.5 Selection of configurations for testing.....	14
5.6 Regional requirements.....	15
5.7 Format and interpretation of tests.....	15
5.8 Repeater configurations.....	16
5.8.1 Power supply options.....	16
5.8.2 Combining of Repeaters .....	16
6 Output power.....	17
6.1 Definition and applicability .....	17
6.2 Minimum Requirements .....	17
6.3 Test purpose .....	17
6.4 Method of test.....	17
6.4.1 Initial conditions .....	17
6.4.2 Procedure .....	18
6.5 Test Requirements .....	18
7 Frequency stability .....	18
7.1 Definition and applicability .....	19
7.2 Minimum Requirement .....	19
7.3 Test purpose .....	19
7.4 Method of test.....	19
7.4.1 Initial conditions .....	19
7.4.2 Procedure .....	19
7.5 Test requirements .....	19

8	Out of band gain .....	19
8.1	Definitions and applicability .....	19
8.2	Minimum requirement .....	20
8.3	Test purpose .....	20
8.4	Method of test .....	20
8.4.1	Initial conditions .....	20
8.4.2	Procedure .....	20
8.5	Test requirements .....	21
9	Unwanted emission .....	21
9.1	Spectrum emission mask .....	21
9.1.1	Definition and applicability .....	21
9.1.2	Minimum Requirements .....	21
9.1.3	Test purpose .....	22
9.1.4	Method of test .....	22
9.1.4.1	Initial conditions .....	22
9.1.4.2	Proceduce .....	22
9.1.5	Test Requirements .....	23
9.2	Spurious emissions .....	24
9.2.1	Definition and applicability .....	24
9.2.2	Minimum Requirements .....	24
9.2.2.1	Mandatory Requirements .....	24
9.2.2.1.1	Spurious emissions (Category A) .....	24
9.2.2.1.2	Spurious emissions (Category B) .....	24
9.2.2.2	Co-existence with GSM 900 .....	25
9.2.2.2.1	Operation in the same geographic area .....	25
9.2.2.2.2	Co-located base stations .....	25
9.2.2.3	Co-existence with DCS 1800 .....	26
9.2.2.3.1	Operation in the same geographic area .....	26
9.2.2.3.2	Co-located base stations .....	26
9.2.2.4	Co-existence with UTRA-FDD .....	26
9.2.2.4.1	Operation in the same geographic area .....	26
9.2.2.4.2	Co-located base stations .....	27
9.2.2.5	Co-existence with unsynchronised TDD .....	27
9.2.2.5.1	Operation in the same geographic area .....	27
9.2.2.5.2	Co-located base stations .....	28
9.2.3	Test purpose .....	28
9.2.4	Method of test .....	29
9.2.4.1	Initial conditions .....	29
9.2.4.2	Proceduce .....	29
9.2.5	Test Requirements .....	29
10	Modulation accuracy .....	29
10.1	Error Vector Magnitude .....	29
10.1.1	Definition and applicability .....	29
10.1.2	Minimum requirements .....	29
10.1.3	Test purpose .....	29
10.1.4	Method of test .....	30
10.1.4.1	Initial conditions .....	30
10.1.4.2	Procedure .....	30
10.1.5	Test requirements .....	30
10.2	Peak code domain error .....	30
10.2.1	Definition and applicability .....	30
10.2.2	Minimum requirement .....	30
10.2.3	Test purpose .....	30
10.2.4	Method of test .....	30
10.2.4.1	Initial conditions .....	30
10.2.4.2	Procedure .....	31
10.2.5	Test requirements .....	31
11	Input Intermodulation .....	31
11.1	Definition and applicability .....	31
11.2	Minimum requirement .....	31

11.2.1	General requirement .....	31
11.2.2	Co-location with BS in other systems .....	33
11.2.3	Co-existence with other systems .....	36
11.3	Test purpose .....	38
11.4	Method of test .....	38
11.4.1	Initial conditions .....	38
11.4.2	Procedure .....	38
11.5	Test requirements .....	39
12	Output Intermodulation .....	39
12.1	Definition and applicability .....	39
12.2	Minimum requirements .....	39
12.3	Test purpose .....	39
12.4	Method of test .....	39
12.4.1	Initial conditions .....	39
12.4.2	Procedures .....	39
12.5	Test requirements .....	40
13	Adjacent Channel Rejection Ratio (ACRR) .....	40
13.1	Definitions and applicability .....	40
13.2	Minimum Requirements .....	40
13.3	Test purpose .....	41
13.4	Method of test .....	41
13.4.1	Initial conditions .....	41
13.4.2	Procedure .....	41
13.5	Test Requirements .....	41
14	Timing Accuracy .....	42
14.1	Definition and applicability .....	42
14.2	Minimum requirements .....	42
14.3	Test purpose .....	43
14.4	Method of test .....	43
14.4.1	Initial conditions .....	43
14.4.2	Procedure .....	43
14.5	Test Requirements .....	44
<b>Annex A (normative): Repeater measurement system set-up .....</b>		<b>45</b>
A.1	Maximum output power .....	45
A.2	Frequency stability .....	45
A.3	Out of band gain .....	45
A.4	Unwanted emission: Spectrum emission mask .....	45
A.5	Unwanted emission: Spurious emission .....	46
A.6	Modulation Accuracy: Error Vector Magnitude .....	46
A.7	Modulation Accuracy: Peak Code Domain Error .....	46
A.8	Input inter modulation .....	46
A.9	Output Intermodulation .....	47
A.10	Timing Accuracy .....	47
<b>Annex B (informative): Derivation of Test Requirements .....</b>		<b>48</b>
<b>Annex C (informative): Acceptable uncertainty of Test Equipment .....</b>		<b>49</b>
<b>Annex D (informative): Change history .....</b>		<b>50</b>
History .....		51

---

# Foreword

This Technical Specification has been produced by the 3<sup>rd</sup> Generation Partnership Project (3GPP).

The contents of the present document are subject to continuing work within the TSG and may change following formal TSG approval. Should the TSG modify the contents of the present document, it will be re-released by the TSG with an identifying change of release date and an increase in version number as follows:

Version x.y.z

where:

- x the first digit:
  - 1 presented to TSG for information;
  - 2 presented to TSG for approval;
  - 3 or greater indicates TSG approved document under change control.
- y the second digit is incremented for all changes of substance, i.e. technical enhancements, corrections, updates, etc.
- z the third digit is incremented when editorial only changes have been incorporated in the document.

---

# 1 Scope

The present document specifies the Radio Frequency (RF) test methods and Minimum Requirements for LCR TDD Repeaters. These have been derived from, and are consistent with the LCR TDD Repeater specifications defined in TS 25.116.

This document establishes the minimum RF characteristics of the LCR TDD Repeater.

---

# 2 References

The following documents contain provisions which, through reference in this text, constitute provisions of the present document.

- References are either specific (identified by date of publication, edition number, version number, etc.) or non-specific.
- For a specific reference, subsequent revisions do not apply.
- For a non-specific reference, the latest version applies. In the case of a reference to a 3GPP document (including a GSM document), a non-specific reference implicitly refers to the latest version of that document *in the same Release as the present document*.

- [1] 3GPP TS 25.105: “Base Station (BS) radio transmission and reception (TDD)”.
- [2] 3GPP TS 25.942: “RF system scenarios”.
- [3] 3GPP TS 25.113 : “ Base station EMC ”.
- [4] ITU-R recommendation SM.329: “Unwanted emissions in the spurious domain “.
- [5] ITU-T recommendation O.153: “Basic parameters for the measurement of error performance at bit rates below the primary rate”.
- [6] IEC 60721-3-3 (1994): “Classification of environmental conditions – Part 3: Classification of groups of environmental parameters and their severities – Section 3: Stationary use at weather protected locations”.
- [7] IEC 60721-3-4 (1995): “Classification of environmental conditions – Part 3: Classification of groups of environmental parameters and their severities – Section 4: Stationary use at non-weather protected locations”.
- [8] IEC 60068-2-1 (1990): “Environmental testing – Part 2: Tests. Tests A: Cold”.
- [9] IEC 60068-2-2 (1974): “Environmental testing – Part 2: Tests. Tests B: Dry heat”.
- [10] IEC 60068-2-6 (1995): “Environmental testing – Part 2: Tests – Test Fc: Vibration (sinusoidal)”.
- [11] 3GPP TS 25.142: “Base station conformance testing (TDD)”.
- [12] 3GPP TS 25.106: “UTRA Repeater; Radio transmission and reception”.
- [13] 3GPP TS 25.116: “LCR TDD Repeater; Radio transmission and reception”

---

# 3 Definitions, symbols and abbreviations

## 3.1 Definitions

For the purposes of the present document, the following terms and definitions apply:

**Donor coupling loss:** is the coupling loss between the repeater and the donor base station.



**Down-link:** signal path where base station transmits and mobile receives

**Maximum output power,  $P_{max}$ :** This is the mean power level per carrier measured at the antenna connector of the Repeater in specified reference condition.

**Pass band:** the Repeater can have one or several pass bands. The pass band is the frequency range that the Repeater operates in with operational configuration. This frequency range can correspond to one or several consecutive nominal 5 MHz channels. If they are not consecutive each subset of channels shall be considered as an individual pass band.

**Repeater:** a device that receives, amplifies and transmits the radiated or conducted RF carrier both in the down-link direction (from the base station to the mobile area) and in the up-link direction (from the mobile to the base station).

**Up-link:** signal path where mobile transmits and base station receives.

## 3.2 Symbols

For the purposes of the present document, the following symbols apply:

$BW_{Channel}$	Channel bandwidth
$BW_{Config}$	Transmission bandwidth configuration, expressed in MHz.
$BW_{Meas}$	Measurement bandwidth
$BW_{Signal}$	Bandwidth of the repeater input signal filling the repeater pass band
$F_{DL\_low}$	The lowest frequency of the downlink operating band
$F_{DL\_high}$	The highest frequency of the downlink operating band
$F_{UL\_low}$	The lowest frequency of the uplink operating band
$F_{UL\_high}$	The highest frequency of the uplink operating band
$f_{offset\_PB}$	Distance from the channel edge frequency of the first or last channel in the pass band
$N_{DL}$	Downlink LARFCN
$N_{Offs-DL}$	Offset used for calculating downlink LARFCN
$N_{Offs-UL}$	Offset used for calculating uplink LARFCN
$N_{RB}$	Transmission bandwidth configuration, expressed in units of resource blocks
$N_{UL}$	Uplink LARFCN
$P_{max}$	Maximum output power
$P_{out}$	Output power

## 3.3 Abbreviations

For the purposes of the present document, the following abbreviations apply:

BTS	Base Transceiver Station
CW	Continuous Wave (unmodulated signal)
EVM	Error Vector Magnitude
FDD	Frequency Division Duplex
FFS	For Further Study
IMT2000	International Mobile Telecommunication-2000
ITU	International Telecommunication Union
MS	Mobile Station
RF	Radio Frequency
TDD	Time Division Duplex
LARFCN	LCR TDD Absolute Radio Frequency Channel Number
UMTS	Universal Mobile Telecommunication System
UTRA	Universal Terrestrial Radio Access

---

# 4 Frequency bands and channel arrangement

## 4.1 Frequency bands

UTRA/TDD is designed to operate in the following bands;

- a) 1900 - 1920 MHz: Uplink and downlink transmission

- 2010 - 2025 MHz Uplink and downlink transmission
- b) 1850 - 1910 MHz Uplink and downlink transmission
- 1930 - 1990 MHz Uplink and downlink transmission
- c) 1910 - 1930 MHz Uplink and downlink transmission
- d) 2570 - 2620 MHz Uplink and downlink transmission
- e) 2300 - 2400 MHz Uplink and downlink transmission
- f) 1880 - 1920 MHz: Uplink and downlink transmission

Note: Deployment in existing and other frequency bands is not precluded.

## 4.2 TX-RX frequency separation

No TX-RX frequency separation is required as Time Division Duplex (TDD) is employed. Each subframe consists of 7 main timeslots where all main timeslots (at least the first one) before the single switching point are allocated DL and all main timeslots (at least the last one) after the single switching point are allocated UL.

## 4.3 Channel arrangement

### 4.3.1 Channel spacing

The channel spacing is 1.6MHz, but this can be adjusted to optimise performance in a particular deployment scenario.

### 4.3.2 Channel raster

The channel raster is 200 kHz for all bands, which means that the carrier frequency must be a multiple of 200 kHz.

### 4.3.3 Channel number

The carrier frequency is designated by the UTRA absolute radio frequency channel number (UARFCN). The value of the UARFCN in the IMT2000 band is defined in the general case as follows:

$$N_t = 5 * F \qquad 0.0 \leq F \leq 3276.6 \text{ MHz}$$

where F is the carrier frequency in MHz.

---

# 5 General test conditions and declarations

This specification applies only to LCR TDD Repeater.

The requirements of this clause apply to all applicable tests in this specification. Many of the tests in this specification measure a parameter relative to a value, that is not fully specified in the LCR TDD specifications. For these tests, the Minimum Requirement is determined relative to a nominal value specified by the manufacturer.

Some requirements for the Repeater may be regional as listed in subClause 5.6.

When specified in a test, the manufacturer shall declare the nominal value of a parameter, or whether an option is supported.

Schematic drawings for the individual measurement set-up can be found in the Annex A.

## 5.1 Acceptable uncertainty of Test System

The maximum acceptable uncertainty of the Test System is specified below for each test, where appropriate. The Test System shall enable the stimulus signals in the test case to be adjusted to within the specified tolerance, and the equipment under test to be measured with an uncertainty not exceeding the specified values. All tolerances and uncertainties are absolute values, and are valid for a confidence level of 95 %, unless otherwise stated.

A confidence level of 95% is the measurement uncertainty tolerance interval for a specific measurement that contains 95% of the performance of a population of test equipment.

For RF test it should be noted that the uncertainties in subClause 5.1 apply to the Test System operating into a nominal 50 ohm load and do not include system effects due to mismatch between the DUT and the Test System.

### 5.1.1 Measurements of test environments

The measurement accuracy of the Repeater test environments defined in SubClause 5.4, Test environments shall be.

Pressure:	$\pm 5$ kPa.
Temperature:	$\pm 2$ degrees.
Relative Humidity:	$\pm 5$ %.
DC Voltage:	$\pm 1,0$ %.
AC Voltage:	$\pm 1,5$ %.
Vibration:	10 %.
Vibration frequency:	0,1 Hz.

The above values shall apply unless the test environment is otherwise controlled and the specification for the control of the test environment specifies the uncertainty for the parameter.

## 5.1.2 Measurements of Repeater

**Table 5.1: Maximum Test System Uncertainty**

Subclause	Maximum Test System Uncertainty	Range over which Test System Uncertainty applies
6 Maximum output power	$\pm 0,7$ dB	
7 Frequency error	$\pm 12$ Hz	Measurement results of $\pm 500$ Hz
8 Out of band gain	$\pm 0,5$ dB Calibration of test set-up shall be made without D.U.T. in order to achieve the accuracy	
9.1 Spectrum emission mask	$\pm 1,5$ dB	
9.2 Spurious emissions	$\pm 2,0$ dB for BS and coexistence bands for results $> -60$ dBm $\pm 3,0$ dB for results $< -60$ dBm  Outside above range: $f \leq 2,2$ GHz: $\pm 1,5$ dB $2,2$ GHz $< f \leq 4$ GHz: $\pm 2,0$ dB $f > 4$ GHz: $\pm 4,0$ dB	
10.1 Error vector magnitude	$\pm 2,5$ % (single code applied)  ( $\pm 2,5$ % measurement error for single code).  5,0 % EVM in the stimulus signal (single code) will shift the EVM maximum value 0,7% to 18,2%. (RSS repeater EVM and Stimulus EVM.)	Measurement results from 12,5% to 22,5% at signal power = $P_{max} - 3$ dB to $P_{max} - 18$ dB
10.2 Peak code domain error	$\pm 1,1$ dB  Formula: RSS measurement error and impedance mismatch error  (using $\pm 1,0$ dB measurement error and $\pm 0,5$ dB impedance mismatch error (stimulus side) assuming 14 dB return loss)	Measurement results from $-36$ dB to $-30$ dB, at signal power = $P_{max} - 3$ dB to $P_{max} - 18$ dB
11 Input intermodulation Characteristics	$\pm 1,2$ dB  Formula: RSS CW1 level error, 2 x CW2 level error, and measurement error (using all errors = $\pm 0,5$ dB)	
12 Output Intermodulation	The value below applies to the setting of the interference signal level only and is unrelated to the measurement uncertainty of the tests (9.1 and 9.2) which have to be carried out in the presence of the interference signal.  $\pm 1$ dB	The uncertainty of the interferer has double the effect on the result due to the frequency offset.
13 Adjacent Channel Rejection Ratio	$\pm 0,7$ dB	

## 5.2 Repeater test tolerances (informative)

The Test Tolerances defined in this subclause have been used to relax the Minimum Requirements in this specification to derive the Test Requirements.

The Test Tolerances are derived from Test System uncertainties, regulatory requirements and criticality to system performance. As a result, the Test Tolerances may sometimes be set to zero.

The test tolerances should not be modified for any reason e.g. to take account of commonly known test system errors (such as mismatch, cable loss, etc.)

**Table 5.2: Test Tolerance**

Subclause	Test Tolerance (Note 1)	Notes
6 Maximum output power	0,7 dB	
9.1 Spectrum emission mask	1,5 dB	0 dB test tolerance for the additional Band II, IV and V requirements
9.2 Spurious emissions	0 dB	
7 Frequency error	12 Hz	
10.1 Error vector magnitude	0 %	Target value is shifted due to stimulus EVM
10.2 Peak code domain error	1,1 dB	
8 Out of band gain	0,5dB	
11 Input intermodulation Characteristics	1,2dB	
12 Output intermodulation	1,5 dB for spectrum emission 0 dB for spurious emission	
13 Adjacent Channel Rejection Ratio	0,7 dB	
NOTE 1: Unless otherwise stated, The Test Tolerances are applied to the DUT Minimum Requirement. See Annex B.		

## 5.3 Interpretation of measurement results

The measurement results returned by the Test System are compared - without any modification - against the Test Requirements as defined by the shared risk principle.

The Shared Risk principle is defined in ETR 273 Part 1 sub-part 2 section 6.5.

The actual measurement uncertainty of the Test System for the measurement of each parameter shall be included in the test report.

The recorded value for the Test System uncertainty shall be, for each measurement, equal to or lower than the appropriate figure in subClause 5.1 of this specification.

If the Test System for a test is known to have a measurement uncertainty greater than that specified in subClause 5.1, it is still permitted to use this equipment provided that an adjustment is made as follows:

Any additional uncertainty in the Test System over and above that specified in subClause 5.1 shall be used to tighten the Test Requirement - making the test harder to pass.

This procedure will ensure that a Test System not compliant with subClause 4.1 does not increase the chance of passing a device under test where that device would otherwise have failed the test if a Test System compliant with subClause 4.1 had been used.

## 5.4 Test Environment

For each test in the present document, the environmental conditions under which the Repeater is to be tested are defined.

### 5.4.1 Normal test environment

When a normal test environment is specified for a test, the test should be performed under any combination of conditions between the minimum and maximum limits stated in table 5.3.

**Table 5.3: Limits of conditions for Normal Test Environment**

Condition	Minimum	Maximum
Barometric pressure	86 kPa	106 kPa
Temperature	15°C	30°C
Relative Humidity	20 %	85 %
Power supply	Nominal, as declared by the manufacturer	
Vibration	Negligible	

The ranges of barometric pressure, temperature and humidity represent the maximum variation expected in the uncontrolled environment of a test laboratory. If it is not possible to maintain these parameters within the specified limits, the actual values shall be recorded in the test report.

NOTE: This may, for instance, be the case for measurements of radiated emissions performed on an open field test site.

## 5.4.2 Extreme test environment

The manufacturer shall declare one of the following:

- a) The equipment class for the equipment under test, as defined in IEC 60721-3-3 [2].
- b) The equipment class for the equipment under test, as defined in IEC 60721-3-4 [3].
- c) For equipment that does not comply to the mentioned classes, the relevant classes from IEC 60 721 documentation for Temperature, Humidity and Vibration shall be declared.

NOTE: Reduced functionality for conditions that fall out side of the standard operational conditions are not tested in this TS. These may be stated and tested separately.

### 5.4.2.1 Extreme temperature

When an extreme temperature test environment is specified for a test, the test shall be performed at the standard minimum and maximum operating temperatures defined by the manufacturer's declaration for the equipment under test.

#### Minimum temperature:

- The test shall be performed with the environmental test equipment and methods of inducing the required environmental phenomena into the equipment, conforming to the test procedure of IEC 60 068-2-1 [4], Environmental Testing, Part 2: Tests - Tests A: Cold. The equipment shall be maintained at the stabilized condition for the duration of the test sequence.

#### Maximum temperature:

- The test shall be performed with the environmental test equipment and methods of inducing the required environmental phenomena in to the equipment, conforming to the test procedure of IEC 60 068-2-2 [5] (Environmental Testing, Part 2: Tests - Tests Bd Dry heat). The equipment shall be maintained at the stabilized condition for the duration of the test sequence.

NOTE: It is recommended that the equipment is made fully operational prior to the equipment being taken to its lower operating temperature.

## 5.4.3 Vibration

When vibration conditions are specified for a test, the test shall be performed while the equipment is subjected to a vibration sequence as defined by the manufacturers declaration for the equipment under test. This shall use the environmental test equipment and methods of inducing the required environmental phenomena in to the equipment, conforming to the test procedure of IEC 60 068-2-6 [8], Environmental Testing, Part 2: Tests - Test Fc and guidance: Vibration (Sinusoidal). Other environmental conditions shall be within the ranges specified in subClause 4.4.1, Normal test environment.

NOTE: The higher levels of vibration may induce undue physical stress in to equipment after a prolonged series of tests. The testing body should only vibrate the equipment during the RF measurement process.

## 5.4.4 Power supply

When extreme power supply conditions are specified for a test, the test shall be performed at the standard upper and lower limits of operating voltage defined by the manufacturer's declaration for the equipment under test.

#### Upper voltage limit

- The equipment shall be supplied with a voltage equal to the upper limit declared by the manufacturer (as measured at the input terminals to the equipment). The tests shall be carried out at a steady state minimum and maximum limit declared by the manufacturer for the equipment, to the methods described in IEC 60 068-2-1 [4] Test Ab/Ad: Cold and IEC 60 068-2-2 [5] Test Bb/Bd: Dry Heat.

#### **Lower voltage limit**

- The equipment shall be supplied with a voltage equal to the lower limit declared by the manufacturer (as measured at the input terminals to the equipment). The tests shall be carried out at a steady state minimum and maximum limit declared by the manufacturer for the equipment, to the methods described in IEC 60 068-2-1 [4] Test Ab/Ad: Cold and IEC 60 068-2-2 [5] Test Bb/Bd: Dry Heat.

## **5.5 Selection of configurations for testing**

Measurements shall be performed within the time slots under test as specified individually for each test within the subclause " Procedure ".

Most tests in this TS are only performed for a subset of the possible combinations of test conditions. For instance:

- Only one RF channel may be specified to be tested.
- Only one timeslot may be specified to be tested.

When a test is performed by a test laboratory, the choice of which combinations are to be tested shall be specified by the laboratory. The laboratory may consult with operators, the manufacturer or other bodies.

When a test is performed by a manufacturer, the choice of which combinations are to be tested may be specified by an operator.

## 5.6 Regional requirements

Some requirements in TS 25.153 may only apply in certain regions. Table 5.4 lists all requirements that may be applied differently in different regions.

**Table 5.4: List of regional requirements**

Sub-clause number	Requirement	Comments
4.1	Frequency bands	Some bands may be applied regionally.
4.2	Up-link to down-link frequency separation	The requirement is applied according to what frequency bands in clause 5.1 that are supported by the Repeater.
4.3	Channel arrangement	The requirement is applied according to what frequency bands in clause 5.1 that are supported by the Repeater.
6	Maximum output power	In certain regions, the minimum requirement for normal conditions may apply also for some conditions outside the ranges of conditions defined as normal.
9.1	Spectrum emission mask	The mask specified may be mandatory in certain regions. In other regions this mask may not be applied.
9.2.2.1.1	Spurious emissions (Category A)	These requirements shall be met in cases where Category A limits for spurious emissions, as defined in ITU-R Recommendation SM.329 [4], are applied.
9.2.2.1.2	Spurious emissions (Category B)	These requirements shall be met in cases where Category B limits for spurious emissions, as defined in ITU-R Recommendation SM.329 [4], are applied.
9.2.2.2.1	Co-existence with GSM900 - Operation in the same geographic area	This requirement may be applied for the protection of GSM 900 MS and GSM 900 BTS in geographic areas in which both GSM 900 and UTRA are deployed.
9.2.2.2.2	Co-existence with GSM900 - Co-located base stations	This requirement may be applied for the protection of GSM 900 BTS receivers when GSM 900 BTS and UTRA BS are co-located.
9.2.2.3.1	Co-existence with DCS1800 - Operation in the same geographic area	This requirement may be applied for the protection of DCS 1800 MS and DCS 1800 BTS in geographic areas in which both DCS 1800 and UTRA are deployed.
9.2.2.3.2	Co-existence with DCS1800 - Co-located base stations	This requirement may be applied for the protection of DCS 1800 BTS receivers when DCS 1800 BTS and UTRA BS are co-located.
9.2.2.4.1	Co-existence with UTRA FDD - Operation in the same geographic area	This requirement may be applied to geographic areas in which both UTRA-TDD and UTRA-FDD are deployed.
9.2.2.4.2	Co-existence with UTRA FDD - Co-located base stations	This requirement may be applied for the protection of UTRA-FDD BS receivers when UTRA-TDD BS and UTRA FDD BS are co-located.
9.2.2.5.1	Co-existence with unsynchronised TDD - Operation in the same geographic area	This requirement may be applied for the protection of TDD BS receivers in geographic areas in which unsynchronised TDD is deployed.
9.2.2.5.2	Co-existence with unsynchronised TDD - Co-located base stations	This requirement may be applied for the protection of TDD BS receivers when unsynchronised TDD BS are co-located.
11.2.2	Input intermodulation: Co-location with other systems	The requirement may be applied when GSM 900, DCS 1800, PCS1900, GSM850 and/or UTRA FDD BS operating in another frequency band and LCR TDD Repeaters are co-located.
11.2.3	Input Intermodulation: Co-existence with other systems	These requirements may apply in geographic areas in which both LCR TDD Repeater and GSM900, DCS1800, PCS1900, GSM850 and/or UTRA FDD operating in another frequency band are deployed.

## 5.7 Format and interpretation of tests

Each test in the following clauses has a standard format:

**X**                      **Title**

All tests are applicable to all equipment within the scope of the present document, unless otherwise stated.



**X.1 Definition and applicability**

This subclause gives the general definition of the parameter under consideration and specifies whether the test is applicable to all equipment or only to a certain subset.

**X.2 Minimum Requirements**

This subclause is an informative copy of the Minimum Requirement defined by the core specification.

In addition, this subclause contains the reference to the subclause to the 3GPP reference (or core) specification which defines the Minimum Requirement.

**X.3 Test purpose**

This subclause defines the purpose of the test.

**X.4 Method of test****X.4.1 Initial conditions**

This subclause defines the initial conditions for each test, including the basic measurement set-up.

**X.4.2 Procedure**

This subclause describes the steps necessary to perform the test and provides further details of the test definition like point of access (e.g. antenna port), domain (e.g. frequency-span), range, weighting (e.g. bandwidth), and algorithms (e.g. averaging).

**X.5 Test Requirements**

This subclause defines the pass/fail criteria for the equipment under test. See subClause 4.3 Interpretation of measurement results.

## 5.8 Repeater configurations

### 5.8.1 Power supply options

If the repeater is supplied with a number of different power supply configurations, it may not be necessary to test RF parameters for each of the power supply options, provided that it can be demonstrated that the range of conditions over which the equipment is tested is at least as great as the range of conditions due to any of the power supply configurations.

### 5.8.2 Combining of Repeaters

If the repeater is intended for combination with additional apparatus connected to a repeater port and this combination is supplied as a system, the combination of repeater together with the additional apparatus shall also fulfil the repeater requirements. E.g. if the repeater is intended for combination such that multiple repeaters amplify the same signals into the same ports the combination shall also fulfil the repeater requirements.

An example of such a configuration is shown in figure 5.1

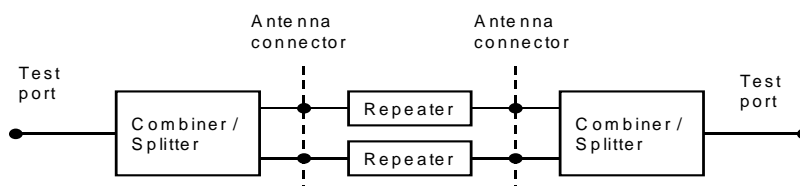

Figure 5.1: Example of repeater configuration

## 6 Output power

Output power,  $P_{out}$ , of the repeater is the mean power of one carrier at maximum repeater gain delivered to a load with resistance equal to the nominal load impedance of the transmitter.

Rated output power, PRAT, of the repeater is the mean power level per carrier at maximum repeater gain that the manufacturer has declared to be available at the antenna connector.

### 6.1 Definition and applicability

Maximum output power,  $P_{max}$ , of the repeater is the mean power level per carrier measured at the antenna connector in specified reference condition.

### 6.2 Minimum Requirements

The requirements shall apply at maximum gain, with LCR TDD signals in the pass band of the repeater, at levels that produce the maximum rated output power per channel.

When the power of all signals is increased by 10 dB, compared to the power level that produce the maximum rated output power, the requirements shall still be met.

In normal conditions, the Repeater maximum output power shall remain within limits specified in Table 6.1 relative to the manufacturer's rated output power.

**Table 6.1: Repeater output power; normal conditions**

Rated output power	Limit
$P \geq 31$ dBm	+2 dB and -2 dB
$P < 31$ dBm	+3 dB and -3 dB

In extreme conditions, the Repeater maximum output power shall remain within the limits specified in Table 6.2 relative to the manufacturer's rated output power.

**Table 6.2: Repeater output power; extreme conditions**

Rated output power	Limit
$P \geq 31$ dBm	+2,5 dB and -2,5 dB
$P < 31$ dBm	+4 dB and -4 dB

In certain regions, the minimum requirement for normal conditions may apply also for some conditions outside the ranges of conditions defined as normal.

### 6.3 Test purpose

To verify that the Repeater maximum output power is within the limit specified in 6.1.2.

### 6.4 Method of test

#### 6.4.1 Initial conditions

- 1) Set-up the equipment as shown in annex A.
- 2) Connect the signal generator equipment to the Repeater input port.
- 3) Connect the power measuring equipment to the Repeater output port.

## 6.4.2 Procedure

- 1) Set the signal generator to transmit a signal according to table 6.3.

**Table 6.3: Parameters of the transmitted signal for output power test**

Parameter	Value/description
TDD Duty Cycle	TS $i$ ; $i = 0, 1, 2, 3, 4, 5, 6$ : transmit, if $i$ is 0,4,5,6; receive, if $i$ is 1,2,3.
Time slots under test	TS4, TS5 and TS6
output power setting	PRAT
Number of DPCH in each time slot under test	8
Power of each DPCH	1/8 of Base Station output power
Data content of DPCH	real life (sufficient irregular)

- 2) Adjust the input power to the Repeater to create the maximum nominal Repeater output power at maximum gain.
- 3) Measure the mean power at the RF output port over a certain slot.
- 4) Increase the power with 10 dB compare to the level obtained in step 2.
- 5) Measure the mean power at the RF output port over a certain slot.

In addition, on one UARFCN only, the test shall be performed under extreme power supply as defined in subclause 5.4.4

NOTE: Tests under extreme power supply also test extreme temperature.

## 6.5 Test Requirements

In normal conditions as specified in section 5.4.1, the Repeater maximum output power shall remain within limits specified in Table 6.3 relative to the manufacturer's rated output power.

**Table 6.4: Repeater output power; normal conditions**

Rated output power	Limit
$P \geq 31$ dBm	+2,7 dB and -2,7 dB
$P < 31$ dBm	+3,7 dB and -3,7 dB

In extreme conditions as specified in section 5.4.2 and 5.4.4, the Repeater maximum output power shall remain within limits specified in Table 6.4 relative to the manufacturer's rated output power.

**Table 6.5: Repeater output power; extreme conditions**

Rated output power	Limit
$P \geq 31$ dBm	+3,2 dB and -3,2 dB
$P < 31$ dBm	+4,7 dB and -4,7 dB

In certain regions, the minimum requirement for normal conditions may apply also for some conditions outside the ranges defined for the Normal test environment in subclause 5.4.1.

NOTE: If the above Test Requirement differs from the Minimum Requirement then the Test Tolerance applied for this test is non zero. The Test Tolerance for this test is defined in subclause 5.2 and the explanation of how the Minimum Requirement has been relaxed by the Test Tolerance is given in Annex B.

## 7 Frequency stability

Frequency error is the measure of the difference between the frequency of the received signal and the frequency of the re-transmitted signal.

## 7.1 Definition and applicability

The frequency stability is a measure of the frequency deviation of the output signal with respect to the input signal. The test shall address the uplink and the downlink path of the Repeater.

## 7.2 Minimum Requirement

In normal conditions as specified in section 5.4.1 the frequency deviation shall be within  $\pm 0,01$  ppm.

## 7.3 Test purpose

To verify that the Frequency Error is within the limit specified in 7.2.

## 7.4 Method of test

### 7.4.1 Initial conditions

- 1) Set-up the equipment as shown in annex A.
- 2) Connect the signal generator equipment to the Repeater input port.
- 3) Connect the signal analyser to the Repeater output port..

### 7.4.2 Procedure

- 1) Set the signal generator to transmit one signal according to table 7.1.

**Table 7.1: Parameters of the transmitted signal for Frequency stability test**

Parameter	Value/description
TDD Duty Cycle	TS $i$ ; $i = 0, 1, 2, \dots, 6$ : transmit, if $i$ is 0, 4,5,6; receive, if $i$ is 1,2,3.
Time slots under test	TS4, TS5 and TS6
Number of DPCH in eachtime slot under test	1
BS output power setting	PRAT
Data content of DPCH	real life (sufficient irregular)

- 2) Adjust the input power to the Repeater to create the maximum nominal Repeater output power at maximum gain.
- 3) Measure the frequency error for both paths uplink and downlink of the Repeater.

## 7.5 Test requirements

The measurement result of 7.4.2 shall not exceed:

$$|f_{IN} - f_{out}| \leq (f_{out} * 0,01 \text{ ppm}) + 12 \text{ Hz}$$

# 8 Out of band gain

## 8.1 Definitions and applicability

Out of band gain refers to the gain of the Repeater immediately outside the pass band. The measurements shall apply to both paths uplink and downlink of the Repeater.

## 8.2 Minimum requirement

The intended use of a repeater in a system is to amplify the in band signals and not to amplify the out of band emission of the donor base station.

In the intended application of the repeater, the out of band gain is less than the donor coupling loss.

The repeater minimum donor coupling loss shall be declared by the manufacturer. This is this the minimum required attenuation between the donor BS and the repeater for proper repeater operation.

The gain outside the pass band shall not exceed the maximum level specified in table 8.1, where:

- $f_{\text{offset}}$  is the distance from the centre frequency of the first or last channel within the pass band.

**Table 8.1: Out of band gain limits 1**

Frequency offset from the carrier frequency, $f_{\text{offset}}$	Maximum gain
$1,0 \leq f_{\text{offset}} < 1,8$ MHz	60 dB
$1,8 \leq f_{\text{offset}} < 5,8$ MHz	45 dB
$5,8 \leq f_{\text{offset}} < 10,8$ MHz	45 dB
$10,8 \text{ MHz} \leq f_{\text{offset}}$	35 dB

For  $10,8 \text{ MHz} \leq f_{\text{offset}}$  the out of band gain shall not exceed the maximum gain of table 8.2 or the maximum gain stated in table 8.1 whichever is lower.

**Table 8.2: Out of band gain limits 2**

Repeater maximum output power as in 9.1.1.1	Maximum gain
$P < 31$ dBm	Out of band gain $\leq$ minimum donor coupling loss
$31 \text{ dBm} \leq P < 43$ dBm	Out of band gain $\leq$ minimum donor coupling loss
$P \geq 43$ dBm	Out of band gain $\leq$ minimum donor coupling loss - (P-43dBm)
NOTE 1: The out of band gain is considered with $10,8 \text{ MHz} \leq f_{\text{offset}}$	

## 8.3 Test purpose

The purpose of this test is to verify that the Repeater meets the out of band gain requirements as specified by the minimum requirements.

## 8.4 Method of test

### 8.4.1 Initial conditions

- 1) Set-up the equipment as shown in annex A.
- 2)  $f_{\text{offset\_CW}}$  is the offset between the outer channel edge frequency of the outer channel in the pass band and a CW-signal.
- 3) The test shall be performed with an  $f_{\text{offset\_CW}}$  of 1 MHz, 1.8 MHz, 5.8 MHz, 10.8 MHz, 15 MHz and 20 MHz, excluding other pass bands. In addition the test shall also be performed for all harmonic frequencies of the repeaters pass band up to 12,75 GHz.

### 8.4.2 Procedure

- 1) Set the Repeater to maximum gain.
- 2) Set the signal generator to generate a CW-signal, applied to the input port of the Repeater. The power level of the RF input signal shall be at least 5 dB below the power level which, when applied within the pass band, would produce the maximum rated output power, as declared by the manufacturer. This is to ensure that the equipment is operating in the linear output range.

- 3) The average output power in each case shall be measured using a spectrum analyser connected to the output port of the Repeater and the net gain shall be recorded compared to table 8.3 or table 8.4 whichever is lower.
- 4) With the same input power as in step 1) set the repeater gain to the minimum specified by the manufacturer.
- 5) The average output power in each case shall be measured using a spectrum analyser connected to the output port of the Repeater and the net gain shall be recorded and compared to table 8.3 or table 8.4 whichever is lower.

## 8.5 Test requirements

**Table 8.3: Out of band gain limits**

Frequency offset from the carrier frequency, $f_{\text{offset}}$	Maximum gain
$1,0 \leq f_{\text{offset}} < 1,8$ MHz	60,5 dB
$1,8 \leq f_{\text{offset}} < 5,8$ MHz	45,5 dB
$5,8 \leq f_{\text{offset}} < 10,8$ MHz	45,5 dB
$10,8 \text{ MHz} \leq f_{\text{offset}}$	35,5 dB

**Table 8.4: Out of band gain limits 2**

Repeater maximum output power as in 9.1.1.1	Maximum gain
$P < 31$ dBm	Out of band gain $\leq$ minimum donor coupling loss + 0,5 dB
$31 \text{ dBm} \leq P < 43$ dBm	Out of band gain $\leq$ minimum donor coupling loss + 0,5 dB
$P \geq 43$ dBm	Out of band gain $\leq$ minimum donor coupling loss – $(P-43\text{dBm}) + 0,5$ dB
NOTE: The donor coupling loss is considered with $10,8 \text{ MHz} \leq f_{\text{offset}}$	

## 9 Unwanted emission

### 9.1 Spectrum emission mask

#### 9.1.1 Definition and applicability

The spectrum emission mask specifies the limit of the transmitter out of band emissions at frequency offsets from the assigned channel frequency of the wanted signal between 0,8 MHz and 4 MHz.

The mask defined in Table 9.1 to 9.3 may be mandatory in certain regions. In other regions this mask may not be applied.

#### 9.1.2 Minimum Requirements

For regions where this subclause applies, the requirement shall be met by LCR TDD repeater transmitting on a single RF carrier configured in accordance with the manufacturer's specification. Emissions shall not exceed the maximum level specified in tables 9.1 to 9.3 in the frequency range of  $f_{\text{offset}}$  from 0.815 MHz to  $f_{\text{offset}_{\text{max}}}$  from the carrier frequency, where:

- $f_{\text{offset}}$  is the separation between the carrier frequency and the centre of the measurement filter
- $f_{\text{offset}_{\text{max}}}$  is either 4 MHz or the offset to the UMTS Tx band edge as defined in subclause 4.2, whichever is the greater.

**Table 9.1: Spectrum emission mask values, maximum output power  $P \geq 34$  dBm**

Frequency offset of measurement filter centre frequency, $f_{\text{offset}}$	Maximum level	Measurement bandwidth
$0.815\text{MHz} \leq f_{\text{offset}} < 1.015\text{MHz}$	-20 dBm	30 kHz
$1.015\text{MHz} \leq f_{\text{offset}} < 1.815\text{MHz}$	$-20\text{dBm} - 10 \cdot \left( \frac{f_{\text{offset}}}{\text{MHz}} - 1,015 \right) \text{dB}$	30 kHz
$1.815\text{MHz} \leq f_{\text{offset}} < 2.3\text{MHz}$	-28 dBm	30 kHz
$2.3\text{MHz} \leq f_{\text{offset}} < f_{\text{offset}_{\text{max}}}$	-13 dBm	1 MHz

**Table 9.2: Spectrum emission mask values, maximum output power  $26 \leq P < 34$  dBm**

Frequency offset of measurement filter centre frequency, $f_{\text{offset}}$	Maximum level	Measurement bandwidth
$0.815\text{MHz} \leq f_{\text{offset}} < 1.015\text{MHz}$	$P - 54$ dB	30 kHz
$1.015\text{MHz} \leq f_{\text{offset}} < 1.815\text{MHz}$	$P - 54\text{dB} - 10 \cdot \left( \frac{f_{\text{offset}}}{\text{MHz}} - 1,015 \right) \text{dB}$	30 kHz
$1.815\text{MHz} \leq f_{\text{offset}} < 2.3\text{MHz}$	$P - 62$ dB	30 kHz
$2.3\text{MHz} \leq f_{\text{offset}} < f_{\text{offset}_{\text{max}}}$	$P - 47$ dB	1 MHz

**Table 9.3: Spectrum emission mask values, maximum output power  $P < 26$  dBm**

Frequency offset of measurement filter centre frequency, $f_{\text{offset}}$	Maximum level	Measurement bandwidth
$0.815\text{MHz} \leq f_{\text{offset}} < 1.015\text{MHz}$	-28 dBm	30 kHz
$1.015\text{MHz} \leq f_{\text{offset}} < 1.815\text{MHz}$	$-28\text{dBm} - 10 \cdot \left( \frac{f_{\text{offset}}}{\text{MHz}} - 1,015 \right) \text{dB}$	30 kHz
$1.815\text{MHz} \leq f_{\text{offset}} < 2.3\text{MHz}$	-36 dBm	30 kHz
$2.3\text{MHz} \leq f_{\text{offset}} < f_{\text{offset}_{\text{max}}}$	-21 dBm	1 MHz

NOTE: This frequency range ensures that the range of values of  $f_{\text{offset}}$  is continuous.

### 9.1.3 Test purpose

The purpose of this test is to verify that the Repeater meet the spectrum emission requirements as specified in TS 25.116.

### 9.1.4 Method of test

#### 9.1.4.1 Initial conditions

- 1) Set-up the equipment as shown in annex A.
- 2) Connect the signal generator equipment to the Repeater input port.
- 3) Connect the power measuring equipment to the Repeater output port.

#### 9.1.4.2 Procedure

- 1) Set the Repeater to maximum gain.
- 2) Set the signal generator(s) to generate signal(s) in accordance to table 9.4, at level(s) which produce the manufacturer specified maximum output power at maximum gain.

**Table 9.4: Parameters of the transmitted signal for spectrum emission mask testing**

Parameter	Value/description
TDD Duty Cycle	TS $i$ ; $i = 0, 1, 2, 3, 4, 5, 6$ : transmit, if $i$ is 0,4,5,6; receive, if $i$ is 1,2,3.
Time slots under test	TS4, TS5 and TS6
BS output power setting	PRAT
Number of DPCH in each time slot under test	8
Power of each DPCH	1/8 of Base Station output power
Data content of DPCH	real life (sufficient irregular)

- 3) Measure the emission at the specified frequencies with specified measurement bandwidth and note that the measured value does not exceed the specified value.
- 4) Increase the power with 10 dB compare to the level obtained in step 2.
- 5) Measure the emission at the specified frequencies with specified measurement bandwidth and note that the measured value does not exceed the specified value.

### 9.1.5 Test Requirements

The spectrum emissions measured according to subclause 9.1.4.2 shall be within the mask defined in the table 9.5 to 9.7.

**Table 9.5: Spectrum emission mask values, maximum output power  $P \geq 34$  dBm**

Frequency offset of measurement filter centre frequency, $f_{\text{offset}}$	Maximum level	Measurement bandwidth
$0.815\text{MHz} \leq f_{\text{offset}} < 1.015\text{MHz}$	-18.5 dBm	30 kHz
$1.015\text{MHz} \leq f_{\text{offset}} < 1.815\text{MHz}$	$-18.5\text{dBm} - 10 \cdot \left( \frac{f_{\text{offset}}}{\text{MHz}} - 1,015 \right) \text{dB}$	30 kHz
$1.815\text{MHz} \leq f_{\text{offset}} < 2.3\text{MHz}$	-26.5 dBm	30 kHz
$2.3\text{MHz} \leq f_{\text{offset}} < f_{\text{offset}_{\text{max}}}$	-11.5 dBm	1 MHz

**Table 9.6: Spectrum emission mask values, maximum output power  $26 \leq P < 34$  dBm**

Frequency offset of measurement filter centre frequency, $f_{\text{offset}}$	Maximum level	Measurement bandwidth
$0.815\text{MHz} \leq f_{\text{offset}} < 1.015\text{MHz}$	$P - 52.5$ dB	30 kHz
$1.015\text{MHz} \leq f_{\text{offset}} < 1.815\text{MHz}$	$P - 52.5\text{dB} - 10 \cdot \left( \frac{f_{\text{offset}}}{\text{MHz}} - 1,015 \right) \text{dB}$	30 kHz
$1.815 \text{ MHz} \leq f_{\text{offset}} < 2.3 \text{ MHz}$	$P - 60.5$ dB	30 kHz
$2.3 \text{ MHz} \leq f_{\text{offset}} < f_{\text{offset}_{\text{max}}}$	$P - 45.5$ dB	1 MHz



**Table 9.7: Spectrum emission mask values, maximum output power P < 26 dBm**

Frequency offset of measurement filter centre frequency, $f_{\text{offset}}$	Maximum level	Measurement bandwidth
$0.815\text{MHz} \leq f_{\text{offset}} < 1.015\text{MHz}$	-26.5 dBm	30 kHz
$1.015\text{MHz} \leq f_{\text{offset}} < 1.815\text{MHz}$	$-26.5\text{dBm} - 10 \cdot \left( \frac{f_{\text{offset}}}{\text{MHz}} - 1,015 \right) \text{dB}$	30 kHz
$1.815\text{MHz} \leq f_{\text{offset}} < 2.3\text{MHz}$	-34.5 dBm	30 kHz
$2.3\text{MHz} \leq f_{\text{offset}} < f_{\text{offset}_{\text{max}}}$	-19.5 dBm	1 MHz

## 9.2 Spurious emissions

### 9.2.1 Definition and applicability

Spurious emissions are emissions which are caused by unwanted transmitter effects such as harmonics emission, parasitic emission, intermodulation products and frequency conversion products, but exclude out of band emissions. This is measured at the base station RF output port.

The requirements shall apply whatever the type of transmitter considered (single carrier or multi carrier). It applies for all transmission modes foreseen by the manufacturer's.

For 1.28 Mcps TDD option, either requirement applies at frequencies within the specified frequency ranges which are more than 4 MHz under the first carrier frequency used or more than 4 MHz above the last carrier frequency used.

Unless otherwise stated, all requirements are measured as mean power.

### 9.2.2 Minimum Requirements

#### 9.2.2.1 Mandatory Requirements

The requirements of either subclause 9.2.2.1.1 or subclause 9.2.2.1.2 shall apply.

##### 9.2.2.1.1 Spurious emissions (Category A)

The following requirements shall be met in cases where Category A limits for spurious emissions, as defined in ITU-R Recommendation SM.329 [6], are applied.

The power of any spurious emission shall not exceed the maximum level given in Table 9.8.

**Table 9.8: LCR TDD repeater Mandatory spurious emissions limits, Category A**

Band	Minimum requirement	Measurement Bandwidth	Notes
9kHz - 150kHz	-13 dBm	1 kHz	Note 1
150kHz - 30MHz		10 kHz	Note 1
30MHz - 1GHz		100 kHz	Note 1
1GHz - 12.75 GHz		1 MHz	Note 2
NOTE 1: Bandwidth as in ITU SM.329 [6], s4.1			
NOTE 2: Upper frequency as in ITU SM.329 [6], s2.5 table 1			

NOTE: only the measurement bands are different according to the occupied bandwidth.

##### 9.2.2.1.2 Spurious emissions (Category B)

The following requirements shall be met in cases where Category B limits for spurious emissions, as defined in ITU-R Recommendation SM.329-9 [6], are applied.

The power of any spurious emission shall not exceed the maximum levels given in Table 9.9.

**Table 9.9: LCR TDD repeater Mandatory spurious emissions limits, Category B**

Band	Maximum Level	Measurement Bandwidth	Notes
9kHz - 150kHz	-36 dBm	1 kHz	Note 1
150kHz - 30MHz	- 36 dBm	10 kHz	Note 1
30MHz - 1GHz	-36 dBm	100 kHz	Note 1
1GHz ↔ Fl -10 MHz	-30 dBm	1 MHz	Note 1
Fl -10MHz ↔ Fu +10 MHz	-15 dBm	1 MHz	Note 2
Fu +10 MHz ↔ 12,5 GHz	-30 dBm	1 MHz	Note 3
NOTE 1: Bandwidth as in ITU-R SM.329 [6], s4.1 NOTE 2: Specification in accordance with ITU-R SM.329 [6], s4.1 NOTE 3: Bandwidth as in ITU-R SM.329-9, s4.1. Upper frequency as in ITU-R SM.329-9, s2.5 table 1			

Fl: Lower frequency of the band in which TDD operates

Fu: Upper frequency of the band in which TDD operates

## 9.2.2.2 Co-existence with GSM 900

### 9.2.2.2.1 Operation in the same geographic area

This requirement may be applied for the protection of GSM 900 MS and GSM 900 BTS receivers in geographic areas in which both GSM 900 and UTRA are deployed.

The power of any spurious emission shall not exceed the maximum level given in Table 9.10.

**Table 9.10: LCR TDD repeater Spurious emissions limits for LCR TDD repeater in geographic coverage area of GSM 900 MS and GSM 900 BTS receiver**

Band	Maximum Level	Measurement Bandwidth	Note
876 - 915 MHz	-61 dBm	100 kHz	
921 - 960MHz	-57 dBm	100 kHz	

### 9.2.2.2.2 Co-located base stations

This requirement may be applied for the protection of GSM 900 BTS receivers when GSM 900 BTS and UTRA BS are co-located.

The power of any spurious emission shall not exceed the maximum level given in table 9.11.

**Table 9.11: LCR TDD repeater Spurious emissions limits for protection of the GSM 900 BTS receiver**

Band	Maximum Level	Measurement Bandwidth	Note
876 - 915 MHz	-98 dBm	100 kHz	

### 9.2.2.3 Co-existence with DCS 1800

#### 9.2.2.3.1 Operation in the same geographic area

This requirement may be applied for the protection of DCS 1800 MS and DCS 1800 BTS receivers in geographic areas in which both DCS 1800 and UTRA are deployed.

The power of any spurious emission shall not exceed the maximum level given in table 9.12.

**Table 9.12: LCR TDD repeater Spurious emissions limits for LCR TDD repeater in the band a), d) and e) when operating in geographic coverage area of DCS 1800 MS and DCS 1800 BTS receiver**

Band	Maximum Level	Measurement Bandwidth	Note
1710 - 1785 MHz	-61 dBm	100 kHz	
1805 - 1880MHz	-47 dBm	100 kHz	

**Table 9.12a: LCR TDD repeater Spurious emissions limits for LCR TDD repeater in the band f) when operating in geographic coverage area of DCS 1800 MS and DCS 1800 BTS receiver operating in 1710-1755 MHz/1805-1850 MHz**

Band	Maximum Level	Measurement Bandwidth	Note
1710 - 1755 MHz	-61 dBm	100 kHz	
1805 - 1850MHz	-47 dBm	100 kHz	

#### 9.2.2.3.2 Co-located base stations

This requirement may be applied for the protection of DCS 1800 BTS receivers when DCS 1800 BTS and UTRA BS are co-located.

The power of any spurious emission shall not exceed the maximum level given in table 9.13.

**Table 9.13: LCR TDD repeater Spurious emissions limits for LCR TDD repeater in the band a), d) and e) when co-located with DCS 1800 BTS**

Band	Maximum Level	Measurement Bandwidth	Note
1710 - 1785 MHz	-98 dBm	100 kHz	

**Table 9.13a: LCR TDD repeater Spurious emissions limits for LCR TDD repeater in the band f) when co-located with DCS1800 BTS**

Band	Maximum Level	Measurement Bandwidth	Note
1710 - 1755 MHz	-98 dBm	100 kHz	

### 9.2.2.4 Co-existence with UTRA-FDD

#### 9.2.2.4.1 Operation in the same geographic area

This requirement may be applied to geographic areas in which both UTRA-TDD and UTRA-FDD operating in bands specified in Table 9.11 are deployed.

For LCR TDD repeater which use carrier frequencies within the band 2010 - 2025 MHz the requirements applies at all frequencies within the specified frequency bands in table 9.11. For LCR TDD repeater which use carrier frequencies within the band 1900-1920 MHz, the requirement applies at frequencies within the specified frequency range which are more than 4 MHz above the last carrier used in the frequency band 1900-1920 MHz.

The power of any spurious emission shall not exceed the maximum level given in table 9.14.

**Table 9.14: LCR TDD repeater Spurious emissions limits for LCR TDD repeater in geographic coverage area of UTRA-FDD**

Band	Maximum Level	Measurement Bandwidth	Note
1920 - 1980 MHz	-43 dBm (*)	3,84 MHz	
2110 - 2170 MHz	-52 dBm	1 MHz	
2500 - 2570 MHz	-43 dBm(**)	3.84 MHz	
2620 - 2690 MHz	-52 dBm	1 MHz	
NOTE*	For LCR TDD repeater which use carrier frequencies within the band 1900 - 1920 MHz or 1880-1920MHz, the requirement shall be measured RRC filtered mean power with the lowest centre frequency of measurement at 1922.6 MHz or 6.6 MHz above the highest TDD carrier used, whichever is higher.		
NOTE**	For LCR TDD repeater which use carrier frequencies within the band 2570 - 2620 MHz, the requirement shall be measured RRC filtered mean power with the highest centre frequency of measurement at 2567.5 MHz or 6.6 MHz below the lowest TDD carrier used, whichever is lower.		

NOTE: The requirements in Table 9.14 are based on a coupling loss of 70 dB between LCR TDD repeater and FDD Wide Area base stations.

#### 9.2.2.4.2 Co-located base stations

This requirement may be applied for the protection of UTRA-FDD BS receivers when UTRA-TDD BS and UTRA FDD BS are co-located.

For LCR TDD repeater which use carrier frequencies within the band 2010 - 2025 MHz the requirements applies at all frequencies within the specified frequency bands in table 9.12. For LCR TDD repeater which use carrier frequencies within the band 1900-1920 MHz, the requirement applies at frequencies within the specified frequency range which are more than 4 MHz above the last carrier used in the frequency band 1900-1920 MHz.

The power of any spurious emission shall not exceed the maximum level given in table 9.15.

**Table 9.15: LCR TDD repeater Spurious emissions limits for BS co-located with UTRA-FDD**

Band	Maximum Level	Measurement Bandwidth
1920 - 1980 MHz	-80 dBm (*)	3,84 MHz
2110 - 2170 MHz	-52 dBm	1 MHz
2500 - 2570 MHz	- 80 dBm(**)	3.84 MHz
2620 - 2690 MHz	-52 dBm	1 MHz
NOTE *	For LCR TDD repeater which use carrier frequencies within the band 1900 - 1920 MHz or 1880-1920MHz, the requirement shall be measured RRC filtered mean power with the lowest centre frequency of measurement at 1922.6 MHz or 6.6 MHz above the highest TDD carrier used, whichever is higher.	
NOTE **	For LCR TDD repeater which use carrier frequencies within the band 2570 - 2620 MHz, the requirement shall be measured RRC filtered mean power with the highest centre frequency of measurement at 2567.5 MHz or 6.6MHz below the lowest TDD carrier used, whichever is lower.	

NOTE: The requirements in Table 9.15 are based on a minimum coupling loss of 30 dB between LCR TDD repeater and UTRA-FDD base stations.

#### 9.2.2.5 Co-existence with unsynchronised TDD

##### 9.2.2.5.1 Operation in the same geographic area

This requirement may be applied for the protection of TDD BS receivers in geographic areas in which unsynchronised TDD is deployed.

In geographic areas where only 1,28 Mcps TDD is deployed, the RRC filtered mean power of any spurious emission shall not exceed the limits specified in table 9.16, otherwise the limits in table 9.17 shall apply.

**Table 9.16: LCR TDD repeater Spurious emissions limits for operation in same geographic area with unsynchronised 1,28 Mcps TDD**

Band	Maximum Level	Measurement Bandwidth
1900 - 1920 MHz	-39 dBm	1,28 MHz
2010 - 2025 MHz	-39 dBm	1,28 MHz
2300 - 2400 MHz	-39 dBm	1,28 MHz
2570 - 2620 MHz	-39 dBm	1,28 MHz
1880 – 1920 MHz	-39 dBm	1,28 MHz

**Table 9.17: LCR TDD repeater Spurious emissions limits for operation in same geographic area with unsynchronised TDD**

Band	Maximum Level	Measurement Bandwidth
1900 - 1920 MHz	-39 dBm	3,84 MHz
2010 - 2025 MHz	-39 dBm	3,84 MHz
2570 - 2620 MHz	-39 dBm	3,84 MHz

NOTE: The requirements in Table 9.16 and 9.17 for the LCR TDD repeater are based on a minimum coupling loss of 67 dB between LCR TDD repeater and unsynchronised TDD base stations.

#### 9.2.2.5.2 Co-located base stations

This requirement may be applied for the protection of TDD BS receivers when unsynchronised TDD BS are co-located.

In geographic areas where only 1,28 Mcps TDD is deployed, the RRC filtered mean power of any spurious emission in case of co-location shall not exceed the limits specified in table 9.18, otherwise the limits in table 9.19 shall apply.

**Table 9.18: LCR TDD repeater Spurious emissions limits for co-location with unsynchronised 1,28 Mcps TDD**

Band	Maximum Level	Measurement Bandwidth
1900 - 1920 MHz	-76 dBm	1,28 MHz
2010 - 2025 MHz	-76 dBm	1,28 MHz
2300 - 2400 MHz	-76 dBm	1,28 MHz
2570 - 2620 MHz	-76 dBm	1,28 MHz
1880 - 1920 MHz	-76 dBm	1,28 MHz
NOTE: The requirement applies for frequencies more than 10 MHz below or above the supported frequency range declared by the vendor.		

**Table 9.19: LCR TDD repeater Spurious emissions limits for co-location with unsynchronised TDD**

Band	Maximum Level	Measurement Bandwidth
1900 - 1920 MHz	-76 dBm	3,84 MHz
2010 - 2025 MHz	-76 dBm	3,84 MHz
2570 - 2620MHz	-76 dBm	3,84 MHz

NOTE: The requirements in Table 9.18 and 9.19 for the LCR TDD repeater are based on a minimum coupling loss of 30 dB between unsynchronised TDD base stations.

### 9.2.3 Test purpose

The test purpose is to verify the ability of the LCR TDD repeater to limit the interference caused by unwanted transmitter effects to other systems operating at frequencies which are more than 4 MHz away from of the UTRA band used.

## 9.2.4 Method of test

### 9.2.4.1 Initial conditions

- 1) Set-up the equipment as shown in annex A.
- 2) Connect the signal generator equipment to the Repeater input port.
- 3) Connect the power measuring equipment to the Repeater output port.

### 9.2.4.2 Procedure

- 1) Set the Repeater to maximum gain.
- 2) Set the signal generator(s) to generate signal(s) in accordance to table 9.4, at level(s) which produce the manufacturer specified maximum output power at maximum gain.
- 3) The detecting device shall be configured with a measurement bandwidth as stated in the tables.
- 4) Measure the emission at the specified frequencies with specified measurement bandwidth and note that the measured value does not exceed the specified value.
- 5) Increase the input power with 10 dB compare to the level obtained in step 2.
- 6) Measure the emission at the specified frequencies with specified measurement bandwidth and note that the measured value does not exceed the specified value.

## 9.2.5 Test Requirements

The spurious emissions measured according to subclause 9.2.4.2 shall not exceed the limits specified in the relevant tables of 9.2.2.

---

# 10 Modulation accuracy

## 10.1 Error Vector Magnitude

### 10.1.1 Definition and applicability

The modulation accuracy is defined by the Error Vector Magnitude (EVM), which is a measure of the difference between the theoretical waveform and a modified version of the measured waveform. This difference is called the error vector. The measured waveform is modified by first passing it through a matched root raised cosine filter with bandwidth 1.28MHz and roll-off  $\alpha=0.22$ . The waveform is then further modified by selecting the frequency, absolute phase, absolute amplitude and chip clock timing so as to minimise the error vector. The EVM result is defined as root of the ratio of the mean error vector power to the mean reference signal power expressed as a %.

The measurement interval is one power control group (timeslot). The repeater shall operate with an ideal LCR TDD signal in the pass band of the repeater at a level, which produce the maximum rated output power per channel, as specified by the manufacturer.

### 10.1.2 Minimum requirements

The Error Vector Magnitude shall not be worse than 8 %.

### 10.1.3 Test purpose

To verify that the EVM is within the limit specified in 10.1.2 after the signal passed through the Repeater..

## 10.1.4 Method of test

### 10.1.4.1 Initial conditions

- 1) Set-up the equipment as shown in annex A.
- 2) Connect the signal generator equipment to the Repeater input port.
- 3) Connect the signal analyser to the Repeater output port..

### 10.1.4.2 Procedure

- 1) Set the signal generator to transmit one signal according to table 10.1.

**Table 10.1: Parameters of the transmitted signal for Error Vector Magnitude testing**

Parameter	Value/description
TDD Duty Cycle	TS $i$ ; $i = 0, 1, 2, \dots, 6$ : Transmit, if $i$ is 0,4,5,6; receive, if $i$ is 1,2,3.
Time slots under test	TS4, TS5 and TS6
Number of DPCH in each time slot under test	10
Power of each DPCH	1/10 of Base Station output power
Base station power	PRAT

- 2) Adjust the input power to the Repeater to create the maximum nominal Repeater output power at maximum gain.
- 3) Measure the Error Vector Magnitude for both paths uplink and downlink of the Repeater.

## 10.1.5 Test requirements

The error vector magnitude (EVM) measured according to subclause 10.1.4.2 shall not exceed 8 %.

## 10.2 Peak code domain error

### 10.2.1 Definition and applicability

The code domain error is computed by projecting the error vector power onto the code domain at a specific spreading factor. The error power for each code is defined as the ratio to the mean power of the reference waveform expressed in dB. And the Peak Code Domain Error is defined as the maximum value for Code Domain Error. The measurement interval is one timeslot.

### 10.2.2 Minimum requirement

The peak code domain error shall not exceed -30 dB at spreading factor 16.

### 10.2.3 Test purpose

To verify that the peak code domain error is within the limit specified in 10.2.2 after the signal passed through the Repeater.

## 10.2.4 Method of test

### 10.2.4.1 Initial conditions

- 1) Set-up the equipment as shown in annex A.

- 2) Connect the signal generator equipment to the Repeater input port.
- 3) Connect the signal analyser to the Repeater output port..

#### 10.2.4.2 Procedure

- 1) Set the signal generator to transmit one signal according to table 10.2.

**Table 10.2: Parameters of the transmitted signal for Peak Code Domain Error testing**

Parameter	Value/description
TDD Duty Cycle	TS $i$ ; $i = 0, 1, 2, \dots, 6$ : transmit, if $i$ is 0,4,5,6; receive, if $i$ is 1,2,3.
Time slots under test	TS4, TS5 and TS6
BS output power setting	PRAT
Number of DPCH in each time slot under test	10
Power of each DPCH	1/10 of Base Station output power
Data content of DPCH	real life (sufficient irregular)
Spreading factor	16

- 2) Adjust the input power to the Repeater to create the maximum nominal Repeater output power at maximum gain.
- 3) Measure the Peak Code Domain Error for both paths uplink and downlink of the Repeater.

#### 10.2.5 Test requirements

The peak code domain error measured according to subclause 10.2.4.2 shall not exceed -30 dB at spreading factor 16.

---

## 11 Input Intermodulation

The input intermodulation is a measure of the capability of the repeater to inhibit the generation of interference in the pass band, in the presence of interfering signals on frequencies other than the pass band.

### 11.1 Definition and applicability

Third and higher order mixing of the two interfering RF signals can produce an interfering signal in the band of the desired channel. Intermodulation response rejection is a measure of the capability of the Repeater to maintain the wanted frequency free of internally created interference.

This test applies to uplink and downlink path of the Repeater.

### 11.2 Minimum requirement

#### 11.2.1 General requirement

For the parameters specified in table 11.1, the power in the pass band shall not increase with more than 10 dB at the output of the repeater as measured in the centre of the pass band, compared to the level obtained without interfering signals applied.

The frequency separation between the two interfering signals shall be adjusted so that the 3<sup>rd</sup> order intermodulation product is positioned in the centre of the pass band.

Table 11.1 specifies the parameters for two interfering signals, where:

- $f_1$  offset is the offset from the channel edge frequency of the first or last channel in the pass band of the closer carrier.



**Table 11.1: Input intermodulation requirement**

<b>f<sub>1</sub> offset</b>	<b>Interfering Signal Levels</b>	<b>Type of signals</b>	<b>Measurement bandwidth</b>
1,0 MHz	-40 dBm	2 CW carriers	1 MHz

## 11.2.2 Co-location with BS in other systems

This additional input intermodulation requirement may be applied for the protection of TDD Repeater input when GSM900, DCS1800, PCS1900, GSM850, UTRA FDD, UTRA TDD and/or E-UTRA BS are co-located with an LCR TDD Repeater.

Unless otherwise stated this requirement applies to the uplink and downlink of the repeater, at maximum gain.

For the parameters specified in table 11.2, the power in the pass band shall not increase with more than 10 dB at the output of the repeater as measured in the centre of the pass band, compared to the level obtained without interfering signals applied.

The frequency separation between the two interfering signals shall be adjusted so that the lowest order intermodulation product is positioned in the centre of the pass band.

NOTE 1: The lowest intermodulation products correspond to the 4<sup>th</sup> and 3<sup>rd</sup> order for the GSM 900 and DCS 1800 bands, respectively.

### **Table 11.2: Input intermodulation requirements for interfering signals in co-located other systems**

Co-located other systems	Frequency of interfering signals	Interfering Signal Levels	Type of signals	Measurement bandwidth	Note
GSM900	921 - 960 MHz	+16 dBm	2 CW carriers	1 MHz	
DCS1800	1805 - 1880 MHz	+16 dBm	2 CW carriers	1 MHz	
PCS1900	1930 - 1990 MHz	+16 dBm	2 CW carriers	1 MHz	
GSM850	869 - 894 MHz	+16 dBm	2 CW carriers	1 MHz	
UTRA-FDD Band I or E-UTRA Band 1	2110 - 2170 MHz	+16 dBm	2 CW carriers	1 MHz	
UTRA-FDD Band II or E-UTRA Band 2	1930 - 1990 MHz	+16 dBm	2 CW carriers	1 MHz	
UTRA-FDD Band III or E-UTRA Band 3	1805 - 1880 MHz	+16 dBm	2 CW carriers	1 MHz	
UTRA-FDD Band IV or E-UTRA Band 4	2110 - 2155 MHz	+16 dBm	2 CW carriers	1 MHz	
UTRA-FDD Band V or E-UTRA Band 5	869 - 894 MHz	+16 dBm	2 CW carriers	1 MHz	
UTRA-FDD Band VI or E-UTRA Band 6	875 - 885 MHz	+16 dBm	2 CW carriers	1 MHz	
UTRA-FDD Band VII or E-UTRA Band 7	2620 - 2690 MHz	+16 dBm	2 CW carriers	1 MHz	
UTRA-FDD Band VIII or E-UTRA Band 8	925 - 960 MHz	+16 dBm	2 CW carriers	1 MHz	
UTRA-FDD Band IX or E-UTRA Band 9	1844.9 - 1879.9 MHz	+16 dBm	2 CW carriers	1 MHz	
UTRA-FDD Band X or E-UTRA Band 10	2110 - 2170 MHz	+16 dBm	2 CW carriers	1 MHz	
UTRA-FDD Band XI or E-UTRA Band 11	1475.9 - 1500.9 MHz	+16 dBm	2 CW carriers	1 MHz	
UTRA FDD Band XII or E-UTRA Band 12	728 - 746 MHz	+16 dBm	2 CW carriers	1 MHz	
UTRA FDD Band XIII or E-UTRA Band 13	746 - 756 MHz	+16 dBm	2 CW carriers	1 MHz	
UTRA FDD Band XIV or E-UTRA Band 14	758 - 768 MHz	+16 dBm	2 CW carriers	1 MHz	

UTRA TDD in Band a) or E-UTRA Band 33	1900 - 1920 MHz	+16 dBm	2 CW carriers	1 MHz	This requirement does not apply to LCR TDD Repeater operating in band a), since it is already covered by the requirement in sub-clause 11.1, but requires a 86dB coupling loss between base station and the repeater DL receive port.
UTRA TDD in Band a) or E-UTRA Band 34	2010 - 2025 MHz	+16 dBm	2 CW carriers	1 MHz	This requirement does not apply to LCR TDD Repeater operating in band a), since it is already covered by the requirement in sub-clause 11.1, but requires a 86dB coupling loss between base station and the repeater DL receive port.
UTRA TDD in Band b) or E-UTRA Band 35	1850 – 1910 MHz	+16 dBm	2 CW carriers	1 MHz	This requirement does not apply to LCR TDD Repeater operating in band b), since it is already covered by the requirement in sub-clause 11.1, but requires a 86dB coupling loss between base station and the repeater DL receive port.
UTRA TDD in Band b) or E-UTRA Band 36	1930 – 1990 MHz	+16 dBm	2 CW carriers	1 MHz	This requirement does not apply to LCR TDD Repeater operating in band b), since it is already covered by the requirement in sub-clause 11.1, but requires a 86dB coupling loss between base station and the repeater DL receive port.
UTRA TDD in Band c) or E-UTRA Band 37	1910 - 1930 MHz	+16 dBm	2 CW carriers	1 MHz	This requirement does not apply to LCR TDD Repeater operating in band c), since it is already covered by the requirement in sub-clause 11.1, but requires a 86dB coupling loss between base station and the repeater DL receive port.
UTRA TDD in Band d) or E-UTRA Band 38	2570 – 2620 MHz	+16 dBm	2 CW carriers	1 MHz	This requirement does not apply to LCR TDD Repeater operating in band d), since it is already covered by the requirement in sub-clause 11.1, but requires a 86dB coupling loss between base station and the repeater DL receive port.
UTRA TDD in Band e) or E-UTRA Band 40	2300 – 2400 MHz	+16 dBm	2 CW carriers	1 MHz	This requirement does not apply to LCR TDD Repeater operating in band e), since it is already covered by the requirement in sub-clause 11.1, but requires a 86dB coupling loss between base station and the repeater DL receive port.
UTRA TDD in Band f) or E-UTRA Band 39	1880 – 1920 MHz	+16 dBm	2 CW carriers	1 MHz	This requirement does not apply to LCR TDD Repeater operating in band f), since it is already covered by the requirement in sub-clause 11.1, but requires a 86dB coupling loss between base station and the repeater DL receive port.

NOTE 1: The co-location requirements in Table 11.2 do not apply when the repeaters pass band frequency range is adjacent to the band for the co-location requirement in the Table 11.2. The current state-of-the-art technology does not allow a single generic solution for co-location with other system on adjacent frequencies for 30dB Repeater-BS minimum coupling loss. However, there are certain site-engineering solutions that can be used. These techniques are addressed in TR 25.942 [13].

NOTE 2: The Table 11.2 assumes that two operating bands, where the corresponding transmit and receive frequency ranges would be overlapping, are not deployed in the same geographical area. For such a case of operation with overlapping frequency arrangements in the same geographical area, special co-location requirements may apply that are not covered by the 3GPP specifications.

### 11.2.3 Co-existence with other systems

This additional input intermodulation requirement may be applied when GSM900, DCS1800, PCS1900, GSM850, UTRA FDD, UTRA TDD and/or E-UTRA BS operating in another frequency band co-exist with an E-UTRA FDD Repeater.

Unless otherwise stated this requirement applies to the uplink and downlink of the repeater, at maximum gain.

For the parameters specified in table 11.3, the power in the pass band shall not increase with more than 10 dB at the output of the repeater as measured in the centre of the pass band, compared to the level obtained without interfering signals applied.

The frequency separation between the two interfering signals shall be adjusted so that the lowest order intermodulation product is positioned in the centre of the pass band.

NOTE 1: The lowest intermodulation products correspond to the 4<sup>th</sup> and 3<sup>rd</sup> order for the GSM 900 and DCS 1800 bands, respectively.

**Table 11.3: Input intermodulation requirements for interfering signals in co-existing other systems**

Co-existence with other systems	Frequency of interfering signals	Interfering Signal Levels	Type of signals	Measurement bandwidth	Note
GSM900	876 - 915 MHz	-15 dBm	2 CW carriers	1 MHz	
DCS1800	1710 - 1785 MHz	-15 dBm	2 CW carriers	1 MHz	
PCS1900	1850 - 1910 MHz	-15 dBm	2 CW carriers	1 MHz	
GSM850	824 - 849 MHz	-15 dBm	2 CW carriers	1 MHz	
UTRA FDD Band I or E-UTRA Band 1	1920 - 1980 MHz	-15 dBm	2 CW carriers	1 MHz	
UTRA FDD Band II or E-UTRA Band 2	1850 - 1910 MHz	-15 dBm	2 CW carriers	1 MHz	
UTRA FDD Band III or E-UTRA Band 3	1710 - 1785 MHz	-15 dBm	2 CW carriers	1 MHz	
UTRA FDD Band IV or E-UTRA Band 4	1710 - 1755 MHz	-15 dBm	2 CW carriers	1 MHz	
UTRA FDD Band V or E-UTRA Band 5	824 - 849 MHz	-15 dBm	2 CW carriers	1 MHz	
UTRA FDD Band VI or E-UTRA Band 6	815 - 850 MHz	-15 dBm	2 CW carriers	1 MHz	
UTRA FDD Band VII or E-UTRA Band 7	2500 - 2570 MHz	-15 dBm	2 CW carriers	1 MHz	
UTRA FDD Band VIII or E-UTRA Band 8	880 - 915 MHz	-15 dBm	2 CW carriers	1 MHz	
UTRA FDD Band IX or E-UTRA Band 9	1749.9 - 1784.9 MHz	-15 dBm	2 CW carriers	1 MHz	
UTRA FDD Band X or E-UTRA Band 10	1710 - 1770 MHz	-15 dBm	2 CW carriers	1 MHz	
UTRA FDD Band XI or E-UTRA Band 11	1427.9 - 1452.9 MHz	-15 dBm	2 CW carriers	1 MHz	
UTRA FDD Band XII or E-UTRA Band 12	698 - 716 MHz	-15 dBm	2 CW carriers	1 MHz	
UTRA FDD Band XIII or E-UTRA Band 13	777 - 787 MHz	-15 dBm	2 CW carriers	1 MHz	
UTRA FDD Band XIV or E-UTRA Band 14	788 - 798 MHz	-15 dBm	2 CW carriers	1 MHz	
UTRA TDD in Band a) or E-UTRA Band 33	1900 - 1920 MHz	-15 dBm	2 CW carriers	1 MHz	This requirement does not apply to LCR TDD Repeater operating in band a), since it is already covered by the requirement in sub-clause 11.1.
UTRA TDD in Band a) or E-UTRA Band 34	2010 - 2025 MHz	-15 dBm	2 CW carriers	1 MHz	This requirement does not apply to LCR TDD Repeater operating in band a), since it is already covered by the requirement in sub-clause 11.1.

UTRA TDD in Band b) or E-UTRA Band 35	1850 – 1910 MHz	-15 dBm	2 CW carriers	1 MHz	This requirement does not apply to LCR TDD Repeater operating in band b), since it is already covered by the requirement in sub-clause 11.1.
UTRA TDD in Band b) or E-UTRA Band 36	1930 – 1990 MHz	-15 dBm	2 CW carriers	1 MHz	This requirement does not apply to LCR TDD Repeater operating in band b), since it is already covered by the requirement in sub-clause 11.1.
UTRA TDD in Band c) or E-UTRA Band 37	1910 - 1930 MHz	-15 dBm	2 CW carriers	1 MHz	This requirement does not apply to LCR TDD Repeater operating in band c), since it is already covered by the requirement in sub-clause 11.1.
UTRA TDD in Band d) or E-UTRA Band 38	2570 – 2620 MHz	-15 dBm	2 CW carriers	1 MHz	This requirement does not apply to LCR TDD Repeater operating in band d), since it is already covered by the requirement in sub-clause 11.1.
UTRA TDD in Band e) or E-UTRA Band 40	2300 – 2400 MHz	-15 dBm	2 CW carriers	1 MHz	This requirement does not apply to LCR TDD Repeater operating in band e), since it is already covered by the requirement in sub-clause 11.1.
UTRA TDD in Band f) or E-UTRA Band 39	1880 – 1920 MHz	-15 dBm	2 CW carriers	1 MHz	This requirement does not apply to LCR TDD Repeater operating in band f), since it is already covered by the requirement in sub-clause 11.1.

NOTE 1: The co-existence requirements in Table 11.3 do not apply when the repeaters pass band frequency range is adjacent to the band for the co-existence requirement in the Table 11.3. The current state-of-the-art technology does not allow a single generic solution for co-existence.

NOTE 2: The Table 11.3 assumes that two operating bands, where the frequency ranges would be overlapping, are not deployed in the same geographical area. For such a case of operation with overlapping frequency arrangements in the same geographical area, special co-existence requirements may apply that are not covered by the 3GPP specifications.

## 11.3 Test purpose

The purpose of this test is to verify that the Repeater meets the intermodulation characteristics requirements as specified by the minimum requirements.

## 11.4 Method of test

### 11.4.1 Initial conditions

- 1) A measurement system set-up is shown in annex A.
- 2) Set the Repeater to maximum gain.
- 3) Connect two signal generators with a combining circuit or one signal generator with the ability to generate several CW carriers to the input.
- 4) Connect a spectrum analyser to the output of the Repeater. Set the resolution bandwidth to 1 MHz in the centre of the pass band. Set averaging to 1 second or more.

### 11.4.2 Procedure

- 1) Adjust the frequency of the input signals, either below or above the pass band, so that one carrier,  $f_1$ , is 1 MHz outside the channel edge frequency of the first or last channel in the pass band, and the lowest order intermodulation product from the two carriers is positioned in the centre of the pass band, according to subclause 11.2.
- 2) Take the measurement of the rise of the output signal.

- 3) Repeat the measurement for the opposite path of the Repeater.

## 11.5 Test requirements

The Input intermodulation measured according to subclause 11.4.2 shall not exceed the limits specified in the relevant tables of 11.2.

---

# 12 Output Intermodulation

The transmit intermodulation performance is a measure of the capability of the transmitter to inhibit the generation of signals in its non linear elements caused by presence of the wanted signal and an interfering signal reaching the transmitter via the antenna.

## 12.1 Definition and applicability

The transmit intermodulation level is the power of the intermodulation products when a LCR TDD modulated interference signal is injected into the antenna connector at a mean power level of 30 dB lower than that of the mean power of the subject signal.

The requirement is applicable for downlink signals.

## 12.2 Minimum requirements

The frequency of the interference signal shall be  $\pm 1.6$  MHz,  $\pm 3.2$  MHz and  $\pm 4.8$  MHz offset from the subject signal. The Transmit intermodulation level shall not exceed the out of band or the spurious emission requirements of section 9.1 and 9.2.

## 12.3 Test purpose

The test purpose is to verify the ability of the repeater to restrict the generation of intermodulation products in the presence of a subject signal on the repeater input and output ports, and an interfering signal applied at the repeater output port.

## 12.4 Method of test

### 12.4.1 Initial conditions

- 1) A measurement system set-up is shown in annex A.
- 2) Connect a signal generator to the input port of the Repeater (wanted signal). Connect a signal generator to the circulator on the output port (interfering signal) and make sure the signal generator power is directed to the repeater output port.
- 3) Detection mode: True RMS.

### 12.4.2 Procedures

- 1) Set the Repeater to maximum gain.
- 2) Set the signal generator at the repeater input port (subject signal) to generate a signal in accordance to table 12.1, at the level which produce the manufacturer specified maximum output power at maximum gain.



**Table 12.1: Parameters of the transmitted signal for transmit intermodulation testing**

Parameter	Value/description
TDD Duty Cycle	TS $i$ ; $i = 0, 1, 2, 3, 4, 5, 6$ : transmit, if $i$ is 0,4,5,6; receive, if $i$ is 1,2,3.
Time slots under test	TS4, TS5 and TS6
BS output power setting	PRAT
Number of DPCH in each time slot under test	8
Power of each DPCH	1/8 of Base Station output power
Data content of DPCH	real life (sufficient irregular)

- 3) Set the signal generator at the repeater output port (interference signal) to generate a signal in accordance to table 12.1, at the level producing signal power corresponding to 30 dB below the manufacturer specified maximum output power at the repeater output port with the specified frequency offset from the wanted signal.
- 4) Measure the emission at the specified frequencies with specified measurement bandwidth and note that the measured value does not exceed the specified value. Measurements in the band of the interfering signal shall be excluded. The measurements can be limited to the power of all third and fifth order intermodulation products.
- 5) Repeat from clause 3 until interference signals  $\pm 1,6\text{MHz}$ ,  $\pm 3,2\text{MHz}$  and  $\pm 4,8\text{MHz}$  frequency offset from the wanted signal has been tested. Note that interfering signals outside the UTRA-FDD allocated frequency band, as specifies in section 4.1. need not be tested.

## 12.5 Test requirements

The mean power level of the interference signal shall be 30 dB below the mean power level of the wanted signal.

At the frequencies of all third and fifth order intermodulation products, the Test Requirements for out of band and spurious emissions as specified in subclauses 9.1.5 (Spectrum emission mask), and 9.2.5 (Spurious emissions) shall be met.

---

## 13 Adjacent Channel Rejection Ratio (ACRR)

### 13.1 Definitions and applicability

Adjacent Channel Rejection Ratio (ACRR) is the ratio of the RRC weighted gain per carrier of the repeater in the pass band to the RRC weighted gain of the repeater on an adjacent channel. The carrier in the pass band and in the adjacent channel shall be of the same type (reference carrier).

The requirement shall apply to the uplink and downlink of Repeater, at maximum gain, where the donor link is maintained via antennas (over the air Repeater).

### 13.2 Minimum Requirements

In normal conditions the ACRR shall be higher than the value specified in the Table 13.1.

**Table 13.1: Repeater ACRR**

Repeater maximum output P <sub>max</sub>	Channel offset from the channel edge from the first or last channel within the pass band.	ACRR limit
$P \geq 31$ dBm	1,6 MHz	33dB
$P \geq 31$ dBm	3,2 MHz	33dB
$P < 31$ dBm	1,6 MHz	20dB
$P < 31$ dBm	3,2 MHz	20dB

Note: For co-existence with TDD, a narrow band requirement is for further study.

## 13.3 Test purpose

To verify that the Repeater ACRR requirement shall be met as specified in subclause 13.1.

## 13.4 Method of test

### 13.4.1 Initial conditions

- 1) Set-up the equipment as shown in annex A.
- 2) Connect the signal generator equipment to the Repeater input port.
- 3) Connect the power measuring equipment to the Repeater output port.
- 4) The measurement device characteristics shall be:
  - measurement filter bandwidth: defined in subclause 13.1;
  - detection mode: true RMS voltage or true average power.

### 13.4.2 Procedure

- 1) Set the signal generator to transmit a signal according to table 13.2.

**Table 13.2: Parameters of the transmitted signal for ACRR test**

Parameter	Value/description
TDD Duty Cycle	TS $i$ ; $i = 0, 1, 2, 3, 4, 5, 6$ : transmit, if $i$ is 0,4,5,6; receive, if $i$ is 1,2,3.
Time slots under test	TS4, TS5 and TS6
output power setting	PRAT
Number of DPCH in each time slot under test	8
Power of each DPCH	1/8 of Base Station output power
Data content of DPCH	real life (sufficient irregular)

- 2) Adjust the input power to the Repeater to create the maximum nominal Repeater output power at maximum gain
- 3) Measure the RRC filtered mean power at the RF output port over a certain slot.
- 4) Set the signal generator to transmit the same signal and the same input power at one of the channel offsets according to Table 13.1.
- 5) Measure the RRC filtered mean power at the RF output port over a certain slot.
- 6) Calculate the ratio of the measured power in the pass band to the measured power at the channel offset.
- 7) Repeat step 4) to 6) until all channel offsets in Table 13.1 are measured.

## 13.5 Test Requirements

In normal conditions as specified in section 5.4.1, the ACRR shall be higher than the value specified in the Table 13.3.

Table 13.3: Repeater ACRR

Repeater maximum output power as in 9.1.1.1	Channel offset from the centre frequency of the first or last channel within the pass band.	ACRR limit
$P \geq 31$ dBm	1,6 MHz	32,3dB
$P \geq 31$ dBm	3,2 MHz	32,3dB
$P < 31$ dBm	1,6 MHz	19,3dB
$P < 31$ dBm	3,2 MHz	19,3dB

## 14 Timing Accuracy

### 14.1 Definition and applicability

Timing Accuracy is the repeater synchronization accuracy with NodeB, it includes the downlink ramp on/off time and uplink ramp on/off time.

### 14.2 Minimum requirements

The downlink gain versus time should meet the mask specified in figure 14.1. The beginning and end point of downlink burst is calculated according to the trigger given by NodeB or LCR TDD signal generator.

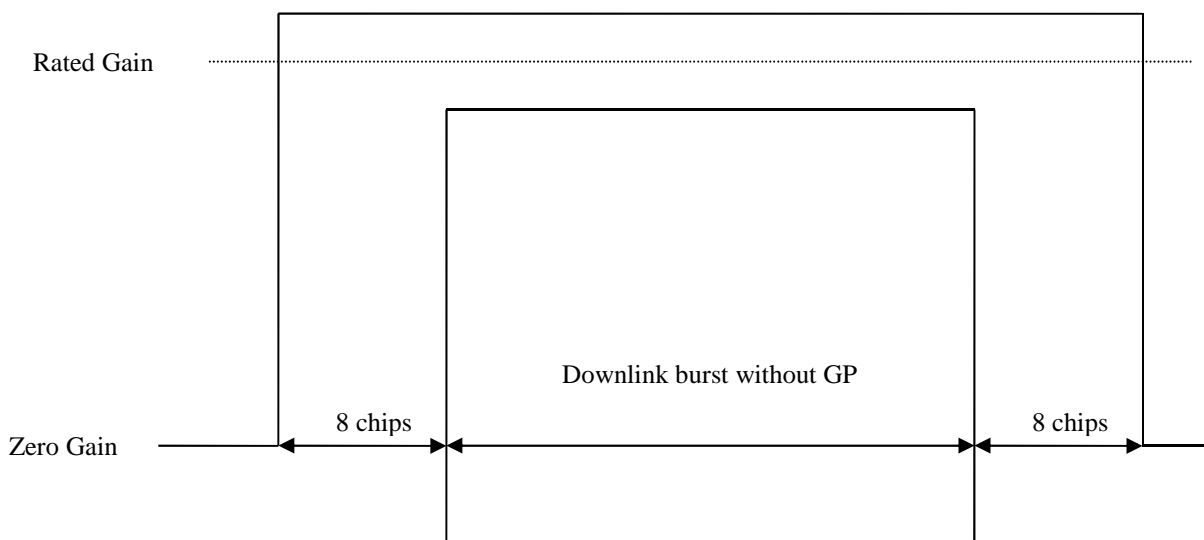

Figure 14.1: Downlink gain ON/OFF template

The uplink gain versus time should meet the mask specified in figure 14.2. The beginning and end point of uplink burst is calculated according to the trigger given by NodeB or LCR TDD signal generator.

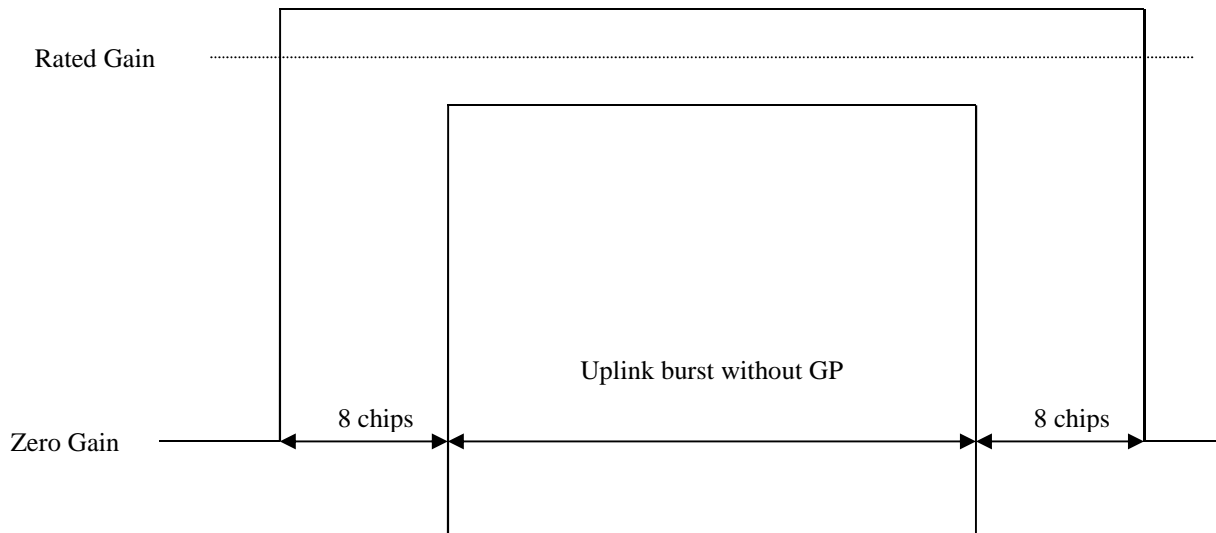

Figure 14.2: Uplink gain ON/OFF template

### 14.3 Test purpose

This test verifies the ability of the LCR TDD repeater to reduce its transmit power outside of the active part of the Tx time slot (burst without guard period) to values below specified limits. This ability is needed to minimize the interference for other users receiving on the same frequency.

### 14.4 Method of test

#### 14.4.1 Initial conditions

- 1) Set-up the equipment as shown in annex A.
- 2) Connect the signal generator equipment to the Repeater input port.
- 3) Connect the signal analyser to the Repeater output port..

#### 14.4.2 Procedure

- 1) Set the signal generator to transmit one signal according to table 14.1.

**Table 14.1: Parameters of the transmitted signal for Timing Accuracy testing**

Parameter	Value/description
TDD Duty Cycle	TS <i>i</i> ; <i>i</i> = 0, 1, 2, 3, 4, 5, 6: transmit, if <i>i</i> is 0,4,5,6; receive, if <i>i</i> is UpPCH,1,2,3.
Time slots under test	TS4, TS5 and TS6
BS output power setting	PRAT
Number of DPCH in each time slot under test	8
Power of each DPCH	1/8 of Base Station output power

- 2) Measure the RRC filtered mean power of the LCR TDD repeater output signal chipwise (i.e. averaged over time intervals of one chip duration) over the transmit off power period starting 8 chips before the beginning point of uplink/downlink burst, and ending 8 chips after the end point of uplink/downlink burst.

## 14.5 Test Requirements

The Timing Accuracy measured according to subclause 14.4.2 shall not exceed the limits specified in the relevant figures of 14.1 and 14.2.

## Annex A (normative): Repeater measurement system set-up

Example of measurement system set-ups are attached below as an informative annex.

### A.1 Maximum output power

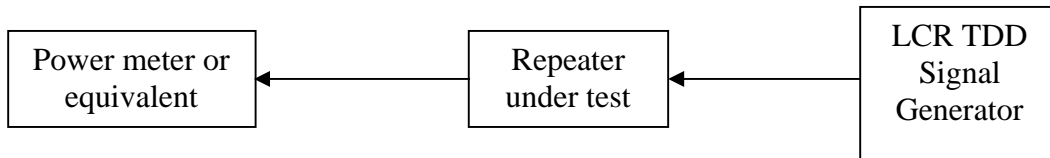

**Figure A.1: Measuring system set-up for maximum output power.**

Note that a repeater is a bi-directional device. The signal generator may need protection.

### A.2 Frequency stability

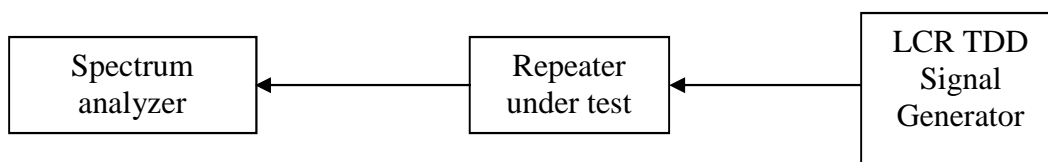

**Figure A.2: Measurement system set-up for RF frequency stability.**

Note that a repeater is a bi-directional device. The signal generator may need protection.

### A.3 Out of band gain

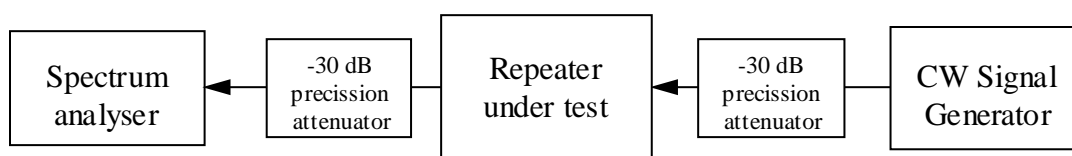

**Figure A.3: Measuring system set-up for out of band gain.**

Note that a repeater is a bi-directional device. The signal generator may need protection.

### A.4 Unwanted emission: Spectrum emission mask

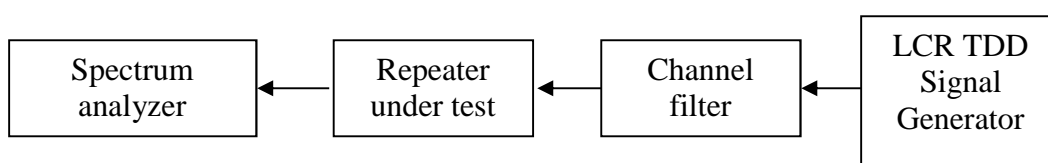

**Figure A.4: Measuring system Set-up for unwanted emission: spectrum emission mask.**

Note that a repeater is a bi-directional device. The signal generator may need protection.

## A.5 Unwanted emission: Spurious emission

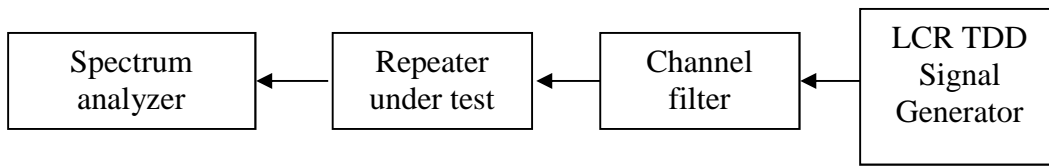

**Figure A.5: Measuring system set-up for unwanted emission: spurious emission.**

Note that a repeater is a bi-directional device. The signal generator may need protection.

## A.6 Modulation Accuracy: Error Vector Magnitude

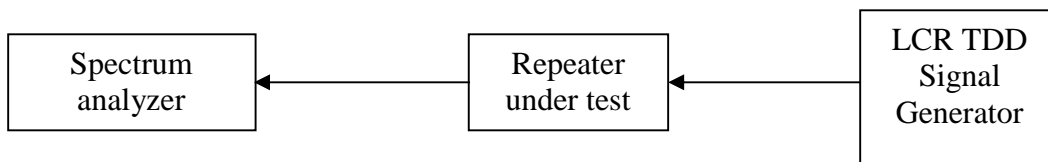

**Figure A.6: Measuring system set-up for modulation accuracy: error vector magnitude.**

Note that a repeater is a bi-directional device. The signal generator may need protection.

## A.7 Modulation Accuracy: Peak Code Domain Error

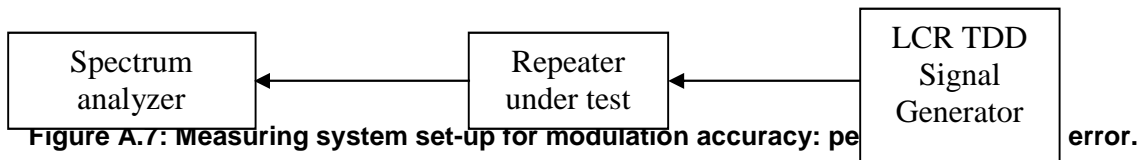

**Figure A.7: Measuring system set-up for modulation accuracy: peak code domain error.**

Note that a repeater is a bi-directional device. The signal generator may need protection.

## A.8 Input inter modulation

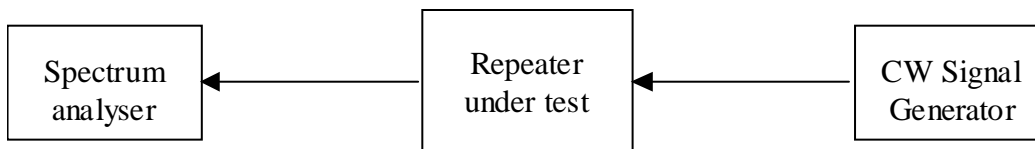

**Figure A.8: Measuring system set-up for input intermodulation.**

## A.9 Output Intermodulation

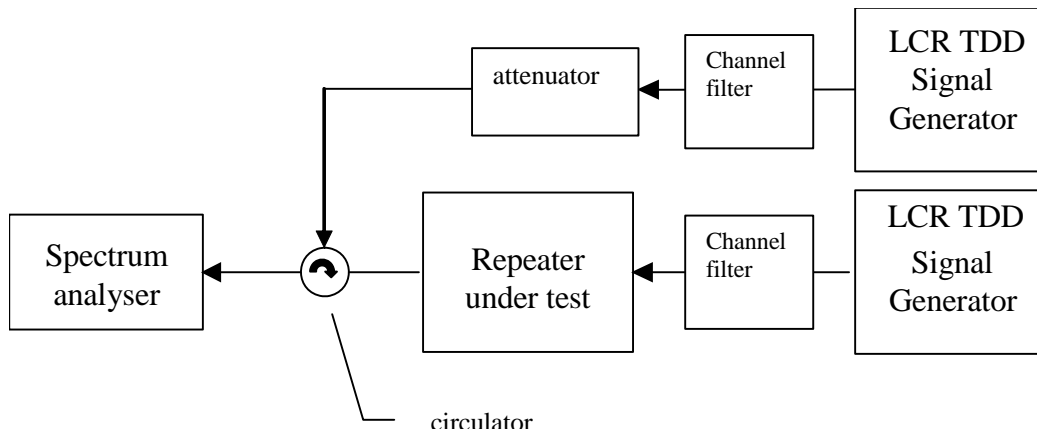

**Figure A.9: Measuring system set-up for Output Intermodulation.**

Note that a repeater is a bi-directional device. The signal generator may need protection.

## A.10 Timing Accuracy

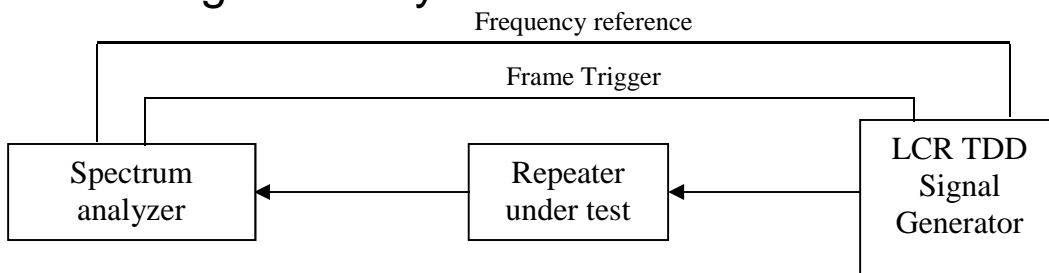

**Figure A.10: Measuring system set-up for Timing Accuracy.**

Note that a repeater is a bi-directional device. The signal generator may need protection.



## Annex B (informative): Derivation of Test Requirements

The Test Requirements in this specification have been calculated by relaxing the Minimum Requirements of the core specification using the Test Tolerances defined in subclause 4.2. When the Test Tolerance is zero, the Test Requirement will be the same as the Minimum Requirement. When the Test Tolerance is non-zero, the Test Requirements will differ from the Minimum Requirements, and the formula used for this relaxation is given in table B.1.

Table B.1: Derivation of Test Requirements

Clause number	Title	Minimum Requirement in TS 25.116	Test Tolerance (TT)	Test Requirement in TS 25.153
6	Maximum output power	In normal conditions Table 6.1	0,7 dB	Formula: Upper limit + TT Lower limit – TT In normal conditions refer to Table 6.4
		In extreme conditions Tabel 6.2	0,7dB	In extreme conditions refer to Table 6.5
9.1	Spectrum emission mask	Tables 9.1, 9.2 and 9.3: "Maximum level" = X dB	1,5 dB	Formula: Maximum level + TT Refer to tables 9.5, 9.6 and 9.7
7	Frequency stability	7.1 minimum requirement	12 Hz	Formula: Relative error + TT Refer to 7.5 Test requirements
8	Out of Band Gain	Table 8.1: Out of band gain limits	0,5 dB	Formula: Maximum level + TT Refer to table 8.2
9.2	Spurious emissions	Tables 9.8, to 9.19	0 dB	
10.1	Error Vector Magnitude	10.1.2 Minimum requirement	0 %	Formula: RSS Stimulus EVM and Repeater EVM to get target EVM Refer to 10.1.5 Test requirements
10.2	Peak code domain error	10.2.2 Minimum requirement	1,1 dB	Formula: Maximum error + TT Refer to 10.2.5 Test requirements
11	Input intermodulation	11.2 Minimum requirements, and Tables 11.1 ,11.2and 11.3	1,2 dB	Maximum in-band power increase + TT Refer to 11.5 Test requirements.
12	Output intermodulation	12.2 Minimum requirements	1,5 dB for spectrum emission mask. 0 dB for spurious emissions	Maximum level + TT Refer to tables 9.5 to 9.19

## Annex C (informative): Acceptable uncertainty of Test Equipment

This informative annex specifies the critical parameters of the components of an overall Test System (e.g. signal generators, signal analysers etc.) which are necessary when assembling a Test System which complies with subclause 5.1 Acceptable uncertainty of Test System. These Test Equipment parameters are fundamental to the accuracy of the overall Test System and are unlikely to be improved upon through System Calibration.

**Table C.1: Equipment accuracy**

Test	Equipment accuracy	Test condition
6 Output power	Not critical	Not critical
9.1 Spectrum emission mask	Not critical	Not critical
9.2 Spurious emissions	Not critical	Not critical
11 Input intermodulation (interferer requirement)	Not critical	Not critical
7 Frequency error	$\pm 10$ Hz + timebase = 12 Hz	Range 0 to 500 Hz. (This is to allow for UE range that at 0,1 PPM is larger than BTS).
10.1 Error vector magnitude	$\pm 2,5$ % (for single code)	P_Max-3 to P_Max – 18 dB Applies for reading from 10% to 25%.
10.2 Peak code domain error	$\pm 1$ dB	Measurements in the range -25 dB to -30 dB at signal power = Pmax
8 Out of band gain		
11 Input intermodulation	Not critical	Not critical
12 Output intermodulation	Not critical	Not critical
13 ACRR		
14 Timing Accuracy	Not critical	Not critical

## Annex D (informative): Change history

Change history							
Date	TSG #	TSG Doc.	CR	Rev	Subject/Comment	Old	New
2009-10	RAN4#52 bis	R4-093748			TS skeleton created from 3GPP TS template.		0.0.1
2010-02	RAN4#54	R4-100999			TS with the TP approved at RAN4#52bis and RAN4#53 R4-093756 Text proposal for TS25.153: Output Power R4-094018 Text proposal for TS25.153: Frequency Error R4-093752 Text proposal for TS25.153: EVM R4-093757 Text proposal for TS25.153: PCDE R4-093755 Text proposal for TS25.153: Output Intermodulation R4-094017 Text proposal for TS25.153: Frequency bands and channel arrangements R4-093753 Text proposal for TS25.153: Input Intermodulation R4-093754 Text proposal for TS25.153: Out of Band Gain R4-093751 Text proposal for TS25.153: ACRR R4-094019 Text proposal for TS25.153: Timing Accuracy R4-093759 Text proposal for TS25.153: Unwanted Emissions R4-093760 Text proposal for 25.153: Clause 1 to Clause 3 R4-094638 Text proposal for 25.153: Clause 4 R4-094768 Text proposal for 25.153: Annex A to Annex D R4-100998 Correction of the Figure A.10 of TS 25.153	0.0.1	1.0.0
2010-03	RAN#47	RP-100111			Presentation to TSG for approval	1.0.0	1.0.0
2010-03	RAN#47	RP-100111			Approved by TSG RAN	1.0.0	10.0.0
2012-09	SP-57	-	-	-	Update to Rel-11 version (MCC)	10.0.0	11.0.0
2014-09	SP-65	-	-	-	Update to Rel-12 version (MCC)	11.0.0	12.0.0
2016-01	SP-70	-	-	-	Update to Rel-13 version (MCC)	12.0.0	13.0.0
2017-03	-	-	-	-	Update to Rel-14 version (MCC)	13.0.0	14.0.0

---

# History

<b>Document history</b>		
V14.0.0	April 2017	Publication