

ETSI TS 125 214 V3.6.0 (2001-03)

Technical Specification

**Universal Mobile Telecommunications System (UMTS);
Physical layer procedures (FDD)
(3GPP TS 25.214 version 3.6.0 Release 1999)**



Reference

RTS/TSGR-0125214UR5

Keywords

UMTS

ETSI

650 Route des Lucioles
F-06921 Sophia Antipolis Cedex - FRANCE

Tel.: +33 4 92 94 42 00 Fax: +33 4 93 65 47 16

Siret N° 348 623 562 00017 - NAF 742 C
Association à but non lucratif enregistrée à la
Sous-Préfecture de Grasse (06) N° 7803/88

Important notice

Individual copies of the present document can be downloaded from:

<http://www.etsi.org>

The present document may be made available in more than one electronic version or in print. In any case of existing or perceived difference in contents between such versions, the reference version is the Portable Document Format (PDF). In case of dispute, the reference shall be the printing on ETSI printers of the PDF version kept on a specific network drive within ETSI Secretariat.

Users of the present document should be aware that the document may be subject to revision or change of status. Information on the current status of this and other ETSI documents is available at <http://www.etsi.org/tb/status/>

If you find errors in the present document, send your comment to:
editor@etsi.fr

Copyright Notification

No part may be reproduced except as authorized by written permission.
The copyright and the foregoing restriction extend to reproduction in all media.

© European Telecommunications Standards Institute 2001.

All rights reserved.

Intellectual Property Rights

IPRs essential or potentially essential to the present document may have been declared to ETSI. The information pertaining to these essential IPRs, if any, is publicly available for **ETSI members and non-members**, and can be found in ETSI SR 000 314: "*Intellectual Property Rights (IPRs); Essential, or potentially Essential, IPRs notified to ETSI in respect of ETSI standards*", which is available from the ETSI Secretariat. Latest updates are available on the ETSI Web server (<http://www.etsi.org/ipr>).

Pursuant to the ETSI IPR Policy, no investigation, including IPR searches, has been carried out by ETSI. No guarantee can be given as to the existence of other IPRs not referenced in ETSI SR 000 314 (or the updates on the ETSI Web server) which are, or may be, or may become, essential to the present document.

Foreword

This Technical Specification (TS) has been produced by the ETSI 3rd Generation Partnership Project (3GPP).

The present document may refer to technical specifications or reports using their 3GPP identities, UMTS identities or GSM identities. These should be interpreted as being references to the corresponding ETSI deliverables.

The cross reference between GSM, UMTS, 3GPP and ETSI identities can be found under www.etsi.org/key.

Contents

Foreword.....	5
1 Scope	6
2 References	6
3 Abbreviations	6
4 Synchronisation procedures.....	7
4.1 Cell search.....	7
4.2 Common physical channel synchronisation	7
4.3 DPCCH/DPDCH synchronisation.....	7
4.3.1 Synchronisation primitives	7
4.3.1.1 General	7
4.3.1.2 Downlink synchronisation primitives	7
4.3.1.3 Uplink synchronisation primitives.....	8
4.3.2 Radio link establishment	8
4.3.2.1 General	8
4.3.2.2 No existing radio link	9
4.3.2.3 One or several existing radio links	9
4.3.3 Radio link monitoring.....	10
4.3.3.1 Downlink radio link failure	10
4.3.3.2 Uplink radio link failure/restore	10
4.3.4 Transmission timing adjustments	10
5 Power control	11
5.1 Uplink power control	11
5.1.1 PRACH.....	11
5.1.1.1 General	11
5.1.1.2 Setting of PRACH control and data part power difference	11
5.1.2 DPCCH/DPDCH.....	11
5.1.2.1 General	11
5.1.2.2 Ordinary transmit power control	12
5.1.2.2.1 General.....	12
5.1.2.2.2 Algorithm 1 for processing TPC commands.....	13
5.1.2.2.3 Algorithm 2 for processing TPC commands.....	13
5.1.2.3 Transmit power control in compressed mode.....	14
5.1.2.4 Transmit power control in the uplink DPCCH power control preamble	17
5.1.2.5 Setting of the uplink DPCCH/DPDCH power difference.....	17
5.1.2.5.1 General.....	17
5.1.2.5.2 Signalled gain factors.....	17
5.1.2.5.3 Computed gain factors	18
5.1.2.5.4 Setting of the uplink DPCCH/DPDCH power difference in compressed mode	18
5.1.2.6 Maximum and minimum power limits	19
5.1.3 PCPCH	19
5.1.3.1 General	19
5.1.3.2 Power control in the message part.....	19
5.1.3.3 Power control in the power control preamble.....	20
5.2 Downlink power control.....	21
5.2.1 DPCCH/DPDCH	21
5.2.1.1 General	21
5.2.1.2 Ordinary transmit power control	21
5.2.1.2.1 UE behaviour	21
5.2.1.2.2 UTRAN behaviour	21
5.2.1.3 Power control in compressed mode.....	22
5.2.1.4 Site selection diversity transmit power control.....	23
5.2.1.4.1 General.....	23
5.2.1.4.2 TPC procedure in UE.....	24
5.2.1.4.3 Selection of primary cell	24

5.2.1.4.4	Delivery of primary cell ID.....	25
5.2.1.4.5	TPC procedure in the network	25
5.2.2	PDSCH	25
5.2.3	AICH	26
5.2.4	PICH.....	26
5.2.5	S-CCPCH	26
5.2.6	CSICH	26
6	Random access procedure	26
6.1	Physical random access procedure	26
6.1.1	RACH sub-channels	27
6.1.2	RACH access slot sets	28
6.2	CPCH Access Procedures	28
7	Closed loop mode transmit diversity	32
7.1	Determination of feedback information	33
7.2	Closed loop mode 1.....	34
7.2.1	Mode 1 end of frame adjustment.....	35
7.2.2	Mode 1 normal initialisation.....	35
7.2.3	Mode 1 operation during compressed mode.....	36
7.2.3.1	Downlink in compressed mode and uplink in normal mode	36
7.2.3.2	Both downlink and uplink in compressed mode.....	36
7.3	Closed loop mode 2.....	37
7.3.1	Mode 2 end of frame adjustment	38
7.3.2	Mode 2 normal initialisation.....	38
7.3.3	Mode 2 operation during compressed mode.....	39
7.3.3.1	Downlink in compressed mode and uplink in normal mode	39
7.3.3.2	Both downlink and uplink in compressed mode.....	39
8	Idle periods for IPDL location method.....	40
8.1	General.....	40
8.2	Parameters of IPDL.....	40
8.3	Calculation of idle period position	40
Annex A (informative):	Antenna verification	42
Annex B (informative):	Downlink power control	43
B.1	Power control timing	43
B.2	Example of implementation in the UE	44
Annex C (informative):	Cell search procedure.....	45
Annex D (informative):	Change history	46

Foreword

This Technical Specification (TS) has been produced by the 3rd Generation Partnership Project (3GPP).

The contents of the present document are subject to continuing work within the TSG and may change following formal TSG approval. Should the TSG modify the contents of this present document, it will be re-released by the TSG with an identifying change of release date and an increase in version number as follows:

Version x.y.z

where:

- x the first digit:
 - 1 presented to TSG for information;
 - 2 presented to TSG for approval;
 - 3 or greater indicates TSG approved document under change control.
- y the second digit is incremented for all changes of substance, i.e. technical enhancements, corrections, updates, etc.
- z the third digit is incremented when editorial only changes have been incorporated in the document.

1 Scope

The present document specifies and establishes the characteristics of the physical layer procedures in the FDD mode of UTRA.

2 References

The following documents contain provisions which, through reference in this text, constitute provisions of the present document.

- References are either specific (identified by date of publication, edition number, version number, etc.) or non-specific.
- For a specific reference, subsequent revisions do not apply.
- For a non-specific reference, the latest version applies.

- [1] 3GPP TS 25.211: "Physical channels and mapping of transport channels onto physical channels (FDD)".
- [2] 3GPP TS 25.212: "Multiplexing and channel coding (FDD)".
- [3] 3GPP TS 25.213: "Spreading and modulation (FDD)".
- [4] 3GPP TS 25.215: "Physical layer – Measurements (FDD)".
- [5] 3GPP TS 25.331: "RRC Protocol Specification".
- [6] 3GPP TS 25.433: "UTRAN Iub Interface NBAP Signalling".
- [7] 3GPP TS 25.101: "UE Radio transmission and Reception (FDD)".
- [8] 3GPP TS 25.133: "Requirements for Support of Radio Resource Management (FDD)".
- [9] 3GPP TS 25.321: " MAC protocol specification".

3 Abbreviations

For the purposes of the present document, the following abbreviations apply:

AICH	Acquisition Indicator Channel
ASC	Access Service Class
AP	Access Preamble
BCH	Broadcast Channel
CA	Channel Assignment
CCC	CPCH Control Command
CCPCH	Common Control Physical Channel
CCTrCH	Coded Composite Transport Channel
CD	Collision Detection
CPCH	Common Packet Channel
CPICH	Common Pilot Channel
CRC	Cyclic Redundancy Check
CSICH	CPCH Status Indicator Channel
DCH	Dedicated Channel
DL	Downlink
DPCCH	Dedicated Physical Control Channel
DPCH	Dedicated Physical Channel
DPDCH	Dedicated Physical Data Channel
DTX	Discontinuous Transmission

P-CCPCH	Primary Common Control Physical Channel
PCA	Power Control Algorithm
PCPCH	Physical Common Packet Channel
PDSCH	Physical Downlink Shared Channel
PICH	Paging Indicator Channel
PRACH	Physical Random Access Channel
RACH	Random Access Channel
RL	Radio Link
RPL	Recovery Period Length
RSCP	Received Signal Code Power
S-CCPCH	Secondary Common Control Physical Channel
SCH	Synchronisation Channel
SFN	System Frame Number
SIR	Signal-to-Interference Ratio
SNIR	Signal to Noise Interference Ratio
SSDT	Site Selection Diversity TPC
TFC	Transport Format Combination
TPC	Transmit Power Control
TrCH	Transport Channel
TTI	Transmission Time Interval
UE	User Equipment
UL	Uplink
UTRAN	UMTS Terrestrial Radio Access Network

4 Synchronisation procedures

4.1 Cell search

During the cell search, the UE searches for a cell and determines the downlink scrambling code and common channel frame synchronisation of that cell. How cell search is typically done is described in Annex C.

4.2 Common physical channel synchronisation

The radio frame timing of all common physical channels can be determined after cell search. The P-CCPCH radio frame timing is found during cell search and the radio frame timing of all common physical channel are related to that timing as described in [1].

4.3 DPCCH/DPDCH synchronisation

4.3.1 Synchronisation primitives

4.3.1.1 General

For the dedicated channels, synchronisation primitives are used to indicate the synchronisation status of radio links, both in uplink and downlink. The definition of the primitives is given in the following subclauses.

4.3.1.2 Downlink synchronisation primitives

Layer 1 in the UE shall every radio frame check synchronisation status of the downlink dedicated channels. Synchronisation status is indicated to higher layers using the CPHY-Sync-IND and CPHY-Out-of-Sync-IND primitives.

The criteria for reporting synchronisation status are defined in two different phases.

The first phase starts when higher layers initiate physical dedicated channel establishment (as described in [5]) and lasts until 160 ms after the downlink dedicated channel is considered established by higher layers (physical channel

establishment is defined in [5]). During this time out-of-sync shall not be reported and in-sync shall be reported using the CPHY-Sync-IND primitive if the following criterion is fulfilled:

- The UE estimates the DPCCH quality over the previous 40 ms period to be better than a threshold Q_{in} . This criterion shall be assumed not to be fulfilled before 40 ms of DPCCH quality measurements have been collected. Q_{in} is defined implicitly by the relevant tests in [7].

The second phase starts 160 ms after the downlink dedicated channel is considered established by higher layers. During this phase both out-of-sync and in-sync are reported as follows.

Out-of-sync shall be reported using the CPHY-Out-of-Sync-IND primitive if either of the following criteria are fulfilled:

- The UE estimates the DPCCH quality over the previous 160 ms period to be worse than a threshold Q_{out} . Q_{out} is defined implicitly by the relevant tests in [7].
- The 20 most recently received transport blocks with a CRC attached, as observed on all TrCHs using CRC, have been received with incorrect CRC. In addition, over the previous 160 ms, all transport blocks with a CRC attached have been received with incorrect CRC. In case of no TFCI is used this criterion shall be considered only for TrCHs using CRC in all transport formats.

In-sync shall be reported using the CPHY-Sync-IND primitive if both of the following criteria are fulfilled:

- The UE estimates the DPCCH quality over the previous 160 ms period to be better than a threshold Q_{in} . Q_{in} is defined implicitly by the relevant tests in [7].
- At least one transport block with a CRC attached, as observed on all TrCHs using CRC, is received in a TTI ending in the current frame with correct CRC. If no transport blocks are received, or no transport block has a CRC attached, this criterion shall be assumed to be fulfilled. In case of no TFCI is used this criterion shall be considered only for TrCHs using CRC in all transport formats.

How the primitives are used by higher layers is described in [5]. The above definitions may lead to radio frames where neither the in-sync nor the out-of-sync primitives are reported.

4.3.1.3 Uplink synchronisation primitives

Layer 1 in the Node B shall every radio frame check synchronisation status of all radio link sets. Synchronisation status is indicated to the RL Failure/Restored triggering function using either the CPHY-Sync-IND or CPHY-Out-of-Sync-IND primitive. Hence, only one synchronisation status indication shall be given per radio link set.

The exact criteria for indicating in-sync/out-of-sync is not subject to specification, but could e.g. be based on received DPCCH quality or CRC checks. One example would be to have the same criteria as for the downlink synchronisation status primitives.

4.3.2 Radio link establishment

4.3.2.1 General

The establishment of a radio link can be divided into two cases:

- when there is no existing radio link, i.e. when at least one downlink dedicated physical channel and one uplink dedicated physical channel are to be set up;
- or when one or several radio links already exist, i.e. when at least one downlink dedicated physical channel is to be set up and an uplink dedicated physical channel already exists.

The two cases are described in subclauses 4.3.2.2 and 4.3.2.3 respectively.

In Node B, each radio link set can be in three different states: initial state, out-of-sync state and in-sync state. Transitions between the different states is shown in figure 1 below. The state of the Node B at the start of radio link establishment is described in the following subclauses. Transitions between initial state and in-sync state are described in subclauses 4.3.2.2 and 4.3.2.3 and transitions between the in-sync and out-of-sync states are described in subclause 4.3.3.2.

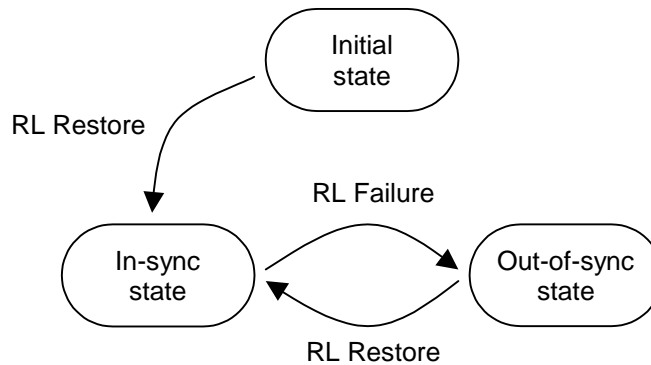

Figure 1: Node B radio link set states and transitions

4.3.2.2 No existing radio link

When one or several radio links are to be established and there is no existing radio link for the UE already, a dedicated physical channel is to be set up in uplink and at least one dedicated physical channel is to be set up in downlink. This corresponds to the case when a dedicated physical channel is initially set up on a frequency.

The radio link establishment is as follows:

- a) Node B considers the radio link sets which are to be set up to be in the initial state. UTRAN shall start the transmission of the downlink DPCCH and may start the transmission of DPDCH if any data is to be transmitted. The initial downlink DPCCH transmit power is set by higher layers [6]. Downlink TPC commands are generated as described in 5.1.2.2.1.2.
- b) The UE establishes downlink chip and frame synchronisation of DPCCH, using the P-CCPCH timing and timing offset information notified from UTRAN. Frame synchronisation can be confirmed using the frame synchronisation word. Downlink synchronisation status is reported to higher layers every radio frame according to subclause 4.3.1.2.
- c) If no activation time for uplink DPCCH has been signalled to the UE, uplink DPCCH transmission shall start when higher layers consider the downlink physical channel established. If an activation time has been given, uplink DPCCH transmission shall not start before the downlink physical channel has been established and the activation time has been reached. Physical channel establishment and activation time are defined in [5]. The initial uplink DPCCH transmit power is set by higher layers [5]. The total signalling response delay for the establishment of a new DPCH shall not exceed the requirements given in [8] sub-clause 7.3. The transmission of the uplink DPCCH power control preamble shall start N_{pcp} radio frames prior to the start of uplink DPDCH transmission, where N_{pcp} is a higher layer parameter set by UTRAN [5]. Note that the transmission start delay between DPCCH and DPDCH may be cancelled using a power control preamble of 0 length. The starting time for transmission of DPDCHs shall also satisfy the constraints on adding transport channels to a CCTrCH, as defined in [2] sub-clause 4.2.14, independently of whether there are any bits mapped to the DPDCHs. During the uplink DPCCH power control preamble, independently of the selected TFC, no transmission is done on the DPDCH.
- d) UTRAN establishes uplink chip and frame synchronisation. Frame synchronisation can be confirmed using the frame synchronisation word. Radio link sets remain in the initial state until $N_{\text{INSYNC_IND}}$ successive in-sync indications are received from layer 1, when Node B shall trigger the RL Restore procedure indicating which radio link set has obtained synchronisation. When RL Restore has been triggered the radio link set shall be considered to be in the in-sync state. The parameter value of $N_{\text{INSYNC_IND}}$ is configurable, see [6]. The RL Restore procedure may be triggered several times, indicating when synchronisation is obtained for different radio link sets.

4.3.2.3 One or several existing radio links

When one or several radio links are to be established and one or several radio links already exist, there is an existing DPCCH/DPDCH in the uplink, and at least one corresponding dedicated physical channel shall be set up in the downlink. This corresponds to the case when new radio links are added to the active set and downlink transmission starts for those radio links.

The radio link establishment is as follows:

- a) Node B considers new radio link sets to be set up to be in initial state. If a radio link is to be added to an existing radio link set this radio link set shall be considered to be in the state the radio link set was prior to the addition of the radio link, i.e. if the radio link set was in the in-sync state before the addition of the radio link it shall remain in that state.
- b) UTRAN starts the transmission of the downlink DPCCH/DPDCH at a frame timing such that the frame timing received at the UE will be within $T_0 \pm 148$ chips prior to the frame timing of the uplink DPCCH/DPDCH at the UE. Simultaneously, UTRAN establishes uplink chip and frame synchronisation of the new radio link. Frame synchronisation can be confirmed using the frame synchronization word. Radio link sets considered to be in the initial state shall remain in the initial state until N_INSYNC_IND successive in-sync indications are received from layer 1, when Node B shall trigger the RL Restore procedure indicating which radio link set has obtained synchronisation. When RL Restore is triggered the radio link set shall be considered to be in the in-sync state. The parameter value of N_INSYNC_IND is configurable, see [6]. The RL Restore procedure may be triggered several times, indicating when synchronisation is obtained for different radio link sets.
- c) The UE establishes chip and frame synchronisation of the new radio link. Frame synchronisation can be confirmed using the frame synchronization word. Downlink synchronisation status shall be reported to higher layers every radio frame according to subclause 4.3.1.2.

4.3.3 Radio link monitoring

4.3.3.1 Downlink radio link failure

The downlink radio links shall be monitored by the UE, to trigger radio link failure procedures. The downlink radio link failure criteria is specified in [5], and is based on the synchronisation status primitives CPHY-Sync-IND and CPHY-Out-of-Sync-IND, indicating in-sync and out-of-sync respectively.

4.3.3.2 Uplink radio link failure/restore

The uplink radio link sets are monitored by the Node B, to trigger radio link failure/restore procedures. Once the radio link sets have been established, they will be in the in-sync or out-of-sync states as shown in figure 1 in subclause 4.3.2.1. Transitions between those two states are described below.

The uplink radio link failure/restore criteria is based on the synchronisation status primitives CPHY-Sync-IND and CPHY-Out-of-Sync-IND, indicating in-sync and out-of-sync respectively. Note that only one synchronisation status indication shall be given per radio link set.

When the radio link set is in the in-sync state, Node B shall start timer T_RLFAILURE after receiving N_OUTSYNC_IND consecutive out-of-sync indications. Node B shall stop and reset timer T_RLFAILURE upon receiving successive N_INSYNC_IND in-sync indications. If T_RLFAILURE expires, Node B shall trigger the RL Failure procedure and indicate which radio link set is out-of-sync. When the RL Failure procedure is triggered, the state of the radio link set change to the out-of-sync state.

When the radio link set is in the out-of-sync state, after receiving N_INSYNC_IND successive in-sync indications Node B shall trigger the RL Restore procedure and indicate which radio link set has re-established synchronisation. When the RL Restore procedure is triggered, the state of the radio link set change to the in-sync state.

The specific parameter settings (values of T_RLFAILURE, N_OUTSYNC_IND, and N_INSYNC_IND) are configurable, see [6].

4.3.4 Transmission timing adjustments

During a connection the UE may adjust its DPDCH/DPCCH transmission time instant.

If the receive timing for any downlink DPCCH/DPDCH in the current active set has drifted, so the time between reception of the downlink DPCCH/DPDCH in question and transmission of uplink DPCCH/DPDCH lies outside the valid range, L1 shall inform higher layers of this, so that the network can be informed of this and downlink timing can be adjusted by the network.

NOTE: The maximum rate of uplink TX time adjustment, and the valid range for the time between downlink DPCCH/DPDCH reception and uplink DPCCH/DPDCH transmission in the UE is to be specified by RAN WG4.

5 Power control

5.1 Uplink power control

5.1.1 PRACH

5.1.1.1 General

The power control during the physical random access procedure is described in clause 6. The setting of power of the message control and data parts is described in the next subclause.

5.1.1.2 Setting of PRACH control and data part power difference

The message part of the uplink PRACH channel shall employ gain factors to control the control/data part relative power similar to the uplink dedicated physical channels. Hence, subclause 5.1.2.5 applies also for the RACH message part, with the differences that:

- β_c is the gain factor for the control part (similar to DPCCH);
- β_d is the gain factor for the data part (similar to DPDCH);
- no inner loop power control is performed.

5.1.2 DPCCH/DPDCH

5.1.2.1 General

The initial uplink DPCCH transmit power is set by higher layers. Subsequently the uplink transmit power control procedure simultaneously controls the power of a DPCCH and its corresponding DPDCHs (if present). The relative transmit power offset between DPCCH and DPDCHs is determined by the network and is computed according to subclause 5.1.2.5 using the gain factors signalled to the UE using higher layer signalling.

The operation of the inner power control loop, described in sub clause 5.1.2.2, adjusts the power of the DPCCH and DPDCHs by the same amount, provided there are no changes in gain factors. Additional adjustments to the power of the DPCCH associated with the use of compressed mode are described in sub clause 5.1.2.3.

Any change in the uplink DPCCH transmit power shall take place immediately before the start of the pilot field on the DPCCH. The change in DPCCH power with respect to its previous value is derived by the UE and is denoted by Δ_{DPCCH} (in dB). The previous value of DPCCH power shall be that used in the previous slot, except in the event of an interruption in transmission due to the use of compressed mode, when the previous value shall be that used in the last slot before the transmission gap.

During the operation of the uplink power control procedure the UE transmit power shall not exceed a maximum allowed value which is the lower out of the maximum output power of the terminal power class and a value which may be set by higher layer signalling.

Uplink power control shall be performed while the UE transmit power is below the maximum allowed output power.

The provisions for power control at the maximum allowed value and below the required minimum output power (as defined in [7]) are described in sub-clause 5.1.2.6.

5.1.2.2 Ordinary transmit power control

5.1.2.2.1 General

The uplink inner-loop power control adjusts the UE transmit power in order to keep the received uplink signal-to-interference ratio (SIR) at a given SIR target, SIR_{target} .

The serving cells (cells in the active set) should estimate signal-to-interference ratio SIR_{est} of the received uplink DPCH. The serving cells should then generate TPC commands and transmit the commands once per slot according to the following rule: if $SIR_{est} > SIR_{target}$ then the TPC command to transmit is "0", while if $SIR_{est} < SIR_{target}$ then the TPC command to transmit is "1".

Upon reception of one or more TPC commands in a slot, the UE shall derive a single TPC command, TPC_{cmd} , for each slot, combining multiple TPC commands if more than one is received in a slot. Two algorithms shall be supported by the UE for deriving a TPC_{cmd} . Which of these two algorithms is used is determined by a UE-specific higher-layer parameter, "PowerControlAlgorithm", and is under the control of the UTRAN. If "PowerControlAlgorithm" indicates "algorithm1", then the layer 1 parameter PCA shall take the value 1 and if "PowerControlAlgorithm" indicates "algorithm2" then PCA shall take the value 2.

If PCA has the value 1, Algorithm 1, described in subclause 5.1.2.2.2, shall be used for processing TPC commands.

If PCA has the value 2, Algorithm 2, described in subclause 5.1.2.2.3, shall be used for processing TPC commands.

The step size Δ_{TPC} is a layer 1 parameter which is derived from the UE-specific higher-layer parameter "TPC-StepSize" which is under the control of the UTRAN. If "TPC-StepSize" has the value "dB1", then the layer 1 parameter Δ_{TPC} shall take the value 1 dB and if "TPC-StepSize" has the value "dB2", then Δ_{TPC} shall take the value 2 dB. The parameter "TPC-StepSize" only applies to Algorithm 1 as stated in [5]. For Algorithm 2 Δ_{TPC} shall always take the value 1 dB.

After deriving of the combined TPC command TPC_{cmd} using one of the two supported algorithms, the UE shall adjust the transmit power of the uplink DPCCCH with a step of Δ_{DPCCCH} (in dB) which is given by:

$$\Delta_{DPCCCH} = \Delta_{TPC} \times TPC_{cmd}.$$

5.1.2.2.1.1 Out of synchronisation handling

After 160 ms after physical channel establishment (defined in [5]), the UE shall control its transmitter according to a downlink DPCCCH quality criterion as follows:

- The UE shall shut its transmitter off when the UE estimates the DPCCCH quality over the last 160 ms period to be worse than a threshold Q_{out} . Q_{out} is defined implicitly by the relevant tests in [7].
- The UE can turn its transmitter on again when the UE estimates the DPCCCH quality over the last 160 ms period to be better than a threshold Q_{in} . Q_{in} is defined implicitly by the relevant tests in [7]. When transmission is resumed, the power of the DPCCCH shall be the same as when the UE transmitter was shut off.

5.1.2.2.1.2 TPC command generation on downlink during RL initialisation

When commanded by higher layers the TPC commands sent on a downlink radio link from Node Bs that have not yet achieved uplink synchronisation shall follow a pattern as follows:

If higher layers indicate by "First RLS indicator" that the radio link is part of the first radio link set sent to the UE

- a value 'n' is obtained from the parameter "DL TPC pattern 01 count" passed by higher layers,
- the TPC pattern shall consist of n instances of "01" plus one instance of "1",
- the TPC pattern continuously repeat but shall be forcibly re-started at the beginning of each frame where $CFN \bmod 4 = 0$.

else

- The TPC pattern shall consist of all "1".

The TPC pattern shall terminate once uplink synchronisation is achieved.

5.1.2.2.2 Algorithm 1 for processing TPC commands

5.1.2.2.2.1 Derivation of TPC_cmd when only one TPC command is received in each slot

When a UE is not in soft handover, only one TPC command will be received in each slot. In this case, the value of TPC_cmd shall be derived as follows:

- If the received TPC command is equal to 0 then TPC_cmd for that slot is -1.
- If the received TPC command is equal to 1, then TPC_cmd for that slot is 1.

5.1.2.2.2.2 Combining of TPC commands from radio links of the same radio link set

When a UE is in soft handover, multiple TPC commands may be received in each slot from different cells in the active set. In some cases, the UE has the knowledge that some of the transmitted TPC commands in a slot are the same. This is the case when the radio links are in the same radio link set. For these cases, the TPC commands from the same radio link set shall be combined into one TPC command, to be further combined with other TPC commands as described in subclause 5.1.2.2.2.3.

5.1.2.2.2.3 Combining of TPC commands from radio links of different radio link sets

This subclause describes the general scheme for combination of the TPC commands from radio links of different radio link sets.

First, the UE shall conduct a soft symbol decision W_i on each of the power control commands TPC_i , where $i = 1, 2, \dots, N$, where N is greater than 1 and is the number of TPC commands from radio links of different radio link sets, that may be the result of a first phase of combination according to subclause 5.1.2.2.2.2.

Finally, the UE derives a combined TPC command, TPC_cmd, as a function γ of all the N soft symbol decisions W_i :

- $TPC_cmd = \gamma(W_1, W_2, \dots, W_N)$, where TPC_cmd can take the values 1 or -1.

The function γ shall fulfil the following criteria:

If the N TPC_i commands are random and uncorrelated, with equal probability of being transmitted as "0" or "1", the probability that the output of γ is equal to 1 shall be greater than or equal to $1/(2^N)$, and the probability that the output of γ is equal to -1 shall be greater than or equal to 0.5. Further, the output of γ shall equal 1 if the TPC commands from all the radio link sets are reliably "1", and the output of γ shall equal -1 if a TPC command from any of the radio link sets is reliably "0".

5.1.2.2.3 Algorithm 2 for processing TPC commands

NOTE: Algorithm 2 makes it possible to emulate smaller step sizes than the minimum power control step specified in subclause 5.1.2.2.1, or to turn off uplink power control by transmitting an alternating series of TPC commands.

5.1.2.2.3.1 Derivation of TPC_cmd when only one TPC command is received in each slot

When a UE is not in soft handover, only one TPC command will be received in each slot. In this case, the UE shall process received TPC commands on a 5-slot cycle, where the sets of 5 slots shall be aligned to the frame boundaries and there shall be no overlap between each set of 5 slots.

The value of TPC_cmd shall be derived as follows:

- For the first 4 slots of a set, TPC_cmd = 0.
- For the fifth slot of a set, the UE uses hard decisions on each of the 5 received TPC commands as follows:

- If all 5 hard decisions within a set are 1 then $TPC_cmd = 1$ in the 5th slot.
- If all 5 hard decisions within a set are 0 then $TPC_cmd = -1$ in the 5th slot.
- Otherwise, $TPC_cmd = 0$ in the 5th slot.

5.1.2.2.3.2 Combining of TPC commands from radio links of the same radio link set

When a UE is in soft handover, multiple TPC commands may be received in each slot from different cells in the active set. In some cases, the UE has the knowledge that some of the transmitted TPC commands in a slot are the same. This is the case when the radio links are in the same radio link set. For these cases, the TPC commands from radio links of the same radio link set shall be combined into one TPC command, to be processed and further combined with any other TPC commands as described in subclause 5.1.2.2.3.3.

5.1.2.2.3.3 Combining of TPC commands from radio links of different radio link sets

This subclause describes the general scheme for combination of the TPC commands from radio links of different radio link sets.

The UE shall make a hard decision on the value of each TPC_i , where $i = 1, 2, \dots, N$ and N is the number of TPC commands from radio links of different radio link sets, that may be the result of a first phase of combination according to subclause 5.1.2.2.3.2.

The UE shall follow this procedure for 5 consecutive slots, resulting in N hard decisions for each of the 5 slots.

The sets of 5 slots shall be aligned to the frame boundaries and there shall be no overlap between each set of 5 slots.

The value of TPC_cmd is zero for the first 4 slots. After 5 slots have elapsed, the UE shall determine the value of TPC_cmd for the fifth slot in the following way:

The UE first determines one temporary TPC command, TPC_temp_i , for each of the N sets of 5 TPC commands as follows:

- If all 5 hard decisions within a set are "1", $TPC_temp_i = 1$.
- If all 5 hard decisions within a set are "0", $TPC_temp_i = -1$.
- Otherwise, $TPC_temp_i = 0$.

Finally, the UE derives a combined TPC command for the fifth slot, TPC_cmd , as a function γ of all the N temporary power control commands TPC_temp_i :

$TPC_cmd(5^{\text{th}} \text{ slot}) = \gamma(TPC_temp_1, TPC_temp_2, \dots, TPC_temp_N)$, where $TPC_cmd(5^{\text{th}} \text{ slot})$ can take the values 1, 0 or -1, and γ is given by the following definition:

- TPC_cmd is set to 1 if $\frac{1}{N} \sum_{i=1}^N TPC_temp_i > 0.5$.
- TPC_cmd is set to -1 if $\frac{1}{N} \sum_{i=1}^N TPC_temp_i < -0.5$.

Otherwise, TPC_cmd is set to 0.

5.1.2.3 Transmit power control in compressed mode

In compressed mode, one or more transmission gap pattern sequences are active. Therefore some frames are compressed and contain transmission gaps. The uplink power control procedure is as specified in clause 5.1.2.2, using the same UTRAN supplied parameters for Power Control Algorithm and step size (Δ_{TPC}), but with additional features which aim to recover as rapidly as possible a signal-to-interference ratio (SIR) close to the target SIR after each transmission gap.

The serving cells (cells in the active set) should estimate signal-to-interference ratio SIR_{est} of the received uplink DPCH. The serving cells should then generate TPC commands and transmit the commands once per slot, except during downlink transmission gaps, according to the following rule: if $SIR_{est} > SIR_{cm_target}$ then the TPC command to transmit is "0", while if $SIR_{est} < SIR_{cm_target}$ then the TPC command to transmit is "1".

SIR_{cm_target} is the target SIR during compressed mode and fulfils

$$SIR_{cm_target} = SIR_{target} + \Delta SIR_{PILOT} + \Delta SIR1_coding + \Delta SIR2_coding,$$

where $\Delta SIR1_coding$ and $\Delta SIR2_coding$ are computed from uplink parameters DeltaSIR1, DeltaSIR2, DeltaSIRafter1, DeltaSIRafter2 signalled by higher layers as:

- $\Delta SIR1_coding = \Delta SIR1$ if the start of the first transmission gap in the transmission gap pattern is within the current uplink frame.
- $\Delta SIR1_coding = \Delta SIRafter1$ if the current uplink frame just follows a frame containing the start of the first transmission gap in the transmission gap pattern.
- $\Delta SIR2_coding = \Delta SIR2$ if the start of the second transmission gap in the transmission gap pattern is within the current uplink frame.
- $\Delta SIR2_coding = \Delta SIRafter2$ if the current uplink frame just follows a frame containing the start of the second transmission gap in the transmission gap pattern.
- $\Delta SIR1_coding = 0$ dB and $\Delta SIR2_coding = 0$ dB in all other cases.

ΔSIR_{PILOT} is defined as: $\Delta SIR_{PILOT} = 10 \log_{10} (N_{pilot,N} / N_{pilot,curr_frame})$,

where $N_{pilot,curr_frame}$ is the number of pilot bits per slot in the current uplink frame, and $N_{pilot,N}$ is the number of pilot bits per slot in a normal uplink frame without a transmission gap.

In the case of several compressed mode pattern sequences being used simultaneously, $\Delta SIR1_coding$ and $\Delta SIR2_coding$ offsets are computed for each compressed mode pattern and all $\Delta SIR1_coding$ and $\Delta SIR2_coding$ offsets are summed together.

In compressed mode, compressed frames may occur in either the uplink or the downlink or both. In uplink compressed frames, the transmission of uplink DPDCH(s) and DPCCCH shall both be stopped during transmission gaps.

Due to the transmission gaps in compressed frames, there may be missing TPC commands in the downlink. If no downlink TPC command is transmitted, the corresponding TPC_cmd derived by the UE shall be set to zero.

Compressed and non-compressed frames in the uplink DPCCCH may have a different number of pilot bits per slot. A change in the transmit power of the uplink DPCCCH would be needed in order to compensate for the change in the total pilot energy. Therefore at the start of each slot the UE shall derive the value of a power offset Δ_{PILOT} . If the number of pilot bits per slot in the uplink DPCCCH is different from its value in the most recently transmitted slot, Δ_{PILOT} (in dB) shall be given by:

$$\Delta_{PILOT} = 10 \log_{10} (N_{pilot,prev} / N_{pilot,curr});$$

where $N_{pilot,prev}$ is the number of pilot bits in the most recently transmitted slot, and $N_{pilot,curr}$ is the number of pilot bits in the current slot. Otherwise, including during transmission gaps in the downlink, Δ_{PILOT} shall be zero.

Unless otherwise specified, in every slot during compressed mode the UE shall adjust the transmit power of the uplink DPCCCH with a step of Δ_{DPCCCH} (in dB) which is given by:

$$\Delta_{DPCCCH} = \Delta_{TPC} \times TPC_cmd + \Delta_{PILOT}.$$

At the start of the first slot after an uplink or downlink transmission gap the UE shall apply a change in the transmit power of the uplink DPCCCH by an amount Δ_{DPCCCH} (in dB), with respect to the uplink DPCCCH power in the most recently transmitted uplink slot, where:

$$\Delta_{DPCCCH} = \Delta_{RESUME} + \Delta_{PILOT}.$$

The value of Δ_{RESUME} (in dB) shall be determined by the UE according to the Initial Transmit Power mode (ITP). The ITP is a UE specific parameter, which is signalled by the network with the other compressed mode parameters (see [4]). The different modes are summarised in table 1.

Table 1: Initial Transmit Power modes during compressed mode

Initial Transmit Power mode	Description
0	$\Delta_{\text{RESUME}} = \Delta_{\text{TPC}} \times \text{TPC_cmd}_{\text{gap}}$
1	$\Delta_{\text{RESUME}} = \delta_{\text{last}}$

In the case of a transmission gap in the uplink, $\text{TPC_cmd}_{\text{gap}}$ shall be the value of TPC_cmd derived in the first slot of the uplink transmission gap, if a downlink TPC_command is transmitted in that slot. Otherwise $\text{TPC_cmd}_{\text{gap}}$ shall be zero.

δ_{last} shall be equal to the most recently computed value of δ_i . δ_i shall be updated according to the following recursive relations, which shall be executed in all slots in which both the uplink DPCCCH and a downlink TPC command are transmitted, and in the first slot of an uplink transmission gap if a downlink TPC command is transmitted in that slot:

$$\delta_i = 0.9375\delta_{i-1} - 0.96875\text{TPC_cmd}_i\Delta_{\text{TPC}}k_{sc}$$

$$\delta_{i-1} = \delta_i$$

where: TPC_cmd_i is the power control command derived by the UE in that slot;

$k_{sc} = 0$ if additional scaling is applied in the current slot and the previous slot as described in sub-clause 5.1.2.6, and $k_{sc} = 1$ otherwise.

δ_{i-1} is the value of δ_i computed for the previous slot. The value of δ_{i-1} shall be initialised to zero when the uplink DPCCCH is activated, and also at the end of the first slot after each uplink transmission gap, and also at the end of the first slot after each downlink transmission gap. The value of δ_i shall be set to zero at the end of the first slot after each uplink transmission gap.

After a transmission gap in either the uplink or the downlink, the period following resumption of simultaneous uplink and downlink DPCCCH transmission is called a recovery period. RPL is the recovery period length and is expressed as a number of slots. RPL is equal to the minimum value out of the transmission gap length and 7 slots. If a transmission gap is scheduled to start before RPL slots have elapsed, then the recovery period shall end at the start of the gap, and the value of RPL shall be reduced accordingly.

During the recovery period, 2 modes are possible for the power control algorithm. The Recovery Period Power control mode (RPP) is signalled with the other compressed mode parameters (see [4]). The different modes are summarised in the table 2:

Table 2: Recovery Period Power control modes during compressed mode

Recovery Period power control mode	Description
0	Transmit power control is applied using the algorithm determined by the value of PCA, as in subclause 5.1.2.2 with step size Δ_{TPC} .
1	Transmit power control is applied using algorithm 1 (see subclause 5.1.2.2.2) with step size $\Delta_{\text{RP-TPC}}$ during RPL slots after each transmission gap.

For RPP mode 0, the step size is not changed during the recovery period and ordinary transmit power control is applied (see subclause 5.1.2.2), using the algorithm for processing TPC commands determined by the value of PCA (see subclauses 5.1.2.2.2 and 5.1.2.2.3).

For RPP mode 1, during RPL slots after each transmission gap, power control algorithm 1 is applied with a step size $\Delta_{\text{RP-TPC}}$ instead of Δ_{TPC} , regardless of the value of PCA. Therefore, the change in uplink DPCCCH transmit power at the start of each of the RPL+1 slots immediately following the transmission gap (except for the first slot after the transmission gap) is given by:

$$\Delta_{\text{DPCCCH}} = \Delta_{\text{RP-TPC}} \times \text{TPC_cmd} + \Delta_{\text{PILOT}}$$

Δ_{RP-TPC} is called the recovery power control step size and is expressed in dB. If PCA has the value 1, Δ_{RP-TPC} is equal to the minimum value of 3 dB and $2\Delta_{TPC}$. If PCA has the value 2, Δ_{RP-TPC} is equal to 1 dB.

After the recovery period, ordinary transmit power control resumes using the algorithm specified by the value of PCA and with step size Δ_{TPC} .

If PCA has the value 2, the sets of slots over which the TPC commands are processed shall remain aligned to the frame boundaries in the compressed frame. For both RPP mode 0 and RPP mode 1, if the transmission gap or the recovery period results in any incomplete sets of TPC commands, TPC_cmd shall be zero for those sets of slots which are incomplete.

5.1.2.4 Transmit power control in the uplink DPCCH power control preamble

An uplink DPCCH power control preamble is a period of uplink DPCCH transmission prior to the start of the uplink DPDCH transmission. The downlink DPCCH shall also be transmitted during an uplink DPCCH power control preamble.

The length of the uplink DPCCH power control preamble is a higher layer parameter signalled by the network as defined in [5]. The uplink DPDCH transmission shall commence after the end of the uplink DPCCH power control preamble.

During the uplink DPCCH power control preamble the change in uplink DPCCH transmit power shall be given by:

$$\Delta_{DPCCH} = \Delta_{TPC} \times TPC_cmd.$$

During the uplink DPCCH power control preamble TPC_cmd is derived according to algorithm 1 as described in sub clause 5.1.2.2.1, regardless of the value of PCA.

Ordinary power control (see subclause 5.1.2.2), with the power control algorithm determined by the value of PCA and step size Δ_{TPC} , shall be used after the end of the uplink DPCCH power control preamble.

5.1.2.5 Setting of the uplink DPCCH/DPDCH power difference

5.1.2.5.1 General

The uplink DPCCH and DPDCH(s) are transmitted on different codes as defined in subclause 4.2.1 of [3]. The gain factors β_c and β_d may vary for each TFC. There are two ways of controlling the gain factors of the DPCCH code and the DPDCH codes for different TFCs in normal (non-compressed) frames:

- β_c and β_d are signalled for the TFC, or
- β_c and β_d is computed for the TFC, based on the signalled settings for a reference TFC.

Combinations of the two above methods may be used to associate β_c and β_d values to all TFCs in the TFCS. The two methods are described in subclauses 5.1.2.5.2 and 5.1.2.5.3 respectively. Several reference TFCs may be signalled from higher layers.

The gain factors may vary on radio frame basis depending on the current TFC used. Further, the setting of gain factors is independent of the inner loop power control.

After applying the gain factors, the UE shall scale the total transmit power of the DPCCH and DPDCH(s), such that the DPCCH output power follows the changes required by the power control procedure with power adjustments of Δ_{DPCCH} dB, subject to the provisions of sub-clause 5.1.2.6.

The gain factors during compressed frames are based on the nominal power relation defined in normal frames, as specified in subclause 5.1.2.5.4.

5.1.2.5.2 Signalled gain factors

When the gain factors β_c and β_d are signalled by higher layers for a certain TFC, the signalled values are used directly for weighting of DPCCH and DPDCH(s). The variable A_j , called the nominal power relation is then computed as:

$$A_j = \frac{\beta_d}{\beta_c}$$

5.1.2.5.3 Computed gain factors

The gain factors β_c and β_d may also be computed for certain TFCs, based on the signalled settings for a reference TFC.

Let $\beta_{c,ref}$ and $\beta_{d,ref}$ denote the signalled gain factors for the reference TFC. Further, let $\beta_{c,j}$ and $\beta_{d,j}$ denote the gain factors used for the j :th TFC. Also let L_{ref} denote the number of DPDCHs used for the reference TFC and L_j denote the number of DPDCHs used for the j :th TFC.

Define the variable

$$K_{ref} = \sum_i RM_i \cdot N_i ;$$

where RM_i is the semi-static rate matching attribute for transport channel i (defined in [2] subclause 4.2.7), N_i is the number of bits output from the radio frame segmentation block for transport channel i (defined in [2] subclause 4.2.6.1), and the sum is taken over all the transport channels i in the reference TFC.

Similarly, define the variable

$$K_j = \sum_i RM_i \cdot N_i ;$$

where the sum is taken over all the transport channels i in the j :th TFC.

The variable A_j , called the nominal power relation is then computed as:

$$A_j = \frac{\beta_{d,ref}}{\beta_{c,ref}} \cdot \sqrt{\frac{L_{ref}}{L_j}} \sqrt{\frac{K_j}{K_{ref}}}$$

The gain factors for the j :th TFC are then computed as follows:

- If $A_j > 1$, then $\beta_{d,j} = 1.0$ and $\beta_{c,j}$ is the largest quantized β -value, for which the condition $\beta_{c,j} \leq 1 / A_j$ holds. Since $\beta_{c,j}$ may not be set to zero, if the above rounding results in a zero value, $\beta_{c,j}$ shall be set to the lowest quantized amplitude ratio of 1/15 as specified in [3].
- If $A_j \leq 1$, then $\beta_{d,j}$ is the smallest quantized β -value, for which the condition $\beta_{d,j} \geq A_j$ holds and $\beta_{c,j} = 1.0$.

The quantized β -values are defined in [3] subclause 4.2.1, table 1.

5.1.2.5.4 Setting of the uplink DPCCH/DPDCH power difference in compressed mode

The gain factors used during a compressed frame for a certain TFC are calculated from the nominal power relation used in normal (non-compressed) frames for that TFC. Let A_j denote the nominal power relation for the j :th TFC in a normal frame. Further, let $\beta_{c,C,j}$ and $\beta_{d,C,j}$ denote the gain factors used for the j :th TFC when the frame is compressed. The variable $A_{C,j}$ is computed as:

$$A_{C,j} = A_j \cdot \sqrt{\frac{15 \cdot N_{pilot,C}}{N_{slots,C} \cdot N_{pilot,N}}}$$

where $N_{pilot,C}$ is the number of pilot bits per slot when in compressed mode, and $N_{pilot,N}$ is the number of pilot bits per slot in normal mode. $N_{slots,C}$ is the number of slots in the compressed frame used for transmitting the data.

The gain factors for the j :th TFC in a compressed frame are computed as follows:

If $A_{Cj} > 1$, then $\beta_{d,C,j} = 1.0$ and $\beta_{c,C,j}$ is the largest quantized β -value, for which the condition $\beta_{c,C,j} \leq 1 / A_{Cj}$ holds. Since $\beta_{c,C,j}$ may not be set to zero, if the above rounding results in a zero value, $\beta_{c,C,j}$ shall be set to the lowest quantized amplitude ratio of 1/15 as specified in [3].

If $A_{Cj} \leq 1$, then $\beta_{d,C,j}$ is the smallest quantized β -value, for which the condition $\beta_{d,C,j} \geq A_{Cj}$ holds and $\beta_{c,C,j} = 1.0$.

The quantized β -values are defined in [3] subclause 4.2.1, table 1.

5.1.2.6 Maximum and minimum power limits

In the case that the total UE transmit power (after applying DPCCH power adjustments and gain factors) would exceed the maximum allowed value, the UE shall apply additional scaling to the total transmit power so that it is equal to the maximum allowed power. This additional scaling shall be such that the power ratio between DPCCH and DPDCH remains as required by sub-clause 5.1.2.5.

When transmitting on a DPCCH the UE is not required to be capable of reducing its total transmit power below the minimum level required in [7]. However, it may do so, provided that the power ratio between DPCCH and DPDCH remains as specified in sub clause 5.1.2.5. Some further regulations also apply as follows: In the case that the total UE transmit power (after applying DPCCH power adjustments and gain factors) would be at or below the total transmit power in the previously transmitted slot and also at or below the required minimum power specified in [7], the UE may apply additional scaling to the total transmit power, subject to the following restrictions:

- The total transmit power after applying any additional scaling shall not exceed the required minimum power, nor the total transmit power in the previously transmitted slot;
- The magnitude of any reduction in total transmit power between slots after applying any additional scaling shall not exceed the magnitude of the calculated power reduction before the additional scaling.

In the case that the total UE transmit power in the previously transmitted slot is at or below the required minimum power specified in [7] and the DPCCH power adjustment and gain factors for the current slot would result in an increase in total power, then no additional scaling shall be used (i.e. power control shall operate as normal).

If the UE applies any additional scaling to the total transmit power as described above, this scaling shall be included in the computation of any DPCCH power adjustments to be applied in the next transmitted slot.

5.1.3 PCPCH

5.1.3.1 General

The power control during the CPCH access procedure is described in clause 6.2. The inner loop power control for the PCPCH is described in the following sub-clauses.

5.1.3.2 Power control in the message part

The uplink transmit power control procedure simultaneously controls the power of a PCPCH control part and its corresponding PCPCH data part. The relative transmit power offset between the PCPCH control part and the PCPCH data part is determined by the network and is computed according to sub-clause 5.1.2.5 using the gain factors signalled to the UE using higher-layer signalling, with the difference that:

- β_c is the gain factor for the PCPCH control part (similar to DPCCH);
- β_d is the gain factor for the PCPCH data part (similar to DPDCH).

The gain factors are applied as shown in sub clause 4.2.3.2 of [3].

The operation of the inner power control loop adjusts the power of the PCPCH control part and PCPCH data part by the same amount, provided there are no changes in gain factors.

Any change in the uplink PCPCH control part transmit power shall take place immediately before the start of the pilot field on the control part of the message part. The change in PCPCH control part power with respect to its value in the previous slot is derived by the UE and is denoted by $\Delta_{\text{PCPCH-CP}}$ (in dB).

During the operation of the uplink power control procedure the UE transmit power shall not exceed a maximum allowed value which is the lower out of the maximum output power of the terminal power class and a value which may be set by higher layer signalling.

Uplink power control shall be performed while the UE transmit power is below the maximum allowed output power.

The provisions for power control at the maximum allowed value and below the required minimum output power (as defined in [7]) are described in sub-clause 5.1.2.6.

The uplink inner-loop power control adjusts the UE transmit power in order to keep the received uplink signal-to-interference ratio (SIR) at a given SIR target, $\text{SIR}_{\text{target}}$, which is set by the higher layer outer loop.

The network should estimate the signal-to-interference ratio SIR_{est} of the received PCPCH. The network should then generate TPC commands and transmit the commands once per slot according to the following rule: if $\text{SIR}_{\text{est}} > \text{SIR}_{\text{target}}$ then the TPC command to transmit is "0", while if $\text{SIR}_{\text{est}} < \text{SIR}_{\text{target}}$ then the TPC command to transmit is "1".

The UE derives a TPC command, TPC_cmd , for each slot. Two algorithms shall be supported by the UE for deriving a TPC_cmd . Which of these two algorithms is used is determined by a higher-layer parameter, "PowerControlAlgorithm", and is under the control of the UTRAN. If "PowerControlAlgorithm" indicates "algorithm1", then the layer 1 parameter PCA shall take the value 1 and if "PowerControlAlgorithm" indicates "algorithm2" then PCA shall take the value 2.

If PCA has the value 1, Algorithm 1, described in subclause 5.1.2.2.2, shall be used for processing TPC commands.

If PCA has the value 2, Algorithm 2, described in subclause 5.1.2.2.3, shall be used for processing TPC commands.

The step size Δ_{TPC} is a layer 1 parameter which is derived from the higher-layer parameter "TPC-StepSize" which is under the control of the UTRAN. If "TPC-StepSize" has the value "dB1", then the layer 1 parameter Δ_{TPC} shall take the value 1 dB and if "TPC-StepSize" has the value "dB2", then Δ_{TPC} shall take the value 2 dB.

After deriving the TPC command TPC_cmd using one of the two supported algorithms, the UE shall adjust the transmit power of the uplink PCPCH control part with a step of $\Delta_{\text{PCPCH-CP}}$ (in dB) which is given by:

$$\Delta_{\text{PCPCH-CP}} = \Delta_{\text{TPC}} \times \text{TPC_cmd}$$

5.1.3.3 Power control in the power control preamble

A PCPCH power control preamble is a period when both the UL PCPCH control part and the associated DL DPCCH are transmitted prior to the start of the uplink PCPCH data part.

The length of the power control preamble is a higher layer parameter, $L_{\text{pc-preamble}}$ (see section 6.2), and can take the value 0 slots or 8 slots. The uplink PCPCH data part shall not commence before the end of the power control preamble.

If $L_{\text{pc-preamble}} > 0$, the details of power control used during the power control preamble differ from the ordinary power control which is used afterwards. After the first slot of the power control preamble the change in uplink PCPCH control part transmit power shall initially be given by:

$$\Delta_{\text{PCPCH-CP}} = \Delta_{\text{TPC-init}} \times \text{TPC_cmd}$$

If the value of PCA is 1 then $\Delta_{\text{TPC-init}}$ is equal to the minimum value out of 3 dB and $2\Delta_{\text{TPC}}$.

If the value of PCA is 2 then $\Delta_{\text{TPC-init}}$ is equal to 2dB.

TPC_cmd is derived according to algorithm 1 as described in sub clause 5.1.2.2.2, regardless of the value of PCA.

Power control as defined for the message part (see sub-clause 5.1.3.2), with the power control algorithm determined by the value of PCA and step size Δ_{TPC} , shall be used as soon as the sign of TPC_cmd reverses for the first time, or at the end of the power control preamble if the power control preamble ends first.

5.2 Downlink power control

The transmit power of the downlink channels is determined by the network. In general the ratio of the transmit power between different downlink channels is not specified and may change with time. However, regulations exist as described in the following subclauses.

Higher layer power settings shall be interpreted as setting of the total power, i.e. the sum of the power from the two antennas in case of transmit diversity.

5.2.1 DPCCH/DPDCH

5.2.1.1 General

The downlink transmit power control procedure controls simultaneously the power of a DPCCH and its corresponding DPDCHs. The power control loop adjusts the power of the DPCCH and DPDCHs with the same amount, i.e. the relative power difference between the DPCCH and DPDCHs is not changed.

The relative transmit power offset between DPCCH fields and DPDCHs is determined by the network. The TFCI, TPC and pilot fields of the DPCCH are offset relative to the DPDCHs power by PO1, PO2 and PO3 dB respectively. The power offsets may vary in time. The method for controlling the power offsets within UTRAN is specified in [6].

The power of CCC field in DL DPCCH for CPCH is the same as the power of the pilot field.

5.2.1.2 Ordinary transmit power control

5.2.1.2.1 UE behaviour

The UE shall generate TPC commands to control the network transmit power and send them in the TPC field of the uplink DPCCH. An example on how to derive the TPC commands is given in Annex B.2.

The UE shall check the downlink power control mode (DPC_MODE) before generating the TPC command:

- if DPC_MODE = 0 : the UE sends a unique TPC command in each slot and the TPC command generated is transmitted in the first available TPC field in the uplink DPCCH;
- if DPC_MODE = 1 : the UE repeats the same TPC command over 3 slots and the new TPC command is transmitted such that there is a new command at the beginning of the frame.

The DPC_MODE parameter is a UE specific parameter controlled by the UTRAN.

The UE shall not make any assumptions on how the downlink power is set by UTRAN, in order to not prohibit usage of other UTRAN power control algorithms than what is defined in subclause 5.2.1.2.2.

5.2.1.2.2 UTRAN behaviour

Upon receiving the TPC commands UTRAN shall adjust its downlink DPCCH/DPDCH power accordingly. For DPC_MODE = 0, UTRAN shall estimate the transmitted TPC command TPC_{est} to be 0 or 1, and shall update the power every slot. If DPC_MODE = 1, UTRAN shall estimate the transmitted TPC command TPC_{est} over three slots to be 0 or 1, and shall update the power every three slots.

After estimating the k :th TPC command, UTRAN shall adjust the current downlink power $P(k-1)$ [dB] to a new power $P(k)$ [dB] according to the following formula:

$$P(k) = P(k - 1) + P_{TPC}(k) + P_{bal}(k),$$

where $P_{TPC}(k)$ is the k :th power adjustment due to the inner loop power control, and $P_{bal}(k)$ [dB] is a correction according to the downlink power control procedure for balancing radio link powers towards a common reference power. The power balancing procedure and control of the procedure is described in [6].

$P_{TPC}(k)$ is calculated according to the following.

If the value of *Limited Power Raise Used* parameter is 'Not used', then

$$P_{TPC}(k) = \begin{cases} +\Delta_{TPC} & \text{if } TPC_{est}(k) = 1 \\ -\Delta_{TPC} & \text{if } TPC_{est}(k) = 0 \end{cases}, [\text{dB}]. \quad (1)$$

If the value of *Limited Power Raise Used* parameter is 'Used', then the k :th inner loop power adjustment shall be calculated as:

$$P_{TPC}(k) = \begin{cases} +\Delta_{TPC} & \text{if } TPC_{est}(k) = 1 \text{ and } \Delta_{sum}(k) + \Delta_{TPC} < \text{Power_Raise_Limit} \\ 0 & \text{if } TPC_{est}(k) = 1 \text{ and } \Delta_{sum}(k) + \Delta_{TPC} \geq \text{Power_Raise_Limit} \\ -\Delta_{TPC} & \text{if } TPC_{est}(k) = 0 \end{cases}, [\text{dB}] \quad (2)$$

where

$$\Delta_{sum}(k) = \sum_{i=k-DL_Power_Averaging_Window_Size}^{k-1} P_{TPC}(i)$$

is the temporary sum of the last *DL_Power_Averaging_Window_Size* inner loop power adjustments (in dB).

For the first (*DL_Power_Averaging_Window_Size* – 1) adjustments after the activation of the limited power raise method, formula (1) shall be used instead of formula (2). *Power_Raise_Limit* and *DL_Power_Averaging_Window_Size* are parameters configured in the UTRAN.

The power control step size Δ_{TPC} can take four values: 0.5, 1, 1.5 or 2 dB. It is mandatory for UTRAN to support Δ_{TPC} of 1 dB, while support of other step sizes is optional.

In addition to the above described formulas on how the downlink power is updated, the restrictions below apply.

In case of congestion (commanded power not available), UTRAN may disregard the TPC commands from the UE.

The average power of transmitted DPDCH symbols over one timeslot shall not exceed *Maximum_DL_Power* (dB), nor shall it be below *Minimum_DL_Power* (dB). Transmitted DPDCH symbol means here a complex QPSK symbol before spreading which does not contain DTX. *Maximum_DL_Power* (dB) and *Minimum_DL_Power* (dB) are power limits for one channelisation code, relative to the primary CPICH power [6].

5.2.1.3 Power control in compressed mode

The aim of downlink power control in uplink or/and downlink compressed mode is to recover as fast as possible a signal-to-interference ratio (SIR) close to the target SIR after each transmission gap.

The UE behaviour is the same in compressed mode as in normal mode, described in subclause 5.2.1.2.

In compressed mode, compressed frames may occur in either the uplink or the downlink or both. In compressed frames, the transmission of downlink DPDCH(s) and DPCCH shall be stopped during transmission gaps.

The power of the DPCCH and DPDCH in the first slot after the transmission gap should be set to the same value as in the slot just before the transmission gap.

In every slot during compressed mode except during downlink transmission gaps, UTRAN shall estimate the k :th TPC command and adjust the current downlink power $P(k-1)$ [dB] to a new power $P(k)$ [dB] according to the following formula:

$$P(k) = P(k-1) + P_{TPC}(k) + P_{SIR}(k) + P_{bal}(k),$$

where $P_{TPC}(k)$ is the k :th power adjustment due to the inner loop power control, $P_{SIR}(k)$ is the k -th power adjustment due to the downlink target SIR variation, and $P_{bal}(k)$ [dB] is a correction according to the downlink power control procedure for balancing radio link powers towards a common reference power. The power balancing procedure and control of the procedure is described in [6].

Due to transmission gaps in uplink compressed frames, there may be missing TPC commands in the uplink. If no uplink TPC command is received, $P_{TPC}(k)$ derived by the Node B shall be set to zero. Otherwise, $P_{TPC}(k)$ is calculated the same way as in normal mode (see sub-clause 5.2.1.2.2) but with a step size Δ_{STEP} instead of Δ_{TPC} .

The power control step size $\Delta_{STEP} = \Delta_{RP-TPC}$ during RPL slots after each transmission gap and $\Delta_{STEP} = \Delta_{TPC}$ otherwise, where:

- RPL is the recovery period length and is expressed as a number of slots. RPL is equal to the minimum value out of the transmission gap length and 7 slots. If a transmission gap is scheduled to start before RPL slots have elapsed, then the recovery period shall end at the start of the gap, and the value of RPL shall be reduced accordingly.
- Δ_{RP-TPC} is called the recovery power control step size and is expressed in dB. Δ_{RP-TPC} is equal to the minimum value of 3 dB and $2\Delta_{TPC}$.

The power offset $P_{SIR}(k) = \delta P_{curr} - \delta P_{prev}$, where δP_{curr} and δP_{prev} are respectively the value of δP in the current slot and the most recently transmitted slot and δP is computed as follows:

$$\delta P = \max(\Delta P1_compression, \dots, \Delta Pn_compression) + \Delta P1_coding + \Delta P2_coding$$

where n is the number of different TTI lengths amongst TTIs of all TrChs of the CCTrCh, where $\Delta P1_coding$ and $\Delta P2_coding$ are computed from uplink parameters DeltaSIR1, DeltaSIR2, DeltaSIRafter1, DeltaSIRafter2 signaled by higher layers as:

- $\Delta P1_coding = \text{DeltaSIR1}$ if the start of the first transmission gap in the transmission gap pattern is within the current frame.
- $\Delta P1_coding = \text{DeltaSIRafter1}$ if the current frame just follows a frame containing the start of the first transmission gap in the transmission gap pattern.
- $\Delta P2_coding = \text{DeltaSIR2}$ if the start of the second transmission gap in the transmission gap pattern is within the current frame.
- $\Delta P2_coding = \text{DeltaSIRafter2}$ if the current frame just follows a frame containing the start of the second transmission gap in the transmission gap pattern.
- $\Delta P1_coding = 0$ dB and $\Delta P2_coding = 0$ dB in all other cases.

and $\Delta Pi_compression$ is defined by :

- $\Delta Pi_compression = 3$ dB for downlink frames compressed by reducing the spreading factor by 2.
- $\Delta Pi_compression = 10 \log(15 * F_i / (15 * F_i - TGL_i))$ if there is a transmission gap created by puncturing method within the current TTI of length F_i frames, where TGL_i is the gap length in number of slots (either from one gap or a sum of gaps) in the current TTI of length F_i frames.
- $\Delta Pi_compression = 0$ dB in all other cases.

In case several compressed mode patterns are used simultaneously, a δP offset is computed for each compressed mode pattern and the sum of all δP offsets is applied to the frame.

5.2.1.4 Site selection diversity transmit power control

5.2.1.4.1 General

Site selection diversity transmit power control (SSDT) is another macro diversity method in soft handover mode. This method is optional in UTRAN.

Operation is summarised as follows. The UE selects one of the cells from its active set to be 'primary', all other cells are classed as 'non primary'. The main objective is to transmit on the downlink from the primary cell, thus reducing the interference caused by multiple transmissions in a soft handover mode. A second objective is to achieve fast site selection without network intervention, thus maintaining the advantage of the soft handover. In order to select a primary cell, each cell is assigned a temporary identification (ID) and UE periodically informs a primary cell ID to the connecting cells. The non-primary cells selected by UE switch off the transmission power. The primary cell ID is delivered by UE to the active cells via uplink FBI field. SSDT activation, SSDT termination and ID assignment are all carried out by higher layer signalling.

5.2.1.4.1.1 Definition of temporary cell identification

Each cell is given a temporary ID during SSSDT and the ID is utilised as site selection signal. The ID is given a binary bit sequence. There are three different lengths of coded ID available denoted as "long", "medium" and "short". The network decides which length of coded ID is used. Settings of ID codes for 1-bit and 2-bit FBI are exhibited in table 3 and table 4, respectively.

Table 3: Settings of ID codes for 1 bit FBI

ID label	ID code		
	"long"	"medium"	"short"
a	0000000000000000	(0)0000000	00000
b	101010101010101	(0)1010101	01001
c	011001100110011	(0)0110011	11011
d	110011001100110	(0)1100110	10010
e	000111100001111	(0)0001111	00111
f	101101001011010	(0)1011010	01110
g	011110000111100	(0)0111100	11100
h	110100101101001	(0)1101001	10101

Table 4: Settings of ID codes for 2 bit FBI

ID label	ID code (Column and Row denote slot position and FBI-bit position.)		
	"long"	"medium"	"short"
a	(0)0000000	(0)000	000
	(0)0000000	(0)000	000
b	(0)0000000	(0)000	000
	(1)1111111	(1)111	111
c	(0)1010101	(0)101	101
	(0)1010101	(0)101	101
d	(0)1010101	(0)101	101
	(1)0101010	(1)010	010
e	(0)0110011	(0)011	011
	(0)0110011	(0)011	011
f	(0)0110011	(0)011	011
	(1)1001100	(1)100	100
g	(0)1100110	(0)110	110
	(0)1100110	(0)110	110
h	(0)1100110	(0)110	110
	(1)0011001	(1)001	001

The ID code bits shown in table 3 and table 4 are transmitted from left to right. In table 4, the first row gives the first FBI bit in each slot, the second row gives the 2nd FBI bit in each slot. The ID code(s) are transmitted aligned to the radio frame structure (i.e. ID codes shall be terminated within a frame). If FBI space for sending the last ID code within a frame cannot be obtained, the first bit(s) from that ID code are punctured. The bit(s) to be punctured are shown in brackets in table 3 and table 4.

The alignment of the ID codes to the radio frame structure is not affected by transmission gaps resulting from uplink compressed mode.

5.2.1.4.2 TPC procedure in UE

The UE shall generate TPC commands to control the network transmit power and send them in the TPC field of the uplink DPCCCH based on the downlink signals from the primary cell only. An example on how to derive the TPC commands is given in Annex B.2.

5.2.1.4.3 Selection of primary cell

The UE selects a primary cell periodically by measuring the RSCP of CPICHS transmitted by the active cells. The cell with the highest CPICHS RSCP is detected as a primary cell.

5.2.1.4.4 Delivery of primary cell ID

The UE periodically sends the ID code of the primary cell via portion of the uplink FBI field assigned for SSdT use (FBI S field). A cell recognises its state as non-primary if the following conditions are fulfilled simultaneously:

- The received ID code does not match with the own ID code.
- The received uplink signal quality satisfies a quality threshold, Q_{th} , a parameter defined by the network.
- If uplink compressed mode is used, and less than $\lfloor N_{ID}/3 \rfloor$ bits are lost from the ID code (as a result of uplink compressed mode), where N_{ID} is the number of bits in the ID code (after puncturing according to clause 5.2.1.4.1.1, if puncturing has been done).

Otherwise the cell recognises its state as primary.

The state of the cells (primary or non-primary) in the active set is updated synchronously. If a cell receives the last portion of the coded ID in uplink slot j , the state of cell is updated in downlink slot $(j+1+T_{os}) \bmod 15$, where T_{os} is defined as a constant of 2 time slots. The updating of the cell state is not influenced by the operation of downlink compressed mode.

At the UE, the primary ID code to be sent to the cells is segmented into a number of portions. These portions are distributed in the uplink FBI S-field. The cell in SSdT collects the distributed portions of the primary ID code and then detects the transmitted ID. The period of the primary cell update depends on the settings of the code length and the number of FBI bits assigned for SSdT use as shown in table 5.

Table 5: Period of primary cell update

code length	The number of FBI bits per slot assigned for SSdT	
	1	2
"long"	1 update per frame	2 updates per frame
"medium"	2 updates per frame	4 updates per frame
"short"	3 updates per frame	5 updates per frame

5.2.1.4.5 TPC procedure in the network

In SSdT, a non-primary cell can switch off its DPDCH output (i.e. no transmissions).

The cell manages two downlink transmission power levels, P1, and P2. Power level P1 is used for downlink DPCCH transmission power level and this level is updated in the same way with the downlink DPCCH power adjustment specified in 5.2.1.2.2 (for normal mode) and 5.2.1.3 (for compressed mode) regardless of the selected state (primary or non-primary). The actual transmission power of TFCI, TPC and pilot fields of DPCCH is set by adding P1 and the offsets PO1, PO2 and PO3, respectively, as specified in 5.2.1.1. P2 is used for downlink DPDCH transmission power level and this level is set to P1 if the cell is selected as primary, otherwise P2 is switched off. The cell updates P1 first and P2 next, and then the two power settings P1 and P2 are maintained within the power control dynamic range. Table 6 summarizes the updating method of P1 and P2.

Table 6: Updating of P1 and P2

State of cell	P1 (DPCCH)	P2 (DPDCH)
non primary	Updated in the same way with the downlink DPCCH power adjustment specified in 5.2.1.2.2 and 5.2.1.3	Switched off
primary		= P1

5.2.2 PDSCH

The PDSCH power control can be based on the following solutions, which are selectable, by the network:

- Inner-loop power control based on the power control commands sent by the UE on the uplink DPCCCH.
- Slow power control.

5.2.3 AICH

The UE is informed about the relative transmit power of the AICH (measured as the power per transmitted acquisition indicator) compared to the primary CPICH transmit power by the higher layers.

5.2.4 PICH

The UE is informed about the relative transmit power of the PICH (measured as the power over the paging indicators) compared to the primary CPICH transmit power by the higher layers.

5.2.5 S-CCPCH

The TFCI and pilot fields may be offset relative to the power of the data field. The power offsets may vary in time.

5.2.6 CSICH

The UE is informed about the relative transmit power of the CSICH (measured as the power per transmitted status indicator) compared to the primary CPICH transmit power by the higher layers.

6 Random access procedure

6.1 Physical random access procedure

The physical random access procedure described in this subclause is initiated upon request of a PHY-Data-REQ primitive from the MAC sublayer (cf. [9]).

Before the physical random-access procedure can be initiated, Layer 1 shall receive the following information from the higher layers (RRC):

- The preamble scrambling code.
- The message length in time, either 10 or 20 ms.
- The AICH_Transmission_Timing parameter [0 or 1].
- The set of available signatures and the set of available RACH sub-channels for each Access Service Class (ASC). Sub-channels are defined in subclause 6.1.1.
- The power-ramping factor Power Ramp Step [integer > 0].
- The parameter Preamble Retrans Max [integer > 0].
- The initial preamble power Preamble_Initial_Power.
- The Power offset $P_{p-m} = P_{\text{message-control}} - P_{\text{preamble}}$, measured in dB, between the power of the last transmitted preamble and the control part of the random-access message.
- The set of Transport Format parameters. This includes the power offset between the data part and the control part of the random-access message for each Transport Format.

Note that the above parameters may be updated from higher layers before each physical random access procedure is initiated.

At each initiation of the physical random access procedure, Layer 1 shall receive the following information from the higher layers (MAC):

- The Transport Format to be used for the PRACH message part.
- The ASC of the PRACH transmission.
- The data to be transmitted (Transport Block Set).

The physical random-access procedure shall be performed as follows:

- 1 Derive the available uplink access slots, in the next full access slot set, for the set of available RACH sub-channels within the given ASC with the help of subclauses 6.1.1. and 6.1.2. Randomly select one access slot among the ones previously determined. If there is no access slot available in the selected set, randomly select one uplink access slot corresponding to the set of available RACH sub-channels within the given ASC from the next access slot set. The random function shall be such that each of the allowed selections is chosen with equal probability.
- 2 Randomly select a signature from the set of available signatures within the given ASC. The random function shall be such that each of the allowed selections is chosen with equal probability.
- 3 Set the Preamble Retransmission Counter to Preamble Retrans Max.
- 4 Set the parameter Commanded Preamble Power to Preamble_Initial_Power.
- 5 In the case that the Commanded Preamble Power exceeds the maximum allowed value, set the preamble transmission power to the maximum allowed power. In the case that the Commanded Preamble Power is below the minimum level required in [7], set the preamble transmission power to a value, which shall be at or above the Commanded Preamble Power and at or below the required minimum power specified in [7]. Otherwise set the preamble transmission power to the Commanded Preamble Power. Transmit a preamble using the selected uplink access slot, signature, and preamble transmission power.
- 6 If no positive or negative acquisition indicator ($AI \neq +1$ nor -1) corresponding to the selected signature is detected in the downlink access slot corresponding to the selected uplink access slot:
 - 6.1 Select the next available access slot in the set of available RACH sub-channels within the given ASC.
 - 6.2 Randomly select a new signature from the set of available signatures within the given ASC. The random function shall be such that each of the allowed selections is chosen with equal probability.
 - 6.3 Increase the Commanded Preamble Power by $\Delta P_0 = \text{Power Ramp Step [dB]}$. If the Commanded Preamble Power exceeds the maximum allowed power by 6dB, the UE may pass L1 status ("No ack on AICH") to the higher layers (MAC) and exit the physical random access procedure.
 - 6.4 Decrease the Preamble Retransmission Counter by one.
 - 6.5 If the Preamble Retransmission Counter > 0 then repeat from step 5. Otherwise pass L1 status ("No ack on AICH") to the higher layers (MAC) and exit the physical random access procedure.
- 7 If a negative acquisition indicator corresponding to the selected signature is detected in the downlink access slot corresponding to the selected uplink access slot, pass L1 status ("Nack on AICH received") to the higher layers (MAC) and exit the physical random access procedure.
- 8 Transmit the random access message three or four uplink access slots after the uplink access slot of the last transmitted preamble depending on the AICH transmission timing parameter. Transmission power of the control part of the random access message should be P_{p-m} [dB] higher than the power of the last transmitted preamble. Transmission power of the data part of the random access message is set according to subclause 5.1.1.2.
- 9 Pass L1 status "RACH message transmitted" to the higher layers and exit the physical random access procedure.

6.1.1 RACH sub-channels

A RACH sub-channel defines a sub-set of the total set of uplink access slots. There are a total of 12 RACH sub-channels. RACH sub-channel #i ($i = 0, \dots, 11$) consists of the following uplink access slots:

- Uplink access slot #i leading by τ_{p-a} chips the downlink access slot #i contained within the 10 ms interval that is time aligned with P-CCPCH frames for which $\text{SFN mod } 8 = 0$ or $\text{SFN mod } 8 = 1$.

- Every 12th access slot relative to this access slot.

The access slots of different RACH sub-channels are also illustrated in Table 7.

Table 7: The available uplink access slots for different RACH sub-channels

SFN modulo 8 of corresponding P-CCPCH frame	Sub-channel number											
	0	1	2	3	4	5	6	7	8	9	10	11
0	0	1	2	3	4	5	6	7				
1	12	13	14						8	9	10	11
2				0	1	2	3	4	5	6	7	
3	9	10	11	12	13	14						8
4	6	7					0	1	2	3	4	5
5			8	9	10	11	12	13	14			
6	3	4	5	6	7					0	1	2
7						8	9	10	11	12	13	14

6.1.2 RACH access slot sets

The PRACH contains two sets of access slots as shown in Figure 2. Access slot set 1 contains PRACH slots 0 – 7 and starts τ_{p-a} chips before the downlink P-CCPCH frame for which SFN mod 2 = 0. Access slot set 2 contains PRACH slots 8 - 14 and starts $(\tau_{p-a} - 2560)$ chips before the downlink P-CCPCH frame for which SFN mod 2 = 1.

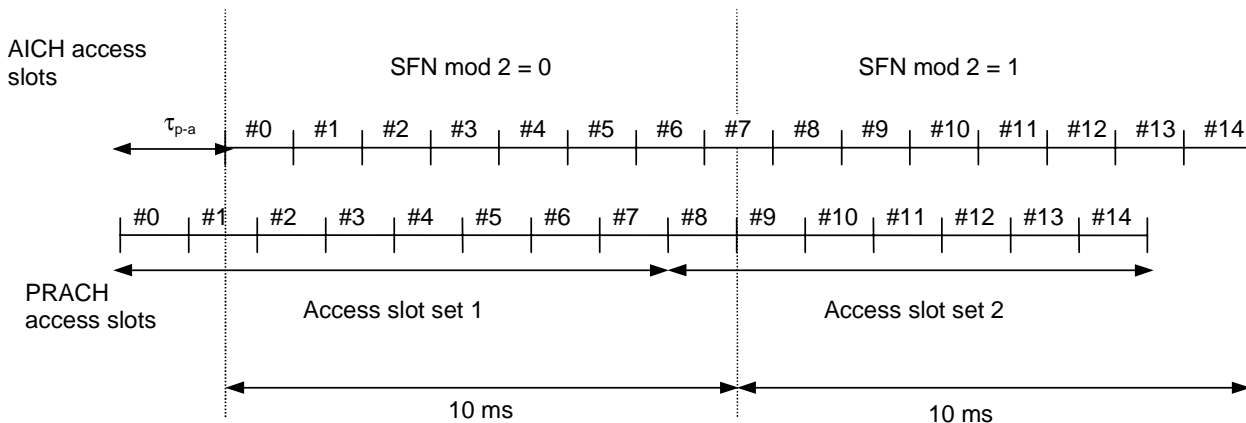

Figure 2: PRACH access slot and downlink AICH relation ($\tau_{p-a} = 7680$ chips)

6.2 CPCH Access Procedures

For each CPCH physical channel in a CPCH set allocated to a cell the following physical layer parameters are included in the System Information message: L1 shall receive the following information from the higher layers (RRC).

- UL Access Preamble (AP) scrambling code.
- UL Access Preamble signature set.
- The Access preamble slot sub-channels group.
- AP- AICH preamble channelization code.
- UL Collision Detection(CD) preamble scrambling code.
- CD Preamble signature set.
- CD preamble slot sub-channels group.
- CD-AICH preamble channelization code.

- CPCH UL scrambling code.
- DPCCH DL channelization code.([512] chip).

NOTE: There may be some overlap between the AP signature set and CD signature set if they correspond to the same scrambling code.

The following physical layer parameters are received from the RRC layer:

- 1) $N_{AP_retrans_max}$ = Maximum Number of allowed consecutive access attempts (retransmitted preambles) if there is no AICH response. This is a CPCH parameter and is equivalent to Preamble Retrans Max in RACH.
- 2) $P_{RACH} = P_{CPCH}$ = Initial open loop power level for the first CPCH access preamble sent by the UE.
 - [RACH/CPCH parameter].
- 3) ΔP_0 = Power step size for each successive CPCH access preamble.
 - [RACH/CPCH parameter].
- 4) ΔP_1 = Power step size for each successive RACH/CPCH access preamble in case of negative AICH. A timer is set upon receipt of a negative AICH. This timer is used to determine the period after receipt of a negative AICH when ΔP_1 is used in place of ΔP_0 .
 - [RACH/CPCH parameter].
- 5) $\Delta P_{p-m} = P_{message-control} - P_{cd}$, measured in dB. This is the power offset between the transmit power of the CD preamble and the initial transmit power of the CPCH power control preamble (or the control part of the CPCH message part if the power control preamble length is 0 slots).

[CPCH parameter]
- 6) T_{cpch} = CPCH transmission timing parameter: This parameter is identical to PRACH/AICH transmission timing parameter.
 - [RACH/CPCH parameter].
- 7) $L_{pc-preamble}$ = Length of power control preamble (0 or 8 slots).
 - [CPCH parameter].
- 8) $N_{Start_Message}$ = Number of frames for the transmission of Start of Message Indicator in DL-DPCCH for CPCH.
- 9) The set of Transport Format parameters. This includes a Transport Format to PCPCH mapping table.

L1 shall receive the following information from MAC prior to packet transmission:

- 1) Transport Format of the message part.
- 2) The data to be transmitted is delivered to L1 once every TTI until the data buffer is empty.

The overall CPCH -access procedure consists of two parts:

- 1) Upon receipt of a Status-REQ message from the MAC layer, the UE shall start monitoring the CSICH to determine the availability of the transport formats in the transport format subset included in the Status-REQ message. UTRAN transmits availability of each PCPCH or maximum available data rate with availability of each PCPCH over the CSICH in case CA is active. Upper layers will supply the UE with information to map the transport formats to the PCPCHs. The UE shall send a Status-CNF message to the MAC layer containing the transport format subset listing the transport formats of the requested subset which are currently indicated as "available".

The actual access procedure is then:

- 2) Upon receipt of the Access-REQ message from the MAC layer, which contains an identified transport format from the available ones ,the following sequence of events occur. The use of step 2a or 2b depends on whether availability of each PCPCH or the Maximum available data rate along with the availability of each PCPCH is transmitted over CSICH. Note that in the first case, each access resource combination (AP signatures and access

subchannel group) maps to each PCPCH resource and in the second case each access resource combination maps to each data rate.

- 2a) (In case CA is not Active) The UE shall test the value(s) of the most recent transmission of the CSICH Status Indicator(s) corresponding to the PCPCH channel(s) for the identified transport format included in the Access-REQ message. If this indicates that no channel is 'available' the UE shall abort the access attempt and send a failure message to the MAC layer. The UE shall also retain the availability status of the each PCPCH for further verification in a later phase.
- 2b) (In case CA is active) The CSICH Status Indicators indicate the maximum available data rate along with individual PCPCH availability. The UE shall test the value of the most recent transmission of the Status Indicator(s). If this indicates that the maximum available data rate is less than the requested data rate, the UE shall abort the access attempt and send a failure message to the MAC layer. The PHY provides the availability information to the MAC. The UE shall also retain the availability status of the each PCPCH for further channel assignment message verification in a later phase in case of success.
- 3) The UE sets the preamble transmit power to the value P_{CPCH} which is supplied by the MAC layer for initial power level for this CPCH access attempt.
- 4) The UE sets the AP Retransmission Counter to $N_{\text{AP_Retrans_Max}}$.
- 5a) In the case CA is not active, the uplink access slot and signature to be used for the CPCH-AP transmission are selected in the following steps:
 - a) The UE selects randomly one PCPCH from the set of available PCPCH channel(s) as indicated on the CSICH and supporting the identified transport format included in the Access-REQ message. The random function shall be such that each of the allowed selections is chosen with equal probability.
 - b) The UE randomly selects a CPCH-AP signature from the set of available signatures in the access resource combination corresponding to the selected PCPCH in step a). The random function shall be such that each of the allowed selections is chosen with equal probability.
 - c) Using the AP access slot sub-channel group of the access resource combination corresponding to selected PCPCH in step a), the UE derives the available CPCH-AP access slots with the help of subclauses 6.1.1. and 6.1.2. The UE randomly selects one uplink access slot from the derived available CPCH-AP access slots. If there is no access slot available in the selected set, the UE randomly selects one uplink access slot corresponding to the selected CPCH sub-channel group from the next access slot set. The random function shall be such that each of the allowed selections is chosen with equal probability.
- 5b) In the case CA is active, the uplink access slot and signature to be used for the CPCH-AP transmission are selected in the following steps:
 - a) The UE randomly selects a CPCH-AP signature from the set of available signatures in the access resource combination corresponding to the transport format identified in the Access-REQ message. The random function shall be such that each of the allowed selections is chosen with equal probability.
 - b) Using the AP access slot sub-channel group of the access resource combination corresponding to the transport format identified in the Access-REQ message, the UE derives the available CPCH-AP access slots with the help of subclauses 6.1.1 and 6.1.2. The UE randomly selects one uplink access slot from the derived available CPCH-AP access slots. If there is no access slot available in the selected set, the UE randomly selects one uplink access slot corresponding to the selected CPCH sub-channel group from the next access slot set. The random function shall be such that each of the allowed selections is chosen with equal probability.
- 6) The UE transmits the AP using the selected uplink access slot and signature, and MAC supplied initial preamble transmission power. The following sequence of events occur based on whether availability of each PCPCH or the Maximum available data rate along with the availability of each PCPCH is transmitted over CSICH.
- 6a) (In case CA is not Active) The UE shall test the value of the most recent transmission of the Status Indicator corresponding to the identified CPCH transport channel immediately before AP transmission. If this indicates that the channel is 'not available' the UE shall abort the access attempt and send a failure message to the MAC layer. Otherwise the UE transmits the AP using the UE selected uplink signature and access slot, and the initial preamble transmission power from step 3, above.

- 6b) (In case CA is active) The Status Indicator indicates the maximum available data rate as well as the availability of each PCPCH. The UE shall test the value of the Status Indicator. If this indicates that the maximum available data rate is less than the requested data rate, the UE shall abort the access attempt and send a failure message to the MAC layer. Otherwise the UE shall transmit the AP using the UE selected uplink access slot, the MAC supplied signature and initial preamble transmission power from step 3, above.
- 7) If the UE does not detect the positive or negative acquisition indicator corresponding to the selected signature in the downlink access slot corresponding to the selected uplink access slot, the UE shall test the value of the most recent transmission of the Status Indicator corresponding to the selected PCPCH immediately before AP transmission. If this indicates that the PCPCH is 'not available' the UE shall abort the access attempt and send a failure message to the MAC layer. Otherwise the following steps shall be executed:
- a) Select the next available access slot in the sub-channel group used. There must be a minimum distance of three or four (per T_{pch} parameter) access slots from the uplink access slot in which the last preamble was transmitted depending on the CPCH/AICH transmission timing parameter.
 - b) Increases the preamble transmission power with the specified offset ΔP . Power offset ΔP_0 is used unless the negative AICH timer is running, in which case ΔP_1 is used instead.
 - c) Decrease the AP Retransmission Counter by one.
 - d) If the AP Retransmission Counter < 0 , the UE aborts the access attempt and sends a failure message to the MAC layer.
- 8) If the UE detects the AP-AICH_nak (negative acquisition indicator) corresponding to the selected signature in the downlink access slot corresponding to the selected uplink access slot, the UE aborts the access attempt and sends a failure message to the MAC layer. The UE sets the negative AICH timer to indicate use of ΔP_1 use as the preamble power offset until timer expiry.
- 9) Upon reception of AP-AICH_ack with matching signature, the access segment ends and the contention resolution segment begins. In this segment, the UE randomly selects a CD signature from the CD signature set and also selects one CD access slot sub-channel from the CD sub-channel group supported in the cell and transmits a CD Preamble at the same power as the last AP, then waits for a CD/CA-ICH and the channel assignment (CA) (in case CA is active) message from the Node B. The slot selection procedure is as follows:
- a) The next available slot when the PRACH and PCPCH scrambling code are not shared. Furthermore, the PCPCH AP preamble scrambling code and CD Preamble scrambling codes are different.
 - b) When the PRACH and PCPCH AP preamble scrambling code and CD preamble scrambling code are shared, the UE randomly selects one of the available access slots in the next 12 access slots. Number of CD sub-channels will be greater than 2.
- 10) If the UE does not receive a CD/CA-ICH in the designated slot, the UE aborts the access attempt and sends a failure message to the MAC layer.
- 11) If the UE receives a CD/CA-ICH in the designated slot with a signature that does not match the signature used in the CD Preamble, the UE aborts the access attempt and sends a failure message to the MAC layer.
- 12a) (In case CA is not Active) If the UE receives a CDI from the CD/CA-ICH with a matching signature, the UE transmits the power control preamble $\tau_{cd-pc-p}$ ms later as measured from initiation of the CD Preamble. The initial transmission power of the power control preamble shall be ΔP_{p-m} [dB] higher than the power of the CD preamble. The inner loop power control in the power control preamble is described in sub clause 5.1.3.3. The transmission of the message portion of the burst starts immediately after the power control preamble. Power control in the message part is described in sub clause 5.1.3.2.
- 12b) (In case CA is active) If the UE receives a CDI from the CD/CA-ICH with a matching signature and CA message that points out to one of the PCPCH's (mapping rule is in [5]) that were indicated to be free by the last received CSICH broadcast, the UE transmits the power control preamble $\tau_{cd-pc-p}$ ms later as measured from initiation of the CD Preamble. The initial transmission power of the power control preamble shall be ΔP_{p-m} [dB] higher than the power of the CD preamble. The inner loop power control in the power control preamble is described in sub clause 5.1.3.3. The transmission of the message portion of the burst starts immediately after the power control preamble. Power control in the message part is described in sub clause 5.1.3.2. If the CA message received points out the channel that was indicated to be busy on the last status information transmission received on the CSICH, the UE shall abort the access attempt and send a failure message to the MAC layer.

- NOTE: If the $L_{pc-preamble}$ parameter indicates a zero length preamble, then there is no power control preamble and the message portion of the burst starts $\tau_{cd-p-pc-p}$ ms after the initiation of the CD Preamble. In this case the initial transmission power of the control part of the message part shall be ΔP_{p-m} [dB] higher than the power of the CD preamble. Power control in the message part is described in sub clause 5.1.3.2
- 13) The UE shall test the value of Start of Message Indicator received from DL-DPCCH for CPCH during the first $N_{Start_Message}$ frames after Power Control preamble. Start of Message Indicator is a known sequence repeated on a frame by frame basis. The value of $N_{Start_Message}$ shall be provided by the higher layers.
 - 14) If the UE does not detect Start of Message Indicator in the first $N_{Start_Message}$ frames of DL-DPCCH for CPCH after Power Control preamble, the UE aborts the access attempt and sends a failure message to the MAC layer. Otherwise, UE continuously transmits the packet data.
 - 15) During CPCH Packet Data transmission, the UE and UTRAN perform inner-loop power control on both the CPCH UL and the DPCCH DL, as described in sub clause 5.1.3.
 - 16) After the first $N_{Start_Message}$ frames after Power Control preamble, upon the detection of an Emergency Stop command sent by UTRAN, the UE halts CPCH UL transmission, aborts the access attempt and sends a failure message to the MAC layer.
 - 17) If the UE detects loss of DPCCH DL during transmission of the power control preamble or the packet data, the UE halts CPCH UL transmission, aborts the access attempt and sends a failure message to the MAC layer.
 - 18) The UE may send empty frames after the end of the packet to indicate the end of transmission. The number of the empty frames is set by higher layers.

7 Closed loop mode transmit diversity

The general transmitter structure to support closed loop mode transmit diversity for DPCH transmission is shown in figure 3. Channel coding, interleaving and spreading are done as in non-diversity mode. The spread complex valued signal is fed to both TX antenna branches, and weighted with antenna specific weight factors w_1 and w_2 . The weight factors are complex valued signals (i.e., $w_i = a_i + jb_i$), in general.

The weight factors (actually the corresponding phase adjustments in closed loop mode 1 and phase/amplitude adjustments in closed loop mode 2) are determined by the UE, and signalled to the UTRAN access point (=cell transceiver) using the D-bits of the FBI field of uplink DPCCH.

For the closed loop mode 1 different (orthogonal) dedicated pilot symbols in the DPCCH are sent on the 2 different antennas. For closed loop mode 2 the same dedicated pilot symbols in the DPCCH are sent on both antennas.

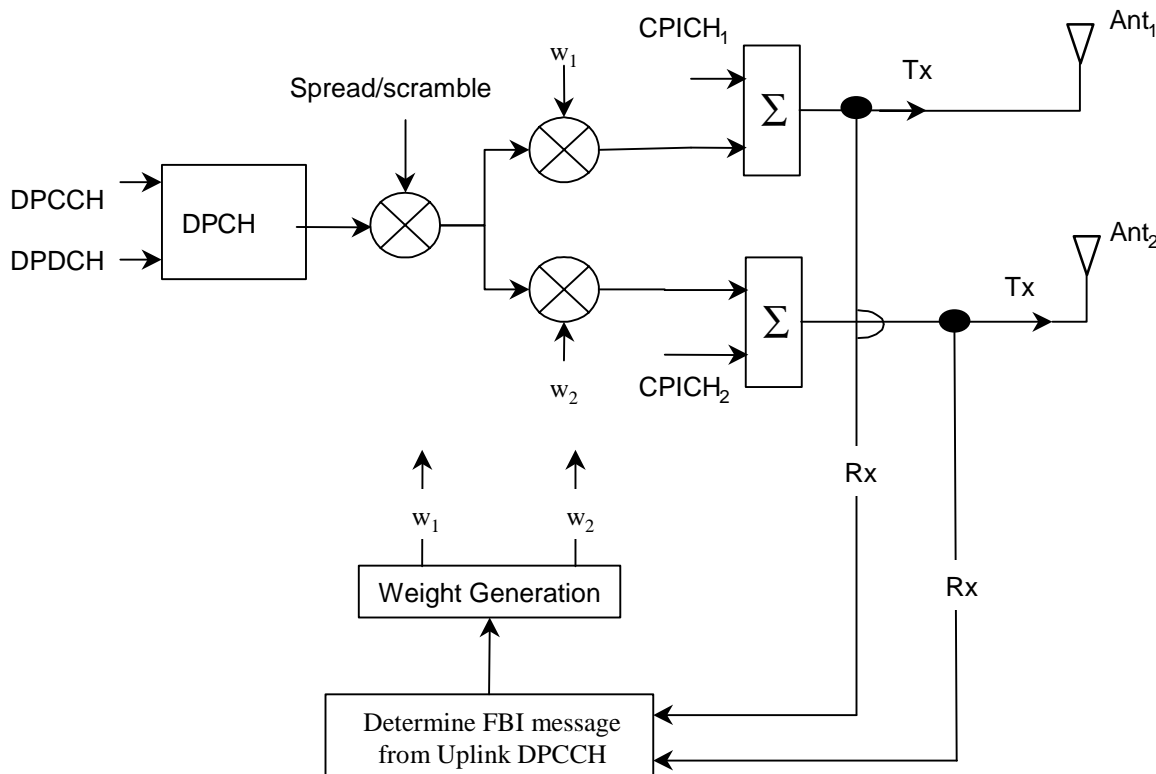

Figure 3: The generic downlink transmitter structure to support closed loop mode transmit diversity for DPCH transmission

There are two closed loop modes whose characteristics are summarised in the table 8. The use of the modes is controlled via higher layer signalling.

Table 8: Summary of number of feedback information bits per slot, N_{FBD} , feedback command length in slots, N_W , feedback command rate, feedback bit rate, number of phase bits, N_{ph} , per signalling word, number of amplitude bits, N_{po} , per signalling word and amount of constellation rotation at UE for the two closed loop modes

Closed loop mode	N_{FBD}	N_W	Update rate	Feedback bit rate	N_{po}	N_{ph}	Constellation rotation
1	1	1	1500 Hz	1500 bps	0	1	$\pi/2$
2	1	4	1500 Hz	1500 bps	1	3	N/A

7.1 Determination of feedback information

The UE uses the Common Pilot Channel (CPICH) to separately estimate the channels seen from each antenna.

Once every slot, the UE computes the phase adjustment, ϕ , and for mode 2 the amplitude adjustment that should be applied at the UTRAN access point to maximise the UE received power. In non-soft handover case, that can be accomplished by e.g. solving for weight vector, \underline{w} , that maximises.

$$P = \underline{w}^H H^H H \underline{w} \tag{1}$$

where

$$H = [h_1 \ h_2] \text{ and } \underline{w} = [w_1, w_2]^T$$

and where the column vectors h_1 and h_2 represent the estimated channel impulse responses for the transmission antennas 1 and 2, of length equal to the length of the channel impulse response. The elements of \underline{w} correspond to the adjustments computed by the UE.

During soft handover or SSTD power control, the antenna weight vector, \underline{w} can be, for example, determined so as to maximise the criteria function:

$$P = \underline{w}^H (H_1^H H_1 + H_2^H H_2 + \dots) \underline{w} \quad (2)$$

where H_i is an estimated channel impulse response for BS#i. In regular SHO, the set of BS#i corresponds to the active set. With SSTD, the set of BS#i corresponds to the primary base station(s).

The UE feeds back to the UTRAN access point the information on which phase/power settings to use. Feedback Signalling Message (FSM) bits are transmitted in the portion of FBI field of uplink DPCCH slot(s) assigned to closed loop mode transmit diversity, the FBI D field (see [1]). Each message is of length $N_W = N_{po} + N_{ph}$ bits and its format is shown in the figure 4. The transmission order of bits is from MSB to LSB, i.e. MSB is transmitted first. FSM_{po} and FSM_{ph} subfields are used to transmit the power and phase settings, respectively.

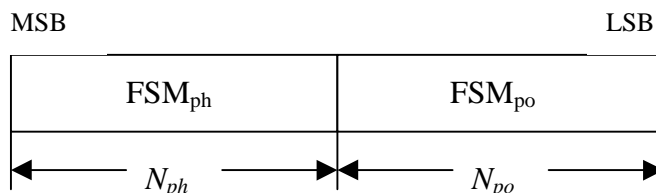

Figure 4: Format of feedback signalling message. FSM_{po} transmits the power setting and FSM_{ph} the phase setting

The adjustments are made by the UTRAN Access Point at the beginning of the downlink DPCCH pilot field. The downlink slot in which the adjustment is done is signalled to L1 of UE by higher layers. Two possibilities exist:

- 1) When feedback command is transmitted in uplink slot i , which is transmitted in a chip offset limited to 1024 ± 148 chips when compared to received downlink slot j , the adjustment is done at the beginning of the pilot field of the downlink slot $(j+1) \bmod 15$.
- 2) When feedback command is transmitted in uplink slot i , which is transmitted in a chip offset limited to 1024 ± 148 chips when compared to received downlink slot j , the adjustment is done at the beginning of the pilot field of the downlink slot $(j+2) \bmod 15$.

Thus, adjustment timing at UTRAN Access Point is either according to 1) or 2) as controlled by the higher layers.

In case a PDSCH is associated with a DPCH for which closed-loop transmit diversity is applied, the antenna weights applied to the PDSCH are the same as the antenna weights applied to the associated DPCH. The timing of the weight adjustment of the PDSCH is such that the PDSCH weight adjustment is done at the PDSCH slot border, N chips after the adjustment of the associated DPCH, where $0 \leq N < 2560$.

7.2 Closed loop mode 1

UE uses the CPICH transmitted both from antenna 1 and antenna 2 to calculate the phase adjustment to be applied at UTRAN access point to maximise the UE received power. In each slot, UE calculates the optimum phase adjustment, ϕ , for antenna 2, which is then quantized into ϕ_Q having two possible values as follows:

$$\phi_Q = \begin{cases} \pi, & \text{if } \pi/2 < \phi - \phi_r(i) \leq 3\pi/2 \\ 0, & \text{otherwise} \end{cases} \quad (2)$$

where:

$$\phi_r(i) = \begin{cases} 0, & i = 0, 2, 4, 6, 8, 10, 12, 14 \\ \pi/2, & i = 1, 3, 5, 7, 9, 11, 13 \end{cases} \quad (3)$$

If $\phi_Q = 0$, a command '0' is sent to UTRAN using the FSM_{ph} field. Correspondingly, if $\phi_Q = \pi$, command '1' is sent to UTRAN using the FSM_{ph} field.

Due to rotation of the constellation at UE the UTRAN interprets the received commands according to table 9 which shows the mapping between phase adjustment, ϕ_i , and received feedback command for each UL slot.

Table 9: Phase adjustments, ϕ_i , corresponding to feedback commands for the slots i of the UL radio frame

Slot #	0	1	2	3	4	5	6	7	8	9	10	11	12	13	14
FSM	0	$\pi/2$	0	$\pi/2$	0	$\pi/2$	0	$\pi/2$	0	$\pi/2$	0	$\pi/2$	0	$\pi/2$	0
	1	π	$-\pi/2$	π	$-\pi/2$	π	$-\pi/2$	π	$-\pi/2$	π	$-\pi/2$	π	$-\pi/2$	π	$-\pi/2$

The weight vector, w_2 , is then calculated by sliding window averaging the received phases over 2 consecutive slots. Algorithmically, w_2 is calculated as follows:

$$w_2 = \frac{\sum_{i=n-1}^n \cos(\phi_i)}{2} + j \frac{\sum_{i=n-1}^n \sin(\phi_i)}{2} \quad (4)$$

where:

$$\phi_i \in \{0, \pi, \pi/2, -\pi/2\} \quad (5)$$

For antenna 1, the weight vector, w_1 , is always:

$$w_1 = 1/\sqrt{2} \quad (6)$$

7.2.1 Mode 1 end of frame adjustment

In closed loop mode 1 at frame borders the sliding window averaging operation is slightly modified. Upon reception of the FB command for slot 0 of the next frame, the average is calculated based on the command for slot 13 of the previous frame and the command for slot 0 of the next frame, i.e. ϕ_i from slot 14 is not used:

$$w_2 = \frac{\cos(\phi_{13}^{j-1}) + \cos(\phi_0^j)}{2} + j \frac{\sin(\phi_{13}^{j-1}) + \sin(\phi_0^j)}{2} \quad (7)$$

where:

- ϕ_{13}^{j-1} = phase adjustment from frame j-1, slot 13.
- ϕ_0^j = phase adjustment from frame j, slot 0.

7.2.2 Mode 1 normal initialisation

For the first frame of transmission UE determines the feedback commands in a normal way and sends them to UTRAN.

Before the first FB command is received, the UTRAN shall use the initial weight $w_2 = \frac{1}{2}(1 + j)$.

Having received the first FB command the UTRAN calculates the w_2 as follows:

$$w_2 = \frac{\cos(\pi/2) + \cos(\phi_0)}{2} + j \frac{\sin(\pi/2) + \sin(\phi_0)}{2} \quad (8)$$

where:

ϕ_0 = phase adjustment from slot 0 of the first frame.

7.2.3 Mode 1 operation during compressed mode

7.2.3.1 Downlink in compressed mode and uplink in normal mode

When downlink is in compressed mode but uplink is operating normally (i.e. not compressed) the UTRAN continues its Tx diversity related functions in the same way as in non-compressed downlink mode.

In compressed downlink transmission there are uplink slots for which no new estimate of the phase adjustment is calculated. During these slots the following rules are applied in UE when determining the feedback command:

- 1) If no new estimate of phase adjustment, ϕ_i , exist corresponding to the feedback command to be send in uplink slot i :
 - If $1 < i < 15$:
 - the feedback command sent in uplink slot $i-2$ is used;
 - else if $i = 0$:
 - the feedback command sent in uplink slot 14 of previous frame is used;
 - else if $i = 1$:
 - the feedback command sent in uplink slot 13 of previous frame is used;
 - end if.
- 2) When transmission in downlink is started again in downlink slot $N_{\text{last}}+1$ (if $N_{\text{last}}+1 = 15$, then slot 0 in the next frame) the UE must resume calculating new estimates of the phase adjustment. The feedback command corresponding to the first new estimate of ϕ_i must be send in the uplink slot which is transmitted 1024 chips in offset from the downlink slot $N_{\text{last}}+1$.

7.2.3.2 Both downlink and uplink in compressed mode

During the uplink idle slots no FB commands are sent from UE to UTRAN. When transmission in downlink is started again in downlink slot $N_{\text{last}}+1$ (if $N_{\text{last}}+1 = 15$, then slot 0 in the next frame) the UE must resume calculating new estimates of the phase adjustment. The feedback command corresponding to the first new estimate of ϕ_i must be send in the uplink slot which is transmitted 1024 chips in offset from the downlink slot $N_{\text{last}}+1$.

The UTRAN continues to update the weight vector, w_2 , until the uplink enters the compressed mode and no more FB commands are received. When the transmission in downlink resumes in slot $N_{\text{last}}+1$, the value of w_2 calculated after receiving the last FB command before uplink entered the compressed mode is applied to antenna 2 signal.

After UE resumes transmission in uplink and sends the first FB command the new value of w_2 is calculated as follows:

- $S_1 = \{0, 2, 4, 6, 8, 10, 12, 14\}$.
- $S_2 = \{1, 3, 5, 7, 9, 11, 13\}$.
- i = number of uplink slot at which the transmission resumes.
- j = number of uplink slot at which the last FB command was send before uplink entered compressed mode.
- Do while ($i \in S_1$ and $j \in S_1$) or ($i \in S_2$ and $j \in S_2$):
 - $j = j-1$;
 - if $j < 0$;
 - $j = 14$;
- end if;
- end do;

- calculate w_2 based on FB commands received in uplink slots i and j .

7.3 Closed loop mode 2

In closed loop mode 2 there are 16 possible combinations of phase and power adjustment from which the UE selects and transmits the FSM according to table 10 and table 11. As opposed to closed loop Mode 1, no constellation rotation is done at UE and no filtering of the received weights is performed at the UTRAN.

Table 10: FSM_{po} subfield of closed loop mode 2 signalling message

FSM _{po}	Power_ant1	Power_ant2
0	0.2	0.8
1	0.8	0.2

Table 11: FSM_{ph} subfield of closed loop mode 2 signalling message

FSM _{ph}	Phase difference between antennas (radians)
000	π
001	$-3\pi/4$
011	$-\pi/2$
010	$-\pi/4$
110	0
111	$\pi/4$
101	$\pi/2$
100	$3\pi/4$

To obtain the best performance, progressive updating is performed at both the UE and the UTRAN Access point. The UE procedure shown below is an example of how to determine FSM at UE. Different implementation is allowed. Every slot time, the UE may refine its choice of FSM, from the set of weights allowed given the previously transmitted bits of the FSM. This is shown in figure 5, where, in this figure b_i ($0 < i < 3$) are the bits of the FSM (from table 10 and table 11) from the MSB to the LSB and $m=0, 1, 2, 3$ (the end of frame adjustment given subclause 7.3.1 is not shown here).

At the beginning of a FSM to be transmitted, the UE chooses the best FSM out of the 16 possibilities. Then the UE starts sending the FSM bits from the MSB to the LSB in the portion of FBI field of the uplink DPCCH during 4 (FSM message length) slots. Within the transmission of the FSM the UE refines its choice of FSM. This is defined in the following:

- define the 4 bits of FSM, which are transmitted from slot number k to $k+3$, as $\{b_3(k) b_2(k+1) b_1(k+2) b_0(k+3)\}$, where $k=0, 4, 8, 12$. Define also the estimated received power criteria defined in Equation 1 for a given FSM as $P(\{x_3, x_2, x_1, x_0\})$, where $\{x_3, x_2, x_1, x_0\}$ is one of the 16 possible FSMs which defines an applied phase and power offset according to table 10 and table 11. The $b_i()$ and x_i are 0 or 1.

The bits transmitted during the m 'th FSM of the frame, where $m=0,1,2,3$, are then given by:

$b_3(4m)=X_3$ from the $\{X_3, X_2, X_1, X_0\}$ which maximises $P(\{x_3, x_2, x_1, x_0\})$ over all x_3, x_2, x_1, x_0 (16 possible combinations);

$b_2(4m+1)=X_2$ from the $\{b_3(4m), X_2, X_1, X_0\}$ which maximises $P(\{b_3(4m), x_2, x_1, x_0\})$ over all x_2, x_1, x_0 (8 possible combinations);

$b_1(4m+2)=X_1$ from the $\{b_3(4m), b_2(4m+1), X_1, X_0\}$ which maximises $P(\{b_3(4m), b_2(4m+1), x_1, x_0\})$ over all x_1, x_0 (4 possible combinations);

$b_0(4m+3)=X_0$ from the $\{b_3(4m), b_2(4m+1), b_1(4m+2), X_0\}$ which maximises $P(\{b_3(4m), b_2(4m+1), b_1(4m+2), x_0\})$ over x_0 (2 possible combinations).

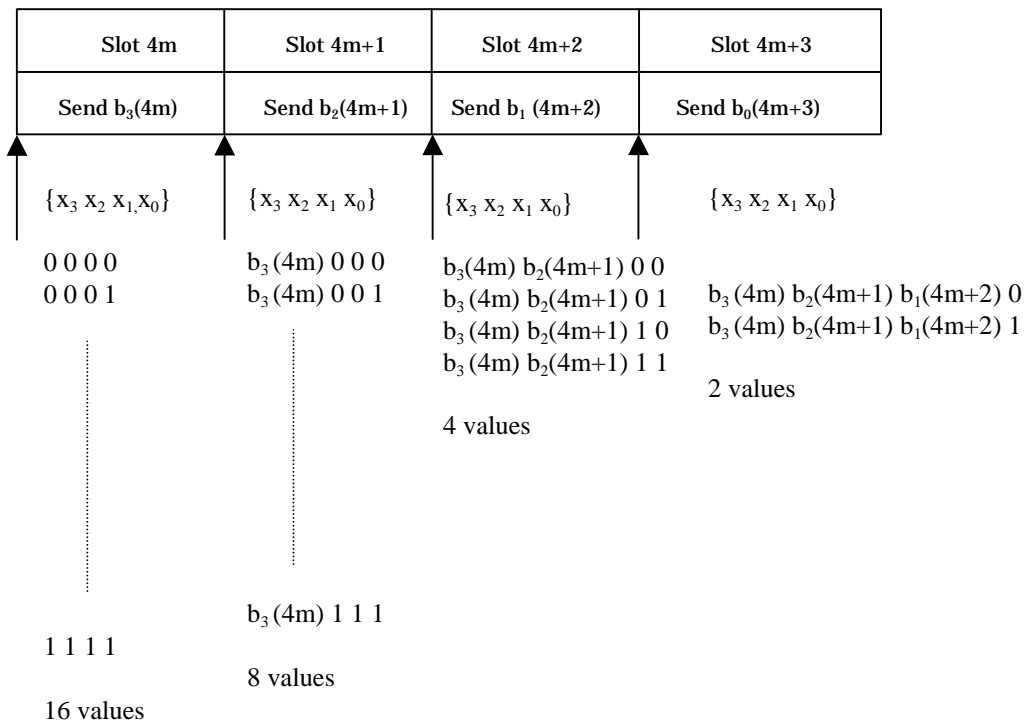

Figure 5: Progressive Refinement at the UE for closed loop mode 2

Every slot time the UTRAN constructs the FSM from the most recently received bits for each position in the word and applies the phase and amplitude (derived from power) as defined by table 10 and table 11. More precisely, the UTRAN operation can be explained as follows. The UTRAN maintains a register $\mathbf{z}=\{z_3 z_2 z_1 z_0\}$, which is updated every slot time according to $z_i=b_i(ns)$ ($i=0:3, ns=0:14$). Every slot time the contents of register \mathbf{z} are used to determine the phase and power adjustments as defined by table 10 and table 11, with $FSM_{ph}=\{z_3 z_2 z_1\}$ and $FSM_{po}=z_0$.

Special procedures for initialisation and end of frame processing are described below.

The weight vector, \underline{w} , is then calculated as:

$$\underline{w} = \begin{bmatrix} \sqrt{power_ant1} \\ \sqrt{power_ant2} \exp(j \text{ phase_diff}) \end{bmatrix} \tag{9}$$

7.3.1 Mode 2 end of frame adjustment

The FSM must be wholly contained within a frame. To achieve this an adjustment is made to the last FSM in the frame where the UE only sends the FSM_{ph} subfield, and the UTRAN takes the power bit FSM_{po} of the previous FSM.

7.3.2 Mode 2 normal initialisation

For the first frame of transmission using closed loop mode 2, the operation is as follows.

The UE starts sending the FSM message from slot 0 in the normal way. The UE may refine its choice of FSM in slots 1 to 3 from the set of weights allowed given the previously transmitted bits of the FSM.

Before the first FSM message is received and during the reception of the first three FSM bits, the UTRAN Access Point shall initialise its transmissions as follows. The power in both antennas is set to 0.5. The phase offset applied between the antennas is updated according to the number and value of FSM_{ph} bits received as given in table 12.

Table 12: FSM_{ph} normal initialisation for closed loop mode 2

FSM _{ph}	Phase difference between antennas (radians)
---	π (normal initialisation) or held from previous setting (compressed mode recovery)
0--	π
1--	0
00-	π
01-	$-\pi/2$
11-	0
10-	$\pi/2$
000	π
001	$-3\pi/4$
011	$-\pi/2$
010	$-\pi/4$
110	0
111	$\pi/4$
101	$\pi/2$
100	$3\pi/4$

This operation applies in both the soft handover and non soft handover cases.

7.3.3 Mode 2 operation during compressed mode

7.3.3.1 Downlink in compressed mode and uplink in normal mode

When the downlink is in compressed mode and the uplink is in normal mode, the closed loop mode 2 functions are described below.

When the UE is not listening to the CPICH from antennas 1 and 2 during the idle downlink slots, the UE sends the last FSM bits calculated before entering in the compressed mode.

For recovery after compressed mode, UTRAN Access Point sets the power in both antennas to 0.5 until a FSM_{po} bit is received. Until the first FSM_{ph} bit is received and acted upon, UTRAN uses the phase offset, which was applied before the transmission interruption (table 12).

Normal initialisation of FSM_{ph} (table 12) occurs if the uplink signalling information resumes at the beginning of a FSM period (that is if signalling resumes in slots 0,4,8,12).

If the uplink signalling does not resume at the beginning of a FSM period, the following operation is performed. In each of the remaining slots of the partial FSM period, and for the first slot of the next full FSM period, the UE sends the first (i.e. MSB) bit of the FSM_{ph} message, and at the UTRAN access point the phase offset applied between the antennas is updated according to the number and value of FSM_{ph} bits received as given in table 13. Initialisation then continues with the transmission by the UE of the remaining FSM_{ph} bits and the UTRAN operation according to table 12.

Table 13: FSM_{ph} subfield of closed loop mode 2 in compressed mode recovery period

FSM _{ph}	Phase difference between antennas (radians)
-	held from previous setting
0	π
1	0

7.3.3.2 Both downlink and uplink in compressed mode

During both downlink and uplink compressed mode, the UTRAN and the UE performs the functions of recovery after compressed mode as described in the previous subclause 7.3.3.1.

8 Idle periods for IPDL location method

8.1 General

To support time difference measurements for location services, idle periods can be created in the downlink (hence the name IPDL) during which time transmission of all channels from a Node B is temporarily seized. During these idle periods the visibility of neighbour cells from the UE is improved.

The idle periods are arranged in a predetermined pseudo random fashion according to higher layer parameters. Idle periods differ from compressed mode in that they are shorter in duration, all channels are silent simultaneously, and no attempt is made to prevent data loss.

In general there are two modes for these idle periods:

- Continuous mode, and
- Burst mode.

In continuous mode the idle periods are active all the time. In burst mode the idle periods are arranged in bursts where each burst contains enough idle periods to allow a UE to make sufficient measurements for its location to be calculated. The bursts are separated by a period where no idle periods occur.

8.2 Parameters of IPDL

The following parameters are signalled to the UE via higher layers:

IP_Status: This is a logic value that indicates if the idle periods are arranged in continuous or burst mode.

IP_Spacing: The number of 10 ms radio frames between the start of a radio frame that contains an idle period and the next radio frame that contains an idle period. Note that there is at most one idle period in a radio frame.

IP_Length: The length of the idle periods, expressed in symbols of the CPICH.

IP_Offset: A cell specific offset that can be used to synchronise idle periods from different sectors within a Node B.

Seed: Seed for the pseudo random number generator.

Additionally in the case of burst mode operation the following parameters are also communicated to the UE.

Burst_Start: The SFN where the first burst of idle periods starts.

Burst_Length: The number of idle periods in a burst of idle periods.

Burst_Freq: The number of radio frames of the primary CPICH between the start of a burst and the start of the next burst.

8.3 Calculation of idle period position

In burst mode, the first burst starts in the radio frame with $SFN = \text{Burst_Start}$. The n :th burst starts in the radio frame with $SFN = \text{Burst_Start} + n \times \text{Burst_Freq}$. The sequence of bursts according to this formula continues up to and including the radio frame with $SFN = 4095$. At the start of the radio frame with $SFN = 0$, the burst sequence is terminated (no idle periods are generated) and at $SFN = \text{Burst_Start}$ the burst sequence is restarted with the first burst followed by the second burst etc., as described above.

Continuous mode is equivalent to burst mode, with only one burst spanning the whole SFN cycle of 4096 radio frames, this burst starting in the radio frame with $SFN = 0$.

Assume that $IP_Position(x)$ is the position of idle period number x within a burst, where $x = 1, 2, \dots$, and $IP_Position(x)$ is measured in number of CPICH symbols from the start of the first radio frame of the burst.

The positions of the idle periods within each burst are then given by the following equation:

$$IP_Position(x) = (x \times IP_Spacing \times 150) + (\text{rand}(x \text{ modulo } 64) \text{ modulo } (150 - IP_Length)) + IP_Offset;$$

where $\text{rand}(n)$ is a pseudo random generator defined as follows:

$$\text{rand}(0) = \text{Seed};$$

$$\text{rand}(n) = (106 \times \text{rand}(n - 1) + 1283) \text{ modulo } 6075, n = 1, 2, 3, \dots$$

Note that x is reset to $x = 1$ for the first idle period in every burst.

Figure 6 below illustrates the idle periods for the burst mode case.

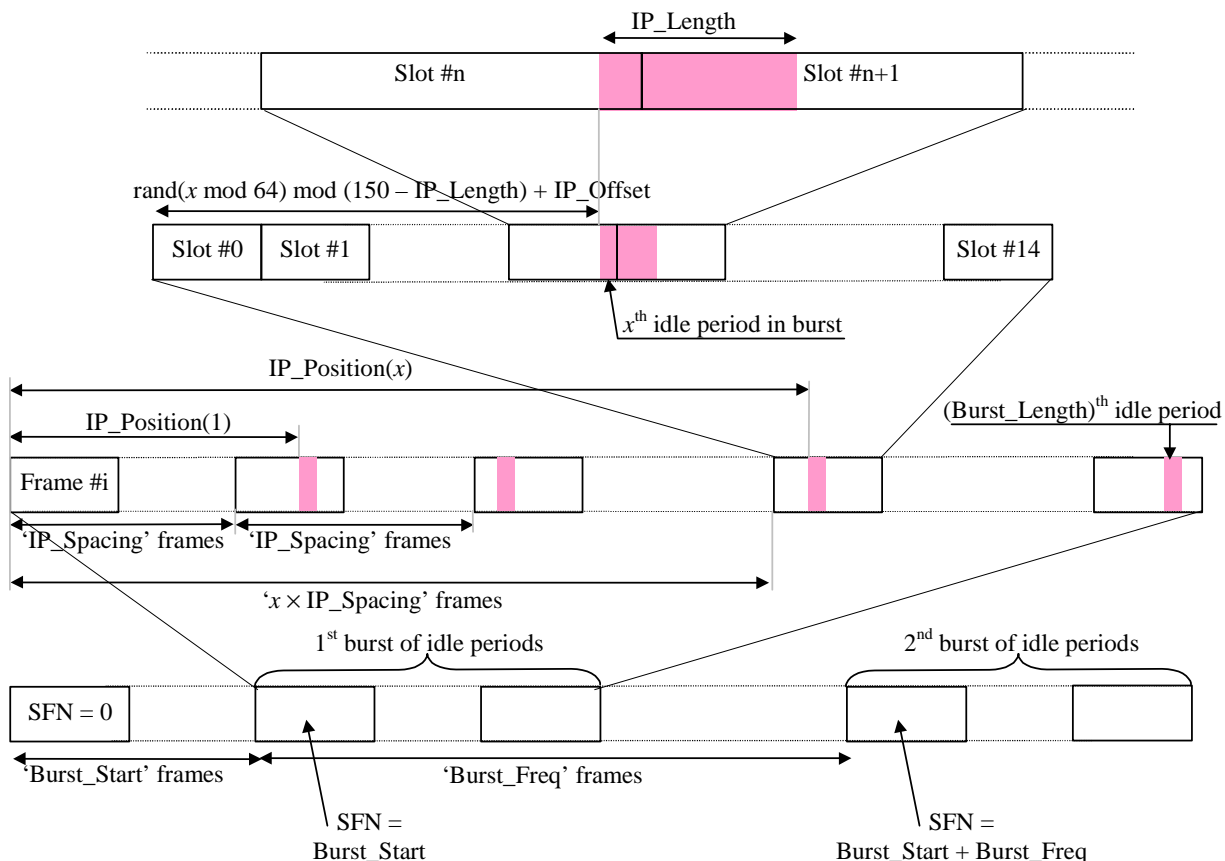

Figure 6: Idle Period placement in the case of burst mode operation

Annex A (informative): Antenna verification

In closed loop mode 1, if channel estimates are taken from the Primary CPICH, the performance will also suffer if the UE can not detect errors since the channel estimates will be taken for the incorrect phase settings. To mitigate this problem, antenna verification can be done, which can make use of antenna specific pilot patterns of the dedicated physical channel. The antenna verification can be implemented with several different algorithms. A straightforward algorithm can use a 4-hypothesis test per slot. Alternatively, a simplified beam former verification (SBV) requiring only a 2-hypothesis test per slot can be used. If we have orthogonal pilot patterns on the downlink DPCCCH we can apply the SBV as follows:

Consider:

$$2 \sum_{i=1}^{N_{path}} \frac{1}{\sigma_i^2} \left\{ \sqrt{2} \operatorname{Re}(\mathcal{H}_{2,i}^{(d)} h_{2,i}^{(p)*}) \right\} > \ln \left(\frac{\bar{p}(\phi_{Rx} = \pi)}{\bar{p}(\phi_{Rx} = 0)} \right)$$

then define the variable x_0 as, $x_0 = 0$ if the above inequality holds good and $x_0 = \pi$ otherwise.

Similarly consider:

$$-2 \sum_{i=1}^{N_{path}} \frac{1}{\sigma_i^2} \left\{ \sqrt{2} \operatorname{Im}(\mathcal{H}_{2,i}^{(d)} h_{2,i}^{(p)*}) \right\} > \ln \left(\frac{\bar{p}(\phi_{Rx} = -\pi/2)}{\bar{p}(\phi_{Rx} = \pi/2)} \right)$$

then define the variable x_1 as, $x_1 = -\pi/2$ if the above inequality holds good and $x_1 = \pi/2$ otherwise.

Whether x_0 or x_1 is to be calculated for each slot is given by the following table:

Slot	0	1	2	3	4	5	6	7	8	9	10	11	12	13	14
	x_0	x_1	x_0	x_1	x_0	x_1	x_0	x_1	x_0	x_1	x_0	x_1	x_0	x_1	x_0

The estimate for the transmitted phase is now obtained as:

$$\sin(\phi_{Tx}) + j \cos(\phi_{Tx}) = \frac{\sum_{i=0}^1 \sin(x_i)}{\sqrt{2}} + j \frac{\sum_{i=0}^1 \cos(x_i)}{\sqrt{2}}$$

where:

- the x_i values are used corresponding to the current slot and the next slot, except in the case of slot 14 wherein the slot 14 and slot 1 of the next frame values are used;
- $h_{2,i}^{(p)}$ is the i 'th estimated channel tap of antenna 2 using the CPICH;
- $h_{2,i}^{(d)}$ is the i 'th estimated channel tap of antenna 2 using the DPCCCH;
- γ^2 is the DPCH Pilot SNIR/ CPICH SNIR;
- σ_i^2 is the noise plus interference power on the i 'th path.

In normal operation the *a priori* probability for selected pilot pattern is assumed to be 96% (assuming there are 4% of errors in the feedback channel for power control and antenna selection).

Annex B (informative): Downlink power control

B.1 Power control timing

The power control timing described in this annex should be seen as an example on how the control bits have to be placed in order to permit a short TPC delay.

In order to maximise the cell radius distance within which one-slot control delay is achieved, the frame timing of an uplink DPCH is delayed by 1024 chips from that of the corresponding downlink DPCH measured at the UE antenna.

Responding to a downlink TPC command, the UE shall change its uplink DPCH output power at the beginning of the first uplink pilot field after the TPC command reception. Responding to an uplink TPC command, the UTRAN access point shall change its DPCH output power at the beginning of the next downlink pilot field after the reception of the whole TPC command. Note that in soft handover, the TPC command is sent over one slot when DPC_MODE is 0 and over three slots when DPC_MODE is 1. Note also that the delay from the uplink TPC command reception to the power change timing is not specified for UTRAN. The UE shall decide and send TPC commands on the uplink based on the downlink SIR measurement. The TPC command field on the uplink starts, when measured at the UE antenna, 512 chips after the end of the downlink pilot field. The UTRAN access point shall decide and send TPC commands based on the uplink SIR measurement. However, the SIR measurement periods are not specified either for UE nor UTRAN.

Figure B.1 illustrates an example of transmitter power control timings.

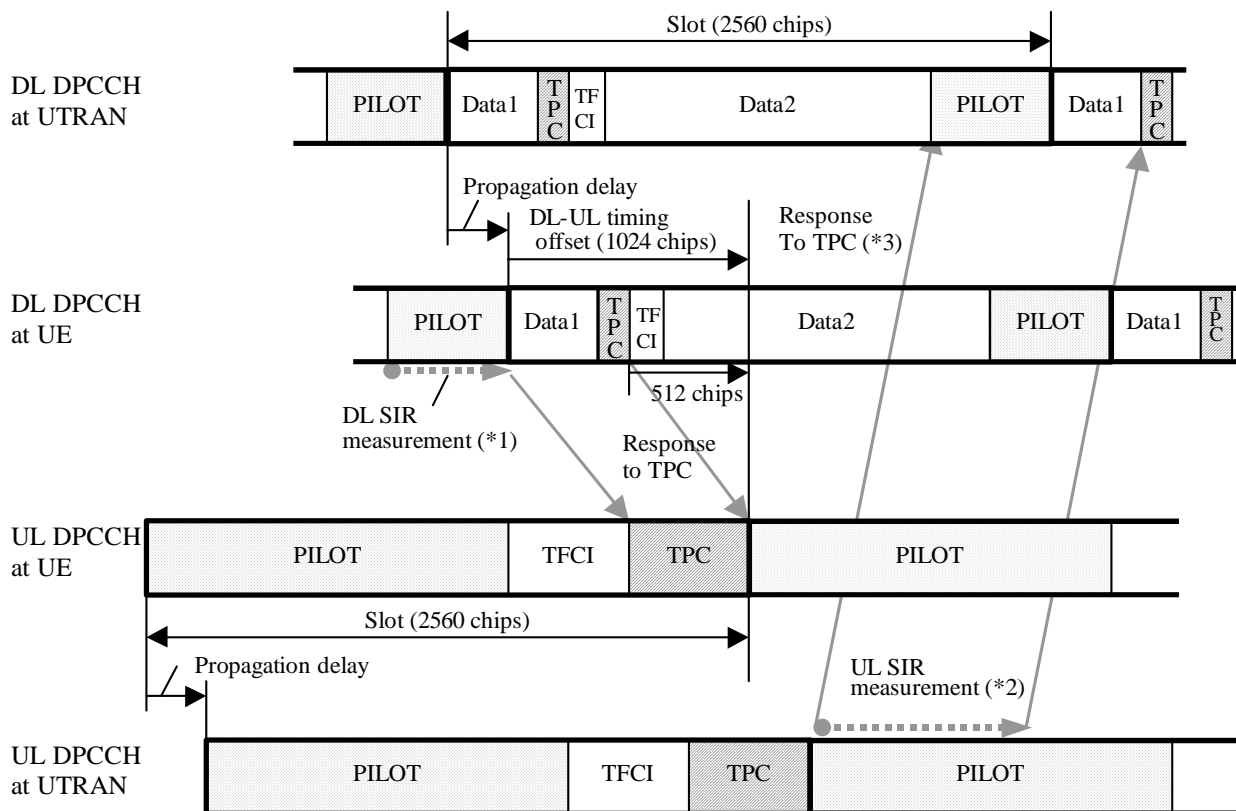

- 1,2 The SIR measurement periods illustrated here are examples. Other ways of measurement are allowed to achieve accurate SIR estimation.
- 3 If there is not enough time for UTRAN to respond to the TPC, the action can be delayed until the next slot.

Figure B.1: Transmitter power control timing

B.2 Example of implementation in the UE

The downlink inner-loop power control adjusts the network transmit power in order to keep the received downlink SIR at a given SIR target, SIR_{target} . A higher layer outer loop adjusts SIR_{target} independently for each connection.

The UE should estimate the received downlink DPCCH/DPDCH power of the connection to be power controlled. Simultaneously, the UE should estimate the received interference and calculate the signal-to-interference ratio, SIR_{est} . SIR_{est} can be calculated as $RSCP/ISCP$, where RSCP refers to the received signal code power on one code and ISCP refers to the non-orthogonal interference signal code power of the received signal on one code. Note that due to the specific SIR target offsets described in [5] that can be applied during compressed frames, the spreading factor shall not be considered in the calculation of SIR_{est} .

The obtained SIR estimate SIR_{est} is then used by the UE to generate TPC commands according to the following rule: if $SIR_{est} > SIR_{target}$ then the TPC command to transmit is "0", requesting a transmit power decrease, while if $SIR_{est} < SIR_{target}$ then the TPC command to transmit is "1", requesting a transmit power increase.

When the UE is in soft handover and SSDT is not activated, the UE should estimate SIR_{est} from the downlink signals of all cells in the active set.

When SSDT is activated, the UE should estimate SIR_{est} from the downlink signals of the primary cell. If the state of the cells (primary or non-primary) in the active set is changed and the UE sends the last portion of the coded ID in uplink slot j , the UE should change the basis for the estimation of SIR_{est} at the beginning of downlink slot $(j+1+T_{os}) \bmod 15$, where T_{os} is defined as a constant of 2 time slots.

Annex C (informative): Cell search procedure

During the cell search, the UE searches for a cell and determines the downlink scrambling code and frame synchronisation of that cell. The cell search is typically carried out in three steps:

Step 1: Slot synchronisation

During the first step of the cell search procedure the UE uses the SCH's primary synchronisation code to acquire slot synchronisation to a cell. This is typically done with a single matched filter (or any similar device) matched to the primary synchronisation code which is common to all cells. The slot timing of the cell can be obtained by detecting peaks in the matched filter output.

Step 2: Frame synchronisation and code-group identification

During the second step of the cell search procedure, the UE uses the SCH's secondary synchronisation code to find frame synchronisation and identify the code group of the cell found in the first step. This is done by correlating the received signal with all possible secondary synchronisation code sequences, and identifying the maximum correlation value. Since the cyclic shifts of the sequences are unique the code group as well as the frame synchronisation is determined.

Step 3: Scrambling-code identification

During the third and last step of the cell search procedure, the UE determines the exact primary scrambling code used by the found cell. The primary scrambling code is typically identified through symbol-by-symbol correlation over the CPICH with all codes within the code group identified in the second step. After the primary scrambling code has been identified, the Primary CCPCH can be detected. And the system- and cell specific BCH information can be read.

If the UE has received information about which scrambling codes to search for, steps 2 and 3 above can be simplified.

Annex D (informative): Change history

Change history							
Date	TSG #	TSG Doc.	CR	Rev	Subject/Comment	Old	New
	RAN_05	RP-99531	-		Approved at TSG RAN #5 and placed under Change Control	-	3.0.0
14/01/00	RAN_06	RP-99686	003	2	Flexible timing of UTRAN response to uplink closed loop Tx diversity feedback commands	3.0.0	3.1.0
14/01/00	RAN_06	RP-99686	006	2	CPCH power control preamble length	3.0.0	3.1.0
14/01/00	RAN_06	RP-99686	007	-	Removal of open loop power control	3.0.0	3.1.0
14/01/00	RAN_06	RP-99687	008	-	Power offset of AICH and PICH	3.0.0	3.1.0
14/01/00	RAN_06	RP-99686	009	1	Update of Random Access Procedure	3.0.0	3.1.0
14/01/00	RAN_06	RP-99686	010	1	oft symbol combining for uplink power control	3.0.0	3.1.0
14/01/00	RAN_06	RP-99685	011	-	Clarification of closed loop transmit diversity figure in clause 8 and closed loop operation in compressed mode for mode 2 in subclause 8.3 of TS 25.214	3.0.0	3.1.0
14/01/00	RAN_06	RP-99686	012	-	Uplink power control maximum TX power	3.0.0	3.1.0
14/01/00	RAN_06	RP-99686	013	1	Setting of beta values for multi-code	3.0.0	3.1.0
14/01/00	RAN_06	RP-99686	014	-	Consolidation of CPCH Power Control Preamble Information	3.0.0	3.1.0
14/01/00	RAN_06	RP-99686	015	1	Consolidation of Power Control Information for DCH Initialisation	3.0.0	3.1.0
14/01/00	RAN_06	RP-99686	016	-	Uplink power control in compressed mode	3.0.0	3.1.0
14/01/00	RAN_06	RP-99686	018	1	Timing for initialisation procedures	3.0.0	3.1.0
14/01/00	RAN_06	RP-99687	021	-	20 ms RACH message length	3.0.0	3.1.0
14/01/00	RAN_06	RP-99684	023	1	Maximum Tx Power at uplink compressed Mode	3.0.0	3.1.0
14/01/00	RAN_06	RP-99687	024	2	Setting of power in uplink compressed mode	3.0.0	3.1.0
14/01/00	RAN_06	RP-99687	025	-	Cleanup of synchronisation procedures	3.0.0	3.1.0
14/01/00	RAN_06	RP-99686	026	2	Downlink power control	3.0.0	3.1.0
14/01/00	RAN_06	RP-99687	029	-	Out-of-synch handling	3.0.0	3.1.0
14/01/00	RAN_06	RP-99687	030	2	State update rule addition to SSSD specification	3.0.0	3.1.0
14/01/00	RAN_06	RP-99687	033	-	Uplink TX timing adjustment	3.0.0	3.1.0
14/01/00	RAN_06	RP-99687	036	-	Inclusion of idle periods for the IPDL LCS	3.0.0	3.1.0
14/01/00	RAN_06	RP-99686	041	-	Revision of power control timing text	3.0.0	3.1.0
14/01/00	RAN_06	RP-99687	042	1	Inclusion of adjustment loop in downlink power control	3.0.0	3.1.0
14/01/00	-	-	-	-	Change history was added by the editor	3.1.0	3.1.1
31/03/00	RAN_07	RP-000064	043	1	Optimum ID Codes for SSSD Power Control	3.1.1	3.2.0
31/03/00	RAN_07	RP-000064	044	-	Editorial clarification to subclause 5.1.2.2.2	3.1.1	3.2.0
31/03/00	RAN_07	RP-000064	047	1	Additional description of TX diversity for PDSCH	3.1.1	3.2.0
31/03/00	RAN_07	RP-000064	048	-	Power offset on S-CCPCH	3.1.1	3.2.0
31/03/00	RAN_07	RP-000064	050	2	Corrections to uplink power control	3.1.1	3.2.0
31/03/00	RAN_07	RP-000064	055	-	Correction of Adjustment loop description	3.1.1	3.2.0
31/03/00	RAN_07	RP-000064	056	1	Clarification of TPC command combining for Algorithm 1	3.1.1	3.2.0
31/03/00	RAN_07	RP-000064	057	-	Clarification of TPC command combining for Algorithm 2	3.1.1	3.2.0
31/03/00	RAN_07	RP-000064	059	2	CPCH:CD subslot-related additions to 6.2	3.1.1	3.2.0
31/03/00	RAN_07	RP-000064	061	1	CPCH: editorial changes and clarifications of 6.2	3.1.1	3.2.0
31/03/00	RAN_07	RP-000064	062	-	Editorial corrections	3.1.1	3.2.0
31/03/00	RAN_07	RP-000064	064	1	Editorial improvement of the IPDL section	3.1.1	3.2.0
31/03/00	RAN_07	RP-000064	065	1	PRACH power offset definition	3.1.1	3.2.0
31/03/00	RAN_07	RP-000064	066	1	Radio link synchronisation in UTRA/FDD	3.1.1	3.2.0
31/03/00	RAN_07	RP-000064	068	-	Definition for maximum and minimum DL power	3.1.1	3.2.0
31/03/00	RAN_07	RP-000064	069	4	Channel assignment and UE channel selection methods of CPCH	3.1.1	3.2.0
31/03/00	RAN_07	RP-000064	071	-	Channelization code allocation method for PCPCH message part	3.1.1	3.2.0
31/03/00	RAN_07	RP-000064	072	1	Limited power raise used -parameter in DL PC	3.1.1	3.2.0
31/03/00	RAN_07	RP-000064	080	-	Downlink power control	3.1.1	3.2.0
31/03/00	RAN_07	RP-000064	081	-	Editorial improvement on SSSD power control section	3.1.1	3.2.0
31/03/00	RAN_07	RP-000065	082	2	Emergency Stop of CPCH transmission and Start of Message Indicator	3.1.1	3.2.0
31/03/00	RAN_07	RP-000065	083	-	Clean up of USTS related specifications	3.1.1	3.2.0
26/06/00	RAN_08	RP-000268	084	-	Addition of CSICH power parameter	3.2.0	3.3.0
26/06/00	RAN_08	RP-000268	085	-	Correction to power control in compressed mode recovery period	3.2.0	3.3.0
26/06/00	RAN_08	RP-000268	086	1	Revisions to power control for CPCH	3.2.0	3.3.0
26/06/00	RAN_08	RP-000268	087	-	Corrections to uplink DCH power control sections	3.2.0	3.3.0
26/06/00	RAN_08	RP-000268	090	3	Level of specification of downlink power control	3.2.0	3.3.0
26/06/00	RAN_08	RP-000268	091	1	Clarification of TX diversity power setting	3.2.0	3.3.0
26/06/00	RAN_08	RP-000268	092	-	PICH undefined bits	3.2.0	3.3.0
26/06/00	RAN_08	RP-000268	095	1	DPDCH/DPCCH gain factors	3.2.0	3.3.0
26/06/00	RAN_08	RP-000268	096	3	Correction to RACH subchannel definition	3.2.0	3.3.0
26/06/00	RAN_08	RP-000268	097	1	The power setting of the CCC field of DL DPCCH for CPCH	3.2.0	3.3.0
26/06/00	RAN_08	RP-000268	098	4	Procedure for end of transmission indicator in CPCH	3.2.0	3.3.0

Change history							
Date	TSG #	TSG Doc.	CR	Rev	Subject/Comment	Old	New
26/06/00	RAN_08	RP-000268	099	-	Downlink inner-loop power control in compressed mode	3.2.0	3.3.0
26/06/00	RAN_08	RP-000268	100	-	Definition of vector transmission weight entity	3.2.0	3.3.0
26/06/00	RAN_08	RP-000268	101	1	Number of slots for DPCH power control preamble	3.2.0	3.3.0
26/06/00	RAN_08	RP-000268	102	-	Clarification of UTRAN Tx diversity reponse timing description in 25.214	3.2.0	3.3.0
26/06/00	RAN_08	RP-000268	103	2	Corrections to transmit diversity section	3.2.0	3.3.0
26/06/00	RAN_08	RP-000268	104	1	Corrections to uplink power control in compressed mode	3.2.0	3.3.0
26/06/00	RAN_08	RP-000268	105	-	Clarification of downlink power control mode	3.2.0	3.3.0
26/06/00	RAN_08	RP-000268	106	-	Clarification of radio link set	3.2.0	3.3.0
26/06/00	RAN_08	RP-000268	107	1	Clarification of radio link synchronisation procedure	3.2.0	3.3.0
26/06/00	RAN_08	RP-000269	108	-	Correctly quantized gainfactors for uplink compressed mode	3.2.0	3.3.0
23/09/00	RAN_09	RP-000342	110	4	Downlink inner-loop power control in compressed mode	3.3.0	3.4.0
23/09/00	RAN_09	RP-000342	112	-	Adding reference for power offset variation text in TS 25.214	3.3.0	3.4.0
23/09/00	RAN_09	RP-000342	113	-	Combining TPC commands in soft handover	3.3.0	3.4.0
23/09/00	RAN_09	RP-000342	115	1	Corrections to power control	3.3.0	3.4.0
23/09/00	RAN_09	RP-000342	116	-	Corrections to 25.214	3.3.0	3.4.0
23/09/00	RAN_09	RP-000342	117	-	Clarification to downlink power control	3.3.0	3.4.0
23/09/00	RAN_09	RP-000342	118	3	Clarification of power control at maximum and minimum power	3.3.0	3.4.0
23/09/00	RAN_09	RP-000342	119	-	Clarification of SSDT text	3.3.0	3.4.0
23/09/00	RAN_09	RP-000342	120	-	Corrections to CL transmit diversity mode 1	3.3.0	3.4.0
23/09/00	RAN_09	RP-000342	121	1	Clarification of SSDT ID code bit transmission order	3.3.0	3.4.0
23/09/00	RAN_09	RP-000342	122	1	Clarification on RACH and CPCH subchannel definition	3.3.0	3.4.0
23/09/00	RAN_09	RP-000342	123	1	DPCH initialisation procedure	3.3.0	3.4.0
23/09/00	RAN_09	RP-000342	124	-	Clarification of closed loop mode TX diversity initialisation	3.3.0	3.4.0
23/09/00	RAN_09	RP-000342	127	2	Uplink power control in compressed mode	3.3.0	3.4.0
15/12/00	RAN_10	RP-000540	128	1	Clarification of downlink quality measurement in SSDT	3.4.0	3.5.0
15/12/00	RAN_10	RP-000540	129	-	Formula typography and reference corrections	3.4.0	3.5.0
15/12/00	RAN_10	RP-000540	130	1	Radio link establishment and sync status reporting	3.4.0	3.5.0
15/12/00	RAN_10	RP-000540	133	-	Correction of RACH/CPCH physical random access procedure	3.4.0	3.5.0
15/12/00	RAN_10	RP-000540	134	-	Correction of uplink power control algorithm 2	3.4.0	3.5.0
15/12/00	RAN_10	RP-000540	135	1	TPC command generation on downlink during RLS initialisation	3.4.0	3.5.0
15/12/00	RAN_10	RP-000540	136	1	Clarification of RACH behaviour at maximum and minimum power	3.4.0	3.5.0
15/12/00	RAN_10	RP-000540	137	-	Clarifications on the description of the radio link establishment procedure (when no radio link exists)	3.4.0	3.5.0
15/12/00	RAN_10	RP-000540	138	1	Corrections on power control preambles	3.4.0	3.5.0
15/12/00	RAN_10	RP-000540	139	1	Clarification of RACH procedure	3.4.0	3.5.0
15/12/00	RAN_10	RP-000540	140	-	Uplink power control in compressed mode	3.4.0	3.5.0
15/12/00	RAN_10	RP-000540	141	1	Revision of the abbreviation list	3.4.0	3.5.0
16/03/01	RAN_11	RP-010060	142	1	Uplink power control in compressed mode	3.5.0	3.6.0
16/03/01	RAN_11	RP-010060	144	-	Removal of the power balancing algorithm from TS 25.214	3.5.0	3.6.0
16/03/01	RAN_11	RP-010254	145	2	Clarification of Nid parameter – when SSDT and uplink compressed mode are in operation	3.5.0	3.6.0
16/03/01	RAN_11	RP-010060	146	-	Clarification of closed loop transmit diversity mode 1 and mode 2 operation during compressed mode	3.5.0	3.6.0
16/03/01	RAN_11	RP-010060	148	1	Clarification of UE SIR estimation	3.5.0	3.6.0
16/03/01	RAN_11	RP-010060	150	1	Clarification of the order of SSDT signalling in 2 bit FBI	3.5.0	3.6.0
16/03/01	RAN_11	RP-010244	154	2	Uplink power control preamble	3.5.0	3.6.0
16/03/01	RAN_11	RP-010060	155	-	Correction of limited power raise	3.5.0	3.6.0
16/03/01	RAN_11	RP-010060	156	-	Clarification of initialisation procedure	3.5.0	3.6.0
16/03/01	RAN_11	RP-010060	158	-	Definition of power control step size for algorithm 2	3.5.0	3.6.0
16/03/01	RAN_11	RP-010060	161	1	Correction of the UE behaviour in SSDT mode	3.5.0	3.6.0
16/03/01	RAN_11	RP-010060	163	-	Correction on downlink synchronisation primitives	3.5.0	3.6.0

History

Document history		
V3.1.1	January 2000	Publication
V3.2.0	March 2000	Publication
V3.3.0	June 2000	Publication
V3.4.0	September 2000	Publication
V3.5.0	December 2000	Publication
V3.6.0	March 2001	Publication