

# ETSI TS 125 221 V5.0.0 (2002-03)

---

*Technical Specification*

## **Universal Mobile Telecommunications System (UMTS); Physical channels and mapping of transport channels onto physical channels (TDD) (3GPP TS 25.221 version 5.0.0 Release 5)**



---

Reference

RTS/TSGR-0125221Uv5

---

Keywords

UMTS

**ETSI**

650 Route des Lucioles  
F-06921 Sophia Antipolis Cedex - FRANCE

Tel.: +33 4 92 94 42 00 Fax: +33 4 93 65 47 16

Siret N° 348 623 562 00017 - NAF 742 C  
Association à but non lucratif enregistrée à la  
Sous-Préfecture de Grasse (06) N° 7803/88

---

**Important notice**

Individual copies of the present document can be downloaded from:

<http://www.etsi.org>

The present document may be made available in more than one electronic version or in print. In any case of existing or perceived difference in contents between such versions, the reference version is the Portable Document Format (PDF). In case of dispute, the reference shall be the printing on ETSI printers of the PDF version kept on a specific network drive within ETSI Secretariat.

Users of the present document should be aware that the document may be subject to revision or change of status. Information on the current status of this and other ETSI documents is available at

<http://portal.etsi.org/tb/status/status.asp>

If you find errors in the present document, send your comment to:

[editor@etsi.fr](mailto:editor@etsi.fr)

---

**Copyright Notification**

No part may be reproduced except as authorized by written permission.  
The copyright and the foregoing restriction extend to reproduction in all media.

© European Telecommunications Standards Institute 2002.  
All rights reserved.

**DECT**<sup>TM</sup>, **PLUGTESTS**<sup>TM</sup> and **UMTS**<sup>TM</sup> are Trade Marks of ETSI registered for the benefit of its Members.  
**TIPHON**<sup>TM</sup> and the **TIPHON logo** are Trade Marks currently being registered by ETSI for the benefit of its Members.  
**3GPP**<sup>TM</sup> is a Trade Mark of ETSI registered for the benefit of its Members and of the 3GPP Organizational Partners.

---

## Intellectual Property Rights

IPRs essential or potentially essential to the present document may have been declared to ETSI. The information pertaining to these essential IPRs, if any, is publicly available for **ETSI members and non-members**, and can be found in ETSI SR 000 314: *"Intellectual Property Rights (IPRs); Essential, or potentially Essential, IPRs notified to ETSI in respect of ETSI standards"*, which is available from the ETSI Secretariat. Latest updates are available on the ETSI Web server (<http://webapp.etsi.org/IPR/home.asp>).

Pursuant to the ETSI IPR Policy, no investigation, including IPR searches, has been carried out by ETSI. No guarantee can be given as to the existence of other IPRs not referenced in ETSI SR 000 314 (or the updates on the ETSI Web server) which are, or may be, or may become, essential to the present document.

---

## Foreword

This Technical Specification (TS) has been produced by ETSI 3rd Generation Partnership Project (3GPP).

The present document may refer to technical specifications or reports using their 3GPP identities, UMTS identities or GSM identities. These should be interpreted as being references to the corresponding ETSI deliverables.

The cross reference between GSM, UMTS, 3GPP and ETSI identities can be found under [www.etsi.org/key](http://www.etsi.org/key).

# Contents

Intellectual Property Rights .....	2
Foreword.....	2
Foreword.....	8
1 Scope .....	9
2 References .....	9
3 Abbreviations .....	9
4 Services offered to higher layers .....	11
4.1 Transport channels .....	11
4.1.1 Dedicated transport channels .....	11
4.1.2 Common transport channels .....	11
4.1.2.1 BCH - Broadcast Channel .....	11
4.1.2.2 FACH – Forward Access Channel .....	11
4.1.2.3 PCH – Paging Channel.....	11
4.1.2.4 RACH – Random Access Channel.....	11
4.1.2.5 USCH – Uplink Shared Channel.....	11
4.1.2.6 DSCH – Downlink Shared Channel.....	11
4.1.2.7 HS-DSCH – High Speed Downlink Shared Channel.....	12
4.2 Indicators .....	12
5 Physical channels for the 3.84 Mcps option.....	12
5.1 Frame structure.....	12
5.2 Dedicated physical channel (DPCH).....	13
5.2.1 Spreading .....	14
5.2.1.1 Spreading for Downlink Physical Channels.....	14
5.2.1.2 Spreading for Uplink Physical Channels.....	14
5.2.2 Burst Types .....	14
5.2.2.1 Burst Type 1 .....	14
5.2.2.2 Burst Type 2.....	15
5.2.2.3 Burst Type 3.....	15
5.2.2.4 Transmission of TFCI .....	16
5.2.2.5 Transmission of TPC.....	17
5.2.2.6 Timeslot formats .....	18
5.2.2.6.1 Downlink timeslot formats .....	18
5.2.2.6.2 Uplink timeslot formats.....	18
5.2.3 Training sequences for spread bursts .....	20
5.2.4 Beamforming .....	22
5.3 Common physical channels .....	22
5.3.1 Primary common control physical channel (P-CCPCH).....	22
5.3.1.1 P-CCPCH Spreading .....	22
5.3.1.2 P-CCPCH Burst Types.....	23
5.3.1.3 P-CCPCH Training sequences .....	23
5.3.2 Secondary common control physical channel (S-CCPCH).....	23
5.3.2.1 S-CCPCH Spreading .....	23
5.3.2.2 S-CCPCH Burst Types.....	23
5.3.2.3 S-CCPCH Training sequences .....	23
5.3.3 The physical random access channel (PRACH) .....	23
5.3.3.1 PRACH Spreading .....	23
5.3.3.2 PRACH Burst Type.....	23
5.3.3.3 PRACH Training sequences.....	23
5.3.3.4 PRACH timeslot formats .....	24
5.3.3.5 Association between Training Sequences and Channelisation Codes.....	24
5.3.4 The synchronisation channel (SCH) .....	25
5.3.5 Physical Uplink Shared Channel (PUSCH).....	26
5.3.5.1 PUSCH Spreading.....	26

5.3.5.2	PUSCH Burst Types .....	27
5.3.5.3	PUSCH Training Sequences .....	27
5.3.5.4	UE Selection .....	27
5.3.6	Physical Downlink Shared Channel (PDSCH) .....	27
5.3.6.1	PDSCH Spreading.....	27
5.3.6.2	PDSCH Burst Types .....	27
5.3.6.3	PDSCH Training Sequences .....	27
5.3.6.4	UE Selection .....	27
5.3.7	The Paging Indicator Channel (PICH).....	27
5.3.7.1	Mapping of Paging Indicators to the PICH bits .....	27
5.3.7.2	Structure of the PICH over multiple radio frames.....	28
5.3.7.3	PICH Training sequences.....	29
5.3.8	The physical node B synchronisation channel (PNBSCCH).....	29
5.3.9	High Speed Physical Downlink Shared Channel (HS-PDSCH) .....	29
5.3.9.1	HS-PDSCH Spreading .....	29
5.3.9.2	HS-PDSCH Burst Types .....	29
5.3.9.3	HS-PDSCH Training Sequences .....	29
5.3.9.4	UE Selection .....	29
5.3.9.5	HS-PDSCH timeslot formats .....	29
5.3.10	Shared Control Channel for HS-DSCH (HS-SCCH).....	30
5.3.10.1	HS-SCCH Spreading.....	30
5.3.10.2	HS-SCCH Burst Types .....	30
5.3.10.3	HS-SCCH Training Sequences .....	30
5.3.10.4	HS-SCCH timeslot formats.....	30
5.3.11	Shared Information Channel for HS-DSCH (HS-SICH) .....	30
5.3.11.1	HS-SICH Spreading .....	30
5.3.11.2	HS-SICH Burst Types.....	30
5.3.11.3	HS-SICH Training Sequences.....	30
5.3.11.4	HS-SICH timeslot formats .....	31
5.4	Transmit Diversity for DL Physical Channels.....	31
5.5	Beacon characteristics of physical channels.....	31
5.5.1	Location of beacon channels.....	31
5.5.2	Physical characteristics of beacon channels.....	31
5.6	Midamble Allocation for Physical Channels.....	32
5.6.1	Midamble Allocation for DL Physical Channels .....	32
5.6.1.1	Midamble Allocation by signalling from higher layers.....	32
5.6.1.2	Midamble Allocation by layer 1.....	32
5.6.1.2.1	Default midamble .....	32
5.6.1.2.2	Common Midamble.....	33
5.6.2	Midamble Allocation for UL Physical Channels .....	33
5.7	Midamble Transmit Power .....	33
6	Physical channels for the 1.28 Mcps option.....	34
6.1	Frame structure.....	35
6.2	Dedicated physical channel (DPCH).....	36
6.2.1	Spreading .....	36
6.2.2	Burst Format .....	36
6.2.2.1	Transmission of TFCI .....	37
6.2.2.2	Transmission of TPC.....	37
6.2.2.3	Transmission of SS .....	40
6.2.2.4	Timeslot formats .....	42
6.2.2.4.1	Timeslot formats for QPSK.....	43
6.2.2.4.2	Time slot formats for 8PSK.....	46
6.2.3	Training sequences for spread bursts .....	46
6.2.4	Beamforming .....	48
6.3	Common physical channels .....	48
6.3.1	Primary common control physical channel (P-CCPCH).....	48
6.3.1.1	P-CCPCH Spreading .....	48
6.3.1.2	P-CCPCH Burst Format .....	48
6.3.1.3	P-CCPCH Training sequences .....	48
6.3.2	Secondary common control physical channel (S-CCPCH).....	48
6.3.2.1	S-CCPCH Spreading .....	49

6.3.2.2	S-CCPCH Burst Format .....	49
6.3.2.3	S-CCPCH Training sequences .....	49
6.3.3	Fast Physical Access CHannel (FPACH) .....	49
6.3.3.1	FPACH burst.....	49
6.3.3.1.1	Signature Reference Number.....	49
6.3.3.1.2	Relative Sub-Frame Number .....	49
6.3.3.1.3	Received starting position of the UpPCH (UpPCH <sub>pos</sub> ).....	49
6.3.3.1.4	Transmit Power Level Command for the RACH message.....	50
6.3.3.2	FPACH Spreading.....	50
6.3.3.2	FPACH Burst Format.....	50
6.3.3.3	FPACH Training sequences .....	50
6.3.3.4	FPACH timeslot formats.....	50
6.3.4	The physical random access channel (PRACH) .....	50
6.3.4.1	PRACH Spreading .....	50
6.3.4.2	PRACH Burst Format .....	50
6.3.4.3	PRACH Training sequences.....	50
6.3.4.4	PRACH timeslot formats .....	50
6.3.4.5	Association between Training Sequences and Channelisation Codes.....	50
6.3.5	The synchronisation channels (DwPCH, UpPCH) .....	51
6.3.6	Physical Uplink Shared Channel (PUSCH).....	51
6.3.7	Physical Downlink Shared Channel (PDSCH) .....	51
6.3.8	The Page Indicator Channel (PICH) .....	52
6.3.8.1	Mapping of Paging Indicators to the PICH bits .....	52
6.3.8.2	Structure of the PICH over multiple radio frames.....	52
6.3.9	High Speed Physical Downlink Shared Channel (HS-PDSCH) .....	52
6.3.9.1	HS-PDSCH Spreading .....	52
6.3.9.2	HS-PDSCH Burst Types .....	52
6.3.9.3	HS-PDSCH Training Sequences.....	52
6.3.9.4	UE Selection .....	53
6.3.9.5	HS-PDSCH timeslot formats .....	53
6.3.10	Shared Control Channel for HS-DSCH (HS-SCCH).....	53
6.3.10.1	HS-SCCH Spreading.....	53
6.3.10.2	HS-SCCH Burst Types .....	53
6.3.10.3	HS-SCCH Training Sequences .....	53
6.3.10.4	HS-SCCH timeslot formats.....	53
6.3.11	Shared Information Channel for HS-DSCH (HS-SICH) .....	53
6.3.11.1	HS-SICH Spreading .....	53
6.3.11.2	HS-SICH Burst Types.....	54
6.3.11.3	HS-SICH Training Sequences.....	54
6.3.11.4	HS-SICH timeslot formats .....	54
6.4	Transmit Diversity for DL Physical Channels.....	54
6.5	Beacon characteristics of physical channels.....	54
6.5.1	Location of beacon channels.....	54
6.5.2	Physical characteristics of the beacon function .....	54
6.6	Midamble Allocation for Physical Channels.....	55
6.6.1	Midamble Allocation for DL Physical Channels .....	55
6.6.1.1	Midamble Allocation by signalling from higher layers.....	55
6.6.1.2	Midamble Allocation by layer 1.....	55
6.6.1.2.1	Default midamble .....	55
6.6.1.2.2	Common Midamble.....	55
6.6.2	Midamble Allocation for UL Physical Channels .....	55
6.7	Midamble Transmit Power .....	55
7	Mapping of transport channels to physical channels for the 3.84 Mcps option .....	56
7.1	Dedicated Transport Channels .....	56
7.2	Common Transport Channels.....	57
7.2.1	The Broadcast Channel (BCH) .....	57
7.2.2	The Paging Channel (PCH) .....	57
7.2.2.1	PCH/PICH Association .....	57
7.2.3	The Forward Channel (FACH).....	57
7.2.4	The Random Access Channel (RACH) .....	57
7.2.5	The Uplink Shared Channel (USCH).....	57

7.2.6	The Downlink Shared Channel (DSCH).....	58
7.2.7	The High Speed Downlink Shared Channel (HS-DSCH).....	58
7.2.7.1	HS-DSCH/HS-SCCH Association and Timing.....	58
7.2.7.2	HS-SCCH/HS-DSCH/HS-SICH Association and Timing.....	58
8	Mapping of transport channels to physical channels for the 1.28 Mcps option .....	59
8.1	Dedicated Transport Channels .....	59
8.2	Common Transport Channels.....	60
8.2.1	The Broadcast Channel (BCH) .....	60
8.2.2	The Paging Channel (PCH) .....	60
8.2.3	The Forward Channel (FACH) .....	60
8.2.4	The Random Access Channel (RACH) .....	60
8.2.5	The Uplink Shared Channel (USCH).....	60
8.2.6	The Downlink Shared Channel (DSCH).....	61
8.2.7	The High Speed Downlink Shared Channel (HS-DSCH).....	61
8.2.7.1	HS-DSCH/HS-SCCH Association and Timing.....	61
8.2.7.2	HS-SCCH/HS-DSCH/HS-SICH Association and Timing.....	61
<b>Annex A (normative): Basic Midamble Codes for the 3.84 Mcps option .....</b>		<b>63</b>
A.1	Basic Midamble Codes for Burst Type 1 and 3 .....	63
A.2	Basic Midamble Codes for Burst Type 2 .....	68
A.3	Association between Midambles and Channelisation Codes .....	71
A.3.1	Association for Burst Type 1/3 and $K_{Cell}=16$ Midambles .....	71
A.3.2	Association for Burst Type 1/3 and $K_{Cell}=8$ Midambles .....	72
A.3.3	Association for Burst Type 1/3 and $K_{Cell}=4$ Midambles .....	72
A.3.4	Association for Burst Type 2 and $K_{Cell}=6$ Midambles .....	73
A.3.5	Association for Burst Type 2 and $K_{Cell}=3$ Midambles .....	73
<b>Annex B (normative): Basic Midamble Codes for the 1.28 Mcps option .....</b>		<b>75</b>
B.1	Basic Midamble Codes.....	75
B.2	Association between Midambles and Channelisation Codes .....	78
B.2.1	Association for $K=16$ Midambles .....	78
B.2.2	Association for $K=14$ Midambles .....	79
B.2.3	Association for $K=12$ Midambles .....	79
B.2.4	Association for $K=10$ Midambles .....	80
B.2.5	Association for $K=8$ Midambles .....	80
B.2.6	Association for $K=6$ Midambles .....	81
B.2.7	Association for $K=4$ Midambles .....	81
B.2.8	Association for $K=2$ Midambles .....	82
<b>Annex C (normative): Signalling of the number of channelisation codes for the DL common midamble case for 3.84Mcps TDD .....</b>		<b>83</b>
C.1	Mapping scheme for Burst Type 1 and $K_{Cell}=16$ Midambles .....	83
C.2	Mapping scheme for Burst Type 1 and $K_{Cell}=8$ Midambles .....	83
C.3	Mapping scheme for Burst Type 1 and $K_{Cell}=4$ Midambles .....	84
C.4	Mapping scheme for beacon timeslots and $K_{Cell}=16$ Midambles .....	84
C.5	Mapping scheme for beacon timeslots and $K_{Cell}=8$ Midambles .....	85
C.6	Mapping scheme for beacon timeslots and $K_{Cell}=4$ Midambles .....	85
C.7	Mapping scheme for Burst Type 2 and $K_{Cell}=6$ Midambles .....	85
C.8	Mapping scheme for Burst Type 2 and $K_{Cell}=3$ Midambles .....	86
<b>Annex D (normative): Signalling of the number of channelisation codes for the DL common midamble case for 1.28Mcps TDD .....</b>		<b>87</b>
D.1	Mapping scheme for $K=16$ Midambles.....	87

D.2	Mapping scheme for K=14 Midambles.....	87
D.3	Mapping scheme for K=12 Midambles.....	88
D.4	Mapping scheme for K=10 Midambles.....	88
D.5	Mapping scheme for K=8 Midambles.....	88
D.6	Mapping scheme for K=6 Midambles.....	88
D.7	Mapping scheme for K=4 Midambles.....	89
D.8	Mapping scheme for K=2 Midambles.....	89
<b>Annex E (informative): CCPCH Multiframe Structure for the 3.84 Mcps option.....</b>		<b>90</b>
<b>Annex F (informative): CCPCH Multiframe Structure for the 1.28 Mcps option.....</b>		<b>92</b>
<b>Annex G (informative): Examples of the association of DL TPC commands to UL uplink time slots for 1.28 Mcps TDD.....</b>		<b>93</b>
<b>Annex H (informative): Examples of the association of DL SS commands to UL uplink time slots.....</b>		<b>94</b>
<b>Annex I (informative): Change history.....</b>		<b>95</b>
History .....		97



---

## Foreword

This Technical Specification (TS) has been produced by the 3<sup>rd</sup> Generation Partnership Project (3GPP).

The contents of the present document are subject to continuing work within the TSG and may change following formal TSG approval. Should the TSG modify the contents of the present document, it will be re-released by the TSG with an identifying change of release date and an increase in version number as follows:

Version x.y.z

where:

- x the first digit:
  - 1 presented to TSG for information;
  - 2 presented to TSG for approval;
  - 3 or greater indicates TSG approved document under change control.
- y the second digit is incremented for all changes of substance, i.e. technical enhancements, corrections, updates, etc.
- z the third digit is incremented when editorial only changes have been incorporated in the document.

---

# 1 Scope

The present document describes the characteristics of the physical channels and the mapping of the transport channels to physical channels in the TDD mode of UTRA.

---

# 2 References

The following documents contain provisions which, through reference in this text, constitute provisions of the present document.

- References are either specific (identified by date of publication, edition number, version number, etc.) or non-specific.
- For a specific reference, subsequent revisions do not apply.
- For a non-specific reference, the latest version applies.

- [1] 3GPP TS 25.201: "Physical layer - general description".
- [2] 3GPP TS 25.211: "Physical channels and mapping of transport channels onto physical channels (FDD)".
- [3] 3GPP TS 25.212: "Multiplexing and channel coding (FDD)".
- [4] 3GPP TS 25.213: "Spreading and modulation (FDD)".
- [5] 3GPP TS 25.214: "Physical layer procedures (FDD)".
- [6] 3GPP TS 25.215: "Physical layer – Measurements (FDD)".
- [7] 3GPP TS 25.222: "Multiplexing and channel coding (TDD)".
- [8] 3GPP TS 25.223: "Spreading and modulation (TDD)".
- [9] 3GPP TS 25.224: "Physical layer procedures (TDD)".
- [10] 3GPP TS 25.225: "Physical layer – Measurements (TDD)".
- [11] 3GPP TS 25.301: "Radio Interface Protocol Architecture".
- [12] 3GPP TS 25.302: "Services Provided by the Physical Layer".
- [13] 3GPP TS 25.401: "UTRAN Overall Description".
- [14] 3GPP TS 25.402: "Synchronisation in UTRAN, Stage 2".
- [15] 3GPP TS 25.304: " UE Procedures in Idle Mode and Procedures for Cell Reselection in Connected Mode".
- [16] 3GPP TS 25.427: "UTRAN Iur and Iub interface user plane protocols for DCH data streams".
- [17] 3GPP TS 25.435: "UTRAN I<sub>ub</sub> Interface User Plane Protocols for Common Transport Channel Data Streams".
- [18] 3GPP TS25.308: High Speed Downlink Packet Access (HSDPA); Overall description; Stage 2

---

# 3 Abbreviations

For the purposes of the present document, the following abbreviations apply:

16QAM      16 Quadrature Amplitude Modulation

BCH	Broadcast Channel
CCPCH	Common Control Physical Channel
CCTrCH	Coded Composite Transport Channel
CDMA	Code Division Multiple Access
CQI	Channel Quality Indicator
DCH	Dedicated Channel
DL	Downlink
DPCH	Dedicated Physical Channel
DRX	Discontinuous Reception
DSCH	Downlink Shared Channel
DTX	Discontinuous Transmission
DwPCH	Downlink Pilot Channel
DwPTS	Downlink Pilot Time Slot
FACH	Forward Access Channel
FDD	Frequency Division Duplex
FEC	Forward Error Correction
GP	Guard Period
GSM	Global System for Mobile Communication
HARQ	Hybrid ARQ
HS-DSCH	High Speed Downlink Shared Channel
HS-PDSCH	High Speed Physical Downlink Shared Channel
HS-SCCH	Shared Control Channel for HS-DSCH
HS-SICH	Shared Information Channel for HS-DSCH
MIB	Master Information Block
NRT	Non-Real Time
OVSF	Orthogonal Variable Spreading Factor
P-CCPCH	Primary CCPCH
PCH	Paging Channel
PDSCH	Physical Downlink Shared Channel
PI	Paging Indicator (value calculated by higher layers)
PICH	Page Indicator Channel
$P_q$	Paging Indicator (indicator set by physical layer)
PRACH	Physical Random Access Channel
PUSCH	Physical Uplink Shared Channel
RACH	Random Access Channel
RF	Radio Frame
RT	Real Time
S-CCPCH	Secondary CCPCH
SCH	Synchronisation Channel
SCTD	Space Code Transmit Diversity
SF	Spreading Factor
SFN	Cell System Frame Number
SS	Synchronisation Shift
TCH	Traffic Channel
TDD	Time Division Duplex
TDMA	Time Division Multiple Access
TFC	Transport Format Combination
TFCI	Transport Format Combination Indicator
TFI	Transport Format Indicator
TPC	Transmitter Power Control
TrCH	Transport Channel
TSTD	Time Switched Transmit Diversity
TTI	Transmission Time Interval
UE	User Equipment
UL	Uplink
UMTS	Universal Mobil Telecommunications System
UpPTS	Uplink Pilot Time Slot
UpPCH	Uplink Pilot Channel
USCH	Uplink Shared Channel
UTRAN	UMTS Terrestrial Radio Access Network

---

## 4 Services offered to higher layers

### 4.1 Transport channels

Transport channels are the services offered by layer 1 to the higher layers. A transport channel is defined by how and with what characteristics data is transferred over the air interface. A general classification of transport channels is into two groups:

- Dedicated Channels, using inherent addressing of UE
- Common Channels, using explicit addressing of UE if addressing is needed

General concepts about transport channels are described in [12].

#### 4.1.1 Dedicated transport channels

The Dedicated Channel (DCH) is an up- or downlink transport channel that is used to carry user or control information between the UTRAN and a UE.

#### 4.1.2 Common transport channels

There are six types of transport channels: BCH, FACH, PCH, RACH, USCH, DSCH

##### 4.1.2.1 BCH - Broadcast Channel

The Broadcast Channel (BCH) is a downlink transport channel that is used to broadcast system- and cell-specific information.

##### 4.1.2.2 FACH – Forward Access Channel

The Forward Access Channel (FACH) is a downlink transport channel that is used to carry control information to a mobile station when the system knows the location cell of the mobile station. The FACH may also carry short user packets.

##### 4.1.2.3 PCH – Paging Channel

The Paging Channel (PCH) is a downlink transport channel that is used to carry control information to a mobile station when the system does not know the location cell of the mobile station.

##### 4.1.2.4 RACH – Random Access Channel

The Random Access Channel (RACH) is an up link transport channel that is used to carry control information from mobile station. The RACH may also carry short user packets.

##### 4.1.2.5 USCH – Uplink Shared Channel

The uplink shared channel (USCH) is an uplink transport channel shared by several UEs carrying dedicated control or traffic data.

##### 4.1.2.6 DSCH – Downlink Shared Channel

The downlink shared channel (DSCH) is a downlink transport channel shared by several UEs carrying dedicated control or traffic data.

#### 4.1.2.7 HS-DSCH – High Speed Downlink Shared Channel

The High Speed Downlink Shared Channel (HS-DSCH) is a downlink transport channel shared by several UEs. The HS-DSCH is associated with one downlink DPCH, and one or several Shared Control Channels (HS-SCCH). The HS-DSCH is transmitted over the entire cell or over only part of the cell using e.g. beam-forming antennas.

## 4.2 Indicators

Indicators are means of fast low-level signalling entities which are transmitted without using information blocks sent over transport channels. The meaning of indicators is implicit to the receiver.

The indicator(s) defined in the current version of the specifications are: Paging Indicator.

---

## 5 Physical channels for the 3.84 Mcps option

All physical channels take three-layer structure with respect to timeslots, radio frames and system frame numbering (SFN), see [14]. Depending on the resource allocation, the configuration of radio frames or timeslots becomes different. All physical channels need a guard period in every timeslot. The time slots are used in the sense of a TDMA component to separate different user signals in the time domain. The physical channel signal format is presented in figure 1.

A physical channel in TDD is a burst, which is transmitted in a particular timeslot within allocated Radio Frames. The allocation can be continuous, i.e. the time slot in every frame is allocated to the physical channel or discontinuous, i.e. the time slot in a subset of all frames is allocated only. A burst is the combination of two data parts, a midamble part and a guard period. The duration of a burst is one time slot. Several bursts can be transmitted at the same time from one transmitter. In this case, the data parts must use different OVFSF channelisation codes, but the same scrambling code. The midamble parts are either identically or differently shifted versions of a cell-specific basic midamble code, see section 5.2.3.

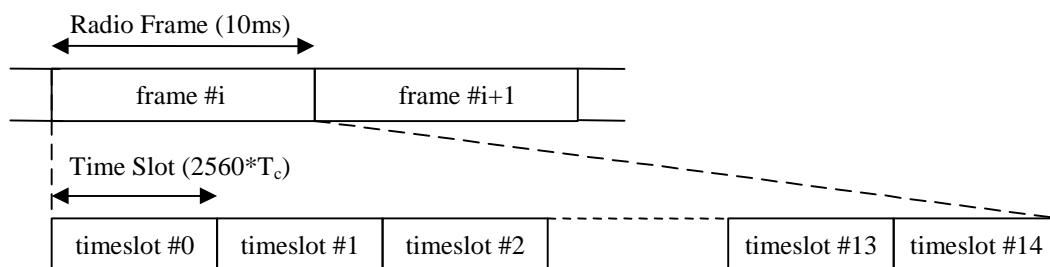

**Figure 1: Physical channel signal format**

The data part of the burst is spread with a combination of channelisation code and scrambling code. The channelisation code is a OVFSF code, that can have a spreading factor of 1, 2, 4, 8, or 16. The data rate of the physical channel is depending on the used spreading factor of the used OVFSF code.

The midamble part of the burst can contain two different types of midambles: a short one of length 256 chips, or a long one of 512 chips. The data rate of the physical channel is depending on the used midamble length.

So a physical channel is defined by frequency, timeslot, channelisation code, burst type and Radio Frame allocation. The scrambling code and the basic midamble code are broadcast and may be constant within a cell. When a physical channel is established, a start frame is given. The physical channels can either be of infinite duration, or a duration for the allocation can be defined.

### 5.1 Frame structure

The TDMA frame has a duration of 10 ms and is subdivided into 15 time slots (TS) of  $2560 \cdot T_c$  duration each. A time slot corresponds to 2560 chips. The physical content of the time slots are the bursts of corresponding length as described in subclause 5.2.2.

Each 10 ms frame consists of 15 time slots, each allocated to either the uplink or the downlink (figure 2). With such a flexibility, the TDD mode can be adapted to different environments and deployment scenarios. In any configuration at least one time slot has to be allocated for the downlink and at least one time slot has to be allocated for the uplink.

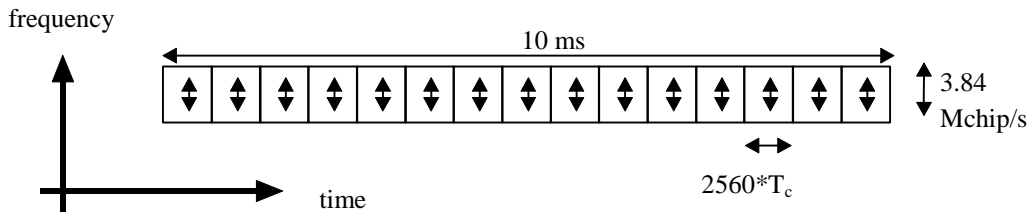

Figure 2: The TDD frame structure

Examples for multiple and single switching point configurations as well as for symmetric and asymmetric UL/DL allocations are given in figure 3.

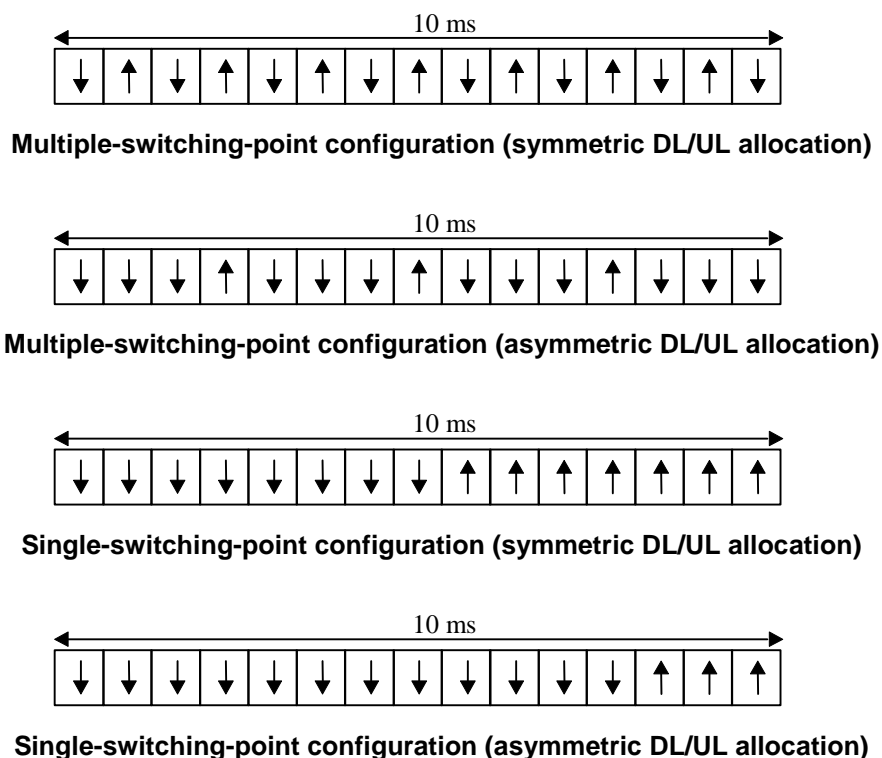

Figure 3: TDD frame structure examples

## 5.2 Dedicated physical channel (DPCH)

The DCH as described in subclause 4.1.1 is mapped onto the dedicated physical channel.

## 5.2.1 Spreading

Spreading is applied to the data part of the physical channels and consists of two operations. The first is the channelisation operation, which transforms every data symbol into a number of chips, thus increasing the bandwidth of the signal. The number of chips per data symbol is called the Spreading Factor (SF). The second operation is the scrambling operation, where a scrambling code is applied to the spread signal. Details on channelisation and scrambling operation can be found in [8].

### 5.2.1.1 Spreading for Downlink Physical Channels

Downlink physical channels shall use SF =16. Multiple parallel physical channels can be used to support higher data rates. These parallel physical channels shall be transmitted using different channelisation codes, see [8]. These codes with SF =16 are generated as described in [8].

Operation with a single code with spreading factor 1 is possible for the downlink physical channels.

### 5.2.1.2 Spreading for Uplink Physical Channels

The range of spreading factor that may be used for uplink physical channels shall range from 16 down to 1. For each physical channel an individual minimum spreading factor  $SF_{min}$  is transmitted by means of the higher layers. There are two options that are indicated by UTRAN:

1. The UE shall use the spreading factor  $SF_{min}$ , independent of the current TFC.
2. The UE shall autonomously increase the spreading factor depending on the current TFC.

If the UE autonomously changes the SF, it shall always vary the channelisation code along the branch with the higher code numbering of the allowed OVFSF sub tree, as depicted in [8].

For multicode transmission a UE shall use a maximum of two physical channels per timeslot simultaneously. These two parallel physical channels shall be transmitted using different channelisation codes, see [8].

## 5.2.2 Burst Types

Three types of bursts for dedicated physical channels are defined. All of them consist of two data symbol fields, a midamble and a guard period, the lengths of which are different for the individual burst types. Thus, the number of data symbols in a burst depends on the SF and the burst type, as depicted in table 1.

**Table 1: Number of data symbols (N) for burst type 1, 2, and 3**

Spreading factor (SF)	Burst Type 1	Burst Type 2	Burst Type 3
1	1952	2208	1856
2	976	1104	928
4	488	552	464
8	244	276	232
16	122	138	116

The support of all three burst types is mandatory for the UE. The three different bursts defined here are well suited for different applications, as described in the following sections.

### 5.2.2.1 Burst Type 1

The burst type 1 can be used for uplink and downlink. Due to its longer midamble field this burst type supports the construction of a larger number of training sequences, see 5.2.3. The maximum number of training sequences depend on the cell configuration, see annex A. For the burst type 1 this number may be 4, 8, or 16.

The data fields of the burst type 1 are 976 chips long. The corresponding number of symbols depends on the spreading factor, as indicated in table 1 above. The midamble of burst type 1 has a length of 512 chips. The guard period for the burst type 1 is 96 chip periods long. The burst type 1 is shown in Figure 4. The contents of the burst fields are described in table 2.

**Table 2: The contents of the burst type 1 fields**

Chip number (CN)	Length of field in chips	Length of field in symbols		Contents of field
0-975	976	Cf table 1		Data symbols
976-1487	512	-		Midamble
1488-2463	976	Cf table 1		Data symbols
2464-2559	96	-		Guard period

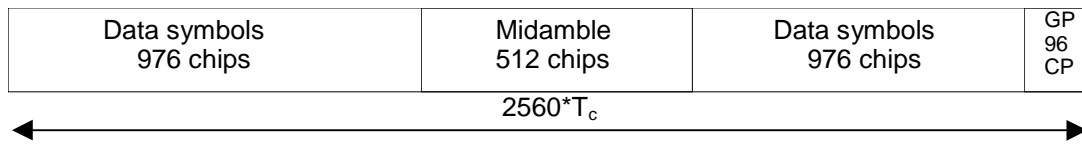

**Figure 4: Burst structure of the burst type 1. GP denotes the guard period and CP the chip periods**

### 5.2.2.2 Burst Type 2

The burst type 2 can be used for uplink and downlink. It offers a longer data field than burst type 1 on the cost of a shorter midamble. Due to the shorter midamble field the burst type 2 supports a maximum number of training sequences of 3 or 6 only, depending on the cell configuration, see annex A.

The data fields of the burst type 2 are 1104 chips long. The corresponding number of symbols depends on the spreading factor, as indicated in table 1 above. The guard period for the burst type 2 is 96 chip periods long. The burst type 2 is shown in Figure 5. The contents of the burst fields are described in table 3.

**Table 3: The contents of the burst type 2 fields**

Chip number (CN)	Length of field in chips	Length of field in symbols		Contents of field
0-1103	1104	cf table 1		Data symbols
1104-1359	256	-		Midamble
1360-2463	1104	cf table 1		Data symbols
2464-2559	96	-		Guard period

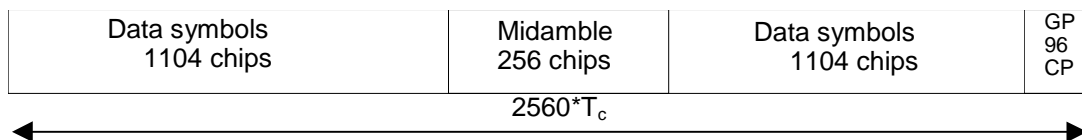

**Figure 5: Burst structure of the burst type 2. GP denotes the guard period and CP the chip periods**

### 5.2.2.3 Burst Type 3

The burst type 3 is used for uplink only. Due to the longer guard period it is suitable for initial access or access to a new cell after handover. It offers the same number of training sequences as burst type 1.

The data fields of the burst type 3 have a length of 976 chips and 880 chips, respectively. The corresponding number of symbols depends on the spreading factor, as indicated in table 1 above. The midamble of burst type 3 has a length of 512 chips. The guard period for the burst type 3 is 192 chip periods long. The burst type 3 is shown in Figure 6. The contents of the burst fields are described in table 4.



**Table 4: The contents of the burst type 3 fields**

Chip number (CN)	Length of field in chips	Length of field in symbols	Contents of field
0-975	976	Cf table 1	Data symbols
976-1487	512	-	Midamble
1488-2367	880	Cf table 1	Data symbols
2368-2559	192	-	Guard period

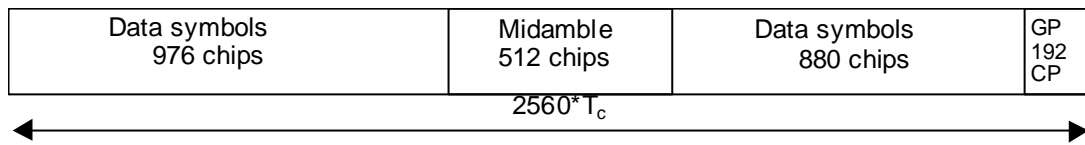

**Figure 6: Burst structure of the burst type 3. GP denotes the guard period and CP the chip periods**

5.2.2.4 Transmission of TFCI

All burst types 1, 2 and 3 provide the possibility for transmission of TFCI.

The transmission of TFCI is negotiated at call setup and can be re-negotiated during the call. For each CCTrCH it is indicated by higher layer signalling, which TFCI format is applied. Additionally for each allocated timeslot it is signalled individually whether that timeslot carries the TFCI or not. The TFCI is always present in the first timeslot in a radio frame for each CCTrCH. If a time slot contains the TFCI, then it is always transmitted using the first allocated channelisation code in the timeslot, according to the order in the higher layer allocation message.

The transmission of TFCI is done in the data parts of the respective physical channel. In DL the TFCI code word bits and data bits are subject to the same spreading procedure as depicted in [8]. In UL, independent of the SF that is applied to the data symbols in the burst, the data in the TFCI field are always spread with SF=16 using the channelisation code in the branch with the highest code numbering of the allowed OVSF sub tree, as depicted in [8]. Hence the midamble structure and length is not changed. The TFCI code word is to be transmitted directly adjacent to the midamble, possibly after the TPC. Figure 7 shows the position of the TFCI code word in a traffic burst in downlink. Figure 8 shows the position of the TFCI code word in a traffic burst in uplink.

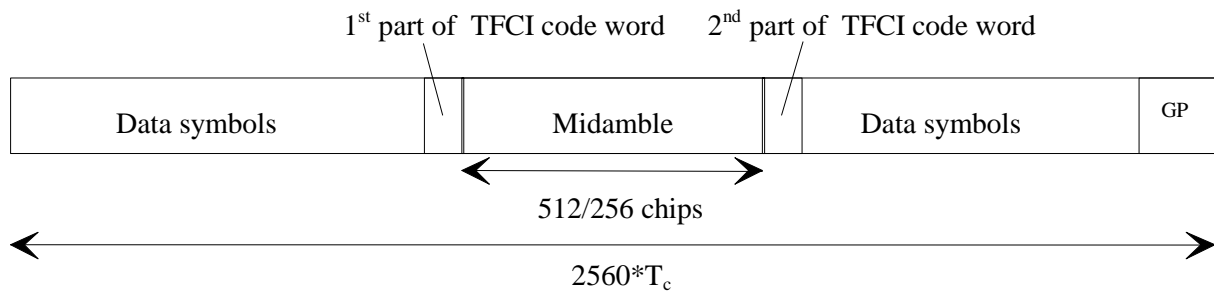

**Figure 7: Position of the TFCI code word in the traffic burst in case of downlink**

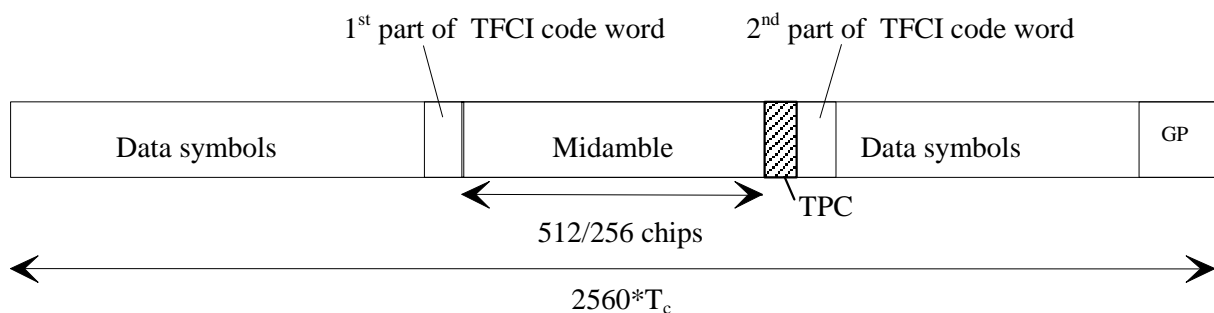

**Figure 8: Position of the TFCI code word in the traffic burst in case of uplink**

Two examples of TFCI transmission in the case of multiple DPCHs used for a connection are given in the Figure 9 and Figure 10 below. Combinations of the two schemes shown are also applicable.

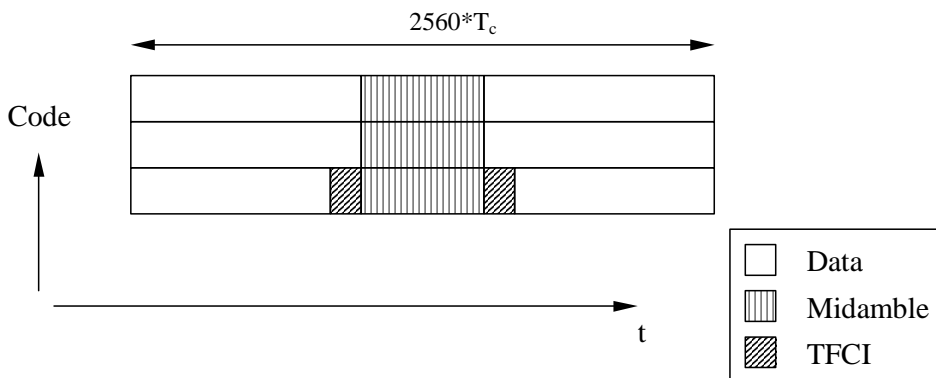

Figure 9: Example of TFCI transmission with physical channels multiplexed in code domain

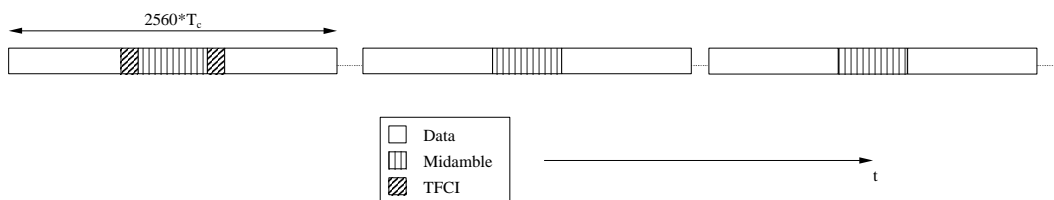

Figure 10: Example of TFCI transmission with physical channels multiplexed in time domain

In case the Node B receives an invalid TFI combination on the DPCHs mapped to one CCTrCH the procedure described in [16] shall be applied. According to this procedure DTX shall be applied to all DPCHs to which the CCTrCH is mapped to.

### 5.2.2.5 Transmission of TPC

All burst types 1, 2 and 3 for dedicated channels provide the possibility for transmission of TPC in uplink.

The transmission of TPC is done in the data parts of the traffic burst. Independent of the SF that is applied to the data symbols in the burst, the data in the TPC field are always spread with SF=16 using the channelisation code in the branch with the highest code numbering of the allowed OVFSF sub tree, as depicted in [8]. Hence the midamble structure and length is not changed. The TPC information is to be transmitted directly after the midamble. Figure 11 shows the position of the TPC in a traffic burst.

For every user the TPC information shall be transmitted at least once per transmitted frame. If a TFCI is applied for a CCTrCH, TPC shall be transmitted with the same channelization codes and in the same timeslots as the TFCI. If no TFCI is applied for a CCTrCH, TPC shall be transmitted using the first allocated channelisation code and the first allocated timeslot, according to the order in the higher layer allocation message.

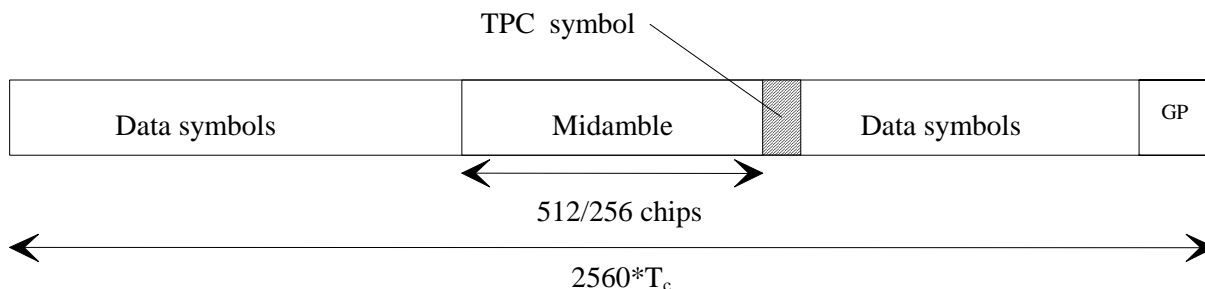

Figure 11: Position of TPC information in the traffic burst

The length of the TPC command is one symbol. The relationship between the TPC symbol and the TPC command is shown in table 4a.

**Table 4a: TPC bit pattern**

TPC Bits	TPC command	Meaning
00	'Down'	Decrease Tx Power
11	'Up'	Increase Tx Power

5.2.2.6 Timeslot formats

5.2.2.6.1 Downlink timeslot formats

The downlink timeslot format depends on the spreading factor, midamble length and on the number of the TFCI code word bits, as depicted in the table 5a.

**Table 5a: Time slot formats for the Downlink**

Slot Format #	Spreading Factor	Midamble length (chips)	N <sub>TFCI</sub> code word (bits)	Bits/slot	N <sub>Data/Slot</sub> (bits)	N <sub>data/data field</sub> (bits)
0	16	512	0	244	244	122
1	16	512	4	244	240	120
2	16	512	8	244	236	118
3	16	512	16	244	228	114
4	16	512	32	244	212	106
5	16	256	0	276	276	138
6	16	256	4	276	272	136
7	16	256	8	276	268	134
8	16	256	16	276	260	130
9	16	256	32	276	244	122
10	1	512	0	3904	3904	1952
11	1	512	4	3904	3900	1950
12	1	512	8	3904	3896	1948
13	1	512	16	3904	3888	1944
14	1	512	32	3904	3872	1936
15	1	256	0	4416	4416	2208
16	1	256	4	4416	4412	2206
17	1	256	8	4416	4408	2204
18	1	256	16	4416	4400	2200
19	1	256	32	4416	4384	2192

5.2.2.6.2 Uplink timeslot formats

The uplink timeslot format depends on the spreading factor, midamble length, guard period length and on the number of the TFCI code word bits. Due to TPC, different amount of bits are mapped to the two data fields. The timeslot formats are depicted in the table 5b.

Table 5b: Timeslot formats for the Uplink

Slot Format #	Spreading Factor	Midamble length (chips)	Guard Period (chips)	N <sub>TFCI</sub> code word (bits)	N <sub>TPC</sub> (bits)	Bits/slot	N <sub>Data/Slot</sub> (bits)	N <sub>data/data field(1)</sub> (bits)	N <sub>data/data field(2)</sub> (bits)
0	16	512	96	0	0	244	244	122	122
1	16	512	96	0	2	244	242	122	120
2	16	512	96	4	2	244	238	120	118
3	16	512	96	8	2	244	234	118	116
4	16	512	96	16	2	244	226	114	112
5	16	512	96	32	2	244	210	106	104
6	16	256	96	0	0	276	276	138	138
7	16	256	96	0	2	276	274	138	136
8	16	256	96	4	2	276	270	136	134
9	16	256	96	8	2	276	266	134	132
10	16	256	96	16	2	276	258	130	128
11	16	256	96	32	2	276	242	122	120
12	8	512	96	0	0	488	488	244	244
13	8	512	96	0	2	486	484	244	240
14	8	512	96	4	2	482	476	240	236
15	8	512	96	8	2	478	468	236	232
16	8	512	96	16	2	470	452	228	224
17	8	512	96	32	2	454	420	212	208
18	8	256	96	0	0	552	552	276	276
19	8	256	96	0	2	550	548	276	272
20	8	256	96	4	2	546	540	272	268
21	8	256	96	8	2	542	532	268	264
22	8	256	96	16	2	534	516	260	256
23	8	256	96	32	2	518	484	244	240
24	4	512	96	0	0	976	976	488	488
25	4	512	96	0	2	970	968	488	480
26	4	512	96	4	2	958	952	480	472
27	4	512	96	8	2	946	936	472	464
28	4	512	96	16	2	922	904	456	448
29	4	512	96	32	2	874	840	424	416
30	4	256	96	0	0	1104	1104	552	552
31	4	256	96	0	2	1098	1096	552	544
32	4	256	96	4	2	1086	1080	544	536
33	4	256	96	8	2	1074	1064	536	528
34	4	256	96	16	2	1050	1032	520	512
35	4	256	96	32	2	1002	968	488	480
36	2	512	96	0	0	1952	1952	976	976
37	2	512	96	0	2	1938	1936	976	960
38	2	512	96	4	2	1910	1904	960	944
39	2	512	96	8	2	1882	1872	944	928
40	2	512	96	16	2	1826	1808	912	896
41	2	512	96	32	2	1714	1680	848	832
42	2	256	96	0	0	2208	2208	1104	1104
43	2	256	96	0	2	2194	2192	1104	1088
44	2	256	96	4	2	2166	2160	1088	1072
45	2	256	96	8	2	2138	2128	1072	1056
46	2	256	96	16	2	2082	2064	1040	1024
47	2	256	96	32	2	1970	1936	976	960

Slot Format #	Spreading Factor	Midamble length (chips)	Guard Period (chips)	N <sub>TFCI</sub> code word (bits)	N <sub>TPC</sub> (bits)	Bits/slot	N <sub>Data/Slot</sub> (bits)	N <sub>data/data field(1)</sub> (bits)	N <sub>data/data field(2)</sub> (bits)
48	1	512	96	0	0	3904	3904	1952	1952
49	1	512	96	0	2	3874	3872	1952	1920
50	1	512	96	4	2	3814	3808	1920	1888
51	1	512	96	8	2	3754	3744	1888	1856
52	1	512	96	16	2	3634	3616	1824	1792
53	1	512	96	32	2	3394	3360	1696	1664
54	1	256	96	0	0	4416	4416	2208	2208
55	1	256	96	0	2	4386	4384	2208	2176
56	1	256	96	4	2	4326	4320	2176	2144
57	1	256	96	8	2	4266	4256	2144	2112
58	1	256	96	16	2	4146	4128	2080	2048
59	1	256	96	32	2	3906	3872	1952	1920
60	16	512	192	0	0	232	232	122	110
61	16	512	192	0	2	232	230	122	108
62	16	512	192	4	2	232	226	120	106
63	16	512	192	8	2	232	222	118	104
64	16	512	192	16	2	232	214	114	100
65	16	512	192	32	2	232	198	106	92
66	8	512	192	0	0	464	464	244	220
67	8	512	192	0	2	462	460	244	216
68	8	512	192	4	2	458	452	240	212
69	8	512	192	8	2	454	444	236	208
70	8	512	192	16	2	446	428	228	200
71	8	512	192	32	2	430	396	212	184
72	4	512	192	0	0	928	928	488	440
73	4	512	192	0	2	922	920	488	432
74	4	512	192	4	2	910	904	480	424
75	4	512	192	8	2	898	888	472	416
76	4	512	192	16	2	874	856	456	400
77	4	512	192	32	2	826	792	424	368
78	2	512	192	0	0	1856	1856	976	880
79	2	512	192	0	2	1842	1840	976	864
80	2	512	192	4	2	1814	1808	960	848
81	2	512	192	8	2	1786	1776	944	832
82	2	512	192	16	2	1730	1712	912	800
83	2	512	192	32	2	1618	1584	848	736
84	1	512	192	0	0	3712	3712	1952	1760
85	1	512	192	0	2	3682	3680	1952	1728
86	1	512	192	4	2	3622	3616	1920	1696
87	1	512	192	8	2	3562	3552	1888	1664
88	1	512	192	16	2	3442	3424	1824	1600
89	1	512	192	32	2	3202	3168	1696	1472

### 5.2.3 Training sequences for spread bursts

In this subclause, the training sequences for usage as midambles in burst type 1, 2 and 3 (see subclause 5.2.2) are defined. The training sequences, i.e. midambles, of different users active in the same cell and same time slot are cyclically shifted versions of one cell-specific single basic midamble code. The applicable basic midamble codes are

given in Annex A.1 and A.2. As different basic midamble codes are required for different burst formats, the Annex A.1 shows the basic midamble codes  $\mathbf{m}_{pL}$  for burst type 1 and 3, and Annex and A.2 shows  $\mathbf{m}_{pS}$  for burst type 2. It should be noted that burst type 2 must not be mixed with burst type 1 or 3 in the same timeslot of one cell.

The basic midamble codes in Annex A.1 and A.2 are listed in hexadecimal notation. The binary form of the basic midamble code shall be derived according to table 6 below.

**Table 6: Mapping of 4 binary elements  $m_i$  on a single hexadecimal digit**

4 binary elements $m_i$	Mapped on hexadecimal digit
-1 -1 -1 -1	0
-1 -1 -1 1	1
-1 -1 1 -1	2
-1 -1 1 1	3
-1 1 -1 -1	4
-1 1 -1 1	5
-1 1 1 -1	6
-1 1 1 1	7
1 -1 -1 -1	8
1 -1 -1 1	9
1 -1 1 -1	A
1 -1 1 1	B
1 1 -1 -1	C
1 1 -1 1	D
1 1 1 -1	E
1 1 1 1	F

For each particular basic midamble code, its binary representation can be written as a vector  $\mathbf{m}_p$  :

$$\mathbf{m}_p = (m_1, m_2, \dots, m_p) \quad (1)$$

According to Annex A.1, the size of this vector  $\mathbf{m}_p$  is  $P=456$  for burst type 1 and 3. Annex A.2 is setting  $P=192$  for burst type 2. As QPSK modulation is used, the training sequences are transformed into a complex form, denoted as the complex vector  $\underline{\mathbf{m}}_p$  :

$$\underline{\mathbf{m}}_p = (\underline{m}_1, \underline{m}_2, \dots, \underline{m}_p) \quad (2)$$

The elements  $\underline{m}_i$  of  $\underline{\mathbf{m}}_p$  are derived from elements  $m_i$  of  $\mathbf{m}_p$  using equation (3):

$$\underline{m}_i = (j)^i \cdot m_i \text{ for all } i = 1, \dots, P \quad (3)$$

Hence, the elements  $\underline{m}_i$  of the complex basic midamble code are alternating real and imaginary.

To derive the required training sequences (different shifts), this vector  $\underline{\mathbf{m}}_p$  is periodically extended to the size:

$$i_{\max} = L_m + (K'-1)W + \lfloor P/K \rfloor \quad (4)$$

Notes on equation (4):

- $L_m$ : Midamble length
- $K'$ : Maximum number of different midamble shifts in a cell, when no intermediate shifts are used. This value depends on the midamble length.
- $K$ : Maximum number of different midamble shifts in a cell, when intermediate shifts are used,  $K=2K'$ . This value depends on the midamble length.
- $W$ : Shift between the midambles, when the number of midambles is  $K'$ .

- $\lfloor x \rfloor$  denotes the largest integer smaller or equal to  $x$

Allowed values for  $L_m$ ,  $K'$  and  $W$  are given in Annex A.1 and A.2.

So we obtain a new vector  $\underline{\mathbf{m}}$  containing the periodic basic midamble sequence:

$$\underline{\mathbf{m}} = (m_1, m_2, \dots, m_{i_{\max}}) = (m_1, m_2, \dots, m_{L_m + (K'-1)W + \lfloor P/K \rfloor}) \quad (5)$$

The first  $P$  elements of this vector  $\underline{\mathbf{m}}$  are the same ones as in vector  $\underline{\mathbf{m}}_p$ , the following elements repeat the beginning:

$$m_i = m_{i-P} \text{ for the subset } i = (P+1), \dots, i_{\max} \quad (6)$$

Using this periodic basic midamble sequence  $\underline{\mathbf{m}}$  for each shift  $k$  a midamble  $\underline{\mathbf{m}}^{(k)}$  of length  $L_m$  is derived, which can be written as a shift specific vector:

$$\underline{\mathbf{m}}^{(k)} = (m_1^{(k)}, m_2^{(k)}, \dots, m_{L_m}^{(k)}) \quad (7)$$

The  $L_m$  midamble elements  $m_i^{(k)}$  are generated for each midamble of the first  $K'$  shifts ( $k = 1, \dots, K'$ ) based on:

$$m_i^{(k)} = m_{i+(K'-k)W} \text{ with } i = 1, \dots, L_m \text{ and } k = 1, \dots, K' \quad (8)$$

The elements of midambles for the second  $K'$  shifts ( $k = (K'+1), \dots, K = (K'+1), \dots, 2K'$ ) are generated based on a slight modification of this formula introducing intermediate shifts:

$$m_i^{(k)} = m_{i+(K-k-1)W + \lfloor P/K \rfloor} \text{ with } i = 1, \dots, L_m \text{ and } k = K'+1, \dots, K-1 \quad (9)$$

$$m_i^{(k)} = m_{i+(K'-1)W + \lfloor P/K \rfloor} \text{ with } i = 1, \dots, L_m \text{ and } k = K \quad (10)$$

The number  $K_{\text{Cell}}$  of midambles that is supported in each cell can be smaller than  $K$ , depending on the cell size and the possible delay spreads, see annex A. The number  $K_{\text{Cell}}$  is signalled by higher layers. The midamble sequences derived according to equations (7) to (10) have complex values and are not subject to channelisation or scrambling process, i.e. the elements  $m_i^{(k)}$  represent complex chips for usage in the pulse shaping process at modulation.

The term 'a midamble code set' or 'a midamble code family' denotes  $K$  specific midamble codes  $\underline{\mathbf{m}}^{(k)}$ ;  $k=1, \dots, K$ , based on a single basic midamble code  $\underline{\mathbf{m}}_p$  according to (1).

## 5.2.4 Beamforming

When DL beamforming is used, at least that user to which beamforming is applied and which has a dedicated channel shall get one individual midamble according to subclause 5.2.3, even in DL.

## 5.3 Common physical channels

### 5.3.1 Primary common control physical channel (P-CCPCH)

The BCH as described in subclause 4.1.2 is mapped onto the Primary Common Control Physical Channel (P-CCPCH). The position (time slot / code) of the P-CCPCH is known from the Physical Synchronisation Channel (PSCH), see subclause 5.3.4.

#### 5.3.1.1 P-CCPCH Spreading

The P-CCPCH uses fixed spreading with a spreading factor  $SF = 16$  as described in subclause 5.2.1.1. The P-CCPCH always uses channelisation code  $C_{Q=16}^{(k=1)}$ .

### 5.3.1.2 P-CCPCH Burst Types

The burst type 1 as described in subclause 5.2.2 is used for the P-CCPCH. No TFCI is applied for the P-CCPCH.

### 5.3.1.3 P-CCPCH Training sequences

The training sequences, i.e. midambles, as described in subclause 5.2.3 are used for the P-CCPCH. For those timeslots in which the P-CCPCH is transmitted, the midambles  $m^{(1)}$  and  $m^{(2)}$  are reserved for P-CCPCH in order to support Space Code transmit Diversity (SCTD) and the beacon function, see 5.4 and 5.5. The use of midambles depends on whether SCTD is applied to the P-CCPCH:

- If no antenna diversity is applied to P-CCPCH,  $m^{(1)}$  is used and  $m^{(2)}$  is left unused. The maximum number  $K_{\text{Cell}}$  of midambles in a cell may be 4, 8 or 16.
- If SCTD antenna diversity is applied to P-CCPCH,  $m^{(1)}$  is used for the first antenna and  $m^{(2)}$  is used for the diversity antenna. The maximum number  $K_{\text{Cell}}$  of midambles in a cell may be 8 or 16. The case of 4 midambles is not allowed for SCTD.

## 5.3.2 Secondary common control physical channel (S-CCPCH)

PCH and FACH as described in subclause 4.1.2 are mapped onto one or more secondary common control physical channels (S-CCPCH). In this way the capacity of PCH and FACH can be adapted to the different requirements.

### 5.3.2.1 S-CCPCH Spreading

The S-CCPCH uses fixed spreading with a spreading factor  $SF = 16$  as described in subclause 5.2.1.1.

### 5.3.2.2 S-CCPCH Burst Types

The burst types 1 or 2 as described in subclause 5.2.2 are used for the S-CCPCHs. TFCI may be applied for S-CCPCHs.

### 5.3.2.3 S-CCPCH Training sequences

The training sequences, i.e. midambles, as described in subclause 5.2.3 are used for the S-CCPCH.

## 5.3.3 The physical random access channel (PRACH)

The RACH as described in subclause 4.1.2 is mapped onto one uplink physical random access channel (PRACH).

### 5.3.3.1 PRACH Spreading

The uplink PRACH uses either spreading factor  $SF=16$  or  $SF=8$  as described in subclause 5.2.1.2. The set of admissible spreading codes for use on the PRACH and the associated spreading factors are broadcast on the BCH (within the RACH configuration parameters on the BCH).

### 5.3.3.2 PRACH Burst Type

The UEs send uplink access bursts of type 3 randomly in the PRACH. TFCI and TPC are not applied for the PRACH.

### 5.3.3.3 PRACH Training sequences

The training sequences, i.e. midambles, of different users active in the same time slot are time shifted versions of a single periodic basic code. The basic midamble codes for burst type 3 are shown in Annex A. The necessary time shifts are obtained by choosing either *all*  $k=1,2,3,\dots,K'$  (for cells with small radius) or *uneven*  $k=1,3,5,\dots\leq K'$  (for cells with large radius). Different cells use different periodic basic codes, i.e. different midamble sets.

For cells with large radius additional midambles may be derived from the time-inverted Basic Midamble Sequence. Thus, the second Basic Midamble Code  $m_2$  is the time inverted version of Basic Midamble Code  $m_1$ .



In this way, a joint channel estimation for the channel impulse responses of all active users within one time slot can be performed by a maximum of two cyclic correlations (in cells with small radius, a single cyclic correlator suffices). The different user specific channel impulse response estimates are obtained sequentially in time at the output of the cyclic correlators.

### 5.3.3.4 PRACH timeslot formats

For the PRACH the timeslot format is only spreading factor dependent. The timeslot formats 60 and 66 of table 5b are applicable for the PRACH.

### 5.3.3.5 Association between Training Sequences and Channelisation Codes

For the PRACH there exists a fixed association between the training sequence and the channelisation code. The generic rule to define this association is based on the order of the channelisation codes  $c_Q^{(k)}$  given by  $k$  and the order of the midambles  $m_j^{(k)}$  given by  $k$ , firstly, and  $j$ , secondly, with the constraint that the midamble for a spreading factor  $Q$  is the same as in the upper branch for the spreading factor  $2Q$ . The index  $j=1$  or  $2$  indicates whether the original Basic Midamble Sequence ( $j=1$ ) or the time-inverted Basic Midamble Sequence is used ( $j=2$ ).

- For the case that all  $k$  are allowed and only one periodic basic code  $m_1$  is available for the RACH, the association depicted in figure 12 is straightforward.
- For the case that only odd  $k$  are allowed the principle of the association is shown in figure 13. This association is applied for one and two basic periodic codes.

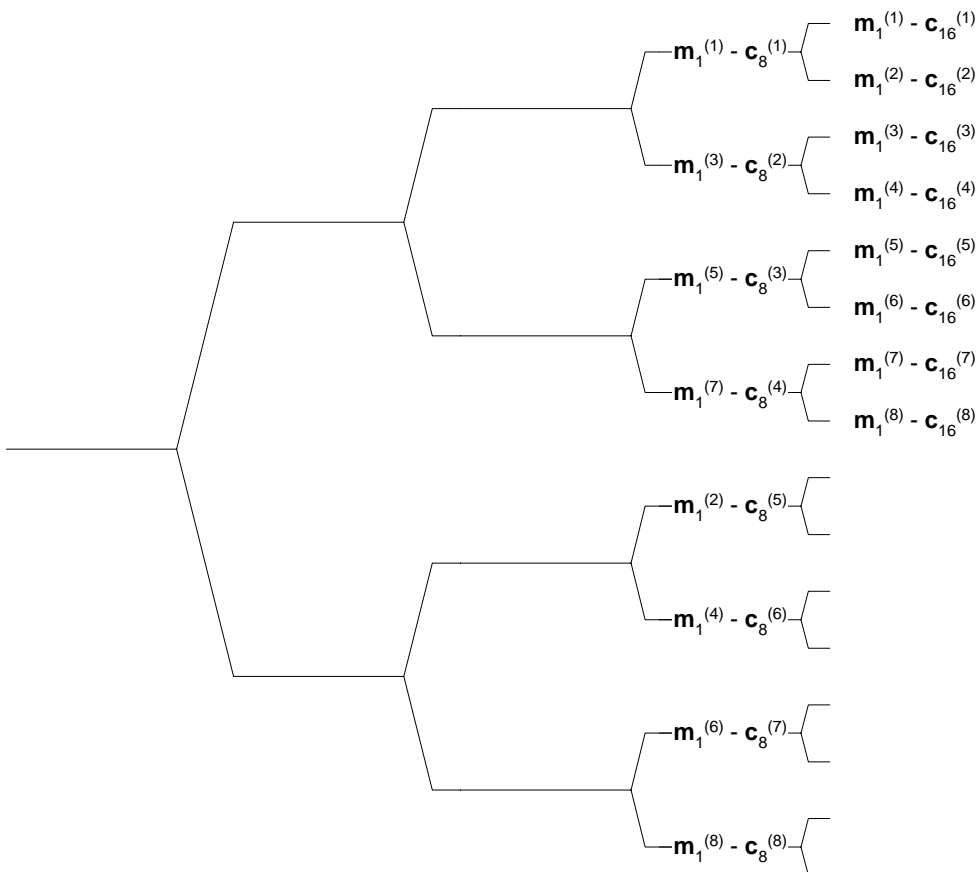

Figure 12: Association of Midambles to Channelisation Codes in the OVSF tree for all  $k$

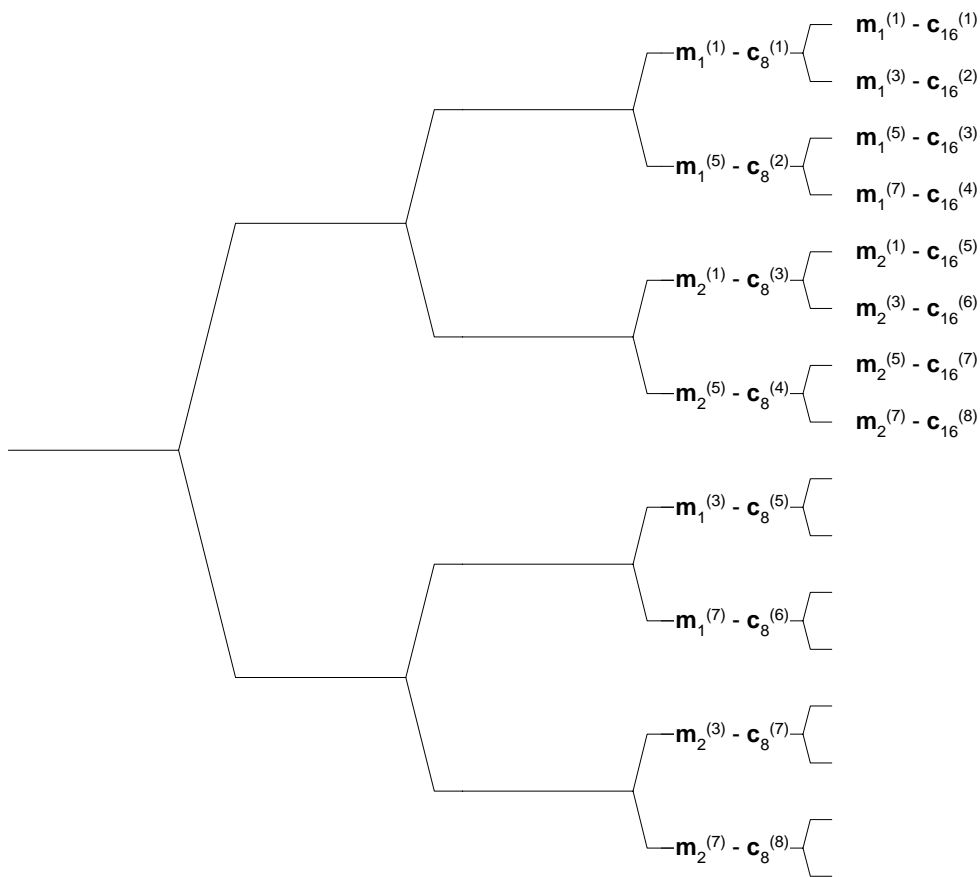

Figure 13: Association of Midambles to Channelisation Codes in the OVSF tree for odd *k*

### 5.3.4 The synchronisation channel (SCH)

In TDD mode code group of a cell can be derived from the synchronisation channel. In order not to limit the uplink/downlink asymmetry the SCH is mapped on one or two downlink slots per frame only.

There are two cases of SCH and P-CCPCH allocation as follows:

- Case 1) SCH and P-CCPCH allocated in TS#*k*, *k*=0...14
- Case 2) SCH allocated in two TS: TS#*k* and TS#*k*+8, *k*=0...6; P-CCPCH allocated in TS#*k*.

The position of SCH (value of *k*) in frame can change on a long term basis in any case.

Due to this SCH scheme, the position of P-CCPCH is known from the SCH.

Figure 14 is an example for transmission of SCH, *k*=0, of Case 2.

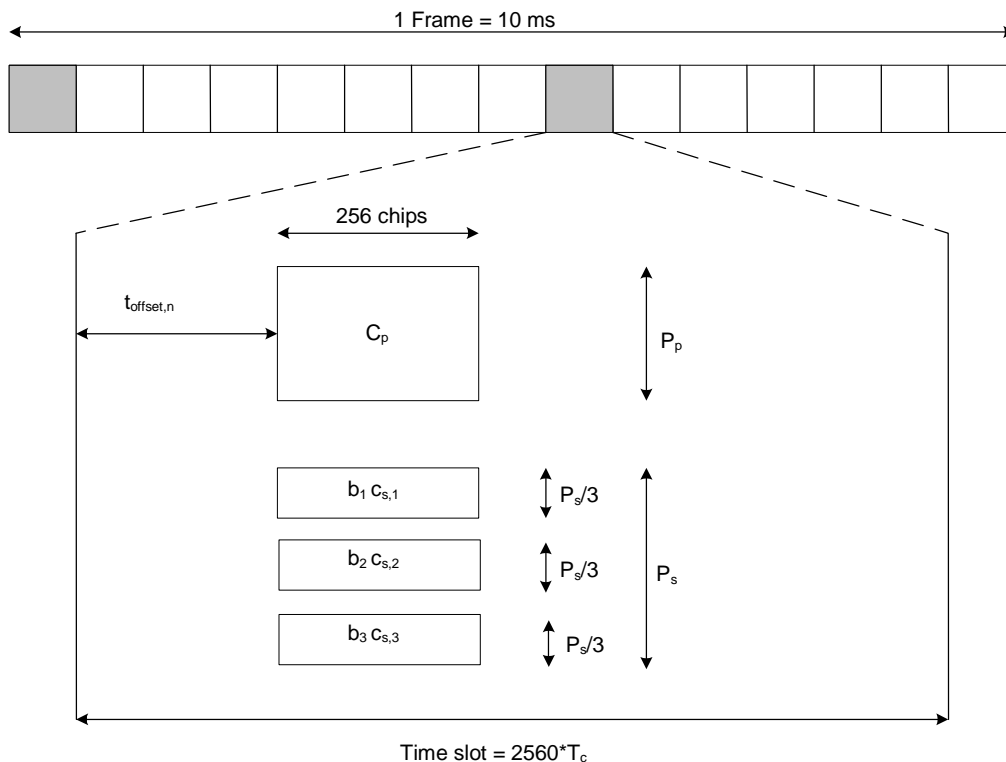

$$b_i \in \{\pm 1, \pm j\}, C_{s,i} \in \{C_0, C_1, C_3, C_4, C_5, C_6, C_8, C_{10}, C_{12}, C_{13}, C_{14}, C_{15}\}, i=1,2,3; \text{ see [8]}$$

**Figure 14: Scheme for Synchronisation channel SCH consisting of one primary sequence  $C_p$  and 3 parallel secondary sequences  $C_{s,i}$  in slot  $k$  and  $k+8$  (example for  $k=0$  in Case 2)**

As depicted in figure 14, the SCH consists of a primary and three secondary code sequences each 256 chips long. The primary and secondary code sequences are defined in [8] clause 8 'Synchronisation codes for the 3.84 Mcps option'.

Due to mobile to mobile interference, it is mandatory for public TDD systems to keep synchronisation between base stations. As a consequence of this, a capture effect concerning SCH can arise. The time offset  $t_{offset,n}$  enables the system to overcome the capture effect.

The time offset  $t_{offset,n}$  is one of 32 values, depending on the code group of the cell,  $n$ , cf. 'table 6 Mapping scheme for Cell Parameters, Code Groups, Scrambling Codes, Midambles and  $t_{offset}$ ' in [8]. Note that the cell parameter will change from frame to frame, cf. 'Table 7 Alignment of cell parameter cycling and system frame number' in [8], but the cell will belong to only one code group and thus have one time offset  $t_{offset,n}$ . The exact value for  $t_{offset,n}$ , regarding column 'Associated  $t_{offset}$ ' in table 6 in [8] is given by:

$$t_{offset,n} = \begin{cases} n \cdot 48 \cdot T_c & n < 16 \\ (720 + n \cdot 48) T_c & n \geq 16 \end{cases}; \quad n = 0, \dots, 31$$

### 5.3.5 Physical Uplink Shared Channel (PUSCH)

The USCH as described in subclause 4.1.2 is mapped onto one or more physical uplink shared channels (PUSCH). Timing advance, as described in [9], subclause 4.3, is applied to the PUSCH.

#### 5.3.5.1 PUSCH Spreading

The spreading factors that can be applied to the PUSCH are SF = 1, 2, 4, 8, 16 as described in subclause 5.2.1.2.

### 5.3.5.2 PUSCH Burst Types

Burst types 1, 2 or 3 as described in subclause 5.2.2 can be used for PUSCH. TFCI and TPC can be transmitted on the PUSCH.

### 5.3.5.3 PUSCH Training Sequences

The training sequences as described in subclause 5.2.3 are used for the PUSCH.

### 5.3.5.4 UE Selection

The UE that shall transmit on the PUSCH is selected by higher layer signalling.

## 5.3.6 Physical Downlink Shared Channel (PDSCH)

The DSCH as described in subclause 4.1.2 is mapped onto one or more physical downlink shared channels (PDSCH).

### 5.3.6.1 PDSCH Spreading

The PDSCH uses either spreading factor  $SF = 16$  or  $SF = 1$  as described in subclause 5.2.1.1.

### 5.3.6.2 PDSCH Burst Types

Burst types 1 or 2 as described in subclause 5.2.2 can be used for PDSCH. TFCI can be transmitted on the PDSCH.

### 5.3.6.3 PDSCH Training Sequences

The training sequences as described in subclause 5.2.3 are used for the PDSCH.

### 5.3.6.4 UE Selection

To indicate to the UE that there is data to decode on the DSCH, three signalling methods are available:

- 1) using the TFCI field of the associated channel or PDSCH;
- 2) using on the DSCH user specific midamble derived from the set of midambles used for that cell;
- 3) using higher layer signalling.

When the midamble based method is used, the UE specific midamble allocation method shall be employed (see subclause 5.6), and the UE shall decode the PDSCH if the PDSCH was transmitted with the midamble assigned to the UE by UTRAN. For this method no other physical channels may use the same time slot as the PDSCH and only one UE may share the PDSCH time slot within one TTI.

Note: From the above mentioned signalling methods, only the higher layer signalling method is supported by higher layers in Release 4.

## 5.3.7 The Paging Indicator Channel (PICH)

The Paging Indicator Channel (PICH) is a physical channel used to carry the paging indicators.

### 5.3.7.1 Mapping of Paging Indicators to the PICH bits

Figure 15 depicts the structure of a PICH burst and the numbering of the bits within the burst. The same burst type is used for the PICH in every cell.  $N_{PIB}$  bits in a normal burst of type 1 or 2 are used to carry the paging indicators, where  $N_{PIB}$  depends on the burst type:  $N_{PIB}=240$  for burst type 1 and  $N_{PIB}=272$  for burst type 2. The bits  $s_{N_{PIB}+1}, \dots, s_{N_{PIB}+4}$  adjacent to the midamble are reserved for possible future use.

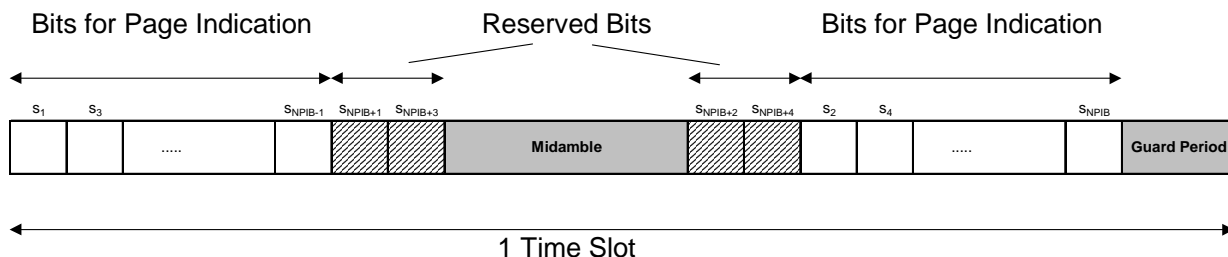

Figure 15: Transmission and numbering of paging indicator carrying bits in a PICH burst

Each paging indicator  $P_q$  in one time slot is mapped to the bits  $\{s_{2L_{PI} \cdot q+1}, \dots, s_{2L_{PI} \cdot (q+1)}\}$  within this time slot. Thus, due to the interleaved transmission of the bits half of the symbols used for each paging indicator are transmitted in the first data part, and the other half of the symbols are transmitted in the second data part, as exemplary shown in figure 16 for a paging indicator length  $L_{PI}$  of 4 symbols.

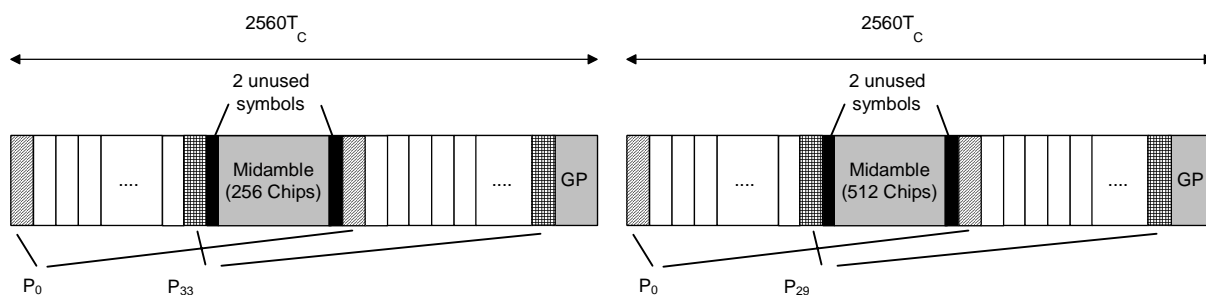

Figure 16: Example of mapping of paging indicators on PICH bits for  $L_{PI}=4$

The setting of the paging indicators and the corresponding PICH bits (including the reserved ones) is described in [7].

$N_{PI}$  paging indicators of length  $L_{PI}=2$ ,  $L_{PI}=4$  or  $L_{PI}=8$  symbols are transmitted in each radio frame that contains the PICH. The number of paging indicators  $N_{PI}$  per radio frame is given by the paging indicator length and the burst type, which are both known by higher layer signalling. In table 7 this number is shown for the different possibilities of burst types and paging indicator lengths.

Table 7: Number  $N_{PI}$  of paging indicators per time slot for the different burst types and paging indicator lengths  $L_{PI}$

	$L_{PI}=2$	$L_{PI}=4$	$L_{PI}=8$
Burst Type 1	$N_{PI}=60$	$N_{PI}=30$	$N_{PI}=15$
Burst Type 2	$N_{PI}=68$	$N_{PI}=34$	$N_{PI}=17$

### 5.3.7.2 Structure of the PICH over multiple radio frames

As shown in figure 17, the paging indicators of  $N_{PICH}$  consecutive frames form a PICH block,  $N_{PICH}$  is configured by higher layers. Thus,  $N_P=N_{PICH} \cdot N_{PI}$  paging indicators are transmitted in each PICH block.

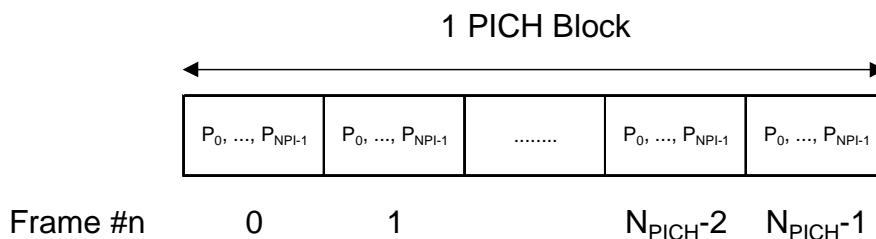

Figure 17: Structure of a PICH block

The value PI ( $PI = 0, \dots, N_P - 1$ ) calculated by higher layers for use for a certain UE, see [15], is associated to the paging indicator  $P_q$  in the  $n$ th frame of one PICH block, where  $q$  is given by

$$q = PI \bmod N_{PI}$$

and  $n$  is given by

$$n = PI \operatorname{div} N_{PI}$$

The PI bitmap in the PCH data frames over  $I_{ub}$  contains indication values for all possible higher layer PI values, see [17]. Each bit in the bitmap indicates if the paging indicator  $P_q$  associated with that particular PI shall be set to 0 or 1. Hence, the calculation in the formulas above is to be performed in Node B to make the association between PI and  $P_q$ .

### 5.3.7.3 PICH Training sequences

The training sequences, i.e. midambles for the PICH, are generated as described in subclause 5.2.3. The allocation of midambles depends on whether SCTD is applied to the PICH.

- If no antenna diversity is applied to the PICH the midambles can be allocated as described in subclause 5.6.
- If SCTD antenna diversity is applied to the PICH the allocation of midambles shall be as described in [9].

## 5.3.8 The physical node B synchronisation channel (PNBSCH)

In case cell sync bursts are used for Node B synchronisation the PNBSCH shall be used for the transmission of the cell sync burst [8]. The PNBSCH shall be mapped on the same timeslot as the PRACH acc. to a higher layer schedule. The cell sync burst shall be transmitted at the beginning of a timeslot. In case of Node B synchronisation via the air interface the transmission of a RACH may be prohibited on higher layer command in specified frames and timeslots.

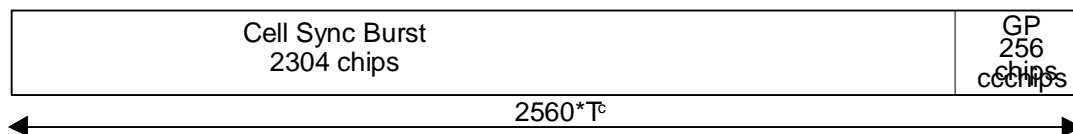

## 5.3.9 High Speed Physical Downlink Shared Channel (HS-PDSCH)

The HS-DSCH as described in subclause 4.1.2 is mapped onto one or more high speed physical downlink shared channels (HS-PDSCH).

### 5.3.9.1 HS-PDSCH Spreading

The HS-PDSCH shall use either spreading factor  $SF = 16$  or  $SF = 1$ , as described in 5.2.1.1.

### 5.3.9.2 HS-PDSCH Burst Types

Burst types 1 or 2 as described in subclause 5.2.2 can be used for PDSCH. TFCI shall not be transmitted on the HS-PDSCH. The TF of the HS-DSCH is derived from the associated HS-SCCH.

### 5.3.9.3 HS-PDSCH Training Sequences

The training sequences as described in subclause 5.2.3 are used for the HS-PDSCH.

### 5.3.9.4 UE Selection

To indicate to the UE that there is data to decode on the HS-DSCH, the UE id on the associated HS-SCCH shall be used.

### 5.3.9.5 HS-PDSCH timeslot formats

An HS-PDSCH may use QPSK or 16QAM modulation symbols. The time slot formats are shown in table 8.

Table 8: Time slot formats for the HS-PDSCH

Slot Format #	Spreading Factor	Midamble length (chips)	$N_{\text{TFCI}}$ code word (bits)	Bits/slot	$N_{\text{Data/Slot}}$ (bits)	$N_{\text{data/data field}}$ (bits)
0 (QPSK)	16	512	0	244	244	122
1 (16QAM)	16	512	0	488	488	244
2 (QPSK)	16	256	0	276	276	138
3 (16QAM)	16	256	0	552	552	276
4 (QPSK)	1	512	0	3904	3904	1952
5 (16QAM)	1	512	0	7808	7808	3904
6 (QPSK)	1	256	0	4416	4416	2208
7(16QAM)	1	256	0	8832	8832	4416

### 5.3.10 Shared Control Channel for HS-DSCH (HS-SCCH)

The HS-SCCH is a DL physical channel that carries higher layer control information for HS-DSCH. The physical layer will process this information according to [7] and will transmit the resulting bits on the HS-SCCH the structure of which is described below.

#### 5.3.10.1 HS-SCCH Spreading

The HS-SCCH shall use spreading factor  $SF = 16$ , as described in 5.2.1.1.

#### 5.3.10.2 HS-SCCH Burst Types

Burst type 1 as described in subclause 5.2.2 can be used for HS-SCCH. TFCI shall not be transmitted on the HS-SCCH.

#### 5.3.10.3 HS-SCCH Training Sequences

The training sequences as described in subclause 5.2.3 are used for the HS-SCCH.

#### 5.3.10.4 HS-SCCH timeslot formats

The HS-SCCH always uses time slot format #0 from table 5a, see section 5.2.2.6.1.

### 5.3.11 Shared Information Channel for HS-DSCH (HS-SICH)

The HS-SICH is a UL physical channel that carries higher layer control information and the Channel Quality Indicator CQI for HS-DSCH. The physical layer will process this information according to [7] and will transmit the resulting bits on the HS-SICH the structure of which is described below.

#### 5.3.11.1 HS-SICH Spreading

The HS-SICH shall use spreading factor  $SF = 16$ , as described in 5.2.1.2.

#### 5.3.11.2 HS-SICH Burst Types

Burst types 1 or 2 as described in subclause 5.2.2 can be used for HS-SICH. TFCI shall not be transmitted on the HS-SICH, however, the HS-SICH shall carry TPC information.

#### 5.3.11.3 HS-SICH Training Sequences

The training sequences as described in subclause 5.2.3 are used for the HS-SICH.

#### 5.3.11.4 HS-SICH timeslot formats

The HS-SICH may use time slot format #1 or #7 from table 5b, see section 5.2.2.6.2.

### 5.4 Transmit Diversity for DL Physical Channels

Table 9 summarizes the different transmit diversity schemes for different downlink physical channel types that are described in [9].

**Table 9: Application of Tx diversity schemes on downlink physical channel types**  
"X" – can be applied, "-" – must not be applied

Physical channel type	Open loop TxDiversity		Closed loop TxDiversity
	TSTD	SCTD	
P-CCPCH	–	X	–
SCH	X	–	–
DPCH	–	–	X
PDSCH	–	–	X
PICH	–	X	–

### 5.5 Beacon characteristics of physical channels

For the purpose of measurements, physical channels at particular locations (time slot, code) shall have particular physical characteristics, called beacon characteristics. Physical channels with beacon characteristics are called beacon channels. The locations of the beacon channels are called beacon locations. The ensemble of beacon channels shall provide the beacon function, i.e. a reference power level at the beacon locations, regularly existing in each radio frame. Thus, beacon channels must be present in each radio frame, the only exception is when idle periods are used to support time difference measurements for location services [9]. Then it may be possible that the beacon channels occur in the same frame and time slot as the idle periods. In this case, the beacon channels will not be transmitted in that particular frame and time slot.

#### 5.5.1 Location of beacon channels

The beacon locations are determined by the SCH and depend on the SCH allocation case, see subclause 5.3.4:

- Case 1) The beacon function shall be provided by the physical channels that are allocated to channelisation code  $c_{Q=16}^{(k=1)}$  and to TS#k, k=0,...,14.
- Case 2) The beacon function shall be provided by the physical channels that are allocated to channelisation code  $c_{Q=16}^{(k=1)}$  and to TS#k and TS#k+8, k=0,...,6.

Note that by this definition the P-CCPCH always has beacon characteristics.

#### 5.5.2 Physical characteristics of beacon channels

The beacon channels shall have the following physical characteristics. They:

- are transmitted with reference power;
- are transmitted without beamforming;
- use burst type 1;
- use midamble  $m^{(1)}$  and  $m^{(2)}$  exclusively in this time slot; and
- midambles  $m^{(9)}$  and  $m^{(10)}$  are always left unused in this time slot, if 16 midambles are allowed in that cell.

Note that in the time slot where the P-CCPCH is transmitted only the midambles  $m^{(1)}$  to  $m^{(8)}$  shall be used, see 5.6.1. Thus, midambles  $m^{(9)}$  and  $m^{(10)}$  are always left unused in this time slot.



The reference power corresponds to the sum of the power allocated to both midambles  $m^{(1)}$  and  $m^{(2)}$ . Two possibilities exist:

- If no SCTD antenna diversity is applied to the P-CCPCH and PICH all the reference power of any beacon channel is allocated to  $m^{(1)}$ .
- If SCTD antenna diversity is applied to the P-CCPCH and PICH for any beacon channel midambles  $m^{(1)}$  and  $m^{(2)}$  are each allocated half of the reference power. Midamble  $m^{(1)}$  is used for the first antenna and  $m^{(2)}$  is used for the diversity antenna. SCTD is applied to the P-CCPCH and PICH, see [9]; for all other beacon channels identical spread data sequences are transmitted on both antennas.

## 5.6 Midamble Allocation for Physical Channels

Midambles are part of the physical channel configuration which is performed by higher layers. Three different midamble allocation schemes exist:

- UE specific midamble allocation: A UE specific midamble for DL or UL is explicitly assigned by higher layers.
- Default midamble allocation: The midamble for DL or UL is allocated by layer 1 depending on the associated channelisation code.
- Common midamble allocation: The midamble for the DL is allocated by layer 1 depending on the number of channelisation codes currently being present in the DL time slot.

If a midamble is not explicitly assigned and the use of the common midamble allocation scheme is not signalled by higher layers, the midamble shall be allocated by layer 1, based on the default midamble allocation scheme. This default midamble allocation scheme is given by a fixed association between midambles and channelisation codes, see clause A.3, and shall be applied individually to all channelisation codes within one time slot. Different associations apply for different burst types and cell configurations with respect to the maximum number of midambles.

### 5.6.1 Midamble Allocation for DL Physical Channels

Beacon channels shall always use the reserved midambles  $m^{(1)}$  and  $m^{(2)}$ , see 5.5. For DL physical channels that are located in the same time slot as the P-CCPCH, midambles shall be allocated based on the default midamble allocation scheme, using the association for burst type 1 and  $K_{\text{Cell}}=8$  midambles. For all other DL physical channels, the midamble is explicitly assigned by higher layers or allocated by layer 1.

#### 5.6.1.1 Midamble Allocation by signalling from higher layers

UE specific midambles may be signalled by higher layers to UE's as a part of the physical channel configuration, if:

- multiple UEs use the physical channels in one DL time slot; and
- beamforming is applied to all of these DL physical channels; and
- no closed loop TxDiversity is applied to any of these DL physical channels;

or

- PDSCH physical layer signalling based on the midamble is used.

#### 5.6.1.2 Midamble Allocation by layer 1

##### 5.6.1.2.1 Default midamble

If a midamble is not explicitly assigned and the use of the common midamble allocation scheme is not signalled by higher layers, the UE shall derive the midambles from the allocated channelisation codes and shall use an individual midamble for each channelisation code group containing one primary and a set of secondary channelisation codes. The association between midambles and channelisation code groups is given in annex A.3. All the secondary channelisation codes within a set use the same midamble as the primary channelisation code to which they are associated.

Higher layers shall allocate the channelisation codes in a particular order. Primary channelisation codes shall be allocated prior to associated secondary channelisation codes. If midambles are reserved for the beacon channels, all primary and secondary channelisation codes that are associated with the reserved midambles shall not be used.

Channelisation codes of one channelisation code group shall not be allocated to different UE's.

In the case that secondary channelisation codes are used, secondary channelisation codes of one set shall be allocated in ascending order, with respect to their numbering.

The UE shall assume different channel estimates for each of the individual midambles.

The default midamble allocation shall not apply for those downlink channels that are intended for a UE which will be the only UE assigned to a given time slot or slots for the duration of the assigned channel's existence (as in the case of high rate services).

#### 5.6.1.2.2 Common Midamble

The use of the common midamble allocation scheme is signalled to the UE by higher layers as a part of the physical channel configuration. A common midamble may be assigned by layer 1 to all physical channels in one DL time slot, if:

- a single UE uses all physical channels in one DL time slot (as in the case of high rate service);

or

- multiple UEs use the physical channels in one DL time slot; and
- no beamforming is applied to any of these DL physical channels; and
- no closed loop TxDiversity is applied to any of these DL physical channels; and
- midambles are not used for PDSCH physical layer signalling.

The number of channelisation codes currently employed in the DL time slot is associated with the use of a particular common midamble. Different associations apply for different burst types and cell configurations with respect to the maximum number of midambles, see annex C.

### 5.6.2 Midamble Allocation for UL Physical Channels

If the midamble is explicitly assigned by higher layers, an individual midamble shall be assigned to all UE's in one UL time slot.

If no midamble is explicitly assigned by higher layers, the UE shall derive the midamble from the channelisation code that is used for the data part (except for TFCI/TPC) of the burst. The associations between midamble and channelisation code are the same as for DL physical channels.

## 5.7 Midamble Transmit Power

There shall be no offset between the sum of the powers allocated to all midambles in a timeslot and the sum of the powers allocated to the data symbol fields. The transmit power within a timeslot is hence constant.

The midamble transmit power of beacon channels is equal to the reference power. If SCTD is used for the P-CCPCH, the reference power is equally divided between the midambles  $m^{(1)}$  and  $m^{(2)}$ .

The midamble transmit power of all other physical channels depends on the midamble allocation scheme used. The following rules apply

- In case of Default Midamble Allocation, every midamble is transmitted with the same power as the associated codes.
- In case of Common Midamble Allocation in the downlink, the transmit power of this common midamble is such that there is no power offset between the data parts and the midamble part of the overall transmit signal within one time slot.

- In case of UE Specific Midamble Allocation, the transmit power of the UE specific midamble is such that there is no power offset between the data parts and the midamble part of every user within one time slot.

The following figure 18 depicts the midamble powers for the different channel types and midamble allocation schemes.

Note 1: In figure 18, the codes  $c(1)$  to  $c(16)$  represent the set of usable codes and not the set of used codes.

Note 2: The common midamble allocation and the midamble allocation by higher layers are not applicable in those beacon time slots, in which the P-CCPCH is located, see section 5.6.1.

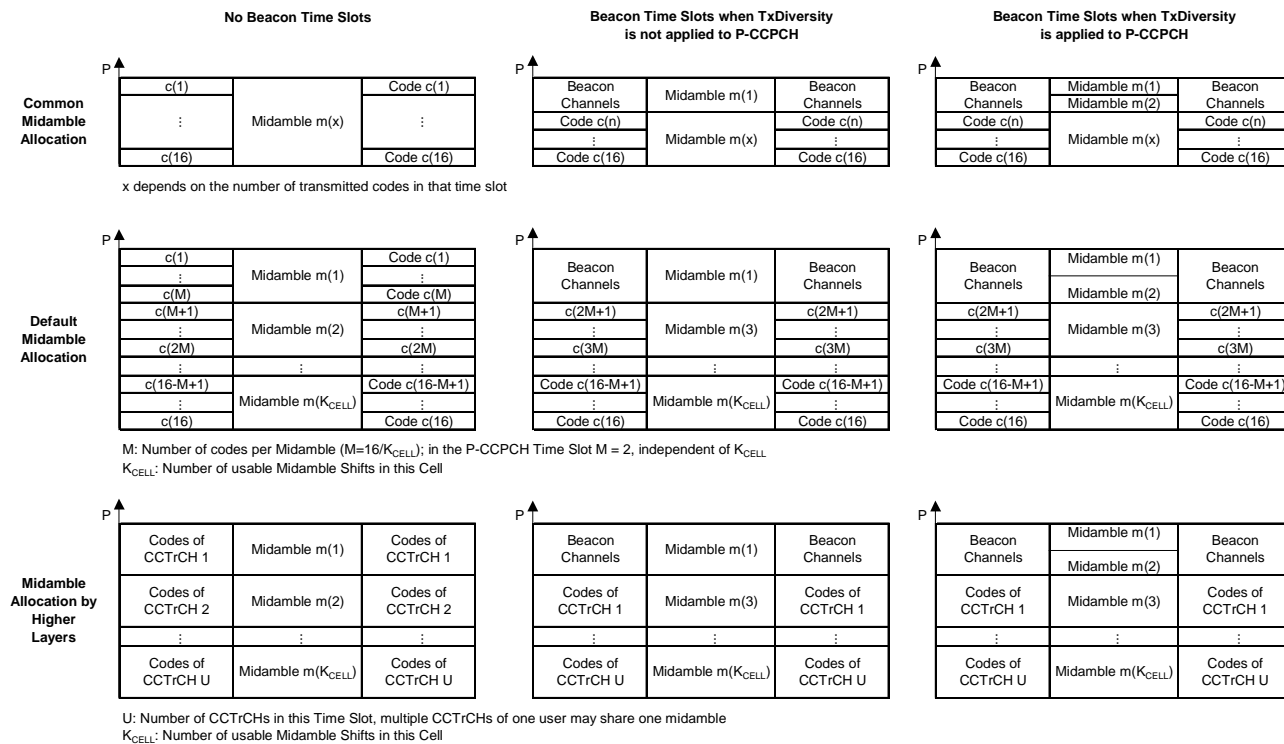
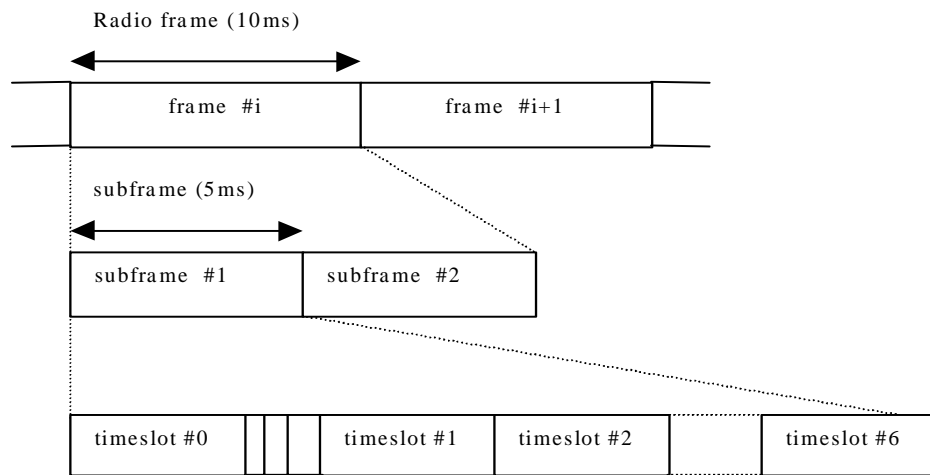

**Figure 18: Midamble powers for the different midamble allocation schemes**

## 6 Physical channels for the 1.28 Mcps option

All physical channels take three-layer structure with respect to timeslots, radio frames and system frame numbering (SFN), see [14]. Depending on the resource allocation, the configuration of radio frames or timeslots becomes different. All physical channels need guard symbols in every timeslot. The time slots are used in the sense of a TDMA component to separate different user signals in the time and the code domain. The physical channel signal format for 1.28Mcps TDD is presented in figure 19.

A physical channel in TDD is a burst, which is transmitted in a particular timeslot within allocated Radio Frames. The allocation can be continuous, i.e. the time slot in every frame is allocated to the physical channel or discontinuous, i.e. the time slot in a subset of all frames is allocated only. A burst is the combination of a data part, a midamble and a guard period. The duration of a burst is one time slot. Several bursts can be transmitted at the same time from one transmitter. In this case, the data part must use different OVFS channelisation codes, but the same scrambling code. The midamble part has to use the same basic midamble code, but can use different midambles.



**Figure 19: Physical channel signal format for 1.28Mcps TDD option**

The data part of the burst is spread with a combination of channelisation code and scrambling code. The channelisation code is a OVFSF code, that can have a spreading factor of 1, 2, 4, 8, or 16. The data rate of the physical channel is depending on the used spreading factor of the used OVFSF code.

So a physical channel is defined by frequency, timeslot, channelisation code, burst type and Radio Frame allocation. The scrambling code and the basic midamble code are broadcast and may be constant within a cell. When a physical channel is established, a start frame is given. The physical channels can either be of infinite duration, or a duration for the allocation can be defined.

### 6.1 Frame structure

The TDMA frame has a duration of 10 ms and is divided into 2 sub-frames of 5ms. The frame structure for each sub-frame in the 10ms frame length is the same.

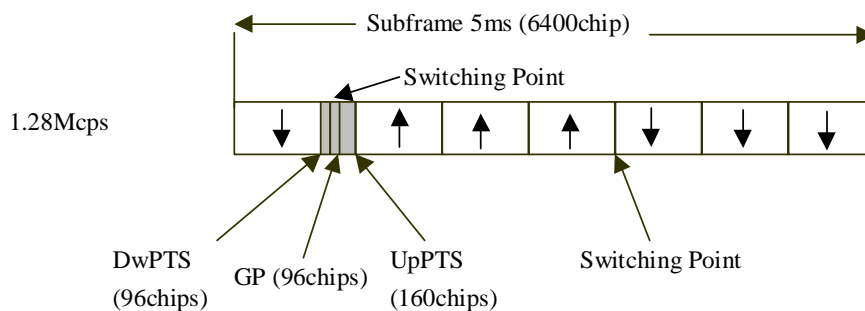

**Figure 20: Structure of the sub-frame for 1.28Mcps TDD option**

Time slot#n (n from 0 to 6): the n<sup>th</sup> traffic time slot, 864 chips duration;

DwPTS: downlink pilot time slot, 96 chips duration;

UpPTS: uplink pilot time slot, 160 chips duration;

GP: main guard period for TDD operation, 96 chips duration;

In Figure 20, the total number of traffic time slots for uplink and downlink is 7, and the length for each traffic time slot is 864 chips duration. Among the 7 traffic time slots, time slot#0 is always allocated as downlink while time slot#1 is always allocated as uplink. The time slots for the uplink and the downlink are separated by switching points. Between

the downlink time slots and uplink time slots, the special period is the switching point to separate the uplink and downlink. In each sub-frame of 5ms for 1.28Mcps option, there are two switching points (uplink to downlink and vice versa).

Using the above frame structure, the 1.28Mcps TDD option can operate on both symmetric and asymmetric mode by properly configuring the number of downlink and uplink time slots. In any configuration at least one time slot (time slot#0) has to be allocated for the downlink and at least one time slot has to be allocated for the uplink (time slot#1).

Examples for symmetric and asymmetric UL/DL allocations are given in figure 21.

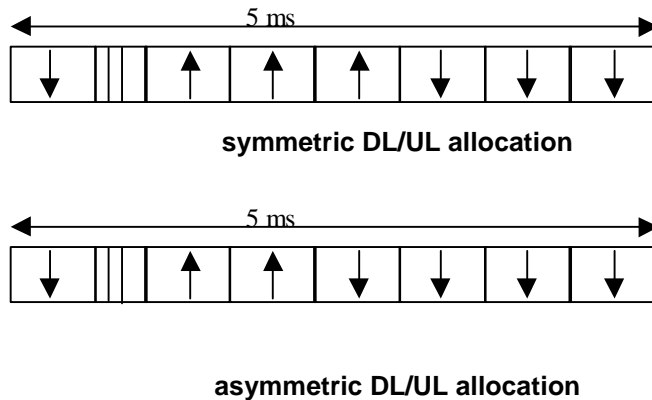

Figure 21: 1.28Mcps TDD sub-frame structure examples

## 6.2 Dedicated physical channel (DPCH)

The DCH as described in subclause 4.1 'Dedicated transport channels' is mapped onto the dedicated physical channel.

### 6.2.1 Spreading

The spreading of physical channels is the same as in 3.84 Mcps TDD (cf. 5.2.1 'Spreading').

### 6.2.2 Burst Format

A traffic burst consists of two data symbol fields, a midamble of 144 chips and a guard period. The data fields of the burst are 352 chips long. The corresponding number of symbols depends on the spreading factor, as indicated in table 10 below. The guard period is 16 chip periods long.

The burst format is shown in Figure 22. The contents of the traffic burst fields is described in table 10.

Table 10: number of symbols per data field in a traffic burst

Spreading factor (Q)	Number of symbols (N) per data field in Burst
1	352
2	176
4	88
8	44
16	22

Table 11: The contents of the traffic burst format fields

Chip number (CN)	Length of field in chips	Length of field in symbols	Contents of field
0-351	352	cf table 10	Data symbols
352-495	144	-	Midamble
496-847	352	cf table 10	Data symbols
848-863	16	-	Guard period

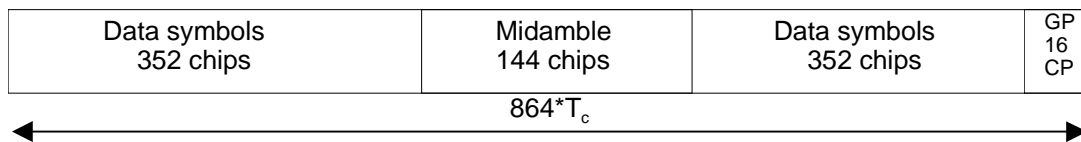

**Figure 22: Burst structure of the traffic burst format (GP denotes the guard period and CP the chip periods)**

6.2.2.1 Transmission of TFCI

The traffic burst format provides the possibility for transmission of TFCI in uplink and downlink.

The transmission of TFCI is configured by higher Layers. For each CCTrCH it is indicated by higher layer signalling, which TFCI format is applied. Additionally for each allocated timeslot it is signalled individually whether that timeslot carries the TFCI or not. If a time slot contains the TFCI, then it is always transmitted using the first allocated channelisation code in the timeslot, according to the order in the higher layer allocation message.

The transmission of TFCI is done in the data parts of the respective physical channel, this means that TFCI code word bits and data bits are subject to the same spreading procedure as depicted in [8]. Hence the midamble structure and length is not changed.

The TFCI code word bits are equally distributed between the two subframes and the respective data fields. The TFCI code word is to be transmitted possibly either directly adjacent to the midamble or after the SS and TPC symbols. Figure 23 shows the position of the TFCI code word in a traffic burst, if neither SS nor TPC are transmitted. Figure 24 shows the position of the TFCI code word in a traffic burst, if SS and TPC are transmitted.

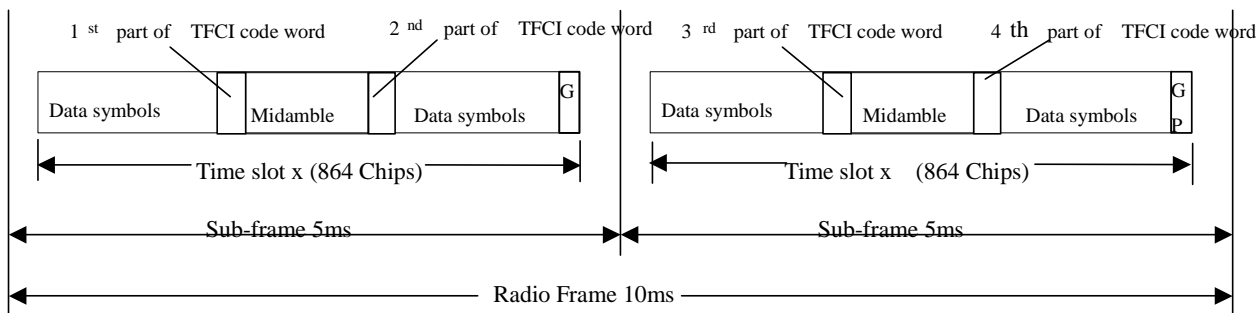

**Figure 23: Position of the TFCI code word in the traffic burst in case of no TPC and SS in 1.28 Mcps TDD**

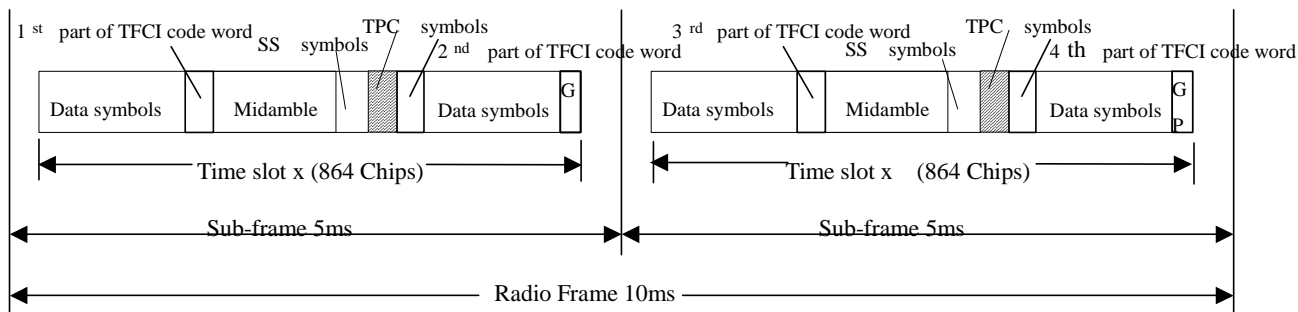

**Figure 24: Position of the TFCI code word in the traffic burst in case of TPC and SS in 1.28 Mcps TDD**

6.2.2.2 Transmission of TPC

The burst type for dedicated channels provides the possibility for transmission of TPC in uplink and downlink.

The transmission of TPC is done in the data parts of the traffic burst. Hence the midamble structure and length is not changed. The TPC information is to be transmitted directly after the SS information, which is transmitted after the midamble. Figure 25 shows the position of the TPC command in a traffic burst.

For every user the TPC information is to be transmitted at least once per 5ms sub-frame. If applied, transmission of TPC is done in the data parts of the traffic burst and it can be transmitted using the first allocated channelisation code and the first allocated timeslot (according to the order in the higher layer allocation message). Other allocations (more than one TPC transmission in one sub-frame) of TPC are also possible. The TPC is spread with the same spreading factor (SF) and spreading code as the data parts of the respective physical channel.

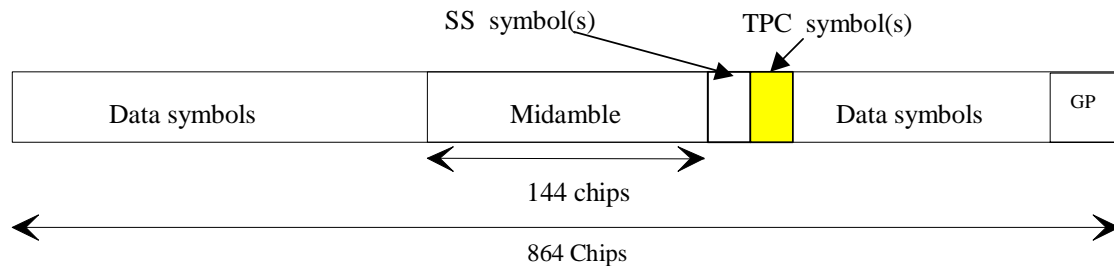

**Figure 25: Position of TPC information in the traffic burst in downlink and uplink**

For the number of layer 1 symbols per channelisation code there are 3 possibilities for each channelisation code, configured by higher layers:

- 1) one SS and one TPC symbol
- 2) no SS and no TPC symbols
- 3) 16/SF SS and 16/SF TPC symbols

So, in case 3), when SF=1, there are 16 TPC symbols which correspond to 32 bits (for QPSK) and 48 bits (for 8PSK).

In the following the uplink is described only. For the description of the downlink, downlink (DL) and uplink (UL) have to be interchanged.

Each of the TPC symbols for uplink power control in the DL will be associated with an UL time slot and an UL CCTrCH pair. This association varies with

- the number of allocated UL time slots and UL CCTrCHs on these time slots (time slot and CCTrCH pair) and
- the allocated TPC symbols in the DL.

In case a UE has

- more than one channelisation code

and/or

- channelisation codes being of lower spreading factor than 16 and using 16/SF SS and 16/SF TPC symbols,

the TPC commands for each ULtime slot CCTrCH pair (all channelisation codes on that time slot belonging to the same time slot and CCTrCH pair have the same TPC command) will be distributed to the following rules:

1. The ULtime slots and CCTrCH pairs the TPC commands are intended for will be numbered from the first to the last ULtime slot and CCTrCH pair allocated to the regarded UE (starting with 0). The number of a time slot and CCTrCH pair is smaller than the number of another time slot and CCTrCH pair within the same time slot if its spreading code with the lowest SC number according to the following table has a lower SC number than the spreading code with the lowest SC number of the other time slot and CCTrCH pair.
2. The commanding TPC symbols on all DL CCTrCHs allocated to one UE are numbered consecutively starting with zero according to the following rules:
  - a) The numbers of the TPC commands of a regarded DL time slot are lower than those of DL time slots being transmitted after that time slot
  - b) Within a DL time slot the numbers of the TPC commands of a regarded channelisation code are lower than those of channelisation codes having a higher spreading code number

The spreading code number is defined by the following table (see[8]):

SC number	SF (Q)	Walsh code number (k)
0	16	$\mathbf{c}_{Q=16}^{(k=1)}$
	...	
15	16	$\mathbf{c}_{Q=16}^{(k=16)}$
16	8	$\mathbf{c}_{Q=8}^{(k=1)}$
	...	
23	8	$\mathbf{c}_{Q=8}^{(k=8)}$
24	4	$\mathbf{c}_{Q=4}^{(k=1)}$
	...	
27	4	$\mathbf{c}_{Q=4}^{(k=4)}$
28	2	$\mathbf{c}_{Q=2}^{(k=1)}$
29	2	$\mathbf{c}_{Q=2}^{(k=2)}$
30	1	$\mathbf{c}_{Q=1}^{(k=1)}$

Note: Spreading factors 2-8 are not used in DL

- c) Within a channelisation code numbers of the TPC commands are lower than those of TPC commands being transmitted after that time

The following equation is used to determine the UL time slot which is controlled by the regarded TPC symbol in the DL:

$$UL_{pos} = (SFN' \cdot N_{UL\_TPCsymbols} + TPC_{DLpos}) \bmod(N_{ULslot}),$$

where

$UL_{pos}$  is the number of the controlled uplink time slot and CCTrCH pairs.

$SFN'$  is the system frame number counting the sub-frames. The system frame number of the radio frames ( $SFN$ ) can be derived from  $SFN'$  by

$SFN = SFN' \text{ div } 2$ , where div is the remainder free division operation.

$N_{UL\_PCsymbols}$  is the number of UL TPC symbols in a sub-frame.

$TPC_{DLpos}$  is the number of the regarded UL TPC symbol in the DL within the sub-frame.

$N_{ULslot}$  is the number of UL slots and CCTrCH pairs in a frame.

In Annex G two examples of the association of TPC commands to time slots and CCTrCH pairs are shown.

Coding of TPC:

The relationship between the TPC Bits and the transmitter power control command for QPSK is the same as in the 3.84Mcps TDD cf. [5.2.2.5 'Transmission of TPC'].

The relationship between the TPC Bits and the transmitter power control command for 8PSK is given in table 12



**Table 12: TPC Bit Pattern for 8PSK**

TPC Bits	TPC command	Meaning
000	'Down'	Decrease Tx Power
110	'Up'	Increase Tx Power

### 6.2.2.3 Transmission of SS

The burst type for dedicated channels provides the possibility for transmission of uplink synchronisation control (ULSC).

The transmission of ULSC is done in the data parts of the traffic burst. Hence the midamble structure and length is not changed. The ULSC information is to be transmitted directly after the midamble. Figure 26 shows the position of the SS command in a traffic burst.

For every user the ULSC information shall be transmitted at least once per transmitted sub-frame. By default the following rules apply:

1. If a TFCI is applied for a CCTrCH, the SS command(s) shall be transmitted using the same channelisation code and the same timeslots as the TFCI.
2. If no TFCI is applied for a CCTrCH, the SS command(s) shall be transmitted using the first allocated channelisation code and the first allocated timeslot, according to the order in the higher layer allocation message.

Apart from the default rules other allocations of SS commands are possible according higher layer signalling – e.g. the transmission of more than one SS command (on more than one time slot).

The SS command is spread with the same spreading factor (SF) and spreading code as the data parts of the respective physical channel.

The SS is utilised to command a timing adjustment by  $(k/8) T_c$  each M sub-frames, where  $T_c$  is the chip period. The k and M values are signalled by the network. The SS, as one of L1 signals, is to be transmitted once per 5ms sub-frame.

M (1-8) and k (1-8) can be adjusted during call setup or readjusted during the call.

Note: The smallest step for the SS signalled by the UTRAN is  $1/8 T_c$ . For the UE capabilities regarding the SS adjustment of the UE it is suggested to set the tolerance for the executed command to be  $[1/9; 1/7] T_c$ .

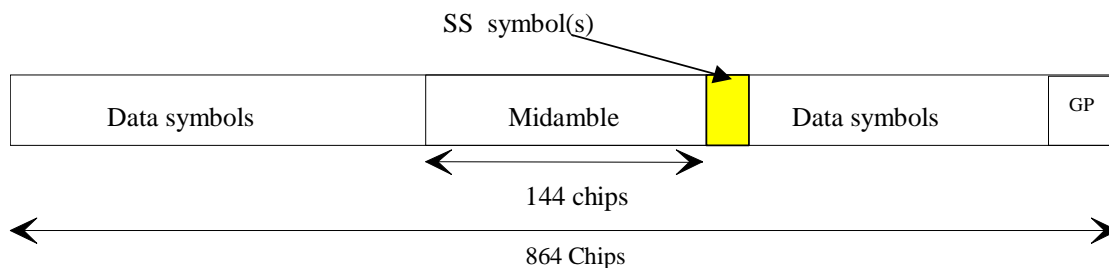

**Figure 26: Position of ULSC information in the traffic burst (downlink and uplink)**

Note that for the uplink where there is no SS symbol used, the SS symbol space is reserved for future use. This can keep UL and DL slots the same structure.

For the number of layer 1 symbols there are 3 possibilities configurable for each channelisation code during the call setup:

- one SS symbol
- no SS symbol
- $16/SF$  SS symbols

So, in case 3, when  $SF=1$ , there are 16 SS symbols which correspond to 32 bits (for QPSK) and 48 bits (for 8PSK).

Each of the SS symbols in the DL will be associated with an UL time slot depending on the allocated UL time slots and the allocated SS symbols in the DL.

Note: Even though the different time slots of the UE are controlled with independent SS commands, the UE is not in need to execute SS commands leading to a deviation of more than [3] chip with respect to the average timing advance applied by the UE.

The synchronisation shift commands for each UL time slot (all channelisation codes on that time slot have the same SS command) will be distributed to the following rules:

1. The UL time slots the SS commands are intended for will be numbered from the first to the last UL time slot occupied by the regarded UE (starting with 0) considering all CCTrCHs allocated to that UE.
2. The commanding SS symbols on all downlink CCTrCHs allocated to one UE are numbered consecutively starting with zero according to the following rules:
  - a) The numbers of the SS commands of a regarded DL time slot are lower than those of DL time slots being transmitted after that time slot
  - b) Within a DL time slot the numbers of the SS commands of a regarded channelisation code are lower than those of channelisation codes having a bigger spreading code number

The spreading code number is defined by the following table: (see TS 25.223)

Spreading code number	SF (Q)	Walsh code number (k)
0	16	$c_{Q=16}^{(k=1)}$
	...	
15	16	$c_{Q=16}^{(k=16)}$
	Spreading factors 2-8 are not used in DL	
30	1	$c_{Q=1}^{(k=1)}$

- c) Within a channelisation code numbers of the SS commands are lower than those of SS commands being transmitted after that time

The following equation is used to determine the UL time slot which is controlled by the regarded SS symbol:

$$UL_{pos} = (SFN' \cdot N_{SSsymbols} + SS_{pos}) \bmod (N_{ULslot}),$$

where

$UL_{pos}$  is the number of the controlled uplink time slot.

$SFN'$  is the system frame number counting the sub-frames. The system frame number of the radio frames (SFN) can be derived from  $SFN'$  by

$SFN = SFN' \text{ div } 2$ , where div is the remainder free division operation.

$N_{SSsymbols}$  is the number of SS symbols in a frame.

$SS_{pos}$  is the number of the regarded SS symbol within the sub-frame.

$N_{ULslot}$  is the number of UL slots in a frame.

The relationship between the SS Bits and the SS command for QPSK is the given in table 13:

**Table 13: Coding of the SS for QPSK**

<b>SS Bits</b>	<b>SS command</b>	<b>Meaning</b>
00	'Down'	Decrease synchronisation shift by $k/8 T_c$
11	'Up'	Increase synchronisation shift by $k/8 T_c$
01	'Do nothing'	No change

The relationship between the SS Bits and the SS command for 8PSK is given in table 14:

**Table 14: Coding of the SS for 8PSK**

<b>SS Bits</b>	<b>SS command</b>	<b>Meaning</b>
000	'Down'	Decrease synchronisation shift by $k/8 T_c$
110	'Up'	Increase synchronisation shift by $k/8 T_c$
011	'Do nothing'	No change

#### 6.2.2.4 Timeslot formats

The timeslot format depends on the spreading factor, the number of the TFCI code word bits, the number of SS and TPC symbols and the applied modulation scheme (QPSK/8PSK) as depicted in the following tables.

## 6.2.2.4.1 Timeslot formats for QPSK

## 6.2.2.4.1.1 Downlink timeslot formats

Table 15 : Time slot formats for the Downlink

Slot Format #	Spreading Factor	Midamble length (chips)	N <sub>TFCI</sub> code word (bits)	N <sub>SS</sub> & N <sub>TPC</sub> (bits)	Bits/slot	N <sub>Data/Slot</sub> (bits)	N <sub>data/data</sub> field(1) (bits)	N <sub>data/data</sub> field(2) (bits)
0	16	144	0	0 & 0	88	88	44	44
1	16	144	4	0 & 0	88	86	42	44
2	16	144	8	0 & 0	88	84	42	42
3	16	144	16	0 & 0	88	80	40	40
4	16	144	32	0 & 0	88	72	36	36
5	16	144	0	2 & 2	88	84	44	40
6	16	144	4	2 & 2	88	82	42	40
7	16	144	8	2 & 2	88	80	42	38
8	16	144	16	2 & 2	88	76	40	36
9	16	144	32	2 & 2	88	68	36	32
10	1	144	0	0 & 0	1408	1408	704	704
11	1	144	4	0 & 0	1408	1406	702	704
12	1	144	8	0 & 0	1408	1404	702	702
13	1	144	16	0 & 0	1408	1400	700	700
14	1	144	32	0 & 0	1408	1392	696	696
15	1	144	0	2 & 2	1408	1404	704	700
16	1	144	4	2 & 2	1408	1402	702	700
17	1	144	8	2 & 2	1408	1400	702	698
18	1	144	16	2 & 2	1408	1396	700	696
19	1	144	32	2 & 2	1408	1388	696	692
20	1	144	0	32 & 32	1408	1344	704	640
21	1	144	4	32 & 32	1408	1342	702	640
22	1	144	8	32 & 32	1408	1340	702	638
23	1	144	16	32 & 32	1408	1336	700	636
24	1	144	32	32 & 32	1408	1328	696	632

6.2.2.4.1.2 Uplink timeslot formats

Table 16 : Time slot formats for the Uplink

Slot Format #	Spreading Factor	Midamble length (chips)	N <sub>TFCI</sub> code word (bits)	N <sub>SS</sub> & N <sub>TPC</sub> (bits)	Bits/slot	N <sub>Data/Slot</sub> (bits)	N <sub>data/data</sub> field(1) (bits)	N <sub>data/data</sub> field(2) (bits)
0	16	144	0	0 & 0	88	88	44	44
1	16	144	4	0 & 0	88	86	42	44
2	16	144	8	0 & 0	88	84	42	42
3	16	144	16	0 & 0	88	80	40	40
4	16	144	32	0 & 0	88	72	36	36
5	16	144	0	2 & 2	88	84	44	40
6	16	144	4	2 & 2	88	82	42	40
7	16	144	8	2 & 2	88	80	42	38
8	16	144	16	2 & 2	88	76	40	36
9	16	144	32	2 & 2	88	68	36	32
10	8	144	0	0 & 0	176	176	88	88
11	8	144	4	0 & 0	176	174	86	88
12	8	144	8	0 & 0	176	172	86	86
13	8	144	16	0 & 0	176	168	84	84
14	8	144	32	0 & 0	176	160	80	80
15	8	144	0	2 & 2	176	172	88	84
16	8	144	4	2 & 2	176	170	86	84
17	8	144	8	2 & 2	176	168	86	82
18	8	144	16	2 & 2	176	164	84	80
19	8	144	32	2 & 2	176	156	80	76
20	8	144	0	4 & 4	176	168	88	80
21	8	144	4	4 & 4	176	166	86	80
22	8	144	8	4 & 4	176	164	86	78
23	8	144	16	4 & 4	176	160	84	76
24	8	144	32	4 & 4	176	152	80	72
25	4	144	0	0 & 0	352	352	176	176
26	4	144	4	0 & 0	352	350	174	176
27	4	144	8	0 & 0	352	348	174	174
28	4	144	16	0 & 0	352	344	172	172
29	4	144	32	0 & 0	352	336	168	168
30	4	144	0	2 & 2	352	348	176	172
31	4	144	4	2 & 2	352	346	174	172
32	4	144	8	2 & 2	352	344	174	170
33	4	144	16	2 & 2	352	340	172	168
34	4	144	32	2 & 2	352	332	168	164
35	4	144	0	8 & 8	352	336	176	160
36	4	144	4	8 & 8	352	334	174	160
37	4	144	8	8 & 8	352	332	174	158
38	4	144	16	8 & 8	352	328	172	156
39	4	144	32	8 & 8	352	320	168	152
40	2	144	0	0 & 0	704	704	352	352
41	2	144	4	0 & 0	704	702	350	352
42	2	144	8	0 & 0	704	700	350	350
43	2	144	16	0 & 0	704	696	348	348
44	2	144	32	0 & 0	704	688	344	344
45	2	144	0	2 & 2	704	700	352	348
46	2	144	4	2 & 2	704	698	350	348

Slot Format #	Spreading Factor	Midamble length (chips)	N <sub>TFCI</sub> code word (bits)	N <sub>SS</sub> & N <sub>TPC</sub> (bits)	Bits/slot	N <sub>Data/Slot</sub> (bits)	N <sub>data/data</sub> field(1) (bits)	N <sub>data/data</sub> field(2) (bits)
47	2	144	8	2 & 2	704	696	350	346
48	2	144	16	2 & 2	704	692	348	344
49	2	144	32	2 & 2	704	684	344	340
50	2	144	0	16 & 16	704	672	352	320
51	2	144	4	16 & 16	704	670	350	320
52	2	144	8	16 & 16	704	668	350	318
53	2	144	16	16 & 16	704	664	348	316
54	2	144	32	16 & 16	704	656	344	312
55	1	144	0	0 & 0	1408	1408	704	704
56	1	144	4	0 & 0	1408	1406	702	704
57	1	144	8	0 & 0	1408	1404	702	702
58	1	144	16	0 & 0	1408	1400	700	700
59	1	144	32	0 & 0	1408	1392	696	696
60	1	144	0	2 & 2	1408	1404	704	700
61	1	144	4	2 & 2	1408	1402	702	700
62	1	144	8	2 & 2	1408	1400	702	698
63	1	144	16	2 & 2	1408	1396	700	696
64	1	144	32	2 & 2	1408	1388	696	692
65	1	144	0	32 & 32	1408	1344	704	640
66	1	144	4	32 & 32	1408	1342	702	640
67	1	144	8	32 & 32	1408	1340	702	638
68	1	144	16	32 & 32	1408	1336	700	636
69	1	144	32	32 & 32	1408	1328	696	632

## 6.2.2.4.2 Time slot formats for 8PSK

The Downlink and the Uplink timeslot formats are described together in the following table.

**Table 17: Timeslot formats for 8PSK modulation**

Slot Format #	Spreading Factor	Midamble length (chips)	N <sub>TFCI</sub> code word (bits)	N <sub>SS</sub> & N <sub>TPC</sub> (bits)	Bits/slot	N <sub>Data/Slot</sub> (bits)	N <sub>data/data</sub> field(1) (bits)	N <sub>data/data</sub> field(2) (bits)
0	1	144	0	0 & 0	2112	2112	1056	1056
1	1	144	6	0 & 0	2112	2109	1053	1056
2	1	144	12	0 & 0	2112	2106	1053	1053
3	1	144	24	0 & 0	2112	2100	1050	1050
4	1	144	48	0 & 0	2112	2088	1044	1044
5	1	144	0	3 & 3	2112	2106	1056	1050
6	1	144	6	3 & 3	2112	2103	1053	1050
7	1	144	12	3 & 3	2112	2100	1053	1047
8	1	144	24	3 & 3	2112	2094	1050	1044
9	1	144	48	3 & 3	2112	2082	1044	1038
10	1	144	0	48 & 48	2112	2016	1056	960
11	1	144	6	48 & 48	2112	2013	1053	960
12	1	144	12	48 & 48	2112	2010	1053	957
13	1	144	24	48 & 48	2112	2004	1050	954
14	1	144	48	48 & 48	2112	1992	1044	948
15	16	144	0	0 & 0	132	132	66	66
16	16	144	6	0 & 0	132	129	63	66
17	16	144	12	0 & 0	132	126	63	63
18	16	144	24	0 & 0	132	120	60	60
19	16	144	48	0 & 0	132	108	54	54
20	16	144	0	3 & 3	132	126	66	60
21	16	144	6	3 & 3	132	123	63	60
22	16	144	12	3 & 3	132	120	63	57
23	16	144	24	3 & 3	132	114	60	54
24	16	144	48	3 & 3	132	102	54	48

## 6.2.3 Training sequences for spread bursts

In this subclause, the training sequences for usage as midambles are defined. The training sequences, i.e. midambles, of different users active in the same cell and same time slot are cyclically shifted versions of one single basic midamble code. The applicable basic midamble codes are given in Annex B.1.

The basic midamble codes in Annex B.1 are listed in hexadecimal notation. The binary form of the basic midamble code shall be derived according to table 18 below.

Table 18: Mapping of 4 binary elements  $m_i$  on a single hexadecimal digit:

4 binary elements $m_i$	Mapped on hexadecimal digit
-1 -1 -1 -1	0
-1 -1 -1 1	1
-1 -1 1 -1	2
-1 -1 1 1	3
-1 1 -1 -1	4
-1 1 -1 1	5
-1 1 1 -1	6
-1 1 1 1	7
1 -1 -1 -1	8
1 -1 -1 1	9
1 -1 1 -1	A
1 -1 1 1	B
1 1 -1 -1	C
1 1 -1 1	D
1 1 1 -1	E
1 1 1 1	F

For each particular basic midamble code, its binary representation can be written as a vector  $\mathbf{m}_p$  :

$$\mathbf{m}_p = (m_1, m_2, \dots, m_p) \quad (1)$$

According to Annex B.1, the size of this vector  $\mathbf{m}_p$  is  $P=128$ . As QPSK modulation is used, the training sequences are transformed into a complex form, denoted as the complex vector  $\underline{\mathbf{m}}_p$  :

$$\underline{\mathbf{m}}_p = (\underline{m}_1, \underline{m}_2, \dots, \underline{m}_p) \quad (2)$$

The elements  $\underline{m}_i$  of  $\underline{\mathbf{m}}_p$  are derived from elements  $m_i$  of  $\mathbf{m}_p$  using equation (3):

$$\underline{m}_i = (j)^i \cdot m_i \text{ for all } i = 1, \dots, P \quad (3)$$

Hence, the elements  $\underline{m}_i$  of the complex basic midamble code are alternating real and imaginary.

To derive the required training sequences, this vector  $\underline{\mathbf{m}}_p$  is periodically extended to the size:

$$i_{\max} = L_m + (K-1)W \quad (4)$$

Notes on equation (4):

K and W are taken from Annex B.1

So we obtain a new vector  $\underline{\mathbf{m}}$  containing the periodic basic midamble sequence:

$$\underline{\mathbf{m}} = (\underline{m}_1, \underline{m}_2, \dots, \underline{m}_{i_{\max}}) = (\underline{m}_1, \underline{m}_2, \dots, \underline{m}_{L_m + (K-1)W}) \quad (5)$$

The first P elements of this vector  $\underline{\mathbf{m}}$  are the same ones as in vector  $\underline{\mathbf{m}}_p$ , the following elements repeat the beginning:

$$\underline{m}_i = \underline{m}_{i-P} \text{ for the subset } i = (P+1), \dots, i_{\max} \quad (6)$$

Using this periodic basic midamble sequence  $\underline{\mathbf{m}}$  for each user k a midamble  $\underline{\mathbf{m}}^{(k)}$  of length  $L_m$  is derived, which can be written as a user specific vector:

$$\underline{\mathbf{m}}^{(k)} = (\underline{m}_1^{(k)}, \underline{m}_2^{(k)}, \dots, \underline{m}_{L_m}^{(k)}) \quad (7)$$



The  $L_m$  midamble elements  $\underline{m}_i^{(k)}$  are generated for each midamble of the  $k$  users ( $k = 1, \dots, K$ ) based on:

$$\underline{m}_i^{(k)} = \underline{m}_{i+(K-k)W} \text{ with } i = 1, \dots, L_m \text{ and } k = 1, \dots, K \quad (8)$$

The midamble sequences derived according to equations (7) to (8) have complex values and are not subject to channelisation or scrambling process, i.e. the elements  $\underline{m}_i^{(k)}$  represent complex chips for usage in the pulse shaping process at modulation.

The term 'a midamble code set' or 'a midamble code family' denotes  $K$  specific midamble codes  $\underline{\mathbf{m}}^{(k)}$ ;  $k=1, \dots, K$ , based on a single basic midamble code  $\underline{\mathbf{m}}_p$  according to (1).

## 6.2.4 Beamforming

Beamforming is same as that of the 3.84Mcps TDD, cf. [ 5.2.4 Beamforming ].

## 6.3 Common physical channels

### 6.3.1 Primary common control physical channel (P-CCPCH)

The BCH as described in section 4.1.2 'Common Transport Channels' is mapped onto the Primary Common Control Physical Channels (P-CCPCH1 and P-CCPCH2). The position (time slot / code) of the P-CCPCHs is fixed in the 1.28Mcps TDD. The P-CCPCHs are mapped onto the first two code channels of timeslot#0 with spreading factor of 16. The P-CCPCH is always transmitted with an antenna pattern configuration that provides whole cell coverage.

#### 6.3.1.1 P-CCPCH Spreading

The P-CCPCH uses fixed spreading with a spreading factor  $SF = 16$ . The P-CCPCH1 and P-CCPCH2 always use channelisation code  $c_{Q=16}^{(k=1)}$  and  $c_{Q=16}^{(k=2)}$  respectively.

#### 6.3.1.2 P-CCPCH Burst Format

The burst format as described in section 6.2.2 is used for the P-CCPCH. No TFCI is applied for the P-CCPCH.

#### 6.3.1.3 P-CCPCH Training sequences

The training sequences, i.e. midambles, as described in subclause 6.2.3 are used for the P-CCPCH. For timeslots#0 in which the P-CCPCH is transmitted, the midambles  $m^{(1)}$  and  $m^{(2)}$  are reserved for P-CCPCH in order to support Space Code Transmit Diversity (SCTD) and the beacon function, see 6.4 and 6.5. The use of midambles depends on whether SCTD is applied to the P-CCPCH:

- If no antenna diversity is applied to P-CCPCH,  $m^{(1)}$  is used and  $m^{(2)}$  is left unused.
- If SCTD antenna diversity is applied to P-CCPCH,  $m^{(1)}$  is used for the first antenna and  $m^{(2)}$  is used for the diversity antenna.

### 6.3.2 Secondary common control physical channel (S-CCPCH)

PCH and FACH as described in subclause 4.1.2 are mapped onto one or more secondary common control physical channels (S-CCPCH). In this way the capacity of PCH and FACH can be adapted to the different requirements. The time slot and codes used for the S-CCPCH are broadcast on the BCH.

### 6.3.2.1 S-CCPCH Spreading

The S-CCPCH uses fixed spreading with a spreading factor  $SF = 16$ . The S-CCPCHs ( S-CCPCH 1 and S-CCPCH 2 ) are always used in pairs, mapped onto two code channels with spreading factor 16. There can be more than one pair of S-CCPCHs in use in one cell.

### 6.3.2.2 S-CCPCH Burst Format

The burst format as described in section 6.2.2 is used for the S-CCPCH. TFCI may be applied for S-CCPCHs.

### 6.3.2.3 S-CCPCH Training sequences

The training sequences, i.e. midambles, as described in the subclause 6.2.3 are also used for the S-CCPCH.

## 6.3.3 Fast Physical Access CHannel (FPACH)

The Fast Physical Access CHannel (FPACH) is used by the Node B to carry, in a single burst, the acknowledgement of a detected signature with timing and power level adjustment indication to a user equipment. FPACH makes use of one code with spreading factor 16, so that its burst is composed by 44 symbols. The spreading code, training sequence and time slot position are configured by the network and signalled on the BCH.

### 6.3.3.1 FPACH burst

The FPACH burst contains 32 information bits. Table 19 reports the content description of the FPACH information bits and their priority order:

**Table 19: FPACH information bits description**

Information field	Length (in bits)
Signature Reference Number	3 (MSB)
Relative Sub-Frame Number	2
Received starting position of the UpPCH (UpPCH <sub>POS</sub> )	11
Transmit Power Level Command for RACH message	7
Reserved bits (default value: 0)	9 (LSB)

In the use and generation of the information fields is explained in [9].

#### 6.3.3.1.1 Signature Reference Number

The reported number corresponds to the numbering principle for the cell signatures as described in [8].

The Signature Reference Number value range is 0 – 7 coded in 3 bits such that:

bit sequence(0 0 0) corresponds to the first signature of the cell; ...; bit sequence (1 1 1) corresponds to the 8<sup>th</sup> signature of the cell.

#### 6.3.3.1.2 Relative Sub-Frame Number

The Relative Sub-Frame Number value range is 0 – 3 coded such that:

bit sequence (0 0) indicates one sub-frame difference; ...; bit sequence (1 1) indicates 4 sub-frame difference.

#### 6.3.3.1.3 Received starting position of the UpPCH (UpPCH<sub>POS</sub>)

The received starting position of the UpPCH value range is 0 – 2047 coded such that:

bit sequence (0 0 ... 0 0 0) indicates the received starting position zero chip; ...; bit sequence (1 1 ... 1 1 1) indicates the received starting position 2047\*1/8 chip.

#### 6.3.3.1.4 Transmit Power Level Command for the RACH message

The transmit power level command is transmitted in 7 bits.

#### 6.3.3.2 FPACH Spreading

The FPACH uses only spreading factor SF=16 as described in subclause 6.3.3. The set of admissible spreading codes for use on the FPACH is broadcast on the BCH.

#### 6.3.3.2 FPACH Burst Format

The burst format as described in section 6.2.2 is used for the FPACH.

#### 6.3.3.3 FPACH Training sequences

The training sequences, i.e. midambles, as described in subclause 6.2.3 are used for FPACH.

#### 6.3.3.4 FPACH timeslot formats

The FPACH uses slot format #0 of the DL time slot formats given in subclause 6.2.2.4.1.1.

### 6.3.4 The physical random access channel (PRACH)

The RACH as described in subclause 4.1.2 is mapped onto one or more uplink physical random access channels (PRACH). In such a way the capacity of RACH can be flexibly scaled depending on the operators need.

#### 6.3.4.1 PRACH Spreading

The uplink PRACH uses either spreading factor SF=16, SF=8 or SF=4 as described in subclause 6.2.1. The set of admissible spreading codes for use on the PRACH and the associated spreading factors are broadcast on the BCH (within the RACH configuration parameters on the BCH).

#### 6.3.4.2 PRACH Burst Format

The burst format as described in section 6.2.2 is used for the PRACH.

#### 6.3.4.3 PRACH Training sequences

The training sequences, i.e. midambles, of different users active in the same time slot are time shifted versions of a single periodic basic code. The basic midamble codes as described in subclause 6.2.3 are used for PRACH.

#### 6.3.4.4 PRACH timeslot formats

The PRACH uses the following time slot formats taken from the uplink timeslot formats described in sub-clause 6.2.2.4.1.2:

Spreading Factor	Slot Format #
16	0
8	10
4	25

#### 6.3.4.5 Association between Training Sequences and Channelisation Codes

The association between training sequences and channelisation codes of PRACH in the 1.28McpsTDD is same as that of the DPCH.

### 6.3.5 The synchronisation channels (DwPCH, UpPCH)

There are two dedicated physical synchronisation channels —DwPCH and UpPCH in each 5ms sub-frame of the 1.28Mcps TDD. The DwPCH is used for the down link synchronisation and the UpPCH is used for the uplink synchronisation.

The position and the contents of the DwPCH are equal to the DwPTS as described in the subclause 6.1., while the position and the contents of the UpPCH are equal to the UpPTS.

The DwPCH is transmitted at each sub-frame with an antenna pattern configuration which provides whole cell coverage. Furthermore it is transmitted with a constant power level which is signalled by higher layers.

The burst structure of the DwPCH ( DwPTS) is described in the figure 27.

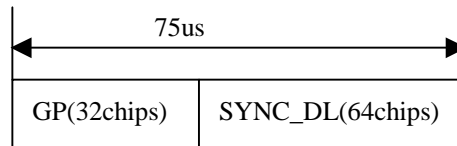

**Figure 27: burst structure of the DwPCH ( DwPTS)**

Note: 'GP' for 'Guard Period'

The burst structure of the UpPCH ( UpPTS) is described in the figure 28.

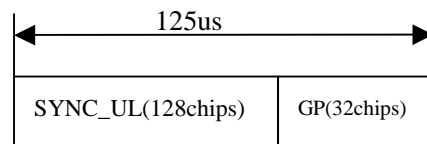

**Figure 28: burst structure of the UpPCH ( UpPTS)**

The SYNC-DL code in DwPCH and the SYNC-UL code in UpPCH are not spreaded. The details about the SYNC-DL and SYNC-UL code are described in the corresponding subclause and annex in [8].

### 6.3.6 Physical Uplink Shared Channel (PUSCH)

For Physical Uplink Shared Channel (PUSCH) the burst structure of DPCH as described in subclause 6.2 shall be used. PUSCH provides the possibility for transmission of TFCI in uplink.

### 6.3.7 Physical Downlink Shared Channel (PDSCH)

For Physical Downlink Shared Channel (PDSCH) the burst structure of DPCH as described in subclause 6.2 shall be used. PDSCH provides the possibility for transmission of TFCI in downlink.

To indicate to the UE that there is data to decode on the DSCH, three signalling methods are available:

- 1) using the TFCI field of the associated channel or PDSCH;
- 2) using on the DSCH user specific midamble derived from the set of midambles used for that cell;
- 3) using higher layer signalling.

When the midamble based method is used, the UE shall decode the PDSCH if the PDSCH was transmitted with the midamble assigned to the UE by UTRAN, see 6.6.1.1.2 . For this method no other physical channels may use the same time slot as the PDSCH and only one UE may share the PDSCH time slot at the same time.

### 6.3.8 The Page Indicator Channel (PICH)

The Paging Indicator Channel (PICH) is a physical channel used to carry the paging indicators.

#### 6.3.8.1 Mapping of Paging Indicators to the PICH bits

Figure 29 depicts the structure of a PICH transmission and the numbering of the bits within the bursts. The burst type as described in [6.2.2 ‘Burst Format’] is used for the PICH.  $N_{PIB}$  bits are used to carry the paging indicators, where  $N_{PIB}=352$ .

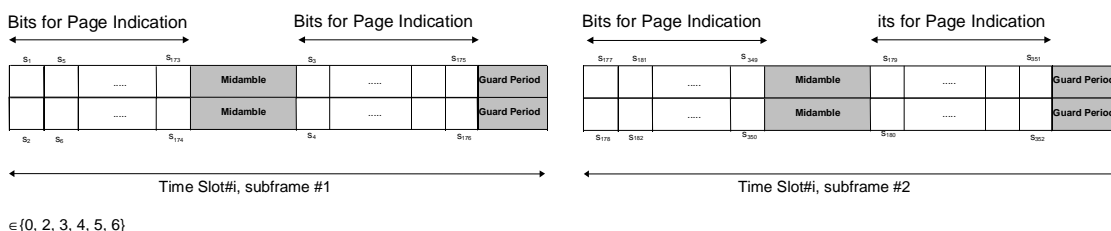

**Figure 29: Transmission and numbering of paging indicator carrying bits in the PICH bursts**

Each paging indicator  $P_q$  (where  $P_q, q = 0, \dots, N_{PI}-1, P_q \in \{0, 1\}$ ) in one radio frame is mapped to the bits  $\{s_{2L_{PI} \cdot q+1}, \dots, s_{2L_{PI} \cdot (q+1)}\}$  in subframe #1 or subframe #2.

The setting of the paging indicators and the corresponding PICH bits is described in [7].

$N_{PI}$  paging indicators of length  $L_{PI}=2, L_{PI}=4$  or  $L_{PI}=8$  symbols are transmitted in each radio frame that contains the PICH. The number of paging indicators  $N_{PI}$  per radio frame is given by the paging indicator length, which signalled by higher layers. In table 20 this number is shown for the different possibilities of paging indicator lengths.

**Table 20: Number  $N_{PI}$  of paging indicators per radio frame for different paging indicator lengths  $L_{PI}$**

	$L_{PI}=2$	$L_{PI}=4$	$L_{PI}=8$
$N_{PI}$ per radio frame	88	44	22

#### 6.3.8.2 Structure of the PICH over multiple radio frames

The structure of the PICH over multiple radio frames is common with 3.84 Mcps TDD, cf. [5.3.7.2 Structure of the PICH over multiple radio frames]

### 6.3.9 High Speed Physical Downlink Shared Channel (HS-PDSCH)

The HS-DSCH as described in subclause 4.1.2 is mapped onto one or more high speed physical downlink shared channels (HS-PDSCH).

#### 6.3.9.1 HS-PDSCH Spreading

Spreading of the HS-PDSCH is common with 3.84 Mcps TDD, cf. [5.3.91HS-PDSCH Spreading]

#### 6.3.9.2 HS-PDSCH Burst Types

The burst type as described in section 6.2.2 shall be used for the HS-PDSCH.

#### 6.3.9.3 HS-PDSCH Training Sequences

The training sequences as described in subclause 6.2.3 are used for the HS-PDSCH.

### 6.3.9.4 UE Selection

UE selection is common with 3.84 Mcps TDD, cf. [5.3.9.4 UE selection].

### 6.3.9.5 HS-PDSCH timeslot formats

An HS-PDSCH may use QPSK or 16QAM modulation symbols. The time slot formats are shown in table 21.

**Table 21: Time slot formats for the HS-PDSCH**

Slot Format #	SF	Midamble length (chips)	N <sub>TFCI</sub> code word (bits)	N <sub>SS</sub> & N <sub>TPC</sub> (bits)	Bits/slot	N <sub>Data/Slot</sub> (bits)	N <sub>data/data</sub> field(1) (bits)	N <sub>data/data</sub> field(2) (bits)
0 (QPSK)	16	144	0	0 & 0	88	88	44	44
1 (16QAM)	16	144	0	0 & 0	176	176	88	88
2 (QPSK)	1	144	0	0 & 0	1408	1408	704	704
3 (16QAM)	1	144	0	0 & 0	2816	2816	1408	1408

### 6.3.10 Shared Control Channel for HS-DSCH (HS-SCCH)

The HS-SCCH is a DL physical channel that carries higher layer control information for HS-DSCH. The physical layer will process this information according to [7] and will transmit the resulting bits on the HS-SCCH the structure of which is described below.

The information on the HS-SCCH is carried by two separate physical channels (HS-SCCH1 and HS-SCCH2). The term HS-SCCH refers to the ensemble of these physical channels.

#### 6.3.10.1 HS-SCCH Spreading

Spreading of the HS-SCCH is common with 3.84 Mcps TDD, cf. [5.3.10.1 HS-SCCH Spreading].

#### 6.3.10.2 HS-SCCH Burst Types

The burst type as described in section 6.2.2 shall be used for the HS-SCCH.

#### 6.3.10.3 HS-SCCH Training Sequences

The training sequences as described in subclause 6.2.3 are used for the HS-SCCH.

#### 6.3.10.4 HS-SCCH timeslot formats

HS-SCCH1 shall use time slot format #5 and HS-SCCH2 shall use time slot format #0 from table 15, see section 6.2.2.4.1.1, i.e. HS-SCCH shall carry TPC and SS but no TFCI.

### 6.3.11 Shared Information Channel for HS-DSCH (HS-SICH)

The HS-SICH is a UL physical channel that carries higher layer control information and the Channel Quality Indicator CQI for HS-DSCH. The physical layer will process this information according to [7] and will transmit the resulting bits on the HS-SICH the structure of which is described below.

#### 6.3.11.1 HS-SICH Spreading

Spreading of the HS-SICH is common with 3.84 Mcps TDD, cf. [5.3.11.1 HS-SICH Spreading].

### 6.3.11.2 HS-SICH Burst Types

The burst type as described in section 6.2.2 shall be used for the HS-SICH.

### 6.3.11.3 HS-SICH Training Sequences

The training sequences as described in subclause 6.2.3 are used for the HS-SCCH.

### 5.3.11.4 HS-SICH timeslot formats

The HS-SICH may use time slot format #5 from table 16, see section 6.2.2.4.1.2, i.e., it shall carry TPC and SS but no TFCI.

## 6.4 Transmit Diversity for DL Physical Channels

Table 22 summarizes the different transmit diversity schemes for different downlink physical channel types in 1.28Mcps TDD that are described in [9].

**Table 22: Application of Tx diversity schemes on downlink physical channel types in 1.28Mcps TDD**  
"X" – can be applied, "-" – must not be applied

Physical channel type	Open loop TxDiversity		Closed loop TxDiversity
	TSTD	SCTD	
P-CCPCH	X	X	–
DwPCH	X	–	–
DPCH	X	–	X
PDSCH	X	–	X

## 6.5 Beacon characteristics of physical channels

For the purpose of measurements, physical channels at particular locations (time slot, code) shall have particular physical characteristics, called beacon characteristics. Physical channels with beacon characteristics are called beacon channels. The location of the beacon channels is called beacon location. The beacon channels shall provide the beacon function, i.e. a reference power level at the beacon location, regularly existing in each subframe. Thus, beacon channels must be present in each subframe.

### 6.5.1 Location of beacon channels

The beacon location is described as follows :

The beacon function shall be provided by the physical channels that are allocated to channelisation code  $c_{Q=16}^{(k=1)}$  and  $c_{Q=16}^{(k=2)}$  in Timeslot#0.

Note that by this definition the P-CCPCH always has beacon characteristics.

### 6.5.2 Physical characteristics of the beacon function

The beacon channels shall have the following physical characteristics.

They:

- are transmitted with reference power;
- are transmitted without beamforming;
- use midamble  $m^{(1)}$  and  $m^{(2)}$  exclusively in this time slot

The reference power corresponds to the sum of the power allocated to both midambles  $m^{(1)}$  and  $m^{(2)}$ . Two possibilities exist:

- If no antenna diversity is applied to the P-CCPCH, all the reference power of any beacon channel is allocated to  $m^{(1)}$ .
- If SCTD antenna diversity is applied to the P-CCPCH, for any beacon channel midambles  $m^{(1)}$  and  $m^{(2)}$  are each allocated half of the reference power. Midamble  $m^{(1)}$  is used for the first antenna and  $m^{(2)}$  is used for the diversity antenna. SCTD is applied to the P-CCPCH, see [9]; for all other beacon channels identical spread data sequences are transmitted on both antennas.

## 6.6 Midamble Allocation for Physical Channels

The midamble allocation schemes for physical channels are the same as in the 3.84 Mcps TDD option. The associations between channelisation codes and midambles for the default and common midamble allocation differ from the 3.84 Mcps TDD option. The associations are given in Annex B.2 [Association between Midambles and channelisation Codes] and D [Signalling of the number of channelisation codes for the DL common midamble case for 1.28 Mcps TDD] respectively

### 6.6.1 Midamble Allocation for DL Physical Channels

Beacon channels shall always use the reserved midambles  $m^{(1)}$  and  $m^{(2)}$ , see 6.5. For the other DL physical channels that are located in timeslot #0, midambles shall be allocated based on the default midamble allocation scheme, using the association for  $K=8$  midambles. For all other DL physical channels, the midamble is explicitly assigned by higher layers or allocated by layer 1.

#### 6.6.1.1 Midamble Allocation by signalling from higher layers

The midamble allocation by signalling is the same like in the 3.84 Mcps TDD cf. [5.6.1.1 Midamble allocation by signalling from higher layers]

#### 6.6.1.2 Midamble Allocation by layer 1

##### 6.6.1.2.1 Default midamble

The default midamble allocation by layer 1 is the same like in the 3.84 Mcps TDD cf. [5.6.1.2.1 Default midamble]. The associations between midambles and channelisation codes are given in Annex B.2 [Association between Midambles and channelisation Codes].

##### 6.6.1.2.2 Common Midamble

The common midamble allocation by layer 1 is the same like in the 3.84 Mcps TDD cf. [5.6.1.2.2 Common midamble]. The respective associations are given in Annex D [Signalling of the number of channelisation codes for the DL common midamble case for 1.28 Mcps TDD].

### 6.6.2 Midamble Allocation for UL Physical Channels

The midamble allocation for UL Physical Channels is the same as in the 3.84 Mcps TDD cf. [5.6.2 Midamble allocation for UL Physical Channels]

## 6.7 Midamble Transmit Power

The setting of the midamble transmit power is done as in the 3.84 Mcps TDD option cf. 5.7 'Midamble Transmit Power'



# 7 Mapping of transport channels to physical channels for the 3.84 Mcps option

This clause describes the way in which transport channels are mapped onto physical resources, see figure 30.

Transport Channels	Physical Channels
DCH _____	Dedicated Physical Channel (DPCH)
BCH _____	Primary Common Control Physical Channel (P-CCPCH)
FACH _____	Secondary Common Control Physical Channel (S-CCPCH)
PCH _____	
RACH _____	Physical Random Access Channel (PRACH)
USCH _____	Physical Uplink Shared Channel (PUSCH)
DSCH _____	Physical Downlink Shared Channel (PDSCH)
	Paging Indicator Channel (PICH)
	Synchronisation Channel (SCH)
	Physical Node B Synchronisation Channel (PNBSCH)
HS-DSCH _____	High Speed Physical Downlink Shared Channel (HS-PDSCH)
	Shared Control Channel for HS-DSCH (HS-SCCH)
	Shared Information Channel for HS-DSCH (HS-SICH)

**Figure 30: Transport channel to physical channel mapping**

## 7.1 Dedicated Transport Channels

A dedicated transport channel is mapped onto one or more physical channels. An interleaving period is associated with each allocation. The frame is subdivided into slots that are available for uplink and downlink information transfer. The mapping of transport blocks on physical channels is described in TS 25.222 ("multiplexing and channel coding").

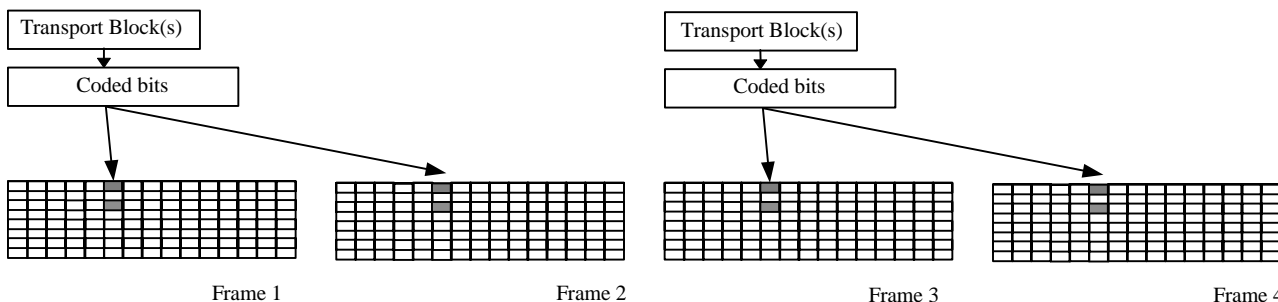

**Figure 31: Mapping of Transport Blocks onto the physical bearer**

For NRT packet data services, shared channels (USCH and DSCH) can be used to allow efficient allocations for a short period of time.

## 7.2 Common Transport Channels

### 7.2.1 The Broadcast Channel (BCH)

The BCH is mapped onto the P-CCPCH. The secondary SCH codes indicate in which timeslot a mobile can find the P-CCPCH containing BCH.

### 7.2.2 The Paging Channel (PCH)

The PCH is mapped onto one or several S-CCPCHs so that capacity can be matched to requirements. The location of the PCH is indicated on the BCH. It is always transmitted at a reference power level.

To allow an efficient DRX, the PCH is divided into PCH blocks, each of which comprising  $N_{PCH}$  paging sub-channels.  $N_{PCH}$  is configured by higher layers. Each paging sub-channel is mapped onto 2 consecutive PCH frames within one PCH block. Layer 3 information to a particular UE is transmitted only in the paging sub-channel, that is assigned to the UE by higher layers, see [15]. The assignment of UEs to paging sub-channels is independent of the assignment of UEs to page indicators.

#### 7.2.2.1 PCH/PICH Association

As depicted in figure 32, a paging block consists of one PICH block and one PCH block. If a paging indicator in a certain PICH block is set to '1' it is an indication that UEs associated with this paging indicator shall read their corresponding paging sub-channel within the same paging block. The value  $N_{GAP} > 0$  of frames between the end of the PICH block and the beginning of the PCH block is configured by higher layers.

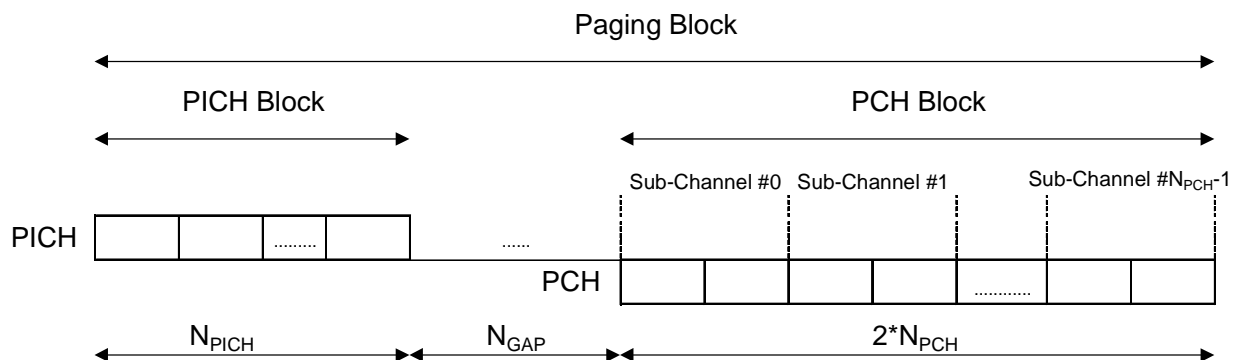

Figure 32: Paging Sub-Channels and Association of PICH and PCH blocks

### 7.2.3 The Forward Channel (FACH)

The FACH is mapped onto one or several S-CCPCHs. The location of the FACH is indicated on the BCH and both, capacity and location can be changed, if required. FACH may or may not be power controlled.

### 7.2.4 The Random Access Channel (RACH)

The RACH has intraslot interleaving only and is mapped onto PRACH. The same slot may be used for PRACH by more than one cell. Multiple transmissions using different spreading codes may be received in parallel. More than one slot per frame may be administered for the PRACH. The location of slots allocated to PRACH is broadcast on the BCH. The PRACH uses open loop power control. The details of the employed open loop power control algorithm may be different from the corresponding algorithm on other channels.

### 7.2.5 The Uplink Shared Channel (USCH)

The uplink shared channel is mapped on one or several PUSCH, see subclause 5.5.

## 7.2.6 The Downlink Shared Channel (DSCH)

The downlink shared channel is mapped on one or several PDSCH, see subclause 5.6.

## 7.2.7 The High Speed Downlink Shared Channel (HS-DSCH)

The high speed downlink shared channel is mapped on one or several HS-PDSCH, see subclause 5.3.9.

### 7.2.7.1 HS-DSCH/HS-SCCH Association and Timing

The HS-DSCH is always associated with one DL DPCH and a number of High Speed Shared Control Channels (HS-SCCH). The number of HS-SCCHs that are associated with an HS-DSCH for one UE can range from a minimum of one HS-SCCH ( $M=1$ ) to a maximum of four HS-SCCH ( $M=4$ ). All relevant Layer 1 control information is transmitted in the associated HS-SCCH i.e. the HS-PDSCH does not carry any Layer 1 control information.

The HS-DSCH related time slot information that is carried on the HS-SCCH refers to the next valid HS-PDSCH allocation, which is given by the following limitation: There shall be an offset of  $n_{HS-SCCH} \geq 6$  time slots between the HS-SCCH carrying the HS-DSCH related information and the first indicated HS-PDSCH (in time) for a given UE. The HS-DSCH related time slot information shall not refer to two subsequent radio frames but shall always refer to either the same or the following radio frame, as illustrated in figure 33. Note that the figure only shows the HS-SCCH that carries the HS-DSCH related information for the given UE.

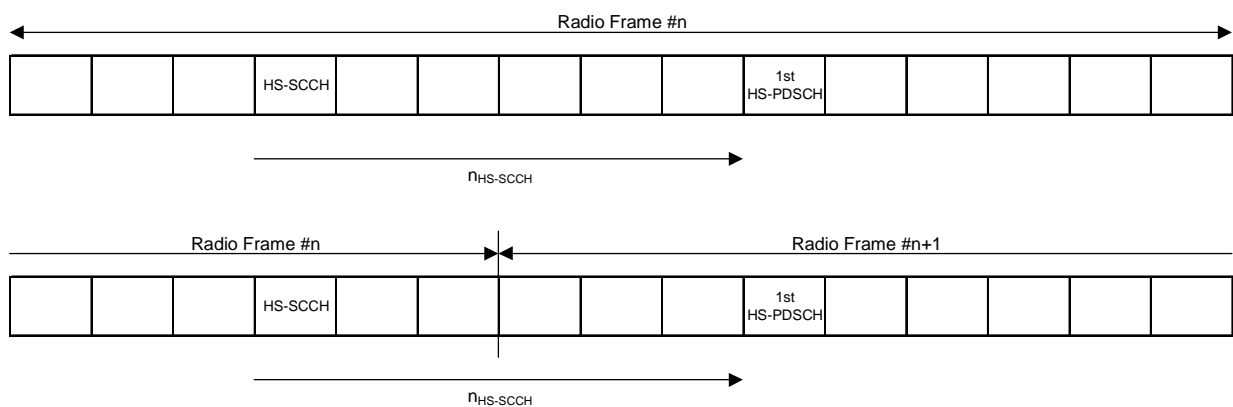

**Figure 33: Timing for HS-SCCH and HS-DSCH for different radio frame configurations for a given UE**

### 7.2.7.2 HS-SCCH/HS-DSCH/HS-SICH Association and Timing

The HS-SCCH is always associated with one HS-SICH. The association between the HS-SCCH in DL and HS-SICH in UL shall be pre-defined by higher layers and is common for all UEs.

The UE shall transmit HS-DSCH related information on the next available associated HS-SICH with the following limitation: There shall be an offset of  $n_{HS-SICH} \geq 19$  time slots between the last allocated HS-PDSCH (in time) and the HS-SICH for the given UE. Hence, the HS-SICH transmission shall be made in the next or next but one radio frame, following the HS-DSCH transmission, as illustrated in figure 34. Note that the figure only shows the HS-SICH that carries the HS-DSCH related information for the given UE.

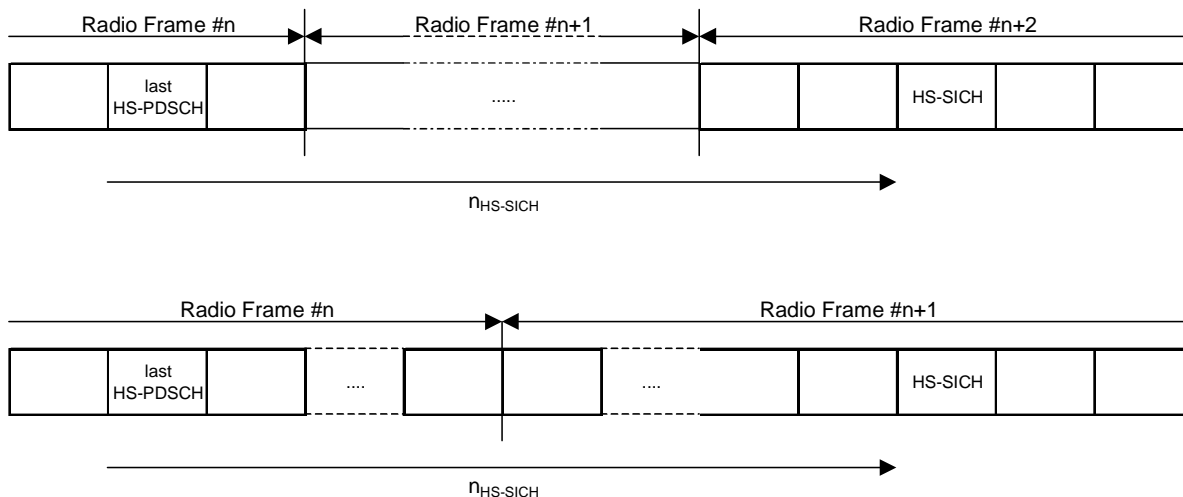

Figure 34: Timing for HS-DSCH and HS-SICH for different radio frame configurations for a given UE

## 8 Mapping of transport channels to physical channels for the 1.28 Mcps option

This clause describes the way in which the transport channels are mapped onto physical resources, see figure 35.

Transport channels	Physical channels
DCH	Dedicated Physical Channel (DPCH)
BCH	Primary Common Control Physical Channels (P-CCPCH)
PCH	Secondary Common Control Physical Channels(S-CCPCH)
FACH	Secondary Common Control Physical Channels(S-CCPCH)
	PICH
RACH	Physical Random Access Channel (PRACH)
USCH	Physical Uplink Shared Channel (PUSCH)
DSCH	Physical Downlink Shared Channel (PDSCH)
	Down link Pilot Channel (DwPCH)
	Up link Pilot Channel (UpPCH)
	FPACH
HS-DSCH	High Speed Physical Downlink Shared Channel (HS-PDSCH)
	Shared Control Channel for HS-DSCH (HS-SCCH)
	Shared Information Channel for HS-DSCH (HS-SICH)

Figure 35: Transport channel to physical channel mapping for 1.28Mcps TDD

### 8.1 Dedicated Transport Channels

The mapping of transport blocks to physical bearers is in principle the same as in 3.84 Mcps TDD but due to the subframe structure the coded bits are mapped onto each of the subframes within the given TTI.

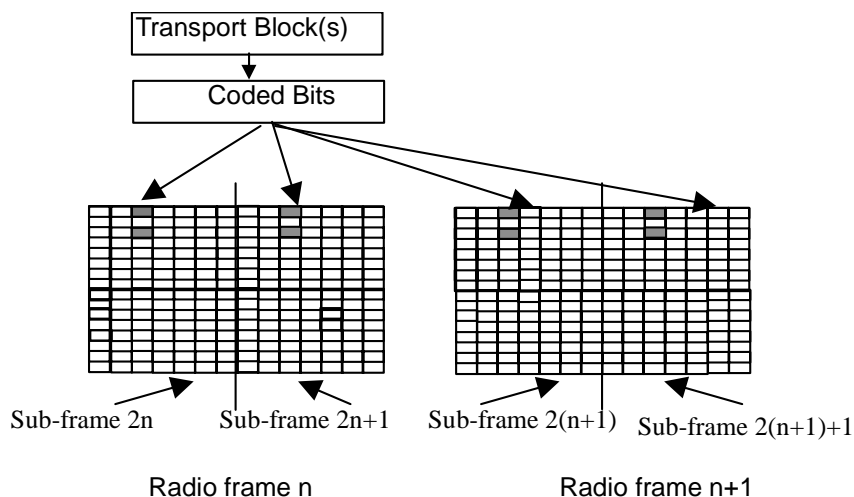

Figure 36 : Mapping of Transport Blocks onto the physical bearer ( TTI= 20ms )

## 8.2 Common Transport Channels

### 8.2.1 The Broadcast Channel (BCH)

There are two P-CCPCHs, P-CCPCH 1 and P-CCPCH 2 which are mapped onto timeslot#0 using the channelisation codes  $c_{Q=16}^{(k=1)}$  and  $c_{Q=16}^{(k=2)}$  with spreading factor 16. The BCH is mapped onto the P-CCPCH1+P-CCPCH2.

The position of the P-CCPCHs is indicated by the relative phases of the bursts in the DwPTS with respect to the P-CCPCHs midamble sequences, see [8]. One special combination of the phase differences of the burst in the DwPTS with respect to the P-CCPCH midamble indicates the position of the P-CCPCH in the multi-frame and the start position of the interleaving period.

### 8.2.2 The Paging Channel (PCH)

The mapping of Paging Channels onto S-CCPCHs and the association between PCHs and Paging Indicator Channels is the same as in the 3.84 Mcps TDD option, cf. 7.2.2 'The paging Channel' and 7.2.2.1 'PCH/PICH Association' respectively.

### 8.2.3 The Forward Channel (FACH)

The FACH is mapped onto one or several S-CCPCHs. The location of the FACH is indicated on the BCH and both, capacity and location can be changed, if required. FACH may or may not be power controlled.

### 8.2.4 The Random Access Channel (RACH)

The RACH is mapped onto PRACH. More than one slot per frame may be administered for the PRACH. The location of slots allocated to PRACH is broadcast on the BCH. The uplink sync codes (SYNC-UL sequences) used by the UEs for UL synchronisation have a well known association with the P-RACHs, as broadcast on the BCH. On the PRACH, both power control and uplink synchronisation control are used.

### 8.2.5 The Uplink Shared Channel (USCH)

The uplink shared channel is mapped onto one or several PUSCH, see subclause 6.3.6 'Physical Uplink Shared Channel (PUSCH)'

## 8.2.6 The Downlink Shared Channel (DSCH)

The downlink shared channel is mapped onto one or several PDSCH, see subclause 6.3.7 ‘Physical Downlink Shared Channel (PDSCH)’

## 8.2.7 The High Speed Downlink Shared Channel (HS-DSCH)

The high speed downlink shared channel is mapped on one or several HS-PDSCH, see subclause 6.3.9.

### 8.2.7.1 HS-DSCH/HS-SCCH Association and Timing

The HS-DSCH is always associated with one DL DPCH and a number of High Speed Shared Control Channels (HS-SCCH). The number of HS-SCCHs that are associated with an HS-DSCH for one UE can range from a minimum of one HS-SCCH ( $M=1$ ) to a maximum of four HS-SCCH ( $M=4$ ). All relevant Layer 1 control information is transmitted in the associated HS-SCCH i.e. the HS-PDSCH does not carry any Layer 1 control information.

The HS-DSCH related time slot information that is carried on the HS-SCCH refers to the next valid HS-PDSCH allocation, which is given by the following limitation: There shall be an offset of  $n_{HS-SCCH} \geq 3$  time slots between the HS-SCCH carrying the HS-DSCH related information and the first indicated HS-PDSCH (in time) for a given UE. DwPTS and UpPTS shall not be taken into account in this limitation. The HS-DSCH related time slot information shall not refer to two subsequent sub-frames but shall always refer to either the same or the following sub-frame, as illustrated in figure 37. Note that the figure only shows the HS-SCCH that carries the HS-DSCH related information for the given UE and that DwPTS and UpPTS are not considered in this figure.

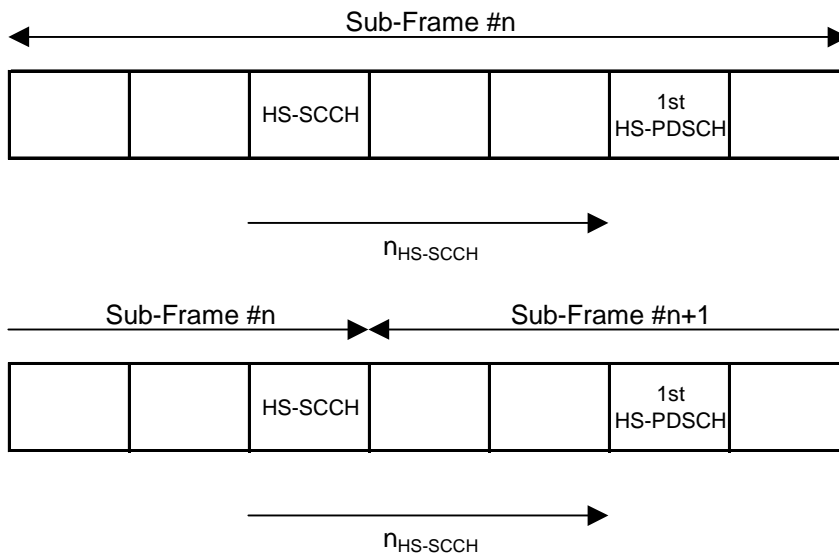

Figure 37: Timing for HS-SCCH and HS-DSCH for different radio frame configurations for a given UE

### 8.2.7.2 HS-SCCH/HS-DSCH/HS-SICH Association and Timing

The HS-SCCH is always associated with one HS-SICH, carrying the ACK/NACK and Channel Quality information (CQI). The association between the HS-SCCH in DL and HS-SICH in UL shall be pre-defined by higher layers and is common for all UEs.

The UE shall transmit HS-DSCH related information on the next available associated HS-SICH with the following limitation: There shall be an offset of  $n_{HS-SICH} \geq 9$  time slots between the last allocated HS-PDSCH (in time) and the HS-SICH for the given UE. DwPTS and UpPTS shall not be taken into account in this limitation. Hence, the HS-SICH transmission shall always be made in the next but one sub-frame, following the HS-DSCH transmission, as illustrated in figure 38. Note that the figure only shows the HS-SICH that carries the HS-DSCH related information for the given UE and that DwPTS and UpPTS are not considered in this figure.

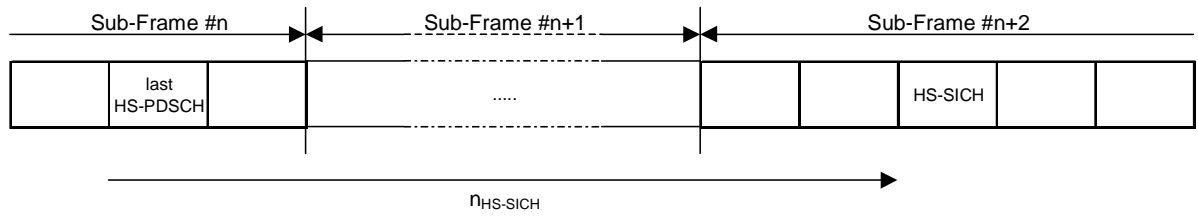

Figure 38: Timing for HS-DSCH and HS-SICH for different radio frame configurations for a given UE

# Annex A (normative): Basic Midamble Codes for the 3.84 Mcps option

## A.1 Basic Midamble Codes for Burst Type 1 and 3

In the case of burst type 1 or 3 (see subclause 5.2.2) the midamble has a length of  $L_m=512$ , which is corresponding to:  $K'=8$ ;  $W=57$ ;  $P=456$ .

Depending on the possible delay spread cells are configured to use  $K_{Cell}$  midambles which are generated from the Basic Midamble Codes (see table A-1)

- for all  $k=1,2,\dots,K$ ;  $K=2K'$  or
- for  $k=1,2,\dots,K'$ , only, or
- for odd  $k=1,3,5,\dots,\leq K'$ , only.

Depending on the cell size midambles for PRACH are generated from the Basic Midamble Codes (see table A-1)

- for  $k=1,2,\dots,K'$  or
- for odd  $k=1,3,5,\dots,\leq K'$ , only.

The cell configuration is broadcast on BCH.

The mapping of these Basic Midamble Codes to Cell Parameters is shown in TS 25.223.

**Table A-1: Basic Midamble Codes  $m_p$  according to equation (5) from subclause 5.2.3 for case of burst type 1 and 3**

Code ID	Basic Midamble Codes $m_{PL}$ of length $P=456$
$m_{PL0}$	8DF65B01E4650910A4BF89992E48F43860B07FE55FA0028E454EDCD1F0A09A6F029668F55427253FB8A71E5EF2EF360E539C489584413C6DC4
$m_{PL1}$	4C63F9BC3FD7B655D5401653BE75E1018DC26D271AADA1CF13FD348386759506270F2F953E93A44468E0A76605EAE8526225903B1201077602
$m_{PL2}$	8522611FFCAEB55A5F07D966036C852E7B15B893B3ABA9672C327380283D168564B8E1200F0E2205AF1BB23A58679899785CFA2A6C131CFDC4
$m_{PL3}$	F58107E6B777C221999BDE9340E192DC6C31AB8AE85E70AA9BBEB39727435412A5A27C0EF73AB453ED0D28E5B032B94306EC1304736C91E922
$m_{PL4}$	89670985013DFD2223164B68A63BD58C7867E97316742D3ABD6CBDA4FC4E08C0B0CBE44451575C72F887507956BD1F27C466681800B4B016EE
$m_{PL5}$	FCDEF63500D6745CDB962594AF171740241E982E9210FC238C4DD85541F08C1A010F7B3161A7F4DF19BAD916FD308AB1CED2A32538C184E92C
$m_{PL6}$	DB04CE77A5BA7C0E09B6D3551072B11A7A43B6A355C1D6FDCF725D587874999895748DD09832ABC35CEC3008338249612E6FE5005E13B03103
$m_{PL7}$	D2F61A622D0BA9E448CD29587D398EF8CDC3B6582B6CDD50E9E20BF5FE2B3258041E14D60821DC6725132C22D787CD5D497780D4241E3B420D
$m_{PL8}$	7318524E62D806FA149ECC5435058A2B74111524B84727FE9A7923B4A1F0D8FCD89208F34BE55CADEB90130F9954BB30605A98C11045FF173D
$m_{PL9}$	8E832B4FA1A11E0BF318E84F54725C8052E0D099EF0AF54BC342BEE44976C9F38DE701623C7BF6474DF90D2E222A4915C8080E7CD3EC84DAC
$m_{PL10}$	CFA5BAC90780876C417933C43103B55699A8AD51164E590AF9DA6AF0C18804E1F74862F00CE7ECC899C85B6ABB0CAD5E50836AD7A39878FE2F
$m_{PL11}$	AD539094A19858A75458F1B98E286A4F7DC3A117083D04724CBE83F34102817C5531329CDB437FFF712241B644BDF0C1FEC8598A63C2F21BD7
$m_{PL12}$	BEB8483139529BDE23E42DA6AB8170DD0BFBB30CE28A4502FAF3C8EDA219B9A6D5B849D9C9E4451F74E2408EA046061201E0C1D69CF48F3A94
$m_{PL13}$	C482462CA7846266060D21688BA00B72E1EC84A3D5B7194C8DA39E21A3CE12BF512C8AAB6A7079F73C0D3E4F40AC555A4BCC453F1DFE3F6C82



Code ID	Basic Midamble Codes $m_{PL}$ of length $P=456$
$m_{PL14}$	9663373935FD5C213AC58C0670206683D579D2526C05B0A81030DDF61A221D8A68EAD8D6F7A A0D662C07C6D0115A54D39F03F7122B0675AC
$m_{PL15}$	387397AE5CD3F2B3912C26B8F87CE82CEFEC55507DB08FB0C4CF2FD6858896201ACA726428 1D0298440DD3481E5E9DDB24C16F30EB7A22948A
$m_{PL16}$	AFE9266843C892571B6230D808788C63B9065EA3BDFF687B92B8734A8D7099559FEA22C94165 76D0C087EB4503E87E356471B330182A24A3E6
$m_{PL17}$	6E6C550A4CB74010F6C3E0328651DF421C456D9A5E8AE9D3946C10189D72B579184552EE3E7 99970969C870FE8A37B6C4BA890992103486DC0
$m_{PL18}$	D803CA71B6F99CFB3105D40F4695D61EB0B62E803F79302EE3D2A6BF12EA70D304B181E8B3 8B3B74F5022B67EB8109808C62532688C563D4BE
$m_{PL19}$	E599ED48D01772055DBE9D343A4EA5EABE643DA38F06904FC7523B08C4101F021B199AF759A 00D9AC298881D79413A77470992A75C771492D0
$m_{PL20}$	9F30AC4162CE5D185953705F3D45F026F38E9B5721AEFE07370214D526A2C4B344B508B57BF B2492320C05903C79CBEE08C6E7F218B57E14D6
$m_{PL21}$	B5971060DA84685B4D042ED0189FAF13C961B2EF61CC164E363B22AAB14AC8AF607906C1C6 E04F2054C687AA6741A9E70639857DA02B6FFFA
$m_{PL22}$	97135FC2226C4B4A5CBA5FCA3732763B87455F73A1148006F3DF214BD4C936D061E04045160 E2CE33B9CD09D08FDE2A37F4E998322B4401D27
$m_{PL23}$	4D256D57C861B9791151A78D5299C56D116B6178B2A2D04BB95FB76540AF28341DC6EC4E7E D3BF9E508478D9C8F44914805DA82429E1CF320E
$m_{PL24}$	858EF5C84CE32D18D9ABA110EEA7474CF0CD70254D2928C3F4DFF6BB3A518587CADA190290 78AC90A8336C8178203BE3289E601F07D089CB64
$m_{PL25}$	920A8796A511650AEF32F93DD3C39C624E07AE03CE8C96139973F54DCB9803C5164ADB502D 4FF561564D607037FCD172921F1982B102C3312C
$m_{PL26}$	485C5DAE76B360A9C56E20B8422EA3E6ACF07CB093B5587CB0E6A5498A4714081EA98DBCD B0482B26E0D097C03444473D233BEF3C8E440DEBF
$m_{PL27}$	565A9D54EA789892B024F97E728E8EE112411942C48BD0C5BC8AA457D8DC9941F0F7424B386 43FFE6521CD306FBC56FE10F1428D4C245B5606
$m_{PL28}$	5AEF2C0C2C378179A1AC36242E6B3EDB72C42D3624437674F8D51260C0898C201837CBA14E9 E23D1EF6451C4ACF27AB031F457A8A1BFD148AE
$m_{PL29}$	87D8FE685417822A23D925307E6C11081ADAC4702BCCD9BE448E78984D109B50DEF5B7C58B C71EA1F0A6826BA8AD1978843E7697F3E416AADA

Code ID	Basic Midamble Codes $m_{PL}$ of length $P=456$
$m_{PL30}$	84802B72AF27B5BE724D1FB629E0E627BDB0D9061292562F98350C1D0C9D4B9D8E2BF71123C82EBB161003AE9829E07244D78F19926F8847A2
$m_{PL31}$	8CCB5128238BCB088E30972D62792AEF02B9BBDDCAD68C9916C00BF91CBE788B0F03851FAAF88605534FD73436C259D270B1013CB14226F658
$m_{PL32}$	62F4E6FAC2BF1979CE6854AA2D33534BFB2F946519101A6589131C3640707D40E67ED804AF8736AD213CAF5935741900061967E8285C27E34C
$m_{PL33}$	4095E5B4EEAFDCF68A34B267EEA28D8444FA533900F41499E260D2E65C256A52E1DD5861F5227C98E00687D107233F51A1167BCF72FB184654
$m_{PL34}$	5630E9A79FCAD303404D9E5A802299162657AAC734761C6E90DA8BCE4F61A763E0BB48D3FE3F78468C828ABA4828DAD06E0F904CFD40421DC
$m_{PL35}$	CD12B24C0BCA8AAC1FCBF050A3BC684A180E863D888F2506B48C68ECF17F76CB285991FBA18EB6397211FAD002F482D57A258CD45DE3FF1A6
$m_{PL36}$	AFCF2A50877286CD3405442730C45514F082D9EC296B367C0F64F04C4E0007DCA9E50BEED5C102126E319ACBC64F1729272F2F72C9397029FE
$m_{PL37}$	18F89EE8589D20882A72A44DCDF0050FOA3D88DBA6531614973D26905FDF41E3F779FF0648E8AF1540928511BCF4C25D9C64AF34AC31B8965
$m_{PL38}$	F890D550F33F032ECDA3A51FED427D634F64EB29AF1332A23CD961258E4BAED040E7B336918E250EC272A12816B9EBFFA1E0AE401185F08C10
$m_{PL39}$	ACE5DD61506047E80FB7D41BD3992DF4D7F18EB46CC145C0E9105428C2F8F299141F5D66691904A7DC2513A3B83994ACB1292246B32818FE9D
$m_{PL40}$	150680FF900C9B46E1E24D54BE2238CB950A934E5CCDE9BC3939EB51CB0AE202B7D339EEC2018B33A0AB9B63DA5D512D64FB58C0E51A1C82C2
$m_{PL41}$	51A579EED2663A002D32D10A0753173612F4D5BA167D1807C61F25C4D42C063682E8E9DD019F79D446A046EB3F75E50FEB228DC52F08E694B6
$m_{PL42}$	CDC644FE4C0C6897604F9D14D714123BF16FFF0E49F35F674908CA60653702FE27BCCA2A47098453AF8661055C8C549EB6A951A8396AD4B94D
$m_{PL43}$	750A10366C595373C5001CA3E4239764B1409D602CF6052B39BC6A3255A15FE06C782C4C5F847026A7E79838A2933A61C77BB6CBF5915B2DA5
$m_{PL44}$	B7490686D78E409082C4C48FE18D4C35429C20AADF96076B92FC4E85490664753DB0891A0B27FD849BB7FCA99E3B38F22F8C662852C0D35AA6
$m_{PL45}$	D86E1B575B47D23DA811806A54C231281F03317830E7BD305D3CAA7D6382A5233104CFD54D22DF9F34535E5B390D9040CF1375FEA44CEC29E2
$m_{PL46}$	828655960C026EC67B683480992AC2ED2C43ABC606F5220C2945F373470BE7ED5BCCF7C1AA0986BBCC84F11F1658AA568FAA0A60C5F0B5BFA
$m_{PL47}$	D76230E02C8533653AAB99B288AA2ADE25A1C1BF28516C04239240EAF1EFC0B98974B51F886861D8A1E9F5D62CFFEC309F071A9716B325101B
$m_{PL48}$	EA207662865B8A07D69648964DED818EE474A90B94473408871880E63EF0596B9FCFEC3C06B86EA6AD2B06C91672EFB33C70241A5450B59B8A
$m_{PL49}$	9CB5459549909835FAB22F0D99298C120ACF479F814CCE749079D40688F28101037762F125C776DA9C5FA1FCE0E76E452F8185354FDCDE94E2
$m_{PL50}$	227506304AEC1D6F93569B51FDC3405A0F38194F65BE17163A3CB9827A35AECEA757D020FE249377ECD561428A38FEED004EC859C272563185
$m_{PL51}$	96B9AEC9938910F0E533422A3977519B05CD4AD3909BC15A7502D48D49C124FA192A8E57027CFEB11DF542010603CE5C9FDF8E626D4FBF8CF4
$m_{PL52}$	A6AAD06E095A9BE0BD9F8A2ED40C3CBDBAE91C700CBB778C8696CC06F3A675C16BDB2918E5F2111005A8727206DC6A9684E05655185C398EEB
$m_{PL53}$	CD168D384A78DA172991AD333EE2A9880905AFE59E2A2A4AC4414C40F82874F98A3CBE7B44F4C7F4710B35FD88AFC0399FAEB070EB9CA4D30A
$m_{PL54}$	22016CA87AD1549174A8699DD65599697871091457E83E0912E7E77A06531C209394D283D18A38662B73681DD9C5BF330FED978BDA7D487CA8
$m_{PL55}$	B9401B0843AA6F7827A13BD66C922287E8886C31EB5B90B82B472CCD6DA3D8D4FBF78B8F8496DFA8252B06429D5DD17142F1C908ACCD70EAOOC
$m_{PL56}$	E42B9EFDC5D09AC27B3C7DA28D02493A70521223B9D7A76A9D13E9C171017964D16A70C08EAD02C3DC948889C23E365AFCF01BF20B89B0BF5C
$m_{PL57}$	9DA0180168DB915E9F3597B59312198E1B5CC00D743C2ECB0DBAADA3E35A2465ED1EAA9D74734D49A313CE4DFF020D0760E3153DC485603943
$m_{PL58}$	B6C966619ECB98191D719C187C07BD503425650CAA3A2D1F2DF5212B1441D7A0C1D36A4C9C2550240AD17CA43BB3943DFFFBF1E283D81299CC
$m_{PL59}$	DB0E8C41F08A03D477C1AA548799274C4BF3EB68F2636166FDC8D4B1E7132539930297E228BA232BB5C279FA5ECA3AC10E24361AF050A453B8
$m_{PL60}$	89BCE2DE2974EEBA833CF32F224C85A2891484478527DB48FA6ECEA84C5E288CC3914CB54ADA0476278750187F68FBEA41017E1E58DF1A5A3D
$m_{PL61}$	70A457D1314A278625443EEB52520815EC92CEF17417B97440DCB531BC1CE83212F63270418D0FBDE71F6DB9E0EA88772E1E4535B6633E4425

Code ID	Basic Midamble Codes m <sub>PL</sub> of length P=456
m <sub>PL62</sub>	C388460AD54B36C4452CF0433BD347100ACCC24C79C535AD3E1F23FE0425E93A044C553BFA116E09AA4BB32F13CFA76FBA1BC17520F45EFD44
m <sub>PL63</sub>	0BAFCADCDF9AA2846681782CD3B90CA036A863C78EE1507620BC394D0C6804B4C97A15BC9C0D7B79E6892EA1BFF1A0DD9573A9213AB140D0D2
m <sub>PL64</sub>	833B0226789A62882FCD27A30885E67872B1A1C2FA484AD498011599DD57E8E2A07A560B47167AA5F60EF47177DBB1632D5387A2896348640B
m <sub>PL65</sub>	8F52820323ABA5E6C6B465821B621600B980E59F53A599DA5646BA103214336836CF17E3386CE4FB2BC5F25CCB30CF7F500546828EC8786B8E
m <sub>PL66</sub>	E2E9A29C3C8207B9A4508FD2F667A159F068EEE8D00686F46EA904C3692C1D79DFF1B32E5103720D47B4B58AC35384A26087027E141B3126A8
m <sub>PL67</sub>	70E7C39FD2D3AE1DCE341699A544D801A8688A6EE47C5CB3630022147DDC06241FC5337A348A462B2472DEC5E104DD520ADA5114DB065D4B0D
m <sub>PL68</sub>	9E3483CAB164BD053C4971D4D87494CC689033D589EF80E5453376E4A8DCC02183B98C36B0FF7DDC0AD07FCE8B4D5164371BD03A2110AD1247
m <sub>PL69</sub>	04DA1C649B0608938DAADD3FE920A4F681690C54505429DBDCDCF10067AB5714BCDDFE1F28692710F794765781C1D233344E119BEE8A8416DC
m <sub>PL70</sub>	7A18D6D30BDF44410714C3DCA27D8F9EA8A542D87122205640B98313C91AD9A0B993A5A7BC3E035F93B88BBE6D4204BC82A9FA8D4C1A7618CF
m <sub>PL71</sub>	EB9525E10265A48733C8E0E77E459310112A71DCA680F68AC044B64BC0A31D02EEA0F7ACAAAB7F1E574E94FEA2D1301CB14B03263DA8122B76
m <sub>PL72</sub>	E706C6ED2D6F89153835079BE0C6D45310845EF2F9F6C6AE91B7419810508BA501C0148BF09955BAD90D6391BA8EBA5CEFBBD23221CC75143D7
m <sub>PL73</sub>	DF071A10AC4120CD1431590BEDCFF9483CA7047B19590D035D309240BDB4264E9A3A2761402EC97FD8BC51B4AF32E37FBC47162A2357D18751
m <sub>PL74</sub>	F0F952B2238139F46D8254D1A2C1C22A16BA71EC0C0C900ED1442452D7F44C798BC65FF40671B88074BA0B74C6510996EEAC495C5B49C37DEB
m <sub>PL75</sub>	1C86BD82EDA81FD65418D3837B5552A853791456D93B06C62C650D86CFBEC269AFFD772763064062C03751B9428C6DA2E60383025F9E404B70
m <sub>PL76</sub>	B390978DD2552C88AABA7838489A6F5A8E9C41E95FFA2215819BF8A5BFE39C8A706CC658E549E966611B843A1468406C41C09D1560BEDA4F1B
m <sub>PL77</sub>	1A69EC9D053C7E84BAE7A48CCC71857D0C6B06D1065E3EA4633B133AA022B8104F6EE7C69B6184B746C8822958B0A16686F27C8A0E3B4FEAD
m <sub>PL78</sub>	C95B2070816DC97C6D8DD2583263E73F9AAAFD13F0548D2EBD835824418F11E54111005FB713AB234BE412347358281C7DE331EDD21B8BEA52
m <sub>PL79</sub>	56D6408399F23C2ED85EE0F68111D69A91A3AD9A732AC57CA08F86CC28B3CF4E4B02EBBA0BCE5CAE5BACC4D52004070797C04093A84BB18DBA
m <sub>PL80</sub>	E662E7043867BE250764DA0596D34A582A619B408B505E6211DD6286E93A37F95B1EA680C0C5F3E777E3F71E8D75495D59043217FC0E222E16
m <sub>PL81</sub>	27D5E681C222297AD478A079EF12F1A98F744B66335303322EF8880B931FEBF8322F4302944E80BED468A0A516D410B183D863795992DA7DDB
m <sub>PL82</sub>	5100336C05F9E5BF35201906C1C588858E0DAF56130DF5554B9AB21CA15311A90290624CD63E03F5EDA49DB7A0C32AB5F1CA427A2D5635FDA5
m <sub>PL83</sub>	C696DC993BFAEA9A61B781B9C5C3F5CF4A4C8339D8B03A9B0387883D0482A41AC78D6522425959846E561D26A30FF79A205C801A85889736B2
m <sub>PL84</sub>	D562297561AFF42D3168296C1153E4E39BE7B2EB0348BC704625AA08391235075EE0DE0A79AB03222FEDB27218C56F96EAC2F91CC8FCE64B12
m <sub>PL85</sub>	DD0B6768FC01CC0A551F8ACC36907129623E975AB8B3FF58037F1859E2FA8C62C2D9D1E8506916029A2C3F8CAD9A26AE2CC652F48800859F5C
m <sub>PL86</sub>	923920696EB3AB413786C41854822282BB83F6900D33A232D470BE198BBF086067B72613300C593B74251E2F079857ADBBCD86583A9DCAA6DC
m <sub>PL87</sub>	B8EF30C797D8D2C4EF11244F137D806E556A436626D0115A621C92C34D166A68BCEDFA0040DA8FD6F987B1CD5C2AA1C1B045E64475F0F8DABD
m <sub>PL88</sub>	E1887001D414405ED6419E9EE1D1D346D924ED57ADF04B31B7948099976B2D1501A60DFFB287AD44C8783DF0C1EA5AA5D273D1389C8EA22DCC
m <sub>PL89</sub>	8C2E379A58AA96748141CA84C35987905F984A49D3AD9BFF7807AC244C16C1DF74343C2E1F25514F5A0954CFBB3C92E25EF783136844998AC5
m <sub>PL90</sub>	78F8A99E0A54E27F51C0726FE7A11EB26B1E29FE65F55AC8AC58011465900B958488A90F6DF614A58431DC8B6C6B9A6F032EE0E0B1306EC4B4
m <sub>PL91</sub>	88F7A31B7B20E0F05CA26E729B4F8A1933962D7BD7BE3E1EB130B28C794C0B4D01CADE09006FF97E80117509733F3A9DC225413A0AE08CA662
m <sub>PL92</sub>	BE4DFCEAC18905AC8D5DA27A794F88A4D3058D2EFA3B075A819DEAE688EAF8940A653ED7104E7B403D490F0A9030264E1F12B8922C75775E61
m <sub>PL93</sub>	5BA4B79FC4550234D8922963BF3537485E3C8745A5DB90D3E2E454B30FF61112F508155B7C2B3C4C628AF846240C2021ACDE547E5A41F666B8

Code ID	Basic Midamble Codes $m_{PL}$ of length $P=456$
$m_{PL94}$	00556D35649F7610AB24A43C4F16D6AC0571FD126F11880C5CD72100D730E4E4D6BB73C33F837FAF1072743B249ADA2E09598B1EB23F1180A7
$m_{PL95}$	7A0CC9F21BD69CF3023E944545C2176EF0D4F450B765C28359FB8A32137D043D0E5713E67B3F61320985D2C6106605081F87D2296321468A2F
$m_{PL96}$	DA669880995B0671201172BABFF141D5854A245E211879EF3038A7C84170DADBD368455F24653161E7886E15B253F93E3A3C568EFB17CDEB1A
$m_{PL97}$	4E294E53D1661C1F6F748302A7723DA951C00FDB8BE8BF67A68710BA0F1A255DFB1627059D41A23D3961726DE6FEB10E5D209CC4505B209812
$m_{PL98}$	73385DF701414E144768A67EF72924B1653479E962FB1554B7E54BC5284D9B3E41C0C133F878972230721918AA425501B920B204FECE0C7F8A
$m_{PL99}$	F4492160805F258CE592DF4D1200566F81D173458D78EA3ABED79A14AF88170DB1D4A9A5931D2B80C58C27FE17D806E3E6A66CDAAD09F118D4
$m_{PL100}$	44D562D9012D8B07B8F44596467C11A163982BB7EAEAC184078B6B8CE46B5D7E17C39CEF576A025491183017FA09931D070B307B86524B03FF
$m_{PL101}$	FCAEEFC49A13B4FFA12C0CC6A2B90CF4F57D78B1E98294B04675C2F0991661FDC61A452A247F8C29E0284AA21026F368307375AA2C3F1E12C
$m_{PL102}$	C486DF0510DCAD5AB86E178A686D398E11A0ECFAC5A326C10129257E5456B22FB8E147E9190D9929A5DFFE44715FA47D62F04CFC9B1C201414
$m_{PL103}$	C10AF383DC708E257E15A8AB337BCE684A2F4AC7A22DC2C25C277F8E8D0858E79317CDDD9AA2EA6CBE604D24AC0945026103E7B4126FD361A4
$m_{PL104}$	A5C60A181148D9A931B2DDDB9D169648BA54F366B4EFAE88F6861909EE0F07C037EE349D0EC59A823286E366CA3943589EEA7F828C3728085F
$m_{PL105}$	96136AEBD5E28462B0421DF292BA899FFA660D80EA01620D2C7490E5347127884AA3C3D1FF44BCCEE6C29EC589CDEF200C5742C5964F8B2B52
$m_{PL106}$	40F63C04ACAD986255D1E16B769A6D4C11A1D075E804BDC0AC61923E9A67F5D7417756328072455F6E22B1C64E06F367D1B0808295C2D90E22
$m_{PL107}$	F4B82D413578C4888C5F002CF6D0E03778134A860436551FD57537E4CED334B3C9CEBACE615238271717AA762448B86FA53D2074BCE35658A7
$m_{PL108}$	BCCC92D72C920E685530591FC351743D1E23DE044BF81D32650406113E23ECC757FDE4E386B6E2E7195EE4969717A7BD0812AC312B33A54308
$m_{PL109}$	6ED59DE0D44370A861CE2B42CF5E578E764A682AB5777905EE027D7160490EDC6C28989B23805AA697FCD215CB401BC5E4D430624C01B16192
$m_{PL110}$	DE80C0E273B92CC3C5034F7A20DB3914643C430B425C8B9249EAF73ACE8C3BCF17957242CF534D87A67D4DC0252275262E737F4095450CFA14
$m_{PL111}$	9505C4FEF2A397D5059F4729D013292A8321FFFA929ACB0A210D0A13E13061227C44A68FBD8CE6B66CE3D783363CD039AB35EE52603E09B758
$m_{PL112}$	E8BE90D7F954B14D8002A4CAC20765ABEED80634498C836D79B0F9338DBC17B28F05CF4E79136779E1C55AA30B6215F890882887B3B53C23E2
$m_{PL113}$	9F4B622C1358AE5468DC31E4B2CA320E5E20458C1DE5405BF4F9AD7D45A5BCAA39EC0626FFFC698C16A009CCCB7A18A64E85E70BA71731BA24
$m_{PL114}$	B91B2624843CF48299AFC2B1442570B41F28F578530D1E322E0B54282372131C71ACB924E70768A243EECC3200E7A5EBFA77111D9FB07FEA8AE
$m_{PL115}$	965F42DDA3A4650FE2F5103932B68F166FA424B9F0F045311D962C2A9F66B9BC6C66FB480F9800354E0C54A72251071422CF1DFC44F94C00C
$m_{PL116}$	08ADCE48699FC30FA0788073BDAADB9177BBB4C1CED41F93085218364B8BAD8488561EF0FE1B0DDAA403C602494CB35697D62AA0A2B93A64CF
$m_{PL117}$	9A313BED80B1220D77C8ADA4B2E0B3D284A5120A94B741380923C78D3AD32BC3E71EC6EEA520E9D447D8727697598BB987F17506F482003ABD
$m_{PL118}$	24C9AD4C14EFEC002A3473FCAB04E492F2E269161A2960BA8AF09FD710B444A40C4E8B138418E62301E91FBA97AFDC58759A76D00F676736C7
$m_{PL119}$	6514C7733711CE4942CD2123AB37186EB7FECB7E78ABB28744864942FCF4C0F810054AF55B1042EB53064F0857C61D85B2CF0D2DC5826AF22F
$m_{PL120}$	B2C80CDC83E48C36BC6FDAB8661208EAD392F3A0571BE41DFAD765E744932ADEA50061E66C05498A5381B2A1F1B446587089DC4E4A2DF03D82
$m_{PL121}$	639368BA75CC709A3D9F28EDA237E32C2017A9BF1E382045B9426AEE0A4049DCB4E1D7EBE4647B855212824557497CFA039885A3BA42F98F63
$m_{PL122}$	6A70DDC17D0C8024B1C853F0C1948561EF32510151BE0C63BCA9171F20217891D1021EE72586CAFF557F8973336913A9A2A699B8740B054B8
$m_{PL123}$	2E32E3A35CCD001172CE310B63B4E406126045A0FA3795BE3E3D9B56F72405FC94FD89946818BAECC24A61BABB2D23052AB01EF73CA0CF4A
$m_{PL124}$	823995C35205A480AC1351C25E234BF52D384A3DE1C5138A650A6F82F739757D812D9C38231AB9FD81AA0648B11F6F6113F9312C57624FC746
$m_{PL125}$	D98FFE19C0AAAAB0571A9075ECD3E7373F5255DC669116A8C6913F0123E598F930934C5F6A601C37C529C371A0C391B59AC5A9E286D04011

Code ID	Basic Midamble Codes $m_{PL}$ of length $P=456$
$m_{PL126}$	C1A108192BCE96C2430A63C189BB33856BE6B8B524703FCB205DAEF37EF544CD43CA09B6181B417398083FF2F781BA4AE89A5CA291DB928D71
$m_{PL127}$	42568DF9F61849BF9E7DEE750604BE2E0BC16CC464B1CDE15015E01D6498E9F3E6D6950E5824651F212BA0057CE9529B9CCAB88D8136B8545E

## A.2 Basic Midamble Codes for Burst Type 2

In the case of burst type 2 (see subclause 5.2.2) the midamble has a length of  $L_m=256$ , which is corresponding to:

$K'=3$ ;  $W=64$ ;  $P=192$ .

Depending on the possible delay spread cells are configured to use  $K_{cell}$  midambles which are generated from the Basic Midamble Codes (see table A-2)

- for all  $k=1,2,\dots,K$ ;  $K=2K'$  or
- for  $k=1,2,\dots,K'$ , only.

The cell configuration is broadcast on BCH.

The mapping of these Basic Midamble Codes to Cell Parameters is shown in TS 25.223.

**Table A-2: Basic Midamble Codes  $m_p$  according to equation (5) from subclause 6.2.3 for case of burst type 2**

Code ID	Basic Midamble Codes $m_{PS}$ of length $P=192$
$m_{PS0}$	5D253744435A24EF0ECC21F43AA5B8144FBDB348C746080C
$m_{PS1}$	9D7174187201B5CE0136B7A6D85D39A9DD8D4B00E23835E4
$m_{PS2}$	AE90B477C294E55D28467476C6011029CDE29B7325DF0683
$m_{PS3}$	BC8A44125F823E51E568641EC12A6C68EAFDFA2350E3233C
$m_{PS4}$	898B7317B830D207C9BC7B521D5715680824DC08347B2943
$m_{PS5}$	466C7482C8827655BC13F479C7C1417290679A9841297C4A
$m_{PS6}$	AC0734C27C7DC1B818A8492744290DFE866B0EBA62B0B56E
$m_{PS7}$	0A92106325B15A8C15FC3764724CE67A5056D50A77F9360E
$m_{PS8}$	AE69F62E23035083E6094B89493D33E06FDB6532D473A280
$m_{PS9}$	B485D4E3614C9C373EA1365FA6FA890E9844084EBA90EB0C
$m_{PS10}$	66182885E2D28360D2FEAB842C65304FFC956CE8DC8A90C7
$m_{PS11}$	CC30A9B0A742FCC1E9A408415368391F1299AEA3CB6509FE
$m_{PS12}$	673928915886947F464FDDAAD29A07D182328EBC5839089A
$m_{PS13}$	4418861C14D62B46EE6D70D4BF05A3ED801A01BD6CDC5235
$m_{PS14}$	DAD62DC88F52F2D140062C2330BE6540E6F86192322AFB04
$m_{PS15}$	A2122BAF24529CEA9855FB43CE40923E7CA7B30D92E40702
$m_{PS16}$	6C44AB41E11F54B0929DF65673BD231F92A380132D9F1712
$m_{PS17}$	1DC2742E756CDA6421340D0087DD087A615E4B8688CB2F75
$m_{PS18}$	2E0105328B56E9E07D9B5A62F38B08AF8D8C2817B54F3302
$m_{PS19}$	88315EC30A94CA4EDB2C77079D9BD810A2E280B50DABB213
$m_{PS20}$	440E0093D28CB2B2B0A95D18CEB4AB934C33FA45C1CFC7B0
$m_{PS21}$	CC9BF85D41A96A6EC314F9611D5E1C0672556C8850801BB4
$m_{PS22}$	1ABEA04C99BC26972715F01957C0B6B959CC71CD88120817
$m_{PS23}$	EC5A33DA0BA4470442C5CB324A8E47B0A9F7968FC8108EE8
$m_{PS24}$	F82086290271DB446B5B1DC15D9BE96414B19B3D5E0F540C
$m_{PS25}$	11A1A790D6958FD3A9157DF1E05D1378248CA201EBCC7592
$m_{PS26}$	AA8564882231907BCE78092DC6C9DD4F5A0E4A34AFCFB809
$m_{PS27}$	912EE2238212F87BC7CDA7F30441ED184A6AA954EC4D20C8
$m_{PS28}$	2D200D8B8891B804673E380A1AF5AB875986E29D37D3FDC9
$m_{PS29}$	75E086B6C818423491BF9D6365C52FD1C5E42A576E268170
$m_{PS30}$	50ADBF27DA2A3701470186B699118E16DDB0D10F705607B1
$m_{PS31}$	656C0692B4E22023590A906D2A74DFD471C883A7B1E0B3A2
$m_{PS32}$	C21FDACD09A3CDCE74C4794010A3E45769B142505C56A0E6
$m_{PS33}$	CD9392A87C2D4D7CE5801CDDA8A76339B6F900F008B290E2

Code ID	Basic Midamble Codes $m_{PS}$ of length $P=192$
$m_{PS34}$	956426FEFD8B8D52073E87984E10C4D255064E1372C04A24
$m_{PS35}$	C4F4D6DF1B754AD6063FD10C331C1428ABB27B0700134B94
$m_{PS36}$	B65548082B34E9FAF43F33C4070F79099758CFD41B491A11
$m_{PS37}$	C8317EA111A82B04E78B88B864B1EF5D711BBEB4A0527036
$m_{PS38}$	8FB7AD1188E8D1A5219845013672560FD38904E70537403B
$m_{PS39}$	B41A324E0D80AA0598A8D391C1D7FFC82B4A075218E98EC3
$m_{PS40}$	49A6350A62E208B011E86528B9A481A0E76D723F6675FF82
$m_{PS41}$	C344C8C23C42A7B7442E6022E95AE4B08A4BFA786F35F911
$m_{PS42}$	28F430CF67D69C9DF60E25656413BC5F932A022DB1406C44
$m_{PS43}$	2FA5D70CF0FED4213F32116051450391C2A627D9B670C428
$m_{PS44}$	959537D988FDD4F1360B4E84701AE5409229C30EDF8BC404
$m_{PS45}$	CDD2E0450F9EC12F81391AD4633CB29F315B4A0A890A9A22
$m_{PS46}$	158776A20B4B82C563EC08F086830EA66DBD2DCCB4DF6026
$m_{PS47}$	431FCACBE48208975950342709D11F19AD5FB047F3B440C9
$m_{PS48}$	86B141AC571BA6B42653B12FF04D4F0E6C81F3EB608660A2
$m_{PS49}$	86D297ABD34E8510F6CDB0EA617F1F1051C8799117B02211
$m_{PS50}$	80B2D9530B34E781311D95CFA3857F277CC07014D324AF5A
$m_{PS51}$	2B607B93FD8B45601C1E574E14CFC6912C22AEC1045ADC49
$m_{PS52}$	D234C5C45E105A837E6DD74BC4E534523A20317BA0625A29
$m_{PS53}$	768CCDB3E2A7A2B863128382590946B25472BE2BFFC40641
$m_{PS54}$	3DA38212E0A987EE1F665D4E13C2AA4446E00A76C948A073
$m_{PS55}$	09173135E4A2CFC8F2678750AB5257110906F013587BDE82
$m_{PS56}$	522E070B266F35E99C1F3C42D2017F8E415550492B72F086
$m_{PS57}$	D63E4BD805262A3DEF05C7D86C422E5048921E5531784132
$m_{PS58}$	564AF806E28131611E5F884229265D446A50E1E488EAFBBA
$m_{PS59}$	A2603E009D3D30147727B750C35C62299AF754D3E4A54E1C
$m_{PS60}$	938504B02599D33E28246E4271C375AE81A3BBE8D3F8A920
$m_{PS61}$	461516B2CAC6FC42A4B707CC6073BBE573C014892C811776
$m_{PS62}$	29186DE4CCAAB2CD0100BB19EA595879D63F0F0CFA881AA5
$m_{PS63}$	A064B449CB784A91B803369CDC5EF61A670AAAC044BA3E68
$m_{PS64}$	8719C454D88FF5149DB943CB6CADA01D0B9664B357A18203
$m_{PS65}$	A27EC68720F00A714AA2C45A7EF232286984D7B193F5C916
$m_{PS66}$	AC8361676AB424E48F0789082B0CD2EFB8D2E627D041DD66
$m_{PS67}$	ABA1BEB0064733A0620906BF2B29C95883F069D7E4C35D39
$m_{PS68}$	9E22EEDED47D92CA1D0B7530EC6062287BD83A04874AE00C
$m_{PS69}$	0BADEF288B20F5686C5DE3A71219AC2172054326BE831696
$m_{PS70}$	953801EB2AF58C2F80E49A6CC46085CB554243E3B3BBEC8C
$m_{PS71}$	333A504C51C8FAC5025994565C3F600F154F64FAEF4EA484
$m_{PS72}$	A6583E19647662005474153A6F8DD88A473853E94B720CE7
$m_{PS73}$	90ACAF707D18AF34F5848C58166830AF620ACDC1B2DFDDA8
$m_{PS74}$	39C5C598A374EA82F3F83378258248DAD3808812DD0E74BB
$m_{PS75}$	F79525DE694629346D73F6256CC0F140F82603197AAA1844
$m_{PS76}$	B8C2A8F139097699A693022E78588D4058DB0A65FF52F813
$m_{PS77}$	449B50C2A52996FA5A828A907F30F9F460EE3D99930DF890
$m_{PS78}$	62CEC9574D30184BCB4F94EECF0CC23D2D2A8D0003F0AA33
$m_{PS79}$	B56D258889703F76A0738EE3A7D355994159A4851833E198
$m_{PS80}$	65894AA54C0F6C9A206521C9FC379A8AAF6E621C03CF849C
$m_{PS81}$	2D47F3414E30CC02C6835D95C9BA204488F0FFCB4852677D
$m_{PS82}$	12BE4DD8B906B584010F8A330AB67B278E8642FA33D51B68
$m_{PS83}$	BC928A90A4B10906CAEE638BF768E08542F48F1676006DF0
$m_{PS84}$	30C544E437C8ADA143566CD1BC4E9E7BA84139A08505C2F4
$m_{PS85}$	84FD5B05506192B753FBA2C719B584E0EDA01814999867D2
$m_{PS86}$	191F14DD00034E03AB5BB4342F1138B2CD33784E60CFD75A
$m_{PS87}$	B8ACE7990B6A98A80A61162C4D2D5F88F24E8F7DE4207590
$m_{PS88}$	EC1DBE72E8EED0C61054FC2695422AC0AD2D888265B21AB0
$m_{PS89}$	9A1B4CA467AB7E082AF4278E44D177EA78424508C23E8B08
$m_{PS90}$	999EE541C608164AC975214F3A37A677FC2CA03E2C2A4B20
$m_{PS91}$	1BDCC20265031432917A2EB828FB356A22DF9CB609C0F8F3
$m_{PS92}$	EB4A81859C93338B8A1B87C02C815AE09D765F6F2249B958
$m_{PS93}$	E6A5D1629F4CF09A1F280DE0C480D4C73B26ADE321A50AEE
$m_{PS94}$	BAAB7286DD24C80B15A7958039B904F1CA83C310C8C7AFF2
$m_{PS95}$	12220F72619E983717C68FFE1C4148F2354B7B1955B65620
$m_{PS96}$	A198706E24FAA08BD09EE392414816038E667BB34307D6B2

Code ID	Basic Midamble Codes $m_{PS}$ of length $P=192$
$m_{PS97}$	30B3493B4C035881A7A722E4546527AAE787FA2C0893AC46
$m_{PS98}$	5A7318126522843DCB7F00A2D9F9BA8F88963E4152BC923C
$m_{PS99}$	844844B0CACAB702C332CE2692B4166F4B0C63E62BF151BF
$m_{PS100}$	B8297389526410313692F861DC60DA86A23607F7DDE24755
$m_{PS101}$	6C1144CF8BC01538D655D29ED62DE6E74A3180EC905BF1E0
$m_{PS102}$	E9DB3221FACFC5C88691A7013EF09672A130D52C3413AAE2
$m_{PS103}$	2FD0508615EC4CD4BF18ADD46D777078869130C8921A4F0E
$m_{PS104}$	40911B4E0525AC874228F6EF642E59154730CB187C7E417A
$m_{PS105}$	2034C6A027D4D850F5184AA64C3153231F4651B616BBFCF9
$m_{PS106}$	57833235451525A1DFA213FCE0B419B6494BC7B99F488410
$m_{PS107}$	6DC3D57F2E39158D036825F8804810D77CA1ECA610ECD894
$m_{PS108}$	F5C50DE43AA7B731CAB7683524021701F97650499A7070E4
$m_{PS109}$	F2184D2699785442E09FA22CC2D60A5A13FFF22AE660A470
$m_{PS110}$	EF0029DE0D79207205458CF4D7328E81A93518D93C9A74BD
$m_{PS111}$	9D6D8992482FB885AA5E878C3BA2045538B09886C23CDC2D
$m_{PS112}$	C0A5AB67D1CEA126F6476C75443F0A11CBE749412EF03104
$m_{PS113}$	1853A5C20CDF968C5A180D8EB5E72BF15517D06680D98412
$m_{PS114}$	8CEA1223227ADF37D0DAAB320906E1C79029F480D25181A7
$m_{PS115}$	5561038E96A658EF3EC665612FF92B064065D1ACC1F54812
$m_{PS116}$	C55A6263F08D664A1E53584560DFF5E611640D8281D9A843
$m_{PS117}$	4386A8EA59124D043F29056A4598735A4FC7BC11119B90C1
$m_{PS118}$	D6571B20668BED50BD7C80388C162632BCB069AA67C7FC22
$m_{PS119}$	4F9F09ABBC1391EC2CCA5359FB52250E533BF04324154106
$m_{PS120}$	662659F42188C9453F6E6DF00C579627045DA1461A3A0EA5
$m_{PS121}$	8DCC9274C0C2A9BA6096BF27FACA542CD01CA8653D60A80F
$m_{PS122}$	5C1210A1E50E505F6B73C90156C9D9F19AE2310BBD820DF0
$m_{PS123}$	B1E0A7CE26202E223D4FC06D5C9BBA4E5F6D98204D2D5286
$m_{PS124}$	DB506776958E34552F7E60E4B400D836153218F918E22FA6
$m_{PS125}$	ECAA60300439B2360B2AC3C43FB6241ACDE5055B295FA71C
$m_{PS126}$	BF1E6D9AA9CA4AC092BE60500C77D0DC7A6A236520F86722
$m_{PS127}$	051C5FA122845A30B4EC306B38016B45667C7754F92F13A0

## A.3 Association between Midambles and Channelisation Codes

The following mapping schemes apply for the association between midambles and channelisation codes if no midamble is allocated by higher layers. Secondary channelisation codes are marked with a (\*). These associations apply both for UL and DL.

### A.3.1 Association for Burst Type 1/3 and $K_{Cell} = 16$ Midambles

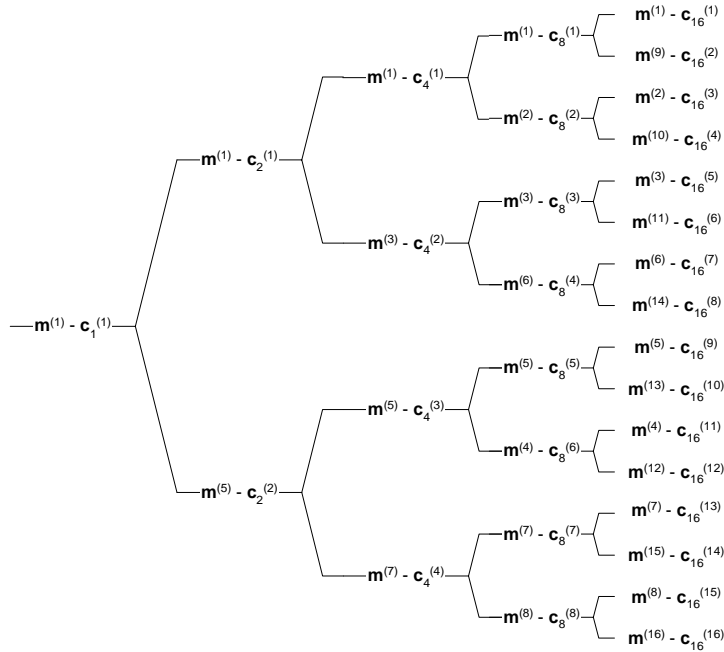

Figure A-1: Association of Midambles to Spreading Codes for Burst Type 1/3 and  $K_{Cell} = 16$



### A.3.2 Association for Burst Type 1/3 and $K_{Cell}=8$ Midambles

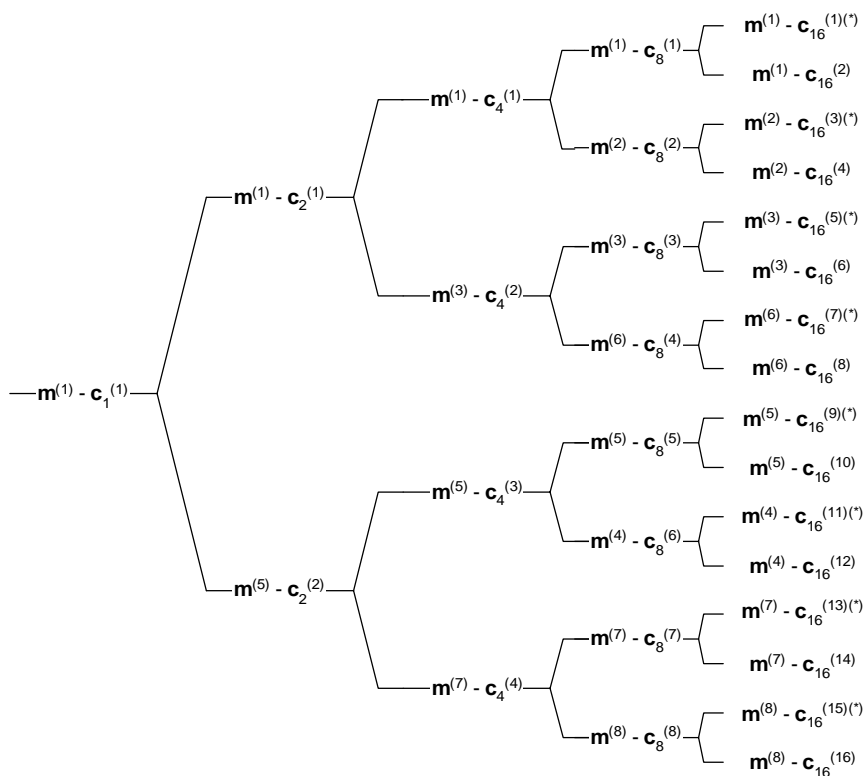

Figure A-2: Association of Midambles to Spreading Codes for Burst Type 1/3 and  $K_{Cell}=8$

### A.3.3 Association for Burst Type 1/3 and $K_{Cell}=4$ Midambles

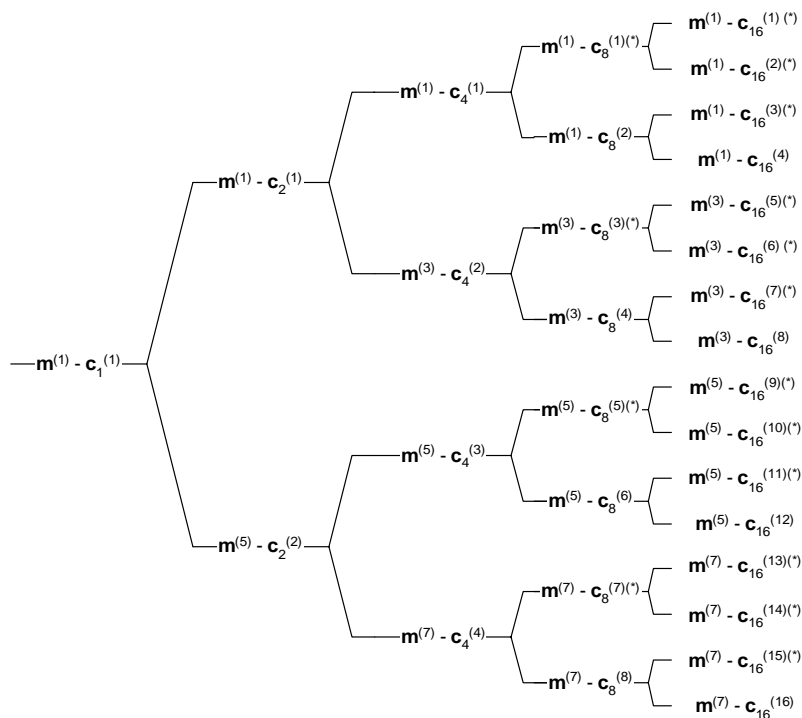

Figure A-3: Association of Midambles to Spreading Codes for Burst Type 1/3 and  $K_{Cell}=4$

### A.3.4 Association for Burst Type 2 and $K_{Cell}=6$ Midambles

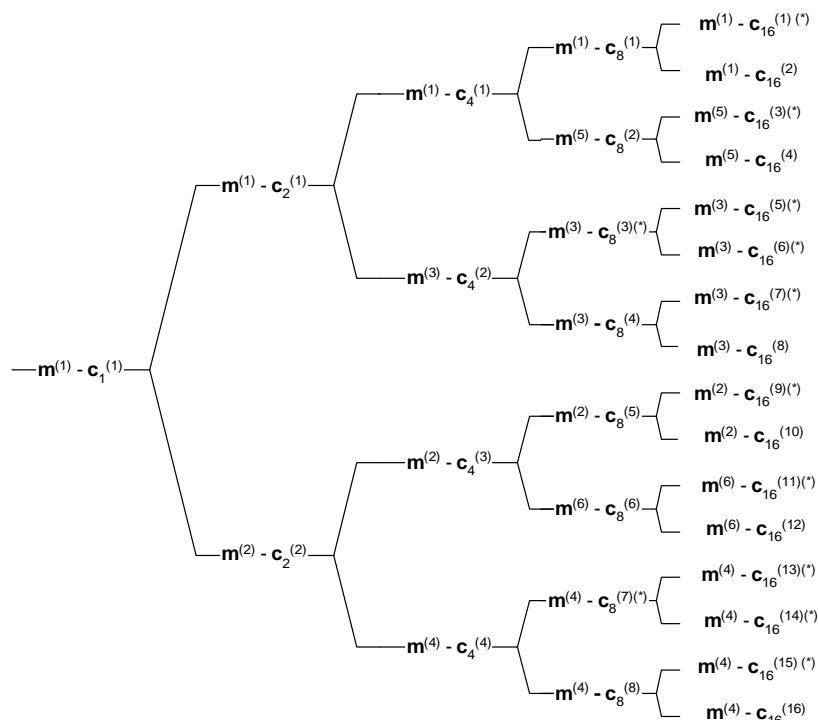

Figure A-4: Association of Midambles to Spreading Codes for Burst Type 2 and  $K_{Cell}=6$

### A.3.5 Association for Burst Type 2 and $K_{Cell}=3$ Midambles

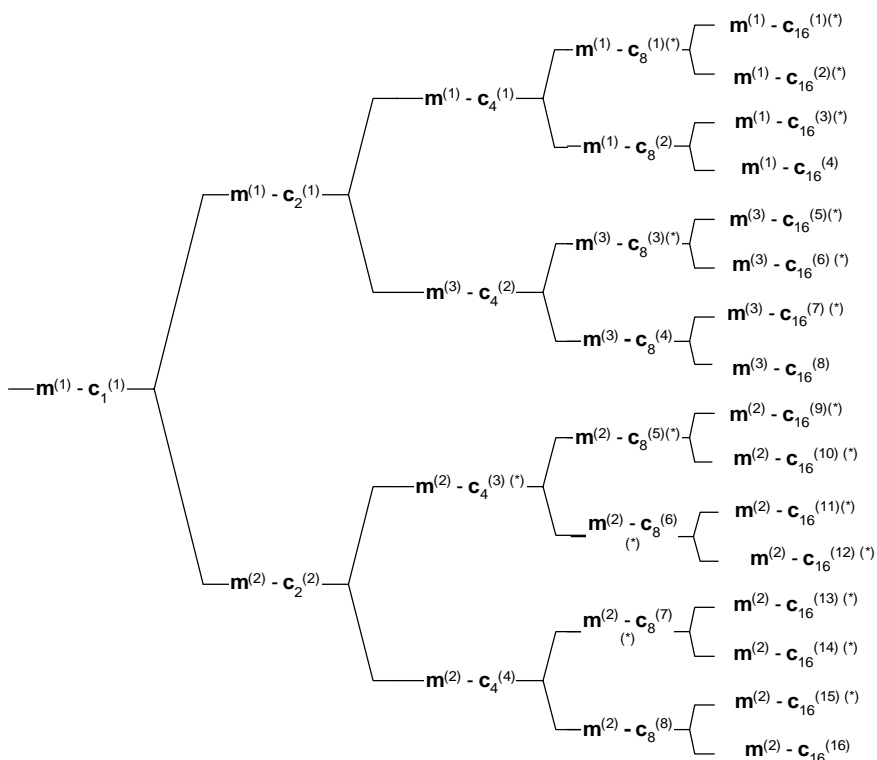

Figure A-5: Association of Midambles to Spreading Codes for Burst Type 2 and  $K_{Cell}=3$

Note that the association for burst type 2 can be derived from the association for burst type 1 and 3, using the following table:

Burst Type 1/3	m(1)	m(2)	m(3)	m(4)	m(5)	m(6)	m(7)	m(8)
Burst Type 2	m(1)	m(5)	m(3)	m(6)	m(2)	m(4)	-	-

---

## Annex B (normative): Basic Midamble Codes for the 1.28 Mcps option

### B.1 Basic Midamble Codes

The midamble has a length of  $L_m=144$ , which is corresponding to:

$$K=2, 4, 6, 8, 10, 12, 14, 16, \quad W = \left\lfloor \frac{P}{K} \right\rfloor, P=128$$

Note: that  $\lfloor x \rfloor$  denotes the largest integer number less or equal to  $x$ .

Depending on the possible delay spread cells are configured to use midambles which are generated from the Basic Midamble Codes (see table B.1). The cell configuration is broadcast on BCH.

The mapping of these Basic Midamble Codes to Cell Parameters is shown in [8].

Table B.1: Basic Midamble Codes  $m_p$  according to equation (5) from subclause 6.2.3

Code ID	Basic Midamble Codes $m_p$ of length $P=128$
$m_{P0}$	B2AC420F7C8DEBFA69505981BCD028C3
$m_{P1}$	0C2E988E0DBA046643F57B0EA6A435E2
$m_{P2}$	D5CEC680C36A4454135F86DD37043962
$m_{P3}$	E150D08CAC2A00FF9B32592A631CF85B
$m_{P4}$	E0A9C3A8F6E40329B2F2943246003D44
$m_{P5}$	FE22658100A3A683EA759018739BD690
$m_{P6}$	B46062F89BB2A1139D76A1EF32450DA0
$m_{P7}$	EE63D75CC099092579400D956A90C3E0
$m_{P8}$	D9C0E040756D427A2611DAA35E6CD614
$m_{P9}$	EB56D03A498EC4FEC98AE220BC390450
$m_{P10}$	F598703DB0838112ED0BABB98642B665
$m_{P11}$	A0BC26A992D4558B9918986C14861EFF
$m_{P12}$	541350D109F1DD68099796637B824F88
$m_{P13}$	892D344A962314662F01F9455F7BC302
$m_{P14}$	49F270E29CCD742A40480DD4215E1632
$m_{P15}$	6A5C0410C6C39AA04E77423C355926DE
$m_{P16}$	7976615538203103D4DBCC219B16A9E1
$m_{P17}$	A6C3C3175845400BD2B738C43EE2645F
$m_{P18}$	A0FD56258D228642C6F641851C3751ED
$m_{P19}$	EFA48C3FC84AC625783C6C9510A2269A
$m_{P20}$	62A8EB1A420334B23396E8D76BC19740
$m_{P21}$	9E96235699D5D41C9816C921023BC741
$m_{P22}$	4362AE4CAE0DCC32D60A3FED1341A848
$m_{P23}$	454C068E6C4F190942E0904B95D61DFB
$m_{P24}$	607FEEA6E2E99206718A49C0D6A25034
$m_{P25}$	E1D1BCDA39A09095B5C81645103A077C
$m_{P26}$	994B445E558344DE211C8286DDD3D1A3
$m_{P27}$	C15233273581417638906ADB61FDCA3C
$m_{P28}$	8B79A274D542F096FB1388098230F8A1
$m_{P29}$	DF58AC1C5F44B2A40266385CE1DA5640
$m_{P30}$	B5949A1CC69962C464401D05FF5C1A7A
$m_{P31}$	85AC489841ED3EAA2D83BBB0039CC707
$m_{P32}$	AE371CC144BC95923CA8108D8B49FE82
$m_{P33}$	7F188484A649D1C22BDA1F09D49B5117
$m_{P34}$	ADAA3C657089DEF7C0284903A491C9B0
$m_{P35}$	C3F96893C7504DC3B51488604AF64F4C
$m_{P36}$	B4002F5AE0CE8623AC979D368E9148C1
$m_{P37}$	0EEBCC0C795C02A106C24ABB36D08C6E
$m_{P38}$	4B0F537E384A893F58971580D9894433
$m_{P39}$	08E0035AB29B7ECC53C15DAA0687CC8F
$m_{P40}$	8611ACBC4C82781D77654EE862506D60
$m_{P41}$	63315261A8F1CB02549802DBFD197C07
$m_{P42}$	9A2609A434F43E7DCADC0E22B2EF4012
$m_{P43}$	F4C9F0A127A88461209ABF8C69CE4D00
$m_{P44}$	C79124EE3FFC28C5C4524D2B01670D42
$m_{P45}$	C91985C4FED53D09361914354BA80E79
$m_{P46}$	82AA517260779ECFF26212C1A10BDC29
$m_{P47}$	561DE2040ACB458E0DBD354E43E111D9
$m_{P48}$	2E58C7202D17392BC1235782CEFABB09
$m_{P49}$	C4FAA121C698047650F6503126A577C1
$m_{P50}$	E7B75206A9B410E44346E0DAE842A23C
$m_{P51}$	3F8B1C32682B28D098D3805ED130EA7F
$m_{P52}$	8D5FC2C1C6715F824B401434C8D4BB82
$m_{P53}$	0B2A43453ACC028FE6EB6E1CB0740B59
$m_{P54}$	BC56948FC700BA4883262EE73E12D82A
$m_{P55}$	558D136710272912FA4F183D1189A7FD
$m_{P56}$	5709E7F82DC6500B7B12A3072D182645
$m_{P57}$	86D4F161C844AE5E20EE39FD5493B044
$m_{P58}$	8729B6EDC382B152185885F013DAE222
$m_{P59}$	154C45B50720F4C362C14C77FE8335A1
$m_{P60}$	C6A0962890351F4EB802DE43A7662C9E

mP61	D19D69D6B380B4B22457CB80033519F0
mP62	C7D89509FB0DAE9255998E0A00C2B262
mP63	DFD481C652C0C905D61D66F1732C4AA2
mP64	06C848619AF1D6C910A8EAC4B622FC06
mP65	0635E29D4E7AC8ABC189890241F45ECA
mP66	B272B020586AAD7B093AC2F459076638
mP67	B608ACE46E1A6BC96181EEDD88B54140
mP68	0A516092B3ED7849B168AFE223B8670E
mP69	D1A658C5009E04D0D7D5E9205EE663E8
mP70	AC316DC39B91EB60B1AABD8280740432
mP71	E3F06825476A026CD287625E514519FC
mP72	A56D092080DDE8994F387C175CC56833
mP73	15EA799DE587C506D0CD99A408217B05
mP74	A59C020BAB9AF6D3F813C391CA244CD2
mP75	74B0101EB9F3167434B94BABC8378882
mP76	CE752975C8DA9B0100386DB82A8C3D20
mP77	BBB38DCDB1E9118570AC147DC05241A4
mP78	944ABBF0866098101F6971731AB2E986
mP79	2BB147B2A30C68B4853F90481A166EB6
mP80	444840ACCF3F23C45B56D7704BF18283
mP81	87604F7450D1AD188C452981A5C7FC9B
mP82	8C3842EBC948A65BC4C8B387F11B7090
mP83	10B4767D071CF5DB2288E4029576135A
mP84	6F07AAB697CD0089572C6B062E2018E4
mP85	D3D65B442057E613A8655060C8D29E27
mP86	5EDA330514C604BF4E0894E09EC57A74
mP87	B0899CD094060724DED82AE85F18A43A
mP88	B2D999B86DF902BC25015CAE3A0823C4
mP89	C23CD40F04242B92D46EED82CD9A9A18
mP90	D22DDCC5CB82960125DD24655F3C8788
mP91	54987218FBD99AE4340FD4C9458E9850
mP92	BE4341822997A7B11EA1E8A1A2767005
mP93	255200FBA6EE48E6DE0A82B0461B8D0F
mP94	6FBD58A663932423503690CF9C171701
mP95	D215033A4AA87EC1C232BAC7EDA09370
mP96	CA0959B01AE48E80204F1E4A3F29CE55
mP97	582043413B9B825903E3A3545ED59463
mP98	5016541922971C703D16E284CBDF633B
mP99	7347EF160A1733CA98D43608A83A920B
mP100	908B22AD433CCA00B3FD47C691F1A290
mP101	BB22A272FC6923DF1B43BA4118806570
mP102	0FA75C87474836B47DC7624D61193802
mP103	A22EBA0658A4D0FF1E9CA5030A65CC06
mP104	6C9C51CA15F1F4981F4C46180A6A6697
mP105	4C847ACF8BC15359C405322851C9BDE2
mP106	C1D29499C0082C9DE473ED15B14D63E0
mP107	7E85ECC98AC761005076C5572869A431
mP108	D8F11121595B8F49F78A7039E44126A0
mP109	1A0BC814445FD71C8E5B1A9163ED2059
mP110	A7591F27F8B0C00C68CC41697954FA04
mP111	6CA2CE595E7406D79C4840183D41B9D0
mP112	C093D3CC701FC20E66F5AB22516C5460
mP113	D0E0CDE9B595546B96C4F8066B469020
mP114	E99F743A451431C8B427054A4E6F2007
mP115	C0D21A344A2C07DF2A6EBE6250C7B91E
mP116	F031223E282CF7A4D8EF174A908668AE
mP117	E4BD244AC16C55C7137FB068FD44280C
mP118	C44920DE2028F19FC2AAB36A0DCFDAD0
mP119	3FA7054E77135250699E6C8A11600742
mP120	D5740B4D8870C1C5B5A214C4266FC537
mP121	F0B7942D43BB6F38446442EB8126AB80
mP122	83DB9534EAD6238FA8968798CDF04848
mP123	EB9663CDDC2B291690703125BABC800
mP124	84D547225D4BBD20DEF1A583240C6E0F

m <sub>P125</sub>	B51F6A771838BE934724AEA6A2669802
m <sub>P126</sub>	D92AC05E10496794BBDC115233B1C068
m <sub>P127</sub>	D3ACF0078EDA9856BBB0AF8651132103

## B.2 Association between Midambles and Channelisation Codes

The following mapping schemes apply for the association between midambles and channelisation codes if no midamble is allocated by higher layers. Secondary channelisation codes are marked with (\*). These associations apply for both UL and DL.

### B.2.1 Association for K=16 Midambles

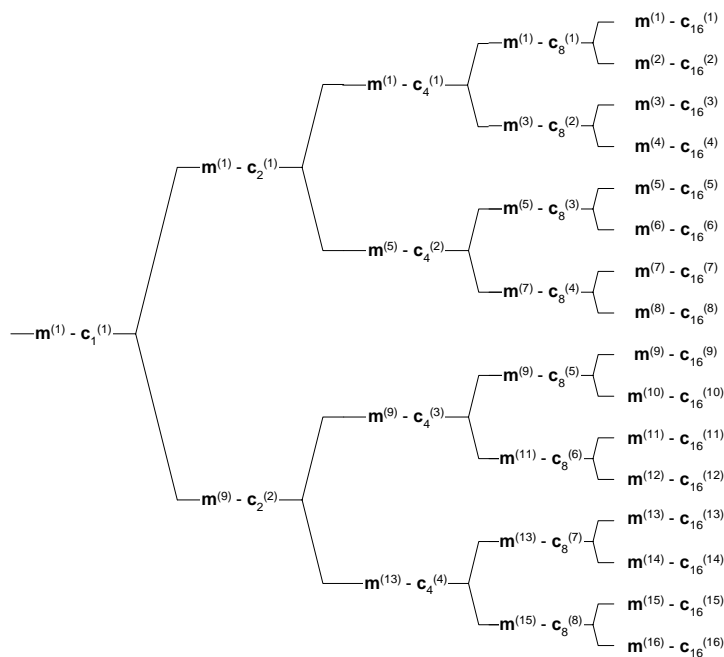

Figure B.2.1: Association of Midambles to Spreading Codes for K=16

### B.2.2 Association for K=14 Midambles

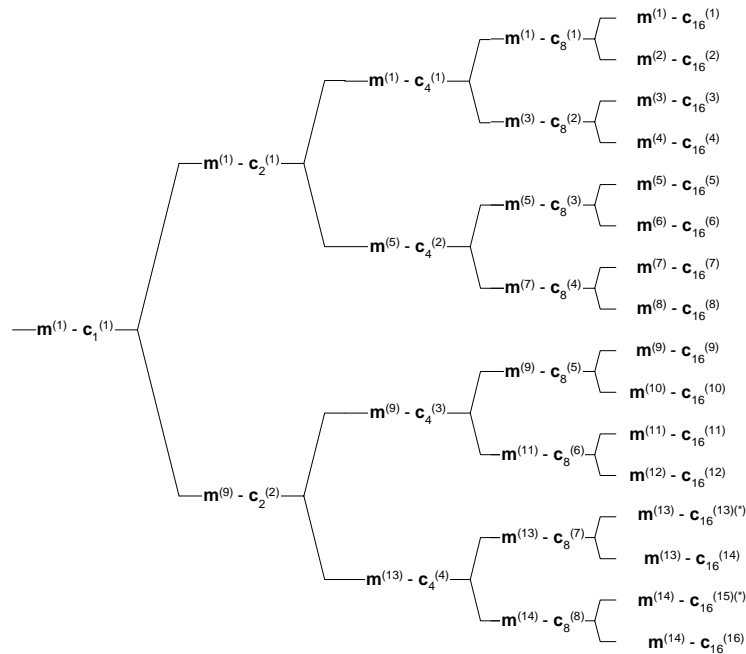

Figure B.2.2: Association of Midambles to Spreading Codes for K=14

### B.2.3 Association for K=12 Midambles

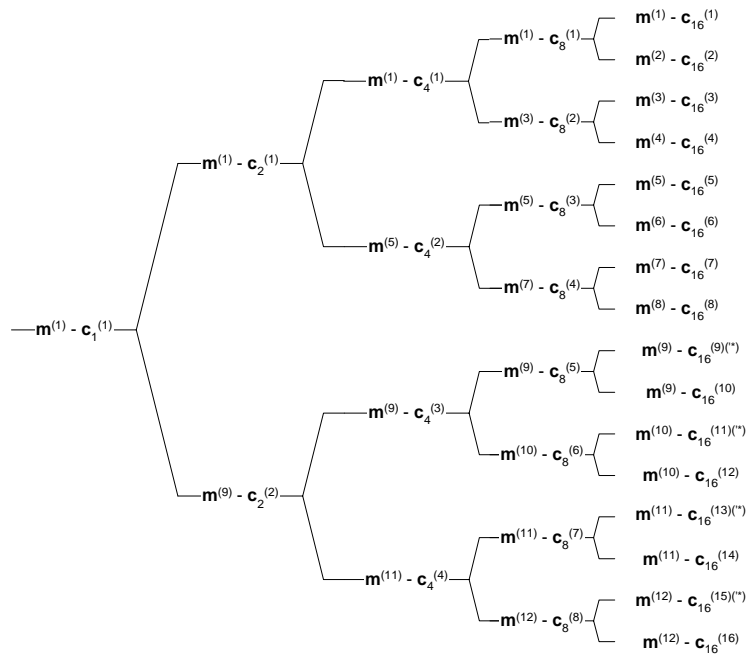

Figure B.2.3: Association of Midambles to Spreading Codes for K=12



### B.2.4 Association for K=10 Midambles

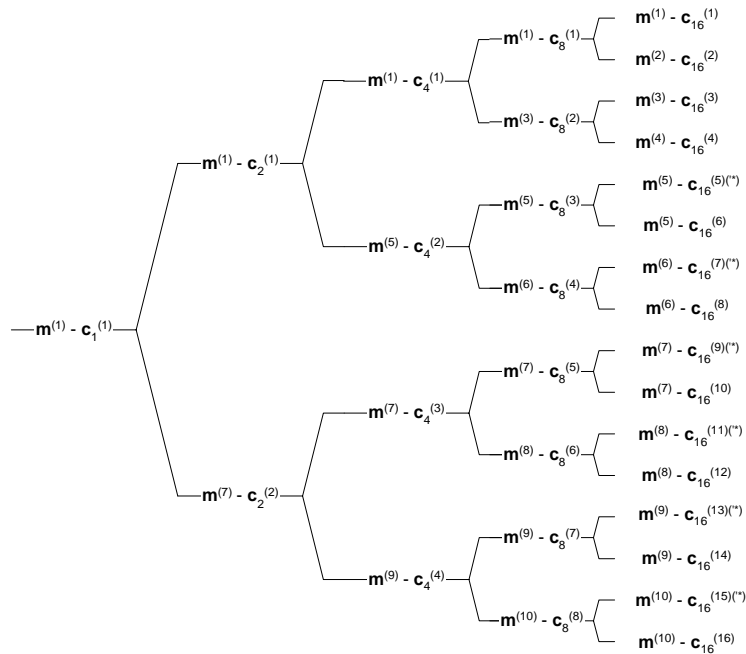

Figure B.2.4: Association of Midambles to Spreading Codes for K=10

### B.2.5 Association for K=8 Midambles

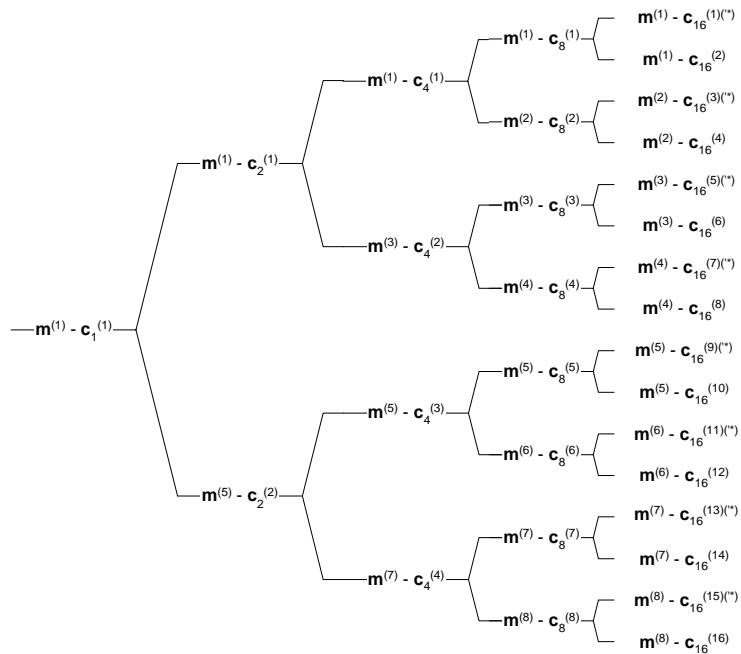

Figure B.2.5: Association of Midambles to Spreading Codes for K=8

### B.2.6 Association for K=6 Midambles

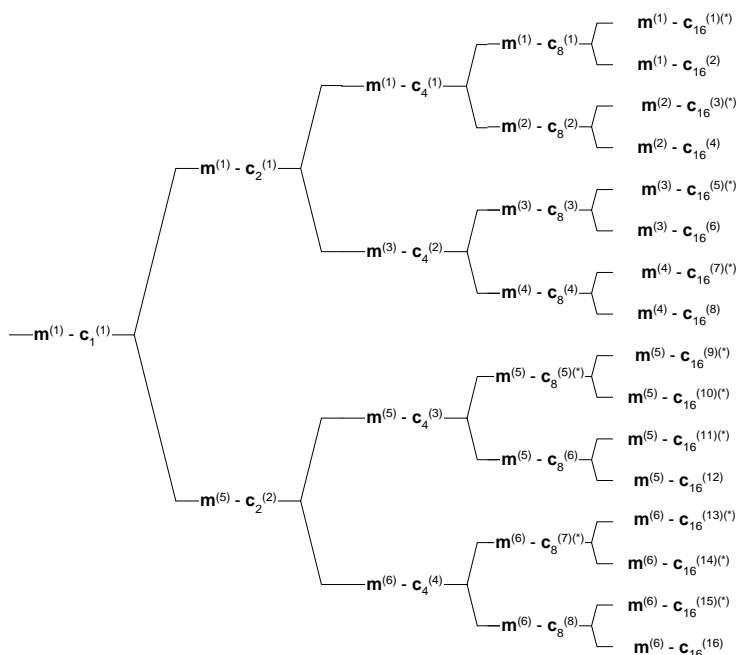

Figure B.2.6: Association of Midambles to Spreading Codes for K=6

### B.2.7 Association for K=4 Midambles

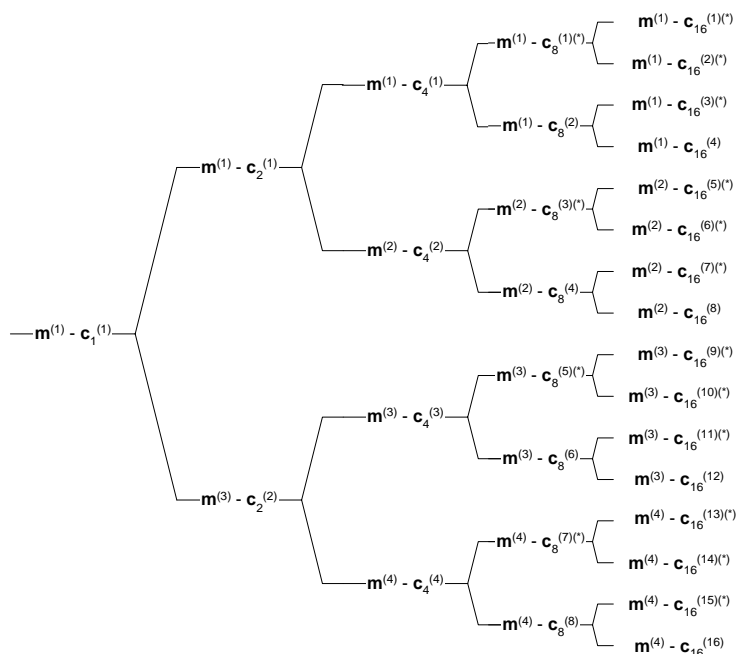

Figure B.2.7: Association of Midambles to Spreading Codes for K=4

### B.2.8 Association for K=2 Midambles

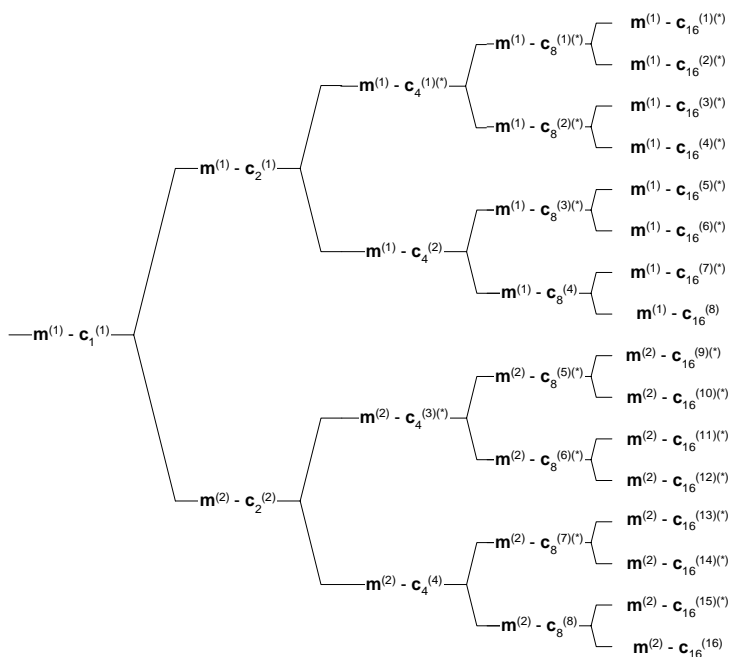

Figure B.2.8: Association of Midambles to Spreading Codes for K=2

## Annex C (normative): Signalling of the number of channelisation codes for the DL common midamble case for 3.84Mcps TDD

The following mapping schemes shall apply for the association between the number of channelisation codes employed in a timeslot and the use of a particular midamble shift in the DL common midamble case. In the following tables the presence of a particular midamble shift is indicated by '1'. Midamble shifts marked with '0' are left unused. Mapping schemes C.4, C.5 and C.6 are not applicable to beacon timeslots where a P-CCPCH is present, because the default midamble allocation scheme is applied to these timeslots. Note that in mapping schemes C.4, C.5 and C.6, the fixed and pre-allocated channelisation code for the beacon channel is included into the number of indicated channelisation codes.

### C.1 Mapping scheme for Burst Type 1 and $K_{Cell}=16$ Midambles

m1	m2	m3	m4	m5	m6	m7	M8	m9	m10	m11	m12	m13	m14	m15	m16	
1	0	0	0	0	0	0	0	0	0	0	0	0	0	0	0	1 code
0	1	0	0	0	0	0	0	0	0	0	0	0	0	0	0	2 codes
0	0	1	0	0	0	0	0	0	0	0	0	0	0	0	0	3 codes
0	0	0	1	0	0	0	0	0	0	0	0	0	0	0	0	4 codes
0	0	0	0	1	0	0	0	0	0	0	0	0	0	0	0	5 codes
0	0	0	0	0	1	0	0	0	0	0	0	0	0	0	0	6 codes
0	0	0	0	0	0	1	0	0	0	0	0	0	0	0	0	7 codes
0	0	0	0	0	0	0	1	0	0	0	0	0	0	0	0	8 codes
0	0	0	0	0	0	0	0	1	0	0	0	0	0	0	0	9 codes
0	0	0	0	0	0	0	0	0	1	0	0	0	0	0	0	10 codes
0	0	0	0	0	0	0	0	0	0	1	0	0	0	0	0	11 codes
0	0	0	0	0	0	0	0	0	0	0	1	0	0	0	0	12 codes
0	0	0	0	0	0	0	0	0	0	0	0	1	0	0	0	13 codes
0	0	0	0	0	0	0	0	0	0	0	0	0	1	0	0	14 codes
0	0	0	0	0	0	0	0	0	0	0	0	0	0	1	0	15 codes
0	0	0	0	0	0	0	0	0	0	0	0	0	0	0	1	16 codes

### C.2 Mapping scheme for Burst Type 1 and $K_{Cell}=8$ Midambles

M1	m2	m3	m4	m5	m6	m7	m8	
1	0	0	0	0	0	0	0	1 code or 9 codes
0	1	0	0	0	0	0	0	2 codes or 10 codes
0	0	1	0	0	0	0	0	3 codes or 11 codes
0	0	0	1	0	0	0	0	4 codes or 12 codes
0	0	0	0	1	0	0	0	5 codes or 13 codes
0	0	0	0	0	1	0	0	6 codes or 14 codes
0	0	0	0	0	0	1	0	7 codes or 15 codes
0	0	0	0	0	0	0	1	8 codes or 16 codes

### C.3 Mapping scheme for Burst Type 1 and $K_{Cell}=4$ Midambles

m1	m3	m5	m7	
1	0	0	0	1 or 5 or 9 or 13 codes
0	1	0	0	2 or 6 or 10 or 14 codes
0	0	1	0	3 or 7 or 11 or 15 codes
0	0	0	1	4 or 8 or 12 or 16 codes

### C.4 Mapping scheme for beacon timeslots and $K_{Cell}=16$ Midambles

m1	m2	m3	M4	m5	m6	m7	M8	m9	m10	m11	M12	m13	m14	m15	m16	
1	$x^{(1)}$	0	0	0	0	0	0	0	0	0	0	0	0	0	0	1 code (see note 1)
1	1	0	0	0	0	0	0	0	0	0	0	0	0	0	0	2 codes (SCTD applied to PICH in this time slot, see note 2)
1	$x^{(1)}$	1	0	0	0	0	0	0	0	0	0	0	0	0	0	13 codes
1	$x^{(1)}$	0	1	0	0	0	0	0	0	0	0	0	0	0	0	2 codes (SCTD not applied to PICH in this time slot) or 14 codes
1	$x^{(1)}$	0	0	1	0	0	0	0	0	0	0	0	0	0	0	3 codes or 15 codes
1	$x^{(1)}$	0	0	0	1	0	0	0	0	0	0	0	0	0	0	4 codes or 16 codes
1	$x^{(1)}$	0	0	0	0	1	0	0	0	0	0	0	0	0	0	5 codes
1	$x^{(1)}$	0	0	0	0	0	1	0	0	0	0	0	0	0	0	6 codes
1	$x^{(1)}$	0	0	0	0	0	0	1	0	1	0	0	0	0	0	7 codes
1	$x^{(1)}$	0	0	0	0	0	0	0	0	0	1	0	0	0	0	8 codes
1	$x^{(1)}$	0	0	0	0	0	0	0	0	0	0	1	0	0	0	9 codes
1	$x^{(1)}$	0	0	0	0	0	0	0	0	0	0	0	1	0	0	10 codes
1	$x^{(1)}$	0	0	0	0	0	0	0	0	0	0	0	0	1	0	11 codes
1	$x^{(1)}$	0	0	0	0	0	0	0	0	0	0	0	0	0	1	12 codes

<sup>(\*)</sup> For the case of SCTD applied to P-CCPCH and PICH, midamble shift 2 is used by the diversity antenna.

Note 1: If only one code is present in a beacon time slot, this code is a beacon channel and the beacon channel is the only channel in this slot, by default. Therefore, only the beacon midamble(s) shall be used.

Note 2: If SCTD is applied to the PICH and only two codes are present in a beacon time slot, the PICH is the beacon channel and the beacon channel is the only channel in this slot, by default. Therefore, only the beacon midambles shall be used.

## C.5 Mapping scheme for beacon timeslots and $K_{\text{Cell}}=8$ Midambles

m1	m2	m3	m4	m5	m6	m7	M8	
1	$x^{(*)}$	0	0	0	0	0	0	1 code (see note 1)
1	1	0	0	0	0	0	0	2 codes (SCTD applied to PICH in this time slot, see note 2)
1	$x^{(*)}$	1	0	0	0	0	0	7 or 13 codes
1	$x^{(*)}$	0	1	0	0	0	0	2 (SCTD not applied to PICH in this time slot) or 8 or 14 codes
1	$x^{(*)}$	0	0	1	0	0	0	3 or 9 or 15 codes
1	$x^{(*)}$	0	0	0	1	0	0	4 or 10 or 16 codes
1	$x^{(*)}$	0	0	0	0	1	0	5 codes or 11 codes
1	$x^{(*)}$	0	0	0	0	0	1	6 codes or 12 codes

(\*) For the case of SCTD applied to P-CCPCH and PICH, midamble shift 2 is used by the diversity antenna.

Note 1: If only one code is present in a beacon time slot, this code is a beacon channel and the beacon channel is the only channel in this slot, by default. Therefore, only the beacon midamble(s) shall be used.

Note 2: If SCTD is applied to the PICH and only two codes are present in a beacon time slot, the PICH is the beacon channel and the beacon channel is the only channel in this slot, by default. Therefore, only the beacon midambles shall be used.

## C.6 Mapping scheme for beacon timeslots and $K_{\text{Cell}}=4$ Midambles

m1	m3	m5	m7	
1	0	0	0	1code (see note 1)
1	1	0	0	4 or 7 or 10 or 13 or 16 codes
1	0	1	0	2 or 5 or 8 or 11 or 14 codes
1	0	0	1	3 or 6 or 9 or 12 or 15 codes

Note 1: If only one code is present in a beacon time slot, this code is a beacon channel and the beacon channel is the only channel in this slot, by default. Therefore, only the beacon midamble shall be used.

## C.7 Mapping scheme for Burst Type 2 and $K_{\text{Cell}}=6$ Midambles

m1	m2	m3	m4	m5	m6	
1	0	0	0	0	0	1 or 7 or 13 codes
0	1	0	0	0	0	2 or 8 or 14 codes
0	0	1	0	0	0	3 or 9 or 15 codes
0	0	0	1	0	0	4 or 10 or 16 codes
0	0	0	0	1	0	5 or 11 codes
0	0	0	0	0	1	6 or 12 codes

---

## C.8 Mapping scheme for Burst Type 2 and $K_{\text{Cell}}=3$ Midambles

m1	m2	m3	
1	0	0	1 or 4 or 7 or 10 or 13 or 16 codes
0	1	0	2 or 5 or 8 or 11 or 14 codes
0	0	1	3 or 6 or 9 or 12 or 15 codes

## Annex D (normative):

### Signalling of the number of channelisation codes for the DL common midamble case for 1.28Mcps TDD

The following mapping schemes shall apply for the association between the number of channelisation codes employed in a timeslot and the use of a particular midamble shift in the DL common midamble case. In the following tables the presence of a particular midamble shift is indicated by '1'. Midamble shifts marked with '0' are left unused.

#### D.1 Mapping scheme for K=16 Midambles

m1	m2	m3	m4	m5	m6	M7	M8	m9	m10	m11	m12	M13	m14	m15	m16	
1	0	0	0	0	0	0	0	0	0	0	0	0	0	0	0	1 code
0	1	0	0	0	0	0	0	0	0	0	0	0	0	0	0	2 codes
0	0	1	0	0	0	0	0	0	0	0	0	0	0	0	0	3 codes
0	0	0	1	0	0	0	0	0	0	0	0	0	0	0	0	4 codes
0	0	0	0	1	0	0	0	0	0	0	0	0	0	0	0	5 codes
0	0	0	0	0	1	0	0	0	0	0	0	0	0	0	0	6 codes
0	0	0	0	0	0	1	0	0	0	0	0	0	0	0	0	7 codes
0	0	0	0	0	0	0	1	0	0	0	0	0	0	0	0	8 codes
0	0	0	0	0	0	0	0	1	0	0	0	0	0	0	0	9 codes
0	0	0	0	0	0	0	0	0	1	0	0	0	0	0	0	10 codes
0	0	0	0	0	0	0	0	0	0	1	0	0	0	0	0	11 codes
0	0	0	0	0	0	0	0	0	0	0	1	0	0	0	0	12 codes
0	0	0	0	0	0	0	0	0	0	0	0	1	0	0	0	13 codes
0	0	0	0	0	0	0	0	0	0	0	0	0	1	0	0	14 codes
0	0	0	0	0	0	0	0	0	0	0	0	0	0	1	0	15 codes
0	0	0	0	0	0	0	0	0	0	0	0	0	0	0	1	16 codes

#### D.2 Mapping scheme for K=14 Midambles

m1	m2	m3	m4	m5	m6	M7	M8	m9	m10	m11	m12	M13	m14	
1	0	0	0	0	0	0	0	0	0	0	0	0	0	1 or 15 code(s)
0	1	0	0	0	0	0	0	0	0	0	0	0	0	2 or 16 codes
0	0	1	0	0	0	0	0	0	0	0	0	0	0	3 codes
0	0	0	1	0	0	0	0	0	0	0	0	0	0	4 codes
0	0	0	0	1	0	0	0	0	0	0	0	0	0	5 codes
0	0	0	0	0	1	0	0	0	0	0	0	0	0	6 codes
0	0	0	0	0	0	1	0	0	0	0	0	0	0	7 codes
0	0	0	0	0	0	0	1	0	0	0	0	0	0	8 codes
0	0	0	0	0	0	0	0	1	0	0	0	0	0	9 codes
0	0	0	0	0	0	0	0	0	1	0	0	0	0	10 codes
0	0	0	0	0	0	0	0	0	0	1	0	0	0	11 codes
0	0	0	0	0	0	0	0	0	0	0	1	0	0	12 codes
0	0	0	0	0	0	0	0	0	0	0	0	1	0	13 codes
0	0	0	0	0	0	0	0	0	0	0	0	0	1	14 codes



### D.3 Mapping scheme for K=12 Midambles

m1	m2	m3	m4	m5	m6	M7	M8	m9	m10	m11	m12	
1	0	0	0	0	0	0	0	0	0	0	0	1 or 13 code(s)
0	1	0	0	0	0	0	0	0	0	0	0	2 or 14 codes
0	0	1	0	0	0	0	0	0	0	0	0	3 or 15 codes
0	0	0	1	0	0	0	0	0	0	0	0	4 or 16 codes
0	0	0	0	1	0	0	0	0	0	0	0	5 codes
0	0	0	0	0	1	0	0	0	0	0	0	6 codes
0	0	0	0	0	0	1	0	0	0	0	0	7 codes
0	0	0	0	0	0	0	1	0	0	0	0	8 codes
0	0	0	0	0	0	0	0	1	0	0	0	9 codes
0	0	0	0	0	0	0	0	0	1	0	0	10 codes
0	0	0	0	0	0	0	0	0	0	1	0	11 codes
0	0	0	0	0	0	0	0	0	0	0	1	12 codes

### D.4 Mapping scheme for K=10 Midambles

m1	m2	m3	m4	m5	m6	M7	M8	m9	m10	
1	0	0	0	0	0	0	0	0	0	1 or 11 code(s)
0	1	0	0	0	0	0	0	0	0	2 or 12 codes
0	0	1	0	0	0	0	0	0	0	3 or 13 codes
0	0	0	1	0	0	0	0	0	0	4 or 14 codes
0	0	0	0	1	0	0	0	0	0	5 or 15 codes
0	0	0	0	0	1	0	0	0	0	6 or 16 codes
0	0	0	0	0	0	1	0	0	0	7 codes
0	0	0	0	0	0	0	1	0	0	8 codes
0	0	0	0	0	0	0	0	1	0	9 codes
0	0	0	0	0	0	0	0	0	1	10 codes

### D.5 Mapping scheme for K=8 Midambles

m1	m2	m3	m4	m5	m6	m7	m8	
1	0	0	0	0	0	0	0	1 or 9 code(s)
0	1	0	0	0	0	0	0	2 or 10 codes
0	0	1	0	0	0	0	0	3 or 11 codes
0	0	0	1	0	0	0	0	4 or 12 codes
0	0	0	0	1	0	0	0	5 or 13 codes
0	0	0	0	0	1	0	0	6 or 14 codes
0	0	0	0	0	0	1	0	7 or 15 codes
0	0	0	0	0	0	0	1	8 or 16 codes

### D.6 Mapping scheme for K=6 Midambles

m1	m2	m3	m4	m5	m6	
1	0	0	0	0	0	1 or 7 or 13 code(s)
0	1	0	0	0	0	2 or 8 or 14 codes
0	0	1	0	0	0	3 or 9 or 15 codes
0	0	0	1	0	0	4 or 10 or 16 codes
0	0	0	0	1	0	5 or 11 codes
0	0	0	0	0	1	6 or 12 codes

---

## D.7 Mapping scheme for K=4 Midambles

m1	m2	m3	m4	
1	0	0	0	1 or 5 or 9 or 13 code(s)
0	1	0	0	2 or 6 or 10 or 14 codes
0	0	1	0	3 or 7 or 11 or 15 codes
0	0	0	1	4 or 8 or 12 or 16 codes

---

## D.8 Mapping scheme for K=2 Midambles

m1	m2	
1	0	1 or 3 or 5 or 7 or 9 or 11 or 13 or 15 code(s)
0	1	2 or 4 or 6 or 8 or 10 or 12 or 14 or 16 codes

---

## Annex E (informative): CCPCH Multiframe Structure for the 3.84 Mcps option

In the following figures C.1 to C.3 some examples for Multiframe Structures on Primary and Secondary CCPCH are given. The figures show the placement of Common Transport Channels on the Common Control Physical Channels. Additional S-CCPCH capacity can be allocated on other codes and timeslots of course, e.g. FACH capacity is related to overall cell capacity and can be configured according to the actual needs. Channel capacities in the annex are derived using bursts with long midambles (Burst format 1). Every TrCH-box in the figures is assumed to be valid for two frames (see row 'Frame #'), i.e. the transport channels in CCPCHs have an interleaving time of 20msec.

The actual CCPCH Multiframe Scheme used in the cell is described and broadcast on BCH. Thus the system information structure has its roots in this particular transport channel and allocations of other Common Channels can be handled this way, i.e. by pointing from BCH.

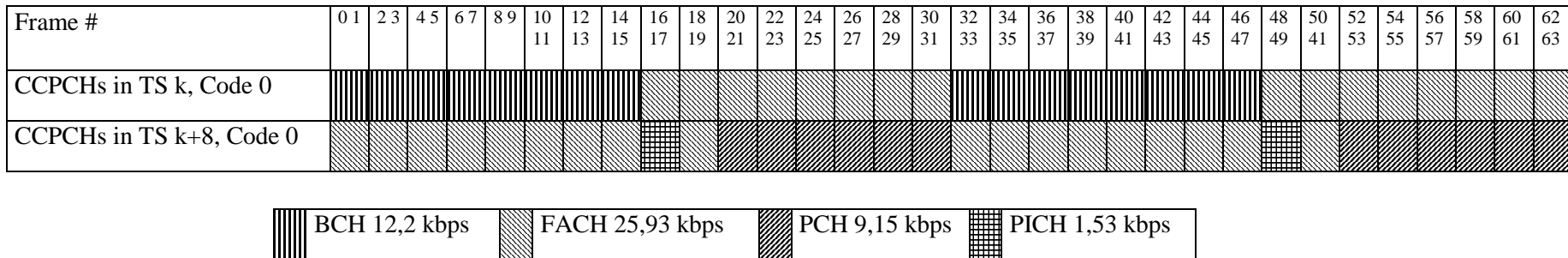

Figure C.1: Example for a multiframe structure for CCPCHs and PICH that is repeated every 64th frame

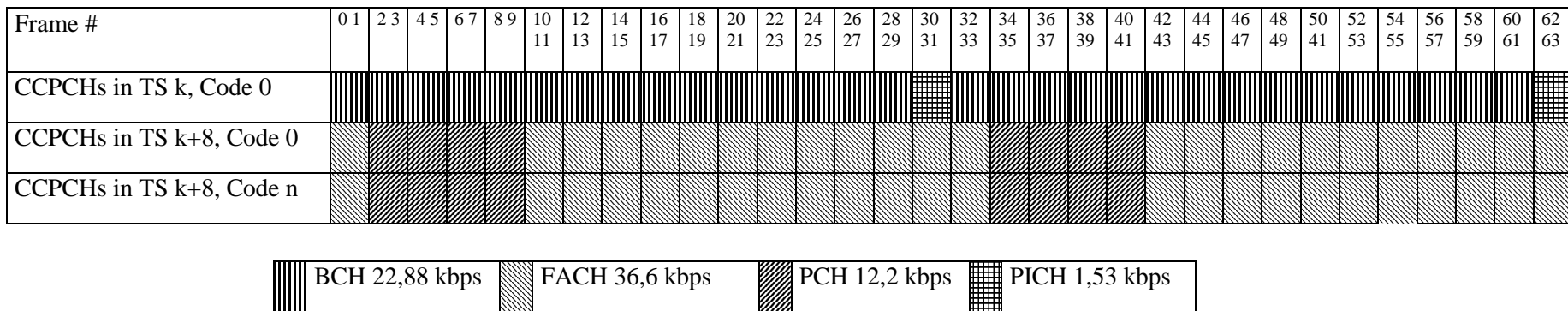

Figure C.2: Example for a multiframe structure for CCPCHs and PICH that is repeated every 64th frame, n=1...7

## Annex F (informative): CCPCH Multiframe Structure for the 1.28 Mcps option

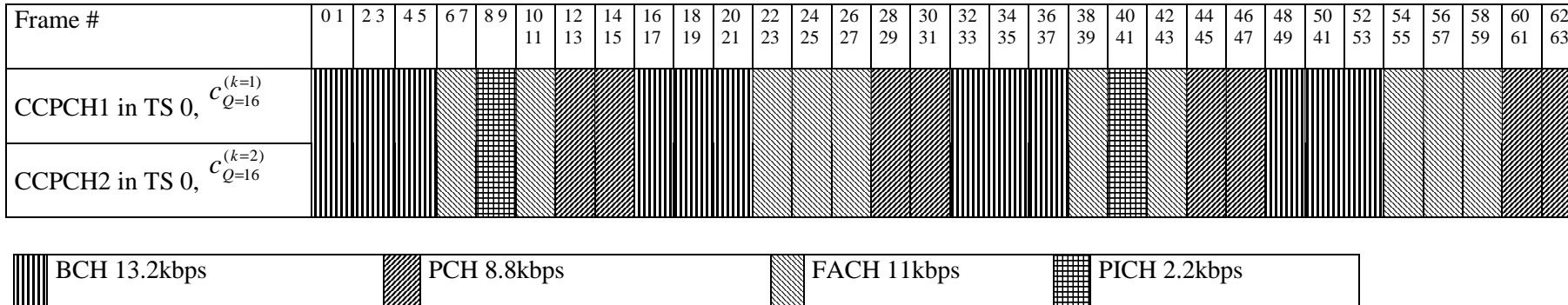

Figure F.1: Example for a multiframe structure for CCPCHs and PICH that is repeated every 64th frame (128 sub-frame)

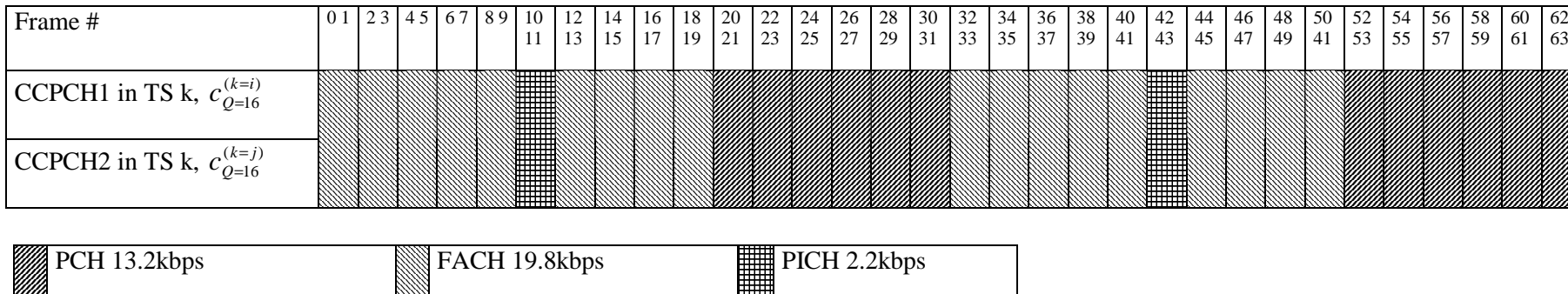

Figure F.2: Example for a multiframe structure for S-CCPCHs and PICH that is repeated every 64th frame,  $i,j=1...16 (i \neq j), k \neq 0, 1, (128 \text{ sub-frame})$

# Annex G (informative): Examples of the association of DL TPC commands to UL uplink time slots for 1.28 Mcps TDD

In the following two examples of the association of UL TPC commands to UL time slots and CCTrCHs are shown (see 6.2.2.2):

**Table G.1 Two examples of the association of DL TPC commands to UL uplink time slots with NULslot=3**

Case 1:  $N_{UL\_TPCsymbols}=2$ ; Case 2:  $N_{UL\_TPCsymbols}=4$

Sub-Frame Number	Case 1 (2 UL TPC symbols)		The order of the served UL time slot and CCTrCH pairs (UL time slot and CCTrCH number)	Case 2 (4 UL TPC symbols)	
	The order of UL TPC symbols			The order of UL TPC symbols	
SFN'=0	(1 <sup>st</sup> UL <sub>pos</sub> =0)	0	0 (TS3)	0	(1 <sup>st</sup> UL <sub>pos</sub> =0)
		1	1 (TS4)	1	
			2 (TS5)	2	
			0 (TS3)	3	
SFN'=1	(1 <sup>st</sup> UL <sub>pos</sub> =2)	0	0 (TS3)	0	(1 <sup>st</sup> UL <sub>pos</sub> =1)
		1	1 (TS4)	1	
			2 (TS5)	2	
			0 (TS3)	3	
SFN'=2	(1 <sup>st</sup> UL <sub>pos</sub> =1)	0	0 (TS3)	0	(1 <sup>st</sup> UL <sub>pos</sub> =2)
		1	1 (TS4)	1	
			2 (TS5)	2	
			0 (TS3)	3	
			1 (TS4)		
			2 (TS5)		
.	.	.	.	.	.
.	.	.	.	.	.
.	.	.	.	.	.

# Annex H (informative): Examples of the association of DL SS commands to UL uplink time slots

In the following two examples of the association of DL SS commands to UL uplink time slots are shown (see 6.2.2.3):

**Table H.1 Two examples of the association of DL SS commands to UL uplink time slots with  $N_{ULslot}=3$**

Case 1:  $N_{SSsymbols}=2$ ; Case 2:  $N_{SSsymbols}=4$

Sub-Frame Number	Case 1 (2 DL SS symbols)		The order of the served UL time slot (UL time slot number)	Case 2 (4 DL SS symbols)	
	The order of DL SS symbols			The order of DL SS symbols	
SFN'=0	(1 <sup>st</sup> $UL_{pos}=0$ )	0	0 (TS3)	0	(1 <sup>st</sup> $UL_{pos}=0$ )
		1	1 (TS4)	1	
			2 (TS5)	2	
			0 (TS3)	3	
SFN'=1	(1 <sup>st</sup> $UL_{pos}=2$ )	0	0 (TS3)	0	(1 <sup>st</sup> $UL_{pos}=1$ )
		1	1 (TS4)	1	
			2 (TS5)	2	
			0 (TS3)	3	
			1 (TS4)		
SFN'=2	(1 <sup>st</sup> $UL_{pos}=1$ )	0	0 (TS3)	0	(1 <sup>st</sup> $UL_{pos}=2$ )
		1	1 (TS4)	1	
			2 (TS5)	2	
			0 (TS3)	3	
			1 (TS4)		
			2 (TS5)		
.	.	.	.	.	.
.	.	.	.	.	.
.	.	.	.	.	.

## Annex I (informative): Change history

Change history							
Date	TSG #	TSG Doc.	CR	Rev	Subject/Comment	Old	New
14/01/00	RAN_05	RP-99591	-	-	Approved at TSG RAN #5 and placed under Change Control	-	3.0.0
14/01/00	RAN_06	RP-99691	001	02	Primary and Secondary CCPCCH in TDD	3.0.0	3.1.0
14/01/00	RAN_06	RP-99691	002	02	Removal of Superframe for TDD	3.0.0	3.1.0
14/01/00	RAN_06	RP-99691	006	-	Corrections to TS25.221	3.0.0	3.1.0
14/01/00	RAN_06	RP-99691	007	1	Clarifications for Spreading in UTRA TDD	3.0.0	3.1.0
14/01/00	RAN_06	RP-99691	008	-	Transmission of TFCI bits for TDD	3.0.0	3.1.0
14/01/00	RAN_06	RP-99691	009	-	Midamble Allocation in UTRA TDD	3.0.0	3.1.0
14/01/00	RAN_06	RP-99690	010	-	Introduction of the timeslot formats to the TDD specifications	3.0.0	3.1.0
14/01/00	-	-	-	-	Change history was added by the editor	3.1.0	3.1.1
31/03/00	RAN_07	RP-000067	003	2	Cycling of cell parameters	3.1.1	3.2.0
31/03/00	RAN_07	RP-000067	011	-	Correction of Midamble Definition for TDD	3.1.1	3.2.0
31/03/00	RAN_07	RP-000067	012	-	Introduction of the timeslot formats for RACH to the TDD specifications	3.1.1	3.2.0
31/03/00	RAN_07	RP-000067	013	-	Paging Indicator Channel reference power	3.1.1	3.2.0
31/03/00	RAN_07	RP-000067	014	1	Removal of Synchronisation Case 3 in TDD	3.1.1	3.2.0
31/03/00	RAN_07	RP-000067	015	1	Signal Point Constellation	3.1.1	3.2.0
31/03/00	RAN_07	RP-000067	016	-	Association between Midambles and Channelisation Codes	3.1.1	3.2.0
31/03/00	RAN_07	RP-000067	017	-	Removal of ODMA from the TDD specifications	3.1.1	3.2.0
26/06/00	RAN_08	RP-000271	018	1	Removal of the reference to ODMA	3.2.0	3.3.0
26/06/00	RAN_08	RP-000271	019	-	Editorial changes in transport channels section	3.2.0	3.3.0
26/06/00	RAN_08	RP-000271	020	1	TPC transmission for TDD	3.2.0	3.3.0
26/06/00	RAN_08	RP-000271	021	-	Editorial modification of 25.221	3.2.0	3.3.0
26/06/00	RAN_08	RP-000271	023	-	Clarifications on TxDiversity for UTRA TDD	3.2.0	3.3.0
26/06/00	RAN_08	RP-000271	024	-	Clarifications on PCH and PICH in UTRA TDD	3.2.0	3.3.0
23/0900	RAN_09	RP-000344	022	1	Correction to midamble generation in UTRA TDD	3.3.0	3.4.0
23/0900	RAN_09	RP-000344	026	2	Some corrections for TS25.221	3.3.0	3.4.0
23/0900	RAN_09	RP-000344	028	-	Terminology regarding the beacon function	3.3.0	3.4.0
23/0900	RAN_09	RP-000344	030	1	TDD Access Bursts for HOV	3.3.0	3.4.0
23/0900	RAN_09	RP-000344	031	1	Number of codes signalling for the DL common midamble case	3.3.0	3.4.0
15/12/00	RAN_10	RP-000542	034	-	Correction on TFCI & TPC Transmission	3.4.0	3.5.0
15/12/00	RAN_10	RP-000542	035	1	Clarifications on Midamble Associations	3.4.0	3.5.0
15/12/00	RAN_10	RP-000542	036	-	Clarification on PICH power setting	3.4.0	3.5.0
16/03/01	RAN_11	-	-	-	Approved as Release 4 specification (v4.0.0) at TSG RAN #11	3.5.0	4.0.0
16/03/01	RAN_11	RP-010062	033	2	Correction to SCH section	3.5.0	4.0.0
16/03/01	RAN_11	RP-010062	037	1	Bit Scrambling for TDD	3.5.0	4.0.0
16/03/01	RAN_11	RP-010062	039	1	Corrections of PUSCH and PDSCH	3.5.0	4.0.0
16/03/01	RAN_11	RP-010062	040	-	Alteration of SCH offsets to avoid overlapping Midamble	3.5.0	4.0.0
16/03/01	RAN_11	RP-010062	041	-	Clarifications & Corrections for TS25.221	3.5.0	4.0.0
16/03/01	RAN_11	RP-010062	045	1	Corrections on the PRACH and clarifications on the midamble generation and the behaviour in case of an invalid TFI combination on the DCHs	3.5.0	4.0.0
16/03/01	RAN_11	RP-010062	046	-	Clarification of TFCI transmission	3.5.0	4.0.0
16/03/01	RAN_11	RP-010062	048	-	Corrections to Table 5.b "Timeslot formats for the Uplink"	3.5.0	4.0.0
16/03/01	RAN_11	RP-010073	042	2	Introduction of the Physical Node B Synchronization Channel	3.5.0	4.0.0
16/03/01	RAN_11	RP-010071	043	1	Inclusion of 1.28Mcps TDD in TS 25.221	3.5.0	4.0.0
16/03/01	RAN_11	RP-010072	044	-	Correction of beacon characteristics due to IPDLs	3.5.0	4.0.0
15/06/01	RAN_12	RP-010336	051	-	Clarification of Midamble Usage in TS25.221	4.0.0	4.1.0
15/06/01	RAN_12	RP-010336	053	-	Addition to the abbreviation list, correction of references to tables and figures	4.0.0	4.1.0
15/06/01	RAN_12	RP-010342	049	-	Correction of spelling in definition of beacon characteristics	4.0.0	4.1.0
15/06/01	RAN_12	RP-010342	055	-	Correction of Note for PDSCH signalling methods	4.0.0	4.1.0
21/09/01	RAN_13	RP-010522	057	-	TFCI Terminology	4.1.0	4.2.0
21/09/01	RAN_13	RP-010522	063	-	Clarification of notations in TS25.221 and TS25.223	4.1.0	4.2.0
21/09/01	RAN_13	RP-010522	062	-	Addition and correction of the reference	4.1.0	4.2.0
21/09/01	RAN_13	RP-010528	058	1	Corrections for TS 25.221	4.1.0	4.2.0
14/12/01	RAN_14	RP-010741	065	1	Transmit Diversity for P-CCPCH and PICH	4.2.0	4.3.0
14/12/01	RAN_14	RP-010741	067	-	Clarification of midamble transmit power in TS25.221	4.2.0	4.3.0
14/12/01	RAN_14	RP-010746	059	-	Bit Scrambling for 1.28 Mcps TDD	4.2.0	4.3.0
14/12/01	RAN_14	RP-010746	068	-	Transmit Diversity for P-CCPCH and PICH	4.2.0	4.3.0
14/12/01	RAN_14	RP-010746	069	-	Corrections of reference numbers in TS 25.221	4.2.0	4.3.0
08/03/02	RAN_15	RP-020049	071	2	Clarification of spreading for UL physical channels	4.3.0	4.4.0
08/03/02	RAN_15	RP-020049	073	1	Common midamble allocation for beacon time slot	4.3.0	4.4.0
08/03/02	RAN_15	RP-020049	075	3	Correction to a transmission of paging indicators bits	4.3.0	4.4.0



08/03/02	RAN_15	RP-020058	076	1	CR to include HSDPA in TS25.221	4.3.0	5.0.0

---

## History

<b>Document history</b>		
V5.0.0	March 2002	Publication