

ETSI TS 125 221 V9.1.0 (2010-04)

Technical Specification

Universal Mobile Telecommunications System (UMTS); Physical channels and mapping of transport channels onto physical channels (TDD) (3GPP TS 25.221 version 9.1.0 Release 9)



ReferenceRTS/TSGR-0125221v910

KeywordsUMTS

ETSI

650 Route des Lucioles
F-06921 Sophia Antipolis Cedex - FRANCE

Tel.: +33 4 92 94 42 00 Fax: +33 4 93 65 47 16

Siret N° 348 623 562 00017 - NAF 742 C
Association à but non lucratif enregistrée à la
Sous-Préfecture de Grasse (06) N° 7803/88

Important notice

Individual copies of the present document can be downloaded from:

<http://www.etsi.org>

The present document may be made available in more than one electronic version or in print. In any case of existing or perceived difference in contents between such versions, the reference version is the Portable Document Format (PDF). In case of dispute, the reference shall be the printing on ETSI printers of the PDF version kept on a specific network drive within ETSI Secretariat.

Users of the present document should be aware that the document may be subject to revision or change of status. Information on the current status of this and other ETSI documents is available at

<http://portal.etsi.org/tb/status/status.asp>

If you find errors in the present document, please send your comment to one of the following services:

http://portal.etsi.org/chaicor/ETSI_support.asp

Copyright Notification

No part may be reproduced except as authorized by written permission.
The copyright and the foregoing restriction extend to reproduction in all media.

© European Telecommunications Standards Institute 2010.
All rights reserved.

DECT™, **PLUGTESTS™**, **UMTS™**, **TIPHON™**, the TIPHON logo and the ETSI logo are Trade Marks of ETSI registered for the benefit of its Members.

3GPP™ is a Trade Mark of ETSI registered for the benefit of its Members and of the 3GPP Organizational Partners.

LTE™ is a Trade Mark of ETSI currently being registered

for the benefit of its Members and of the 3GPP Organizational Partners.

GSM® and the GSM logo are Trade Marks registered and owned by the GSM Association.

Intellectual Property Rights

IPRs essential or potentially essential to the present document may have been declared to ETSI. The information pertaining to these essential IPRs, if any, is publicly available for **ETSI members and non-members**, and can be found in ETSI SR 000 314: "*Intellectual Property Rights (IPRs); Essential, or potentially Essential, IPRs notified to ETSI in respect of ETSI standards*", which is available from the ETSI Secretariat. Latest updates are available on the ETSI Web server (<http://webapp.etsi.org/IPR/home.asp>).

Pursuant to the ETSI IPR Policy, no investigation, including IPR searches, has been carried out by ETSI. No guarantee can be given as to the existence of other IPRs not referenced in ETSI SR 000 314 (or the updates on the ETSI Web server) which are, or may be, or may become, essential to the present document.

Foreword

This Technical Specification (TS) has been produced by ETSI 3rd Generation Partnership Project (3GPP).

The present document may refer to technical specifications or reports using their 3GPP identities, UMTS identities or GSM identities. These should be interpreted as being references to the corresponding ETSI deliverables.

The cross reference between GSM, UMTS, 3GPP and ETSI identities can be found under <http://webapp.etsi.org/key/queryform.asp>.

Contents

Intellectual Property Rights	2
Foreword.....	2
Foreword.....	12
1 Scope	13
2 References	13
3 Abbreviations	14
4 Services offered to higher layers	15
4.1 Transport channels	15
4.1.1 Dedicated transport channels	15
4.1.1.1 DCH – Dedicated Channel.....	15
4.1.1.2 E-DCH – Enhanced Dedicated Channel	15
4.1.2 Common transport channels	15
4.1.2.1 BCH - Broadcast Channel.....	16
4.1.2.2 FACH – Forward Access Channel	16
4.1.2.3 PCH – Paging Channel.....	16
4.1.2.4 RACH – Random Access Channel.....	16
4.1.2.5 USCH – Uplink Shared Channel.....	16
4.1.2.6 DSCH – Downlink Shared Channel.....	16
4.1.2.7 HS-DSCH – High Speed Downlink Shared Channel.....	16
4.1.2.8 E-DCH – Enhanced Dedicated Channel	16
4.2 Indicators.....	16
5 Physical channels for the 3.84 Mcps option.....	17
5.1 Frame structure.....	17
5.2 Dedicated physical channel (DPCH).....	18
5.2.1 Spreading.....	19
5.2.1.1 Spreading for Downlink Physical Channels.....	19
5.2.1.2 Spreading for Uplink Physical Channels.....	19
5.2.2 Burst Types.....	19
5.2.2.1 Burst Type 1.....	19
5.2.2.2 Burst Type 2.....	20
5.2.2.3 Burst Type 3.....	20
5.2.2.3A Burst Type 4.....	21
5.2.2.4 Transmission of TFCI.....	21
5.2.2.5 Transmission of TPC.....	23
5.2.2.6 Timeslot formats	23
5.2.2.6.1 Downlink timeslot formats	23
5.2.2.6.2 Uplink timeslot formats.....	24
5.2.3 Training sequences for spread bursts	26
5.2.4 Beamforming	28
5.3 Common physical channels	29
5.3.1 Primary common control physical channel (P-CCPCH).....	29
5.3.1.1 P-CCPCH Spreading	29
5.3.1.2 P-CCPCH Burst Types.....	29
5.3.1.3 P-CCPCH Training sequences	29
5.3.2 Secondary common control physical channel (S-CCPCH).....	29
5.3.2.1 S-CCPCH Spreading	29
5.3.2.2 S-CCPCH Burst Types.....	29
5.3.2.2A S-CCPCH Modulation	29
5.3.2.3 S-CCPCH Training sequences	29
5.3.3 The physical random access channel (PRACH)	29
5.3.3.1 PRACH Spreading	29
5.3.3.2 PRACH Burst Type.....	30
5.3.3.3 PRACH Training sequences.....	30

5.3.3.4	PRACH timeslot formats	30
5.3.3.5	Association between Training Sequences and Channelisation Codes.....	30
5.3.4	The synchronisation channel (SCH)	32
5.3.5	Physical Uplink Shared Channel (PUSCH).....	33
5.3.5.1	PUSCH Spreading.....	33
5.3.5.2	PUSCH Burst Types	34
5.3.5.3	PUSCH Training Sequences	34
5.3.5.4	UE Selection	34
5.3.6	Physical Downlink Shared Channel (PDSCH)	34
5.3.6.1	PDSCH Spreading.....	34
5.3.6.2	PDSCH Burst Types	34
5.3.6.3	PDSCH Training Sequences	34
5.3.6.4	UE Selection	34
5.3.7	The Paging Indicator Channel (PICH).....	34
5.3.7.1	Mapping of Paging Indicators to the PICH bits	34
5.3.7.2	Structure of the PICH over multiple radio frames.....	35
5.3.7.3	PICH Training sequences.....	36
5.3.8	The physical node B synchronisation channel (PNBSCH).....	36
5.3.9	High Speed Physical Downlink Shared Channel (HS-PDSCH)	36
5.3.9.1	HS-PDSCH Spreading	36
5.3.9.2	HS-PDSCH Burst Types	36
5.3.9.3	HS-PDSCH Training Sequences	36
5.3.9.4	UE Selection	36
5.3.9.5	HS-PDSCH timeslot formats	36
5.3.10	Shared Control Channel for HS-DSCH (HS-SCCH).....	37
5.3.10.1	HS-SCCH Spreading.....	37
5.3.10.2	HS-SCCH Burst Types	37
5.3.10.3	HS-SCCH Training Sequences	37
5.3.10.4	HS-SCCH timeslot formats.....	37
5.3.11	Shared Information Channel for HS-DSCH (HS-SICH)	37
5.3.11.1	HS-SICH Spreading	37
5.3.11.2	HS-SICH Burst Types.....	37
5.3.11.3	HS-SICH Training Sequences.....	37
5.3.11.4	HS-SICH timeslot formats	38
5.3.12	The MBMS Indicator Channel (MICH).....	38
5.3.12.1	Mapping of MBMS Indicators to the MICH bits for burst types 1 and 2	38
5.3.12.1A	Mapping of MBMS Indicators to the MICH bits for burst type 4.....	39
5.3.12.2	MICH Training sequences	39
5.3.13	E-DCH Physical Uplink Channel (E-PUCH)	40
5.3.13.1	E-UCCH.....	40
5.3.13.2	E-PUCH Spreading	41
5.3.13.3	E-PUCH Burst Types.....	41
5.3.13.4	PUSCH Training Sequences	41
5.3.13.5	UE Selection	41
5.3.13.6	E-PUCH timeslot formats	41
5.3.14	E-DCH Random Access Uplink Control Channel (E-RUCCH).....	43
5.3.15	E-DCH Absolute Grant Channel (E-AGCH).....	43
5.3.15.1	E-AGCH Spreading	43
5.3.15.2	E-AGCH Burst Types	43
5.3.15.3	E-AGCH Training Sequences	44
5.3.15.4	E-AGCH timeslot formats.....	44
5.3.16	E-DCH Hybrid ARQ Acknowledgement Indicator Channel (E-HICH).....	44
5.3.16.1	E-HICH Spreading	45
5.3.16.2	E-HICH Burst Types.....	45
5.3.16.3	E-HICH Training Sequences.....	45
5.4	Transmit Diversity for DL Physical Channels.....	45
5.5	Beacon characteristics of physical channels.....	45
5.5.1	Location of beacon channels.....	45
5.5.2	Physical characteristics of beacon channels.....	46
5.6	Midamble Allocation for Physical Channels	46
5.6.1	Midamble Allocation for DL Physical Channels	46
5.6.1.1	Midamble Allocation by signalling from higher layers.....	47

5.6.1.2	Midamble Allocation by layer 1.....	47
5.6.1.2.1	Default midamble	47
5.6.1.2.2	Common Midamble.....	47
5.6.2	Midamble Allocation for UL Physical Channels	48
5.7	Midamble Transmit Power	48
5.8	Physical channels for the 3.84 Mcps MBSFN IMB option	49
5.8.1	Transmit diversity	50
5.8.2	Common physical channels	50
5.8.2.1	Primary Common Pilot Channel (P-CPICH)	50
5.8.2.2	Time-multiplexed Common Pilot Channel (T-CPICH)	50
5.8.2.3	Primary common control physical channel (P-CCPCH).....	51
5.8.2.4	Secondary common control physical channel (S-CCPCH).....	52
5.8.2.5	Synchronisation channel (SCH).....	54
5.8.2.6	The MBMS indicator channel (MICH).....	54
5.8.3	Timing relationship between physical channels	55
5A	Physical channels for the 1.28 Mcps option.....	56
5A.1	Frame structure.....	57
5A.2	Dedicated physical channel (DPCH).....	58
5A.2.1	Spreading	58
5A.2.2	Burst Format	58
5A.2.2a	Dedicated carrier MBSFN Burst Format	59
5A.2.2.1	Transmission of TFCI.....	60
5A.2.2.1a	Transmission of TFCI for MT burst and MS burst	61
5A.2.2.2	Transmission of TPC.....	62
5A.2.2.3	Transmission of SS	65
5A.2.2.4	Timeslot formats	67
5A.2.2.4.1	Timeslot formats for QPSK.....	68
5A.2.2.4.2	Time slot formats for 8PSK.....	71
5A.2.2.4.3	Time slot formats for MBSFN.....	71
5A.2.3	Training sequences for spread bursts	72
5A.2.3a	Training sequences for dedicated carrier MBSFN.....	74
5A.2.4	Beamforming	74
5A.3	Common physical channels	74
5A.3.1	Primary common control physical channel (P-CCPCH).....	74
5A.3.1.1	P-CCPCH Spreading	75
5A.3.1.2	P-CCPCH Burst Format	75
5A.3.1.3	P-CCPCH Training sequences	75
5A.3.2	Secondary common control physical channel (S-CCPCH).....	75
5A.3.2.1	S-CCPCH Spreading	75
5A.3.2.2	S-CCPCH Burst Format	75
5A.3.2.3	S-CCPCH Training sequences	75
5A.3.3	Fast Physical Access CHannel (FPACH)	75
5A.3.3.1	FPACH burst.....	75
5A.3.3.1.1	Signature Reference Number.....	76
5A.3.3.1.2	Relative Sub-Frame Number	76
5A.3.3.1.3	Received starting position of the UpPCH (UpPCH _{pos}).....	76
5A.3.3.1.4	Transmit Power Level Command for the RACH message	76
5A.3.3.2	FPACH Spreading.....	76
5A.3.3.3	FPACH Burst Format.....	76
5A.3.3.4	FPACH Training sequences	76
5A.3.3.5	FPACH timeslot formats	76
5A.3.4	The physical random access channel (PRACH)	77
5A.3.4.1	PRACH Spreading	77
5A.3.4.2	PRACH Burst Format	77
5A.3.4.3	PRACH Training sequences.....	77
5A.3.4.4	PRACH timeslot formats	77
5A.3.4.5	Association between Training Sequences and Channelisation Codes.....	77
5A.3.5	The synchronisation channels (DwPCH, UpPCH)	77
5A.3.6	Physical Uplink Shared Channel (PUSCH)	78
5A.3.7	Physical Downlink Shared Channel (PDSCH)	78
5A.3.8	The Page Indicator Channel (PICH)	78

5A.3.8.1	Mapping of Paging Indicators to the PICH bits	78
5A.3.8.2	Structure of the PICH over multiple radio frames.....	79
5A.3.9	High Speed Physical Downlink Shared Channel (HS-PDSCH)	79
5A.3.9.1	HS-PDSCH Spreading	79
5A.3.9.2	HS-PDSCH Burst Format	79
5A.3.9.3	HS-PDSCH Training Sequences	80
5A.3.9.4	UE Selection	80
5A.3.9.5	HS-PDSCH timeslot formats	80
5A.3.9.6	Transmission of SS and TPC	80
5A.3.10	Shared Control Channel for HS-DSCH (HS-SCCH).....	80
5A.3.10.1	HS-SCCH Spreading.....	81
5A.3.10.2	HS-SCCH Burst Format.....	81
5A.3.10.3	HS-SCCH Training Sequences	81
5A.3.10.4	HS-SCCH timeslot formats.....	81
5A.3.11	Shared Information Channel for HS-DSCH (HS-SICH)	81
5A.3.11.1	HS-SICH Spreading	81
5A.3.11.2	HS-SICH Burst Format	81
5A.3.11.3	HS-SICH Training Sequences.....	81
5A.3.11.4	HS-SICH timeslot formats	81
5A.3.12	The MBMS Indicator Channel (MICH) type1.....	81
5A.3.12.1	Mapping of MBMS Indicators to the type1 MICH bits	82
5A.3.12a	The MBMS Indicator Channel (MICH) type 2.....	82
5A.3.12.1	Mapping of MBMS Indicators to the type 2 MICH bits	82
5A.3.13	Physical Layer Common Control Channel (PLCCH).....	83
5A.3.13.1	PLCCH Spreading.....	83
5A.3.13.2	PLCCH Burst Type	83
5A.3.13.3	PLCCH Training Sequence.....	83
5A.3.13.4	PLCCH timeslot formats.....	84
5A.3.14	E-DCH Physical Uplink Channel	84
5A.3.14.1	E-UCCH.....	84
5A.3.14.2	E-PUCH Spreading	85
5A.3.14.3	E-PUCH Burst Types	85
5A.3.14.4	E-PUCH Training Sequences	85
5A.3.14.5	UE Selection	85
5A.3.14.6	E-PUCH timeslot formats	85
5A.3.15	E-DCH Random Access Uplink Control Channel (E-RUCCH).....	92
5A.3.15.1	E-RUCCH Spreading	92
5A.3.15.2	E-RUCCH Burst Format.....	92
5A.3.15.3	E-RUCCH Training sequences	92
5A.3.15.4	E-RUCCH timeslot formats	92
5A.3.16	E-DCH Absolute Grant Channel (E-AGCH).....	92
5A.3.16.1	E-AGCH Spreading	92
5A.3.16.2	E-AGCH Burst Types	92
5A.3.16.3	E-AGCH Training Sequences	93
5A.3.16.4	E-AGCH timeslot formats.....	93
5A.3.17	E-DCH Hybrid ARQ Acknowledgement Indicator Channel (E-HICH).....	93
5A.3.17.1	E-HICH Spreading.....	94
5A.3.17.2	E-HICH Burst Types.....	94
5A.3.17.3	E-HICH Training Sequences.....	94
5A.3.17.4	E-HICH timeslot formats	94
5A.3.18	Standalone midamble channel	94
5A.3.18.1	Standalone midamble channel Burst Format.....	94
5A.3.18.3	Standalone midamble channel Training Sequences	95
5A.3.18.4	Standalone midamble channel timeslot formats.....	95
5A.4	Transmit Diversity for DL Physical Channels.....	96
5A.5	Beacon characteristics of physical channels.....	96
5A.5.1	Location of beacon channels.....	96
5A.5.2	Physical characteristics of the beacon function	96
5A.6	Midamble Allocation for Physical Channels.....	97
5A.6.1	Midamble Allocation for DL Physical Channels	97
5A.6.1.1	Midamble Allocation by signalling from higher layers.....	97
5A.6.1.2	Midamble Allocation by layer 1.....	97

5A.6.1.2.1	Default midamble	97
5A.6.1.2.2	Common Midamble	98
5A.6.1.2.3	Special Default Midamble	98
5A.6.2	Midamble Allocation for UL Physical Channels	98
5A.7	Midamble Transmit Power	98
5A.7a	Preamble Allocation and Preamble Transmit Power	98
5B	Physical channels for the 7.68 Mcps option	98
5B.1	General	98
5B.2	Frame structure	99
5B.3	Dedicated physical channel (DPCH)	99
5B.3.1	Spreading	100
5B.3.1.1	Spreading for Downlink Physical Channels	100
5B.3.1.2	Spreading for Uplink Physical Channels	100
5B.3.2	Burst Types	100
5B.3.2.1	Burst Type 1	101
5B.3.2.2	Burst Type 2	101
5B.3.2.3	Burst Type 3	102
5B.3.2.3A	Burst Type 4	102
5B.3.2.4	Transmission of TFCI	102
5B.3.2.5	Transmission of TPC	104
5B.3.2.6	Timeslot formats	105
5B.3.2.6.1	Downlink timeslot formats	105
5B.3.2.6.2	Uplink timeslot formats	106
5B.3.3	Training sequences for spread bursts	108
5B.3.4	Beamforming	110
5B.4	Common physical channels	110
5B.4.1	Primary common control physical channel (P-CCPCH)	110
5B.4.1.1	P-CCPCH Spreading	110
5B.4.1.2	P-CCPCH Burst Types	110
5B.4.1.3	P-CCPCH Training sequences	110
5B.4.2	Secondary common control physical channel (S-CCPCH)	110
5B.4.2.1	S-CCPCH Spreading	110
5B.4.2.2	S-CCPCH Burst Types	110
5B.4.2.2A	S-CCPCH Modulation	110
5B.4.2.3	S-CCPCH Training sequences	110
5B.4.3	The physical random access channel (PRACH)	110
5B.4.3.1	PRACH Spreading	111
5B.4.3.2	PRACH Burst Type	111
5B.4.3.3	PRACH Training sequences	111
5B.4.3.4	PRACH timeslot formats	111
5B.4.3.5	Association between Training Sequences and Channelisation Codes	111
5B.4.4	The synchronisation channel (SCH)	112
5B.4.5	Physical Uplink Shared Channel (PUSCH)	113
5B.4.5.1	PUSCH Spreading	113
5B.4.5.2	PUSCH Burst Types	114
5B.4.5.3	PUSCH Training Sequences	114
5B.4.5.4	UE Selection	114
5B.4.6	Physical Downlink Shared Channel (PDSCH)	114
5B.4.6.1	PDSCH Spreading	114
5B.4.6.2	PDSCH Burst Types	114
5B.4.6.3	PDSCH Training Sequences	114
5B.4.6.4	UE Selection	114
5B.4.7	The Paging Indicator Channel (PICH)	114
5B.4.7.1	Mapping of Paging Indicators to the PICH bits	114
5B.4.7.2	Structure of the PICH over multiple radio frames	115
5B.4.7.3	PICH Training sequences	115
5B.4.8	High Speed Physical Downlink Shared Channel (HS-PDSCH)	115
5B.4.8.1	HS-PDSCH Spreading	115
5B.4.8.2	HS-PDSCH Burst Types	115
5B.4.8.3	HS-PDSCH Training Sequences	116
5B.4.8.4	UE Selection	116

5B.4.8.5	HS-PDSCH timeslot formats	116
5B.4.9	Shared Control Channel for HS-DSCH (HS-SCCH).....	116
5B.4.9.1	HS-SCCH Spreading.....	116
5B.4.9.2	HS-SCCH Burst Types	116
5B.4.9.3	HS-SCCH Training Sequences	116
5B.4.9.4	HS-SCCH timeslot formats.....	116
5B.4.10	Shared Information Channel for HS-DSCH (HS-SICH)	117
5B.4.10.1	HS-SICH Spreading	117
5B.4.10.2	HS-SICH Burst Types.....	117
5B.4.10.3	HS-SICH Training Sequences.....	117
5B.4.10.4	HS-SICH timeslot formats	117
5B.4.11	The MBMS Indicator Channel (MICH).....	117
5B.4.11.1	Mapping of MBMS Indicators to the MICH bits for burst types 1 and 2	117
5B.4.11.1A	Mapping of MBMS Indicators to the MICH bits for burst type 4.....	118
5B.4.11.2	MICH Training sequences	119
5B.4.12	E-DCH Physical Uplink Channel (E-PUCH)	119
5B.4.12.1	E-UCCH.....	119
5B.4.12.2	E-PUCH Spreading	120
5B.4.12.3	E-PUCH Burst Types.....	120
5B.4.12.4	PUSCH Training Sequences	120
5B.4.12.5	UE Selection	120
5B.4.12.6	E-PUCH timeslot formats	121
5B.4.13	E-DCH Random Access Uplink Control Channel (E-RUCCH).....	122
5B.4.14	E-DCH Absolute Grant Channel (E-AGCH).....	122
5B.4.14.1	E-AGCH Spreading	123
5B.4.14.2	E-AGCH Burst Types	123
5B.4.14.3	E-AGCH Training Sequences	123
5B.4.14.4	E-AGCH timeslot formats.....	123
5B.4.15	E-DCH Hybrid ARQ Acknowledgement Indicator Channel (E-HICH).....	123
5B.4.15.1	E-HICH Spreading	124
5B.4.15.2	E-HICH Burst Types.....	124
5B.4.15.3	E-HICH Training Sequences.....	124
5B.5	Transmit Diversity for DL Physical Channels.....	124
5B.6	Beacon characteristics of physical channels.....	124
5B.6.1	Location of beacon channels.....	125
5B.6.2	Physical characteristics of beacon channels.....	125
5B.7	Midamble Allocation for Physical Channels.....	125
5B.8	Midamble Transmit Power	125
6	Mapping of transport channels to physical channels for the 3.84 Mcps option	127
6.1	Dedicated Transport Channels	127
6.1.1	The Dedicated Channel (DCH).....	127
6.1.2	The Enhanced Uplink Dedicated Channel (E-DCH)	128
6.1.2.1	E-DCH/E-AGCH Association and Timing	128
6.1.2.2	E-DCH/E-HICH Association and Timing.....	128
6.2	Common Transport Channels.....	129
6.2.1	The Broadcast Channel (BCH)	129
6.2.2	The Paging Channel (PCH)	129
6.2.2.1	PCH/PICH Association	130
6.2.3	The Forward Channel (FACH)	130
6.2.4	The Random Access Channel (RACH)	130
6.2.5	The Uplink Shared Channel (USCH).....	130
6.2.6	The Downlink Shared Channel (DSCH).....	130
6.2.7	The High Speed Downlink Shared Channel (HS-DSCH).....	130
6.2.7.1	HS-DSCH/HS-SCCH Association and Timing.....	130
6.2.7.2	HS-SCCH/HS-DSCH/HS-SICH Association and Timing	131
6.3	Mapping of TrCHs for the 3.84 Mcps MBSFN IMB option.....	132
7	Mapping of transport channels to physical channels for the 1.28 Mcps option	132
7.1	Dedicated Transport Channels	132
7.1.1	The Dedicated Channel (DCH).....	132
7.1.2	The Enhanced Uplink Dedicated Channel (E-DCH)	133

7.1.2.1	E-DCH/E-AGCH Association and Timing	133
7.1.2.2	E-DCH/E-HICH Association and Timing.....	133
7.2	Common Transport Channels.....	134
7.2.1	The Broadcast Channel (BCH)	134
7.2.2	The Paging Channel (PCH)	134
7.2.3	The Forward Channel (FACH)	134
7.2.4	The Random Access Channel (RACH)	134
7.2.5	The Uplink Shared Channel (USCH).....	135
7.2.6	The Downlink Shared Channel (DSCH).....	135
7.2.7	The High Speed Downlink Shared Channel (HS-DSCH).....	135
7.2.7.1	HS-DSCH/HS-SCCH Association and Timing.....	135
7.2.7.2	HS-SCCH/HS-DSCH/HS-SICH Association and Timing.....	136
7.2.7.3	PICH/HS-SCCH/HS-DSCH Association and Timing	137
7.2.7.4	PICH/ HS-DSCH Association and Timing	137
8	Mapping of transport channels to physical channels for the 7.68 Mcps option	138
8.1	Dedicated Transport Channels	138
8.1.1	The Dedicated Channel (DCH).....	138
8.1.2	The Enhanced Uplink Dedicated Channel (E-DCH)	138
8.1.2.1	E-DCH/E-AGCH Association and Timing	138
8.1.2.2	E-DCH/E-HICH Association and Timing.....	139
8.2	Common Transport Channels.....	140
8.2.1	The Broadcast Channel (BCH)	140
8.2.2	The Paging Channel (PCH)	140
8.2.3	The Forward Channel (FACH)	140
8.2.4	The Random Access Channel (RACH)	140
8.2.5	The Uplink Shared Channel (USCH).....	140
8.2.6	The Downlink Shared Channel (DSCH).....	141
8.2.7	The High Speed Downlink Shared Channel (HS-DSCH).....	141
8.2.7.1	HS-DSCH/HS-SCCH Association and Timing.....	141
8.2.7.2	HS-SCCH/HS-DSCH/HS-SICH Association and Timing.....	141
Annex A (normative): Basic Midamble Codes for the 3.84 Mcps option.....		142
A.1	Basic Midamble Codes for Burst Type 1 and 3	142
A.2	Basic Midamble Codes for Burst Type 2 and 4	147
A.3	Association between Midambles and Channelisation Codes	150
A.3.1	Association for Burst Type 1/3 and $K_{Cell}=16$ Midambles.....	150
A.3.2	Association for Burst Type 1/3 and $K_{Cell}=8$ Midambles.....	151
A.3.3	Association for Burst Type 1/3 and $K_{Cell}=4$ Midambles.....	151
A.3.4	Association for Burst Type 2 and $K_{Cell}=6$ Midambles	152
A.3.5	Association for Burst Type 2 and $K_{Cell}=3$ Midambles.....	152
A.3.6	Association for Burst Type 4 and $K_{Cell}=1$ Midamble.....	153
Annex AA (normative): Basic Midamble Codes for the 1.28 Mcps option.....		154
AA.1	Basic Midamble Codes.....	154
AA.2	Association between Midambles and Channelisation Codes for default midamble allocation.....	165
AA.2.1	Association for $K=16$ Midambles	165
AA.2.2	Association for $K=14$ Midambles	166
AA.2.3	Association for $K=12$ Midambles	166
AA.2.4	Association for $K=10$ Midambles	167
AA.2.5	Association for $K=8$ Midambles	167
AA.2.6	Association for $K=6$ Midambles	168
AA.2.7	Association for $K=4$ Midambles	168
AA.2.8	Association for $K=2$ Midambles	169
AA.3	Association between Midambles and Channelisation Codes for special default midamble allocation	169
AA.3.1	Association for $K=16$ Midambles	170
AA.3.2	Association for $K=14$ Midambles	171

AA.3.3	Association for $K=12$ Midambles	172
AA.3.4	Association for $K=10$ Midambles	173
AA.3.5	Association for $K=8$ Midambles	174
AA.3.6	Association for $K=6$ Midambles	175
AA.3.7	Association for $K=4$ Midambles	176
AA.3.8	Association for $K=2$ Midambles	177
Annex AB (normative): Basic Midamble Codes for the 7.68 Mcps option.....		178
AB.1	Basic Midamble Codes for Burst Type 1 and 3	178
AB.2	Basic Midamble Codes for Burst Type 2	186
AB.2A	Basic Midamble Codes for Burst Type 4.....	187
AB.3	Association between Midambles and Channelisation Codes	192
AB.3.1	Association for $K_{Cell} = 16$ Midambles	192
AB.3.2	Association for $K_{Cell} = 8$ Midambles	193
AB.3.3	Association for $K_{Cell} = 4$ Midambles	194
AB.3.4	Association for Burst Types 4 and $K_{Cell}=1$ Midamble	194
Annex B (normative): Signalling of the number of channelisation codes for the DL common midamble case for 3.84Mcps TDD		195
B.1	Mapping scheme for Burst Type 1 and $K_{Cell}=16$ Midambles	195
B.2	Mapping scheme for Burst Type 1 and $K_{Cell}=8$	195
	Midambles	195
B.3	Mapping scheme for Burst Type 1 and $K_{Cell}=4$ Midambles	196
B.4	Mapping scheme for beacon timeslots and $K_{Cell}=16$ Midambles	196
B.5	Mapping scheme for beacon timeslots and $K_{Cell}=8$ Midambles	197
B.6	Mapping scheme for beacon timeslots and $K_{Cell}=4$ Midambles	197
B.7	Mapping scheme for Burst Type 2 and $K_{Cell}=6$ Midambles	197
B.8	Mapping scheme for Burst Type 2 and $K_{Cell}=3$ Midambles	198
B.9	Mapping scheme for Burst Type 4 and $K_{Cell}=1$ Midamble.....	198
Annex BA (normative): Signalling of the number of channelisation codes for the DL common midamble case for 1.28Mcps TDD		199
BA.1	Mapping scheme for $K=16$ Midambles.....	199
BA.2	Mapping scheme for $K=14$ Midambles.....	199
BA.3	Mapping scheme for $K=12$ Midambles.....	200
BA.4	Mapping scheme for $K=10$ Midambles.....	200
BA.5	Mapping scheme for $K=8$ Midambles.....	200
BA.6	Mapping scheme for $K=6$ Midambles.....	201
BA.7	Mapping scheme for $K=4$ Midambles.....	201
BA.8	Mapping scheme for $K=2$ Midambles.....	201
Annex BB (normative): Signalling of the number of channelisation codes for the DL common midamble case for 7.68Mcps TDD		202
BB.1	Mapping scheme for $K_{Cell}=16$ Midambles.....	202
BB.2	Mapping scheme for $K_{Cell}=8$ Midambles.....	202
BB.3	Mapping scheme for $K_{Cell}=4$ Midambles.....	203

BB.4 Mapping scheme for beacon timeslots and $K_{\text{Cell}}=16$ Midambles	203
BB.5 Mapping scheme for beacon timeslots and $K_{\text{Cell}}=8$ Midambles	204
BB.6 Mapping scheme for beacon timeslots and $K_{\text{Cell}}=4$ Midambles	204
BB.7 Mapping scheme for Burst Type 4 and $K_{\text{Cell}}=1$ Midamble.....	204
Annex C (informative): CCPCH Multiframe Structure for the 3.84 Mcps option.....	205
Annex CA (informative): CCPCH Multiframe Structure for the 1.28 Mcps option.....	207
Annex CB (informative): Examples of the association of UL TPC commands to UL uplink time slots and CCTrCH pairs for 1.28 Mcps TDD.....	208
Annex CC (informative): Examples of the association of UL SS commands to UL uplink time slots.....	209
Annex CD (normative): T-CPICH bit sequences for the 3.84 Mcps MBSFN IMB option.....	210
Annex D (informative): Change history	216
History	219

Foreword

This Technical Specification (TS) has been produced by the 3rd Generation Partnership Project (3GPP).

The contents of the present document are subject to continuing work within the TSG and may change following formal TSG approval. Should the TSG modify the contents of the present document, it will be re-released by the TSG with an identifying change of release date and an increase in version number as follows:

Version x.y.z

where:

- x the first digit:
 - 1 presented to TSG for information;
 - 2 presented to TSG for approval;
 - 3 or greater indicates TSG approved document under change control.
- y the second digit is incremented for all changes of substance, i.e. technical enhancements, corrections, updates, etc.
- z the third digit is incremented when editorial only changes have been incorporated in the document.

1 Scope

The present document describes the characteristics of the physical channels and the mapping of the transport channels to physical channels in the TDD mode of UTRA.

2 References

The following documents contain provisions which, through reference in this text, constitute provisions of the present document.

- References are either specific (identified by date of publication, edition number, version number, etc.) or non-specific.
- For a specific reference, subsequent revisions do not apply.
- For a non-specific reference, the latest version applies.

- [1] 3GPP TS 25.201: "Physical layer - general description".
- [2] 3GPP TS 25.211: "Physical channels and mapping of transport channels onto physical channels (FDD)".
- [3] 3GPP TS 25.212: "Multiplexing and channel coding (FDD)".
- [4] 3GPP TS 25.213: "Spreading and modulation (FDD)".
- [5] 3GPP TS 25.214: "Physical layer procedures (FDD)".
- [6] 3GPP TS 25.215: "Physical layer – Measurements (FDD)".
- [7] 3GPP TS 25.222: "Multiplexing and channel coding (TDD)".
- [8] 3GPP TS 25.223: "Spreading and modulation (TDD)".
- [9] 3GPP TS 25.224: "Physical layer procedures (TDD)".
- [10] 3GPP TS 25.225: "Physical layer – Measurements (TDD)".
- [11] 3GPP TS 25.301: "Radio Interface Protocol Architecture".
- [12] 3GPP TS 25.302: "Services Provided by the Physical Layer".
- [13] 3GPP TS 25.401: "UTRAN Overall Description".
- [14] 3GPP TS 25.402: "Synchronisation in UTRAN, Stage 2".
- [15] 3GPP TS 25.304: "UE Procedures in Idle Mode and Procedures for Cell Reselection in Connected Mode".
- [16] 3GPP TS 25.427: "UTRAN Iur and Iub interface user plane protocols for DCH data streams".
- [17] 3GPP TS 25.435: "UTRAN I_{ub} Interface User Plane Protocols for Common Transport Channel Data Streams".
- [18] 3GPP TS 25.308: High Speed Downlink Packet Access (HSDPA); Overall description; Stage 2
- [19] 3GPP TS 25.331: "RRC Protocol Specification".

3 Abbreviations

For the purposes of the present document, the following abbreviations apply:

16QAM	16 Quadrature Amplitude Modulation
BCH	Broadcast Channel
CCPCH	Common Control Physical Channel
CCTrCH	Coded Composite Transport Channel
CDMA	Code Division Multiple Access
CQI	Channel Quality Indicator
DCH	Dedicated Channel
DL	Downlink
DPCH	Dedicated Physical Channel
DRX	Discontinuous Reception
DSCH	Downlink Shared Channel
DTX	Discontinuous Transmission
DwPCH	Downlink Pilot Channel
DwPTS	Downlink Pilot Time Slot
E-AGCH	E-DCH Absolute Grant Channel
E-DCH	Enhanced Dedicated Channel
E-HICH	E-DCH Hybrid ARQ Indicator Channel
E-PUCH	E-DCH Physical Uplink Channel
E-RUCCH	E-DCH Random Access Uplink Control Channel
E-UCCH	E-DCH Uplink Control Channel
FACH	Forward Access Channel
FDD	Frequency Division Duplex
FEC	Forward Error Correction
GP	Guard Period
GSM	Global System for Mobile Communication
HARQ	Hybrid ARQ
HS-DSCH	High Speed Downlink Shared Channel
HS-PDSCH	High Speed Physical Downlink Shared Channel
HS-SCCH	Shared Control Channel for HS-DSCH
HS-SICH	Shared Information Channel for HS-DSCH
IMB	Integrated Mobile Broadcast
MBSFN	MBMS over a Single Frequency Network
MIB	Master Information Block
MICH	MBMS Indicator Channel
MIMO	Multiple Input Multiple Output
MS burst	MBSFN Special burst
MT burst	MBSFN Traffic burst
NI	MBMS Notification Indicator
NRT	Non-Real Time
OVSF	Orthogonal Variable Spreading Factor
P-CCPCH	Primary CCPCH
PCH	Paging Channel
PDSCH	Physical Downlink Shared Channel
PI	Paging Indicator (value calculated by higher layers)
PICH	Page Indicator Channel
PLCCH	Physical Layer Common Control Channel
P _q	Paging Indicator (indicator set by physical layer)
PRACH	Physical Random Access Channel
PUSCH	Physical Uplink Shared Channel
RACH	Random Access Channel
RF	Radio Frame
RT	Real Time
S-CCPCH	Secondary CCPCH
SCH	Synchronisation Channel
SCTD	Space Code Transmit Diversity
SF	Spreading Factor
SFN	Cell System Frame Number

SS	Synchronisation Shift
TCH	Traffic Channel
TDD	Time Division Duplex
TDMA	Time Division Multiple Access
TFC	Transport Format Combination
TFCI	Transport Format Combination Indicator
TFI	Transport Format Indicator
TPC	Transmitter Power Control
TrCH	Transport Channel
TSTD	Time Switched Transmit Diversity
TTI	Transmission Time Interval
UE	User Equipment
UL	Uplink
UMTS	Universal Mobil Telecommunications System
UpPTS	Uplink Pilot Time Slot
UpPCH	Uplink Pilot Channel
USCH	Uplink Shared Channel
UTRAN	UMTS Terrestrial Radio Access Network

4 Services offered to higher layers

4.1 Transport channels

Transport channels are the services offered by layer 1 to the higher layers. A transport channel is defined by how and with what characteristics data is transferred over the air interface. A general classification of transport channels is into two groups:

- Dedicated Channels, using inherent addressing of UE
- Common Channels, using explicit addressing of UE if addressing is needed

General concepts about transport channels are described in [12].

4.1.1 Dedicated transport channels

There exists two types of dedicated transport channel, the Dedicated Channel (DCH) and the Enhanced Dedicated Channel (E-DCH).

4.1.1.1 DCH – Dedicated Channel

The Dedicated Channel (DCH) is an up- or downlink transport channel that is used to carry user or control information between the UTRAN and a UE.

4.1.1.2 E-DCH – Enhanced Dedicated Channel

The Enhanced Dedicated Channel (E-DCH) is an uplink transport channel.

4.1.2 Common transport channels

There are seven types of common transport channels for 3.84Mcps and 7.68Mcps TDD: BCH, FACH, PCH, RACH, USCH, DSCH, HS-DSCH.

There are eight types of common transport channels for 1.28Mcps TDD: BCH, FACH, PCH, RACH, USCH, DSCH, HS-DSCH, E-DCH.

4.1.2.1 BCH - Broadcast Channel

The Broadcast Channel (BCH) is a downlink transport channel that is used to broadcast system- and cell-specific information.

4.1.2.2 FACH – Forward Access Channel

The Forward Access Channel (FACH) is a downlink transport channel that is used to carry control information to a mobile station when the system knows the location cell of the mobile station. The FACH may also carry short user packets.

4.1.2.3 PCH – Paging Channel

The Paging Channel (PCH) is a downlink transport channel that is used to carry control information to a mobile station when the system does not know the location cell of the mobile station.

4.1.2.4 RACH – Random Access Channel

The Random Access Channel (RACH) is an up link transport channel that is used to carry control information from mobile station. The RACH may also carry short user packets.

4.1.2.5 USCH – Uplink Shared Channel

The uplink shared channel (USCH) is an uplink transport channel shared by several UEs carrying dedicated control or traffic data.

4.1.2.6 DSCH – Downlink Shared Channel

The downlink shared channel (DSCH) is a downlink transport channel shared by several UEs carrying dedicated control or traffic data.

4.1.2.7 HS-DSCH – High Speed Downlink Shared Channel

The High Speed Downlink Shared Channel (HS-DSCH) is a downlink transport channel shared by several UEs. The HS-DSCH is associated with one or several Shared Control Channels (HS-SCCH). The HS-DSCH is transmitted over the entire cell or over only part of the cell using e.g. beam-forming antennas.

For 1.28Mcps TDD, in a multi-frequency HS-DSCH cell, the HS-DSCH may be transmitted to a UE on one or more carriers in CELL_DCH state and on only one carrier in CELL_FACH, CELL_PCH and URA_PCH state in a TTI. The term 'multi-carrier HS-DSCH reception' refers to the HS-DSCH reception on multiple carriers in a TTI for a UE.

4.1.2.8 E-DCH – Enhanced Dedicated Channel

The Enhanced Dedicated Channel (E-DCH) is an uplink transport channel in CELL_FACH and IDLE mode for 1.28Mcps TDD only.

4.2 Indicators

Indicators are means of fast low-level signalling entities which are transmitted without using information blocks sent over transport channels. The meaning of indicators is implicit to the receiver.

The indicator(s) defined in the current version of the specifications are: Paging Indicator (PI) and MBMS Notification Indicator (NI).

5 Physical channels for the 3.84 Mcps option

Sub-clauses 5.1 to 5.7 do not apply to 3.84 Mcps MBSFN IMB. Sub-clause 5.8 describes physical channels for 3.84 Mcps MBSFN IMB.

All physical channels take three-layer structure with respect to timeslots, radio frames and system frame numbering (SFN), see [14]. Depending on the resource allocation, the configuration of radio frames or timeslots becomes different. All physical channels need a guard period in every timeslot. The time slots are used in the sense of a TDMA component to separate different user signals in the time domain. The physical channel signal format is presented in figure 1.

A physical channel in TDD is a burst, which is transmitted in a particular timeslot within allocated Radio Frames. The allocation can be continuous, i.e. the time slot in every frame is allocated to the physical channel or discontinuous, i.e. the time slot in a subset of all frames is allocated only. A burst is the combination of two data parts, a midamble part and a guard period. The duration of a burst is one time slot. Several bursts can be transmitted at the same time from one transmitter. In this case, the data parts must use different OVFSF channelisation codes, but the same scrambling code. The midamble parts are either identically or differently shifted versions of a cell-specific basic midamble code, see section 5.2.3. Note when in MBSFN operation, a midamble is not necessarily cell-specific.

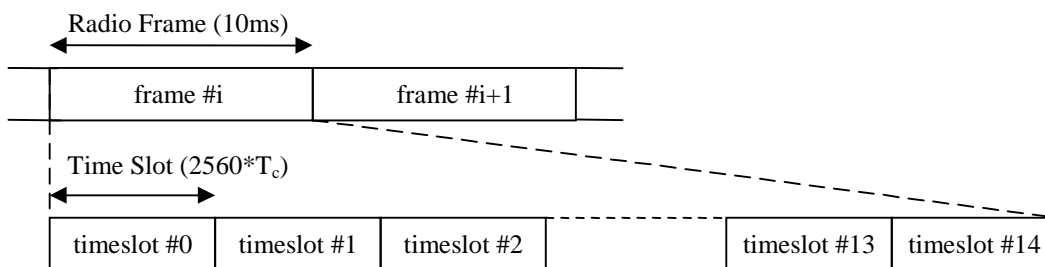

Figure 1: Physical channel signal format

The data part of the burst is spread with a combination of channelisation code and scrambling code. The channelisation code is a OVFSF code, that can have a spreading factor of 1, 2, 4, 8, or 16. The data rate of the physical channel is depending on the used spreading factor of the used OVFSF code.

The midamble part of the burst can contain two different types of midambles: a short one of length 256 chips, or a long one of 512 chips. The data rate of the physical channel is depending on the used midamble length. Additionally, when in MBSFN operation a midamble of length 320 chips is used.

So a physical channel is defined by frequency, timeslot, channelisation code, burst type and Radio Frame allocation. The scrambling code and the basic midamble code are broadcast and may be constant within a cell. When a physical channel is established, a start frame is given. The physical channels can either be of infinite duration, or a duration for the allocation can be defined.

5.1 Frame structure

The TDMA frame has a duration of 10 ms and is subdivided into 15 time slots (TS) of 2560*T_c duration each. A time slot corresponds to 2560 chips. The physical content of the time slots are the bursts of corresponding length as described in subclause 5.2.2.

Each 10 ms frame consists of 15 time slots, each allocated to either the uplink or the downlink (figure 2). With such a flexibility, the TDD mode can be adapted to different environments and deployment scenarios. In any configuration at least one time slot has to be allocated for the downlink and at least one time slot has to be allocated for the uplink with the exception of no uplink timeslots when the entire carrier is dedicated to MBSFN

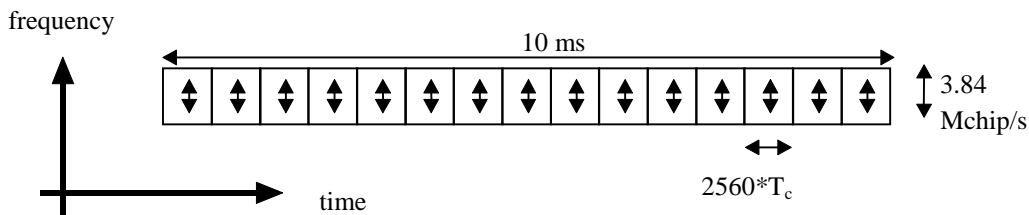

Figure 2: The TDD frame structure

Examples for multiple and single switching point configurations as well as for symmetric and asymmetric UL/DL allocations are given in figure 3.

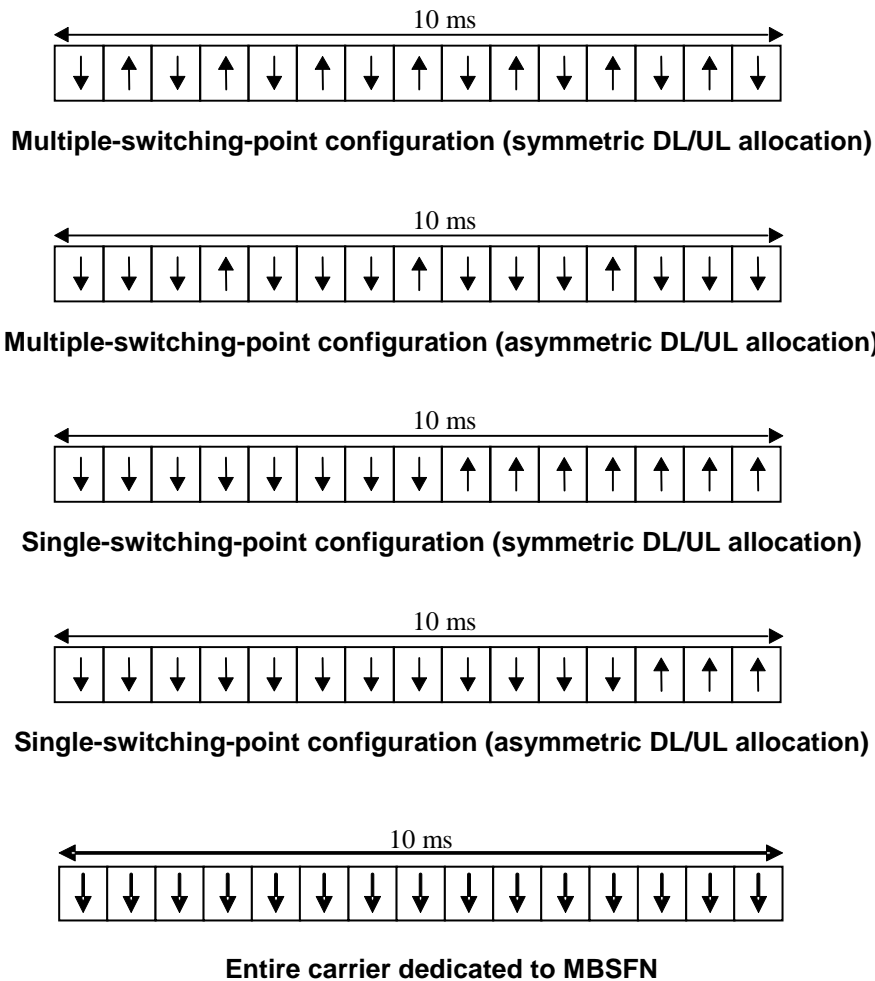

Figure 3: TDD frame structure examples

5.2 Dedicated physical channel (DPCH)

The DCH as described in subclause 4.1.1 is mapped onto the dedicated physical channel.

5.2.1 Spreading

Spreading is applied to the data part of the physical channels and consists of two operations. The first is the channelisation operation, which transforms every data symbol into a number of chips, thus increasing the bandwidth of the signal. The number of chips per data symbol is called the Spreading Factor (SF). The second operation is the scrambling operation, where a scrambling code is applied to the spread signal. Details on channelisation and scrambling operation can be found in [8].

5.2.1.1 Spreading for Downlink Physical Channels

Downlink physical channels shall use SF =16. Multiple parallel physical channels can be used to support higher data rates. These parallel physical channels shall be transmitted using different channelisation codes, see [8]. These codes with SF =16 are generated as described in [8].

Operation with a single code with spreading factor 1 is possible for the downlink physical channels.

5.2.1.2 Spreading for Uplink Physical Channels

The range of spreading factor that may be used for uplink physical channels shall range from 16 down to 1. For each physical channel an individual minimum spreading factor SF_{min} is transmitted by means of the higher layers. There are two options that are indicated by UTRAN:

1. The UE shall use the spreading factor SF_{min} , independent of the current TFC.
2. The UE shall autonomously increase the spreading factor depending on the current TFC.

If the UE autonomously changes the SF, it shall always vary the channelisation code along the branch with the higher code numbering of the allowed OVFSF sub tree, as depicted in [8]. In the event that code hopping is configured by higher layers, the allowed OVFSF sub-tree is that subtended by the effective allocated OVFSF code after the hop sequence has been applied to the allocated OVFSF code (see [9]).

For multicode transmission a UE shall use a maximum of two physical channels per timeslot simultaneously. These two parallel physical channels shall be transmitted using different channelisation codes, see [8].

5.2.2 Burst Types

Four types of bursts for dedicated physical channels are defined. All of them consist of two data symbol fields, a midamble and a guard period, the lengths of which are different for the individual burst types. Thus, the number of data symbols in a burst depends on the SF and the burst type, as depicted in table 1.

Table 1: Number of data symbols (N) for burst types 1, 2, 3 and 4

Spreading factor (SF)	Burst Type 1	Burst Type 2	Burst Type 3	Burst Type 4
1	1952	2208	1856	2112
2	976	1104	928	N/A
4	488	552	464	N/A
8	244	276	232	N/A
16	122	138	116	132

The support of burst types 1, 2 and 3 is mandatory for UEs supporting transmit and receive functions. UEs supporting transmit and receive functions and also MBSFN operation must additionally support burst type 4. UEs with receive only capability need only support burst type 4. The four different bursts defined here are well suited for different applications, as described in the following sections.

5.2.2.1 Burst Type 1

The burst type 1 can be used for uplink and downlink. Due to its longer midamble field this burst type supports the construction of a larger number of training sequences, see 5.2.3. The maximum number of training sequences depend on the cell configuration, see annex A. For the burst type 1 this number may be 4, 8, or 16.

The data fields of the burst type 1 are 976 chips long. The corresponding number of symbols depends on the spreading factor, as indicated in table 1 above. The midamble of burst type 1 has a length of 512 chips. The guard period for the burst type 1 is 96 chip periods long. The burst type 1 is shown in Figure 4. The contents of the burst fields are described in table 2.

Table 2: The contents of the burst type 1 fields

Chip number (CN)	Length of field in chips	Length of field in symbols	Contents of field
0-975	976	Cf table 1	Data symbols
976-1487	512	-	Midamble
1488-2463	976	Cf table 1	Data symbols
2464-2559	96	-	Guard period

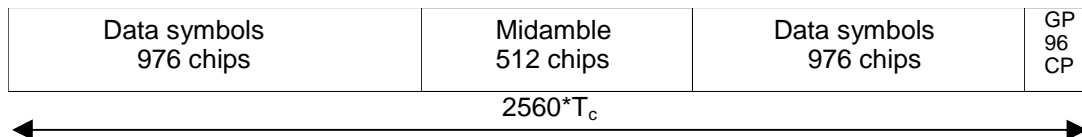

Figure 4: Burst structure of the burst type 1. GP denotes the guard period and CP the chip periods

5.2.2.2 Burst Type 2

The burst type 2 can be used for uplink and downlink. It offers a longer data field than burst type 1 on the cost of a shorter midamble. Due to the shorter midamble field the burst type 2 supports a maximum number of training sequences of 3 or 6 only, depending on the cell configuration, see annex A.

The data fields of the burst type 2 are 1104 chips long. The corresponding number of symbols depends on the spreading factor, as indicated in table 1 above. The guard period for the burst type 2 is 96 chip periods long. The burst type 2 is shown in Figure 5. The contents of the burst fields are described in table 3.

Table 3: The contents of the burst type 2 fields

Chip number (CN)	Length of field in chips	Length of field in symbols	Contents of field
0-1103	1104	cf table 1	Data symbols
1104-1359	256	-	Midamble
1360-2463	1104	cf table 1	Data symbols
2464-2559	96	-	Guard period

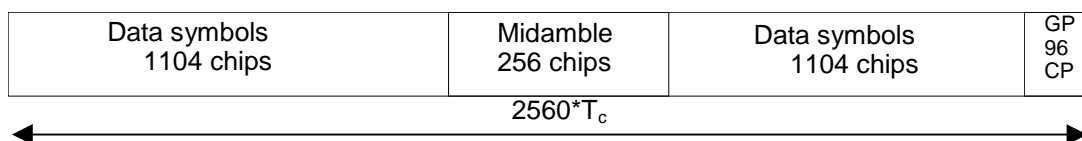

Figure 5: Burst structure of the burst type 2. GP denotes the guard period and CP the chip periods

5.2.2.3 Burst Type 3

The burst type 3 is used for uplink only. Due to the longer guard period it is suitable for initial access or access to a new cell after handover. It offers the same number of training sequences as burst type 1.

The data fields of the burst type 3 have a length of 976 chips and 880 chips, respectively. The corresponding number of symbols depends on the spreading factor, as indicated in table 1 above. The midamble of burst type 3 has a length of 512 chips. The guard period for the burst type 3 is 192 chip periods long. The burst type 3 is shown in Figure 6. The contents of the burst fields are described in table 4.

Table 4: The contents of the burst type 3 fields

Chip number (CN)	Length of field in chips	Length of field in symbols		Contents of field
0-975	976	Cf table 1		Data symbols
976-1487	512	-		Midamble
1488-2367	880	Cf table 1		Data symbols
2368-2559	192	-		Guard period

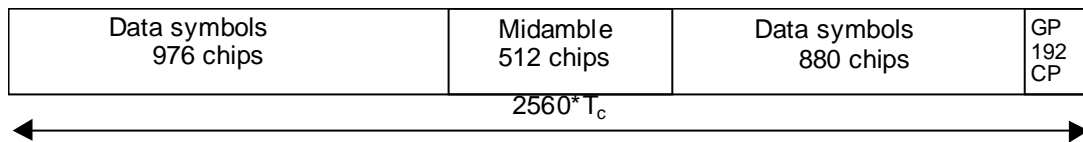
**Figure 6: Burst structure of the burst type 3. GP denotes the guard period and CP the chip periods**

5.2.2.3A Burst Type 4

The burst type 4 is used for downlink MBSFN operation only and supports a single training sequence.

The data fields of the burst type 4 are 1056 chips long. The corresponding number of symbols is 132 as indicated in table 1 above. The midamble of burst type 4 has a length of 320 chips. The guard period for the burst type 4 is 128 chip periods long. The burst type 4 is shown in Figure 6A. The contents of the burst fields are described in table 4A.

Table 4A: The contents of the burst type 4 fields

Chip number (CN)	Length of field in chips	Length of field in symbols		Contents of field
0-1055	1056	Cf table 1		Data symbols
1056-1375	320	-		Midamble
1376-2431	1056	Cf table 1		Data symbols
2432-2559	128	-		Guard period

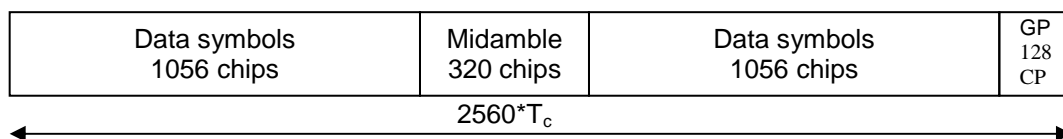
**Figure 6A: Burst structure of the burst type 4. GP denotes the guard period and CP the chip periods**

5.2.2.4 Transmission of TFCI

All burst types 1, 2, 3 and 4 provide the possibility for transmission of TFCI.

The transmission of TFCI is negotiated at call setup and can be re-negotiated during the call. For each CCTrCH it is indicated by higher layer signalling, which TFCI format is applied, except for the MBSFN FACH where the (16,5) bi-orthogonal code is always used for TFCI when TFCI is applied. Additionally for each allocated timeslot it is signalled individually whether that timeslot carries the TFCI or not. The TFCI is always present in the first timeslot in a radio frame for each CCTrCH. If a time slot contains the TFCI, then it is always transmitted using the physical channel with the lowest physical channel sequence number (p) in that timeslot. Physical channel sequence numbering is determined by the rate matching function and is described in [7].

The transmission of TFCI is done in the data parts of the respective physical channel. In DL the TFCI code word bits and data bits are subject to the same spreading procedure as depicted in [8]. In DL, the modulation applied to the TFCI code word bits is the same as that applied to the data symbols. In UL, independent of the SF that is applied to the data symbols in the burst, the data in the TFCI field are always spread with SF=16 using the channelisation code in the branch with the highest code numbering of the allowed OVSF sub tree, as depicted in [8]. Hence the midamble structure and length is not changed. The TFCI code word is to be transmitted directly adjacent to the midamble, possibly after the TPC. Figure 7 shows the position of the TFCI code word in a traffic burst in downlink. Figure 8 shows the position of the TFCI code word in a traffic burst in uplink.

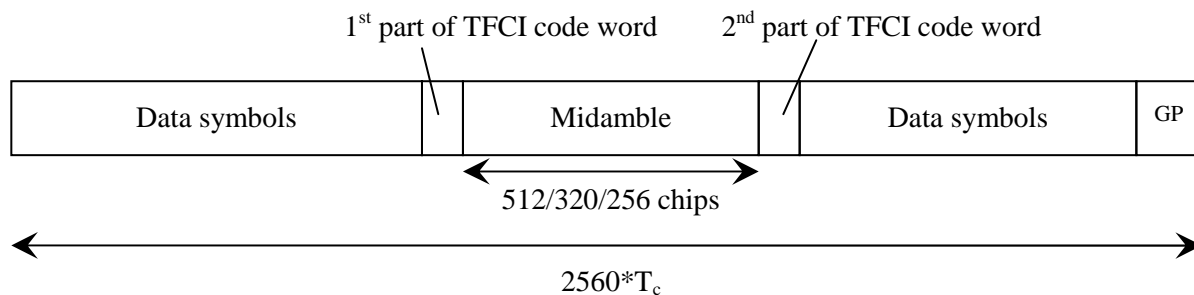

Figure 7: Position of the TFCI code word in the traffic burst in case of downlink

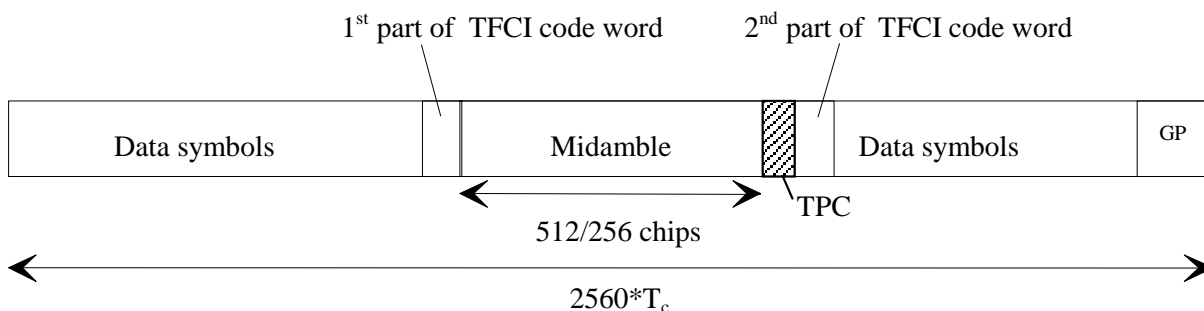

Figure 8: Position of the TFCI code word in the traffic burst in case of uplink

Two examples of TFCI transmission in the case of multiple DPCHs used for a connection are given in the Figure 9 and Figure 10 below. Combinations of the two schemes shown are also applicable.

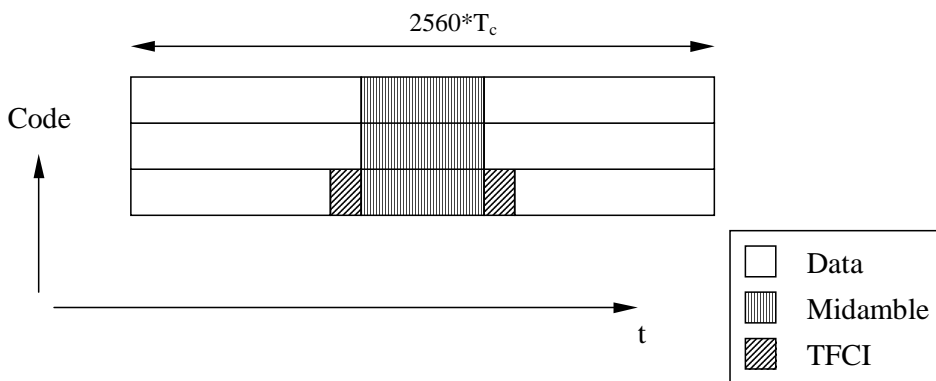

Figure 9: Example of TFCI transmission with physical channels multiplexed in code domain

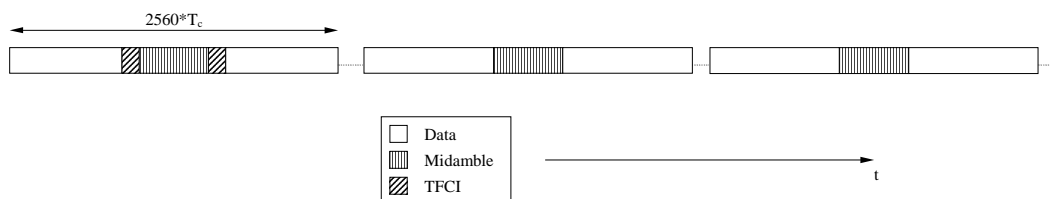

Figure 10: Example of TFCI transmission with physical channels multiplexed in time domain

In case the Node B receives an invalid TFI combination on the DCHs mapped to one CCTrCH the procedure described in [16] shall be applied. According to this procedure DTX shall be applied to all DPCHs to which the CCTrCH is mapped to.

5.2.2.5 Transmission of TPC

Burst types 1, 2 and 3 for dedicated channels provide the possibility for transmission of TPC in uplink.

The transmission of TPC is done in the data parts of the traffic burst. Independent of the SF that is applied to the data symbols in the burst, the data in the TPC field are always spread with SF=16 using the channelisation code in the branch with the highest code numbering of the allowed OVSF sub tree, as depicted in [8]. Hence the midamble structure and length is not changed. The TPC information is to be transmitted directly after the midamble. Figure 11 shows the position of the TPC in a traffic burst.

For every user the TPC information shall be transmitted at least once per transmitted frame. If a TFCI is applied for a CCTrCH, TPC shall be transmitted with the same channelization codes and in the same timeslots as the TFCI. If no TFCI is applied for a CCTrCH, TPC shall be transmitted using the physical channel corresponding to physical channel sequence number $p=1$. Physical channel sequence numbering is determined by the rate matching function and is described in [7].

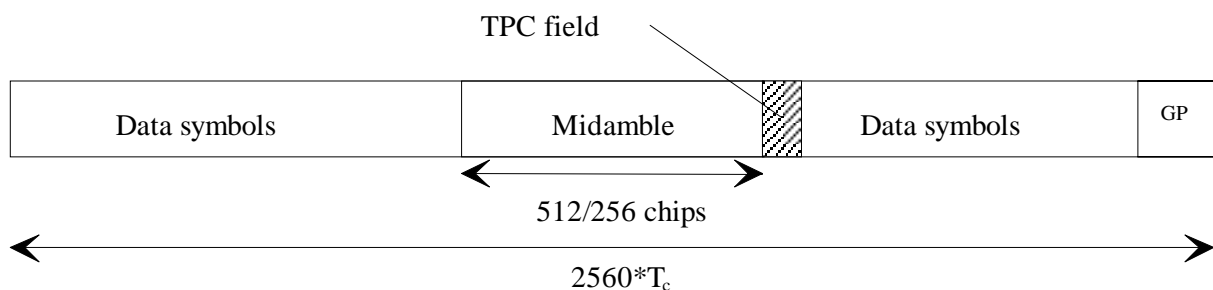

Figure 11: Position of TPC information in the traffic burst

The length of the TPC field is N_{TPC} bits. The TPC field is formed via repetition encoding a single bit b_{TPC} , N_{TPC} times.

The relationship between b_{TPC} and the TPC command is shown in table 4B.

Table 4B: TPC bit pattern

b_{TPC}	TPC command	Meaning
0	'Down'	Decrease Tx Power
1	'Up'	Increase Tx Power

5.2.2.6 Timeslot formats

5.2.2.6.1 Downlink timeslot formats

The downlink timeslot format depends on the spreading factor, midamble length and on the number of the TFCI code word bits, as depicted in the table 5a. For MBSFN operation the timeslot format also depends upon the symbol modulation scheme used. Slot formats 20-27 are only applicable to MBSFN operation with burst type 4.

Table 5a: Time slot formats for the Downlink

Slot Format #	Spreading Factor	Midamble length (chips)	N_{TFCI} code word (bits)	Bits/slot	$N_{\text{Data/Slot}}$ (bits)	$N_{\text{data/data field}}$ (bits)
0	16	512	0	244	244	122
1	16	512	4	244	240	120
2	16	512	8	244	236	118
3	16	512	16	244	228	114
4	16	512	32	244	212	106
5	16	256	0	276	276	138
6	16	256	4	276	272	136
7	16	256	8	276	268	134
8	16	256	16	276	260	130
9	16	256	32	276	244	122
10	1	512	0	3904	3904	1952
11	1	512	4	3904	3900	1950
12	1	512	8	3904	3896	1948
13	1	512	16	3904	3888	1944
14	1	512	32	3904	3872	1936
15	1	256	0	4416	4416	2208
16	1	256	4	4416	4412	2206
17	1	256	8	4416	4408	2204
18	1	256	16	4416	4400	2200
19	1	256	32	4416	4384	2192
20 (QPSK)	16	320	0	264	264	132
21 (QPSK)	16	320	16	264	248	124
22 (16QAM)	16	320	0	528	528	264
23 (16QAM)	16	320	16	528	512	256
24 (QPSK)	1	320	0	4224	4224	2112
25 (QPSK)	1	320	16	4224	4208	2104
26 (16QAM)	1	320	0	8448	8448	4224
27 (16QAM)	1	320	16	8448	8432	4216

5.2.2.6.2 Uplink timeslot formats

The uplink timeslot format depends on the spreading factor, midamble length, guard period length and on the number of the TFCI code word bits. Due to TPC, different amount of bits are mapped to the two data fields. The timeslot formats are depicted in the table 5b. Note that slot format #90 shall only be used for HS_SICH.

Table 5b: Timeslot formats for the Uplink

Slot Format #	Spreading Factor	Midamble length (chips)	Guard Period (chips)	N _{TFCI} code word (bits)	N _{TPC} (bits)	Bits/slot	N _{Data/Slot} (bits)	N _{data/data field(1)} (bits)	N _{data/data field(2)} (bits)
0	16	512	96	0	0	244	244	122	122
1	16	512	96	0	2	244	242	122	120
2	16	512	96	4	2	244	238	120	118
3	16	512	96	8	2	244	234	118	116
4	16	512	96	16	2	244	226	114	112
5	16	512	96	32	2	244	210	106	104
6	16	256	96	0	0	276	276	138	138
7	16	256	96	0	2	276	274	138	136
8	16	256	96	4	2	276	270	136	134
9	16	256	96	8	2	276	266	134	132
10	16	256	96	16	2	276	258	130	128
11	16	256	96	32	2	276	242	122	120
12	8	512	96	0	0	488	488	244	244
13	8	512	96	0	2	486	484	244	240
14	8	512	96	4	2	482	476	240	236
15	8	512	96	8	2	478	468	236	232
16	8	512	96	16	2	470	452	228	224
17	8	512	96	32	2	454	420	212	208
18	8	256	96	0	0	552	552	276	276
19	8	256	96	0	2	550	548	276	272
20	8	256	96	4	2	546	540	272	268
21	8	256	96	8	2	542	532	268	264
22	8	256	96	16	2	534	516	260	256
23	8	256	96	32	2	518	484	244	240
24	4	512	96	0	0	976	976	488	488
25	4	512	96	0	2	970	968	488	480
26	4	512	96	4	2	958	952	480	472
27	4	512	96	8	2	946	936	472	464
28	4	512	96	16	2	922	904	456	448
29	4	512	96	32	2	874	840	424	416
30	4	256	96	0	0	1104	1104	552	552
31	4	256	96	0	2	1098	1096	552	544
32	4	256	96	4	2	1086	1080	544	536
33	4	256	96	8	2	1074	1064	536	528
34	4	256	96	16	2	1050	1032	520	512
35	4	256	96	32	2	1002	968	488	480
36	2	512	96	0	0	1952	1952	976	976
37	2	512	96	0	2	1938	1936	976	960
38	2	512	96	4	2	1910	1904	960	944
39	2	512	96	8	2	1882	1872	944	928
40	2	512	96	16	2	1826	1808	912	896
41	2	512	96	32	2	1714	1680	848	832
42	2	256	96	0	0	2208	2208	1104	1104
43	2	256	96	0	2	2194	2192	1104	1088
44	2	256	96	4	2	2166	2160	1088	1072
45	2	256	96	8	2	2138	2128	1072	1056
46	2	256	96	16	2	2082	2064	1040	1024
47	2	256	96	32	2	1970	1936	976	960

Slot Format #	Spreading Factor	Midamble length (chips)	Guard Period (chips)	N _{TFCI} code word (bits)	N _{TPC} (bits)	Bits/slot	N _{Data/Slot} (bits)	N _{data/data field(1)} (bits)	N _{data/data field(2)} (bits)
48	1	512	96	0	0	3904	3904	1952	1952
49	1	512	96	0	2	3874	3872	1952	1920
50	1	512	96	4	2	3814	3808	1920	1888
51	1	512	96	8	2	3754	3744	1888	1856
52	1	512	96	16	2	3634	3616	1824	1792
53	1	512	96	32	2	3394	3360	1696	1664
54	1	256	96	0	0	4416	4416	2208	2208
55	1	256	96	0	2	4386	4384	2208	2176
56	1	256	96	4	2	4326	4320	2176	2144
57	1	256	96	8	2	4266	4256	2144	2112
58	1	256	96	16	2	4146	4128	2080	2048
59	1	256	96	32	2	3906	3872	1952	1920
60	16	512	192	0	0	232	232	122	110
61	16	512	192	0	2	232	230	122	108
62	16	512	192	4	2	232	226	120	106
63	16	512	192	8	2	232	222	118	104
64	16	512	192	16	2	232	214	114	100
65	16	512	192	32	2	232	198	106	92
66	8	512	192	0	0	464	464	244	220
67	8	512	192	0	2	462	460	244	216
68	8	512	192	4	2	458	452	240	212
69	8	512	192	8	2	454	444	236	208
70	8	512	192	16	2	446	428	228	200
71	8	512	192	32	2	430	396	212	184
72	4	512	192	0	0	928	928	488	440
73	4	512	192	0	2	922	920	488	432
74	4	512	192	4	2	910	904	480	424
75	4	512	192	8	2	898	888	472	416
76	4	512	192	16	2	874	856	456	400
77	4	512	192	32	2	826	792	424	368
78	2	512	192	0	0	1856	1856	976	880
79	2	512	192	0	2	1842	1840	976	864
80	2	512	192	4	2	1814	1808	960	848
81	2	512	192	8	2	1786	1776	944	832
82	2	512	192	16	2	1730	1712	912	800
83	2	512	192	32	2	1618	1584	848	736
84	1	512	192	0	0	3712	3712	1952	1760
85	1	512	192	0	2	3682	3680	1952	1728
86	1	512	192	4	2	3622	3616	1920	1696
87	1	512	192	8	2	3562	3552	1888	1664
88	1	512	192	16	2	3442	3424	1824	1600
89	1	512	192	32	2	3202	3168	1696	1472
90	16	512	96	0	8	244	236	122	114

5.2.3 Training sequences for spread bursts

In this subclause, the training sequences for usage as midambles in burst type 1, 2,3 and 4 (see subclause 5.2.2) are defined. The training sequences, i.e. midambles, of different users active in the same cell and same time slot are

cyclically shifted versions of one cell-specific single basic midamble code. In the case of MBSFN timeslots there is only a single midamble and this is derived from a single basic midamble code which is not necessarily cell-specific. The applicable basic midamble codes are given in Annex A.1 and A.2. As different basic midamble codes are required for different burst formats, the Annex A.1 shows the basic midamble codes \mathbf{m}_{pL} for burst type 1 and 3, and Annex A.2 shows \mathbf{m}_{pS} for burst types 2 and 4. It should be noted that burst type 2 must not be mixed with burst type 1 or 3 in the same timeslot of one cell and furthermore burst type 4 shall not be mixed with any other burst type in the same timeslot of one cell.

The basic midamble codes in Annex A.1 and A.2 are listed in hexadecimal notation. The binary form of the basic midamble code shall be derived according to table 6 below.

Table 6: Mapping of 4 binary elements m_i on a single hexadecimal digit

4 binary elements m_i	Mapped on hexadecimal digit
-1 -1 -1 -1	0
-1 -1 -1 1	1
-1 -1 1 -1	2
-1 -1 1 1	3
-1 1 -1 -1	4
-1 1 -1 1	5
-1 1 1 -1	6
-1 1 1 1	7
1 -1 -1 -1	8
1 -1 -1 1	9
1 -1 1 -1	A
1 -1 1 1	B
1 1 -1 -1	C
1 1 -1 1	D
1 1 1 -1	E
1 1 1 1	F

For each particular basic midamble code, its binary representation can be written as a vector \mathbf{m}_p :

$$\mathbf{m}_p = (m_1, m_2, \dots, m_p) \quad (1)$$

According to Annex A.1, the size of this vector \mathbf{m}_p is $P=456$ for burst types 1 and 3. Annex A.2 is setting $P=192$ for burst types 2 and 4. As QPSK modulation is used, the training sequences are transformed into a complex form, denoted as the complex vector $\underline{\mathbf{m}}_p$:

$$\underline{\mathbf{m}}_p = (\underline{m}_1, \underline{m}_2, \dots, \underline{m}_p) \quad (2)$$

The elements \underline{m}_i of $\underline{\mathbf{m}}_p$ are derived from elements m_i of \mathbf{m}_p using equation (3):

$$\underline{m}_i = (j)^i \cdot m_i \text{ for all } i = 1, \dots, P \quad (3)$$

Hence, the elements \underline{m}_i of the complex basic midamble code are alternating real and imaginary.

To derive the required training sequences (different shifts), this vector $\underline{\mathbf{m}}_p$ is periodically extended to the size:

$$i_{\max} = L_m + (K'-1)W + \lfloor P / K \rfloor \quad (4)$$

Notes on equation (4):

- L_m : Midamble length
- K' : Maximum number of different midamble shifts in a cell, when no intermediate shifts are used. This value depends on the midamble length.

- K: Maximum number of different midamble shifts in a cell, when intermediate shifts are used, $K=2K'$. This value depends on the midamble length.

Note that intermediate shifts are not used for burst type 4, i.e $K=K'=1$ for burst type 4

- W: Shift between the midambles, when the number of midambles is K' .
- $\lfloor x \rfloor$ denotes the largest integer smaller or equal to x

Allowed values for L_m , K' and W are given in Annex A.1 and A.2.

So we obtain a new vector $\underline{\mathbf{m}}$ containing the periodic basic midamble sequence:

$$\underline{\mathbf{m}} = (\underline{m}_1, \underline{m}_2, \dots, \underline{m}_{i_{\max}}) = (\underline{m}_1, \underline{m}_2, \dots, \underline{m}_{L_m + (K'-1)W + \lfloor P/K \rfloor}) \quad (5)$$

The first P elements of this vector $\underline{\mathbf{m}}$ are the same ones as in vector $\underline{\mathbf{m}}_p$, the following elements repeat the beginning:

$$\underline{m}_i = \underline{m}_{i-P} \text{ for the subset } i = (P+1), \dots, i_{\max} \quad (6)$$

Using this periodic basic midamble sequence $\underline{\mathbf{m}}$ for each shift k a midamble $\underline{\mathbf{m}}^{(k)}$ of length L_m is derived, which can be written as a shift specific vector:

$$\underline{\mathbf{m}}^{(k)} = (\underline{m}_1^{(k)}, \underline{m}_2^{(k)}, \dots, \underline{m}_{L_m}^{(k)}) \quad (7)$$

The L_m midamble elements $\underline{m}_i^{(k)}$ are generated for each midamble of the first K' shifts ($k = 1, \dots, K'$) based on:

$$\underline{m}_i^{(k)} = \underline{m}_{i+(K'-k)W} \text{ with } i = 1, \dots, L_m \text{ and } k = 1, \dots, K' \quad (8)$$

The elements of midambles for the second K' shifts ($k = (K'+1), \dots, K = (K'+1), \dots, 2K'$) are generated based on a slight modification of this formula introducing intermediate shifts:

$$\underline{m}_i^{(k)} = \underline{m}_{i+(K-k-1)W + \lfloor P/K \rfloor} \text{ with } i = 1, \dots, L_m \text{ and } k = K'+1, \dots, K-1 \quad (9)$$

$$\underline{m}_i^{(k)} = \underline{m}_{i+(K'-1)W + \lfloor P/K \rfloor} \text{ with } i = 1, \dots, L_m \text{ and } k = K \quad (10)$$

The number K_{Cell} of midambles that is supported in each cell can be smaller than K , depending on the cell size and the possible delay spreads, see annex A. The number K_{Cell} is signalled by higher layers. The midamble sequences derived according to equations (7) to (10) have complex values and are not subject to channelisation or scrambling process, i.e. the elements $\underline{m}_i^{(k)}$ represent complex chips for usage in the pulse shaping process at modulation.

The term 'a midamble code set' or 'a midamble code family' denotes K specific midamble codes $\underline{\mathbf{m}}^{(k)}$; $k=1, \dots, K$, based on a single basic midamble code $\underline{\mathbf{m}}_p$ according to (1).

5.2.4 Beamforming

When DL beamforming is used, at least that user to which beamforming is applied and which has a dedicated channel shall get one individual midamble according to subclause 5.2.3, even in DL. DL beamforming is not applied to timeslots containing burst type 4.

5.3 Common physical channels

5.3.1 Primary common control physical channel (P-CCPCH)

The BCH as described in subclause 4.1.2 is mapped onto the Primary Common Control Physical Channel (P-CCPCH). The position (time slot / code) of the P-CCPCH is known from the Physical Synchronisation Channel (PSCH), see subclause 5.3.4.

5.3.1.1 P-CCPCH Spreading

The P-CCPCH uses fixed spreading with a spreading factor $SF = 16$ as described in subclause 5.2.1.1. The P-CCPCH always uses channelisation code $c_{Q=16}^{(k=1)}$.

5.3.1.2 P-CCPCH Burst Types

The burst type 1 as described in subclause 5.2.2 is used for the P-CCPCH unless the entire carrier is dedicated to MBSFN then burst type 4 is used for P-CCPCH. No TFCI is applied for the P-CCPCH.

5.3.1.3 P-CCPCH Training sequences

The training sequences, i.e. midambles, as described in subclause 5.2.3 are used for the P-CCPCH.

5.3.2 Secondary common control physical channel (S-CCPCH)

PCH and FACH as described in subclause 4.1.2 are mapped onto one or more secondary common control physical channels (S-CCPCH). In this way the capacity of PCH and FACH can be adapted to the different requirements.

5.3.2.1 S-CCPCH Spreading

The S-CCPCH uses fixed spreading with a spreading factor $SF = 16$ as described in subclause 5.2.1.1. When S-CCPCH is used for MBSFN operation the spreading factor may be $SF = 16$ or $SF = 1$.

5.3.2.2 S-CCPCH Burst Types

The burst types 1,2 or 4 as described in subclause 5.2.2 are used for the S-CCPCHs. TFCI may be applied for S-CCPCHs.

5.3.2.2A S-CCPCH Modulation

When S-CCPCH is used for MBSFN operation, burst type 4 shall be used and the modulation may be QPSK or 16QAM, see table 5A for slot formats. When S-CCPCH is used for all other purposes the modulation shall be QPSK.

5.3.2.3 S-CCPCH Training sequences

The training sequences, i.e. midambles, as described in subclause 5.2.3 are used for the S-CCPCH.

5.3.3 The physical random access channel (PRACH)

The RACH as described in subclause 4.1.2 is mapped onto one uplink physical random access channel (PRACH).

5.3.3.1 PRACH Spreading

The uplink PRACH uses either spreading factor $SF=16$ or $SF=8$ as described in subclause 5.2.1.2. The set of admissible spreading codes for use on the PRACH and the associated spreading factors are broadcast on the BCH (within the RACH configuration parameters on the BCH).

5.3.3.2 PRACH Burst Type

The UEs send uplink access bursts of type 3 randomly in the PRACH. TFCI and TPC are not applied for the PRACH.

5.3.3.3 PRACH Training sequences

The training sequences, i.e. midambles, of different users active in the same time slot are time shifted versions of a single periodic basic code. The basic midamble codes for burst type 3 are shown in Annex A. The necessary time shifts are obtained by choosing either *all* $k=1,2,3,\dots,K'$ (for cells with small radius) or *uneven* $k=1,3,5,\dots\leq K'$ (for cells with large radius). Different cells use different periodic basic codes, i.e. different midamble sets.

For cells with large radius additional midambles may be derived from the time-inverted Basic Midamble Sequence. Thus, the second Basic Midamble Code m_2 is the time inverted version of Basic Midamble Code m_1 .

In this way, a joint channel estimation for the channel impulse responses of all active users within one time slot can be performed by a maximum of two cyclic correlations (in cells with small radius, a single cyclic correlator suffices). The different user specific channel impulse response estimates are obtained sequentially in time at the output of the cyclic correlators.

5.3.3.4 PRACH timeslot formats

For the PRACH the timeslot format is only spreading factor dependent. The timeslot formats 60 and 66 of table 5b are applicable for the PRACH.

5.3.3.5 Association between Training Sequences and Channelisation Codes

For the PRACH there exists a fixed association between the training sequence and the channelisation code. The generic rule to define this association is based on the order of the channelisation codes $c_Q^{(k)}$ given by k and the order of the midambles $m_j^{(k)}$ given by k , firstly, and j , secondly, with the constraint that the midamble for a spreading factor Q is the same as in the upper branch for the spreading factor $2Q$. The index $j=1$ or 2 indicates whether the original Basic Midamble Sequence ($j=1$) or the time-inverted Basic Midamble Sequence is used ($j=2$).

- For the case that all k are allowed and only one periodic basic code m_1 is available for the RACH, the association depicted in figure 12 is straightforward.
- For the case that only odd k are allowed the principle of the association is shown in figure 13. This association is applied for one and two basic periodic codes.

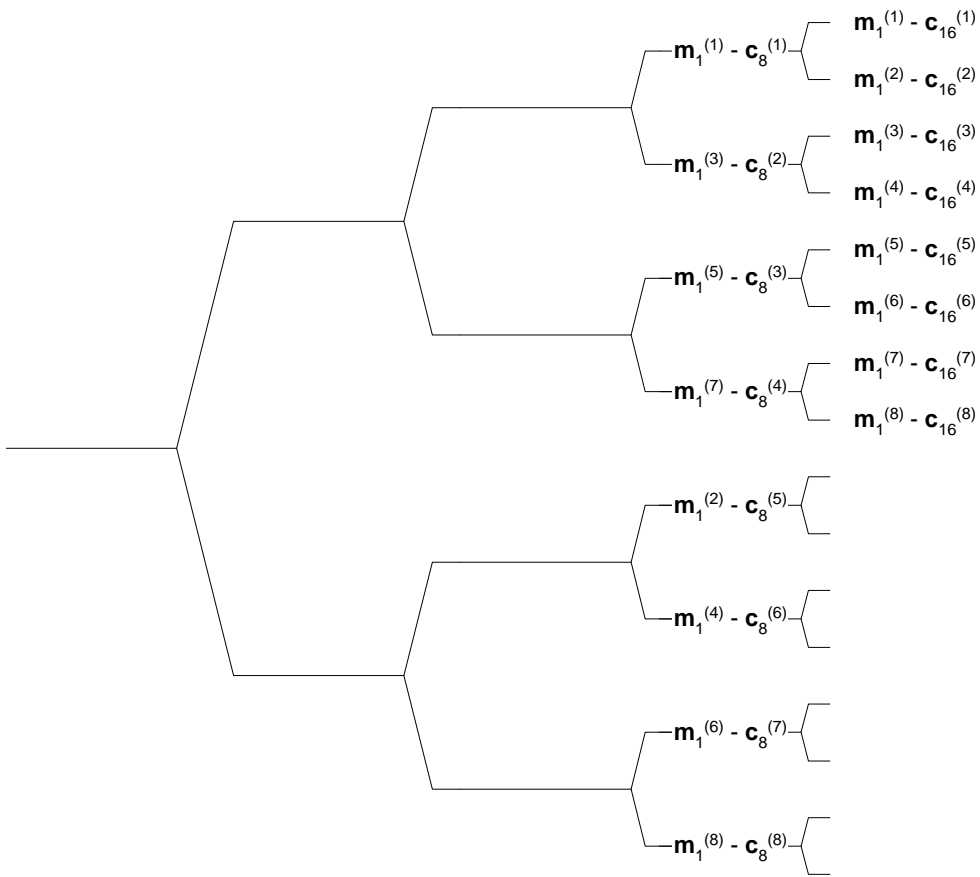

Figure 12: Association of Midambles to Channelisation Codes in the OVFS tree for all k

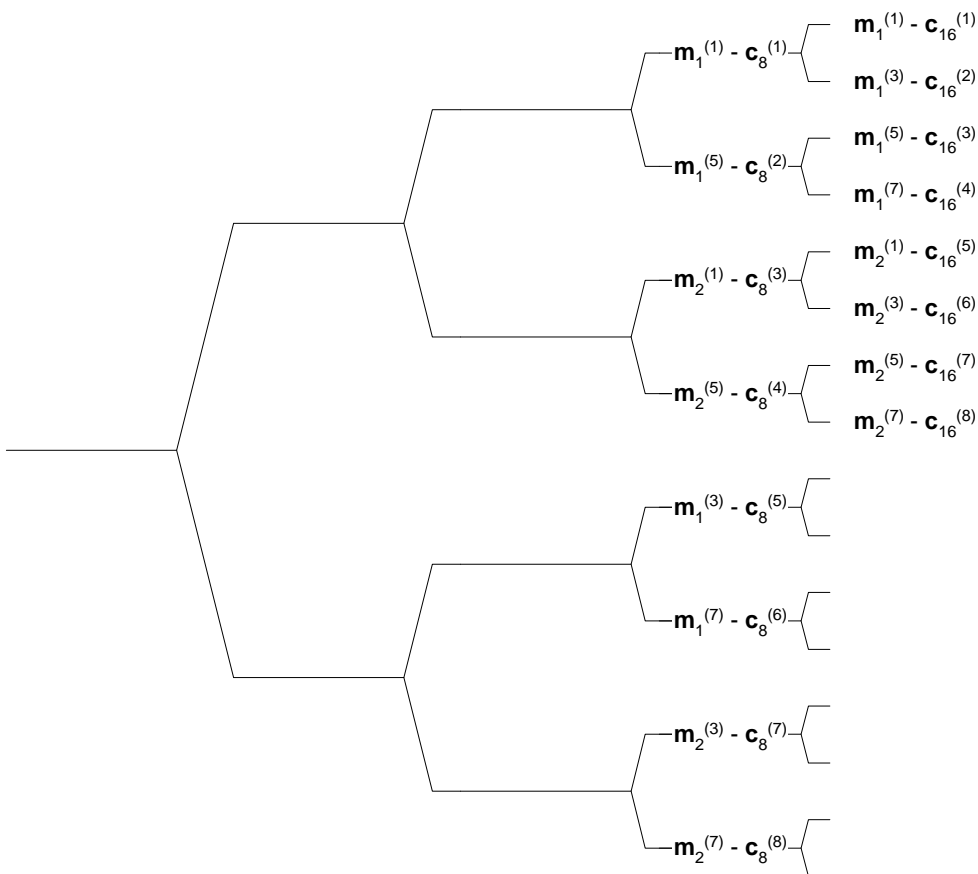

Figure 13: Association of Midambles to Channelisation Codes in the OVSF tree for odd k

5.3.4 The synchronisation channel (SCH)

In TDD mode code group of a cell can be derived from the synchronisation channel. In order not to limit the uplink/downlink asymmetry the SCH is mapped on one or two downlink slots per frame only.

There are two cases of SCH and P-CCPCH allocation as follows:

- Case 1) SCH and P-CCPCH allocated in TS#k, $k=0\dots14$
- Case 2) SCH allocated in two TS: TS#k and TS#k+8, $k=0\dots6$; P-CCPCH allocated in TS#k.

Only case 1 is supported in the case that the entire carrier is dedicated to MBSFN.

The position of SCH (value of k) in frame can change on a long term basis in any case.

Due to this SCH scheme, the position of P-CCPCH is known from the SCH.

Figure 14 is an example for transmission of SCH, $k=0$, of Case 2.

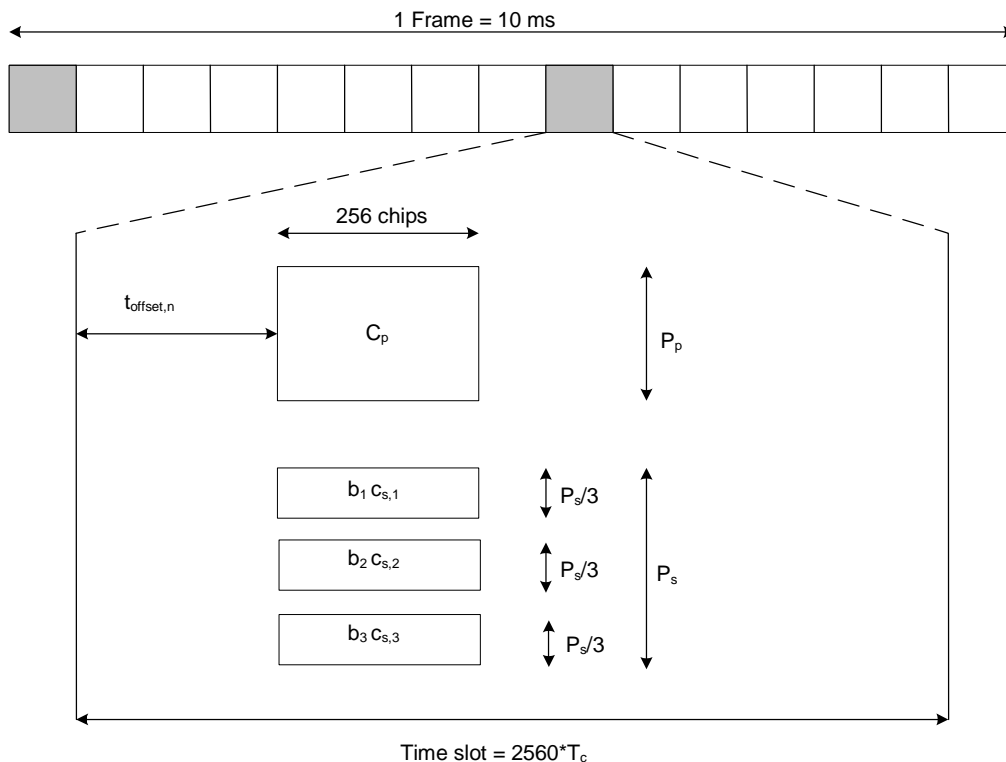

$$b_i \in \{\pm 1, \pm j\}, C_{s,i} \in \{C_0, C_1, C_3, C_4, C_5, C_6, C_8, C_{10}, C_{12}, C_{13}, C_{14}, C_{15}\}, i=1,2,3; \text{ see [8]}$$

Figure 14: Scheme for Synchronisation channel SCH consisting of one primary sequence Cp and 3 parallel secondary sequences Cs,i in slot k and k+8 (example for k=0 in Case 2)

As depicted in figure 14, the SCH consists of a primary and three secondary code sequences each 256 chips long. The primary and secondary code sequences are defined in [8] clause 7 'Synchronisation codes for the 3.84 Mcps option'.

Due to mobile to mobile interference, it is mandatory for public TDD systems to keep synchronisation between base stations. As a consequence of this, a capture effect concerning SCH can arise. The time offset $t_{offset,n}$ enables the system to overcome the capture effect.

The time offset $t_{offset,n}$ is one of 32 values, depending on the code group of the cell, n, cf. 'table 6 Mapping scheme for Cell Parameters, Code Groups, Scrambling Codes, Midambles and t_{offset} ' in [8]. Note that the cell parameter will change from frame to frame, cf. 'Table 7 Alignment of cell parameter cycling and system frame number' in [8], but the cell will belong to only one code group and thus have one time offset $t_{offset,n}$. The exact value for $t_{offset,n}$, regarding column 'Associated t_{offset} ' in table 6 in [8] is given by:

$$t_{offset,n} = \begin{cases} n \cdot 48 \cdot T_c & n < 16 \\ (720 + n \cdot 48) T_c & n \geq 16 \end{cases}; \quad n = 0, \dots, 31$$

5.3.5 Physical Uplink Shared Channel (PUSCH)

The USCH as described in subclause 4.1.2 is mapped onto one or more physical uplink shared channels (PUSCH). Timing advance, as described in [9], subclause 4.3, is applied to the PUSCH.

5.3.5.1 PUSCH Spreading

The spreading factors that can be applied to the PUSCH are SF = 1, 2, 4, 8, 16 as described in subclause 5.2.1.2.

5.3.5.2 PUSCH Burst Types

Burst types 1, 2 or 3 as described in subclause 5.2.2 can be used for PUSCH. TFCI and TPC can be transmitted on the PUSCH.

5.3.5.3 PUSCH Training Sequences

The training sequences as described in subclause 5.2.3 are used for the PUSCH.

5.3.5.4 UE Selection

The UE that shall transmit on the PUSCH is selected by higher layer signalling.

5.3.6 Physical Downlink Shared Channel (PDSCH)

The DSCH as described in subclause 4.1.2 is mapped onto one or more physical downlink shared channels (PDSCH).

5.3.6.1 PDSCH Spreading

The PDSCH uses either spreading factor $SF = 16$ or $SF = 1$ as described in subclause 5.2.1.1.

5.3.6.2 PDSCH Burst Types

Burst types 1 or 2 as described in subclause 5.2.2 can be used for PDSCH. TFCI can be transmitted on the PDSCH.

5.3.6.3 PDSCH Training Sequences

The training sequences as described in subclause 5.2.3 are used for the PDSCH.

5.3.6.4 UE Selection

To indicate to the UE that there is data to decode on the DSCH, three signalling methods are available:

- 1) using the TFCI field of the associated channel or PDSCH;
- 2) using on the DSCH user specific midamble derived from the set of midambles used for that cell;
- 3) using higher layer signalling.

When the midamble based method is used, the UE specific midamble allocation method shall be employed (see subclause 5.6), and the UE shall decode the PDSCH if the PDSCH was transmitted with the midamble assigned to the UE by UTRAN. For this method no other physical channels may use the same time slot as the PDSCH and only one UE may share the PDSCH time slot within one TTI.

Note: From the above mentioned signalling methods, only the higher layer signalling method is supported by higher layers in this release.

5.3.7 The Paging Indicator Channel (PICH)

The Paging Indicator Channel (PICH) is a physical channel used to carry the paging indicators.

5.3.7.1 Mapping of Paging Indicators to the PICH bits

Figure 15 depicts the structure of a PICH burst and the numbering of the bits within the burst. The same burst type is used for the PICH in every cell. N_{PIB} bits in a normal burst of type 1 or 2 are used to carry the paging indicators, where N_{PIB} depends on the burst type: $N_{PIB}=240$ for burst type 1 and $N_{PIB}=272$ for burst type 2. The bits $s_{N_{PIB}+1}, \dots, s_{N_{PIB}+4}$ adjacent to the midamble are reserved for possible future use.

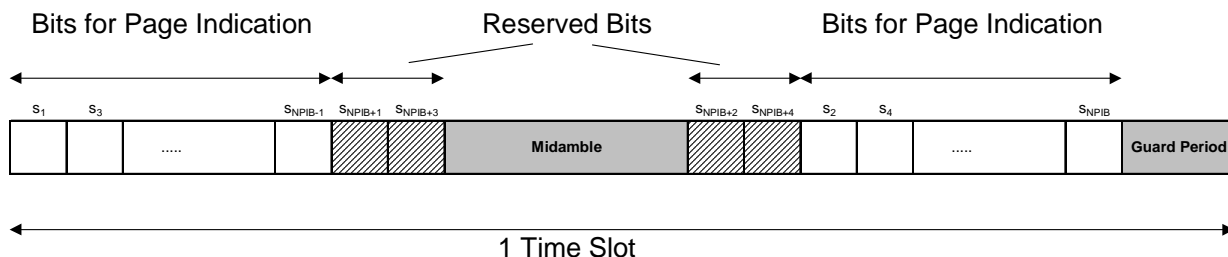

Figure 15: Transmission and numbering of paging indicator carrying bits in a PICH burst

Each paging indicator P_q in one time slot is mapped to the bits $\{s_{2L_{PI} \cdot q+1}, \dots, s_{2L_{PI} \cdot (q+1)}\}$ within this time slot. Thus, due to the interleaved transmission of the bits half of the symbols used for each paging indicator are transmitted in the first data part, and the other half of the symbols are transmitted in the second data part, as exemplary shown in figure 16 for a paging indicator length L_{PI} of 4 symbols.

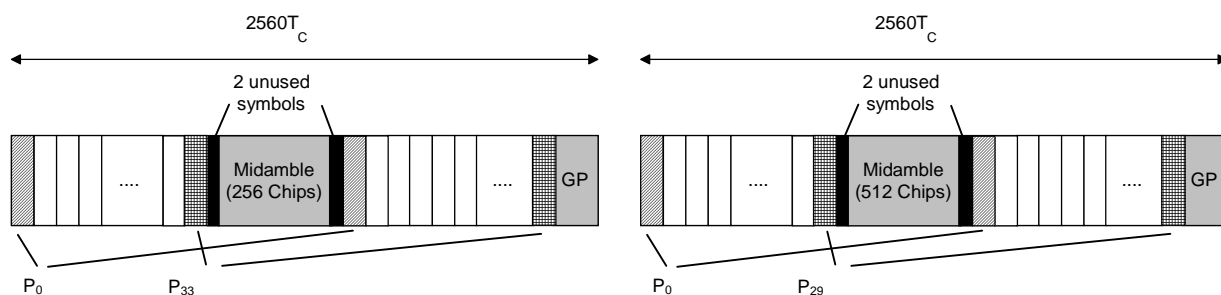

Figure 16: Example of mapping of paging indicators on PICH bits for $L_{PI}=4$

The setting of the paging indicators and the corresponding PICH bits (including the reserved ones) is described in [7].

N_{PI} paging indicators of length $L_{PI}=2$, $L_{PI}=4$ or $L_{PI}=8$ symbols are transmitted in each radio frame that contains the PICH. The number of paging indicators N_{PI} per radio frame is given by the paging indicator length and the burst type, which are both known by higher layer signalling. In table 7 this number is shown for the different possibilities of burst types and paging indicator lengths.

Table 7: Number N_{PI} of paging indicators per time slot for the different burst types and paging indicator lengths L_{PI}

	$L_{PI}=2$	$L_{PI}=4$	$L_{PI}=8$
Burst Type 1	$N_{PI}=60$	$N_{PI}=30$	$N_{PI}=15$
Burst Type 2	$N_{PI}=68$	$N_{PI}=34$	$N_{PI}=17$

5.3.7.2 Structure of the PICH over multiple radio frames

As shown in figure 17, the paging indicators of N_{PICH} consecutive frames form a PICH block, N_{PICH} is configured by higher layers. Thus, $N_P=N_{PICH} \cdot N_{PI}$ paging indicators are transmitted in each PICH block.

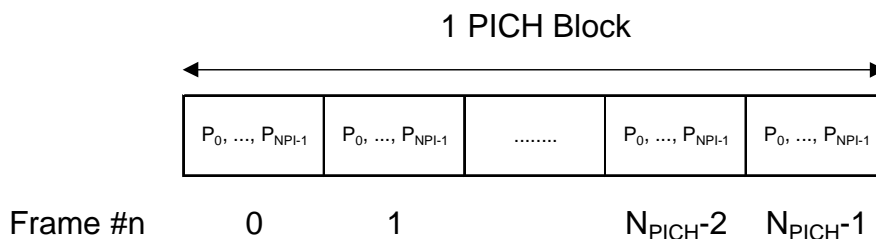

Figure 17: Structure of a PICH block

The value PI (PI = 0, ..., N_P-1) calculated by higher layers for use for a certain UE, see [15], is associated to the paging indicator P_q in the n th frame of one PICH block, where q is given by

$$q = \text{PI mod } N_{PI}$$

and n is given by

$$n = \text{PI div } N_{PI}$$

The PI bitmap in the PCH data frames over I_{ub} contains indication values for all possible higher layer PI values, see [17]. Each bit in the bitmap indicates if the paging indicator P_q associated with that particular PI shall be set to 0 or 1. Hence, the calculation in the formulas above is to be performed in Node B to make the association between PI and P_q .

5.3.7.3 PICH Training sequences

The training sequences, i.e. midambles for the PICH, are generated as described in subclause 5.2.3. The allocation of midambles depends on whether SCTD is applied to the PICH.

- If no antenna diversity is applied to the PICH the midambles can be allocated as described in subclause 5.6.
- If SCTD antenna diversity is applied to the PICH the allocation of midambles shall be as described in [9].

5.3.8 The physical node B synchronisation channel (PNBSCH)

In case cell sync bursts are used for Node B synchronisation the PNBSCH shall be used for the transmission of the cell sync burst [8]. The PNBSCH shall be mapped on the same timeslot as the PRACH acc. to a higher layer schedule. The cell sync burst shall be transmitted at the beginning of a timeslot. In case of Node B synchronisation via the air interface the transmission of a RACH may be prohibited on higher layer command in specified frames and timeslots.

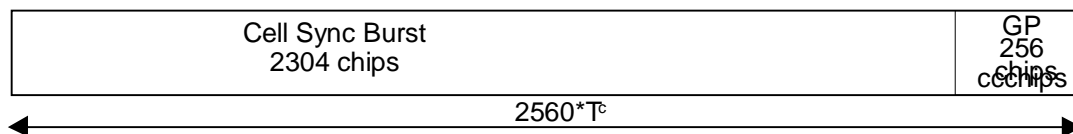

5.3.9 High Speed Physical Downlink Shared Channel (HS-PDSCH)

The HS-DSCH as described in subclause 4.1.2 is mapped onto one or more high speed physical downlink shared channels (HS-PDSCH).

5.3.9.1 HS-PDSCH Spreading

The HS-PDSCH shall use either spreading factor $SF = 16$ or $SF=1$, as described in 5.2.1.1.

5.3.9.2 HS-PDSCH Burst Types

Burst types 1 or 2 as described in subclause 5.2.2 can be used for PDSCH. TFCI shall not be transmitted on the HS-PDSCH. The TF of the HS-DSCH is derived from the associated HS-SCCH.

5.3.9.3 HS-PDSCH Training Sequences

The training sequences as described in subclause 5.2.3 are used for the HS-PDSCH.

5.3.9.4 UE Selection

To indicate to the UE that there is data to decode on the HS-DSCH, the UE id on the associated HS-SCCH shall be used.

5.3.9.5 HS-PDSCH timeslot formats

An HS-PDSCH may use QPSK or 16QAM modulation symbols. The time slot formats are shown in table 7A.

Table 7A: Time slot formats for the HS-PDSCH

Slot Format #	Spreading Factor	Midamble length (chips)	N_{TFCI} code word (bits)	Bits/slot	$N_{\text{Data/Slot}}$ (bits)	$N_{\text{data/data field}}$ (bits)
0 (QPSK)	16	512	0	244	244	122
1 (16QAM)	16	512	0	488	488	244
2 (QPSK)	16	256	0	276	276	138
3 (16QAM)	16	256	0	552	552	276
4 (QPSK)	1	512	0	3904	3904	1952
5 (16QAM)	1	512	0	7808	7808	3904
6 (QPSK)	1	256	0	4416	4416	2208
7(16QAM)	1	256	0	8832	8832	4416

5.3.10 Shared Control Channel for HS-DSCH (HS-SCCH)

The HS-SCCH is a DL physical channel that carries higher layer control information for HS-DSCH. The physical layer will process this information according to [7] and will transmit the resulting bits on the HS-SCCH the structure of which is described below.

5.3.10.1 HS-SCCH Spreading

The HS-SCCH shall use spreading factor $SF = 16$, as described in 5.2.1.1.

5.3.10.2 HS-SCCH Burst Types

Burst type 1 as described in subclause 5.2.2 can be used for HS-SCCH. TFCI shall not be transmitted on the HS-SCCH.

5.3.10.3 HS-SCCH Training Sequences

The training sequences as described in subclause 5.2.3 are used for the HS-SCCH.

5.3.10.4 HS-SCCH timeslot formats

The HS-SCCH always uses time slot format #0 from table 5a, see section 5.2.2.6.1.

5.3.11 Shared Information Channel for HS-DSCH (HS-SICH)

The HS-SICH is a UL physical channel that carries higher layer control information and the Channel Quality Indicator CQI for HS-DSCH. The physical layer will process this information according to [7] and will transmit the resulting bits on the HS-SICH the structure of which is described below.

5.3.11.1 HS-SICH Spreading

The HS-SICH shall use spreading factor $SF = 16$, as described in 5.2.1.2.

5.3.11.2 HS-SICH Burst Types

Burst type 1 as described in subclause 5.2.2 can be used for HS-SICH. TFCI shall not be transmitted on the HS-SICH, however, the HS-SICH shall carry TPC information.

5.3.11.3 HS-SICH Training Sequences

The training sequences as described in subclause 5.2.3 are used for the HS-SICH.

5.3.11.4 HS-SICH timeslot formats

The HS-SICH shall use time slot format #90 from table 5b, see section 5.2.2.6.2.

5.3.12 The MBMS Indicator Channel (MICH)

The MBMS Indicator Channel (MICH) is a physical channel used to carry the MBMS notification indicators. The UE may use multiple MICH within the MBMS modification period in order to make decisions on individual MBMS notification indicators.

5.3.12.1 Mapping of MBMS Indicators to the MICH bits for burst types 1 and 2

Figure 17a depicts the structure of a MICH burst and the numbering of the bits within the burst. The same burst type is used for the MICH in every cell. N_{NIB} bits in a normal burst of type 1 or 2 are used to carry the MBMS notification indicators, where N_{NIB} depends on the burst type: $N_{NIB}=240$ for burst type 1 and $N_{NIB}=272$ for burst type 2. The bits $s_{N_{NIB}+1}, \dots, s_{N_{NIB}+4}$ adjacent to the midamble are reserved for possible future use.

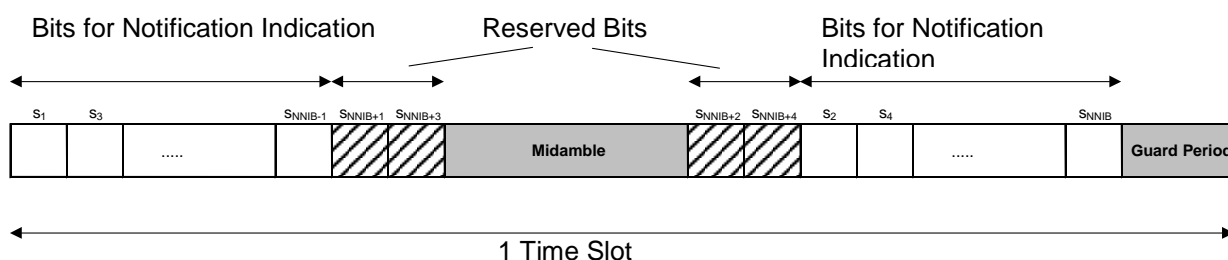

Figure 17a: Transmission and numbering of MBMS notification indicator carrying bits in a MICH burst using burst types 1 and 2

Each notification indicator N_q in one time slot is mapped to the bits $\{s_{2L_{NI} \cdot q+1}, \dots, s_{2L_{NI} \cdot (q+1)}\}$ within this time slot. Thus, due to the interleaved transmission of the bits half of the symbols used for each MBMS notification indicator are transmitted in the first data part, and the other half of the symbols are transmitted in the second data part: an example is shown in figure 17b for a MBMS notification indicator length L_{NI} of 4 symbols.

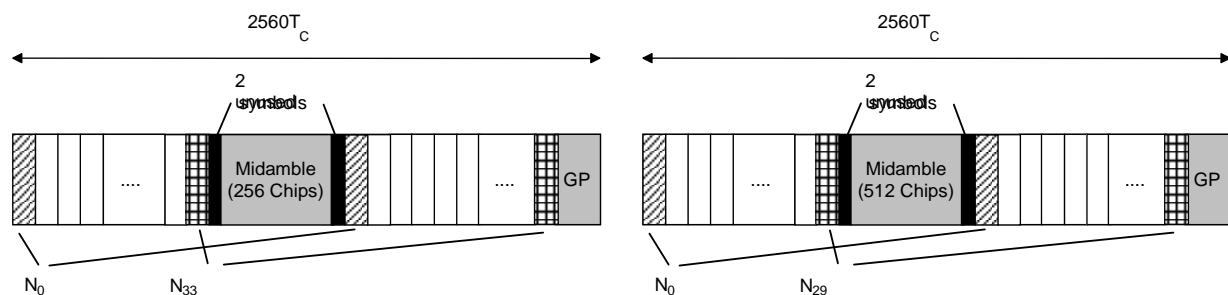

Figure 17b: Example of mapping of MBMS notification indicators on MICH bits for $L_{NI}=4$ for burst types 2 and 1 respectively

The setting of the MBMS notification indicators and the corresponding MICH bits (including the reserved ones) is described in [7].

N_n MBMS notification indicators of length $L_{NI}=2, L_{NI}=4$ or $L_{NI}=8$ symbols are transmitted in each MICH. The number of MBMS notification indicators N_n per MICH is given by the MBMS notification indicator length and the burst type, which are both known by higher layer signalling. In table 7B this number is shown for burst types 1 and 2 and differing MBMS notification indicator lengths.

Table 7B: Number N_n of MBMS notification indicators per time slot for the different burst types 1 and 2 and differing MBMS notification indicator lengths L_{NI}

	$L_{NI}=2$	$L_{NI}=4$	$L_{NI}=8$
Burst Type 1	$N_n=60$	$N_n=30$	$N_n=15$
Burst Type 2	$N_n=68$	$N_n=34$	$N_n=17$

The value NI ($NI = 0, \dots, N_{NI}-1$) calculated by higher layers, is associated to the MBMS notification indicator N_q , where $q = NI \bmod N_n$.

The set of NI passed over the I_{ub} indicates all higher layer NI values for which the notification indicator on MICH should be set to 1 during the corresponding modification period; all other indicators shall be set to 0.

5.3.12.1A Mapping of MBMS Indicators to the MICH bits for burst type 4

When an entire carrier is dedicated to MBSFN operation, the MICH shall use burst type 4. In this case $N_{NIB}=256$ and there are 8 reserved/unused bits adjacent to the midamble reserved for possible future use. The transmission and numbering of MBMS notification indicator carrying bits in a MICH burst is similar to that of figure 17a with the exception of 4 reserved bits either side of the midamble as opposed to 2 for burst types 1 and 2. An example mapping is shown in figure 17ba for a MBMS notification indicator length L_{NI} of 4 symbols.

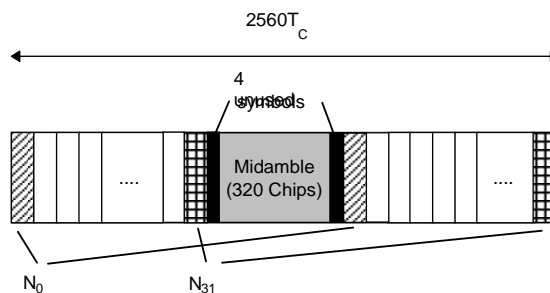

Figure 17ba: Example of mapping of MBMS notification indicators on MICH bits for $L_{NI}=4$ for burst type 4

The setting of the MBMS notification indicators and the corresponding MICH bits (including the reserved ones) is described in [7].

N_n MBMS notification indicators of length $L_{NI}=2, L_{NI}=4$ or $L_{NI}=8$ symbols are transmitted in each MICH. The number of MBMS notification indicators N_n per MICH is given by the MBMS notification indicator length and the burst type, which are both known by higher layer signalling. In table 7BA this number is shown for the different possibilities of burst types and MBMS notification indicator lengths.

Table 7BA: Number N_n of MBMS notification indicators per time slot for burst type 4 and differing MBMS notification indicator lengths L_{NI}

	$L_{NI}=2$	$L_{NI}=4$	$L_{NI}=8$
Burst Type 4	$N_n=64$	$N_n=32$	$N_n=16$

The value NI ($NI = 0, \dots, N_{NI}-1$) calculated by higher layers, is associated to the MBMS notification indicator N_q , where $q = NI \bmod N_n$.

The set of NI passed over the I_{ub} indicates all higher layer NI values for which the notification indicator on MICH should be set to 1 during the corresponding modification period; all other indicators shall be set to 0.

5.3.12.2 MICH Training sequences

The training sequences, i.e. midambles for the MICH, are generated as described in subclause 5.2.3. The allocation of midambles depends on whether SCTD is applied to the MICH.

- If no antenna diversity is applied the MICH the midambles can be allocated as described in subclause 5.6.
- If SCTD antenna diversity is applied to the MICH the allocation of midambles shall be as described in [9].

Note that when the entire carrier is dedicated to MBSFN operation MICH employs burst type 4 as described in subclause 5.3.12.1A. Burst type 4 supports a single midamble and hence SCTD is precluded from operation in such a scenario.

5.3.13 E-DCH Physical Uplink Channel (E-PUCH)

One or more E-PUCH are used to carry the uplink E-DCH transport channel and associated control information (E-UCCH) in each E-DCH TTI. In a timeslot designated by UTRAN for E-PUCH use, up to one E-PUCH may be transmitted by a UE. No other physical channels may be transmitted by a UE in an E-PUCH timeslot.

Timing advance, as described in [9], subclause 4.3, is applied to the E-PUCH.

5.3.13.1 E-UCCH

The E-DCH Uplink Control Channel (E-UCCH) carries uplink control information associated with the E-DCH and is carried within indicator fields mapped to E-PUCH. Depending on the configuration by higher layers, an E-PUCH burst may or may not contain E-UCCH and TPC. When E-PUCH does contain E-UCCH, TPC is also transmitted. When E-PUCH does not contain E-UCCH, TPC is not transmitted.

Higher layers shall indicate the maximum number of timeslots (N_{E-UCCH}) that may contain E-UCCH/TPC in the E-DCH TTI. For an allocation of n_{TS} E-PUCH timeslots, the UE shall transmit E-UCCH and TPC on the first m allocated timeslots of the E-DCH TTI, where $m = \min(n_{TS}, N_{E-UCCH})$.

The E-UCCH comprises two parts, E-UCCH part 1 and E-UCCH part 2.

E-UCCH part 1:

- is of length 32 physical channel bits
- is mapped to the TFCI field of the E-PUCH (16 bits either side of the midamble)
- is spread at SF=16 using the channelisation code in the branch with the highest code numbering of the allowed OVSF sub tree, as depicted in [8]
- uses QPSK modulation

E-UCCH part 2:

- is of length 32 physical channel bits
- is spread using the same spreading factor as the data payloads
- uses the same modulation as the data payloads

Figures 17c and 17d show the E-PUCH data burst with and without the E-UCCH/TPC fields.

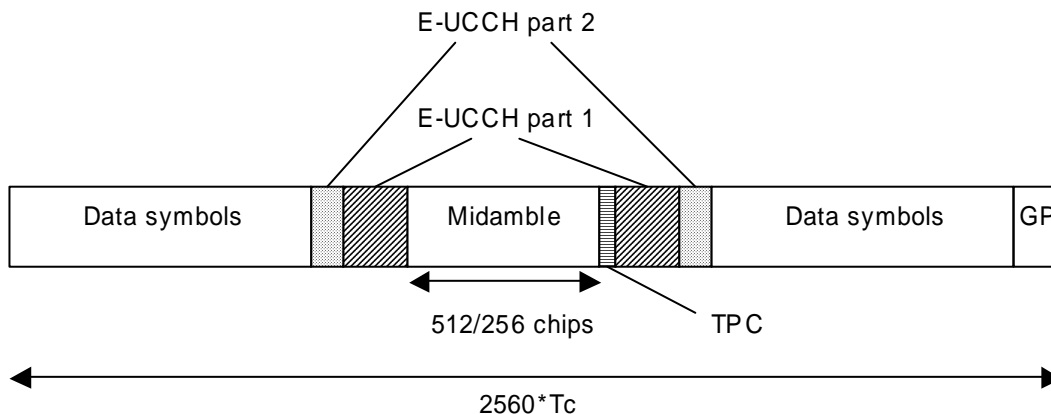

Figure 17c: Location of E-UCCH part 1, E-UCCH part 2 and TPC in the E-PUCH data burst

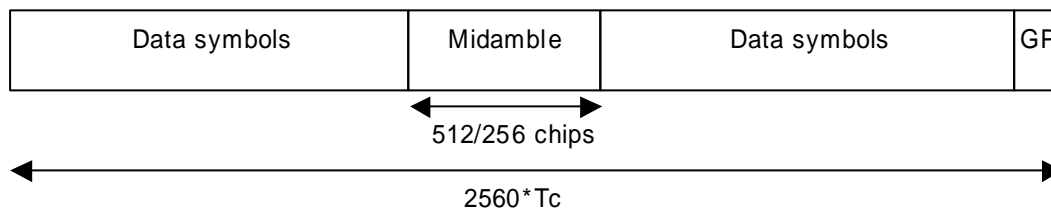

Figure 17d: E-PUCH data burst without E-UCCH/TPC

5.3.13.2 E-PUCH Spreading

The spreading factors that can be applied to the E-PUCH are SF = 1, 2, 4, 8, 16 as described in subclause 5.2.1.2.

5.3.13.3 E-PUCH Burst Types

Burst types 1, 2 or 3 as described in subclause 5.2.2 can be used for E-PUCH. E-UCCH and TPC can be transmitted on the E-PUCH.

5.3.13.4 PUSCH Training Sequences

The training sequences as described in subclause 5.2.3 are used for the E-PUCH.

5.3.13.5 UE Selection

UEs that shall transmit on the E-PUCH are selected by higher layers. The UE id on the associated E-AGCH shall be used for identification.

5.3.13.6 E-PUCH timeslot formats

An E-PUCH may use QPSK or 16QAM modulation symbols and may or may not contain E-UCCH/TPC. The time slot formats are shown in table 7c.

Table 7c: Timeslot formats for E-PUCH

slot format #	SF	Midamble Length (chips)	GP (chips)	N_{EUCCH1} (bits)	N_{EUCCH2} (bits)	N_{TPC} (bits)	Bits/slot	$N_{data/slot}$ (bits)	$N_{data/data}$ field(1) (bits)	$N_{data/data}$ field(2) (bits)
0 (QPSK)	16	512	96	0	0	0	244	244	122	122
1 (16QAM)	16	512	96	0	0	0	488	488	244	244
2 (QPSK)	16	512	96	32	32	2	244	178	90	88
3 (16QAM)	16	512	96	32	32	2	454	388	196	192
4 (QPSK)	16	256	96	0	0	0	276	276	138	138
5 (16QAM)	16	256	96	0	0	0	552	552	276	276
6 (QPSK)	16	256	96	32	32	2	276	210	106	104
7 (16QAM)	16	256	96	32	32	2	518	452	228	224
8 (QPSK)	8	512	96	0	0	0	488	488	244	244
9 (16QAM)	8	512	96	0	0	0	976	976	488	488
10 (QPSK)	8	512	96	32	32	2	454	388	196	192
11 (16QAM)	8	512	96	32	32	2	874	808	408	400
12 (QPSK)	8	256	96	0	0	0	552	552	276	276
13 (16QAM)	8	256	96	0	0	0	1104	1104	552	552
14 (QPSK)	8	256	96	32	32	2	518	452	228	224
15 (16QAM)	8	256	96	32	32	2	1002	936	472	464
16 (QPSK)	4	512	96	0	0	0	976	976	488	488
17 (16QAM)	4	512	96	0	0	0	1952	1952	976	976
18 (QPSK)	4	512	96	32	32	2	874	808	408	400
19 (16QAM)	4	512	96	32	32	2	1714	1648	832	816
20 (QPSK)	4	256	96	0	0	0	1104	1104	552	552
21 (16QAM)	4	256	96	0	0	0	2208	2208	1104	1104
22 (QPSK)	4	256	96	32	32	2	1002	936	472	464
23 (16QAM)	4	256	96	32	32	2	1970	1904	960	944
24 (QPSK)	2	512	96	0	0	0	1952	1952	976	976
25 (16QAM)	2	512	96	0	0	0	3904	3904	1952	1952
26 (QPSK)	2	512	96	32	32	2	1714	1648	832	816
27 (16QAM)	2	512	96	32	32	2	3394	3328	1680	1648
28 (QPSK)	2	256	96	0	0	0	2208	2208	1104	1104
29 (16QAM)	2	256	96	0	0	0	4416	4416	2208	2208
30 (QPSK)	2	256	96	32	32	2	1970	1904	960	944
31 (16QAM)	2	256	96	32	32	2	3906	3840	1936	1904
32 (QPSK)	1	512	96	0	0	0	3904	3904	1952	1952
33 (16QAM)	1	512	96	0	0	0	7808	7808	3904	3904
34 (QPSK)	1	512	96	32	32	2	3394	3328	1680	1648
35 (16QAM)	1	512	96	32	32	2	6754	6688	3376	3312
36 (QPSK)	1	256	96	0	0	0	4416	4416	2208	2208
37 (16QAM)	1	256	96	0	0	0	8832	8832	4416	4416
38 (QPSK)	1	256	96	32	32	2	3906	3840	1936	1904
39 (16QAM)	1	256	96	32	32	2	7778	7712	3888	3824
40 (QPSK)	16	512	192	0	0	0	232	232	122	110
41 (16QAM)	16	512	192	0	0	0	464	464	244	220
42 (QPSK)	16	512	192	32	32	2	232	166	90	76
43 (16QAM)	16	512	192	32	32	2	430	364	196	168
44 (QPSK)	8	512	192	0	0	0	464	464	244	220
45 (16QAM)	8	512	192	0	0	0	928	928	488	440

slot format #	SF	Midamble Length (chips)	GP (chips)	NEUCCH1 (bits)	NEUCCH2 (bits)	N _{TPC} (bits)	Bits/slot	N _{data/slot} (bits)	N _{data/data field(1)} (bits)	N _{data/data field(2)} (bits)
46 (QPSK)	8	512	192	32	32	2	430	364	196	168
47 (16QAM)	8	512	192	32	32	2	826	760	408	352
48 (QPSK)	4	512	192	0	0	0	928	928	488	440
49 (16QAM)	4	512	192	0	0	0	1856	1856	976	880
50 (QPSK)	4	512	192	32	32	2	826	760	408	352
51 (16QAM)	4	512	192	32	32	2	1618	1552	832	720
52 (QPSK)	2	512	192	0	0	0	1856	1856	976	880
53 (16QAM)	2	512	192	0	0	0	3712	3712	1952	1760
54 (QPSK)	2	512	192	32	32	2	1618	1552	832	720
55 (16QAM)	2	512	192	32	32	2	3202	3136	1680	1456
56 (QPSK)	1	512	192	0	0	0	3712	3712	1952	1760
57 (16QAM)	1	512	192	0	0	0	7424	7424	3904	3520
58 (QPSK)	1	512	192	32	32	2	3202	3136	1680	1456
59 (16QAM)	1	512	192	32	32	2	6370	6304	3376	2928

5.3.14 E-DCH Random Access Uplink Control Channel (E-RUCCH)

The E-RUCCH is used to carry E-DCH-associated uplink control signalling when E-PUCH resources are not available. The characteristics of the E-RUCCH physical channel are identical to those of PRACH (see subclause 5.3.3).

Physical resources available for E-RUCCH are configured by higher layers. E-RUCCH may be mapped to the same physical resources that are assigned for PRACH.

5.3.15 E-DCH Absolute Grant Channel (E-AGCH)

The E-DCH Absolute Grant Channel (E-AGCH) is a downlink physical channel carrying the uplink E-DCH absolute grant control information. E-AGCH carries a TPC field (located immediately after the midamble and spread using SF16) which is used to control the E-PUCH power. Figure 17e illustrates the burst structure of the E-AGCH.

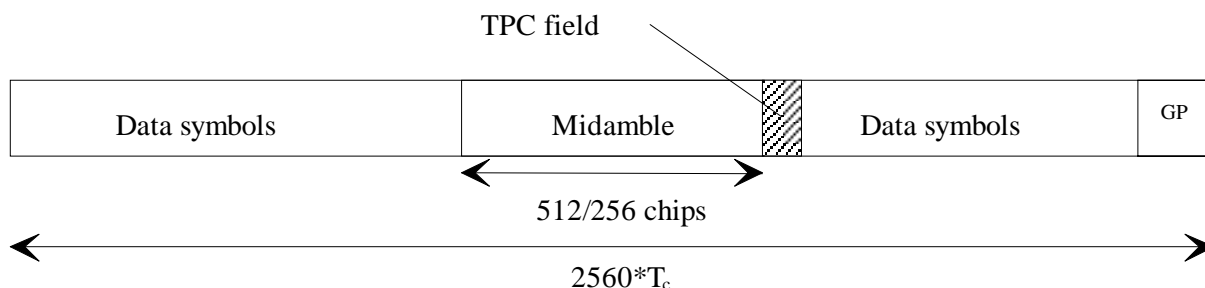

Figure 17e: Burst structure of E-AGCH

One E-DCH absolute grant for a UE shall be transmitted over one E-AGCH.

5.3.15.1 E-AGCH Spreading

The E-AGCH shall use spreading factor SF = 16, as described in 5.2.1.1.

5.3.15.2 E-AGCH Burst Types

Burst types 1 and 2 as described in subclause 5.2.2 can be used for E-AGCH. TPC shall be transmitted on E-AGCH whereas TFCI shall not be transmitted.

5.3.15.3 E-AGCH Training Sequences

The training sequences as described in subclause 5.2.3 are used for the E-AGCH.

5.3.15.4 E-AGCH timeslot formats

The E-AGCH uses the timeslot formats of Table 7d. These augment downlink slot formats 0...19 of table 5a, see subclause 5.2.2.6.1.

Table 7d: Time slot formats for E-AGCH

Slot Format #	SF	Midamble length (chips)	N_{TFCI} code word (bits)	N_{TPC} (bits)	Bits/slot	$N_{Data/Slot}$ (bits)	$N_{data/data}$ field (1) (bits)	$N_{data/data}$ field (2) (bits)
20	16	512	0	2	244	242	122	120
21	16	256	0	2	276	274	138	136

5.3.16 E-DCH Hybrid ARQ Acknowledgement Indicator Channel (E-HICH)

The E-DCH HARQ Acknowledgement indicator channel (E-HICH) is defined in terms of a SF16 downlink physical channel and a signature sequence. The E-HICH carries the uplink E-DCH hybrid ARQ acknowledgement indicator. Figure 17f illustrates the structure of the E-HICH.

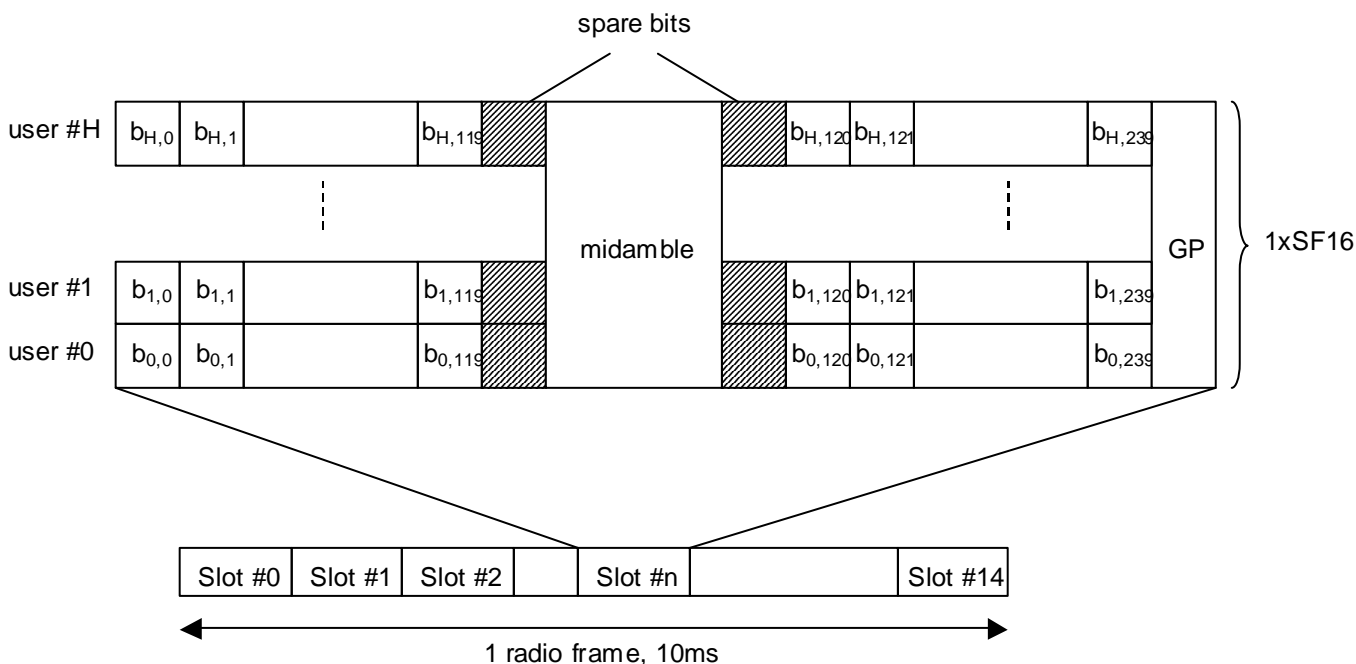

Figure 17f – E-HICH Structure

A single channelisation code may carry one or multiple signature sequences. Each signature sequence conveys a HARQ acknowledgement indicator. A maximum of one indicator may be transmitted to a UE. Each acknowledgement indicator is coded to form a signature sequence of 240 bits (b_0, b_1, \dots, b_{239}) as defined in [7] and is transmitted within a single E-HICH timeslot. The E-HICH also contains U spare bit locations, where $U=4$ for burst type 1 and $U=36$ for burst type 2. The spare bit values are not defined.

5.3.16.1 E-HICH Spreading

Signature sequences (including spare bits inserted) that share the same channelisation code are combined and spread using spreading factor SF=16 as described in [8].

5.3.16.2 E-HICH Burst Types

Burst types 1 and 2 as described in subclause 5.2.2 can be used for E-HICH. Neither TFCI nor TPC shall be transmitted on the E-HICH.

5.3.16.3 E-HICH Training Sequences

The training sequences as described in subclause 5.2.3 are used for the E-HICH.

5.4 Transmit Diversity for DL Physical Channels

Table 8 summarizes the different transmit diversity schemes for different downlink physical channel types that are described in [9].

Table 8: Application of Tx diversity schemes on downlink physical channel types
"X" – can be applied, "-" – must not be applied

Physical channel type	Open loop Tx Diversity		Closed loop Tx Diversity
	TSTD	SCTD ^(*)	
P-CCPCH	–	X(†)	–
S-CCPCH	X(**)	X(†)	--
SCH	X	–	–
DPCH	–	–	X
PDSCH	–	X	X
PICH	–	X	–
MICH	–	X(†)	–
HS-SCCH	--	X	X
HS-PDSCH	--	X	X
E-AGCH	--	X	X
E-HICH	--	X	--

(*) Note: SCTD may only be applied to physical channels when they are allocated to beacon locations.

(**) Note: TSTD may not be applied to S-CCPCH in beacon locations.

(†) Note: that when the entire carrier is dedicated to MBSFN operation SCTD shall not be applied.

5.5 Beacon characteristics of physical channels

For the purpose of measurements, common physical channels that are allocated to particular locations (time slot, code) shall have particular physical characteristics, called beacon characteristics. Physical channels with beacon characteristics are called beacon channels. The locations of the beacon channels are called beacon locations. The ensemble of beacon channels shall provide the beacon function, i.e. a reference power level at the beacon locations, regularly existing in each radio frame. Thus, beacon channels must be present in each radio frame, the only exception is when idle periods are used to support time difference measurements for location services [9]. Then it may be possible that the beacon channels occur in the same frame and time slot as the idle periods. In this case, the beacon channels will not be transmitted in that particular frame and time slot.

5.5.1 Location of beacon channels

The beacon locations are determined by the SCH and depend on the SCH allocation case, see subclause 5.3.4:

- Case 1) The beacon function shall be provided by the physical channels that are allocated to channelisation code $c_{Q=16}^{(k=1)}$ and to TS#k, k=0,...,14.

- Case 2) The beacon function shall be provided by the physical channels that are allocated to channelisation code $c_{Q=16}^{(k=1)}$ and to TS#k and TS#k+8, k=0,...,6.

Note that by this definition the P-CCPCH always has beacon characteristics.

5.5.2 Physical characteristics of beacon channels

The beacon channels shall have the following physical characteristics. They:

- are transmitted with reference power;
- are transmitted without beamforming;
- use burst type 1 or burst type 4 when MBSFN is applied to beacon channels;
- use midamble $m^{(1)}$ and $m^{(2)}$ exclusively in this time slot; and
- midambles $m^{(9)}$ and $m^{(10)}$ are always left unused in this time slot, if 16 midambles are allowed in that cell.

Note that in the time slot where the P-CCPCH is transmitted only the midambles $m^{(1)}$ to $m^{(8)}$ shall be used, see 5.6.1. Thus, midambles $m^{(9)}$ and $m^{(10)}$ are always left unused in this time slot.

Note that when MBSFN is applied to beacon channels there is a single midamble and hence midamble $m^{(1)}$ is exclusively used in the timeslot.

The reference power corresponds to the sum of the power allocated to both midambles $m^{(1)}$ and $m^{(2)}$. Two possibilities exist:

- If SCTD antenna diversity is not applied to beacon channels all the reference power of any beacon channel is allocated to $m^{(1)}$.
- If SCTD antenna diversity is applied to beacon channels, for any beacon channel midambles $m^{(1)}$ and $m^{(2)}$ are each allocated half of the reference power.

5.6 Midamble Allocation for Physical Channels

Midambles are part of the physical channel configuration which is performed by higher layers. Three different midamble allocation schemes exist:

- UE specific midamble allocation: A UE specific midamble for DL or UL is explicitly assigned by higher layers.
- Default midamble allocation: The midamble for DL or UL is allocated by layer 1 depending on the associated channelisation code.
- Common midamble allocation: The midamble for the DL is allocated by layer 1 depending on the number of channelisation codes currently being present in the DL time slot.

If a midamble is not explicitly assigned and the use of the common midamble allocation scheme is not signalled by higher layers, the midamble shall be allocated by layer 1, based on the default midamble allocation scheme. This default midamble allocation scheme is given by a fixed association between midambles and channelisation codes, see clause A.3, and shall be applied individually to all channelisation codes within one time slot. Different associations apply for different burst types and cell configurations with respect to the maximum number of midambles.

For timeslots employing MBSFN operation burst type 4 is used and hence DL beamforming is not applied, subclause 5.2.4. Furthermore, as this burst type contains only a single midamble, i.e. $K_{\text{Cell}}=1$, then all physical channels in such timeslots employ the same midamble and thus default and common midamble allocation amount to the same allocation strategies.

5.6.1 Midamble Allocation for DL Physical Channels

Beacon channels shall always use the reserved midambles $m^{(1)}$ and $m^{(2)}$, see 5.5. For DL physical channels that are located in the same time slot as the P-CCPCH, midambles shall be allocated based on the default midamble allocation

scheme, using the association for burst type 1 and $K_{\text{Cell}}=8$ midambles. For all other DL physical channels, the midamble is explicitly assigned by higher layers or allocated by layer 1.

5.6.1.1 Midamble Allocation by signalling from higher layers

UE specific midambles may be signalled by higher layers to UE's as a part of the physical channel configuration, if:

- multiple UEs use the physical channels in one DL time slot; and
- beamforming is applied to all of these DL physical channels; and
- no closed loop TxDiversity is applied to any of these DL physical channels;

or

- PDSCH physical layer signalling based on the midamble is used.

5.6.1.2 Midamble Allocation by layer 1

5.6.1.2.1 Default midamble

If a midamble is not explicitly assigned and the use of the common midamble allocation scheme is not signalled by higher layers, the UE shall derive the midambles from the allocated channelisation codes and shall use an individual midamble for each channelisation code group containing one primary and a set of secondary channelisation codes. The association between midambles and channelisation code groups is given in annex A.3. All the secondary channelisation codes within a set use the same midamble as the primary channelisation code to which they are associated.

Higher layers shall allocate the channelisation codes in a particular order. Secondary codes shall only be allocated if the associated primary code is also allocated. If midambles are reserved for the beacon channels, all primary and secondary channelisation codes that are associated with the reserved midambles shall not be used.

Channelisation codes of one channelisation code group shall not be allocated to different UE's.

In the case that secondary channelisation codes are used, secondary channelisation codes of one channelisation code group shall be allocated in ascending order, with respect to their numbering, and beginning with the lowest code index in this channelisation code group.

The UE shall assume different channel estimates for each of the individual midambles.

The default midamble allocation shall not apply for those downlink channels that are intended for a UE which will be the only UE assigned to a given time slot or slots for the duration of the assigned channel's existence (as in the case of high rate services).

5.6.1.2.2 Common Midamble

The use of the common midamble allocation scheme is signalled to the UE by higher layers as a part of the physical channel configuration. A common midamble may be assigned by layer 1 to all physical channels in one DL time slot, if:

- a single UE uses all physical channels in one DL time slot (as in the case of high rate service);

or

- multiple UEs use the physical channels in one DL time slot; and
- no beamforming is applied to any of these DL physical channels; and
- no closed loop TxDiversity is applied to any of these DL physical channels; and
- midambles are not used for PDSCH physical layer signalling.

The number of channelisation codes currently employed in the DL time slot is associated with the use of a particular common midamble. Different associations apply for different burst types and cell configurations with respect to the maximum number of midambles, see annex B.

5.6.2 Midamble Allocation for UL Physical Channels

If the midamble is explicitly assigned by higher layers, an individual midamble shall be assigned to all UE's in one UL time slot.

If no midamble is explicitly assigned by higher layers, the UE shall derive the midamble from the channelisation code that is used for the data part (except for TFCI/TPC) of the burst. Note that in the event that code hopping is employed the midamble is derived from the channelisation code actually transmitted (i.e. the code used after the hop sequence has been applied – see [9]). The associations between midamble and channelisation code are the same as for DL physical channels.

5.7 Midamble Transmit Power

There shall be no offset between the sum of the powers allocated to all midambles in a timeslot and the sum of the powers allocated to the data symbol fields. The transmit power within a timeslot is hence constant.

The midamble transmit power of beacon channels is equal to the reference power. If SCTD is used for beacon channels, the reference power is equally divided between the midambles $m^{(1)}$ and $m^{(2)}$.

The midamble transmit power of all other physical channels depends on the midamble allocation scheme used. The following rules apply

- In case of Default Midamble Allocation, every midamble is transmitted with the same power as the associated codes.
- In case of Common Midamble Allocation in the downlink, the transmit power of this common midamble is such that there is no power offset between the data parts and the midamble part of the overall transmit signal within one time slot.
- In case of UE Specific Midamble Allocation, the transmit power of the UE specific midamble is such that there is no power offset between the data parts and the midamble part of every user within one time slot.

The following figure 18 depicts the midamble powers for the different channel types and midamble allocation schemes.

Note 1: In figure 18, the codes $c(1)$ to $c(16)$ represent the set of usable codes and not the set of used codes.

Note 2: The common midamble allocation and the midamble allocation by higher layers are not applicable in those beacon time slots, in which the P-CCPCH is located, see section 5.6.1.

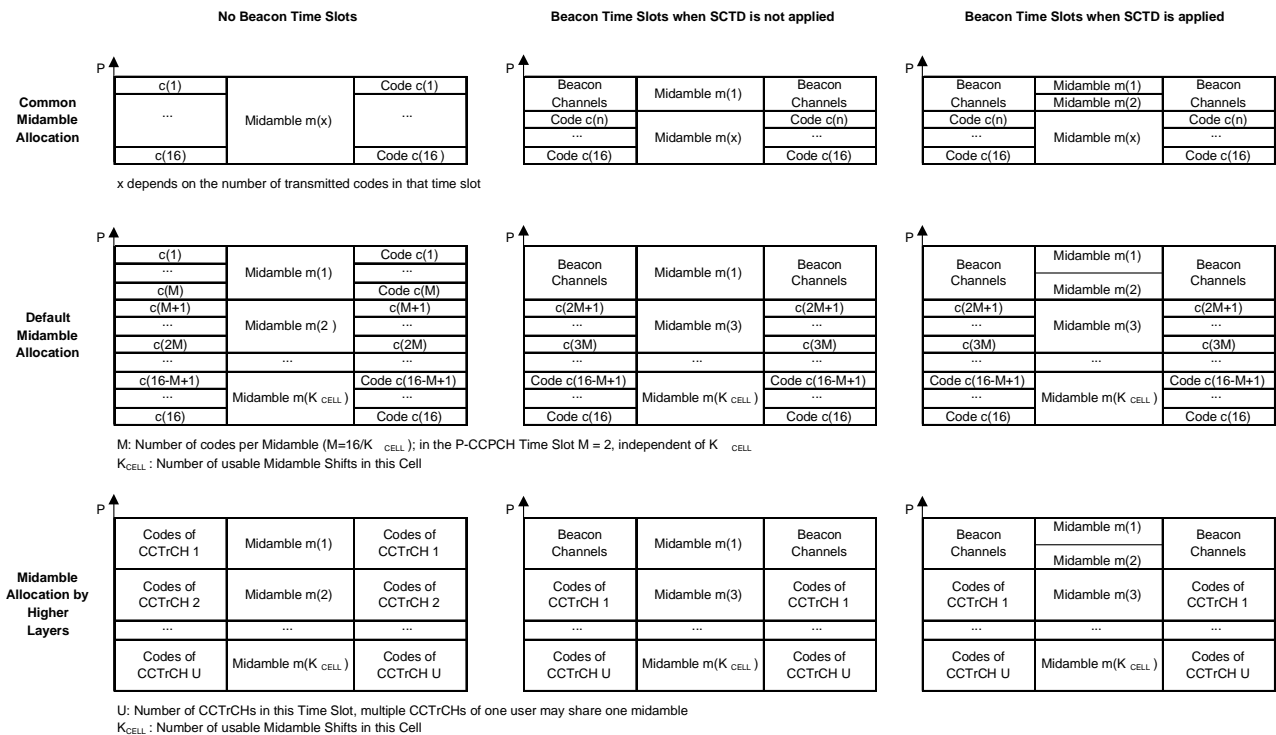

Figure 18: Midamble powers for the different midamble allocation schemes

5.8 Physical channels for the 3.84 Mcps MBSFN IMB option

Physical channels are defined by a specific carrier frequency, scrambling code, channelization code and in some cases a time start & stop (giving a duration). Scrambling and channelization codes are specified in [8]. Time durations are defined by start and stop instants, measured in integer multiples of chips. Suitable multiples of chips also used in specification are:

- Radio frame: A radio frame is a processing duration which consists of 15 slots. The length of a radio frame corresponds to 38400 chips (10 ms).
- Slot: A slot is a duration which consists of fields containing bits. The length of a slot corresponds to 2560 chips.
- Sub-frame: A sub-frame corresponds to 3 slots (2 ms).

The default time duration for a physical channel is continuous from the instant when it is started to the instant when it is stopped. Physical channels that are not continuous will be explicitly described. In the case of 2 ms physical channel duration, the physical channel is active for only one 2 ms sub-frame (7680 chips) per radio frame. A physical channel of 2 ms duration may start at one of 5 start instances per radio frame. These correspond to 0 ms, 2 ms, 4 ms, 6 ms or 8 ms following the commencement of the radio frame and are denoted as sub-frames 0, 1, 2, 3 and 4 respectively.

Transport channels are described (in more abstract higher layer models of the physical layer) as being capable of being mapped to physical channels. Within the physical layer itself the exact mapping is from a composite coded transport channel (CCTrCH) to the data part of a physical channel. In addition to data parts there are also channel control parts and physical signals. For the IMB option, both a continuous and a discontinuous pilot physical channel shall be transmitted using specific OVSF channelisation codes.

The IMB option is only applicable for dedicated carrier MBSFN operations in which all TDD slots of the radio frame are configured in the downlink direction. All physical channels are common and downlink only.

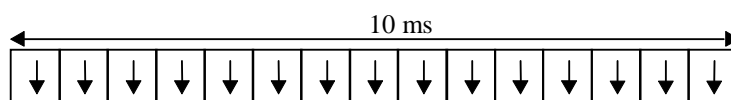

Figure 18iA: Downlink transmissions in all TDD slots

5.8.1 Transmit diversity

Transmit diversity is not applicable to IMB physical channels for MBSFN operations.

5.8.2 Common physical channels

The common physical channels used on a dedicated carrier for the IMB option are P-CPICH, T-CPICH, P-CCPCH, S-CCPCH frame type 1, S-CCPCH frame type 2, SCH and MICH.

5.8.2.1 Primary Common Pilot Channel (P-CPICH)

The primary common pilot channel (P-CPICH) is a fixed rate (30 kbps, SF=256) downlink physical channel using QPSK modulation and carrying a pre-defined bit sequence in which all bits are set to logical "0". The P-CPICH is transmitted continuously on all slots of the radio frame. Figure 18iiA shows the frame structure of the P-CPICH.

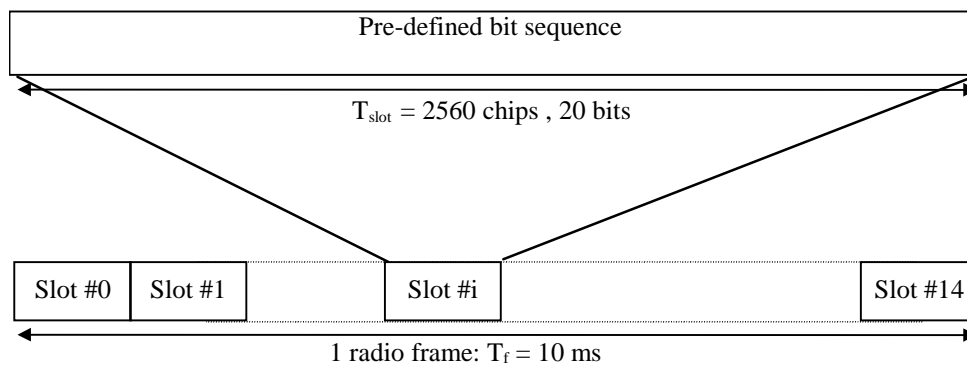

Figure 18iiA: Frame structure for Primary Common Pilot Channel

The P-CPICH has the following characteristics:

- The same channelization code is always used for the P-CPICH, see [8];
- The P-CPICH is scrambled by the primary scrambling code, see [8];
- There is one and only one P-CPICH per MBSFN cluster;
- The P-CPICH is broadcast over the entire MBSFN cluster.

5.8.2.2 Time-multiplexed Common Pilot Channel (T-CPICH)

The time-multiplexed common pilot channel (T-CPICH) is composed of a set of 15 SF=16 physical channels using 16-QAM modulation, each carrying a pre-defined pilot bit sequence of length 64 bits. All of the channelization codes used to carry T-CPICH are OVSF codes as defined in [8] and are orthogonal to the P-CPICH. The T-CPICH chip-level sequence has a length of 256 chips and is transmitted at the end of each slot of the radio frame. The T-CPICH is not transmitted during the first 2304 chips of each slot. The structure of the T-CPICH is shown in figure 18iiiA.

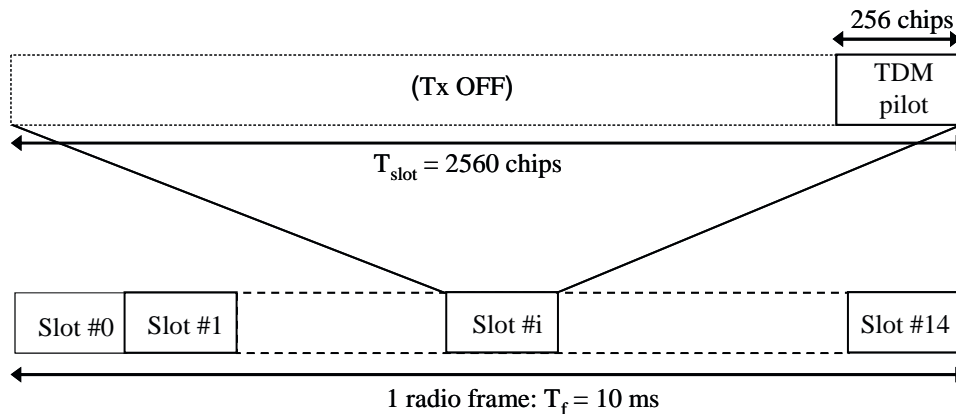

Figure 18iiiA: Structure of the Time-multiplexed Common Pilot Channel (T-CPICH)

The T-CPICH has the following characteristics:

- The T-CPICH is scrambled by the same scrambling code as P-CPICH
- There is one and only one T-CPICH per MBSFN cluster;
- The T-CPICH is broadcasted over the entire MBSFN cluster

The UE may use the T-CPICH as the phase reference for all downlink physical channels.

The pilot bit sequences carried on T-CPICH are defined as a function of the scrambling code index used for the MBSFN cluster and the slot index in which the T-CPICH is transmitted. With index n of the primary scrambling code as defined in [4] and with the index $i = 0 \dots 14$, of the slot in which the T-CPICH is transmitted, the T-CPICH pilot bit sequences $B_{T-CPICH,0}^{(n)} \dots B_{T-CPICH,959}^{(n)}$ are defined in table CD.1 of annex CD. For each slot index i , the bit sequences $B_{T-CPICH,0}^{(n)} \dots B_{T-CPICH,959}^{(n)}$ are a concatenation of the 15 bit sequences $b_{T-CPICH,0,m}^{(n)} \dots b_{T-CPICH,63,m}^{(n)}$ carried on each OVSF code $C_{ch,16,m}$ (see [8]) with $m = 1 \dots 15$ such that:

$$\{ B_{T-CPICH,0}^{(n)}, B_{T-CPICH,1}^{(n)}, \dots, B_{T-CPICH,959}^{(n)} \} = \{ \{ b_{T-CPICH,0,1}^{(n)}, b_{T-CPICH,1,1}^{(n)} \dots b_{T-CPICH,63,1}^{(n)} \}, \dots \\ \{ b_{T-CPICH,0,2}^{(n)}, b_{T-CPICH,1,2}^{(n)} \dots b_{T-CPICH,63,2}^{(n)} \}, \dots \\ \dots \{ b_{T-CPICH,0,15}^{(n)}, b_{T-CPICH,1,15}^{(n)} \dots b_{T-CPICH,63,15}^{(n)} \} \}$$

The OVSF code $C_{ch,16,0}$ is not used by T-CPICH.

5.8.2.3 Primary common control physical channel (P-CCPCH)

The Primary CCPCH is a fixed rate (30 kbps, SF=256) downlink physical channels used to carry the BCH transport channel. The BCH transport channel has a fixed transport format combination, hence the Primary CCPCH does not support TFCI. The P-CCPCH uses QPSK modulation.

Figure 18ivA shows the frame structure of the P-CCPCH. The P-CCPCH is not transmitted during the first and last 256 chips of each slot. Instead, Primary SCH and Secondary SCH are transmitted during first DTX period and T-CPICH is transmitted during the last DTX period.

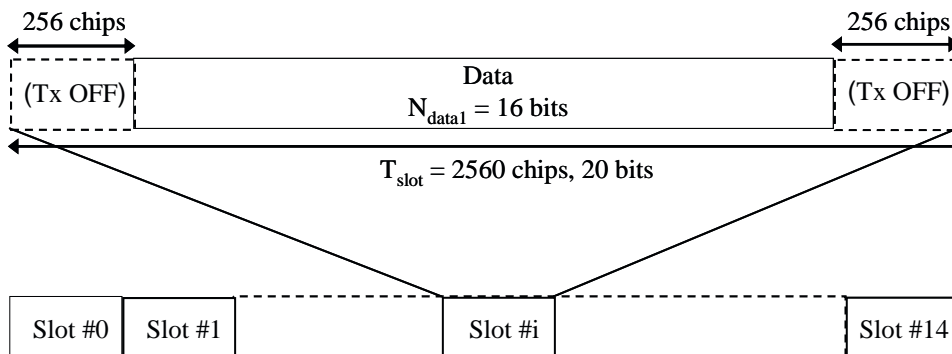

Figure 18ivA: Frame structure for Primary Common Control Physical Channel

5.8.2.4 Secondary common control physical channel (S-CCPCH)

The Secondary CCPCH is used to carry FACH transport channels.

For MBSFN IMB, there are two types of Secondary CCPCH:

- Secondary CCPCH frame type 1; consists of 15 slots per radio frame
- Secondary CCPCH frame type 2; consists of 3 slots (i.e. one sub-frame) per radio frame.

Both of the Secondary CCPCH frame types may include TFCI in order to support multiple transport format combinations. It is the UTRAN that determines if a TFCI should be transmitted, hence making it mandatory for all UEs to support the use of TFCI. The structures of the Secondary CCPCH frame type 1 and Secondary CCPCH frame type 2 are shown in figure 18vA and figure 18viA, respectively.

Physical channel bits of Secondary CCPCH frame type 1 slots are mapped to a QPSK signal point constellation whereas physical channel bits of Secondary CCPCH frame type 2 can be mapped either to QPSK or 16QAM signal point constellations. In the case of Secondary CCPCH frame type 2, the signal point constellation to be used for the data field is given by higher layer signalling.

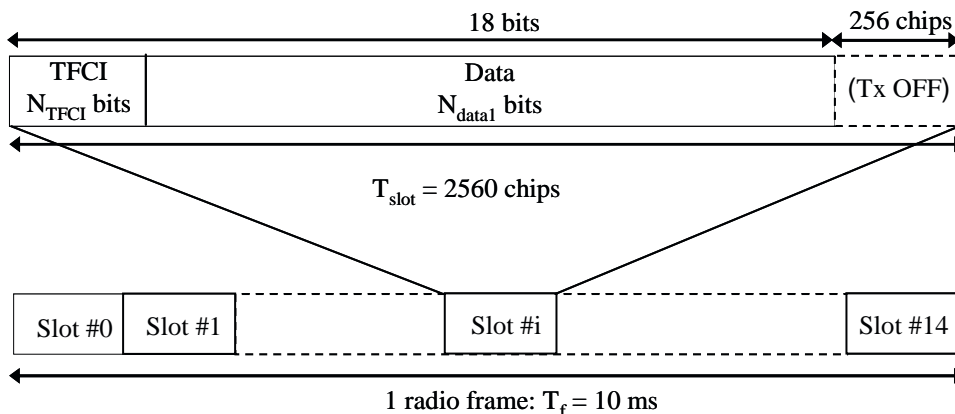

Figure 18vA: Frame structure for Secondary Common Control Physical Channel frame type 1

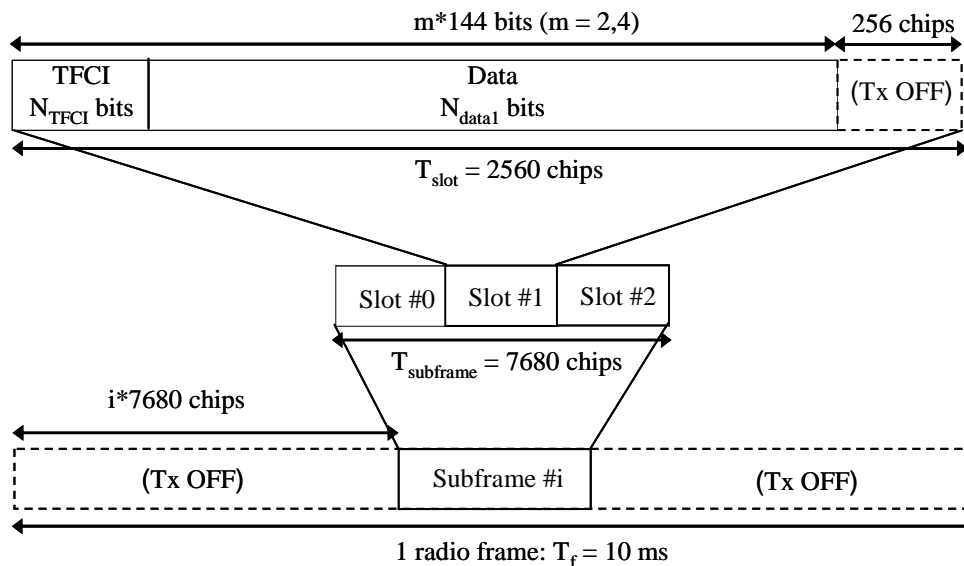

Figure 18viA: Frame structure for Secondary Common Control Physical Channel frame type 2

The parameter m in figure 18viA determines the total number of bits per Secondary CCPCH slot. The parameter m takes the value of 2 for QPSK modulation and 4 for 16-QAM modulation. The sub-frame index i in figure 18viA determines the start position of the sub-frame within the radio frame.

The values for the number of bits per field are given in table 8iA in which the channel bit and symbol rates are the rates immediately before spreading.

A FACH transport channel may be mapped to one Secondary CCPCH of frame type 1 or to one or more Secondary CCPCHs of frame type 2 that reside within the same sub-frame.

Table 8iA: Secondary CCPCH frame type 1 and 2 fields

Slot Format #i	Channel Bit Rate (kbps)	Channel Symbol Rate (kbps)	SF	S-CCPCH frame type	Bits/ Frame	Bits/ Slot	N_{data1}	N_{TFCI}
0	30	15	256	1	270	18	18	0
1	30	15	256	1	270	18	16	2
2	480	240	16	2	864	288	288	0
3	480	240	16	2	864	288	272	16
4*	960	240	16	2	1728	576	576	0
5*	960	240	16	2	1728	576	560	16**

* Slot formats applicable to 16QAM.

** This indicates that the number of modulation symbols occupied by TFCI is 4. As described in [7] and [8], QPSK modulation is applied to 8 TFCI bits per slot which results in the same number of 4 TFCI symbols

For slot formats using TFCI, the TFCI value in each radio frame corresponds to a certain transport format combination of the FACHs currently in use. This correspondence is (re-)negotiated at each FACH addition/removal. The mapping of the TFCI bits onto slots for the IMB option is described in [7].

In the case of S-CCPCH frame type 1, when an S-CCPCH CCTrCH carries TFCI, the TFCI field shall be present on all slots of the radio frame. In this case there is only one S-CCPCH in the CCTrCH.

In the case of S-CCPCH frame type 2, when an S-CCPCH CCTrCH carries TFCI, the TFCI field shall be present on all slots of the sub-frame for the S-CCPCH with the lowest channelization code index in the CCTrCH. In this case, the TFCI field shall not be present on the other S-CCPCHs of the same CCTrCH.

5.8.2.5 Synchronisation channel (SCH)

The Synchronisation Channel (SCH) is a downlink signal used for cell search and radio frame synchronisation on the MBSFN carrier. The SCH consists of two sub channels, the Primary and Secondary SCH. The 10 ms radio frames of the Primary and Secondary SCH are divided into 15 slots, each of length 2560 chips. Figure 18viiA illustrates the structure of the SCH radio frame.

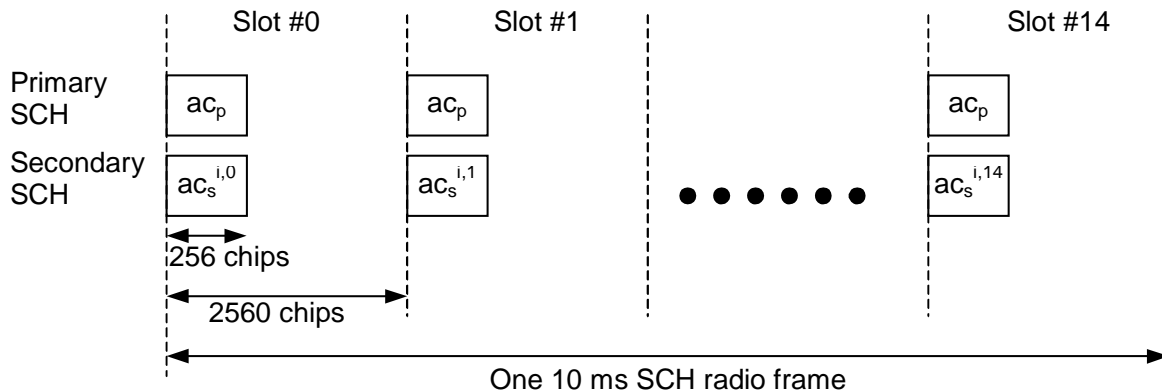

Figure 18viiA: Structure of Synchronisation Channel (SCH)

The Primary SCH consists of a modulated code of length 256 chips, the Primary Synchronisation Code (PSC) denoted c_p in figure 18viiA, transmitted once every slot. The PSC is the same for every cell in the system.

The Secondary SCH consists of repeatedly transmitting a length 15 sequence of modulated codes of length 256 chips, the Secondary Synchronisation Codes (SSC), transmitted in parallel with the Primary SCH. The SSC is denoted $c_s^{i,k}$ in figure 18viiA, where $i = 0, 1, \dots, 7$ is the number of the scrambling code group, and $k = 0, 1, \dots, 14$ is the slot number. Each SSC is chosen from a set of 16 different codes of length 256. This sequence on the Secondary SCH indicates which of the code groups the cell's downlink scrambling code belongs to.

The primary and secondary synchronization codes for the MBSFN IMB option, defined in [8], are modulated by the symbol $a = -1$.

5.8.2.6 The MBMS indicator channel (MICH)

The MBMS Indicator Channel (MICH) is a fixed rate (SF=256) physical channel used to carry the MBMS notification indicators. The MICH is always associated with an S-CCPCH frame type 1 to which a FACH transport channel carrying MBMS control data is mapped. MICH uses QPSK modulation.

Figure 18viiiA illustrates the frame structure of the MICH where the 10 ms radio frames of the MICH are divided into 15 slots, each of length 2560 chips. One MICH radio frame of length 10 ms consists of 270 bits (b_0, b_1, \dots, b_{269}). Of these, 256 bits (b_0, b_1, \dots, b_{255}) are used to carry notification indicators. The remaining 14 bits are not formally part of the MICH and shall not be transmitted (DTX). This implies that the transmitter is turned off during the last 2048 chips of slot #14 in every radio frame.

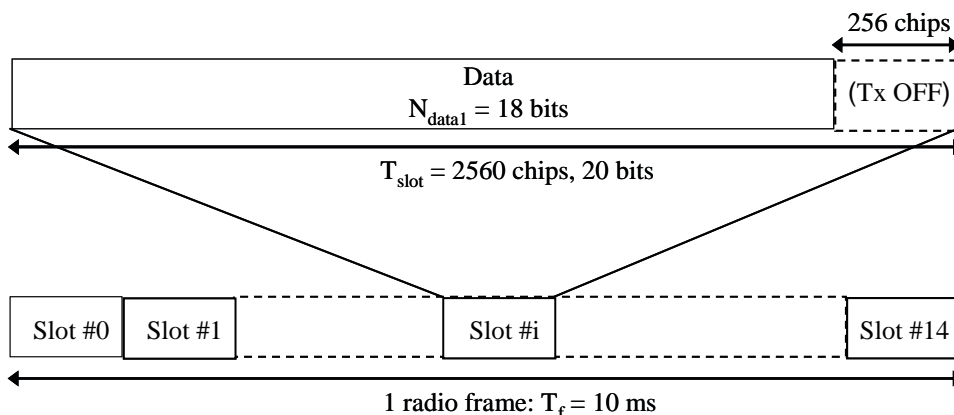

Figure 18viiiA: Frame structure for the MBMS Indicator Channel (MICH)

In each MICH frame, N_n notification indicators $\{N_0, \dots, N_{N_n-1}\}$ are transmitted, where $N_n=16, 32, 64,$ or 128 .

The NI calculated by higher layers is associated to the index q of the notification indicator N_q , where q is computed as a function of the NI computed by higher layers, the SFN of the P-CCPCH radio frame during which the start of the MICH radio frame occurs, and the number of notification indicators per frame (N_n):

$$q = \left\lfloor \left((C \times (NI \oplus ((C \times SFN) \bmod G))) \bmod G \right) \times \frac{N_n}{G} \right\rfloor$$

where $G = 2^{16}$, $C = 25033$ and NI is the 16 bit Notification Indicator calculated by higher layers.

The set of NI signalled over Iub indicates all higher layer NI values for which the associated notification indicator on MICH shall be set to 1 during the corresponding modification period. Hence, the calculation in the formula above shall be performed in the Node B every MICH frame for each NI signalled over Iub to make the association between NI and q and set the related N_q to 1. All other notification indicators on MICH shall be set to 0.

The mapping from $\{N_0, \dots, N_{N_n-1}\}$ to the MICH bits $\{b_0, \dots, b_{255}\}$ are according to table 8iiA.

Table 8iiA: Mapping of notification indicators N_q to MICH bits

Number of notification indicators per frame (N_n)	$N_q = 1$	$N_q = 0$
$N_n=16$	$\{b_{16q}, \dots, b_{16q+15}\} = \{1, 1, \dots, 1\}$	$\{b_{16q}, \dots, b_{16q+15}\} = \{0, 0, \dots, 0\}$
$N_n=32$	$\{b_{8q}, \dots, b_{8q+7}\} = \{1, 1, \dots, 1\}$	$\{b_{8q}, \dots, b_{8q+7}\} = \{0, 0, \dots, 0\}$
$N_n=64$	$\{b_{4q}, \dots, b_{4q+3}\} = \{1, 1, \dots, 1\}$	$\{b_{4q}, \dots, b_{4q+3}\} = \{0, 0, \dots, 0\}$
$N_n=128$	$\{b_{2q}, b_{2q+1}\} = \{1, 1\}$	$\{b_{2q}, b_{2q+1}\} = \{0, 0\}$

5.8.3 Timing relationship between physical channels

Timing between the common physical channels is summarized in figure 18ixA. The P-CCPCH, on which the cell SFN is transmitted, is used as timing reference for all the physical channels. The SCH, P-CPICH, T-CPICH, P-CCPCH and S-CCPCH frame types 1 and 2 have identical radio frame timings. The sub-frame number i of an S-CCPCH frame type 2 radio frame is signalled by higher layers. The start position of an S-CCPCH frame type 2 sub-frame is then given by $i \cdot 7680$, ($i = 0,1,2,3,4$), chips after the start of the radio frame.

The frame timing of MICH is advanced by $\tau_{\text{MICH}} = 3$ slots (7680 chips) with respect to the timings of the other physical channels.

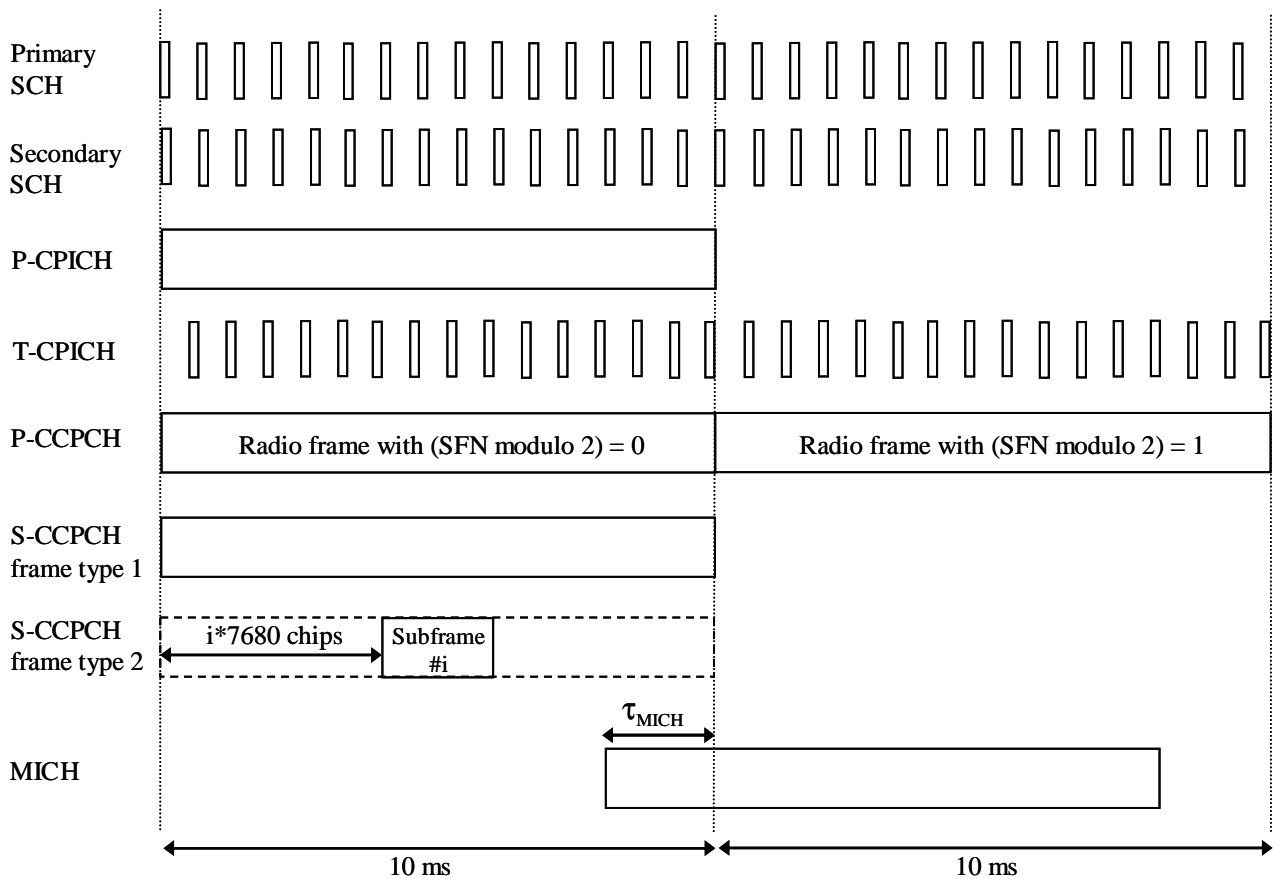

Figure 18ixA: Radio frame and sub-frame timing of downlink physical channels

5A Physical channels for the 1.28 Mcps option

All physical channels take three-layer structure with respect to timeslots, radio frames and system frame numbering (SFN), see [14]. Depending on the resource allocation, the configuration of radio frames or timeslots becomes different. All physical channels need guard symbols in every timeslot. The time slots are used in the sense of a TDMA component to separate different user signals in the time and the code domain. The physical channel signal format for 1.28Mcps TDD is presented in figure 18A.

A physical channel in TDD is a burst, which is transmitted in a particular timeslot within allocated Radio Frames. The allocation can be continuous, i.e. the time slot in every frame is allocated to the physical channel or discontinuous, i.e. the time slot in a subset of all frames is allocated only. A burst is the combination of a data part, a midamble and a guard period or only a midamble for standalone midamble channel. The duration of a burst is one time slot. Note when in the entire carrier dedicated to MBSFN operation, a burst is the combination of a preamble and a data part. Several bursts can be transmitted at the same time from one transmitter. In this case, the data part must use different OVFSF channelisation codes, but the same scrambling code. The midamble part has to use the same basic midamble code, but can use different midambles. In a multi-frequency cell the midamble parts in different carrier shall also have to use the same basic midamble code, but can use different midambles. Note when in MBSFN operation, a midamble or preamble is not necessarily cell-specific.

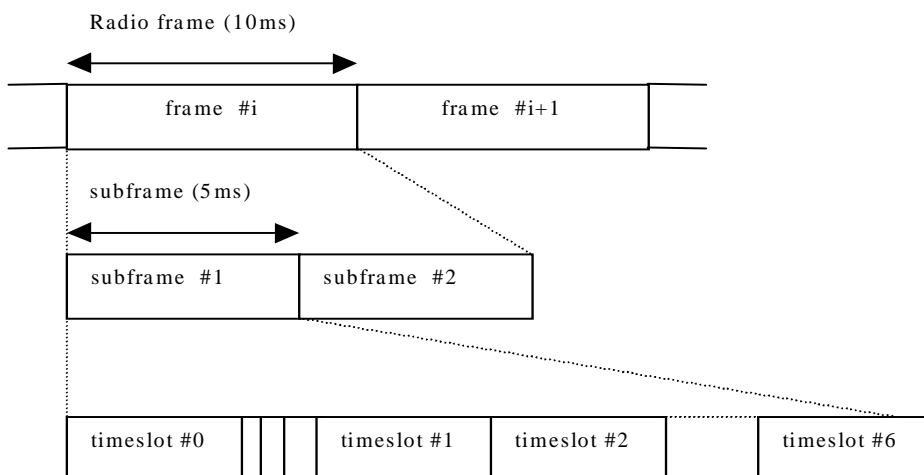

Figure 18A: Physical channel signal format for 1.28Mcps TDD option

The data part of the burst is spread with a combination of channelisation code and scrambling code. The channelisation code is a OVSF code, that can have a spreading factor of 1, 2, 4, 8, or 16. The data rate of the physical channel is depending on the used spreading factor of the used OVSF code.

So a physical channel is defined by frequency, timeslot, channelisation code, burst type and Radio Frame allocation. The scrambling code and the basic midamble code or preamble code are broadcast and may be constant within a cell. When a physical channel is established, a start frame is given. The physical channels can either be of infinite duration, or a duration for the allocation can be defined.

5A.1 Frame structure

The TDMA frame has duration of 10 ms and is divided into 2 sub-frames of 5ms. The frame structure for each sub-frame in the 10ms frame length is the same.

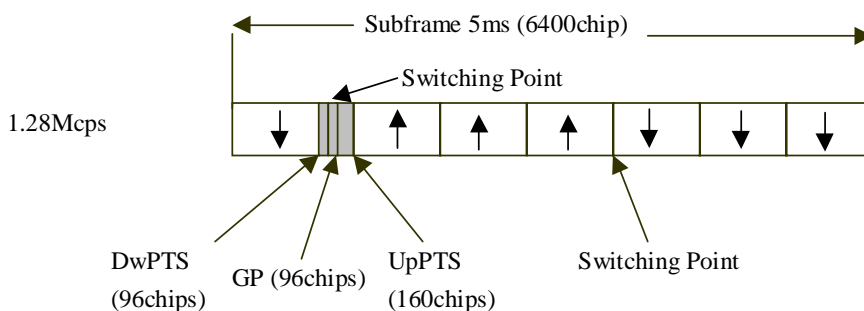

Figure 18B: Structure of the sub-frame for 1.28Mcps TDD option

Time slot#n (n from 0 to 6): the nth traffic time slot, 864 chips duration;

DwPTS: downlink pilot time slot, 96 chips duration;

UpPTS: uplink pilot time slot, 160 chips duration;

GP: main guard period for TDD operation, 96 chips duration;

In Figure 18B, the total number of traffic time slots for uplink and downlink is 7, and the length for each traffic time slot is 864 chips duration. Among the 7 traffic time slots, time slot#0 is always allocated as downlink while time slot#1 is always allocated as uplink. The time slots for the uplink and the downlink are separated by switching points. Between the downlink time slots and uplink time slots, the special period is the switching point to separate the uplink and

downlink. In each sub-frame of 5ms for 1.28Mcps option, there are two switching points (uplink to downlink and vice versa).

Using the above frame structure, the 1.28Mcps TDD option can operate on both symmetric and asymmetric mode by properly configuring the number of downlink and uplink time slots. In any configuration at least one time slot (time slot#0) has to be allocated for the downlink and at least one time slot has to be allocated for the uplink (time slot#1).

In case of entire carrier dedicated to MBSFN, no uplink timeslot is used, and DwPTS, UpPTS and GP(96 chips duration) are combined into one short timeslot, the duration of which is 0.275ms.

In a multi-frequency cell the traffic time slots allocated for uplink and downlink pair(s) for one UE should be on the same carrier.

Examples for symmetric and asymmetric UL/DL allocations are given in figure 18C.

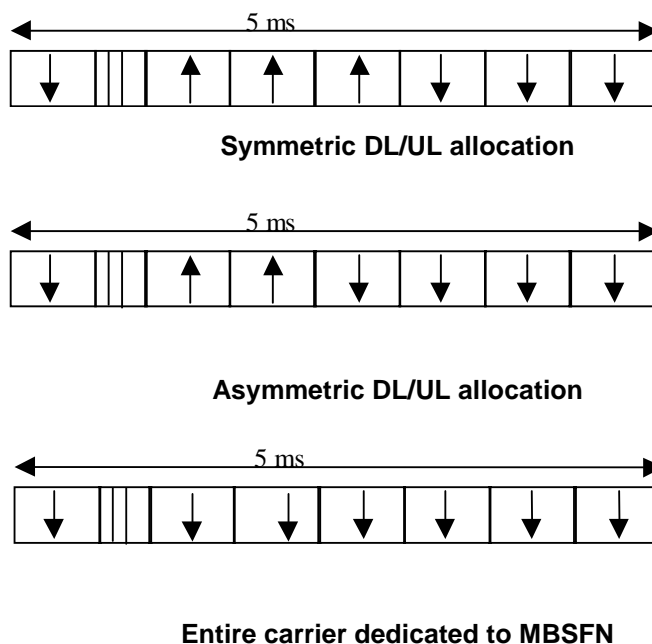

Figure 18C: 1.28Mcps TDD sub-frame structure examples

Note 1: In a multi-frequency cell, it is suggested the switching point configuration on secondary frequencies to be the same as that on primary frequency.

5A.2 Dedicated physical channel (DPCH)

The DCH as described in subclause 4.1.1 'Dedicated transport channels' is mapped onto the dedicated physical channel.

5A.2.1 Spreading

The spreading of physical channels is the same as in 3.84 Mcps TDD (cf. 5.2.1 'Spreading'). When there are more than two uplink physical channels to be transmitted in one timeslot, UE shall always guarantee the transmission of DPCH with data to be transmitted and non-scheduled E-PUCH.

5A.2.2 Burst Format

A traffic burst consists of two data symbol fields, a midamble of 144 chips and a guard period. The data fields of the burst are 352 chips long. The corresponding number of symbols depends on the spreading factor, as indicated in table 8A below. The guard period is 16 chip periods long.

The burst format is shown in Figure 18D. The contents of the traffic burst fields is described in table 8B.

Table 8A: number of symbols per data field in a traffic burst

Spreading factor (Q)	Number of symbols (N) per data field in Burst
1	352
2	176
4	88
8	44
16	22

Table 8B: The contents of the traffic burst format fields

Chip number (CN)	Length of field in chips	Length of field in symbols	Contents of field
0-351	352	cf table 8A	Data symbols
352-495	144	-	Midamble
496-847	352	cf table 8A	Data symbols
848-863	16	-	Guard period

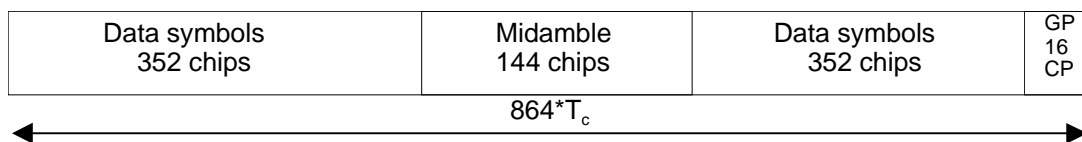

Figure 18D: Burst structure of the traffic burst format (GP denotes the guard period and CP the chip periods)

5A.2.2a Dedicated carrier MBSFN Burst Format

In this case, there are two bursts, one is MBSFN Traffic burst (MT burst) for 7 normal timeslots, and the other is MBSFN Special burst (MS burst) for 1 short timeslot. Both of them consist of a preamble and a data symbol field, the lengths of which are different for the individual bursts. Thus, the number of data symbols in a burst depends on the SF and the burst type, as depicted in table 8A.a.

Table 8A.a: number of symbols per data field in a MBSFN burst

Spreading factor (Q)	Number of symbols (N) per data field in Burst	
	MT Burst	MS Burst
1	768	N/A
2	384	N/A
16	48	16

Note: MS burst only supports SF=16.

The support of both bursts is mandatory and only used in dedicated carrier MBSFN. The both different bursts defined here are well suited for this application, as described in the following paragraphs.

The MT burst can be used for the regular timeslots, the duration of which is 0.675ms. The data fields of the MT burst are 768 chips long. The corresponding number of symbols depends on the spreading factor, as indicated in table 8A.a above. The preamble of MT burst has a length of 96 chips. The MT burst is shown in Figure 18D.a. The contents of the burst fields are described in table 8B.a.

Table 8B.a: The contents of the MT burst

Chip number (CN)	Length of field in chips	Length of field in symbols	Contents of field
0-95	96	-	Preamble
96-863	768	cf table 8A.a	Data symbols

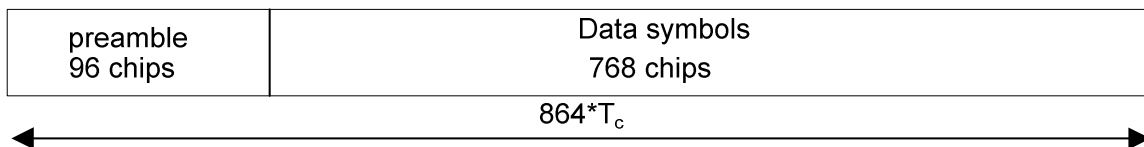

Figure 18D.a: Burst structure of the MT burst

The MS burst can be used for the short timeslot, the duration of which is 0.275ms. The data fields of the MS burst are 256 chips long. The corresponding number of symbols is 16, as indicated in table 8A.a above. The preamble of the MS burst has a length of 96 chips. The MS burst format is shown in Figure 18D.b. The contents of the burst fields are described in table 8B.b.

Table 8B.b: The contents of the MS burst

Chip number (CN)	Length of field in chips	Length of field in symbols	Contents of field
0-95	96	-	Preamble
96-351	256	cf table 8A.a	Data symbols

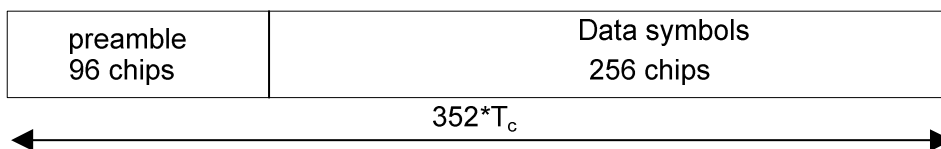

Figure 18D.b: Burst structure of the MS burst

5A.2.2.1 Transmission of TFCI

The traffic burst format provides the possibility for transmission of TFCI in uplink and downlink.

The transmission of TFCI is configured by higher Layers. For each CCTrCH it is indicated by higher layer signalling, which TFCI format is applied. Additionally for each allocated timeslot it is signalled individually whether that timeslot carries the TFCI or not. The TFCI is always present in the first timeslot in a radio frame for each CCTrCH. If a time slot contains the TFCI, then it is always transmitted using the physical channel with the lowest physical channel sequence number (p) in that timeslot. Physical channel sequence numbering is determined by the rate matching function and is described in [7].

The transmission of TFCI is done in the data parts of the respective physical channel, this means that TFCI code word bits and data bits are subject to the same spreading procedure as depicted in [8]. Hence the midamble structure and length is not changed.

The TFCI code word bits are equally distributed between the two subframes and the respective data fields. The TFCI code word is to be transmitted possibly either directly adjacent to the midamble or after the SS and TPC symbols. Figure 18E shows the position of the TFCI code word in a traffic burst, if neither SS nor TPC are transmitted. Figure 18F shows the position of the TFCI code word in a traffic burst, if SS and TPC are transmitted.

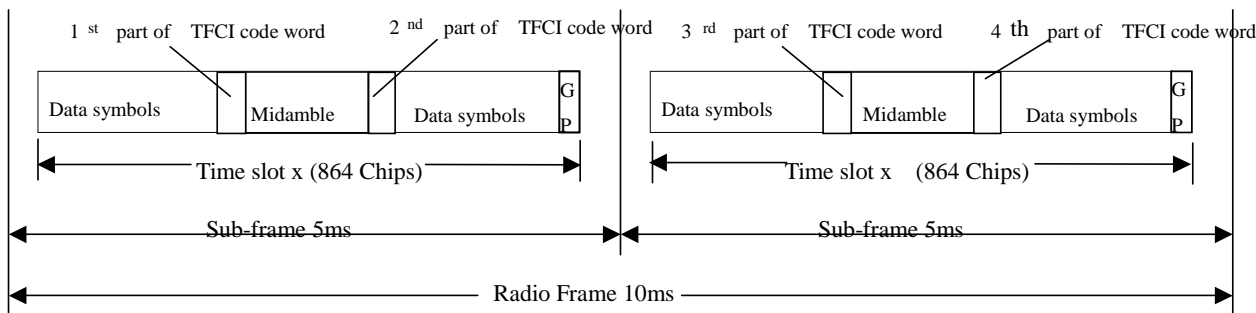

Figure 18E: Position of the TFCI code word in the traffic burst in case of no TPC and SS in 1.28 Mcps TDD

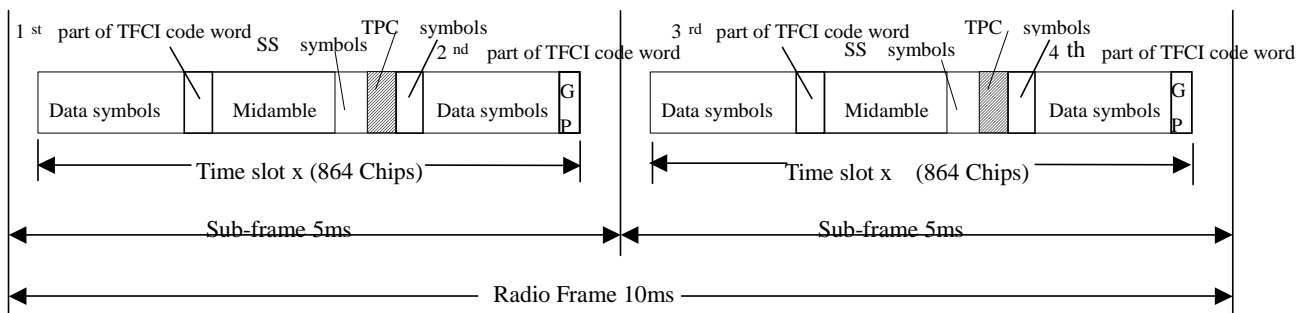

Figure 18F: Position of the TFCI code word in the traffic burst in case of TPC and SS in 1.28 Mcps TDD

5A.2.2.1a Transmission of TFCI for MT burst and MS burst

Both MT burst and MS burst provide the possibility for transmission of TFCI in downlink. The procedure of transmitting TFCI is the same as 5A.2.2.

The transmission of TFCI is done in the data parts of the respective physical channel, this means that TFCI code word bits and data bits are subject to the same spreading procedure as depicted in [8]. Hence the preamble structure and length is not changed.

The TFCI code word bits are equally distributed among the four subframes and the respective data fields. The TFCI code word is to be transmitted directly at the beginning and at the end of data symbols. Figure 18E.a shows the position of the TFCI code word in the MT burst. Figure 18E.b shows the position of the TFCI code word in the MS burst.

Note: when the modulation is 16QAM the number of the TFCI bits need be expanded. The procedure of expansion is detailed described in [7]

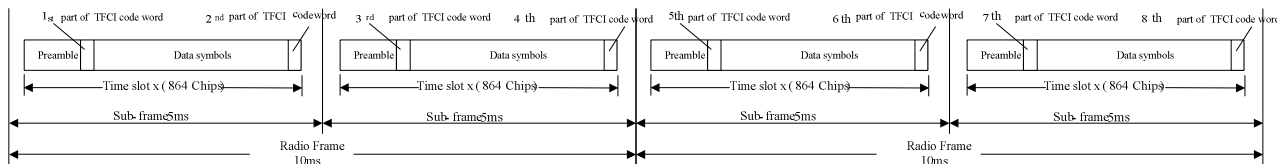

Figure 18E.a: Position of the TFCI code word in the MT burst format in 1.28 Mcps TDD

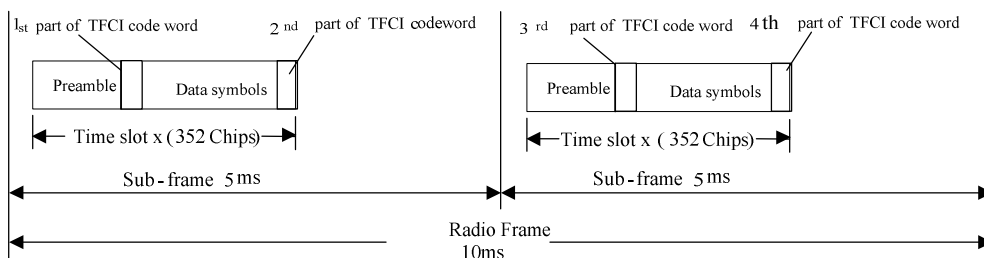

Figure 18E.b: Position of the TFCI code word in the MS burst format in 1.28 Mcps TDD

5A.2.2.2 Transmission of TPC

In this section, transmission of TPC over dedicated physical channels is described. Optionally, UTRAN may configure some UL CCTrCH's to be controlled via TPC commands on PLCCCH (for example in the case of HS-DSCH operation without an associated downlink DPCH). PLCCCH is described in section 5A.3.13.

Within the context of this subclause, only those TPC commands not borne by PLCCCH (in the DL case) nor by PLCCCH-controlled physical channels (in the UL case) are considered. That is to say that those UL timeslot/CCTrCH pairs controlled by PLCCCH and those DL TPC commands mapped to PLCCCH are excluded from consideration when deriving the mapping between UL/DL TPC commands and the UL/DL CCTrCH's they control. The association between PLCCCH and UL timeslot/CCTrCH pair(s) is signalled by higher layers.

The burst type for dedicated channels provides the possibility for transmission of TPC in uplink and downlink.

The transmission of TPC is done in the data parts of the traffic burst. Hence the midamble structure and length is not changed. The TPC information is to be transmitted directly after the SS information, which is transmitted after the midamble. Figure 18G shows the position of the TPC command in a traffic burst.

For every user the TPC information is to be transmitted at least once per 5ms sub-frame. For each allocated timeslot it is signalled individually whether that timeslot carries TPC information or not. If applied in a timeslot, transmission of TPC symbols is done in the data parts of the traffic burst and they are transmitted using the physical channel with the lowest physical channel sequence number (p) in that timeslot. Physical channel sequence numbering is determined by the rate matching function and is described in [7].

TPC symbols may also be transmitted on more than one physical channel in a time slot. For this purpose, higher layers allocate an additional number of N_{TPC} physical channels, individually for each time slot. The TPC symbols shall then be transmitted using the physical channels with the $N_{TPC}+1$ lowest physical channel sequence numbers (p) in that time slot. Physical channel sequence numbering is determined by the rate matching function and is described in [7]. If the rate matching function results in $N_{RM} < N_{TPC}+1$ remaining physical channels in this time slot, TPC symbols shall be transmitted only on the N_{RM} remaining physical channels.

The TPC symbols are spread with the same spreading factor (SF) and spreading code as the data parts of the respective physical channel.

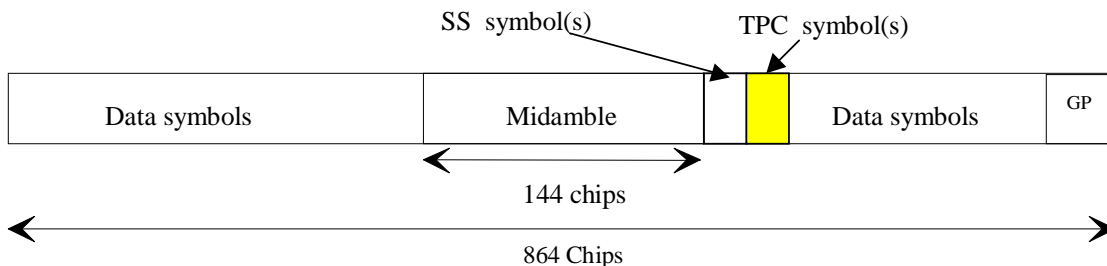

Figure 18G: Position of TPC information in the traffic burst in downlink and uplink

For the number of TPC symbols per time slot there are 3 possibilities, that can be configured by higher layers, individually for each timeslot:

- 1) one TPC symbol

- 2) no TPC symbols
- 3) 16/SF TPC symbols

So, in case 3), when SF=1, there are 16 TPC symbols which correspond to 32 bits (for QPSK) and 48 bits (for 8PSK).

In the following the uplink is described only. For the description of the downlink, downlink (DL) and uplink (UL) have to be interchanged.

Each of the TPC symbols for uplink power control in the DL will be associated with an UL time slot and an UL CCH pair. This association varies with

- the number of allocated UL time slots and UL CCHs on these time slots (time slot and CCH pair) and
- the allocated TPC symbols in the DL.

In case a UE has

- more than one channelisation code

and/or

- channelisation codes being of lower spreading factor than 16 and using 16/SF SS and 16/SF TPC symbols,

the TPC commands for each UL time slot CCH pair (all channelisation codes on that time slot belonging to the same time slot and CCH pair have the same TPC command) will be distributed to the following rules:

1. The UL time slots and CCH pairs the TPC commands are intended for will be numbered from the first to the last UL time slot and CCH pair allocated to the regarded UE (starting with 0). The number of a time slot and CCH pair is smaller than the number of another time slot and CCH pair within the same time slot if its spreading code with the lowest SC number according to the following table has a lower SC number than the spreading code with the lowest SC number of the other time slot and CCH pair.
2. The commanding TPC symbols on all DL CCHs allocated to one UE are numbered consecutively starting with zero according to the following rules:
 - a) The numbers of the TPC commands of a regarded DL time slot are lower than those of DL time slots being transmitted after that time slot
 - b) Within a DL time slot the numbers of the TPC commands of a regarded channelisation code are lower than those of channelisation codes having a higher spreading code number

The spreading code number is defined by the following table (see[8]):

SC number	SF (Q)	Walsh code number (k)
0	16	$c_{Q=16}^{(k=1)}$
	...	
15	16	$c_{Q=16}^{(k=16)}$
16	8	$c_{Q=8}^{(k=1)}$
	...	
23	8	$c_{Q=8}^{(k=8)}$
24	4	$c_{Q=4}^{(k=1)}$
	...	
27	4	$c_{Q=4}^{(k=4)}$
28	2	$c_{Q=2}^{(k=1)}$
29	2	$c_{Q=2}^{(k=2)}$
30	1	$c_{Q=1}^{(k=1)}$

Note: Spreading factors 2-8 are not used in DL

- c) Within a channelisation code numbers of the TPC commands are lower than those of TPC commands being transmitted after that time

The following equation is used to determine the UL time slot which is controlled by the regarded TPC symbol in the DL:

$$UL_{pos} = (SFN' \cdot N_{UL_TPCsymbols} + TPC_{DLpos} + ((SFN' \cdot N_{UL_TPCsymbols} + TPC_{DLpos}) \text{div}(N_{ULslot}))) \text{mod}(N_{ULslot}),$$

where

UL_{pos} is the number of the controlled uplink time slot and CCTrCH pairs.

SFN' is the system frame number counting the sub-frames. The system frame number of the radio frames (SFN) can be derived from SFN' by

$SFN = SFN' \text{ div } 2$, where div is the remainder free division operation.

$N_{UL_PCsymbols}$ is the number of UL TPC symbols in a sub-frame (excluding those on PLCCCH-controlled resources).

TPC_{DLpos} is the number of the regarded UL TPC symbol in the DL within the sub-frame.

N_{ULslot} is the number of UL slots and CCTrCH pairs in a sub-frame (excluding those associated with PLCCCH).

When one of the above parameters is changed due to higher layer reconfiguration, the new relationship between TPC symbols and controlled UL time slots shall be valid, beginning with the radio frame, for which the new parameters are set.

In Annex CB two examples of the association of TPC commands to time slots and CCTrCH pairs are shown.

Coding of TPC:

The relationship between the TPC Bits and the transmitter power control command for QPSK is the same as in the 3.84Mcps TDD cf. [5.2.2.5 'Transmission of TPC'].

The relationship between the TPC Bits and the transmitter power control command for 8PSK is given in table 8C

Table 8C: TPC Bit Pattern for 8PSK

TPC Bits	TPC command	Meaning
000	'Down'	Decrease Tx Power
110	'Up'	Increase Tx Power

5A.2.2.3 Transmission of SS

In this section, transmission of SS over dedicated physical channels is described. Optionally, UTRAN may configure some UL CCTrCH's to be controlled via SS commands on PLCCCH (for example in the case of HS-DSCH operation without an associated downlink DPCH). PLCCCH is described in section 5A.3.13.

Within the context of this subclause, only those SS commands not borne by PLCCCH are considered. That is to say that those UL timeslots controlled exclusively by PLCCCH and those SS commands carried by PLCCCH are excluded from consideration when deriving the mapping between DL SS commands and the UL timeslots they control. The association between PLCCCH and UL timeslot/CCTrCH pair(s) is signalled by higher layers.

The burst type for dedicated channels provides the possibility for transmission of uplink synchronisation control (ULSC).

The transmission of ULSC is done in the data parts of the traffic burst. Hence the midamble structure and length is not changed. The ULSC information is to be transmitted directly after the midamble. Figure 18H shows the position of the SS command in a traffic burst.

For every user the ULSC information shall be transmitted at least once per transmitted sub-frame.

For each allocated timeslot it is signalled individually whether that timeslot carries ULSC information or not. If applied in a time slot, transmission of SS symbols is done in the data parts of the traffic burst and they are transmitted using the physical channel with the lowest physical channel sequence number (*p*) in that timeslot. Physical channel sequence numbering is determined by the rate matching function and is described in [7].

SS symbols may also be transmitted on more than one physical channel in a time slot. For this purpose, higher layers allocate an additional number of N_{SS} physical channels, individually for each time slot. The SS symbols shall then be transmitted using the physical channels with the $N_{SS}+1$ lowest physical channel sequence numbers (*p*) in that time slot. Physical channel sequence numbering is determined by the rate matching function and is described in [7]. If the rate matching function results in $N_{RM} < N_{SS}+1$ remaining physical channels in this time slot, SS symbols shall be transmitted only on the N_{RM} remaining physical channels.

The SS symbols are spread with the same spreading factor (SF) and spreading code as the data parts of the respective physical channel.

The SS is utilised to command a timing adjustment by $(k/8) T_c$ each *M* sub-frames, where T_c is the chip period. The *k* and *M* values are signalled by the network. The SS, as one of *L1* signals, is to be transmitted once per 5ms sub-frame.

M (1-8) and *k* (1-8) can be adjusted during call setup or readjusted during the call.

Note: The smallest step for the SS signalled by the UTRAN is $1/8 T_c$. For the UE capabilities regarding the SS adjustment of the UE it is suggested to set the tolerance for the executed command to be $[1/9;1/7] T_c$.

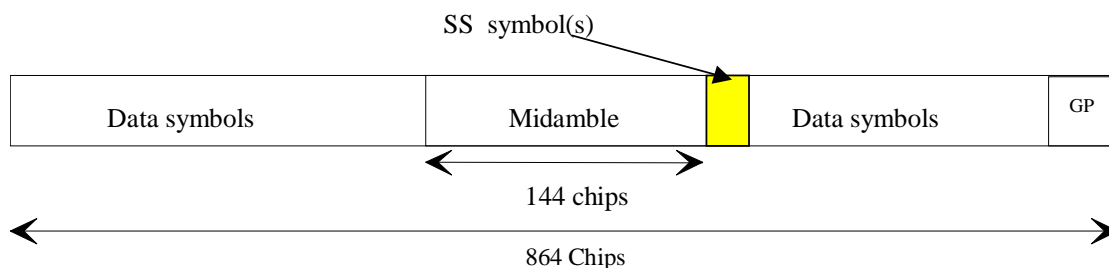

Figure 18H: Position of ULSC information in the traffic burst (downlink and uplink)

Note that for the uplink where there is no SS symbol used, the SS symbol space is reserved for future use. This can keep UL and DL slots the same structure.

For the number of SS symbols per time slot there are 3 possibilities, that can be configured by higher layers individually for each time slot:

- one SS symbol
- no SS symbol
- 16/SF SS symbols

So, in case 3, when SF=1, there are 16 SS symbols which correspond to 32 bits (for QPSK) and 48 bits (for 8PSK).

Each of the SS symbols in the DL will be associated with an UL time slot depending on the allocated UL time slots and the allocated SS symbols in the DL.

Note: Even though the different time slots of the UE are controlled with independent SS commands, the UE is not in need to execute SS commands leading to a deviation of more than [3] chip with respect to the average timing advance applied by the UE.

The synchronisation shift commands for each UL time slot (all channelisation codes on that time slot have the same SS command) will be distributed to the following rules:

1. The UL time slots the SS commands are intended for will be numbered from the first to the last UL time slot occupied by the regarded UE (starting with 0) considering all CCTrCHs allocated to that UE.
2. The commanding SS symbols on all downlink CCTrCHs allocated to one UE are numbered consecutively starting with zero according to the following rules:
 - a) The numbers of the SS commands of a regarded DL time slot are lower than those of DL time slots being transmitted after that time slot
 - b) Within a DL time slot the numbers of the SS commands of a regarded channelisation code are lower than those of channelisation codes having a bigger spreading code number

The spreading code number is defined by the following table: (see TS 25.223)

Spreading code number	SF (Q)	Walsh code number (k)
0	16	$c_{Q=16}^{(k=1)}$
	...	
15	16	$c_{Q=16}^{(k=16)}$
	Spreading factors 2-8 are not used in DL	
30	1	$c_{Q=1}^{(k=1)}$

- c) Within a channelisation code numbers of the SS commands are lower than those of SS commands being transmitted after that time

The following equation is used to determine the UL time slot which is controlled by the regarded SS symbol:

$$UL_{pos} = (SFN \cdot N_{SSymbols} + SS_{pos} + ((SFN \cdot N_{SSymbols} + SS_{pos}) \div N_{ULslot})) \bmod(N_{ULslot}),$$

where

UL_{pos} is the number of the controlled uplink time slot.

SFN' is the system frame number counting the sub-frames. The system frame number of the radio frames (SFN) can be derived from SFN' by

$SFN = SFN' \text{ div } 2$, where div is the remainder free division operation.

$N_{SSsymbols}$ is the number of SS symbols in a sub-frame (excluding those associated with PLCCH).

SS_{pos} is the number of the regarded SS symbol within the sub-frame.

N_{ULslot} is the number of UL slots in a sub-frame (excluding those slots exclusively controlled by PLCCH).

When one of the above parameters is changed due to higher layer reconfiguration, the new relationship between SS symbols and controlled UL time slots shall be valid, beginning with the radio frame, for which the new parameters are set.

The relationship between the SS Bits and the SS command for QPSK is the given in table 8D:

Table 8D: Coding of the SS for QPSK

SS Bits	SS command	Meaning
00	'Down'	Decrease synchronisation shift by $k/8 T_c$
11	'Up'	Increase synchronisation shift by $k/8 T_c$
01	'Do nothing'	No change

The relationship between the SS Bits and the SS command for 8PSK is given in table 8E:

Table 8E: Coding of the SS for 8PSK

SS Bits	SS command	Meaning
000	'Down'	Decrease synchronisation shift by $k/8 T_c$
110	'Up'	Increase synchronisation shift by $k/8 T_c$
011	'Do nothing'	No change

5A.2.2.4 Timeslot formats

The timeslot format depends on the spreading factor, the number of the TFCI code word bits, the number of SS and TPC symbols and the applied modulation scheme (QPSK/8PSK) as depicted in the following tables.

5A.2.2.4.1 Timeslot formats for QPSK

5A.2.2.4.1.1 Downlink timeslot formats

Table 8F : Time slot formats for the Downlink

Slot Format #	Spreading Factor	Midamble length (chips)	N _{TFCI} code word (bits)	N _{SS} & N _{TPC} (bits)	Bits/slot	N _{Data/Slot} (bits)	N _{data/data} field(1) (bits)	N _{data/data} field(2) (bits)
0	16	144	0	0 & 0	88	88	44	44
1	16	144	4	0 & 0	88	86	42	44
2	16	144	8	0 & 0	88	84	42	42
3	16	144	16	0 & 0	88	80	40	40
4	16	144	32	0 & 0	88	72	36	36
5	16	144	0	2 & 2	88	84	44	40
6	16	144	4	2 & 2	88	82	42	40
7	16	144	8	2 & 2	88	80	42	38
8	16	144	16	2 & 2	88	76	40	36
9	16	144	32	2 & 2	88	68	36	32
10	1	144	0	0 & 0	1408	1408	704	704
11	1	144	4	0 & 0	1408	1406	702	704
12	1	144	8	0 & 0	1408	1404	702	702
13	1	144	16	0 & 0	1408	1400	700	700
14	1	144	32	0 & 0	1408	1392	696	696
15	1	144	0	2 & 2	1408	1404	704	700
16	1	144	4	2 & 2	1408	1402	702	700
17	1	144	8	2 & 2	1408	1400	702	698
18	1	144	16	2 & 2	1408	1396	700	696
19	1	144	32	2 & 2	1408	1388	696	692
20	1	144	0	32 & 32	1408	1344	704	640
21	1	144	4	32 & 32	1408	1342	702	640
22	1	144	8	32 & 32	1408	1340	702	638
23	1	144	16	32 & 32	1408	1336	700	636
24	1	144	32	32 & 32	1408	1328	696	632

5A.2.2.4.1.2

Uplink timeslot formats

Table 8G : Time slot formats for the Uplink

Slot Format #	Spreading Factor	Midamble length (chips)	N _{TFCI} code word (bits)	N _{SS} & N _{TPC} (bits)	Bits/slot	N _{Data/Slot} (bits)	N _{data/data field(1)} (bits)	N _{data/data field(2)} (bits)
0	16	144	0	0 & 0	88	88	44	44
1	16	144	4	0 & 0	88	86	42	44
2	16	144	8	0 & 0	88	84	42	42
3	16	144	16	0 & 0	88	80	40	40
4	16	144	32	0 & 0	88	72	36	36
5	16	144	0	2 & 2	88	84	44	40
6	16	144	4	2 & 2	88	82	42	40
7	16	144	8	2 & 2	88	80	42	38
8	16	144	16	2 & 2	88	76	40	36
9	16	144	32	2 & 2	88	68	36	32
10	8	144	0	0 & 0	176	176	88	88
11	8	144	4	0 & 0	176	174	86	88
12	8	144	8	0 & 0	176	172	86	86
13	8	144	16	0 & 0	176	168	84	84
14	8	144	32	0 & 0	176	160	80	80
15	8	144	0	2 & 2	176	172	88	84
16	8	144	4	2 & 2	176	170	86	84
17	8	144	8	2 & 2	176	168	86	82
18	8	144	16	2 & 2	176	164	84	80
19	8	144	32	2 & 2	176	156	80	76
20	8	144	0	4 & 4	176	168	88	80
21	8	144	4	4 & 4	176	166	86	80
22	8	144	8	4 & 4	176	164	86	78
23	8	144	16	4 & 4	176	160	84	76
24	8	144	32	4 & 4	176	152	80	72
25	4	144	0	0 & 0	352	352	176	176
26	4	144	4	0 & 0	352	350	174	176
27	4	144	8	0 & 0	352	348	174	174
28	4	144	16	0 & 0	352	344	172	172
29	4	144	32	0 & 0	352	336	168	168
30	4	144	0	2 & 2	352	348	176	172
31	4	144	4	2 & 2	352	346	174	172
32	4	144	8	2 & 2	352	344	174	170
33	4	144	16	2 & 2	352	340	172	168
34	4	144	32	2 & 2	352	332	168	164
35	4	144	0	8 & 8	352	336	176	160
36	4	144	4	8 & 8	352	334	174	160
37	4	144	8	8 & 8	352	332	174	158
38	4	144	16	8 & 8	352	328	172	156
39	4	144	32	8 & 8	352	320	168	152
40	2	144	0	0 & 0	704	704	352	352
41	2	144	4	0 & 0	704	702	350	352
42	2	144	8	0 & 0	704	700	350	350
43	2	144	16	0 & 0	704	696	348	348
44	2	144	32	0 & 0	704	688	344	344
45	2	144	0	2 & 2	704	700	352	348
46	2	144	4	2 & 2	704	698	350	348

Slot Format #	Spreading Factor	Midamble length (chips)	N _{TFCI} code word (bits)	N _{SS} & N _{TPC} (bits)	Bits/slot	N _{Data/Slot} (bits)	N _{data/data} field(1) (bits)	N _{data/data} field(2) (bits)
47	2	144	8	2 & 2	704	696	350	346
48	2	144	16	2 & 2	704	692	348	344
49	2	144	32	2 & 2	704	684	344	340
50	2	144	0	16 & 16	704	672	352	320
51	2	144	4	16 & 16	704	670	350	320
52	2	144	8	16 & 16	704	668	350	318
53	2	144	16	16 & 16	704	664	348	316
54	2	144	32	16 & 16	704	656	344	312
55	1	144	0	0 & 0	1408	1408	704	704
56	1	144	4	0 & 0	1408	1406	702	704
57	1	144	8	0 & 0	1408	1404	702	702
58	1	144	16	0 & 0	1408	1400	700	700
59	1	144	32	0 & 0	1408	1392	696	696
60	1	144	0	2 & 2	1408	1404	704	700
61	1	144	4	2 & 2	1408	1402	702	700
62	1	144	8	2 & 2	1408	1400	702	698
63	1	144	16	2 & 2	1408	1396	700	696
64	1	144	32	2 & 2	1408	1388	696	692
65	1	144	0	32 & 32	1408	1344	704	640
66	1	144	4	32 & 32	1408	1342	702	640
67	1	144	8	32 & 32	1408	1340	702	638
68	1	144	16	32 & 32	1408	1336	700	636
69	1	144	32	32 & 32	1408	1328	696	632

5A.2.2.4.2 Time slot formats for 8PSK

The Downlink and the Uplink timeslot formats are described together in the following table.

Table 8H: Timeslot formats for 8PSK modulation

Slot Format #	Spreading Factor	Midamble length (chips)	N _{TFCI} code word (bits)	N _{SS} & N _{TPC} (bits)	Bits/slot	N _{Data/Slot} (bits)	N _{data/data field(1)} (bits)	N _{data/data field(2)} (bits)
0	1	144	0	0 & 0	2112	2112	1056	1056
1	1	144	6	0 & 0	2112	2109	1053	1056
2	1	144	12	0 & 0	2112	2106	1053	1053
3	1	144	24	0 & 0	2112	2100	1050	1050
4	1	144	48	0 & 0	2112	2088	1044	1044
5	1	144	0	3 & 3	2112	2106	1056	1050
6	1	144	6	3 & 3	2112	2103	1053	1050
7	1	144	12	3 & 3	2112	2100	1053	1047
8	1	144	24	3 & 3	2112	2094	1050	1044
9	1	144	48	3 & 3	2112	2082	1044	1038
10	1	144	0	48 & 48	2112	2016	1056	960
11	1	144	6	48 & 48	2112	2013	1053	960
12	1	144	12	48 & 48	2112	2010	1053	957
13	1	144	24	48 & 48	2112	2004	1050	954
14	1	144	48	48 & 48	2112	1992	1044	948
15	16	144	0	0 & 0	132	132	66	66
16	16	144	6	0 & 0	132	129	63	66
17	16	144	12	0 & 0	132	126	63	63
18	16	144	24	0 & 0	132	120	60	60
19	16	144	48	0 & 0	132	108	54	54
20	16	144	0	3 & 3	132	126	66	60
21	16	144	6	3 & 3	132	123	63	60
22	16	144	12	3 & 3	132	120	63	57
23	16	144	24	3 & 3	132	114	60	54
24	16	144	48	3 & 3	132	102	54	48

5A.2.2.4.3 Time slot formats for MBSFN

Downlink timeslot formats using QPSK or 16QAM modulation is dedicated for MBSFN operation and is described in the following table.

Table 8Ha : Time slot formats for MBSFN

Slot Format #	Spreading Factor	Midamble /preamble length (chips)	N _{TFCI} code word (bits)	N _{SS} & N _{TPC} (bits)	Bits/slot	N _{Data/Slot} (bits)	N _{data/data field(1)} (bits)	N _{data/data field(2)} (bits)
0(QPSK) [*]	1	144	16	0 & 0	1408	1404	702	702
1(QPSK) [*]	16	144	16	0 & 0	88	84	42	42
2(16QAM) [*]	1	144	32	0 & 0	2816	2808	1404	1404
3(16QAM) [*]	16	144	32	0 & 0	176	168	84	84
4(QPSK) ^{**}	1	96	16	0 & 0	1536	1532	N/A	N/A
5(QPSK) ^{**}	2	96	16	0 & 0	768	764	N/A	N/A
6(QPSK) ^{**}	16	96	16	0 & 0	96	92	N/A	N/A
7(16QAM) ^{**}	1	96	32	0 & 0	3072	3064	N/A	N/A
8(16QAM) ^{**}	2	96	16	0 & 0	1536	1528	N/A	N/A
9(16QAM) ^{**}	16	96	32	0 & 0	192	184	N/A	N/A
10(QPSK) ^{***}	16	96	16	0 & 0	32	24	N/A	N/A
11(QPSK) ^{***}	16	96	0	0 & 0	32	32	N/A	N/A

NOTE: * denotes that these timeslot formats are used in the traffic burst for mixed carrier MBSFN. ** denotes that these timeslot formats are used in the MT burst for dedicated carrier MBSFN. *** denotes that these timeslot formats are used in the MS burst for dedicated carrier MBSFN. The burst in the dedicated carrier MBSFN has only one data field.

5A.2.3 Training sequences for spread bursts

In this subclause, the training sequences for usage as midambles are defined. The training sequences, i.e. midambles, of different users active in the same cell and same time slot are cyclically shifted versions of one single basic midamble code. In the case of MBSFN timeslots there is only a single midamble and this is derived from a single basic midamble code which is not necessarily cell-specific. The applicable basic midamble codes are given in Annex AA.1.

The basic midamble codes in Annex AA.1 are listed in hexadecimal notation. The binary form of the basic midamble code shall be derived according to table 8I below.

Table 8I: Mapping of 4 binary elements m_i on a single hexadecimal digit:

4 binary elements m_i	Mapped on hexadecimal digit
-1 -1 -1 -1	0
-1 -1 -1 1	1
-1 -1 1 -1	2
-1 -1 1 1	3
-1 1 -1 -1	4
-1 1 -1 1	5
-1 1 1 -1	6
-1 1 1 1	7
1 -1 -1 -1	8
1 -1 -1 1	9
1 -1 1 -1	A
1 -1 1 1	B
1 1 -1 -1	C
1 1 -1 1	D
1 1 1 -1	E
1 1 1 1	F

For each particular basic midamble code, its binary representation can be written as a vector \mathbf{m}_p :

$$\mathbf{m}_p = (m_1, m_2, \dots, m_p) \quad (1)$$

According to Annex AA.1, the size of this vector \mathbf{m}_p is $P=128$. As QPSK modulation is used, the training sequences are transformed into a complex form, denoted as the complex vector $\underline{\mathbf{m}}_p$:

$$\underline{\mathbf{m}}_p = (\underline{m}_1, \underline{m}_2, \dots, \underline{m}_p) \quad (2)$$

The elements \underline{m}_i of $\underline{\mathbf{m}}_p$ are derived from elements m_i of \mathbf{m}_p using equation (3):

$$\underline{m}_i = (j)^i \cdot m_i \text{ for all } i = 1, \dots, P \quad (3)$$

Hence, the elements \underline{m}_i of the complex basic midamble code are alternating real and imaginary.

To derive the required training sequences, this vector $\underline{\mathbf{m}}_p$ is periodically extended to the size:

$$i_{\max} = L_m + (K - 1)W \quad (4)$$

Notes on equation (4):

K and W are taken from Annex AA.1

So we obtain a new vector $\underline{\mathbf{m}}$ containing the periodic basic midamble sequence:

$$\underline{\mathbf{m}} = (\underline{m}_1, \underline{m}_2, \dots, \underline{m}_{i_{\max}}) = (\underline{m}_1, \underline{m}_2, \dots, \underline{m}_{L_m + (K-1)W}) \quad (5)$$

The first P elements of this vector $\underline{\mathbf{m}}$ are the same ones as in vector $\underline{\mathbf{m}}_p$, the following elements repeat the beginning:

$$\underline{m}_i = \underline{m}_{i-P} \text{ for the subset } i = (P + 1), \dots, i_{\max} \quad (6)$$

Using this periodic basic midamble sequence $\underline{\mathbf{m}}$ for each user k a midamble $\underline{\mathbf{m}}^{(k)}$ of length L_m is derived, which can be written as a user specific vector:

$$\underline{\mathbf{m}}^{(k)} = \left(\underline{m}_1^{(k)}, \underline{m}_2^{(k)}, \dots, \underline{m}_{L_m}^{(k)} \right) \quad (7)$$

The L_m midamble elements $\underline{m}_i^{(k)}$ are generated for each midamble of the k users ($k = 1, \dots, K$) based on:

$$\underline{m}_i^{(k)} = \underline{m}_{i+(K-k)W} \quad \text{with } i = 1, \dots, L_m \text{ and } k = 1, \dots, K \quad (8)$$

The midamble sequences derived according to equations (7) to (8) have complex values and are not subject to channelisation or scrambling process, i.e. the elements $\underline{m}_i^{(k)}$ represent complex chips for usage in the pulse shaping process at modulation.

The term 'a midamble code set' or 'a midamble code family' denotes K specific midamble codes $\underline{\mathbf{m}}^{(k)}$; $k=1, \dots, K$, based on a single basic midamble code \mathbf{m}_p according to (1).

5A.2.3a Training sequences for dedicated carrier MBSFN

When the entire carrier is dedicated to MBSFN, preamble is used for the training sequences in each timeslot. In this case, for all timeslots employing MBSFN operation, only a single preamble is needed, i.e. $K_{\text{Cell}}=1$, then all physical channels in such timeslots employ the same preamble with the same allocation strategies.

For dedicated carrier MBSFN, the preamble has a fixed length of $L_p=96$, and the generation of preamble is the same as in the 1.28 Mcps TDD cf. [5A.2.3 Training sequences for spread bursts], which is corresponding to:

$$K=1, \quad W = \left\lfloor \frac{P}{K} \right\rfloor, \quad P=64$$

Note: that $\lfloor x \rfloor$ denotes the largest integer number less or equal to x .

The preamble is generated from one of the basic preamble codes shown in table AA.1a.

The mapping of these Basic Preamble Codes to MBSFN Cell Parameters is shown in [8].

5A.2.4 Beamforming

Beamforming is same as that of the 3.84Mcps TDD, cf. [5.2.4 Beamforming].

Beamforming is not applicable to DL time slots with MBSFN transmission.

5A.3 Common physical channels

5A.3.1 Primary common control physical channel (P-CCPCH)

The BCH as described in section 4.1.2 'Common Transport Channels' is mapped onto the Primary Common Control Physical Channels (P-CCPCH1 and P-CCPCH2). The position (time slot / code) of the P-CCPCHs is fixed in the 1.28Mcps TDD. The P-CCPCHs are mapped onto the first two code channels of timeslot#0 with spreading factor of 16. When the entire carrier is dedicated to MBSFN, the P-CCPCH is mapped onto the first two code channels of MS timeslot with spreading factor of 16. The P-CCPCH is always transmitted with an antenna pattern configuration that provides whole cell coverage.

In a multi-frequency cell the carrier which transmits P-CCPCH is called the primary frequency and the others are called secondary frequencies. A multi-frequency cell has only one primary frequency.

5A.3.1.1 P-CCPCH Spreading

The P-CCPCH uses fixed spreading with a spreading factor $SF = 16$. The P-CCPCH1 and P-CCPCH2 always use channelisation code $C_{Q=16}^{(k=1)}$ and $C_{Q=16}^{(k=2)}$ respectively.

5A.3.1.2 P-CCPCH Burst Format

The burst format as described in section 5A.2.2 is used for the P-CCPCH. No TFCI is applied for the P-CCPCH.

5A.3.1.3 P-CCPCH Training sequences

The training sequences, i.e. midambles, as described in subclause 5A.2.3 are used for the P-CCPCH. When the entire carrier is dedicated to MBSFN, the training sequences, i.e. preambles, as described in subclause 5A.2.3.a are used for the P-CCPCH.

5A.3.2 Secondary common control physical channel (S-CCPCH)

PCH and FACH as described in subclause 4.1.2 are mapped onto one or more secondary common control physical channels (S-CCPCH). In this way the capacity of PCH and FACH can be adapted to the different requirements. The time slot and codes used for the S-CCPCH are broadcast on the BCH.

In a multi-frequency cell S-CCPCH shall be transmitted only on the primary frequency.

5A.3.2.1 S-CCPCH Spreading

Except for physical channels in MBSFN time slot, the S-CCPCH uses fixed spreading with a spreading factor $SF = 16$, as described in subclause 5A.2.1. And the S-CCPCH in MBSFN time slot may use spreading with spreading factor $SF = 1, 2$ or 16 .

Note: $SF=2$ is only used on dedicated MBSFN frequency.

5A.3.2.2 S-CCPCH Burst Format

The burst format as described in section 5A.2.2 is used for the S-CCPCH. TFCI may be applied for S-CCPCHs.

5A.3.2.3 S-CCPCH Training sequences

The training sequences, i.e. midambles, as described in the subclause 5A.2.3 are also used for the S-CCPCH.

5A.3.3 Fast Physical Access CHannel (FPACH)

The Fast Physical Access CHannel (FPACH) is used by the Node B to carry, in a single burst, the acknowledgement of a detected signature with timing and power level adjustment indication to an user equipment. FPACH makes use of one code with spreading factor 16, so that its burst is composed by 44 symbols. The spreading code, training sequence and time slot position are configured by the network and signalled on the BCH.

In a multi-frequency cell the FPACH is transmitted on the primary frequency. The FPACH may also be also transmitted on the secondary frequency in case of handover or E-DCH procedure.

5A.3.3.1 FPACH burst

The FPACH burst contains 32 information bits. Table 8J reports the content description of the FPACH information bits and their priority order:

Table 8J: FPACH information bits description

Information field	Length (in bits)
Signature Reference Number	3 (MSB)
Relative Sub-Frame Number	2
Received starting position of the UpPCH (UpPCH _{POS})	11
Transmit Power Level Command for RACH message	7
Extended part of Received starting position of the UpPCH (UpPCH _{POS})	2
Reserved bits (default value: 0)	7 (LSB)

The use and generation of the information fields is explained in [9].

5A.3.3.1.1 Signature Reference Number

The reported number corresponds to the numbering principle for the cell signatures as described in [8].

The Signature Reference Number value range is 0 – 7 coded in 3 bits such that:

bit sequence(0 0 0) corresponds to the first signature of the cell; ...; bit sequence (1 1 1) corresponds to the 8th signature of the cell.

5A.3.3.1.2 Relative Sub-Frame Number

The Relative Sub-Frame Number value range is 0 – 3 coded such that:

bit sequence (0 0) indicates one sub-frame difference; ...; bit sequence (1 1) indicates 4 sub-frame difference.

5A.3.3.1.3 Received starting position of the UpPCH (UpPCH_{POS})

The size of UpPCH_{POS} is extended to be 13bits and the received starting position of the UpPCH value range is 0 – 8191 coded such that:

The 11 least significant bits (LSB) of UpPCH_{POS} are transmitted in the Received starting position of the UpPCH information field and the 2 most significant bits (MSB) of UpPCH_{POS} are transmitted in the first 2bits of the Reserve bits information field. Bit sequence (0 0 ... 0 0 0) indicates the received starting position zero chip; ...; bit sequence (1 1 ... 1 1 1) indicates the received starting position 8191*1/8 chip.

5A.3.3.1.4 Transmit Power Level Command for the RACH message

The transmit power level command is transmitted in 7 bits.

5A.3.3.2 FPACH Spreading

The FPACH uses only spreading factor SF=16 as described in subclause 5A.3.3. The set of admissible spreading codes for use on the FPACH is broadcast on the BCH.

5A.3.3.3 FPACH Burst Format

The burst format as described in section 5A.2.2 is used for the FPACH.

5A.3.3.4 FPACH Training sequences

The training sequences, i.e. midambles, as described in subclause 5A.2.3 are used for FPACH.

5A.3.3.5 FPACH timeslot formats

The FPACH uses slot format #0 of the DL time slot formats given in subclause 5A.2.2.4.1.1.

5A.3.4 The physical random access channel (PRACH)

The RACH as described in subclause 4.1.2 is mapped onto one or more uplink physical random access channels (PRACH). In such a way the capacity of RACH can be flexibly scaled depending on the operators need.

In a multi-frequency cell the PRACH shall be transmitted only on the primary frequency.

5A.3.4.1 PRACH Spreading

The uplink PRACH uses either spreading factor SF=16, SF=8 or SF=4 as described in subclause 5A.2.1. The set of admissible spreading codes for use on the PRACH and the associated spreading factors are broadcast on the BCH (within the RACH configuration parameters on the BCH).

5A.3.4.2 PRACH Burst Format

The burst format as described in section 5A.2.2 is used for the PRACH.

5A.3.4.3 PRACH Training sequences

The training sequences, i.e. midambles, of different users active in the same time slot are time shifted versions of a single periodic basic code. The basic midamble codes as described in subclause 5A.2.3 are used for PRACH.

5A.3.4.4 PRACH timeslot formats

The PRACH uses the following time slot formats taken from the uplink timeslot formats described in sub-clause 5A.2.2.4.1.2:

Spreading Factor	Slot Format #
16	0
8	10
4	25

5A.3.4.5 Association between Training Sequences and Channelisation Codes

The association between training sequences and channelisation codes of PRACH in the 1.28McpsTDD is same as that of the DPCH.

5A.3.5 The synchronisation channels (DwPCH, UpPCH)

There are two dedicated physical synchronisation channels —DwPCH and UpPCH in each 5ms sub-frame of the 1.28Mcps TDD. The DwPCH is used for the down link synchronisation and the UpPCH is used for the uplink synchronisation.

The position and the contents of the DwPCH are equal to the DwPTS as described in the subclause 5A.1., while the position and the contents of the UpPCH are equal to the UpPTS or other uplink access position indicated by the higher layers.

The DwPCH is transmitted at each sub-frame with an antenna pattern configuration which provides whole cell coverage. Furthermore it is transmitted with a constant power level which is signalled by higher layers.

In a multi-frequency cell the DwPCH shall be transmitted only on the primary frequency. The UpPCH is transmitted on the primary frequency. The UpPCH may also be transmitted on the secondary frequencies in case of handover.

The burst structure of the DwPCH (DwPTS) is described in the figure 18I.

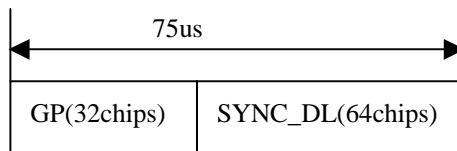

Figure 18I: burst structure of the DwPCH (DwPTS)

Note: 'GP' for 'Guard Period'

The burst structure of the UpPCH (UpPTS) is described in the figure 18J.

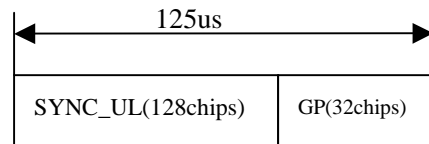

Figure 18J: burst structure of the UpPCH (UpPTS)

The SYNC-DL code in DwPCH and the SYNC-UL code in UpPCH are not spreaded. The details about the SYNC-DL and SYNC-UL code are described in the corresponding subclause and annex in [8].

5A.3.6 Physical Uplink Shared Channel (PUSCH)

For Physical Uplink Shared Channel (PUSCH) the burst structure of DPCH as described in subclause 5A.2 and the training sequences as described in subclause 5A.2.3 shall be used. PUSCH provides the possibility for transmission of TFCI, SS, and TPC in uplink.

The PUSCH is common with 3.84 Mcps TDD with respect to Spreading and UE selection, cf. [5.3.5 Physical Uplink Shared Channel (PUSCH)].

5A.3.7 Physical Downlink Shared Channel (PDSCH)

For Physical Downlink Shared Channel (PDSCH) the burst structure of DPCH as described in subclause 5A.2 and the training sequences as described in subclause 5A.2.3 shall be used. PDSCH provides the possibility for transmission of TFCI, SS, and TPC in downlink.

The PDSCH is common with 3.84 Mcps TDD with respect to Spreading and UE selection, cf. [5.3.6 Physical Downlink Shared Channel (PDSCH)].

5A.3.8 The Page Indicator Channel (PICH)

The Paging Indicator Channel (PICH) is a physical channel used to carry the paging indicators.

The PICH may be associated with

- an S-CCPCH to which a PCH transport channel is mapped, or
- an HS-SCCH associated with the HS-PDSCH(s) to which an HS-DSCH transport channel is mapped, or

an HS-PDSCH to which an HS-DSCH transport channel carrying paging message is mapped.

In a multi-frequency cell the PICH shall be transmitted only on the primary frequency.

5A.3.8.1 Mapping of Paging Indicators to the PICH bits

Figure 18K depicts the structure of a PICH transmission and the numbering of the bits within the bursts. The burst type as described in [5A.2.2 'Burst Format'] is used for the PICH. N_{PIB} bits are used to carry the paging indicators, where $N_{PIB}=352$.

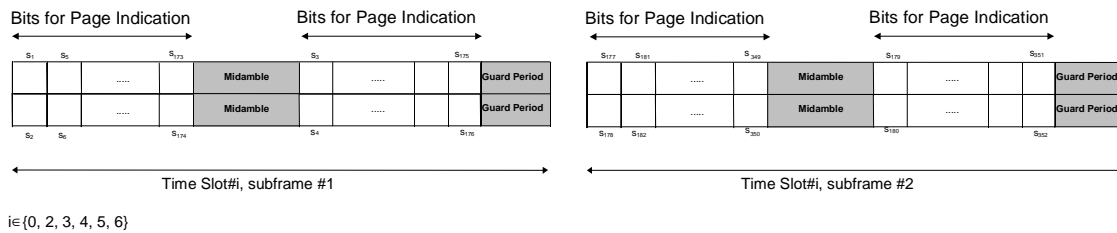

Figure 18K: Transmission and numbering of paging indicator carrying bits in the PICH bursts

Each paging indicator P_q (where $P_q, q = 0, \dots, N_{PI}-1, P_q \in \{0, 1\}$) in one radio frame is mapped to the bits $\{s_{2L_{PI} \cdot q+1}, \dots, s_{2L_{PI} \cdot (q+1)}\}$ in subframe #1 or subframe #2.

The setting of the paging indicators and the corresponding PICH bits is described in [7].

N_{PI} paging indicators of length $L_{PI}=2, L_{PI}=4$ or $L_{PI}=8$ symbols are transmitted in each radio frame that contains the PICH. The number of paging indicators N_{PI} per radio frame is given by the paging indicator length, which signalled by higher layers. In table 8K this number is shown for the different possibilities of paging indicator lengths.

Table 8K: Number N_{PI} of paging indicators per radio frame for different paging indicator lengths L_{PI}

	$L_{PI}=2$	$L_{PI}=4$	$L_{PI}=8$
N_{PI} per radio frame	88	44	22

5A.3.8.2 Structure of the PICH over multiple radio frames

The structure of the PICH over multiple radio frames is common with 3.84 Mcps TDD, cf. [5.3.7.2 Structure of the PICH over multiple radio frames]

5A.3.9 High Speed Physical Downlink Shared Channel (HS-PDSCH)

The HS-DSCH as described in subclause 4.1.2 is mapped onto one or more high speed physical downlink shared channels (HS-PDSCH). In a multi-frequency HS-DSCH cell, HS-PDSCHs may be transmitted on one or more carriers in CELL_DCH state and on only one carrier in CELL_FACH, CELL_PCH and URA_PCH state in a TTI to a UE and the carriers allocated to the UE shall be on contiguous frequencies. In CELL_FACH state, the HS-PDSCHs shall be transmitted on a same carrier as the one on which the uplink transmission resources are allocated to the UE. This carrier can be the primary frequency or the secondary frequency. In CELL_PCH and URA_PCH state, HS-PDSCHs can only be transmitted on the primary frequency. For UE not supporting multi-carrier HS-DSCH reception, the HS-PDSCHs shall be allocated on a same carrier as the one on which the associated DPCH or the uplink transmission resources is allocated.

5A.3.9.1 HS-PDSCH Spreading

For the UEs not configured in MIMO mode, the HS-PDSCH shall use either spreading factor $SF = 16$ or $SF=1$, as described in 5.2.1.1.

For the UEs configured in MIMO mode, if $SF=16$ is configured by higher layers [19] to be not supported for dual stream transmission, the HS-PDSCH shall use spreading factor $SF=1$ only. Otherwise, the HS-PDSCH shall use either spreading factor $SF = 16$ or $SF=1$.

Spreading of the HS-PDSCH is common with 3.84 Mcps TDD, cf. [5.3.9.1HS-PDSCH Spreading]

5A.3.9.2 HS-PDSCH Burst Format

The burst format as described in section 5A.2.2 shall be used for the HS-PDSCH.

5A.3.9.3 HS-PDSCH Training Sequences

The training sequences as described in subclause 5A.2.3 are used for the HS-PDSCH.

5A.3.9.4 UE Selection

UE selection is common with 3.84 Mcps TDD, cf. [5.3.9.4 UE selection].

5A.3.9.5 HS-PDSCH timeslot formats

An HS-PDSCH may use QPSK, 16QAM or 64QAM modulation symbols. The time slot formats are shown in table 8KA.

Table 8KA: Time slot formats for the HS-PDSCH

Slot Format #	SF	Midamble length (chips)	N _{TFCI} code word (bits)	N _{SS} & N _{TPC} (bits)	Bits/slot	N _{Data/Slot} (bits)	N _{data/data} field(1) (bits)	N _{data/data} field(2) (bits)
0 (QPSK)	16	144	0	0 & 0	88	88	44	44
1 (16QAM)	16	144	0	0 & 0	176	176	88	88
2 (QPSK)	1	144	0	0 & 0	1408	1408	704	704
3 (16QAM)	1	144	0	0 & 0	2816	2816	1408	1408
4(64QAM)	16	144	0	0 & 0	264	264	132	132
5 (64QAM)	1	144	0	0 & 0	4224	4224	2112	2112
6(QPSK)	16	144	0	2 & 2	88	84	44	40
7(16QAM)	16	144	0	2 & 2	172	168	88	80
8(QPSK)	1	144	0	2 & 2	1408	1404	704	700
9(16QAM)	1	144	0	2 & 2	2812	2808	1408	1400

Note: Time slot format 6-9 are exclusively used for semi-persistent HS-PDSCH resources. Whether data field is QPSK or 16QAM modulated, QPSK modulation is used for SS and TPC symbols.

5A.3.9.6 Transmission of SS and TPC

For the transmissions on the semi-persistent HS-PDSCH resources without an HS-SCCH, the SS and TPC command for HS-SICH can be conveyed in HS-PDSCH. The transmission of SS and TPC is done in the data parts of the traffic burst. Hence the midamble structure and length is not changed. The TPC information is to be transmitted directly after the SS information, which is transmitted after the midamble. The SS and TPC are transmitted using the physical channel with the lowest physical channel number and the timeslot with the lowest timeslot number.

5A.3.10 Shared Control Channel for HS-DSCH (HS-SCCH)

The HS-SCCH is a DL physical channel that carries higher layer control information for HS-DSCH. The physical layer will process this information according to [7] and will transmit the resulting bits on the HS-SCCH the structure of which is described below. A number of HS-SCCH types are defined for different purpose, and the actual description is given in [7].

The information on the HS-SCCH is carried by two separate physical channels (HS-SCCH1 and HS-SCCH2). The term HS-SCCH refers to the ensemble of these physical channels.

In CELL_FACH or CELL_PCH state, HS-SCCH order may carry an uplink synchronization establishment command. The structure is the same as described above.

In case of multi-carrier HS-DSCH reception, the HS-DSCH transmission on each allocated carrier is associated with its respective HS-SCCHs. The HS-SCCHs and HS-SICHs controlling the same HS-DSCH transmission on a carrier for the same UE shall be allocated on a same carrier.

5A.3.10.1 HS-SCCH Spreading

Spreading of the HS-SCCH is common with 3.84 Mcps TDD, cf. [5.3.10.1 HS-SCCH Spreading].

5A.3.10.2 HS-SCCH Burst Format

The burst format as described in section 5A.2.2 shall be used for the HS-SCCH.

5A.3.10.3 HS-SCCH Training Sequences

The training sequences as described in subclause 5A.2.3 are used for the HS-SCCH.

5A.3.10.4 HS-SCCH timeslot formats

HS-SCCH1 shall use time slot format #5 and HS-SCCH2 shall use time slot format #0 from table 8F, see section 5A.2.2.4.1.1, i.e. HS-SCCH shall carry TPC and SS but no TFCL.

5A.3.11 Shared Information Channel for HS-DSCH (HS-SICH)

The HS-SICH is a UL physical channel that carries higher layer control information and the Channel Quality Indicator CQI for HS-DSCH. If there is associated HS-SICH to an HS-SCCH order, the HS-SICH carries the acknowledgement to the HS-SCCH order command. The HS-SICH may also be used as the acknowledgement for an HS-SCCH allocating semi-persistent HS-PDSCH resources. The physical layer will process this information according to [7] and will transmit the resulting bits on the HS-SICH the structure of which is described below.

In case of multi-carrier HS-DSCH reception, the HS-DSCH transmission on each allocated carrier is related to its respective HS-SICHs. The HS-SCCHs and HS-SICHs controlling the same HS-DSCH transmission on a carrier for the same UE shall be allocated on a same carrier.

5A.3.11.1 HS-SICH Spreading

The HS-SICH shall use spreading factor $SF = 16$, as described in 5.2.1.2.

When MIMO dual-stream is transmitted, the HS-SICH shall use spreading factor $SF=8$ which shall utilize an additional $SF=16$ channelisation code along the branch with the higher code numbering of the allowed OVVSF sub tree.

5A.3.11.2 HS-SICH Burst Format

The burst format as described in section 5A.2.2 shall be used for the HS-SICH.

5A.3.11.3 HS-SICH Training Sequences

The training sequences as described in subclause 5A.2.3 are used for the HS-SICH.

5A.3.11.4 HS-SICH timeslot formats

The HS-SICH Type 1 shall use time slot format #5 while HS-SICH Type 2 shall use time slot format #20 from table 8G, see section 5A.2.2.4.1.2, i.e., it shall carry TPC and SS but no TFCL. For HS-SICH type 2, two identical TPC symbols denoting one TPC command are transmitted directly after the two identical SS symbols denoting one SS command, which are transmitted after the midamble.

5A.3.12 The MBMS Indicator Channel (MICH) type1

The MBMS Indicator Channel (MICH) type1 is a physical channel used to carry the MBMS notification indicators on a non MBSFN dedicated carrier. The UE may use multiple MICH within the MBMS modification period in order to make decisions on individual MBMS notification indicators.

5A.3.12.1 Mapping of MBMS Indicators to the type1 MICH bits

Figure 18L depicts the structure of a type1 MICH transmission and the numbering of the bits within the bursts. The burst type as described in [5A.2.2 ‘Burst Format’] is used for the MICH. N_{NIB} bits are used to carry the MBMS notification indicators, where $N_{NIB}=352$.

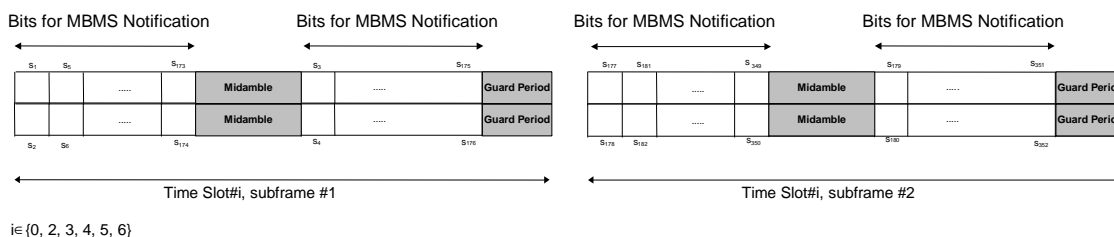

Figure 18L: Transmission and numbering of MBMS notification indicator carrying bits in a type1 MICH burst

Each notification indicator N_q (where $N_q, q = 0, \dots, N_n-1, N_q \in \{0, 1\}$) in one radio frame is mapped to the bits $\{s_{2L_{NI} \cdot q+1}, \dots, s_{2L_{NI} \cdot (q+1)}\}$ in subframe #1 or subframe #2.

The setting of the MBMS notification indicators and the corresponding type1 MICH bits is described in [7].

N_n MBMS notification indicators of length $L_{NI}=2, L_{NI}=4$ or $L_{NI}=8$ symbols are transmitted in each radio frame that contains the MICH. The number of MBMS notification indicators N_{NI} per radio frame is given by the MBMS notification indicator length, which is signalled by higher layers. In table 8KB this number is shown for the different possibilities of MBMS notification indicator lengths.

Table 8KB: Number N_{NI} of MBMS notification indicators per radio frame on type1 MICH for different MBMS notification indicator lengths L_{NI}

	$L_{NI}=2$	$L_{NI}=4$	$L_{NI}=8$
N_n per radio frame	88	44	22

The value NI ($NI = 0, \dots, N_{NI}-1$) calculated by higher layers, is associated to the MBMS notification indicator N_q , where $q = NI \bmod N_n$.

The set of NI passed over the Iub indicates all higher layer NI values for which the notification indicator on MICH type1 should be set to 1 during the corresponding modification period; all other indicators shall be set to 0.

5A.3.12a The MBMS Indicator Channel (MICH) type 2

The MBMS Indicator Channel (MICH) type 2 is a physical channel used to carry the MBMS notification indicators and system information change indicator on a MBSFN dedicated carrier only. The UE may use multiple MICH within the MBMS modification period in order to make decisions on individual MBMS notification indicators.

5A.3.12.1 Mapping of MBMS Indicators to the type 2 MICH bits

Figure 18La depicts the structure of a type 2 MICH transmission and the numbering of the bits within the bursts. The burst type as described in [5A.2.2a ‘MS Burst Format’] is used for the type 2 MICH. $2 \cdot L_{NI}$ bits are used to carry the system information change indicators and $N_{NIB} - 2 \cdot L_{NI}$ bits are used to carry the MBMS notification indicators, where $N_{NIB}=128$ for 10ms long MICH type 2.

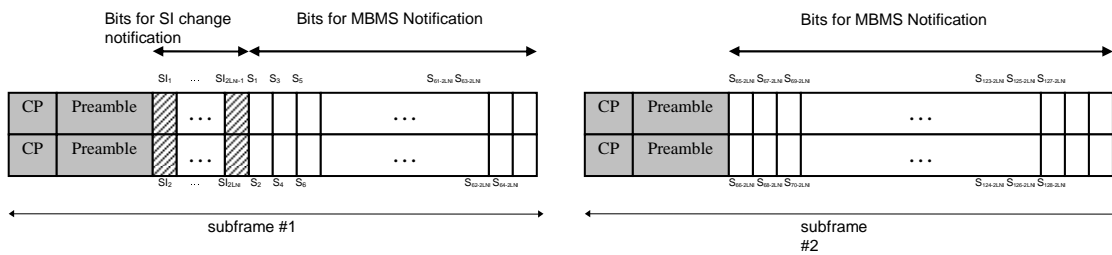

Figure 18La: Transmission and numbering of MBMS notification indicator carrying bits in a type 2 MICH burst

Each notification indicator N_q (where $N_q, q = 0, \dots, N_n-1, N_q \in \{0, 1\}$) in one radio frame is mapped to the bits $\{s_{2L_{NI} \cdot q+1}, \dots, s_{2L_{NI} \cdot (q+1)}\}$ in subframe #1 or subframe #2.

The setting of the MBMS notification indicators and the corresponding MICH bits is described in [7].

N_n MBMS notification indicators of length $L_{NI}=2, L_{NI}=4$ or $L_{NI}=8$ symbols are transmitted in each radio frame that contains the MICH. The number of MBMS notification indicators N_{NI} per MICH length is given by the MBMS notification indicator length, which is signalled by higher layers. In table 8KBa this number is shown for the different possibilities of MBMS notification indicator lengths.

Table 8KBa: Number N_{NI} of MBMS notification indicators per radio frame on type 2 MICH for different MBMS notification indicator lengths L_{NI}

	$L_{NI}=2$	$L_{NI}=4$	$L_{NI}=8$
N_n per radio frame	31	15	7

The value NI ($NI = 0, \dots, N_{NI}-1$) calculated by higher layers, is associated to the MBMS notification indicator N_q , where $q = NI \bmod N_n$.

The set of NI passed over the I_{ub} indicates all higher layer NI values for which the notification indicator on type 2 MICH should be set to 1 during the corresponding modification period; all other indicators shall be set to 0.

5A.3.13 Physical Layer Common Control Channel (PLCCH)

The Physical Layer Common Control Channel (PLCCH) is a Node B terminated channel which may be used to carry dedicated (UE-specific) TPC and SS information to multiple UEs. The PLCCH carries TPC and SS information only. No higher layer data is mapped to PLCCH. Each uplink CCTrCH is controlled either by PLCCH or by other appropriate downlink physical channels, under the control of higher layer signalling.

5A.3.13.1 PLCCH Spreading

The PLCCH uses only spreading factor $SF=16$ as described in subclause 5A.2.1. The spreading codes for use on the PLCCH are indicated by higher layers.

5A.3.13.2 PLCCH Burst Type

The burst format as described in section 5A.2.2 is used for the PLCCH.

5A.3.13.3 PLCCH Training Sequence

The training sequences as described in subclause 5A.2.3 are used for PLCCH.

5A.3.13.4 PLCCCH timeslot formats

The PLCCCH shall use time slot format #0 from table 8G, see section 5A.2.2.4.1.2.

5A.3.14 E-DCH Physical Uplink Channel

One or more E-PUCH are used to carry the uplink E-DCH transport channel and associated control information (E-UCCH) in each E-DCH TTI. In a timeslot designated by UTRAN for E-PUCH use, up to one E-PUCH may be transmitted by a UE.

5A.3.14.1 E-UCCH

The E-DCH Uplink Control Channel (E-UCCH) carries uplink control information associated with the E-DCH and is mapped to E-PUCH. Depending on the configuration of the number of E-UCCH instances and the number of E-PUCH timeslots, an E-PUCH burst may or may not contain E-UCCH and TPC. When E-PUCH does contain E-UCCH, TPC is also transmitted. When E-PUCH does not contain E-UCCH, TPC is not transmitted.

One E-UCCH instance :

- is of length 32 physical channel bits
- is mapped to the data field of the E-PUCH
- is spread at SF appointed by CRRI
- uses QPSK modulation

There shall be at least one E-UCCH and TPC in every E-DCH TTI. Multiple instances of the same E-UCCH information and TPC can be transmitted within an E-DCH TTI, the detailed number of instances can be set by NodeB MAC-e for scheduled transmissions and signalled by higher layers for non-scheduled transmissions. When an E-DCH data block is transmitted on multiple (N) timeslots in one TTI, there will be multiple E-PUCH timeslots. All repetitions of E-UCCH and TPC are evenly distributed on multiple E-PUCH timeslots. N is the number of timeslots of the E-PUCH, M is the number of E-UCCH and TPC instances in one TTI; K is the integral part of M/N; L is the residue of M/N. S is the number of E-UCCHs and TPCs in one E-PUCH timeslot. S equals K+1 for the first L E-PUCH timeslots and equals K for the last (N-L) E-PUCH timeslots.

The burst composition of the E-UCCH information and the E-DCH data is shown in figure 18M.

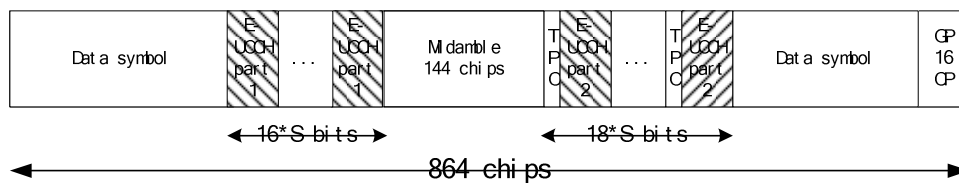

Figure 18M: Multiplexing structure of E-DCH and E-UCCH

An E-UCCH is composed of 32 bits: $k_0, k_1 \dots k_{31}$. It is segmented evenly into two parts shown in figure 18N.

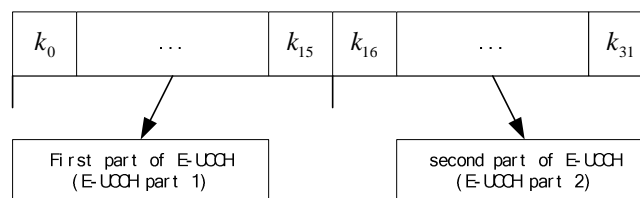

Figure 18N: E-UCCH code composition

Figures 18O and 18P show the E-PUCH data burst with and without the E-UCCH/TPC fields.

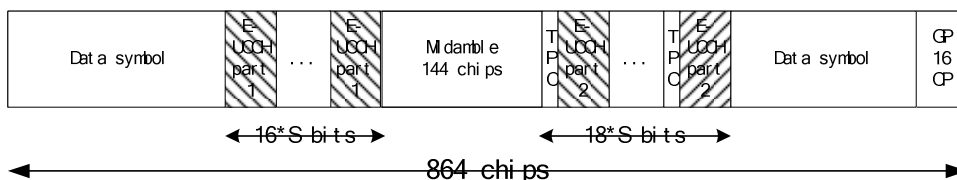

Figure 18O: E-PUCH data burst with E-UCCH/TPC

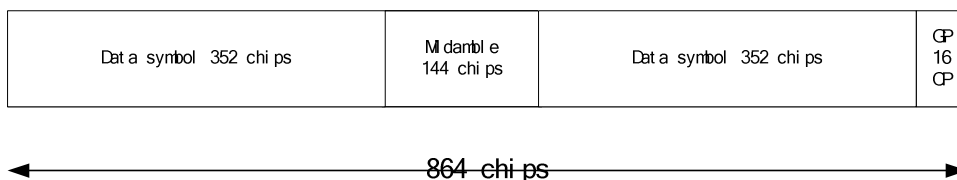

Figure 18P: E-PUCH data burst without E-UCCH/TPC

5A.3.14.2 E-PUCH Spreading

The spreading factors that can be applied to the E-PUCH are SF = 1, 2, 4, 8, 16 as described in subclause 5A.2.1. All E-PUCH use the same spreading factor within an E-DCH TTI. For scheduled transmissions, E-PUCHs use the spreading factor indicated by CRR1 on E-AGCH.

5A.3.14.3 E-PUCH Burst Types

The burst types as described in subclause 5A.2.2 can be used for E-PUCH. E-UCCH and TPC can be transmitted on the E-PUCH.

In case that TPC on non-scheduled E-PUCH is not used to adjust transmitting power level of downlink DPCH, Node B should not apply TPC commands received from non-scheduled E-PUCH.

5A.3.14.4 E-PUCH Training Sequences

The training sequences as described in subclause 5A.2.3 are used for the E-PUCH.

5A.3.14.5 UE Selection

UEs that shall transmit on the E-PUCH are selected by higher layers. The UE id on the associated E-AGCH shall be used for identification.

5A.3.14.6 E-PUCH timeslot formats

An E-PUCH may use QPSK or 16QAM modulation symbols and may or may not contain E-UCCH/TPC. The time slot formats are shown in table 8KC.

Table 8KC: Time slot formats for the E-PUCH

Slot Format #	0 (QPSK)	1 (16QAM)	2 (QPSK)	3 (16QAM)	4 (QPSK)	5 (16QAM)	6 (QPSK)	7 (16QAM)	8 (QPSK)	9 (16QAM)	10 (QPSK)	11 (16QAM)	12 (QPSK)	13 (16QAM)
Spreading Factor	16	16	16	16	16	16	8	8	8	8	8	8	8	8
Midamble length (chips)	144	144	144	144	144	144	144	144	144	144	144	144	144	144
Bits/slot	88	176	88	142	88	108	176	352	176	318	176	284	176	250
N _{Data/Slot} (bits)	88	176	54	108	20	40	176	352	142	284	108	216	74	148
N _{data/data field(1)} (bits)	44	88	28	56	12	24	88	176	72	144	56	112	40	80
N _{EUCC8_part1} (bits)	0	0	0	0	0	0	0	0	0	0	0	0	0	0
N _{EUCC7_part1} (bits)	0	0	0	0	0	0	0	0	0	0	0	0	0	0
N _{EUCC6_part1} (bits)	0	0	0	0	0	0	0	0	0	0	0	0	0	0
N _{EUCC5_part1} (bits)	0	0	0	0	0	0	0	0	0	0	0	0	0	0
N _{EUCC4_part1} (bits)	0	0	0	0	0	0	0	0	0	0	0	0	0	0
N _{EUCC3_part1} (bits)	0	0	0	0	0	0	0	0	0	0	0	0	16	16
N _{EUCC2_part1} (bits)	0	0	0	0	16	16	0	0	0	0	16	16	16	16
N _{EUCC1_part1} (bits)	0	0	16	16	16	16	0	0	16	16	16	16	16	16
N _{TPC1} (bits)	0	0	2	2	2	2	0	0	2	2	2	2	2	2
N _{EUCC1_part2} (bits)	0	0	16	16	16	16	0	0	16	16	16	16	16	16
N _{TPC2} (bits)	0	0	0	0	2	2	0	0	0	0	2	2	2	2
N _{EUCC2_part2} (bits)	0	0	0	0	16	16	0	0	0	0	16	16	16	16
N _{TPC3} (bits)	0	0	0	0	0	0	0	0	0	0	0	0	2	2
N _{EUCC3_part2} (bits)	0	0	0	0	0	0	0	0	0	0	0	0	16	16
N _{TPC4} (bits)	0	0	0	0	0	0	0	0	0	0	0	0	0	0
N _{EUCC4_part2} (bits)	0	0	0	0	0	0	0	0	0	0	0	0	0	0
N _{TPC5} (bits)	0	0	0	0	0	0	0	0	0	0	0	0	0	0
N _{EUCC5_part2} (bits)	0	0	0	0	0	0	0	0	0	0	0	0	0	0
N _{TPC6} (bits)	0	0	0	0	0	0	0	0	0	0	0	0	0	0
N _{EUCC6_part2} (bits)	0	0	0	0	0	0	0	0	0	0	0	0	0	0
N _{TPC7} (bits)	0	0	0	0	0	0	0	0	0	0	0	0	0	0
N _{EUCC7_part2} (bits)	0	0	0	0	0	0	0	0	0	0	0	0	0	0
N _{TPC8} (bits)	0	0	0	0	0	0	0	0	0	0	0	0	0	0
N _{EUCC8_part2} (bits)	0	0	0	0	0	0	0	0	0	0	0	0	0	0
N _{data/data field(2)}	44	88	26	52	8	16	88	176	70	140	52	104	34	68

Slot Format #	0 (QPSK)	1 (16QAM)	2 (QPSK)	3 (16QAM)	4 (QPSK)	5 (16QAM)	6 (QPSK)	7 (16QAM)	8 (QPSK)	9 (16QAM)	10 (QPSK)	11 (16QAM)	12 (QPSK)	13 (16QAM)
(bits)														

Slot Format #	14 (QPSK)	15 (16QAM)	16 (QPSK)	17 (16QAM)	18 (QPSK)	19 (16QAM)	20 (QPSK)	21 (16QAM)	22 (QPSK)	23 (16QAM)	24 (QPSK)	25 (16QAM)	26 (QPSK)	27 (16QAM)
Spreading Factor	8	8	4	4	4	4	4	4	4	4	4	4	4	4
Midamble length (chips)	144	144	144	144	144	144	144	144	144	144	144	144	144	144
Bits/slot	176	216	352	704	352	670	352	636	352	602	352	568	352	534
N_{Data}/Slot (bits)	40	80	352	704	318	636	284	568	250	500	216	432	182	364
N_{data}/data field(1) (bits)	24	48	176	352	160	320	144	288	128	256	112	224	96	192
N_{EUCC8_part1}(bits)	0	0	0	0	0	0	0	0	0	0	0	0	0	0
N_{EUCC7_part1}(bits)	0	0	0	0	0	0	0	0	0	0	0	0	0	0
N_{EUCC6_part1}(bits)	0	0	0	0	0	0	0	0	0	0	0	0	0	0
N_{EUCC5_part1}(bits)	0	0	0	0	0	0	0	0	0	0	0	0	16	16
N_{EUCC4_part1}(bits)	16	16	0	0	0	0	0	0	0	0	16	16	16	16
N_{EUCC3_part1}(bits)	16	16	0	0	0	0	0	0	16	16	16	16	16	16
N_{EUCC2_part1}(bits)	16	16	0	0	0	0	16	16	16	16	16	16	16	16
N_{EUCC1_part1}(bits)	16	16	0	0	16	16	16	16	16	16	16	16	16	16
N_{TPC1}(bits)	2	2	0	0	2	2	2	2	2	2	2	2	2	2
N_{EUCC1_part2}(bits)	16	16	0	0	16	16	16	16	16	16	16	16	16	16
N_{TPC2}(bits)	2	2	0	0	0	0	2	2	2	2	2	2	2	2
N_{EUCC2_part2}(bits)	16	16	0	0	0	0	16	16	16	16	16	16	16	16
N_{TPC3}(bits)	2	2	0	0	0	0	0	0	2	2	2	2	2	2
N_{EUCC3_part2}(bits)	16	16	0	0	0	0	0	0	16	16	16	16	16	16
N_{TPC4}(bits)	2	2	0	0	0	0	0	0	0	0	2	2	2	2
N_{EUCC4_part2}(bits)	16	16	0	0	0	0	0	0	0	0	16	16	16	16
N_{TPC5}(bits)	0	0	0	0	0	0	0	0	0	0	0	0	2	2
N_{EUCC5_part2}(bits)	0	0	0	0	0	0	0	0	0	0	0	0	16	16
N_{TPC6}(bits)	0	0	0	0	0	0	0	0	0	0	0	0	0	0
N_{EUCC6_part2}(bits)	0	0	0	0	0	0	0	0	0	0	0	0	0	0
N_{TPC7}(bits)	0	0	0	0	0	0	0	0	0	0	0	0	0	0
N_{EUCC7_part2}(bits)	0	0	0	0	0	0	0	0	0	0	0	0	0	0

Slot Format #	14 (QPSK)	15 (16QAM)	16 (QPSK)	17 (16QAM)	18 (QPSK)	19 (16QAM)	20 (QPSK)	21 (16QAM)	22 (QPSK)	23 (16QAM)	24 (QPSK)	25 (16QAM)	26 (QPSK)	27 (16QAM)
N_{TPC8}(bits)	0	0	0	0	0	0	0	0	0	0	0	0	0	0
N_{EUCC8_part2}(bits)	0	0	0	0	0	0	0	0	0	0	0	0	0	0
N_{data/data field(2)}(bits)	16	32	176	352	158	316	140	280	122	244	104	208	86	172

Slot Format #	28 (QPSK)	29 (16QAM)	30 (QPSK)	31 (16QAM)	32 (QPSK)	33 (16QAM)	34 (QPSK)	35 (16QAM)	36 (QPSK)	37 (16QAM)	38 (QPSK)	39 (16QAM)	40 (QPSK)	41 (16QAM)
Spreading Factor	4	4	4	4	4	4	2	2	2	2	2	2	2	2
Midamble length (chips)	144	144	144	144	144	144	144	144	144	144	144	144	144	144
Bits/slot	352	500	352	466	352	432	704	1408	704	1374	704	1340	704	1306
N_{Data/Slot}(bits)	148	296	114	228	80	160	704	1408	670	1340	636	1272	602	1204
N_{data/data field(1)}(bits)	80	160	64	128	48	96	352	704	336	672	320	640	304	608
N_{EUCC8_part1}(bits)	0	0	0	0	16	16	0	0	0	0	0	0	0	0
N_{EUCC7_part1}(bits)	0	0	16	16	16	16	0	0	0	0	0	0	0	0
N_{EUCC6_part1}(bits)	16	16	16	16	16	16	0	0	0	0	0	0	0	0
N_{EUCC5_part1}(bits)	16	16	16	16	16	16	0	0	0	0	0	0	0	0
N_{EUCC4_part1}(bits)	16	16	16	16	16	16	0	0	0	0	0	0	0	0
N_{EUCC3_part1}(bits)	16	16	16	16	16	16	0	0	0	0	0	0	16	16
N_{EUCC2_part1}(bits)	16	16	16	16	16	16	0	0	0	0	16	16	16	16
N_{EUCC1_part1}(bits)	16	16	16	16	16	16	0	0	16	16	16	16	16	16
N_{TPC1}(bits)	2	2	2	2	2	2	0	0	2	2	2	2	2	2
N_{EUCC1_part2}(bits)	16	16	16	16	16	16	0	0	16	16	16	16	16	16
N_{TPC2}(bits)	2	2	2	2	2	2	0	0	0	0	2	2	2	2
N_{EUCC2_part2}(bits)	16	16	16	16	16	16	0	0	0	0	16	16	16	16
N_{TPC3}(bits)	2	2	2	2	2	2	0	0	0	0	0	0	2	2
N_{EUCC3_part2}(bits)	16	16	16	16	16	16	0	0	0	0	0	0	16	16
N_{TPC4}(bits)	2	2	2	2	2	2	0	0	0	0	0	0	0	0
N_{EUCC4_part2}(bits)	16	16	16	16	16	16	0	0	0	0	0	0	0	0
N_{TPC5}(bits)	2	2	2	2	2	2	0	0	0	0	0	0	0	0
N_{EUCC5_part2}(bits)	16	16	16	16	16	16	0	0	0	0	0	0	0	0
N_{TPC6}(bits)	2	2	2	2	2	2	0	0	0	0	0	0	0	0

Slot Format #	28 (QPSK)	29 (16QAM)	30 (QPSK)	31 (16QAM)	32 (QPSK)	33 (16QAM)	34 (QPSK)	35 (16QAM)	36 (QPSK)	37 (16QAM)	38 (QPSK)	39 (16QAM)	40 (QPSK)	41 (16QAM)
N_{EUCCH6_part2}(bits)	16	16	16	16	16	16	0	0	0	0	0	0	0	0
N_{TPC7}(bits)	0	0	2	2	2	2	0	0	0	0	0	0	0	0
N_{EUCCH7_part2}(bits)	0	0	16	16	16	16	0	0	0	0	0	0	0	0
N_{TPC8}(bits)	0	0	0	0	2	2	0	0	0	0	0	0	0	0
N_{EUCCH8_part2}(bits)	0	0	0	0	16	16	0	0	0	0	0	0	0	0
N_{data/data field(2)}(bits)	68	136	50	100	32	64	352	704	334	668	316	632	298	596

Slot Format #	42 (QPSK)	43 (16QAM)	44 (QPSK)	45 (16QAM)	46 (QPSK)	47 (16QAM)	48 (QPSK)	49 (16QAM)	50 (QPSK)	51 (16QAM)	52 (QPSK)	53 (16QAM)	54 (QPSK)	55 (16QAM)
Spreading Factor	2	2	2	2	2	2	2	2	2	2	1	1	1	1
Midamble length (chips)	144	144	144	144	144	144	144	144	144	144	144	144	144	144
Bits/slot	704	1272	704	1238	704	1204	704	1170	704	1136	1408	2816	1408	2782
N_{Data/Slot}(bits)	568	1136	534	1068	500	1000	466	932	432	864	1408	2816	1374	2748
N_{data/data field(1)}(bits)	288	576	272	544	256	512	240	480	224	448	704	1408	688	1376
N_{EUCCH8_part1}(bits)	0	0	0	0	0	0	0	0	16	16	0	0	0	0
N_{EUCCH7_part1}(bits)	0	0	0	0	0	0	16	16	16	16	0	0	0	0
N_{EUCCH6_part1}(bits)	0	0	0	0	16	16	16	16	16	16	0	0	0	0
N_{EUCCH5_part1}(bits)	0	0	16	16	16	16	16	16	16	16	0	0	0	0
N_{EUCCH4_part1}(bits)	16	16	16	16	16	16	16	16	16	16	0	0	0	0
N_{EUCCH3_part1}(bits)	16	16	16	16	16	16	16	16	16	16	0	0	0	0
N_{EUCCH2_part1}(bits)	16	16	16	16	16	16	16	16	16	16	0	0	0	0
N_{EUCCH1_part1}(bits)	16	16	16	16	16	16	16	16	16	16	0	0	16	16
N_{TPC1}(bits)	2	2	2	2	2	2	2	2	2	2	0	0	2	2
N_{EUCCH1_part2}(bits)	16	16	16	16	16	16	16	16	16	16	0	0	16	16
N_{TPC2}(bits)	2	2	2	2	2	2	2	2	2	2	0	0	0	0
N_{EUCCH2_part2}(bits)	16	16	16	16	16	16	16	16	16	16	0	0	0	0
N_{TPC3}(bits)	2	2	2	2	2	2	2	2	2	2	0	0	0	0
N_{EUCCH3_part2}(bits)	16	16	16	16	16	16	16	16	16	16	0	0	0	0
N_{TPC4}(bits)	2	2	2	2	2	2	2	2	2	2	0	0	0	0
N_{EUCCH4_part2}(bits)	16	16	16	16	16	16	16	16	16	16	0	0	0	0

Slot Format #	42 (QPSK)	43 (16QAM)	44 (QPSK)	45 (16QAM)	46 (QPSK)	47 (16QAM)	48 (QPSK)	49 (16QAM)	50 (QPSK)	51 (16QAM)	52 (QPSK)	53 (16QAM)	54 (QPSK)	55 (16QAM)
N_{TPC5}(bits)	0	0	2	2	2	2	2	2	2	2	0	0	0	0
N_{EUCC5_part2}(bits)	0	0	16	16	16	16	16	16	16	16	0	0	0	0
N_{TPC6}(bits)	0	0	0	0	2	2	2	2	2	2	0	0	0	0
N_{EUCC6_part2}(bits)	0	0	0	0	16	16	16	16	16	16	0	0	0	0
N_{TPC7}(bits)	0	0	0	0	0	0	2	2	2	2	0	0	0	0
N_{EUCC7_part2}(bits)	0	0	0	0	0	0	16	16	16	16	0	0	0	0
N_{TPC8}(bits)	0	0	0	0	0	0	0	0	2	2	0	0	0	0
N_{EUCC8_part2}(bits)	0	0	0	0	0	0	0	0	16	16	0	0	0	0
N_{data/data field(2)}(bits)	280	560	262	524	244	488	226	452	208	416	704	1408	686	1372

Slot Format #	56 (QPSK)	57 (16QAM)	58 (QPSK)	59 (16QAM)	60 (QPSK)	61 (16QAM)	62 (QPSK)	63 (16QAM)	64 (QPSK)	65 (16QAM)	66 (QPSK)	67 (16QAM)	68 (QPSK)	69 (16QAM)
Spreading Factor	1	1	1	1	1	1	1	1	1	1	1	1	1	1
Midamble length (chips)	144	144	144	144	144	144	144	144	144	144	144	144	144	144
Bits/slot	1408	2748	1408	2714	1408	2680	1408	2646	1408	2612	1408	2578	1408	2544
N_{data/Slot}(bits)	1340	2680	1306	2612	1272	2544	1238	2476	1204	2408	1170	2340	1136	2272
N_{data/data field(1)}(bits)	672	1344	656	1312	640	1280	624	1248	608	1216	592	1184	576	1152
N_{EUCC8_part1}(bits)	0	0	0	0	0	0	0	0	0	0	0	0	16	16
N_{EUCC7_part1}(bits)	0	0	0	0	0	0	0	0	0	0	16	16	16	16
N_{EUCC6_part1}(bits)	0	0	0	0	0	0	0	0	16	16	16	16	16	16
N_{EUCC5_part1}(bits)	0	0	0	0	0	0	16	16	16	16	16	16	16	16
N_{EUCC4_part1}(bits)	0	0	0	0	16	16	16	16	16	16	16	16	16	16
N_{EUCC3_part1}(bits)	0	0	16	16	16	16	16	16	16	16	16	16	16	16
N_{EUCC2_part1}(bits)	16	16	16	16	16	16	16	16	16	16	16	16	16	16
N_{EUCC1_part1}(bits)	16	16	16	16	16	16	16	16	16	16	16	16	16	16
N_{TPC1}(bits)	2	2	2	2	2	2	2	2	2	2	2	2	2	2
N_{EUCC1_part2}(bits)	16	16	16	16	16	16	16	16	16	16	16	16	16	16
N_{TPC2}(bits)	2	2	2	2	2	2	2	2	2	2	2	2	2	2
N_{EUCC2_part2}(bits)	16	16	16	16	16	16	16	16	16	16	16	16	16	16
N_{TPC3}(bits)	0	0	2	2	2	2	2	2	2	2	2	2	2	2

Slot Format #	56 (QPSK)	57 (16QAM)	58 (QPSK)	59 (16QAM)	60 (QPSK)	61 (16QAM)	62 (QPSK)	63 (16QAM)	64 (QPSK)	65 (16QAM)	66 (QPSK)	67 (16QAM)	68 (QPSK)	69 (16QAM)
N_{EUCCH3_part2}(bits)	0	0	16	16	16	16	16	16	16	16	16	16	16	16
N_{TPC4}(bits)	0	0	0	0	2	2	2	2	2	2	2	2	2	2
N_{EUCCH4_part2}(bits)	0	0	0	0	16	16	16	16	16	16	16	16	16	16
N_{TPC5}(bits)	0	0	0	0	0	0	2	2	2	2	2	2	2	2
N_{EUCCH5_part2}(bits)	0	0	0	0	0	0	16	16	16	16	16	16	16	16
N_{TPC6}(bits)	0	0	0	0	0	0	0	0	2	2	2	2	2	2
N_{EUCCH6_part2}(bits)	0	0	0	0	0	0	0	0	16	16	16	16	16	16
N_{TPC7}(bits)	0	0	0	0	0	0	0	0	0	0	2	2	2	2
N_{EUCCH7_part2}(bits)	0	0	0	0	0	0	0	0	0	0	16	16	16	16
N_{TPC8}(bits)	0	0	0	0	0	0	0	0	0	0	0	0	2	2
N_{EUCCH8_part2}(bits)	0	0	0	0	0	0	0	0	0	0	0	0	16	16
N_{data/data field(2)}(bits)	668	1336	650	1300	632	1264	614	1228	596	1192	578	1156	560	1120

5A.3.15 E-DCH Random Access Uplink Control Channel (E-RUCCH)

The E-RUCCH is used to carry E-DCH-associated uplink control signalling when E-PUCH resources are not available. It shall be mapped to the same random access physical resources defined by UTRAN.

5A.3.15.1 E-RUCCH Spreading

The E-RUCCH uses spreading factor SF=16 or SF=8 as described in subclause 5A.2.1. The set of admissible spreading codes used on the E-RUCCH are based on the spreading codes of PRACH.

5A.3.15.2 E-RUCCH Burst Format

The burst format as described in section 5A.2.2 is used for the E-RUCCH.

5A.3.15.3 E-RUCCH Training sequences

The training sequences, i.e. midambles, as described in subclause 5A.2.3 are used for E-RUCCH.

5A.3.15.4 E-RUCCH timeslot formats

The timeslot format depends on the spreading factor of the E-RUCCH:

Spreading Factor	Slot Format #
16	0
8	10

5A.3.16 E-DCH Absolute Grant Channel (E-AGCH)

The E-DCH Absolute Grant Channel (E-AGCH) is a downlink physical channel carrying the uplink E-DCH absolute grant control information. The E-AGCH uses two separate physical channels (E-AGCH1 and E-AGCH2). The term E-AGCH refers to the ensemble of these physical channels.

5A.3.16.1 E-AGCH Spreading

Spreading of the E-AGCH is common with 3.84Mcps TDD, cf. [5.3.15.1 E-AGCH Spreading].

5A.3.16.2 E-AGCH Burst Types

The burst structures for E-AGCH1 and E-AGCH2 are shown in figure 18Q and 18R.

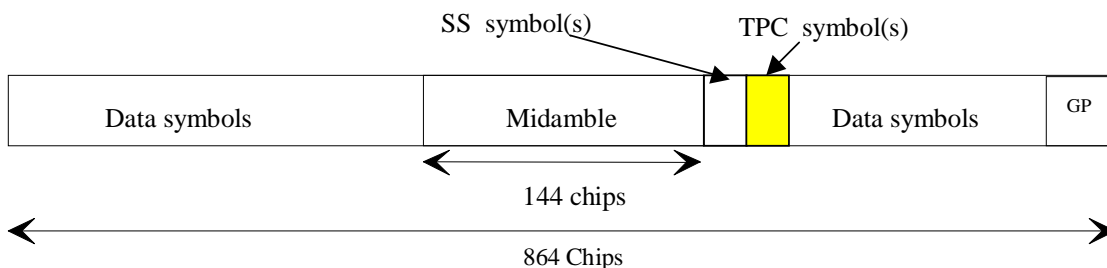

Figure 18Q: E-AGCH1 burst structure

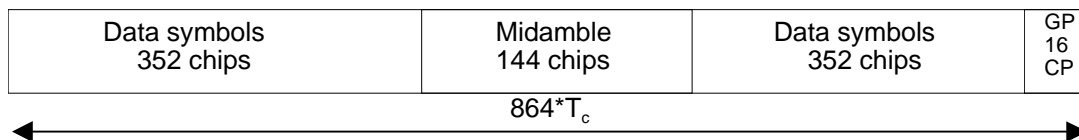

Figure 18R: E-AGCH2 burst structure

5A.3.16.3 E-AGCH Training Sequences

The training sequences as described in subclause 5A.2.3 are used for the E-AGCH.

5A.3.16.4 E-AGCH timeslot formats

E-AGCH1 shall use time slot format #5 and E-AGCH2 shall use time slot format #0 from table 8F, see section 5A.2.2.4.1.1, i.e. E-AGCH shall carry TPC and SS for E-PUCH power control and synchronization but no TFCI.

Table 8KD: Timeslot formats for the E-AGCH

Slot Format #	Spreading Factor	Midamble length (chips)	N _{TFCI} code word (bits)	N _{ss} &N _{TPC} (bits)	Bits/slot	N _{Data/Slot} (bits)	N _{data/data} field (1) (bits)	N _{data/data} field (2) (bits)
0	16	144	0	0&0	88	88	44	44
5	16	144	0	2&2	88	84	44	40

5A.3.17 E-DCH Hybrid ARQ Acknowledgement Indicator Channel (E-HICH)

The E-DCH HARQ Acknowledgement indicator channel (E-HICH) is defined in terms of a SF16 downlink physical channel and a signature sequence.

The E-HICH carries one or multiple users' acknowledgement indicator. Figure 18S illustrates the structure of the E-HICH. The E-HICH contains 8 spare bit locations. The spare bit values are undefined. The power of each user's acknowledgement indicator may be set independently by the Node-B. The number of E-HICHs in a cell is configured by the system. Scheduled traffic's and non-scheduled traffic's acknowledgement indicators are transmitted on different E-HICHs.

The acknowledgement indicators for the E-PUCH semi-persistent scheduling operation can be transmitted on the same E-HICH carrying indicators for scheduled traffic or the E-HICH carrying indicators for non-scheduled traffic.

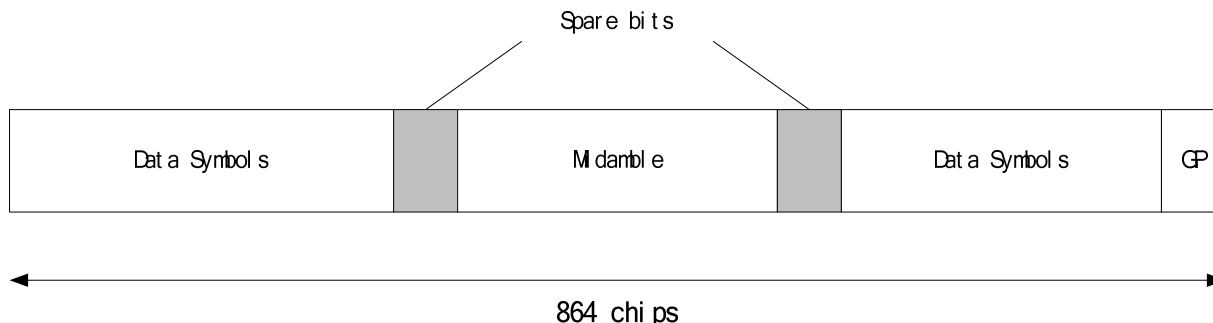

Figure 18S: E-HICH Structure

For Scheduled transmissions, at most four E-HICHs can be configured for one user's scheduled transmission. Which E-HICH is used to convey the HARQ acknowledgment indicator is indicated by the 2-bit E-HICH indicator on E-AGCH. A single E-HICH may carry one or multiple HARQ acknowledgement indicator(s) which are decided by the Node-B.

For Non-Scheduled transmissions, E-HICHs carry not only the HARQ acknowledgement indicators but also TPC and SS commands. The 80 signature sequences are divided into 20 groups while each group includes 4 sequences. Every non-scheduled user is assigned only one group which are signalled by higher layer. Among the 4 sequences, the first one is used to indicate ACK/NACK, and the other three are used to indicate the TPC/SS commands. The three sequences and their three reverse sequences are the six possible sequences used to indicate the TPC/SS combination state. The reverse sequence is constructed by reverse every bit of the sequence from 0 to 1 or from 1 to 0. The mapping between the index and the TPC/SS command is shown in table 8KE. The index is calculated according to the equation: $index=2*A+B$, ($A=0,1,2$; $B=0,1$). A is the relative index of the selected sequence among the three assigned sequences and B equals to 1 when the reverse sequence is chosen, otherwise, B equals to 0. The power of the sequence used for TPC/SS indication can be set differently from the one used to indicate ACK/NACK.

Table 8KE: Mapping between the index and TPC/SS command

index	TPC command	SS command
0	'DOWN'	'DOWN'
1	'UP'	'DOWN'
2	'DOWN'	'UP'
3	'UP'	'UP'
4	'DOWN'	'Do Nothing'
5	'UP'	'Do Nothing'

For the E-DCH semi-persistent scheduling operation, E-HICHs carry not only the HARQ acknowledgement indicators but also TPC and SS commands. Each user is also assigned one signature sequence group including 4 sequences whose usage is completely complying with the definition in non-scheduled transmissions.

The acknowledgement indicator for an E-DCH transmission in TTI "N" is carried by the E-HICH in TTI " $N+[T_A]$ " (T_A is determined according to the value of n_{E-HICH}). The E-HICH is thus synchronously related to those E-DCH transmissions for which it carries acknowledgement information.

5A.3.17.1 E-HICH Spreading

Multiple users' signature sequences (including the inserted spare bits) sharing the same channelisation code are combined and spread using spreading factor $SF=16$ as described in [8].

5A.3.17.2 E-HICH Burst Types

The burst structures for E-HICH are shown in figure 18D.

5A.3.17.3 E-HICH Training Sequences

The training sequences as described in subclause 5A.2.3 are used for the E-HICH.

5A.3.17.4 E-HICH timeslot formats

E-HICH shall use time slot format #0 from table 8F.

5A.3.18 Standalone midamble channel

5A.3.18.1 Standalone midamble channel Burst Format

A standalone midamble channel traffic burst consists of a midamble of 144 chips only. The burst format is shown in Figure 18T. The contents of the traffic burst fields are described in table 8KF.

Table 8KF: The contents of the standalone midamble channel traffic burst format fields

Chip number (CN)	Length of field in chips	Contents of field
0-351	352	NULL
352-495	144	Midamble
496-863	368	NULL

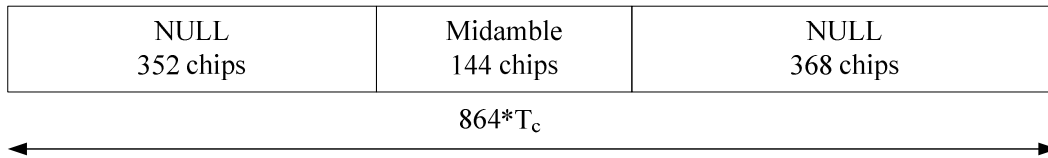

Figure 18T: Burst structure of the standalone midamble channel traffic burst format

5A.3.18.3 Standalone midamble channel Training Sequences

The training sequences as described in subclause 5A.2.3 are used for the standalone midamble channel.

5A.3.18.4 Standalone midamble channel timeslot formats

The timeslot formats for the standalone midamble channel are shown in table 8KG.

Table 8KG: Timeslot formats for the standalone midamble channel

Slot Format #	Midamble length (chips)	N_{TFCI} code word (bits)	N_{SS} & N_{TPC} (bits)	Bits/slot	$N_{Data/Slot}$ (bits)	$N_{data/data}$ field(1) (bits)	$N_{data/data}$ field(2) (bits)
0	144	0	0 & 0	0	0	0	0

5A.4 Transmit Diversity for DL Physical Channels

Table 8L summarizes the different transmit diversity schemes for different downlink physical channel types in 1.28Mcps TDD that are described in [9].

Table 8L: Application of Tx diversity schemes on downlink physical channel types in 1.28Mcps TDD
"X" – can be applied, "-" – must not be applied

Physical channel type	Open loop TxDiversity		Closed loop TxDiversity
	TSTD	SCTD	
P-CCPCH	X(†)	X(†)	–
S-CCPCH	X(†)	X(†)	–
DwPCH	X	–	–
DPCH	X	–	X
PDSCH	X	X	X
PICH	X	X	-
MICH	X(†)	X(†)	-
PLCCH	X	X	-
HS-SCCH	-	X	X
HS-PDSCH (UE not in MIMO mode)	-	-	X
HS-PDSCH (UE in MIMO mode)	–	–	–
E-AGCH	--	X	X
E-HICH	--	X	--

(*) Note: SCTD may only be applied to physical channels when they are allocated to beacon locations.

(†) Note: that when the entire carrier is dedicated to MBSFN operation, TSTD and SCTD shall not be applied.

5A.5 Beacon characteristics of physical channels

For the purpose of measurements, common physical channels that are allocated to particular locations (time slot, code) shall have particular physical characteristics, called beacon characteristics. Physical channels with beacon characteristics are called beacon channels. The location of the beacon channels is called beacon location. The beacon channels shall provide the beacon function, i.e. a reference power level at the beacon location, regularly existing in each subframe. Thus, beacon channels must be present in each subframe.

5A.5.1 Location of beacon channels

The beacon location is described as follows:

The beacon function shall be provided by the physical channels that are allocated to channelisation code $c_{Q=16}^{(k=1)}$ and $c_{Q=16}^{(k=2)}$ in Timeslot#0.

Note that by this definition the P-CCPCH always has beacon characteristics. In a multi-frequency cell beacon channels are always transmitted on the primary frequency.

5A.5.2 Physical characteristics of the beacon function

The beacon channels shall have the following physical characteristics.

They:

- are transmitted with reference power;
- are transmitted without beamforming;
- use midamble $m^{(1)}$ and $m^{(2)}$ exclusively in this time slot

The reference power corresponds to the sum of the power allocated to both midambles $m^{(1)}$ and $m^{(2)}$. Two possibilities exist:

- If SCTD antenna diversity is not applied to beacon channels, all the reference power of any beacon channel is allocated to $m^{(1)}$.
- If SCTD antenna diversity is applied to beacon channels, for any beacon channel midambles $m^{(1)}$ and $m^{(2)}$ are each allocated half of the reference power.

5A.6 Midamble Allocation for Physical Channels

Midambles are part of the physical channel configuration which is performed by higher layers. Four different midamble allocation schemes exist:

- UE specific midamble allocation: A UE specific midamble for DL or UL is explicitly assigned by higher layers.
- Default midamble allocation: The midamble for DL or UL is allocated by layer 1 depending on the associated channelisation code.
- Common midamble allocation: The midamble for the DL is allocated by layer 1 depending on the number of channelisation codes currently being present in the DL time slot.
- Special Default midamble allocation: The midamble for DL or UL is also allocated by layer 1 depending on the associated channelisation code while the association is different from default midamble allocation.

If a midamble is not explicitly assigned and the use of the common midamble allocation scheme is not signalled by higher layers, the midamble shall be allocated by layer 1, based on default or special default midamble allocation scheme. This default or special default midamble allocation scheme is given by a fixed association between midambles and channelisation codes, and shall be applied individually to all channelisation codes within one time slot. Different associations apply for different burst types and cell configurations with respect to the maximum number of midambles.

The associations between channelisation codes and midambles for the default, special default and common midamble allocation differ from the 3.84 Mcps TDD option. The associations are given in Annex AA.2 [Association between Midambles and channelisation Codes for default midamble allocation], Annex AA.3 [Association between Midambles and channelisation Codes for special default midamble allocation] and BA [Signalling of the number of channelisation codes for the DL common midamble case for 1.28Mcps TDD] respectively.

However, for timeslots employing MBSFN operation there is no single midamble restriction per MBSFN timeslot, i.e. $K_{\text{Cell}} \geq 1$, whilst this does not undermine the specification that all physical channels in such timeslots employ the same midamble(s) and thus default and common midamble allocation amount to the same allocation strategies.

5A.6.1 Midamble Allocation for DL Physical Channels

Beacon channels shall always use the reserved midambles $m^{(1)}$ and $m^{(2)}$, see 5A.5. For the other DL physical channels that are located in timeslot #0, midambles shall be allocated based on the default midamble allocation scheme, using the association for $K=8$ midambles. For all other DL physical channels, the midamble is explicitly assigned by higher layers or allocated by layer 1.

5A.6.1.1 Midamble Allocation by signalling from higher layers

The midamble allocation by signalling is the same like in the 3.84 Mcps TDD cf. [5.6.1.1 Midamble allocation by signalling from higher layers]

5A.6.1.2 Midamble Allocation by layer 1

5A.6.1.2.1 Default midamble

The default midamble allocation by layer 1 is the same like in the 3.84 Mcps TDD cf. [5.6.1.2.1 Default midamble]. The associations between midambles and channelisation codes are given in Annex AA.2 [Association between Midambles and channelisation Codes for default midamble allocation].

5A.6.1.2.2 Common Midamble

The common midamble allocation by layer 1 is the same like in the 3.84 Mcps TDD cf. [5.6.1.2.2 Common midamble]. The respective associations are given in Annex BA [Signalling of the number of channelisation codes for the DL common midamble case for 1.28 Mcps TDD].

5A.6.1.2.3 Special Default Midamble

There are two patterns of the association between midambles and channelisation codes for special default midamble allocation scheme for each cell configurations with respect to the maximum number of midambles. The special default midamble allocation is used for the MIMO dual stream transmission. The association between midambles and channelisation codes are given in Annex AA.3 [Association between Midambles and channelisation Codes for special default midamble allocation].

5A.6.2 Midamble Allocation for UL Physical Channels

The midamble allocation for UL Physical Channels is the same as in the 3.84 Mcps TDD cf. [5.6.2 Midamble allocation for UL Physical Channels]

5A.7 Midamble Transmit Power

When standalone midamble channel is not transmitted, the setting of the midamble transmit power is done as in the 3.84 Mcps TDD option cf. 5.7 'Midamble Transmit Power'

5A.7a Preamble Allocation and Preamble Transmit Power

When the entire carrier is dedicated to MBSFN, for all timeslots employing MBSFN operation, only a single preamble is needed, i.e. $K_{\text{Cell}}=1$, then all physical channels in such timeslots employ the same preamble with the same allocation strategies.

There shall be no offset between the sum of the powers allocated to all preambles in a timeslot and the sum of the powers allocated to the data symbol fields. The transmit power within a timeslot is hence constant.

5B Physical channels for the 7.68 Mcps option

5B.1 General

All physical channels take a three-layer structure with respect to timeslots, radio frames and system frame numbering (SFN). Depending on the resource allocation, the configuration of radio frames or timeslots becomes different. All physical channels need a guard period in every timeslot. The time slots are used in the sense of a TDMA component to separate different user signals in the time domain. The physical channel signal format is presented in figure 18AA.

A physical channel in the 7.68Mcps TDD option is a burst, which is transmitted in a particular timeslot within allocated Radio Frames. The allocation can be continuous, i.e. the time slot in every frame is allocated to the physical channel or discontinuous, i.e. the time slot in a subset of all frames is allocated only. A burst is the combination of two data parts, a midamble part and a guard period. The duration of a burst is one time slot. Several bursts can be transmitted at the same time from one transmitter. In this case, the data parts must use different OVVSF channelisation codes, but the same scrambling code. The midamble parts are either identically or differently shifted versions of a cell-specific basic midamble code, see section 5B.3.3. Note when in MBSFN operation, a midamble is not necessarily cell-specific.

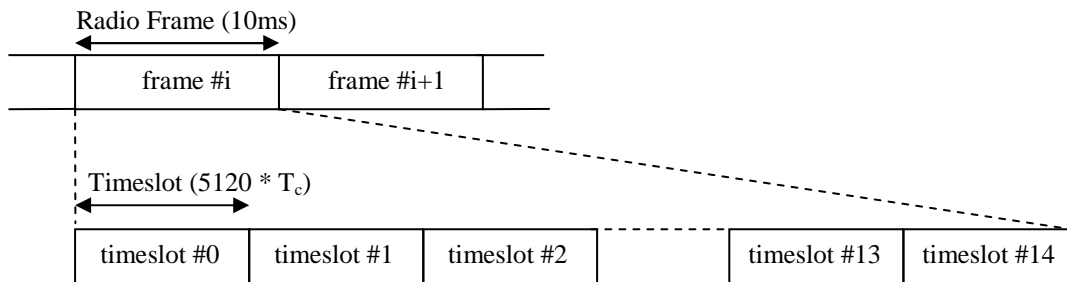

Figure 18AA: Physical channel signal format

The data part of the burst is spread with a combination of channelisation code and scrambling code. The channelisation code is an OVSF code, that can have a spreading factor of 1, 2, 4, 8, 16 or 32. The data rate of the physical channel depends on the used spreading factor of the used OVSF code.

The midamble part of the burst can contain two different types of midambles: a short one of length 512 chips, or a long one of length 1024 chips. The data rate of the physical channel depends on the used midamble length. Additionally, when in MBSFN operation a midamble of length 640 chips is used.

So a physical channel is defined by frequency, timeslot, channelisation code, burst type and Radio Frame allocation. The scrambling code and the basic midamble code are broadcast and may be constant within a cell. When a physical channel is established, a start frame is given. The physical channels can either be of infinite duration, or of a duration defined by allocation.

5B.2 Frame structure

The TDMA frame has a duration of 10 ms and is subdivided into 15 time slots (TS) of $5120 \cdot T_c$ duration each. A time slot corresponds to 5120 chips. The physical content of the time slots are the bursts of corresponding length as described in subclause 5B.3.2.

Each 10 ms frame consists of 15 time slots, each allocated to either the uplink or the downlink (figure 18AB). With such a flexibility, the TDD mode can be adapted to different environments and deployment scenarios. In any configuration at least one time slot has to be allocated for the downlink and at least one time slot has to be allocated for the uplink with the exception of no uplink timeslots when the entire carrier is dedicated to MBSFN.

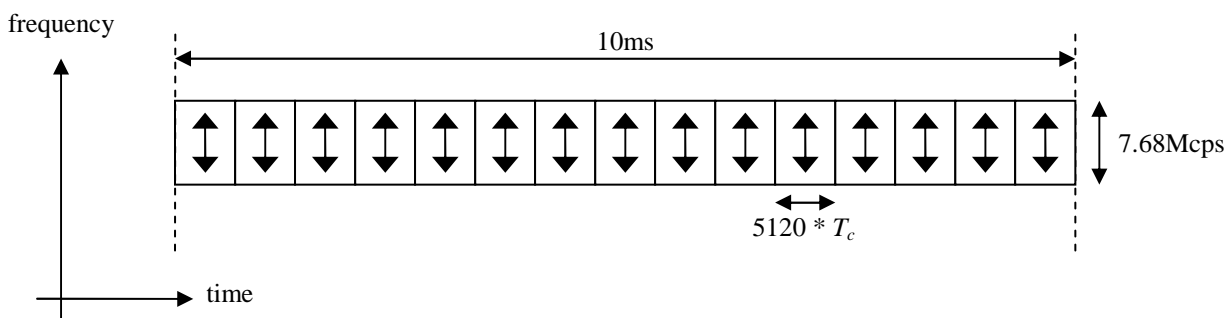

Figure 18AB: The TDD frame structure

Examples for multiple and single switching point configurations as well as for symmetric and asymmetric UL/DL allocations are given in figure 3.

5B.3 Dedicated physical channel (DPCH)

The DCH as described in subclause 4.1.1 is mapped onto the dedicated physical channel.

5B.3.1 Spreading

Spreading is applied to the data part of the physical channels and consists of two operations. The first is the channelisation operation, which transforms every data symbol into a number of chips, thus increasing the bandwidth of the signal. The number of chips per data symbol is called the Spreading Factor (SF). The second operation is the scrambling operation, where a scrambling code is applied to the spread signal. Details on channelisation and scrambling operation can be found in [8].

5B.3.1.1 Spreading for Downlink Physical Channels

Downlink physical channels shall use SF=32 or SF=1.

Multiple parallel physical channels can be used to support higher data rates. Within a timeslot, parallel physical channels shall be transmitted using different channelisation codes, see [8]. These codes with SF =32 are generated as described in [8].

5B.3.1.2 Spreading for Uplink Physical Channels

The range of spreading factors that may be used for uplink physical channels shall range from 32 down to 1. For each physical channel an individual minimum spreading factor SF_{min} is transmitted by means of the higher layers. There are two options that are indicated by UTRAN:

1. The UE shall use the spreading factor SF_{min} , independent of the current TFC.
2. The UE shall autonomously increase the spreading factor depending on the current TFC.

If the UE autonomously changes the SF, it shall always vary the channelisation code along the branch with the higher code numbering of the allowed OVFSF sub tree, as depicted in [8]. In the event that code hopping is configured by higher layers, the allowed OVFSF sub-tree is that subtended by the effective allocated OVFSF code after the hop sequence has been applied to the allocated OVFSF code (see [9]).

For multicode transmission a UE shall use a maximum of two physical channels per timeslot simultaneously. These two parallel physical channels shall be transmitted using different channelisation codes, see [8].

5B.3.2 Burst Types

Four types of bursts are defined. All of them consist of two data symbol fields, a midamble and a guard period, the lengths of which are different for the individual burst types. Thus, the number of data symbols in a burst depends on the SF and the burst type, as depicted in table 8AA.

Table 8AA: Number of data symbols (N) for burst type 1, 2, 3 and 4

Spreading factor (SF)	Burst Type 1	Burst Type 2	Burst Type 3	Burst Type 4
1	3904	4416	3712	4224
2	1952	2208	1856	N/A
4	976	1104	928	N/A
8	488	552	464	N/A
16	244	276	232	N/A
32	122	138	116	132

The support of burst types 1, 2 and 3 is mandatory for UEs supporting transmit and receive functions. UEs supporting transmit and receive functions and also MBSFN operation must additionally support burst type 4. UEs with receive only capability need only support burst type 4.. The three different bursts defined here are well suited for different applications, as described in the following sections.

5B.3.2.1 Burst Type 1

Burst type 1 can be used for uplink and downlink. Due to its longer midamble field this burst type supports the construction of a larger number of training sequences. The maximum number of training sequences depends on the cell configuration. For burst type 1 this number may be 4, 8, or 16.

The data fields of burst type 1 are 1952 chips long. The corresponding number of symbols depends on the spreading factor, as indicated in table 8AA above. The midamble of burst type 1 has a length of 1024 chips. The guard period for the burst type 1 is 192 chip periods long. Burst type 1 is shown in Figure 18AC. The contents of the burst fields are described in table 8AB.

Table 8AB: The contents of burst type 1 fields

Chip number (CN)	Length of field in chips	Length of field in symbols		Contents of field
0-1951	1952	Cf table 8AA		Data symbols
1952-2975	1024	-		Midamble
2976-4927	1952	Cf table 8AA		Data symbols
4928-5119	192	-		Guard period

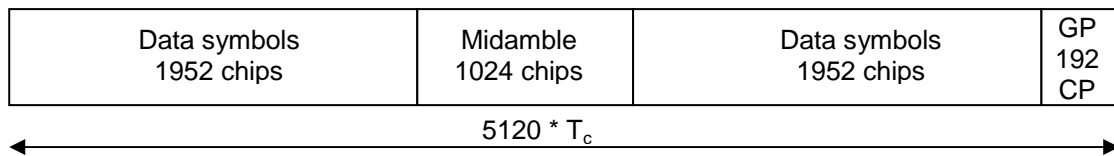

Figure 18AC: Burst structure of burst type 1. GP denotes the guard period and CP the chip periods

5B.3.2.2 Burst Type 2

Burst type 2 can be used for uplink and downlink. It offers a longer data field than burst type 1 at the cost of a shorter midamble. Due to the shorter midamble field the burst type 2 supports a maximum number of training sequences of 4 or 8 only, depending on the cell configuration.

The data fields of the burst type 2 are 2208 chips long. The corresponding number of symbols depends on the spreading factor, as indicated in table 8AA above. The guard period for the burst type 2 is 192 chip periods long. Burst type 2 is shown in Figure 18AD. The contents of the burst fields are described in table 8AC.

Table 8AC: The contents of burst type 2 fields

Chip number (CN)	Length of field in chips	Length of field in symbols		Contents of field
0-2207	2208	cf table 8AA		Data symbols
2208-2719	512	-		Midamble
2720-4927	2208	cf table 8AA		Data symbols
4928-5119	192	-		Guard period

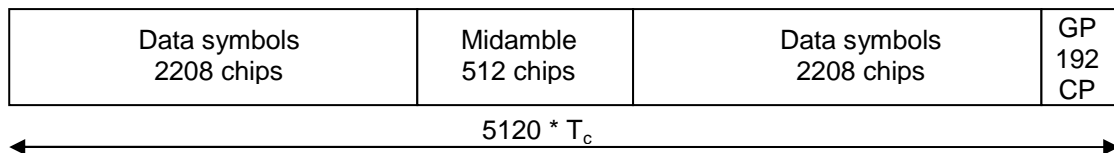

Figure 18AD: Burst structure of the burst type 2. GP denotes the guard period and CP the chip periods

5B.3.2.3 Burst Type 3

Burst type 3 is used for uplink only. Due to the longer guard period it is suitable for initial access or access to a new cell after handover. It offers the same number of training sequences as burst type 1.

The data fields of the burst type 3 have a length of 1952 chips and 1760 chips, respectively. The corresponding number of symbols depends on the spreading factor, as indicated in table 8AA above. The midamble of burst type 3 has a length of 1024 chips. The guard period for the burst type 3 is 384 chip periods long. Burst type 3 is shown in Figure 18AE. The contents of the burst fields are described in table 8AD.

Table 8AD: The contents of burst type 3 fields

Chip number (CN)	Length of field in chips	Length of field in symbols		Contents of field
0-1951	1952	Cf table 8AA		Data symbols
1952-2975	1024	-		Midamble
2976-4735	1760	Cf table 8AA		Data symbols
4736-5119	384	-		Guard period

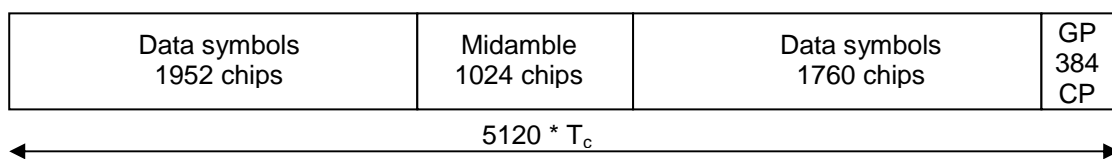

Figure 18AE: Burst structure of the burst type 3. GP denotes the guard period and CP the chip periods

5B.3.2.3A Burst Type 4

The burst type 4 is used for downlink MBSFN operation only and supports a single training sequence.

The data fields of the burst type 4 are 2112 chips long. The corresponding number of symbols is 132 as indicated in table 8AA above. The midamble of burst type 4 has a length of 640 chips. The guard period for the burst type 4 is 256 chip periods long. The burst type 4 is shown in Figure 18AEA. The contents of the burst fields are described in table 8ADA.

Table 8ADA: The contents of burst type 4 fields

Chip number (CN)	Length of field in chips	Length of field in symbols		Contents of field
0-2111	2112	Cf table 8AA		Data symbols
2112-2751	640	-		Midamble
2752-4863	2112	Cf table 8AA		Data symbols
4864-5119	256	-		Guard period

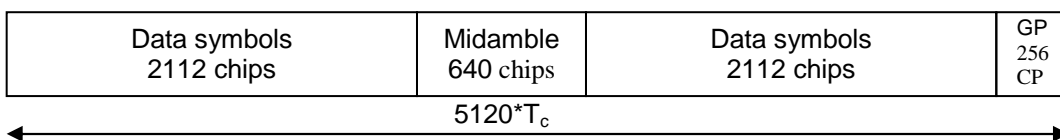

Figure 18AEA: Burst structure of the burst type 4. GP denotes the guard period and CP the chip periods

5B.3.2.4 Transmission of TFCI

All burst types 1, 2, 3 and 4 provide the possibility for transmission of TFCI.

The transmission of TFCI is negotiated at call setup and can be re-negotiated during the call. For each CCTrCH it is indicated by higher layer signalling, which TFCI format is applied, except for the MBSFN FACH where the (16,5) bi-orthogonal code is always used for TFCI when TFCI is applied. Additionally for each allocated timeslot it is signalled individually whether that timeslot carries the TFCI or not. The TFCI is always present in the first timeslot in a radio frame for each CCTrCH. If a time slot contains the TFCI, then it is always transmitted using the physical channel with

the lowest physical channel sequence number (p) in that timeslot. Physical channel sequence numbering is determined by the rate matching function and is described in [7].

The transmission of TFCI is done in the data parts of the respective physical channel. In DL the TFCI code word bits and data bits are subject to the same spreading procedure as depicted in [8]. In DL, the modulation applied to the TFCI code word bits is the same as that applied to the data symbols. In UL, independent of the SF that is applied to the data symbols in the burst, the data in the TFCI field are always spread with SF=32 using the channelisation code in the branch with the highest code numbering of the allowed OVFSF sub tree, as depicted in [8]. Hence the midamble structure and length is not changed. The TFCI code word is to be transmitted directly adjacent to the midamble, possibly after the TPC. Figure 18AF shows the position of the TFCI code word in a traffic burst in downlink. Figure 18AG shows the position of the TFCI code word in a traffic burst in uplink.

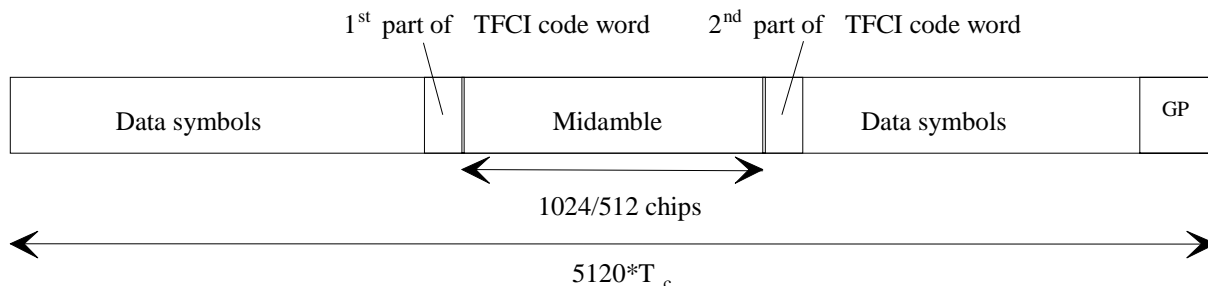

Figure 18AF: Position of the TFCI code word in the traffic burst in case of downlink

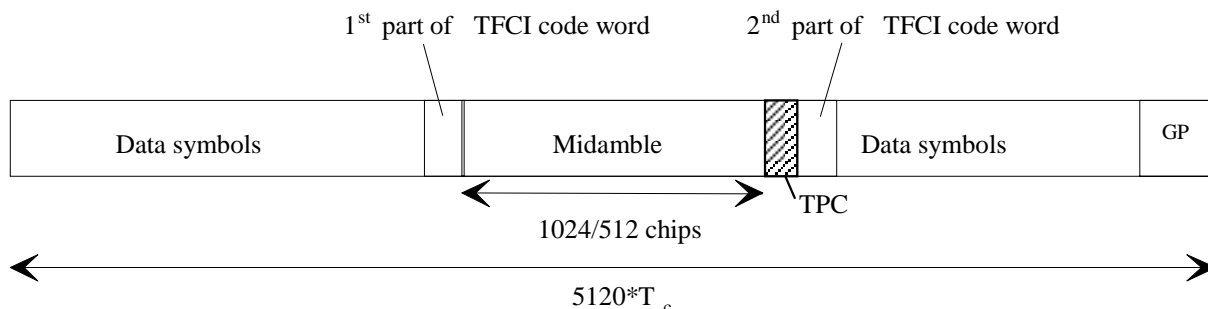

Figure 18AG: Position of the TFCI code word in the traffic burst in case of uplink

Two examples of TFCI transmission in the case of multiple DPCHs used for a connection are given in the Figure 18AH and Figure 18AI below. Combinations of the two schemes shown are also applicable.

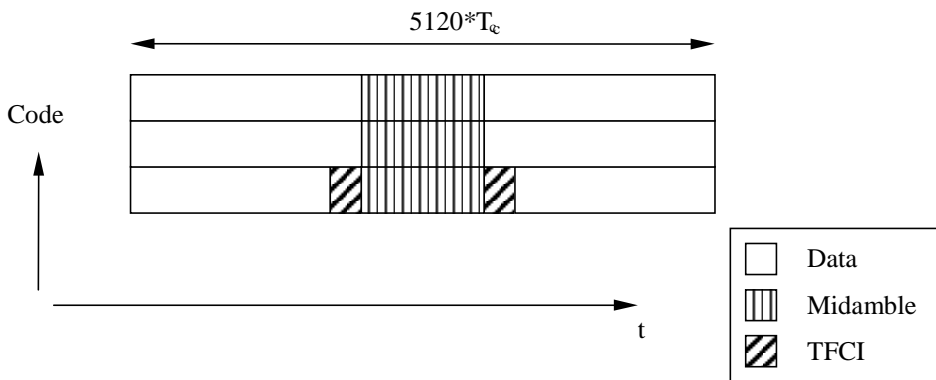

Figure 18AH: Example of TFCI transmission with physical channels multiplexed in code domain

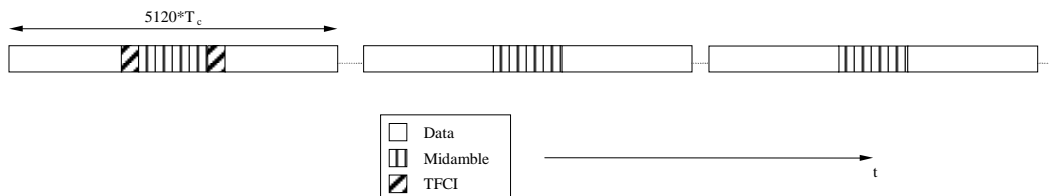

Figure 18AI: Example of TFCI transmission with physical channels multiplexed in time domain

5B.3.2.5 Transmission of TPC

Burst types 1, 2 and 3 for dedicated and shared channels provide the possibility for transmission of TPC in uplink.

The transmission of TPC is done in the data parts of the traffic burst. Independent of the SF that is applied to the data symbols in the burst, the data in the TPC field are always spread with SF=32 using the channelisation code in the branch with the highest code numbering of the allowed OVSF sub tree, as depicted in [8]. Hence the midamble structure and length is not changed. The TPC information is to be transmitted directly after the midamble. Figure 18AJ shows the position of the TPC in a traffic burst.

For every user the TPC information shall be transmitted at least once per transmitted frame. If a TFCI is applied for a CCTrCH, TPC shall be transmitted with the same channelization codes and in the same timeslots as the TFCI. If no TFCI is applied for a CCTrCH, TPC shall be transmitted using the physical channel corresponding to physical channel sequence number $p=1$. Physical channel sequence numbering is determined by the rate matching function and is described in [7].

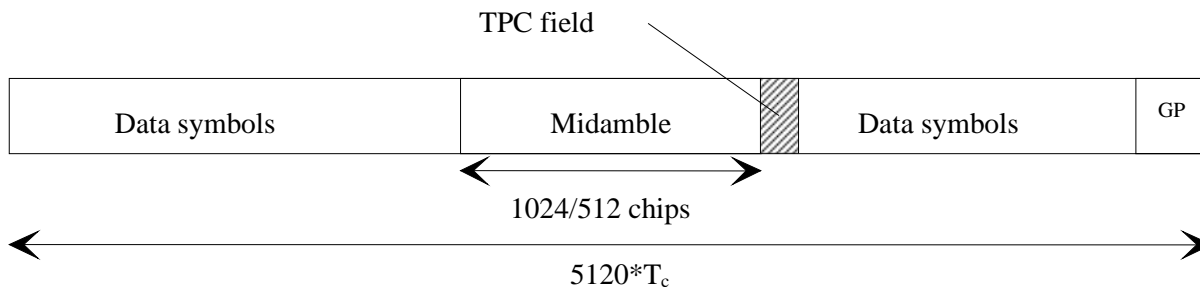

Figure 18AJ: Position of TPC information in the traffic burst

The length of the TPC field is N_{TPC} bits. The TPC field is formed via repetition encoding a single bit b_{TPC} , N_{TPC} times.

The relationship between b_{TPC} and the TPC command is shown in table 8AE.

Table 8AE: TPC bit pattern

b_{TPC}	TPC command	Meaning
0	'Down'	Decrease Tx Power
1	'Up'	Increase Tx Power

5B.3.2.6 Timeslot formats

5B.3.2.6.1 Downlink timeslot formats

The downlink timeslot format depends on the spreading factor, midamble length and on the number of TFCI code word bits, as depicted in the table 8AF. For MBSFN operation the timeslot format also depends upon the symbol modulation scheme used. Slot formats 20-27 are only applicable to MBSFN operation with burst type 4.

Table 8AF: Time slot formats for the Downlink

Slot Format #	Spreading Factor	Midamble length (chips)	N_{TFCI} code word (bits)	Bits/slot	$N_{Data/Slot}$ (bits)	$N_{data/data\ field}$ (bits)
0	32	1024	0	244	244	122
1	32	1024	4	244	240	120
2	32	1024	8	244	236	118
3	32	1024	16	244	228	114
4	32	1024	32	244	212	106
5	32	512	0	276	276	138
6	32	512	4	276	272	136
7	32	512	8	276	268	134
8	32	512	16	276	260	130
9	32	512	32	276	244	122
10	1	1024	0	7808	7808	3904
11	1	1024	4	7808	7804	3902
12	1	1024	8	7808	7800	3900
13	1	1024	16	7808	7792	3896
14	1	1024	32	7808	7776	3888
15	1	512	0	8832	8832	4416
16	1	512	4	8832	8828	4414
17	1	512	8	8832	8824	4412
18	1	512	16	8832	8816	4408
19	1	512	32	8832	8800	4400
20 (QPSK)	32	640	0	264	264	132
21 (QPSK)	32	640	16	264	248	124
22 (16QAM)	32	640	0	528	528	264
23 (16QAM)	32	640	16	528	512	256
24 (QPSK)	1	640	0	8448	8448	4224
25 (QPSK)	1	640	16	8448	8432	4216
26 (16QAM)	1	640	0	16896	16896	8448
27 (16QAM)	1	640	16	16896	16880	8440

5B.3.2.6.2 Uplink timeslot formats

The uplink timeslot format depends on the spreading factor, midamble length, guard period length and on the number of TFCI code word bits. Due to TPC, different amount of bits are mapped to the two data fields. The timeslot formats are depicted in the table 8AG. Note that slot format #90 shall only be used for HS_SICH.

Table 8AG: Time slot formats for the Uplink

Slot Format #	Spreading Factor	Midamble length (chips)	Guard Period (chips)	N _{TFCI} code word (bits)	N _{TPC} (bits)	Bits/slot	N _{Data/Slot} (bits)	N _{data/data field(1)} (bits)	N _{data/data field(2)} (bits)
0	32	1024	192	0	0	244	244	122	122
1	32	1024	192	0	2	244	242	122	120
2	32	1024	192	4	2	244	238	120	118
3	32	1024	192	8	2	244	234	118	116
4	32	1024	192	16	2	244	226	114	112
5	32	1024	192	32	2	244	210	106	104
6	32	512	192	0	0	276	276	138	138
7	32	512	192	0	2	276	274	138	136
8	32	512	192	4	2	276	270	136	134
9	32	512	192	8	2	276	266	134	132
10	32	512	192	16	2	276	258	130	128
11	32	512	192	32	2	276	242	122	120
12	16	1024	192	0	0	488	488	244	244
13	16	1024	192	0	2	486	484	244	240
14	16	1024	192	4	2	482	476	240	236
15	16	1024	192	8	2	478	468	236	232
16	16	1024	192	16	2	470	452	228	224
17	16	1024	192	32	2	454	420	212	208
18	16	512	192	0	0	552	552	276	276
19	16	512	192	0	2	550	548	276	272
20	16	512	192	4	2	546	540	272	268
21	16	512	192	8	2	542	532	268	264
22	16	512	192	16	2	534	516	260	256
23	16	512	192	32	2	518	484	244	240
24	8	1024	192	0	0	976	976	488	488
25	8	1024	192	0	2	970	968	488	480
26	8	1024	192	4	2	958	952	480	472
27	8	1024	192	8	2	946	936	472	464
28	8	1024	192	16	2	922	904	456	448
29	8	1024	192	32	2	874	840	424	416
30	8	512	192	0	0	1104	1104	552	552
31	8	512	192	0	2	1098	1096	552	544
32	8	512	192	4	2	1086	1080	544	536
33	8	512	192	8	2	1074	1064	536	528
34	8	512	192	16	2	1050	1032	520	512
35	8	512	192	32	2	1002	968	488	480
36	4	1024	192	0	0	1952	1952	976	976
37	4	1024	192	0	2	1938	1936	976	960
38	4	1024	192	4	2	1910	1904	960	944
39	4	1024	192	8	2	1882	1872	944	928
40	4	1024	192	16	2	1826	1808	912	896
41	4	1024	192	32	2	1714	1680	848	832
42	4	512	192	0	0	2208	2208	1104	1104

Slot Format #	Spreading Factor	Midamble length (chips)	Guard Period (chips)	N _{TF} CI code word (bits)	N _{TPC} (bits)	Bits/slot	N _{Data/Slot} (bits)	N _{data/data field(1)} (bits)	N _{data/data field(2)} (bits)
43	4	512	192	0	2	2194	2192	1104	1088
44	4	512	192	4	2	2166	2160	1088	1072
45	4	512	192	8	2	2138	2128	1072	1056
46	4	512	192	16	2	2082	2064	1040	1024
47	4	512	192	32	2	1970	1936	976	960
48	2	1024	192	0	0	3904	3904	1952	1952
49	2	1024	192	0	2	3874	3872	1952	1920
50	2	1024	192	4	2	3814	3808	1920	1888
51	2	1024	192	8	2	3754	3744	1888	1856
52	2	1024	192	16	2	3634	3616	1824	1792
53	2	1024	192	32	2	3394	3360	1696	1664
54	2	512	192	0	0	4416	4416	2208	2208
55	2	512	192	0	2	4386	4384	2208	2176
56	2	512	192	4	2	4326	4320	2176	2144
57	2	512	192	8	2	4266	4256	2144	2112
58	2	512	192	16	2	4146	4128	2080	2048
59	2	512	192	32	2	3906	3872	1952	1920
59a	1	1024	192	0	0	7808	7808	3904	3904
59b	1	1024	192	0	2	7746	7744	3904	3840
59c	1	1024	192	4	2	7622	7616	3840	3776
59d	1	1024	192	8	2	7498	7488	3776	3712
59e	1	1024	192	16	2	7250	7232	3648	3584
59f	1	1024	192	32	2	6754	6720	3392	3328
59g	1	512	192	0	0	8832	8832	4416	4416
59h	1	512	192	0	2	8770	8768	4416	4352
59i	1	512	192	4	2	8646	8640	4352	4288
59j	1	512	192	8	2	8522	8512	4288	4224
59k	1	512	192	16	2	8274	8256	4160	4096
59l	1	512	192	32	2	7778	7744	3904	3840
60	32	1024	384	0	0	232	232	122	110
61	32	1024	384	0	2	232	230	122	108
62	32	1024	384	4	2	232	226	120	106
63	32	1024	384	8	2	232	222	118	104
64	32	1024	384	16	2	232	214	114	100
65	32	1024	384	32	2	232	198	106	92
66	16	1024	384	0	0	464	464	244	220
67	16	1024	384	0	2	462	460	244	216
68	16	1024	384	4	2	458	452	240	212
69	16	1024	384	8	2	454	444	236	208
70	16	1024	384	16	2	446	428	228	200
71	16	1024	384	32	2	430	396	212	184
72	8	1024	384	0	0	928	928	488	440
73	8	1024	384	0	2	922	920	488	432
74	8	1024	384	4	2	910	904	480	424
75	8	1024	384	8	2	898	888	472	416
76	8	1024	384	16	2	874	856	456	400
77	8	1024	384	32	2	826	792	424	368
78	4	1024	384	0	0	1856	1856	976	880
79	4	1024	384	0	2	1842	1840	976	864

Slot Format #	Spreading Factor	Midamble length (chips)	Guard Period (chips)	N _{TFCI} code word (bits)	N _{TPC} (bits)	Bits/slot	N _{Data/Slot} (bits)	N _{data/data} field(1) (bits)	N _{data/data} field(2) (bits)
80	4	1024	384	4	2	1814	1808	960	848
81	4	1024	384	8	2	1786	1776	944	832
82	4	1024	384	16	2	1730	1712	912	800
83	4	1024	384	32	2	1618	1584	848	736
84	2	1024	384	0	0	3712	3712	1952	1760
85	2	1024	384	0	2	3682	3680	1952	1728
86	2	1024	384	4	2	3622	3616	1920	1696
87	2	1024	384	8	2	3562	3552	1888	1664
88	2	1024	384	16	2	3442	3424	1824	1600
89	2	1024	384	32	2	3202	3168	1696	1472
89a	1	1024	384	0	0	7424	7424	3904	3520
89b	1	1024	384	0	2	7362	7360	3904	3456
89c	1	1024	384	4	2	7238	7232	3840	3392
89d	1	1024	384	8	2	7114	7104	3776	3328
89e	1	1024	384	16	2	6866	6848	3648	3200
89f	1	1024	384	32	2	6370	6336	3392	2944
90	32	1024	192	0	8	244	236	122	114

5B.3.3 Training sequences for spread bursts

In this subclause, the training sequences for usage as midambles in burst type 1, 2, 3 and 4 (see subclause 5B.3.2) are defined. The training sequences, i.e. midambles, of different users active in the same cell and same time slot are cyclically shifted versions of one cell-specific single basic midamble code. In the case of MBSFN timeslots there is only a single midamble and this is derived from a single basic midamble code which is not necessarily cell-specific. The applicable basic midamble codes are given in Annex AB.1, Annex AB.2 and Annex AB.2A. As different basic midamble codes are required for different burst formats, Annex AB.1 shows the basic midamble codes \mathbf{m}_p for burst type 1 and 3, Annex AB.2 shows \mathbf{m}_{ps} for burst type 2 and Annex AB.2A shows \mathbf{m}_p for burst type 4. It should be noted that burst type 2 must not be mixed with burst type 1 or 3 in the same timeslot of one cell and furthermore burst type 4 shall not be mixed with any other burst type in the same timeslot of one cell.

The basic midamble codes in Annex AB.1, Annex AB.2 and Annex AB.2A are listed in hexadecimal notation. The binary form of the basic midamble code shall be derived according to table 6 (section 5.2.3).

For each particular basic midamble code, its binary representation can be written as a vector \mathbf{m}_p :

$$\mathbf{m}_p = (m_1, m_2, \dots, m_p) \quad (1)$$

According to Annex AB.1, the size of this vector \mathbf{m}_p is $P=912$ for burst type 1 and 3. According to Annex AB.2, the size of this vector \mathbf{m}_p is $P=456$ for burst type 2. According to Annex AB.2A, the size of vector \mathbf{m}_p is $P=384$ for burst type 4. As QPSK modulation is used, the training sequences are transformed into a complex form, denoted as the complex vector $\underline{\mathbf{m}}_p$:

$$\underline{\mathbf{m}}_p = (\underline{m}_1, \underline{m}_2, \dots, \underline{m}_p) \quad (2)$$

The elements \underline{m}_i of $\underline{\mathbf{m}}_p$ are derived from elements m_i of \mathbf{m}_p using equation (3):

$$\underline{m}_i = (j)^i \cdot m_i \text{ for all } i = 1, \dots, P \quad (3)$$

Hence, the elements \underline{m}_i of the complex basic midamble code are alternating real and imaginary.

To derive the required training sequences (different shifts), this vector $\underline{\mathbf{m}}_P$ is periodically extended to the size:

$$i_{\max} = L_m + (K'-1)W + \lfloor P/K \rfloor \quad (4)$$

Notes on equation (4):

- L_m : Midamble length
- K' : Maximum number of different midamble shifts in a cell, when no intermediate shifts are used. This value depends on the midamble length.
- K : Maximum number of different midamble shifts in a cell, when intermediate shifts are used, $K=2K'$. This value depends on the midamble length.

Note that intermediate shifts are not used for burst type 4, i.e. $K=K'=1$ for burst type 4.

- W : Shift between the midambles, when the number of midambles is K' .
- $\lfloor x \rfloor$ denotes the largest integer smaller or equal to x

Allowed values for L_m , K' and W are given in Annex AB.1, Annex AB.2 and Annex AB.2A.

So we obtain a new vector $\underline{\mathbf{m}}$ containing the periodic basic midamble sequence:

$$\underline{\mathbf{m}} = (\underline{m}_1, \underline{m}_2, \dots, \underline{m}_{i_{\max}}) = (\underline{m}_1, \underline{m}_2, \dots, \underline{m}_{L_m + (K'-1)W + \lfloor P/K \rfloor}) \quad (5)$$

The first P elements of this vector $\underline{\mathbf{m}}$ are the same ones as in vector $\underline{\mathbf{m}}_P$, the following elements repeat the beginning:

$$\underline{m}_i = \underline{m}_{i-P} \text{ for the subset } i = (P+1), \dots, i_{\max} \quad (6)$$

Using this periodic basic midamble sequence $\underline{\mathbf{m}}$ for each shift k a midamble $\underline{\mathbf{m}}^{(k)}$ of length L_m is derived, which can be written as a shift specific vector:

$$\underline{\mathbf{m}}^{(k)} = (\underline{m}_1^{(k)}, \underline{m}_2^{(k)}, \dots, \underline{m}_{L_m}^{(k)}) \quad (7)$$

The L_m midamble elements $\underline{m}_i^{(k)}$ are generated for each midamble of the first K' shifts ($k = 1, \dots, K'$) based on:

$$\underline{m}_i^{(k)} = \underline{m}_{i+(K'-k)W} \text{ with } i = 1, \dots, L_m \text{ and } k = 1, \dots, K' \quad (8)$$

The elements of midambles for the second K' shifts ($k = (K'+1), \dots, K = (K'+1), \dots, 2K'$) are generated based on a slight modification of this formula introducing intermediate shifts:

$$\underline{m}_i^{(k)} = \underline{m}_{i+(K-k-1)W + \lfloor P/K \rfloor} \text{ with } i = 1, \dots, L_m \text{ and } k = K'+1, \dots, K-1 \quad (9)$$

$$\underline{m}_i^{(k)} = \underline{m}_{i+(K'-1)W + \lfloor P/K \rfloor} \text{ with } i = 1, \dots, L_m \text{ and } k = K \quad (10)$$

The number K_{Cell} of midambles that is supported in each cell can be smaller than K , depending on the cell size and the possible delay spreads, see Annex AB. The number K_{Cell} is signalled by higher layers. The midamble sequences derived according to equations (7) to (10) have complex values and are not subject to channelisation or scrambling process, i.e. the elements $\underline{m}_i^{(k)}$ represent complex chips for usage in the pulse shaping process at modulation.

The term 'a midamble code set' or 'a midamble code family' denotes K specific midamble codes $\underline{\mathbf{m}}^{(k)}$; $k=1, \dots, K$, based on a single basic midamble code $\underline{\mathbf{m}}_P$ according to (1).

5B.3.4 Beamforming

Support for beamforming is identical to 3.84Mcps TDD cf. [5.2.4 Beamforming].

5B.4 Common physical channels

5B.4.1 Primary common control physical channel (P-CCPCH)

The BCH as described in subclause 4.1.2 is mapped onto the Primary Common Control Physical Channel (P-CCPCH). The position (time slot / code) of the P-CCPCH is known from the Physical Synchronisation Channel (PSCH), see subclause 5B.4.4.

5B.4.1.1 P-CCPCH Spreading

The P-CCPCH uses fixed spreading with a spreading factor $SF = 32$ as described in subclause 5B.3.1.1. The P-CCPCH always uses channelisation code $c_{Q=32}^{(k=1)}$.

5B.4.1.2 P-CCPCH Burst Types

Burst type 1 as described in subclause 5B.2.2 is used for the P-CCPCH unless the entire carrier is dedicated to MBSFN then burst type 4 is used for P-CCPCH. No TFCI is applied for the P-CCPCH.

5B.4.1.3 P-CCPCH Training sequences

The training sequences, i.e. midambles, as described in subclause 5B.3.3 are used for the P-CCPCH.

5B.4.2 Secondary common control physical channel (S-CCPCH)

PCH and FACH as described in subclause 4.1.2 are mapped onto one or more secondary common control physical channels (S-CCPCH). In this way the capacity of PCH and FACH can be adapted to the different requirements.

5B.4.2.1 S-CCPCH Spreading

The S-CCPCH uses fixed spreading with a spreading factor $SF = 32$ as described in subclause 5B.3.1.1. When S-CCPCH is used for MBSFN operation the spreading factor may be $SF = 32$ or $SF = 1$.

5B.4.2.2 S-CCPCH Burst Types

Burst types 1, 2 or 4 as described in subclause 5B.3.2 are used for the S-CCPCHs. TFCI may be applied for S-CCPCHs.

5B.4.2.2A S-CCPCH Modulation

When S-CCPCH is used for MBSFN operation, burst type 4 shall be used and the modulation may be QPSK or 16QAM, see table 8AF for slot formats. When S-CCPCH is used for all other purposes the modulation shall be QPSK.

5B.4.2.3 S-CCPCH Training sequences

The training sequences, i.e. midambles, as described in subclause 5B.3.3 are used for the S-CCPCH.

5B.4.3 The physical random access channel (PRACH)

The RACH as described in subclause 4.1.2 is mapped onto one uplink physical random access channel (PRACH).

5B.4.3.1 PRACH Spreading

The uplink PRACH uses either spreading factor SF=32 or SF=16 as described in subclause 5B.3.1.2. The set of admissible spreading codes for use on the PRACH and the associated spreading factors are broadcast on the BCH (within the RACH configuration parameters on the BCH).

5B.4.3.2 PRACH Burst Type

The UEs send uplink access bursts of type 3 randomly in the PRACH. TFCI and TPC are not applied for the PRACH.

5B.4.3.3 PRACH Training sequences

The training sequences, i.e. midambles, of different users active in the same time slot are time shifted versions of a basic midamble code, m_1 , or a second basic midamble code, m_2 , which is a time inverted version of the basic midamble code m_1 . The basic midamble codes for burst type 3 are shown in Annex AB. The necessary time shifts are obtained by choosing all $k=1,2,3,\dots,K'$. Different cells use different periodic basic codes, i.e. different midamble sets.

5B.4.3.4 PRACH timeslot formats

For the PRACH the timeslot format is only spreading factor dependent. The timeslot formats 60 and 66 of table 8AG are applicable for the PRACH.

5B.4.3.5 Association between Training Sequences and Channelisation Codes

For the PRACH the fixed association between a training sequence and associated channelisation code is defined in figure 18AK. In this figure, midamble $\mathbf{m}_j^{(k)}$ is formed from the k^{th} shift of the original basic midamble code ($j=1$) or of the time-inverted basic midamble code ($j=2$).

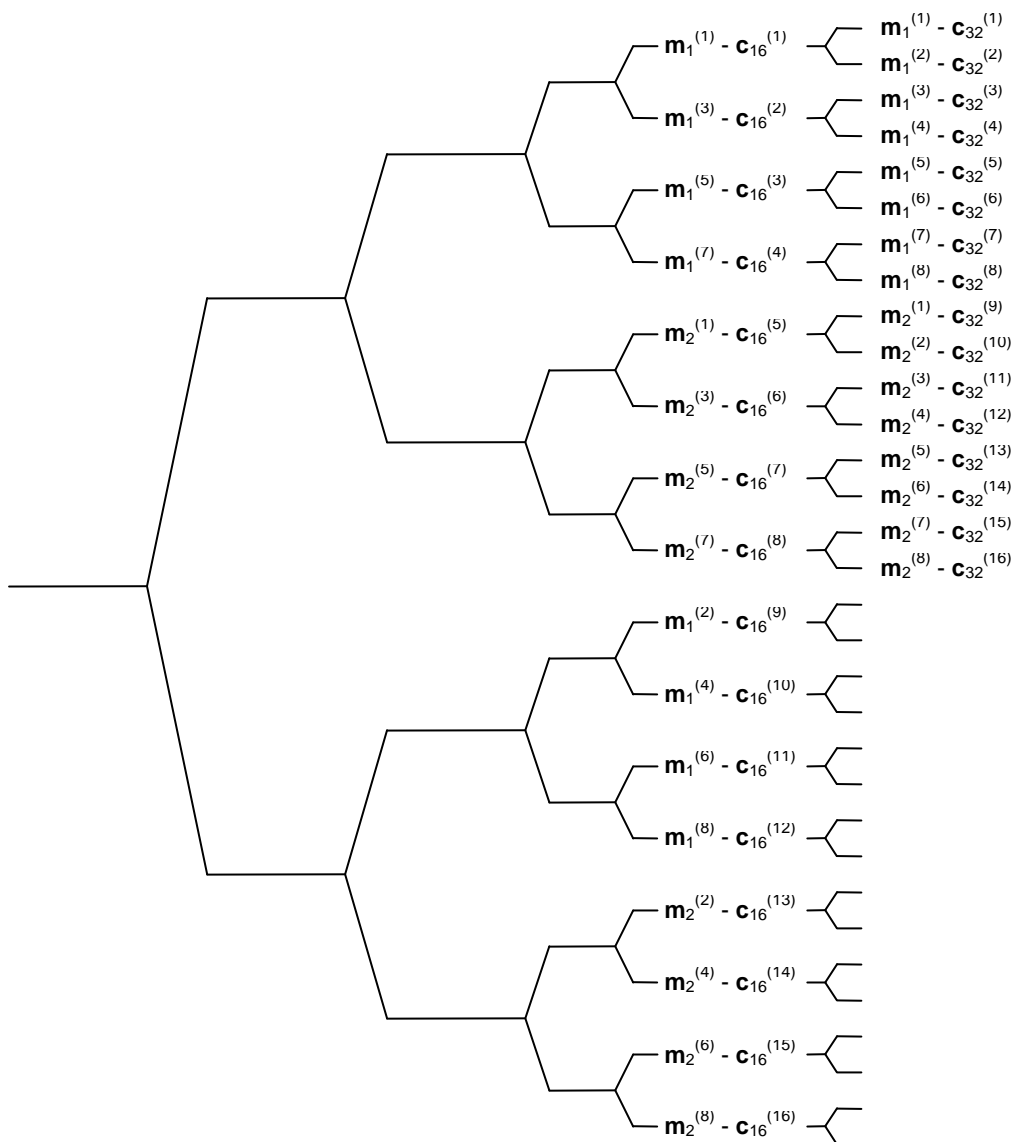

Figure 18AK: Association of midambles to channelisation codes for PRACH in the OVFS tree

5B.4.4 The synchronisation channel (SCH)

The code group of a cell can be derived from the synchronisation channel. In order not to limit uplink/downlink asymmetry, the SCH is mapped on one or two downlink slots per frame only.

There are two cases of SCH and P-CCPCH allocation as follows:

- Case 1) SCH and P-CCPCH allocated in TS#k, k=0...14
- Case 2) SCH allocated in two TS: TS#k and TS#k+8, k=0...6; P-CCPCH allocated in TS#k.

The position of SCH (value of k) in the frame can change on a long term basis in any case.

Due to this SCH scheme, the position of P-CCPCH is known from the SCH.

Figure 18AL is an example for transmission of SCH, k=0, of Case 2.

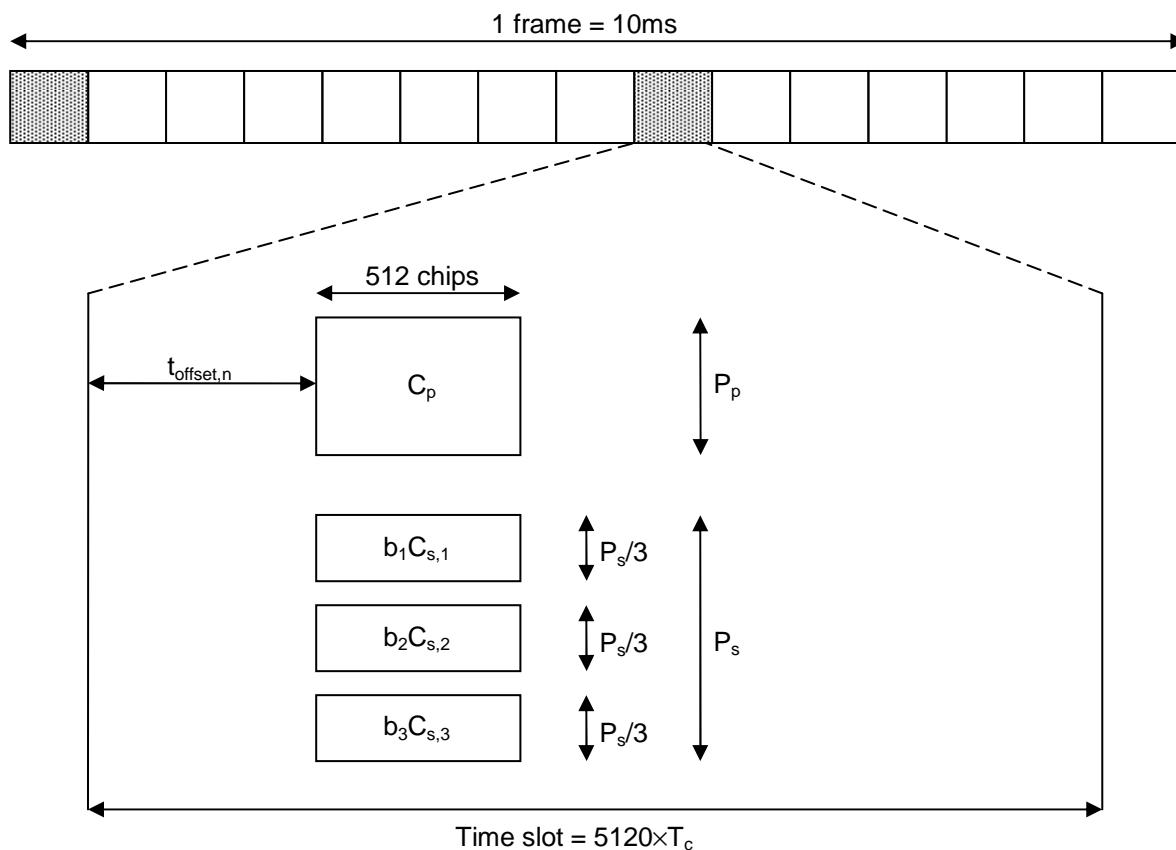

$b_i \in \{\pm 1, \pm j\}$, $C_{s,i} \in \{C_0, C_1, C_3, C_4, C_5, C_6, C_8, C_{10}, C_{12}, C_{13}, C_{14}, C_{15}\}$, $i = 1,2,3$; see section 8.4

Figure 18AL: Scheme for Synchronisation channel SCH consisting of one primary sequence C_p and 3 parallel secondary sequences $C_{s,i}$ in slot k and $k+8$ (example for $k=0$ in Case 2)

As depicted in figure 18AL, the SCH consists of a primary and three secondary code sequences each 512 chips long. The primary and secondary code sequences are defined in [8].

Due to mobile to mobile interference, it is mandatory for public TDD systems to keep synchronisation between base stations. As a consequence of this, a capture effect concerning SCH can arise. The time offset $t_{offset,n}$ enables the system to overcome the capture effect.

The time offset $t_{offset,n}$ is one of 32 values, depending on the code group of the cell, n , [8]. Note that the cell parameter will change from frame to frame, but the cell will belong to only one code group and thus have one time offset $t_{offset,n}$. The exact value for $t_{offset,n}$ is given by:

$$t_{offset,n} = \begin{cases} n \cdot 96 \cdot T_c & n < 16 \\ (1440 + n \cdot 96) \cdot T_c & n \geq 16 \end{cases}; \quad n = 0, \dots, 31$$

5B.4.5 Physical Uplink Shared Channel (PUSCH)

The USCH as described in subclause 4.1.2 is mapped onto one or more physical uplink shared channels (PUSCH). Timing advance, as described in [9], is applied to the PUSCH.

5B.4.5.1 PUSCH Spreading

The spreading factors that can be applied to the PUSCH are SF = 1, 2, 4, 8, 16 or 32 as described in subclause 5B.3.1.2.

5B.4.5.2 PUSCH Burst Types

Burst types 1, 2 or 3 as described in subclause 5B.3.2 can be used for PUSCH. TFCI and TPC can be transmitted on the PUSCH.

5B.4.5.3 PUSCH Training Sequences

The training sequences as described in subclause 5B.3.3 are used for the PUSCH.

5B.4.5.4 UE Selection

The UE that shall transmit on the PUSCH is selected by higher layer signalling.

5B.4.6 Physical Downlink Shared Channel (PDSCH)

The DSCH as described in subclause 4.1.2 is mapped onto one or more physical downlink shared channels (PDSCH).

5B.4.6.1 PDSCH Spreading

The PDSCH uses either spreading factor $SF = 32$ or $SF = 1$ as described in subclause 5B.3.1.1.

5B.4.6.2 PDSCH Burst Types

Burst types 1 or 2 as described in subclause 5B.3.2 can be used for PDSCH. TFCI can be transmitted on the PDSCH.

5B.4.6.3 PDSCH Training Sequences

The training sequences as described in subclause 5B.3.3 are used for the PDSCH.

5B.4.6.4 UE Selection

To indicate to the UE that there is data to decode on the DSCH, higher layer signalling is used.

5B.4.7 The Paging Indicator Channel (PICH)

The Paging Indicator Channel (PICH) is a physical channel used to carry the paging indicators.

5B.4.7.1 Mapping of Paging Indicators to the PICH bits

Figure 18AM depicts the structure of a PICH burst and the numbering of the bits within the burst. The same burst type is used for the PICH in every cell. N_{PIB} bits in a normal burst of type 1 or 2 are used to carry the paging indicators, where N_{PIB} depends on the burst type: $N_{PIB}=240$ for burst type 1 and $N_{PIB}=272$ for burst type 2. The bits $s_{N_{PIB}+1}, \dots, s_{N_{PIB}+4}$ adjacent to the midamble are reserved for possible future use.

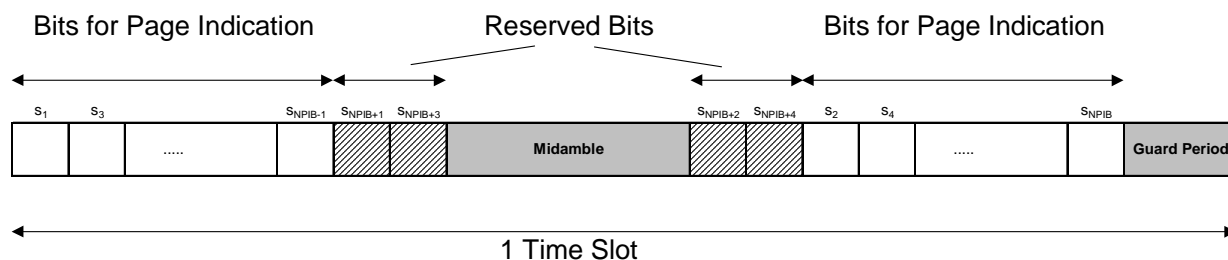

Figure 18AM: Transmission and numbering of paging indicator carrying bits in a PICH burst

Each paging indicator P_q in one time slot is mapped to the bits $\{s_{2L_{pi} \cdot q+1}, \dots, s_{2L_{pi} \cdot (q+1)}\}$ within this time slot. Thus, due to the interleaved transmission of the bits half of the symbols used for each paging indicator are transmitted in the first

data part, and the other half of the symbols are transmitted in the second data part; an example is shown in figure 18AN for a paging indicator length L_{PI} of 4 symbols.

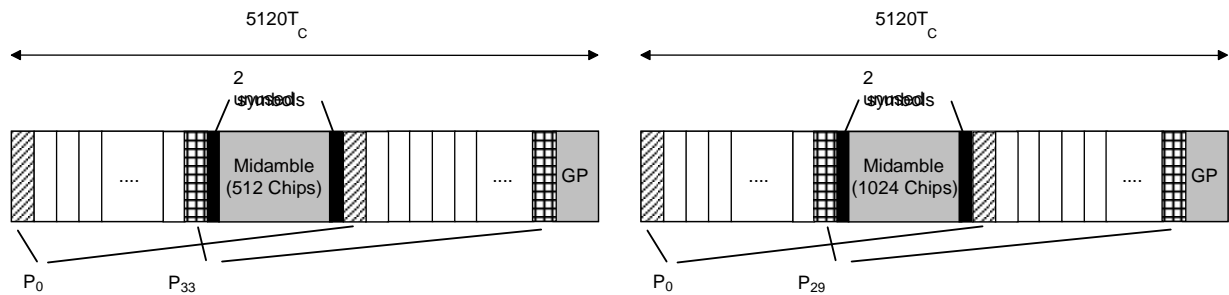

Figure 18AN: Example of mapping of paging indicators on PICH bits for $L_{PI}=4$

The setting of the paging indicators and the corresponding PICH bits (including the reserved ones) is described in [4].

N_{PI} paging indicators of length $L_{PI}=2$, $L_{PI}=4$ or $L_{PI}=8$ symbols are transmitted in each radio frame that contains the PICH. The number of paging indicators N_{PI} per radio frame is given by the paging indicator length and the burst type, which are both known by higher layer signalling. In table 8AH this number is shown for the different possibilities of burst types and paging indicator lengths.

Table 8AH: Number N_{PI} of paging indicators per time slot for the different burst types and paging indicator lengths L_{PI}

	$L_{PI}=2$	$L_{PI}=4$	$L_{PI}=8$
Burst Type 1	$N_{PI}=60$	$N_{PI}=30$	$N_{PI}=15$
Burst Type 2	$N_{PI}=68$	$N_{PI}=34$	$N_{PI}=17$

5B.4.7.2 Structure of the PICH over multiple radio frames

The structure of PICH over multiple radio frames is identical to the structure of PICH in 3.84Mcps TDD cf [section 5.3.7.2].

5B.4.7.3 PICH Training sequences

The training sequences, i.e. midambles for the PICH, are generated as described in subclause 5B.3.3. The allocation of midambles depends on whether SCTD is applied to the PICH.

- If no antenna diversity is applied to the PICH the midambles can be allocated as described in subclause 5B.7.
- If SCTD antenna diversity is applied to the PICH the allocation of midambles shall be as described in [9].

5B.4.8 High Speed Physical Downlink Shared Channel (HS-PDSCH)

The HS-DSCH as described in subclause 4.1.2 is mapped onto one or more high speed physical downlink shared channels (HS-PDSCH).

5B.4.8.1 HS-PDSCH Spreading

The HS-PDSCH shall use either spreading factor $SF = 32$ or $SF=1$, as described in 5B.3.1.1.

5B.4.8.2 HS-PDSCH Burst Types

Burst types 1 or 2 as described in subclause 5B.3.2 can be used for PDSCH. TFCI shall not be transmitted on the HS-PDSCH. The TF of the HS-DSCH is derived from the associated HS-SCCH.

5B.4.8.3 HS-PDSCH Training Sequences

The training sequences as described in subclause 5B.3.3 are used for the HS-PDSCH.

5B.4.8.4 UE Selection

To indicate to the UE that there is data to decode on the HS-DSCH, the UE id on the associated HS-SCCH shall be used.

5B.4.8.5 HS-PDSCH timeslot formats

An HS-PDSCH may use QPSK or 16QAM modulation symbols. The time slot formats are shown in table 8AI.

Table 8AI: Time slot formats for the HS-PDSCH

Slot Format #	Spreading Factor	Midamble length (chips)	$N_{\text{TFCI code word}}$ (bits)	Bits/slot	$N_{\text{Data/Slot}}$ (bits)	$N_{\text{data/data field}}$ (bits)
0 (QPSK)	32	1024	0	244	244	122
1 (16QAM)	32	1024	0	488	488	244
2 (QPSK)	32	512	0	276	276	138
3 (16QAM)	32	512	0	552	552	276
4 (QPSK)	1	1024	0	7808	7808	3904
5 (16QAM)	1	1024	0	15616	15616	7808
6 (QPSK)	1	512	0	8832	8832	4416
7(16QAM)	1	512	0	17664	17664	8832

5B.4.9 Shared Control Channel for HS-DSCH (HS-SCCH)

The HS-SCCH is a DL physical channel that carries higher layer control information for HS-DSCH. The physical layer will process this information according to [7] and will transmit the resulting bits on the HS-SCCH the structure of which is described below.

5B.4.9.1 HS-SCCH Spreading

The HS-SCCH shall use spreading factor $SF = 32$, as described in 5B.3.1.1.

5B.4.9.2 HS-SCCH Burst Types

Burst type 1 as described in subclause 5B.3.2 can be used for HS-SCCH. TFCI shall not be transmitted on the HS-SCCH.

5B.4.9.3 HS-SCCH Training Sequences

The training sequences as described in subclause 5B.3.3 are used for the HS-SCCH.

5B.4.9.4 HS-SCCH timeslot formats

The HS-SCCH always uses time slot format #0 from table 8AF, see section 5B.3.2.6.1.

5B.4.10 Shared Information Channel for HS-DSCH (HS-SICH)

The HS-SICH is a UL physical channel that carries higher layer control information and the Channel Quality Indicator CQI for HS-DSCH. The physical layer will process this information according to [7] and will transmit the resulting bits on the HS-SICH the structure of which is described below.

5B.4.10.1 HS-SICH Spreading

The HS-SICH shall use spreading factor $SF = 32$, as described in 5B.3.1.2.

5B.4.10.2 HS-SICH Burst Types

Burst type 1 as described in subclause 5B.3.2 can be used for HS-SICH. TFCI shall not be transmitted on the HS-SICH, however, the HS-SICH shall carry TPC information.

5B.4.10.3 HS-SICH Training Sequences

The training sequences as described in subclause 5B.3.3 are used for the HS-SICH.

5B.4.10.4 HS-SICH timeslot formats

The HS-SICH shall use time slot format #90 from table 8AF, see section 5B.3.2.6.2.

5B.4.11 The MBMS Indicator Channel (MICH)

The MBMS Indicator Channel (MICH) is a physical channel used to carry the MBMS notification indicators. The UE may use multiple MICH within the MBMS modification period in order to make decisions on individual MBMS notification indicators.

5B.4.11.1 Mapping of MBMS Indicators to the MICH bits for burst types 1 and 2

Figure 18AO depicts the structure of a MICH burst and the numbering of the bits within the burst. The same burst type is used for the MICH in every cell. N_{NIB} bits in a normal burst of type 1 or 2 are used to carry the MBMS notification indicators, where N_{NIB} depends on the burst type: $N_{NIB}=240$ for burst type 1 and $N_{NIB}=272$ for burst type 2. The bits $s_{NNIB+1}, \dots, s_{NNIB+4}$ adjacent to the midamble are reserved for possible future use.

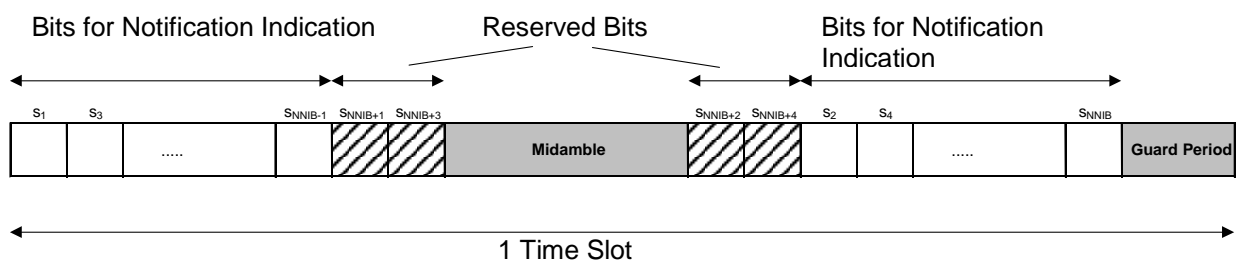

Figure 18AO: Transmission and numbering of MBMS notification indicator carrying bits in a MICH burst using burst types 1 and 2

Each notification indicator N_q in one time slot is mapped to the bits $\{s_{2L_{NI} \cdot q+1}, \dots, s_{2L_{NI} \cdot (q+1)}\}$ within this time slot. Thus, due to the interleaved transmission of the bits half of the symbols used for each MBMS notification indicator are transmitted in the first data part, and the other half of the symbols are transmitted in the second data part: an example is shown in figure 18AP for a MBMS notification indicator length L_{NI} of 4 symbols.

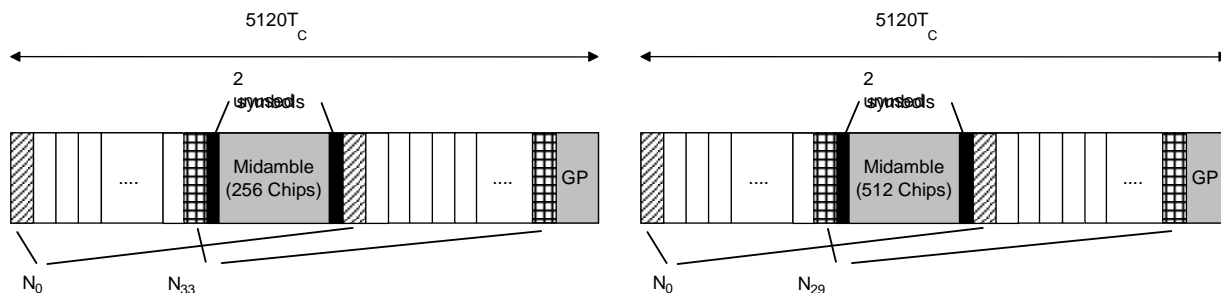

Figure 18AP: Example of mapping of MBMS notification indicators on MICH bits for $L_{NI}=4$ for burst types 2 and 1 respectively

The setting of the MBMS notification indicators and the corresponding MICH bits (including the reserved ones) is described in [7].

N_n MBMS notification indicators of length $L_{NI}=2$, $L_{NI}=4$ or $L_{NI}=8$ symbols are transmitted in each MICH. The number of MBMS notification indicators N_n per MICH is given by the MBMS notification indicator length and the burst type, which are both known by higher layer signalling. In table 18AJ this number is shown for burst types 1 and 2 and differing MBMS notification indicator lengths.

Table 18AJ: Number N_n of MBMS notification indicators per time slot for burst types 1 and 2 and differing MBMS notification indicator lengths L_{NI}

	$L_{NI}=2$	$L_{NI}=4$	$L_{NI}=8$
Burst Type 1	$N_n=60$	$N_n=30$	$N_n=15$
Burst Type 2	$N_n=68$	$N_n=34$	$N_n=17$

The value NI ($NI = 0, \dots, N_{NI}-1$) calculated by higher layers, is associated to the MBMS notification indicator N_q , where $q = NI \bmod N_n$.

The set of NI passed over the Iub indicates all higher layer NI values for which the notification indicator on MICH should be set to 1 during the corresponding modification period; all other indicators shall be set to 0.

5B.4.11.1A Mapping of MBMS Indicators to the MICH bits for burst type 4

When an entire carrier is dedicated to MBSFN operation, the MICH shall use burst type 4. In this case $N_{NIB}=256$ and there are 8 reserved/unused bits adjacent to the midamble reserved for possible future use. The transmission and numbering of MBMS notification indicator carrying bits in a MICH burst is similar to that of figure 18AO with the exception of 4 reserved bits either side of the midamble as opposed to 2 for burst types 1 and 2. An example mapping is shown in figure 18AP.1 for a MBMS notification indicator length L_{NI} of 4 symbols.

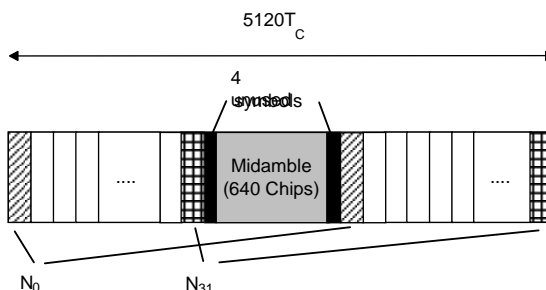

Figure 18AP.1: Example of mapping of MBMS notification indicators on MICH bits for $L_{NI}=4$ for burst type 4

The setting of the MBMS notification indicators and the corresponding MICH bits (including the reserved ones) is described in [7].

N_n MBMS notification indicators of length $L_{NI}=2$, $L_{NI}=4$ or $L_{NI}=8$ symbols are transmitted in each MICH. The number of MBMS notification indicators N_n per MICH is given by the MBMS notification indicator length and the burst type, which are both known by higher layer signalling. In table 18AK this number is shown for the different possibilities of burst types and MBMS notification indicator lengths.

Table 18AK: Number N_n of MBMS notification indicators per time slot for burst type 4 and differing MBMS notification indicator lengths L_{NI}

	$L_{NI}=2$	$L_{NI}=4$	$L_{NI}=8$
Burst Type 4	$N_n=64$	$N_n=32$	$N_n=16$

The value NI ($NI = 0, \dots, N_{NI}-1$) calculated by higher layers, is associated to the MBMS notification indicator N_q , where $q = NI \bmod N_n$.

The set of NI passed over the I_{ub} indicates all higher layer NI values for which the notification indicator on MICH should be set to 1 during the corresponding modification period; all other indicators shall be set to 0.

5B.4.11.2 MICH Training sequences

The training sequences, i.e. midambles for the MICH, are generated as described in subclause 5B.3.3. The allocation of midambles depends on whether SCTD is applied to the MICH.

- If no antenna diversity is applied the MICH the midambles can be allocated as described in subclause 5B.7.
- If SCTD antenna diversity is applied to the MICH the allocation of midambles shall be as described in [9].

Note that when the entire carrier is dedicated to MBSFN operation MICH employs burst type 4 as described in subclause 5B.4.11.1A. Burst type 4 supports a single midamble and hence SCTD is precluded from operation in such a scenario.

5B.4.12 E-DCH Physical Uplink Channel (E-PUCH)

One or more E-PUCH are used to carry the uplink E-DCH transport channel and associated control information (E-UCCH) in each E-DCH TTI. In a timeslot designated by UTRAN for E-PUCH use, up to one E-PUCH may be transmitted by a UE. No other physical channels may be transmitted by a UE in an E-PUCH timeslot.

Timing advance, as described in [9], subclause 4.3, is applied to the E-PUCH.

5B.4.12.1 E-UCCH

The E-DCH Uplink Control Channel (E-UCCH) carries uplink control information associated with the E-DCH and is carried within indicator fields mapped to E-PUCH. Depending on the configuration by higher layers, an E-PUCH burst may or may not contain E-UCCH and TPC. When E-PUCH does contain E-UCCH, TPC is also transmitted. When E-PUCH does not contain E-UCCH, TPC is not transmitted.

Higher layers shall indicate the maximum number of timeslots (N_{E-UCCH}) that may contain E-UCCH/TPC in the E-DCH TTI. For an allocation of n_{TS} E-PUCH timeslots, the UE shall transmit E-UCCH and TPC on the first m allocated timeslots of the E-DCH TTI, where $m = \min(n_{TS}, N_{E-UCCH})$.

The E-UCCH comprises two parts, E-UCCH part 1 and E-UCCH part 2.

E-UCCH part 1:

- is of length 32 physical channel bits
- is mapped to the TFCI field of the E-PUCH (16 bits either side of the midamble)
- is spread at SF=32 using the channelisation code in the branch with the highest code numbering of the allowed OVFSF sub tree, as depicted in [8]
- uses QPSK modulation

E-UCCH part 2:

- is of length 32 physical channel bits
- is spread using the same spreading factor as the data payloads
- uses the same modulation as the data payloads

Figures 18APA and 18APB show the E-PUCH data burst with and without the E-UCCH/TPC fields.

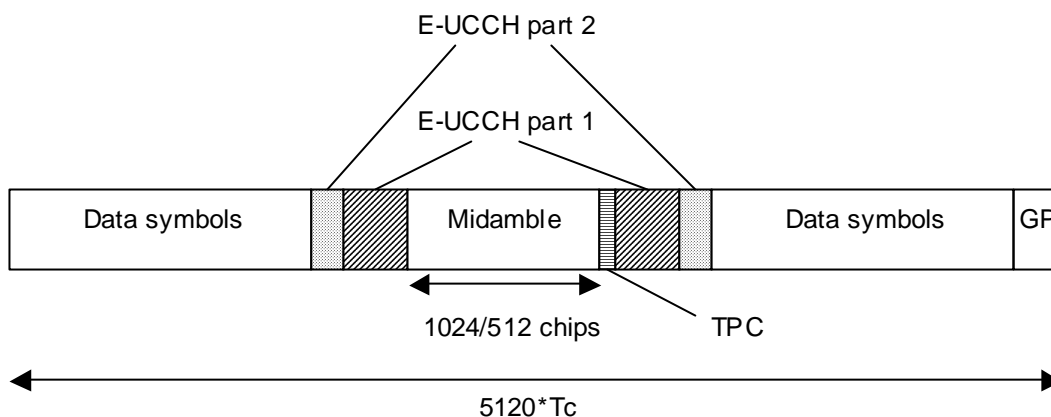

Figure 18APA: Location of E-UCCH part 1, E-UCCH part 2 and TPC in the E-PUCH data burst

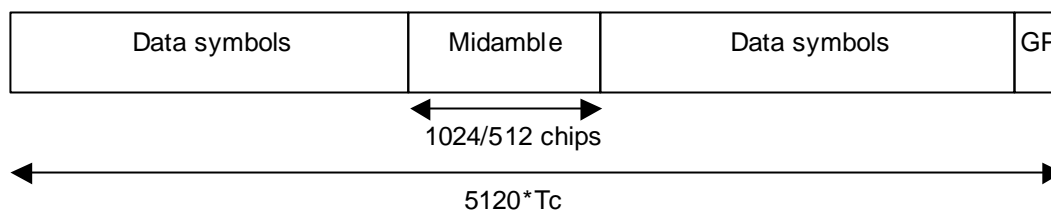

Figure 18APB: E-PUCH data burst without E-UCCH/TPC

5B.4.12.2 E-PUCH Spreading

The spreading factors that can be applied to the E-PUCH are SF = 1, 2, 4, 8, 16, 32 as described in subclause 5B.3.1.2.

5B.4.12.3 E-PUCH Burst Types

Burst types 1, 2 or 3 as described in subclause 5B.3.2 can be used for E-PUCH. E-UCCH and TPC can be transmitted on the E-PUCH.

5B.4.12.4 PUSCH Training Sequences

The training sequences as described in subclause 5B.3.3 are used for the E-PUCH.

5B.4.12.5 UE Selection

UEs that shall transmit on the E-PUCH are selected by higher layers. The UE id on the associated E-AGCH shall be used for identification.

5B.4.12.6 E-PUCH timeslot formats

An E-PUCH may use QPSK or 16QAM modulation symbols and may or may not contain E-UCCH/TPC. The time slot formats are shown in table 19.

Table 19: Timeslot formats for E-PUCH

slot format #	SF	Midamble Length (chips)	GP (chips)	N _{EUCCH1} (bits)	N _{EUCCH2} (bits)	N _{TPC} (bits)	Bits/slot	N _{data/slot} (bits)	N _{data/data field(1)} (bits)	N _{data/data field(2)} (bits)
0 (QPSK)	32	1024	192	0	0	0	244	244	122	122
1 (16QAM)	32	1024	192	0	0	0	488	488	244	244
2 (QPSK)	32	1024	192	32	32	2	244	178	90	88
3 (16QAM)	32	1024	192	32	32	2	454	388	196	192
4 (QPSK)	32	512	192	0	0	0	276	276	138	138
5 (16QAM)	32	512	192	0	0	0	552	552	276	276
6 (QPSK)	32	512	192	32	32	2	276	210	106	104
7 (16QAM)	32	512	192	32	32	2	518	452	228	224
8 (QPSK)	16	1024	192	0	0	0	488	488	244	244
9 (16QAM)	16	1024	192	0	0	0	976	976	488	488
10 (QPSK)	16	1024	192	32	32	2	454	388	196	192
11 (16QAM)	16	1024	192	32	32	2	874	808	408	400
12 (QPSK)	16	512	192	0	0	0	552	552	276	276
13 (16QAM)	16	512	192	0	0	0	1104	1104	552	552
14 (QPSK)	16	512	192	32	32	2	518	452	228	224
15 (16QAM)	16	512	192	32	32	2	1002	936	472	464
16 (QPSK)	8	1024	192	0	0	0	976	976	488	488
17 (16QAM)	8	1024	192	0	0	0	1952	1952	976	976
18 (QPSK)	8	1024	192	32	32	2	874	808	408	400
19 (16QAM)	8	1024	192	32	32	2	1714	1648	832	816
20 (QPSK)	8	512	192	0	0	0	1104	1104	552	552
21 (16QAM)	8	512	192	0	0	0	2208	2208	1104	1104
22 (QPSK)	8	512	192	32	32	2	1002	936	472	464
23 (16QAM)	8	512	192	32	32	2	1970	1904	960	944
24 (QPSK)	4	1024	192	0	0	0	1952	1952	976	976
25 (16QAM)	4	1024	192	0	0	0	3904	3904	1952	1952
26 (QPSK)	4	1024	192	32	32	2	1714	1648	832	816
27 (16QAM)	4	1024	192	32	32	2	3394	3328	1680	1648
28 (QPSK)	4	512	192	0	0	0	2208	2208	1104	1104
29 (16QAM)	4	512	192	0	0	0	4416	4416	2208	2208
30 (QPSK)	4	512	192	32	32	2	1970	1904	960	944
31 (16QAM)	4	512	192	32	32	2	3906	3840	1936	1904
32 (QPSK)	2	1024	192	0	0	0	3904	3904	1952	1952
33 (16QAM)	2	1024	192	0	0	0	7808	7808	3904	3904
34 (QPSK)	2	1024	192	32	32	2	3394	3328	1680	1648
35 (16QAM)	2	1024	192	32	32	2	6754	6688	3376	3312
36 (QPSK)	2	512	192	0	0	0	4416	4416	2208	2208
37 (16QAM)	2	512	192	0	0	0	8832	8832	4416	4416
38 (QPSK)	2	512	192	32	32	2	3906	3840	1936	1904
39 (16QAM)	2	512	192	32	32	2	7778	7712	3888	3824
40 (QPSK)	1	1024	192	0	0	0	7808	7808	3904	3904
41 (16QAM)	1	1024	192	0	0	0	15616	15616	7808	7808

slot format #	SF	Midamble Length (chips)	GP (chips)	NEUCCH1 (bits)	NEUCCH2 (bits)	N _{TPC} (bits)	Bits/slot	N _{data/slot} (bits)	N _{data/data field(1)} (bits)	N _{data/data field(2)} (bits)
42 (QPSK)	1	1024	192	32	32	2	6754	6688	3376	3312
43 (16QAM)	1	1024	192	32	32	2	13474	13408	6768	6640
44 (QPSK)	1	512	192	0	0	0	8832	8832	4416	4416
45 (16QAM)	1	512	192	0	0	0	17664	17664	8832	8832
46 (QPSK)	1	512	192	32	32	2	7778	7712	3888	3824
47 (16QAM)	1	512	192	32	32	2	15522	15456	7792	7664
48 (QPSK)	32	1024	384	0	0	0	232	232	122	110
49 (16QAM)	32	1024	384	0	0	0	464	464	244	220
50 (QPSK)	32	1024	384	32	32	2	232	166	90	76
51 (16QAM)	32	1024	384	32	32	2	430	364	196	168
52 (QPSK)	16	1024	384	0	0	0	464	464	244	220
53 (16QAM)	16	1024	384	0	0	0	928	928	488	440
54 (QPSK)	16	1024	384	32	32	2	430	364	196	168
55 (16QAM)	16	1024	384	32	32	2	826	760	408	352
56 (QPSK)	8	1024	384	0	0	0	928	928	488	440
57 (16QAM)	8	1024	384	0	0	0	1856	1856	976	880
58 (QPSK)	8	1024	384	32	32	2	826	760	408	352
59 (16QAM)	8	1024	384	32	32	2	1618	1552	832	720
60 (QPSK)	4	1024	384	0	0	0	1856	1856	976	880
61 (16QAM)	4	1024	384	0	0	0	3712	3712	1952	1760
62 (QPSK)	4	1024	384	32	32	2	1618	1552	832	720
63 (16QAM)	4	1024	384	32	32	2	3202	3136	1680	1456
64 (QPSK)	2	1024	384	0	0	0	3712	3712	1952	1760
65 (16QAM)	2	1024	384	0	0	0	7424	7424	3904	3520
66 (QPSK)	2	1024	384	32	32	2	3202	3136	1680	1456
67 (16QAM)	2	1024	384	32	32	2	6370	6304	3376	2928
68 (QPSK)	1	1024	384	0	0	0	7424	7424	3904	3520
69 (16QAM)	1	1024	384	0	0	0	14848	14848	7808	7040
70 (QPSK)	1	1024	384	32	32	2	6370	6304	3376	2928
71 (16QAM)	1	1024	384	32	32	2	12706	12640	6768	5872

5B.4.13 E-DCH Random Access Uplink Control Channel (E-RUCCH)

The E-RUCCH is used to carry E-DCH-associated uplink control signalling when E-PUCH resources are not available. The characteristics of the E-RUCCH physical channel are identical to those of PRACH (see subclause 5B.4.3).

Physical resources available for E-RUCCH are configured by higher layers. E-RUCCH may be mapped to the same physical resources that are assigned for PRACH.

5B.4.14 E-DCH Absolute Grant Channel (E-AGCH)

The E-DCH Absolute Grant Channel (E-AGCH) is a downlink physical channel carrying the uplink E-DCH absolute grant control information. Unlike other downlink physical channel types, E-AGCH also carries a TPC field (located immediately after the midamble and spread using SF32) which is used to control the E-PUCH power. Figure 18APC illustrates the burst structure of the E-AGCH.

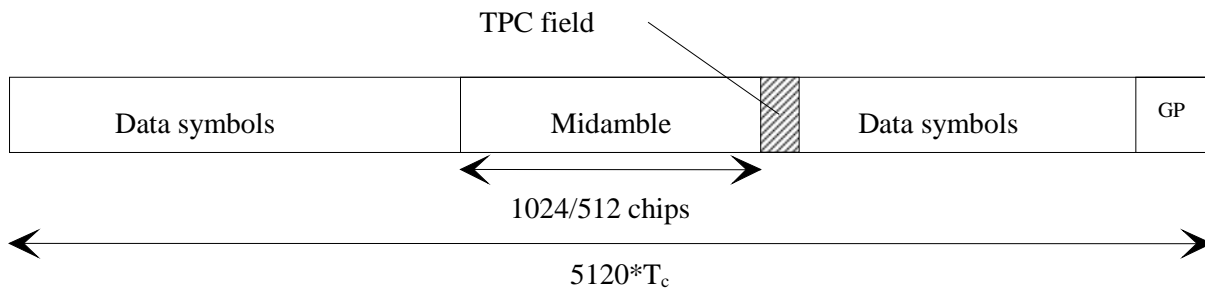

Figure 18APC: Burst structure of E-AGCH

One E-DCH absolute grant for a UE shall be transmitted over one E-AGCH.

5B.4.14.1 E-AGCH Spreading

The E-AGCH shall use spreading factor $SF = 32$, as described in 5B.3.1.1.

5B.4.14.2 E-AGCH Burst Types

Burst types 1 and 2 as described in subclause 5B.3.2 can be used for E-AGCH. TPC shall be transmitted on E-AGCH whereas TFCI shall not be transmitted.

5B.4.14.3 E-AGCH Training Sequences

The training sequences as described in subclause 5B.3.3 are used for the E-AGCH.

5B.4.15.4 E-AGCH timeslot formats

The E-AGCH uses the timeslot formats of Table 20. These augment downlink slot formats 0...19 of table 8AF, see subclause 5B.3.2.6.1.

Table 20: Time slot formats for E-AGCH

Slot Format #	SF	Midamble length (chips)	N_{TFCI} code word (bits)	N_{TPC} (bits)	Bits/slot	$N_{Data/Slot}$ (bits)	$N_{data/data}$ field (1) (bits)	$N_{data/data}$ field (2) (bits)
20	32	1024	0	2	244	242	122	120
21	32	512	0	2	276	274	138	136

5B.4.15 E-DCH Hybrid ARQ Acknowledgement Indicator Channel (E-HICH)

The E-DCH HARQ Acknowledgement indicator channel (E-HICH) is defined in terms of a SF32 downlink physical channel and a signature sequence. The E-HICH carries the uplink E-DCH hybrid ARQ acknowledgement indicator. Figure 18APD illustrates the structure of the E-HICH.

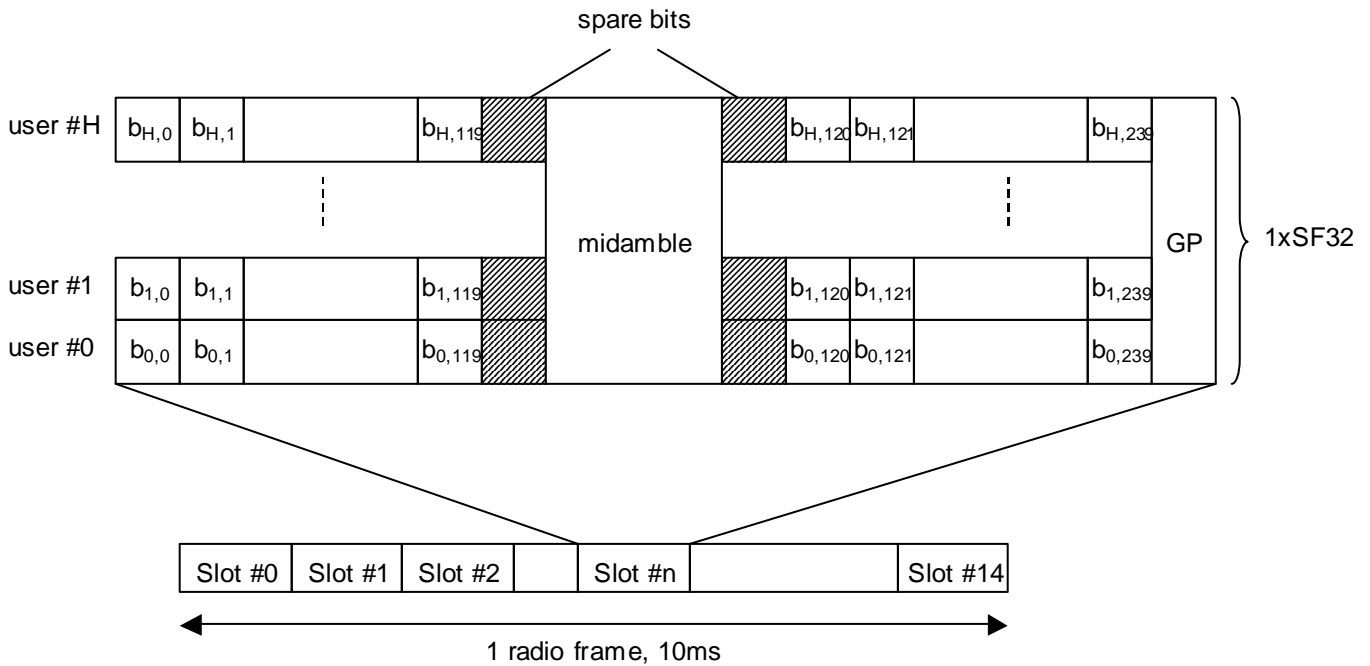

Figure 18APD – E-HICH Structure

A single channelisation code may carry one or multiple signature sequences. Each signature sequence conveys a HARQ acknowledgement indicator. A maximum of one indicator may be transmitted to a UE. Each acknowledgement indicator is coded to form a signature sequence of 240 bits (b_0, b_1, \dots, b_{239}) as defined in [7] and is transmitted within a single E-HICH timeslot. The E-HICH also contains U spare bit locations, where $U=4$ for burst type 1 and $U=36$ for burst type 2. The spare bit values are not defined.

5B.4.15.1 E-HICH Spreading

Signature sequences (including spare bits inserted) that share the same channelisation code are combined and spread using spreading factor $SF=32$ as described in [8].

5B.4.15.2 E-HICH Burst Types

Burst types 1 and 2 as described in subclause 5B.3.2 can be used for E-HICH. Neither TFCI nor TPC shall be transmitted on the E-HICH.

5B.4.15.3 E-HICH Training Sequences

The training sequences as described in subclause 5B.3.3 are used for the E-HICH.

5B.5 Transmit Diversity for DL Physical Channels

Support for transmit diversity is the same as that for the 3.84 Mcps TDD option cf. [5.4 Transmit Diversity].

5B.6 Beacon characteristics of physical channels

For the purpose of measurements, common physical channels that are allocated to particular locations (time slot, code) shall have particular physical characteristics, called beacon characteristics. Physical channels with beacon characteristics are called beacon channels. The locations of the beacon channels are called beacon locations. The ensemble of beacon channels shall provide the beacon function, i.e. a reference power level at the beacon locations, regularly existing in each radio frame. Thus, beacon channels must be present in each radio frame, the only exception is

when idle periods are used to support time difference measurements for location services [9]. Then it may be possible that the beacon channels occur in the same frame and time slot as the idle periods. In this case, the beacon channels will not be transmitted in that particular frame and time slot.

5B.6.1 Location of beacon channels

The beacon locations are determined by the SCH and depend on the SCH allocation case, see subclause 5B.4.4:

- Case 1) The beacon function shall be provided by the physical channels that are allocated to channelisation code $C_{Q=32}^{(k=1)}$ and to TS#k, k=0,...,14.
- Case 2) The beacon function shall be provided by the physical channels that are allocated to channelisation code $C_{Q=32}^{(k=1)}$ and to TS#k and TS#k+8, k=0,...,6.

Note that by this definition the P-CCPCH always has beacon characteristics.

5B.6.2 Physical characteristics of beacon channels

The beacon channels shall have the following physical characteristics. They:

- are transmitted with reference power;
- are transmitted without beamforming;
- use burst type 1 or burst type 4 when MBSFN is applied to beacon channels;
- use midamble $m^{(1)}$ and $m^{(2)}$ exclusively in this time slot; and
- midambles $m^{(9)}$ and $m^{(10)}$ are always left unused in this time slot, if 16 midambles are allowed in that cell.

Note that in the time slot where the P-CCPCH is transmitted only the midambles $m^{(1)}$ to $m^{(8)}$ shall be used, see 5B.7.1. Thus, midambles $m^{(9)}$ and $m^{(10)}$ are always left unused in this time slot.

Note that when MBSFN is applied to beacon channels there is a single midamble and hence midamble $m^{(1)}$ is exclusively used in the timeslot.

The reference power corresponds to the sum of the power allocated to both midambles $m^{(1)}$ and $m^{(2)}$. Two possibilities exist:

- If SCTD antenna diversity is not applied to beacon channels all the reference power of any beacon channel is allocated to $m^{(1)}$.
- If SCTD antenna diversity is applied to beacon channels, for any beacon channel midambles $m^{(1)}$ and $m^{(2)}$ are each allocated half of the reference power.

5B.7 Midamble Allocation for Physical Channels

Midamble allocation for physical channels is identical to 3.84Mcps TDD [section 5.6]. The association between midambles and channelisation codes is given in Annex AB.3.

5B.8 Midamble Transmit Power

There shall be no offset between the sum of the powers allocated to all midambles in a timeslot and the sum of the powers allocated to the data symbol fields. The transmit power within a timeslot is hence constant.

The midamble transmit power of beacon channels is equal to the reference power. If SCTD is used for beacon channels, the reference power is equally divided between the midambles $m^{(1)}$ and $m^{(2)}$.

The midamble transmit power of all other physical channels depends on the midamble allocation scheme used. The following rules apply

- In case of Default Midamble Allocation, every midamble is transmitted with the same power as the associated codes.
- In case of Common Midamble Allocation in the downlink, the transmit power of this common midamble is such that there is no power offset between the data parts and the midamble part of the overall transmit signal within one time slot.
- In case of UE Specific Midamble Allocation, the transmit power of the UE specific midamble is such that there is no power offset between the data parts and the midamble part of every user within one time slot.

The following figure 18AQ depicts the midamble powers for the different channel types and midamble allocation schemes.

Note 1: In figure 18AQ, the codes $c(1)$ to $c(32)$ represent the set of usable codes and not the set of used codes.

Note 2: The common midamble allocation and the midamble allocation by higher layers are not applicable in those beacon time slots, in which the P-CCPCH is located, see section 5B.7.

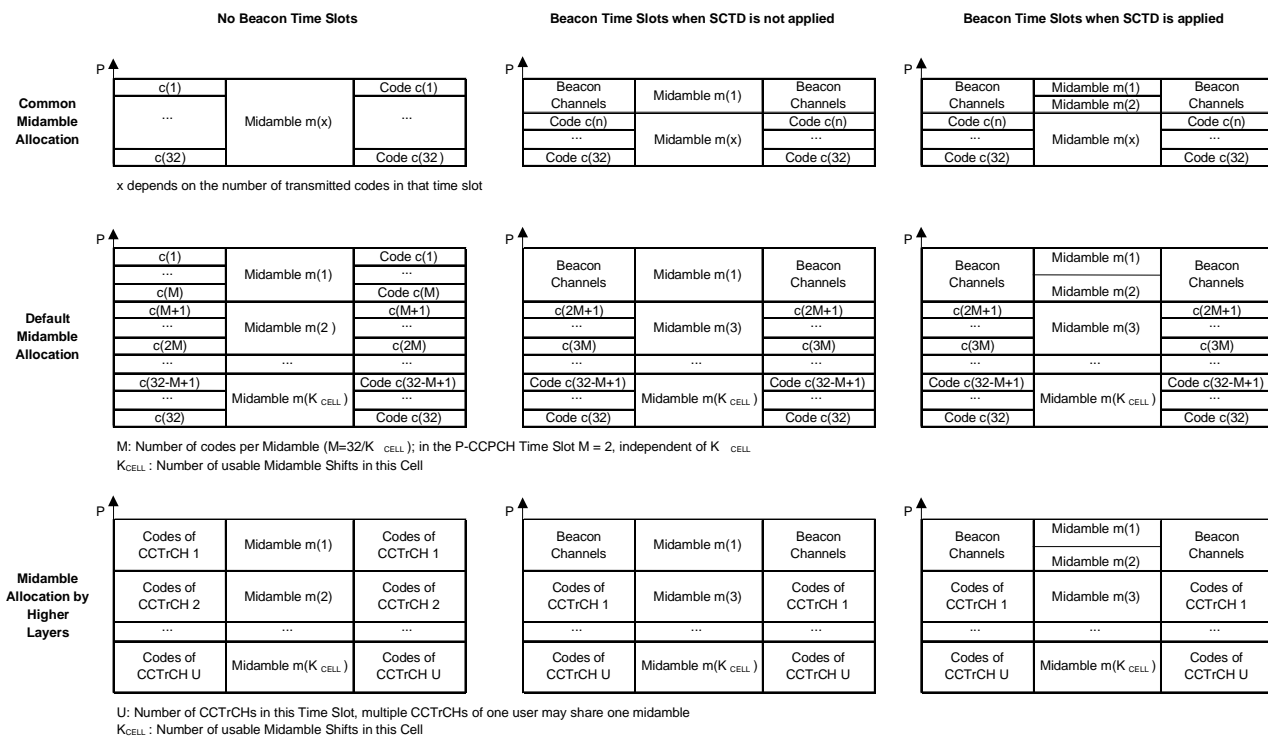

Figure 18AQ: Midamble powers for the different midamble allocation schemes

6 Mapping of transport channels to physical channels for the 3.84 Mcps option

This clause describes the way in which transport channels are mapped onto physical resources, see figure 19. Sub-clauses 6.1 and 6.2 do not apply to 3.84 Mcps MBSFN IMB. Mappings between transport channels and physical resources for 3.84 Mcps MBSFN IMB are described in sub-clause 6.3.

Transport Channels	Physical Channels
DCH	Dedicated Physical Channel (DPCH)
BCH	Primary Common Control Physical Channel (P-CCPCH)
FACH	Secondary Common Control Physical Channel (S-CCPCH)
PCH	
RACH	Physical Random Access Channel (PRACH)
USCH	Physical Uplink Shared Channel (PUSCH)
DSCH	Physical Downlink Shared Channel (PDSCH)
	Paging Indicator Channel (PICH)
	MBMS Indication Channel (MICH)
	Synchronisation Channel (SCH)
	Physical Node B Synchronisation Channel (PNBSCH)
HS-DSCH	High Speed Physical Downlink Shared Channel (HS-PDSCH)
	Shared Control Channel for HS-DSCH (HS-SCCH)
	Shared Information Channel for HS-DSCH (HS-SICH)
E-DCH	E-DCH Physical Uplink Channel (E-PUCH)
	E-DCH Random Access Uplink Control Channel (E-RUCCH)
	E-DCH Absolute Grant Channel (E-AGCH)
	E-DCH Hybrid ARQ Indicator Channel (E-HICH)

Figure 19: Transport channel to physical channel mapping

6.1 Dedicated Transport Channels

6.1.1 The Dedicated Channel (DCH)

A dedicated transport channel is mapped onto one or more physical channels. An interleaving period is associated with each allocation. The frame is subdivided into slots that are available for uplink and downlink information transfer. The mapping of transport blocks on physical channels is described in TS 25.222 ("multiplexing and channel coding").

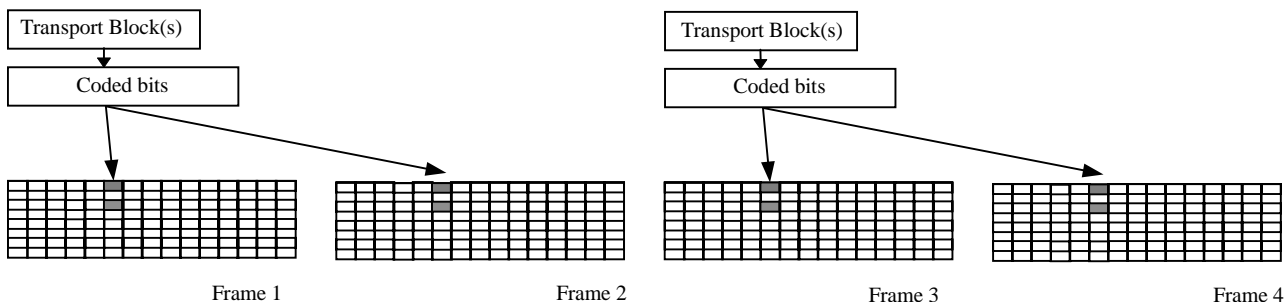

Figure 20: Mapping of Transport Blocks onto the physical bearer

For NRT packet data services, shared channels (USCH and DSCH) can be used to allow efficient allocations for a short period of time.

6.1.2 The Enhanced Uplink Dedicated Channel (E-DCH)

The enhanced uplink dedicated channel is mapped on one or several E-PUCH, see subclause 5.3.13.

6.1.2.1 E-DCH/E-AGCH Association and Timing

The E-DCH is always associated with a number of E-DCH Absolute Grant Channels (E-AGCH) and one hybrid ARQ indicator channel (E-HICH). A grant of E-DCH transmission resources may be transmitted to the UE on any one of the associated E-AGCH. All relevant Layer 1 control information related to an E-DCH TTI is transmitted in the associated E-AGCH and E-HICH.

The E-DCH related time slot information that is carried on the E-AGCH refers to the next valid E-PUCH allocation, which is given by the following limitation: There shall be an offset of $n_{E-AGCH} \geq 6$ time slots between the E-AGCH carrying the E-DCH related information and the first indicated E-PUCH (in time) for a given UE. The E-DCH related time slot information shall not refer to two subsequent radio frames but shall always refer to either the same or the following radio frame, as illustrated in figure 20a. Note that the figure only shows the E-AGCH that carries the E-DCH related information for the given UE.

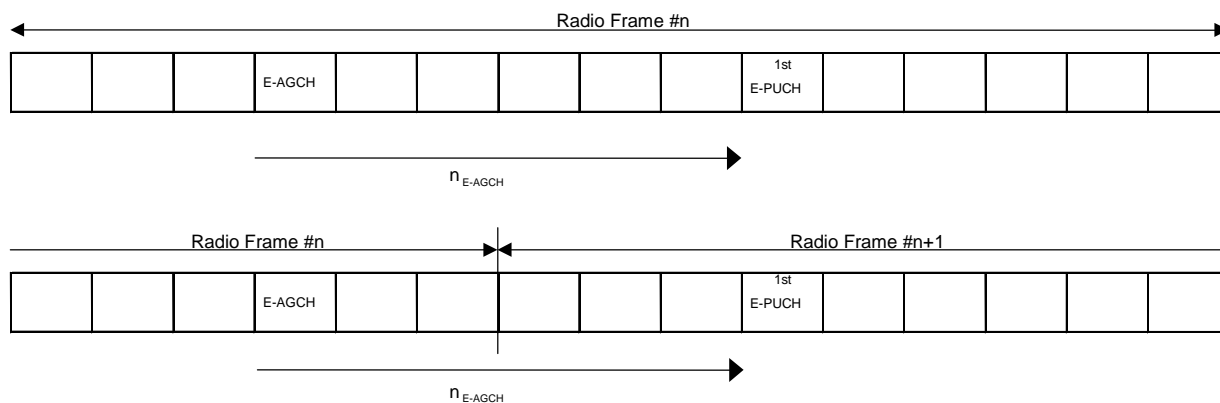

Figure 20a: Timing for E-AGCH and E-DCH for different radio frame configurations for a given UE

6.1.2.2 E-DCH/E-HICH Association and Timing

All E-DCH operations within the cell are associated with the same E-HICH channelisation code. A single E-HICH channelisation code exists in the cell per E-DCH TTI (10ms). For a given UE, a HARQ acknowledgement indicator is synchronously linked with the E-DCH TTI transmission to which it relates. There is thus a one-to-one association between an E-DCH TTI transmission and its respective HARQ acknowledgment indicator on the associated E-HICH.

The associated E-HICH shall reside on the first instance of the E-HICH channelisation code to occur after n_{E-HICH} timeslots have elapsed since the start of the last E-PUCH of the corresponding E-DCH TTI (see examples of figure 20b). The value of n_{E-HICH} is configurable by higher layers within the range 4 to 44 timeslots.

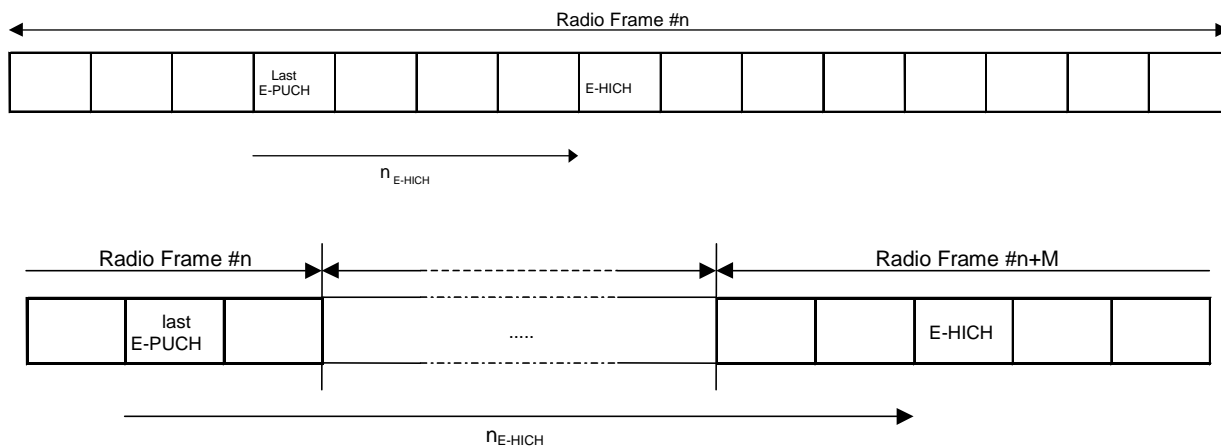

Figure 20b: Timing for E-DCH and E-HICH for a given UE

The HARQ acknowledgement indicator associated with an E-DCH transmission is transmitted using one of 240 signature sequences carried by the associated E-HICH channelisation code. Which signature sequence $r = 0, 1, 2, \dots, 239$ is used is calculated for each E-DCH resource allocation using the information signalled on the associated E-AGCH as follows:

$$r = 16(t_0 - 1) + (q_0 - 1) \frac{16}{Q_0}$$

- where:

- o t_0 is the bit position ($1 \dots n_{TRRI}$) of the first active timeslot in the timeslot resource related information bitmap (see [7]) on E-AGCH and where bit position 1 corresponds to the lowest-numbered timeslot
- o q_0 is the allocated channelisation code index ($1, 2, 3, \dots, Q_0$)
- o Q_0 is the spreading factor of the allocated uplink channelisation code

6.2 Common Transport Channels

6.2.1 The Broadcast Channel (BCH)

The BCH is mapped onto the P-CCPCH. The secondary SCH codes indicate in which timeslot a mobile can find the P-CCPCH containing BCH.

6.2.2 The Paging Channel (PCH)

The PCH is mapped onto one or several S-CCPCHs so that capacity can be matched to requirements. The location of the PCH is indicated on the BCH. It is always transmitted at a reference power level.

To allow an efficient DRX, the PCH is divided into PCH blocks, each of which comprising N_{PCH} paging sub-channels. N_{PCH} is configured by higher layers. Each paging sub-channel is mapped onto 2 consecutive PCH frames within one PCH block. Layer 3 information to a particular UE is transmitted only in the paging sub-channel, that is assigned to the

UE by higher layers, see [15]. The assignment of UEs to paging sub-channels is independent of the assignment of UEs to page indicators.

6.2.2.1 PCH/PICH Association

As depicted in figure 21, a paging block consists of one PICH block and one PCH block. If a paging indicator in a certain PICH block is set to '1' it is an indication that UEs associated with this paging indicator shall read their corresponding paging sub-channel within the same paging block. The value $N_{GAP} > 0$ of frames between the end of the PICH block and the beginning of the PCH block is configured by higher layers.

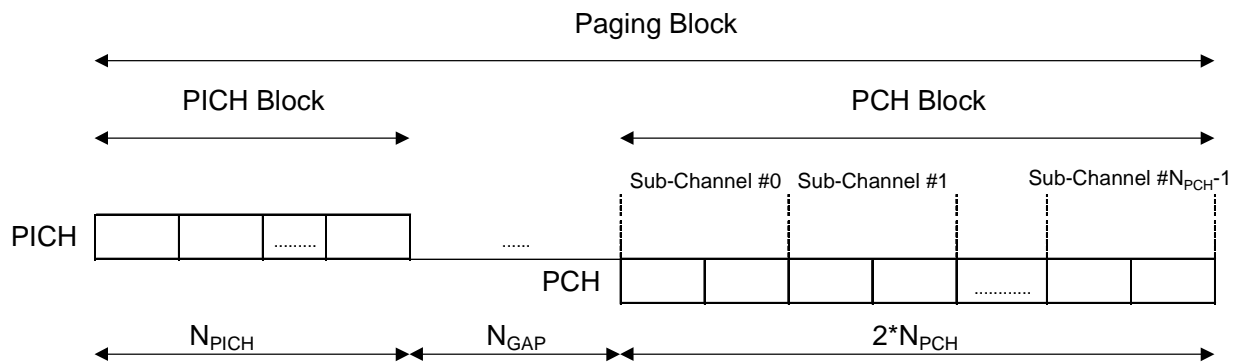

Figure 21: Paging Sub-Channels and Association of PICH and PCH blocks

6.2.3 The Forward Channel (FACH)

The FACH is mapped onto one or several S-CCPCHs. The location of the FACH is indicated on the BCH and both, capacity and location can be changed, if required. FACH may or may not be power controlled.

6.2.4 The Random Access Channel (RACH)

The RACH has intraslot interleaving only and is mapped onto PRACH. The same slot may be used for PRACH by more than one cell. Multiple transmissions using different spreading codes may be received in parallel. More than one slot per frame may be administered for the PRACH. The location of slots allocated to PRACH is broadcast on the BCH. The PRACH uses open loop power control. The details of the employed open loop power control algorithm may be different from the corresponding algorithm on other channels.

6.2.5 The Uplink Shared Channel (USCH)

The uplink shared channel is mapped on one or several PUSCH, see subclause 5.3.5.

6.2.6 The Downlink Shared Channel (DSCH)

The downlink shared channel is mapped on one or several PDSCH, see subclause 5.3.6.

6.2.7 The High Speed Downlink Shared Channel (HS-DSCH)

The high speed downlink shared channel is mapped on one or several HS-PDSCH, see subclause 5.3.9.

6.2.7.1 HS-DSCH/HS-SCCH Association and Timing

The HS-DSCH is always associated with a number of High Speed Shared Control Channels (HS-SCCH). The number of HS-SCCHs that are associated with an HS-DSCH for one UE can range from a minimum of one HS-SCCH ($M=1$) to a maximum of four HS-SCCH ($M=4$). All relevant Layer 1 control information is transmitted in the associated HS-SCCH i.e. the HS-PDSCH does not carry any Layer 1 control information.

The HS-DSCH related time slot information that is carried on the HS-SCCH refers to the next valid HS-PDSCH allocation, which is given by the following limitation: There shall be an offset of $n_{HS-SCCH} \geq 4$ time slots between the HS-SCCH carrying the HS-DSCH related information and the first indicated HS-PDSCH (in time) for a given UE. The HS-DSCH related time slot information shall not refer to two subsequent radio frames but shall always refer to either the same or the following radio frame, as illustrated in figure 21A. Note that the figure only shows the HS-SCCH that carries the HS-DSCH related information for the given UE.

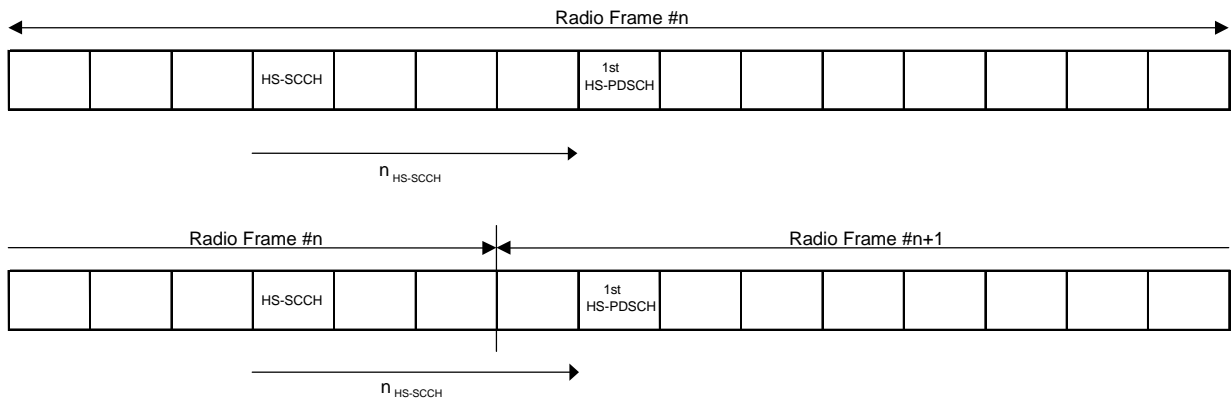

Figure 21A: Timing for HS-SCCH and HS-PDSCH for different radio frame configurations for a given UE

6.2.7.2 HS-SCCH/HS-DSCH/HS-SICH Association and Timing

The HS-SCCH is always associated with one HS-SICH. The association between the HS-SCCH in DL and HS-SICH in UL shall be pre-defined by higher layers and is common for all UEs.

The UE shall transmit the HS-DSCH related ACK / NACK on the next available associated HS-SICH with the following limitation: There shall be an offset of $n_{HS-SICH} \geq 17$ time slots between the last allocated HS-PDSCH (in time) and the HS-SICH for the given UE. Hence, the HS-SICH transmission shall be made in the next or next but one radio frame, following the HS-DSCH transmission, as illustrated in figure 21B. Note that the figure only shows the HS-SICH that carries the HS-DSCH related ACK / NACK for the given UE.

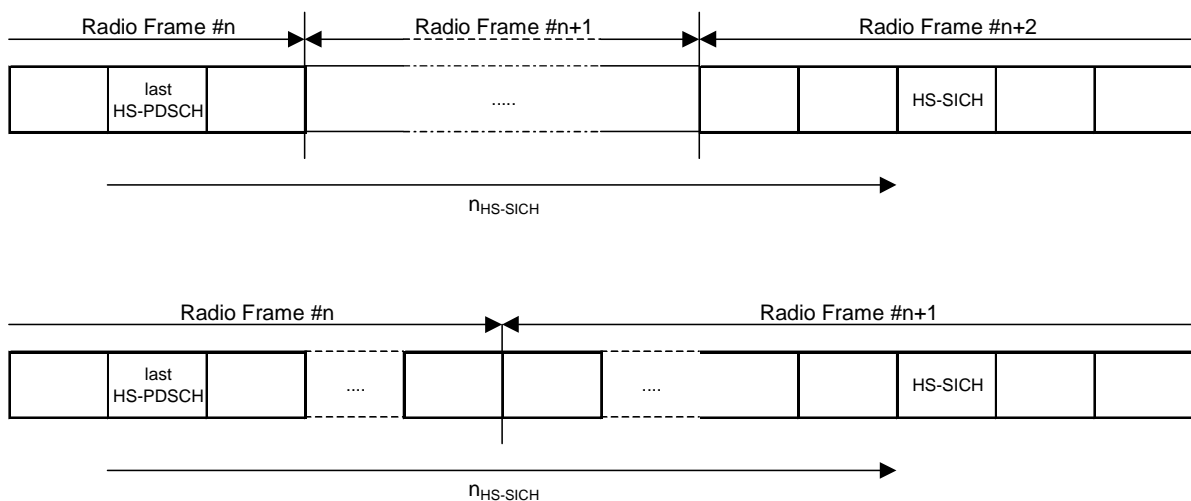

Figure 21B: Timing for HS-PDSCH and HS-SICH for different radio frame configurations for a given UE

6.3 Mapping of TrCHs for the 3.84 Mcps MBSFN IMB option

The following mappings are supported:

- BCH mapped to P-CCPCH.
- FACH mapped to S-CCPCH
- MICH (no transport channel is mapped to MICH)

7 Mapping of transport channels to physical channels for the 1.28 Mcps option

This clause describes the way in which the transport channels are mapped onto physical resources, see figure 22.

Transport channels	Physical channels
DCH	Dedicated Physical Channel (DPCH)
BCH	Primary Common Control Physical Channels (P-CCPCH)
PCH	Secondary Common Control Physical Channels(S-CCPCH)
FACH	Secondary Common Control Physical Channels(S-CCPCH)
	PICH
	MICH
	PLCCH
RACH	Physical Random Access Channel (PRACH)
USCH	Physical Uplink Shared Channel (PUSCH)
DSCH	Physical Downlink Shared Channel (PDSCH)
	Down link Pilot Channel (DwPCH)
	Up link Pilot Channel (UpPCH)
	FPACH
HS-DSCH	High Speed Physical Downlink Shared Channel (HS-PDSCH)
	Shared Control Channel for HS-DSCH (HS-SCCH)
	Shared Information Channel for HS-DSCH (HS-SICH)
E-DCH	E-DCH Physical Uplink Channel (E-PUCH)
	E-DCH Random Access Uplink Control Channel (E-RUCCH)
	E-DCH Absolute Grant Channel (E-AGCH)
	E-DCH Hybrid ARQ Indicator Channel (E-HICH)

Figure 22: Transport channel to physical channel mapping for 1.28Mcps TDD

7.1 Dedicated Transport Channels

7.1.1 The Dedicated Channel (DCH)

The mapping of transport blocks to physical bearers is in principle the same as in 3.84 Mcps TDD but due to the subframe structure the coded bits are mapped onto each of the subframes within the given TTI.

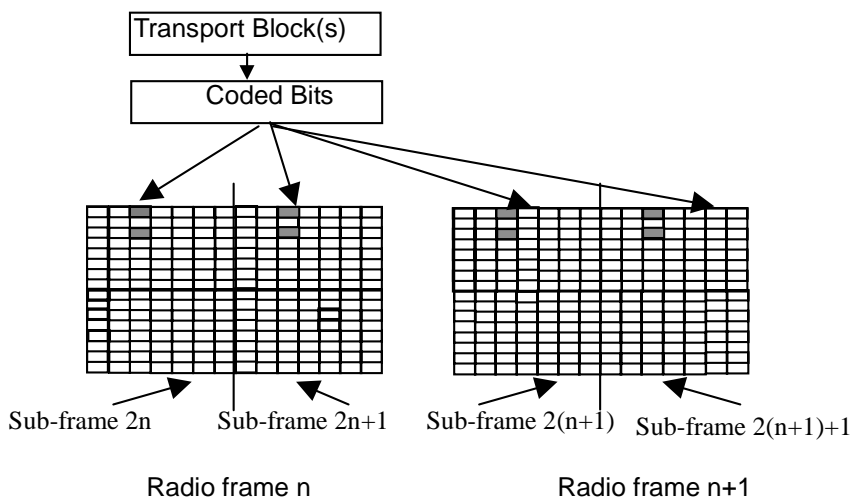

Figure 23 : Mapping of Transport Blocks onto the physical bearer (TTI= 20ms)

7.1.2 The Enhanced Uplink Dedicated Channel (E-DCH)

The enhanced uplink dedicated channel is mapped on one or several E-PUCH, see subclause 5A.3.14.

7.1.2.1 E-DCH/E-AGCH Association and Timing

The E-DCH is always associated with a number of E-DCH Absolute Grant Channels (E-AGCH) and up to four hybrid ARQ Indicator Channel (E-HICH). A grant of E-DCH transmission resources may be transmitted to the UE on any one of the associated E-AGCH. All relevant Layer 1 control information related to an E-DCH TTI is transmitted in the associated E-AGCH and E-HICH.

The E-DCH related timeslot information that is carried on the E-AGCH refers to the next valid E-PUCH allocation, which is given by the following limitation: There shall be an offset of $n_{E-AGCH} \geq 7$ time slots between the E-AGCH carrying the E-DCH related information and the first indicated E-PUCH (in time) for a given UE. DwPTS and UpPTS shall not be taken into account in this limitation as illustrated in figure 23A. Note that the figure only shows the E-AGCH that carries the E-DCH related information for the given UE and that DwPTS and UpPTS are not considered in this figure.

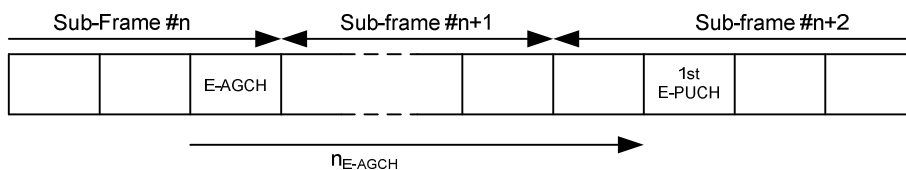

Figure 23A: Timing for E-AGCH and E-PUCH for different radio frame configurations for a given UE

When E-AGCH is allocated in TS0, the timing between E-AGCH and the associated E-PUCH is defined as: E-AGCH is sent in the n-th sub-frame while the E-PUCH is sent in the (n+2)-th sub-frame.

For the semi-persistent E-DCH resources, the timing between E-AGCH and the first E-PUCH can also use the same limitation: There shall be an offset of $n_{E-AGCH} \geq 7$ time slots between the E-AGCH carrying the semi-persistent E-DCH related information and the first indicated semi-persistent E-PUCH (in time) for a given UE. Once the semi-persistent resources are assigned to UE, UE can use these resources continuously until the semi-persistent resources have been released or reconfigured by Node B or RNC.

7.1.2.2 E-DCH/E-HICH Association and Timing

For a given UE, a HARQ acknowledgement indicator (E-HICH) is synchronously linked with the E-DCH TTI transmission to which it relates.

The associated E-HICH shall reside on the first E-HICH instance of the E-HICH channelisation code to occur after n_{E-HICH} timeslots have elapsed since the start of the last E-PUCH of the corresponding E-DCH TTI (see examples of figure 23B). DwPTS and UpPTS are not considered in the figure. The value of n_{E-HICH} is configurable by higher layers within the range 4 to 15 timeslots. DwPTS and UpPTS shall not be taken into account in this limitation.

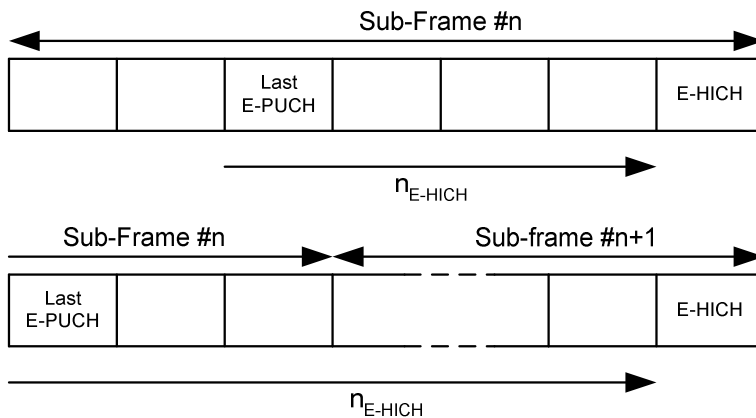

Figure 23B: Timing for E-DCH and E-HICH for a given UE

7.2 Common Transport Channels

7.2.1 The Broadcast Channel (BCH)

There are two P-CCPCHs, P-CCPCH 1 and P-CCPCH 2 which are mapped onto timeslot#0 using the channelisation codes $C_{Q=16}^{(k=1)}$ and $C_{Q=16}^{(k=2)}$ with spreading factor 16. The BCH is mapped onto the P-CCPCH1+P-CCPCH2.

The position of the P-CCPCHs is indicated by the relative phases of the bursts in the DwPTS with respect to the P-CCPCHs midamble sequences, see [8]. One special combination of the phase differences of the burst in the DwPTS with respect to the P-CCPCH midamble indicates the position of the P-CCPCH in the multi-frame and the start position of the interleaving period.

7.2.2 The Paging Channel (PCH)

If the PICH is associated with an S-CCPCH to which a PCH transport channel is mapped, the mapping of Paging Channels onto S-CCPCHs and the association between PCHs and Paging Indicator Channels is the same as in the 3.84 Mcps TDD option, cf. 6.2.2 'The paging Channel' and 6.2.2.1 'PCH/PICH Association' respectively.

7.2.3 The Forward Channel (FACH)

The FACH is mapped onto one or several S-CCPCHs. The location of the FACH is indicated on the BCH and both, capacity and location can be changed, if required. FACH may or may not be power controlled.

7.2.4 The Random Access Channel (RACH)

The RACH is mapped onto PRACH. More than one slot per frame may be administered for the PRACH. The location of slots allocated to PRACH is broadcast on the BCH. The uplink sync codes (SYNC-UL sequences) used by the UEs for UL synchronisation have a well known association with the P-RACHs, as broadcast on the BCH. On the PRACH, both power control and uplink synchronisation control are used.

7.2.5 The Uplink Shared Channel (USCH)

The uplink shared channel is mapped onto one or several PUSCH, see subclause 5A.3.6 ‘Physical Uplink Shared Channel (PUSCH)’

7.2.6 The Downlink Shared Channel (DSCH)

The downlink shared channel is mapped onto one or several PDSCH, see subclause 5A.3.7 ‘Physical Downlink Shared Channel (PDSCH)’

7.2.7 The High Speed Downlink Shared Channel (HS-DSCH)

The high speed downlink shared channel is mapped on one or several HS-PDSCH, see subclause 5A.3.9.

7.2.7.1 HS-DSCH/HS-SCCH Association and Timing

The HS-DSCH can be associated with a number of High Speed Shared Control Channels (HS-SCCH). In a multi-frequency HS-DSCH cell, HS-DSCH may be mapped on HS-PDSCHs on one or more carrier in CELL_DCH state and on only one carrier in CELL_FACH, CELL_PCH and URA_PCH state for UE supporting multi-carrier HS-DSCH reception configured by higher layers. HS-DSCH transmission on each carrier is associated with a HS-SCCH subset and the number of HS-SCCHs in one HS-SCCH subset can range from a minimum of one HS-SCCH ($M=1$) to a maximum of four HS-SCCH ($M=4$). All the HS-SCCH subsets for one UE constitute a HS-SCCH set. For UE not supporting multi-carrier HS-DSCH reception, only one HS-SCCH subset is allocated by higher layers. All relevant Layer 1 control information is transmitted in the associated HS-SCCH i.e. the HS-PDSCH does not carry any Layer 1 control information.

The HS-DSCH related time slot information that is carried on the HS-SCCH refers to the next valid HS-PDSCH allocation, which is given by the following limitation: The indicated HS-PDSCH shall be on the sub-frame next to the HS-SCCH carrying the HS-DSCH related information. The HS-DSCH related time slot information shall not refer to two subsequent sub-frames but shall always refer to the following sub-frame, as illustrated in figure 24. Note that the figure only shows the HS-SCCH that carries the HS-DSCH related information for the given UE and that DwPTS and UpPTS are not considered in this figure. In case of multi-carrier HS-DSCH reception, the timing for HS-DSCH transmission on each carrier and its associated HS-SCCH applies the same rule.

When the indicated HS-PDSCH includes TS0, the timing between HS-SCCH and HS-PDSCH including TS0 is defined as: HS-SCCH is sent in the n -th sub-frame while HS-PDSCH is sent in the $(n+1)$ -th sub-frame, where the included TS0 is sent in TS0 of the $(n+2)$ -th sub-frame.

For the semi-persistent HS-DSCH resources, the timing between HS-SCCH and the first HS-PDSCH applies the rule that, if the HS-SCCH is transmitted in subframe N , then the first HS-PDSCH is transmitted in subframe $N+2$, as illustrated in figure 24A. Once the semi-persistent resources are assigned to UE, UE can use these resources continuously until the semi-persistent resources have been released or reconfigured by Node B or RNC.

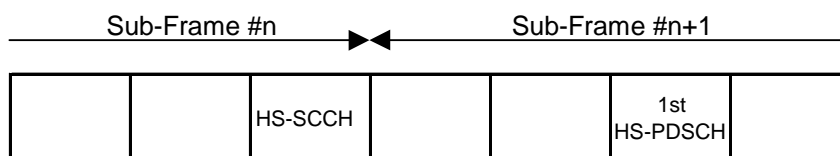

Figure 24: Timing for HS-SCCH and HS-DSCH for different radio frame configurations for a given UE

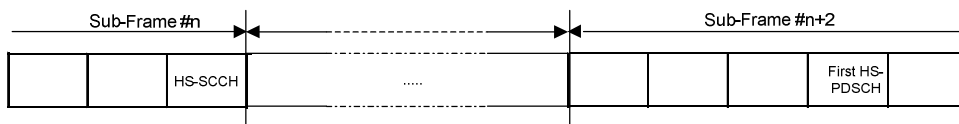

Figure 24A: Timing for HS-SCCH and first semi-persistent HS-DSCH for different radio frame configurations for a given UE

7.2.7.2 HS-SCCH/HS-DSCH/HS-SICH Association and Timing

The HS-SCCH is always associated with one HS-SICH, carrying the ACK/NACK and Channel Quality information (CQI). The association between the HS-SCCH in DL and HS-SICH in UL shall be pre-defined by higher layers and is common for all UEs. For the HS-DSCH semi-persistent scheduling operation, the associated HS-SICH to the HS-DSCH is conveyed by HS-SICH Indicator on HS-SCCH.

The UE in CELL_DCH state and in CELL_FACH state with a dedicated UE identity shall transmit the HS-DSCH related ACK / NACK on the next available associated HS-SICH with the following limitation: There shall be an offset of $n_{HS-SICH} \geq 9$ time slots between the last allocated HS-PDSCH (in time) and the HS-SICH for the given UE. DwPTS and UpPTS shall not be taken into account in this limitation. Hence, the HS-SICH transmission shall always be made in the next but one sub-frame, following the HS-DSCH transmission, as illustrated in figure 25. Note that the figure only shows the HS-SICH that carries the HS-DSCH related ACK / NACK for the given UE and that DwPTS and UpPTS are not considered in this figure. In case of multi-carrier HS-DSCH reception, the timing for HS-DSCH transmission on each carrier and its related HS-SICH applies the same rule.

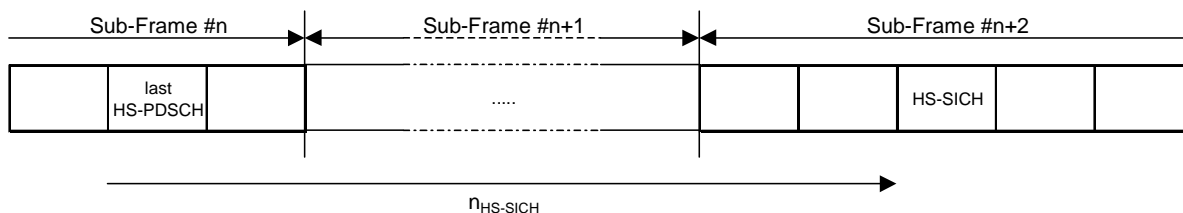

Figure 25: Timing for HS-DSCH and HS-SICH for different radio frame configurations for a given UE

When the indicated HS-PDSCH includes TS0, the timing between HS-PDSCH including TS0 and HS-SICH is defined as: HS-PDSCH is sent in the n-th sub-frame while HS-SICH is sent in the (n+2)-th sub-frame, where the included TS0 is sent in TS0 of the (n+1)-th sub-frame and there shall be an offset of $n_{HS-SICH} \geq 9$ time slots between the last allocated HS-PDSCH (in time) and the HS-SICH.

There shall be an associated HS-SICH for the HS-SCCH command for allocation or release of the semi-persistent HS-PDSCH resources and HS-SCCH command for activation or deactivation of DRX. There shall also be an associated HS-SICH for HS-SCCH type1 or HS-SCCH type 4 or HS-SCCH type 8 with transport block size information set to all zeros. There is no associated HS-PDSCH in these cases. The timing between the HS-SCCH and the HS-SICH for the given UE as illustrated in figure 25A. The UE shall transmit the HS-SCCH related ACK on the next available associated HS-SICH with the following limitation: There shall be an offset of $n'_{HS-SICH} \geq 14$ time slots between the HS-SCCH (in time) and the HS-SICH for the given UE. DwPTS and UpPTS shall not be taken into account in this limitation.

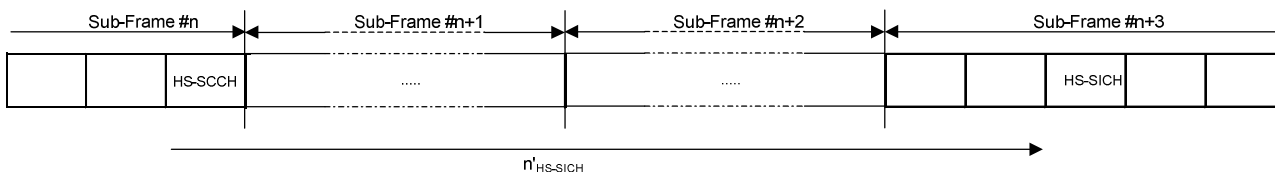

Figure 25A: Timing for HS-SCCH and HS-SICH for different radio frame configurations for a given UE

When HS-SCCH is allocated in TS0, the timing between HS-SCCH for the HS-SCCH command and the associated HS-SICH is defined as: HS-SCCH is sent in the n-th sub-frame while HS-SICH is sent in the (n+3)-th sub-frame.

7.2.7.3 PICH/HS-SCCH/HS-DSCH Association and Timing

When the UE in CELL_PCH state with a dedicated UE identity detects the PICH identifying DCCH/DTCH/BCCH transmission, the UE shall receive the corresponding HS-SCCH subframes. The association and timing between PICH and HS-SCCH is depicted in figure 25A. If a paging indicator in a certain PICH block is set to '1' it is an indication that UEs associated with this paging indicator shall read their corresponding HS-SCCH in the M frames where M is Reception window size configured by higher layers. The value $N_{GAP} > 0$ of frames between the end of the PICH block and the beginning of the HS-SCCH is configured by higher layers. Note: for DCCH/DTCH transmission, HS-SCCH shall be HS-SCCH order; while for BCCH transmission, the association and timing between HS-SCCH and HS-DSCH is the same as described in subclause 7.2.7.1.

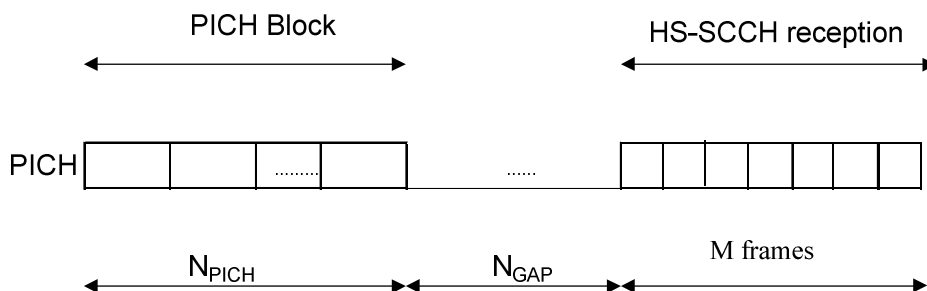

Figure 25A: Timing for PICH and HS-SCCH for different radio frame configurations for a given UE

7.2.7.4 PICH/ HS-DSCH Association and Timing

When the UE in URA_PCH or CELL_PCH state without a dedicated UE identity detects the PICH identifying PCCH transmission, the UE shall receive the corresponding HS-DSCH TTIs. The association and timing between PICH and HS-DSCH is depicted in figure 25B. If a paging indicator in a certain PICH block is set to '1' it is an indication that UEs associated with this paging indicator shall read their corresponding sub-channel and consider that paging message is retransmitted in $2 * m$ subframes where m denotes Paging Sub-Channel Size configured by higher layers which is the number of frames that each paging sub-channel occupies. The value $N_{GAP} > 0$ of frames between the end of the PICH block and the beginning of the HS-DSCH is configured by higher layers.

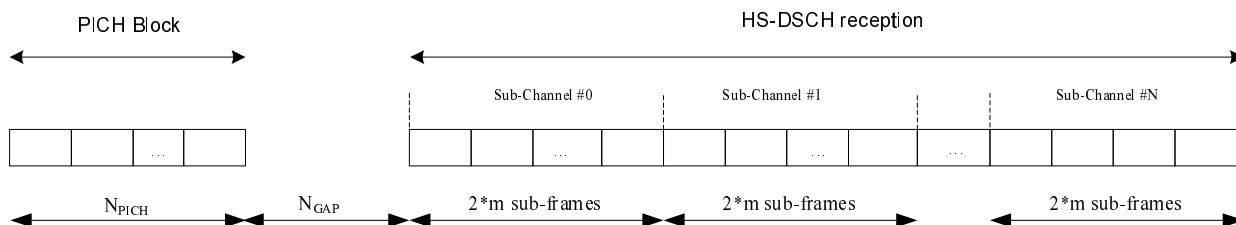

Figure 25B: Timing for PICH and HS-DSCH for different radio frame configurations for a given UE

8 Mapping of transport channels to physical channels for the 7.68 Mcps option

This clause describes the way in which transport channels are mapped onto physical resources, see figure 26.

Transport Channels	Physical Channels
DCH	Dedicated Physical Channel (DPCH)
BCH	Primary Common Control Physical Channel (P-CCPCH)
FACH	Secondary Common Control Physical Channel (S-CCPCH)
PCH	
RACH	Physical Random Access Channel (PRACH)
USCH	Physical Uplink Shared Channel (PUSCH)
DSCH	Physical Downlink Shared Channel (PDSCH)
	Paging Indicator Channel (PICH)
	MBMS Indication Channel (MICH)
	Synchronisation Channel (SCH)
HS-DSCH	High Speed Physical Downlink Shared Channel (HS-PDSCH)
	Shared Control Channel for HS-DSCH (HS-SCCH)
	Shared Information Channel for HS-DSCH (HS-SICH)
E-DCH	E-DCH Physical Uplink Channel (E-PUCH)
	E-DCH Random Access Uplink Control Channel (E-RUCCH)
	E-DCH Absolute Grant Channel (E-AGCH)
	E-DCH Hybrid ARQ Indicator Channel (E-HICH)

Figure 26: Transport channel to physical channel mapping

8.1 Dedicated Transport Channels

8.1.1 The Dedicated Channel (DCH)

Mapping of dedicated transport channels to physical channels is identical to 3.84Mcps TDD cf. [6.1 Dedicated Transport Channels].

8.1.2 The Enhanced Uplink Dedicated Channel (E-DCH)

The enhanced uplink dedicated channel is mapped on one or several E-PUCH, see subclause 5B.4.12.

8.1.2.1 E-DCH/E-AGCH Association and Timing

The E-DCH is always associated with a number of E-DCH Absolute Grant Channels (E-AGCH) and with one or two hybrid ARQ indicator channels (E-HICH). A grant of E-DCH transmission resources may be transmitted to the UE on

any one of the associated E-AGCH. All relevant Layer 1 control information related to an E-DCH TTI is transmitted in the associated E-AGCH and one of the E-HICHs.

The E-DCH related time slot information that is carried on the E-AGCH refers to the next valid E-PUCH allocation, which is given by the following limitation: There shall be an offset of $n_{E-AGCH} \geq 6$ time slots between the E-AGCH carrying the E-DCH related information and the first indicated E-PUCH (in time) for a given UE. The E-DCH related time slot information shall not refer to two subsequent radio frames but shall always refer to either the same or the following radio frame, as illustrated in figure 27. Note that the figure only shows the E-AGCH that carries the E-DCH related information for the given UE.

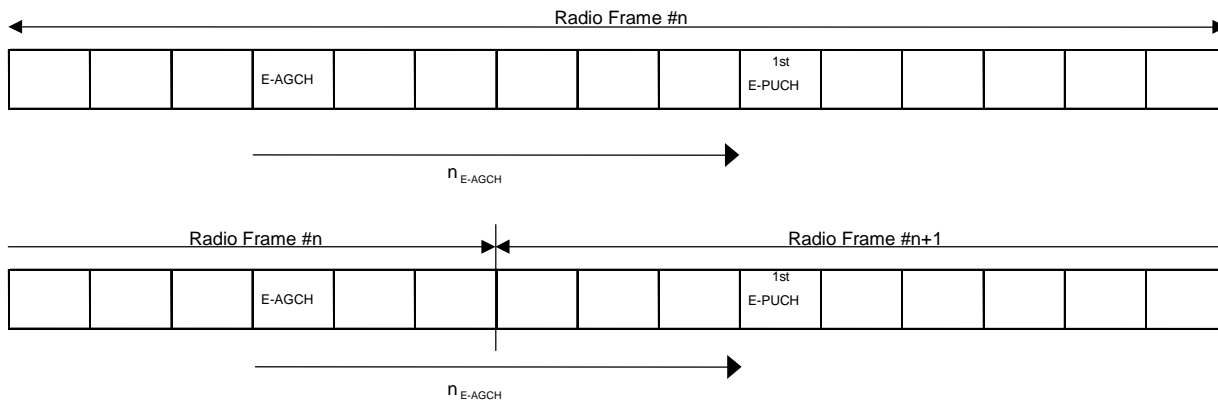

Figure 27: Timing for E-AGCH and E-DCH for different radio frame configurations for a given UE

8.1.2.2 E-DCH/E-HICH Association and Timing

E-DCH operations within the cell are associated with one or two channelisation codes carrying E-HICH (E-HICH₁ and E-HICH₂). If the number of timeslots configured for E-DCH use is 7 or more (this corresponds to the length of the timeslot resource related information field on E-AGCH – see [7]), both E-HICH₁ and E-HICH₂ channelisation codes shall be configured by higher layers, otherwise only the channelisation code E-HICH₁ is configured.

A single instance of E-HICH₁ (and E-HICH₂ if configured) channelisation codes exist in the cell per E-DCH TTI (10ms). For a given UE, a HARQ acknowledgement indicator is synchronously linked with the E-DCH TTI transmission to which it relates. There is thus a one-to-one association between an E-DCH TTI transmission and its respective HARQ acknowledgment indicator on one of the associated E-HICHs.

For each channelisation code carrying E-HICH, the associated instance shall be the first instance of that channelisation code to occur after n_{E-HICH} timeslots have elapsed since the start of the last E-PUCH of the corresponding E-DCH TTI (see examples of figure 28). The value of n_{E-HICH} is configurable by higher layers within the range 4 to 44 timeslots.

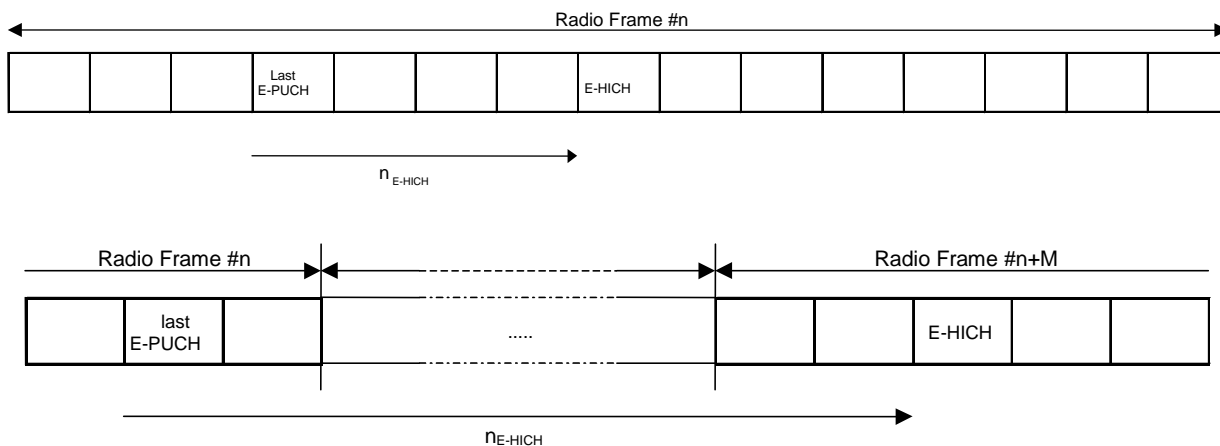

Figure 28: Timing for E-DCH and E-HICH for a given UE

The HARQ acknowledgement indicator associated with an E-DCH transmission is transmitted using one of 240 signature sequences carried by one of the associated E-HICH channelisation codes. Which signature sequence $r = 0, 1, 2, \dots, 239$ and (in the case that two channelisation codes are configured for E-HICH) which channelisation code is used are calculated for each E-DCH resource allocation using the following information signalled on the associated E-AGCH:

- t_0 is the bit position ($1 \dots n_{\text{TRRI}}$) of the first active timeslot in the timeslot resource related information bitmap (see [7]) on E-AGCH and where bit position 1 corresponds to the lowest-numbered timeslot
- q_0 is the allocated channelisation code index ($1, 2, 3, \dots, Q_0$)
- Q_0 is the spreading factor of the allocated uplink channelisation code

The value r' is first calculated as:

$$r' = 32(t_0 - 1) + (q_0 - 1) \frac{32}{Q_0}$$

Then:

- if $r' \leq 239$, $r = r'$ and channelisation code E-HICH₁ is used
- if $r' > 239$, $r = (r' - 240)$ and channelisation code E-HICH₂ is used.

8.2 Common Transport Channels

8.2.1 The Broadcast Channel (BCH)

The mapping of the broadcast channel (BCH) to physical channels is identical to 3.84Mcps TDD cf. [6.2.1 The Broadcast Channel (BCH)].

8.2.2 The Paging Channel (PCH)

The mapping of the paging channel (PCH) to physical channels is identical to 3.84Mcps TDD cf. [6.2.2 The Paging Channel (PCH)].

8.2.3 The Forward Channel (FACH)

The mapping of the forward access channel (FACH) to physical channels is identical to 3.84Mcps TDD cf. [6.2.3 The Forward Access Channel (FACH)].

8.2.4 The Random Access Channel (RACH)

The mapping of the random access channel (RACH) to physical channels is identical to 3.84Mcps TDD cf. [6.2.4 The Random Access Channel (RACH)].

8.2.5 The Uplink Shared Channel (USCH)

The mapping of the uplink shared channel (USCH) to physical channels is identical to 3.84Mcps TDD cf. [6.2.5 The Uplink Shared Channel (USCH)].

8.2.6 The Downlink Shared Channel (DSCH)

The mapping of the downlink shared channel (DSCH) to physical channels is identical to 3.84Mcps TDD cf. [6.2.6 The Downlink Shared Channel (DSCH)].

8.2.7 The High Speed Downlink Shared Channel (HS-DSCH)

The high speed downlink shared channel is mapped on one or several HS-PDSCH, see subclause 5B.4.8.

8.2.7.1 HS-DSCH/HS-SCCH Association and Timing

The HS-DSCH/HS-SCCH association and timing is identical to 3.84Mcps TDD cf. [section 6.2.7.1 HS-DSCH/HS-SCCH Association and Timing] with the exception that the number of HS-SCCHs that are associated with an HS-DSCH for one UE can range from a minimum of one HS-SCCH ($M=1$) to a maximum of eight HS-SCCH ($M=8$).

8.2.7.2 HS-SCCH/HS-DSCH/HS-SICH Association and Timing

The HS-SCCH/HS-DSCH/HS-SICH association and timing is identical to 3.84Mcps TDD cf. [6.2.7.2 HS-SCCH/HS-DSCH/HS-SICH Association and Timing].

Annex A (normative): Basic Midamble Codes for the 3.84 Mcps option

A.1 Basic Midamble Codes for Burst Type 1 and 3

In the case of burst type 1 or 3 (see subclause 5.2.2) the midamble has a length of $L_m=512$, which is corresponding to: $K'=8$; $W=57$; $P=456$.

Depending on the possible delay spread timeslots are configured to use K_{Cell} midambles which are generated from the Basic Midamble Codes (see table A.1)

- for all $k=1,2,\dots,K$; $K=2K'$ or
- for $k=1,2,\dots,K'$, only, or
- for odd $k=1,3,5,\dots,\leq K'$, only.

In the beacon slot # k , where the P-CCPCH is located, the number of midambles $K_{Cell}=8$ (cf section 5.6.1). In all of the other timeslots that use burst type 1 or 3, K_{Cell} is individually configured from higher layers.

Depending on the cell size midambles for PRACH are generated from the Basic Midamble Codes (see table A.1)

- for $k=1,2,\dots,K'$ or
- for odd $k=1,3,5,\dots,\leq K'$, only.

The mapping of these Basic Midamble Codes to Cell Parameters is shown in TS 25.223.

Table A.1: Basic Midamble Codes m_p according to equation (5) from subclause 5.2.3 for case of burst type 1 and 3

Code ID	Basic Midamble Codes m_{PL} of length $P=456$
m_{PL0}	8DF65B01E4650910A4BF89992E48F43860B07FE55FA0028E454EDCD1F0A09A6F029668F55427253FB8A71E5EF2EF360E539C489584413C6DC4
m_{PL1}	4C63F9BC3FD7B655D5401653BE75E1018DC26D271AADA1CF13FD348386759506270F2F953E93A44468E0A76605EAE8526225903B1201077602
m_{PL2}	8522611FFCAEB55A5F07D966036C852E7B15B893B3ABA9672C327380283D168564B8E1200F0E2205AF1BB23A58679899785CFA2A6C131CFDC4
m_{PL3}	F58107E6B777C221999BDE9340E192DC6C31AB8AE85E70AA9BBEB39727435412A5A27C0EF73AB453ED0D28E5B032B94306EC1304736C91E922
m_{PL4}	89670985013DFD2223164B68A63BD58C7867E97316742D3ABD6CDBA4FC4E08C0B0CBE44451575C72F887507956BD1F27C466681800B4B016EE
m_{PL5}	FCDEF63500D6745CDB962594AF171740241E982E9210FC238C4DD85541F08C1A010F7B3161A7F4DF19BAD916FD308AB1CED2A32538C184E92C
m_{PL6}	DB04CE77A5BA7C0E09B6D3551072B11A7A43B6A355C1D6FDCF725D587874999895748DD09832ABC35CEC3008338249612E6FE5005E13B03103
m_{PL7}	D2F61A622D0BA9E448CD29587D398EF8CDC3B6582B6CDD50E9E20BF5FE2B3258041E14D60821DC6725132C22D787CD5D497780D4241E3B420D
m_{PL8}	7318524E62D806FA149ECC5435058A2B74111524B84727FE9A7923B4A1F0D8FCD89208F34BE E5CADEB90130F9954BB30605A98C11045FF173D
m_{PL9}	8E832B4FA1A11E0BF318E84F54725C8052E0D099EF0AF54BC342BEE44976C9F38DE701623C7BF6474DF90D2E222A4915C8080E7CD3EC84DAC
m_{PL10}	CFA5BAC90780876C417933C43103B55699A8AD51164E590AF9DA6AF0C18804E1F74862F00CE7ECC899C85B6ABB0CAD5E50836AD7A39878FE2F
m_{PL11}	AD539094A19858A75458F1B98E286A4F7DC3A117083D04724CBE83F34102817C5531329CDB437FFF712241B644BDF0C1FEC8598A63C2F21BD7
m_{PL12}	BEB8483139529BDE23E42DA6AB8170DD0BFBB30CE28A4502FAF3C8EDA219B9A6D5B849D9C9E4451F74E2408EA046061201E0C1D69CF48F3A94
m_{PL13}	C482462CA7846266060D21688BA00B72E1EC84A3D5B7194C8DA39E21A3CE12BF512C8AAB6A7079F73C0D3E4F40AC555A4BCC453F1DFE3F6C82

Code ID	Basic Midamble Codes m_{PL} of length $P=456$
m_{PL14}	9663373935FD5C213AC58C0670206683D579D2526C05B0A81030DDF61A221D8A68EAD8D6F7AA0D662C07C6DCCD0115A54D39F03F7122B0675AC
m_{PL15}	387397AE5CD3F2B3912C26B8F87CE82CEFEC55507DB08FB0C4CF2FD6858896201ACA7264281D0298440DD3481E5E9DDB24C16F30EB7A22948A
m_{PL16}	AFE9266843C892571B6230D808788C63B9065EA3BDFF687B92B8734A8D7099559FEA22C9416576D0C087EB4503E87E356471B330182A24A3E6
m_{PL17}	6E6C550A4CB74010F6C3E0328651DF421C456D9A5E8AE9D3946C10189D72B579184552EE3E799970969C870FE8A37B6C4BA890992103486DC0
m_{PL18}	D803CA71B6F99CFB3105D40F4695D61EB0B62E803F79302EE3D2A6BF12EA70D304B181E8B38B3B74F5022B67EB8109808C62532688C563D4BE
m_{PL19}	E599ED48D01772055DBE9D343A4EA5EABE643DA38F06904FC7523B08C4101F021B199AF759A00D9AC298881D79413A77470992A75C771492D0
m_{PL20}	9F30AC4162CE5D185953705F3D45F026F38E9B5721AEFE07370214D526A2C4B344B508B57BF B2492320C05903C79CBEE08C6E7F218B57E14D6
m_{PL21}	B5971060DA84685B4D042ED0189FAF13C961B2EF61CC164E363B22AAB14AC8AF607906C1C6E04F2054C687AA6741A9E70639857DA02B6FFFFA
m_{PL22}	97135FC2226C4B4A5CBA5FCA3732763B87455F73A1148006F3DF214BD4C936D061E04045160E2CE33B9CD09D08FDE2A37F4E998322B4401D27
m_{PL23}	4D256D57C861B9791151A78D5299C56D116B6178B2A2D04BB95FB76540AF28341DC6EC4E7E D3BF9E508478D9C8F44914805DA82429E1CF320E
m_{PL24}	858EF5C84CE32D18D9ABA110EEA7474CF0CD70254D2928C3F4DFF6BB3A518587CADA19029078AC90A8336C8178203BE3289E601F07D089CB64
m_{PL25}	920A8796A511650AEF32F93DD3C39C624E07AE03CE8C96139973F54DCB9803C5164ADB502D4FF561564D607037FCD172921F1982B102C3312C
m_{PL26}	485C5DAE76B360A9C56E20B8422EA3E6ACF07CB093B5587CB0E6A5498A4714081EA98DBCD B0482B26E0D097C03444473D233BEF3C8E440DEBF
m_{PL27}	565A9D54EA789892B024F97E728E8EE112411942C48BD0C5BC8AA457D8DC9941F0F7424B38643FFE6521CD306FBC56FE10F1428D4C245B5606
m_{PL28}	5AEF2C0C2C378179A1AC36242E6B3EDB72C42D3624437674F8D51260C0898C201837CBA14E9E23D1EF6451C4ACF27AB031F457A8A1BFD148AE
m_{PL29}	87D8FE685417822A23D925307E6C11081ADAC4702BCCD9BE448E78984D109B50DEF5B7C58B C71EA1F0A6826BA8AD1978843E7697F3E416AADA

Code ID	Basic Midamble Codes m_{PL} of length $P=456$
m_{PL30}	84802B72AF27B5BE724D1FB629E0E627BDB0D9061292562F98350C1D0C9D4B9D8E2BF71123C82EBB161003AE9829E07244D78F19926F8847A2
m_{PL31}	8CCB5128238BCB088E30972D62792AEF02B9BBDDCAD68C9916C00BF91CBE788B0F03851FAAF88605534FD73436C259D270B1013CB14226F658
m_{PL32}	62F4E6FAC2BF1979CE6854AA2D33534BFB2F946519101A6589131C3640707D40E67ED804AF8736AD213CAF5935741900061967E8285C27E34C
m_{PL33}	4095E5B4EEAFCD68A34B267EEA28D8444FA533900F41499E260D2E65C256A52E1DD5861F5227C98E00687D107233F51A1167BCF72FB184654
m_{PL34}	5630E9A79FCAD303404D9E5A802299162657AAC734761C6E90DA8BCE4F61A763E0BB48D3FEB3F78468C828ABA4828DAD06E0F904CFD40421DC
m_{PL35}	CD12B24C0BCA8AAC1FCBF050A3BC684A180E863D888F2506B48C68ECF17F76CB285991FBA18EB6397211FAD002F482D57A258CD45DE3FF1A6
m_{PL36}	AFCF2A50877286CD3405442730C45514F082D9EC296B367C0F64F04C4E0007DCA9E50BEED5C102126E319ACBC64F1729272F2F72C9397029FE
m_{PL37}	18F89EE8589D20882A72A44DCDF0050FOA3D88DBA6531614973D26905FDF41E3F779FF0648E8AF1540928511BCF4C25D9C64AF34AC31B8965
m_{PL38}	F890D550F33F032ECD3A51FED427D634F64EB29AF1332A23CD961258E4BAED040E7B336918E250EC272A12816B9EBFFA1E0AE401185F08C10
m_{PL39}	ACE5DD61506047E80FB7D41BD3992DF4D7F18EB46CC145C0E9105428C2F8F299141F5D66691904A7DC2513A3B83994ACB1292246B32818FE9D
m_{PL40}	150680FF900C9B46E1E24D54BE2238CB950A934E5CCDE9BC3939EB51CB0AE202B7D339EEC2018B33A0AB9B63DA5D512D64FB58C0E51A1C82C2
m_{PL41}	51A579EED2663A002D32D10A0753173612F4D5BA167D1807C61F25C4D42C063682E8E9DD019F79D446A046EB3F75E50FEB22DC52F08E694B6
m_{PL42}	CDC644FE4C0C6897604F9D14D714123BF16FFF0E49F35F674908CA60653702FE27BCCA2A47098453AF8661055C8C549EB6A951A8396AD4B94D
m_{PL43}	750A10366C595373C5001CA3E4239764B1409D602CF6052B39BC6A3255A15FE06C782C4C5F847026A7E79838A2933A61C77BB6CBF5915B2DA5
m_{PL44}	B7490686D78E409082C4C48FE18D4C35429C20AADF96076B92FC4E85490664753DB0891A0B27FD849BB7FCA99E3B38F22F8C662852C0D35AA6
m_{PL45}	D86E1B575B47D23DA811806A54C231281F03317830E7BD305D3CAA7D6382A5233104CFD54D22DF9F34535E5B390D9040CF1375FEA44CEC29E2
m_{PL46}	828655960C026EC67B683480992AC2ED2C43ABC606F5220C2945F373470BE7ED5BCCF7C1AA0986BBCC84F11F1658AA568FAA0A60C5F0B5BFA
m_{PL47}	D76230E02C8533653AAB99B288AA2ADE25A1C1BF28516C04239240EAF1EFC0B98974B51F886861D8A1E9F5D62CFFEC309F071A9716B325101B
m_{PL48}	EA207662865B8A07D69648964DED818EE474A90B94473408871880E63EF0596B9FCFEC3C06B86EA6AD2B06C91672EFB33C70241A5450B59B8A
m_{PL49}	9CB5459549909835FAB22F0D99298C120ACF479F814CCE749079D40688F28101037762F125C776DA9C5FA1FCE0E76E452F8185354FDCDE94E2
m_{PL50}	227506304AEC1D6F93569B51FDC3405A0F38194F65BE17163A3CB9827A35AECEA757D020FE249377ECD561428A38FEED004EC859C272563185
m_{PL51}	96B9AEC9938910F0E533422A3977519B05CD4AD3909BC15A7502D48D49C124FA192A8E57027CFEB11DF542010603CE5C9FDF8E626D4FBF8CF4
m_{PL52}	A6AAD06E095A9BE0BD9F8A2ED40C3CBDBAE91C700CBB778C8696CC06F3A675C16BDB2918E5F2111005A8727206DC6A9684E05655185C398EEB
m_{PL53}	CD168D384A78DA172991AD333EE2A9880905AFE59E2A2A4AC4414C40F82874F98A3CBE7B44F4C7F4710B35FD88AFC0399FAEB070EB9CA4D30A
m_{PL54}	22016CA87AD1549174A8699DD65599697871091457E83E0912E7E77A06531C209394D283D18A38662B73681DD9C5BF330FED978BDA7D487CA8
m_{PL55}	B9401B0843AA6F7827A13BD66C92287E8886C31EB5B90B82B472CCD6DA3D8D4FBBF78B8F8496DFA8252B06429D5DD17142F1C908ACCD70EA0C
m_{PL56}	E42B9EFDC5D09AC27B3C7DA28D02493A70521223B9D7A76A9D13E9C171017964D16A70C08EAD02C3DC948889C23E365AFCF01BF20B89B0BF5C
m_{PL57}	9DA0180168DB915E9F3597B59312198E1B5CC00D743C2ECB0DBAADA3E35A2465ED1EAA9D74734D49A313CE4DFF020D0760E3153DC485603943
m_{PL58}	B6C966619ECB98191D719C187C07BD503425650CAA3A2D1F2DF5212B1441D7A0C1D36A4C9C2550240AD17CA43BB3943DFFFBF1E283D81299CC
m_{PL59}	DB0E8C41F08A03D477C1AA548799274C4BF3EB68F2636166FDC8D4B1E7132539930297E228BA232BB5C279FA5ECA3AC10E24361AF050A453B8
m_{PL60}	89BCE2DE2974EEBA833CF32F224C85A2891484478527DB48FA6ECEA84C5E288CC3914CB54ADA0476278750187F68FBEA41017E1E58DF1A5A3D
m_{PL61}	70A457D1314A278625443EEB52520815EC92CEF17417B97440DCB531BC1CE83212F63270418D0FBDE71F6DB9E0EA88772E1E4535B6633E4425

Code ID	Basic Midamble Codes m_{PL} of length $P=456$
m_{PL62}	C388460AD54B36C4452CF0433BD347100ACCC24C79C535AD3E1F23FE0425E93A044C553BFA116E09AA4BB32F13CFA76FBA1BC17520F45EFD44
m_{PL63}	0BAFCADCDF9AA2846681782CD3B90CA036A863C78EE1507620BC394D0C6804B4C97A15BC9C0D7B79E6892EA1BFF1A0DD9573A9213AB140D0D2
m_{PL64}	833B0226789A62882FCD27A30885E67872B1A1C2FA484AD498011599DD57E8E2A07A560B47167AA5F60EF47177DBB1632D5387A2896348640B
m_{PL65}	8F52820323ABA5E6C6B465821B621600B980E59F53A599DA5646BA103214336836CF17E3386CE4FB2BC5F25CCB30CF7F500546828EC8786B8E
m_{PL66}	E2E9A29C3C8207B9A4508FD2F667A159F068EEE8D00686F46EA904C3692C1D79DFF1B32E5103720D47B4B58AC35384A26087027E141B3126A8
m_{PL67}	70E7C39FD2D3AE1DCE341699A544D801A8688A6EE47C5CB3630022147DDC06241FC5337A348A462B2472DEC5E104DD520ADA5114DB065D4B0D
m_{PL68}	9E3483CAB164BD053C4971D4D87494CC689033D589EF80E5453376E4A8DCC02183B98C36B0FF7DDC0AD07FCE8B4D5164371BD03A2110AD1247
m_{PL69}	04DA1C649B0608938DAADD3FE920A4F681690C54505429DBDCDCF10067AB5714BCDDFE1F28692710F794765781C1D233344E119BEE8A8416DC
m_{PL70}	7A18D6D30BDF44410714C3DCA27D8F9EA8A542D87122205640B98313C91AD9A0B993A5A7BC3E035F93B88BBE6D4204BC82A9FA8D4C1A7618CF
m_{PL71}	EB9525E10265A48733C8E0E77E459310112A71DCA680F68AC044B64BC0A31D02EEA0F7ACAAAB7F1E574E94FEA2D1301CB14B03263DA8122B76
m_{PL72}	E706C6ED2D6F89153835079BE0C6D45310845EF2F9F6C6AE91B7419810508BA501C0148BF09955BAD90D6391BA8EBA5CEFB23221CC75143D7
m_{PL73}	DF071A10AC4120CD1431590BEDCFF9483CA7047B19590D035D309240BDB4264E9A3A2761402EC97FD8BC51B4AF32E37FBC47162A2357D18751
m_{PL74}	F0F952B2238139F46D8254D1A2C1C22A16BA71EC0C0C900ED1442452D7F44C798BC65FF40671B88074BA0B74C6510996EEAC495C5B49C37DEB
m_{PL75}	1C86BD82EDA81FD65418D3837B5552A853791456D93B06C62C650D86CFBEC269AFFD772763064062C03751B9428C6DA2E60383025F9E404B70
m_{PL76}	B390978DD2552C88AABA7838489A6F5A8E9C41E95FFA2215819BF8A5BFE39C8A706CC658E549E966611B843A1468406C41C09D1560BEDA4F1B
m_{PL77}	1A69EC9D053C7E84BAE7A48CCC71857D0C6B06D1065E3EA4633B133AA022B8104F6EE7C69B6184B746C8822958B0A16686F27C8A0E3B4EFEAD
m_{PL78}	C95B2070816DC97C6D8DD2583263E73F9AAAFD13F0548D2EBD835824418F11E54111005FB713AB234BE412347358281C7DE331EDD21B8BEA52
m_{PL79}	56D6408399F23C2ED85EE0F68111D69A91A3AD9A732AC57CA08F86CC28B3CF4E4B02EBBA0BCE5CAE5BACC4D52004070797C04093A84BB18DBA
m_{PL80}	E662E7043867BE250764DA0596D34A582A619B408B505E6211DD6286E93A37F95B1EA680C0C5F3E777E3F71E8D75495D59043217FC0E222E16
m_{PL81}	27D5E681C222297AD478A079EF12F1A98F744B66335303322EF8880B931FEBF8322F4302944E80BED468A0A516D410B183D863795992DA7DDB
m_{PL82}	5100336C05F9E5BF35201906C1C588858E0DAF56130DF5554B9AB21CA15311A90290624CD63E03F5EDA49DB7A0C32AB5F1CA427A2D5635FDA5
m_{PL83}	C696DC993BFAEA9A61B781B9C5C3F5CFAA4C8339D8B03A9B0387883D0482A41AC78D6522425959846E561D26A30FF79A205C801A85889736B2
m_{PL84}	D562297561AFF42D3168296C1153E4E39BE7B2EB0348BC704625AA08391235075EE0DE0A79AB03222FEDB27218C56F96EAC2F91CC8FCE64B12
m_{PL85}	DD0B6768FC01CC0A551F8ACC36907129623E975AB8B3FF58037F1859E2FA8C62C2D9D1E8506916029A2C3F8CAD9A26AE2CC652F48800859F5C
m_{PL86}	923920696EB3AB413786C41854822282BB83F6900D33A232D470BE198BBF086067B72613300C593B74251E2F079857ADBBCD86583A9DCAA6DC
m_{PL87}	B8EF30C797D8D2C4EF11244F137D806E556A436626D0115A621C92C34D166A68BCEDFA0040DA8FD6F987B1CD5C2AA1C1B045E64475F0F8DABD
m_{PL88}	E1887001D414405ED6419E9EE1D1D346D924ED57ADF04B31B7948099976B2D1501A60DFFB287AD44C8783DF0C1EA5AA5D273D1389C8EA22DCC
m_{PL89}	8C2E379A58AA96748141CA84C35987905F984A49D3AD9BFF7807AC244C16C1DF74343C2E1F25514F5A0954CFBB3C92E25EF783136844998AC5
m_{PL90}	78F8A99E0A54E27F51C0726FE7A11EB26B1E29FE65F55AC8AC58011465900B958488A90F6DF614A58431DC8B6C6B9A6F032EE0E0B1306EC4B4
m_{PL91}	88F7A31B7B20E0F05CA26E729B4F8A1933962D7BD7BE3E1EB130B28C794C0B4D01CADE09006FF97E80117509733F3A9DC225413A0AE08CA662
m_{PL92}	BE4DFCEAC18905AC8D5DA27A794F88A4D3058D2EFA3B075A819DEAE688EAF8940A653ED7104E7B403D490F0A9030264E1F12B8922C75775E61
m_{PL93}	5BA4B79FC4550234D8922963BF3537485E3C8745A5DB90D3E2E454B30FF61112F508155B7C2B3C4C628AF846240C2021ACDE547E5A41F666B8

Code ID	Basic Midamble Codes m _{PL} of length P=456
m _{PL94}	00556D35649F7610AB24A43C4F16D6AC0571FD126F11880C5CD72100D730E4E4D6BB73C33F837FAF1072743B249ADA2E09598B1EB23F1180A7
m _{PL95}	7A0CC9F21BD69CF3023E944545C2176EF0D4F450B765C28359FB8A32137D043D0E5713E67B3F61320985D2C6106605081F87D2296321468A2F
m _{PL96}	DA669880995B0671201172BABFF141D5854A245E211879EF3038A7C84170DADBD368455F24653161E7886E15B253F93E3A3C568EFB17CDEB1A
m _{PL97}	4E294E53D1661C1F6F748302A7723DA951C00FDB8BE8BFF67A68710BA0F1A255DFB1627059D41A23D3961726DE6FEB10E5D209CC4505B209812
m _{PL98}	73385DF701414E144768A67EF72924B1653479E962FB1554B7E54BC5284D9B3E41C0C133F878972230721918AA425501B920B204FECE0C7F8A
m _{PL99}	F4492160805F258CE592DF4D1200566F81D173458D78EA3ABED79A14AF88170DB1D4A9A5931D2B80C58C27FE17D806E3E6A66CDAAD09F118D4
m _{PL100}	44D562D9012D8B07B8F44596467C11A163982BB7EAEAC184078B6B8CE46B5D7E17C39CEF576A025491183017FA09931D070B307B86524B03FF
m _{PL101}	FCAEEFC49A13B4FFA12C0CC6A2B90CF4F57D78B1E98294B04675C2F0991661FDC61A452A247F8C29E0284AA21026F368307375AA2C3F1E12C
m _{PL102}	C486DF0510DCAD5AB86E178A686D398E11A0ECFAC5A326C10129257E5456B22FB8E147E9190D9929A5DFFE44715FA47D62F04CFC9B1C201414
m _{PL103}	C10AF383DC708E257E15A8AB337BCE684A2F4AC7A22DC2C25C277F8E8D0858E79317CDDD9AA2EA6CBE604D24AC0945026103E7B4126FD361A4
m _{PL104}	A5C60A181148D9A931B2DDDB9D169648BA54F366B4EFAE88F6861909EE0F07C037EE349D0EC59A823286E366CA3943589EEA7F828C3728085F
m _{PL105}	96136AEBD5E28462B0421DF292BA899FFA660D80EA01620D2C7490E5347127884AA3C3D1FF44BCDEF6C29EC589CDEF200C5742C5964F8B2B52
m _{PL106}	40F63C04ACAD986255D1E16B769A6D4C11A1D075E804BDC0AC61923E9A67F5D7417756328072455F6E22B1C64E06F367D1B0808295C2D90E22
m _{PL107}	F4B82D413578C4888C5F002CF6D0E03778134A860436551FD57537E4CED334B3C9CEBACE615238271717AA762448B86FA53D2074BCE35658A7
m _{PL108}	BCCC92D72C920E685530591FC351743D1E23DE044BF81D32650406113E23ECC757FDE4E386B6E2E7195EE4969717A7BD0812AC312B33A54308
m _{PL109}	6ED59DE0D44370A861CE2B42CF5E578E764A682AB5777905EE027D7160490EDC6C28989B23805AA697FCD215CB401BC5E4D430624C01B16192
m _{PL110}	DE80C0E273B92CC3C5034F7A20DB3914643C430B425C8B9249EAF73ACE8C3BCF17957242CF534D87A67D4DC0252275262E737F4095450CFA14
m _{PL111}	9505C4FEF2A397D5059F4729D013292A8321FFFA929ACB0A210D0A13E13061227C44A68FBD8CE6B66CE3D783363CD039AB35EE52603E09B758
m _{PL112}	E8BE90D7F954B14D8002A4CAC20765ABEED80634498C836D79B0F9338DBC17B28F05CF4E79136779E1C55AA30B6215F890882887B3B53C23E2
m _{PL113}	9F4B622C1358AE5468DC31E4B2CA320E5E20458C1DE5405BF4F9AD7D45A5BCAA39EC0626FFFC698C16A009CCCB7A18A64E85E70BA71731BA24
m _{PL114}	B91B2624843CF48299AFC2B1442570B41F28F578530D1E322E0B54282372131C71ACB924E70768A243EEC3200E7A5EBFA77111D9FB07FEA8AE
m _{PL115}	965F42DDA3A4650FE2F5103932B68F166FA424B9F0F7045311D962C2A9F66B9BC6C66FB480F9800354E0C54A72251071422CF1DFC44F94C00C
m _{PL116}	08ADCE48699FC30FA0788073BDAADB9177BBB4C1CED41F93085218364B8BAD8488561EF0FE1B0DDAA403C602494CB35697D62AA0A2B93A64CF
m _{PL117}	9A313BED80B1220D77C8ADA4B2E0B3D284A5120A94B741380923C78D3AD32BC3E71EC6EEA520E9D447D8727697598BB987F17506F482003ABD
m _{PL118}	24C9AD4C14EFEC002A3473FCAB04E492F2E269161A2960BA8AF09FD710B444A40C4E8B138418E62301E91FBA97AFDC58759A76D00F676736C7
m _{PL119}	6514C7733711CE4942CD2123AB37186EB7FECB7E78ABB28744864942FCF4C0F810054AF55B1042EB53064F0857C61D85B2CF0D2DC5826AF22F
m _{PL120}	B2C80CDC83E48C36BC6FDAB8661208EAD392F3A0571BE41DFAD765E744932ADEA50061E66C05498A5381B2A1F1B446587089DC4E4A2DF03D82
m _{PL121}	639368BA75CC709A3D9F28EDA237E32C2017A9BF1E382045B9426AEE0A4049DCB4E1D7EBE4647B855212824557497CFA039885A3BA42F98F63
m _{PL122}	6A70DDC17D0C8024B1C853F0C1948561EF32510151BE0C63BCA9171F20217891D1021EE72586CAFF557F8973336913A9A2A699B8740B054B8
m _{PL123}	2E32E3A35CCD001172CE310B63B4E406126045A0FA3795BE3E3D9B56F72405FC94FD89946818BAECD24A61BABBBE2D23052AB01EF73CA0CF4A
m _{PL124}	829395C35205A480AC1351C25E234BF52D384A3DE1C5138A650A6F82F739757D812D9C38231AB9FD81AA0648B11F6F6113F9312C57624FC746
m _{PL125}	D98FFE19C0AAAAB0571A9075ECDFD3E7373F5255DC669116A8C6913F0123E598F930934C5F6A601C37C529C371A0C391B59AC5A9E286D04011

Code ID	Basic Midamble Codes m_{PL} of length $P=456$
m_{PL126}	C1A108192BCE96C2430A63C189BB33856BE6B8B524703FCB205DAEF37EF544CD43CA09B6181B417398083FF2F781BA4AE89A5CA291DB928D71
m_{PL127}	42568DF9F61849BF9E7DEE750604BE2E0BC16CC464B1CDE15015E01D6498E9F3E6D6950E5824651F212BA0057CE9529B9CCAB88D8136B8545E

A.2 Basic Midamble Codes for Burst Type 2 and 4

In the case of burst type 2 (see subclause 5.2.2) the midamble has a length of $L_m=256$, which is corresponding to:

$K'=3$; $W=64$; $P=192$.

Depending on the possible delay spread timeslots are configured to use K_{Cell} midambles which are generated from the Basic Midamble Codes (see table A.2)

- for all $k=1,2,\dots,K$; $K=2K'$ or
- for $k=1,2,\dots,K'$, only.

In all timeslots that use burst type 2, K_{Cell} is individually configured from higher layers.

In the case of burst type 4 (see subclause 5.2.2) the midamble has a length of $L_m=320$, which corresponds to:

$K=K'=1$; $W=128$; $P=192$.

Thus for burst type 4, K_{Cell} shall have a value of 1 and the midamble is generated from the Basic Midamble Codes (see table A.2).

The mapping of these Basic Midamble Codes to Cell Parameters is shown in TS 25.223.

Table A.2: Basic Midamble Codes m_p according to equation (5) from subclause 5A.2.3 for case of burst types 2 and 4

Code ID	Basic Midamble Codes m_{PS} of length $P=192$
m_{PS0}	5D253744435A24EF0ECC21F43AA5B8144FBDB348C746080C
m_{PS1}	9D7174187201B5CE0136B7A6D85D39A9DD8D4B00E23835E4
m_{PS2}	AE90B477C294E55D28467476C6011029CDE29B7325DF0683
m_{PS3}	BC8A44125F823E51E568641EC12A6C68EAFDFA2350E3233C
m_{PS4}	898B7317B830D207C9BC7B521D5715680824DC08347B2943
m_{PS5}	466C7482C8827655BC13F479C7C1417290679A9841297C4A
m_{PS6}	AC0734C27C7DC1B818A8492744290DFE866B0EBA62B0B56E
m_{PS7}	0A92106325B15A8C15FC3764724CE67A5056D50A77F9360E
m_{PS8}	AE69F62E23035083E6094B89493D33E06FDB6532D473A280
m_{PS9}	B485D4E3614C9C373EA1365FA6FA890E9844084EBA90EB0C
m_{PS10}	66182885E2D28360D2FEAB842C65304FFC956CE8DC8A90C7
m_{PS11}	CC30A9B0A742FCC1E9A408415368391F1299AEA3CB6509FE
m_{PS12}	673928915886947F464FDDAAD29A07D182328EBC5839089A
m_{PS13}	4418861C14D62B46EE6D70D4BF05A3ED801A01BD6CDC5235
m_{PS14}	DAD62DC88F52F2D140062C2330BE6540E6F86192322AFB04
m_{PS15}	A2122BAF24529CEA9855FB43CE40923E7CA7B30D92E40702
m_{PS16}	6C44AB41E11F54B0929DF65673BD231F92A380132D9F1712
m_{PS17}	1DC2742E756CDA6421340D0087DD087A615E4B8688CB2F75
m_{PS18}	2E0105328B56E9E07D9B5A62F38B08AF8D8C2817B54F3302
m_{PS19}	88315EC30A94CA4EDB2C77079D9BD810A2E280B50DABB213
m_{PS20}	440E0093D28CB2B2B0A95D18CEB4AB934C33FA45C1CFC7B0
m_{PS21}	CC9BF85D41A96A6EC314F9611D5E1C0672556C8850801BB4
m_{PS22}	1ABEA04C99BC26972715F01957C0B6B959CC71CD88120817
m_{PS23}	EC5A33DA0BA4470442C5CB324A8E47B0A9F7968FC8108EE8
m_{PS24}	F82086290271DB446B5B1DC15D9BE96414B19B3D5E0F540C
m_{PS25}	11A1A790D6958FD3A9157DF1E05D1378248CA201EBCC7592
m_{PS26}	AA8564882231907BCE78092DC6C9DD4F5A0E4A34AFCFB809

Code ID	Basic Midamble Codes m_{PS} of length $P=192$
m_{PS27}	912EE2238212F87BC7CDA7F30441ED184A6AA954EC4D20C8
m_{PS28}	2D200D8B8891B804673E380A1AF5AB875986E29D37D3FDC9
m_{PS29}	75E086B6C818423491BF9D6365C52FD1C5E42A576E268170
m_{PS30}	50ADBF27DA2A3701470186B699118E16DDB0D10F705607B1
m_{PS31}	656C0692B4E22023590A906D2A74DFD471C883A7B1E0B3A2
m_{PS32}	C21FDACD09A3CDCE74C4794010A3E45769B142505C56A0E6
m_{PS33}	CD9392A87C2D4D7CE5801CDDA8A76339B6F900F008B290E2
m_{PS34}	956426FEFD8B8D52073E87984E10C4D255064E1372C04A24
m_{PS35}	C4F4D6DF1B754AD6063FD10C331C1428ABB27B0700134B94
m_{PS36}	B65548082B34E9FAF43F33C4070F79099758CFD41B491A11
m_{PS37}	C8317EA111A82B04E78B88B864B1EF5D711BBEB4A0527036
m_{PS38}	8FB7AD1188E8D1A5219845013672560FD38904E70537403B
m_{PS39}	B41A324E0D80AA0598A8D391C1D7FFC82B4A075218E98EC3
m_{PS40}	49A6350A62E208B011E86528B9A481A0E76D723F6675FF82
m_{PS41}	C344C8C23C42A7B7442E6022E95AE4B08A4BFA786F35F911
m_{PS42}	28F430CF67D69C9DF60E25656413BC5F932A022DB1406C44
m_{PS43}	2FA5D70CF0FED4213F32116051450391C2A627D9B670C428
m_{PS44}	959537D988FDD4F1360B4E84701AE5409229C30EDF8BC404
m_{PS45}	CDD2E0450F9EC12F81391AD4633CB29F315B4A0A890A9A22
m_{PS46}	158776A20B482C563EC08F086830EA66DBD2DCCB4DF6026
m_{PS47}	431FCACBE48208975950342709D11F19AD5FB047F3B440C9
m_{PS48}	86B141AC571BA6B42653B12FF04D4F0E6C81F3EB608660A2
m_{PS49}	86D297ABD34E8510F6CDB0EA617F1F1051C8799117B02211
m_{PS50}	80B2D9530B34E781311D95CFA3857F277CC07014D324AF5A
m_{PS51}	2B607B93FD8B45601C1E574E14CFC6912C22AEC1045ADC49
m_{PS52}	D234C5C45E105A837E6DD74BC4E534523A20317BA0625A29
m_{PS53}	768CCDB3E2A7A2B863128382590946B25472BE2BFFC40641
m_{PS54}	3DA38212E0A987EE1F665D4E13C2AA4446E00A76C948A073
m_{PS55}	09173135E4A2CFC8F2678750AB5257110906F013587BDE82
m_{PS56}	522E070B266F35E99C1F3C42D2017F8E415550492B72F086
m_{PS57}	D63E4BD805262A3DEF05C7D86C422E5048921E5531784132
m_{PS58}	564AF806E28131611E5F884229265D446A50E1E488EAFBBA
m_{PS59}	A2603E009D3D30147727B750C35C62299AF754D3E4A54E1C
m_{PS60}	938504B02599D33E28246E4271C375AE81A3BBE8D3F8A920
m_{PS61}	461516B2CAC6FC42A4B707CC6073BBE573C014892C811776
m_{PS62}	29186DE4CCAAB2CD0100BB19EA595879D63F0F0CFA881AA5
m_{PS63}	A064B449CB784A91B803369CDC5EF61A670AAAC044BA3E68
m_{PS64}	8719C454D88FF5149DB943CB6CADA01D0B9664B357A18203
m_{PS65}	A27EC68720F00A714AA2C45A7EF232286984D7B193F5C916
m_{PS66}	AC8361676AB424E48F0789082B0CD2EFB8D2E627D041DD66
m_{PS67}	ABA1BEB0064733A0620906BF2B29C95883F069D7E4C35D39
m_{PS68}	9E22EEDED47D92CA1D0B7530EC6062287BD83A04874AE00C
m_{PS69}	0BADEF288B20F5686C5DE3A71219AC2172054326BE831696
m_{PS70}	953801EB2AF58C2F80E49A6CC46085CB554243E3B3BBEC8C
m_{PS71}	333A504C51C8FAC5025994565C3F600F154F64FAEF4EA484
m_{PS72}	A6583E19647662005474153A6F8DD88A473853E94B720CE7
m_{PS73}	90ACAF707D18AF34F5848C58166830AF620ACDC1B2DFDDA8
m_{PS74}	39C5C598A374EA82F3F83378258248DAD3808812DD0E74BB
m_{PS75}	F79525DE694629346D73F6256CC0F140F82603197AAA1844
m_{PS76}	B8C2A8F139097699A693022E78588D4058DB0A65FF52F813
m_{PS77}	449B50C2A52996FA5A828A907F30F9F460EE3D99930DF890
m_{PS78}	62CEC9574D30184BCB4F94EECF0CC23D2D2A8D0003F0AA33
m_{PS79}	B56D258889703F76A0738EE3A7D355994159A4851833E198
m_{PS80}	65894AA54C0F6C9A206521C9FC379A8AAF6E621C03CF849C
m_{PS81}	2D47F3414E30CC02C6835D95C9BA204488F0FFCB4852677D
m_{PS82}	12BE4DD8B906B584010F8A330AB67B278E8642FA33D51B68
m_{PS83}	BC928A90A4B10906CAEE638BF768E08542F48F1676006DF0
m_{PS84}	30C544E437C8ADA143566CD1BC4E9E7BA84139A08505C2F4
m_{PS85}	84FD5B05506192B753FBA2C719B584E0EDA01814999867D2
m_{PS86}	191F14DD00034E03AB5BB4342F1138B2CD33784E60CFD75A
m_{PS87}	B8ACE7990B6A98A80A61162C4D2D5F88F24E8F7DE4207590
m_{PS88}	EC1DBE72E8EED0C61054FC2695422AC0AD2D888265B21AB0
m_{PS89}	9A1B4CA467AB7E082AF4278E44D177EA78424508C23E8B08

Code ID	Basic Midamble Codes m_{PS} of length $P=192$
m_{PS90}	999EE541C608164AC975214F3A37A677FC2CA03E2C2A4B20
m_{PS91}	1BDCC20265031432917A2EB828FB356A22DF9CB609C0F8F3
m_{PS92}	EB4A81859C93338B8A1B87C02C815AE09D765F6F2249B958
m_{PS93}	E6A5D1629F4CF09A1F280DE0C480D4C73B26ADE321A50AEE
m_{PS94}	BAAB7286DD24C80B15A7958039B904F1CA83C310C8C7AFF2
m_{PS95}	12220F72619E983717C68FFE1C4148F2354B7B1955B65620
m_{PS96}	A198706E24FAA08BD09EE392414816038E667BB34307D6B2
m_{PS97}	30B3493B4C035881A7A722E4546527AAE787FA2C0893AC46
m_{PS98}	5A7318126522843DCB7F00A2D9F9BA8F88963E4152BC923C
m_{PS99}	844844B0CACAB702C332CE2692B4166F4B0C63E62BF151BF
m_{PS100}	B8297389526410313692F861DC60DA86A23607F7DDE24755
m_{PS101}	6C1144CF8BC01538D655D29ED62DE6E74A3180EC905BF1E0
m_{PS102}	E9DB3221FACFC5C88691A7013EF09672A130D52C3413AAE2
m_{PS103}	2FD0508615EC4CD4BF18ADD46D777078869130C8921A4F0E
m_{PS104}	40911B4E0525AC874228F6EF642E59154730CB187C7E417A
m_{PS105}	2034C6A027D4D850F5184AA64C3153231F4651B616BBFCF9
m_{PS106}	57833235451525A1DFA213FCE0B419B6494BC7B99F488410
m_{PS107}	6DC3D57F2E39158D036825F8804810D77CA1ECA610ECD894
m_{PS108}	F5C50DE43AA7B731CAB7683524021701F97650499A7070E4
m_{PS109}	F2184D2699785442E09FA22CC2D60A5A13FFF22AE660A470
m_{PS110}	EF0029DE0D79207205458CF4D7328E81A93518D93C9A74BD
m_{PS111}	9D6D8992482FB885AA5E878C3BA2045538B09886C23CDC2D
m_{PS112}	C0A5AB67D1CEA126F6476C75443F0A11CBE749412EF03104
m_{PS113}	1853A5C20CDF968C5A180D8EB5E72BF15517D06680D98412
m_{PS114}	8CEA1223227ADF37D0DAAB320906E1C79029F480D25181A7
m_{PS115}	5561038E96A658EF3EC665612FF92B064065D1ACC1F54812
m_{PS116}	C55A6263F08D664A1E53584560DFF5E611640D8281D9A843
m_{PS117}	4386A8EA59124D043F29056A4598735A4FC7BC11119B90C1
m_{PS118}	D6571B20668BED50BD7C80388C162632BCB069AA67C7FC22
m_{PS119}	4F9F09ABBC1391EC2CCA5359FB52250E533BF04324154106
m_{PS120}	662659F42188C9453F6E6DF00C579627045DA1461A3A0EA5
m_{PS121}	8DCC9274C0C2A9BA6096BF27FACA542CD01CA8653D60A80F
m_{PS122}	5C1210A1E50E505F6B73C90156C9D9F19AE2310BBD820DF0
m_{PS123}	B1E0A7CE26202E223D4FC06D5C9BBA4E5F6D98204D2D5286
m_{PS124}	DB506776958E34552F7E60E4B400D836153218F918E22FA6
m_{PS125}	ECAA60300439B2360B2AC3C43FB6241ACDE5055B295FA71C
m_{PS126}	BF1E6D9AA9CA4AC092BE60500C77D0DC7A6A236520F86722
m_{PS127}	051C5FA122845A30B4EC306B38016B45667C7754F92F13A0

A.3 Association between Midambles and Channelisation Codes

The following mapping schemes apply for the association between midambles and channelisation codes if no midamble is allocated by higher layers. Secondary channelisation codes are marked with a *. These associations apply both for UL and DL.

A.3.1 Association for Burst Type 1/3 and $K_{Cell}=16$ Midambles

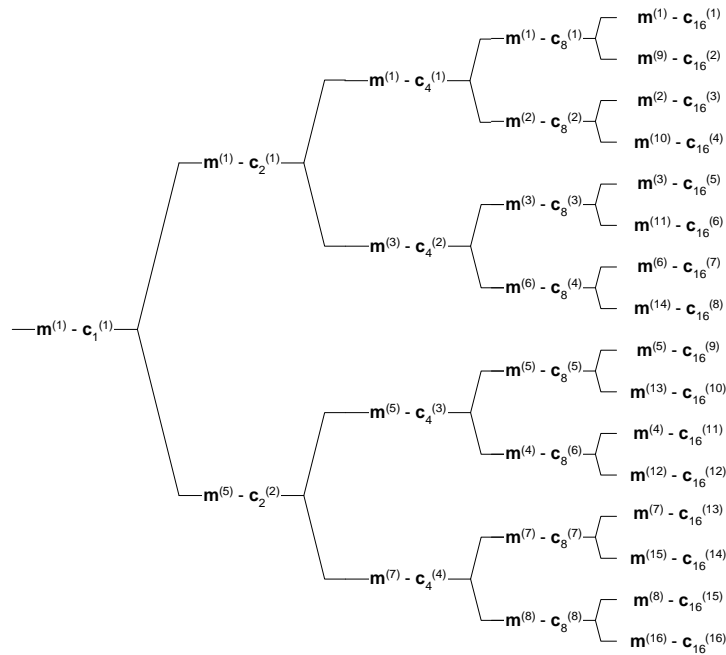

Figure A.1: Association of Midambles to Spreading Codes for Burst Type 1/3 and $K_{Cell}=16$

A.3.2 Association for Burst Type 1/3 and $K_{Cell}=8$ Midambles

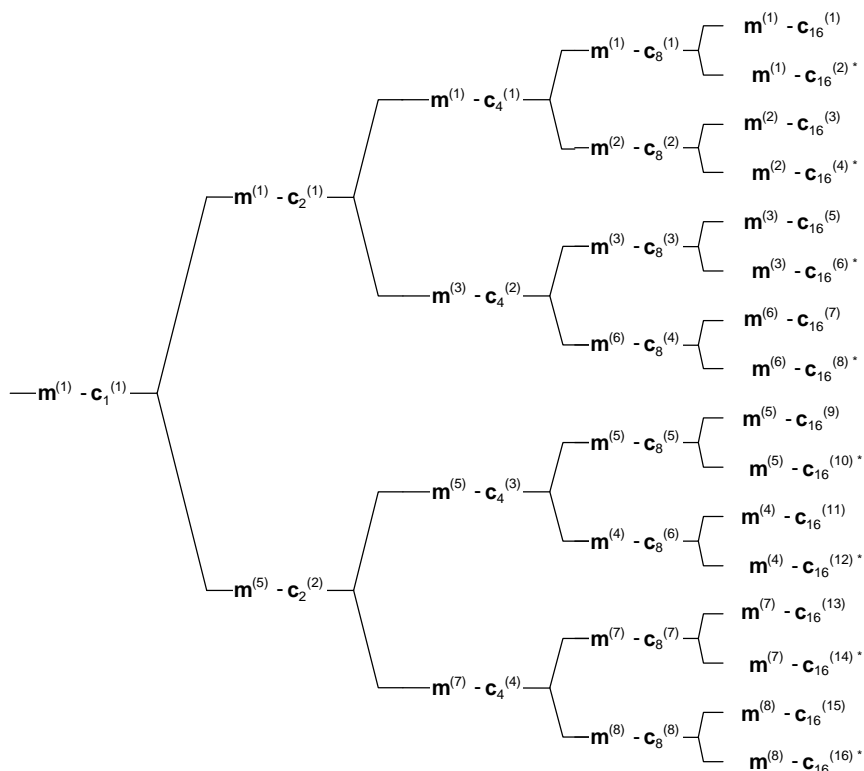

Figure A.2: Association of Midambles to Spreading Codes for Burst Type 1/3 and $K_{Cell}=8$

A.3.3 Association for Burst Type 1/3 and $K_{Cell}=4$ Midambles

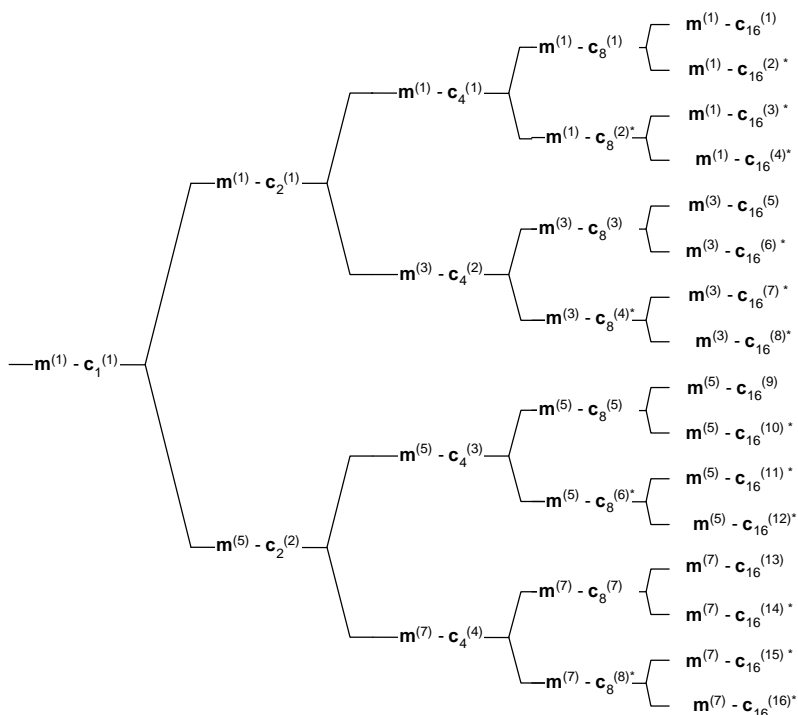

Figure A.3: Association of Midambles to Spreading Codes for Burst Type 1/3 and $K_{Cell}=4$

A.3.4 Association for Burst Type 2 and $K_{Cell}=6$ Midambles

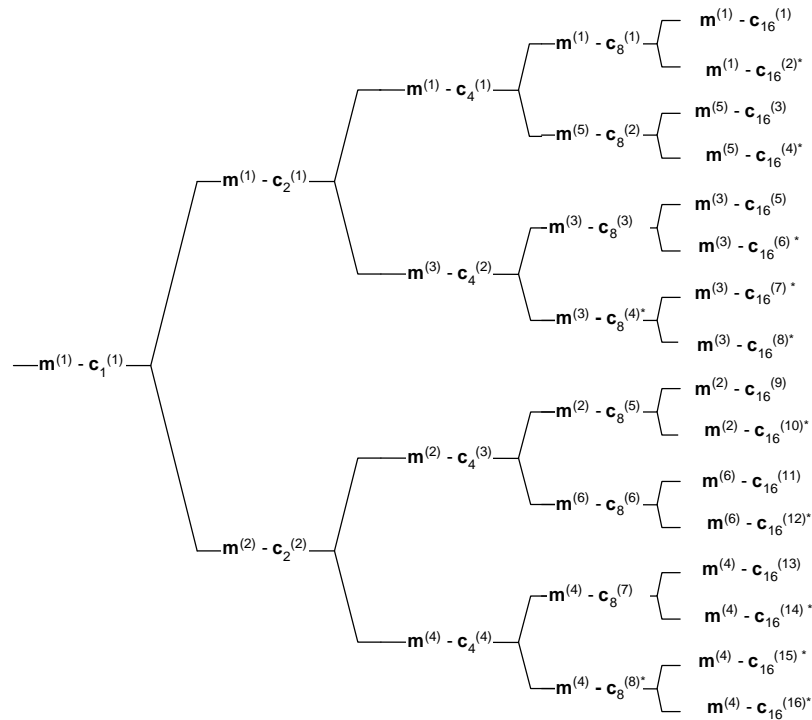

Figure A.4: Association of Midambles to Spreading Codes for Burst Type 2 and $K_{Cell}=6$

A.3.5 Association for Burst Type 2 and $K_{Cell}=3$ Midambles

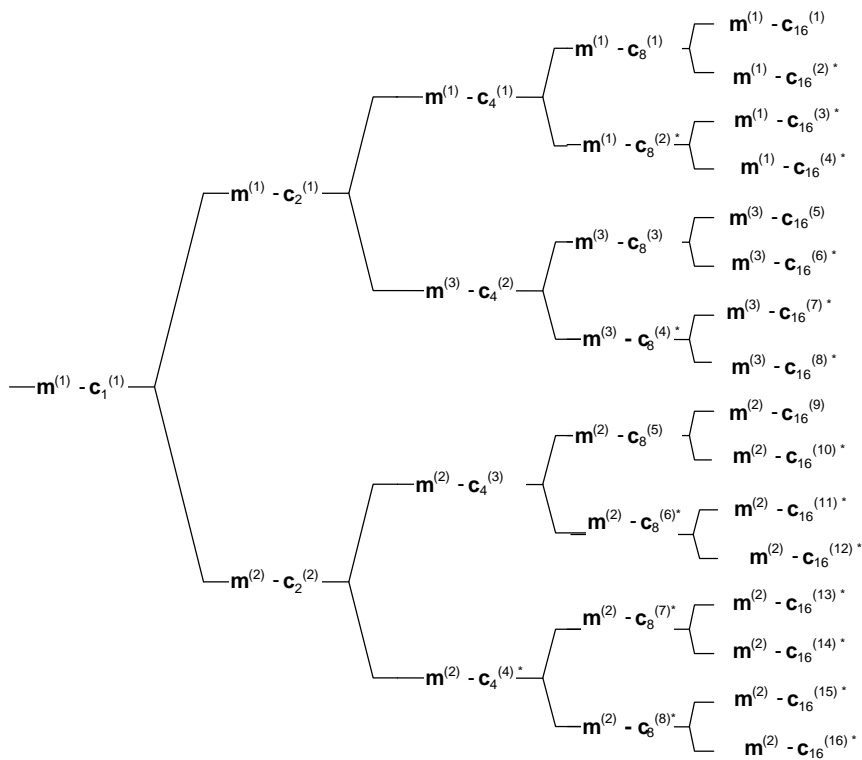

Figure A.5: Association of Midambles to Spreading Codes for Burst Type 2 and $K_{Cell}=3$

Note that the association for burst type 2 can be derived from the association for burst type 1 and 3, using the following table:

Burst Type 1/3	m(1)	m(2)	m(3)	m(4)	m(5)	m(6)	m(7)	m(8)
Burst Type 2	m(1)	m(5)	m(3)	m(6)	m(2)	m(4)	-	-

A.3.6 Association for Burst Type 4 and $K_{\text{Cell}}=1$ Midamble

For burst type 4 there is only a single midamble defined, thus all channelisation codes are associated with the same midamble.

Annex AA (normative): Basic Midamble Codes for the 1.28 Mcps option

AA.1 Basic Midamble Codes

The midamble has a length of $L_m=144$, which is corresponding to:

$$K=2, 4, 6, 8, 10, 12, 14, 16, \quad W = \left\lfloor \frac{P}{K} \right\rfloor, P=128$$

Note: that $\lfloor x \rfloor$ denotes the largest integer number less or equal to x .

Depending on the possible delay spread timeslots are configured to use K midambles. In timeslot 0 the number of midambles $K=8$ (cf section 6.6.1). In all of the other timeslots, K is individually configured from higher layers.

The K midambles are generated from one of the basic midamble codes shown in table AA.1.

The mapping of these Basic Midamble Codes to Cell Parameters is shown in [8].

Table AA.1: Basic Midamble Codes m_p according to equation (5) from subclause 5A.2.3

Code ID	Basic Midamble Codes m_p of length $P=128$
m_{P0}	B2AC420F7C8DEBFA69505981BCD028C3
m_{P1}	0C2E988E0DBA046643F57B0EA6A435E2
m_{P2}	D5CEC680C36A4454135F86DD37043962
m_{P3}	E150D08CAC2A00FF9B32592A631CF85B
m_{P4}	E0A9C3A8F6E40329B2F2943246003D44
m_{P5}	FE22658100A3A683EA759018739BD690
m_{P6}	B46062F89BB2A1139D76A1EF32450DA0
m_{P7}	EE63D75CC099092579400D956A90C3E0
m_{P8}	D9C0E040756D427A2611DAA35E6CD614
m_{P9}	EB56D03A498EC4FEC98AE220BC390450
m_{P10}	F598703DB0838112ED0BABB98642B665
m_{P11}	A0BC26A992D4558B9918986C14861EFF
m_{P12}	541350D109F1DD68099796637B824F88
m_{P13}	892D344A962314662F01F9455F7BC302
m_{P14}	49F270E29CCD742A40480DD4215E1632
m_{P15}	6A5C0410C6C39AA04E77423C355926DE
m_{P16}	7976615538203103D4DBCC219B16A9E1
m_{P17}	A6C3C3175845400BD2B738C43EE2645F
m_{P18}	A0FD56258D228642C6F641851C3751ED
m_{P19}	EFA48C3FC84AC625783C6C9510A2269A
m_{P20}	62A8EB1A420334B23396E8D76BC19740
m_{P21}	9E96235699D5D41C9816C921023BC741
m_{P22}	4362AE4CAE0DCC32D60A3FED1341A848
m_{P23}	454C068E6C4F190942E0904B95D61DFB
m_{P24}	607FEEA6E2E99206718A49C0D6A25034
m_{P25}	E1D1BCDA39A09095B5C81645103A077C
m_{P26}	994B445E558344DE211C8286DDD3D1A3
m_{P27}	C15233273581417638906ADB61FDCA3C
m_{P28}	8B79A274D542F096FB1388098230F8A1
m_{P29}	DF58AC1C5F44B2A40266385CE1DA5640
m_{P30}	B5949A1CC69962C464401D05FF5C1A7A
m_{P31}	85AC489841ED3EAA2D83BBB0039CC707
m_{P32}	AE371CC144BC95923CA8108D8B49FE82
m_{P33}	7F188484A649D1C22BDA1F09D49B5117
m_{P34}	ADAA3C657089DEF7C0284903A491C9B0
m_{P35}	C3F96893C7504DC3B51488604AF64F4C
m_{P36}	B4002F5AE0CE8623AC979D368E9148C1
m_{P37}	0EEBCC0C795C02A106C24ABB36D08C6E
m_{P38}	4B0F537E384A893F58971580D9894433
m_{P39}	08E0035AB29B7ECC53C15DAA0687CC8F
m_{P40}	8611ACBC4C82781D77654EE862506D60
m_{P41}	63315261A8F1CB02549802DBFD197C07
m_{P42}	9A2609A434F43E7DCADC0E22B2EF4012
m_{P43}	F4C9F0A127A88461209ABF8C69CE4D00
m_{P44}	C79124EE3FFC28C5C4524D2B01670D42
m_{P45}	C91985C4FED53D09361914354BA80E79
m_{P46}	82AA517260779ECFF26212C1A10BDC29
m_{P47}	561DE2040ACB458E0DBD354E43E111D9
m_{P48}	2E58C7202D17392BC1235782CEFABB09
m_{P49}	C4FAA121C698047650F6503126A577C1
m_{P50}	E7B75206A9B410E44346E0DAE842A23C
m_{P51}	3F8B1C32682B28D098D3805ED130EA7F
m_{P52}	8D5FC2C1C6715F824B401434C8D4BB82
m_{P53}	0B2A43453ACC028FE6EB6E1CB0740B59
m_{P54}	BC56948FC700BA4883262EE73E12D82A
m_{P55}	558D136710272912FA4F183D1189A7FD
m_{P56}	5709E7F82DC6500B7B12A3072D182645
m_{P57}	86D4F161C844AE5E20EE39FD5493B044
m_{P58}	8729B6EDC382B152185885F013DAE222
m_{P59}	154C45B50720F4C362C14C77FE8335A1
m_{P60}	C6A0962890351F4EB802DE43A7662C9E

mP61	D19D69D6B380B4B22457CB80033519F0
mP62	C7D89509FB0DAE9255998E0A00C2B262
mP63	DFD481C652C0C905D61D66F1732C4AA2
mP64	06C848619AF1D6C910A8EAC4B622FC06
mP65	0635E29D4E7AC8ABC189890241F45ECA
mP66	B272B020586AAD7B093AC2F459076638
mP67	B608ACE46E1A6BC96181EEDD88B54140
mP68	0A516092B3ED7849B168AFE223B8670E
mP69	D1A658C5009E04D0D7D5E9205EE663E8
mP70	AC316DC39B91EB60B1AABD8280740432
mP71	E3F06825476A026CD287625E514519FC
mP72	A56D092080DDE8994F387C175CC56833
mP73	15EA799DE587C506D0CD99A408217B05
mP74	A59C020BAB9AF6D3F813C391CA244CD2
mP75	74B0101EB9F3167434B94BABC8378882
mP76	CE752975C8DA9B0100386DB82A8C3D20
mP77	BBB38DCDB1E9118570AC147DC05241A4
mP78	944ABBF0866098101F6971731AB2E986
mP79	2BB147B2A30C68B4853F90481A166EB6
mP80	444840ACCF3F23C45B56D7704BF18283
mP81	87604F7450D1AD188C452981A5C7FC9B
mP82	8C3842EBC948A65BC4C8B387F11B7090
mP83	10B4767D071CF5DB2288E4029576135A
mP84	6F07AAB697CD0089572C6B062E2018E4
mP85	D3D65B442057E613A8655060C8D29E27
mP86	5EDA330514C604BF4E0894E09EC57A74
mP87	B0899CD094060724DED82AE85F18A43A
mP88	B2D999B86DF902BC25015CAE3A0823C4
mP89	C23CD40F04242B92D46EED82CD9A9A18
mP90	D22DDCC5CB82960125DD24655F3C8788
mP91	54987218FBD99AE4340FD4C9458E9850
mP92	BE4341822997A7B11EA1E8A1A2767005
mP93	255200FBA6EE48E6DE0A82B0461B8D0F
mP94	6FBD58A663932423503690CF9C171701
mP95	D215033A4AA87EC1C232BAC7EDA09370
mP96	CA0959B01AE48E80204F1E4A3F29CE55
mP97	582043413B9B825903E3A3545ED59463
mP98	5016541922971C703D16E284CBDF633B
mP99	7347EF160A1733CA98D43608A83A920B
mP100	908B22AD433CCA00B3FD47C691F1A290
mP101	BB22A272FC6923DF1B43BA4118806570
mP102	0FA75C87474836B47DC7624D61193802
mP103	A22EBA0658A4D0FF1E9CA5030A65CC06
mP104	6C9C51CA15F1F4981F4C46180A6A6697
mP105	4C847ACF8BC15359C405322851C9BDE2
mP106	C1D29499C0082C9DE473ED15B14D63E0
mP107	7E85ECC98AC761005076C5572869A431
mP108	D8F11121595B8F49F78A7039E44126A0
mP109	1A0BC814445FD71C8E5B1A9163ED2059
mP110	A7591F27F8B0C00C68CC41697954FA04
mP111	6CA2CE595E7406D79C4840183D41B9D0
mP112	C093D3CC701FC20E66F5AB22516C5460
mP113	D0E0CDE9B595546B96C4F8066B469020
mP114	E99F743A451431C8B427054A4E6F2007
mP115	C0D21A344A2C07DF2A6EBE6250C7B91E
mP116	F031223E282CF7A4D8EF174A908668AE
mP117	E4BD244AC16C55C7137FB068FD44280C
mP118	C44920DE2028F19FC2AAB36A0DCFDAD0
mP119	3FA7054E77135250699E6C8A11600742
mP120	D5740B4D8870C1C5B5A214C4266FC537
mP121	F0B7942D43BB6F38446442EB8126AB80
mP122	83DB9534EAD6238FA8968798CDF04848
mP123	EB9663CDDC2B291690703125BABC8B00
mP124	84D547225D4BBD20DEF1A583240C6E0F

m _P 125	B51F6A771838BE934724AEA6A2669802
m _P 126	D92AC05E10496794BBDC115233B1C068
m _P 127	D3ACF0078EDA9856BBB0AF8651132103

Table AA.1a: Basic Preamble Codes

Code ID	Basic Preamble Codes of length P=64
PP0	1.000000+j0.000000, 0.989177+j0.146730, 0.923880+j0.382683, 0.740951+j0.671559, 0.382683+j0.923880, -0.146730+j0.989177, -0.707107+j0.707107, -0.998795+j0.049068, -0.707107-j0.707107, 0.146731-j0.989176, 0.923880-j0.382683, 0.740951+j0.671559, -0.382684+j0.923879, -0.989176-j0.146731, 0.000000-j1.000000, 0.998795-j0.049067, 0.000000+j1.000000, -0.989176-j0.146731, 0.382684-j0.923879, 0.740951+j0.671559, -0.923880+j0.382683, 0.146731-j0.989176, 0.707107+j0.707107, -0.998795+j0.049067, 0.707107-j0.707106, -0.146731+j0.989176, -0.382683-j0.923880, 0.740951+j0.671559, -0.923879-j0.382684, 0.989176+j0.146731, -1.000000-j0.000001, 0.998795-j0.049067, -1.000000-j0.000001, 0.989176+j0.146731, -0.923879-j0.382684, 0.740950+j0.671560, -0.382683-j0.923880, -0.146732+j0.989176, 0.707108-j0.707106, -0.998796+j0.049067, 0.707106+j0.707108, 0.146732-j0.989176, -0.923880+j0.382682, 0.740950+j0.671560, 0.382685-j0.923879, -0.989176-j0.146732, -0.000002+j1.000000, 0.998796-j0.049066, 0.000002-j1.000000, -0.989176-j0.146732, -0.382685+j0.923879, 0.740950+j0.671560, 0.923880-j0.382682, 0.146733-j0.989176, -0.707105-j0.707108, -0.998796+j0.049065, -0.707108+j0.707105, -0.146733+j0.989176, 0.382681+j0.923880, 0.740949+j0.671561, 0.923879+j0.382686, 0.989176+j0.146733, 1.000000+j0.000003, 0.998796-j0.049065
PP1	1.000000+j0.000000, 0.903989+j0.427555, 0.382683+j0.923880, -0.595699+j0.803208, -0.923880-j0.382683, 0.427555-j0.903989, 0.707107+j0.707107, -0.989177+j0.146730, 0.707107-j0.707107, -0.427555+j0.903989, 0.382684-j0.923879, -0.595700+j0.803207, 0.923880-j0.382683, -0.903989-j0.427555, 0.000000+j1.000000, 0.989177-j0.146730, 0.000001-j1.000000, -0.903989-j0.427556, -0.923880+j0.382683, -0.595700+j0.803207, -0.382684+j0.923879, -0.427556+j0.903989, -0.707108+j0.707106, -0.989177+j0.146729, -0.707106-j0.707108, 0.427556-j0.903989, 0.923879+j0.382685, -0.595701+j0.803207, -0.382682-j0.923880, 0.903988+j0.427557, -1.000000-j0.000002, 0.989177-j0.146728, -1.000000-j0.000002, 0.903988+j0.427557, -0.382681-j0.923881, -0.595702+j0.803206, 0.923878+j0.382686, 0.427558-j0.903988, -0.707104-j0.707109, -0.989177+j0.146727, -0.707109+j0.707104, -0.427559+j0.903988, -0.382687+j0.923878, -0.595703+j0.803205, -0.923881+j0.382679, -0.903987-j0.427559, 0.000005-j1.000000, 0.989177-j0.146726, -0.000005+j1.000000, -0.903987-j0.427560, 0.923882-j0.382678, -0.595704+j0.803204, 0.382689-j0.923877, -0.427561+j0.903987, 0.707111-j0.707102, -0.989178+j0.146724, 0.707102+j0.707112, 0.427562-j0.903986, -0.923877-j0.382690, -0.595706+j0.803203, 0.382676+j0.923883, 0.903986+j0.427563, 1.000000+j0.000009, 0.989178-j0.146722
PP2	1.000000+j0.000000, 0.740951+j0.671559, -0.382683+j0.923880, -0.857729-j0.514103, 0.923880-j0.382683, -0.671559+j0.740951, 0.707107-j0.707107, -0.970031+j0.242980, 0.707107+j0.707107, 0.671559-j0.740951, -0.382683-j0.923880, -0.857728-j0.514103, -0.923879-j0.382684, -0.740951-j0.671559, 0.000001-j1.000000, 0.970031-j0.242979, -0.000001+j1.000000, -0.740950-j0.671560, 0.923879+j0.382685, -0.857728-j0.514104, 0.382682+j0.923880, 0.671560-j0.740950, -0.707105-j0.707108, -0.970032+j0.242978, -0.707108+j0.707105, -0.671561+j0.740949, -0.923881+j0.382681, -0.857727-j0.514105, 0.382686-j0.923878, 0.740949+j0.671561, -1.000000-j0.000003, 0.970032-j0.242977, -1.000000-j0.000004, 0.740948+j0.671562, 0.382688-j0.923878, -0.857726-j0.514107, -0.923881+j0.382679, -0.671563+j0.740948, -0.707111+j0.707103, -0.970033+j0.242975, -0.707102-j0.707111, 0.671564-j0.740947, 0.382677+j0.923882, -0.857725-j0.514109, 0.923877+j0.382690, -0.740946-j0.671565, -0.000008+j1.000000, 0.970033-j0.242972, 0.000009-j1.000000, -0.740945-j0.671566, -0.923876-j0.382692, -0.857724-j0.514111, -0.382674-j0.923883, 0.671567-j0.740944, 0.707099+j0.707115, -0.970034+j0.242969, 0.707115-j0.707098, -0.671568+j0.740943, 0.923884-j0.382672, -0.857722-j0.514114, -0.382696+j0.923874, 0.740942+j0.671569, 1.000000+j0.000014, 0.970035-j0.242966
PP3	1.000000+j0.000000, 0.514103+j0.857729, -0.923880+j0.382683, 0.427555-j0.903989, -0.382684+j0.923879, 0.857729-j0.514103, -0.707107-j0.707107, -0.941544+j0.336890, -0.707107+j0.707106, -0.857729+j0.514102, -0.923879-j0.382684, 0.427556-j0.903989, 0.382683+j0.923880, -0.514102-j0.857729, -0.000001+j1.000000, 0.941545-j0.336889, 0.000001-j1.000000, -0.514101-j0.857729, -0.382682-j0.923880, 0.427557-j0.903988, 0.923879+j0.382685, -0.857730+j0.514101, 0.707109-j0.707105, -0.941545+j0.336887, 0.707105+j0.707109, 0.857730-j0.514100, 0.382687-j0.923878, 0.427559-j0.903988, 0.923881-j0.382679, 0.514099+j0.857731, -1.000000-j0.000005, 0.941546-j0.336885, -1.000000-j0.000006, 0.514098+j0.857732, 0.923882-j0.382678, 0.427561-j0.903986, 0.382690-j0.923877, 0.857732-j0.514096, 0.707101+j0.707112, -0.941547+j0.336882, 0.707113-j0.707101, -0.857733+j0.514095, 0.923876+j0.382692, 0.427564-j0.903985, -0.382674-j0.923883, -0.514094-j0.857734, 0.000011-j1.000000, 0.941548-j0.336879, -0.000012+j1.000000, -0.514092-j0.857735, 0.382671+j0.923885, 0.427567-j0.903983, -0.923874-j0.382697, -0.857736+j0.514090, -0.707118+j0.707096, -0.941549+j0.336875, -0.707095-j0.707118, 0.857737-j0.514088, -0.382700+j0.923873, 0.427572-j0.903981, -0.923887+j0.382666, 0.514086+j0.857739, 1.000000+j0.000020, 0.941551-j0.336870
PP4	1.000000+j0.000000, 0.242980+j0.970031, -0.923880-j0.382683, 0.941544+j0.336890, -0.382683-j0.923880, -0.970031+j0.242980, -0.707107+j0.707107, -0.903989+j0.427555, -0.707106-j0.707107, 0.970031-j0.242980, -0.923880+j0.382683, 0.941544+j0.336891, 0.382684-j0.923879, -0.242979-

	j0.970032, 0.000001-j1.000000, 0.903990-j0.427554, -0.000002+j1.000000, -0.242978-j0.970032, -0.382686+j0.923879, 0.941543+j0.336892, 0.923881-j0.382681, 0.970032-j0.242977, 0.707104+j0.707109, -0.903991+j0.427552, 0.707110-j0.707104, -0.970032+j0.242976, 0.382679+j0.923881, 0.941542+j0.336895, 0.923877+j0.382688, 0.242974+j0.970033, -1.000000-j0.000006, 0.903992-j0.427549, -1.000000-j0.000007, 0.242973+j0.970033, 0.923876+j0.382691, 0.941541+j0.336898, 0.382675+j0.923883, -0.970034+j0.242971, 0.707114-j0.707100, -0.903994+j0.427546, 0.707099+j0.707115, 0.970034-j0.242969, 0.923884-j0.382672, 0.941540+j0.336902, -0.382696+j0.923874, -0.242967-j0.970035, -0.000014+j1.000000, 0.903996-j0.427542, 0.000016-j1.000000, -0.242964-j0.970035, 0.382699-j0.923873, 0.941538+j0.336906, -0.923887+j0.382667, 0.970036-j0.242962, -0.707093-j0.707121, -0.903998+j0.427537, -0.707122+j0.707092, -0.970037+j0.242959, -0.382662-j0.923888, 0.941536+j0.336912, -0.923870-j0.382706, 0.242956+j0.970037, 1.000000+j0.000026, 0.904001-j0.427531
DP5	1.000000+j0.000000, -0.049068+j0.998795, -0.382683-j0.923880, -0.242980+j0.970031, 0.923879+j0.382684, 0.998795+j0.049068, 0.707107+j0.707107, -0.857729+j0.514102, 0.707107-j0.707106, -0.998795-j0.049068, -0.382684+j0.923879, -0.242981+j0.970031, -0.923880+j0.382682, 0.049069-j0.998795, -0.000002+j1.000000, 0.857730-j0.514101, 0.000002-j1.000000, 0.049070-j0.998795, 0.923881-j0.382681, -0.242983+j0.970030, 0.382687-j0.923878, -0.998795-j0.049072, -0.707110+j0.707104, -0.857731+j0.514099, -0.707103-j0.707110, 0.998795+j0.049073, -0.923877-j0.382689, -0.242986+j0.970030, 0.382677+j0.923882, -0.049075+j0.998795, -1.000000-j0.000008, 0.857733-j0.514096, -1.000000-j0.000009, -0.049077+j0.998795, 0.382674+j0.923883, -0.242990-j0.970029, -0.923875-j0.382694, 0.998795+j0.049079, -0.707098-j0.707115, -0.857735+j0.514092, -0.707116+j0.707097, -0.998795-j0.049082, 0.382697-j0.923874, -0.242995+j0.970028, 0.923886-j0.382669, 0.049085-j0.998795, 0.000018-j1.000000, 0.857738-j0.514087, -0.000019+j1.000000, 0.049088-j0.998794, -0.923887+j0.382664, -0.243001+j0.970026, -0.382704+j0.923871, -0.998794-j0.049091, 0.707124-j0.707090, -0.857741+j0.514081, 0.707088+j0.707125, 0.998794+j0.049094, 0.923869+j0.382709, -0.243008+j0.970024, -0.382656-j0.923891, -0.049098+j0.998794, 1.000000+j0.000032, 0.857745-j0.514075
DP6	1.000000+j0.000000, -0.336890+j0.941544, 0.382684-j0.923880, -0.989176-j0.146731, -0.923880+j0.382683, -0.941544-j0.336890, 0.707107-j0.707106, -0.803208+j0.595699, 0.707106+j0.707107, 0.941544+j0.336891, 0.382682+j0.923880, -0.989176-j0.146732, 0.923879+j0.382685, 0.336892-j0.941543, 0.000002-j1.000000, 0.803209-j0.595697, -0.000003+j1.000000, 0.336893-j0.941543, -0.923878-j0.382687, -0.989176-j0.146734, -0.382680-j0.923881, 0.941543+j0.336894, -0.707103-j0.707110, -0.803211+j0.595695, -0.707111+j0.707103, -0.941542-j0.336896, 0.923882-j0.382677, -0.989175-j0.146738, -0.382691+j0.923877, -0.336898+j0.941541, -1.000000-j0.000009, 0.803213-j0.595692, -1.000000-j0.000010, -0.336900+j0.941540, -0.382694+j0.923875, -0.989175-j0.146743, 0.923884-j0.382672, -0.941539-j0.336903, -0.707117+j0.707097, -0.803217+j0.595687, -0.707096-j0.707118, 0.941538+j0.336906, -0.382667-j0.923886, -0.989174-j0.146749, -0.923872-j0.382701, 0.336909-j0.941537, -0.000021+j1.000000, 0.803220-j0.595682, 0.000023-j1.000000, 0.336912-j0.941536, 0.923870+j0.382706, -0.989173-j0.146756, 0.382659+j0.923890, 0.941535+j0.336916, 0.707087+j0.707127, -0.803225+j0.595676, 0.707128-j0.707085, -0.941533-j0.336920, -0.923892+j0.382653, -0.989172-j0.146764, 0.382716-j0.923866, -0.336924+j0.941532, 1.000000+j0.000037, 0.803231-j0.595668
DP7	1.000000+j0.000000, -0.595699+j0.803208, 0.923880-j0.382683, 0.049068-j0.998795, 0.382684-j0.923879, 0.803207+j0.595700, -0.707106-j0.707107, -0.740952+j0.671558, -0.707107+j0.707106, -0.803207-j0.595700, 0.923879+j0.382685, 0.049069-j0.998795, -0.382682-j0.923880, 0.595701-j0.803206, -0.000002+j1.000000, 0.740953-j0.671557, 0.000003-j1.000000, 0.595702-j0.803205, 0.382680+j0.923881, 0.049072-j0.998795, -0.923878-j0.382688, -0.803204-j0.595704, 0.707111-j0.707103, -0.740955+j0.671554, 0.707102+j0.707112, 0.803203+j0.595705, -0.382691+j0.923877, 0.049076-j0.998795, -0.923883+j0.382675, -0.595707+j0.803202, -1.000000-j0.000010, 0.740959-j0.671551, -1.000000-j0.000012, -0.595709+j0.803200, -0.923885+j0.382671, 0.049082-j0.998795, -0.382697+j0.923874, 0.803198+j0.595712, 0.707095+j0.707118, -0.740963+j0.671546, 0.707120-j0.707094, -0.803196-j0.595715, -0.923872-j0.382702, 0.049089-j0.998794, 0.382663+j0.923888, 0.595718-j0.803194, 0.000024-j1.000000, 0.740968-j0.671540, -0.000026+j1.000000, 0.595721-j0.803191, -0.382657-j0.923890, 0.049097-j0.998794, 0.923868+j0.382712, -0.803189-j0.595725, -0.707130+j0.707084, -0.740974+j0.671534, -0.707082-j0.707132, 0.803186+j0.595729, 0.382718-j0.923865, 0.049107-j0.998794, 0.923895-j0.382646, -0.595733+j0.803183, 1.000000+j0.000043, 0.740981-j0.671526
DP8	1.000000+j0.000000, -0.803208+j0.595699, 0.923879+j0.382684, 0.998795-j0.049067, 0.382683+j0.923880, -0.595699-j0.803208, -0.707107+j0.707106, -0.671560+j0.740951, -0.707106-j0.707107, 0.595698+j0.803208, 0.923880-j0.382682, 0.998796-j0.049066, -0.382685+j0.923879, 0.803209-j0.595697, 0.000003-j1.000000, 0.671561-j0.740949, -0.000004+j1.000000, 0.803210-j0.595696, 0.382688-j0.923878, 0.998796-j0.049063, -0.923882+j0.382678, 0.595695+j0.803211, 0.707102+j0.707111, -0.671564+j0.740946, 0.707112-j0.707101, -0.595693-j0.803212, -0.382675-j0.923883, 0.998796-j0.049058, -0.923876-j0.382693, -0.803214+j0.595690, -1.000000-j0.000012, 0.671568-j0.740943, -1.000000-j0.000013, -0.803216+j0.595688, -0.923874-j0.382697, 0.998796-j0.049052, -0.382668-j0.923886, -0.595685-j0.803218, 0.707120-j0.707094, -0.671574+j0.740938,

	0.707092+j0.707121, 0.595682+j0.803220, -0.923888+j0.382662, 0.998797-j0.049044, 0.382706-j0.923870, 0.803223-j0.595678, -0.000027+j1.000000, 0.671580-j0.740932, 0.000030-j1.000000, 0.803226-j0.595675, -0.382713+j0.923867, 0.998797-j0.049034, 0.923893-j0.382651, 0.595670+j0.803229, -0.707080-j0.707133, -0.671588+j0.740925, -0.707135+j0.707078, -0.595666-j0.803232, 0.382644+j0.923896, 0.998798-j0.049023, 0.923862+j0.382726, -0.803236+j0.595661, 1.000000+j0.000049, 0.671596-j0.740917
DP9	1.000000+j0.000000, -0.941544+j0.336890, 0.382683+j0.923880, 0.146730+j0.989177, -0.923879-j0.382684, 0.336889+j0.941544, 0.707106+j0.707107, -0.595700+j0.803207, 0.707108-j0.707106, -0.336889-j0.941545, 0.382685-j0.923879, 0.146729+j0.989177, 0.923880-j0.382681, 0.941545-j0.336887, -0.000003+j1.000000, 0.595702-j0.803205, 0.000004-j1.000000, 0.941546-j0.336886, -0.923881+j0.382679, 0.146725+j0.989177, -0.382689+j0.923877, -0.336884-j0.941546, -0.707112+j0.707102, -0.595706+j0.803203, -0.707101-j0.707113, 0.336881+j0.941547, 0.923876+j0.382693, 0.146720+j0.989178, -0.382673-j0.923884, -0.941548+j0.336878, -1.000000-j0.000013, 0.595711-j0.803199, -1.000000-j0.000015, -0.941549+j0.336875, -0.382668-j0.923886, 0.146713+j0.989179, 0.923872+j0.382701, 0.336871+j0.941551, -0.707092-j0.707122, -0.595717+j0.803194, -0.707123+j0.707090, -0.336867-j0.941552, -0.382707+j0.923870, 0.146704+j0.989180, -0.923890+j0.382658, 0.941554-j0.336862, 0.000030-j1.000000, 0.595725-j0.803189, -0.000033+j1.000000, 0.941556-j0.336857, 0.923893-j0.382650, 0.146694+j0.989182, 0.382719-j0.923865, -0.336852-j0.941558, 0.707136-j0.707077, -0.595734+j0.803182, 0.707075+j0.707138, 0.336846+j0.941560, -0.923861-j0.382728, 0.146681+j0.989184, 0.382636+j0.923899, -0.941562+j0.336840, 1.000000+j0.000055, 0.595745-j0.803174
DP10	1.000000+j0.000000, -0.998795+j0.049068, -0.382684+j0.923879, -0.970031+j0.242980, 0.923880-j0.382683, -0.049067-j0.998795, 0.707107-j0.707106, -0.514104+j0.857728, 0.707106+j0.707108, 0.049066+j0.998796, -0.382682-j0.923880, -0.970032+j0.242978, -0.923879-j0.382686, 0.998796-j0.049065, 0.000003-j1.000000, 0.514106-j0.857727, -0.000004+j1.000000, 0.998796-j0.049063, 0.923877+j0.382688, -0.970033+j0.242974, 0.382677+j0.923882, 0.049060+j0.998796, -0.707101-j0.707112, -0.514110+j0.857724, -0.707114+j0.707100, -0.049057-j0.998796, -0.923884+j0.382673, -0.970034+j0.242969, 0.382695-j0.923875, -0.998796+j0.049054, -1.000000-j0.000015, 0.514116-j0.857721, -1.000000-j0.000017, -0.998796+j0.049050, 0.382701-j0.923872, -0.970036+j0.242961, -0.923888+j0.382664, -0.049046-j0.998797, -0.707123+j0.707090, -0.514124+j0.857716, -0.707089-j0.707125, 0.049041+j0.998797, 0.382657+j0.923890, -0.970038+j0.242952, 0.923868+j0.382712, 0.998797-j0.049036, -0.000034+j1.000000, 0.514133-j0.857711, 0.000037-j1.000000, 0.998797-j0.049030, -0.923864-j0.382720, -0.970041+j0.242940, -0.382644-j0.923896, 0.049023+j0.998798, 0.707074+j0.707139, -0.514144+j0.857704, 0.707142-j0.707072, -0.049017-j0.998798, 0.923900-j0.382634, -0.970045+j0.242927, -0.382736+j0.923858, -0.998798+j0.049009, 1.000000+j0.000060, 0.514156-j0.857697
DP11	1.000000+j0.000000, -0.970031-j0.242980, -0.923880+j0.382683, -0.336890-j0.941544, -0.382684+j0.923879, -0.242981+j0.970031, -0.707106-j0.707107, -0.427556+j0.903989, -0.707108+j0.707106, 0.242982-j0.970031, -0.923879-j0.382685, -0.336888-j0.941545, 0.382681+j0.923881, 0.970030+j0.242983, -0.000004+j1.000000, 0.427559-j0.903987, 0.000005-j1.000000, 0.970030+j0.242985, -0.382678-j0.923882, -0.336884-j0.941546, 0.923877+j0.382690, 0.242988-j0.970029, 0.707113-j0.707101, -0.427564+j0.903985, 0.707099+j0.707114, -0.242991+j0.970029, 0.382695-j0.923875, -0.336878-j0.941548, 0.923885-j0.382670, -0.970028-j0.242995, -1.000000-j0.000016, 0.427571-j0.903982, -1.000000-j0.000018, -0.970027-j0.242999, 0.923887-j0.382665, -0.336870-j0.941551, 0.382705-j0.923871, -0.243004+j0.970025, 0.707089+j0.707125, -0.427579+j0.903978, 0.707127-j0.707087, 0.243009-j0.970024, 0.923868+j0.382712, -0.336859-j0.941555, -0.382652-j0.923892, 0.970023+j0.243014, 0.000037-j1.000000, 0.427590-j0.903973, -0.000040+j1.000000, 0.970021+j0.243021, 0.382643+j0.923896, -0.336847-j0.941559, -0.923862-j0.382727, 0.243027-j0.970019, -0.707142+j0.707071, -0.427602+j0.903967, -0.707068-j0.707145, -0.243035+j0.970018, -0.382737+j0.923857, -0.336833-j0.941564, -0.923903+j0.382626, -0.970016-j0.243042, 1.000000+j0.000066, 0.427617-j0.903960
DP12	1.000000+j0.000000, -0.857729-j0.514103, -0.923879-j0.382684, 0.903989-j0.427555, -0.382683-j0.923880, 0.514103-j0.857728, -0.707107+j0.707106, -0.336891+j0.941544, -0.707106-j0.707108, -0.514104+j0.857728, -0.923880+j0.382681, 0.903990-j0.427553, 0.382686-j0.923878, 0.857727+j0.514106, 0.000004-j1.000000, 0.336894-j0.941543, -0.000005+j1.000000, 0.857726+j0.514108, -0.382689+j0.923877, 0.903992-j0.427549, 0.923883-j0.382676, -0.514110+j0.857724, 0.707100+j0.707114, -0.336900+j0.941541, 0.707115-j0.707099, 0.514113-j0.857722, 0.382671+j0.923885, 0.903995-j0.427542, 0.923874+j0.382698, -0.857720-j0.514117, -1.000000-j0.000017, 0.336907-j0.941538, -1.000000-j0.000020, -0.857718-j0.514121, 0.923871+j0.382704, 0.903999-j0.427534, 0.382661+j0.923889, 0.514125-j0.857715, 0.707126-j0.707087, -0.336917+j0.941534, 0.707085+j0.707128, -0.514130+j0.857712, 0.923892-j0.382652, 0.904004-j0.427523, -0.382717+j0.923865, 0.857709+j0.514136, -0.000040+j1.000000, 0.336929-j0.941530, 0.000044-j1.000000, 0.857705-j0.514142, 0.382727-j0.923861, 0.904010-j0.427511, -0.923899+j0.382636, -0.514148+j0.857701, -0.707068-j0.707146, -0.336943+j0.941525, -0.707148+j0.707065, 0.514155-j0.857697, -0.382625-j0.923904, 0.904017-j0.427496, -0.923854-j0.382746, -0.857693-j0.514163, 1.000000+j0.000072, 0.336960-j0.941519

DP13	<p>1.000000+j0.000000, -0.671559-j0.740951, -0.382683-j0.923880, 0.514102+j0.857729, 0.923879+j0.382684, -0.740952+j0.671558, 0.707106+j0.707107, -0.242981+j0.970031, 0.707108-j0.707106, 0.740952-j0.671558, -0.382686+j0.923879, 0.514100+j0.857730, -0.923881+j0.382680, 0.671556+j0.740954, -0.000004+j1.000000, 0.242985-j0.970030, 0.000006-j1.000000, 0.671554+j0.740955, 0.923882-j0.382677, 0.514096+j0.857733, 0.382691-j0.923876, 0.740957-j0.671552, -0.707114+j0.707099, -0.242991+j0.970029, -0.707098-j0.707115, -0.740960+j0.671549, -0.923874-j0.382697, 0.514090+j0.857736, 0.382668+j0.923886, -0.671546-j0.740963, -1.000000-j0.000019, 0.243000-j0.970026, -1.000000-j0.000021, -0.671542-j0.740966, 0.382661+j0.923889, 0.514081+j0.857742, -0.923869-j0.382708, -0.740970+j0.671538, -0.707086-j0.707128, -0.243011+j0.970024, -0.707130+j0.707084, 0.740974-j0.671533, 0.382717-j0.923866, 0.514070+j0.857748, 0.923895-j0.382647, 0.671528+j0.740979, 0.000043-j1.000000, 0.243024-j0.970020, -0.000047+j1.000000, 0.671523+j0.740984, -0.923899+j0.382636, 0.514057+j0.857756, -0.382734+j0.923858, 0.740989-j0.671517, 0.707149-j0.707065, -0.243040+j0.970016, 0.707062+j0.707152, -0.740995+j0.671510, 0.923853+j0.382746, 0.514042+j0.857765, -0.382616-j0.923907, -0.671503-j0.741002, 1.000000+j0.000078, 0.243058-j0.970012</p>
DP14	<p>1.000000+j0.000000, -0.427555-j0.903989, 0.382684-j0.923879, -0.803208+j0.595699, -0.923880+j0.382683, 0.903990-j0.427554, 0.707107-j0.707106, -0.146732+j0.989176, 0.707106+j0.707108, -0.903990+j0.427553, 0.382681+j0.923880, -0.803209+j0.595697, 0.923878-j0.382687, 0.427551+j0.903991, 0.000005-j1.000000, 0.146736-j0.989176, -0.000006+j1.000000, 0.427549+j0.903992, -0.923877-j0.382690, -0.803213+j0.595693, -0.382675-j0.923883, -0.903994+j0.427546, -0.707099-j0.707115, -0.146742+j0.989175, -0.707116+j0.707098, 0.903995-j0.427542, 0.923885-j0.382669, -0.803217+j0.595686, -0.382700+j0.923873, -0.427538-j0.903997, -1.000000-j0.000020, 0.146752-j0.989173, -1.000000-j0.000023, -0.427533-j0.904000, -0.382707+j0.923870, -0.803224+j0.595677, 0.923891-j0.382657, 0.904002-j0.427528, -0.707129+j0.707084, -0.146764+j0.989172, -0.707082-j0.707132, -0.904005+j0.427522, -0.382648-j0.923894, -0.803232+j0.595667, -0.923863-j0.382723, 0.427515+j0.904008, -0.000046+j1.000000, 0.146778-j0.989169, 0.000050-j1.000000, 0.427508+j0.904012, 0.923859+j0.382734, -0.803241+j0.595654, 0.382629+j0.923902, -0.904016+j0.427500, 0.707062+j0.707152, -0.146796+j0.989167, 0.707155-j0.707058, 0.904020-j0.427491, -0.923908+j0.382616, -0.803253+j0.595639, 0.382756-j0.923850, -0.427482-j0.904024, 1.000000+j0.000083, 0.146816-j0.989164</p>
DP15	<p>1.000000+j0.000000, -0.146730-j0.989177, 0.923880-j0.382683, -0.671559-j0.740951, 0.382684-j0.923879, -0.989177+j0.146730, -0.707106-j0.707108, -0.049069+j0.998795, -0.707108+j0.707106, 0.989177-j0.146728, 0.923879+j0.382686, -0.671557-j0.740953, -0.382680-j0.923881, 0.146726+j0.989177, -0.000005+j1.000000, 0.049073-j0.998795, 0.000006-j1.000000, 0.146723+j0.989178, 0.382676+j0.923883, -0.671552-j0.740957, -0.923876-j0.382693, 0.989178-j0.146720, 0.707115-j0.707098, -0.049081+j0.998795, 0.707097+j0.707117, -0.989179+j0.146715, -0.382699+j0.923873, -0.671546-j0.740963, -0.923887+j0.382666, -0.146710-j0.989179, -1.000000-j0.000022, 0.049091-j0.998794, -1.000000-j0.000024, -0.146705-j0.989180, -0.923890+j0.382658, -0.671537-j0.740971, -0.382712+j0.923868, -0.989181+j0.146698, 0.707083+j0.707131, -0.049104+j0.998794, 0.707133-j0.707080, 0.989182-j0.146691, -0.923864-j0.382722, -0.671527-j0.740980, 0.382641+j0.923897, 0.146683+j0.989183, 0.000050-j1.000000, 0.049119-j0.998793, -0.000054+j1.000000, 0.146675+j0.989185, -0.382629-j0.923902, -0.671514-j0.740992, 0.923855+j0.382742, 0.989186-j0.146666, -0.707155+j0.707059, -0.049138+j0.998792, -0.707055-j0.707158, -0.989188+j0.146656, 0.382756-j0.923850, -0.671499-j0.741005, 0.923912-j0.382606, -0.146645-j0.989189, 1.000000+j0.000089, 0.049160-j0.998791</p>
DP16	<p>1.000000+j0.000000, 0.146731-j0.989176, 0.923879+j0.382684, 0.671559-j0.740951, 0.382683+j0.923880, 0.989176+j0.146731, -0.707108+j0.707106, 0.049066+j0.998796, -0.707105-j0.707108, -0.989176-j0.146733, 0.923881-j0.382681, 0.671561-j0.740949, -0.382687+j0.923878, -0.146735+j0.989176, 0.000005-j1.000000, -0.049062-j0.998796, -0.000007+j1.000000, -0.146738+j0.989175, 0.382691-j0.923876, 0.671566-j0.740945, -0.923884+j0.382674, -0.989175-j0.146742, 0.707098+j0.707116, 0.049054+j0.998796, 0.707117-j0.707096, 0.989174+j0.146746, -0.382667-j0.923886, 0.671573-j0.740939, -0.923872-j0.382702, 0.146752-j0.989173, -1.000000-j0.000023, -0.049043-j0.998797, -1.000000-j0.000026, 0.146758-j0.989172, -0.923868-j0.382710, 0.671582-j0.740930, -0.382653-j0.923892, 0.989171+j0.146765, 0.707133-j0.707081, 0.049029+j0.998797, 0.707078+j0.707135, -0.989170-j0.146772, -0.923896+j0.382643, 0.671593-j0.740920, 0.382728-j0.923861, -0.146781+j0.989169, -0.000053+j1.000000, -0.049013-j0.998798, 0.000057-j1.000000, -0.146790+j0.989168, -0.382741+j0.923856, 0.671607-j0.740908, 0.923905-j0.382621, -0.989166-j0.146799, -0.707056-j0.707158, 0.048993+j0.998799, -0.707162+j0.707052, 0.989165+j0.146810, 0.382606+j0.923911, 0.671623-j0.740893, 0.923845+j0.382766, 0.146821-j0.989163, 1.000000+j0.000095, -0.048970-j0.998800</p>
DP17	<p>1.000000+j0.000000, 0.427555-j0.903989, 0.382683+j0.923880, 0.803207+j0.595700, -0.923879-j0.382684, -0.903989-j0.427556, 0.707106+j0.707108, 0.146729+j0.989177, 0.707108-j0.707105, 0.903988+j0.427557, 0.382686-j0.923878, 0.803205+j0.595702, 0.923881-j0.382679, -0.427560+j0.903987, -0.000006+j1.000000, -0.146724-j0.989177, 0.000007-j1.000000, -0.427563+j0.903986, -0.923883+j0.382675, 0.803201+j0.595707, -0.382694+j0.923875, 0.903984+j0.427566, -0.707116+j0.707097, 0.146716+j0.989179, -0.707096-j0.707118, -0.903982-j0.427571, 0.923872+j0.382701, 0.803196+j0.595715, -0.382664-j0.923888, 0.427576-j0.903980, -</p>

	1.000000-j0.000024, -0.146705-j0.989180, -1.000000-j0.000028, 0.427582-j0.903977, -0.382655-j0.923891, 0.803188+j0.595726, 0.923866+j0.382716, -0.903974-j0.427588, -0.707080-j0.707134, 0.146690+j0.989182, -0.707137+j0.707077, 0.903970+j0.427596, -0.382727+j0.923862, 0.803178+j0.595739, -0.923899+j0.382636, -0.427604+j0.903966, 0.000056-j1.000000, -0.146673-j0.989185, -0.000061+j1.000000, -0.427612+j0.903962, 0.923905-j0.382622, 0.803167+j0.595754, 0.382749-j0.923852, 0.903958+j0.427622, 0.707161-j0.707053, 0.146652+j0.989188, 0.707048+j0.707165, -0.903953-j0.427632, -0.923846-j0.382765, 0.803153+j0.595773, 0.382596+j0.923916, 0.427643-j0.903948, 1.000000+j0.000101, -0.146628-j0.989192
PP18	1.000000+j0.000000, 0.671559-j0.740951, -0.382684+j0.923879, -0.514103+j0.857728, 0.923880-j0.382683, 0.740950+j0.671560, 0.707108-j0.707106, 0.242979+j0.970032, 0.707105+j0.707108, -0.740949-j0.671561, -0.382680-j0.923881, -0.514106+j0.857727, -0.923878-j0.382688, -0.671563+j0.740948, 0.000006-j1.000000, -0.242974-j0.970033, -0.000008+j1.000000, -0.671565+j0.740945, 0.923876+j0.382692, -0.514112+j0.857723, 0.382673+j0.923884, -0.740942-j0.671569, -0.707097-j0.707117, 0.242965+j0.970035, -0.707119+j0.707095, 0.740939+j0.671572, -0.923887+j0.382665, -0.514121+j0.857718, 0.382704-j0.923871, 0.671577-j0.740935, -1.000000-j0.000026, -0.242954-j0.970038, -1.000000-j0.000029, 0.671582-j0.740930, 0.382714-j0.923867, -0.514133+j0.857711, -0.923894+j0.382650, 0.740925+j0.671588, -0.707136+j0.707078, 0.242939+j0.970042, -0.707075-j0.707139, -0.740919-j0.671594, 0.382638+j0.923899, -0.514147+j0.857702, 0.923859+j0.382734, -0.671601+j0.740913, -0.000059+j1.000000, -0.242920-j0.970046, 0.000064-j1.000000, -0.671609+j0.740906, -0.923853-j0.382748, -0.514165+j0.857691, -0.382614-j0.923908, -0.740899-j0.671617, 0.707049+j0.707164, 0.242899+j0.970052, 0.707168-j0.707045, 0.740891+j0.671626, 0.923915-j0.382597, -0.514186+j0.857679, -0.382776+j0.923841, 0.671635-j0.740882, 1.000000+j0.000106, -0.242874-j0.970058
PP19	1.000000+j0.000000, 0.857729-j0.514103, -0.923880+j0.382683, -0.903989-j0.427555, -0.382684+j0.923879, -0.514102-j0.857729, -0.707106-j0.707108, 0.336888+j0.941545, -0.707108+j0.707105, 0.514100+j0.857730, -0.923878-j0.382687, -0.903988-j0.427559, 0.382679+j0.923881, -0.857731+j0.514098, -0.000006+j1.000000, -0.336883-j0.941546, 0.000008-j1.000000, -0.857733+j0.514095, -0.382674-j0.923883, -0.903984-j0.427565, 0.923875+j0.382695, 0.514091+j0.857736, 0.707117-j0.707096, 0.336875+j0.941550, 0.707094+j0.707119, -0.514086-j0.857738, 0.382702-j0.923872, -0.903980-j0.427575, 0.923889-j0.382661, 0.857742-j0.514081, -1.000000-j0.000027, -0.336863-j0.941554, -1.000000-j0.000031, 0.857745-j0.514075, 0.923893-j0.382651, -0.903974-j0.427588, 0.382719-j0.923865, -0.514068-j0.857750, 0.707076+j0.707137, 0.336847+j0.941559, 0.707140-j0.707073, 0.514060+j0.857754, 0.923860+j0.382732, -0.903966-j0.427605, -0.382631-j0.923901, -0.857759+j0.514051, 0.000062-j1.000000, -0.336829-j0.941566, -0.000068+j1.000000, -0.857765+j0.514042, 0.382615+j0.923908, -0.903957-j0.427624, -0.923849-j0.382757, 0.514032+j0.857771, -0.707167+j0.707046, 0.336806+j0.941574, -0.707042-j0.707172, -0.514021-j0.857778, -0.382774+j0.923842, -0.903946-j0.427647, -0.923920+j0.382586, 0.857784-j0.514010, 1.000000+j0.000112, -0.336781-j0.941583
PP20	1.000000+j0.000000, 0.970031-j0.242980, -0.923879-j0.382684, 0.336890-j0.941544, -0.382683-j0.923880, 0.242979+j0.970032, -0.707108+j0.707106, 0.427553+j0.903990, -0.707105-j0.707108, -0.242977-j0.970032, -0.923881+j0.382680, 0.336894-j0.941543, 0.382688-j0.923878, -0.970033+j0.242975, 0.000007-j1.000000, -0.427548-j0.903993, -0.000009+j1.000000, -0.970034+j0.242971, -0.382693+j0.923875, 0.336901-j0.941540, 0.923885-j0.382671, -0.242966-j0.970035, 0.707096+j0.707118, 0.427540+j0.903997, 0.707120-j0.707094, 0.242961+j0.970036, 0.382663+j0.923888, 0.336912-j0.941536, 0.923870+j0.382707, 0.970038-j0.242954, -1.000000-j0.000029, -0.427528-j0.904002, -1.000000-j0.000032, 0.970040-j0.242947, 0.923866+j0.382717, 0.336926-j0.941531, 0.382646+j0.923895, 0.242939+j0.970042, 0.707139-j0.707075, 0.427512+j0.904010, 0.707071+j0.707142, -0.242929-j0.970044, 0.923901-j0.382633, 0.336944-j0.941525, -0.382739+j0.923857, -0.970047+j0.242919, -0.000066+j1.000000, -0.427493-j0.904019, 0.000071-j1.000000, -0.970049+j0.242908, 0.382755-j0.923850, 0.336966-j0.941517, -0.923911+j0.382606, -0.242896-j0.970052, -0.707043-j0.707170, 0.427471+j0.904029, -0.707175+j0.707038, 0.242883+j0.970056, -0.382588-j0.923919, 0.336991-j0.941508, -0.923837-j0.382786, 0.970059-j0.242869, 1.000000+j0.000118, -0.427445-j0.904041
PP21	1.000000+j0.000000, 0.998795+j0.049068, -0.382683-j0.923880, 0.970031+j0.242981, 0.923879+j0.382684, 0.049069-j0.998795, 0.707106+j0.707108, 0.514101+j0.857730, 0.707109-j0.707105, -0.049071+j0.998795, -0.382687+j0.923878, 0.970030+j0.242985, -0.923882+j0.382679, -0.998795-j0.049074, -0.000007+j1.000000, -0.514096-j0.857733, 0.000009-j1.000000, -0.998795-j0.049078, 0.923884-j0.382673, 0.970028+j0.242992, 0.382696-j0.923874, -0.049083+j0.998795, -0.707118+j0.707095, 0.514087+j0.857738, -0.707093-j0.707121, 0.049089-j0.998794, -0.923871-j0.382704, 0.970025+j0.243004, 0.382659+j0.923890, 0.998794+j0.049096, -1.000000-j0.000030, -0.514075-j0.857745, -1.000000-j0.000034, 0.998794+j0.049104, 0.382648+j0.923894, 0.970021+j0.243019, -0.923863-j0.382723, 0.049113-j0.998793, -0.707073-j0.707140, 0.514060+j0.857754, -0.707144+j0.707070, -0.049123+j0.998793, 0.382737-j0.923857, 0.970017+j0.243039, 0.923904-j0.382625, -0.998792-j0.049134, 0.000069-j1.000000, -0.514041-j0.857766, -0.000075+j1.000000, -0.998792-j0.049146, -0.923911+j0.382609, 0.970011+j0.243062, -0.382764+j0.923846, -0.049158+j0.998791, 0.707173-j0.707040, 0.514019+j0.857779, 0.707035+j0.707178, 0.049172-j0.998790, 0.923838+j0.382784,

	0.970004+j0.243089, -0.382576-j0.923924, 0.998790+j0.049187, 1.000000+j0.000124, -0.513993-j0.857794
DP22	1.000000+j0.000000, 0.941544+j0.336890, 0.382684-j0.923879, -0.146731+j0.989176, -0.923880+j0.382683, -0.336891+j0.941544, 0.707108-j0.707106, 0.595698+j0.803209, 0.707105+j0.707109, 0.336893-j0.941543, 0.382680+j0.923881, -0.146735+j0.989176, 0.923877-j0.382688, -0.941542-j0.336896, 0.000007-j1.000000, -0.595693-j0.803212, -0.000009+j1.000000, -0.941541-j0.336900, -0.923875-j0.382694, -0.146743+j0.989175, -0.382670-j0.923885, 0.336905-j0.941539, -0.707095-j0.707119, 0.595684+j0.803219, -0.707121+j0.707092, -0.336911+j0.941537, 0.923889-j0.382661, -0.146756+j0.989173, -0.382709+j0.923869, 0.941534+j0.336917, -1.000000-j0.000031, -0.595672-j0.803227, -1.000000-j0.000036, 0.941531+j0.336925, -0.382720+j0.923864, -0.146772+j0.989170, 0.923897-j0.382642, -0.336934+j0.941528, -0.707142+j0.707072, 0.595657+j0.803239, -0.707068-j0.707146, 0.336944-j0.941525, -0.382628-j0.923903, -0.146793+j0.989167, -0.923854-j0.382744, -0.941521-j0.336955, -0.000072+j1.000000, -0.595639-j0.803252, 0.000078-j1.000000, -0.941517-j0.336967, 0.923847+j0.382762, -0.146818+j0.989164, 0.382599+j0.923915, 0.336979-j0.941512, 0.707037+j0.707177, 0.595617+j0.803268, 0.707182-j0.707032, -0.336993+j0.941507, -0.923923+j0.382579, -0.146847+j0.989159, 0.382796-j0.923833, 0.941502+j0.337008, 1.000000+j0.000129, -0.595592-j0.803287
DP23	1.000000+j0.000000, 0.803207+j0.595699, 0.923880-j0.382683, -0.998795-j0.049068, 0.382684-j0.923879, 0.595700-j0.803207, -0.707106-j0.707108, 0.671557+j0.740953, -0.707109+j0.707105, -0.595702+j0.803206, 0.923878+j0.382687, -0.998795-j0.049073, -0.382678-j0.923882, -0.803204-j0.595705, -0.000008+j1.000000, -0.671553-j0.740957, 0.000010-j1.000000, -0.803201-j0.595708, 0.382672+j0.923884, -0.998795-j0.049081, -0.923874-j0.382697, -0.595713+j0.803198, 0.707120-j0.707094, 0.671544+j0.740964, 0.707092+j0.707122, 0.595718-j0.803194, -0.382706+j0.923870, -0.998794-j0.049094, -0.923890+j0.382657, 0.803189+j0.595724, -1.000000-j0.000033, -0.671533-j0.740975, -1.000000-j0.000037, 0.803184+j0.595731, -0.923895+j0.382645, -0.998793-j0.049112, -0.382727+j0.923862, 0.595739-j0.803178, 0.707070+j0.707143, 0.671519+j0.740988, 0.707147-j0.707066, -0.595748+j0.803172, -0.923855-j0.382742, -0.998792-j0.049134, 0.382620+j0.923906, -0.803165-j0.595757, 0.000075-j1.000000, -0.671501-j0.741004, -0.000082+j1.000000, -0.803157-j0.595768, -0.382602-j0.923913, -0.998791-j0.049160, 0.923843+j0.382772, -0.595779+j0.803148, -0.707180+j0.707034, 0.671480+j0.741023, -0.707029-j0.707185, 0.595791-j0.803139, 0.382793-j0.923834, -0.998789-j0.049190, 0.923928-j0.382566, 0.803130+j0.595805, 1.000000+j0.000135, -0.671456-j0.741045
DP24	1.000000+j0.000000, 0.595699+j0.803208, 0.923879+j0.382684, -0.049067-j0.998795, 0.382683+j0.923880, -0.803208+j0.595698, -0.707108+j0.707106, 0.740950+j0.671561, -0.707105-j0.707109, 0.803210-j0.595696, 0.923881-j0.382679, -0.049063-j0.998796, -0.382689+j0.923877, -0.595694-j0.803212, 0.000008-j1.000000, -0.740945-j0.671566, -0.000010+j1.000000, -0.595690-j0.803214, 0.382695-j0.923875, -0.049054-j0.998796, -0.923886+j0.382669, 0.803218-j0.595686, 0.707094+j0.707120, 0.740937+j0.671574, 0.707122-j0.707091, -0.803222+j0.595680, -0.382660-j0.923889, -0.049040-j0.998797, -0.923868-j0.382711, 0.595674+j0.803227, -1.000000-j0.000034, -0.740927-j0.671586, -1.000000-j0.000039, 0.595666+j0.803232, -0.923863-j0.382724, -0.049022-j0.998798, -0.382639-j0.923898, -0.803238+j0.595658, 0.707145-j0.707069, 0.740913+j0.671601, 0.707065+j0.707149, 0.803245-j0.595649, -0.923905+j0.382623, -0.048999-j0.998799, 0.382750-j0.923852, -0.595639-j0.803252, -0.000078+j1.000000, -0.740896-j0.671620, 0.000085-j1.000000, -0.595628-j0.803260, -0.382769+j0.923844, -0.048972-j0.998800, 0.923918-j0.382591, 0.803269-j0.595616, -0.707031-j0.707183, 0.740876+j0.671641, -0.707188+j0.707025, -0.803279+j0.595603, 0.382569+j0.923927, -0.048940-j0.998802, 0.923829+j0.382806, 0.595590+j0.803289, 1.000000+j0.000141, -0.740853-j0.671667
DP25	1.000000+j0.000000, 0.336890+j0.941544, 0.382683+j0.923880, 0.989177-j0.146730, -0.923879-j0.382684, 0.941545-j0.336889, 0.707106+j0.707108, 0.803206+j0.595701, 0.707109-j0.707105, -0.941545+j0.336886, 0.382688-j0.923878, 0.989177-j0.146725, 0.923882-j0.382678, -0.336883-j0.941546, -0.000008+j1.000000, -0.803202-j0.595707, 0.000011-j1.000000, -0.336879-j0.941548, -0.923885+j0.382671, 0.989179-j0.146716, -0.382698+j0.923873, -0.941550+j0.336873, -0.707121+j0.707093, 0.803195+j0.595716, -0.707090-j0.707123, 0.941552-j0.336866, 0.923869+j0.382708, 0.989181-j0.146702, -0.382655-j0.923891, 0.336859+j0.941555, -1.000000-j0.000036, -0.803185-j0.595730, -1.000000-j0.000040, 0.336850+j0.941558, -0.382642-j0.923897, 0.989184-j0.146683, 0.923860+j0.382730, 0.941562-j0.336840, -0.707067-j0.707147, 0.803172+j0.595747, -0.707151+j0.707063, -0.941566+j0.336828, -0.382747+j0.923853, 0.989187-j0.146660, -0.923908+j0.382614, -0.336816-j0.941570, 0.000082-j1.000000, -0.803157-j0.595768, -0.000089+j1.000000, -0.336803-j0.941575, 0.923916-j0.382595, 0.989191-j0.146632, 0.382779-j0.923840, -0.941580+j0.336788, 0.707186-j0.707028, 0.803138+j0.595792, 0.707022+j0.707192, 0.941586-j0.336773, -0.923830-j0.382802, 0.989196-j0.146599, 0.382556+j0.923932, 0.336756+j0.941592, 1.000000+j0.000147, -0.803117-j0.595821
DP26	1.000000+j0.000000, 0.049068+j0.998795, -0.382684+j0.923879, 0.242980+j0.970031, 0.923880-j0.382683, -0.998796+j0.049066, 0.707108-j0.707105, 0.857727+j0.514105, 0.707105+j0.707109, 0.998796-j0.049064, -0.382679-j0.923881, 0.242975+j0.970033, -0.923877-j0.382689, -0.049060-j0.998796, 0.000009-j1.000000, -0.857724-j0.514111, -0.000011+j1.000000, -0.049055-j0.998796, 0.923874+j0.382696, 0.242965+j0.970035, 0.382668+j0.923886, 0.998796-j0.049049, -0.707092-

	j0.707121, 0.857717+j0.514122, -0.707124+j0.707090, -0.998797+j0.049042, -0.923890+j0.382658, 0.242951+j0.970039, 0.382713-j0.923867, 0.049033+j0.998797, -1.000000-j0.000037, -0.857708-j0.514136, -1.000000-j0.000042, 0.049023+j0.998798, 0.382727-j0.923862, 0.242932+j0.970043, -0.923900+j0.382635, -0.998798+j0.049012, -0.707148+j0.707065, 0.857697+j0.514155, -0.707061-j0.707152, 0.998799-j0.049000, 0.382618+j0.923907, 0.242908+j0.970049, 0.923850+j0.382755, -0.048986-j0.998799, -0.000085+j1.000000, -0.857683-j0.514179, 0.000092-j1.000000, -0.048972-j0.998800, -0.923841-j0.382776, 0.242879+j0.970056, -0.382584-j0.923921, 0.998801-j0.048956, 0.707025+j0.707189, 0.857667+j0.514206, 0.707195-j0.707019, -0.998802+j0.048939, 0.923931-j0.382560, 0.242846+j0.970065, -0.382816+j0.923825, 0.048920+j0.998803, 1.000000+j0.000153, -0.857648-j0.514238
DP27	1.000000+j0.000000, -0.242980+j0.970031, -0.923880+j0.382683, -0.941544+j0.336889, -0.382684+j0.923879, 0.970031+j0.242982, -0.707105-j0.707108, 0.903988+j0.427557, -0.707109+j0.707105, -0.970030-j0.242984, -0.923878-j0.382688, -0.941546+j0.336884, 0.382677+j0.923882, 0.242988-j0.970029, -0.000009+j1.000000, -0.903985-j0.427564, 0.000011-j1.000000, 0.242993-j0.970028, -0.382670-j0.923885, -0.941549+j0.336875, 0.923873+j0.382700, -0.970027-j0.242999, 0.707122-j0.707092, 0.903979+j0.427576, 0.707089+j0.707124, 0.970025+j0.243006, 0.382710-j0.923868, -0.941555+j0.336860, 0.923892-j0.382652, -0.243015+j0.970023, -1.000000-j0.000038, -0.903972-j0.427592, -1.000000-j0.000043, -0.243025+j0.970020, 0.923898-j0.382638, -0.941561+j0.336841, 0.382734-j0.923859, 0.970017+j0.243036, 0.707064+j0.707150, 0.903962+j0.427613, 0.707154-j0.707059, -0.970014-j0.243048, 0.923851+j0.382752, -0.941570+j0.336817, -0.382609-j0.923910, 0.243062-j0.970011, 0.000088-j1.000000, -0.903950-j0.427638, -0.000096+j1.000000, 0.243077-j0.970007, 0.382588+j0.923919, -0.941580+j0.336788, -0.923837-j0.382787, -0.970003-j0.243093, -0.707192+j0.707021, 0.903936+j0.427668, -0.707015-j0.707198, 0.969999+j0.243110, -0.382812+j0.923826, -0.941592+j0.336755, -0.923936+j0.382546, -0.243129+j0.969994, 1.000000+j0.000158, -0.903919-j0.427703
DP28	1.000000+j0.000000, -0.514103+j0.857729, -0.923879-j0.382684, -0.427555-j0.903990, -0.382683-j0.923880, -0.857728-j0.514104, -0.707108+j0.707105, 0.941543+j0.336892, -0.707104-j0.707109, 0.857727+j0.514106, -0.923881+j0.382679, -0.427550-j0.903992, 0.382690-j0.923877, 0.514110-j0.857724, 0.000009-j1.000000, -0.941541-j0.336900, -0.000012+j1.000000, 0.514114-j0.857722, -0.382697+j0.923874, -0.427540-j0.903996, 0.923886-j0.382667, 0.857718+j0.514120, 0.707091+j0.707122, 0.941536+j0.336912, 0.707125-j0.707089, -0.857714-j0.514127, 0.382656+j0.923891, -0.427526-j0.904003, 0.923866+j0.382716, -0.514135+j0.857710, -1.000000-j0.000040, -0.941530-j0.336930, -1.000000-j0.000045, -0.514144+j0.857704, 0.923860+j0.382730, -0.427507-j0.904012, 0.382631+j0.923901, -0.857698-j0.514154, 0.707151-j0.707062, 0.941522+j0.336952, 0.707058+j0.707156, 0.857691+j0.514165, 0.923909-j0.382613, -0.427483-j0.904023, -0.382761+j0.923848, 0.514178-j0.857684, -0.000091+j1.000000, -0.941512-j0.336979, 0.000099-j1.000000, 0.514191-j0.857676, 0.382783-j0.923838, -0.427454-j0.904037, -0.923924+j0.382576, 0.857667+j0.514206, -0.707018-j0.707195, 0.941500+j0.337012, -0.707202+j0.707012, -0.857657-j0.514222, -0.382551-j0.923935, -0.427421-j0.904053, -0.923821-j0.382825, -0.514239+j0.857647, 1.000000+j0.000164, -0.941487-j0.337049
DP29	1.000000+j0.000000, -0.740951+j0.671559, -0.382683-j0.923880, 0.857729-j0.514102, 0.923879+j0.382684, 0.671558+j0.740952, 0.707105+j0.707108, 0.970031+j0.242983, 0.707109-j0.707104, -0.671556-j0.740954, -0.382688+j0.923878, 0.857732-j0.514097, -0.923882+j0.382677, 0.740957-j0.671553, -0.000010+j1.000000, -0.970029-j0.242991, 0.000012-j1.000000, 0.740960-j0.671549, 0.923885-j0.382669, 0.857737-j0.514088, 0.382701-j0.923872, -0.671544-j0.740965, -0.707123+j0.707091, 0.970025+j0.243004, -0.707088-j0.707126, 0.671538+j0.740971, -0.923868-j0.382712, 0.857746-j0.514074, 0.382650+j0.923893, -0.740977+j0.671530, -1.000000-j0.000041, -0.970021-j0.243023, -1.000000-j0.000047, -0.740984+j0.671522, 0.382635+j0.923900, 0.857757-j0.514055, -0.923857-j0.382738, 0.671513+j0.740993, -0.707061-j0.707153, 0.970015+j0.243047, -0.707158+j0.707056, -0.671503-j0.741002, 0.382756-j0.923849, 0.857771-j0.514032, 0.923913-j0.382603, 0.741012-j0.671492, 0.000094-j1.000000, -0.970007-j0.243076, -0.000103+j1.000000, 0.741023-j0.671480, -0.923922+j0.382581, 0.857788-j0.514004, -0.382794+j0.923834, -0.671467-j0.741035, 0.707198-j0.707015, 0.969999+j0.243110, 0.707009+j0.707205, 0.671452+j0.741048, 0.923823+j0.382821, 0.857808-j0.513971, -0.382536-j0.923940, -0.741062+j0.671437, 1.000000+j0.000170, -0.969989-j0.243150
DP30	1.000000+j0.000000, -0.903989+j0.427555, 0.382684-j0.923879, 0.595699+j0.803208, -0.923880+j0.382682, -0.427554-j0.903990, 0.707108-j0.707105, 0.989176+j0.146733, 0.707104+j0.707109, 0.427551+j0.903991, 0.382679+j0.923882, 0.595694+j0.803211, 0.923877+j0.382690, 0.903993-j0.427547, 0.000010-j1.000000, -0.989175-j0.146742, -0.000013+j1.000000, 0.903995-j0.427542, -0.923873-j0.382698, 0.595685+j0.803218, -0.382665-j0.923887, 0.427536+j0.903998, -0.707090-j0.707123, 0.989173+j0.146756, -0.707126+j0.707087, -0.427528-j0.904002, 0.923892-j0.382654, 0.595671+j0.803228, -0.382718+j0.923865, -0.904006-j0.427519, -1.000000-j0.000042, -0.989170-j0.146775, -1.000000-j0.000048, -0.904011+j0.427509, -0.382733+j0.923859, 0.595653+j0.803242, 0.923903-j0.382628, -0.427497-j0.904017, -0.707154+j0.707059, 0.989166+j0.146800, -0.707054-j0.707159, 0.427485+j0.904023, -0.382608-j0.923911, 0.595631+j0.803259, -0.923845-j0.382766, 0.904029-j0.427471, -

	0.000098+j1.000000, -0.989162-j0.146831, 0.000106-j1.000000, 0.904037-j0.427455, 0.923836+j0.382790, 0.595603+j0.803279, 0.382569+j0.923927, 0.427439+j0.904044, 0.707012+j0.707201, 0.989156+j0.146868, 0.707208-j0.707005, -0.427421-j0.904053, -0.923938+j0.382541, 0.595571+j0.803302, 0.382835-j0.923817, -0.904062+j0.427401, 1.000000+j0.000176, -0.989150-j0.146910
PP31	1.000000+j0.000000, -0.989177+j0.146730, 0.923880-j0.382683, -0.740952+j0.671558, 0.382684-j0.923879, 0.146729+j0.989177, -0.707105-j0.707108, 0.998795+j0.049071, -0.707109+j0.707104, -0.146726-j0.989177, 0.923877+j0.382688, -0.740956+j0.671554, -0.382676-j0.923882, 0.989178-j0.146722, -0.000010+j1.000000, -0.998795-j0.049079, 0.000013-j1.000000, 0.989179-j0.146716, 0.382668+j0.923886, -0.740963+j0.671545, -0.923872-j0.382702, -0.146709-j0.989180, 0.707124-j0.707090, 0.998794+j0.049094, 0.707087+j0.707127, 0.146700+j0.989181, -0.382714+j0.923867, -0.740975+j0.671532, -0.923894+j0.382648, -0.989183+j0.146690, -1.000000-j0.000044, -0.998793-j0.049114, -1.000000-j0.000050, -0.989184+j0.146678, -0.923901+j0.382632, -0.740991+j0.671515, -0.382741+j0.923856, 0.146665+j0.989186, 0.707058+j0.707156, 0.998792+j0.049141, 0.707161-j0.707053, -0.146651-j0.989188, -0.923847-j0.382761, -0.741010+j0.671493, 0.382598+j0.923915, 0.989191-j0.146635, 0.000101-j1.000000, -0.998790-j0.049173, -0.000110+j1.000000, 0.989193-j0.146618, -0.382574-j0.923925, -0.741034+j0.671467, 0.923830+j0.382802, -0.146599-j0.989196, -0.707204+j0.707009, 0.998788+j0.049211, -0.707002-j0.707212, 0.146578+j0.989199, 0.382830-j0.923819, -0.741062+j0.671437, 0.923945-j0.382526, -0.989202+j0.146557, 1.000000+j0.000181, -0.998786-j0.049255

AA.2 Association between Midambles and Channelisation Codes for default midamble allocation

The following mapping schemes apply for the association between midambles and channelisation codes if no midamble is allocated by higher layers. Secondary channelisation codes are marked with *. These associations apply for both UL and DL.

AA.2.1 Association for K=16 Midambles

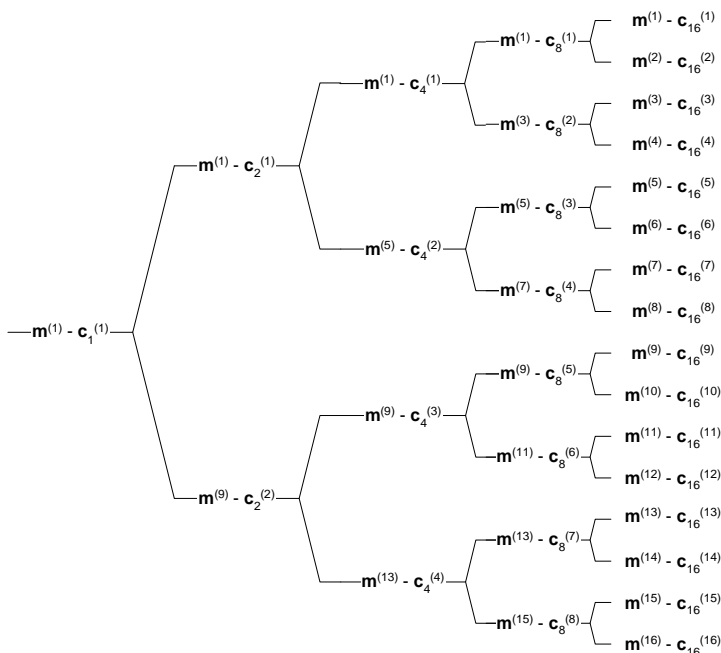

Figure AA.1: Association of Midambles to Spreading Codes for K=16

AA.2.2 Association for K=14 Midambles

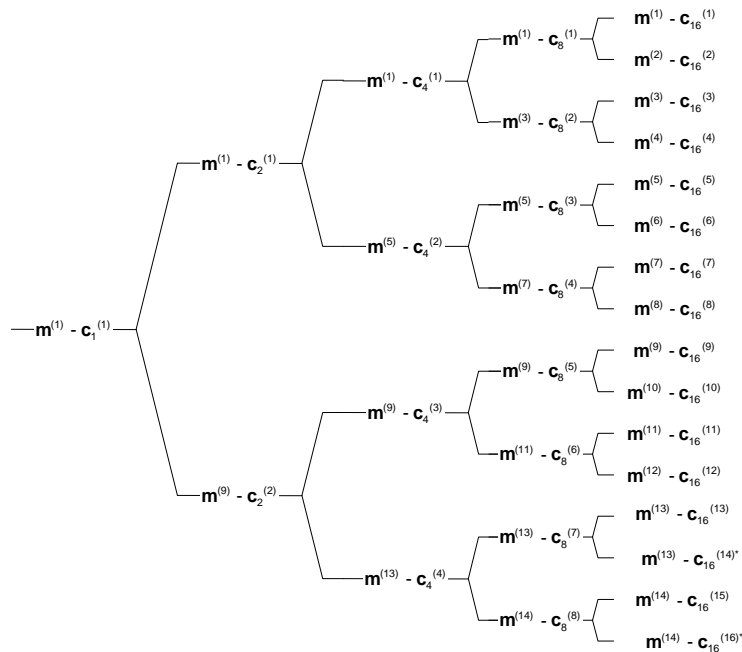

Figure AA.2: Association of Midambles to Spreading Codes for K=14

AA.2.3 Association for K=12 Midambles

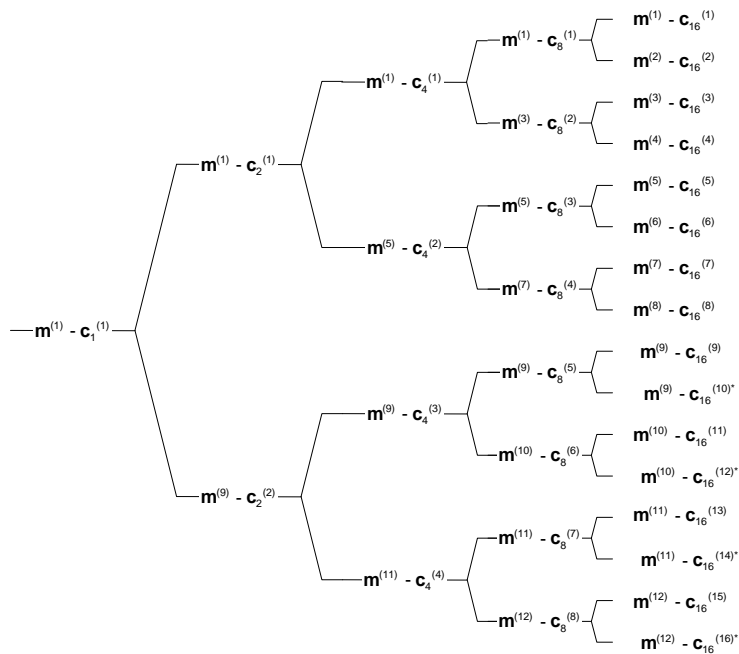

Figure AA.3: Association of Midambles to Spreading Codes for K=12

AA.2.4 Association for K=10 Midambles

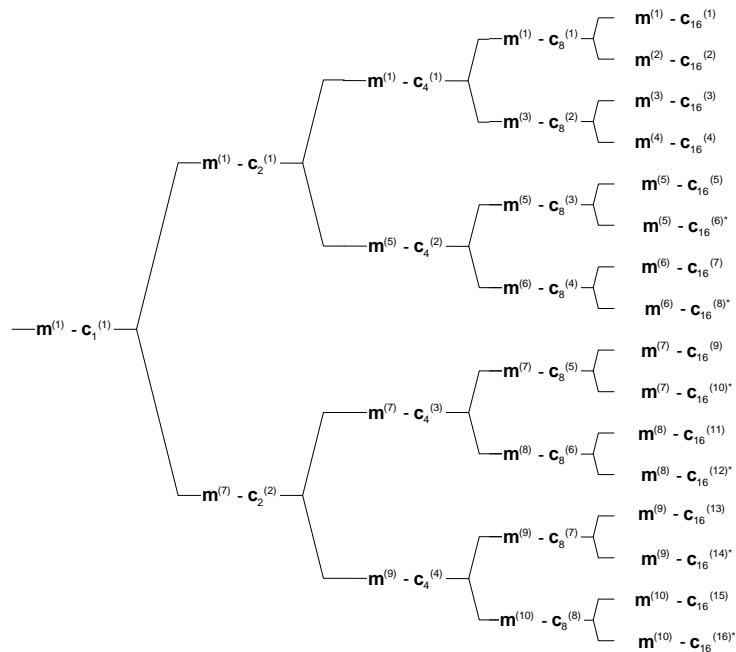

Figure AA.4: Association of Midambles to Spreading Codes for K=10

AA.2.5 Association for K=8 Midambles

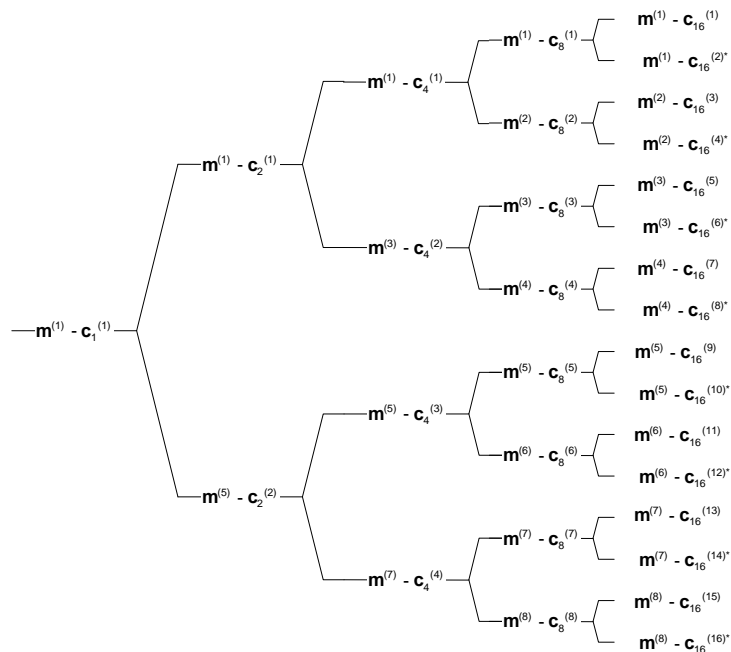

Figure AA.5: Association of Midambles to Spreading Codes for K=8

AA.2.6 Association for K=6 Midambles

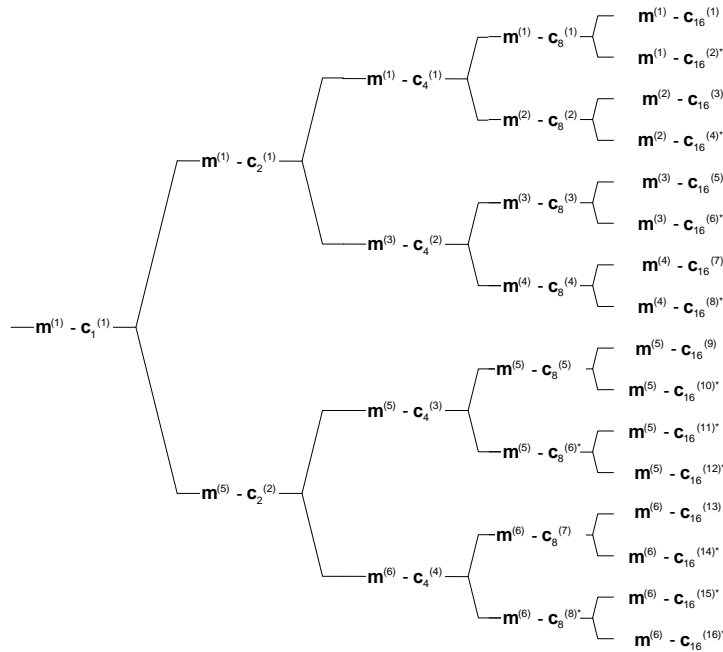

Figure AA.6: Association of Midambles to Spreading Codes for K=6

AA.2.7 Association for K=4 Midambles

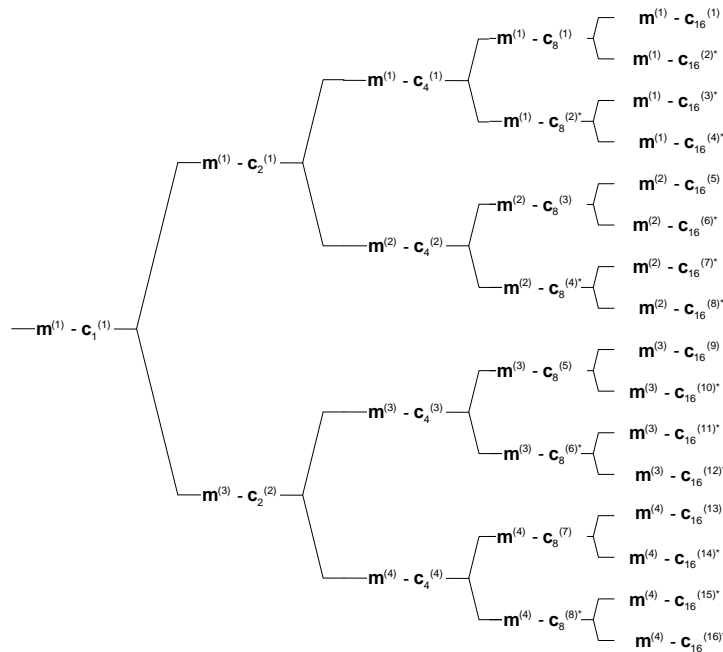

Figure AA.7: Association of Midambles to Spreading Codes for K=4

AA.2.8 Association for K=2 Midambles

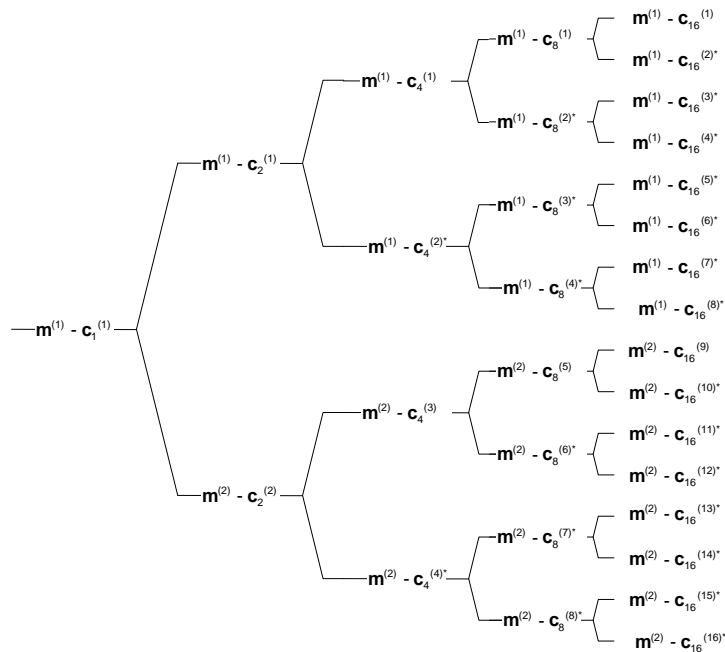

Figure AA.8: Association of Midambles to Spreading Codes for K=2

AA.3 Association between Midambles and Channelisation Codes for special default midamble allocation

The following mapping schemes apply for the association between midambles and channelisation codes if no midamble is allocated by higher layers. Secondary channelisation codes are marked with *. These associations apply for both UL and DL.

AA.3.1 Association for K=16 Midambles

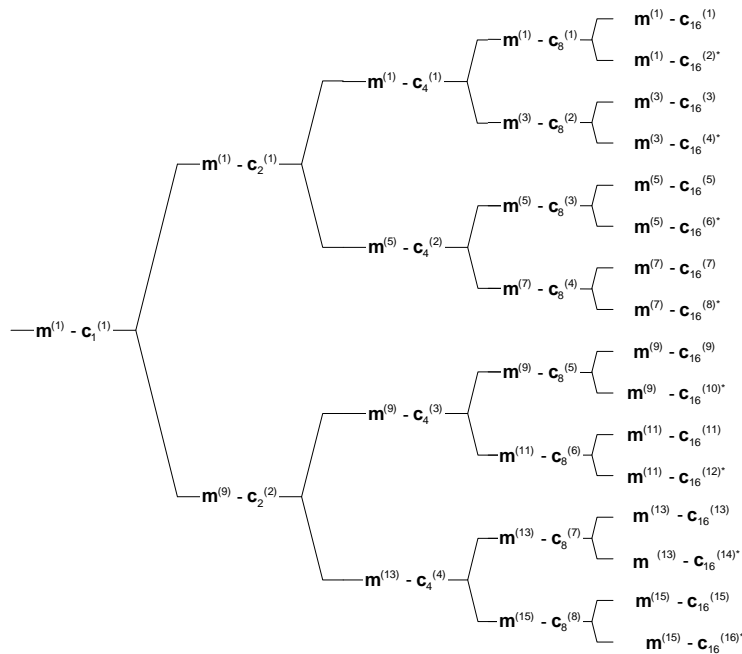

Figure AA.3.1a: Association of Midambles to Spreading Codes for K=16 pattern 1

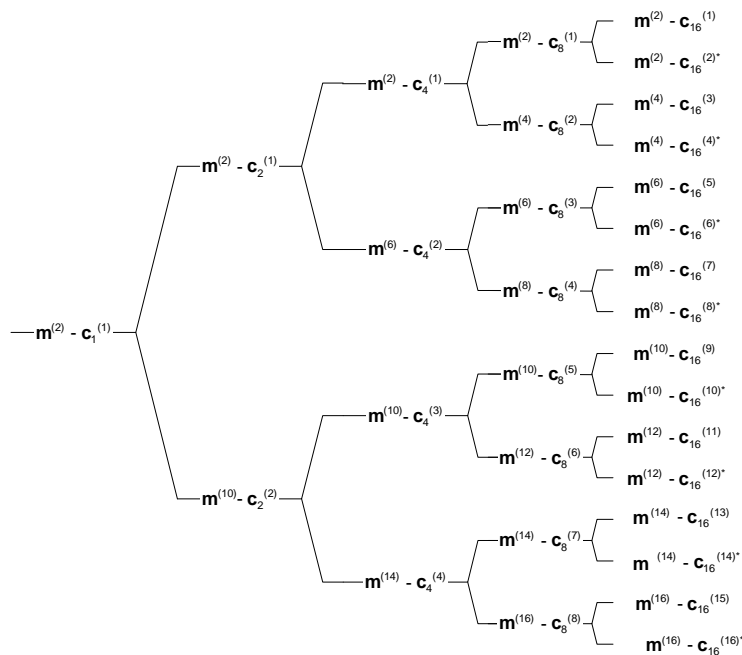

Figure AA.3.1b: Association of Midambles to Spreading Codes for K=16 pattern 2

AA.3.2 Association for K=14 Midambles

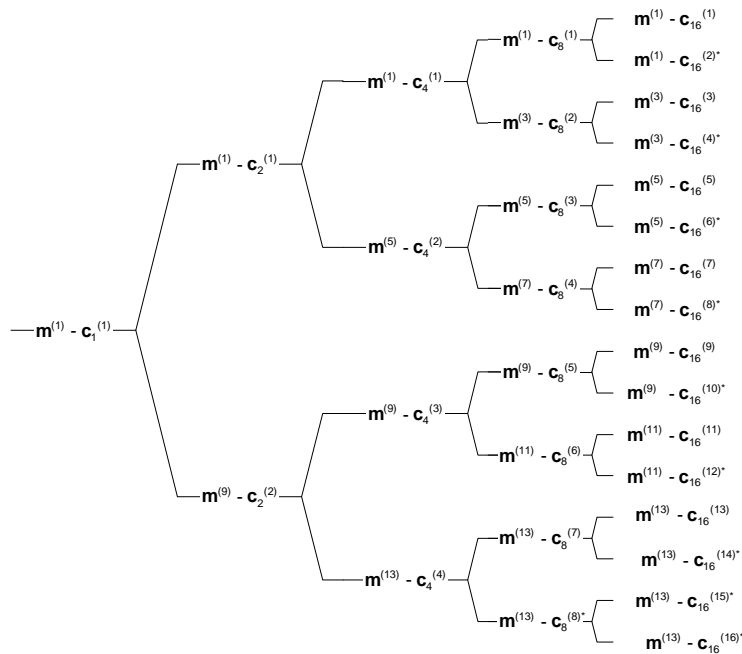

Figure AA.3.2a: Association of Midambles to Spreading Codes for K=14 pattern 1

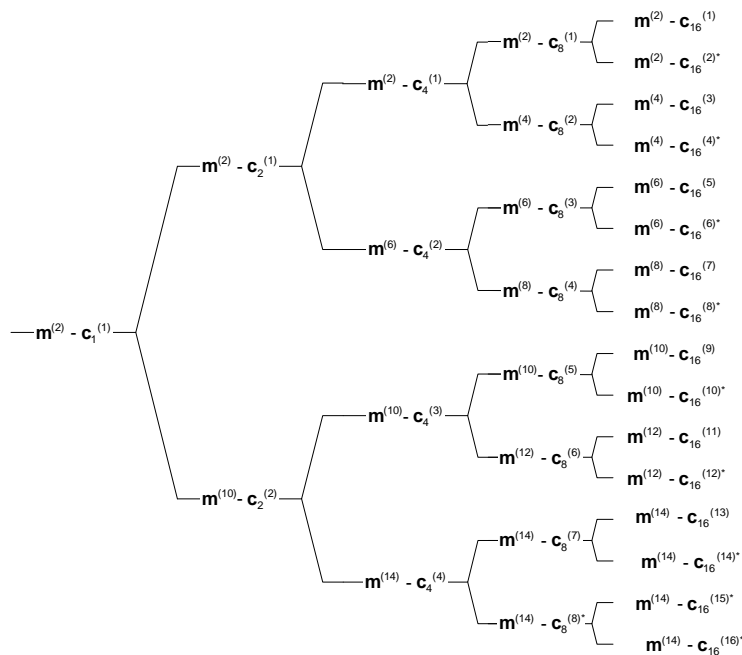

Figure AA.3.2b: Association of Midambles to Spreading Codes for K=14 pattern 2

AA.3.3 Association for K=12 Midambles

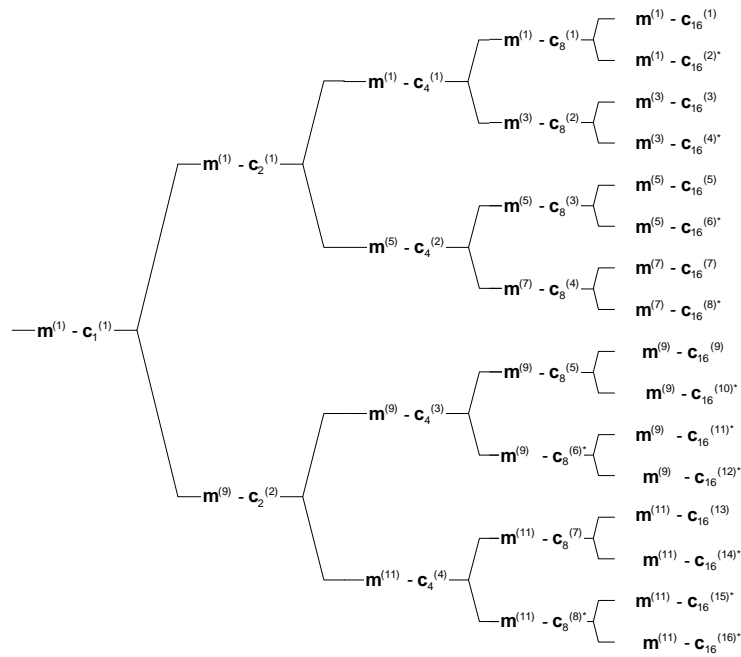

Figure AA.3.3a: Association of Midambles to Spreading Codes for K=12 pattern 1

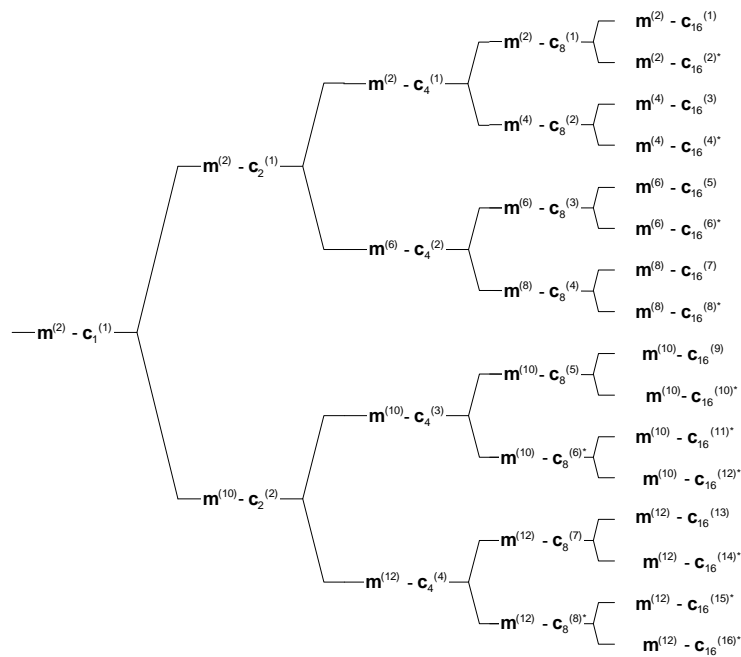

Figure AA.3.3b: Association of Midambles to Spreading Codes for K=12 pattern 2

AA.3.4 Association for K=10 Midambles

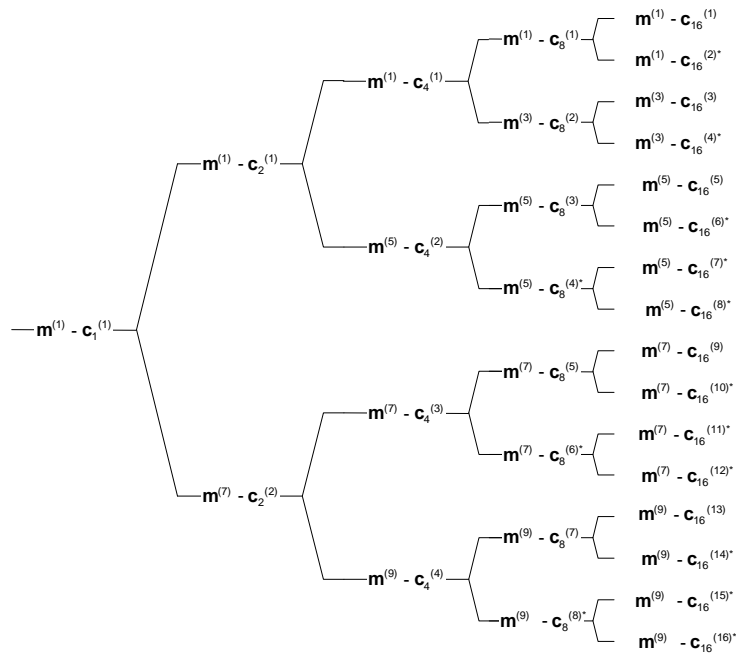

Figure AA.3.4a: Association of Midambles to Spreading Codes for K=10 pattern 1

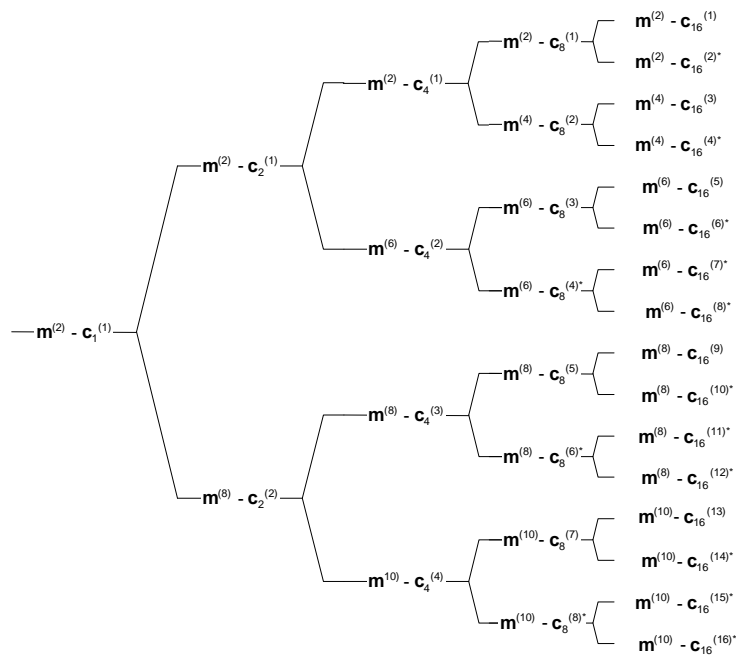

Figure AA.3.4b: Association of Midambles to Spreading Codes for K=10 pattern 2

AA.3.5 Association for K=8 Midambles

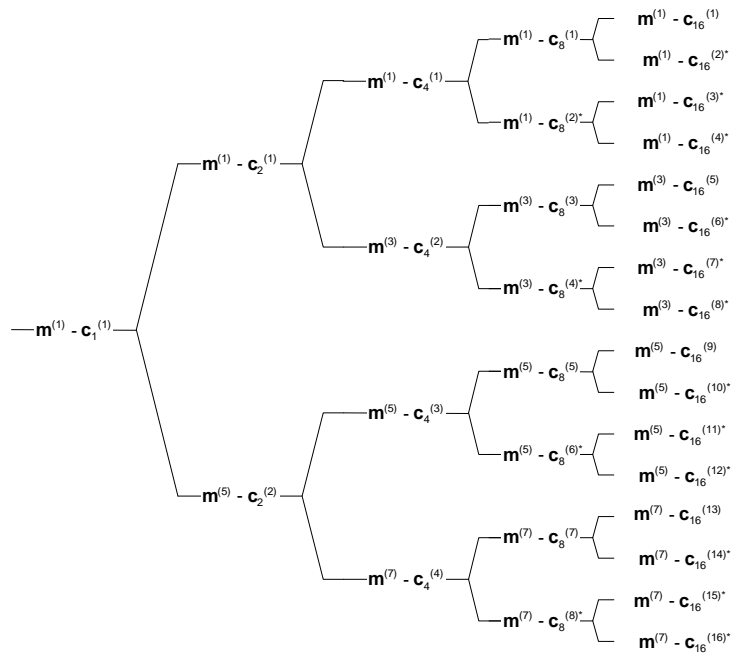

Figure AA.3.5a: Association of Midambles to Spreading Codes for K=8 pattern 1

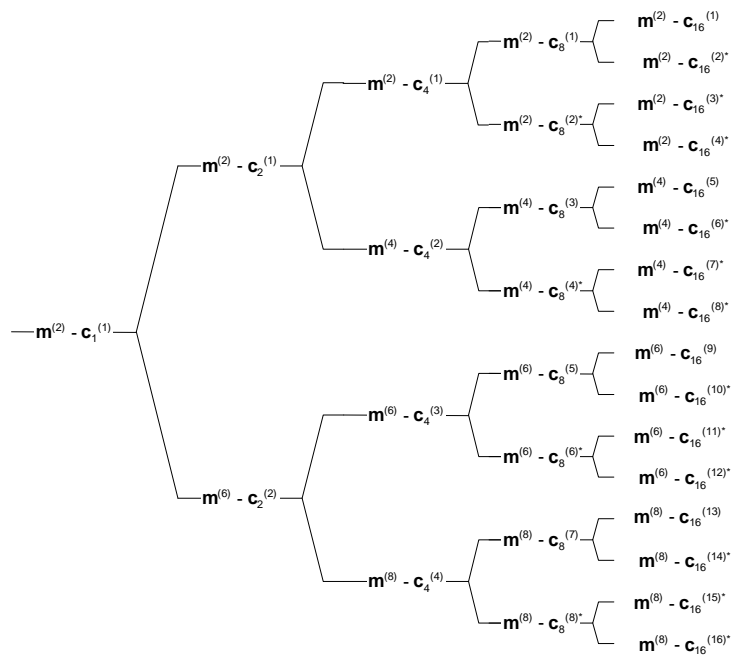

Figure AA.3.5b: Association of Midambles to Spreading Codes for K=8 pattern 2

AA.3.6 Association for K=6 Midambles

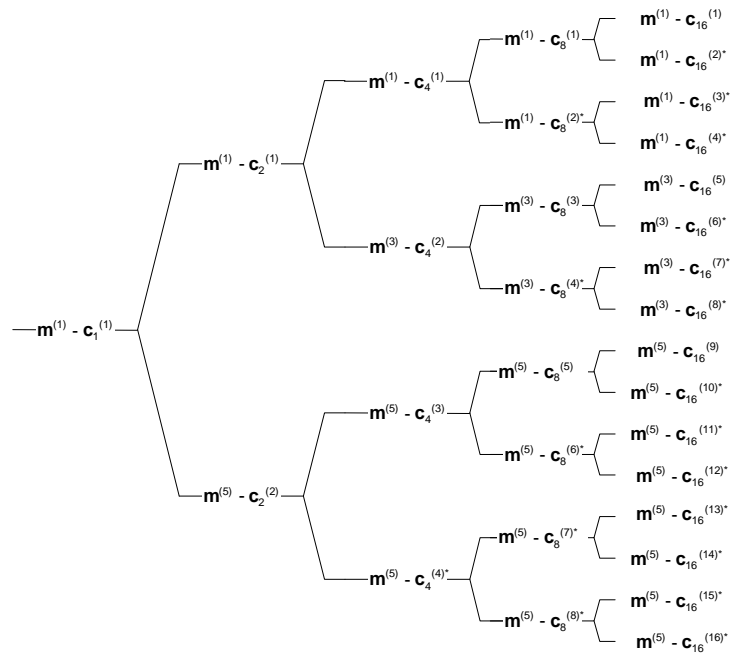

Figure AA.3.6a: Association of Midambles to Spreading Codes for K=6 pattern 1

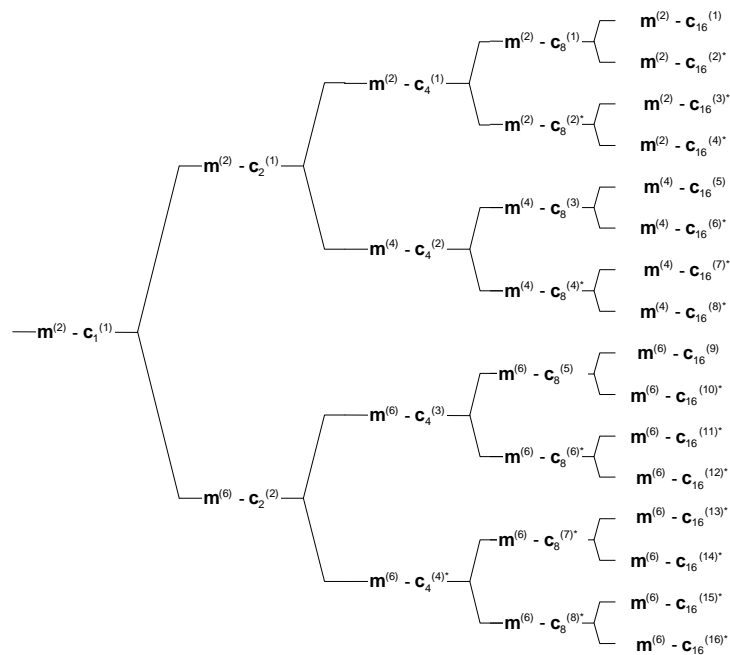

Figure AA.3.6b: Association of Midambles to Spreading Codes for K=6 pattern 2

AA.3.7 Association for K=4 Midambles

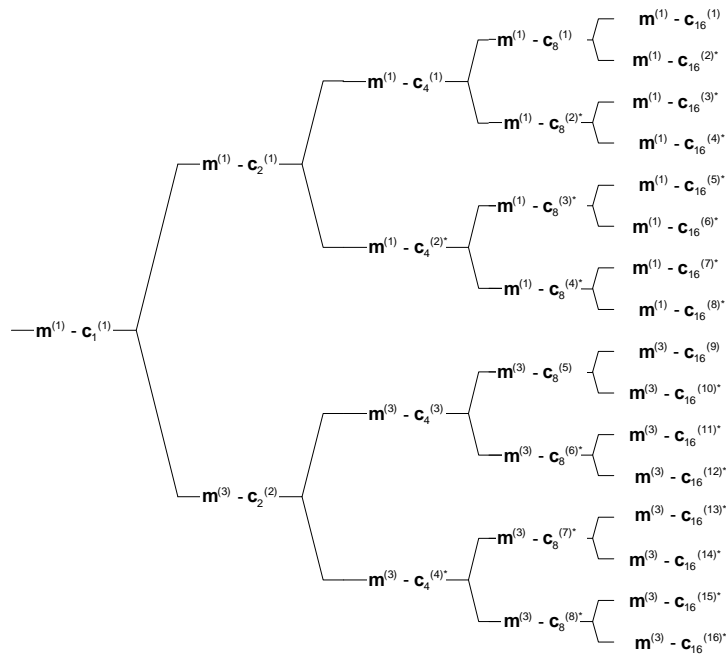

Figure AA.3.7a: Association of Midambles to Spreading Codes for K=4 pattern 1

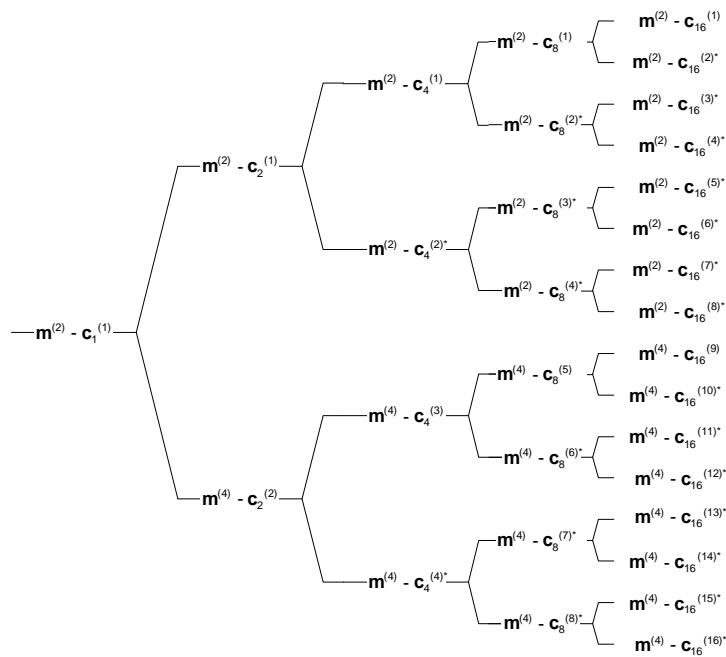

Figure AA.3.7b: Association of Midambles to Spreading Codes for K=4 pattern 2

AA.3.8 Association for K=2 Midambles

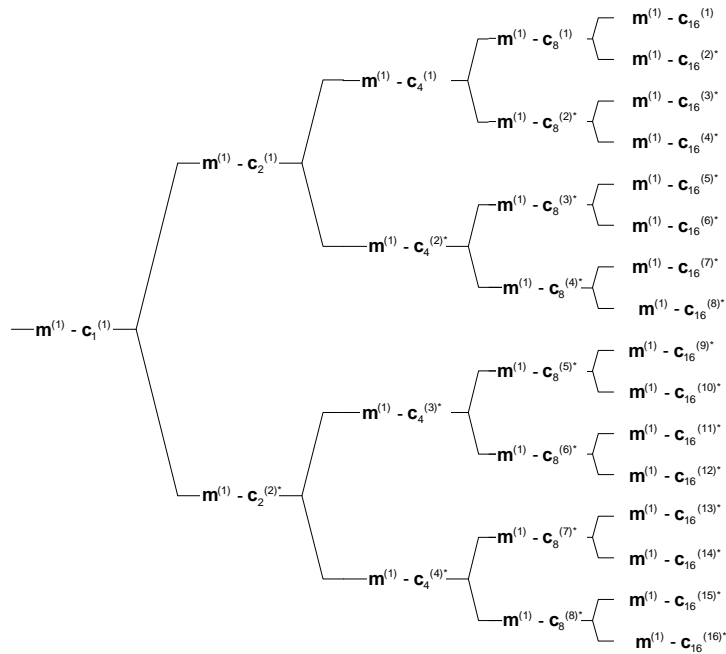

Figure AA.3.8a: Association of Midambles to Spreading Codes for K=2 pattern 1

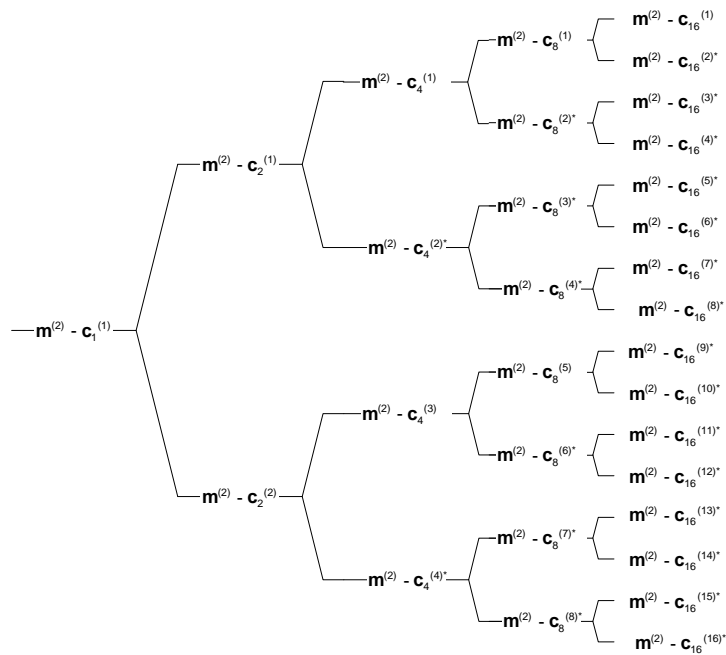

Figure AA.3.8b: Association of Midambles to Spreading Codes for K=2 pattern 2

Annex AB (normative): Basic Midamble Codes for the 7.68 Mcps option

AB.1 Basic Midamble Codes for Burst Type 1 and 3

In the case of burst type 1 or 3 (see subclause 5B.3.2) the midamble has a length of $L_m=1024$, which corresponds to:

$$K'=8; W=114; P=912.$$

Depending on the possible delay spread cells are configured to use K_{Cell} midambles which are generated from the Basic Midamble Codes of length 912 defined in table AB.1 below

- for all $k=1,2,\dots,K$; $K=2K'$ or
- for $k=1,2,\dots,K'$, only, or
- for odd $k=1,3,5,\dots,\leq K'$, only.

In the beacon slot # k , where the P-CCPCH is located, the number of midambles $K_{\text{Cell}}=8$ (cf section 5B.7). In all of the other timeslots that use burst type 1 or 3, K_{Cell} is individually configured from higher layers.

The mapping of these Basic Midamble Codes to Cell Parameters is shown in TS 25.223.

Table AB.1: Basic Midamble Codes m_p according to equation (5) from subclause 5B.3.3 for case of burst type 1 and 3

Code ID	Basic Midamble Codes m_p of length $P=912$
m_{p0}	9E57CC4EFF411BC3A56568FCBECB53005A3A19CA729C922826FB5E2F55D4A0C6D57335B055188F2274154ED0F61107BD34023FDC3887072689755E733FABEED9B7967C46E9452F78E0CBE97CAFB92DD44C90E40E3CFE9DB4054AC45EB8F260FDF8CFB5C3C23733F7344633F26CB092AC89F4
m_{p1}	3AC41CCDCCEB89F45AA67884536D0B796A5E048D76D2F9531E2E31516496B3B76196D68FB7F6CFD8C5EA232B5C012953FFCF4C1CA7A2BDEB236426E422FD4F050C4022188D8068F47441FC31B005F8F53452DB8D72839DF021A45D8BC51D1CF440A665D1F751145D2F04CA352BF2C0BCF589E
m_{p2}	4241DBD18BB9C42E335530533B27F0411A0588156421FA0F306C2598CD9C2D3F7D954C64E4EEC699B2414356F1D47E2A3D09A56EA850ED4319AFE7AF07538A9499206DD943AE990F43FA33FAB6CA8E6B3615D16D17B7FF914377BC59870C269E851B4E012B107EF92542B3A2B458E10DA709
m_{p3}	CCF886D4B65C6CEC0E3F8D8186F6CEA1FCFFEE878506F22EF69AAD6F51FDF2071B34E4ACBCD2545866C36B31C3235DD38361403E53DE6CD4FB1DC91752BF5F6C3AB442E292A90471F2A5B9FE7599CEB4651D235D505052C22F54F868C18AB14205FD41FD468375B661BE35F0AA67E5F33693
m_{p4}	F95E0D6F5101D3D7BBB354646818EAED147E3E4CB0249F696738B3F3A65192F5F012868C190BCB967DEB112D907A85F33161C68B9E425A3F5EA26022F6C40ED01B8DE7FF6A6F75F313FAC3DCD47C7EAAAC32A9AE47D633CA6F47AAB8EA282B467D8CE21B1352FFCD36966F0A9B2EDE0DF6252
m_{p5}	6FCD348CB614E6C68534737B6AB3F693A7256A85D5C28C6A77DBEA1ED62E1813E7CC88AE990BE4432387ED43C60FBA6556C5DBD7111B1B53FF5FBAFAF86CB761F15EE2782C7616C816A1C77E27F197DAE6BCBD028F37E5DA7906198C98F72207A0A8FF108EAA66C84D976049E4BA42E0C27D
m_{p6}	94503C230B52660711010625B04D9B98ABD0872DE470F3323F1D4120F46518715929FFF4714212C26EC813F9B0601B573A3B38F8833B3BCB57390D8E16A8561C54E6FEF9D8A64B2E06C07E417B426671CDFAC9C7FA20D15B556CB39FADF128560A57D26B0C9354C1CFA5334A7C5F96B95281A
m_{p7}	92B52AE0D72D7559C4A277EC57995B7B8BF3CBDA1DF8FA7D6A96DD02F93B28F84C18E6F905D87A12D923E38C4DD659819F1CECFDB48DB8EB129DD472A2718045ACDE58C35A273FEC7A71365FA35130215FD801BFA471D27ECBA3A8CA946E83060465BFA9A1F3C8888133D22BF43E1C89F26F2
m_{p8}	BD71D9BF8F8250A64EC5131043F2B0E7424A365508E4E268A4A9857BAE4E3360058B8AF6FB4A10B3C2BFAD8ED116229056B01F7E59E3D9D4120089EB213106B920925EB2422196AF8FA9998389664E80DA294E1B4B7D6807FF3743EAE53276AB634EA1B080FD55425C318B1EF670E9783EFO
m_{p9}	D61ABD7705BAB371765DE3FD732D2C5A51D5DA1BA0BF789170F01936183A55CD1693685BD1BEC7BF691144BE24A8B74D7FCF1830425997806FE10C49E98F73BBE07835ACE5F2E6E083294BA4048D8AD59A4E6EFE538B6D1991C21BD130D25555985D5E8AC1623FAC93663C5E1CCC77A2B3FA
m_{p10}	652DE6FBD477D92AFC5424953C64A722EAA5D5CB0E6A04CB43273841F71525016D8DD8370811E3F38851E973D8EC2CEF3180D1462E6530623B004813C1E154B6CF790BE4C712573ED73489BC2952048A5C17F51A25604A6CA660EA480618F8DA78470580CA9B987BE33F3EC6485AF440ADC3
m_{p11}	49AADFAED5D1C27455F2FE9D2C66B31E3792F088E20562C3B6DB2E4F2C67445690164E34043B5C98819236020C15264BAD09CD75608EE4BF2F62D3671611443D541DA129FF475E26214AFE00419D12EDFDC443A4F7A6DD38B2BF62F64294A80937969E9920FC3A33DE7B131C61F20C195621
m_{p12}	6D408E783793B8F8B438F512CC4AA7F94B296885D9F59505F339C5C1F7FDB8F2567866B876F16614BB6E3788E1B237DD8BB955341911ABADD6E7D3276F7068DCAD08737243631C42CB77CCFF77FD7A03B52D5D4C73F8716A83B6094827098095F19F136491EB1405992E3ADB80B685FECB2A
m_{p13}	349BA9F2D6B07CC41DDBDBB446F844D77A86E96C9C2F191F1BA42D0402754B40DFE76BAF4DBEF3DFC28E426ACCEA6327FA51C4DAD1B6F2A9082332FA4E0BC21FCF10CA9822CDDEAEC38760194855253E3E3D46C8565CE9EE86761B7E28BBF5C4958A3EE709B8FE9CDD0CF9560A1DAF6CF971
m_{p14}	033E68B1E9D433BC88119CCAB47004E20B6E1B8F0E4C2756DD549EBDBC5243BC898694426A3EDECEAAF00A7AD02D4AD1F0189A1E99B0B1D796E8BB8C5EE977280408DA0F772EA3A1AD744CC0C78C39070BFD324269BF86D67916D157A9BE63D9E94B76F690050368150867198BD0A68031CA

Code ID	Basic Midamble Codes m_P of length $P=912$
m_{P15}	C08FA672B545FA416E4856DF87BA5CFBBD64EC62A2A294427A563F691A28EF5610A0CCA37ABA21BD98535B4BC3F0C009CAA962384B5004063D16083C93D1A7C6002BD1D51A27B671EBBC4860092DF3B3C389A0E909E664FC4B99E5B1A39B72500335491372956E1782EDC5330CBEAB7A636
m_{P16}	F8AB480C79497D13EF846E58F4D6A0B52CF2A71AB1236661B0D84D8CCA603B157BC07C0000306487C41A7CFC6A3A58C1276E8BBB592F9341C298E17886E3A2AA2A08576FA2380C710422FCC0B1AB50B13D6B676EA102B6A035449A77652524F3D79B05F9EB24C286D7A8E4AFA1596788C987
m_{P17}	53F0FFAEB51656B7DC819B749FB5DF94E4A9545B669AFA52F385C5869C4D9A2F3BB5FC874B9DE055EAD1159C47E7BAE8F08C7F3A202D18AF084CB9DA377C3BF8F9B710F9262855E5E04F9C92C11E4B03DCBDFDF06311DFB839969036DD115654AD90E2096862B37338272506327E3D39D189
m_{P18}	BA58B8BE4FB00B6122DA4EB61BFB9B775811B88EE9444BD8400CC9866193AD636A86A23588F59E176DA8A18B856E8FFB41A8D7E91A9E874AB50B89E971AB36050058BC70C84220ED0D5681F7CD84CD493A65B41B42E10D38B18598C63F73163EAAAC1C93CF3A3CAA3BDFB29D0252177714756
m_{P19}	0C0769A781CC98EDFB93319AC2BEB03C8475C874CA1AFF16BEDE90B07D5C6EA8ECB401916B5688AD4C0D97DF085CB0A16CA4D678A0AC1E00F9737B4CAA93A163F827B39AFF1AFB831CEDB26EF565102DB24ECC2B6BAF72B44FF5EB88574B38ACF3EEFD87E4F6173846B151271DD1E1466DC4
m_{P20}	132C03285553D9205AA3746EAF108D92461B3DBA03866E70A2F47360DF17502559E5AFAA2EE6C7DC800D8F620A3294A3E2B1FFFC17AA6634D6B7F3353A652CB0825A4E13A3CE5E91F7225181A0678F53B3D038BACAFE214FD4BB4C2D80EF35D42A2F19B69CA2162E30543BE9BD8548185D0D
m_{P21}	C2E92D3AA8981AE97C3325B1FC1843CB0E8C5E394C201981A8DD8D1BEBF8F649166508A5A17819D02EB0A8EF797D8C51DADBCA9A66D949A4C7E6B37ACCE1A2E578469D1B9D8D1A47E7BEA9DD0002FF7D64BF6519A63D9084C0841A8841E183973644DF590AD107E852F3357A70A2A5637E22
m_{P22}	9BEF2F948ABC4CAC809972EA52EFE03907142A44F3053F970445B1EDF5D1FC9F03B6EE30F7CD74C04B68389D5826E85E763653ED75D1469A240E406B3989EDA065BD84E34F790D74D2D17D7ABCEC25CF7FF130C4BDA979BB5A9133CF3E79B3558E921EAF013A0CC4B87C5FDCA4AA9F245E15
m_{P23}	6DE4817165AAC324EA17347B78FB4E1D642F74E15F292880975C42F405D440B1FB101E64DBF0A0ABDDCDDDB388672248D2BE9431F7BD77CEF1583F04680865B315E8551A232547A807CEF742E529CCE892EE7FB2F312E96EF7372AB4F7310F87912793FC2BAE5DC0E6DE2CE9FB40F53513
m_{P24}	FF5034A2747FF78F34664125AD31AB2ADD077839D8CC44372D13589649381A2198631F1454BC450ECD0AC8D8695034CA8130B5E5DABB9EDF7A4AFC0738D82B7BAC7086FE813289092AF218F5D04BCBCF98A07F4C2E0F8BC9C52F45C5813A693EF555A2B1EF308908FC993B2266B2AA09C3DA
m_{P25}	FE1DBAC430C3B1815990B234583A86EB45EDCB32A38C92C3502B5611819701B1F545410092CAD7E962D3D6E232059CF0C9E8DEA6F7DA21D89F611EFE129D854C5B957FC810E0730EA0C5603B035DD9D19686BD7BD8FF0C9979C900E955A649616DA71D0FAFF079176E541F1AA27F024E669E
m_{P26}	8C0A6F60BEF5DA92E8702CEF3563B50B8C1C2D29DC82B97FDEFBE322024205726A0E5B9E6CBE0F9F02FEFB264E62FF99955B536091CEFE5C6986957149C2954E0EC43C73650855376E0A8A4ED9873AA8AED98D10579ADFB05A8713C37851692C3B4405D9D86E6BDA0EA9A4BD0CEB7C79E6FD
m_{P27}	205BB79C6DEFF102C2FEDA5301BC5B6D62957A3A02B486DD6BEB878558827499DFC1DC79EC55241B208599E32B99959F9589624E2C0AAF11E3C8CCCFA7EB88AE7B844B483BE360CF34411EF739BF073AAAF3F84E516CFA10992D606789A20F15686F54CBCE8A1305BEBF7EFE8EBA95F723B5
m_{P28}	F32AE20D70B2FDB523682A5AE7A83307F740DFAAE0DBB58F828DF0ED20AC79C85E2FCAE3EC342E79F0EC8054231A541952736CFFED94A4F44FB7DF473C476FFB3CC87BF18A0938AC776A26DEB32BF906D2C90F57ED192BC33F1312746B143AF383C972A2B61AD8D46F3C4E560261506CC87B
m_{P29}	8F6A99C81370432B4D05459359C92D87DC3D10E82454B911EAD9E80AF07F26B198C6ED71E72F608118B67C61E8C64EA654B7BB0ED91A3DAB2B77C5CCF92AEEA8D6DB9E9AFC142F6FA9D2E79E443DD42D0F66BFE92D9BAE58113B8811E50FF8796E13C43BB210076AE2F8FD0A1FDF3D5B2AFE
m_{P30}	3BE3E2BD5546AFE1933CDBEA679EC8FBAB69C0ACFD5B2DF9A72CC5B4132123D6EFE9F907CB187DB647C6C7E59F71E830DB84472B40C011CB418DACED36025BEF7289FA803D1E32FA2D35F667D2AF8B78985D469532B5FA8336072B7FC74A515B8700CAEFCB625AC212AE335E6EB C37207FA3
m_{P31}	2642A80A8DD998C3198E6EF691B68257560C5E875A32F8C101478B24F9150883476B03F26B6A137E117057B525F37E3749D1C1DFFC2BD059C6F4FBA8765D58493C87894E819EBC1172A62D

Code ID	Basic Midamble Codes m_P of length $P=912$
	D6F3DFF2B18A5987B0841FE85BC85575B0B1048A9138E6C9181017A501CBE76337926BD9AC778F
m_{P32}	362817D18ED89453CFAAB83B0D182FC12F3E90C124514F404743D223487FD2A2026603D3CEC04AADB26D2DD8123B2D18C4ADFA6FA95260FC8055D29B0EC561FC355BEA5E97CA030B0187773B726299C2CB91CD7E0EE28B89C63EBE333F316DB6209B012A230FAAA29C52D41F9DBC6B66F7BF
m_{P33}	6E92DBCC6445EDBDAE1D566F99C4FA5AD9823981B71A883BCD14967C2358711A59B856EC4890697E030009682A332D0F7CD85FA7E509CB2538BF395306603EE229C950D749D3A4EC4172F8400B1E1BA5479098A79F48F3F977C400D54135F75DBC6CF97019E30954AAA550D95ED4E08FC2AE
m_{P34}	82B02C0023B142BFFF4C2EAC7E5F83D3C76A7A18EAC7B621A0F9B65152E475C8F8E2A30479EC3EE9263F73426722E9A96DC53EC42D7C0BC50A643E66E9B8C0BDE8E893A7562CA33856D4219A5A59F599590164B4015BB9EDCD26904B9716449FD02CA7380C6A50CE22A40E0CDB787D109122
m_{P35}	CF2673929413ED857B0DC9894D8AE460C19CEE9CBEDB810388C0ED13E11FB7201ED5A6865ADA459DC8E5023C73FC13D159A7A540F64FBF586A2504C18843F42714D4699DF6591944AB44126A4A83D175E8C41EFB28D34048E2EBEF454150F4878F6A02A874B1BE46CCBF8577A5EBF377578
m_{P36}	E0FAEF096093575ADD91187D72DDB6E6401BC189A5014D6149E092146BF879450EFC3E504C306D0151ED465840ED503FF3BF92CE33E411A17AA7DADB365731D271791B8C21BED3557892C4D0B3795A24EB61566C3143A54797B8BF25194A9F8CE20C5C991FA29BBA64211B4807066A45B9E8
m_{P37}	234F19C1B17B1C403171712FDB575CB8FCBFE15B39F548E682452117597AB24B8E7E51834F222508ADF3260AEC2246AE84359DC0130229580F98275BD036F82BCCACBFDA34391C556EE7E4C90A2C67252C2614175A2D0C37D5C861A0D735DA8E05D2E7712332C0BC0B33FDFED4FD90A61D2F
m_{P38}	415B84B33D1F23316B8C7DE312EBDA1091AA5BA44319C7289C78701DD437028F8CBCA30C534FFF1875A230EF762F1293A9C9BFB32856DBE06EE915D1AD66417474A705B7BFF4EC8DD448834789AE9BBBA1D2D99080CF03841DA0242E0204D3B80680C1AA6935F3F6E9F0AA2B51E5A7A227D0
m_{P39}	FF16F0619F5A297CC40FC2F97DA2A92A9D144C2D1C1043F53DA05909FB7F23DD82ECE70545330C327A097FBB2F93A0E7970DC64768F76FCA0E5D255B4116550E838664791055B8D24A5837B6DE3CA65C522A50CC25284D68C3BF61440DEA011345F3127A802234B66E5FCB893830BD39C6E3
m_{P40}	E9EF50791AEFDCEA8D5FCE9398C3FD7A8AFBB50F2268234F62FD799FCA3BE94285C92BEE044A546DBC29319E983C6FDA5431BCB78AED499872F24F228FA4782FEBEB6AA13606239E56F7D19107CFA441C2004192386AD0BB6DB381ECACE4D153DD844F9179263E899DB195F16D9581248259
m_{P41}	C310A1E57CDA2246752056F432E5808F423AE04F5757F6B3D2E798FBCAF12517BA77CACDDF11B18D6A04CB37D80A077C8F90FDED0D33F8739312401B6889E16B8665ACA75075210424AB7BB2516828B2CAF89ADD0B8CD223FA9850B170D465125723D43C5DCFB7264F4247B4C0F5D3283C15
m_{P42}	DF2A1C8FF69CFDEB8D36F67744F0C94A6028C7FFC376E4F32AE818557C2F017F040D88096141C90B1F4F55A22AC386BC40ED96EA1B7BFAC91AA0BF97E36F60E225E167D926536AA22BB1CE36BB9B42C53CD1A56B2354F23807B350BDCE7C9B01CE6AC7AF212C050F8E827CBC3AFF71D50E97
m_{P43}	88F8ED04165EA0D34E412F8C7175D3C387A9B18E0316E00DB2F6BB74CB24BA74EDDA374036FA0A4224F6434752B67462C8445EA3E51884BB5C079A862E7711AAEBE14C50DA149B032066C88E38CD0FA85AA6213F28E5BB2D67BB1E000E16B6330BDD9796AFA27EEBB6A0A7A1395DFFF1588
m_{P44}	5439C5FF080A258601EDAB8A0B54F51AC7C66B6D8165AEA5BE1E15AD85DFAAE4F908AC8404DA4CAEB3FA93AD698C835F3B60205DCDE971BE63D570267B04CC26A8CF3D5051B22D9B0F4099CA151A89508E1838185F90D7BE73161CA5CC3950E2E848B26F85B98331398AFFEFEB9A046A5A3E
m_{P45}	9D26B1376B5C4F5F586486CF35762FF481842D6353D6006AC191D1157CC39678F0B4D31A1668AF65E2B78B57D7ADDB45621DAE6A3E4B0322FE0D5713485234392040C32551461A0749B53627F0364A998A18CC02EE708732DCA8189E523D588EF5D3CF70E87EA5140007BF84AEC5BC1BB391
m_{P46}	89530DB4E7FEC9DB64622E6FB8F0879B24F3D023C83AD69D674189910F1EE52BED4FCCC501EA81E122E8336A89D209FACD7F6A89F65611A470C16B12CF8B84AE475E6B82895CDA52F564DA7726210D073B38342F6BAA22014A7D0EAFD6202DE5B03CAACA0610884223E4C787E06F84A8CBFB
m_{P47}	A9E83B98E0C2ED7950FEB892BCAC4ECD503CBDB193D143BD03F2459DC6895A81314861930CBD9ECFF114865CFECFBF025075D3FD471558FB7C6A6CEF8547E937CF52DA324E4EA04319B78376D2F4BFFFE8E467DD8C29DD0D44135ADF1D179886A82320FC35AABE4957641C9762F7C3AA7D970

Code ID	Basic Midamble Codes m_P of length $P=912$
m_{P48}	E113DC0ACF1E85730EA81E964487D1D8263A186C5B627B8F96D95244284FAF1E9D8351D1DD7957D205C15F26F3919B34196FBED8E88D96C00441A438D27B215AB448B6F6D9DA895FFF10EB3D4FEB44468F21E77CE64757F6D8A627C4A2BF0DD9D67684F80F3C1BDDADAD192EF32BAE5479
m_{P49}	687C6FAAB36FF9C20DDBCF1CBB7AE82F334E48CC6C10B988D8154DA5D18746F3E9153A5510C2B026F5CC7B6A7562644E5936CEF2A023F40BF239A1F2A6DC75782F2D056174E8A904A7A11D3E301C0842F8BEAAA3D36C86F240309635A90E10E766FD8149844F8B42A9C4A59FE4863AD0E285
m_{P50}	FFDBD37063D55715CEC274D716DB7DEDAB90ED8808952BEDA0E75599D5A29C13C483FB97D3A0822F46F2E1F4ABB756A7FD4710DE7333B488203F7152FE1D1DECBE5AB17EDB806681DED8CC12C11753418E2B2A5C95D60FD2DC9970DF38C84CE7864833B69046AD039D261DC1C14CF056DC8
m_{P51}	F1748076429321CABC98153CA2C18D3ECD24CAF8B22CD97C1674F6A3EE26C016CC1B8E8C3D0BBB98482D09ADB2B06CAAFD73FEA2203F8A2B791ADE9C14A5DA7015A442392535CC10A10399B2F80D818DF180707211A8D858ADD9DB1EE10BBD6F92F2DA9CC03512EAAE5BE18F7AA87573FDC
m_{P52}	81DDF8E2BBAD0D040EF4796A5EA19DFA9C0CA8067068909896A83C2E1E239D83D2B858E0864A7BDD2962AD001EB19665E4414BE81FBA6D7BBB1787AEDB0C81913D5C86E3905B20DBA6C9DAC555B4BA05574F3120FE8F3326B336B61BBC2068BCE2788641CD59032731BFA73E58869A11E4B7
m_{P53}	0F59625A8BBF1E83A906E5EB9E5E1CF85DADC7BCF7736DC02DDEADC8736F7399E4CE10601DD832D32AEA53AC895EB92DF5FFB409985EED5BC9C775C7A655102E644435ED2EB84DDF30130F101FBF2A93FE65D473593FF3A4134A41C4C7EA6A50448F8B2FE1F91F1E9E84C95818D2CA340C59
m_{P54}	3AA62BAC2BB34A4B7D06A968E20E16A1C79D865C1F87DCA2B3DE6F3D49D962175B4D7FACE8EB162E9E0FFF9FABD6F57305051838A7D5A370DB79F9246B3ABF10719EF9EFD86664DEC9B06137911903AFE43D00DC992F9F8FAD1C017CBB7591E1A02BDE56B75B2F82FE61234ADCE34AFA8017
m_{P55}	1682757D7852076B78872B235412EA5CE2AA997BD66C8689DB605F04779E70F61A4E5AB75C65F1BD3D9948C2442D9AF89EEAEC6609E7E1DFC95294C318AAE8FB0C2E025713BE5B38A08F8A8463D12081EF250C482A2DD9803628B07C9076CACFFEF49EDD6A3440A6952C73493E0DEA0DB112
m_{P56}	016B428AAA41A03CB6BAEB518F27D34CD9F4E0A7F0C149D3B8F35B9481274E4258C01E6D1F0EF01256E48B00C7D4F9FFC242273890A4D5BF9338A1F5D74F01BF56EB2E5DE461AD46F78446DC2B56667E8732E73E95768CC05615752A8D2C88DF077277F026CA1A1057DA0C15D10CD6093DAA
m_{P57}	68C2F3594AD2A41BFD7BBF60702C5581B3F75E54CE7D1B3A598400306FAA22783335DAC415AF939C4596A104724F53953BB51239BEB77D2574FDC37CA1B07C5E7AAC2774DC35DFD6B83DCCEFC3C0A9B3EACE9A6052C44E8C327B24D173A760BF9535EF8095F35D9DA3E289F636521ED06584
m_{P58}	BC27B7917AA3ECA9ACE1F94A1A917FE1CE6754E906AD4645719CB3818FC58A48F8CBBF32938D18D68203507A4D2205C049AA7741E089777205F1EDA69439984BA8DFFE45C210253D528305BFAD36FCC90683801A0F19022923E45DD0A52F6E2E3F9A49333250F76A8BA8C325A39B362D9F2F
m_{P59}	057CA87F217E30182A60109027005CEF36F98571B1C11A6525308632CD39232853177DB25A639192FB65EA70A70D90CCAA34FBF7C2E6233A362F46345F15CC5B2565DD7537010E1BCC22AAD2C7BB05EB6BC05A5DF289A8AE249EAC10F21666C742A09462FE8F1D38B5860CDEFCAE2FE8BDB0
m_{P60}	A2AD4999053CFAA50A1093DB07AEABCF6F80C293E00D8ECCB12B56CE7FBA3F62D686C15B3E1A941AB480ADD6F2176C537686F770D73ED366086E67F2C46B8AC06B870880AAA2D9B444217504ED74C7B90390485AFC46A63F15CAD9251C638278707D46A384DB62A7BA27245A5E16D6231908
m_{P61}	A196D99A227C44C27BF2BB0B6029557118925061AC9ECE965EA7AC380CFE1C0C33E5B7567E4FB77B7AC7DF34E4557545366A943D375E4D8A211CF03FB7F37620E9EE47267D78ED1D0A2478A353D2217AD5AD76892388EE7F0144ECD69CE3B5B04928CFA6A68C9FD0FE817942FF143D9C2DD3
m_{P62}	2968ADAE21E52DC8AE811AD840AB7600A5C6FACB2F3BF707D0DE018178B5FF73BB31F5C88E9B6C02C54B8D7B1A049E39CD7960F7109AA5EE9A18E9C3E9F0E8359952E144169870381391E3761E3137204CA71CCC4DB38CE4394068303F088A2497FD49DF4864CBFA1675AAA895068577AD0
m_{P63}	AF21B04CE4B418B9A0AD80221A9C47978750483A83E9096D9F09069C3065E8F6F1FA68EAD50B78736311BDD70F72D97290C06888ACDEA4FBCA3B25FFBC5C8E91676C4384EC68C5D3C40CCD5AC3E75116CDC28C05F08B479A73E2AF7D380F69CEDA810A60B6FD6609CFB8A7D4E98DE0596C4A
m_{P64}	56BC72E0F1CB9DA84FBABFF84FA635E1AF9B60BEA6C22F8953156C90691F44D2B4078EBD8E8A8BF6760BCE5217E2B0C2E19D4470D3321083486339AFD6D57FF66E21C149B40FCFC5CDAC8

Code ID	Basic Midamble Codes m_P of length $P=912$
	0F7B6ED2AE576F3ECD4D14A5C56DCE7CD04147F9D725A783D9915D2E7A036FC854CC373EE8333305
m_{P65}	EDF8D061318EC3126958D38D4E0A0C71460B5F46E16CB7FD7A4084D174F900BC8A79C672C612E46E2AECDFCF3C744F40510FB20D15FD9C2E696F8FCCFBF80FA6A435369889E17A612EB222D50A6B88BA06408DE022EBF4EA74295F5B921AE86029D376E2D51250B79053EB3AA58B4C6F3199
m_{P66}	B86E98A32DEB7FB6F9A120725EC9C07CF1864670A9D5082D7DB7FC7656AEA8EFA05D661E63A06D436DEA5CB02E5F29F4B3D364701B1481BCACF306804FC14EE48A19CB8095F9C456502B39A08593AE258DBC12B358D6918C3EB8546F9F3E36646282E08142CFA309CECC823549E02946606A
m_{P67}	070850FC776EF3F88456CC9841604D144CDD4B58247B2938AA074009F128682E25FE0E6DF2C3991A5029A7E4EECA22C5718D6C457F3B529702EF34C7CBE96B6EC2A2391DD6079A21941855B5BAE1729CEDE009BFE8CBA54C25E7F0960990B004755A647D568D290A645C4C3B8E7262C347B5
m_{P68}	D96CD3FAF18CE3B8D470CCA2567E54544F4F9FC471F02F6441AB5F786DC9099E16C9482468A2BF0DD84C87E36C8A7D39500538FECCF76B03086065EBF38819530458E0D4B3ADF3C66C066A0651D3E8A84BBF6A4697C05DE066B112A8B6118977923DC3A01F43014B02C525663748B4F65E79
m_{P69}	F660B66151AC70269D9405C9A987C3FF25DFB65AEA14E5EB2A699BFA335AB16974D0011206212F3A3FEA6F0A6971FB3C6F4D73A6D44543FF1FA0775D57D13AEF2E470177C55F1D823299B1DCFE4CA851D7E9075CE9B8D6344B47354DA209DCE4EA6C0EB1F43ED231C04DBB510C68B2D2F336
m_{P70}	88C9890A01B550D44B635B0D4C01C20AEC17B0EA42389FFFB0D70386CC2BAD4D5A8E021A228BBD4059FD12854187F2F0DB1D6CF7AB654AEC2877D2B1A3A8C508CD9329A096F161B8DE72866C2C99BB67024C9261A24AFCFAFF3A483E8D71BA7AD985E9DD0CEC2A4B31E088A7CCB7C4F39CDC8
m_{P71}	1309529E28E71D99D501350D9662F3BF5E3D54AC16408117F0083FBA22F1AAD9CC29552590B051B725B81B56E33E36C72F8EEFDA5F3EEF4629885BF827E05A4B918B831FCFDACC9656FC41D30FAC255D2C931D3E090897C3E75CCA520061DE330C60AFA9545148B27A1377300B0643897976
m_{P72}	AAB7E27B83CD46F2EF18B91FFE9D9C69BB92327B0DDE3664C8974EF7BCBC77234772C02007B344BB99DDF344F7E5A6C3CA3F01B0F28DCD566BE913C274F296F056A74CEDD7680CA7969A34CD785597008543208DFC63DB6C847BD364BAFE11751515287B210554A5610D7035A374E0243E72
m_{P73}	7972CD5FFC6AF3780BB7A88BD4BF9799AC403D1976D8B4ABEAEF4888BF0C269C96572D81B3BB55E33D30900CBEEAAF1969F08E4EFC7CFE7F99DB9A184869DCB18A3D143AC725E46F01B11EEF3940932A7AFA30E87E156428EA927872FB64CFD072106F00811359CB146C957C15C3E920DA96B
m_{P74}	D62ABF2E9F79492FD2A22FF60CAA94DBEC39C380F12290B133DE53F18B1914DB0555BF6AAF47539337FDFEADC58B320D67644408C4F5105F8907F2254731D319FC3CA221974D5E9006979BCA2BD89C04F2D1E1FF2D4C51F3BBF2CA5BB2FE8FD34CF05AB45599BCD6DCE5C2BC53E114A723DC
m_{P75}	A0D97790B621153CF61E6DF09D07FABB17CD0EDFD030E300ADB777FE3569C35F747E4DD1566196305DA32BDE5BF26E395D6836254BFF3DAC9FE2BBACC4A5900A14E2E72E0D4D05D09A7A3BCF211D1E2F7E36CA379B52BC21D937BC628D6686F59171C5DC4A223D9AB1B8F89019FD50683ED
m_{P76}	A133814EC7D9BA19C3BF38946484310280B2333E631F2A29137230EF8B8F9A30A958D8AEE03A5578EA40ADC014AB6D8204C396AD7EAB3C17B1325D7D55FFE946525ADD5CBE28F3DA392D8873C82C6CB6CB65760DB5B0D985786A7B04237C0D0C5F43C903E9CC3126AEFB3BC5CD4349FE2602
m_{P77}	89D74B62E35F853EC718FE7A32C7B39AFCA27A41C87CA9BC76FF6640DA6ADADA997562B010AA1841DB918E947989291BDCB50C9F40FFF623CCB0336FAAF878FD49BE092804AA73A3A41907D5CD32A375C898373D93FCC4C9EA84A2DB9802521FD5376F9635EE1D0C3E8DC34849369A757F5C
m_{P78}	2DDE87087BDB66B5DF7744CB16AE7164D2E5AA7B7B2CD8BB46C6A602DC9A108752DB6967F1728B12FEEEB1FCB681DDC48ED7C1C3DA5536AD84CFD9F5E94E6148F4DD3D9CF3C830F3B6401C8206B0ADF952AD505B96C74C615FC6F70381949B2E6E25F42D3E6563041FA5F501CAAA93C519D
m_{P79}	ACD35DB85397D81E1124B62A60CE35E4E8214318527F96F273AB6718822971BA76448B3A6E662FAFF4D37BB2176934F80AFB3E03FF494AEE2F7C5B1D0B723E316AC0D67AE53A1C0637E155729422E7F78F5FE19BB9DCF674D13157B2F8994C5DC03780B6EEC2AA0E57FB7F8A6FC0EC81AF87
m_{P80}	43FCF00452F2E93D9A4110003601467549D08A20E4DE27F025843FAE54D9E2E5820D890558C7541FC771CDDECEA6648984D63183ADD8E5BA52F6E56956B6F1CBCD93374F34F4709DBB812D155528403D364CA2E54BF1F6828FB342B3D378185A6E3E8572B2F28EF6AB194C184ACF4FC409FC

Code ID	Basic Midamble Codes m_P of length $P=912$
m_{P81}	B130A5C2EC864C8FF71CFDC347DB4CEE38259F34A8F9C8BD143763AA9DE869CA25E1A6A49D7A6FE1DC029DB9076FB6F111351C6FDBF0D1C1DDE412B835FCF0B97ADEEE7AE09241C2FD620D63F894BB09E839021D4D81932BE52926A33AC9C81AB3D9586AD2E8AE53CFEDB55D43965CA9EE422
m_{P82}	7AE9E0D3F5D0295917B116C28DC20E9B305296A3FF02339C1BBA86CD3D566D0C8948839C2D4751730DB66179EEDF5B04404B7D867219715C87F9A18408284F0C0894E1864A55596DB9851D0DB68B8AF7EEBAC5C01DA3284E6B42F7FCE8877AF04713C98274FB93FC8C8D421B0B572B5DD1F0
m_{P83}	9737D9C29C179CA57976D04DF9597432A763D93B69B799EC14FFEF6F84A2F56EA0EAFD13FD6D2C69462FFB551A58C17B06E32C59E605C34CA287EF8EA38F99C45D93A922C50B19FD02B130F5E704BF435A8998BE97F76181B64C56760D8A5B0043F290C1637783FBE77E9D113955431B6F21
m_{P84}	29FE9F4CB903F8BFFB5134A5D8A2B3D7A8936A3311BB1905D9ADBA1E3467AC5D3F5F6A7758130E4445856422CE094D85B620611E7D8F5B3C0CF386490214FB6DED5CF761BD2BC87CBB0F4171B566FA32761C9CF11147417F50C47BD1986AFB9EC129CDA74EB0947C06B935F5A175D22E2E35
m_{P85}	50D3795F988F865B3A9739FB23047D301913B7BDA5F87D0A3EAC478002A20C571D553EA190393D404E1718BDE3C780D26BC9FB48EB55A9228C323036F000CEC60AF43E23F734B104A4998B4662D1770B46B1643EE6A9B4D8D9308F4410821FDB39403652D53952D5CDE7903BEB66FDA2596
m_{P86}	F84F4D2894AFF4B26CF0FB72DE03D5C43D98F7A13C95FCFAFA16D9AD2DEE38EBA7CE7CCD51F02DDEA932436451B6AF185E2C27173FC5DC4D52172E0451F4864933F7D829691994CD982D2D7D7B302333F13CAE7DAF6EC9E67188955207AC461AC2AC124FF94ABD2705560E5DCFC6F98C8AF0E
m_{P87}	058C6EE106A2DCE93EF5220D1BDFDF725CBC4DB869698A72F89A886AD38A0F42ABEDC4966FADF33AD0C39388055421F2D4D22FF5E698C4B1F002633C051582D899A9CC51973000BC3D43E64BB0E080F392DAA65ED11D081DB55BAA3AE3EF2B5B135136E2BBBF81F17A926D9293233C08F58A
m_{P88}	600EE81F7C9864F1B8C7337A7C1582B1A038B8461F5381276E514C27A86B1C96F61A3DFC4890023AA73A8F8FAD7750B3A632BF745881704C91198D40F0C6DE51293656203E4545EC660659EFDE97CB52C4540AD7E6942B475BF5C8C2047E38E3F79731AB972F64B519B4DF44BF25254FB28A
m_{P89}	FDDF8C811955AA732713A5973F621C8A763E4057047D3CE2791D20A49250C5BCAB0FC702FA6563274372D03275D6B3FDFB4E981D7D35A7EEA2D99F607E88CB38D7D4B35A40934EA67B3EC9E7FE2ABFED68969E0534FC6720346D8C07CDEFC5173554F14E05BD81DCA647C355AB8379BEE206
m_{P90}	624518F8749EFD5DCF5729A3D5BF4AB67A5854398C8D6A2CCB07F2BE0D676221F764716E0AEF70515873645A9F438C1250072FA65A167AEB30CF099AFC2C2504E129D7FF2BDB28B78A36A0D621F74FDD36D5EEC9BC4625EFEC4AF6CDCDC496B747134E6D94D87F7141481DEEB83B841C0E33
m_{P91}	F8DF107B028097DB928CF7A03F0157BC3B50EACC30063934EE28413D7764CDDA46D17EF91CA7205516B76933B3D50D385D871357AEFA2E34D1E3E929FCD08B940AD54762D21B73B0C144C4C2309A26AD3EBEDBDBDCBB0B1A49AF796DC5D8F62F479A6CC739D6B391D97C39FA017EF2D85855
m_{P92}	A45FCBE0688A55D051B057C34508507010F607661BA244DB1A7CE599CB4ABC6F3575A765E41C2EB8B5BC49E61162478CEB07461787B0EB6AD14CEAC878DC9257E48418C2F3292BD087FF3B4CB7758B00BC5380427E620776FFF7128254CAEF743129B317B8C21D0ED02B3B94785048B3B274
m_{P93}	432250D31BCDC883439F92FFA76470DE1B6689465A0FBD3A12AB4D165012AB32B7EDEBC85968CB1BA84C24321CDDCAADB0175DC6C2FE2EBA78EB788E049F8ED34A3AF1F42519957C74896872C3BC6C0A7A210E8438EC84085A3C4E3884E8B79AA57F85937D815C493C044B80519F76EAC075
m_{P94}	4E3834426643F2C419007C48053C6B7AEA54D231D68631D5CE305FC33C155405B2566ADF0BC3E4D70B498B3CB2981425D610559C2EB63213F07AAF3E240653230436ABF9D823799A05D78D4D5A45A67F6637C9D9A4BEF410BC0290BCFB47E206A64FB6EADA1CCFC9B77023EC705670A9439C
m_{P95}	B655DDE80717690057C86FB8C2F94A922D4965624E527B42C080EDC3114472B5D58E3076EE606A6513515FF6FE1F5C6CC4F6A34AD865C7EAF03558BDDA4A96A838B1D13543B87E382A4CEC3383E4F2EC960D9707CC52624905326B32B0F6C8F3CB3FE7D912B8040518E61C0C1D0BE6135F4
m_{P96}	D3817A6FD2936F4738A55F19CFBD1EE3801CB86F9B9656D39BB4CCE5EC930CB801BA371A05876F63F2A9919BF8E769F140338176169439309841D43FC304EED8D80164D2EFABDE83DBBAEA927748597DC553E6A2EC52E3D7340FFBEAF817484A7558B59753BD8661596C940CA6F16570D6F3
m_{P97}	0CCD1503DBC6DB746E369372930B18BEC1C972C30D3BAC9547590AA432AA5280492851CF8935F74A5431E97169A3322586719FD703B122B70A0394D784A010D6B9BCA2A9C7284B8368127F

Code ID	Basic Midamble Codes m_P of length $P=912$
	2C00BB31CFC8EC1B3A31EF6EE148114BC0867C1182A742FA26A2EF1F62F948762C3FC6DF7E1E4C
m_{P98}	68AD9382C2FB0471F415D72240613B24F019FD981423501796E76898F2D423801EA8321E01CFEB9DCE4AADE7CBDF0C10F94F98E6C9A561204D4051487E5326173030FBE760C28D8BE6815FCE78805E9C55CF7994AC8482B6A13254CE7FD3ACCD6D96CC35913962F57965D2BA905D50F4F7F4
m_{P99}	965AD6AFC7F7A822E2D0A7F3F8B23BDD89DA7667882789C85A010B0CD095E2BD43919DD6BC8F290FD5FB7B1F0A4F8C47C348EEC37F483B75721352856568DFCFC16AA1168E1D948E9861A5E693AA0AC4F26225CC888DF6F326DF4D5014C892ED9A6A8E99C4140BAF7C03873532F0CB1EDB7EF
m_{P100}	11514B31D4E01ABB0202CD8B26B4F3610886058BA519EF4C9701EDF8ED2E935F65AFC454C0B672B14B06672BB742640EA5BDBDA47FA5F87BE583F65331E2A30CD850B4619637DD7B8464606F10236714131E1D2AB4EC55654D05A93050E6F8748B4DC83C6202B7FD63CA1FC0EA00DBD48538
m_{P101}	F6FE8BDAEBB7FAA334EC95ADC619F8A04171707C84C79A7C96F973392176EB7AC5626FB24D0F88EE8D5FC99DA5F03C381A93ED455B13DAAA4DA3EF7A092D114316F6D25F319473BFA8EF025438B0A510DB7F4E8436A38B16606150D2B35B2872DC206AFB17732FD16219BA58CBA1CE402B9A
m_{P102}	912FF3C82D2B7FDA4703DAE6E349E1844212B4672DB02A4D0D4465220C1A4CF0E7D56C945ADA538D465A76C7DC3AE272BCBBAA4FB9D9925EC41FAE0735380C1126E36EBEE55270F99A0D851FEB280B103E3F51080B99496B2E3027F6EC16D91EF42C58E4089AAE68CE075D323C4A2D409CE0
m_{P103}	4789D7468124CE0AB731772154704A07BDD14C319DAA60E9E3B55E30D61616301AC560BB31B6341FA629F630204D057A74B8226EDE4A4696159DF3BC7DC3597072A1A95464142AF23103CB7C28AA69A7D2CB990967427F9EADF3EB65FB95DD72CEA804DEEE0924307794D99FF406F0AC40F6
m_{P104}	9A5C8700EF68ECFC28CD6552C267515F58593EA84FD48BB5D63EA028DA77F92787FECA4FEDAAC04591502198A10725B62AA7361C932B58C6F4D431103A56AF5A8400E8DE5AD26788F28526387908EE52B030B639DEBA260A321B09BD60E7BF3C54E1D8264A04B0F65D81F9473622CC05C3AC
m_{P105}	9F6A2D1D54D09A6A3AF7BF514DC754301A164602D531807186D9930FCFAF112D40F72D17DCE9C40E9EEE8FD2E5D1D3BA4543ED609DAF163CED9BD0074D3E5F7E17F5AC7B4FC4CA0690977DA3533AFDBA5BD328BA079BF2335364035D68673B98330B92AF5E3C26A9AB596986EFE9665219F8
m_{P106}	FFEDAA9F3DC1F267C121D6303743286B1AB1094A1790B58B1E4DDA9D16303A3289BC4440987775D6491383589C96181AE093289D42230FD88BA098F3575FC393246726C9EAF6C955EF135EF07E862915734A5994D2CA7301FE844DE7B4BA9417CF10045BEF5F4D4C5BC044A347E5C9E99821
m_{P107}	644CA39E3F93C4AC795EFC5B8BD90228E2638BAE24CF4C3DE75697823DF4AEDD3253E98081C4BD215DC64A9E6BC0115027F6BA4E4FE2A93FC726DBA4D9D21DACDBC76B45377B68863F9FD426E4F89625657EF97C03D277C373E15D21EB721AFEAD246ADF1A0A2A0CEA730BCA98CDD4CB808
m_{P108}	AF16DD60C5458A3D27E36850281E401B10116D5B0BCEA1B159C97487584652047981333D5573686F4C0A063E1186306FD02DEFE2C61722C5BBED60249AA2D9260ACDF870B3B5F5CFD7581580DE486D8D9F332A6C6B6464AB0E9D54159CCD03D6F9CA12C13DE34145B34FA40703FDC76AEE7
m_{P109}	33FC7C9D9FF74A2FF009240C3AF398937D078012219BA54C6B0B0D9448391CD1D4017CBDB54AA59355EF05A9712779D71761D96F650EE10546C39694938AEE89F7CE6FCCF4BF987D0E9DD584992F2732D5838A92E537559EDE2FCEE82302D7FD8B1C9CF8215B67BE61D4EF4523EF9032B1E2
m_{P110}	DDAC8DB73BF5A8FD9A74561DE805959C2ADC755274740993616B3771D10C6F5B0B8E4939A444F280B39CFD29EA0F562FEE0405451D8D9DAEFB8B1E0C8D69CBEDD6D23D8A56A3A9B87BD6EDE46FBCCC135D70B8FD4619C35F9A72E93E8954FA787B8452347E4B209013736D0EC059A243803B
m_{P111}	516913696CB4D961C939529F64585F08C42D1FD1DCDC78F16DFD5BCE287434ED251FA1AABF676006D75FC455DDE30C8840BE6AEAD10F8A12C641800C35B8CECC9BB54037AB1075190EE3D2D8D81F675898FC442A57B3A7B18B0AF90528DA8019245182E920B926AE569D656E3BB03A975CD9
m_{P112}	B2419222199441C48BB085E7982DCFC0FAEB16D39DBFD22270AB8EA6A802DF3580ED6A68A90E3AF03281B48ED3FAA2DC45371E3733539E70B137ED82D5A2CCC2031BE3D6A4786EE9D9A9153658EA0B483EDD49F9D1E189F3D418B73825CAF3B4D05A805F80FCCC5949704252390DD3E86EF6
m_{P113}	04D96F94A767AB70BE85D6EBFF3831E2825595CAF1583CAF2B75010816DF65757F4BB4BC58E011FC5CC50F220EC72ABF672E8C9A29821D4A106603187276492C366618C68CECF60AA6D4B4F03505EE0BEB591336E130EF4593C5C11749CC3D2974B1AACD0DF19672F9330457241E201DB7CC

Code ID	Basic Midamble Codes m_P of length $P=912$
m_{P114}	12CE52D22E8BDFC665F49D86AC6C488C9012088FA091E5EE13B7C45A9A5CB156F147D6ACB FF87C4817350AD15C5FC3773F3C58FD0D3B88242CC46DD43A5288933ABE5A6055FD67B1159 3C900A9654D82BE40200E38C7A9643BF25419861A2D674B84995301121FB34389CC5AC83E94 CCC738
m_{P115}	3831B0AED8C54E6F5F348C22351E35AB1099C47149117A40521B30D005DB13A81337A7EF75B 0A6FDEE2012E394935C2D61C0BAED3B65D4FC768C30F654E97BD33A54F49A2753915CAA137 F8B99861872F00F6C019DA1A27277E1FD648608CC108EFA2D85490980F7570C37619D5F4785E A45
m_{P116}	2D7BD4C93F3175F441994A9B188976A7F4F714A80AF693139FBB757C1D0D71274167EEF2C 36F891612ABF8B3504FB2A1F0BC1DF24186A6C2B79A4EF118F67FF477AFD650F6BD208599D3 31C3B5ECFBD173C25D7CBB9A0C9D4E0F455509A8BEF805201429E3192D82477E4E85D606C 53AC
m_{P117}	01E085F900F58E7769F8C8A24DCA26984EE56F2D8CF0A0726508094A20ACAEF0703351EBF8E DDC1C59012F9A3032B11D5BB260FAD321280BE48642CE84C0D3681E57784332A87DA3C06C2 CCF0993A6EC2BE1A979414EFADEEF3CEC8E12C41F55DE52D48F0B851EA968C159B9CB2D51 4CF4C5
m_{P118}	32814E789480CDAF8D0E09BF65DC4863B99B8542F0693D77ADAF6F32D0173110789E26F1BB8 F9A8A71D09DAB03FD52935945D7A4EC68C8B043B27AA81200CCA1DA23A9833217CFCAB5D6 2E0C488EA2DA2C73DB031F205D7F960E9D8918A5C652C1501EE93204D273464BEF438A94DF 4496AE
m_{P119}	15DD44EF0204B908795A090C32188643FBE7366EBF30DADCFB2C41953A854FEE39EAA7E9E4 E58E30B45409B72AD05B43BAE11095FB1D20FB2A73E04448DEC973926BD7BA0EC291A29AA7 EBDA5783A2A253649F036962A0E4525A07C66653394116352439A2520891F8E18D2CD360FFE0 B111
m_{P120}	89217691E99FDDE0598092D7413C6946390C718299455B5B455CFDE3E2E15CAE056389BE60C 836B500053044568990C9EE40582F6978F91EE5ABD501408EFD805F4F64FCE2FAA5607976AC0 16633E12FED435EDC627548B79898DE3B5FA8B246196CB2F4289A0E3FBC7A4A911274D4CCC 980
m_{P121}	B3047C6EC9C960702C122202B7BA48D54A1015C1F9CA22D879FF5435C6EF930FC5EF8FD811 3B48BE47D794B87E5194F8E7B4525B4CEE45FF5D0D70CCC00C67496943EBDC878DE4F9BC8 849A24CFB05282B117F140A4B1967B8F4E38A0637A4E8C916914CFAC15D399174B1AA65C86D A472EA
m_{P122}	CED19A2B452FB08A4E677AE137AD75601BD7824CE59E4FA627A3C5AD101920FFD89328B3A9 17782F05781BA0292EEB18193BC1C3C02B48D272D449F381CA20B12B1C27A480C628A33AC47 2F2EBEEB775D3D3681A365C728DB9476CBF8744D84448FC6303BDD28BC38413277F6B61CCD 4A913
m_{P123}	EA7FD3D0732484865089964AFD0181F0A64E0B9BF58C20C3F34D45739C01ECDD11681E3B4D 175D237A19C2800C8024FB7D3A14DDDA53180B10E8F1C569DD9CE06FF19EC958989AE43ED2 6E96DCA2E954BCBB6EB502F0C269EA75F5CF002BF49B383A00159C0D39AC71D502B5571636 16B66E
m_{P124}	D08DC6EE2CB2EB2D3890230CF7411F51F71024C8F05CDA7F958CBCB81B12C0CF27342431C CD1BBF61DEF50298E87ECB4A98C489D3CABDB55CE95EEAFF850BA13C0F772CD9F2943F961 227078A05FA3AEE18E61657D04AA37B7F98BF5B6DDEF0F87ACAA5B4D1D2CE0622DF6B8816 EFAA2F448
m_{P125}	70C1FC8BAE04C07CD256269A02056B79CD0014D188197B4BE89AF8A460026EA8FBC7C13A77 93F2822A94A4A7234727516D44A5BA521E3E28C34396C69BEC8233FD0D82FA8D5B2C4F12F92 84962A6F19C2E655AC44BA85F064E8D134F28F9EC479FDBFBA74223466D185CA34C7188C6E7 E515
m_{P126}	82323B03B81937932EF44D0BB2A22DF5F8803080618940A4F1DED2778230FBE3D04545B86B1A AC4AFD43A90DA09148456DD81684F7C143C48C710076ED7A60BD6128BB9C4717DB97331CFB 667E9EC1D4B03191B3A218B12CC957A3F5182A452694FDE1A4241B1410DD104BE1551F1E85F 8A5
m_{P127}	BE616513AE32C4143C92A7CECDB56F082F7907098FF61403161D95CA3767AAF7F46A8D60D66 C6195D27F25FC5D0D840F7DDDD67A3E492FD9FB85A805CA0438F822BDE583BC11B74C760E D2FBC9DAC6F361EDF71B17B96B065D5E2E43A9A87A7CD561FC8F4BC809F474D68E6C4B6A7 542065A

AB.2 Basic Midamble Codes for Burst Type 2

In the case of burst type 2 (see subclause 5B.3.2) the midamble has a length of $L_m=512$, which corresponds to:

$$K'=8; W=57; P=456.$$

Depending on the possible delay spread cells are configured to use K_{Cell} midambles which are generated from the Basic Midamble Codes of length P defined in Annex A.1.

- for $k=1,2,\dots,K'$, only, or
- for odd $k=1,3,5,\dots,\leq K'$, only.

AB.2A Basic Midamble Codes for Burst Type 4

In the case of burst type 4 (see subclause 5B.3.2.3A) the midamble has a length of $L_m=640$, which corresponds to:

$K=K'=1$; $W=256$; $P=384$.

Thus for burst type 4, K_{Cell} shall have a value of 1 and the midamble is generated from the Basic Midamble Codes (see table AB.2).

The mapping of these Basic Midamble Codes to Cell Parameters is shown in TS 25.223.

Table AB.2: Basic Midamble Codes m_p according to equation (5) from subclause 5B.3.3 for the case of burst type 4

Code ID	Basic Midamble Codes m_p of length $P=384$
m_{p0}	A88E403803494ACD25F9E40A2DCDD572F13461ABE91E3931AE9BAA94CB6250B33216EC49AE028C3BBC10389C97F8652F
m_{p1}	CC81718FE2E076D4CF6787847831AAD28E7B131136D8F6BA65B6F32240918434A3F445405562FB1449F10E152DAF8E57
m_{p2}	F40249685685DC493F2F7B8FA91E3373C9CC902C0BD54963EB4661355AE6F0CAA345E3043FD5943520360E136708D755
m_{p3}	7699416BBFC40E597656AB7B319EBEA4B6B898BA357DC20BF01A36A2FCBBC1191012836E532F0F16EDF1B1CEF8C8B8CF
m_{p4}	FAEFD4A1EAB45332B43D34DD877032192973A4D6F3DF1394E26FCB2FE608A777FBACAFB87B8598AFEC0387456274D828
m_{p5}	D7E24FEBBDEE2558FD4B77BE0F9C79D86192A829A93A8B8B4D93322B1ED2C5D8408D9F64E75390B7FA9E471EE94503C8
m_{p6}	419C96CBF5D07CF7E8CA5F0F768F635EDB2AC91013955685FC464F533BC0A7258D1F820E79FB4E3D64AAC88DCDBB3089
m_{p7}	E3A9C7C56BD042B22E63B7A593F95A82FF67F59F50DF76D419022A69C986F86F98C0D3981B3297BA8844BB0E9CFD7C81
m_{p8}	6D15CF45BA384523320B323033CAD89B6738F7AB22D252DC51AE9EE06F290819C6BE3F7F9A07DE5BB70E57E8F878BDE4
m_{p9}	D8EEF2FB18D658B7C0BB3A1186FCCB4F5EFC5768F6989946D7858A678EE850D90BBF2520B92A7131143B9F7EB9F92E8A
m_{p10}	13C613CF8AB1ADBB998FA7E415710C87FB2C4C64B040E153FD2A8FD05DB395B4BC4BBF5611855AD3F354DB99F1A7364C
m_{p11}	64B93D117F33C1FB4BDCFC82823C977CD7F749512ED50B51D9399EEDEADF57C39B1EEFD1823272C26121F74967803ADD4
m_{p12}	E9757EF85FFC178DD991A01C81AE8A36E47B1450E6DA60C96967E798E47B43C3BABA4E7FEF186B305E6AEDDC8D0A4A2
m_{p13}	D83562B863CAECEB41458179A04E4D90DA7B6F15C627A81480ACF210A3403E7E60506E859665EB6AE94BB2079988DBCF
m_{p14}	54D018301703F6E38A1DB4496DB91650AA4715A51D4D1807401CEC4AFEB6368B9AD50A15FB B7238935963FB0987671C8
m_{p15}	20176660D98A8C4D0442BDF1F0EE3FB4D1684B7A93684FA4395B784D1CA8838A238F28AFE9003C4D3CEC0562C5E79DEA6
m_{p16}	C5771FEDE124CE07C75F48321D8B0EEF34275CFFDD49F7D59685CCA298D09D36A558C903E2EE5C74A20EB02E50FFBF9A
m_{p17}	7B2AD0AA898419CE863FA812CF47B32F369C9A404A936648F0DBBFBF521E822635E7A87B17C138E2357E957737F4D67F
m_{p18}	0005E4C456A52687FB8C38217E39A6CB CD18EC8AC6951F7482CC19BACE70BA1E6E116AA6A5780F656C72B49EAFCD0312
m_{p19}	F7561674AA43738CC1EFE9434061CF17B8FC55792BFFBEEA2B61F5E1A46BB14B19926DC98B D4B747166044BC0F652693
m_{p20}	C1F98B595BFB89F7F40B1D84965981E7035455112C337DA389E04D8146B6F40D83352895247E53142A8D7BF7063A0E88
m_{p21}	2374B1EB35DE57B4114DA547D25C39887663800D53E7C0A4A8A97525E7E364FA011B23A113A4C1067763DA770E58CAEC
m_{p22}	D3E5382DF383595C983C2CC2369703A5867C84AB2EBD9C72044EDD8CD5683BDF4CDF10ED04D4DEB1D3D459020247A206
m_{p23}	7344E4A74618745A817E7036FF6535629AF647E852129F6F70887CEAA8393DC859725FC7BD52CDF241B31FA7BEDF9BD4
m_{p24}	E1EAA999935A9C04CE360B3077241EF63FE1103A3C15AFB1CFB7AEEFB93CCD5357B0068E70F28EDA990B6906AAFFA4D2
m_{p25}	39BF69ED889CD875DA83108FEF691ACD1FFAD5B5E76218318EB45DEAB2022D82455B592C1FC550FE197165A07E346D5D
m_{p26}	B817C216E9A0A224D8E5A4DF3F68D53BBB89B156261C5FD877FA96352A073B6B0E53BCF0765093DB7AF0C6E13AD98BE8
m_{p27}	075DCFD E008B110F56C59A61219770846DAA58B896D4914047EF786F03E13F985B03BBE4FB3B352A19548163C5144B69
m_{p28}	913AFDAD21CDAB1D363C8FFEE158E9EB5EB699D54DE5E65770A963D349744BC935C4ED0C49903CFA0F13EEFEE3BDD511
m_{p29}	B6C348E72A210714B90035C905F22D6777849F28C0922E3356DF84F655896C2E8E8DAD0C1AA

Code ID	Basic Midamble Codes m_P of length $P=384$
	BD7CC81633CEA68E8AC47
m_{P30}	51813E8CB9F2259B52C62FA1955034D0BD52B39C108EC46D3AFF6F8F8C3BDD1ACB3725345CE83C0AD7DCDBEC4547FC96
m_{P31}	CD1DDE061856436714BEDDE2EE9DE7A9A2D795125FBE023A13AE1DE727EAF0B6265AAD72BA3BF4C40C82996F486A50EE
m_{P32}	1690CBF556A6D9268773D5840033E9DF832FFBE2BD0F09D93DFC18E92340EF9CFD11BB6331D7D572D7D17CECAC6D2D23
m_{P33}	244048BA6D32A3793E12532E670BAA42EE28BF58116F67B9EDD184E1861476D928447A874A1EB0A6A43F1760EB19B83C
m_{P34}	81FE8B4F56FC4BCB5E1366CF41E6C559FC109846FFF538636862AA52A5F12E1F974B656D3811C882A30D56CF2775E473
m_{P35}	921F5B3F5FC92ECE95B09141BAFC214696D1E534E711856E327FD1D8823D4854C510E6C381BABC0B29C600B193F9130A
m_{P36}	50A3DF0CC1B0A1BB8573F7F973106FBC94504D86DFDA067C119072D8745FA8D6A263D07DADDA3723ADB439BDE5DB539E
m_{P37}	C3C0412A03C79A6A77AE17DFD4C56963BB56550C3745C9A5DF8E68855CCB60290CDC0F314E260AFF330194A62CD4DB44
m_{P38}	66B2C238B87005022F58273AFA04E2C590C6D710ADE4549E735E99E17D1170A1244AED82D51465FF3FB6416C179C246C
m_{P39}	CC0D235E5D80947EB754EFC63F6EECA6F0B9D9197C24C7A14CD72CAAB26A8F5386A231B77A3AE0D204369C57DF0D8E6B
m_{P40}	6CBC1D14CFB4B14362940B67BFFE9B3C333F1DD8A97D9F947292EC91A3D01BE0FCED3529F78AFA2A2F74213B87218E6C
m_{P41}	C3119C5FF33FC2CB957EBB2E9B993A85BD70BB99E3A6CDA07E4343ED282293A5F4E7F9C9ED356B322C38259FE10EEFD4
m_{P42}	B684A2F64D90CAB23140481057AED62E36315FD5759ED05747E4A149E784C78C52FC09EF81232BD1C1647C95CE10CCC3
m_{P43}	A70B5E173176C74A6CD11BA10D026B8C86BB44814CD7C27C0A03137CAB8725AF6CE05F7A6B2BA9BCFB1072A8152843A6
m_{P44}	9257486C5A5AEA7B21B9D736FA20C34C22AA3FBC1EC9B66CAB8F8625DE7F4522DDFD8D7A522F6AC31AD7B03463310C1E
m_{P45}	1FAEF03FD59EC8BF1FA57595018F1F7EF9F4517CD0F1AC5B82FED8877AD34E7333F06C3D5BCB3592B2B1084036664A51
m_{P46}	F838C88284898DDA2EBE40972DA884AFE7912367CBCF5453894E639EA54A053653E888038530BC516737C43786A5F2C0
m_{P47}	1171FD1E14B8A432BAA6401868CEA05A02572C83FFA26E16444B0AD21C67B3F190D9C3A61C3F123523266BD232BC4BB5
m_{P48}	6055579BEFD3E751073BE2EF913BE962643CA37C14A172E607C7A8A8C57B521D34B121ACF6AFE419DC7E4DE665239251
m_{P49}	5D9DA3875FF37C084F7917873538EB73E66B62B74B82EF127855AAF990DF7D2D06FEFB331681846B928BDE429E01551C
m_{P50}	24A63008BB9355A32892C8BB5F50D6B1B0007563BB7E2526DF1C9D4C2439630E9EA3E8FC6FFA34E297324EF00AD1D063
m_{P51}	2E64310629FBDD2F27B3487A7882789B23B833273D1E7AF4E7DF99E26555DA45AAA7BAD244FA71B00B6155C0CA50EFE9
m_{P52}	E47949C3577D92C3635CB7A96E8D63A778815DB1324053579BA12560B46E7EF7B935183E3DE0A79FE88FF857B90DF2A8
m_{P53}	D11CD2FCD449E3504A3CB8A92650B9376A927F882231507D9FC7A851AF31AD0977E1DBD59452532C0E841E82501CF8B1
m_{P54}	D9173DEB459627122EB6F6E27B11FFFF944AD65E9F2729DF0F340486AA4F2E58CA7647C25DEC30FF55530922C46314F9
m_{P55}	70ED8ABA76E26BC7C9E8748930944691EC16B7F702042733306D10824DA33E8A2EF190FA80ED616212F2926A8457C7DC
m_{P56}	D7CB3386C837EF00E8E56C07A3620AA239E182929956B9423B364E3117D2E6165EDE6FAF13A009C4304AF6F3A5154ECA
m_{P57}	E1671C07DDCF6CF5DF9A9E0CD9E6FE5C56E21CBF48028EEF2DC57993E44A46C1D32B0DAFDA39695EEB5D8AE603315355
m_{P58}	036B1806C6F2E9C263C0470BCDE197D43C8B9A2046A26B8FDAAC49FFA1E6096A7E87229574A67B7BB7FBBEB9754A7EDB
m_{P59}	BE3B978749D105923F6B5D8FB00F96D7C9B6C50989513D7197FE2C5DF74BEF6B328B9E884C6BF848A9C57D0C42613CE5
m_{P60}	54195927E67F3D1A28EA929625B6FD934EBF60662A37D64B2BCCFD8A3C806E5EDEBE9BCFC37F7EEA5026E071C2F10CEB
m_{P61}	088C7E3F08322F71C5234A2DC35A19E385FE21BEE0CC9C2E6DF7E9F4BE424B86A583F64A9C

Code ID	Basic Midamble Codes m_P of length $P=384$
	EABA6FE76E0A9D9DAC9545
m_{P62}	2BD321E1A7ABFAAC6CF26EE71D2EC4373C05FA907BFDD3C929446FCE9714F98A89A0F41260E658C8BDEEA291EDF5ED3F
m_{P63}	0CACCF6119FFB876DC319D3F95AB34899FEA7DA7C264A8B897087F5D58776F4978D9F4A8DF40E0858655C82E7974F3C0
m_{P64}	370B1A0FA2DA6E5F8B79D567C59404BB5DCF7584C3193BD37CBF1CFE465FC28EF6F15634E46B7620CC3AFE5482ADCD40
m_{P65}	C4EF59CE4C46245B85E50AAEBDA987F51614860DBF05A0BF66706D08B2CBEF9306A9A3A8117682CD40A02C394DA8563B
m_{P66}	3C77FF11EA6861254F844E393C6D8856939780A8A1F86148AE88E8C09320627CE6176936FF96ED6642AE7E33A82C5599
m_{P67}	A5AD10EFCF9DE41D6436B38590FFF5C582B9AA60ED65FE5596DE566CED7E8E41C11156B5418926875F06DBA319CCDA1A
m_{P68}	82B543431DDF83D2647C3778A41BCAD41295CDDD0A496D133E2F5F4577582F7D377AB993CF18516298EADFB3BE01AE7B
m_{P69}	027F6793D64483CF5569FEF03190B2190CD0A210AAED5C13D8A726433660F8095A6A46715276050C77B2FBA0DCF5A3C5
m_{P70}	B37EECA1A844DA19736EF3C5FDC6E3571BC7E04FB0A1E2522D1A39E21A0BF2D1D066BB9C0B99F6CA0D3A82FB7561272E
m_{P71}	AB07BD3A4F83028263156FF5E307FD5D253689D76A8AE789691F339258EE9BD1EED8DF3C3E625E325B28A96A467FA181
m_{P72}	2A7DA74C4C39B7BEE0CFC2C9F22E00910EC527B3515F486A767FD63B4C72C24F87EEAA337E3357B868D6B88C6A19FE2D
m_{P73}	21008CAA6C91705013C5753F1400B994BB1F197327B09D0E7DC7DA0A6436DEB19835E26A949051EF75DAE4BF7864250F
m_{P74}	3CB53B21CF1908B000B5675EA9FDC8DD3501FD7C5CB77A3C48C6EDA3F4D6133E9EC68374E708978B296CCD708C75DFDA
m_{P75}	6F9CF0F9C735DAEEEE85FEEB096A163D18DFB7D165F2A9BBECBE152C8CEEBFA32CEA5816A4966469DDCC92CC095728360
m_{P76}	597EC8A534D095769B15D0337343CCDCA78E696E9C7F18E7BE1C4C474FCFFCBA2E4EB257C04012BD7094ABAC47842FB5
m_{P77}	333D73827842A2203FEB548072C28C290492A2B355EDD78C1B65E0ED270680E67B98929EE5C89743A78FC342CCD00AFE
m_{P78}	5BF3C14AB0643D1DBAE821BACFFD1A47A6FE901F2338162624331AFC25A2A66E38EA958114398D13E4FB4699A4051AC2
m_{P79}	C99275C3D2108C1C9BAFD62AD68C51DC57ACBBE8B263A18868F4A1A89823C914FE19C85B4163B4B10177A2B0513FBC2C
m_{P80}	4C66765966E60CB0B1D25566FFD085EBE34571B31C820D42F30A53BA4BB2C3C220DB0B717C7D3961DED7902B25FFF67D
m_{P81}	1602E7FB6ADDE8FE385D43E33322D734D8E7B920CFAD9F71ACAD855C71A57B8B40CEC5ACA32E073B642E070B6BA6A2AC
m_{P82}	5B43BD325ECE4E2DFAE4DB8C861F5A7445897406EBCC625E075184D18440B395DC4EDABBC20E29518A41F7F1652003A9
m_{P83}	3FF81A8A1493C202BB1062C49D88395F74DAF53A69BA63896571383099CA5F8B915E0670867C61EC8A794FAAC0A44A17
m_{P84}	FF8DBBA2E6C93F02CA775F8510E975E825AF2F43D3818746BB4BF930D54E84EF5E34B447CC375DE50CF61436C62DDDCD
m_{P85}	40D95EFAD7A7D2B1E00839BD4892ADB5CD1F93B8BAF7CFE528BAB563AF711CE5A6A4C1C9019FC705FE07A8364B9BC866
m_{P86}	531F4E313FB8FAF0B40B70B65DD7414C4CD9028D34CE27730690B5BF05FA3C7E5F0FDE11AEA05A450BB358433FFABAF3
m_{P87}	A2FF0392249EB69A3EE41A07D50AAB42B1786988D5C3569D31238B86320529825A03432995CCF599561A6E728C1077FE
m_{P88}	6FDB10A9B40B83D1D5335E99DFDCA540CB0AF54157145634F60AD3690EDED4688BFFB1C36F38D95ECAFFC363D1C32DC
m_{P89}	92E6BBCDAD4D50572520D0FA4D6957A844180CE6B56814CDAC0D01FCD45973860CCF95D0438D2E99740EB6247F362BBF
m_{P90}	64F199A6673EEBEE362837001ED5CB04C787CA34B5812D1EB9ACDFC26BD8CF7D6837A3E175776E47EA7BA8A185BAEE02
m_{P91}	677B0CDD0AA2362F9FE396A86105F98DF40DA2F6F9056BEC59D4F58FDF9F8B3C96CB75691229298B087CECCE960FF58A
m_{P92}	DEF9FAEEDEF2419FA4B449D1B89B5682E2737893D73861E8896751C98EDB97FE420C49B47BD5C613C6FA4975D45C9E1
m_{P93}	1726AFC63875C59FE90AAC65B025B474391B5260DC7CE6BB922B02ECBFA91C53B9110C02AA

Code ID	Basic Midamble Codes m_P of length $P=384$
	5251ACF6E8C1360B26A00E
m_{P94}	35312E77E51F7B5DE09F130BB39C8EAF2CEB52F25D1E212FF6ED76A1FF24B777C40887143C8A62794595D0B1D0BF2CD8
m_{P95}	5D24F5A606D43E707271201EFA13E6895BA4F2902A20A40D58E238E601644ADA7CD86D9E99C5656ABF1202B6CC8E43B1
m_{P96}	F80DF53DF2589FF24B7B328D55FC7F0D48FB86C29C29621C6A430B08AAFB7D5AA85198373A77F7B12892E881C3926E7A
m_{P97}	D052486802107E23E728599BB13AF620978666D0D7754F5865C0D22E9360DA73D581D8C4438EBC5C2C3D56C74222297D
m_{P98}	C31DC3517E333297B221A9F7CE515A937E73E7CA83267C2E9F5EBEAE1B2560FE08ACEDF23F36BC3ADE463F2D54D20846
m_{P99}	88A39E4C76F47734449643EEDA50D53FF03257408630A124DF37A3E1CEE6CE99774A8D4F4BBC051610E8678D178102C1
m_{P100}	F97DF22FC49643368615CF1AE6D533DF665526FF687D6700FDABAE8508387A0F3C8CC57009533C6CB4E6BE4745BD79D9
m_{P101}	CA8B772CF3F8D8DDA7F6F150055AC969C3DD65E9877C874BF8FF647059C4F72A73571B46913EC206CAC682EDDCB01563
m_{P102}	211E6E505E3B7C4BDC9DFAF1EB0457627847593C0557E1426A1DA992CDF40CCADA7C9FA6DECDF1D3CCB9C23DFCFA6B1
m_{P103}	548D9792FE5C5707FB28B1277DB9735FA78847F0DA1D6C153EC719BBDD5187C496F72579E6C74405859C218A03B9FEA3
m_{P104}	49FCBC2408159269EE42A32A5F0F44D1D30DC91756E274E573DF961E7B05DA1C532AF3036BB31BFE77AEBC37051FC96A
m_{P105}	09C767858FB0AA0BCFBA1FE6BBEBEC75765BDA2456959A84FE9161E2E5F4260666D3FEBA71924E26447BAD5B92E58E79
m_{P106}	622AF5FCD674D2C2D87205243E19B1C65726D78513C8FB88945A5F38D1C6400411753F63402F6280CF702ECD6852E4BD
m_{P107}	B53353D78D382A74373C16B36888D56575DD25E5701E7F8C8619DB360B422632E7002905B16B1B6D9BD5023B815C2C6C
m_{P108}	E183A082E8344992730B23036E315AED6E156FA27045DF86B067A99FB68D2DFA3201205457D3BD31A88F0BD88BF8C32D
m_{P109}	9AB97BB759FDDE364A61F5158E6938AE346A03F6D073D0C4ED838015ECF56477D736A487650670FDD6D0AB1245EB60FC
m_{P110}	08C36A4F926400AF9A17D43CAF2613A9D639549C94EED7CD6FF00E60D985DAFC394AB8BA4CCC9EBFC7939D5C3AB27FEA
m_{P111}	9881A3B723E688515287243A605FA52838AE13E94BFBF4D97D6E04530C2EE43906F7F81019E86AE4B32504A92F399AA1
m_{P112}	2807EC91A1E3CC4847A758D16EAFE7E3AB0DB5180A978BFF7450F06778DA79CAA15E467B1BCCBF6992DEC69AE88D89D3
m_{P113}	9E9A5527723F3A4F339E828920D2556D21CD5E6FDC89B6575AF9FFA38233BBC05E8F2AE7052AC7DBF622BF369A76F0E2
m_{P114}	71812CEECEAC08C71C633D4C815AD805555A6ED7A778FD5F4D4810E5D92DA662B6836015E8F9303A79798493E4166CC0
m_{P115}	4147CB2F5C019034CADC1EBB6331B3DE37197611A6635B0784B4BF0DBBF12AEEAEA3D2E794B9C1B6BB97FCC9D408DAAF
m_{P116}	445499D892AE276B0C2CE2BD81924E91B6A8D072EA3E63503F2287EB5F5E639EDE88082C16418FC294E08D069F4CC127
m_{P117}	66EE0C821076D702D1D5C35D37F25F0DCE3C8692B9CB65C4CEA5579F5AC3EF25CB06691B76DE6D972AF370A27F1415EC
m_{P118}	D60A097019B8C9171A344854DDDCF6472F39DE9B9447956F78B60763A80EF6CF93B650E7B0A81D59DD4B0FCBCD25FB0E
m_{P119}	7244FEEA50F90D284132D7DFE7E93C0EF16DA1A10765118691471255518CB76C44AE6B274C0D3BC5C143B06AEE07615B
m_{P120}	8D6B45351ABE278271368F0E2DA5EE5BD014746202478243DAC30EB011326BF99845BDAAF743D54214C193A2DF54F991
m_{P121}	42B80322CDB54071258B9B6911523E063CFC88AF918ACBBADDFE89EB7C261003E32931C3FCBA525A48553A533458E872
m_{P122}	3E1A4867271132EB25B853FEB3B44F80F69D57BF796D71F53C46D598E5BD2D22F8347B645591FAC08AFCDFE5C838317
m_{P123}	91AB7E8D6CB2EBCB099F275B1BA0C7D8D18E8A6FA2EFF169100AE4FF0ECB94F79FDDDA7F5AD42EAC766741C96E608D6F
m_{P124}	E16CC4455F92D7F7AAC7D83A63E94A286AE4B9CFDBC3181FFB94CC26CFDB43DCA63A169A20BE959E65062A5524DCCB86
m_{P125}	9E1BEC0CB9835F5FAFEB3C4A27D32A982346ADC4215F5A7237C4D1009CB2DECB9C1C486DD

Code ID	Basic Midamble Codes m_P of length $P=384$
	ACDADEAE123F958666B0EE7
m_{P126}	CB04C57E4069E0CF9D4AD9D71567C2D243A9FB0DEDEECBA8D77EBF02CCFA77B4C491915B039FE851A4B8D9197D577A16
m_{P127}	7CB3DEC05A1E73C703BF610AC8914E2F4D63329FEFB69E1B35E86F92AB87EB27EEBC098B5B1119CC8BD1B149B2A01946

AB.3 Association between Midambles and Channelisation Codes

The following mapping schemes apply for the association between midambles and channelisation codes if no midamble is allocated by higher layers. These mapping schemes apply for all burst types 1,2 and 3. Secondary channelisation codes are marked with a *. These associations apply both for UL and DL.

AB.3.1 Association for $K_{Cell} = 16$ Midambles

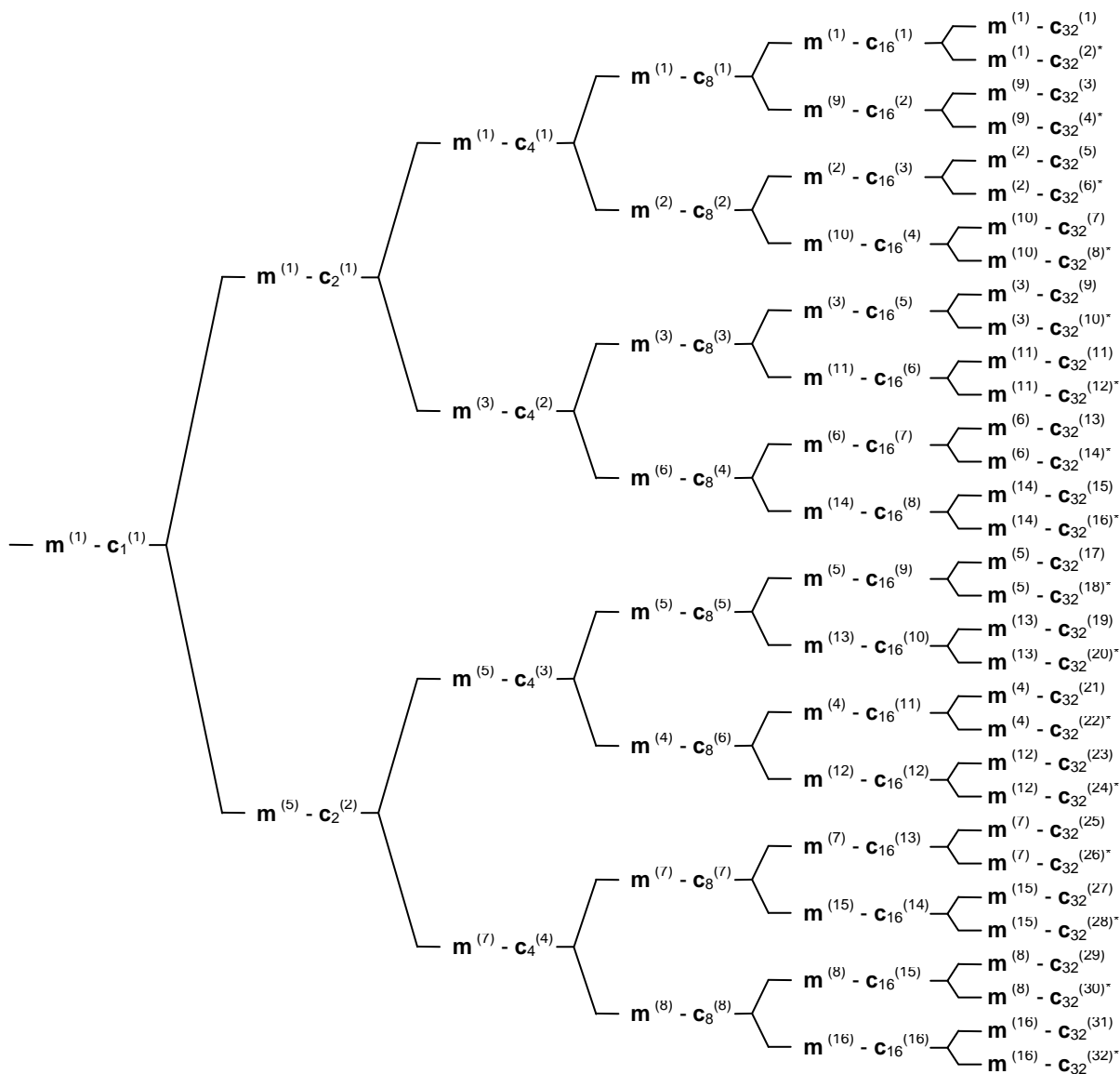

Figure AB.1: Association of Midambles to Spreading Codes for $K_{Cell} = 16$

AB.3.2 Association for $K_{Cell} = 8$ Midambles

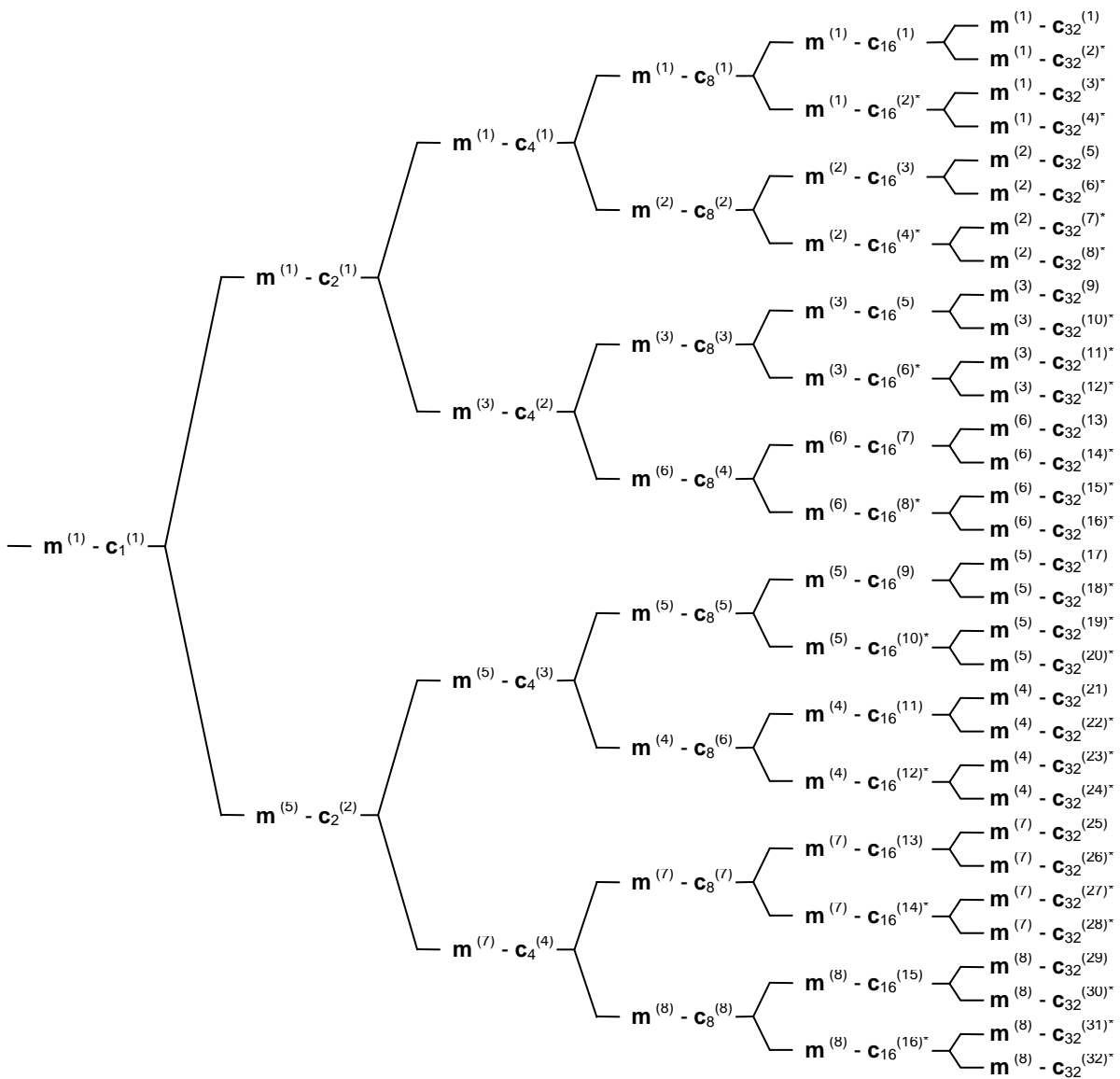

Figure AB.2: Association of Midambles to Spreading Codes for $K_{Cell} = 8$

AB.3.3 Association for $K_{Cell} = 4$ Midambles

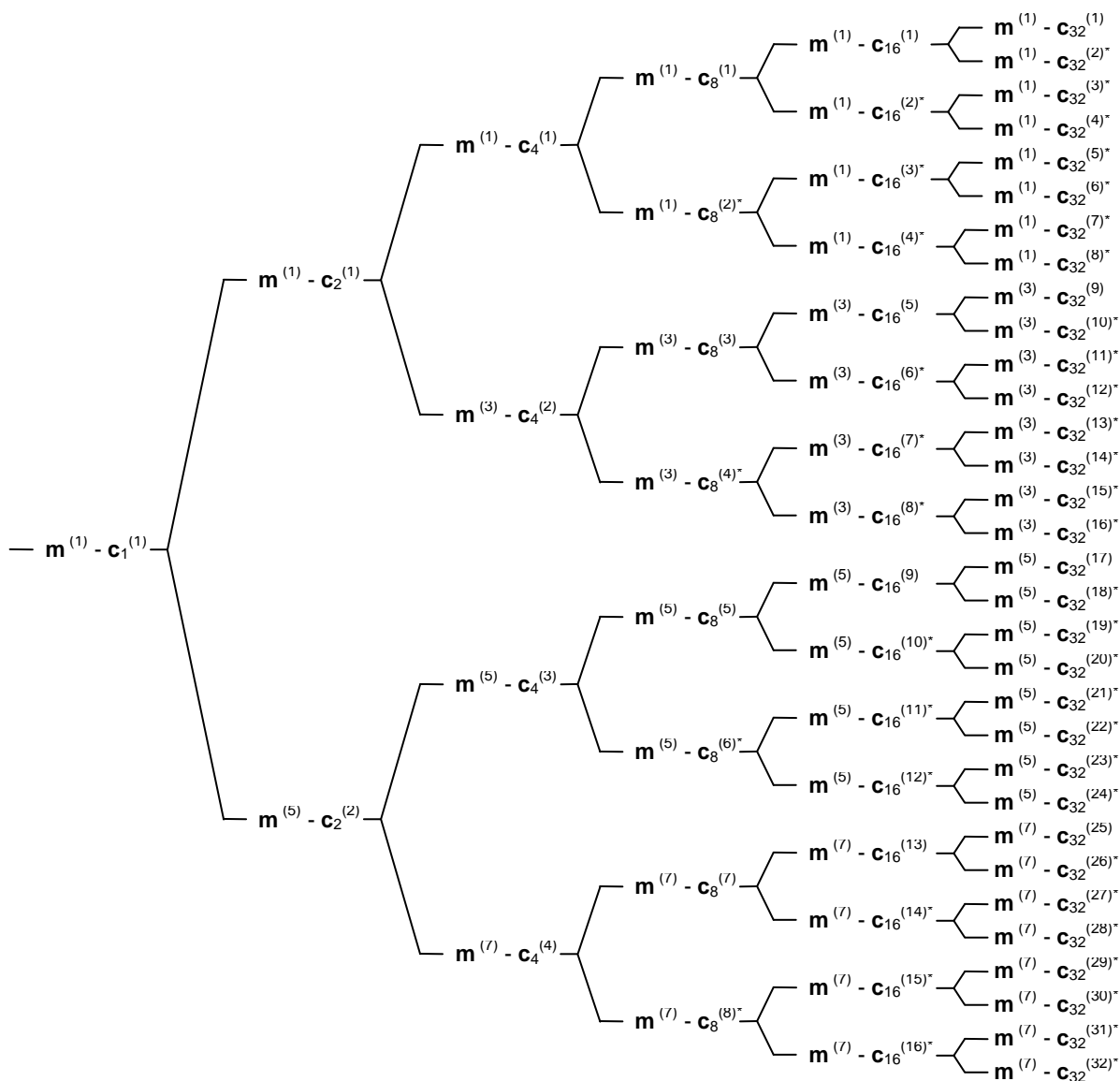

Figure AB.3: Association of Midambles to Spreading Codes for $K_{Cell} = 4$

AB.3.4 Association for Burst Types 4 and $K_{Cell} = 1$ Midamble

For burst type 4 there is only a single midamble defined, thus all channelisation codes are associated with the same midamble.

Annex B (normative):

Signalling of the number of channelisation codes for the DL common midamble case for 3.84Mcps TDD

The following mapping schemes shall apply for the association between the number of channelisation codes employed in a timeslot and the use of a particular midamble shift in the DL common midamble case. In the following tables the presence of a particular midamble shift is indicated by '1'. Midamble shifts marked with '0' are left unused. Mapping schemes B.4, B.5 and B.6 are not applicable to beacon timeslots where a P-CCPCH is present, because the default midamble allocation scheme is applied to these timeslots. Note that in mapping schemes B.4, B.5 and B.6, the fixed and pre-allocated channelisation code for the beacon channel is included into the number of indicated channelisation codes.

B.1 Mapping scheme for Burst Type 1 and $K_{\text{Cell}}=16$ Midambles

m1	m2	m3	m4	m5	m6	m7	M8	m9	m10	m11	m12	m13	m14	m15	m16	
1	0	0	0	0	0	0	0	0	0	0	0	0	0	0	0	1 code
0	1	0	0	0	0	0	0	0	0	0	0	0	0	0	0	2 codes
0	0	1	0	0	0	0	0	0	0	0	0	0	0	0	0	3 codes
0	0	0	1	0	0	0	0	0	0	0	0	0	0	0	0	4 codes
0	0	0	0	1	0	0	0	0	0	0	0	0	0	0	0	5 codes
0	0	0	0	0	1	0	0	0	0	0	0	0	0	0	0	6 codes
0	0	0	0	0	0	1	0	0	0	0	0	0	0	0	0	7 codes
0	0	0	0	0	0	0	1	0	0	0	0	0	0	0	0	8 codes
0	0	0	0	0	0	0	0	1	0	0	0	0	0	0	0	9 codes
0	0	0	0	0	0	0	0	0	1	0	0	0	0	0	0	10 codes
0	0	0	0	0	0	0	0	0	0	1	0	0	0	0	0	11 codes
0	0	0	0	0	0	0	0	0	0	0	1	0	0	0	0	12 codes
0	0	0	0	0	0	0	0	0	0	0	0	1	0	0	0	13 codes
0	0	0	0	0	0	0	0	0	0	0	0	0	1	0	0	14 codes
0	0	0	0	0	0	0	0	0	0	0	0	0	0	1	0	15 codes
0	0	0	0	0	0	0	0	0	0	0	0	0	0	0	1	16 codes

B.2 Mapping scheme for Burst Type 1 and $K_{\text{Cell}}=8$

Midambles

M1	m2	m3	m4	m5	m6	m7	m8	
1	0	0	0	0	0	0	0	1 code or 9 codes
0	1	0	0	0	0	0	0	2 codes or 10 codes
0	0	1	0	0	0	0	0	3 codes or 11 codes
0	0	0	1	0	0	0	0	4 codes or 12 codes
0	0	0	0	1	0	0	0	5 codes or 13 codes
0	0	0	0	0	1	0	0	6 codes or 14 codes
0	0	0	0	0	0	1	0	7 codes or 15 codes
0	0	0	0	0	0	0	1	8 codes or 16 codes

B.3 Mapping scheme for Burst Type 1 and $K_{Cell}=4$ Midambles

m1	m3	m5	m7	
1	0	0	0	1 or 5 or 9 or 13 codes
0	1	0	0	2 or 6 or 10 or 14 codes
0	0	1	0	3 or 7 or 11 or 15 codes
0	0	0	1	4 or 8 or 12 or 16 codes

B.4 Mapping scheme for beacon timeslots and $K_{Cell}=16$ Midambles

m1	m2	m3	M4	m5	m6	m7	M8	m9	m10	m11	M12	m13	m14	m15	m16	
1	0	0	0	0	0	0	0	0	0	0	0	0	0	0	0	1 code (see note 1)
1	1	0	0	0	0	0	0	0	0	0	0	0	0	0	0	2 codes (SCTD applied to beacon in this time slot, see note 2)
1	x ^(*)	1	0	0	0	0	0	0	0	0	0	0	0	0	0	13 codes
1	0	0	1	0	0	0	0	0	0	0	0	0	0	0	0	2 codes (SCTD not applied to beacon in this time slot) or 14 codes
1	x ^(*)	0	0	1	0	0	0	0	0	0	0	0	0	0	0	3 codes or 15 codes
1	x ^(*)	0	0	0	1	0	0	0	0	0	0	0	0	0	0	4 codes or 16 codes
1	x ^(*)	0	0	0	0	1	0	0	0	0	0	0	0	0	0	5 codes
1	x ^(*)	0	0	0	0	0	1	0	0	0	0	0	0	0	0	6 codes
1	x ^(*)	0	0	0	0	0	0	0	0	1	0	0	0	0	0	7 codes
1	x ^(*)	0	0	0	0	0	0	0	0	0	1	0	0	0	0	8 codes
1	x ^(*)	0	0	0	0	0	0	0	0	0	0	1	0	0	0	9 codes
1	x ^(*)	0	0	0	0	0	0	0	0	0	0	0	1	0	0	10 codes
1	x ^(*)	0	0	0	0	0	0	0	0	0	0	0	0	1	0	11 codes
1	x ^(*)	0	0	0	0	0	0	0	0	0	0	0	0	0	1	12 codes

^(*) For the case of SCTD applied to beacon, midamble shift 2 is used by the diversity antenna.

Note 1: If only one code is present in a beacon time slot, this code is a beacon channel and the beacon channel is the only channel in this slot, by default. Therefore, only the beacon midamble(s) shall be used.

Note 2: If SCTD is applied to the beacon and only two codes are present in a beacon time slot, the beacon channel is the only channel in this slot, by default. Therefore, only the beacon midambles shall be used.

B.5 Mapping scheme for beacon timeslots and $K_{Cell}=8$ Midambles

m1	m2	m3	m4	m5	m6	m7	M8	
1	0	0	0	0	0	0	0	1 code (see note 1)
1	1	0	0	0	0	0	0	2 codes (SCTD applied to beacon in this time slot, see note 2)
1	$x^{(*)}$	1	0	0	0	0	0	7 or 13 codes
1	0	0	1	0	0	0	0	2 (SCTD not applied to beacon in this time slot) or 8 or 14 codes
1	$x^{(*)}$	0	0	1	0	0	0	3 or 9 or 15 codes
1	$x^{(*)}$	0	0	0	1	0	0	4 or 10 or 16 codes
1	$x^{(*)}$	0	0	0	0	1	0	5 codes or 11 codes
1	$x^{(*)}$	0	0	0	0	0	1	6 codes or 12 codes

(*) For the case of SCTD applied to beacon, midamble shift 2 is used by the diversity antenna.

Note 1: If only one code is present in a beacon time slot, this code is a beacon channel and the beacon channel is the only channel in this slot, by default. Therefore, only the beacon midamble(s) shall be used.

Note 2: If SCTD is applied to beacon and only two codes are present in a beacon time slot, the beacon channel is the only channel in this slot, by default. Therefore, only the beacon midambles shall be used.

B.6 Mapping scheme for beacon timeslots and $K_{Cell}=4$ Midambles

m1	m3	m5	m7	
1	0	0	0	1code (see note 1)
1	1	0	0	4 or 7 or 10 or 13 or 16 codes
1	0	1	0	2 or 5 or 8 or 11 or 14 codes
1	0	0	1	3 or 6 or 9 or 12 or 15 codes

Note 1: If only one code is present in a beacon time slot, this code is a beacon channel and the beacon channel is the only channel in this slot, by default. Therefore, only the beacon midamble shall be used.

B.7 Mapping scheme for Burst Type 2 and $K_{Cell}=6$ Midambles

m1	m2	m3	m4	m5	m6	
1	0	0	0	0	0	1 or 7 or 13 codes
0	1	0	0	0	0	2 or 8 or 14 codes
0	0	1	0	0	0	3 or 9 or 15 codes
0	0	0	1	0	0	4 or 10 or 16 codes
0	0	0	0	1	0	5 or 11 codes
0	0	0	0	0	1	6 or 12 codes

B.8 Mapping scheme for Burst Type 2 and $K_{\text{Cell}}=3$ Midambles

m1	m2	m3	
1	0	0	1 or 4 or 7 or 10 or 13 or 16 codes
0	1	0	2 or 5 or 8 or 11 or 14 codes
0	0	1	3 or 6 or 9 or 12 or 15 codes

B.9 Mapping scheme for Burst Type 4 and $K_{\text{Cell}}=1$ Midamble

m1	
1	1, 2, 3, 4, 5, 6, 7, 8, 9, 10, 11, 12, 13, 14, 15 or 16 codes

Annex BA (normative): Signalling of the number of channelisation codes for the DL common midamble case for 1.28Mcps TDD

The following mapping schemes shall apply for the association between the number of channelisation codes employed in a timeslot and the use of a particular midamble shift in the DL common midamble case. In the following tables the presence of a particular midamble shift is indicated by '1'. Midamble shifts marked with '0' are left unused.

BA.1 Mapping scheme for K=16 Midambles

m1	m2	m3	m4	m5	m6	M7	M8	m9	m10	m11	m12	M13	m14	m15	m16	
1	0	0	0	0	0	0	0	0	0	0	0	0	0	0	0	1 code
0	1	0	0	0	0	0	0	0	0	0	0	0	0	0	0	2 codes
0	0	1	0	0	0	0	0	0	0	0	0	0	0	0	0	3 codes
0	0	0	1	0	0	0	0	0	0	0	0	0	0	0	0	4 codes
0	0	0	0	1	0	0	0	0	0	0	0	0	0	0	0	5 codes
0	0	0	0	0	1	0	0	0	0	0	0	0	0	0	0	6 codes
0	0	0	0	0	0	1	0	0	0	0	0	0	0	0	0	7 codes
0	0	0	0	0	0	0	1	0	0	0	0	0	0	0	0	8 codes
0	0	0	0	0	0	0	0	1	0	0	0	0	0	0	0	9 codes
0	0	0	0	0	0	0	0	0	1	0	0	0	0	0	0	10 codes
0	0	0	0	0	0	0	0	0	0	1	0	0	0	0	0	11 codes
0	0	0	0	0	0	0	0	0	0	0	1	0	0	0	0	12 codes
0	0	0	0	0	0	0	0	0	0	0	0	1	0	0	0	13 codes
0	0	0	0	0	0	0	0	0	0	0	0	0	1	0	0	14 codes
0	0	0	0	0	0	0	0	0	0	0	0	0	0	1	0	15 codes
0	0	0	0	0	0	0	0	0	0	0	0	0	0	0	1	16 codes

BA.2 Mapping scheme for K=14 Midambles

m1	m2	m3	m4	m5	m6	M7	M8	m9	m10	m11	m12	M13	m14	
1	0	0	0	0	0	0	0	0	0	0	0	0	0	1 or 15 code(s)
0	1	0	0	0	0	0	0	0	0	0	0	0	0	2 or 16 codes
0	0	1	0	0	0	0	0	0	0	0	0	0	0	3 codes
0	0	0	1	0	0	0	0	0	0	0	0	0	0	4 codes
0	0	0	0	1	0	0	0	0	0	0	0	0	0	5 codes
0	0	0	0	0	1	0	0	0	0	0	0	0	0	6 codes
0	0	0	0	0	0	1	0	0	0	0	0	0	0	7 codes
0	0	0	0	0	0	0	1	0	0	0	0	0	0	8 codes
0	0	0	0	0	0	0	0	1	0	0	0	0	0	9 codes
0	0	0	0	0	0	0	0	0	1	0	0	0	0	10 codes
0	0	0	0	0	0	0	0	0	0	1	0	0	0	11 codes
0	0	0	0	0	0	0	0	0	0	0	1	0	0	12 codes
0	0	0	0	0	0	0	0	0	0	0	0	1	0	13 codes
0	0	0	0	0	0	0	0	0	0	0	0	0	1	14 codes

BA.3 Mapping scheme for K=12 Midambles

m1	m2	m3	m4	m5	m6	M7	M8	m9	m10	m11	m12	
1	0	0	0	0	0	0	0	0	0	0	0	1 or 13 code(s)
0	1	0	0	0	0	0	0	0	0	0	0	2 or 14 codes
0	0	1	0	0	0	0	0	0	0	0	0	3 or 15 codes
0	0	0	1	0	0	0	0	0	0	0	0	4 or 16 codes
0	0	0	0	1	0	0	0	0	0	0	0	5 codes
0	0	0	0	0	1	0	0	0	0	0	0	6 codes
0	0	0	0	0	0	1	0	0	0	0	0	7 codes
0	0	0	0	0	0	0	1	0	0	0	0	8 codes
0	0	0	0	0	0	0	0	1	0	0	0	9 codes
0	0	0	0	0	0	0	0	0	1	0	0	10 codes
0	0	0	0	0	0	0	0	0	0	1	0	11 codes
0	0	0	0	0	0	0	0	0	0	0	1	12 codes

BA.4 Mapping scheme for K=10 Midambles

m1	m2	m3	m4	m5	m6	M7	M8	m9	m10	
1	0	0	0	0	0	0	0	0	0	1 or 11 code(s)
0	1	0	0	0	0	0	0	0	0	2 or 12 codes
0	0	1	0	0	0	0	0	0	0	3 or 13codes
0	0	0	1	0	0	0	0	0	0	4 or 14 codes
0	0	0	0	1	0	0	0	0	0	5 or 15 codes
0	0	0	0	0	1	0	0	0	0	6 or 16 codes
0	0	0	0	0	0	1	0	0	0	7 codes
0	0	0	0	0	0	0	1	0	0	8 codes
0	0	0	0	0	0	0	0	1	0	9 codes
0	0	0	0	0	0	0	0	0	1	10 codes

BA.5 Mapping scheme for K=8 Midambles

m1	m2	m3	m4	m5	m6	m7	m8	
1	0	0	0	0	0	0	0	1 or 9 code(s)
0	1	0	0	0	0	0	0	2 or 10 codes
0	0	1	0	0	0	0	0	3 or 11 codes
0	0	0	1	0	0	0	0	4 or 12 codes
0	0	0	0	1	0	0	0	5 or 13 codes
0	0	0	0	0	1	0	0	6 or 14 codes
0	0	0	0	0	0	1	0	7 or 15 codes
0	0	0	0	0	0	0	1	8 or 16 codes

BA.6 Mapping scheme for K=6 Midambles

m1	m2	m3	m4	m5	m6	
1	0	0	0	0	0	1 or 7 or 13 code(s)
0	1	0	0	0	0	2 or 8 or 14 codes
0	0	1	0	0	0	3 or 9 or 15 codes
0	0	0	1	0	0	4 or 10 or 16 codes
0	0	0	0	1	0	5 or 11 codes
0	0	0	0	0	1	6 or 12 codes

BA.7 Mapping scheme for K=4 Midambles

m1	m2	m3	m4	
1	0	0	0	1 or 5 or 9 or 13 code(s)
0	1	0	0	2 or 6 or 10 or 14 codes
0	0	1	0	3 or 7 or 11 or 15 codes
0	0	0	1	4 or 8 or 12 or 16 codes

BA.8 Mapping scheme for K=2 Midambles

m1	m2	
1	0	1 or 3 or 5 or 7 or 9 or 11 or 13 or 15 code(s)
0	1	2 or 4 or 6 or 8 or 10 or 12 or 14 or 16 codes

Annex BB (normative): Signalling of the number of channelisation codes for the DL common midamble case for 7.68Mcps TDD

The following mapping schemes shall apply for the association between the number of channelisation codes employed in a timeslot and the use of a particular midamble shift in the DL common midamble case. In the following tables the presence of a particular midamble shift is indicated by '1'. Midamble shifts marked with '0' are left unused. Mapping schemes in section BB.4, BB.5 and BB.6 are not applicable to beacon timeslots where a P-CCPCH is present, because the default midamble allocation scheme is applied to these timeslots. Note that in the mapping schemes of sections BB.4, BB.5 and BB.6, the fixed and pre-allocated channelisation code for the beacon channel is included into the number of indicated channelisation codes.

BB.1 Mapping scheme for $K_{Cell}=16$ Midambles

m1	m2	m3	m4	m5	m6	m7	M8	m9	m10	m11	m12	m13	m14	m15	m16	
1	0	0	0	0	0	0	0	0	0	0	0	0	0	0	0	1 or 17 code
0	1	0	0	0	0	0	0	0	0	0	0	0	0	0	0	2 or 18 codes
0	0	1	0	0	0	0	0	0	0	0	0	0	0	0	0	3 or 19 codes
0	0	0	1	0	0	0	0	0	0	0	0	0	0	0	0	4 or 20 codes
0	0	0	0	1	0	0	0	0	0	0	0	0	0	0	0	5 or 21 codes
0	0	0	0	0	1	0	0	0	0	0	0	0	0	0	0	6 or 22 codes
0	0	0	0	0	0	1	0	0	0	0	0	0	0	0	0	7 or 23 codes
0	0	0	0	0	0	0	1	0	0	0	0	0	0	0	0	8 or 24 codes
0	0	0	0	0	0	0	0	1	0	0	0	0	0	0	0	9 or 25 codes
0	0	0	0	0	0	0	0	0	1	0	0	0	0	0	0	10 or 26 codes
0	0	0	0	0	0	0	0	0	0	1	0	0	0	0	0	11 or 27 codes
0	0	0	0	0	0	0	0	0	0	0	1	0	0	0	0	12 or 28 codes
0	0	0	0	0	0	0	0	0	0	0	0	1	0	0	0	13 or 29 codes
0	0	0	0	0	0	0	0	0	0	0	0	0	1	0	0	14 or 30 codes
0	0	0	0	0	0	0	0	0	0	0	0	0	0	1	0	15 or 31 codes
0	0	0	0	0	0	0	0	0	0	0	0	0	0	0	1	16 or 32 codes

BB.2 Mapping scheme for $K_{Cell}=8$ Midambles

M1	m2	m3	m4	m5	m6	m7	m8	
1	0	0	0	0	0	0	0	1 or 9 or 17 or 25 codes
0	1	0	0	0	0	0	0	2 or 10 or 18 or 26 codes
0	0	1	0	0	0	0	0	3 or 11 or 19 or 27 codes
0	0	0	1	0	0	0	0	4 or 12 or 20 or 28 codes
0	0	0	0	1	0	0	0	5 or 13 or 21 or 29 codes
0	0	0	0	0	1	0	0	6 or 14 or 22 or 30 codes
0	0	0	0	0	0	1	0	7 or 15 or 23 or 31 codes
0	0	0	0	0	0	0	1	8 or 16 or 24 or 32 codes

BB.3 Mapping scheme for $K_{Cell}=4$ Midambles

m1	m3	m5	m7	
1	0	0	0	1 or 5 or 9 or 13 or 17 or 21 or 25 or 29 codes
0	1	0	0	2 or 6 or 10 or 14 or 18 or 22 or 26 or 30 codes
0	0	1	0	3 or 7 or 11 or 15 or 19 or 23 or 27 or 31 codes
0	0	0	1	4 or 8 or 12 or 16 or 20 or 24 or 28 or 32 codes

BB.4 Mapping scheme for beacon timeslots and $K_{Cell}=16$ Midambles

m1	m2	m3	M4	m5	m6	m7	M8	m9	m10	m11	M12	m13	m14	m15	m16	
1	0	0	0	0	0	0	0	0	0	0	0	0	0	0	0	1 code (see note 1)
1	1	0	0	0	0	0	0	0	0	0	0	0	0	0	0	2 codes (SCTD applied to beacon in this time slot, see note 2)
1	$x^{(*)}$	1	0	0	0	0	0	0	0	0	0	0	0	0	0	13 or 25 codes
1	0	0	1	0	0	0	0	0	0	0	0	0	0	0	0	2 codes (SCTD not applied to beacon in this time slot) or 14 or 26 codes
1	$x^{(*)}$	0	0	1	0	0	0	0	0	0	0	0	0	0	0	3 or 15 or 27 codes
1	$x^{(*)}$	0	0	0	1	0	0	0	0	0	0	0	0	0	0	4 or 16 or 28 codes
1	$x^{(*)}$	0	0	0	0	1	0	0	0	0	0	0	0	0	0	5 or 17 or 29 codes
1	$x^{(*)}$	0	0	0	0	0	1	0	0	0	0	0	0	0	0	6 or 18 or 30 codes
1	$x^{(*)}$	0	0	0	0	0	0	0	0	1	0	0	0	0	0	7 or 19 or 31 codes
1	$x^{(*)}$	0	0	0	0	0	0	0	0	0	1	0	0	0	0	8 or 20 or 32 codes
1	$x^{(*)}$	0	0	0	0	0	0	0	0	0	0	1	0	0	0	9 or 21 codes
1	$x^{(*)}$	0	0	0	0	0	0	0	0	0	0	0	1	0	0	10 or 22 codes
1	$x^{(*)}$	0	0	0	0	0	0	0	0	0	0	0	0	1	0	11 or 23 codes
1	$x^{(*)}$	0	0	0	0	0	0	0	0	0	0	0	0	0	1	12 or 24 codes

(*) For the case of SCTD applied to beacon, midamble shift 2 is used by the diversity antenna.

Note 1: If only one code is present in a beacon time slot, this code is a beacon channel and the beacon channel is the only channel in this slot, by default. Therefore, only the beacon midamble(s) shall be used.

Note 2: If SCTD is applied to the beacon and only two codes are present in a beacon time slot, the beacon channel is the only channel in this slot, by default. Therefore, only the beacon midambles shall be used.

BB.5 Mapping scheme for beacon timeslots and $K_{Cell}=8$ Midambles

m1	m2	m3	m4	m5	m6	m7	M8	
1	0	0	0	0	0	0	0	1 code (see note 1)
1	1	0	0	0	0	0	0	2 codes (SCTD applied to beacon in this time slot, see note 2)
1	x ^(*)	1	0	0	0	0	0	7 or 13 or 19 or 25 or 31 codes
1	0	0	1	0	0	0	0	2 (SCTD not applied to beacon in this time slot) or 8 or 14 or 20 or 26 or 32 codes
1	x ^(*)	0	0	1	0	0	0	3 or 9 or 15 or 21 or 27 codes
1	x ^(*)	0	0	0	1	0	0	4 or 10 or 16 or 22 or 28 codes
1	x ^(*)	0	0	0	0	1	0	5 or 11 or 17 or 23 or 29 codes
1	x ^(*)	0	0	0	0	0	1	6 or 12 or 18 or 24 or 30 codes

^(*) For the case of SCTD applied to beacon, midamble shift 2 is used by the diversity antenna.

Note 1: If only one code is present in a beacon time slot, this code is a beacon channel and the beacon channel is the only channel in this slot, by default. Therefore, only the beacon midamble(s) shall be used.

Note 2: If SCTD is applied to beacon and only two codes are present in a beacon time slot, the beacon channel is the only channel in this slot, by default. Therefore, only the beacon midambles shall be used.

BB.6 Mapping scheme for beacon timeslots and $K_{Cell}=4$ Midambles

m1	m3	m5	m7	
1	0	0	0	1code (see note 1)
1	1	0	0	4 or 7 or 10 or 13 or 16 or 19 or 22 or 25 or 28 or 31 codes
1	0	1	0	2 or 5 or 8 or 11 or 14 or 17 or 20 or 23 or 26 or 29 or 32 codes
1	0	0	1	3 or 6 or 9 or 12 or 15 or 18 or 21 or 24 or 27 or 30 codes

Note 1: If only one code is present in a beacon time slot, this code is a beacon channel and the beacon channel is the only channel in this slot, by default. Therefore, only the beacon midamble shall be used.

BB.7 Mapping scheme for Burst Type 4 and $K_{Cell}=1$ Midamble

m1	
1	1, 2, 3, 4, 5, 6, 7, 8, 9, 10, 11, 12, 13, 14, 15, 16, 17, 18, 19, 20, 21, 22, 23, 24, 25, 26, 27, 28, 29, 30, 31 or 32 codes

Annex C (informative): CCPCH Multiframe Structure for the 3.84 Mcps option

In the following figures C.1 to C.3 some examples for Multiframe Structures on Primary and Secondary CCPCH are given. The figures show the placement of Common Transport Channels on the Common Control Physical Channels. Additional S-CCPCH capacity can be allocated on other codes and timeslots of course, e.g. FACH capacity is related to overall cell capacity and can be configured according to the actual needs. Channel capacities in the annex are derived using bursts with long midambles (Burst format 1). Every TrCH-box in the figures is assumed to be valid for two frames (see row 'Frame #'), i.e. the transport channels in CCPCHs have an interleaving time of 20msec.

The actual CCPCH Multiframe Scheme used in the cell is described and broadcast on BCH. Thus the system information structure has its roots in this particular transport channel and allocations of other Common Channels can be handled this way, i.e. by pointing from BCH.

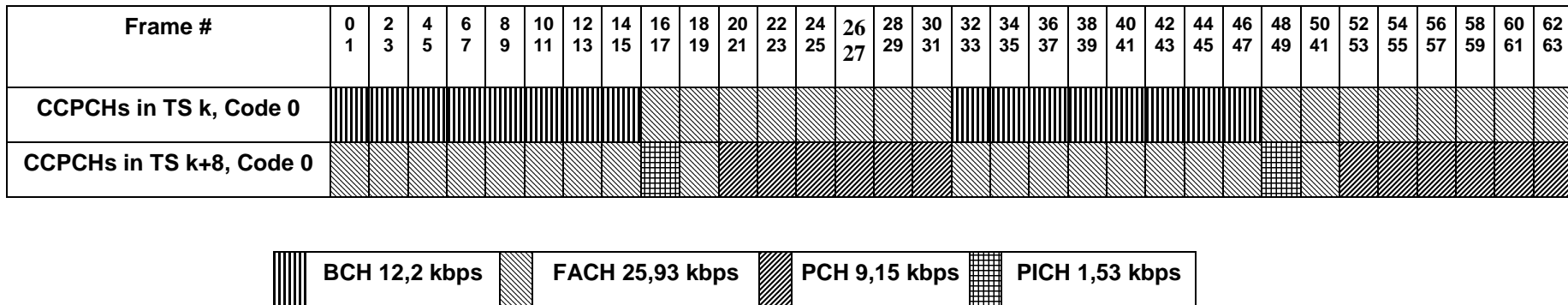

Figure C.1: Example for a multiframe structure for CCPCHs and PICH that is repeated every 64th frame

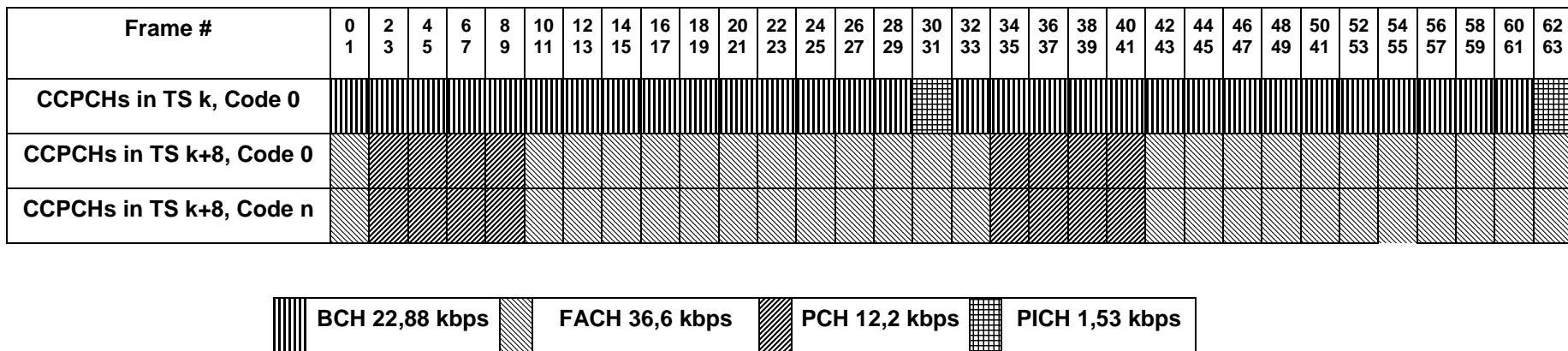

Figure C.2: Example for a multiframe structure for CCPCHs and PICH that is repeated every 64th frame, n=1...7

Annex CA (informative): CCPCH Multiframe Structure for the 1.28 Mcps option

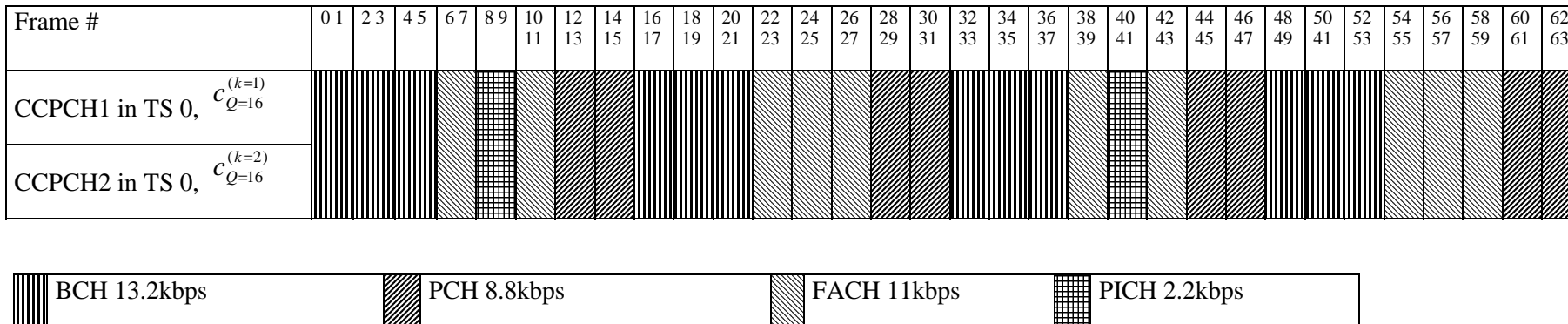

Figure CA.1: Example for a multiframe structure for CCPCHs and PICH that is repeated every 64th frame (128 sub-frame)

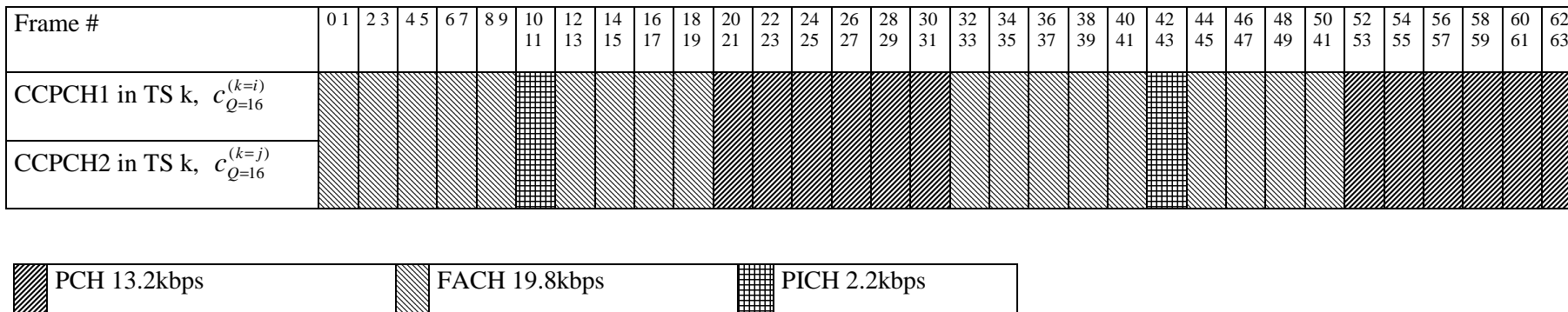

Figure CA.2: Example for a multiframe structure for S-CCPCHs and PICH that is repeated every 64th frame, $i,j=1...16$ ($i \neq j$), $k \neq 0, 1$, (128 sub-frame)

Annex CB (informative): Examples of the association of UL TPC commands to UL uplink time slots and CCTrCH pairs for 1.28 Mcps TDD

In the following two examples of the association of UL TPC commands to UL time slots and CCTrCHs are shown (see 5A.2.2.2):

Table CB.1 Two examples of the association of UL TPC commands to UL uplink time slots and CCTrCH pairs with NULslot=3

Case 1: $N_{UL_TPCsymbols}=2$; Case 2: $N_{UL_TPCsymbols}=4$

Sub-Frame Number	Case 1 (2 UL TPC symbols)	The order of the served UL time slot and CCTrCH pairs (UL time slot and CCTrCH number)	Case 2 (4 UL TPC symbols)
	The order of UL TPC symbols		The order of UL TPC symbols
SFN'=0	(1 st UL _{pos} =0)	0 → 0 (TS3) ← 0 1 → 1 (TS4) ← 1 2 (TS5) ← 2 1 (TS4) ← 3	(1 st UL _{pos} =0)
SFN'=1	(1 st UL _{pos} =2)	0 → 0 (TS3) ← 0 1 → 1 (TS4) ← 1 2 (TS5) ← 2 0 (TS3) ← 3 1 (TS4)	(1 st UL _{pos} =2)
SFN'=2	(1 st UL _{pos} =2)	0 → 0 (TS3) ← 0 1 → 1 (TS4) ← 1 2 (TS5) ← 2 0 (TS3) ← 3 1 (TS4) ← 3 2 (TS5) ← 3	(1 st UL _{pos} =1)
...

Annex CC (informative): Examples of the association of UL SS commands to UL uplink time slots

In the following two examples of the association of UL SS commands to UL uplink time slots are shown (see 5A.2.2.3):

Table CC.1 Two examples of the association of UL SS commands to UL uplink time slots with $N_{ULslot}=3$

Case 1: $N_{SSsymbols}=2$; Case 2: $N_{SSsymbols}=4$

Sub-Frame Number	Case 1 (2 UL SS symbols)		The order of the served UL time slot (UL time slot number)	Case 2 (4 UL SS symbols)	
	The order of UL SS symbols			The order of UL SS symbols	
SFN'=0	(1 st $UL_{pos}=0$)	0	→ 0 (TS3)	← 0	(1 st $UL_{pos}=0$)
		1	→ 1 (TS4)	← 1	
			→ 2 (TS5)	← 2	
			→ 1 (TS4)	← 3	
SFN'=1	(1 st $UL_{pos}=2$)	0	→ 0 (TS3)	← 0	(1 st $UL_{pos}=2$)
		1	→ 1 (TS4)	← 1	
			→ 2 (TS5)	← 2	
			→ 0 (TS3)	← 3	
			→ 1 (TS4)		
SFN'=2	(1 st $UL_{pos}=2$)	0	→ 0 (TS3)	← 0	(1 st $UL_{pos}=1$)
		1	→ 1 (TS4)	← 1	
			→ 2 (TS5)	← 2	
			→ 0 (TS3)	← 3	
			→ 1 (TS4)		
			→ 2 (TS5)		
...

Annex CD (normative): T-CPICH bit sequences for the 3.84 Mcps MBSFN IMB option

Table CD.1: T-CPICH pilot bit sequences for the 3.84 Mcps MBSFN IMB option

Primary scrambling code index <i>n</i>	Slot index <i>i</i>	T-CPICH pilot bit sequences $B^{(n)}_{T-CPICH,0} \dots B^{(n)}_{T-CPICH,959}$ in hexadecimal representation (reading from left to right, then from top to bottom)
0	0	B8BC9229F99056BF241881D6EDFD552DDED31C7E5CB4830D2C88B7949337D640E518702906868AE4F0D2E4EF09DCE5CD845CAF825488880EC5FC89408420FFD854389FE54E5AEB782B4447049A3B1810C3574F0DB9C88A8F0DCF11ECE48ECC5A872D9EB65270EB5113004A8500E6B7EEB46A79CD5B9E1742
	1	A619B3A7F98FAD8EB1C5A49B826DF7E600A2A26565B4B31079586E83F864340538C2BA87E957A7B8FC30E32CFB648F8529110A492AB99CD6820E84064C6F8C1E08CBCAF8492D97A0CF135BCE0ED9C4845ADDE53A1545C943D4982F0D1CAD790BD7B349959C840C4B1798CC9C666EC934EC54A4A5E42AFF00
	2	4248448A60CDC808CEE8DA329AD54888F3B74035717A9ADE41A2EC0AEE4DFD006D4EC2EB5D72D50D9DC8A76D9646749EDC6003918938455DAE0A5C008A008C3074A58F00D88FAB9B12936CC672528C3624B9CF484EA0E91AE617B94A9B4144C9D1FB321B16184187FDAC28C5495CB94F41C819096626641F
	3	E7D15E21FAEEAEDE08C75EC4CC49C9C9C30BE4098C1AEDC781D99C13575248A207D51525A52964D8FF62E2D64FCA2CF838A96FAB92397AC4B48CE614A8EDEAA0736CEE29275951CC189A2012D292E433E098AF3C01B43D10B946355CCC55C1F85BBEA6C80794FEF080793AD070F104C10CAA8828B02E7B4A
	4	64EF0E94CE9129C86724EB94583C257C647D63548480D9344CBFE1A9D28163E549AF594EA6D25AAC1F3E72FFC18109095600C2DA848D2382AEDBEF410C374C20C10AA2DCA53A7983842DF2CE81F570518299D57D9E97D4C90AEEDCEF16646A0416C968841E12B7672C94FD4816FE154EE990290849C2EE56
	5	1D922F3889C4D6606EB1D622E65EA16F4F28B40B49E90C49B62E84F1E4C04D2D4345220E9008E1A5C45C8AD0872E626FAABA048CBF75D0082C3A706C99842A9B6B1E0ADD4A5820402C43535768650B380B80594224E7B531A46CC15BAF3A18E913C2C43EA15A9CB716636CDDF76BE4C8488CB8F8847080F0
	6	CE94A497F0BF9CBADEC3C49D4D94B076889E24B55C0583851C30787A2427044AF3B8CE94EF101D4E2A4008557E924862E1116261C4C4D4F89A8262C757EDE1B71EC054983482618B288D698E48FD6329C213076CE28C85B0D1EC918782C5B0083868600C9FAD0469CDE6915FB2481A4966E71B2B6838E023
	7	63B60CAB008C3BD59577111A4818BB84A61C99D08A2C84CE954818DCAFE4999EAED0BDE9078234D792CC2F9839BE4AE418D65B0392C10D58501E4967E3445315900C2691B27D23751594BF21820D2D310509EE6A4222B21F0A212EC8453E8C4AE9158DD1BD4A8A9D98284A55313CA8ED508896A2A8C522D5
	8	A6D910704AFC9CD24324B764913B7E20DD71E4F4DAB12543658168AC14CA9095E9C8B54FD1C00A8E1051A1CF30A363E4F8F749AC48A1828B92A6EC411925D2F1E7F1D63410C93E2DA43ACDC96E6D06749547E387DA5BF4C0024DF044A71354CC74E7CE9B92647216ABCC16BC26EF0ECD8CB8C806BBE4E3D9
	9	4088C20812CEC1246ABE6AE55EA2C842C7F56E1B9E4BA6C8CEFE187C56D48637CC1A83064504478A741674C048EB018A12BA6C5CB790EB0382ADB2E9E689ED79D3C262917D4B9DE30C5F05ECE97CDCEE42C80CE72CF0D1DFB1CE4D9A85DDB46879CC8009DCF84D62BCC489A14D49D949852E32A6C468F154
	10	24FB5A5C09ECD46F410A52349BC0C4E080F5579B29C3EA418407794AC8FE45495564F48703EDC180D059288DC674217AD2EF00A6C6FE44A296FA485B0928CD88ACDCFCFF9F9C254E23D9D1E849764A982DC83ACBCDDF8F2FAA074A26F48A52F27A16D2970C0BF4DFCFC123CAABB6D3C66EA68C1D551BDA6A
	11	C93DD61EA5D6D473E29B8422C8D14D8A035B692327D6492F888B42A6578B01E9061DED09237CC07131A1F992665078CAA72C7F51C7F00EC64E28989E56E2C97902B88D226446B46A26AE4C68CC4F1A0D1B1AD23242F9484AD0F0C1CD4C8863784138C48D6F711DDE890409D9A5ECC2001A828929D93247FF
	12	CD0E265B8DF204AFDC655FB7CECAF603B4E0EA685E97BE4E64B85C01A414C490C565485A19EFA8F5C10B1A31A9E841369502CB0E0D5B32D3E120ADA0EE07DD7422A5808386EC474CE750C886240901296A12600AD616E1463C8B3BAF6AE08C4A2B585700B028DD0C440DE4B06CA8856DAFBF1D17E5478B67
	13	36F087C42AE04202FC029EA0A8098749966E394ED214846821196EEFEA23185C79A68584351BAF400F03B5ACED8CE7FADFC884485B448900C4C1E5C79B15CE489213C66580F35CD155516FCD7845AB69449D48040E2E8EC17C2EC8510E1AF70377E0A26E3EA354AC35F5588C386ABB6A0213082D7E7245545
	14	C5E241B1C1F6F78AE0192A590FC25DE1AE529BE2F554806451197AE4B65EDFC26200CD0BBCB95B70F0A4D31F48E4B411EA390D821A1BD31428BBB50CC0C99B03CA194BC9E4BACC0E0ABA2DE816414E1CF550D55989A18FE8E5C36AAEFDDAC6C2A50CC2898E8348175387D8FF15C2D618418826911EE07E17
128	0	6A1E8328A92DD0BC88C805C2C69604C3DE84E19DF5AA89942E66F9FCC41A8C26B604E4D8458A5760CEE09C8822CC068075318E1B50263DAC873E02347FBD25191D5859C285866CD8E80BD27B7604AA22DC6DC7F8D8953A52B00D9C896CB5CD62388FA050175FEFA0BC2ED888FB9550DB0F5819F90186C6C
	1	5EA97D8C6A17B02A01BBE2C589943DDE2FB17E827FE400F6DF582700B244865CF8D4D20C912F380D6494D81AD350219C1EC7A5FCF8504B81B89BCE12D845A38032682C9BC6C5585AE47F4A1F95B96884C01446E2A46DC0013453FDF6300F67840231CC8D53C7A447420A28C999EF3866C12B084C0C3D45
	2	C63FA876D54C06CA8D1198252AA2D79AFE579FAC8E39954EAF5CE8CB1B680C49B24000C042C24C36

	4CC86FD4151C768EF771F840C4C477E019FC249436C267118646D4A07468864DEA4CA781825C505B
2	41A9C458FAEC095BE34D11978C96344F340205907066B8ABFC6EB6F53719583F96D0861C774129A8 4BC4F94C5EC2C1C44EA5908FB4DF46456992425E119C86E0A467EE436008DB4657B6D68892FD3886 548DF6781740991D7828A5B39452ACD101CCA411C4410AA0E880D38C0CD8A37C6B6D6477CC20B9ED
3	0C0660753C1A2C8DE6CEC2AC4C03F541CBA8CF27078D5E582BD62E3B87DD0C624543534410437383 809E0C066FA2C676C352BFC7D35EC6E86CBF3E1CB0572E2D293B60A5C5334DE790BB6C7C43EB8418 39C0CABD205B006185069D842AD5CB9226659ECA8EFFD5C16D2908678CDAE4BEED04C4D35C9E7821
4	65CD384F2B9666D909DF68CDD637C33C1696F5E819784A8A2AD6CD9823EE1E40DE62CD1272440E5A 524A2603CC24EE6498CCFA1C919F870458140D851A0CD0E571196974BDC30ED8918CAAEC12446ACA CE0F4F080A6C9887D96703CD88C7E49AC3648D7F0BC72B7DC9B1A1D4B1CAF3A46943A680F849ED9A
5	E52994D6BDC01558000D3F22E416BB651A5E194EEE823A4C05793E665C5A6BA77960FC1081B6355A BA480753A0EE860434D01AC81DE4092403D05E12B0468A65A800C82447977C814A52326415FBE568 1BA286727FF095384C288DEAD496C4E41E99C62DA8B62102D420184487A48043E97B81C053041C72
6	28ACC0A9E893A55F1CBBCA24BDB83295E813168BEE80AA22148CD06F0F608B8AEF2E4C424004EEA5 B000E8C90CDBD46ACC5385110D1E470F8F66E6012706C025292C8D1F302955D2E1B64AC11B65AC0F 9124D981E19DC8129B6C2928687541187FDABFF5B7FA354814F523464FB138A54488970EB455C0D5
7	BDBB40572F15AA8050CD6F44E23D8AB1A9D9157A909716E41BBFD6C0E884E10E58A4E27FCCC45091 E689CC84D458D14B12FAF47CC4C0CA9DCA15873FD4FEC05AD00989BC06E24F6D4F82400EAF0B43C5 E285E2CF365E63448D42B0E20F89F461807055CCAAFDAA123374CDC3B364F858064CD30C67710330
8	A1CDC0AC064A07BDE5F496CCAFA3C91A98CFE182DD0C54F9ECCE25E981D129A8A23B630E8C78E0DA 58742533BB3D2A2FEEC1C139AC9DD60CE2083846F4B0C303E9E5999DB105E7E9C6F35326BE895580 4BC4AE86C4155D02966887724BCD8FC0E44DC118546BA6AF2F82EA4EE80447A418B8CE492CF49ECA
9	EC1C57AADEC8FBBC0B4140BC8C1D38DAC1416C48D5B482C839C469803288B6454FA8718D80FE92AF 81BDE6EE147C5EBEDD8730D582C141C001730D43021360E25D1C1769AEEDABD44F4E6F75DCDC9018 74A2E6C88B460A49501CD946E5FE0725EC9C68F6DFAB1D74CD55CE3C909E9065863022100A8C2F03
10	1CCD864CA6FDC0FD6AA18EE7B48A1F6B214645141D07AF691CD58C8F82DA596FC931023DBF026C0E 0282A1798C069848668CE08E82902E72BD6D46A381D8AA922DDA785A6858D85CCCF8F28FB8CDEF98 9B04606D9B08B8ACDD09CD5545EA4DDA4E548E5B587D1E894D50725E0968C0F949EEA3D5DBEC826D
11	9BD4603A5C0BAA644862019295B6F09CC05CAAE86306DF955307116D1852005A98C8EFE844ED14C4 A49DC462F596130E492C7DCCC47D64FC0045EAFD1E01CEAAF6C38255CB7ECB4446174CACAA116ED8 5A7050B48ED5B178B8F2A722544C90720DC9961E0AD6B868AE9DB5E045C6CCA35DEEEE08B9E6E58D
12	C0A81E46262DE865209B11883FC6ECD70E049C8341EABAC7D8B8E615C2027A820887866E12B86F2A FA70A8BD50A049203A1D7188006422598E461C27749329C00090916AFD453874AD4EAC9150B8C4AD C5E25FD38AE19C8CA6A4CA1244BD37383AB8BE81181944579F93C3D3CB7E04C7977CC0600CBC6FFD
13	7124526DAED23B9E828FDD9B9E8B3D4C214E87148BE9DF3AE1890EEACB11569EAC09E5955A160CCE A0A9EAD06B3C96B5A395A6B32A8CF1F1EED05ADB4EDDCF49882B202D1CD4BA67E248730D2280CC27 02D100406641C0E6B7F0910566C1AD0461A807CFE1BAE09EEE4660B55A4EEBC4EE122B0ECE694E8D
14	C3AE1C4C5C0BF009AA4D4171F41786A49CC55A01C5C5CD9A56F342E9B870650E88A1A48D0AD96F66 8448A9210D83A655448F7AA2024D1DBCDB49ACC485C3EBCDD7494D5406D590FE5B74ED031C076588 168BC607880040641BB6D65E0F5FDA160C32C671639FA86DE4E36A1D7454B40C900A93DEE3B4E10F

Annex D (informative): Change history

Change history							
Date	TSG #	TSG Doc.	CR	Rev	Subject/Comment	Old	New
14/01/00	RAN_05	RP-99591	-		Approved at TSG RAN #5 and placed under Change Control	-	3.0.0
14/01/00	RAN_06	RP-99691	001	02	Primary and Secondary CCPCH in TDD	3.0.0	3.1.0
14/01/00	RAN_06	RP-99691	002	02	Removal of Superframe for TDD	3.0.0	3.1.0
14/01/00	RAN_06	RP-99691	006	-	Corrections to TS25.221	3.0.0	3.1.0
14/01/00	RAN_06	RP-99691	007	1	Clarifications for Spreading in UTRA TDD	3.0.0	3.1.0
14/01/00	RAN_06	RP-99691	008	-	Transmission of TFCI bits for TDD	3.0.0	3.1.0
14/01/00	RAN_06	RP-99691	009	-	Midamble Allocation in UTRA TDD	3.0.0	3.1.0
14/01/00	RAN_06	RP-99690	010	-	Introduction of the timeslot formats to the TDD specifications	3.0.0	3.1.0
14/01/00	-	-	-	-	Change history was added by the editor	3.1.0	3.1.1
31/03/00	RAN_07	RP-000067	003	2	Cycling of cell parameters	3.1.1	3.2.0
31/03/00	RAN_07	RP-000067	011	-	Correction of Midamble Definition for TDD	3.1.1	3.2.0
31/03/00	RAN_07	RP-000067	012	-	Introduction of the timeslot formats for RACH to the TDD specifications	3.1.1	3.2.0
31/03/00	RAN_07	RP-000067	013	-	Paging Indicator Channel reference power	3.1.1	3.2.0
31/03/00	RAN_07	RP-000067	014	1	Removal of Synchronisation Case 3 in TDD	3.1.1	3.2.0
31/03/00	RAN_07	RP-000067	015	1	Signal Point Constellation	3.1.1	3.2.0
31/03/00	RAN_07	RP-000067	016	-	Association between Midambles and Channelisation Codes	3.1.1	3.2.0
31/03/00	RAN_07	RP-000067	017	-	Removal of ODMA from the TDD specifications	3.1.1	3.2.0
26/06/00	RAN_08	RP-000271	018	1	Removal of the reference to ODMA	3.2.0	3.3.0
26/06/00	RAN_08	RP-000271	019	-	Editorial changes in transport channels section	3.2.0	3.3.0
26/06/00	RAN_08	RP-000271	020	1	TPC transmission for TDD	3.2.0	3.3.0
26/06/00	RAN_08	RP-000271	021	-	Editorial modification of 25.221	3.2.0	3.3.0
26/06/00	RAN_08	RP-000271	023	-	Clarifications on TxDiversity for UTRA TDD	3.2.0	3.3.0
26/06/00	RAN_08	RP-000271	024	-	Clarifications on PCH and PICH in UTRA TDD	3.2.0	3.3.0
23/0900	RAN_09	RP-000344	022	1	Correction to midamble generation in UTRA TDD	3.3.0	3.4.0
23/0900	RAN_09	RP-000344	026	2	Some corrections for TS25.221	3.3.0	3.4.0
23/0900	RAN_09	RP-000344	028	-	Terminology regarding the beacon function	3.3.0	3.4.0
23/0900	RAN_09	RP-000344	030	1	TDD Access Bursts for HOV	3.3.0	3.4.0
23/0900	RAN_09	RP-000344	031	1	Number of codes signalling for the DL common midamble case	3.3.0	3.4.0
15/12/00	RAN_10	RP-000542	034	-	Correction on TFCI & TPC Transmission	3.4.0	3.5.0
15/12/00	RAN_10	RP-000542	035	1	Clarifications on Midamble Associations	3.4.0	3.5.0
15/12/00	RAN_10	RP-000542	036	-	Clarification on PICH power setting	3.4.0	3.5.0
16/03/01	RAN_11	-	-	-	Approved as Release 4 specification (v4.0.0) at TSG RAN #11	3.5.0	4.0.0
16/03/01	RAN_11	RP-010062	033	2	Correction to SCH section	3.5.0	4.0.0
16/03/01	RAN_11	RP-010062	037	1	Bit Scrambling for TDD	3.5.0	4.0.0
16/03/01	RAN_11	RP-010062	039	1	Corrections of PUSCH and PDSCH	3.5.0	4.0.0
16/03/01	RAN_11	RP-010062	040	-	Alteration of SCH offsets to avoid overlapping Midamble	3.5.0	4.0.0
16/03/01	RAN_11	RP-010062	041	-	Clarifications & Corrections for TS25.221	3.5.0	4.0.0
16/03/01	RAN_11	RP-010062	045	1	Corrections on the PRACH and clarifications on the midamble generation and the behaviour in case of an invalid TFI combination on the DCHs	3.5.0	4.0.0
16/03/01	RAN_11	RP-010062	046	-	Clarification of TFCI transmission	3.5.0	4.0.0
16/03/01	RAN_11	RP-010062	048	-	Corrections to Table 5.b "Timeslot formats for the Uplink"	3.5.0	4.0.0
16/03/01	RAN_11	RP-010073	042	2	Introduction of the Physical Node B Synchronization Channel	3.5.0	4.0.0
16/03/01	RAN_11	RP-010071	043	1	Inclusion of 1.28Mcps TDD in TS 25.221	3.5.0	4.0.0
16/03/01	RAN_11	RP-010072	044	-	Correction of beacon characteristics due to IPDLs	3.5.0	4.0.0
15/06/01	RAN_12	RP-010336	051	-	Clarification of Midamble Usage in TS25.221	4.0.0	4.1.0
15/06/01	RAN_12	RP-010336	053	-	Addition to the abbreviation list, correction of references to tables and figures	4.0.0	4.1.0
15/06/01	RAN_12	RP-010342	049	-	Correction of spelling in definition of beacon characteristics	4.0.0	4.1.0
15/06/01	RAN_12	RP-010342	055	-	Correction of Note for PDSCH signalling methods	4.0.0	4.1.0
21/09/01	RAN_13	RP-010522	057	-	TFCI Terminology	4.1.0	4.2.0
21/09/01	RAN_13	RP-010522	063	-	Clarification of notations in TS25.221 and TS25.223	4.1.0	4.2.0
21/09/01	RAN_13	RP-010522	062	-	Addition and correction of the reference	4.1.0	4.2.0
21/09/01	RAN_13	RP-010528	058	1	Corrections for TS 25.221	4.1.0	4.2.0
14/12/01	RAN_14	RP-010741	065	1	Transmit Diversity for P-CCPCH and PICH	4.2.0	4.3.0
14/12/01	RAN_14	RP-010741	067	-	Clarification of midamble transmit power in TS25.221	4.2.0	4.3.0
14/12/01	RAN_14	RP-010746	059	-	Bit Scrambling for 1.28 Mcps TDD	4.2.0	4.3.0
14/12/01	RAN_14	RP-010746	068	-	Transmit Diversity for P-CCPCH and PICH	4.2.0	4.3.0
14/12/01	RAN_14	RP-010746	069	-	Corrections of reference numbers in TS 25.221	4.2.0	4.3.0
08/03/02	RAN_15	RP-020049	071	2	Clarification of spreading for UL physical channels	4.3.0	4.4.0
08/03/02	RAN_15	RP-020049	073	1	Common midamble allocation for beacon time slot	4.3.0	4.4.0
08/03/02	RAN_15	RP-020049	075	3	Correction to a transmission of paging indicators bits	4.3.0	4.4.0

Change history							
Date	TSG #	TSG Doc.	CR	Rev	Subject/Comment	Old	New
08/03/02	RAN_15	RP-020058	076	1	CR to include HSDPA in TS25.221	4.3.0	5.0.0
07/06/02	RAN_16	RP-020434	080	2	Clarification of shared channel functionality for TDD	5.0.0	5.1.0
07/06/02	RAN_16	RP-020313	082	-	Clarification of shared channel functionality for TDD	5.0.0	5.1.0
07/06/02	RAN_16	RP-020317	081	-	TxDiversity for HSDPA in TDD	5.0.0	5.1.0
19/09/02	RAN_17	RP-020559	092	1	Corrections to channelisation code mapping for 1.28 Mcps TDD	5.1.0	5.2.0
19/09/02	RAN_17	RP-020576	094	-	Correction to S-CCPCH description for 1.28 Mcps TDD	5.1.0	5.2.0
19/09/02	RAN_17	RP-020579	104	2	Corrections to transmit diversity mode for TDD beacon-function physical channels	5.1.0	5.2.0
19/09/02	RAN_17	RP-020569	090	1	Corrections to channelisation code mappings for 3.84 Mcps TDD	5.1.0	5.2.0
19/09/02	RAN_17	RP-020572	097	2	Corrections to transmit diversity mode for TDD beacon-function physical channels	5.1.0	5.2.0
21/12/02	RAN_18	RP-020848	105	-	Correction of the number of transport channels in clause 4.1	5.2.0	5.3.0
21/12/02	RAN_18	RP-020852	107	-	Editorial modification to the section numberings	5.2.0	5.3.0
26/03/03	RAN_19	RP-030138	109	3	Clarification of number of midamble shifts in different time slots	5.3.0	5.4.0
26/03/03	RAN_19	RP-030138	110	1	Correction to applicable HS-SICH burst types and timeslot formats	5.3.0	5.4.0
26/03/03	RAN_19	RP-030138	111	-	Correction to HS-SCCH minimum timing requirement for UTRA TDD (3.84 Mcps Option)	5.3.0	5.4.0
26/03/03	RAN_19	RP-030138	112	3	Miscellaneous Corrections	5.3.0	5.4.0
26/03/03	RAN_19	RP-030138	113	-	HSDPA timing requirements	5.3.0	5.4.0
24/06/03	RAN_20	RP-030275	114	1	Corrections to field coding of TPC for support of HS-SICH (3.84Mcps TDD)	5.4.0	5.5.0
13/01/04	RAN_22	-	-	-	Created for M.1457 update	5.5.0	6.0.0
09/06/04	RAN_24	RP-040235	116	2	Addition of TSTD for S-CCPCH in 3.84Mcps TDD	6.0.0	6.1.0
13/12/04	RAN_26	RP-040451	117	-	Introduction of MICH	6.1.0	6.2.0
14/03/05	RAN_27	RP-050089	118	-	Release 6 HS-DSCH operation without a DL DPCH for 3.84Mcps TDD	6.2.0	6.3.0
16/06/05	RAN_28	RP-050240	124	1	Correction to transmission of SS for 1.28Mcps TDD	6.3.0	6.4.0
16/06/05	RAN_28	RP-050255	127	1	Correction to the examples of the association of UL SS commands to UL uplink time slots	6.3.0	6.4.0
16/06/05	RAN_28	RP-050239	130	1	Correction to transmission of TPC for 1.28Mcps TDD	6.3.0	6.4.0
16/06/05	RAN_28	RP-050255	133	1	Correction to the examples of the association of UL TPC commands to UL uplink time slot and CCTrCH pairs	6.3.0	6.4.0
29/06/05	-	-	-	-	Editorial revision to the incorrect implementation of CR127r1 and CR133r1	6.4.0	6.4.1
26/09/05	RAN_29	RP-050448	0134	-	Change of burst type to burst format	6.4.1	6.5.0
20/03/06	RAN_31	RP-060078	0135	-	Introduction of the Physical Layer Common Control Channel (PLCCH)	6.5.0	7.0.0
20/03/06	RAN_31	RP-060079	0136	-	Introduction of 7.68Mcps TDD option	6.5.0	7.0.0
29/09/06	RAN_33	RP-060492	0138	-	Introduction of E-DCH for 3.84Mcps and 7.68Mcps TDD	7.0.0	7.1.0
09/03/07	RAN_35	RP-070118	0139	2	Introduction of E-DCH for 1.28Mcps TDD	7.1.0	7.2.0
30/05/07	RAN_36	RP-070385	0140	2	Support for MBSFN operation	7.2.0	7.3.0
30/05/07	RAN_36	RP-070386	0142	-	Support for LCR TDD MBSFN operation	7.2.0	7.3.0
30/05/07	RAN_36	RP-070386	0143	-	Addition of spreading factor 2 for MBSFN time slot for 1.28Mcps TDD	7.2.0	7.3.0
11/09/07	RAN_37	RP-070650	0144	-	Introduction of multi-frequency operation for 1.28Mcps TDD	7.3.0	7.4.0
11/09/07	RAN_37	RP-070647	0145	-	TFCI mapping for S-CCPCH and 16QAM for 1.28Mcps TDD MBSFN	7.3.0	7.4.0
27/11/07	RAN_38	RP-070943	0148	2	More improvement on dedicated carrier for 1.28Mcps TDD MBMS	7.4.0	7.5.0
04/03/08	RAN_39	RP-080140	0150	-	Clarification of uplink multicode capability for 1.28Mcps TDD EUL	7.5.0	7.6.0
04/03/08	RAN_39	RP-080140	0151	-	EUL power control improvements for 1.28Mcps TDD	7.5.0	7.6.0
04/03/08	RAN_39	RP-080140	0152	-	E-AGCH timing for 1.28Mcps TDD EUL	7.5.0	7.6.0
04/03/08	RAN_39	RP-080140	0153	-	Clarification of the description about E-PUCH for 1.28Mcps TDD EUL	7.5.0	7.6.0
04/03/08	RAN_39	-	-	-	Creation of Release 8 further to RAN_39 decision	7.6.0	8.0.0
28/05/08	RAN_40	RP-080356	0155	-	Introduction of 64QAM for 1.28 Mcps TDD HSDPA	8.0.0	8.1.0
28/05/08	RAN_40	RP-080348	0157	-	Applicability of sync case 2	8.0.0	8.1.0
09/09/08	RAN_41	RP-080663	0161	-	Modification of the timing requirement between HS-SCCH and HS-PDSCH for 1.28Mcps TDD	8.1.0	8.2.0
09/09/08	RAN_41	RP-080662	0163	-	Correction on the time slot format for LCR TDD MBSFN	8.1.0	8.2.0
03/12/08	RAN_42	RP-080977	166	-	Correction on FPACH misalignment for 1.28Mcps TDD	8.2.0	8.3.0
03/12/08	RAN_42	RP-080976	168	-	Correction of E-PUCH TPC description for 1.28Mcps TDD	8.2.0	8.3.0
03/12/08	RAN_42	RP-080987	169	1	Introduction of the Enhanced CELL_FACH, CELL_PCH, URA_PCH state for 1.28Mcps TDD	8.2.0	8.3.0
03/12/08	RAN_42	RP-081118	170	1	Support for 3.84 Mcps MBSFN IMB operation	8.2.0	8.3.0
03/03/09	RAN_43	RP-090230	172	-	Clarification of uplink multicode transmission for 1.28Mcps TDD	8.3.0	8.4.0
03/03/09	RAN_43	RP-090239	173	-	TFCI for Secondary CCPCH frame type 2 with 16QAM	8.3.0	8.4.0
03/03/09	RAN_43	RP-090241	174	-	Introducing of MIMO for 1.28Mcps TDD	8.3.0	8.4.0
03/03/09	RAN_43	RP-090240	175	1	Introduction CPC for 1.28Mcps TDD	8.3.0	8.4.0
03/03/09	RAN_43	RP-090231	177	-	Editorial correction for annex CB & CC	8.3.0	8.4.0
03/03/09	RAN_43	RP-090239	178	-	Specification of T-CPICH sequences for MBSFN IMB	8.3.0	8.4.0

Change history							
Date	TSG #	TSG Doc.	CR	Rev	Subject/Comment	Old	New
26/05/09	RAN_44	RP-090531	179	-	Minor corrections for MBSFN IMB	8.4.0	8.5.0
26/05/09	RAN_44	RP-090533	180	-	Corrections of HS-PDSCH timeslot formats for 1.28Mcps TDD	8.4.0	8.5.0
26/05/09	RAN_44	RP-090526	182	-	E-PUCH timeslot format parameter corrections for 1.28Mcps TDD	8.4.0	8.5.0
15/09/09	RAN_45	RP-090893	184	-	Clarification of the transmission of SS and TPC in CPC for 1.28Mcps TDD	8.5.0	8.6.0
15/09/09	RAN_45	RP-090893	185	1	Change of the timing definition in CELL-PCH for 1.28Mcps TDD	8.5.0	8.6.0
01/12/09	RAN_46	RP-091166	189	1	Correction on E-AGCH and SPS E-PUCH Association and Timing for 1.28Mcps TDD	8.6.0	8.7.0
01/12/09	RAN_46	RP-091166	197	-	Timing association between HS-SCCH and SPS HS-PDSCH for LCR TDD	8.6.0	8.7.0
01/12/09	RAN_46	RP-091176	195	1	Modification to HSPA timing relationship for TS0 for 1.28Mcps TDD	8.7.0	9.0.0
16/03/10	RAN_47	RP-100202	200	1	Clarification of timing association between HS	9.0.0	9.1.0
16/03/10	RAN_47	RP-100203	202	1	Clarification of TPC and SS transmission on HS	9.0.0	9.1.0

History

Document history		
V9.0.0	February 2010	Publication
V9.1.0	April 2010	Publication