

# ETSI TS 125 303 V4.5.0 (2002-06)

---

*Technical Specification*

## **Universal Mobile Telecommunications System (UMTS); Interlayer procedures in Connected Mode (3GPP TS 25.303 version 4.5.0 Release 4)**

---



---

Reference

RTS/TSGR-0225303v450

---

Keywords

UMTS

**ETSI**

650 Route des Lucioles  
F-06921 Sophia Antipolis Cedex - FRANCE

Tel.: +33 4 92 94 42 00 Fax: +33 4 93 65 47 16

Siret N° 348 623 562 00017 - NAF 742 C  
Association à but non lucratif enregistrée à la  
Sous-Préfecture de Grasse (06) N° 7803/88

---

**Important notice**

Individual copies of the present document can be downloaded from:

<http://www.etsi.org>

The present document may be made available in more than one electronic version or in print. In any case of existing or perceived difference in contents between such versions, the reference version is the Portable Document Format (PDF). In case of dispute, the reference shall be the printing on ETSI printers of the PDF version kept on a specific network drive within ETSI Secretariat.

Users of the present document should be aware that the document may be subject to revision or change of status. Information on the current status of this and other ETSI documents is available at

<http://portal.etsi.org/tb/status/status.asp>

If you find errors in the present document, send your comment to:

[editor@etsi.fr](mailto:editor@etsi.fr)

---

**Copyright Notification**

No part may be reproduced except as authorized by written permission.  
The copyright and the foregoing restriction extend to reproduction in all media.

© European Telecommunications Standards Institute 2002.  
All rights reserved.

**DECT**<sup>TM</sup>, **PLUGTESTS**<sup>TM</sup> and **UMTS**<sup>TM</sup> are Trade Marks of ETSI registered for the benefit of its Members.  
**TIPHON**<sup>TM</sup> and the **TIPHON logo** are Trade Marks currently being registered by ETSI for the benefit of its Members.  
**3GPP**<sup>TM</sup> is a Trade Mark of ETSI registered for the benefit of its Members and of the 3GPP Organizational Partners.

---

## Intellectual Property Rights

IPRs essential or potentially essential to the present document may have been declared to ETSI. The information pertaining to these essential IPRs, if any, is publicly available for **ETSI members and non-members**, and can be found in ETSI SR 000 314: "*Intellectual Property Rights (IPRs); Essential, or potentially Essential, IPRs notified to ETSI in respect of ETSI standards*", which is available from the ETSI Secretariat. Latest updates are available on the ETSI Web server (<http://webapp.etsi.org/IPR/home.asp>).

Pursuant to the ETSI IPR Policy, no investigation, including IPR searches, has been carried out by ETSI. No guarantee can be given as to the existence of other IPRs not referenced in ETSI SR 000 314 (or the updates on the ETSI Web server) which are, or may be, or may become, essential to the present document.

---

## Foreword

This Technical Specification (TS) has been produced by ETSI 3rd Generation Partnership Project (3GPP).

The present document may refer to technical specifications or reports using their 3GPP identities, UMTS identities or GSM identities. These should be interpreted as being references to the corresponding ETSI deliverables.

The cross reference between GSM, UMTS, 3GPP and ETSI identities can be found under [www.etsi.org/key](http://www.etsi.org/key).

# Contents

Intellectual Property Rights .....	2
Foreword.....	2
Foreword.....	5
1 Scope .....	6
2 References .....	6
3 Definitions and abbreviations.....	6
3.1 Definitions .....	6
3.2 Abbreviations .....	6
4 General Description of Connected Mode.....	7
5 Radio Bearer Control - Overview of Procedures .....	8
5.1 Configurable parameters .....	8
5.2 Typical configuration cases .....	8
5.3 RRC Elementary Procedures.....	9
5.3.1 Category 1: Radio Bearer Configuration .....	9
5.3.2 Category 2: Transport Channel Configuration.....	9
5.3.3 Category 3: Physical Channel Configuration.....	10
5.3.4 Category 4: Transport Format Combination Restriction.....	10
5.3.5 Category 5: Uplink Dedicated Channel Control in CRNC .....	10
6 Examples of procedures .....	10
6.1 RRC Connection Establishment and Release Procedures .....	11
6.1.1 RRC connection establishment .....	11
6.1.2 UE Initiated Signalling Connection Establishment.....	13
6.1.3 Normal RRC Connection Release .....	13
6.1.3.1 RRC Connection Release from Dedicated Physical Channel .....	14
6.1.3.2 RRC Connection Release without Dedicated Physical Channel .....	15
6.2 Radio Bearer Control Procedures .....	17
6.2.1 Radio Bearer Configuration .....	17
6.2.1.1 Radio Bearer Establishment .....	17
6.2.1.1.1 Radio Bearer Establishment with Dedicated Physical Channel Activation.....	17
6.2.1.1.2 Radio Bearer Establishment with Unsynchronised Dedicated Physical Channel Modification .....	19
6.2.1.1.3 Radio Bearer Establishment with Synchronised Dedicated Physical Channel Modification .....	20
6.2.1.1.4 Radio Bearer Establishment without Dedicated Physical Channel.....	22
6.2.1.1.5 Radio Bearer Establishment with CPCH Channel Allocation .....	23
6.2.1.2 Radio Bearer Release .....	25
6.2.1.2.1 Radio Bearer Release with Unsynchronised Dedicated Physical Channel Modification .....	25
6.2.1.3 Radio Bearer Reconfiguration.....	27
6.2.1.3.1 Unsynchronised Radio Bearer Reconfiguration .....	27
6.2.2 Transport Channel Reconfiguration.....	29
6.2.2.1 Unsynchronised Transport Format Set Reconfiguration .....	29
6.2.3 Physical Channel Reconfiguration.....	31
6.2.3.1 UE-Originated DCH Activation.....	31
6.2.3.2 UE-terminated synchronised DCH Modify.....	33
6.2.3.3 UE-terminated DCH Release .....	34
6.2.4 Transport Format Combination Control .....	36
6.2.4.1 Transport Format Combination Limitation .....	36
6.2.5 Dynamic Resource Allocation Control of Uplink DCHs.....	37
6.2.6 Variable Rate Transmission of Uplink DCHs.....	39
6.3 Data transmission .....	41
6.3.1 Acknowledged-mode data transmission on DSCH using hard split of TFCI-word .....	41
6.3.2 Acknowledged-mode data transmission on DSCH using logical split of TFCI-word .....	42
6.3.3 Data transmission on CPCH .....	44
6.3.4 Data transfer on USCH (TDD only) .....	46

6.3.5	Data transfer on DSCH (TDD only) .....	48
6.4	RRC Connection mobility procedures.....	49
6.4.1	Handover Measurement Reporting .....	49
6.4.2	Cell Update .....	50
6.4.3	URA Update .....	52
6.4.4	Radio Link Addition (FDD) .....	55
6.4.5	Radio Link Removal (FDD) .....	56
6.4.6	Combined radio link addition and removal.....	57
6.4.7	Hard Handover (FDD and TDD) .....	58
6.4.8	SRNS Relocation .....	59
6.4.8.1	Combined Cell/URA Update and SRNS relocation (lossless radio bearers).....	59
6.4.8.2	Combined Hard Handover and SRNS relocation (lossless radio bearers) .....	62
6.4.8.3	Combined Cell/URA Update and SRNS relocation (seamless radio bearers).....	64
6.4.8.4	Combined Hard Handover and SRNS relocation (seamless radio bearers).....	66
6.4.9	RRC Connection re-establishment.....	68
6.4.10	Inter-system Handover: GSM/BSS to UTRAN .....	69
6.4.11	Inter-RAT Handover: UTRAN to GSM/BSS, CS domain services.....	71
6.5	CN originated paging request in connected mode .....	73
6.5.1	UTRAN coordinated paging using DCCH .....	73
6.6	UTRAN originated paging request and paging response .....	75
6.7	Other procedures .....	76
6.7.1	UE Capability Information .....	76
6.7.2	Random access transmission sequence (FDD) .....	77
6.7.3	Random access transmission sequence (TDD) .....	78
6.7.3.1	Random access transmission sequence (3.84 Mcps TDD).....	78
6.7.3.2	Random access transmission sequence (1.28 Mcps TDD).....	79
6.7.4	CPCH Emergency Stop sequence .....	80
7	Traffic volume monitoring .....	81
<b>Annex A (informative): Change history .....</b>		<b>82</b>
History .....		83

---

# Foreword

This Technical Specification has been produced by the 3<sup>rd</sup> Generation Partnership Project (3GPP).

The contents of the present document are subject to continuing work within the TSG and may change following formal TSG approval. Should the TSG modify the contents of the present document, it will be re-released by the TSG with an identifying change of release date and an increase in version number as follows:

Version x.y.z

where:

- x the first digit:
  - 1 presented to TSG for information;
  - 2 presented to TSG for approval;
  - 3 or greater indicates TSG approved document under change control.
- y the second digit is incremented for all changes of substance, i.e. technical enhancements, corrections, updates, etc.
- z the third digit is incremented when editorial only changes have been incorporated in the document.

---

# 1 Scope

The present document describes all procedures that assign, reconfigure and release radio resources. Included are e.g. procedures for transitions between different states and substates, handovers and measurement reports. The emphasis is on showing the combined usage of both peer-to-peer messages and interlayer primitives to illustrate the functional split between the layers, as well as the combination of elementary procedures for selected examples. The peer-to-peer elementary procedure descriptions are described in the related protocol descriptions /1, 2, 3/ and they are thus not within the scope of the present document.

The interlayer procedures in the present document are informative.

---

# 2 References

The following documents contain provisions which, through reference in this text, constitute provisions of the present document.

- References are either specific (identified by date of publication, edition number, version number, etc.) or non-specific.
- For a specific reference, subsequent revisions do not apply.
- For a non-specific reference, the latest version applies. In the case of a reference to a 3GPP document (including a GSM document), a non-specific reference implicitly refers to the latest version of that document *in the same Release as the present document*.

- [1] 3GPP TS 25.321: "Medium Access Control (MAC) protocol specification".
- [2] 3GPP TS 25.322: "Radio Link Control (RLC) protocol specification".
- [3] 3GPP TS 25.331: "Radio Resource Control (RRC) protocol specification".
- [4] 3GPP TS 25.304: "UE Procedures in Idle Mode and Procedures for Cell Reselection in Connected Mode".
- [5] 3GPP TS 25.301: "Radio Interface Protocol Architecture".
- [6] 3GPP TS 23.060: "General Packet Radio Service (GPRS); Service description; Stage 2".
- [7] 3GPP TS 25.323: "Packet Data Convergence Protocol (PDCP) specification".
- [8] 3GPP TR 21.905: "Vocabulary for 3GPP Specifications".

---

# 3 Definitions and abbreviations

## 3.1 Definitions

For the purposes of the present document, the terms and definitions given in [8] apply.

## 3.2 Abbreviations

For the purposes of the present document, the following abbreviations apply:

ASC	Access Service Class
CPCH	Common Packet CHannel
DC-SAP	Dedicated Control SAP
DCH	Dedicated transport CHannels
RNTI	Radio Network Temporary Identity

## 4 General Description of Connected Mode

The connected mode is entered when the RRC connection is established. The UE is assigned a Radio Network Temporary Identity (RNTI) to be used as UE identity on common transport channels. Two types of RNTI exist. The Serving RNC allocates an s-RNTI for all UEs having an RRC connection. The combination of s-RNTI and an RNC-ID is unique within a PLMN. c-RNTI is allocated by each Controlling RNC through which UE is able to communicate on DCCH. c-RNTI is always allocated by UTRAN when a new UE context is created to an RNC, but the UE needs its c-RNTI only for communicating on common transport channels.

The UE leaves the connected mode and returns to idle mode when the RRC connection is released or at RRC connection failure.

Within connected mode the level of UE connection to UTRAN is determined by the quality of service requirements of the active radio bearers and the characteristics of the traffic on those bearers.

The UE-UTRAN interface is designed to support a large number of UEs using packet data services by providing flexible means to utilize statistical multiplexing. Due to limitations, such as air interface capacity, UE power consumption and network h/w availability, the dedicated resources cannot be allocated to all of the packet service users at all times.

Variable rate transmission provides the means that for services of variable rate the data rate is adapted according to the maximum allowable output power.

The UE state in the connected mode defines the level of activity associated to the UE. The key parameters of each state are the required activity and resources within the state and the required signalling prior to the data transmission. The state of the UE shall at least be dependent on the application requirement and the period of inactivity.

Common Packet Channel (CPCH) uplink resources are available to UEs with an access protocol similar to the RACH. The CPCH resources support uplink packet communication for numerous UEs with a set of shared, contention-based CPCH channels allocated to the cell.

The different levels of UE connection to UTRAN are listed below:

- No signalling connection exists  
The UE is in idle mode and has no relation to UTRAN, only to CN. For data transfer, a signalling connection has to be established.
- Signalling connection exists  
When at least one signalling connection exists, the UE is in connected mode and there is normally an RRC connection between UE and UTRAN. The UE position can be known on different levels:
  - UTRAN Registration Area (URA) level  
The UE position is known on URA level. The URA is a set of cells
  - Cell level  
The UE position is known on cell level. Different transport channel types can be used for data transfer:
  - Common transport channels (RACH / FACH, DSCH, CPCH)
  - Dedicated transport Channels (DCH)

Assuming that there exists an RRC connection, there are two basic families of RRC connection mobility procedures, URA updating and handover. Different families of RRC connection mobility procedures are used in different levels of UE connection (cell level and URA level):

- URA updating is a family of procedures that updates the UTRAN registration area of a UE when an RRC connection exists and the position of the UE is known on URA level in the UTRAN;
- handover is a family of procedures that adds or removes one or several radio links between one UE and UTRAN when an RRC connection exists and the position of the UE is known on cell level in the UTRAN.



## 5 Radio Bearer Control - Overview of Procedures

### 5.1 Configurable parameters

The following layer 1, MAC and RLC parameters should be configurable by RRC. The list is not complete.

- Radio bearer parameters, e.g.:
  - RLC parameters per RLC link (radio bearer), which may include e.g. PDU size and timeout values. Used by RLC.
  - Multiplexing priority per DCCH/DTCH. Used by MAC in case of MAC multiplexing of logical channels.
- Transport channel parameters, e.g.:
  - Scheduling priority per transport channel. Used by MAC in case of layer 1 multiplexing of transport channels.
  - Transport format set (TFS) per transport channel. Used by MAC and L1.
  - Transport format combination set (TFCS) per UE. Used by MAC and L1.
  - Allowed subset of TFCS per UE. Used by MAC.
  - CPCH access parameters per CPCH channel. Used by MAC and L1.
- Physical channel parameters, which may include e.g. carrier frequency and codes. Used by L1.

### 5.2 Typical configuration cases

Table 1 gives a proposal which main combination cases of parameter configuration that shall be supported, in terms of which parameters that shall be able to configure simultaneously (by one procedure). Note that the "Transport channel type switching" is not a parameter as such, it only indicates that switching of transport channel type may take place for that combination case.

**Table 1: Typical configuration cases.**  
An "X" indicates that the parameter can (but need not) be configured

Parameter		Layer	A	B	C	D	E	F
Radio bearer parameters	RLC parameters	RLC	X					
	Logical channel multiplexing priority	MAC	X					
Transport channel parameters	Transport channel scheduling priority	MAC	X					
	TFS	L1+MAC	X	X				
	TFCS	L1+MAC	X	X				
	Subset of TFCS	MAC					X	X
	Transport channel type switching	MAC	X	X	X			
Physical channel parameters		L1	X	X	X	X		

Case A is typically when a radio bearer is established or released, or when the QoS of an existing radio bearer need to be changed.

Case B is when the traffic volume of a radio bearer has changed so the TFS used on the DCH need to be changed, which may in turn affect any assigned set of physical channels. Another example is to make the UE use a new transport channel and at the same time supplying the TFS for that channel.

Case C is when the traffic volume of one radio bearer has changed so that the used transport channel type is changed, e.g. from CELL\_FACH to CELL\_DCH or when the CPCH Set assigned to a UE is switched. This case includes the assignment or release of a set of physical channels.

Case D is e.g. the change of used DL channelisation code, when a DCH is currently used. No transport channel type switching takes place.

Case E is a temporary restriction and/or a release of restriction for usage of the TFCS by the UE (total uplink rate).

Case F is used to dynamically control the allocation of resources on uplink DCHs in the CRNC, using broadcast information such as transmission probability and maximum bit rate.

## 5.3 RRC Elementary Procedures

### 5.3.1 Category 1: Radio Bearer Configuration

The first category of procedures includes Case A and are characterized by:

- are executed upon request by higher layers and the parameter configuration is based on QoS;
- affects L1, MAC and RLC.

There are three RRC procedures included in this category:

- **Radio Bearer Establishment:** this procedure establishes a new radio bearer. The establishment includes, based on QoS, assignment of RLC parameters, multiplexing priority for the DTCH, CPCH Set assignment, scheduling priority for DCH, TFS for DCH and update of TFCS. It may also include assignment of a physical channel(s) and change of the used transport channel types / RRC state.
- **Radio Bearer Release:** this procedure releases a radio bearer. The RLC entity for the radio bearer is released. The procedure may also release a DCH, which affects the TFCS. It may include release of physical channel(s) and change of the used transport channel types / RRC state.
- **Radio Bearer Reconfiguration:** this procedure reconfigures parameters for a radio bearer (e.g. the signalling link) to reflect a change in QoS. It may include change of RLC parameters, change of multiplexing priority for DTCH/DCCH, CPCH Set assignment, change of DCH scheduling priority, change of TFS for DCH, change of TFCS, assignment or release of physical channel(s) and change of used transport channel types.

### 5.3.2 Category 2: Transport Channel Configuration

The second category of procedures includes Case B and are characterized by:

- configuration of TFS for a transport channel and reconfiguration of TFCS is done, but sometimes also physical channel parameters;
- affects L1 and MAC;
- switching of used transport channel(s) may take place.

There is one RRC procedure included in this category:

- **Transport Channel Reconfiguration:** this procedure reconfigures parameters related to a transport channel such as the TFS. The procedure also assigns a TFCS and may change physical channel parameters to reflect a reconfiguration of a transport channel in use.

NOTE: It is expected that the configuration of TFS/TFCS needs to be done more seldom than the assignment of physical channel. A "pre-configuration" of TFS/TFCS of a transport channel not in use can be done by this procedure, to be used after transport channel type switching when the physical channel is assigned.

### 5.3.3 Category 3: Physical Channel Configuration

The third category of procedures includes the cases C and D and are characterized by:

- may assign or release a physical channel for the UE (which may result in transport channel type switching);
- may make a combined release and assignment (replacement) of a physical channel in use (which does not result in transport channel type switching / change of RRC state);
- affects mainly L1, and only the transport channel type switching part of MAC;
- the transport format sets (TFS and TFCS) are not assigned by this type of procedure. However, the UE can be directed to a transport channel, which TFS is already assigned to the UE.

There is one RRC procedure included in this category:

- **Physical Channel Reconfiguration:** this procedure may assign, replace or release a set of physical channels used by an UE. As a result of this, it may also change the used transport channel type (RRC state). For example, when the first physical channel is assigned the UE enters the DCH/DCH state. When the last physical channel is released the UE leaves the CELL\_DCH state and enters a state (and transport channel type) indicated by the network. A special case of using this procedure is to change the DL channelisation code of a dedicated physical channel.

NOTE: The procedure does not change the active set, in the downlink the same number of physical channels are added or replaced for each radio link.

### 5.3.4 Category 4: Transport Format Combination Restriction

The fourth category of procedures includes Case E and are characterized by:

- does only control MAC by means of the transport format combinations that may be used within the set without affecting L1.

There is one RRC procedure included in this category:

- **Transport format combination control:** the network uses this procedure towards an UE, to control the used transport format combinations in the uplink within the transport format combination set.

### 5.3.5 Category 5: Uplink Dedicated Channel Control in CRNC

The fifth category of procedures includes Case F and are characterized by:

- does control UE MAC by means of broadcasting transmission probability and maximum total bit rate that shall be used for uplink DCHs, which are under control by this procedure.

There is one RRC procedure included in this category:

- **Dynamic Resource Allocation Control of Uplink DCHs:** the network uses this procedure towards all UEs, to control the probability of transmission and the maximum total bit rate used by uplink DCHs, which are under control by this procedure.

---

## 6 Examples of procedures

These sequences are examples and do not provide a comprehensive set of all different scenarios.

In cases where the logical and / or transport channel for a given message is known, it can be shown in front of the message name (*Logical\_Ch: Transport\_Ch: Message*). For example: DCCH:RACH:Acknowledged Data indicates a data message on DCCH mapped onto RACH. Either logical or transport channel can be omitted, if it is unspecified for the message.

## 6.1 RRC Connection Establishment and Release Procedures

### 6.1.1 RRC connection establishment

RRC connection establishment (see [5]) is shown in figure 1 (protocol termination for common channels is shown according to former case A, case C can be found for comparison in annex A). The RRC layer in the UE leaves the idle mode and initiates an RRC connection establishment by sending an RRC Connection Request message using transparent mode on CCCH logical channel, and it is transmitted by MAC on the RACH transport channel.

On the network side, upon the reception of RRC Connection Request, the RRC layer performs admission control, assigns an s-RNTI for the RRC connection and selects radio resource parameters (such as transport channel type, transport format sets etc). If a DCH is to be established, CPHY-RL-Setup and CPHY-TrCH-Config request primitives (transmitted as one RADIO LINK SETUP PDU) are sent to all Node Bs that would be involved in the channel establishment. The physical layer operation is started and confirmation primitives are returned from each Node B. RRC configures parameters on layer 2 to establish the DCCH logical channel locally. The selected parameters including the RNTI, are transmitted to the UE in an RRC Connection Setup message using unacknowledged mode on the CCCH logical channel.

Upon reception of the RRC Connection Setup message, the RRC layer in the UE configures the L1 and L2 using these parameters to locally establish the DCCH logical channel. In case of DCH, layer 1 indicates to RRC when it has reached synchronisation.

The RLC signalling link is locally established on both sides. The establishment can be mapped on either RACH / FACH or DCH by MAC. When the UE has established the RLC signalling link, it transmits an RRC Connection Setup Complete message to the network using acknowledged mode on the DCCH.

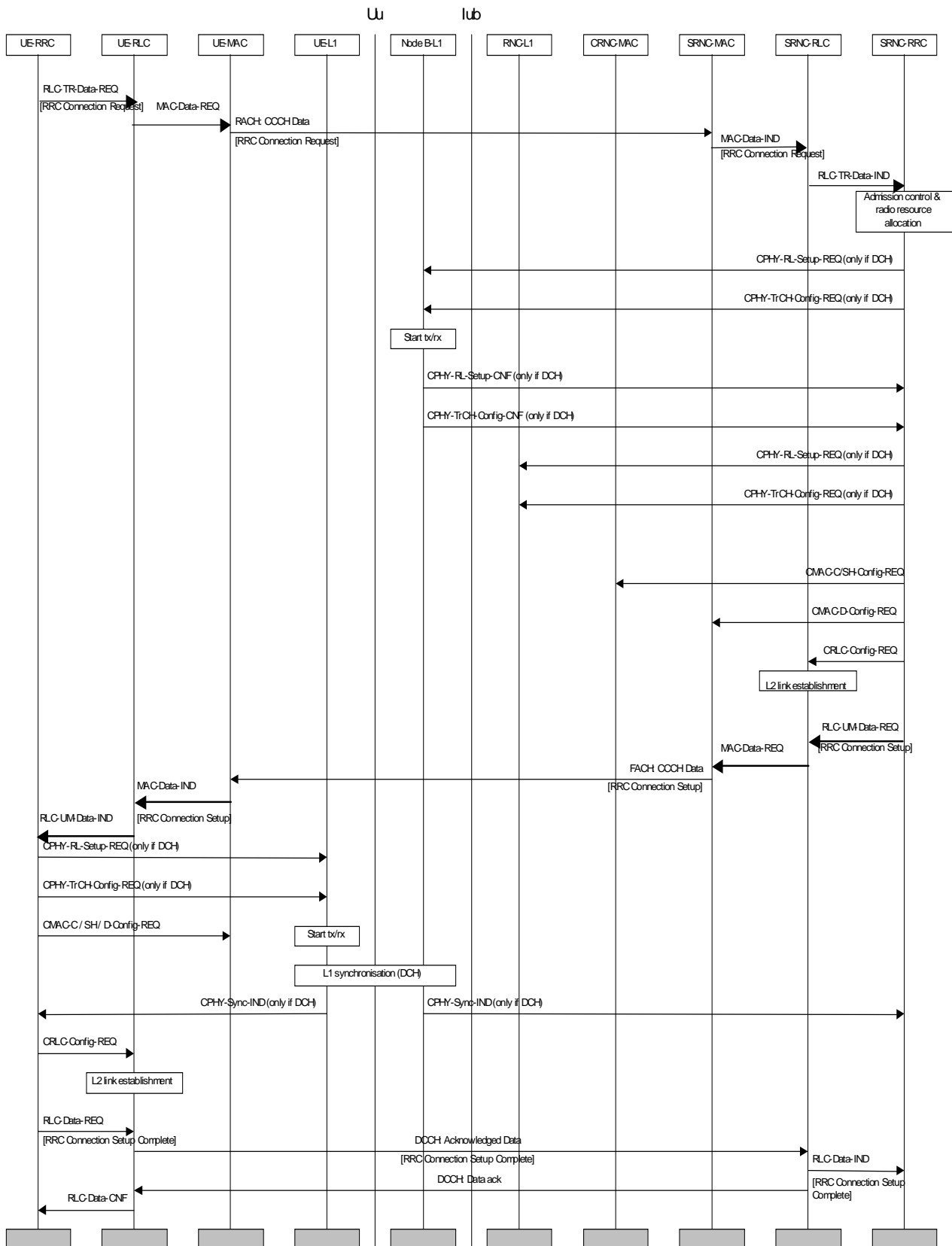

Figure 1: RRC connection establishment (with common channel termination case A)

### 6.1.2 UE Initiated Signalling Connection Establishment

NOTE 1: In case additional UE capability information is needed at RRC Connection Establishment, it is transmitted in the RRC Connection Setup Complete message.

The sequence in figure 2 shows the establishment of the first Signalling Connection for the UE, initiated by the UE.

RRC Signalling Connection Establishment is requested by the non access stratum in the UE with a primitive over the Dedicated Control (DC) SAP. The primitive contains an initial message to be transferred transparently by RRC to the non-access stratum entity on the network side.

NOTE 2: The initial NAS message could for a GSM based Core Network be e.g. CM Service Request, Location Update Request etc.

If no RRC connection exists, the RRC layer makes an RRC connection establishment, which includes the transmission of UE capability information. When the RRC connection establishment is completed, the signalling connection establishment can be resumed.

The initial message from NAS is transferred in the RRC message "Initial Direct Transfer" using acknowledged mode on the DCCH, to the network, where it is passed on with an RRC Signalling Connection Establish IND primitive over the DC-SAP.

When the UE-RRC has requested UE-RLC to transmit the INITIAL DIRECT TRANSFER message, the Signalling Connection Establishment is confirmed by the UE-RRC.

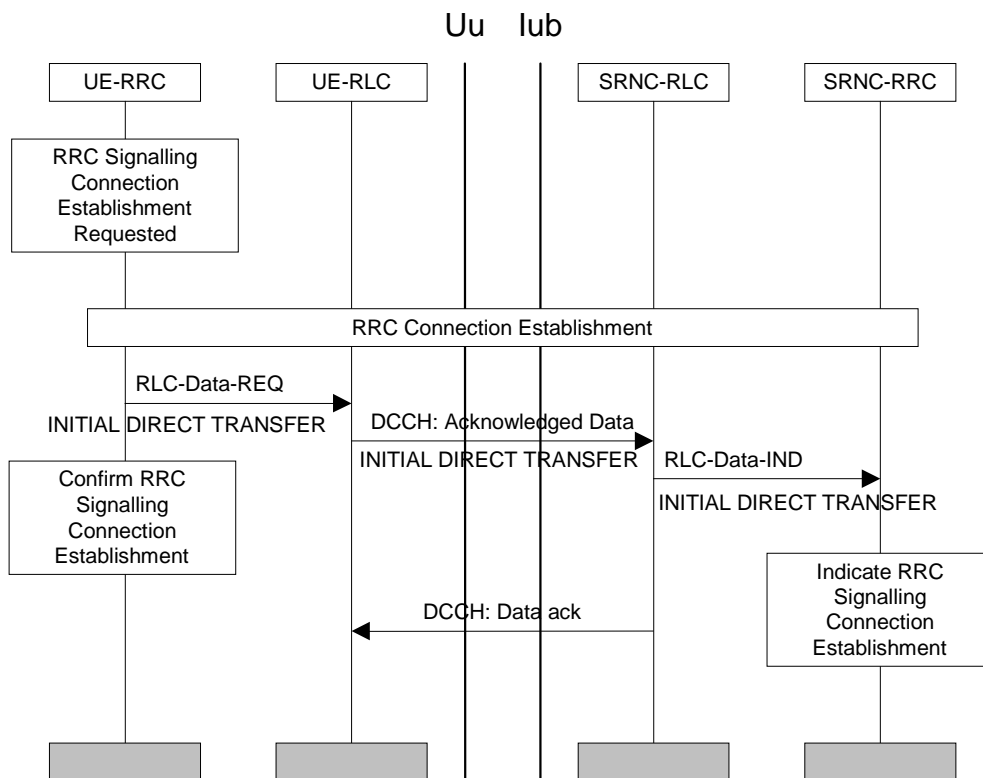

Figure 2: UE initiated Signalling Connection Establishment

### 6.1.3 Normal RRC Connection Release

A normal RRC Connection Release procedure is initiated on the network side by an RRC Signalling Connection Release request for the last Signalling Connection of a UE. The procedure is slightly different depending on whether the UE has dedicated physical channel(s) allocated.

6.1.3.1 RRC Connection Release from Dedicated Physical Channel

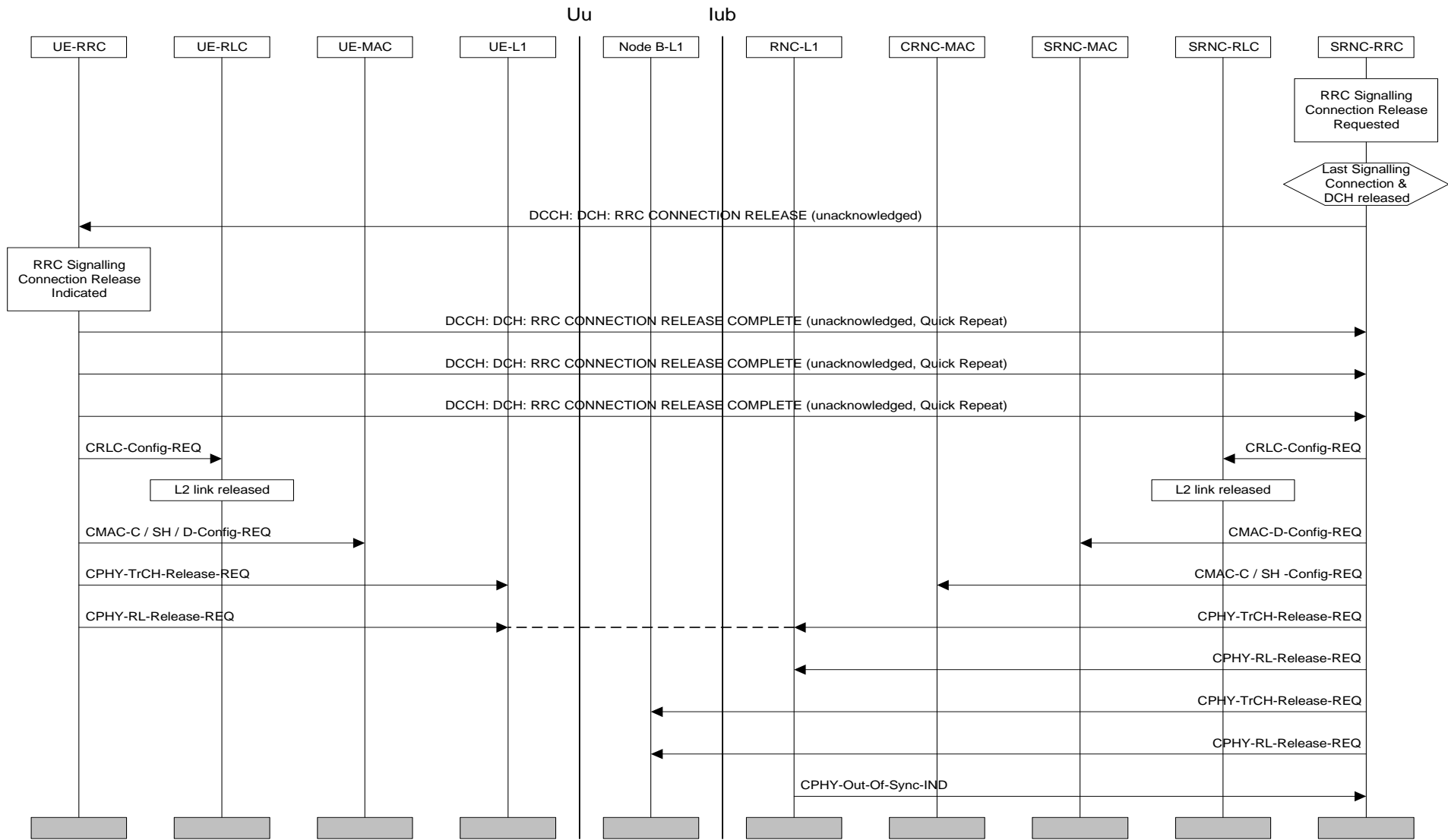

Figure 3: RRC Connection Release from Dedicated Physical Channel

The RRC layer entity in the network issues an RRC CONNECTION RELEASE message using unacknowledged mode on the DCCH. Upon reception of this message the UE-RRC sends an RRC Signalling Connection Release Indication primitive to NAS. The UE replies with an RRC CONNECTION RELEASE COMPLETE message, which is sent in unacknowledged-mode on the dedicated channel. To improve the reliability of the message, quick repeat on RRC-level can be used. The UE will then proceed to release RLC(s), MAC and the radio link(s) after which the UE RRC enters Idle Mode.

The primary method to detect the release of the signalling link in the NW is the RRC CONNECTION RELEASE COMPLETE-message from the UE. Should the message be lost despite the use of quick repeat, the release of the signalling link is detected by the out-of-sync primitive from either Node-B L1 or RNC-L1 to RNC RRC. After receiving this primitive, the RNC-RRC layer releases L2 and L1 resources on the network side and enters the idle mode.

### 6.1.3.2 RRC Connection Release without Dedicated Physical Channel

The RRC layer entity in the network issues an RRC CONNECTION RELEASE message using unacknowledged or acknowledged mode on the DCCH. Upon reception of this message the UE-RRC sends an RRC Signalling Connection Release Indication primitive to NAS and an RRC CONNECTION RELEASE COMPLETE message to UTRAN using acknowledged mode on the DCCH.

After receiving the RRC CONNECTION RELEASE COMPLETE message the network RRC layer releases L2 resources, sends an RRC Signalling Connection Release confirmation to DC-SAP and goes to Idle Mode (more precisely: only the RRC entity dedicated to this UE goes to Idle Mode).



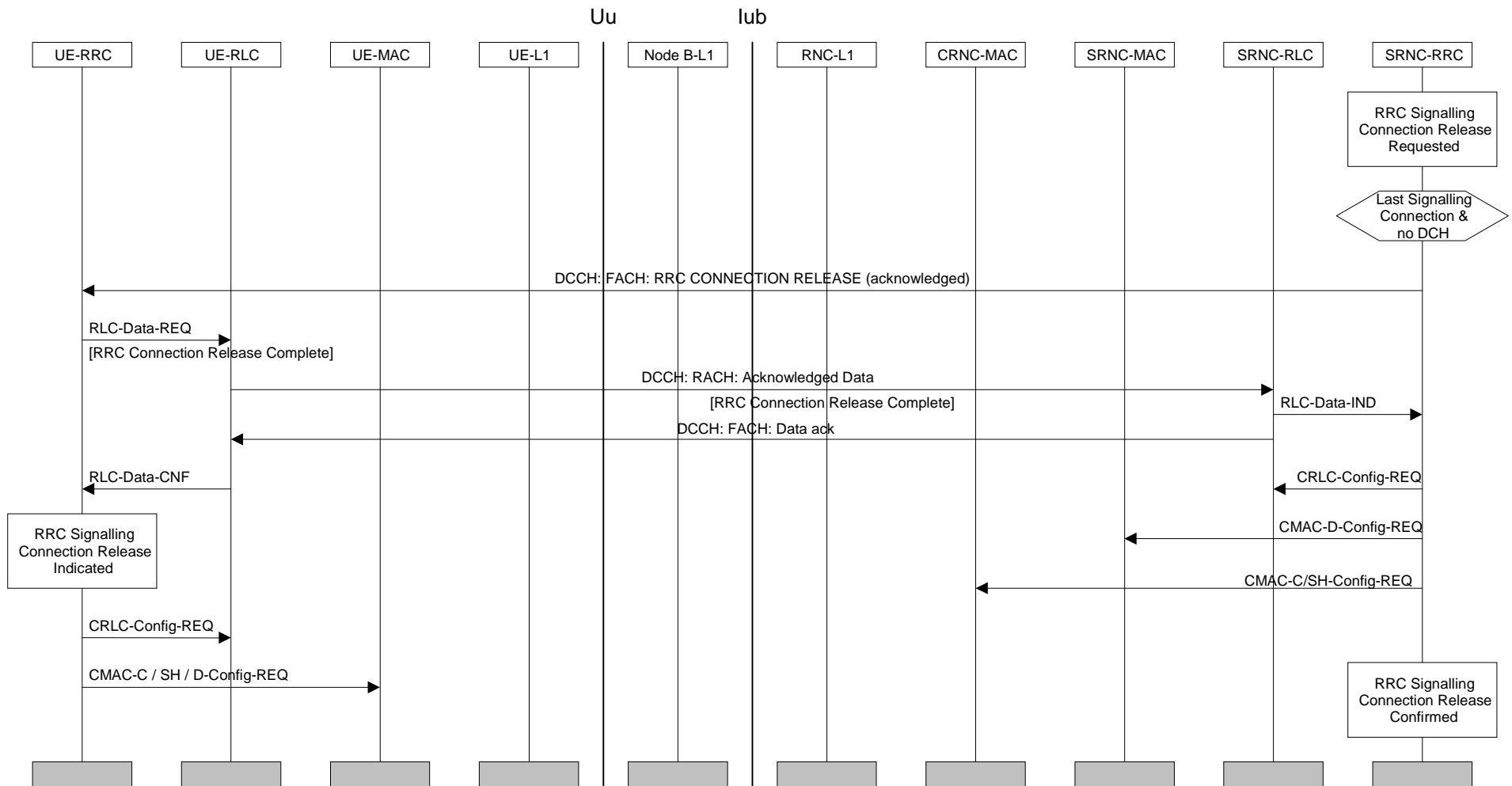

Figure 4: RRC Connection Release without Dedicated Physical Channel

## 6.2 Radio Bearer Control Procedures

### 6.2.1 Radio Bearer Configuration

#### 6.2.1.1 Radio Bearer Establishment

The procedures for establishing radio bearers may vary according to the relation between the radio bearer and a dedicated transport channel. Depending on the QoS parameters, there may or may not be a permanently allocated dedicated channel associated with the RB. Circuit-switched bearers, or bearers classified as real-time services typically need a permanent association to a DCH to meet the delay requirements. Packet-switched bearers, or bearers classified as non-real-time services can in many cases be served as best-effort, requesting capacity from an associated DCH based on need.

When establishing an RB together with a DCH, the DCH may be attached to either a newly activated physical channel or it may be accommodated by modifying an existing physical channel. The modification is further broken down into two different options: synchronised and unsynchronised. If the old and new physical channel settings are compatible (TFCI etc.) in the sense that executing the modification in the NW and the UE with arbitrary timing does not introduce transmission errors, the unsynchronised procedure can be applied. If the old and new settings are incompatible, due to e.g. assignment of the same TFCI value to a new set of physical layer configuration, the synchronised procedure must be used.

##### 6.2.1.1.1 Radio Bearer Establishment with Dedicated Physical Channel Activation

The procedure in figure 5 is applied when a new physical channel needs to be created for the radio bearer. A Radio Bearer Establishment is initiated when an RB Establish Request primitive is received from the DC-SAP on the network side of the RRC layer. This primitive contains a bearer reference and QoS parameters. Based on these QoS parameters, L1 and L2 parameters are chosen by the RRC entity on the network side.

The physical layer processing on the network side is started with the CPHY-RL-Setup request primitive issued to all applicable Node Bs. If any of the intended recipients is / are unable to provide the service, it will be indicated in the confirmation primitive(s). After setting up L1 including the start of Tx / Rx in Node B, the NW-RRC sends a RADIO BEARER SETUP message to its peer entity (acknowledged or unacknowledged transmission optional for the NW). This message contains L1, MAC and RLC parameters. After receiving the message, the UE-RRC configures L1 and MAC.

When L1 synchronisation is indicated, the UE sends a RADIO BEARER SETUP COMPLETE message in acknowledged-mode back to the network. The NW-RRC configures MAC and RLC on the network side.

After receiving the confirmation for the RADIO BEARER SETUP COMPLETE, the UE-RRC creates a new RLC entity associated with the new radio bearer. The applicable method of RLC establishment may depend on RLC transfer mode. The RLC connection can be either implicitly established, or explicit signalling can be applied.

Finally, an RB Establish Indication primitive is sent by UE-RRC and an RB Establish Confirmation primitive is issued by the RNC-RRC.

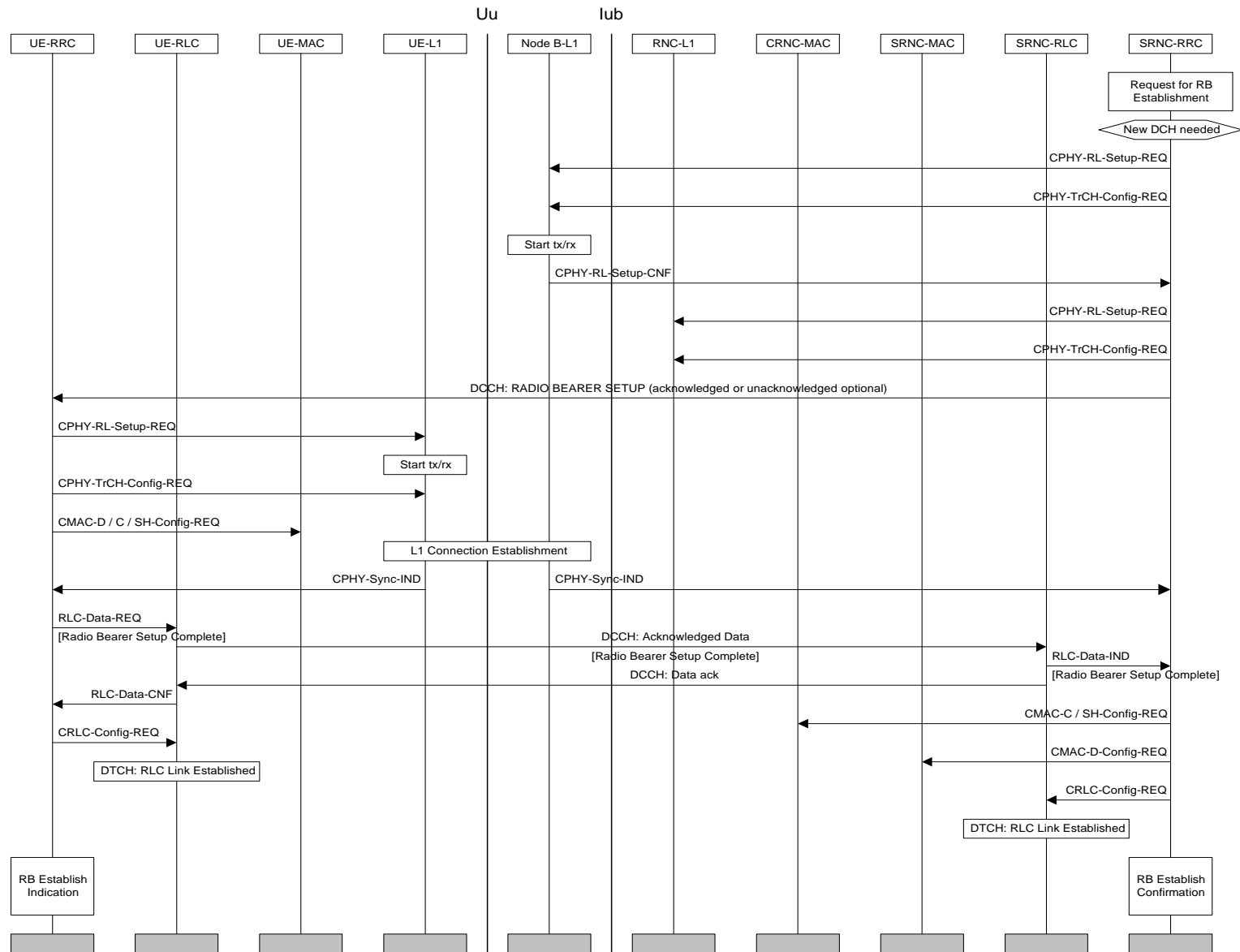

Figure 5: Radio Bearer Establishment with Dedicated Physical Channel Activation

6.2.1.1.2 Radio Bearer Establishment with Unsynchronised Dedicated Physical Channel Modification

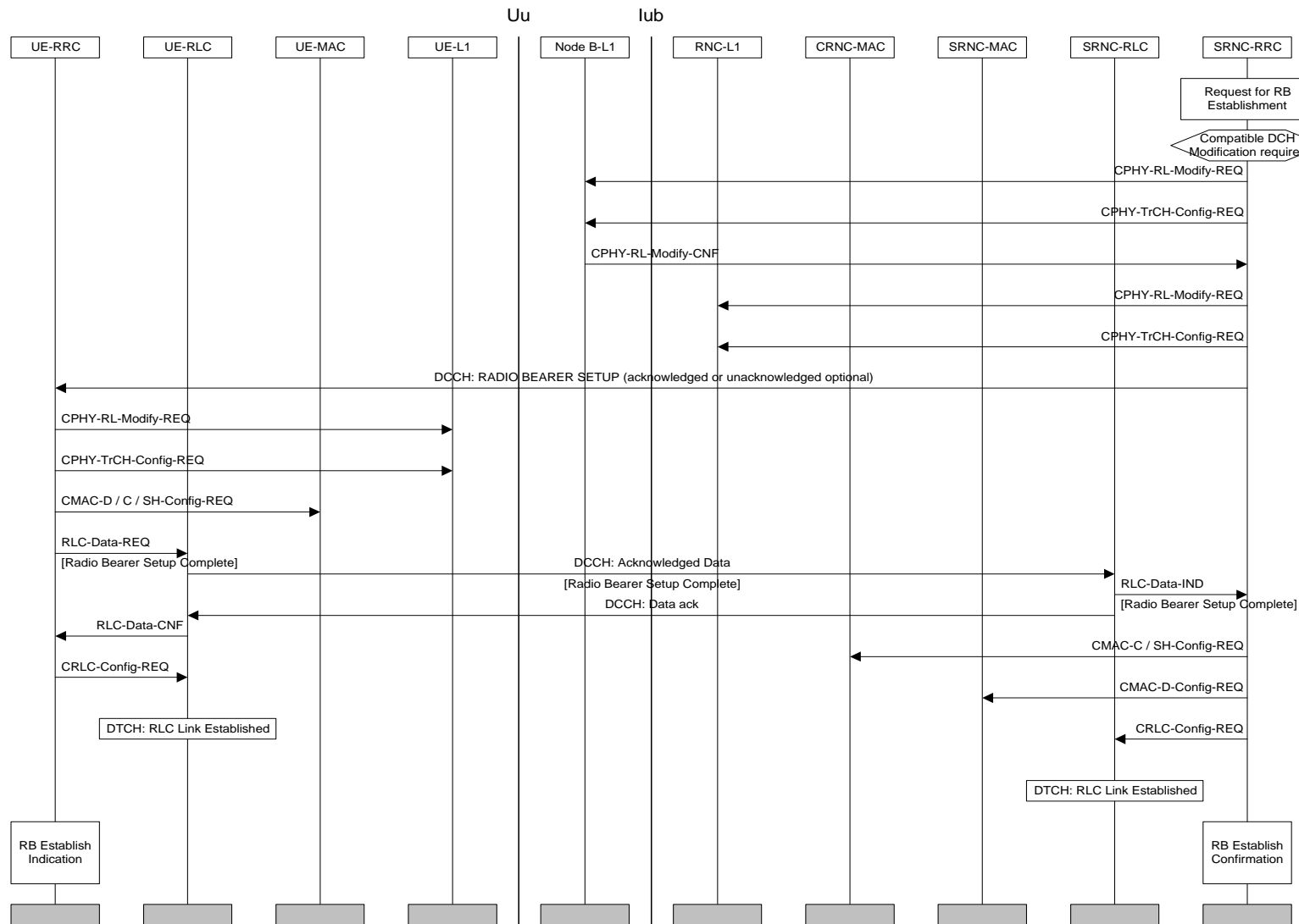

Figure 6: Radio Bearer Establishment with Unsynchronised Dedicated Physical Channel Modification

The establishment of a radio bearer, when unsynchronised physical channel modification is applicable, is shown in figure 6. If the old and new physical layer configurations are compatible in the sense that they can coexist in the peer entities, an unsynchronised procedure for radio bearer establishment can be applied. In this case no fixed activation time is required.

The modifications on the physical layer in the network are done in response to a CPHY\_modify request. Failure to comply is indicated in the confirmation primitive. In an error-free case the RADIO BEARER SETUP message on L3 is transmitted. Acknowledged or unacknowledged transmission is a network option. Configuration changes on the UE-side proceed after this message has been received. Reception of the RADIO BEARER SETUP COMPLETE message triggers configuration changes in MAC and RLC in the network.

#### 6.2.1.1.3 Radio Bearer Establishment with Synchronised Dedicated Physical Channel Modification

In this case the CPHY-RL-Modify request doesn't immediately cause any changes in the physical layer configuration, it only checks the availability of the requested configuration and makes a "reservation". After the confirmations have been received from all applicable Node Bs, the RRC chooses the appropriate "activation time" when the new configuration can be activated. This information is signalled to MAC, RLC and also the physical layer (CPHY\_Commit request primitive).

After the RADIO BEARER SETUP message (acknowledged transmission on L2 required) between peer L3 entities the setup proceeds on the UE-side. The new configuration is now available both on the UE and the network side, and at the scheduled activation time the new configuration is assumed by all applicable peer entities.

In case the old and the new physical channel configurations are incompatible with each other (due to different DPCCH format, TFCI patterns or similar differences), the modification on physical layer and L2 require exact synchronisation between the UE and the NW, as shown in figure 7.

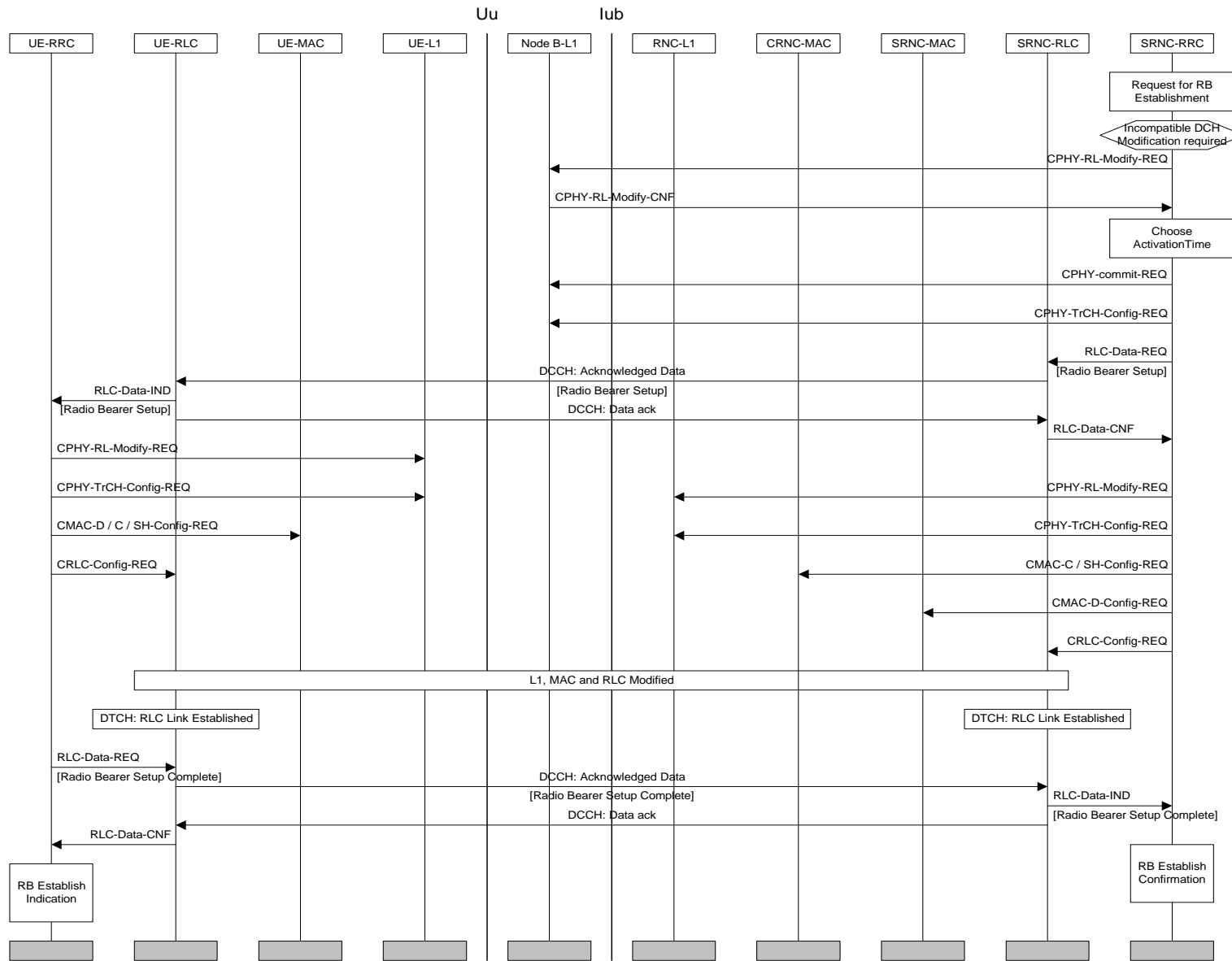

Figure 7: Radio Bearer Establishment with Synchronised Dedicated Physical Channel Modification

6.2.1.1.4 Radio Bearer Establishment without Dedicated Physical Channel

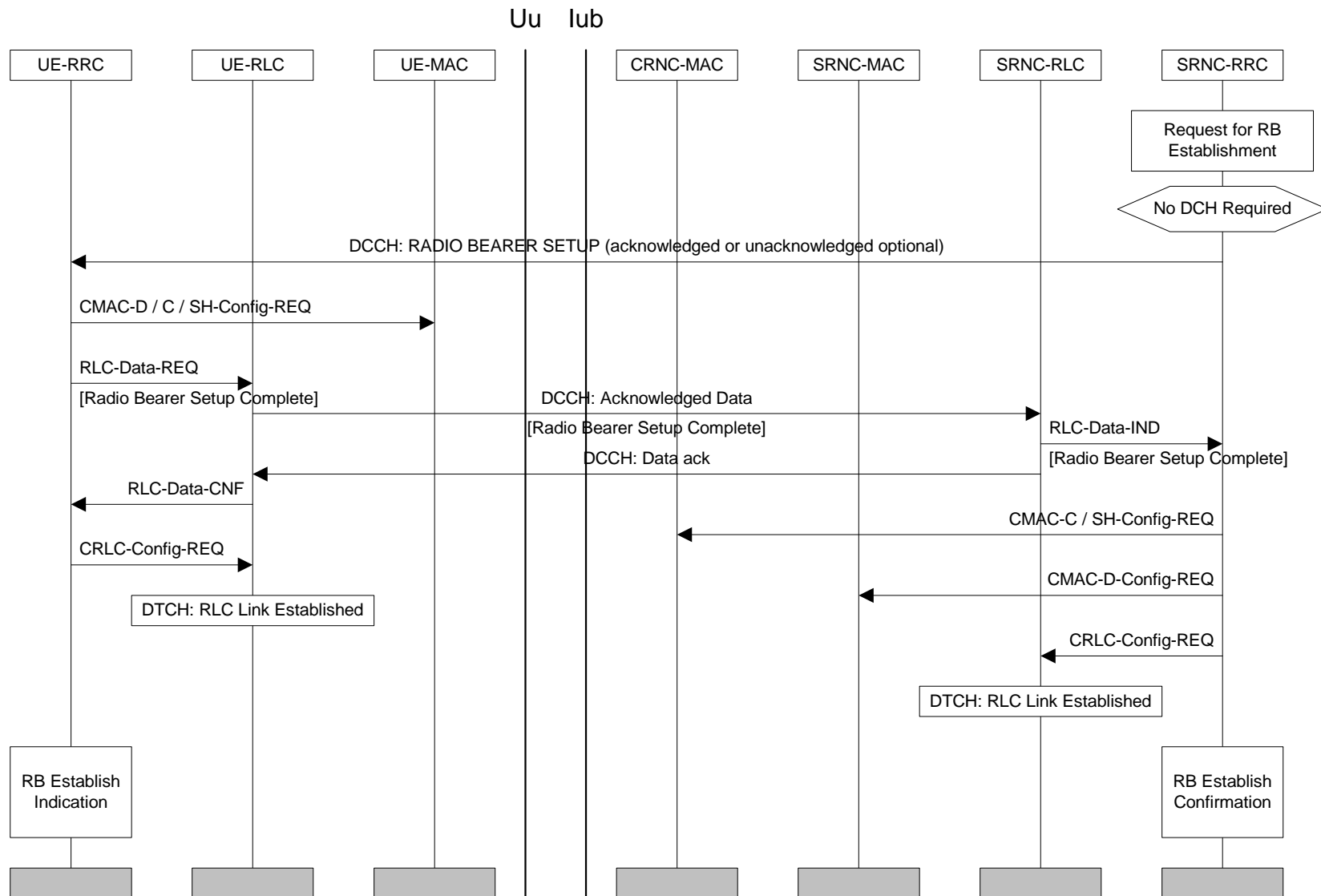

Figure 8: Radio Bearer Establishment without Dedicated Physical Channel

For some radio bearers dedicated radio resources are not permanently associated. Therefore the setting up of the physical resource is separate from the actual radio bearer setup, which involves only RLC and MAC.

MAC can be initially configured to operate either on existing dedicated transport and physical channels or on common channels.

#### 6.2.1.1.5 Radio Bearer Establishment with CPCH Channel Allocation

When the RNC determines the need to assign CPCH UL resources to a UE, the RNC sends an RB Setup message to the UE. Since the CPCH physical parameters are broadcast in the BCCH, the RB Setup message does not include a DPCH part. The Transport Channel information includes the CPCH set (CPCH Set ID#) to which the UE is to be assigned. MAC entities are configured: MAC-D and MAC-C/SH in the UE, MAC-C/SH in the CRNC, and MAC-D in the SRNC. Node B MAC controls access to the individual CPCH channels in the CPCH set. However, Node B MAC does not require configuration, since it was configured to control the CPCH set when the CPCH set was initially allocated to that cell. The Node B MAC can function independently of the number of UEs assigned to the CPCH set. Once the RB setup is complete, the UE may access the CPCH when the logical channel for this RB next presents data to send in the uplink direction.

The message flow diagram for RB establishment for CPCH is similar to the RB establishment without Dedicated Physical Channel (see subclause 6.2.1.1.4).



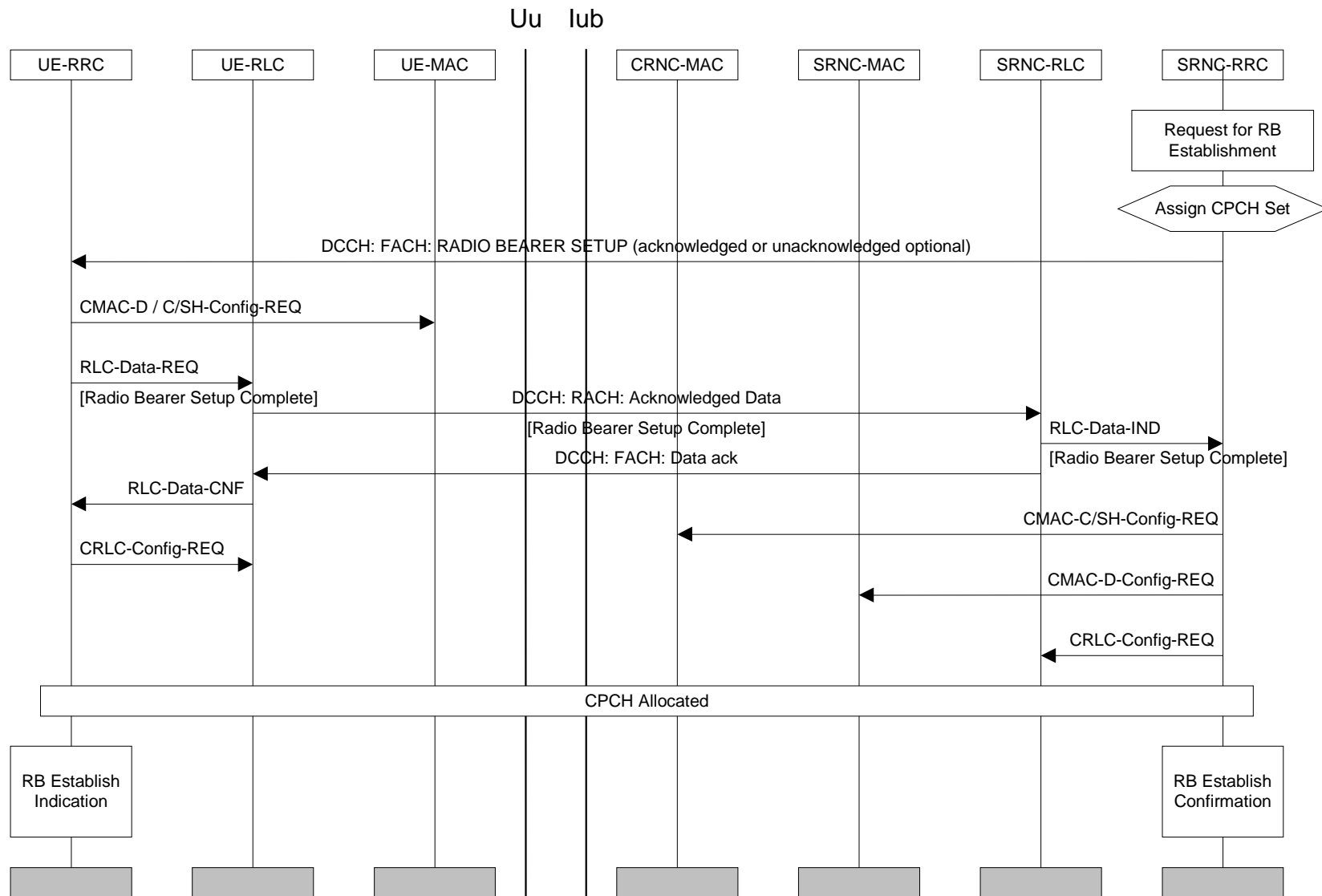

Figure 9: Radio Bearer Establishment with CPCH Channel Allocation

### 6.2.1.2 Radio Bearer Release

Similar as for Radio Bearer Establishment procedure, the Radio Bearer Release can include physical channel modification or physical channel deactivation depending on the differences between new and old QoS parameters. These can also be both synchronised and unsynchronised.

The Radio Bearer Release procedure is initiated when the release is requested from the RRC layer on the NW side. This request contains a bearer reference, and on retrieval a RB Release Confirm primitive is immediately returned to the Non-Access Stratum.

New L1 and L2 parameters may be chosen for remaining radio bearers if any. A RADIO BEARER RELEASE message is sent from the RRC layer in the network to its peer entity in the UE. This message includes possible new L1, MAC and RLC parameters for remaining radio bearers and identification of the radio bearer to be released (note). An RB Release Indication is sent by the UE-RRC.

**NOTE:** In synchronised case a specific activation time would be needed for the change of L1 and L2 configuration to avoid data loss.

The RRC on the UE side configures L1 and MAC, and releases the RLC entity associated to the released radio bearer. After receiving a RADIO BEARER RELEASE COMPLETE message from the UE, the NW-RRC does a similar reconfiguration also on the network side.

#### 6.2.1.2.1 Radio Bearer Release with Unsynchronised Dedicated Physical Channel Modification

The example in figure 10 shows the case where release can be executed as an unsynchronised physical channel modification, i.e. without physical channel deactivation.

After notifying upper layers of the release, a RADIO BEARER RELEASE message (acknowledged or unacknowledged transmission optional for the network) is sent to the UE triggering the reconfiguration in the UE. When this is finalised the UE sends a RADIO BEARER RELEASE COMPLETE message to the network, after which the reconfiguration is executed in the network.

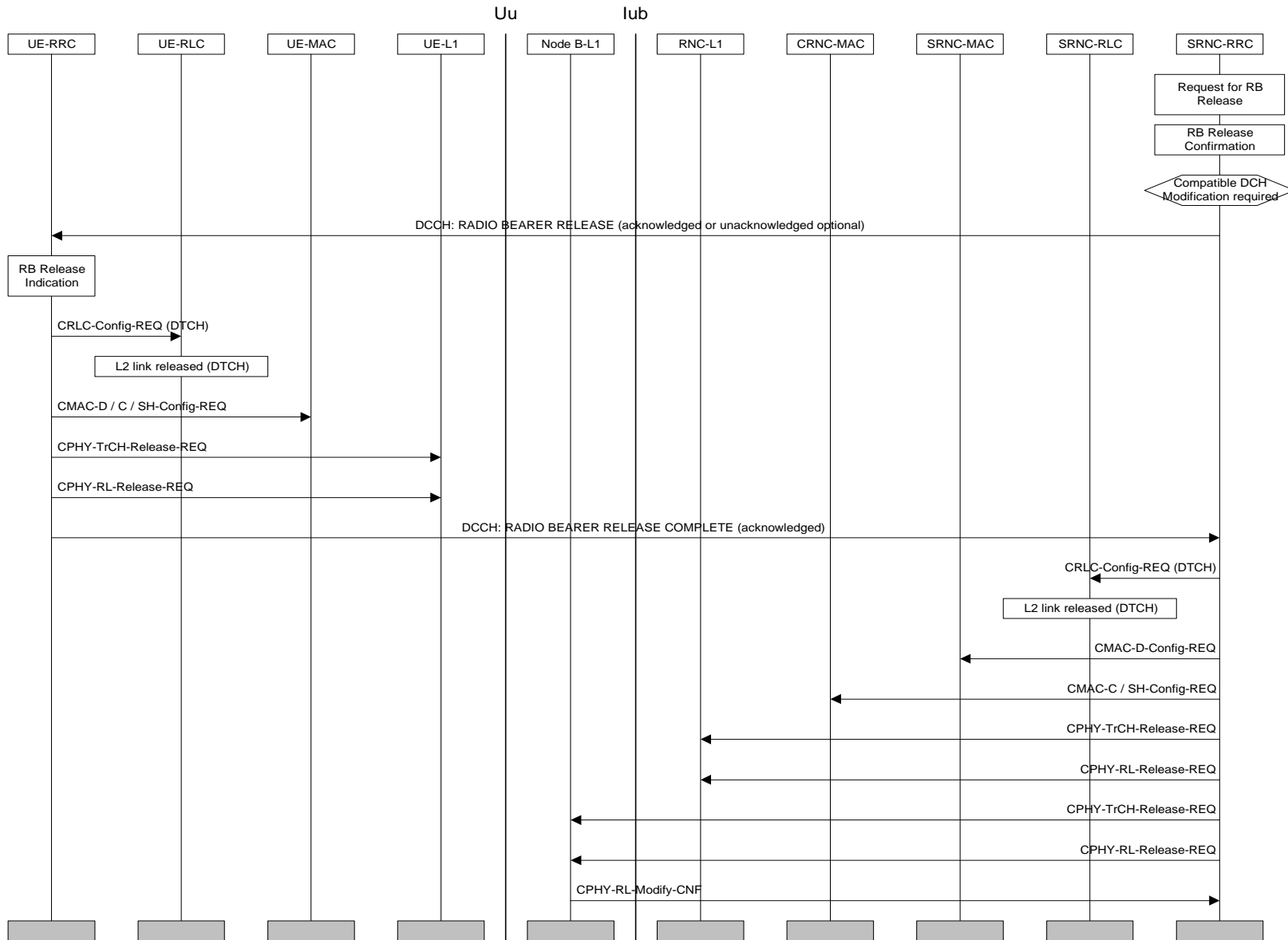

Figure 10: Radio Bearer Release with Unsynchronised Dedicated Physical Channel Modification

### 6.2.1.3 Radio Bearer Reconfiguration

For Radio Bearer Reconfiguration, both synchronised and unsynchronised procedures are applicable. The unsynchronised procedure is shown as an example.

#### 6.2.1.3.1 Unsynchronised Radio Bearer Reconfiguration

Because of the unsynchronised nature of the procedure in figure 11, there is no activation time and no separate commit request for the Node B physical layer is needed. The possibility for executing the requested modification will be reported in the confirmation primitives from the physical layer. If the modification involves the release of an old configuration, the release can be postponed to the end of the procedure. After the reception of a RADIO BEARER RECONFIGURATION from the RNC-RRC (acknowledged or unacknowledged transmission optional for the network), the UE executes the modifications on L1 and L2.

Upon reception of a RADIO BEARER RECONFIGURATION COMPLETE message from the UE-RRC, the NW-RRC executes the modifications on L1 and L2. Finally the old configuration, if any, is released from Node B-L1.

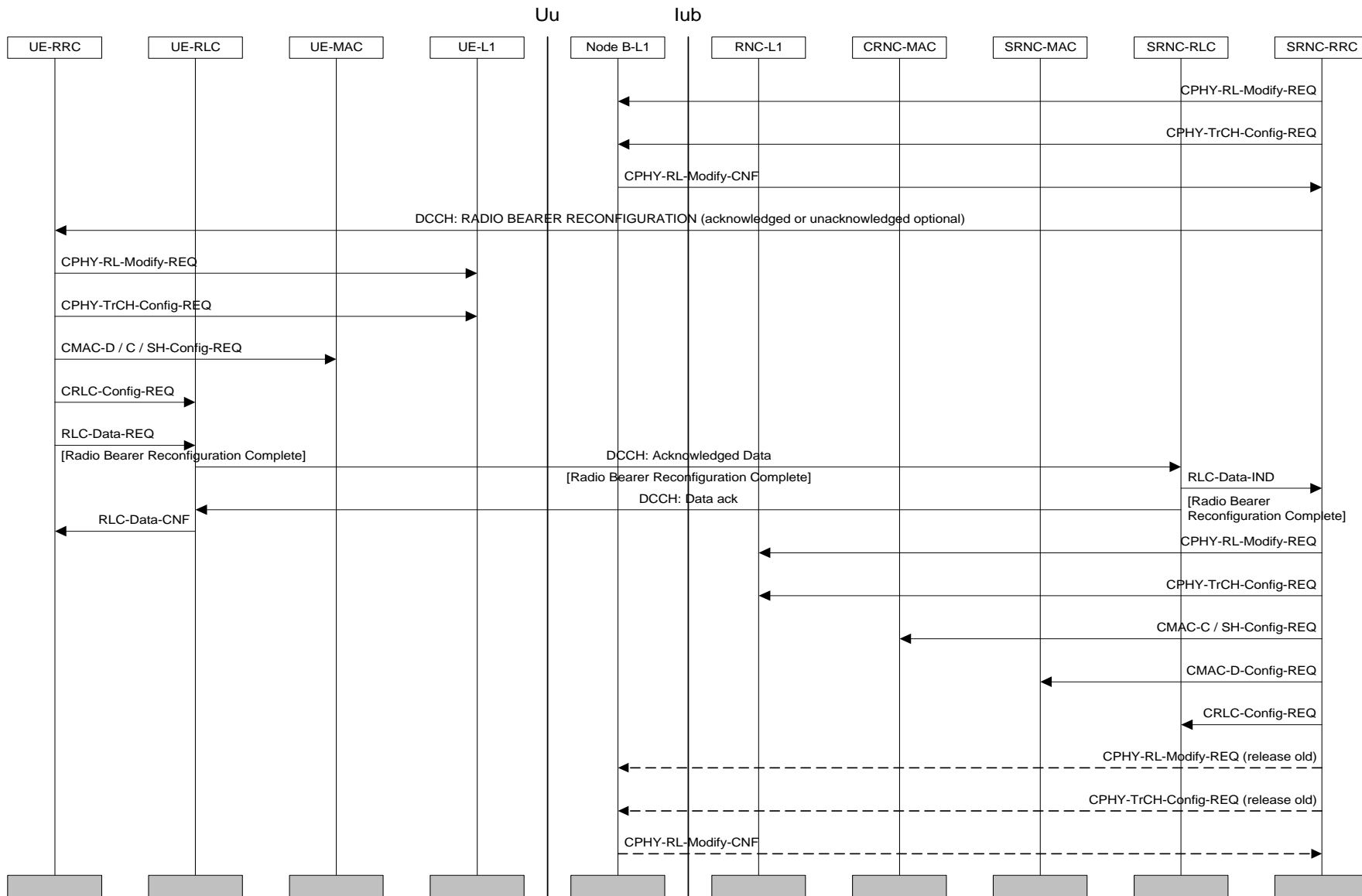

Figure 11: Unsynchronised Radio Bearer Reconfiguration

## 6.2.2 Transport Channel Reconfiguration

For transport channel reconfiguration, both synchronised and unsynchronised procedures are applicable.

### 6.2.2.1 Unsynchronised Transport Format Set Reconfiguration

Figure 12 illustrates an example of a procedure for a change of the Transport Format Set for one transport channel. This is done with the Transport Channel Reconfiguration procedure.

A change of the transport format set for a transport channel is triggered in the RRC layer in the network. A TRANSPORT CHANNEL RECONFIGURATION message is sent from the RRC layer in the network to its peer entity (acknowledged or unacknowledged transmission is a network option). This message contains the new transport format set and a new transport format combination Set, i.e. new parameters for L1 and MAC (note). When this message is received in the UE a reconfiguration of L1 and MAC is done. A similar reconfiguration is also done on the network side after the reception of a TRANSPORT CHANNEL RECONFIGURATION COMPLETE message.

**NOTE:** In a synchronised procedure a specific activation time is needed for the change of L1 and L2 configuration to avoid data loss.

During the reconfiguration of the transport format set for a transport channel, radio traffic on this channel could be halted temporarily since the UE and the network are not necessarily aligned in their configuration. This traffic can resume after the COMPLETE-message.

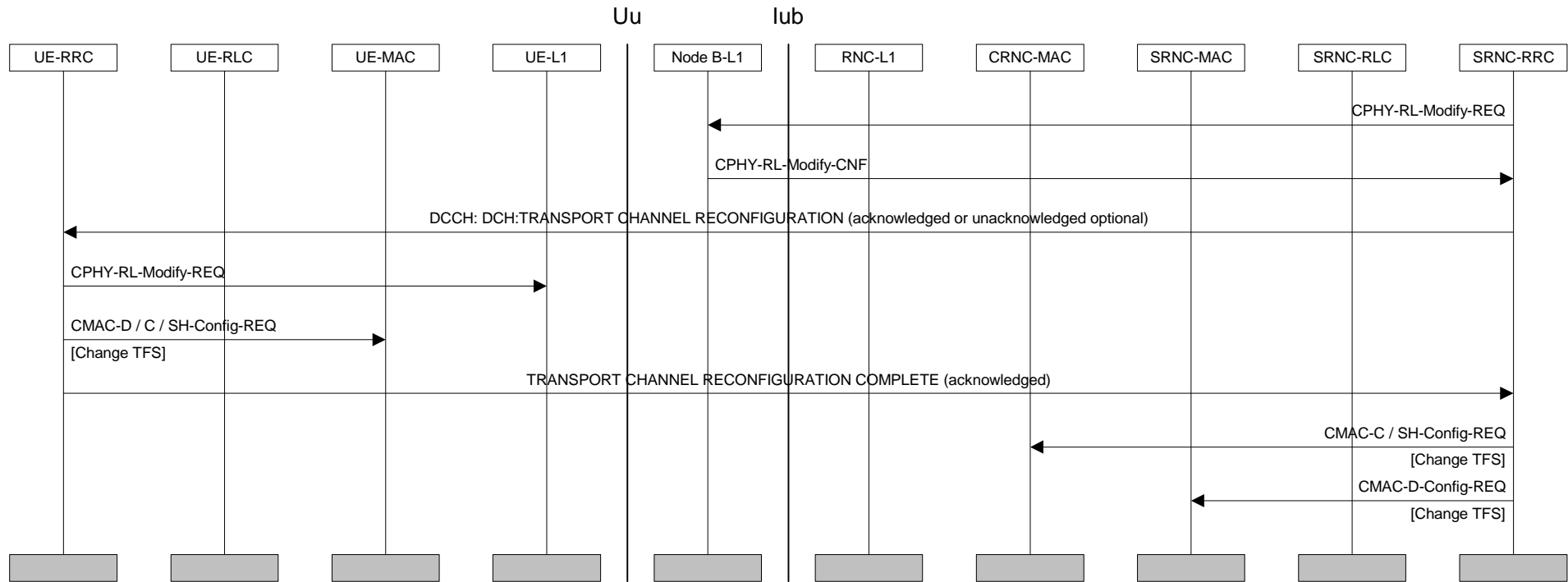

Figure 12: Unsynchronised Transport Format Set Reconfiguration

## 6.2.3 Physical Channel Reconfiguration

For physical channel reconfiguration, both synchronised and unsynchronised procedures are applicable.

### 6.2.3.1 UE-Originated DCH Activation

Figure 13 illustrates an example of a procedure for a switch from common channels (CELL\_FACH) to dedicated (CELL\_DCH) channels.

In the UE the traffic volume measurement function decides to send a MEASUREMENT REPORT message to the network. In the network this measurement report could trigger numerous different actions. For example the network could do a change of transport format set, channel type switching or, if the system traffic is high, no action at all. In this case a switch from CELL\_FACH to CELL\_DCH is initiated.

Whether the report should be sent with acknowledged or unacknowledged data transfer is configured by the network.

First, the modifications on L1 are requested and confirmed on the network side with CPHY-RL-Setup primitives.

The RRC layer on the network side sends a PHYSICAL CHANNEL RECONFIGURATION message to its peer entity in the UE (acknowledged or unacknowledged transmission optional to the network). This message is sent on DCCH mapped to FACH. The message includes information about the new physical channel, such as codes and the period of time for which the DCH is activated (note).

**NOTE:** This message does not include new transport formats. If a change of these is required due to the change of transport channel, this is done with the separate procedure Transport Channel Reconfiguration. This procedure only handles the change of transport channel.

When the UE has detected synchronisation on the new dedicated channel L2 is configured on the UE side and a PHYSICAL CHANNEL RECONFIGURATION COMPLETE message can be sent on DCCH mapped on DCH to RRC in the network. Triggered by either the NW CPHY\_sync\_ind or the L3 complete message, the RNC-L1 and L2 configuration changes are executed in the NW.



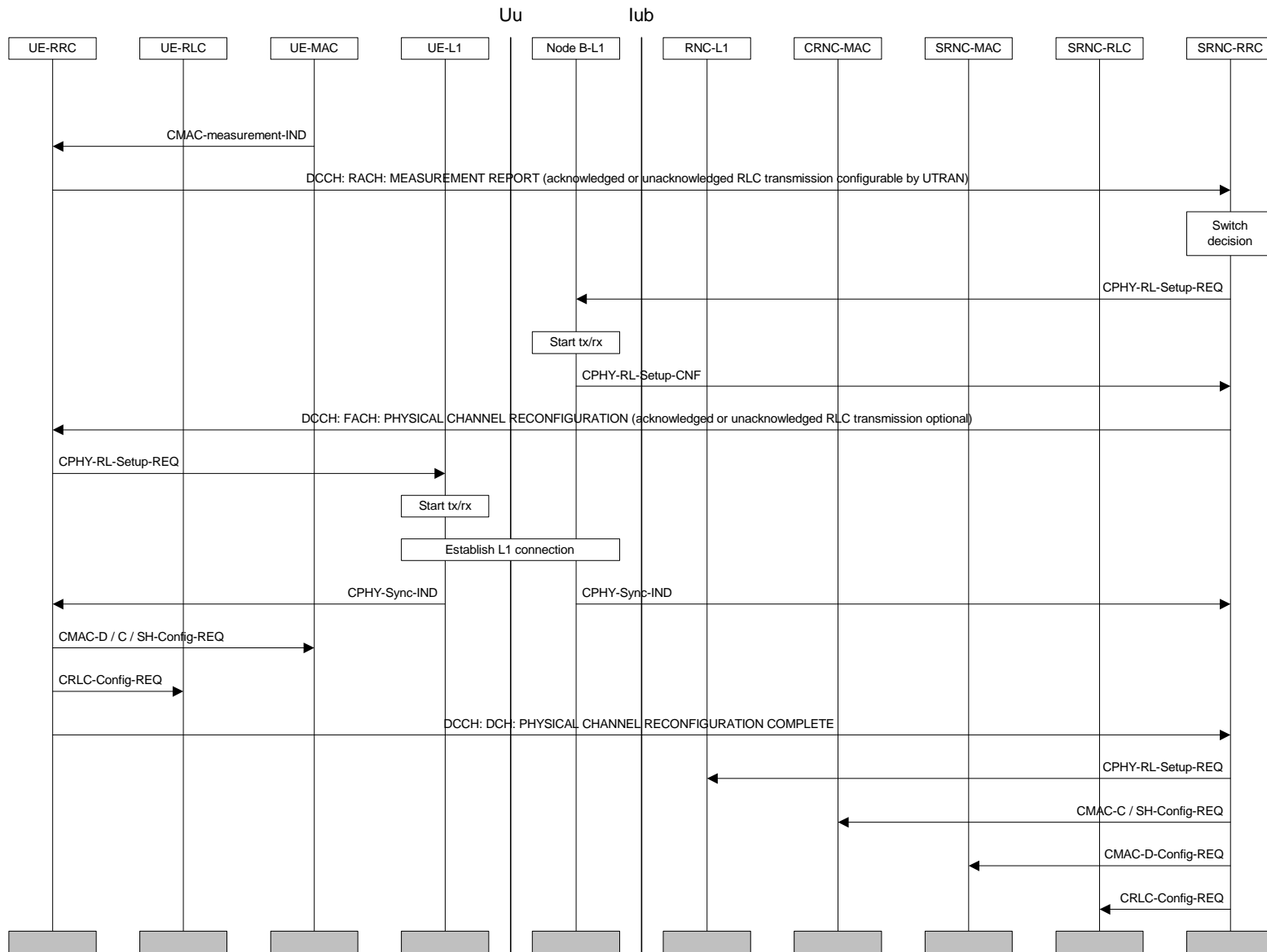

Figure 13: UE-Originated DCH Activation

6.2.3.2 UE-terminated synchronised DCH Modify

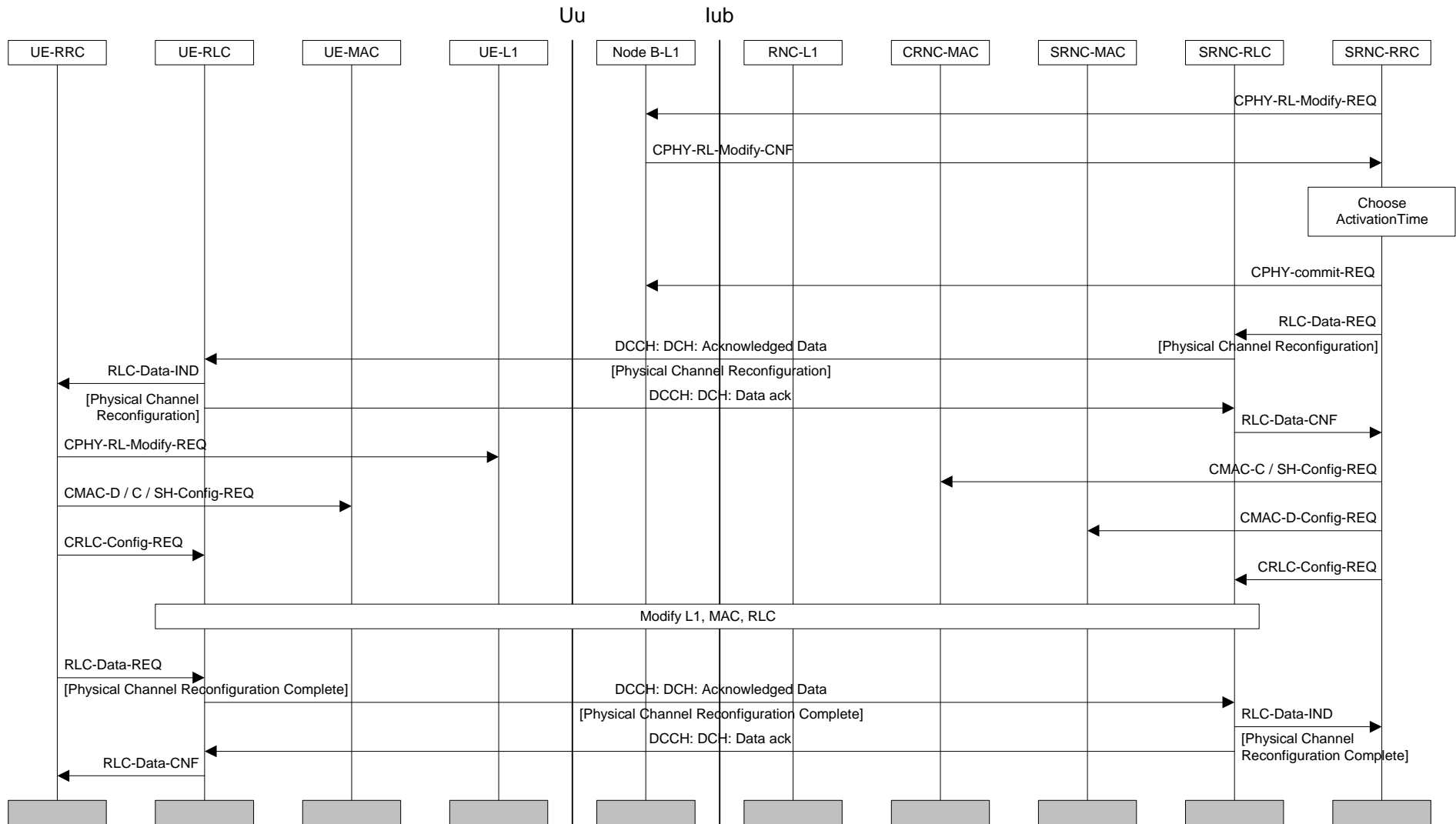

Figure 14: UE-terminated synchronised DCH Modify

Figure 14 illustrates an example of a synchronised procedure for DCH modification. Triggering of this procedure could for example be accomplished by an inactivity timer. The procedure can e.g. release all transport formats of a radio bearer without releasing the DCH, due to another bearer using it. The synchronised procedure is applied in the case when the old and new configurations are not compatible e.g. change of channelisation code.

After the CPHY-RL-Modify requests have been confirmed, an activation time is chosen by NW-RRC. After deciding upon the activation time, the NW-RRC sends a PHYSICAL CHANNEL RECONFIGURATION message as acknowledged data transfer to the UE. In both uplink and downlink this message is sent on DCCH mapped on DCH.

After reception the UE reconfigures L1 and L2 to DCH resources. If a complete message is used it would be sent on DCCH mapped on DCH. In the unsynchronised case this message could trigger a modification of L1 and L2 resources in the network associated with the dedicated channel.

### 6.2.3.3 UE-terminated DCH Release

Figure 15 illustrates an example of a procedure for a switch from dedicated (CELL\_DCH) to common (CELL\_FACH) channels. All DCHs used by a UE are released and all dedicated logical channels are transferred to CELL\_FACH instead. Triggering of this procedure could for example be an inactivity timer.

A switch from DCH to common channels is decided and a PHYSICAL CHANNEL RECONFIGURATION message is sent (acknowledged or unacknowledged data transfer is a network option) from the RRC layer in the network to the UE. This message is sent on DCCH mapped on DCH.

NOTE 1: This message does not include new transport formats. If a change of these is required due to the change of transport channel, this is done with the separate procedure Transport Channel Reconfiguration. This procedure only handles the change of transport channel.

If the loss of L1 sync is used to detect in the NW that the UE has released the DCHs, as is one possibility in the figure, then there may be a need to configure the Node B-L1 to a short timeout for detecting loss of sync. This is presented by the CPHY-Out-of-Sync-Config primitives in the figure.

After reception the UE reconfigures L1 and L2 to release old DCH resources. The PHYSICAL CHANNEL RECONFIGURATION COMPLETE message to the network is here sent on DCCH mapped on RACH (message acknowledgement on FACH). This message triggers a normal release of L1 and L2 resources in the network associated with the dedicated channel.

NOTE 2: When a Switch to CELL\_FACH is done it is important to free the old code as fast as possible so that it can be reused. Therefore instead of waiting for the Physical Channel Reconfiguration Complete message the network can reconfigure L1 and L2 when the acknowledged data confirmation arrives and the network is sure that the UE has received the Physical Channel Reconfiguration message. To be even more certain that the UE has released the old DCH resources the network can wait until after the Out of sync Indication from L1.

These steps including a timer starting when the Physical Channel Reconfiguration is sent, gives the network four different indications that the released DCH is really released, and that resources can be reused.

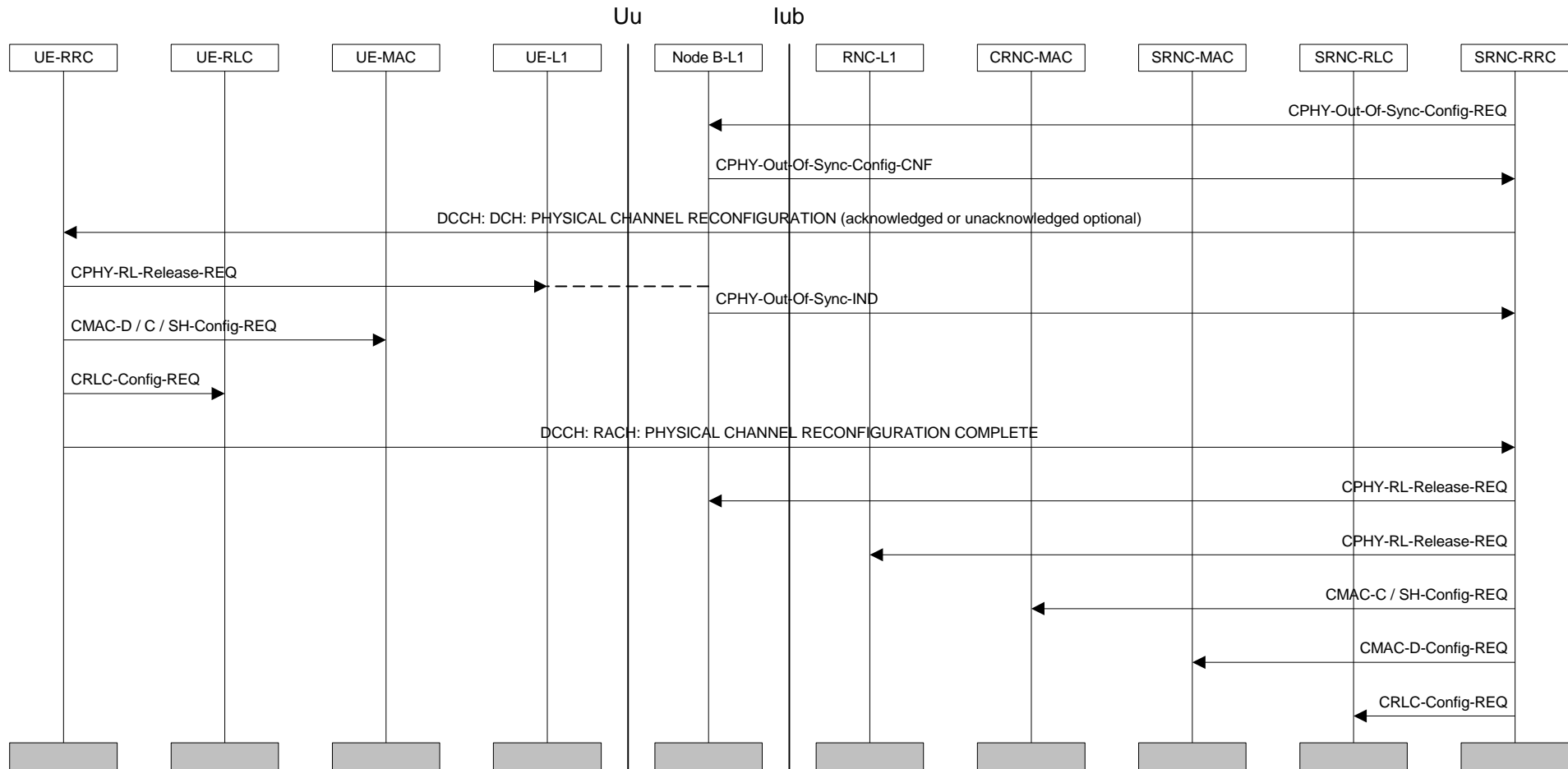
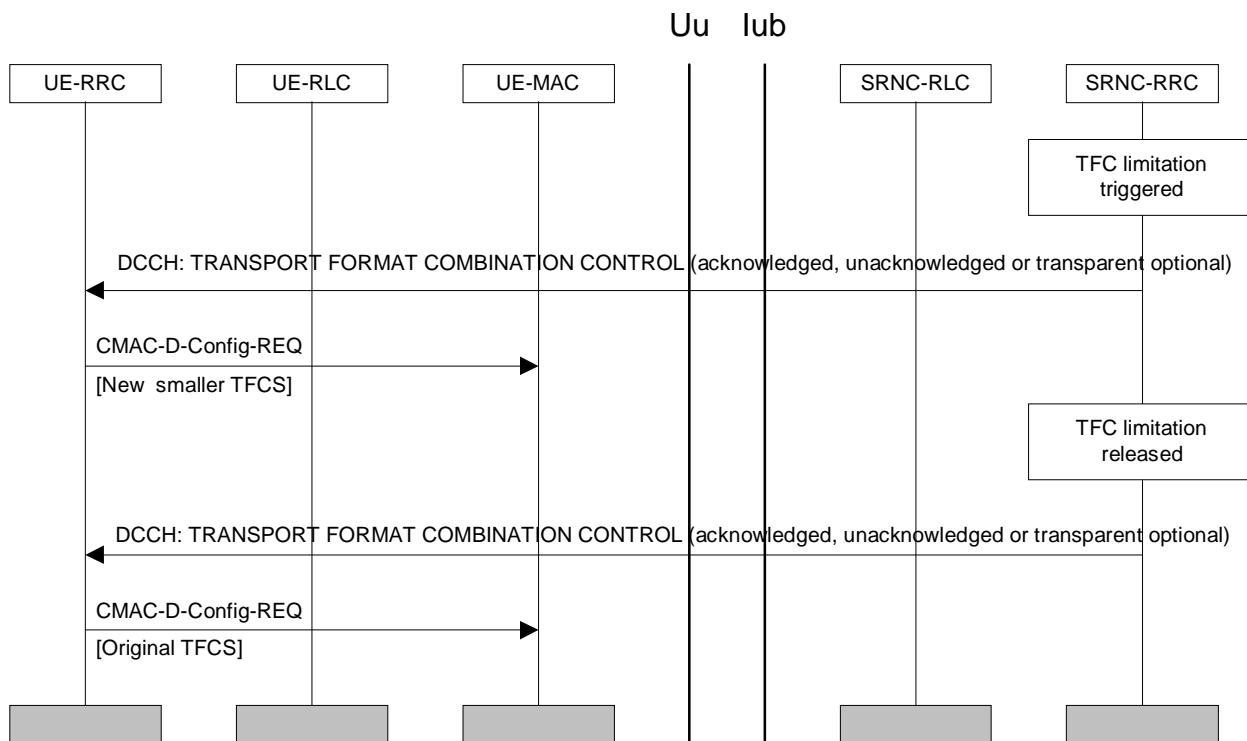

Figure 15: UE-terminated DCH Release

## 6.2.4 Transport Format Combination Control

### 6.2.4.1 Transport Format Combination Limitation



**Figure 16: Transport Format Combination Limitation**

Figure 16 illustrates an example of a Transport Format Combination Control procedure. A congestion situation occurs and allowed transport format combinations are restricted temporarily. When the congestion is resolved the restriction is removed.

This procedure is initiated with a Transport Format Combination Control message from the network to the UE (acknowledged, unacknowledged or transparent transmission optional to the NW). This message contains a subset of the ordinary Transport Format Combination Set. The UE then continues with a reconfiguration of MAC. MAC sees the TFC subset as a completely new set.

Further, after a while when the congestion is resolved a new Transport Format Combination Control message is sent to the UE from the RRC layer in the network. This message contains a subset that is the entire original set. Again, the UE reconfigures the MAC.

### 6.2.5 Dynamic Resource Allocation Control of Uplink DCHs

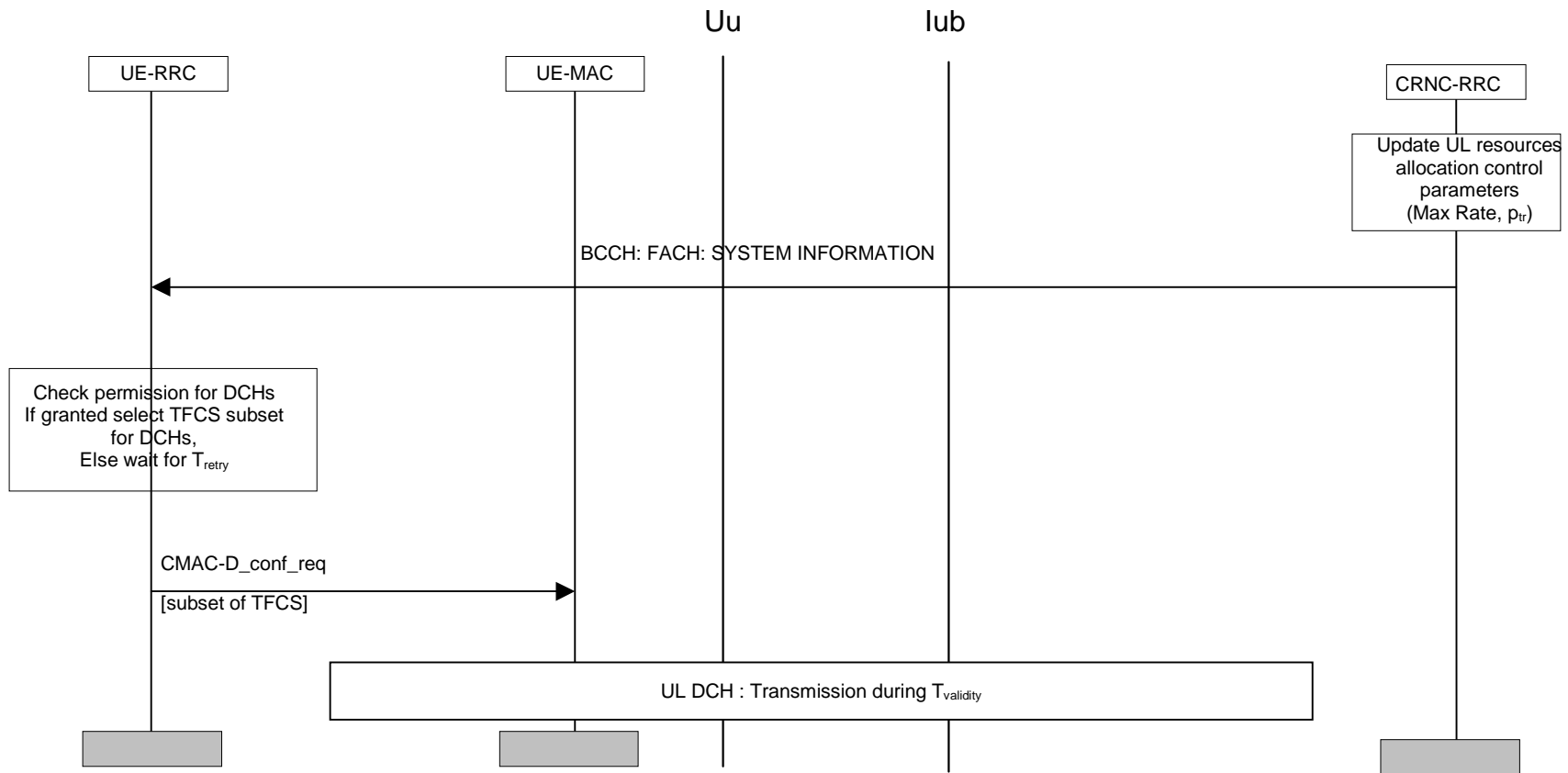

Figure 17: Dynamic Resource Allocation Control of Uplink DCHs

Figure 17 illustrates an example of a Dynamic Resource Allocation Control (DRAC) procedure of uplink DCHs. The CRNC regularly broadcasts the following parameters:

- transmission probability  $p_{tr}$ , which indicates the probability for a UE to be allowed to transmit on its DCHs, which are under control by this procedure, during the next period  $T_{\text{validity}}$ ;
- maximum total bit rate allowed to be used by the UE on its DCH which are under controlled by this procedure, during the next allowed period  $T_{\text{validity}}$ .

Besides these parameters, the RNC has allocated the following parameters to the UE:

- transmission time validity,  $T_{\text{validity}}$ , which indicates the time duration for which an access for transmission is granted;
- reaccess time  $T_{\text{retry}}$ , which indicates the time duration before retrying to access the resources, in case transmission has not been granted.

This procedure is initiated with a SYSTEM INFORMATION message containing the above DRAC parameters regularly broadcast by the CRNC on the FACH. It applies to all UEs capable of simultaneous reception of Secondary CCPCH and DPCH and having DCHs that can be controlled dynamically. The UEs have to listen to this message prior to transmission on these DCHs. The UE RRC checks whether transmission is allowed, and then reconfigures MAC with a new subset of TFCS derived from the maximum total bit rate parameter. This TFCS subset shall control only the DCHs that are under control by this procedure.

In case of soft handover on the uplink DCH, The UE is requested either to listen to broadcast information from its primary cell (the one with the lowest pathloss), or from all cells involved in its Active Set, depending on its class. In the latter case, the UE is expected to react according to the stricter control information.

### 6.2.6 Variable Rate Transmission of Uplink DCHs

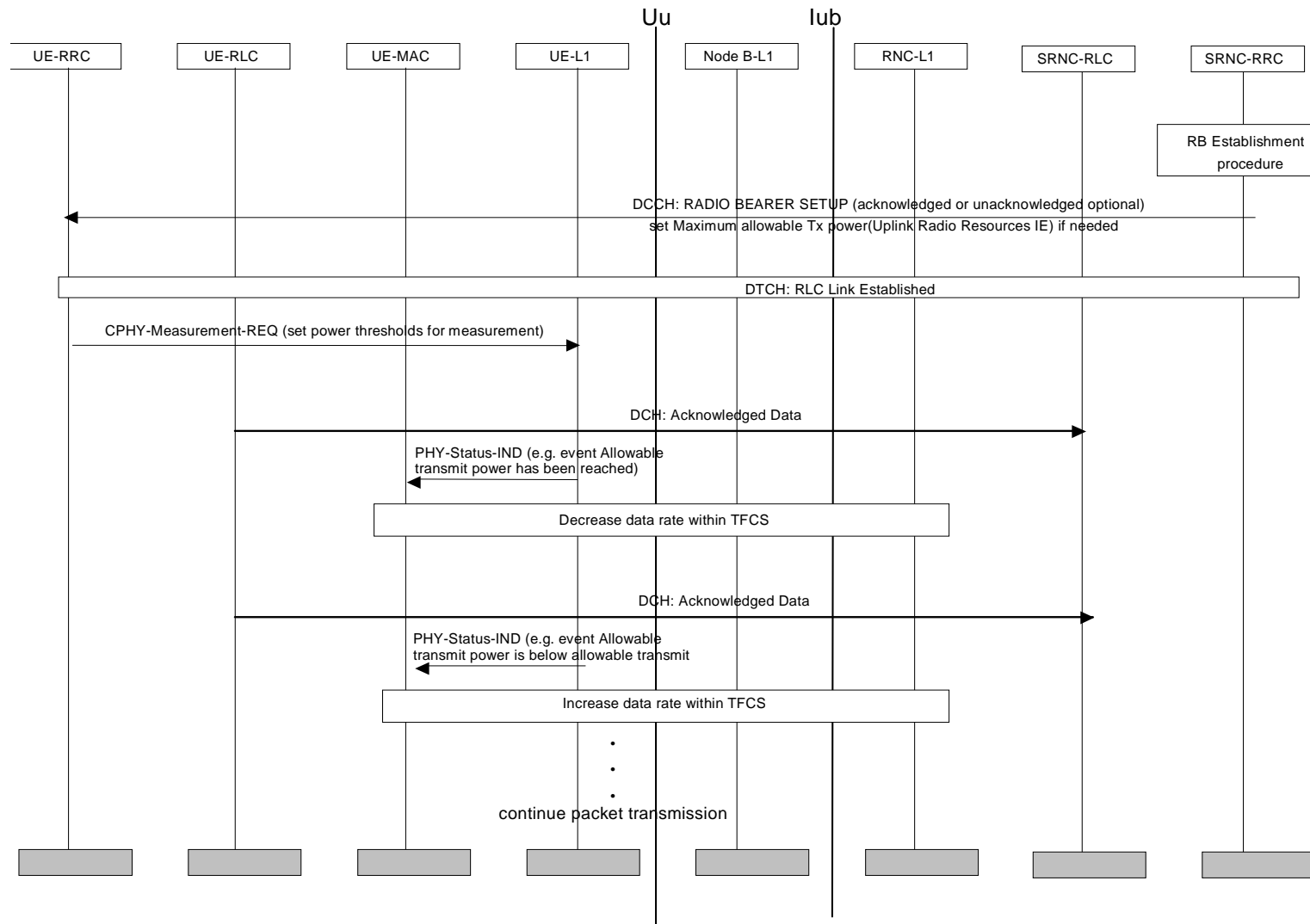

Figure 18: Variable Rate Transmission of Uplink DCHs



Figure 18 illustrates an example of the Variable Rate Transmission procedure of uplink DCHs. With this procedure the QoS of service with variable rate can be maintained and unnecessary interference can be avoided by a temporary reduction of the data rate within the TFCS.

When a connection for a variable rate service is established the RRC assigns the TFCS to MAC. At the radio bearer set-up procedure the maximum allowable Tx power can also be set for each user if it shall be different from the UE capability class.

With the CPHY-Measurement-REQ the power thresholds will be set to the UE. If during a transmission the allowable transmit power is above the set threshold the event will be signalled to the MAC that will decrease the data rate within the set TFCS at the next transmission time interval. In the UE, the PDUs that can not be transmitted in a TTI (i.e. MAC has indicated that some of the available PDUs can not be transmitted) shall be buffered according to the discard configuration set by RRC.

When channel conditions improve and the averaged transmission power falls below the allowable transmission power the physical layer indicates this event to the MAC. If there is enough data to be sent, the MAC in response increases the data rate by increasing the number of transport blocks delivered to L1 and the physical layer increases the total transmission power to the UE by the predefined amount. This allows the data that was buffered during bad channel conditions to be delivered to the UTRAN.

## 6.3 Data transmission

### 6.3.1 Acknowledged-mode data transmission on DSCH using hard split of TFCI-word

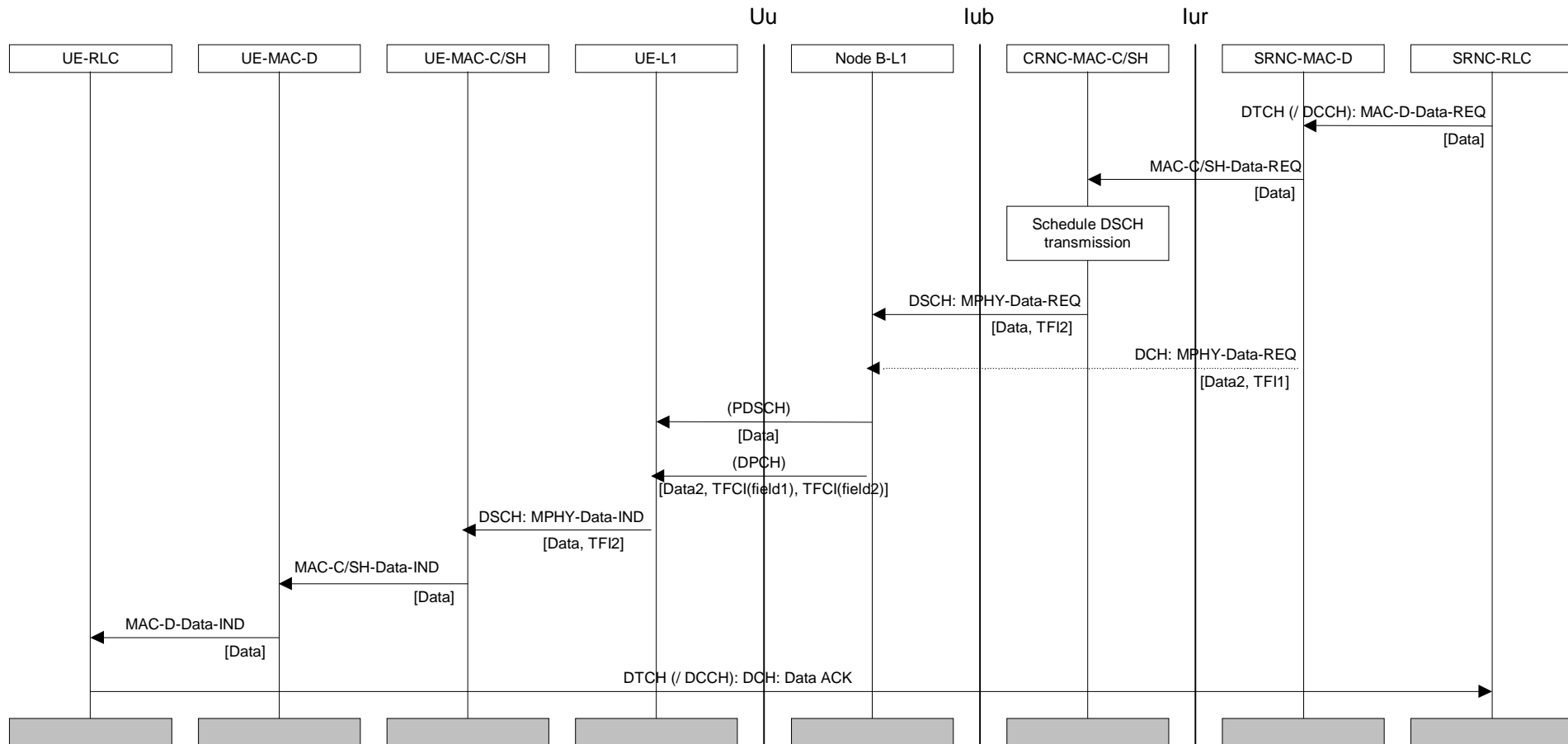

Figure 19: Example of acknowledged-mode data transmission on DSCH

Figure 19 shows an example of acknowledged-mode data transmission on DSCH associated with a DCH. First RLC in SRNC requests data transmission locally from MAC-d. MAC-d routes the request either locally or across the Iur to MAC-c/sh in CRNC, where DSCH transmission scheduling takes place. MAC-c/sh determines the TFI for the data ("TFI2") and requests data transmission across Iub from the physical layer in Node B. At the same time data for an associated dedicated channel may arrive in Node B.

All TFIs for DCHs (e.g. 'TFI1') are translated into TFCI(field1). TFCI(field2) carries corresponding information for the DSCH. TFCI(field1) and TFCI(field2) are combined in the physical layer using 'hard' split of the TFCI-word and transmitted on the DPCCH (dedicated physical control channel) of the associated DPCH (dedicated physical channel). The DSCH data is transmitted separately on the PDSCH (physical downlink shared channel). TFCI(field2) is used to decode DSCH data, which is then forwarded through MAC-c/sh and MAC-d to the receiving RLC. An acknowledgement is eventually sent by the UE-RLC mapped to a DCH, unless the DCH is released before the acknowledgement.

### 6.3.2 Acknowledged-mode data transmission on DSCH using logical split of TFCI-word

NOTE: For this release of the specification this example is only valid in the case where SRNC = CRNC.

Figure 20 shows an example of acknowledged-mode data transmission on DSCH. First RLC in SRNC requests data transmission from MAC-d. MAC-d passes the data on to MAC-c/sh, which schedules the DSCH transmission and determines the TFI2 for the data. TFCI(field2) and CFN (connection frame number) for transmission are given back to MAC-d.

MAC-c/sh transmits the DSCH data while MAC-d transmits all TFIs synchronised with the transmission of any DCH data and TFIs intended for transmission in the same frame. TFCI(field2) for the DSCH and TFCI(field1) for the DCH are combined into the same TFCI on the physical layer using 'logical' split of TFCI-word and transmitted on the DPCCH (dedicated physical control channel) of the associated DPCH (dedicated physical channel). The DSCH data is transmitted separately on the PDSCH (physical downlink shared channel). TFCI(field2) is used to decode DSCH data, which is then forwarded through MAC-c/sh and MAC-d to the receiving RLC. An acknowledgement is eventually sent by the UE-RLC mapped to a DCH, unless the DCH is released before the acknowledgement.

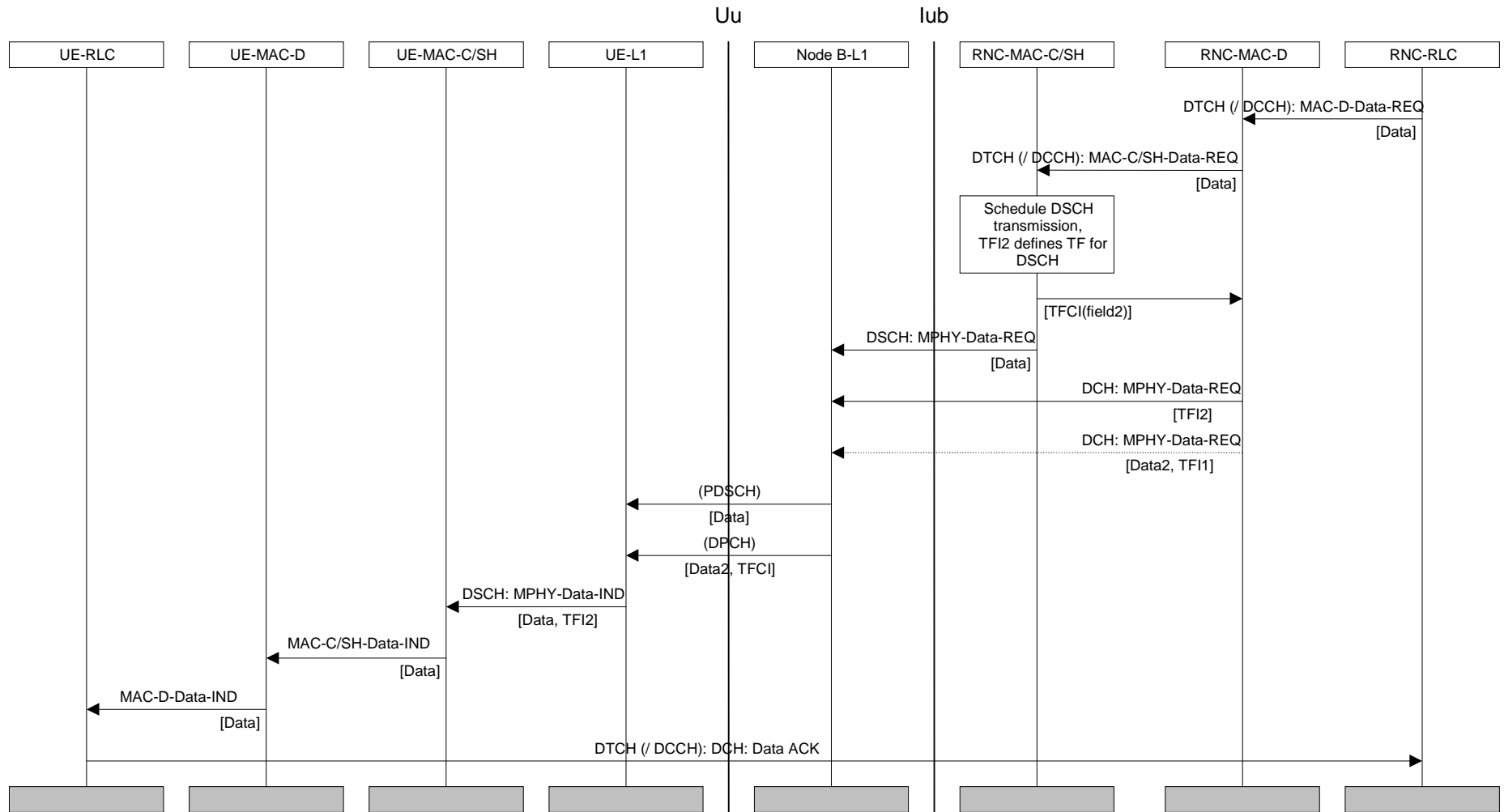

Figure 20: Example of acknowledged-mode data transmission on DSCH

### 6.3.3 Data transmission on CPCH

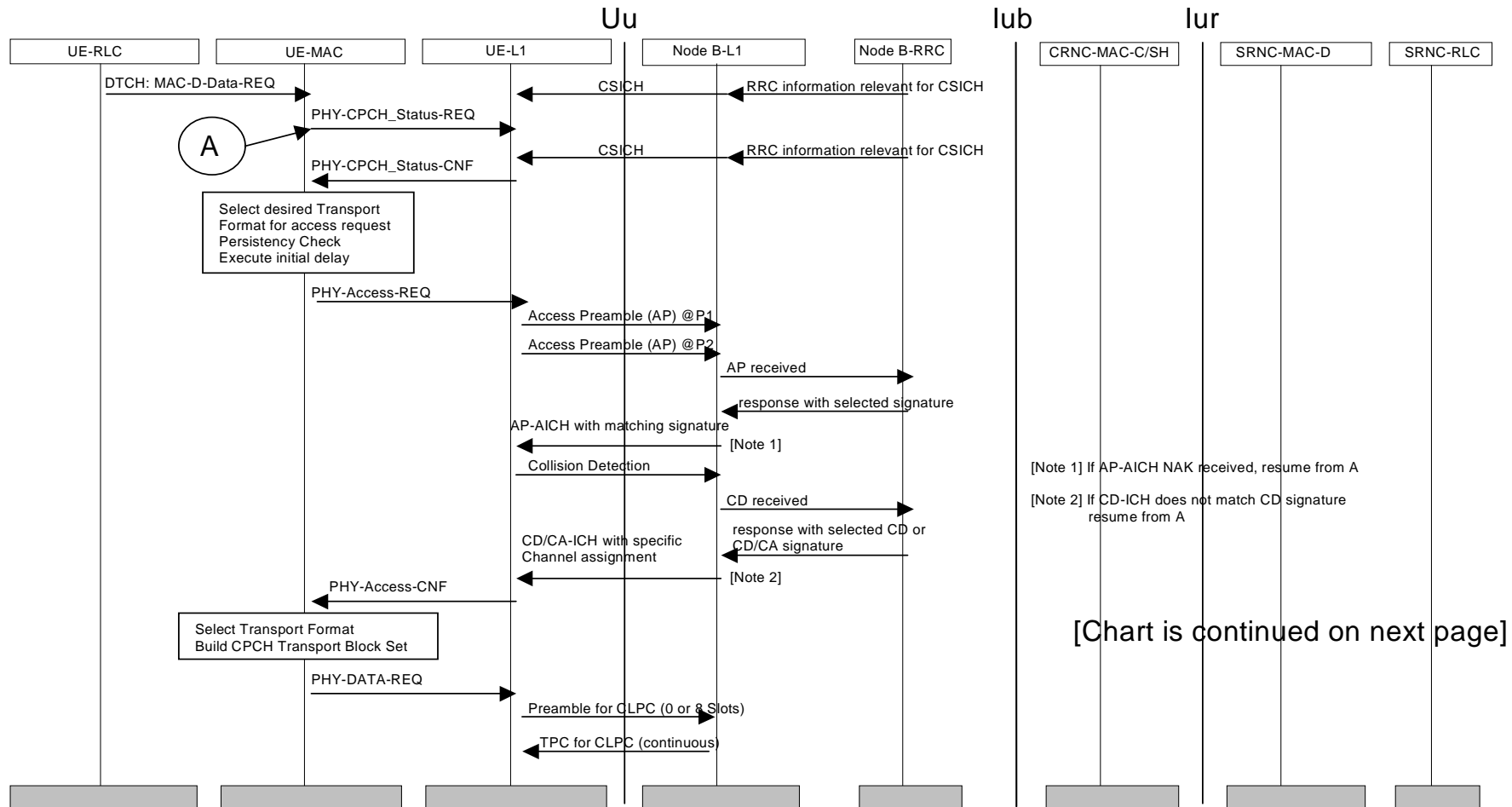

Figure 21: Example of data transmission on CPCH (page 1 of 2)

[Chart is continued on next page]

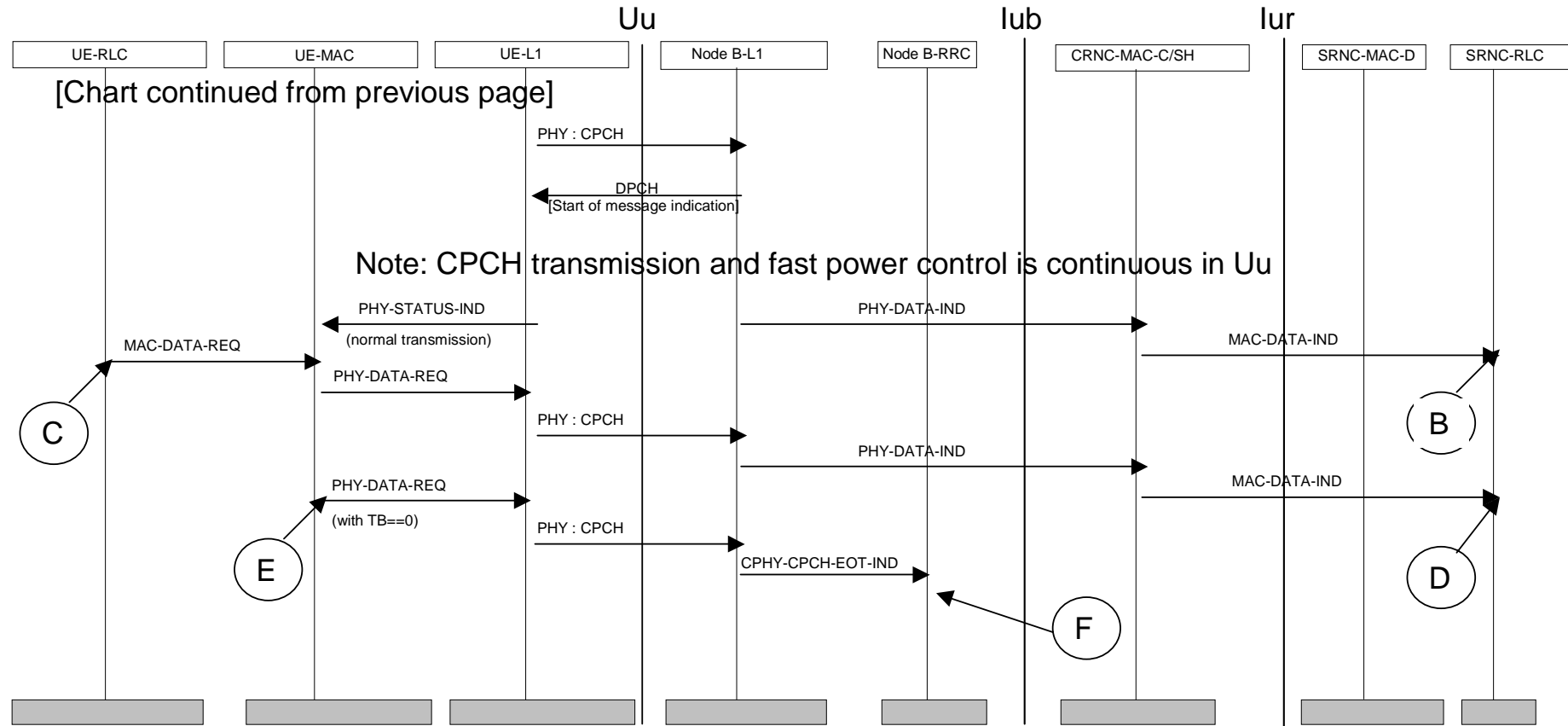

Figure 22: Example of data transmission on CPCH (page 2 of 2)

Figure 21 shows an example of data transmission on CPCH. It is assumed that RLC acknowledged or unacknowledged transmission modes are applied for all logical channels mapped to CPCH.

CPCH transmission is applied in the Connected mode RRC state CELL\_FACH with CPCH resources assigned to the UE. The UE needs to be configured for CPCH transmission via a respective RRC procedure (e.g. with RADIO BEARER SETUP or TRANSPORT CHANNEL RECONFIGURATION messages).

Upon reception of a data transmission request from RLC, MAC first requests CPCH channel status information from the physical layer. It is assumed that CPCH channel status information is broadcast on the CSICH physical channel using the same DL channelisation code as AP-AICH. The status information provides an indication of the maximum available data rate on PCPCH resources when Channel Assignment (CA) is active. When Channel Assignment is not active, then UE Channel Selection is employed. In this case the status information provides indication of the availability of each defined PCPCH. In either case, the channel status information is converted into a set of transport formats that are allowed to be employed at that given time. Whether channel assignment is active or not shall be indicated via System Information message. Current assumption is that the conversion of CPCH status information into Transport Formats is a L1 internal function.

Based on the permitted transport formats and the data available for transmission, MAC selects a desired transport format for CPCH access request. The MAC CPCH transmission control procedure is started by performing the persistency check based on persistence value received from RRC. When persistence check is passed, the physical CPCH transmission procedure is initiated by sending of a PHY-Access-REQ primitive. The PCPCH transmission procedure starts with an access preamble power ramping cycle. MAC then waits for status indication from L1 via PHY-Status-IND primitive. When acquisition of the access preamble is indicated on AP-AICH the CD preamble is sent on PCPCH. Reception of the CD preamble in Node B is indicated on CD-ICH to the UE. If Channel Assignment is active, channel assignment information is simultaneously transmitted on CD/CA-ICH. Layer 1 provides status indication to MAC indicating the CD or CD/CA information. The CA information defines in the UE on L1 the PCPCH to use for the power control preamble and the message part. Then MAC builds the CPCH transport block set to be transmitted via PHY-Data-REQ with the appropriate Transport Format that may differ from the requested transport format.

After the 0 or 8 slot period for the power control preamble, the first Transport Block Set (first TTI) of the message is transmitted.

While the first transport block is being sent, Node B layer 1 sends the start of message indicator whereby upon the reception of this start of message indicator UE can know if it uses correct CPCH channel or not. If UE does not receive the start of message indicator within certain period, it stops its message transmission immediately. Otherwise, UE continues the transmission.

Data transmission on CPCH is continued until all available data has been sent or until the maximum frame length [NF\_max] is reached. If the UE has no more data to send prior to NF\_max, the UE can notify the UTRAN that no more frames will be transmitted prior to the maximum frame length [NF\_max] on the CPCH by using End of Transmission indication. The acknowledgements from RLC entities in SRNC are routed by the NW MAC to the UE RLC entities using the FACH DL transport channel.

In figure 21, the events between points A and B define the CPCH transmission procedure for the first TTI. In figure 22, events from point C to D describe the CPCH transmission procedure for each subsequent TTI. In figure 22, the events from point E to F describe the stop procedure of CPCH transmission when the UE has no more data to send prior to the maximum frame length [NF\_max]. In this case a stop of CPCH transmission can take place for the release of CPCH transmission prior to NF\_max. The stop of CPCH transmission is indicated by the PHY-DATA-REQ primitive indicating the 'end of transmission' event by setting zero sized Transport Block as indicated by TFI.

On request from RRC at the network side, for example, for reacting on temporary overload conditions, an emergency stop of CPCH transmission can take place. The emergency stop is indicated by the PHY-STATUS-IND primitive.

Note also that in the case of transmit power restrictions that are also indicated via PHY-STATUS-IND primitive, restrictions on Transport Format selections may apply at any time during CPCH transmission.

### 6.3.4 Data transfer on USCH (TDD only)

In figure 23 a data transfer procedure on USCH is presented. It is assumed that the RB establishment has been performed for example with the RB Establishment procedure without Dedicated Physical Channel as illustrated in subclause 6.2.1.1.4 and that the RB is mapped on the USCH and DSCH transport channels. Use of the USCH is possible with or without an associated DCH.

In the UE the traffic measurement function decides to send a Capacity Request to the network using the SHCCH logical channel mapped on the RACH or USCH. In the C-RRC the USCH/DSCH scheduling function will decide to allocate physical resources to this logical channel and RRC in C-RNC sends a PhyShChAllocation to its peer entity in the UE. This message specifies the physical resources and the period of time the MAC-c/sh can transfer the data on the USCH transport channel.

Both RRC in the CRNC and the UE configure their respective Layer 1 and MAC for the data transfer on the USCH and at the specified time MAC-c/sh in the UE conveys the data using the specified PUSCH resources.

This operation may be repeated several times till the RLC buffer is empty.

In the diagram it is assumed that the PhyShChAllocation has allocated additionally to the PUSCH resources some PDSCH resources, so that at the time specified in the allocation message both RRC in the CRNC and the UE configure their respective Layer 1 and MAC for the data transfer on the DSCH and at the specified time MAC-c/sh in the C-RNC conveys the acknowledgement message of the UTRAN RLC to its UE peer entity using the specified PDSCH resources.

Transmitting the acknowledgement message via FACH is also possible.

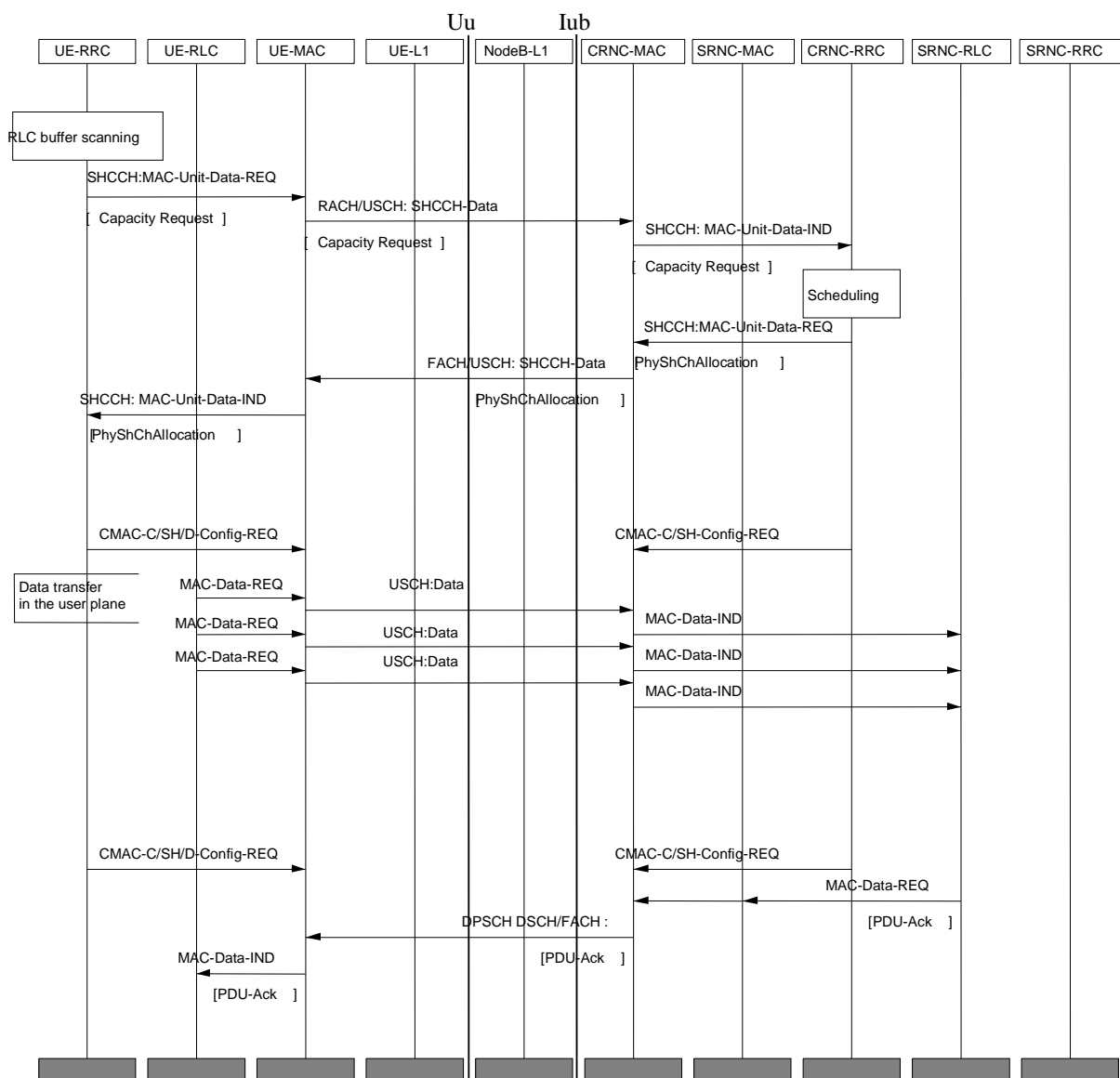

Figure 23: Data transfer on USCH



### 6.3.5 Data transfer on DSCH (TDD only)

In figure 24 a data transfer procedure on DSCH is presented. It is assumed that the RB establishment has been performed for example with the RB Establishment procedure without Dedicated Physical Channel as illustrated in subclause 6.2.1.1.4 and that the RB is mapped on the USCH and DSCH transport channels.

Use of the DSCH is possible with or without an associated DCH.

In the C-RRC the USCH/DSCH scheduling function will decide to allocate physical resources in the downlink and RRC in C-RNC sends a *PhyShChAllocation* message to its peer entity in the UE using SHCCH mapped on the FACH or DSCH. This message specifies the physical resources and the period of time the MAC-c/sh can transfer the data on the DSCH transport channel.

Both RRC in the CRNC and the UE configure their respective Layer 1 and MAC for the data transfer on the DSCH and at the specified time MAC-c/sh in the C-RNC conveys the data using the specified PDSCH resources.

This operation may be repeated several times till the RLC buffer is empty.

In the diagram it is assumed that the *PhyShChAllocation* has allocated additionally to the PDSCH resources some PUSCH resources, so that at the time specified in the allocation message both RRC in the CRNC and the UE configure their respective Layer 1 and MAC for the data transfer on the USCH and at the specified time MAC-c/sh in the UE conveys the acknowledgement message of the UE to its C-RNC peer entity using the specified PUSCH resources.

Transmitting the acknowledgement message via RACH is also possible.

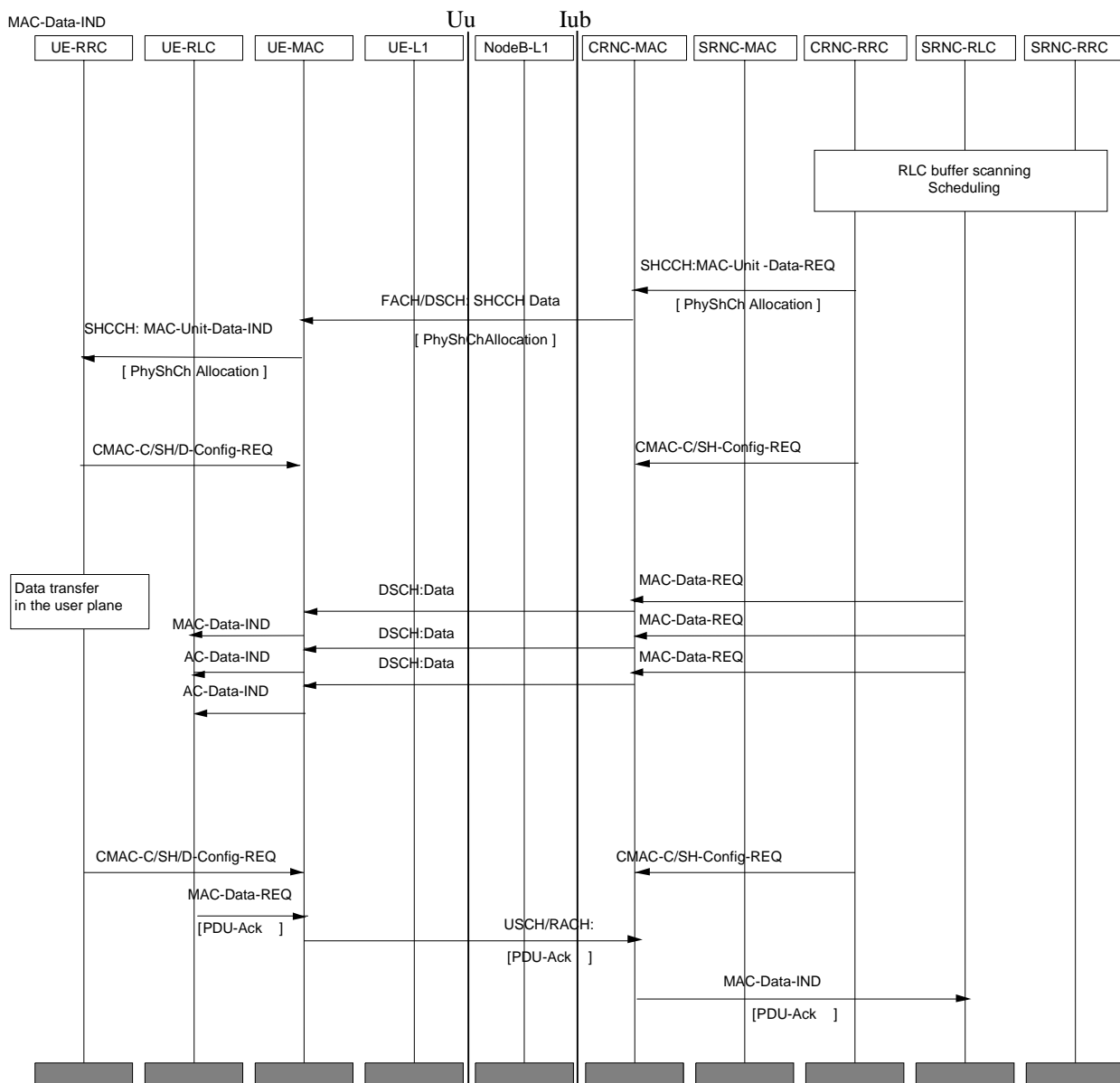

Figure 24: Data transfer on DSCH

## 6.4 RRC Connection mobility procedures

The RRC handover protocol must be common for the FDD and TDD modes. This means that the same protocol must support all the following handover procedures.

### 6.4.1 Handover Measurement Reporting

Figure 25 illustrates an example where a measurement control and a measurement report procedure is used for handover measurements. The NW RRC requests the UE to start measurements and reporting with a MEASUREMENT CONTROL message. The message includes an indication of a measurement type (e.g. intra-frequency measurement), the radio links to evaluate, the reporting criteria and a measurement identity number. The UE configures L1 to start measurements. When measurement reporting criteria are fulfilled the UE sends a MEASUREMENT REPORT message.

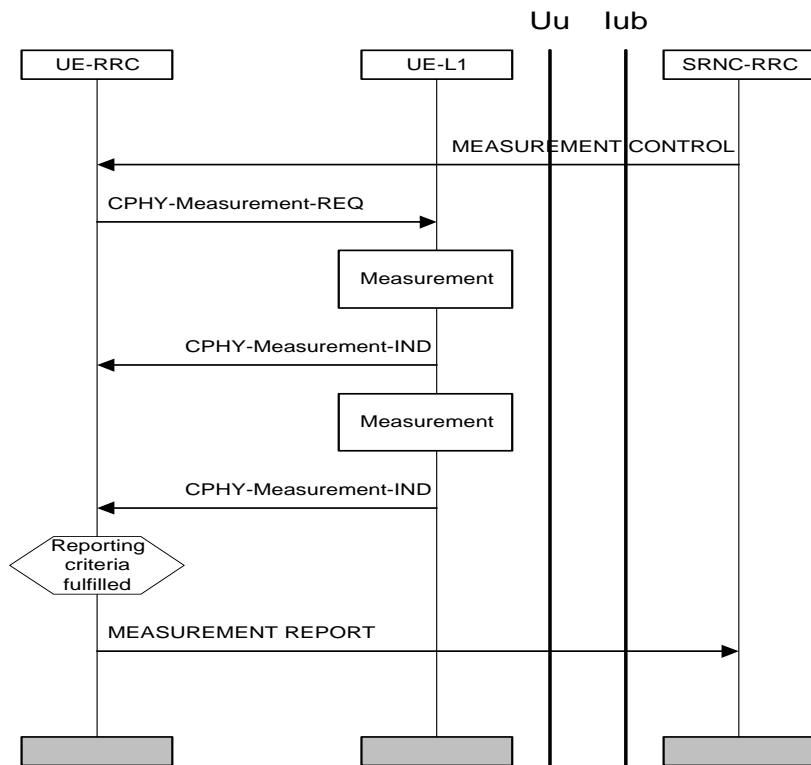

Figure 25: Handover measurement reporting

### 6.4.2 Cell Update

Figure 26 illustrates an example of a cell update procedure.

The cell update procedure is triggered by the cell re-selection function in the UE, which notifies which cell the UE should switch to. The UE reads the broadcast information of the new cell. Subsequently, the UE RRC layer sends a CELL UPDATE message to the UTRAN RRC via the CCCH logical channel and the RACH transport channel. The RACH transmission includes the current U-RNTI (S-RNTI and the SRNC Identity).

Upon reception of the CELL UPDATE, the UTRAN registers the change of cell. If the registration is successful it replies with a CELL UPDATE CONFIRM message transmitted on the DCCH/FACH to the UE. The message includes the current U-RNTI (S-RNTI and SRNC Identity) and it may also include new C-RNTI and / or U-RNTI (S-RNTI + SRNC Identity). By using DCCH for the confirm message the contents of the message can be ciphered.

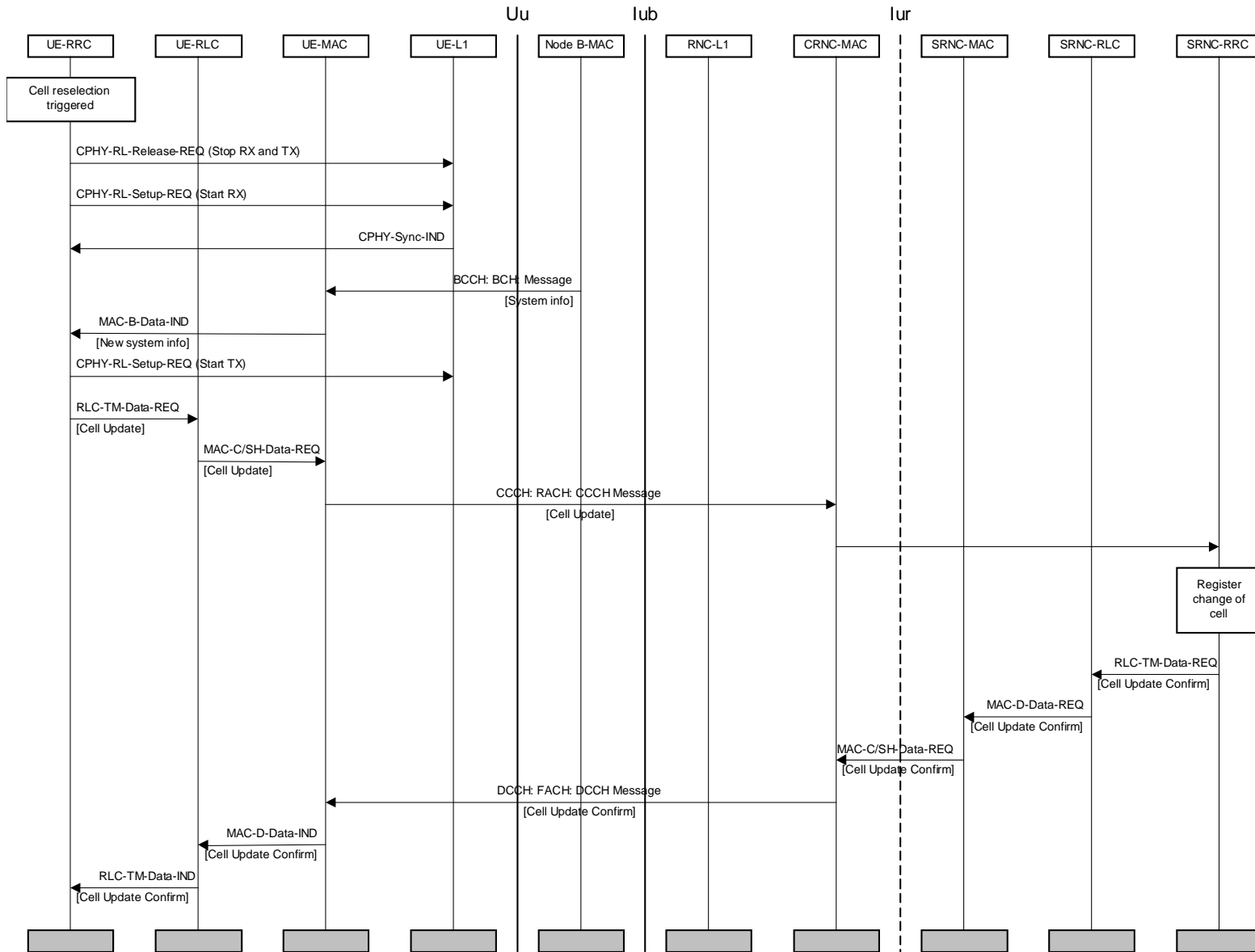

Figure 26: Cell update procedure

### 6.4.3 URA Update

Figure 27 illustrates an example of a URA Update procedure. For a more detailed figure on the interlayer interaction for CCCH or DCCH transmission please refer to "Cell Update" in the previous subclause.

When cell re-selection is triggered, the UE abandons the radio link in the old cell and establishes a radio link to the new cell. The URA update procedure is triggered when the UE reads the broadcast information of the new cell and recognises that a URA update is required. After that, the UE RRC layer sends a URA UPDATE on the CCCH to the UE MAC layer, which transfers the message on the RACH to UTRAN. The RACH transmission includes the current U-RNTI (S-RNTI and SRNC Identity).

Upon reception of the URA UPDATE, the UTRAN registers the change of URA. Then the CRNC-RRC requests the CRNC-MAC to send a URA UPDATE CONFIRM message on the FACH to the UE. The message includes the current U-RNTI (S-RNTI and SRNC Identity) and may also include new C-RNTI, U-RNTI (S-RNTI and SRNC Identity).

The logical channel used for URA UPDATE CONFIRM depends on the SRNC relocation policy. If SRNC is always relocated before URA UPDATE CONFIRM is sent, a DCCH should be used (to allow ciphering of the message contents). If SRNC is not relocated, the CCCH logical channel should be used to be able to utilize the RNSAP Iur procedures and not being forced to set up user plane on the Iur for this procedure.

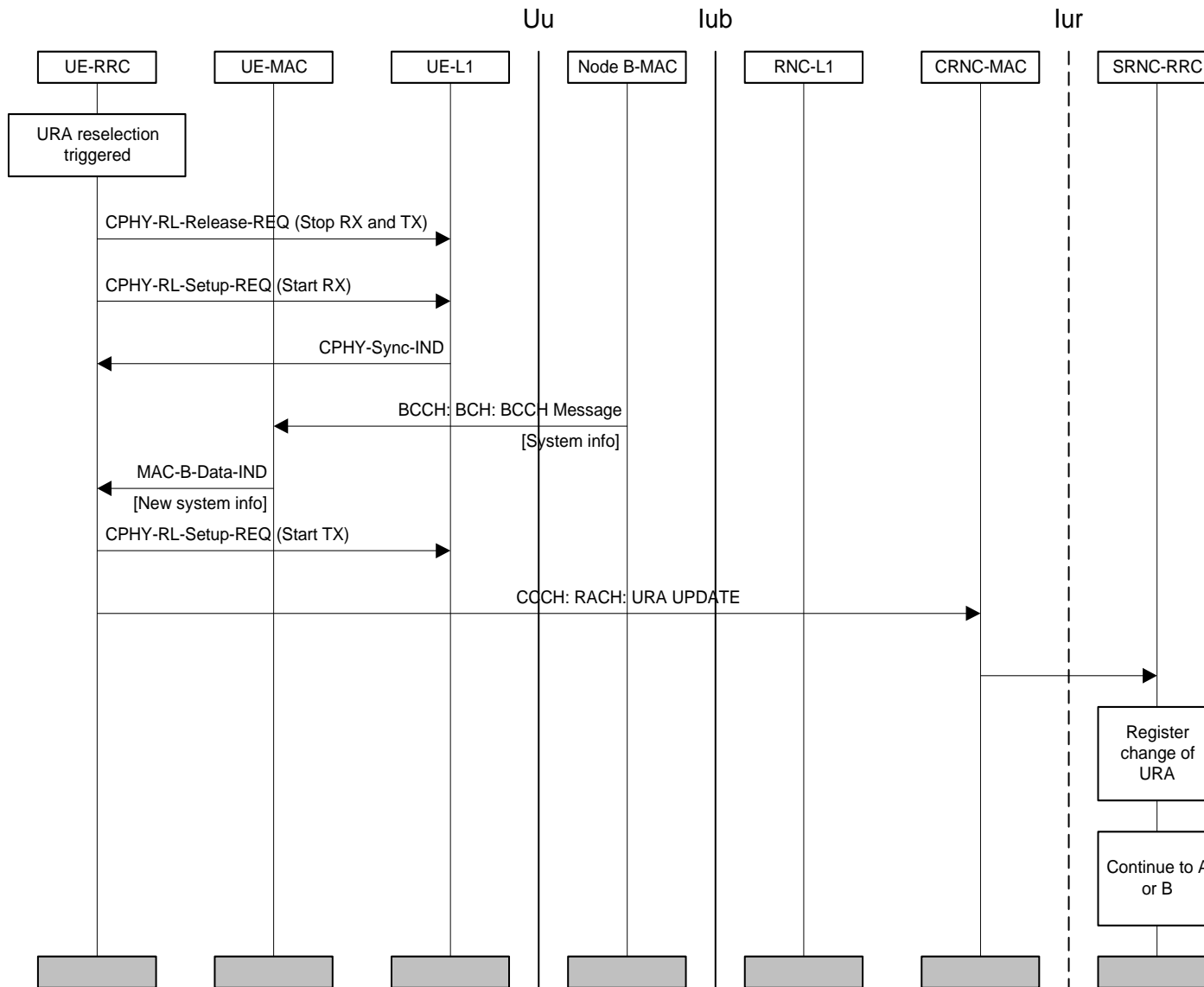

Figure 27: Beginning of the URA update procedure – continue either to case A or case B

Case A: URA UPDATE CONFIRM on DCCH:

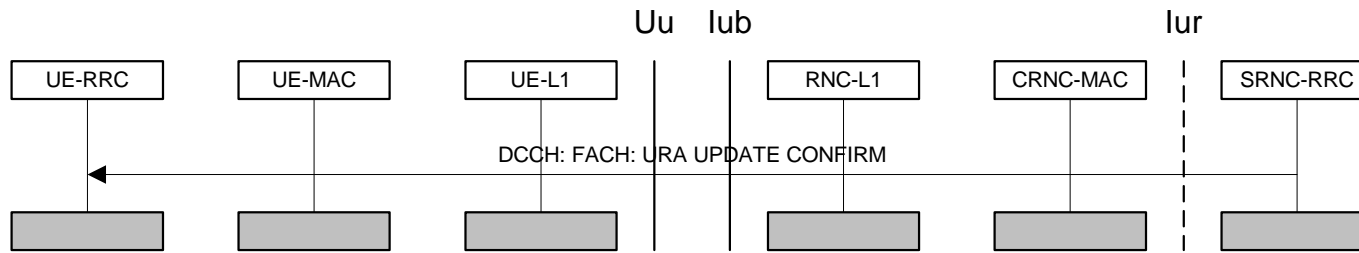

Figure 28: Case A continuation of URA update, CONFIRM message can be ciphered

**Case B: URA UPDATE CONFIRM on CCCH:**

In this case transmission between SRNC and CRNC takes place on the RNSAP Downlink Signalling Transfer and the CCCH logical channel is used.

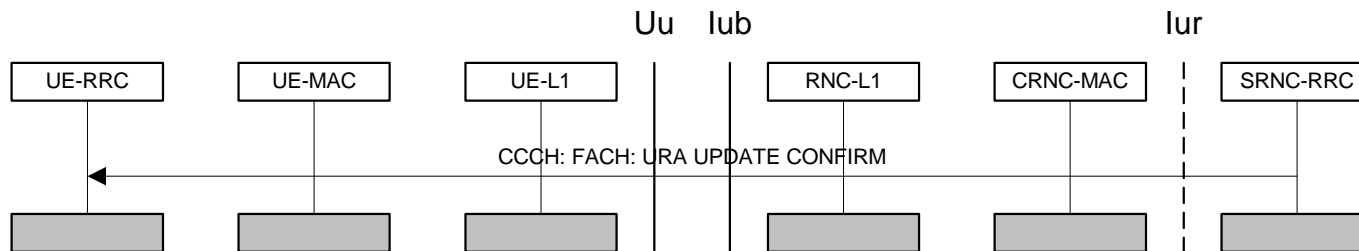
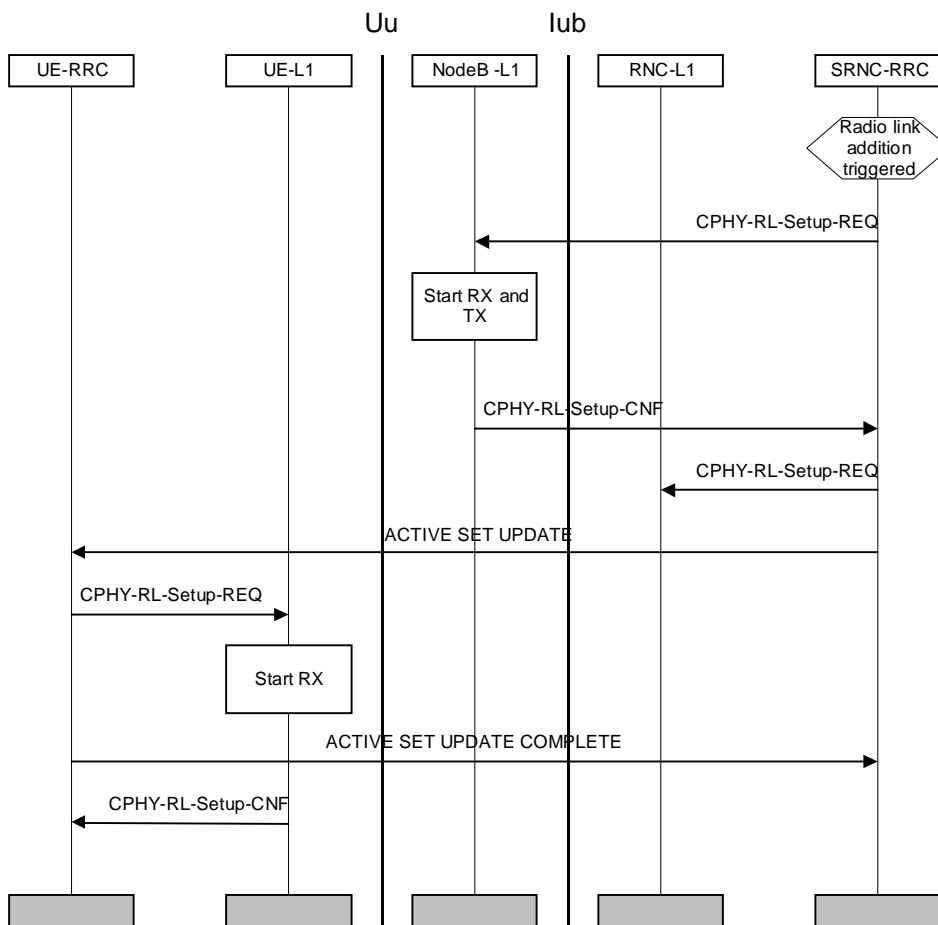

Figure 29: Case B continuation of URA update, CONFIRM message cannot be ciphered

### 6.4.4 Radio Link Addition (FDD)



**Figure 30: Radio Link Addition**

Figure 30 illustrates a radio link addition procedure. Radio link addition is triggered in the network RRC layer by measurement reports sent by the UE. The NW RRC first configures the new radio link on the physical layer in Node B. Transmission and reception begins immediately. The NW RRC then sends an RRC ACTIVE SET UPDATE message to the UE RRC. The UE RRC configures layer 1 to begin reception.

The UE shall send an ACTIVE SET UPDATE COMPLETE message to the RNC-RRC without waiting for an indication of synchronisation from the UE physical layer.



### 6.4.5 Radio Link Removal (FDD)

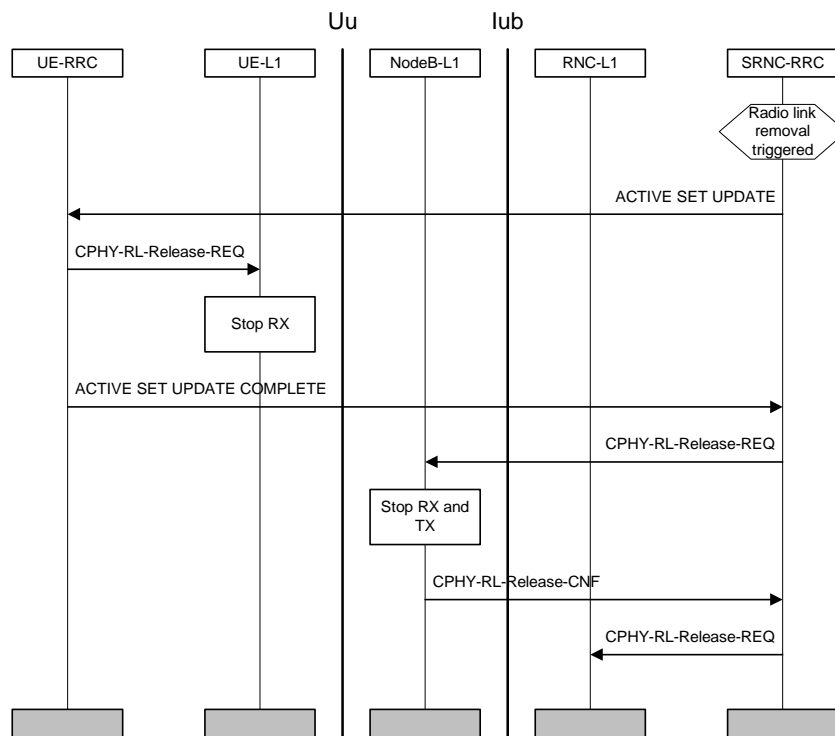
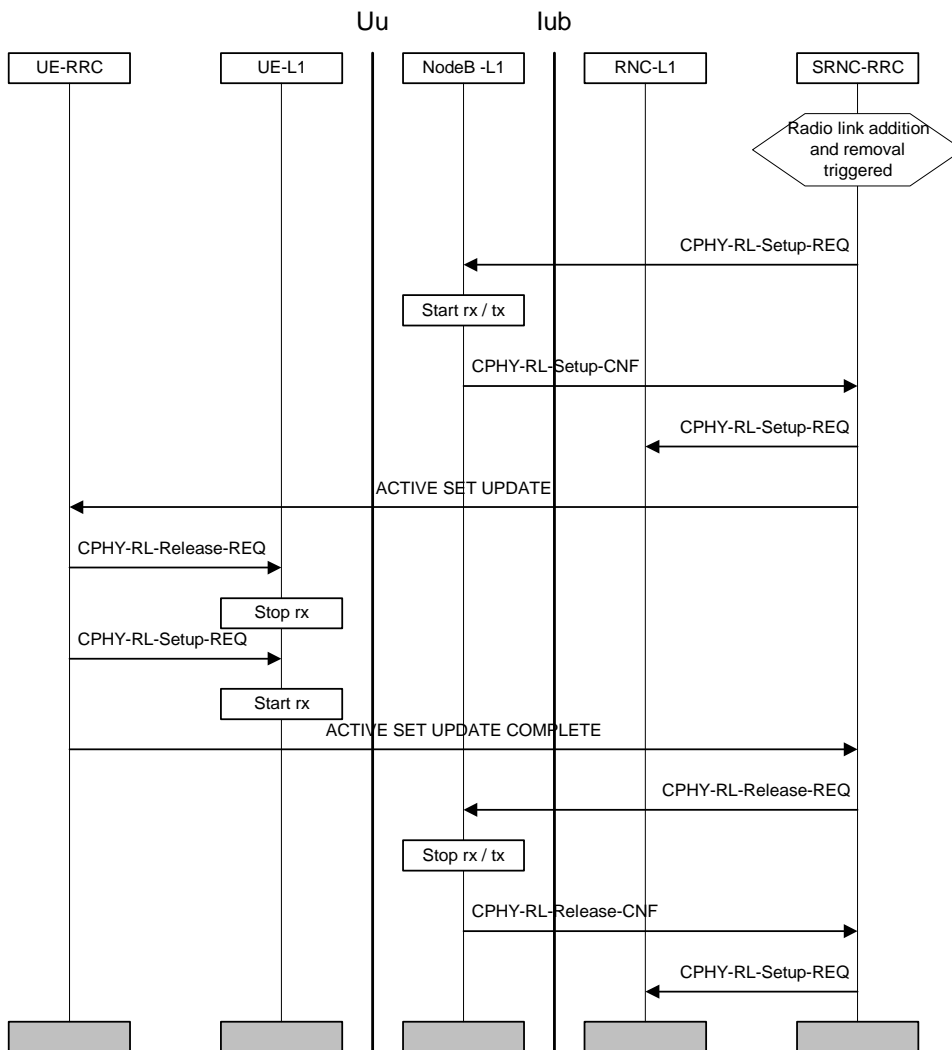

**Figure 31: Radio link removal**

Figure 31 illustrates a radio link removal procedure. Radio link removal is triggered by an algorithm in the network RRC layer by measurement reports sent by the UE. Radio link removal may also be triggered in the NW due to load control algorithms. The radio link is first deactivated by the UE and then in the NW.

The NW RRC sends an ACTIVE SET UPDATE message to the UE RRC. The UE RRC requests UE L1 to terminate reception of the radio link(s) to be removed. After this the UE RRC acknowledges radio link removal with an ACTIVE SET UPDATE COMPLETE message to the NW RRC. The NW RRC proceeds to request the NW L1 in both Node B and the RNC to release the radio link.

### 6.4.6 Combined radio link addition and removal



**Figure 32: Combined Radio Link Addition And Removal**

Figure 32 illustrates a combined radio link addition and removal procedure. The NW RRC determines the need for radio link replacement based on received measurement reports or load control algorithms.

When radio links are to be replaced, the NW RRC first configures the NW L1 to activate the radio link(s) that are being added. The NW RRC then sends an ACTIVE SET UPDATE message to the UE RRC, which configures the UE L1 to terminate reception on the removed radio link(s) and begin reception on the added radio link(s).

If the UE active set is full, the replacement has to be performed in the order defined in figure 32. If UE has only one radio link, then the replacement must be done in reverse order (first add, then remove).

The UE RRC acknowledges the replacement with an ACTIVE SET UPDATE COMPLETE message. The NW RRC then configures the NW L1 to terminate reception and transmission on the removed radio link.

### 6.4.7 Hard Handover (FDD and TDD)

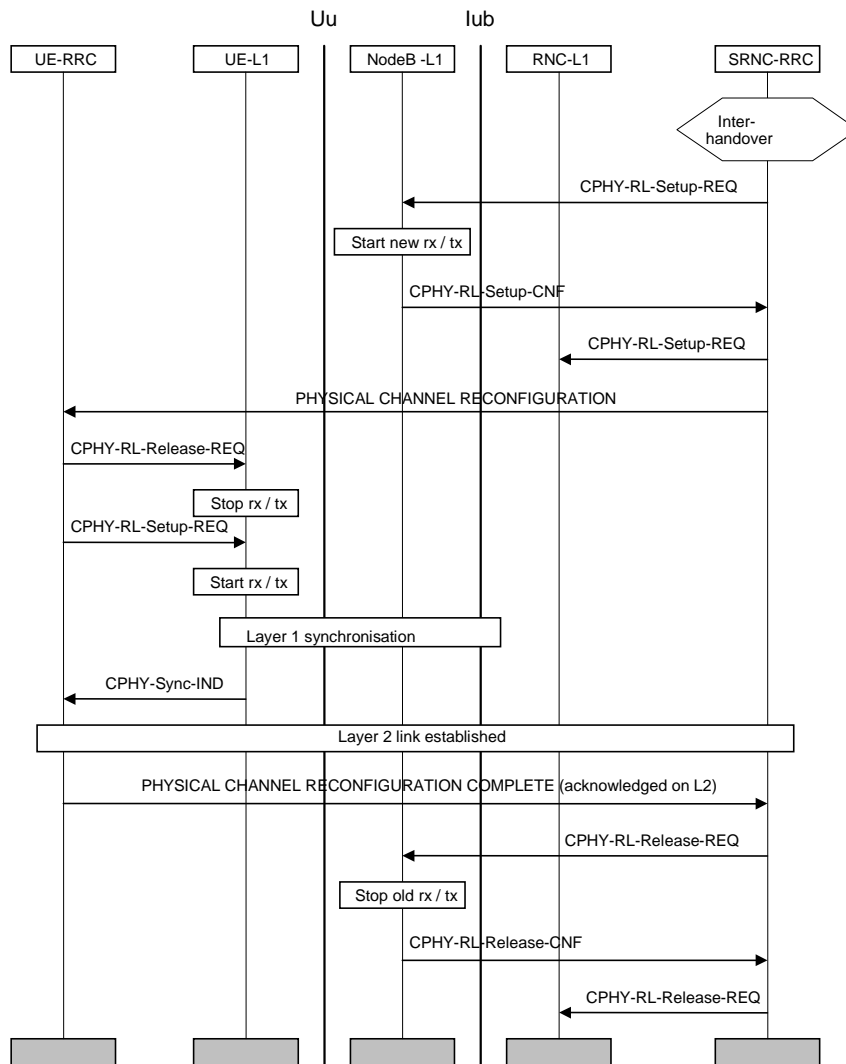

**Figure 33: Hard handover**

Figure 33 illustrates a hard handover. The NW RRC determines the need for hard handover based on received measurement reports or load control algorithms.

For inter-frequency handover the measurements are assumed to be performed in slotted mode.

The NW RRC first configures the NW L1 to activate the new radio links. The NW L1 begins transmission and reception on the new links immediately. The NW RRC then sends the UE RRC a **PHYSICAL CHANNEL RECONFIGURATION** message (several other messages e.g. **RADIO BEARER RECONFIGURATION** and **TRANSPORT CHANNEL RECONFIGURATION** can also be used to perform hard handover). The message indicates the radio resources that should be used for the new radio link. The UE RRC configures the UE L1 to terminate reception on the old radio link and begin reception on the new radio link.

After the UE L1 has achieved downlink synchronisation on the new frequency, a L2 link is established and the UE RRC sends a **PHYSICAL CHANNEL RECONFIGURATION COMPLETE** message to the NW RRC. After having received the L3 acknowledgement, the NW RRC configures the NW L1 to terminate reception and transmission on the old radio link.

## 6.4.8 SRNS Relocation

The SRNS relocation procedure can be divided into two phases. The first phase is relocation preparation; where the resources are reserved, new RABs are established while the second phase is the transfer of the Serving RNS from source to target RNC.

In what follows, lossless radio bearers are RBs using AM and configured to support lossless SRNS relocation. Seamless radio bearers are RBs using UM or AM not configured to support lossless SRNS relocation.

There are three cases in which an SRNS relocation can be performed:

- Serving SRNS relocation: This is used to move the UTRAN to CN connection point at the UTRAN side from the source SRNC to the target RNC.
- Combined Hard Handover and SRNS relocation: This is used to move the UTRAN to CN connection point at the UTRAN side from the source SRNC to the target RNC, while performing a hard handover decided by the UTRAN.
- Combined Cell/URA update and SRNS relocation: This is used to move the UTRAN to CN connection point at the UTRAN side from the source SRNC to the target RNC, while performing a cell re-selection in the UTRAN.

and these are described in subclauses 6.4.8.1, 6.4.8.2 (for lossless radio bearers), 6.4.8.3, 6.4.8.4 (for seamless radio bearers), and in more detail in [6].

### 6.4.8.1 Combined Cell/URA Update and SRNS relocation (lossless radio bearers)

The procedure is initiated by the source RNC deciding to perform a SRNS relocation. Case I represents the situation when the UE is not involved and this is shown in figure 34. Case II represents the situation when the UE is involved and a Combined Cell/URA update and SRNS relocation is performed, also shown in figure 34.

A RANAP Relocation Command is received by the source RNC from the CN, indicating the RABs to be released and the RABs that are subject to data forwarding. Lossless SRNS relocation is always, and only, configured for RABs that are subject to data forwarding. The PDCP layer shall support PDCP sequence numbering when lossless SRNS relocation is supported [7].

For the affected radio bearers, the RLC entity is stopped and the next PDCP sequence numbers are retrieved by RRC. The next PDCP send and receive sequence numbers are then transferred in the RNSAP Relocation Commit message from source to target RNC for RABs that support lossless SRNS relocation. The target RNC becomes the serving RNC when the RANAP Relocation Detect message is sent.

The target RNC then sends on SRB#1 (UM/DCCH) a UTRAN MOBILITY INFORMATION (Case I) or a CELL/URA UPDATE CONFIRM (Case II); which configures the UE with the new U-RNTI and indicates the next uplink receive PDCP sequence number for each radio bearer configured to support lossless SRNS relocation.

The target RNC establishes a UM RLC entity for SRB#1, and the DL HFN and the VT(US) are set to the values in the RRC information container, respectively. In the UM RLC entity, the "Special LI" is used to indicate that an RLC SDU begins in the beginning of an RLC PDU.

Upon reception by the UE of the message, the UE compares the next uplink receive PDCP sequence number with the UE next uplink send PDCP sequence number. If this confirms PDCP SDUs successfully transferred before the start of relocation i.e. already received by the source RNC then these are discarded by the UE. The UE reinitialises the PDCP header compression entities of the radio bearers configured to use a header compression protocol [7]. The AM RLC entity for SRB#2 is (re-)established both on the UTRAN and UE sides, and their HFN values are set to the MAX(UL HFN of SRB2 | DL HFN of SRB2) incremented by one.

If the UE has successfully configured itself, it shall send a UTRAN MOBILITY INFORMATION CONFIRM (Case I and Case II). These messages contain the START values and the next downlink receive PDCP sequence number for each radio bearer configured to support lossless SRNS relocation.

Upon reception and acknowledgement by the UTRAN of the message, the UTRAN compares the next downlink receive PDCP sequence number with the next downlink send PDCP sequence number. The UTRAN initialises the PDCP header compression entities of the radio bearers configured to use a header compression protocol [7]. The RLC entities for affected radio bearers (other than SRB#2) are (re-)established both on the UTRAN and UE side. The HFN values

for each RB are set to the START value in the message for the corresponding CN domain, and all the RLC data buffers are flushed.

In case of failure, the UE shall send a UTRAN MOBILITY INFORMATION FAILURE (Case I and Case II).

Upon reception of the UTRAN MOBILITY INFORMATION CONFIRM/FAILURE (Case I and Case II), the relocation procedure ends.

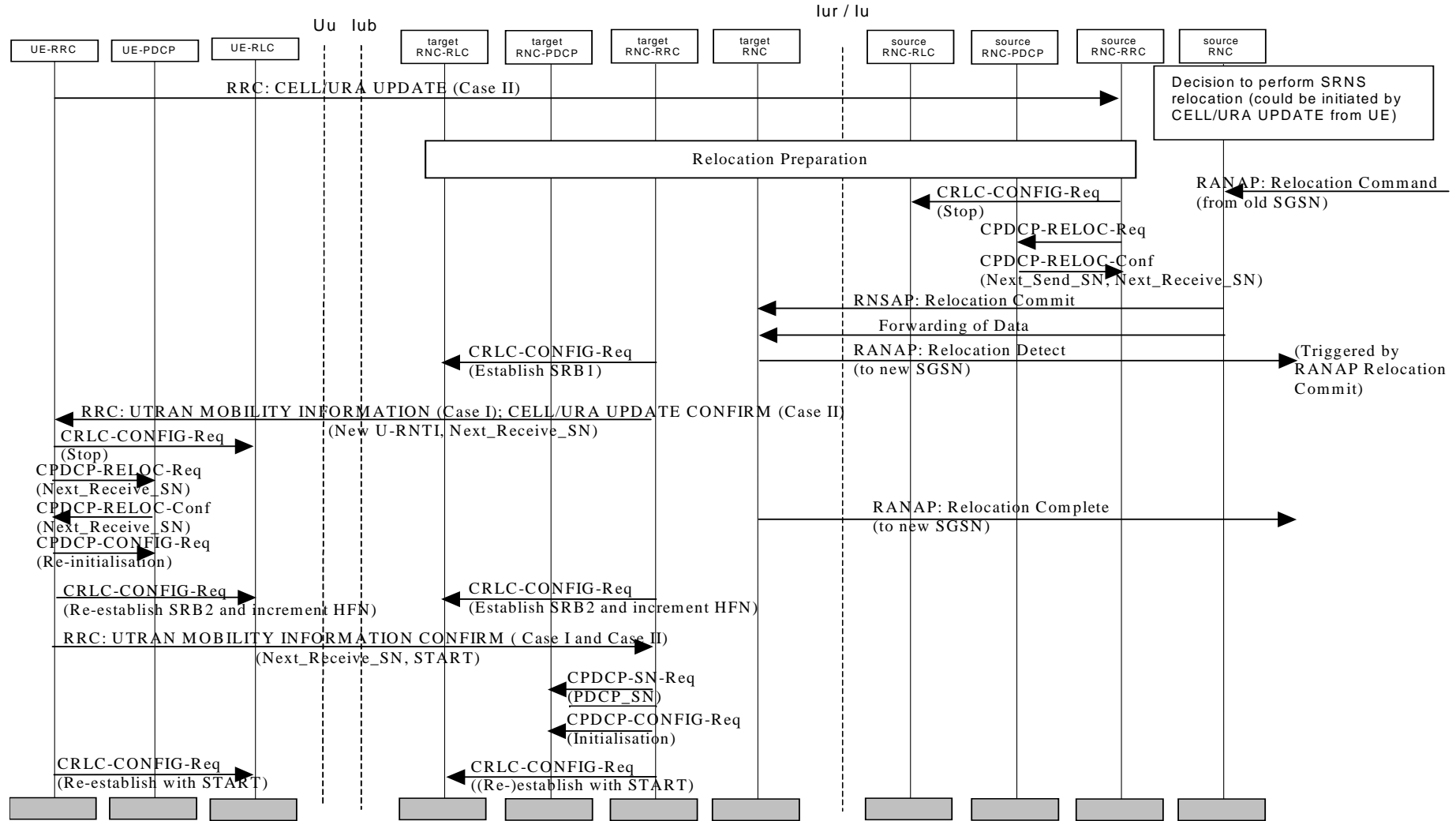

Figure 34: Combined Cell/URA Update and SRNS relocation (lossless radio bearers)

### 6.4.8.2 Combined Hard Handover and SRNS relocation (lossless radio bearers)

Based on measurement results and knowledge of the UTRAN topology, the source SRNC decides to initiate a combined hard handover and SRNS relocation. The UE is still under control of the SRNC but is moving to a location controlled by the target RNC.

A RANAP Relocation Command is received by the source RNC from the CN, indicating the RABs to be released, the Target RNC to Source RNC Transparent Container and the RABs that are subject to data forwarding. Lossless SRNS relocation is always, and only, configured for RABs that are subject to data forwarding. The PDCP layer shall support PDCP sequence numbering when lossless SRNS relocation is supported [7]. The Target RNC to Source RNC Transparent Container includes the RRC message (e.g. PHYSICAL CHANNEL RECONFIGURATION) for hard handover.

Upon reception of the RANAP Relocation Command, the RRC entity in the source RNC stops the RLC entities for the affected radio bearers and retrieves the PDCP sequence numbers. It then triggers the execution of the relocation of SRNS by sending the RRC message to the UE using the acknowledged mode dedicated signalling radio bearer (SRB #2). This message includes the new U-RNTI (from the target RNC) and the next uplink receive PDCP sequence number for each radio bearer configured to support lossless SRNS relocation (from the source RNC). The UE reinitialises the PDCP header compression entities of the radio bearers configured to use a header compression protocol [7].

The next PDCP send and receive sequence numbers are then transferred via the CN during the forwarding of SRNS contexts from source to target RNC. The target RNC becomes the serving RNC when the RANAP Relocation Detect message is sent.

Upon reception and acknowledgment by the UE of the message, the RLC entity for the acknowledged mode dedicated signalling radio bearer (SRB #2) is re-established, both on the UTRAN and UE sides and their HFN values are set to the  $\text{MAX}(\text{uplink HFN of RB2} \mid \text{downlink HFN of RB2}) + 1$ . Care should be taken by UTRAN in timing the SRNS relocation so that there is no risk of a SN rollover on SRB #2 during this procedure.

The UE compares the next uplink receive PDCP sequence number with the next uplink send PDCP sequence number. If this confirms PDCP SDUs successfully transferred before the start of relocation i.e. already received by the source RNC then these are discarded by the UE.

If the UE has successfully configured itself, it sends a response message, in this case a PHYSICAL CHANNEL RECONFIGURATION COMPLETE message to the target RNC using the acknowledged mode dedicated signalling radio bearer (SRB #2). This message contains the START values and the next downlink receive PDCP sequence number for each radio bearer configured to support lossless SRNS relocation.

Upon acknowledgement of the message, the RLC entities for affected radio bearers are re-established both on the UTRAN and UE side. The HFN values for each RB are set to the START value in the message for the corresponding CN domain.

UTRAN compares the next downlink receive PDCP sequence number with the next downlink send PDCP sequence number. The UTRAN initialises the PDCP header compression entities of the radio bearers configured to use a header compression protocol [7].

The UTRAN and the UE continue the RLC and PDCP entities of the affected RBs and the relocation procedure ends.

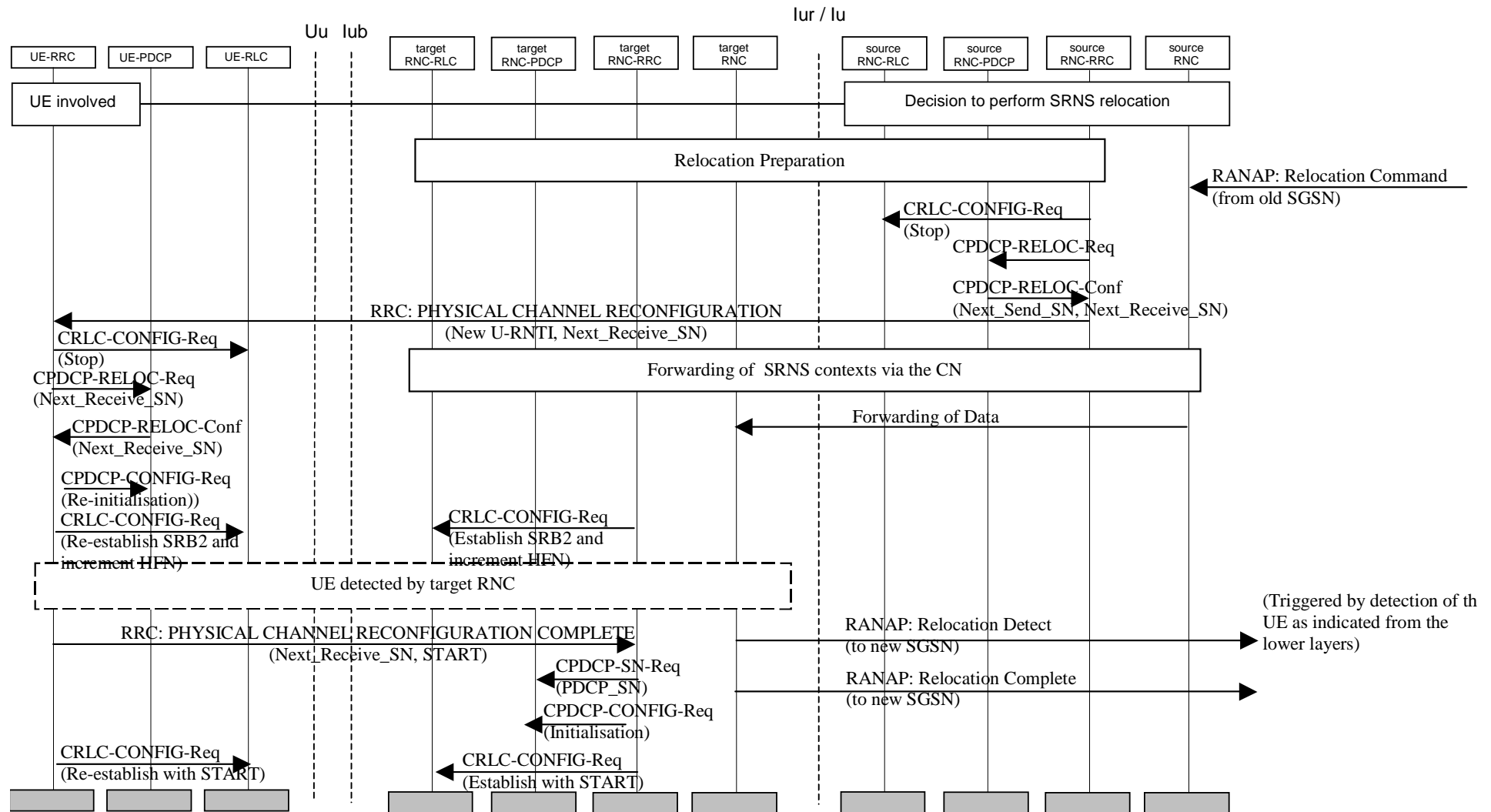

Figure 35: Combined Hard Handover and SRNS relocation (lossless radio bearers)



### 6.4.8.3 Combined Cell/URA Update and SRNS relocation (seamless radio bearers)

The procedure is initiated by the source RNC deciding to perform a SRNS relocation. Case I represents the situation when the UE is not involved and this is shown in figure 36. Case II represents the situation when the UE is involved and a Combined Cell/URA update and SRNS relocation is performed, also shown in figure 36.

A RANAP Relocation Command is received by the source RNC from the CN, indicating the RABs to be released. The source RNC continues the downlink data transmission on radio bearers supporting seamless SRNS relocation until the target RNC becomes the serving RNC. The target RNC becomes the serving RNC when the RANAP Relocation Detect message is sent.

The target RNC sends on SRB#1 (UM/DCCH) a UTRAN MOBILITY INFORMATION (Case I) or a CELL/URA UPDATE CONFIRM (Case II); which configures the UE with the new U-RNTI.

The target RNC establishes a UM RLC entity for SRB#1, and the DL HFN and the VT(US) are set to the values in the RRC information container, respectively. In the UM RLC entity, the "Special LI" is used to indicate that an RLC SDU begins in the beginning of an RLC PDU.

Upon reception by the UE of the message, the AM RLC entity for SRB#2 is (re-)established both on the UTRAN and UE sides, and their HFN values are set to the MAX(UL HFN of SRB2 | DL HFN of SRB2) incremented by one.

If the UE has successfully configured itself, it shall send a UTRAN MOBILITY INFORMATION CONFIRM (Case I and Case II). These messages contain the START values (to be used in integrity protection and in ciphering on radio bearers using UM and AM RLC).

Upon reception and acknowledgement by the UTRAN of the message, the UTRAN initialises and the UE reinitialises the PDCP header compression entities of the radio bearers configured to use a header compression protocol [7]. The RLC entities for affected radio bearers (other than SRB#2) are (re-)established both on the UTRAN and UE side. The HFN values for each RB are set to the START value in the message for the corresponding CN domain, and all the RLC data buffers are flushed.

In case of failure, the UE shall send a UTRAN MOBILITY INFORMATION FAILURE (Case I and Case II).

Upon reception of the UTRAN MOBILITY INFORMATION CONFIRM/FAILURE (Case I and Case II), the relocation procedure ends.

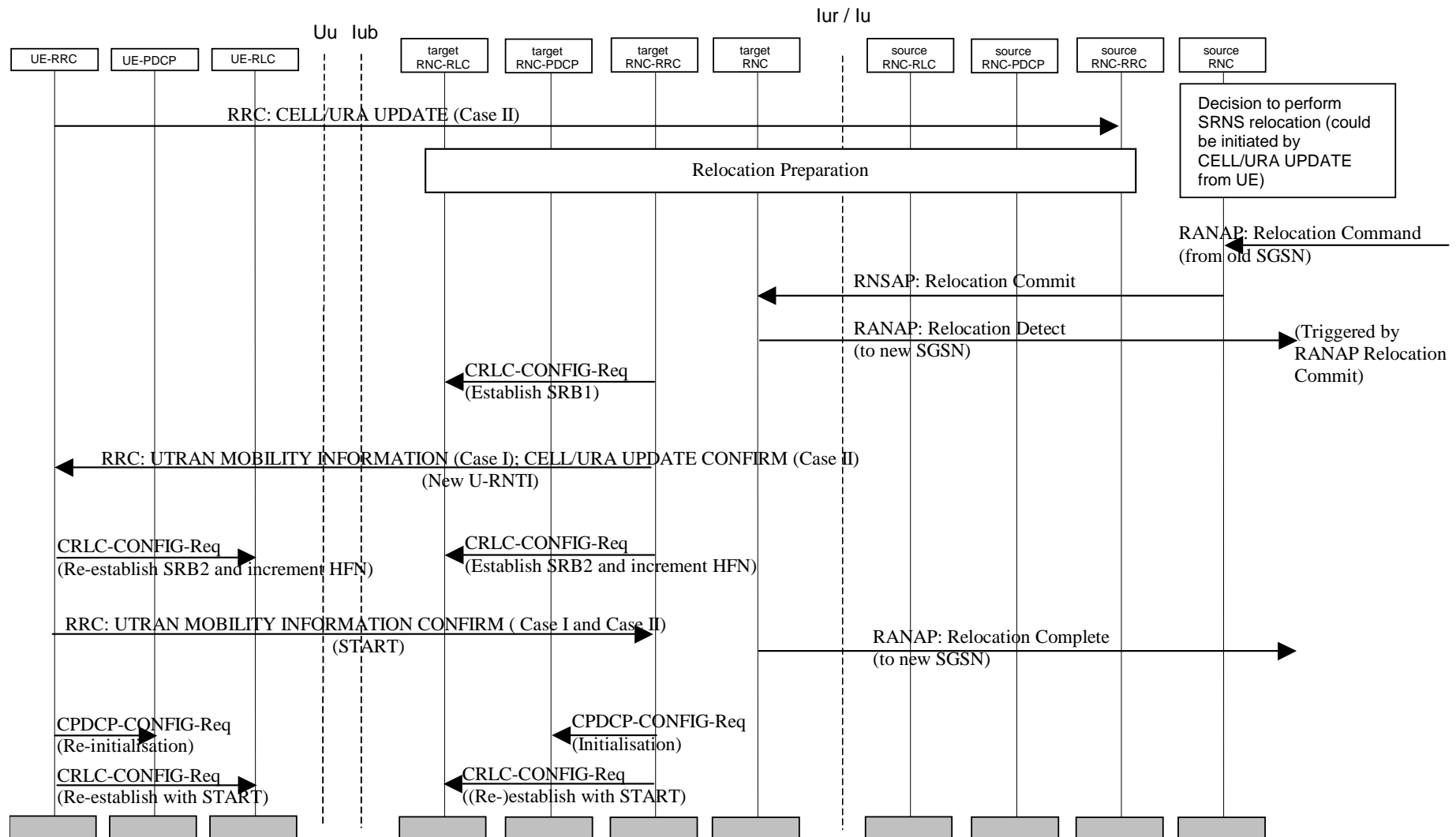

Figure 36: Combined Cell/URA Update and SRNS relocation (seamless radio bearers)

#### 6.4.8.4 Combined Hard Handover and SRNS relocation (seamless radio bearers)

Based on measurement results and knowledge of the UTRAN topology, the source SRNC decides to initiate a combined hard handover and SRNS relocation. The UE is still under control of the SRNC but is moving to a location controlled by the target RNC.

The source RNC continues the downlink data transmission on radio bearers supporting seamless SRNS relocation until the target RNC becomes the serving RNC. The target RNC becomes the serving RNC when the RANAP Relocation Detect message is sent.

A RANAP Relocation Command is received by the source RNC from the CN, indicating the RABs to be released. The Target RNC to Source RNC Transparent Container includes the RRC message (e.g. PHYSICAL CHANNEL RECONFIGURATION) for hard handover. This message includes the new U-RNTI.

Upon reception of the RANAP Relocation Command, the source RNC triggers the execution of the relocation of SRNS by sending the RRC message to the UE using the acknowledged mode dedicated signalling radio bearer.

Upon reception and acknowledgment by the UE of the PHYSICAL CHANNEL RECONFIGURATION message, the RLC entity for the acknowledged mode dedicated signalling radio bearer (SRB #2) is re-established, both on the UTRAN (target SRNC) and UE sides, and their HFN values are set to  $\text{MAX}(\text{uplink HFN of RB2} \mid \text{downlink HFN of RB2}) + 1$ . Care should be taken by UTRAN in timing the SRNS relocation so that there is no risk of a SN rollover on SRB #2 during this procedure.

If the UE has successfully configured itself, it sends a response message, in this case PHYSICAL CHANNEL RECONFIGURATION COMPLETE message to the target RNC using the acknowledged mode dedicated signalling radio bearer (SRB #2). This message is transmitted based on the new RLC context and contains the START values (to be used in integrity protection and in ciphering on radio bearers using UM and AM RLC). The UTRAN initialises and the UE reinitialises the PDCP header compression entities of the radio bearers configured to use a header compression protocol [7].

Upon acknowledgement of the message, the RLC entities for the rest of the affected radio bearers are re-established both on the UTRAN and UE side. The HFN values for each RB are set to the START value in the message for the corresponding CN domain. The HFN values for each remaining signalling radio bearer (other than SRB #2) are set to the START value in the message for the last configured CN domain.

The relocation procedure ends.

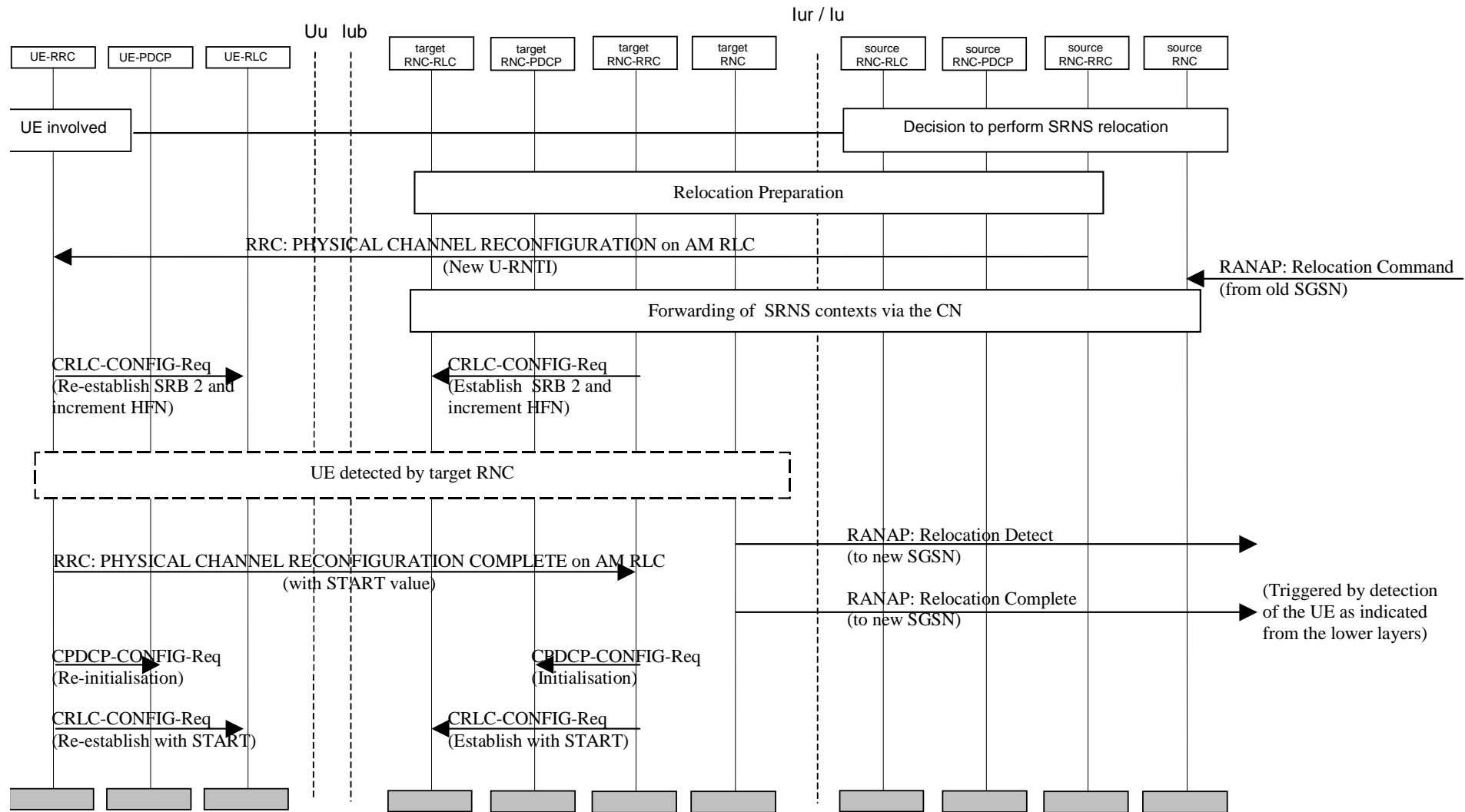

Figure 37: Combined Hard Handover and SRNS relocation (seamless radio bearers)

### 6.4.9 RRC Connection re-establishment

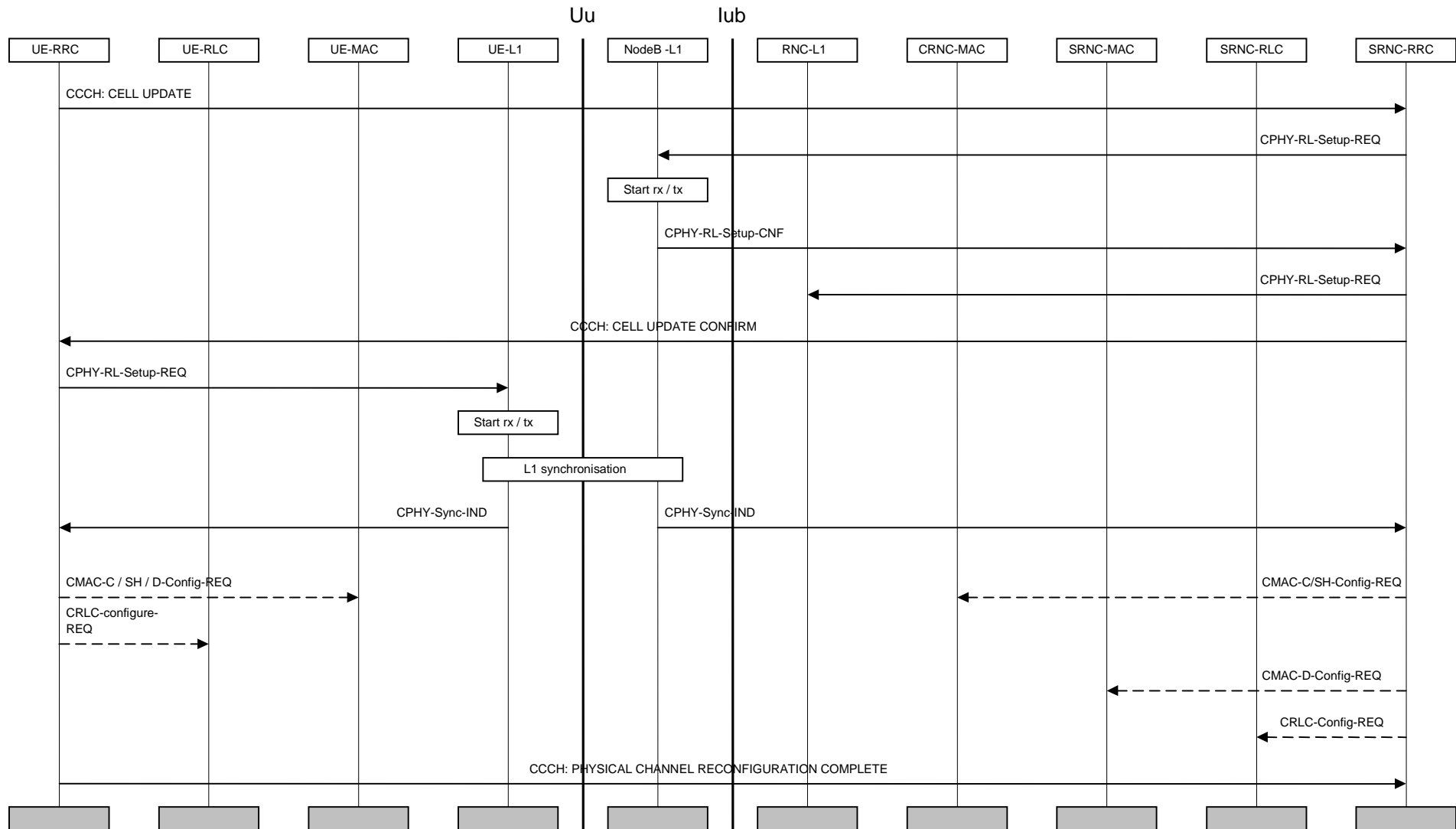

Figure 38: RRC connection re-establishment

Figure 38 shows an example of the procedure when a UE loses radio connection due to e.g. radio link failure. After having selected a new cell, the UE RRC sends the NW RRC a CELL UPDATE message. The CELL UPDATE message contains information to the network that it was sent due to a radio link failure. The NW RRC configures the NW and acknowledges the connection re-establishment to the UE RRC with a CELL UPDATE CONFIRM message. The UE RRC configures the UE L1 to activate the new radio link(s). After the UE has synchronised to at least one radio link, the MAC and RLC layers can be configured (if necessary).

When the procedure is completed on the UE side, a PHYSICAL CHANNEL RECONFIGURATION COMPLETE message is sent.

#### 6.4.10 Inter-system Handover: GSM/BSS to UTRAN

The handover from GSM/BSS to UTRAN for a dual-mode GSM MS / UMTS UE is illustrated in figure 39. On the network side, upon the reception of a HARD HANDOVER PROCEED 2 command through the RANAP protocol, the RRC layer performs admission control and radio resource allocation assigning an RNTI for the RRC connection and selecting radio resource parameters (such as transport channel type, transport format sets, etc). RRC configures these parameters on layer 1 and layer 2 to locally establish the DCH logical channel.

The selected parameters including the RNTI, were previously transmitted to UE via RANAP message HARD HANDOVER PROCEED 1 and GSM upgraded message HANDOVER COMMAND.

Upon reception of the HANDOVER COMMAND message, the GSM RR layer transmits the required parameters to the UMTS RRC layer using an RR-Data-IND primitive. UE RRC configures L1 and L2 using these parameters to locally establish the DCH logical channel. Layer 1 indicates to RRC when it has reached synchronisation. An RLC signalling link establishment is then initiated by the UE. A HANDOVER COMPLETE message is finally sent by the UE.

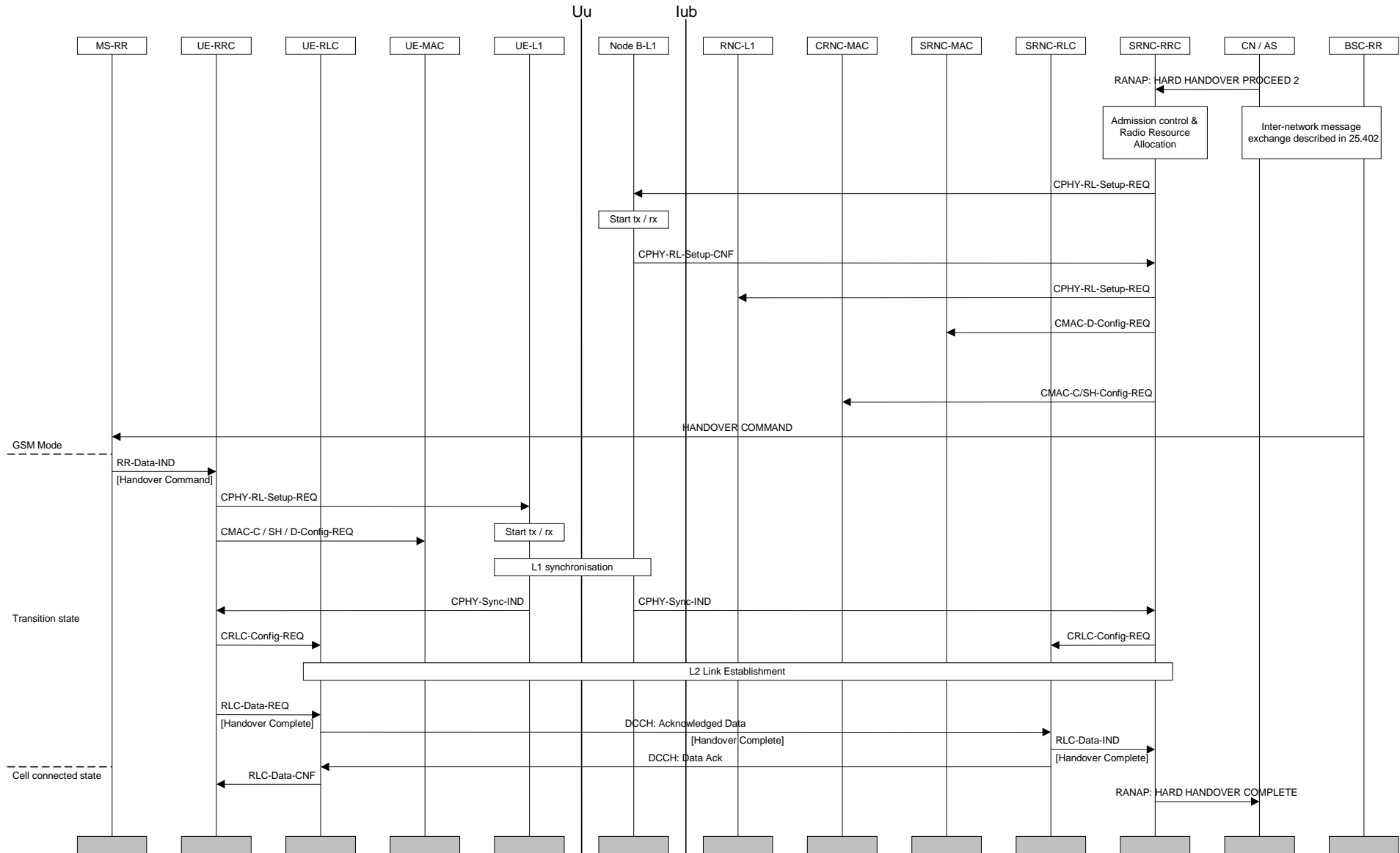

Figure 39: GSM to UMTS inter-system handover

### 6.4.11 Inter-RAT Handover: UTRAN to GSM/BSS, CS domain services

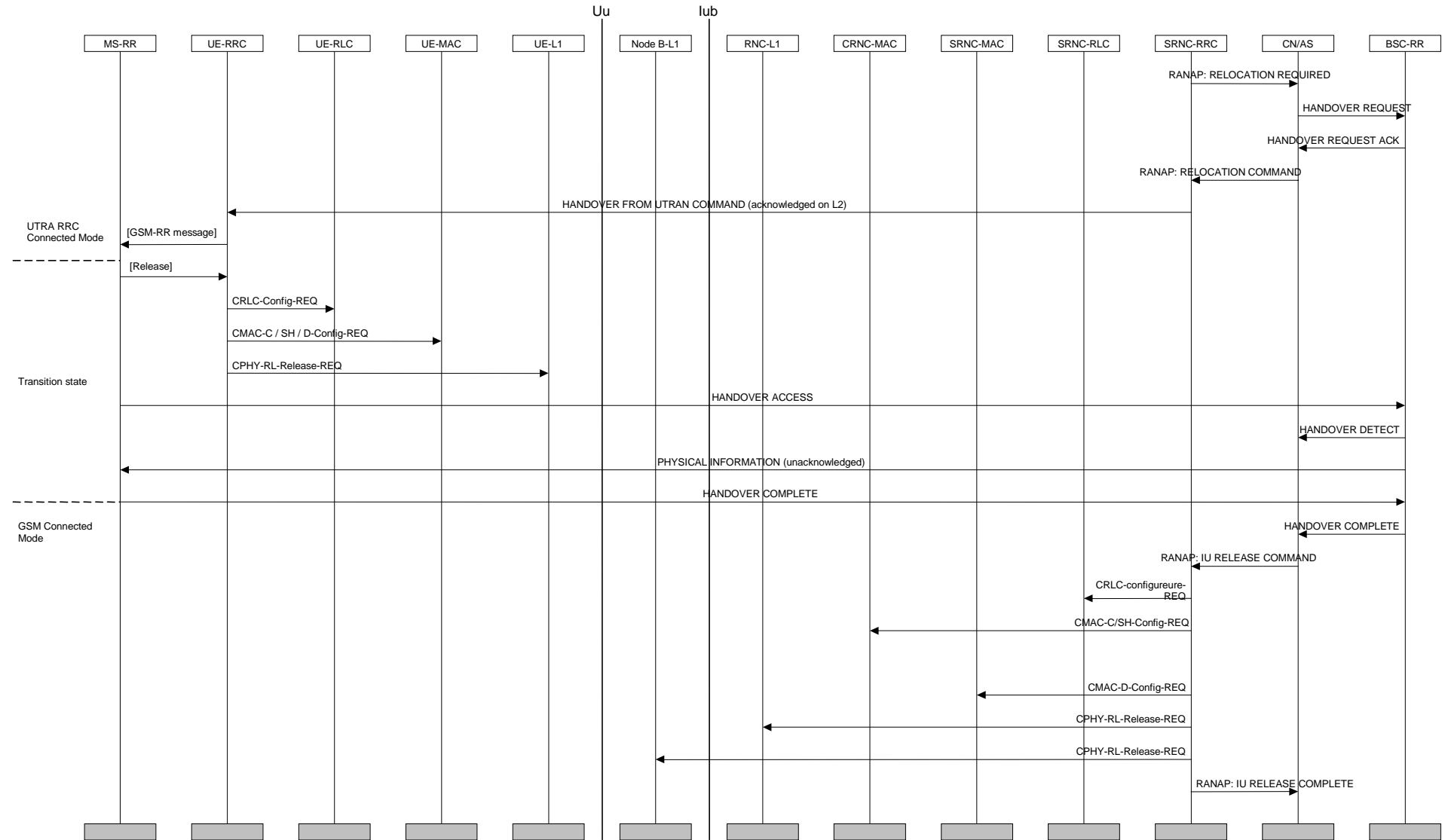

Figure 40: UTRAN to GSM inter-RAT handover



NOTE: The scope of this description is restricted to a UE having a connection only to CS domain services, i.e. no simultaneous PS signalling connection.

For CS domain services UTRAN to GSM inter-RAT Handover procedure is based on measurement reports from the UE but initiated from the UTRAN. HANOVER FROM UTRAN COMMAND is sent using acknowledged data transfer on the DCCH. The UE transition from UTRAN Connected Mode starts when an HANOVER FROM UTRAN COMMAND is received. The transition to GSM Connected mode is finished when HANOVER COMPLETE message is sent from the UE.

UTRAN sends a RELOCATION REQUIRED to CN/AS. This message contains information needed for the GSM system to be able to perform a handover (e.g. serving cell, target cell). Some parts of this information (e.g. MS classmark) have been obtained at setup of the RRC Connection and are stored in CN.

The CN/AS sends a HANOVER REQUEST message to BSC-RR allocating the necessary resources to be able to receive the GSM MS and acknowledge this by sending HANOVER REQUEST ACKNOWLEDGE to CN/AS. The HANOVER REQUEST ACKNOWLEDGE contains a GSM-RR message with all radio-related information that the UE needs for the handover.

CN/AS sends a RELOCATION COMMAND (type UTRAN-to-BSS HARD HANOVER) to the UTRAN to start the execution of the handover. This message contains a GSM-RR message with all the information needed for the UE to be able to switch to the GSM cell and perform a handover to GSM.

Upon reception of the HANOVER FROM UTRAN COMMAND message in the UE, the UE-RRC entity forwards the GSM-RR message to the MS-RR entity. To release the UTRA resources the MS-RR entity requests the UE-RRC entity to release the RRC connection locally. The UE-RRC entity can then locally release the resources on the RLC, MAC and physical layers of the UE.

After having switched to the assigned GSM channel received in the HANOVER FROM UTRAN COMMAND, the GSM MS sends HANOVER ACCESS in successive layer 1 frames, just as it typically would have done for a conventional GSM handover initiation.

When the BSC-RR has received the HANOVER ACCESS it indicates this to the CN/AS by sending a HANOVER DETECT message. The BSC-RR sends a PHYSICAL INFORMATION message to the GSM MS in unacknowledged mode that contains various fields of physical layer -related information allowing a proper transmission by the MS.

After layer 1 and 2 connections are successfully established, the GSM MS returns the HANOVER COMPLETE message.

CN/AS is then able to release the UTRAN resources that were used for the UE in UTRAN Connected Mode. The CN/AS send a IU RELEASE COMMAND to UTRAN, after which UTRAN can release all NW resources from RLC, MAC and the physical layer. When the release operation is complete, a IU RELEASE COMPLETE message is sent to CN / AS.

## 6.5 CN originated paging request in connected mode

### 6.5.1 UTRAN coordinated paging using DCCH

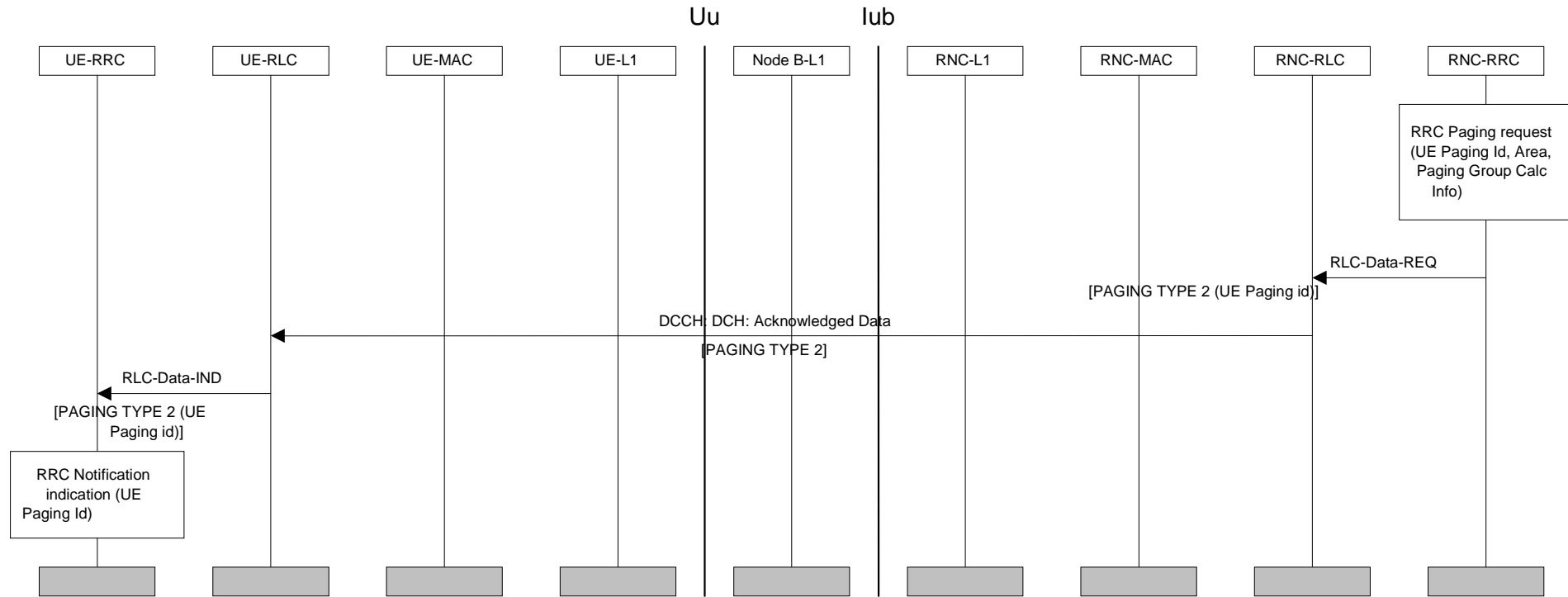

Figure 41: Example sequence of CN initiated paging request using DCCH

The above sequence illustrates a CN originated paging request, when the UE is in connected mode and can be reached on the DCCH. The coordination of the paging request with the existing RRC connection is done in UTRAN.

The entity above RRC on the network side requests paging of a UE over the Nt-SAP. The request contains a UE paging identity, an area where the page request is to be broadcast, information for calculation of the paging group.

Since the UE can be reached on the DCCH, the RRC layer formats a PAGING TYPE 2 message containing the UE paging identity, and the message is transmitted directly to the UE using unacknowledged data transfer.

## 6.6 UTRAN originated paging request and paging response

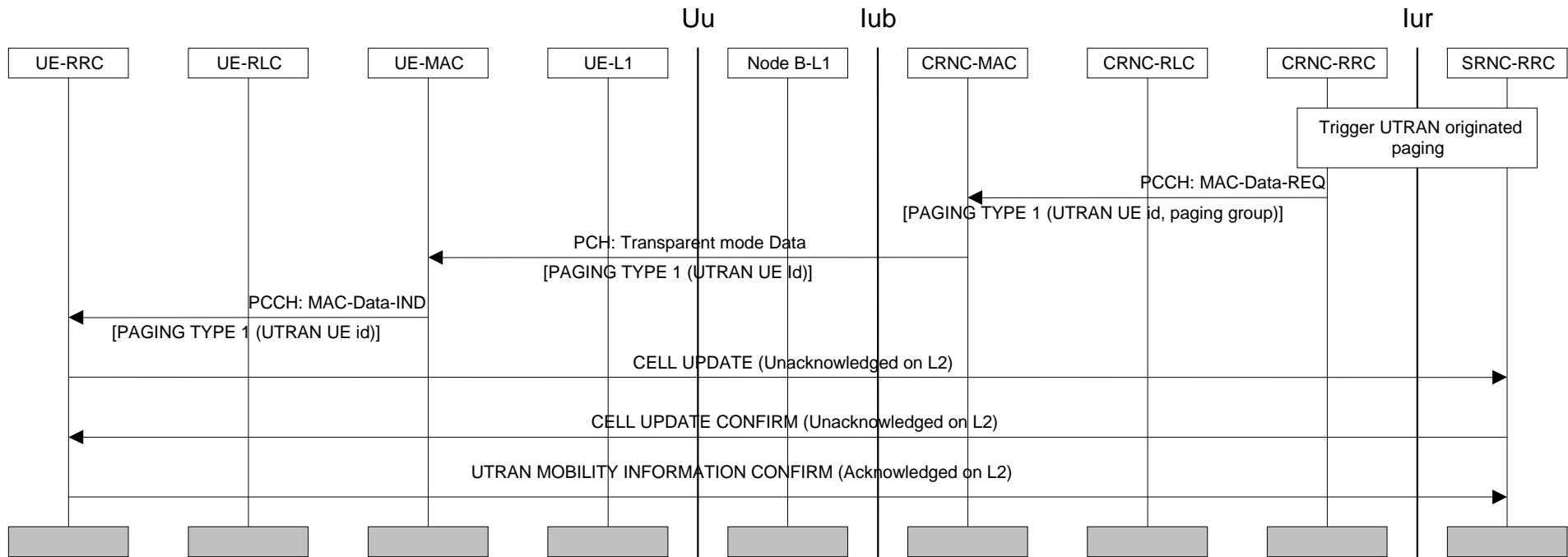

Figure 42: Example sequence for UTRAN initiated paging request with paging response

The RRC layer in the network uses this sequence to trigger a switch to CELL\_FACH state, when the UE can only be reached on the PCH (the CELL\_PCH state or the URA\_PCH state). A Paging Type 1 message is prepared, containing the UTRAN UE identity (s-RNTI + RNC-ID). The RRC requests the transmission of the message by MAC on the PCCH, indicating the paging group.

In the UE, the RRC layer continuously monitors the paging group on the PCH and compares the UE identities in received paging request messages with its own identities. A match occurs, and in this case the RRC layer changes state to CELL\_FACH state.

The UE prepares a Cell Update message, which is sent on CCCH.

When the network receives the Cell Update message, a c-RNTI is allocated and signalled to UE using the Cell Update Confirm message, which is sent on DCCH using unacknowledged mode. The latter message also acknowledges the reception of the Cell Update message. The UE configures MAC to use the new c-RNTI and prepares a UTRAN MOBILITY INFORMATION CONFIRM message. When the network receives the UTRAN MOBILITY INFORMATION CONFIRM message on DCCH it can delete any old c-RNTI and the DCCH/DTCH logical channels can be used also in the downlink using the new c-RNTI.

## 6.7 Other procedures

### 6.7.1 UE Capability Information

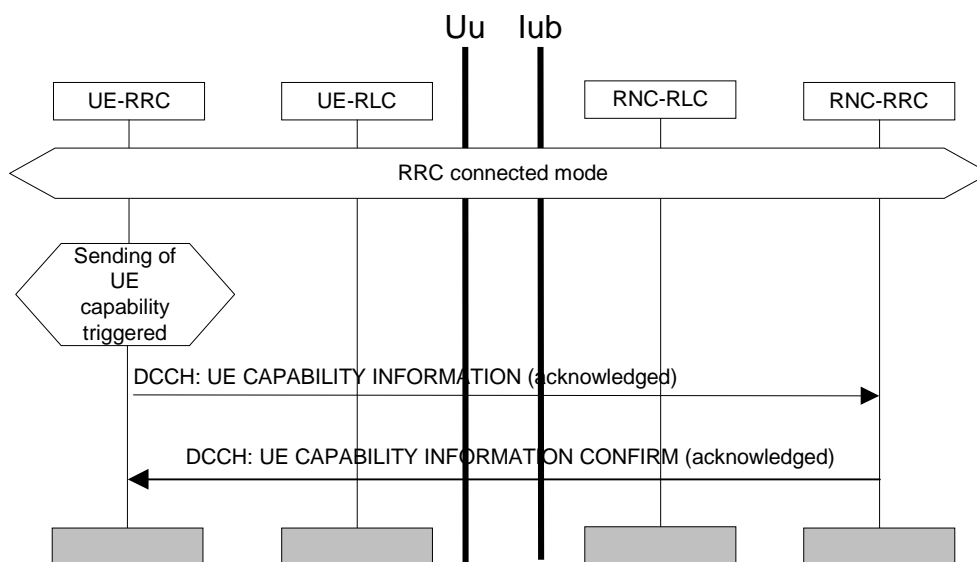

**Figure 43: UE Capability Information**

The UE transfers its capability information to the network by transmitting the RRC message UE Capability Information using acknowledged mode on the DCCH. UTRAN confirms the reception of the UE capabilities by transmitting an UE CAPABILITY INFORMATION CONFIRM message using acknowledged mode on the DCCH. This procedure is performed during the lifetime of the RRC Connection if the UE capability information changes (e.g. due to change in UE power class). UE capability information can also explicitly be requested by UTRAN.

### 6.7.2 Random access transmission sequence (FDD)

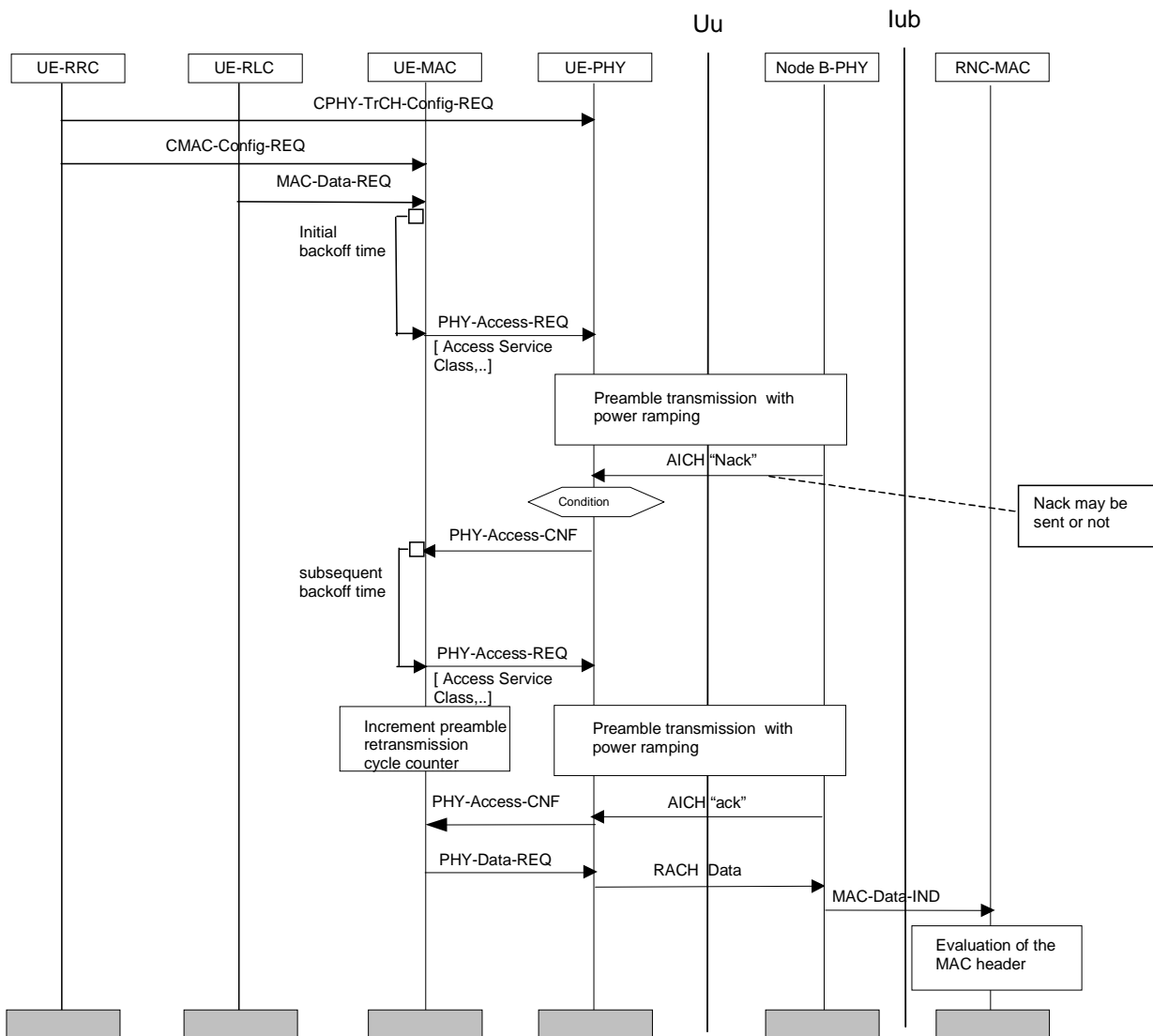

**Figure 44: Random access transmission sequence (FDD)**

The RACH and AICH are configured once via a CPHY-TrCH-Config-REQ primitive. This primitive is issued only for initial configuration or when a parameter shall be changed, not for every RACH transmission.

The CMAC-Config-REQ primitive is used to configure MAC parameters required for the random access procedure (e.g. persistence value, maximum number of preamble ramping cycles, initial and subsequent backoff times).

When there is data to be transmitted on the RACH, i.e. reception of a MAC-Data-REQ primitive, the RACH transmission control procedure is started, which includes selection of Access Service Class (ASC).

After some initial backoff, a primitive PHY-Access-REQ containing the selected ASC is sent to L1. This triggers the PRACH preamble transmission procedure, i.e. the physical layer selects a PRACH access slot and signature without further backoff delay imposed on L1, but within the constraints of the selected ASC.

If the maximum permitted transmission power was reached without receiving an acknowledgement, or a negative acknowledgement (Nack) has been received on AICH, the preamble ramping cycle is repeated. The number of preamble ramping cycles is counted in MAC.

Upon successful transmission of a preamble, MAC receives an acknowledgement via PHY-Access-CNF primitive that the acquisition indicator was received. Then message transmission is requested with the PHY-Data-REQ primitive.

### 6.7.3 Random access transmission sequence (TDD)

#### 6.7.3.1 Random access transmission sequence (3.84 Mcps TDD)

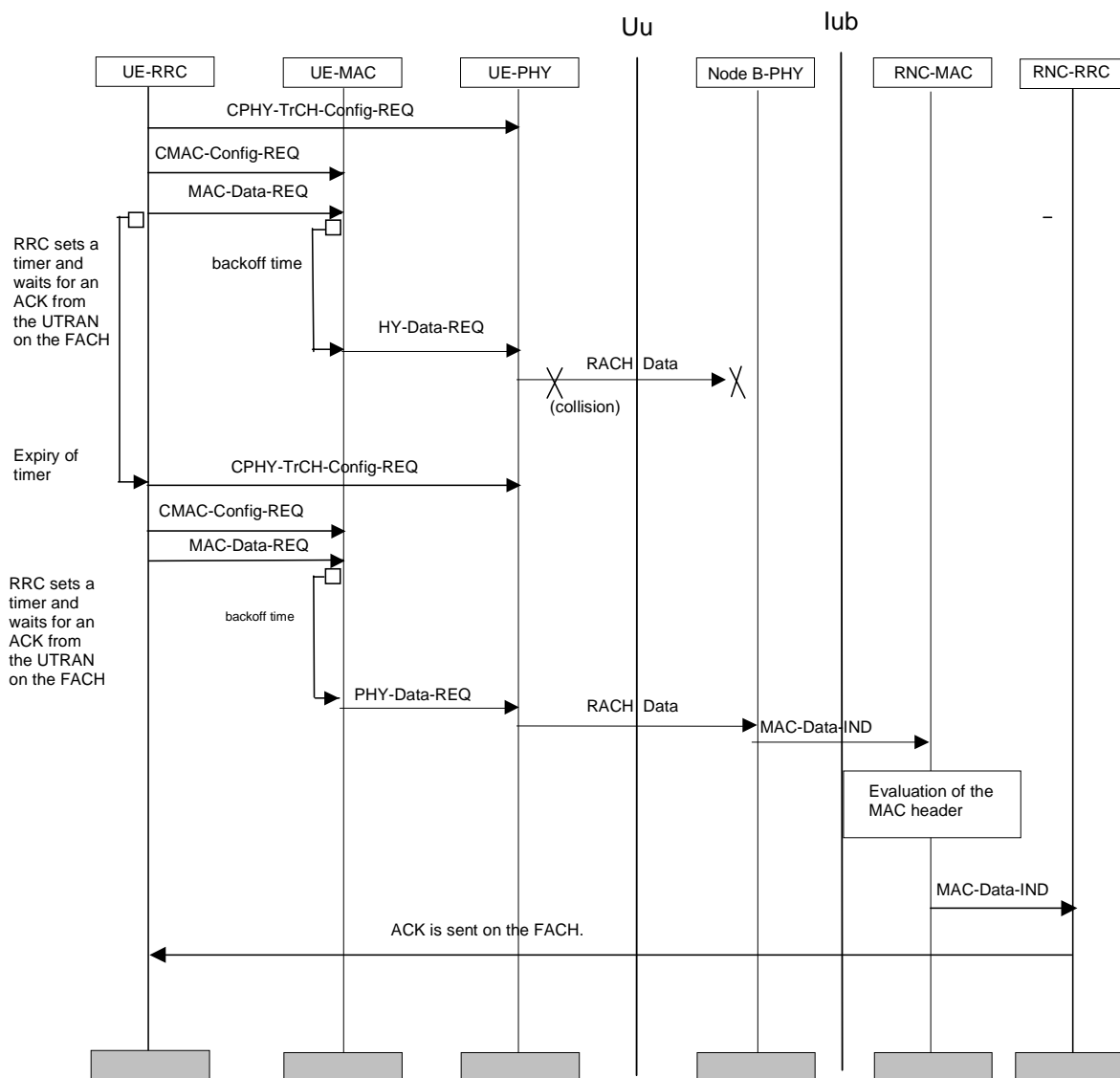

**Figure 45: Random access transmission sequence (3.84 Mcps TDD)**

The RACH is configured once via a CPHY-TrCH-Config-REQ primitive. This primitive needs to be used only for initial configuration (e.g. power parameter) or when a parameter shall be changed, not for every RACH transmission.

The CMAC-Config-REQ primitive is used to configure MAC parameters required for the random access procedure. The parameters could include random access control parameters such as, persistence value and Access Service Class (ASC) parameters.

When there is data to be transmitted on the RACH, i.e. reception of a MAC-Data-REQ primitive, the RACH transmission control procedure is started, which includes selection of an Access Service Class (ASC).

After some backoff, a primitive PHY-Data-REQ is sent to L1, which triggers the PRACH message transmission, i.e. the physical layer selects a PRACH spreading-code without further backoff delay imposed on L1, but within the constraints of the selected ASC. Note that the backoff time on MAC may in certain conditions be set to zero (e.g. when the uplink load is low).

At the UTRAN-side MAC the further processing of received RACH message depends on the MAC header. An acknowledgement that the message was received correctly is given by a RRC procedure. In case of transparent RLC, message retransmission shall be handled entirely on RRC employing retransmission timers. In case of non-transparent RLC, the timers are controlled by the RLC. The parameters of PRACH transmission are chosen such that the number of retransmissions for the messages are kept low. Message loss on the PRACH should be due to a collision on the same spreading code.

6.7.3.2 Random access transmission sequence (1.28 Mcps TDD)

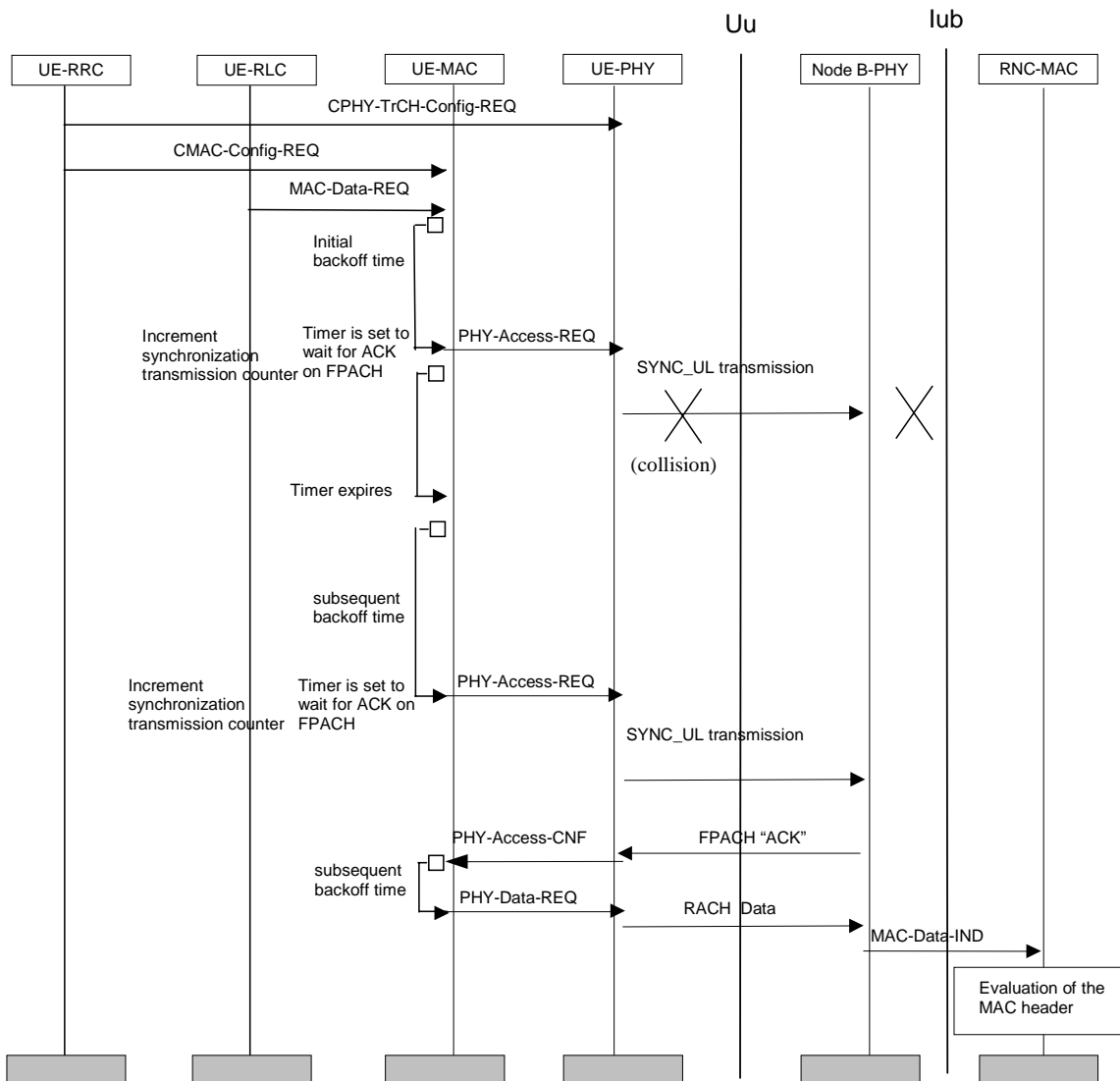

Figure 46: Random access transmission sequence(1.28 Mcps TDD)

The RACH is configured once via a CPHY-TrCH-Config-REQ primitive. This primitive needs to be used only for initial configuration or when a parameter shall be changed, not for every RACH transmission.

The CMAC-Config-REQ primitive is used to configure MAC parameters required for the random access procedure. The parameters could include random access control parameters such as persistence value, Access Service Class (ASC) parameters and maximum number of synchronisation attempts.

When there is data to be transmitted on the RACH, i.e. reception of a MAC-Data-REQ primitive, the RACH transmission control procedure is started, which includes selection of an Access Service Class (ASC).

After some backoff, a primitive PHY-Access-REQ is sent to L1, which triggers the PRACH message transmission, i.e. the physical layer selects a SYNC\_UL code without further backoff delay imposed on L1, but within the constraints of the selected ASC.



If PHY received no acknowledgement on the FPACH and the maximum number of synchronisation attempts permitted has not been exceeded, the PHY-Access-REQ procedure is repeated.

If the SYNC\_UL burst has been acknowledged on the FPACH, MAC receives an acknowledgement via PHY-Access-CNF primitive. Then data transmission is requested with a PHY-DATA-REQ primitive, and the PRACH transmission procedure shall be completed with transmission of the PRACH message on the PRACH resources associated with FPACH.

### 6.7.4 CPCH Emergency Stop sequence

Figure 47 illustrates the CPCH emergency stop procedure. This procedure is invoked by a request from Node B RRC, when Node B detects emergency stop conditions such as temporary overload situation in the cell. CPCH emergency stop is initiated by CPHY-CPCH-Estop-REQ primitive issued from Node B RRC to Node B L1. Upon the reception of this primitive, Node B L1 sends CPCH emergency stop command to UE L1.

Upon the reception of emergency stop command, UE L1 sends CPHY-CPCH-Estop-IND primitive to UE RRC indicating the reception of CPCH emergency stop command. Then, UE RRC replies with CPHY-CPCH-Estop-Resp primitive to command UE L1 to execute CPCH emergency stop. After UE L1 stops on-going CPCH transmission, it sends PHY-Status-IND primitive to UE MAC indicating the completion of CPCH Emergency stop. Meanwhile, when Node B L1 detects CPCH link loss, it sends CPHY-CPCH-Estop-CNF primitive to Node B RRC. This completes CPCH emergency stop procedure.

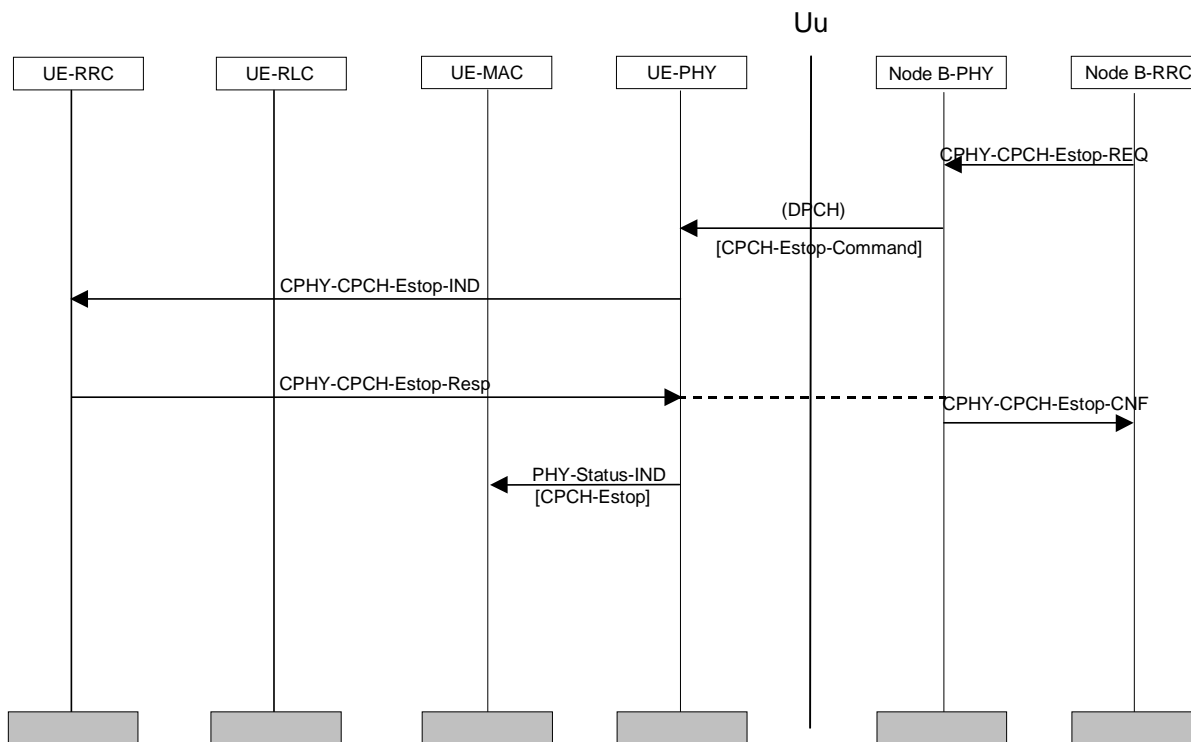

Figure 47: CPCH Emergency Stop Sequence

# 7 Traffic volume monitoring

An algorithm will be defined for the UE to trigger a message to the NW based on transmitter buffer status.

Figure 48 illustrates the example of message sequence of traffic volume monitoring procedure. RRC in UE gets the parameters necessary for traffic volume measurement from Measurement Control message or System information message sent by RRC in UTRAN. RRC in UE passes the MAC the parameters for traffic volume measurement with the CMAC-Measurement-REQ. Meanwhile, RLC passes the data to MAC with buffer status. There are two ways MAC indicates the traffic volume measurement report to RRC, periodic and event-triggered. If it is periodic report, the MAC reports the measurement result to RRC periodically. If it is event-triggered, MAC in UE reports the measurement result to RRC when the result is beyond the specified threshold value. After that, based on the measurement report from MAC and reporting criteria received from UTRAN, RRC makes a decision whether it should send Measurement Report Message to UTRAN. When RRC in UTRAN receives the Measurement Report Message, it takes a proper action based on the measurement report from UE. It can be bearer reconfiguration, transport channel reconfiguration, physical channel reconfiguration or transport channel combination control procedure. The report mode, periodic and event-triggered, can be used exclusively, or simultaneously as shown in figure 1.

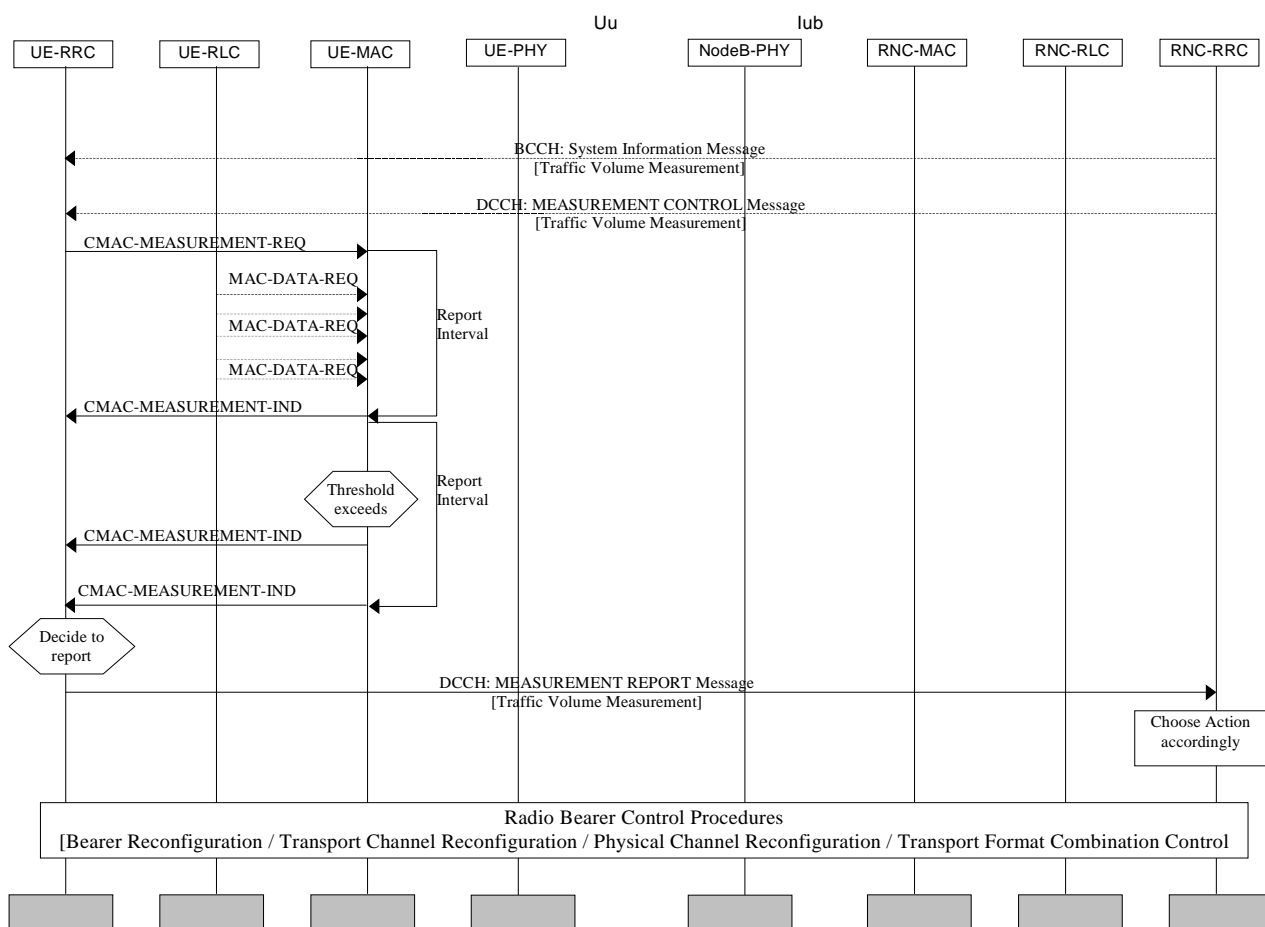

Figure 48: Traffic Volume Measurement Report Procedure

## Annex A (informative): Change history

Change history							
Date	TSG #	TSG Doc.	CR	Rev	Subject/Comment	Old	New
06/1999	RP-04	RP-99310	-		Approved at TSG-RAN #4 placed under Change Control	-	3.0.0
10/1999	RP-05	RP-99462	001		RRC connection establishment procedure	3.0.0	3.1.0
	RP-05	RP-99462	002	1	RRC Connection release procedure	3.0.0	3.1.0
	RP-05	RP-99462	003		Cell update and URA update procedures	3.0.0	3.1.0
	RP-05	RP-99462	004		Removal of FFS in DSCH transmission example	3.0.0	3.1.0
	RP-05	RP-99462	005		Incorporation of DSCH transmission with one TFCI	3.0.0	3.1.0
	RP-05	RP-99462	006		RRC Traffic Volume Monitoring Procedure	3.0.0	3.1.0
	RP-05	RP-99462	007		Transfer and update of system information	3.0.0	3.1.0
	RP-05	RP-99462	008		UE controlled AMR mode adaptation	3.0.0	3.1.0
	RP-05	RP-99462	009		Model of RACH procedures	3.0.0	3.1.0
	RP-05	RP-99462	012		USCH/DSCH data transfer for TDD	3.0.0	3.1.0
	RP-05	RP-99462	013		Removal of UE State Description	3.0.0	3.1.0
	RP-05	RP-99462	014		Editorial renaming request	3.0.0	3.1.0
	RP-05	RP-99462	015		Release version for Asymmetric transport channel reconfiguration procedure	3.0.0	3.1.0
	RP-05	RP-99462	016		Example message sequence for RACH transmissions in TDD mode	3.0.0	3.0.0
12/1999	RP-06	RP-99629	017	1	Support of shared channel operation in TDD and alignment to Mac-c/sh merge	3.1.0	3.2.0
	RP-06	RP-99628	018	2	Corrections to RRC State Names	3.1.0	3.2.0
	RP-06	RP-99628	021		Editorial issues	3.1.0	3.2.0
03/2000	RP-07	RP-000036	022	4	CPCH start of message indication	3.2.0	3.3.0
	RP-07	RP-000036	023		Correction to Transport Format Combination Control procedure	3.2.0	3.3.0
	RP-07	RP-000036	025	1	CPCH Emergency Stop sequence	3.2.0	3.3.0
	RP-07	RP-000036	026	1	Variable Rate Packet Transmission for uplink DCH	3.2.0	3.3.0
	RP-07	RP-000036	027		Random access transmission sequence	3.2.0	3.3.0
06/2000	RP-08	RP-000216	029		Corrections to L2 link management and radio link setup in interlayer message sequence charts	3.3.0	3.4.0
	RP-08	RP-000216	030		Alignment of FDD downlink shared channel descriptions with 25.331	3.3.0	3.4.0
	RP-08	RP-000216	031	1	End of CPCH transmission	3.3.0	3.4.0
	RP-08	RP-000216	033		Out-of-synch corrections	3.3.0	3.4.0
	RP-08	RP-000216	034		Traffic Volume Monitoring	3.3.0	3.4.0
09/2000	RP-09	RP-000354	035	2	SRNS relocation	3.4.0	3.5.0
	RP-09	RP-000354	037		Variable Rate Transmission	3.4.0	3.5.0
12/2000	RP-10	RP-000564	038	1	Corrections to SRNS Relocation	3.5.0	3.6.0
	RP-10	RP-000564	040		Correction to Relocation text	3.5.0	3.6.0
03/2001	RP-11	RP-010021	041	1	Text corrections	3.6.0	3.7.0
	RP-11	RP-010021	042		SRNS relocation	3.6.0	3.7.0
	RP-11	RP-010021	044		Clean-up	3.6.0	3.7.0
	RP-11	RP-010037	043		1.28Mcps TDD	3.7.0	4.0.0
06/2001	RP-12	RP-010304	046		Corrections to procedure examples	4.0.0	4.1.0
09/2001	RP-13	RP-010538	051		SRNS relocation and header compression protocol	4.1.0	4.2.0
	RP-13	RP-010538	053		Alignment on active set update	4.1.0	4.2.0
	RP-13	RP-010538	057		Proposed correction to SRNS relocation procedure	4.1.0	4.2.0
12/2001	RP-14	RP-010755	059		Correction to RNTI in cell-update and URA-update procedures	4.2.0	4.3.0
	RP-14	RP-010755	061		HFN transfer between network nodes in SRNS relocation	4.2.0	4.3.0
03/2002	RP-15	RP-020062	064		Correction on RRC connection establishment procedure	4.3.0	4.4.0
	RP-15	RP-020062	067		Alignment of SRNS relocation in CELL_DCH	4.3.0	4.4.0
	RP-15	RP-020062	069		Corrections on combined Cell/URA update and SRNS relocation	4.3.0	4.4.0
06/2002	RP-16	RP-020323	071		Clarification on lossless SRNS Relocation	4.4.0	4.5.0

---

## History

<b>Document history</b>		
V4.0.0	March 2001	Publication
V4.1.0	June 2001	Publication
V4.2.0	September 2001	Publication
V4.3.0	December 2001	Publication
V4.4.0	March 2002	Publication
V4.5.0	June 2002	Publication