

ETSI TS 125 305 V5.5.0 (2003-03)

Technical Specification

**Universal Mobile Telecommunications System (UMTS);
User Equipment (UE) positioning in
Universal Terrestrial Radio Access Network (UTRAN);
Stage 2
(3GPP TS 25.305 version 5.5.0 Release 5)**



Reference

RTS/TSGR-0225305v550

Keywords

UMTS

ETSI

650 Route des Lucioles
F-06921 Sophia Antipolis Cedex - FRANCE

Tel.: +33 4 92 94 42 00 Fax: +33 4 93 65 47 16

Siret N° 348 623 562 00017 - NAF 742 C
Association à but non lucratif enregistrée à la
Sous-Préfecture de Grasse (06) N° 7803/88

Important notice

Individual copies of the present document can be downloaded from:

<http://www.etsi.org>

The present document may be made available in more than one electronic version or in print. In any case of existing or perceived difference in contents between such versions, the reference version is the Portable Document Format (PDF). In case of dispute, the reference shall be the printing on ETSI printers of the PDF version kept on a specific network drive within ETSI Secretariat.

Users of the present document should be aware that the document may be subject to revision or change of status. Information on the current status of this and other ETSI documents is available at

<http://portal.etsi.org/tb/status/status.asp>

If you find errors in the present document, send your comment to:

editor@etsi.org

Copyright Notification

No part may be reproduced except as authorized by written permission.
The copyright and the foregoing restriction extend to reproduction in all media.

© European Telecommunications Standards Institute 2003.
All rights reserved.

DECTTM, **PLUGTESTS**TM and **UMTS**TM are Trade Marks of ETSI registered for the benefit of its Members.
TIPHONTM and the **TIPHON logo** are Trade Marks currently being registered by ETSI for the benefit of its Members.
3GPPTM is a Trade Mark of ETSI registered for the benefit of its Members and of the 3GPP Organizational Partners.

Intellectual Property Rights

IPRs essential or potentially essential to the present document may have been declared to ETSI. The information pertaining to these essential IPRs, if any, is publicly available for **ETSI members and non-members**, and can be found in ETSI SR 000 314: *"Intellectual Property Rights (IPRs); Essential, or potentially Essential, IPRs notified to ETSI in respect of ETSI standards"*, which is available from the ETSI Secretariat. Latest updates are available on the ETSI Web server (<http://webapp.etsi.org/IPR/home.asp>).

All published ETSI deliverables shall include information which directs the reader to the above source of information.

Foreword

This Technical Specification (TS) has been produced by ETSI 3rd Generation Partnership Project (3GPP).

The present document may refer to technical specifications or reports using their 3GPP identities, UMTS identities or GSM identities. These should be interpreted as being references to the corresponding ETSI deliverables.

The cross reference between GSM, UMTS, 3GPP and ETSI identities can be found under <http://webapp.etsi.org/key/queryform.asp>.

Contents

Intellectual Property Rights	2
Foreword.....	2
Foreword.....	6
1 Scope	7
2 References	7
2.1 Normative references	7
2.2 Informative references.....	8
3 Definitions and abbreviations.....	8
3.1 Definitions.....	8
3.2 Abbreviations	8
4 Main concepts and requirements	9
4.1 Assumptions	10
4.2 UE Positioning Methods	11
4.3 Standard UE Positioning Methods	11
4.3.1 Cell ID Based Method	11
4.3.2 OTDOA-IPDL Method with network configurable idle periods	12
4.3.3 Network-assisted GPS Methods	12
5 UTRAN UE Positioning Architecture.....	12
5.1 UE Positioning Operations	13
5.1.1 Co-ordination, Measurement and Calculation Functions.....	13
5.2 Functional Description of UTRAN UE Positioning related elements	14
5.2.1 Radio Network Controller (RNC).....	14
5.2.1.1 Serving RNC	14
5.2.1.2 Other RNC	15
5.2.1.2.1 Controlling RNC	15
5.2.1.2.2 Drift RNC	15
5.2.2 Node B	16
5.2.3 Location measurement unit (LMU)	16
5.2.4 User Equipment (UE)	17
5.2.5 Stand-alone SMLC	17
6 Signalling protocols and interfaces	18
6.1 LCS signalling between SRNC and MSC/SGSN	18
6.2 SRNC signalling to a target UE.....	18
6.3 Controlling RNC signalling to a standalone LMU	18
6.4 Controlling RNC signalling to an associated LMU.....	18
6.5 RNC-to-RNC signalling for UE Positioning support	18
6.5a SAS to RNC signalling for PCAP	18
6.6 Interfaces	18
6.6.1 Iu Interface.....	18
6.6.2 Iur Interface	18
6.6.2.1 Signalling between SRNC and DRNC	19
6.6.2.2 Signalling between SRNC and CRNC	19
6.6.3 Iub Interface.....	19
6.6.3.1 Signalling between CRNC and associated LMU	19
6.6.4 Uu Interface	19
6.6.4.1 Signalling between SRNC and Target UE	20
6.6.4.1.1 Assistance Data Delivery to UE	20
6.6.4.1.2 Error Handling.....	21
6.6.4.1.3 Broadcast of Assistance Data	21
6.6.4.1.4 Signalling Flow for Assistance Data Broadcast Using the Common UTRAN Broadcast Service	21
6.6.4.1.5 UE Positioning Assistance Data Ciphering	21

6.6.4.1.6	UE Positioning Assistance Data Ciphering Algorithm.....	21
6.6.4.2	Signalling between RNC and stand-alone LMU	22
6.6.5	Iupc Interface	23
6.6.5.1	Signalling between RNC and SAS.....	23
6.6.5.1.1	PCAP Position Calculation.....	23
6.6.5.1.2	PCAP Information Exchange	24
7	General UTRAN UE Positioning procedures.....	25
7.1	General procedures in UTRAN for UE Positioning	25
7.2	Common procedures supporting UE Positioning interaction between RNCs	25
7.2.1	Signalling in case of SRNS relocation.....	25
7.3	Exception procedures	26
7.3.1	Procedures in the SRNC	26
7.3.2	Procedures in a LMU.....	26
7.3.3	Procedures in the target UE	26
7.3.4	Procedures in the SAS	26
7.4	Radio interface timing procedures.....	26
7.4.1	LMU Functions.....	27
7.4.2	CRNC Functions.....	27
7.4.3	LMU-CRNC Interactions	27
8	Cell ID based positioning method	28
8.1	Cell ID determination	29
8.1.1	UE Cell ID is not known.....	29
8.1.2	UE Cell ID is known.....	29
8.1.2.1	UE not in Soft handover.....	29
8.1.2.2	UE in Soft handover	29
8.2	Mapping the Cell ID to Geographic Co-ordinates or a Service Area.....	30
9	OTDOA positioning method	30
9.1	Use of Idle Periods	32
9.2	Relative Time Difference (RTD).....	32
9.3	Time of Day (ToD).....	33
9.4	Node B Synchronisation.....	33
9.5	OTDOA-IPDL and OTDOA Modes	33
9.5.1	Information to be transferred between UTRAN elements	33
9.6	OTDOA network positioning procedures.....	35
10	Network-assisted GPS positioning method	36
10.1	Timing calibration	38
10.2	Timing assistance	38
10.3	GPS assistance data	38
10.4	UE search	38
10.5	Position determination.....	38
10.5.1	Information to be transferred between UTRAN elements	39
10.5.1.1	Almanac data.....	40
10.5.1.2	DGPS corrections.....	40
10.5.1.3	Ionospheric corrections	41
10.5.1.4	Ephemeris data and clock correction	41
10.5.1.5	Real Time integrity monitor function.....	41
10.5.1.6	GPS reference time	41
10.5.1.7	UTC.....	42
10.5.1.8	Reference Location	42
10.5.1.9	Additional non-GPS related information	42
10.6	Network Assisted GPS positioning Procedure	42
11	Information storage	44
Annex A (informative): Definitions and Terms		45
Annex B (informative): Reference Model of Functional Entities for UTRAN UE Positioning		47
B.1	Internal Client Group.....	48
B.1.1	Internal UTRAN Location Client Function (U-LCF)	48
B.2	UTRAN System Handling group	49

B.2.1	UTRAN Location System Control Function (U-LSCF)	49
B.2.2	UTRAN Location System Operations Function (U-LSOF).....	49
B.3	Positioning group	50
B.3.1	UTRAN Position Radio Co-ordination Function (U-PRCF)	50
B.3.2	UTRAN Position Calculation Function (U-PCF)	50
B.3.3	UTRAN Position Signal Measurement Function (U-PSMF).....	50
B.3.4	UTRAN Position Radio Resource Management (U-PRRM).....	51
B.4	Assignment of LCS Functional Entities to UTRAN Elements.....	51
Annex C (informative): Location Services Categories		52
Annex D (informative): Change history		53
History		55

Foreword

This Technical Specification (TS) has been produced by the 3rd Generation Partnership Project (3GPP).

The contents of the present document are subject to continuing work within the TSG and may change following formal TSG approval. Should the TSG modify the contents of the present document, it will be re-released by the TSG with an identifying change of release date and an increase in version number as follows:

Version x.y.z

where:

- x the first digit:
 - 1 presented to TSG for information;
 - 2 presented to TSG for approval;
 - 3 or greater indicates TSG approved document under change control.
- y the second digit is incremented for all changes of substance, i.e. technical enhancements, corrections, updates, etc.
- z the third digit is incremented when editorial only changes have been incorporated in the document.

1 Scope

The present document specifies the stage 2 of the UE Positioning function of UTRAN, which provides the mechanisms to support the calculation of the geographical position of a UE. UE position knowledge can be used for example in support of Radio Resource Management functions, location-based services for operators, subscribers and third party service providers. The purpose of this stage 2 specification is to define the UTRAN UE Positioning architecture, functional entities and operations to support positioning methods. This description is confined to the UTRAN Access Stratum. It does not define nor describe how the results of the UE position calculation can be utilised in the Core Network (e.g. LCS) or in UTRAN (e.g. RRM).

UE Positioning may be considered as a network provided enabling technology consisting of standardised service capabilities, which enable the provision of location applications. The application(s) may be service provider specific. The description of the numerous and varied possible location applications which are enabled by this technology are outside the scope of the present document. However, clarifying examples of how the functionality being described may be used to provide specific location services may be included.

This stage 2 specification covers the UTRAN positioning methods, state descriptions, and message flows to support UE Positioning.

2 References

The following documents contain provisions which, through reference in this text, constitute provisions of the present document.

- References are either specific (identified by date of publication, edition number, version number, etc.) or non-specific.
- For a specific reference, subsequent revisions do not apply.
- For a non-specific reference, the latest version applies. In the case of a reference to a 3GPP document (including a GSM document), a non-specific reference implicitly refers to the latest version of that document *in the same Release as the present document*.

2.1 Normative references

- [1] Void.
- [2] 3GPP TR 21.905: "Vocabulary for 3GPP Specifications".
- [3] Void.
- [4] 3GPP TS 23.271: "Location Services (LCS); (Functional description) - Stage 2".
- [5] 3GPP TS 22.071: "Location Services (LCS); Service description, Stage 1".
- [6] 3GPP TS 22.100: "UMTS phase 1".
- [7] 3GPP TS 22.101: "Services aspects; Service principles".
- [8] 3GPP TS 22.105: "Services and Service Capabilities".
- [9] 3GPP TS 22.115: "Services aspects; Charging and Billing".
- [10] 3GPP TS 22.121: "Services aspects; The Virtual Home Environment; Stage 1".
- [11] 3GPP TS 23.032: "Universal Geographical Area Description (GAD)".
- [12] 3GPP TS 23.110: "UMTS Access Stratum; Services and Functions".
- [13] 3GPP TS 23.171: "Functional stage 2 description of location services in UMTS".

- [14] 3GPP TS 25.214: "Physical layer procedures (FDD)"
- [15] 3GPP TS 25.215: "Physical layer – Measurements (FDD)".
- [16] 3GPP TS 25.225: "Physical layer – Measurements (TDD)".
- [17] 3GPP TS 25.306: "UE Radio Access Capabilities".
- [18] 3GPP TS 25.331: "Radio Resource Control (RRC); protocol specification".
- [19] 3GPP TS 25.413: "UTRAN Iu interface RANAP signalling".
- [20] 3GPP TS 25.423: "UTRAN Iur interface RNSAP signalling".
- [21] 3GPP TS 25.430: "UTRAN Iub interface: General aspects and Principles".
- [22] 3GPP TS 25.433: "UTRAN Iub interface NBAP signalling".
- [23] ICD-GPS-200: "Navstar GPS Space Segment/Navigation User Interfaces".
- [24] RTCM-SC104: "RTCM Recommended Standards for Differential GNSS Service" (v.2.2.)
- [25] 3GPP TS 24.008: "Mobile radio interface layer 3 specification, Core Network Protocols - Stage 3".
- [26] 3GPP TS 25.224: "Physical layer procedures (TDD)".
- [27] 3GPP TS 25.453: "UTRAN Iupc interface PCAP signalling".
- [28] 3GPP TS 25.412: "Iu interface signalling transport".

2.2 Informative references

- [29] Third generation (3G) mobile communication system; Technical study report on the location services and technologies, ARIB ST9 December 1998.
- [30] The North American Interest Group of the GSM MoU ASSOCIATION: Location Based Services, Service Requirements Document of the Services Working Group.

3 Definitions and abbreviations

3.1 Definitions

For the purposes of the present document, the terms and definitions given in [7] and some of the terms and definitions in annex A apply.

3.2 Abbreviations

For the purposes of the present document, the following abbreviations apply.

3G-MSC	3 rd Generation MSC
3G-SGSN	3 rd Generation SGSN
A-GPS	Assisted Global Positioning Systems
ARIB	Association of Radio Industries and Business
CAMEL	Customised Application For Mobile Network Enhanced Logic
CN	Core Network
CRNC	Controlling RNC
DGPS	Differential Global Positioning Systems
DL	Downlink
DRNC	Drift RNC
GMLC	Gateway MLC

GPRS	General Packet Radio System
GPS	Global Positioning System
HLR	Home Location Register
IPDL	Idle Period Downlink
LBS	Location Based Services
LCCF	Location Client Control Function
LCF	Location Client Function
LCS	LoCation Services
LMU	Location Measurement Unit
LSCF	Location System Control Function
LSOF	Location System Operation Function
MLC	Mobile Location Centre
MSC	Mobile services Switching Centre
NAS	Non Access Stratum
OTDOA	Observed Time Difference Of Arrival
PCAP	Positioning Calculation Application Part
PCF	Position Calculation Function
PLMN	Public Land Mobile Network
PRCF	Positioning Radio Co-ordination Function
PRRM	Positioning Radio Resource Management
PSMF	Positioning Signal Measurement Function
QoS	Quality of Service
RAN	Radio Access Network
RANAP	Radio Access Network Application Part
RNC	Radio Network Controller
RRM	Radio Resource Management
RTD	Real Time Difference
RTT	Round Trip Time
SAI	Service Area Identifier
SAS	Stand-Alone SMLC
SGSN	Serving GPRS Support Node
SIM	Subscriber Identity Module
SMS	Short Message Service
SRNC	Serving RNC
SSDT	Site Selection Diversity Transmit
TOA	Time Of Arrival
TOW	Time Of Week
U-.....	UMTS-(LCS functional block)
UE	User Equipment
UL	Uplink
UMTS	Universal Mobile Telecommunication System
USIM	User Service Identity Module
UTC	Universal Time Coordinates
UTRAN	Universal Terrestrial Radio Access Network
WCDMA	Wideband Code Division Multiple Access

4 Main concepts and requirements

The stage 1 LCS description providing an overall service description and the core requirements for the LCS at the service level is given in [5]. The stage 2 LCS description providing a system functional model for the whole system, the LCS system architecture, state descriptions and message flows are described in [13].

By measuring radio signals the capability to determine the geographic position of the UE shall be provided. The position information may be requested by and reported to a client (application) associated with the UE, or by a client within or attached to the CN. The position information may also be utilised internally by UTRAN, for example, for location-assisted handover or to support other features such as home location billing. The position information shall be reported in standard formats, such as those for cell based or geographical co-ordinates, together with the time-of-day and the estimated errors (uncertainty) of the position of the UE. Restrictions on the geographic shape encoded within the 'position information' parameter may exist for certain LCS client types. The SRNC shall comply with any shape restrictions defined in GSM/UMTS and, in a particular country, with any shape restrictions defined for a specific LCS client type in relevant national standards. For example, in the US, national interim standard TIA/EIA/IS-J-STD-036 restricts the geographic shape for an emergency services LCS client to minimally either an "ellipsoid point" or an "ellipsoid point with uncertainty circle and confidence" as defined in [11].

It shall be possible for the majority of the UE (active or inactive) within a network to use the feature without compromising the radio transmission or signalling capabilities of the UTRAN.

The uncertainty of the position measurement shall be network implementation dependent at the choice of the network operator. The uncertainty may vary between networks as well as from one area within a network to another. The uncertainty may be hundreds of metres in some areas and only a few metres in others. In the event that the position measurement is also a UE-assisted process, the uncertainty may also depend on the capabilities of the UE. In some jurisdictions, there is a regulatory requirement for location service accuracy that is part of an emergency service. Further details of the accuracy requirements can be found in [5].

The uncertainty of the position information is dependent on the method used, the position of the UE within the coverage area and the activity of the UE. Several design options of the UTRAN system (e.g. size of cell, adaptive antenna technique, path loss estimation, timing accuracy, Node B surveys) shall allow the network operator to choose a suitable and cost effective UE Positioning method for their market.

There are many different possible uses for the positioning information. The positioning functions may be used internally by the UTRAN, by value-added network services, by the UE itself or through the network, and by "third party" services. The feature may also be used by an emergency service (which may be mandated or "value-added"), but the location service is not exclusively for emergencies.

The UTRAN is a new radio system design without a pre-existing deployment of UE operating according to the radio interface. This freedom from legacy equipment enables the location service feature design to make use of appropriate techniques to provide the most accurate results. The technique must also be a cost-effective total solution, must allow evolution to meet evolving service requirements and be able to take advantage of advances in technology over the lifetime of UTRAN deployments.

4.1 Assumptions

As a basis for the operation of UE Positioning in UTRAN the following assumptions apply:

- the UE shall support SFN-SFN observed time difference type 2 measurements, thus support of Network-based OTDOA without idle periods is mandatory in the UE;
- both TDD and FDD will be supported;
- the provision of the UE Positioning function in UTRAN is optional through support of the specified method(s) in Node B, the SAS, and the RNC;
- UE Positioning is applicable to any target UE whether or not the UE supports LCS, but with restrictions on use of certain positioning method depending on UE capability as defined in [17];
- The SMLC may be either a stand-alone network element (SAS) or an internal function of the RNC;
- UE Positioning information is transported between RNCs via the Iur interface independent of whether the SMLC is a stand-alone network element (SAS) or an internal function of the RNC;
- the positioning information may be used for internal system operations to improve system performance;
- different types of LMU are defined, e.g. a standalone LMU and/or LMU integrated in Node B;

- the UE Positioning architecture and functions shall include the option to accommodate several techniques of measurement and processing to ensure evolution to follow changing service requirements and to take advantage of advancing technology;
- the RNC manages the overall coordination and scheduling of resources required to perform positioning of a UE. It may also calculate the final position estimate and accuracy.

4.2 UE Positioning Methods

The UTRAN may utilise one or more positioning methods in order to determine the position of an UE.

Positioning the UE involves two main steps:

- signal measurements; and
- Position estimate computation based on the measurements.

The signal measurements may be made by the UE, the Node B or an LMU. The basic signals measured are typically the UTRA radio transmissions, however, some methods may make use of other transmissions such as general radio navigation signals.

The positioning function should not be limited to a single method or measurement. That is, it should be capable of utilising other standard methods and measurements, as are available and appropriate, to meet the required service needs of the location service client. This additional information could consist of readily available UTRAN measurements such as RTT in FDD or Rx Timing deviation measurement and knowledge of the UE timing advance, in TDD.

The position estimate computation may be made by the UE or by the UTRAN (i.e. SRNC or SAS).

4.3 Standard UE Positioning Methods

The standard positioning methods supported within UTRAN are:

- cell ID based method;
- OTDOA method that may be assisted by network configurable idle periods;
- network-assisted GPS methods.

4.3.1 Cell ID Based Method

In the cell ID based (i.e. cell coverage) method, the position of an UE is estimated with the knowledge of its serving Node B. The information about the serving Node B and cell may be obtained by paging, locating area update, cell update, URA update, or routing area update.

The cell coverage based positioning information can be indicated as the Cell Identity of the used cell, the Service Area Identity or as the geographical co-ordinates of a position related to the serving cell. The position information shall include a QoS estimate (e.g. regarding achieved accuracy).

When geographical co-ordinates are used as the position information, the estimated position of the UE can be a fixed geographical position within the serving cell (e.g. position of the serving Node B), the geographical centre of the serving cell coverage area, or some other fixed position within the cell coverage area. The geographical position can also be obtained by combining information on the cell specific fixed geographical position with some other available information, such as the signal RTT in FDD ([14]) or Rx Timing deviation measurement and knowledge of the UE timing advance, in TDD ([15]).

The operation of the cell ID based positioning method is described in clause 8.

4.3.2 OTDOA-IPDL Method with network configurable idle periods

The OTDOA-IPDL method involves measurements made by the UE and LMU of the UTRAN frame timing (e.g. SFN-SFN observed time difference). These measures are then sent to the SRNC and, in networks which include an SAS, may be forwarded to the SAS. Depending on the configuration of the network, the position of the UE is calculated in the SRNC or in the SAS.

The simplest case of OTDOA-IPDL is without idle periods. In this case the method can be referred to as simply OTDOA.

The Node B may provide idle periods in the downlink, in order to potentially improve the hearability of neighbouring Node Bs. The support of these idle periods in the UE is optional. Support of idle periods in the UE means that its OTDOA performance will improve when idle periods are available.

Alternatively, the UE may perform the calculation of the position using measurements and assistance data.

The detailed description of the OTDOA-IPDL positioning method and its operation are described in clause 9.

4.3.3 Network-assisted GPS Methods

These methods make use of UEs, which are equipped with radio receivers capable of receiving GPS signals.

The operation of the network-assisted GPS methods is described in clause 10.

5 UTRAN UE Positioning Architecture

Figure 5.1 shows the general arrangement of the UE positioning feature in UTRAN. Communication among the UTRAN UE Positioning entities makes use of the messaging and signalling capabilities of the UTRAN interfaces (Iub, Iur, Iupc).

The SRNC, receives authenticated requests for UE positioning information from the CN across the Iu interface. RNCs manage the UTRAN resources (including Node Bs, LMUs, the SAS) the UE and calculation functions, to estimate the position of the UE and return the result to the CN. SRNC may also make use of the UE Positioning function for internal purpose e.g. position based handover.

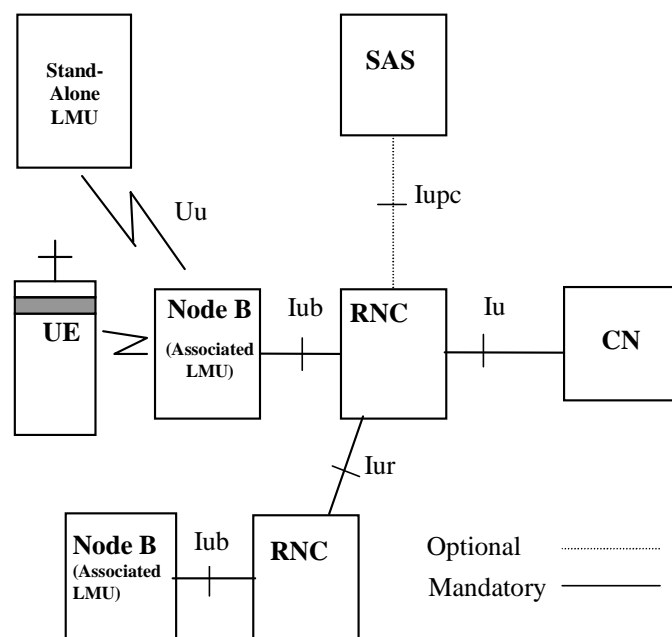

Figure 5.1: General arrangement of UE Positioning in UTRAN

5.1 UE Positioning Operations

The schematic functional description of LCS operations in UTRAN is defined in [13].

Upon request from the Core Network or for internal operations, a RNC UE Positioning function should:

- request measurements, typically from the UE and one or more Node B;
- send the measurement results to the appropriate calculating function within UTRAN;
- receive the result from the calculating function within UTRAN;
- perform any needed co-ordinate transformations;
- send the results to the LCS entities in the CN or to application entities within UTRAN.

In the event that the client is internal to UTRAN the request may be made directly to the UTRAN UE Positioning entities as the internal clients are considered to be "pre-authorised".

As part of its operation, the UTRAN UE Positioning calculating function may require additional information. This may be obtained by the function directly by communication with a database, or it may be through a request to UTRAN UE Positioning entities that will mediate the request and return of information from the appropriate database (or databases if more than one is needed to fulfil the requests).

There may possibly also be available independent information that is able to supply the positioning information directly, or may be able to supply auxiliary information to the calculation function. The UTRAN UE Positioning co-ordination function, as part of its activity to supervise the positioning process, may query the UE or other elements of the UTRAN to determine their capabilities and use this information to select the mode of operation.

This general operation is outlined in the following (generic) sequence diagram figure 5.2. This figure is not intended to show the complete UE Positioning operation for UTRAN, but to simply to outline the basis for operation.

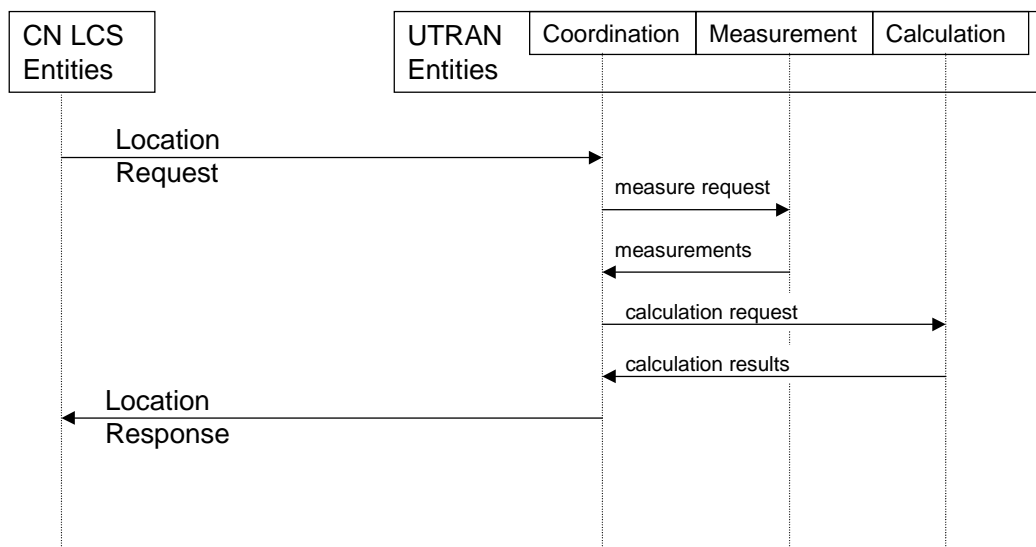

Figure 5.2: General sequence for UE Positioning operation

5.1.1 Co-ordination, Measurement and Calculation Functions

The UTRAN functions for UE Positioning provide the co-ordination, measurement and calculation functions needed to provide a position estimate. The functions interface with the requesting application and select the appropriate positioning method and speed of response. The functions co-ordinate the operations of the radio and measurement equipment to transmit the needed signals and to make the needed measurements. The measurements may be made by the Node Bs, or by the LMU. The LMU may be associated with the Node B, independently located or remote (i.e. communicating over the Uu interface).

The functions may also access databases or other sources of information appropriate for the positioning method. The functions also provide the calculation functions appropriate for the positioning method to estimate the UE position and the accuracy of the report. The functions may also make co-ordinates translations to the geographic co-ordinates system requested by the application. The functions also may record information on the usage of the UE Positioning that may be used for administrative purposes (e.g. forwarded to a billing function in the CN). If needed by the positioning method, the functions will ensure the broadcast of information and gather and update information concerning UTRAN operating parameters (e.g. timing of Node B transmissions) needed for UE Positioning operations.

These entities are mainly concerned with the positioning method, controlling the radio equipment and performing the calculations to determine the position and thus may be associated with the RNC in the UTRAN. These functions may receive location requests from either the CN or from applications internal to the UTRAN.

The UTRAN UE Positioning entities may also request the subscription and authorisation functions in the CN to authenticate an application or a UE subscription or to verify the subscriber privacy parameters.

The RNC functions communicate with the CN across the Iu interface, with other RNC entities across the Iur interface and with the Node B and LMU across the Iub interface, with the SAS across the Iupc interface, and with the UE and the remote LMU across the Uu interface.

5.2 Functional Description of UTRAN UE Positioning related elements

5.2.1 Radio Network Controller (RNC)

5.2.1.1 Serving RNC

The SRNC is a network element of UTRAN and contains functionality required to support LCS in one PLMN.

The SRNC provides the following functionality:

- request of information from other RNC:
The SRNC may request information regarding UE Positioning from other RNCs;
- flow control of positioning requests:
If several simultaneous positioning requests are present within one SRNC, the SRNC co-ordinates the positioning requests taking into account priority of the requests (e.g. for Emergency Clients);
- positioning method selection:
The positioning method selection is based on the location request, QoS, capabilities of UE Positioning elements and UE positioning capabilities;
- position calculation:
The SRNC may calculate the position of a UE and may also support conversion of the position estimate between different geographic reference systems. In case RNC estimates the UE position, it is also responsible to estimate the accuracy of the position estimate. This accuracy estimate should include, for example, the effect of geometric dilution of precision (GDOP), the capabilities of the signal measuring hardware, the effects of multipath propagation and the effects of timing and synchronisation unknowns. The accuracy should be returned as a measure of distance in the same units as the position estimate. The accuracy zone may be reported as the axis and orientation of an ellipse surrounding the position estimate;
- provide UE Positioning assistance data:
The SRNC may provide assistance data in the support of the various positioning methods;
- Overall UE Positioning coordination and control:
If both an SAS and an SRNC with SMLC internal functionality are available, the SRNC is responsible for the overall coordination and control of UE Positioning. For example, although the SAS has a position calculation function, the SRNC may also have a position calculation function. The SRNC is responsible for managing the co-ordination and control of these multiple resources.

The SRNC, of course, also provides CRNC functionality regarding UE Positioning for its associated Node Bs and LMUs.

5.2.1.2 Other RNC

5.2.1.2.1 Controlling RNC

The CRNC provides the following functionality:

- resources management:
When allocating resources the CRNC determines which UTRAN elements are involved and what to measure. The RNC is also responsible for managing the effect of UE Positioning operations on the overall performance of the radio network by:
 - controlling the variation of the UL and DL signal power level due to UE Positioning;
 - calculating the DL and UL power/interference due to UE Positioning;
 - to admit/reject the new positioning requests;
 - co-operating with Admission Control, and entities of the RRM (such as power control) to provide the system stability in terms of radio resources;
 - controlling the IPDL mechanism for OTDOA measurements. This may include the overall control of the periodical measurement fulfilment. Co-ordination among RNCs (e.g. to assure non-overlapping idle periods) will be communicated through the Iur interface.
- broadcast of system information:
The CRNC broadcasts information in support of the selected positioning method. This broadcast information may be specially coded (i.e. encrypted) to ensure its availability only to subscribers of the service. For the case where there exists an SAS, the broadcast data is generated within the CRNC and/or, depending on the positioning method, may also be generated in the SAS which then forwards it to the CRNC over the Iupc interface for eventual broadcast over the Uu interface.

The information to be broadcast could include, for example:

- identification and spreading codes of the neighbouring cells (the channels that are used for measurements);
- Relative Time Difference (RTD), i.e. the timing offsets, asynchronicity between base stations, could be based on measurement results obtained by LMUs;
- roundtrip delay estimates in connected mode;
- the geographic position co-ordinates of the neighbouring Node B;
- the idle period places within the frame structure for multiple cells;
- the local time-of-day;
- reference time, reference position, DGPS corrections, ephemeris and clock data, and almanac data.
- request UE Positioning related measurements from its associated Node Bs and LMUs:
The measurements requested by CRNC from its associated Node Bs and LMUs is dependant on the positioning method used. The following measurement returned by a LMU to a CRNC has a general status and may be used for more than one positioning method:
 - radio interface timing information.

Signalling between Node B or LMU and CRNC is transferred using Iub signalling.

5.2.1.2.2 Drift RNC

The DRNC is a UTRAN element that has an active link to the UE that shall be located. The DRNC, of course, also provides CRNC functionality regarding UE Positioning for its associated Node Bs and LMUs.

5.2.2 Node B

Node B is a network element of UTRAN that may provide measurement results for position estimation and makes measurements of radio signals and communicates these measurements to the CRNC.

The Node B may make its measurements in response to requests (e.g. from the CRNC), or it may autonomously measure and report regularly or when there are significant changes in radio conditions (e.g. changes in the UTRAN GPS timing of cell frames or SFN-SFN Observed Time Difference).

5.2.3 Location measurement unit (LMU)

The Location Measurement Unit (LMU) entity makes measurements (e.g. of radio signals) and communicates these measurements to a RNC. The LMU may also perform calculations associated with the measurements.

All positioning and assistance measurements obtained by an LMU are supplied to a particular CRNC associated with the LMU. Instructions concerning the timing, the nature and any periodicity of these measurements are either provided by the CRNC or are pre-administered in the CRNC (e.g. using O&M).

The LMU may make its measurements in response to requests (e.g. from the CRNC), or it may autonomously measure and report regularly (e.g. timing of Node B transmissions) or when there are significant changes in radio conditions (e.g. changes in the UTRAN GPS timing of cell frames or SFN-SFN Observed Time Difference).

There may be one or more LMU associated with the UTRAN and an UE Positioning request may involve measurements by one or more LMU. The LMU may be of several types and the CRNCs will select the appropriate LMUs depending on the UE Positioning method being used.

The LMU may be used, for example, to measure UTRAN transmissions either UL or DL. These measurements may be made either, for example, to locate the UE or to measure a system parameter needed by the UE Positioning such as the timing offset (UTRAN GPS timing of cell frames or SFN-SFN Observed Time Difference) of transmissions Node Bs. The LMU may also measure other transmissions, such as those of satellite navigation systems (i.e. GPS) and either report the measurements for use by the CRNC, or report the positioning results as determined by internal calculations of the LMU. The details of the measurements to be made by the LMU will be defined by the chosen UE Positioning method.

An LMU makes radio measurements to support one or more positioning methods. These measurements fall into one of two categories:

- (a) positioning measurements specific to one UE and used to compute its position;
- (b) assistance measurements applicable to all UEs in a certain geographic area.

There are two classes of LMU:

- **Stand-Alone LMU:** communicates with RNCs via the Uu interface;
- **Associated LMU:** communicates with RNCs via the Iub interface.

The associated LMU signalling protocol is the NBAP. The protocol for stand-alone LMU UTRAN signalling will be the RRC protocol.

Stand-Alone LMU

A stand-alone LMU is accessed exclusively over the UTRAN air interface (Uu interface). There is no other connection from the stand-alone LMU to any other UTRAN network element.

NOTE 1: This does not preclude a stand-alone LMU from also communicating with other access networks (e.g. GSM) through interfaces that are not part of the present document.

A stand-alone LMU has a serving Node B that provides signalling access to its CRNC. A stand-alone LMU also has a serving 3G-MSC, VLR and a subscription profile in an HLR. A stand-alone LMU always has a unique IMSI and supports all radio resource and mobility management functions of the UTRAN radio interface that are necessary to support signalling. A stand-alone LMU shall support those connection management functions necessary to support UE Positioning signalling transactions with the CRNC and may support certain call control functions of to support signalling to an CRNC using a circuit switched data connection.

NOTE 2: A network operator may assign specific ranges of IMSI for its LMUs and may assign certain digits within the IMSI to indicate the associated CRNC. Certain digits in the IMSI may also be used as a local identifier for an LMU within an CRNC.

To ensure that a Stand-alone LMU and its associated CRNC can always access one another, an LMU may be homed (camped) on a particular cell site or group of cell sites belonging to one 3G-MSC. For any Stand-alone LMU with a subscription profile in an HLR, a special profile may be used to indicate the assigned supplementary services (e.g. the SMS-PP MT for data download via the SIM application toolkit, and barring of all incoming and possibly outgoing calls). An identifier in the HLR profile also distinguishes an LMU from a normal UE. All other data specific to an LMU is administered in the LMU and in its associated CRNC.

Associated LMU

An associated LMU is accessed over the Iub interface from an RNC. An associated LMU may make use of the radio apparatus and antennas of its associated Node B. The LMU may be either a logically separate network element addressed using some pseudo-cell ID, or connected to or integrated in a Node B. Signalling to an associated LMU is by means of messages routed through the controlling Node B.

An associated LMU may be separated from the Node B, but still communicate with the CRNC via the Node B Iub interface. The interface between the associated LMU and its Node B is not part of the present document.

NOTE 3: An associated LMU is not precluded from also communicating with other access networks (e.g. GSM) through interfaces that are not part of the present document.

Measurements

The assistance measurements obtained by an LMU are generic and are usable by more than one positioning method. These include:

- **Radio Interface Timing measurements:** include UTRAN GPS timing of cell frames or SFN-SFN Observed Time Difference of the signals transmitted by Node B, where timing differences are measured relative to either some common reference clock (UTRAN GPS timing of cell frames) or the signals of another Node B (SFN-SFN Observed Time Difference);
- **Inter-System Timing measurements:** include timing measurements between the UTRAN radio signals transmitted by a Node B and an external system such as the GPS or GSM.

5.2.4 User Equipment (UE)

The UE may transmit the needed signals for uplink based UE Positioning measurements and to make measurements of downlink signals. The measurements to be made will be determined by the chosen positioning method.

The UE may also contain LCS applications, or access an LCS application through communication with a network accessed by the UE or an application residing in the UE. This application may include the needed measurement and calculation functions to determine the UE's position with or without assistance of the UTRAN UE Positioning entities. This is outside of the scope of this specification.

The UE may also, for example, contain an independent positioning function (e.g., GPS) and thus be able to report its position, independent of the UTRAN transmissions. The UE with an independent positioning function may also make use of information broadcast by the UTRAN that assists the function.

5.2.5 Stand-alone SMLC

An SAS performs the following procedures:

- Provide GPS assistance data to the RNC, for both UE-assisted and UE-based method types, to be delivered through point-to-point or broadcast channels to UE;
- Act as a location calculation server if the location estimates are not to be calculated in the RNC.

The SAS communicates with the RNC over the Iupc interface enabling it to forward UE Positioning assistance data to UEs and to receive UE Positioning measurement data from the RNC.

When timing assistance is needed, the SAS relies on the RNC (and on the possibility to have GPS receivers co-located with the RNC, the Node Bs and/or present in the UEs) to obtain that.

6 Signalling protocols and interfaces

6.1 LCS signalling between SRNC and MSC/SGSN

LCS signalling between SRNC and MSC/SGSN is handled through the Iu interface, which is described in clause 6.6.1.

6.2 SRNC signalling to a target UE

SRNC signalling to a target UE is handled through the Uu interface, which is described in clause 6.6.4.1.

6.3 Controlling RNC signalling to a standalone LMU

CRNC signalling to a standalone LMU is handled through the Uu interface, which is described in clause 6.6.4.2.

6.4 Controlling RNC signalling to an associated LMU

CRNC signalling to an associated LMU is handled through the Iub interface, which is described in clause 6.6.3.

6.5 RNC-to-RNC signalling for UE Positioning support

The RNC-to-RNC signalling for UE Positioning support is handled through the Iur interface, which is described in clause 6.6.2.

6.5a SAS to RNC signalling for PCAP

The SAS to RNC signalling is described in clause 6.6.5.

6.6 Interfaces

There are five interfaces through which the UE Positioning entities communicate. These are the Iu, Iur, Iub, Uu and Iupc.

NOTE: the interfaces between the Internal or External LCS applications and the 3G-MSC or 3G-SGSN are outside the scope of the present document.

6.6.1 Iu Interface

The Iu interface is used to communicate between the LCS functional entities in the CN and the UE Positioning entities in the UTRAN. Further specification of the messages and operations for LCS across the Iu interface may be found in reference [19].

6.6.2 Iur Interface

UE Positioning operations at the Iur interface are defined in [20].

The Iur interface is used to communicate between the UE Positioning functional entities associated with the SRNC and other RNC in the UTRAN. The Iur interface is also used to communicate between the SRNC and the Internal UE Positioning Applications in the UTRAN. The UE Positioning entities associated with the SRNC are responsible for co-ordinating and responding to positioning requests received from the LCS entities in the CN or Internal Clients.

When communicating between the SRNC and the UTRAN Internal UE Positioning Applications (e.g. located within other RNCs), the messages and protocols are those used over the Iur interface. Some positioning methods may require measurements by several LMU or Node B, some of which may be associated with other RNC. Commands and responses from these UE Positioning Entities are communicated over the Iur interface. In some cases, the UE Positioning Entities in the SRNC may make use of entities associated with other RNC. For example, a calculating function may be used in another RNC if the SRNC is too busy or does not contain the function or database information required by the chosen positioning method.

Iur shall be used for UE Positioning signalling whenever it is available, even in the case when the RNCs connected to different 3G-MSCs or 3G-SGSN.

Within UTRAN, Iur supports inter-RNC soft handover. Inter-RNC handover should also include UE Positioning, meaning that whenever an inter-RNC soft handover occurs, Iur should be able to support the functionality of the UE Positioning entities in RNCs.

Iur shall be used also to collect RTD and other UE Positioning information from Node Bs under different RNCs that are not involved in handover.

6.6.2.1 Signalling between SRNC and DRNC

Signalling between SRNC and DRNC is used to obtain LCS information specific to a UE that has an UE context to the DRNC.

The signalling between SRNC and DRNC is done by using RNSAP procedures specified in [20].

6.6.2.2 Signalling between SRNC and CRNC

Signalling between SRNC and CRNC is used to obtain UE Positioning information and request LCS related transmissions or other radio operation (e.g. information about IPDL configuration) that is needed by SRNC for a certain positioning method. The requested information may be e.g. GPS assistance data in case a reference GPS receiver is not available at the SRNC or RTD results that may be provided by the CRNC.

The procedures used for the signalling between SRNC and CRNC are not specified yet.

6.6.3 Iub Interface

UE Positioning operations at the Iub interface are defined in [21].

The Iub interface is used to communicate among the UE Positioning entities associated with the CRNC, the Node B and the associated LMU.

This interface passes the request for measurements, the measurement results and requests for UE Positioning related transmissions or other radio operations needed by the positioning method (e.g. broadcast of parameters needed for a UE-based positioning method). Measurement requests and results are signalled by using NBAP procedures.

6.6.3.1 Signalling between CRNC and associated LMU

Signalling exchanges between an CRNC and a LMU under the control of that CRNC will be specified in the NBAP protocol for associated LMUs.

The protocol layers employed to enable signalling between the CRNC and an associated LMU are defined in [22]. The LMU signalling information elements are included directly in the NBAP protocol, defined in [22].

6.6.4 Uu Interface

UE Positioning operations at the Uu interface are generally defined in [13]. This specification defines in more detail the procedures needed for messaging for each individual positioning method.

The Uu interface is used to communicate among the UE Positioning entities associated with the SRNC, the UEs and the stand-alone LMU.

The Uu interface may pass measurement requests and results to and from the UE or the stand-alone LMU.

The Uu interface may also be used for broadcast of information that may be used by the UE or stand-alone LMU for their UE Positioning operations. This may, for example, include timing and code information about nearby Node B transmissions that may assist the UE or LMU in making their measurements.

The Uu interface is also used to transport signalling between LCS entities in the CN and the UE, e.g. positioning requests from internal or external LCS Applications at the UE. This is part of the NAS procedures and it is outside the scope of this specification.

6.6.4.1 Signalling between SRNC and Target UE

UE Positioning related signalling between an SRNC and a target UE is supported by the RRC protocol as specified in [18].

The positioning request to UE signalling flow is generic for all UE-based or UE-assisted positioning methods (OTDOA and Network-assisted GPS).

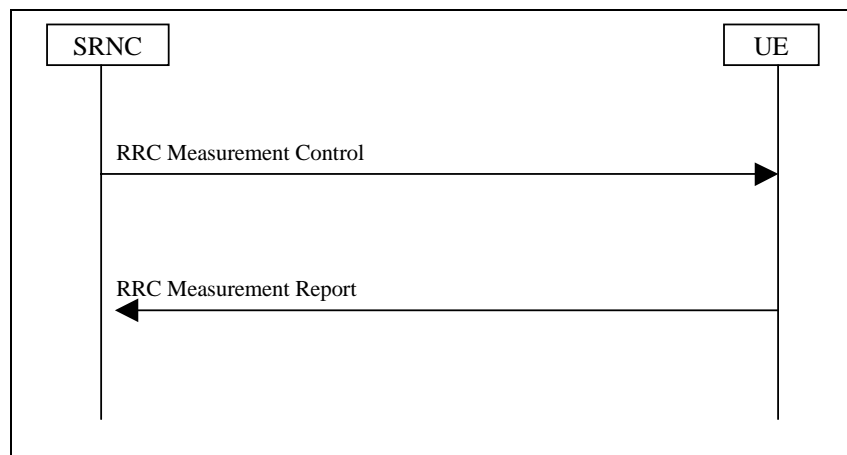

Figure 6.1: OTDOA /GPS Positioning Message Flow

1. The SRNC determines possible assistance data and sends a MEASUREMENT CONTROL request to the UE. In networks that include an SAS, the assistance data is generated within the SRNC or in the SAS and passed to the SRNC over the Iupc interface. If both an SAS and an SRNC with SMLC internal functionality are available, selection is based on SRNC configuration.
2. Provided that the UE Positioning request meets the privacy criteria, the UE performs the requested measurements. If the UE is able to calculate its own position, and this is requested, the UE computes a position estimate based on measurements. Any assistance data necessary to perform these operations will either be provided in the MEASUREMENT CONTROL request or be available from broadcast sources. The resulting measurements or position estimate are returned to UTRAN in a MEASUREMENT REPORT response. If the UE cannot fulfil the request, a MEASUREMENT CONTROL FAILURE message is returned.

6.6.4.1.1 Assistance Data Delivery to UE

The assistance data signalling flow illustrated here is generic for the point-to-point delivery of positioning related assistance data to the UE, including OTDOA and Network-assisted GPS.

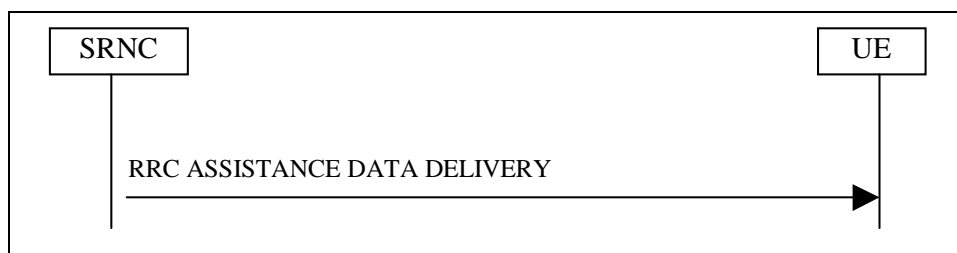

Figure 6.2: OTDOA or GPS Assistance Data Delivery Flow

1. The SRNC determines assistance data and sends it in the RRC ASSISTANCE DATA DELIVERY message to the UE. In networks that include an SAS, the UE Positioning assistance data is generated within in the SAS and passed to the SRNC over the Iupc interface.

6.6.4.1.2 Error Handling

The error handling for signalling on the Uu interface is handled by the RRC protocol in [18].

6.6.4.1.3 Broadcast of Assistance Data

For OTDOA and GPS, UTRAN may broadcast assistance data to the UE.

The assistance data to be broadcast for OTDOA contains the reference and neighbour cells to measure and for each neighbour cell the approximate cell timing and possibly IPDL information. The approximate cell timing may be used to simplify OTDOA measurements. Additionally, RTD values (e.g. in case of a non-synchronised network) and Node B co-ordinates for UE based OTDOA may be included for each neighbour cell. The length of the message depends on how many neighbours are included in the assistance data. Part of the broadcast message (e.g. the serving and neighbour Node B geographic co-ordinates) may be ciphered.

The assistance data to be broadcast for assisted GPS may contain a subset of or all of the following information: reference time, reference position, DGPS corrections, ephemeris and clock corrections, and almanac and other data. The broadcast message may be ciphered.

The broadcast channel that is used for the OTDOA and GPS assistance data makes use of the common UTRAN broadcast service specified in [18].

6.6.4.1.4 Signalling Flow for Assistance Data Broadcast Using the Common UTRAN Broadcast Service

The UTRAN may broadcast positioning related assistance data to UEs within the system information.

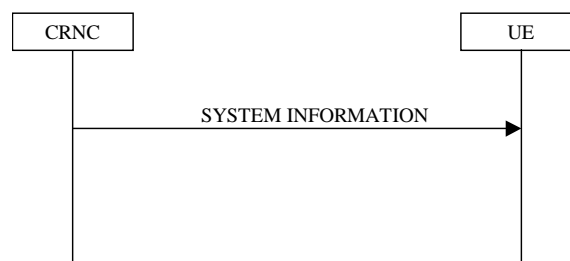

Figure 6.3: Broadcast of system information

6.6.4.1.5 UE Positioning Assistance Data Ciphering

To allow control of access to the assistance data, parts of the broadcast assistance data may be ciphered. Ciphering is done with a specific ciphering key delivered by the CN for this purpose. The management of the key is described in the System Aspects Stage 2 ([13]).

6.6.4.1.6 UE Positioning Assistance Data Ciphering Algorithm

The algorithm used for ciphering the UE Positioning assistance data is the standard 56-bit Data Encryption Standard (DES) algorithm.

The deciphering of broadcast assistance messages is done in the UEs. The deciphering will utilize the deciphering keys delivered during the location update request. Details can be found in [25].

The RNC ciphers the parts of the UE Positioning Broadcast Data message to be protected using the 56-bit DES algorithm and a ciphering keys (56 bits) and Ciphering Serial Number (16 bits) for the broadcast location area.

The ciphered part is variable in length with one bit resolution. By using the UE Positioning Broadcast Data message header, the UEs can determine what part of message is ciphered.

Inputs to the 56-bit DES algorithm are the following:

- 56-bit key K (deciphering key);
- 16-bit Ciphering Serial Number from broadcast message, which is denoted here by IV (Initialisation Vector);
- plain-text bits (the ciphered part of broadcast message).

The ciphering process is illustrated in the following diagram. Ciphering is done by producing a mask bit stream, which is then "XORed" bit-by-bit to the plain-text data to obtain the cipher-text data. First, the Initialisation Vector (IV) is concatenated with 0-bits in order to achieve a 64-bit block I_1 . This block is then encrypted by the DES algorithm using the key K. Output is a 64-bit block I_2 . This constitutes the first 64 bits of the mask bit stream. If the message is longer than 64 bits, then more bits are needed. These are produced by encrypting I_2 again by the DES algorithm using the key K. The output is a 64-bit block I_3 . This is the next 64 bits of the mask bit stream. This iteration is continued until enough bits are produced. The unnecessary bits from the last 64-bit block I_j are discarded. The figure below illustrates the first two mask bit generations and the two ciphered 64-bit blocks.

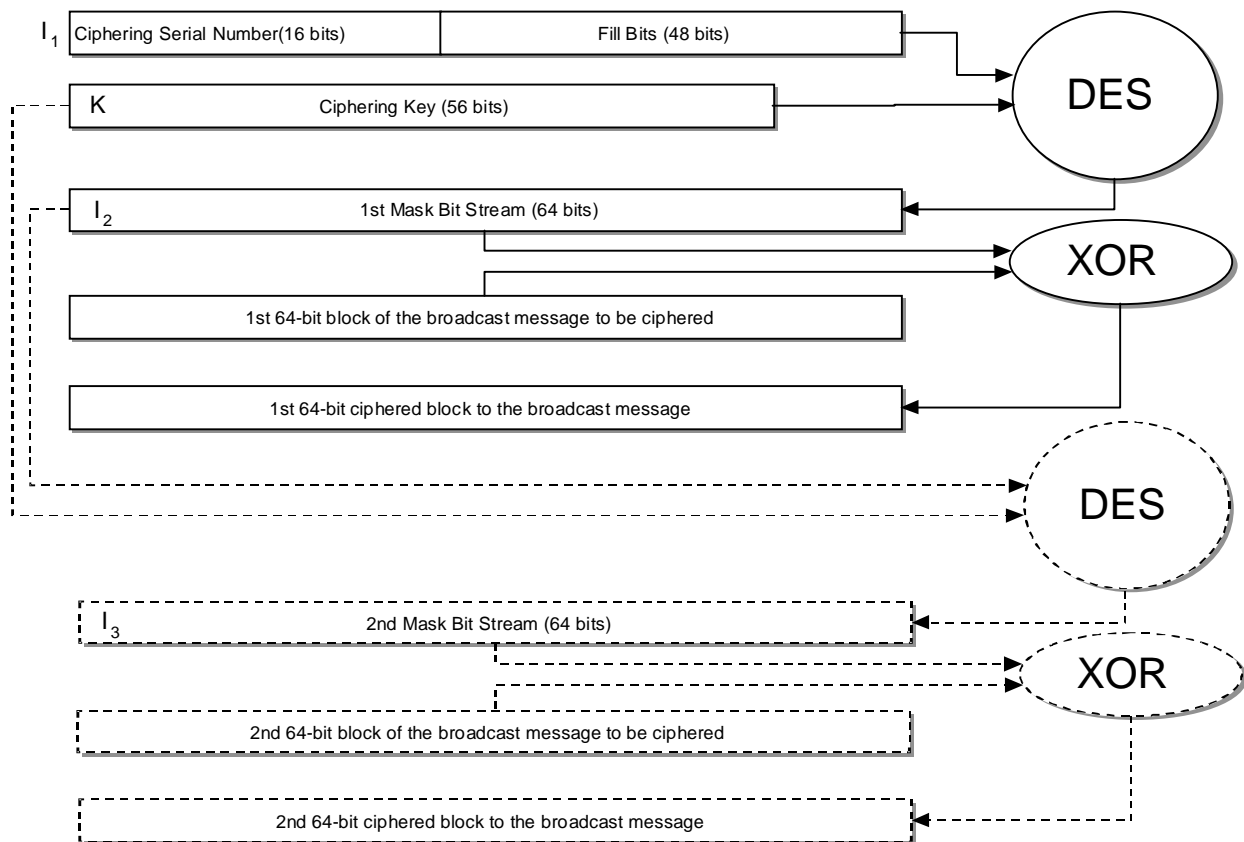

Figure 6.4: Data Assistance Ciphering Algorithm

Deciphering is done similarly. The same mask bit stream is produced and these are XORed, bit-by-bit, to the cipher-text data bits. The result will be the plain-text data.

6.6.4.2 Signalling between RNC and stand-alone LMU

Signalling exchanges between an RNC and a stand-alone LMU under the control of that RNC will be specified in the RRC protocol for stand-alone LMUs. This does not preclude a stand-alone LMU from also communicating with other networks (e.g. GSM) through interfaces (e.g. LLP protocol) that are not part of the present document.

Each update of the LMU measurement (including the initial one) is triggered by a LCS request from the client that is internal to UTRAN. The request may be made directly to the UTRAN LCS entities as the internal clients are considered to be "pre-authorized" (clause 5) or comes from CN with authentication.

The following figure illustrate the protocol layers used to support signalling between an RNC and a stand-alone LMU over the Uu interface.

The protocol layers employed to enable signalling between the RNC and a stand-alone LMU are defined in [18]. The LMU signalling information elements are included directly in the RRC protocol, also defined in [18].

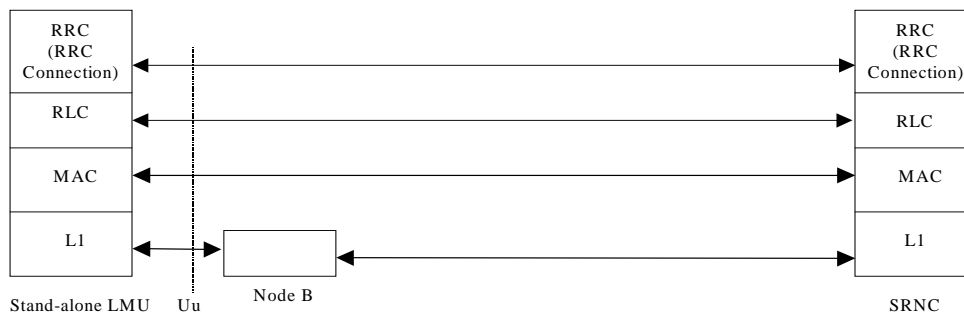

Figure 6.5: Signalling between an RNC and a Stand-Alone LMU using a signalling bearer

6.6.5 Iupc Interface

UE Positioning operations on the Iupc interface are described in [27]. That specification defines in more detail the procedures needed for messages for the UE positioning method.

The Iupc interface is used to allow communication between an RNC and an SAS. This interface is used to signal position estimate requests and responses as well as UE Positioning related information using mechanisms consistent with the other internal UTRAN interfaces. The Iupc interface is used for providing the RNC with UE Positioning data to be used for both point-to-point and broadcast purposes. The Iupc interface uses an Iups-like protocol stack for the transport layer which is described in [28].

6.6.5.1 Signalling between RNC and SAS

The signalling between RNC and SAS is done by using PCAP procedures specified in [27].

6.6.5.1.1 PCAP Position Calculation

The PCAP Position Calculation message flow illustrates how an SRNC invokes an SAS to calculate a position estimate of a UE.

The SRNC initiates the PCAP Position Calculation message flow for UEs that support the following positioning method types:

- UE assisted;
- UE assisted is preferred, but UE based is allowed;
- UE based is preferred, but UE assisted is allowed;

when the chosen positioning method type is 'UE Assisted'.

For UEs that only support the UE based positioning method or that, supporting both, have selected the 'UE Based' option, the PCAP Position Calculation message flow is not applicable.

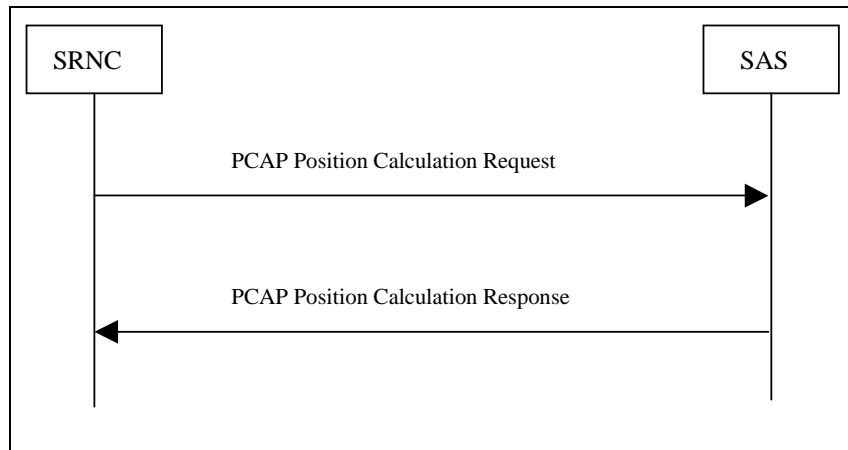

Figure 6.6: PCAP Position Calculation Message Flow

1. The SRNC initiates a PCAP Position Calculation Request Message. This message contains data necessary for the SAS to calculate a position estimate for a UE.
2. If the SAS is able to calculate the position estimate, it shall return it to the SRNC in a PCAP Position Calculation Response Message. If the SAS cannot fulfil the request, it shall return a PCAP Position Calculation Failure Message to the SRNC.

6.6.5.1.2 PCAP Information Exchange

The PCAP Information Exchange message flow illustrates how an RNC initiates and terminates an exchange of UE Positioning related information with an SAS. The UE Positioning related information received from the SAS can be used by the RNC to either provide assistance data to a particular UE through dedicated signalling or to build up System Information Blocks containing assistance data to be broadcast to UEs in a particular area.

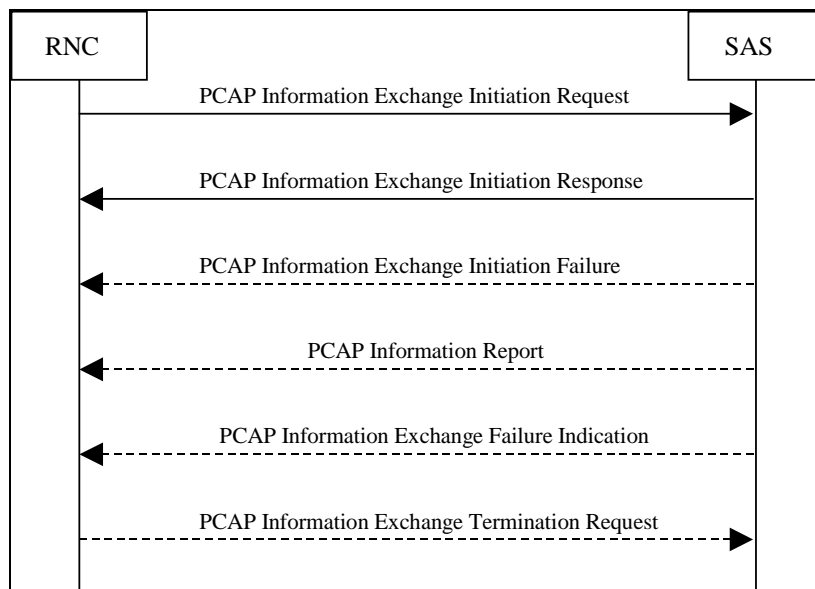

Figure 6.7: PCAP Information Exchange Message Flow

1. The RNC initiates a PCAP Information Exchange Initiation Request Message. This message contains data necessary for the SAS to provide the requested UE Positioning related information to the RNC. Upon reception of this message, the SAS shall provide the requested UE Positioning related information according to the reporting parameters given in the request. These parameters specify how the UE Positioning related information is to be reported (i.e. on-demand, periodically, or on-modification).

2. If the SAS is able to determine the information requested by the RNC, it shall respond with a PCAP Information Exchange Initiation Response Message.
3. If the SAS cannot provide the requested UE Positioning related information, it shall return a PCAP Information Exchange Initiation Failure Message.
4. In cases where the RNC has specified that the UE Positioning related information is to be reported periodically or on-modification, the SAS shall return the requested information in one or more PCAP Information Report Messages.
5. In cases where the RNC has specified that the UE Positioning related information is to be reported periodically or on-modification, the SAS may initiate an Information Exchange Failure Indication Message to notify the RNC that the requested information associated with a particular reporting activity can no longer be reported.
6. In cases where the RNC has specified that the UE Positioning related information is to be reported periodically or on-modification, the RNC may terminate a particular information reporting activity by initiating a PCAP Information Exchange Termination Request Message. Upon reception, the SAS shall terminate the particular information exchange activity indicated by the RNC.

7 General UTRAN UE Positioning procedures

7.1 General procedures in UTRAN for UE Positioning

The General UE positioning procedure in UTRAN starts with a request over Iu from the CN. UTRAN then determines the UE position by selecting a suitable positioning method. UTRAN then responds to the request with the estimated position and possible an associated accuracy.

7.2 Common procedures supporting UE Positioning interaction between RNCs

In the case that the positioning information is needed from an associated LMU in a Node B that is not controlled by the SRNC then the transfer of this information needs to be supported on the Iur interface. This information is the same information that is signalled between an associated LMU and the corresponding CRNC in the case when Iur support is not needed.

The SRNC requests the information it requires (e.g. GPS timing of cell measurements) from the CRNC of the Node B, which has the associated LMU. The CRNC in turn requests the information from the Node B and upon success returns the results to the SRNC.

Similarly when the SRNC needs a Node B measurement on a UE when that Node B is not controlled by that SRNC there needs to be support on the Iur. One example is the RTT measurement.

Other information that may need to be signalled over the Iur includes LMU parameters (geographical position, covered cells etc.).

NOTE: Confirmation or FS is needed by R3 experts.

7.2.1 Signalling in case of SRNS relocation

In case of SRNC relocation UE Positioning functionalities may be transferred in order for DRNC to be able to handle the responsibility of SRNC in LCS process. Therefore the Source RNC may transfer the following information to the Target RNC:

- last known position, time stamp and accuracy of the position calculation;
- LCS capabilities of the UE.

If there is a positioning procedure going on in order to estimate the position of the UE and a SRNS relocation occurs, the positioning procedure shall be stopped in the old SRNC. After SRNS relocation, the new SRNC then decides if a new positioning procedure should be started. In the UE, the positioning procedure is going on and positioning information (e.g. measurement results) may be sent back to UTRAN if the UE was requested to do so. The new SRNC then decides whether it wants to use these information or discard them. If an SAS is used, the SRNC shall send an Abort message to the SAS over the Iupc interface.

7.3 Exception procedures

7.3.1 Procedures in the SRNC

When a positioning attempt fails due to failure of a position method itself (e.g. due to inaccurate or insufficient position measurements and related data) and the SRNC is unable to instigate another positioning attempt (e.g. due to a requirement on response time), the SRNC may return a Location response over the Iu interface containing a less accurate position estimate. If a less accurate estimate is not available or will not meet the accuracy requirement, the SRNC may instead return a Location response message containing no position estimate and indicating the cause of failure.

NOTE: Need to check that Iu has enough flexibility.

When a positioning attempt is interrupted by some other unrecoverable error event inside the SRNC, the SRNC shall immediately terminate the positioning attempt and return a Location Response message containing the reason for the positioning attempt cancellation. In that case, SRNC may also abort any dialogue previously opened with an LMU for the purpose of instigating position measurements for the UE being located.

In networks that include an SAS, the SRNC will receive a PCAP Position Calculation Response message on the Iupc interface and then return a Location response over the Iu interface containing the results that were provided over the Iupc interface (a less accurate position estimate, cause of failure indication, etc). This is described in Subclause 7.3.4.

7.3.2 Procedures in a LMU

An LMU shall return an error indication to its CRNC when positioning measurements previously ordered by the RNC cannot be provided due to any error condition.

7.3.3 Procedures in the target UE

A target UE shall terminate any positioning procedure or the transfer of RRC positioning assistance data without sending any response to the SRNC if any UE Positioning RRC message is received from the SRNC that starts some other RRC management procedure. The new RRC procedure shall then be executed by the UE.

7.3.4 Procedures in the SAS

When a UE positioning attempt fails (e.g. due to inaccurate or insufficient position measurements and related data), the SAS may return a PCAP Position Calculation Response message over the Iupc interface containing a less accurate position estimate. If a less accurate estimate is not available or will not meet the accuracy requirement, the SAS may instead return a PCAP Position Calculation Failure message containing no position estimate and indicating the cause of failure.

When a positioning attempt is interrupted by some other unrecoverable error event inside the SAS, the SAS shall immediately terminate the positioning attempt and return a PCAP Position Calculation Failure message containing the reason for the positioning attempt cancellation.

7.4 Radio interface timing procedures

The Radio Interface Timing determination system consists of functions in LMUs in the SRNC, and in the SAS for networks that include an SAS. The system runs continuously offering cell timing information for UE Positioning.

7.4.1 LMU Functions

The Radio Interface Timing functionality in the LMU should be capable of performing the following functions:

- The LMU performs necessary radio interface measurements from signals transmitted by Node Bs;
- If the LMU contains a common reference clock, e.g. GPS TOW, it time stamps reception of Node B signals by performing measurements of UTRAN GPS timing of cell frames;
- If there is no reference clock available, the LMU may make SFN-SFN Observed Time Difference or measurements, i.e. measures the time difference between arrival of SFNs from neighbouring Node Bs and a reference Node B;
- The LMU may perform some processing of measurements, like averaging and filtering, using parameters delivered to it, or in their absence using default settings.

7.4.2 CRNC Functions

The CRNC must be capable of performing the following functions related to Radio Interface Timing determination:

- The CRNC sends to LMUs requests for Radio Interface Timing measurement information;
- The CRNC will communicate regularly with LMUs; thus, the CRNC can monitor operation of LMUs. If a LMU fails to send Radio Interface Timing information, the CRNC shall try to restart the LMU, and if this restarting fails, the CRNC shall inform O&M system. CRNC can use also diagnostics messages to query the status of LMUs;
- The CRNC receives Radio Interface Timing measurement results from LMUs;
- The CRNC stores or queries extra information required for Node B synchronization determination, like Node B and LMU coordinates, Node B identity information;
- The CRNC determines synchronization differences between different downlink signals using LMU measurements and other information;
- Synchronization information is delivered for UE Positioning purposes.

7.4.3 LMU-CRNC Interactions

The request for Radio Interface Timing measurement information from the CRNC to a LMU contains the following parameters:

- Measurement type. This indicates whether the CRNC wants the LMU to perform UTRAN GPS timing of cell frames or SFN-SFN Observed Time Difference;
- Measurement result reporting frequency. This indicates how often the LMU should send Radio Interface Timing measurement results;
- Measurement duration. This indicates how long the LMU should make measurements and report results;
- Instructions about filtering of raw measurement data;
- Instructions about Primary CPICH signals to be measured. The LMU unit can measure autonomously a certain number of most strongly received signals. Another possibility is that the CRNC tells which Node B signals it should measure;
- In the SFN-SFN Observed Time Difference case, which common Primary CPICH the LMU should use as a reference in the measurements;
- Instruction of how the measurement quality should be reported.

In case a SFN-SFN Observed Time Difference measurement was requested by the CRNC, the LMU returns the following information to CRNC:

- Identity of the Node B at which the associated LMU is residing;

- Primary CPICH info of the measured signals;
- SFN-SFN observed time difference between neighbour cells and reference cell;
- Identity of the neighbour cells;
- SFN-SFN drift between neighbour cells and reference cell;
- Time stamp of the measurement (e.g. SFN);
- Accuracy of the measurement.

In case a UTRAN GPS timing of cell frames measurement was requested by the CRNC, the LMU returns the following information to the CRNC:

- Cell id of the measured cell;
- SFN;
- Time stamp (e.g. GPS TOW) of the SFN;
- Node B clock drift;
- Accuracy of the measurement.

8 Cell ID based positioning method

In the Cell ID based method, the SRNC determines the identification of the cell providing coverage for the target UE. This subclause outlines the procedures for this positioning method. Subclause 8.1 provides procedures for the determination of the cell ID depending on the operational status of the target UE. Subclause 8.3 provides a procedure for the mapping of the cell ID to a corresponding SAI to be returned to the LCS application in the CN. The general flow to determine the cell ID is shown in figure 8.1.

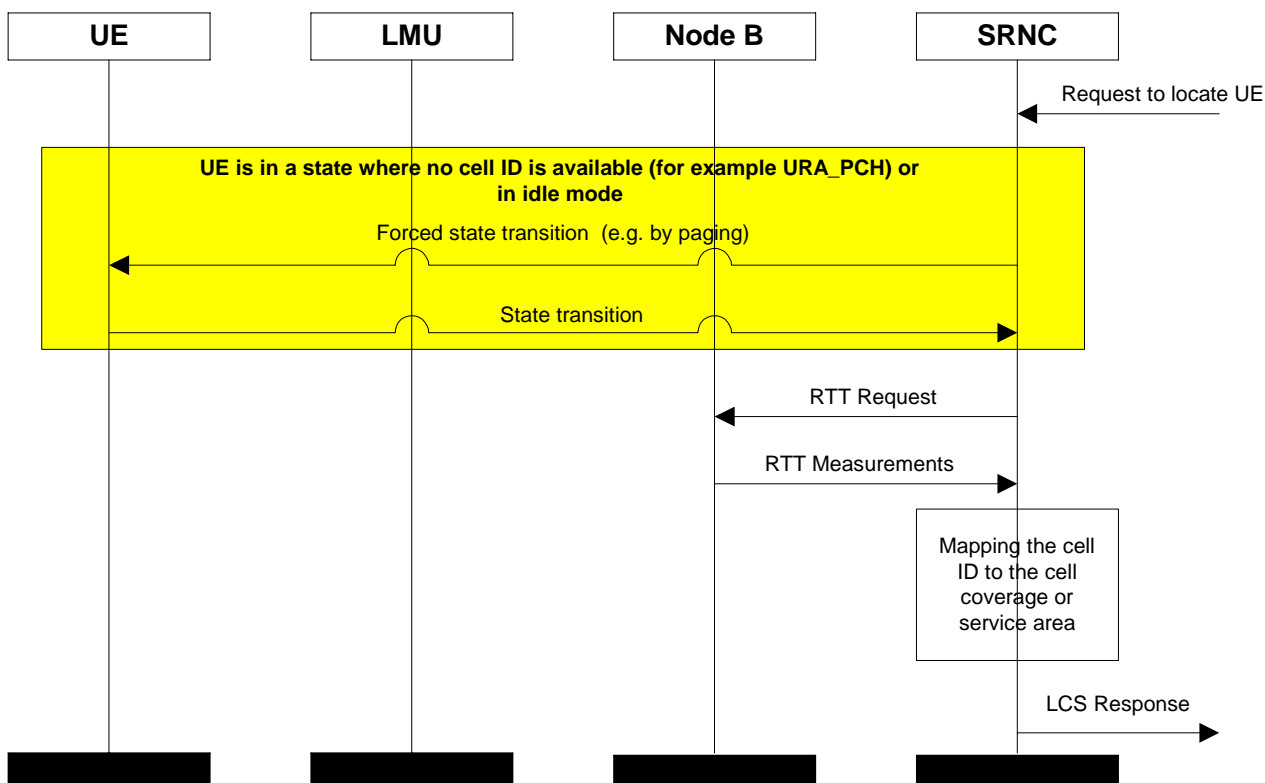

Figure 8.1: Cell ID Based Method

8.1 Cell ID determination

In order for the SRNC to determine the cell ID when an UE Positioning request is received, additional operations may be needed depending on the operational status of the UE.

Figure 8.1 illustrates the procedure for the cell ID based positioning method when the UE is in different RRC states. When the LCS request is received from the CN the SRNC checks the state of the target UE. If the UE is in a state where the cell ID is available, the target cell ID is chosen as the basis for the UE Positioning. In states where the cell ID is not available, the UE is paged, so that SRNC can establish the cell with which the target UE is associated. In order to improve the accuracy of the LCS response the SRNC may also request RTT (FDD only) or RX Timing Deviation (TDD only) or Angle of Arrival (1.28 Mcps TDD only) measurements from the Node B or LMU associated with the cell ID. The SRNC may also map the cell ID to a corresponding SAI to match the service coverage information available in the CN. In the case of 1.28 Mcps TDD, in order to improve the accuracy of the LCS response, the SRNC may request that the UE reports the internal measured result 'timing advance'. This step is not illustrated in figure 8.1.

The cell ID based method shall determine the position of the UE regardless of the UE RRC mode (i.e. connected or idle).

8.1.1 UE Cell ID is not known

For UE for which the cell ID is not known at the time the UE Positioning request is received at the SRNC, the UE may be paged to locate its current cell ID. If the UE is in an idle mode and there is a need for it to be paged, then the paging shall be initiated by the CN. If the UE is in URA_PCH state the paging may be initiated by the SRNC in UTRAN. For example, the UE can be forced to perform a transition to a Cell_FACH state to define the cell ID of its current cell.

If the UE is in an idle mode, or in a RRC connected state when there is a need to page for the UE to obtain the cell ID, the CN may initiate paging, authentication and ciphering, as specified in [13].

Alternatively, the cell ID may be determined as the one that was used during the last active connection to the UE. In the case the UE is not reachable, the last known position should include the age of location field.

8.1.2 UE Cell ID is known

8.1.2.1 UE not in Soft handover

The cell ID may be determined as the cell that is providing an active connection for the UE at the time of receiving the UE Positioning request at the SRNC.

8.1.2.2 UE in Soft handover

In order for the SRNC to provide the geographical co-ordinates of a target UE in soft handover, the SRNC combines the information about all cells associated with the UE.

In soft handover, the UE may have several signal branches connected to different cells, reporting different cell IDs. A reference cell ID may be determined by the SRNC based on the coverage area of each cell. The reference cell ID may be selected based on one or more of the following principles:

- the cell ID may be selected based on the parameters defining the quality of the received signal branches. That is, the cell ID with the best quality signal branch is selected as the reference cell ID;
- the cell ID may be selected that was used during connection set-up between the UE and the serving Node B;
- the cell ID of the cell most recently associated with the UE may be selected;
- the cell ID of the latest "new" cell that the UE has started to receive, but has not yet been handed over to may be selected;
- the cell ID may be selected as the cell to which UE has the shortest distance (to the Node B site);
- the cell ID may be selected as the cell that provides an active connection for the UE at the time of receiving the UE Positioning request at the SRNC.

The selection may also be based on RTT measurements, power levels and received signal strengths in UE and related Node B or LMU.

Other relevant mechanisms such as IPDL or SSDT power control should also be taken into account when applying the cell ID selection procedure for UE in a soft handover mode.

8.2 Mapping the Cell ID to Geographic Co-ordinates or a Service Area

A UTRAN cell ID should be mapped to geographical coordinates or a SAI before being sent from UTRAN to the CN. The Service Area Identifier may include one or several cells. The mapping may be accomplished either in the SRNC, in a Network Management System, including Network Management Unit or by co-operation of various access network elements.

The CN may request the geographical co-ordinates or the SAI, or both for the target UE. The SAI may be used for routing of corresponding Emergency calls, or for CAMEL services to correspond to the usage of Cell ID in the core network of GSM. However, the MSC shall not send the Service Area Identity to GMLC.

Although the mapping of the cell(s) associated with the target UE into geographical co-ordinates by the SRNC is not standardised, the response to the CN Location request with geographical co-ordinates shall be as defined in [11].

In order to determine a cell coverage estimate and to map it to the geographical coordinates or Service Area parameter Identity, the SRNC may use parameters such as the best reference signal, RTT in FDD [15] or Rx Timing Deviation [16] and knowledge of the UE timing advance in TDD, as well as antenna beam direction parameters.

Alternatively, the service area coverage of a cell may be determined by using a reference signal power budget. Based on the reference signal power budget it is possible to obtain, for example, the Node B transmitted power, isotropic path loss, coverage threshold at coverage area border for a given location probability, and a cell radius for an indoor and outdoor coverage.

The SRNC may use a reference signal link budget based cell radius estimate, in conjunction with the cell identifier, to make a coverage estimation for the cell(s) related to the target UE.

Additionally, the SRNC may compare the received power levels with the power budget, whereby more accurate information of the position of the UE may be provided.

Also, the interaction between neighbouring cell coverage areas may be used to determine a more exact UE Positioning.

9 OTDOA positioning method

The primary standard OTDOA measurement is the "SFN-SFN observed time difference" observed at the UE (see [15] and [16]). These measurements, together with other information concerning the surveyed geographic position of the transmitters and the RTD of the actual transmissions of the downlink signals may be used to calculate an estimate of the position of the UE. Each OTDOA measurement for a pair of downlink transmissions describes a line of constant difference (a hyperbola (see note 1)) along which the UE may be located. The UE's position is determined by the intersection of these lines for at least two pairs of Node Bs. The accuracy of the position estimates made with this technique depends on the precision of the timing measurements, the relative position of the Node Bs involved (see note 2), and is also subject to the effects of multipath radio propagation. This is illustrated in the figure 9.1.

NOTE 1: This is really a figure in three dimensions, a hyperboloid. For convenience here, this will be simplified to the hyperbola representing the intersection of this surface with the surface of the earth. For location service in three dimensions the hyperboloid must be considered.

NOTE 2: The geometry of the Node B positions may affect the accuracy of the position estimate. The best results are when the Node Bs equally surround the UE. If they do not, there is a reduction in accuracy, which is sometimes termed the Geometric Dilution of Position (GDP).

The primary OTDOA measurements (made by the UE) are sent to the SRNC. These measures are sent via signalling over the Uu_{Iub} (and Iur) interfaces between the UE and the SRNC. In networks with a SAS, the SRNC may forward the measurement results over the $Iupc$ interface to the SAS. The calculation function makes use of the measurements, the known positions of the transmitter sites and the RTD of the transmissions to estimate the UE's position.

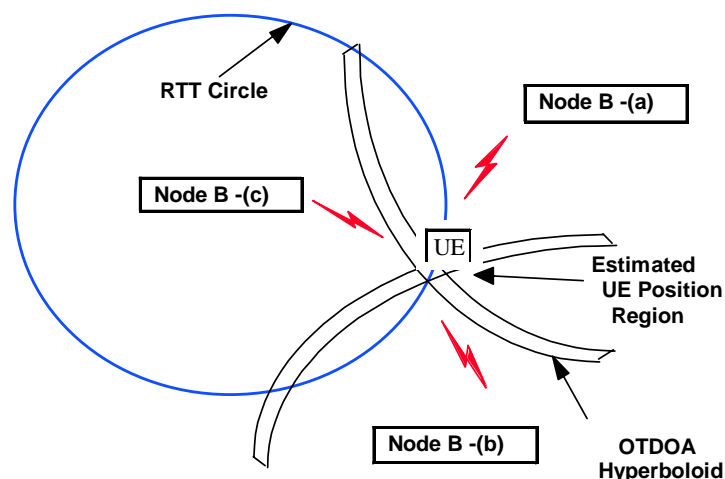

Figure 9.1: OTDOA Positioning Method

The OTDOA method may be operated in two modes: UE-assisted OTDOA and UE-based OTDOA. The two modes differ in where the actual position calculation is carried out.

In the *UE-assisted* mode, the UE measures the difference in time of arrival of several cells and signals the measurement results to the network, where the SRNC or the SAS carries out the position calculation.

In the *UE-based* mode, the UE makes the measurements and also carries out the position calculation, and thus requires additional information (such as the position of the measured Node Bs) that is required for the position calculation.

The signalling requirements for the two OTDOA modes are described in subclause 9.6. As the UE Positioning involves measurements, there is always uncertainty in the results. Physical conditions, errors and resolution limits in the apparatus all contribute to uncertainty. To minimise the uncertainty in the UE Positioning result, it is important that as many measurements of OTDOA (and assistance data as RTT in FDD and Rx Timing Deviation in TDD) as are possible for a UE are provided to the UE. Thus it is important that the standard UE Positioning method not be restricted to rely on a single measure. The UE thus provides SFN-SFN observed time difference measurements for as many cells as it can receive. The cells to be measured shall include those in the active set and the monitored set.

In order to support the OTDOA method, the positions of the UTRAN transmitters needs to be accurately known by the calculation function in SRNC or SAS (for UE-assisted method) or UE (for UE-based method). This information may be measured by appropriate conventional surveying techniques (see note 3). The surveyed position should be the electrical centre of the transmitting antenna (and not the position of the radio equipment building). The use of antenna diversity, beamforming or beam steering techniques may cause the effective antenna position to change with time and this information is also needed to perform calculations. The methods of measuring the position of the UTRAN transmitters are outside the scope of the present document.

NOTE 3: These surveying methods may, for example, make use of a GPS receiver.

In order to support the OTDOA method, the RTD of the DL transmissions must also be known to perform the calculation. If the UTRAN transmitters are unsynchronised, the RTD will change over time as the individual clocks drift. Thus, RTD estimations may need to be made regularly and the calculation function updated appropriately.

One convenient method is to make use of an LMU at a fixed position. This unit performs timing measurements (e.g. UTRAN GPS timing of cell frames or SFN-SFN Observed Time Difference) of all the local transmitters. The CRNC then may convert these measures into the actual (absolute) relative time difference for each of the transmitters by making use of the known position of the LMU and the transmitters.

In some conditions a sufficient number of cells may not be available for measure at the UE. This may occur, for example, if the UE is located quite close to the UTRAN transmitter and its receiver is blocked by the strong local transmissions. This is referred to as the "hearability" problem.

9.1 Use of Idle Periods

Location based services needs the support of physical layer as a prerequisite, so that the measurements required for the UE position calculation can be carried out. In UTRAN there are several factors that must be taken into account while considering the physical layer procedures related to location services:

- hearability: a basic consequence of a CDMA radio system is that a terminal near its serving Node B cannot hear other Node Bs on the same frequency. In order to calculate its position the UE should be able to receive at least three Node Bs. To facilitate this some special means are required;
- asynchronous network causes significant uncertainty to the time-difference-of-arrival (TDOA) measurements. To compensate for the effects of this, the relative time difference (the synchronicity) between Node B transmissions must be measured, and used for correcting OTDOA measurement;
- capacity loss: signalling related to position calculation may take capacity from other services. This capacity loss should be minimised.

Based on the results in [29] a solution for the above mentioned hearability problem is the IPDL method. In this method each Node B ceases its transmission for short periods of time (idle periods). Therefore the Node B is configured appropriately by the CRNC using the NBAP protocol [22]. During an idle period of a Node B, terminals within the cell can measure other Node Bs and the hearability problem is reduced. The UEs are made aware of the occurrences of IPDLs by using RRC signalling over the Uu interface [18]. Also, during idle periods the real time difference measurements can be carried out. Because the IPDL method is based on downlink the location service can be provided efficiently to a large number of terminals simultaneously.

The specification and operation of the IPDL technique are provided in [14] and [26].

9.2 Relative Time Difference (RTD)

In order to calculate the estimate of the position of the UE, the calculation function needs to know:

- the OTDOA measurements;
- the surveyed geographic positions of the Node Bs that have had their signals measured; and
- the actual relative time difference between the transmissions of the Node Bs at the time the OTDOA measurements were made.

The accuracy of each of these measurements contributes to the overall accuracy of the position estimate. The measurement of the RTD is described in the following.

There are several approaches to determining the RTD. One is to synchronise the transmissions of Node B. In this technique the RTD are known constant values (see NOTE) that may be entered in the database and used by the calculation function when making a position estimate. The synchronisation must be done to a level of accuracy of the order of tens of nanoseconds (as 10 nanoseconds uncertainty contributes 3 metres error in the position estimate). Drift and jitter in the synchronisation timing must also be well controlled as these also contribute uncertainty in the position estimate. Synchronisation to this level of accuracy is currently only readily available through satellite based time-transfer techniques. Generally in the TDD operating mode, the Node Bs are synchronised.

NOTE: The transmission times may all be aligned to a common reference (such as UTC) in which case all RTD have a common value. However, in a more general case the transmissions may have a fixed offset with reference to UTC, and thus the RTD values are non-zero and may be stored in the database for use by the calculation function.

Alternatively (typically in FDD mode), Node Bs may be left to free run within some constraint of maximum frequency error. In this scenario, the RTD will change (slowly) with time. The rate of change will depend on the frequency difference and jitter between Node Bs. If, for example, the maximum frequency difference between two Node Bs is $\pm 10^{-9}$, then the start of transmission of a 10 millisecond code sequence will drift through a cycle in about 1 390 hours (or 57 days). With this relatively slow rate of drift the measurements needed to obtain the RTD can be performed by fixed LMUs at known positions and stored in the database for use by the calculation function. The jitter and drift of the individual oscillators in each Node B may cause the change of timing to slow, remain constant or reverse direction over time. Ongoing measurements may be made to assure the most current values are available for the calculation function. The measurement units needed to support RTD estimation may be co-located with the Node Bs or installed at other convenient positions in the UTRAN coverage area, and report their results through the UTRAN signalling.

The LMUs may directly measure the SFN-SFN Observed Time Difference between neighbouring and reference cells and return the measurements to the CRNC. Alternatively the LMUs may measure the UTRAN GPS timing of cell frames of the neighbouring and reference cells and return the measurements to the CRNC. If the CRNC is not the SRNC the information is also forwarded from CRNC to SRNC. In networks with a SAS the information may also be forwarded to the SAS.

The SRNC or SAS then uses the UTRAN GPS timing of cell frames or SFN-SFN Observed Time Difference measurements to calculate the RTD values. The information to be transferred in each case is listed in 7.4.3.

9.3 Time of Day (ToD)

If there are frequency drifts between the (unsynchronised) Node Bs, as noted in subclause 9.2, the OTDOA measurements must be reported together with the time-of-day they were made (timestamp). This is necessary so that the appropriate value of the RTD may be used by the calculation function.

In order to assure less than a 20 nanosecond uncertainty in the RTD value, the time of day must be known to better than 10 seconds (if the maximum frequency difference between the Node Bs is $\pm 10^{-9}$). The method by which the ToD is measured is the system frame number, which provides a 10 millisecond resolution and can be unambiguous up to 40.95 seconds.

9.4 Node B Synchronisation

It is preferable that the positioning methods do not require the Node B to be synchronised. The needed level of synchronisation accuracy for UE Positioning is not by any means straightforward to achieve. The necessary information to obtain RTD between Node Bs can be measured by LMU (e.g. UTRAN GPS timing of cell frames or SFN-SFN Observed Time Difference) and distributed in the network (e.g. as broadcast information). Also, these measurements may benefit from the IPDL option.

In the TDD operating mode the Node Bs will typically be synchronised and this may be of assistance to the UE Positioning technique.

9.5 OTDOA-IPDL and OTDOA Modes

There are two modes of operation for the OTDOA-IPDL and OTDOA methods.

In the *UE-assisted* mode, the UE measures the difference in time of arrival of several cells and signals the measurement results to the network, where the SRNC or SAS carries out the position calculation.

In the *UE-based* mode, the UE makes the measurements and also carries out the position calculation, and thus requires additional information (such as the position of the measured Node Bs) that is required for the position calculation. This information is provided by the System Information Broadcast.

9.5.1 Information to be transferred between UTRAN elements

Table 9.1 lists the required information for both UE-assisted and UE-based modes that may be sent from UTRAN to UE. The required information can be signalled to the UE either in a broadcast channel or partly also as dedicated signalling.

Table 9.1: Information to be transferred from UTRAN to UE ('Yes' = information required, 'No' = Information not required)

Information	UE-assisted	UE-based
Intra frequency Cell Info (neighbour list)	Yes	Yes
Ciphering information for UE Positioning (see note 1)	No	Yes
Measurement control information (idle period locations)	Yes	Yes
Sectorisation of the neighbouring cells	No	Yes
Measurements results needed for RTD values for Cells mentioned at Intra frequency Cell Info	No	Yes
RTD accuracy	No	Yes
Measured roundtrip delay for primary serving cell	No	Yes
Geographical position of the primary serving cell	No	Yes
Relative neighbour cell geographical position	No	Yes
Accuracy range of the geographic position values	No	Yes
IPDL parameters	Yes	Yes
IPDL-Alpha parameter for Open Loop Power Control when using IPDLs in TDD (see note 2)	Yes	Yes
Maximum Power increase the UE may use when using IPDLs in TDD (see note 2)	Yes	Yes
NOTE 1: The idea behind UE Positioning specific ciphering information is e.g. that the operator can sell information that the UE needs for calculating its position. For reference in the GSM world see [4].		
NOTE 2: These parameters are not required for 1.28 Mcps TDD in this release.		

When IPDLs for 3.84 Mcps TDD are applied and the IPDLs occur in the slot carrying the PCCPCH, a special alpha parameter needs to be signalled from SRNC to the UE in order to take the impact of the IPDLs on the Open Loop Power Control into account. Additionally the UE shall not increase the transmit power by a certain value between an IPDL slot and the next slot carrying the PCCPCH when IPDLs are applied within a cell. OTDOA for 1.28 Mcps TDD is based on DwPTS and so these requirements do not apply.

The information that may be signalled from UE to SRNC is listed in table 9.2.

Table 9.2: Information to be transferred from UE to SRNC

Information	UE-assisted	UE-based
OTDOA measurement results	Yes	No
OTDOA measurement accuracy	Yes	No
UE geographical position	No	Yes
Position accuracy indicator (based on the signalled and measurement accuracies)	No	Yes

Table 9.3 shows the information that may be transferred from Node B to its CRNC. If the CRNC is not the SRNC the information is also forwarded from CRNC to SRNC.

Table 9.3: Information to be transferred from Node B/LMU to CRNC and between RNCs

Information	UE assisted	UE based
Measured UTRAN GPS timing of cell frames or SFN-SFN Observed Time Difference values for Cells mentioned at Intra frequency Cell Info	Yes	Yes
UTRAN GPS timing of cell frames or SFN-SFN Observed Time Difference accuracy	Yes	Yes

Table 9.4 shows the information that may be transferred from CRNC to Node B. If the CRNC is not the SRNC the information may also be sent from CRNC to SRNC.

Table 9.4: Information to be transferred from CRNC to Node B/LMU and between RNCs

Information	UE assisted	UE based
IPDL parameters	Yes	Yes

Table 9.5 shows the information that may be transferred between RNCs.

Table 9.5: Information to be transferred between RNCs

Information	UE assisted	UE based
Geographical position of the primary serving cell	Yes	Yes
Relative neighbour cell geographical position	Yes	Yes
Accuracy range of the geographic position values	Yes	Yes
IPDL-Alpha parameter for Open Loop Power Control when using IPDLs in 3.84 Mcps TDD	Yes	Yes
Maximum Power the UE may use when using IPDLs in 3.84 Mcps TDD	Yes	Yes

9.6 OTDOA network positioning procedures

The following diagram illustrates the operations for the OTDOA method for UE Positioning when the request for positioning information is initiated by an LCS application from the CN.

This illustration only includes the information flow related to UE Positioning operations and does not indicate other operations that may be required, for example, to establish a signalling connection between the UE and the SRNC. Also not illustrated is the signalling used to initiate the location service request from the CN or a UE-based application.

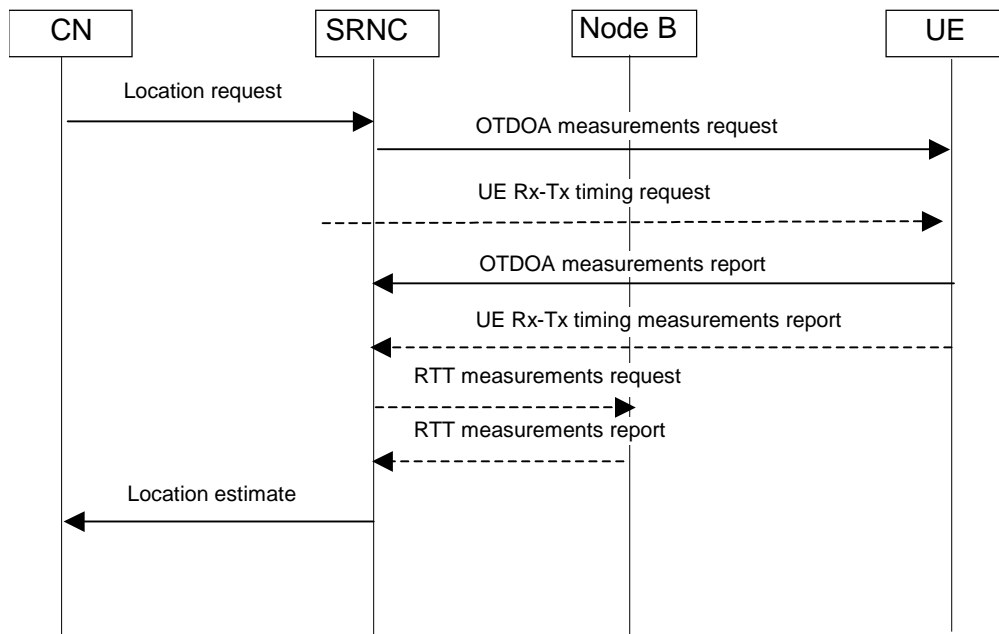

Figure 9.2: OTDOA Signalling Operations

1. The operation begins with an authenticated request for positioning information about a UE from an application in the CN being received at the SRNC. The SRNC considers the request and the UTRAN and UE capabilities.
2. The SRNC requests from the UE the measurement of the OTDOA for the signals in the active and neighbourhood sets. These measurements are made while the UE is in connected mode CELL_DCH state.
3. If it is considered advantageous to do so, the SRNC requests the UE Rx-Tx timing difference (FDD only) or UE timing advance, T_{ADV} , (1.28 Mcps TDD) information from the UE.

4. The UE returns the OTDOA measures to the SRNC. The SRNC receives the OTDOA information and coordinates obtaining other information to support the calculation request.
5. The UE returns the UE Rx-Tx timing difference (FDD only) or UE timing advance, T_{ADV} , (1.28 Mcps TDD) information to the SRNC, together with a time stamp of when the value was obtained.
6. If there are insufficient OTDOA measures, or it is otherwise considered advantageous to do so, the SRNC requests the RTT (in FDD) or Rx timing deviation (in TDD) and/or angle of arrival (in 1.28 Mcps TDD) measure for the UE from the serving Node B.
7. In FDD, the SRNC requests the RTD values for the associated transmitters from the associated database. These may be stored locally if they are constant over time, otherwise they must be updated to represent the RTD timing at the time-of-day the OTDOA measurements were made.
8. The Node B returns the RTT (in FDD) or Rx Timing Deviation (in TDD) and/or angle of arrival (in 1.28 Mcps TDD) measures to the SRNC if they were requested.
9. The SRNC performs a position calculation using the OTDOA, RTD and, if necessary, RTT (in FDD) or Rx timing deviation and UE timing advance (in TDD) information and angle of arrival information (1.28 Mcps TDD). The calculation may include a co-ordinate transformation to the geographic system requested by the application. The position estimate includes the position, the estimated accuracy of the results and the time of day of the estimate. In networks that include the SAS, the SAS may perform the position calculation and then pass the position estimate to the SRNC.
10. The SRNC passes the position estimate to the CN.

10 Network-assisted GPS positioning method

When GPS is designed to inter-work with the UTRAN, the network assists the UE GPS receiver to improve the performance in several respects. These performance improvements will:

- reduce the UE GPS start-up and acquisition times; the search window can be limited and the measurements sped up significantly;
- increase the UE GPS sensitivity; positioning assistance messages are obtained via UTRAN so the UE GPS can operate also in low SNR situations when it is unable to demodulate UE GPS signals;
- allow the UE to consume less handset power than with stand-alone GPS; this is due to rapid start-up times as the GPS can be in idle mode when it is not needed.

The Network-assisted GPS methods rely on signalling between UE GPS receivers (possibly with reduced complexity) and a continuously operating GPS reference receiver network, which has clear sky visibility of the same GPS constellation as the assisted UEs. GPS reference receivers may be connected to the UTRAN to enable derivation of UE assistance signals.

Figures 10.1 and 10.2 provide an example of the end-to-end call flows for UE-assisted and UE-based positioning respectively. The SAS is an optional network element and the call segments do not apply in a network where the UE Positioning resides within the SRNC.

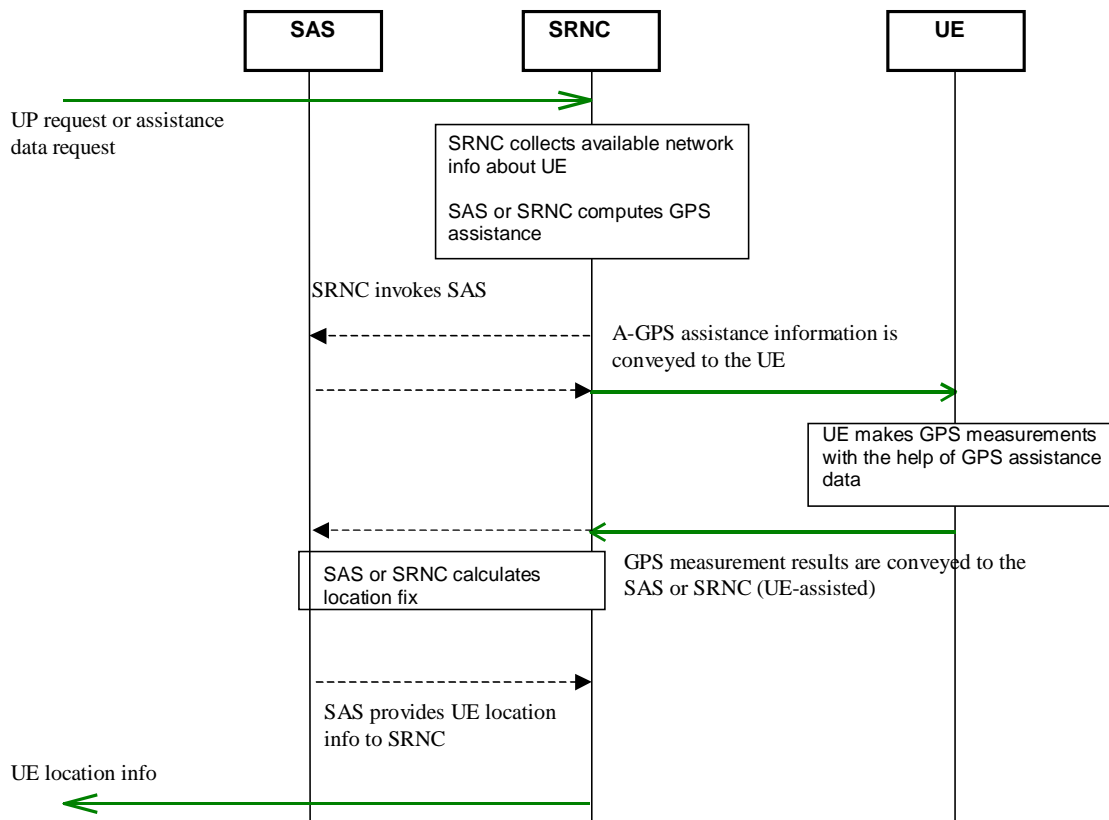

Figure 10.1: Network-assisted GPS methods – UE-Assisted

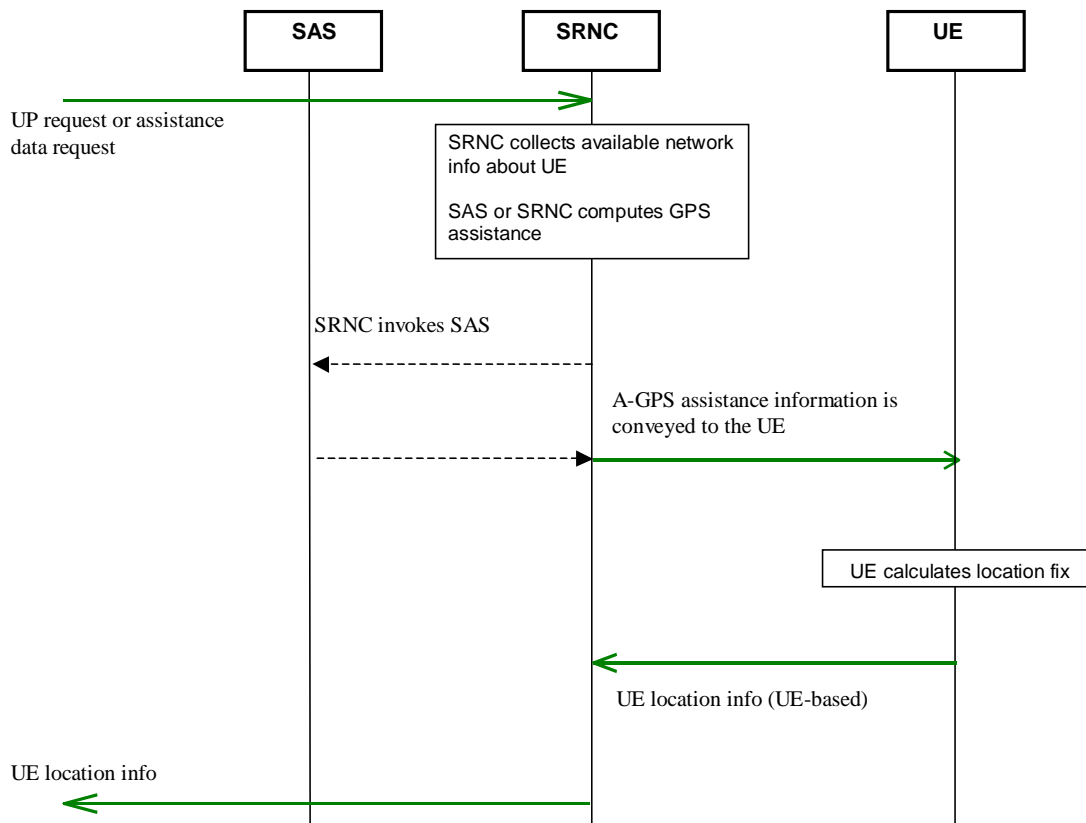

Figure 10.2: Network-assisted GPS methods – UE-Based

10.1 Timing calibration

Timing calibration is achieved by using UE or UTRAN GPS timing measurements as specified in [15].

10.2 Timing assistance

The UTRAN may derive the estimated UE position using UTRAN parameters (e.g. Cell-ID or IPDL) and may use this information, in conjunction with satellite specific ephemeris data received from the GPS reference receiver network, to derive the estimated times of arrival (code phases) for equivalent GPS satellite signals received by the UE-based GPS receiver functionality. For the UE-assisted method, the estimated code phase data may be conveyed, together with $T_{\text{UTRAN-GPS}}$ (as specified in [15] and [16]), from the UTRAN to the UE using higher layer signalling. The estimated code phase data value is uncertain to a degree depending on the accuracy of the UTRAN timing calibration and initial position determination methods used.

Alternatively, for the UE-based method, the UE itself may derive its location aided by assistance messages. The ephemeris data are transmitted from UTRAN to the UE using higher layer signalling. The UE may use this information, in conjunction with the UE's reference location, to derive the times of arrival (code phases) for GPS satellite signals received by the UE-based GPS receiver functionality.

10.3 GPS assistance data

The UE may receive GPS information through the UTRAN radio interface, using higher layer signalling.

When the UE is unable to detect a sufficient number of satellites, the assisted GPS method can be combined with other positioning methods. Altitude assistance can compensate for one satellite measurement.

The assistance data signalled to the UE may include all information listed below or a selected subset:

- data assisting the measurements; e.g. reference time, visible satellite list, satellite signal Doppler, code phase, Doppler and code phase search windows. This data can be valid for a few minutes (e.g., less than 5 minutes) or longer depending on the code phase and Doppler search window size that can be accommodated by the UE;
- data providing means for position calculation; e.g. reference time, reference position, satellite ephemeris, clock corrections. Satellite ephemeris and clock corrections data can be used for up to six hours.

NOTE: Certain types of GPS Assistance data may be derived, wholly or partially, from other types of GPS Assistance data.

If DGPS is utilised, then differential corrections may also be transmitted. If Selective Availability is turned off, these corrections can be valid for a few minutes or more. The DGPS data is valid for a large geographical area, so one centrally located reference receiver can be used to service this large region.

10.4 UE search

Provided that timing assistance, data assistance, and/or frequency reference is available in the UE, they should be applied in the GPS signal search procedure. The UE search procedure involves a three-dimensional search for a satellite pseudorandom code, time of arrival of a signal and the associated carrier Doppler.

"Modulation wipe-off" is defined here to mean a removal of the GPS navigation data bit modulation to GPS signals received at the UE, through the application of UTRAN timing and data assistance provided from the UTRAN to the UE. This process allows the UE to coherently integrate received GPS signals beyond 1 data bit period (i.e., 20 milliseconds).

10.5 Position determination

There are two types of network-assisted GPS methods, namely UE-based and UE-assisted, which differ according to where the actual position calculation is carried out.

Computation of the position fix can either be performed in UTRAN (i.e. SRNC or SAS) for UE-assisted or in the UE for UE-based.

The UE-based method maintains a full GPS receiver functionality in the UE, and the position calculation is carried out by the UE, thus allowing stand-alone position fixes.

In the UE-assisted method, the UE employs a reduced complexity GPS receiver functionality. This carries out the pseudorange (code phase) measurements. These are signalled, using higher layer signalling, to the specific network element that estimates the position of the UE and carries out the remaining GPS operations. In this method, accurately timed code phase signalling (as specified in [15] and [16]) is required on the downlink. If DGPS is performed in the UE, then differential corrections must be signalled to it. On the other hand, DGPS corrections can be applied to the final result in the network to improve the position accuracy without extra signalling to the UE.

10.5.1 Information to be transferred between UTRAN elements

Table 10.1 lists information for both UE-assisted and UE-based modes that may be sent from the network to UE. This information can be signalled to the UE either in a broadcast channel or as dedicated signalling.

Table 10.1: Information that may be transferred from the network to UE ('Yes' = information applicable 'No' = information not applicable)

Information	UE-assisted	UE-based
Number of satellites for which assistance is provided	Yes	Yes
reference time for GPS ($T_{\text{UTRAN-GPS}}$) (specified in [15] and [16])	Yes	Yes
3-d reference position (specified in [11])	No	Yes
ionospheric corrections	No	Yes
satellite ID for identifying the satellites for which assistance data is provided	Yes	Yes
Ephemeris & clock corrections	Yes	Yes
UTC offset	No	Yes
DGPS corrections	No	Yes
almanac data	Yes	Yes
real-time integrity (e.g. a list of unusable satellites)	No	Yes
doppler (0 th order term)	Yes	No
Doppler Search Window width	Yes	No
doppler (1 st order term)	Yes	No
azimuth	Yes	No
elevation	Yes	No
code phase	Yes	No
code phase centre and search window width	Yes	No

The information that may be signalled from UE to the network is listed in table 10.2.

Table 10.2: Information that may be transferred from UE to the network

Information	UE-assisted	UE-based
reference time for GPS ($T_{\text{UE-GPS}}$) (specified in [15] and [16])	Yes	Yes
serving cell information	No	Yes
Latitude/Longitude/Altitude/Error ellipse	No	Yes
velocity estimate in the UE	No	Yes
satellite ID for which measurement data is valid	Yes	No
Whole/Fractional chips for information about the code-phase measurement	Yes	No
C/N ₀ of the received signal from the particular satellite used in the measurements	Yes	No
doppler frequency measured by the UE for the particular satellite	Yes	No
pseudorange RMS error	Yes	No
multipath indicator	Yes	No
number of Pseudoranges	Yes	No

Table 10.3 shows the information that may be transferred from Node B to its CRNC. If the CRNC is not the SRNC the information is also forwarded from CRNC to SRNC.

Table 10.3: Information that may be transferred from Node B/LMU to CRNC and between RNCs

Information	UE-assisted	UE-based
reference time for GPS ($T_{\text{UTRAN-GPS}}$) (specified in [15] and [16])	Yes	Yes

10.5.1.1 Almanac data

The almanac parameters specify the coarse, long-term model of the satellite positions and clocks. These parameters are a subset of the ephemeris and clock correction parameters in the Navigation Model, although with reduced resolution and accuracy. The almanac model is useful for receiver tasks that require coarse accuracy, such as determining satellite visibility. The model is valid for up to one year, typically. Since it is a long-term model, the field should be provided for all satellites in the GPS constellation.

Optionally, "SV Global Health" information may accompany this almanac information. This additional information is composed of the sequence of all non-parity data bits contained in words 3-10 of page 25 of subframe 4 of the GPS navigation message followed by the sequence of all non-parity bits contained in words 3-10 of page 25 of subframe 5 of the GPS navigation message. The following GPS navigation message fields are excluded when constructing these sequences: "Data ID", "SV (Page) ID", and "t".

10.5.1.2 DGPS corrections

In order to allow a UE to estimate its position more accurate, biases in the pseudorange measurements may be provided to the UE.

Status/Health

This information indicates the status of the differential corrections contained in the message.

IODE

This is the sequence number for the ephemeris for the particular satellite. The UE can use this information to determine if new ephemeris is used for calculating the corrections that are provided in the broadcast message. This eight-bit IE is incremented for each new set of ephemeris for the satellite and may occupy the numerical range of [0, 239] during normal operations. More information about this field can be found from [24].

User Differential Range Error (UDRE)

The UDRE provides an estimate of the uncertainty ($1-\sigma$) in the corrections for the particular satellite. The value in this field shall be multiplied by the UDRE Scale Factor in the common Corrections Status/Health field to determine the final UDRE estimate for the particular satellite. More information about this field can be found from [24].

Pseudo-Range Correction (PRC)

The PRC indicates the correction to the pseudorange for the particular satellite at the GPS Reference Time, t_0 . The PRC definition here is different from the one given in [24].

Pseudo-Range Rate Correction (RRC)

This information indicates the rate-of-change of the pseudorange correction for the particular satellite, using the satellite ephemeris identified by the IODE IE. The RRC definition here is different from the one given in [24].

Delta Pseudo-Range Correction 2 (Delta PRC2)

This information indicates the difference in the pseudorange correction between the satellite's ephemeris identified by IODE and the previous ephemeris two issues ago IODE-2.

Delta Pseudo-Range Rate Correction 2 (Delta RRC2)

This information indicates the difference in the pseudorange rate-of-change correction between the satellite's ephemeris identified by IODE and IODE-2.

Delta Pseudo-Range Correction 3 (Delta PRC3)

This information indicates the difference in the pseudorange correction between the satellite's ephemeris identified by IODE and the previous ephemeris three issues ago IODE – 3.

Delta Pseudo-Range Rate Correction 3 (Delta RRC3)

This information indicates the difference in the pseudorange rate-of-change correction between the satellite's ephemeris identified by IODE and IODE-3.

10.5.1.3 Ionospheric corrections

The Ionospheric Model contains information needed to model the propagation delays of the GPS signals through the ionosphere. Proper use of these information allows a single-frequency GPS receiver to remove approximately 50% of the ionospheric delay from the range measurements. The Ionospheric Model is valid for the entire constellation and changes slowly relative to the Navigation Model.

10.5.1.4 Ephemeris data and clock correction

Ephemeris data and clock corrections provide an accurate model of the satellite positions to the UE.

10.5.1.5 Real Time integrity monitor function

An Integrity Monitor (IM) function in the network should detect unhealthy (i.e., failed/failing) satellites. Excessively large pseudo range errors, as evidenced by the magnitude of the corresponding DGPS correction determined by the IM, may be used to detect unhealthy satellites. Unhealthy satellites should be detected very close to the occurrence of the satellite failure (e.g. 10 seconds) and marked in an unhealthy satellite list as unusable/bad. When unhealthy satellites are detected, the assistance and/or DGPS correction data should not be supplied for these satellites. Upon receiving the list of unhealthy satellites from the SRNC, the UE shall consider the data associated with these satellites to be invalid.

The IM function should also inform the UE of measurement quality in DGPS modes when satellites are healthy. This can be done by computing the position of the DGPS reference receiver using its derived pseudo ranges and differential corrections at the IM, and differencing the IM computed position with the known location of the DGPS reference receiver to compute a position error. When the error in the IM computed position is excessive for solutions based upon healthy satellites only, DGPS users should be informed of measurement quality through the supplied User Differential Range Error (UDRE) adjusted values based on the operation of the IM. The UE should use the measurement quality as a factor in weighing data obtained from associated satellites in its position calculation.

NOTE: UDRE is one of the IEs contained in the DGPS information ([19]).

The real-time Integrity Monitor function provides the following information to a UE:

- BadSATid;
- UDRE value adjusted based on the measurement quality.

BadSATid is a list of unhealthy (i.e., failed/failing) satellites. The UE shall consider any assistance or DGPS data of these satellites as invalid.

Adjusted UDRE value reports the measurement quality of the corresponding satellites. The UE should consider the quality while calculating its position.

10.5.1.6 GPS reference time

GPS reference time may be used to provide a mapping between UTRAN and GPS time.

GPS TOW Assist

This information contains several fields in the Telemetry (TLM) Word and Handover Word (HOW) that are currently being broadcast by the respective GPS satellites. Combining this information with GPS TOW helps the UE with time-recovery needed to predict satellite signal.

TLM Message

This information contains a 14-bit value representing the Telemetry Message (TLM) being broadcast by the GPS satellite identified by the particular SatID, with the MSB occurring first in the satellite transmission.

Anti-Spoof/Alert

These information contain the Anti-Spoof and Alert flags that are being broadcast by the GPS satellite identified by SatID.

TLM Reserved

These information contain the two reserved bits in the TLM Word being broadcast by the GPS satellite identified by SatID, with the MSB occurring first in the satellite transmission.

10.5.1.7 UTC

UTC parameters may be used to provide Coordinated Universal Time to the UE.

10.5.1.8 Reference Location

The Reference Location contains a 3-D location (without uncertainty) specified as per [11]. The purpose of this field is to provide the UE with a priori knowledge of its position in order to improve GPS receiver performance.

10.5.1.9 Additional non-GPS related information

Additional non-GPS measurements performed by UTRAN or UE may be used by the SRNC to improve the performance of the UE-assisted GPS method. This information may be RTT in FDD or Rx Timing Deviation in TDD, UE receiving transmitting time (UE Rx-Tx), SFN-SFN observed time difference or CPICH Ec/No. All the additional measurements are defined in [15] and [16] and can be made available through RRC signalling for UE measurements or NBAP signalling for UTRAN measurements.

Furthermore, to those UE technologies requiring externally provided sensitivity and time aiding data, some navigation bits may be sent from UTRAN to UE for sensitivity assistance and time recovery.

10.6 Network Assisted GPS positioning Procedure

The diagram in Figure 10.3 and Figure 10.2 illustrate the operations for the network assisted GPS when the request for position information is initiated by a LCS application signalled from the Core Network. A detailed description of the positioning procedure is given as follows. Note that the procedure is for illustration purpose and actual implementations may vary.

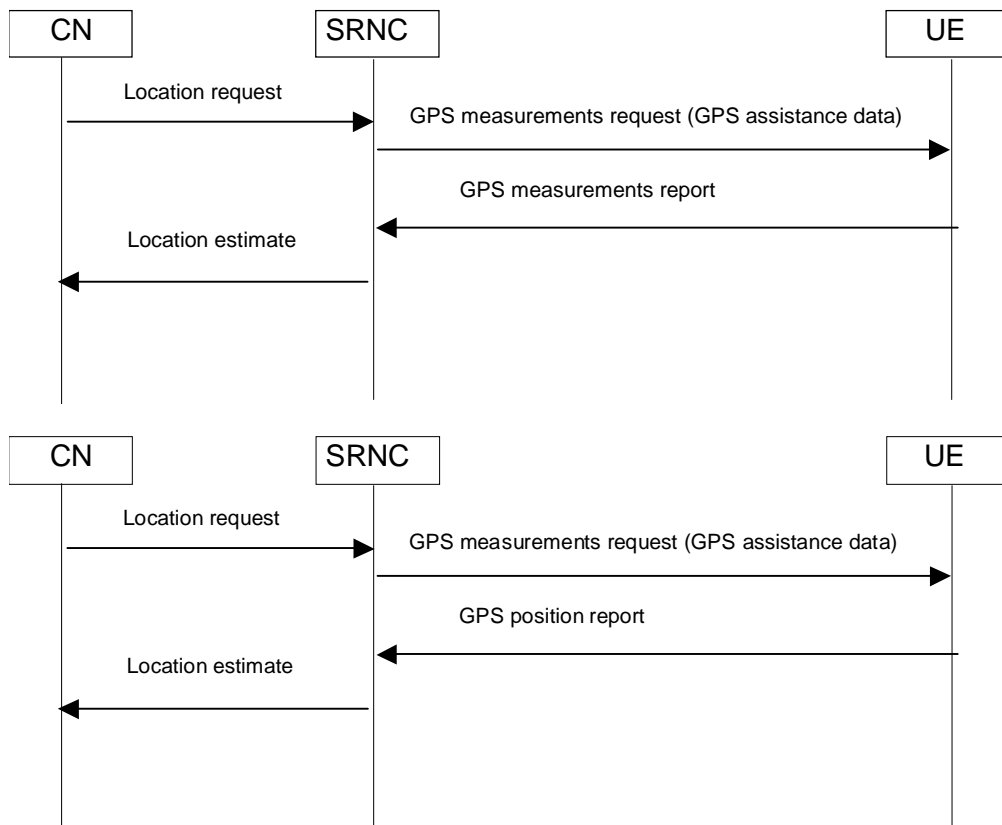

Figure 10.3: Network-assisted GPS methods

1. The operation begins with an authenticated request for positioning information about a UE from an application in the core network being received at the SRNC. The SRNC acts as interface between the Core Network and the UE Positioning entities in the UTRAN. The SRNC considers the request and the capabilities of the UE and the UTRAN. In networks that include the SAS, the SRNC may invoke the SAS via the Iupc interface.
2. Depending on the UE capabilities, the network sends to the UE certain GPS assistance information. This information may include: the reference time for GPS, the satellite IDs, the Doppler frequency, the search window and its centre, the ephemeris and clock corrections, the almanac, and other information specified in 10.5.1.

For UE-based method, jump to step 8.

For UE-assisted method, the SRNC may optionally request the following information before the assistance message(s) is (are) sent to the UE: the LMU update*, the RTT measurements (from the Node Bs in the active set) to compensate for the one-way propagation delays. The LMU (associated or stand-alone) returns the information containing the time difference between the Node B and the GPS (e.g. UTRAN GPS timing of cell frames or SFN-SFN Observed Time Difference) to the CRNC. The Node B returns its RTT measurement to the CRNC. If the CRNC is not the SRNC, the CRNC forwards these information to SRNC.

4. The network requests from the UE the measurement of GPS satellite pseudoranges and other information specified in 10.5.1. These measurements may be made while the UE is in RRC connected mode CELL_DCH state. The SRNC may request SFN-SFN Observed Time Difference measurements and Rx-Tx timing difference information from the UE to support the processing related to the RTT measurements.
5. The UE returns to the network the measurement of GPS satellite pseudoranges and other information specified in 10.5.1. If requested, the UE returns to the SRNC SFN-SFN measurements and the Rx-Tx time difference information, together with a time stamp of when these values were obtained.
6. The UE position is calculated in the network.
7. If there is insufficient information to yield a UE positioning estimate, the SRNC may start a new process from step 3.

8. In case of UE based method, UE returns the position estimate to the SRNC. This estimate includes the position, the estimated accuracy of the results and the time of the estimate.
9. In networks that include the SAS, the SAS passes the position estimate to the SRNC.
10. The SRNC passes the position estimate to the CN.

NOTE: The LMU update (of the time difference between the GPS and the Node B) may be performed on a per-request basis (with respect to each UE Positioning request) or be performed timely that is independent of individual UE Positioning request. The latter is preferable when there is a large volume of UE Positioning requests.

11 Information storage

NOTE This clause just outlines the information that may need to be stored in the UTRAN UE Positioning that may need to be standardised (if any).

Annex A (informative): Definitions and Terms

This annex provides definitions and terms for the general LCS. Not all of these are applicable to the UTRAN environment.

CAMEL: CAMEL is a network functionality, which provides the mechanisms of Intelligent Network to a UE.

Current Position: after a location attempt has successfully delivered a position estimate and its associated time stamp, the position estimate and time stamp is referred to as the 'current position' at that point in time.

Deferred location request: a location request where the location response (responses) is (are) not required immediately.

Frequency reference: the frequency reference of the UE obtained from the UTRAN radio interface that may be used to minimize the frequency search associated with acquiring GPS satellite signals. When the UE acquisition process is aligned to this reference, the carrier Doppler uncertainty that must be searched for a particular satellite signal need only account for minor residual uncertainties related to UE dynamics and initial position. This frequency reference may also be used to maintain the UE's estimate of GPS time between positioning events, thus making accurate GPS time available within the UE to support reacquisition of satellite signals.

Global Positioning System: the Global Positioning System (GPS) consists of three functional elements: Space Segment (satellites), User Segment (receivers), and Control Segment (maintenance etc.). The GPS receiver estimates its own location based on the observed times of arrival of the satellite signals.

Immediate location request: a location request where a single location response only is required immediately.

Initial Position: in the context of an originating emergency call the position estimate and the associated time stamp at the commencement of the call set-up is referred to as 'initial position'.

Last Known Position: the current position estimate and its associated time stamp for Target UE stored in the LCS Server is referred to as the 'last known position' and until replaced by a later position estimate and a new time stamp is referred to as the 'last known position'.

LCS (LoCation Services): LCS is a service concept in system (e.g. GSM or UMTS) standardisation. LCS specifies all the necessary network elements and entities, their functionalities, interfaces, as well as communication messages, due to implement the location service functionality in a cellular network.

NOTE: LCS does not specify any location based (value added) services except locating of emergency calls.

LCS Client: a software and/or hardware entity that interacts with a LCS Server for the purpose of obtaining location information for one or more UEs. LCS Clients subscribe to LCS in order to obtain location information. LCS Clients may or may not interact with human users. The LCS Client is responsible for formatting and presenting data and managing the user interface (dialogue). The LCS Client may reside in the UE.

LCS Client Access barring list: an optional list of MSISDNs per LCS Client where the LCS Client is not allowed to locate any MSISDN therein.

LCS Client Subscription Profile: a collection of subscription attributes of LCS related parameters that have been agreed for a contractual period of time between the LCS client and the service provider.

LCS Feature: the capability of a PLMN to support LCS Client/server interactions for locating Target UEs.

LCS Server: a software and/or hardware entity offering LCS capabilities. The LCS Server accepts requests, services requests, and sends back responses to the received requests. The LCS server consists of LCS components, which are distributed to one or more PLMN and/or service provider.

Local Service: a service, which can be exclusively provided in the current serving network by a Value added Service Provider.

Local Information: information related to a given location, or general information, which is made available in a given location.

Location (Based) Application: a location application is an application software processing location information or utilising it in some way. The location information can be input by a user or detected by UTRAN or UE. Navigation is one location application example.

Location Based Service (LBS): a service provided either by teleoperator or a 3rd party service provider that utilises the available location information of the terminal. Location Application offers the User Interface for the service. LBS is either a pull or a push type of service (see Location Dependent Services and Location Independent Services).

Location Dependent Service: a service provided either by teleoperator or a 3rd party service provider that is available (pull type) or is activated (push type) when the user arrives to a certain area. It doesn't require any subscription in advance, but the push type activation shall be confirmed by the user. The offered service itself can be any kind of service (e.g. a public Xerox machine or the discount list in a store).

Location Independent Service: a service provided either by teleoperator or a 3rd party service provider that is available and therefore can be activated anywhere in the network coverage. It is activated by the user's request or by other user's activated service, and therefore it requires a subscription in advance (pull type). The offered service itself can be any kind of service (e.g. MMS, SWDL, or LBS!).

Position Estimate: the geographic position of a UE expressed in latitude and longitude data, and optionally altitude data. The Position Estimate shall be represented in a well-defined universal format. Translation from this universal format to another geographic positioning system may be supported, although the details are considered outside the scope of the primitive services.

Positioning: positioning is a functionality, which estimates a geographical position (of e.g. a UE).

Positioning method: a principle and/or algorithm that the estimation of geographical position is based on, e.g. AOA, TOA, TDOA. For example, GPS is based on TOA, and E-OTD (on GSM) or OTDOA (on UMTS) are based on TDOA.

Positioning technology: a technology or system concept including the specifications of RF interfaces, data types, etc. to process the estimation of a geographical position, e.g. GPS, E-OTD (GSM), and IPDL-TDOA (UMTS).

PLMN Access barring list: an optional list of MSISDN per PLMN where any LCS Client is not allowed to locate any MSISDN therein except for certain exceptional cases.

Predefined area: a geographical area that is not related to cell or radio coverage. The UE may take special action when it recognises it has entered or left a predefined area.

Privacy Class: list of LCS Clients defined within a privacy exception class to which permission may be granted to locate the target UE. The permission shall be granted either on activation by the target UE or permanently for a contractual period of time agreed between the target UE and the service provider.

Privacy Exception List: a list consisting of various types of privacy classes (i.e. operator related, personal etc.). Certain types of classes may require agreement between the service provider and the target UE.

Prohibited area: an area where the UE must not activate its transmitter. The Prohibited area may be a Predefined area described above or related to radio cell(s).

Subscription Profile: the profile detailing the subscription to various types of privacy classes.

Target UE: the UE being located.

Annex B (informative): Reference Model of Functional Entities for UTRAN UE Positioning

The UTRAN functional entities for UE Positioning are shown in figure B.1 and figure B.2. In these reference models, the LCS clients in the core network communicate with the UTRAN UE Positioning entities across the Iu interface. The RNC LCS Handling Entities and the Positioning Handling Entities work together with the UE to measure and calculate the position information for the requested target UE. These entities within the UTRAN are described in more detail in the following subclauses.

The figure shows the general arrangement of the UE Positioning function in UTRAN. Communication among these entities makes use of the messaging and signalling capabilities of the UTRAN across the Iu, Iur, Iub, Iupc and Uu interfaces. A LMU is also added to the UTRAN to make measurements as needed by the selected positioning method.

This figure does not include elements of 3G Core Network, but focuses on those that participate with the UE Positioning functions in the UTRAN. The association of the LCS entities within the Core Network (CN) (e.g. with 3G-MSC or 3G-SGSN) is outside the scope of the present document and is not illustrated in the diagram.

Within the UTRAN, the UE Positioning Entities may be associated with, or part of the SAS, RNC, the Node B and the UE. Internal LCS Applications may also be part of the RNC and the UE.

The UE Position Calculation Function (PCF) is logically associated with the SRNC or with the SAS.

The UE Positioning in UTRAN also makes use of the standardised Iur interface between RNCs, when Node B information, measurements and results are collected.

The functional model presented in the figure includes functional entities for UE utilising either or both circuit switched (CS) and packet switched (PS) services. This model also supports of all the entities needed for different positioning methods (e.g. network-based, UE-based, UE-assisted, and network assisted (see note 1) methods) exploiting either uplink or downlink measurements.

NOTE 1: In this approach UE may use the GPS technique but still make use of auxiliary information from the serving network.

NOTE 2: Figure B.2 shows the SMLC as a node that implements the PCF. In actuality it is more than the PCF, for example, the SMLC can provide GPS assistance data. See Subclause 5.2.5 for the normative definition of an SMLC.

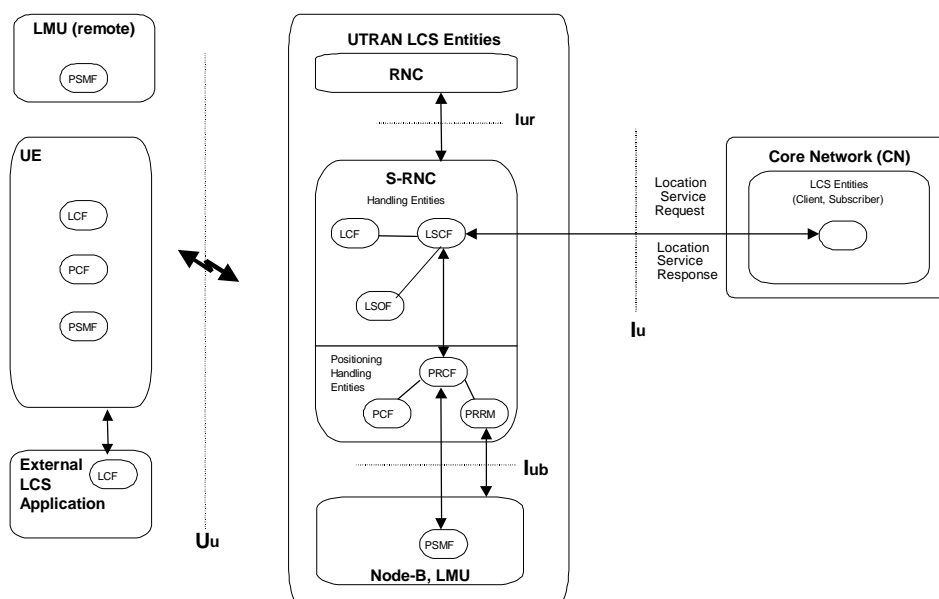

Figure B.1: UTRAN UE Positioning Functional Entities

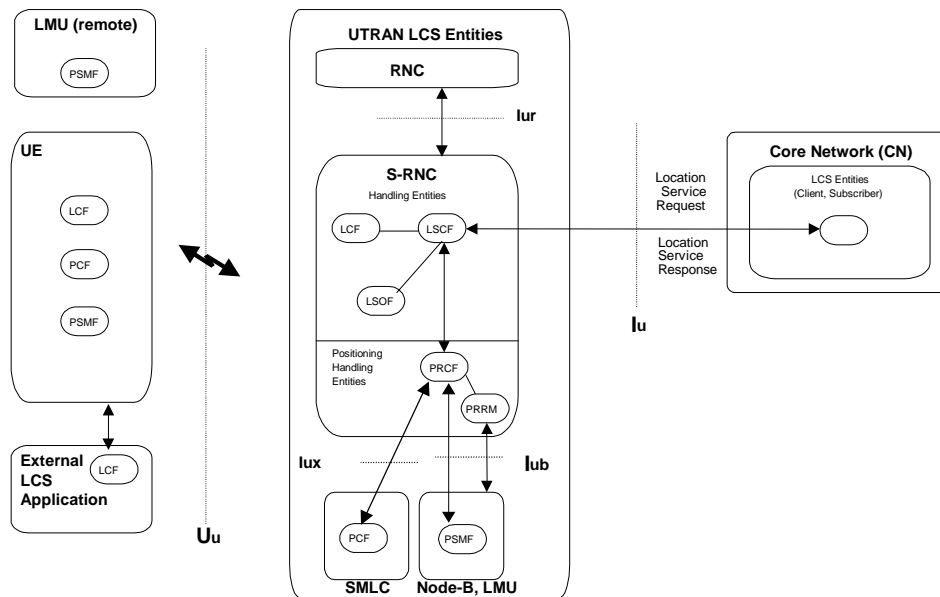

Figure B.2: UTRAN UE Positioning Functional Entities – SAS version

Several functional groupings may be defined to describe the UE Positioning functions. These groupings occur in both the CN and the UTRAN. The overall LCS functional grouping is described in reference [13]. Each grouping encompasses a number of functional components and functions.

Within UTRAN the functional entities may be grouped as follows:

- the *Internal Client* group that includes:
 - Internal UTRAN Location Client Function (U-LCF);
- the *UTRAN System Handling* group that includes:
 - UTRAN Location System Control Function (U-LSCF),
 - UTRAN Location System Operations Function (U-LSOF);
- the *UTRAN Positioning* group that includes:
 - UTRAN Position Radio Co-ordination Function (U-PRCF),
 - UTRAN Position Calculation Function (U-PCF),
 - UTRAN Position Signal Measurement Function (U-PSMF),
 - UTRAN Position Radio Resource Management (U-PRRM).

The functions within the UTRAN are described in more detail in the following subclauses.

B.1 Internal Client Group

B.1.1 Internal UTRAN Location Client Function (U-LCF)

The UTRAN Location Client Function (U-LCF) represents a logical interface between the internal UTRAN LCS applications and the LCS RNC Handling entities (e.g. the Location System Control Function (U-LSCF) in the RNC).

NOTE: There is not necessarily a requirement for a LCCF (Location Client Control Function) for the UTRAN Internal Client as is described for external clients in reference [13] (the system stage specification).

The UTRAN may make use of positioning information for internal operations such as location assisted handover. In such a case, a U-LCF representing the internal UTRAN LCS application may communicate with the U-LSCF to request and receive the positioning information.

B.2 UTRAN System Handling group

B.2.1 UTRAN Location System Control Function (U-LSCF)

The UTRAN Location System Control Function (U-LSCF) in RNC is responsible for co-ordinating UE Positioning requests within the RNC handling entity. This function manages call-related and non-call-related UE Positioning requests and allocates network resources for handling them. This function "insulates" the Location clients in the Core Network from the detailed operation of the positioning method in order that the UTRAN may be used by several types of core network and with several positioning methods.

The U-LSCF provides flow control between simultaneous UE Positioning requests. Simultaneous UE Positioning requests must be queued in a controlled manner to account for priority requests (e.g. for Emergency Clients). The details of the flow control, priority selection and queuing are beyond the scope of the present document.

The U-LSCF will select the appropriate positioning method based on the availability of resources and parameters of the UE Positioning request. The U-LSCF co-ordinates resources and activities needed to obtain data (e.g. Node B geographic co-ordinates) needed for the positioning method. It also records LCS RNC usage data for the location service request that may be passed to a Location System Recording Function (U-LSRF) or OA&M function in the Core Network.

If the positioning method requires the broadcast of system information, the LSCF initiates and maintains this activity through the Position Radio Co-ordination Function (U-PRCF). Broadcast information (such as the geographic co-ordinates of the Node Bs) may be required, for example, to support a Position Calculation Function (U-PCF) located in the UE. These broadcasts may also include other information (such as currently observable satellites) that may assist a UE in the use of external location services.

The information to be broadcast is selected based on the positioning methods offered for use by the LCS and the needs of the UE. This broadcast information may be specially coded (i.e. encrypted) to ensure its availability only to subscribers of the service. The use of broadcasts or other methods for signalling to the UE or the LMU may be selected based on the chosen positioning method.

The information to be broadcast could include, for example:

- identification and spreading codes of the neighbouring Node Bs (the channels that are used for measurements);
- Relative Time Difference (RTD), i.e. the timing offsets, asynchronicity between Node Bs, could be obtained from measurement results obtained by LMUs;
- roundtrip delay estimates in connected mode;
- the geographic position, co-ordinates, of the neighbouring Node Bs;
- the idle period places within the frame structure for multiple Node Bs;
- the local time-of-day.

Some of this information may be broadcast to support other UTRAN operations (e.g. handover). The function of the LSCF is to ensure information is broadcast when needed for the LCS operations and the LSCF may make use of other UTRAN processes to do so.

B.2.2 UTRAN Location System Operations Function (U-LSOF)

The UTRAN Location System Operations Function (U-LSOF) is responsible for provisioning of data, positioning capabilities, data related to clients and subscription (LCS client data and UE data), fault management and performance management of LCS within the RNC.

An LSOF may be associated with each entity. The LSOF interacts with Internal (OAM) Clients for administration and maintenance of the data.

The Iur interface may pass messages relating to changes or reporting of the data associated with the LSOF in the RNC.

The Iub interface may pass messages relating to changes or reporting of the data associated with the LSOF in the Node B or the LMU.

The Uu interface may pass messages relating to changes or reporting of the data associated with the LSOF in the UE or the remote LMU.

B.3 Positioning group

B.3.1 UTRAN Position Radio Co-ordination Function (U-PRCF)

The UTRAN Position Radio Co-ordination Function (U-PRCF) manages a UE Positioning for a UE through overall co-ordination and scheduling of resources to perform positioning measurements. This function interfaces with the U-PSMF, the U-PRRM and the U-PCF. The U-PRCF determines the positioning method to be used based on the UE Positioning request, the QoS, the capabilities of the UTRAN, and the UE's capabilities. The U-PRCF also manages the needed radio resources through the U-PRRM. It determines which U-PSMFs are to be involved, what to measure, and obtains processed signal measurements from the U-PSMF.

Some positioning methods may involve measurements made at the UE. In this case the U-PRCF interfaces with the UE to obtain the measurements (or the positioning results if they have been determined by the UE). Some positioning methods may involve measurements or information from several sources, including radio units at several Node B (or other LMU) and involve a series of transmissions and receptions. The U-PRCF entity also provides ancillary measurements in case of network-assisted positioning method. Ancillary information may be extracted from navigating systems like GPS.

The U-PRCF forwards the signal measurement data to the U-PCF.

It is the function of the U-PRCF to co-ordinate the sequence of activities and compensate for failures (if they occur) to provide the position estimate.

B.3.2 UTRAN Position Calculation Function (U-PCF)

The UTRAN Position Calculation Function (U-PCF) is responsible for calculating the position of the UE. This function applies an algorithmic computation on the collected signal measurements to compute the final position estimate and accuracy.

The U-PCF may also support conversion of the position estimate between different geographic reference systems. It may obtain related data (e.g.: Node B geographic co-ordinates) needed for the calculation. There may be more than one calculating function available within, or associated with, the calculation function of the UTRAN.

In the cell ID based positioning method, the U-PCF shall determine the geographical co-ordinates corresponding to the cell(s) associated with the target UE.

The PCF is also responsible for estimating the accuracy of the position estimate. This accuracy estimate should include, for example, the effect of geometric dilution of precision (GDOP), the capabilities of the signal measuring hardware, the effects of multipath propagation and the effects of timing and synchronisation unknowns. The accuracy should be returned as a measure of distance in the same units as the position estimate. The accuracy zone may be reported as the axis and orientation of an ellipse surrounding the position estimate.

B.3.3 UTRAN Position Signal Measurement Function (U-PSMF)

The UTRAN Position Signal Measurement Function (U-PSMF) is responsible for performing and gathering uplink or downlink radio signal measurements for use in the calculation of a UE position. These measurements can be positioning related or ancillary.

There may be one or more PSMF within a UTRAN and they may be located at the UE, the Node B, or a separate LMU. The PSMF, generally, may provide measurement of signals (i.e. satellite signals) in addition to measurements of the UTRA radio transmissions. The measurements to be made will depend on the selected positioning method.

B.3.4 UTRAN Position Radio Resource Management (U-PRRM)

The UTRAN Position Radio Resource Management (U-PRRM) entity is responsible for managing the effect of LCS operations on the overall performance of the radio network. This may ensure, for example, that the operation of the U-PSMF does not degrade the QoS of other calls. The U-PRRM handles following functions:

- controlling the variation of the UL and DL signal power level due to the LCS application;
- calculating the DL and UL power/interference due to UE positioning operations;
- to admit/reject the new LCS requests;
- co-operating with Admission Control, and entities of the RRM (such as power control) to provide the system stability in terms of radio resources;
- controlling the RTD obtaining mechanism. It may also forward the results of the UTRAN GPS timing of cell frames or SFN-SFN Observed Time Difference (or any similar timing parameter) measurements to the PRCF (or PCF);
- controlling the IPDL mechanism for positioning measurements. This may include the overall control of the periodical measurement fulfilment. Co-ordination among RNCs (e.g. to assure non-overlapping idle periods) will be communicated through the Iur interface.

B.4 Assignment of LCS Functional Entities to UTRAN Elements

Figure B.1, Figure B.2 and table B.1 show the generic configuration for different positioning methods, including network-based, UE-based, UE-assisted and network-assisted methods. With this approach both UTRAN and the UE are able to measure the timing of signals and compute the UE position estimate. Depending on the applied positioning method it is possible to utilise the corresponding configuration containing all needed entities. For instance, if a network-based positioning method is applied, the entities that are involved in measuring the UE's signal and calculating its position estimate are allocated to the network elements of the access stratum. On the other hand, in case UE-based or network-assisted methods are used these entities should be allocated to the UE.

Table B.1: Example Allocation of LCS Functional Entities to Network Elements

UTRAN	UE	Node B	LMU	RNC	SAS
LCF	X			X	
LSCF				X	
PCF				X	
PCF	X			X	X
PRRM				X	
PSMF	X	X	X		
LSOF	X	X	X	X	

Annex C (informative): Location Services Categories

Generally there are four categories of usage of the location service:

- the **Commercial LCS** (or **Value Added Services**);
- the **Internal LCS**;
- the **Emergency LCS**;
- the **Lawful Intercept LCS**.

These location services categories are further defined in [13] and [5].

Annex D (informative): Change history

Change history							
Date	TSG #	TSG Doc.	CR	Rev	Subject/Comment	Old	New
12/1999	RP-06	RP-99635	-		Approved at TSG-RAN #6 and placed under Change Control	-	3.0.0
03/2000	RP-07	RP-000038	001	3	Network assisted GPS LCS	3.0.0	3.1.0
	RP-07	RP-000038	002	1	Enhancements for cell coverage based positioning	3.0.0	3.1.0
	RP-07	RP-000038	003		Replacement for Figure 4.1	3.0.0	3.1.0
	RP-07	RP-000038	004	1	Restructuring	3.0.0	3.1.0
	RP-07	RP-000038	006		Target UE-RNC signalling model	3.0.0	3.1.0
	RP-07	RP-000038	007		LMU description	3.0.0	3.1.0
	RP-07	RP-000038	008	2	LMU signalling description	3.0.0	3.1.0
	RP-07	RP-000038	009		Incorporation of R1 Liaisons R2-000022 and R2-000023	3.0.0	3.1.0
	RP-07	RP-000038	010	3	OTDOA - GPS Location Procedures	3.0.0	3.1.0
	RP-07	RP-000038	011	1	Clarification of the different LMU types	3.0.0	3.1.0
06/2000	RP-08	RP-000218	013	2	Modifications to LCS text on cell-ID method	3.1.0	3.2.0
	RP-08	RP-000218	015		Editorial modifications of OTDOA descriptions for alignment with TDD	3.1.0	3.2.0
	RP-08	RP-000218	016		Update on clause 5	3.1.0	3.2.0
	RP-08	RP-000218	017	1	Editorial additions	3.1.0	3.2.0
	RP-08	RP-000218	018		Clarification of OTDOA signalling operation	3.1.0	3.2.0
	RP-08	RP-000218	019	1	Assisted GPS procedures	3.1.0	3.2.0
09/2000	RP-09	RP-000356	020		Alignment of FDD and TDD positioning methods and editorial changes	3.2.0	3.3.0
	RP-09	RP-000356	021	3	Assisted GPS Procedures	3.2.0	3.3.0
	RP-09	RP-000356	022	2	TDD/FDD alignment of OTDOA and GPS assisted positioning methods	3.2.0	3.3.0
	RP-09	RP-000356	023		Clean-up	3.2.0	3.3.0
	RP-09	RP-000356	024		Corrections from LCS Ad Hoc	3.2.0	3.3.0
12/2000	RP-10	RP-000566	025	1	Editorial and Minor Technical Clean-up	3.3.0	3.4.0
	RP-10	RP-000566	026		Editorial corrections	3.3.0	3.4.0
	RP-10	RP-000566	027		Removal of SoLSA concepts	3.3.0	3.4.0
	RP-10	RP-000566	029	1	Signalling flows on lub and lur	3.3.0	3.4.0
	RP-10	RP-000566	030	1	LCS functionality during SRNS relocation	3.3.0	3.4.0
	RP-10	RP-000566	031		UE Search Correction from R2-001721 (CR 021r3)	3.3.0	3.4.0
	RP-10	RP-000566	032	2	Signaling Between RNC and Stand-Alone LMU	3.3.0	3.4.0
	RP-10	RP-000566	033	5	Use of RTT measurements in the Assisted GPS procedure	3.3.0	3.4.0
	RP-10	RP-000566	034	1	LCS assistance data delivery	3.3.0	3.4.0
	RP-10	RP-000566	035	2	Description for frequency reference	3.3.0	3.4.0
	RP-10	RP-000566	036	2	Editorial clean-up	3.3.0	3.4.0
	RP-10	RP-000566	038	2	Clarification on information to be transferred between UTRAN nodes	3.3.0	3.4.0
	RP-10	RP-000566	039	1	Moving of semantic descriptions from RRC	3.3.0	3.4.0
03/2001	RP-11	RP-010023	040		Correction to Assistance Data Delivery procedure	3.4.0	3.5.0
	RP-11	RP-010023	041	1	Clarification of assisted GPS related parameters	3.4.0	3.5.0
	RP-11	RP-010023	042		Clarification of paging initiation	3.4.0	3.5.0
	RP-11	RP-010023	045	1	Editorial Corrections	3.4.0	3.5.0
	RP-11	RP-010023	046	1	Clarification of Timing Assistance	3.4.0	3.5.0
	RP-11	RP-010023	047		Clarification of Integrity Monitor Function	3.4.0	3.5.0
	RP-11	RP-010040	048	1	Introduction of IPDLs for TDD	3.5.0	4.0.0
	RP-11	RP-010044	044	4	Support of Stand-Alone A-GPS SMLC over an open interface	4.0.0	5.0.0
06/2001	RP-12	RP-010306	053		Removal of positioning request transfer during SRNS relocation	5.0.0	5.1.0
	RP-12	RP-010325	054		lupc architectural aspects modifications	5.0.0	5.1.0
	RP-12	RP-010325	055		Removal of RAN3 dependency w.r.t. PCAP signalling flows	5.0.0	5.1.0
	RP-12	RP-010325	056	1	PCAP message flows	5.0.0	5.1.0
09/2001	RP-13	RP-010556	060	1	Support for all Rel. 4 positioning methods in standalone SMLC	5.1.0	5.2.0
12/2001	RP-14	RP-010757	065		Correction of broadcast of assistance data	5.2.0	5.3.0
	RP-14	RP-010757	072		Migration of Descriptive Text from TS 25.331	5.2.0	5.3.0
	RP-14	RP-010770	062		Correction of RTD usage in TDD	5.2.0	5.3.0
03/2002	RP-15	RP-020080	074		Corrections Relating to IPDL and Timing Advance for 1.28 Mcps TDD	5.3.0	5.4.0
	RP-15	RP-020065	081	1	Correction to CELL ID positioning when UE is not reachable	5.3.0	5.4.0
	RP-15	RP-020090	075		Including IPDL, UE Timing Advance and Angle of Arrival for 1.28 Mcps TDD	5.3.0	5.4.0
03/2003	RP-19	RP-030110	085		Update to figure 5.1, LMU terminology	5.4.0	5.5.0

History

Document history		
V5.4.0	March 2002	Publication
V5.5.0	March 2003	Publication