

ETSI TS 125 321 V5.6.0 (2003-09)

Technical Specification

Universal Mobile Telecommunications System (UMTS); Medium Access Control (MAC) protocol specification (3GPP TS 25.321 version 5.6.0 Release 5)



Reference

RTS/TSGR-0225321v560

Keywords

UMTS

ETSI

650 Route des Lucioles
F-06921 Sophia Antipolis Cedex - FRANCE

Tel.: +33 4 92 94 42 00 Fax: +33 4 93 65 47 16

Siret N° 348 623 562 00017 - NAF 742 C
Association à but non lucratif enregistrée à la
Sous-Préfecture de Grasse (06) N° 7803/88

Important notice

Individual copies of the present document can be downloaded from:

<http://www.etsi.org>

The present document may be made available in more than one electronic version or in print. In any case of existing or perceived difference in contents between such versions, the reference version is the Portable Document Format (PDF). In case of dispute, the reference shall be the printing on ETSI printers of the PDF version kept on a specific network drive within ETSI Secretariat.

Users of the present document should be aware that the document may be subject to revision or change of status. Information on the current status of this and other ETSI documents is available at

<http://portal.etsi.org/tb/status/status.asp>

If you find errors in the present document, send your comment to:

editor@etsi.org

Copyright Notification

No part may be reproduced except as authorized by written permission.
The copyright and the foregoing restriction extend to reproduction in all media.

© European Telecommunications Standards Institute 2003.
All rights reserved.

DECTTM, **PLUGTESTS**TM and **UMTS**TM are Trade Marks of ETSI registered for the benefit of its Members.
TIPHONTM and the **TIPHON logo** are Trade Marks currently being registered by ETSI for the benefit of its Members.
3GPPTM is a Trade Mark of ETSI registered for the benefit of its Members and of the 3GPP Organizational Partners.

Intellectual Property Rights

IPRs essential or potentially essential to the present document may have been declared to ETSI. The information pertaining to these essential IPRs, if any, is publicly available for **ETSI members and non-members**, and can be found in ETSI SR 000 314: "*Intellectual Property Rights (IPRs); Essential, or potentially Essential, IPRs notified to ETSI in respect of ETSI standards*", which is available from the ETSI Secretariat. Latest updates are available on the ETSI Web server (<http://webapp.etsi.org/IPR/home.asp>).

Pursuant to the ETSI IPR Policy, no investigation, including IPR searches, has been carried out by ETSI. No guarantee can be given as to the existence of other IPRs not referenced in ETSI SR 000 314 (or the updates on the ETSI Web server) which are, or may be, or may become, essential to the present document.

Foreword

This Technical Specification (TS) has been produced by ETSI 3rd Generation Partnership Project (3GPP).

The present document may refer to technical specifications or reports using their 3GPP identities, UMTS identities or GSM identities. These should be interpreted as being references to the corresponding ETSI deliverables.

The cross reference between GSM, UMTS, 3GPP and ETSI identities can be found under <http://webapp.etsi.org/key/queryform.asp>.

Contents

Intellectual Property Rights	2
Foreword.....	2
Foreword.....	5
1 Scope	6
2 References	6
3 Definitions and abbreviations.....	7
3.1 Definitions	7
3.2 Abbreviations	7
4 General	8
4.1 Objective	8
4.2 MAC architecture	8
4.2.1 MAC Entities	8
4.2.2 MAC-b.....	8
4.2.3 Traffic Related Architecture - UE Side.....	9
4.2.3.1 MAC-c/sh entity – UE Side	10
4.2.3.2 MAC-d entity – UE Side.....	11
4.2.3.3 MAC-hs entity – UE Side	12
4.2.4 Traffic Related Architecture - UTRAN Side	13
4.2.4.1 MAC-c/sh entity – UTRAN Side	14
4.2.4.2 MAC-d entity – UTRAN Side	15
4.2.4.3 MAC-hs entity – UTRAN Side.....	16
4.3 Channel structure.....	17
4.3.1 Transport channels.....	18
4.3.2 Logical Channels	18
4.3.2.1 Logical channel structure	18
4.3.2.2 Control Channels.....	18
4.3.2.3 Traffic Channels.....	19
5 Services provided to upper layers	19
5.1 Description of Services provided to upper layers.....	19
6 Functions	19
6.1 Description of the MAC functions	19
6.2 Relation between MAC Functions and Transport Channels	20
6.2.1 Relation between MAC Functions and Transport Channels in UTRAN	20
6.2.2 Relation of MAC Functions and Transport Channels in UE	21
7 Services expected from physical layer	21
8 Elements for layer-to-layer communication.....	21
8.1 Primitives between layers 1 and 2.....	21
8.1.1 Primitives.....	21
8.1.2 Parameters.....	22
8.2 Primitives between MAC and RLC.....	22
8.2.1 Primitives.....	22
8.2.2 Parameters.....	22
8.3 Primitives between MAC and RRC	23
8.3.1 Primitives.....	23
8.3.2 Parameters.....	24
9 Elements for peer-to-peer communication	25
9.1 Protocol data units	25
9.1.1 General.....	25
9.1.2 MAC PDU (non-HS-DSCH)	25
9.1.3 MAC-d PDU (HS-DSCH)	26

9.1.4	MAC PDU (HS-DSCH).....	26
9.2	Formats and parameters.....	26
9.2.1	MAC PDU: Parameters of the MAC PDU header (non HS-DSCH) and MAC-d PDU header (HS-DSCH)	26
9.2.1.1	MAC header for DTCH and DCCH (not mapped on HS-DSCH)	29
9.2.1.1a	MAC-d Header for DTCH and DCCH (mapped on HS-DSCH)	30
9.2.1.2	MAC header for BCCH	30
9.2.1.3	MAC header for PCCH	30
9.2.1.4	MAC header for CCCH	30
9.2.1.5	MAC Header for CTCH.....	30
9.2.1.6	MAC Header for SHCCH	30
9.2.2	MAC PDU: Parameters of the MAC header (HS-DSCH)	31
9.2.2.1	MAC header for DTCH and DCCH.....	31
9.2.3	Signalling of Transport Block size for HS-DSCH.....	31
9.2.3.1	Transport block size for FDD.....	32
9.2.3.2	Transport block size for 3.84 Mcps TDD.....	33
9.2.3.3	Transport block size for 1.28 Mcps TDD.....	33
10	Handling of unknown, unforeseen and erroneous protocol data	34
11	Specific functions	34
11.1	Traffic volume measurement for dynamic radio bearer control	34
11.2	Control of RACH transmissions.....	35
11.2.1	Access Service Class selection	35
11.2.2	Control of RACH transmissions for FDD mode.....	35
11.2.3	Control of RACH transmissions for TDD	38
11.2.3.1	Control of RACH transmissions for 3.84 Mcps TDD.....	38
11.2.3.2	Control of RACH Transmissions for 1.28 Mcps TDD.....	39
11.3	Control of CPCH transmissions for FDD	41
11.4	Transport format combination selection in UE	45
11.5	Ciphering.....	47
11.6	Control of HS-DSCH transmission and reception.....	47
11.6.1	Network operation	47
11.6.1.1	Scheduler.....	48
11.6.1.2	HARQ entity	48
11.6.1.3	HARQ process	48
11.6.2	UE operation.....	49
11.6.2.1	HARQ Entity.....	49
11.6.2.2	HARQ process	49
11.6.2.3	Reordering entity.....	50
11.6.2.3.1	Definitions	50
11.6.2.3.2	Reordering functionality.....	50
11.6.2.4	Disassembly entity	52
11.6.2.5	MAC-hs Reset.....	52
11.6.2.6	Reconfiguration of MAC-hs parameters	52
11.7	HS-DSCH Provided Bit Rate measurement	53
Annex A (informative):	Change history	54
History		56

Foreword

This Technical Specification (TS) has been produced by the 3rd Generation Partnership Project (3GPP).

The contents of the present document are subject to continuing work within the TSG and may change following formal TSG approval. Should the TSG modify the contents of the present document, it will be re-released by the TSG with an identifying change of release date and an increase in version number as follows:

Version x.y.z

where:

- x the first digit:
 - 1 presented to TSG for information;
 - 2 presented to TSG for approval;
 - 3 or greater indicates TSG approved document under change control.
- y the second digit is incremented for all changes of substance, i.e. technical enhancements, corrections, updates, etc.
- z the third digit is incremented when editorial only changes have been incorporated in the document.

1 Scope

The present document specifies the MAC protocol.

The specification describes:

- MAC architecture;
- MAC entities;
- channel structure;
- services provided to upper layers;
- MAC functions;
- services expected from the physical layer;
- elements for layer-to-layer communication including primitives between MAC and RLC;
- elements for peer-to-peer communication;
- protocol data units, formats and parameters;
- elementary procedures.

2 References

The following documents contain provisions which, through reference in this text, constitute provisions of the present document.

- References are either specific (identified by date of publication, edition number, version number, etc.) or non-specific.
- For a specific reference, subsequent revisions do not apply.
- For a non-specific reference, the latest version applies. In the case of a reference to a 3GPP document (including a GSM document), a non-specific reference implicitly refers to the latest version of that document *in the same Release as the present document*.

- [1] 3GPP TR 21.905: "Vocabulary for 3GPP Specifications".
- [2] 3GPP TS 25.301: "Radio Interface Protocol Architecture".
- [3] 3GPP TS 25.302: "Services provided by the Physical Layer".
- [4] 3GPP TS 25.303: "Interlayer Procedures in Connected Mode".
- [5] 3GPP TS 25.304: "UE Procedures in Idle Mode and Procedures for Cell Reselection in Connected Mode".
- [6] 3GPP TS 25.322: "RLC Protocol Specification".
- [7] 3GPP TS 25.331: "Radio Resource Control (RRC); protocol specification".
- [8] 3GPP TR 25.921: "Guidelines and Principles for Protocol Description and Error Handling".
- [9] 3GPP TR 25.990: "Vocabulary for the UTRAN".
- [10] 3GPP TS 33.102: "Security architecture".
- [11] 3GPP TS 25.425: "UTRAN Iur Interface User Plane Protocols for Common Transport Channel Data Streams".

- [12] 3GPP TS 25.133: "Requirements for support of radio resource management (FDD)".
- [13] 3GPP TS 25.214: "Physical layer procedures (FDD)".
- [14] 3GPP TS 25.123: "Requirements for support of radio resource management (TDD)".
- [15] 3GPP TS 33.105: "Cryptographic Algorithm Requirements".

3 Definitions and abbreviations

3.1 Definitions

For the purposes of the present document, the terms and definitions given in [9] and [1] apply.

3.2 Abbreviations

For the purposes of the present document, the following abbreviations apply:

ASC	Access Service Class
BCCH	Broadcast Control Channel
BCH	Broadcast Channel
C-	Control-
CCCH	Common Control Channel
CPCH	Common Packet Channel (UL)
DCCH	Dedicated Control Channel
DCH	Dedicated Channel
DL	Downlink
DSCH	Downlink Shared Channel
DTCH	Dedicated Traffic Channel
FACH	Forward Link Access Channel
FDD	Frequency Division Duplex
HARQ	Hybrid Automatic Repeat Request
HCSN	HS-SCCH Cyclic Sequence Number
HS-DSCH	High Speed Downlink Shared Channel
L1	Layer 1 (physical layer)
L2	Layer 2 (data link layer)
L3	Layer 3 (network layer)
MAC	Medium Access Control
PCCH	Paging Control Channel
PCH	Paging Channel
PDU	Protocol Data Unit
PHY	Physical layer
PhyCH	Physical Channels
RACH	Random Access Channel
RLC	Radio Link Control
RNC	Radio Network Controller
RNS	Radio Network Subsystem
RNTI	Radio Network Temporary Identity
RRC	Radio Resource Control
SAP	Service Access Point
SDU	Service Data Unit
SHCCH	Shared Channel Control Channel
SRNC	Serving Radio Network Controller
SRNS	Serving Radio Network Subsystem
TDD	Time Division Duplex
TFCI	Transport Format Combination Indicator
TFI	Transport Format Indicator
TSN	Transmission Sequence Number
U-	User-

UE	User Equipment
UL	Uplink
UMTS	Universal Mobile Telecommunications System
USCH	Uplink Shared Channel
UTRA	UMTS Terrestrial Radio Access
UTRAN	UMTS Terrestrial Radio Access Network

4 General

4.1 Objective

The objective is to describe the MAC architecture and the different MAC entities from a functional point of view.

4.2 MAC architecture

The description in this subclause is a model and does not specify or restrict implementations.

According to the RRC functions the RRC is generally in control of the internal configuration of the MAC.

4.2.1 MAC Entities

The diagrams that describe the MAC architecture are constructed from MAC entities.

The entities are assigned the following names.

- MAC-b is the MAC entity that handles the following transport channels:
 - broadcast channel (BCH)
- MAC-c/sh, is the MAC entity that handles the following transport channels:
 - paging channel (PCH)
 - forward access channel (FACH)
 - random access channel (RACH)
 - common packet channel (UL CPCH). The CPCH exists only in FDD mode.
 - downlink shared channel (DSCH)
 - uplink shared channel (USCH). The USCH exists only in TDD mode.
- MAC-d is the MAC entity that handles the following transport channels:
 - dedicated transport channel (DCH)
- MAC-hs is the MAC entity that handles the following transport channels:
 - high speed downlink shared channel (HS-DSCH)

The exact functions completed by the entities are different in the UE from those completed in the UTRAN.

NOTE: When a UE is allocated resources for exclusive use by the bearers that it supports the MAC-d entities dynamically share the resources between the bearers and are responsible for selecting the TFI/ TFCI that is to be used in each transmission time interval.

4.2.2 MAC-b

The following diagram illustrates the connectivity of the MAC-b entity in a UE and in each cell of the UTRAN.

MAC-b represents the control entity for the broadcast channel (BCH).

There is one (current cell) or multiple (current and neighbour cells) MAC-b entities in each UE and one MAC-b in the UTRAN for each cell.

The MAC Control SAP is used to transfer Control information to MAC-b.

The MAC-b entity is located in the Node B.

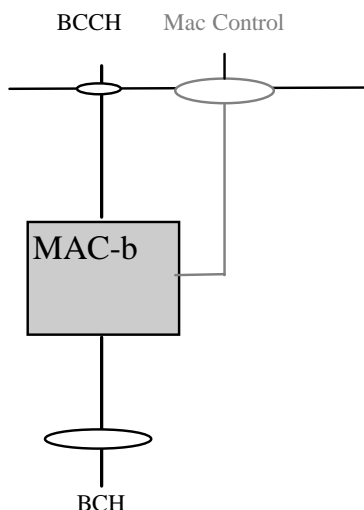

Figure 4.2.2.1: UE side and UTRAN side architecture

4.2.3 Traffic Related Architecture - UE Side

Figure 4.2.3.1 illustrates the connectivity of MAC entities.

The MAC-c/sh controls access to all common transport channels, except the HS-DSCH transport channel.

The MAC-d controls access to all dedicated transport channels, to MAC-c/sh and MAC-hs.

The MAC-hs controls access to the HS-DSCH transport channel.

In the downlink, if logical channels of dedicated type are mapped to common transport channels then MAC-d receives the data from MAC-c/sh or MAC-hs via the illustrated connection between the functional entities.

In the uplink, if logical channels of dedicated type are mapped to common transport channels then MAC-d submits the data to MAC-c/sh via the illustrated connection between the functional entities.

The mapping of logical channels on transport channels depends on the multiplexing that is configured by RRC.

The MAC Control SAP is used to transfer Control information to each MAC entity.

The associated signalling shown in the figure illustrates the exchange of information between layer 1 and layer 2 provided by primitives shown in [3].

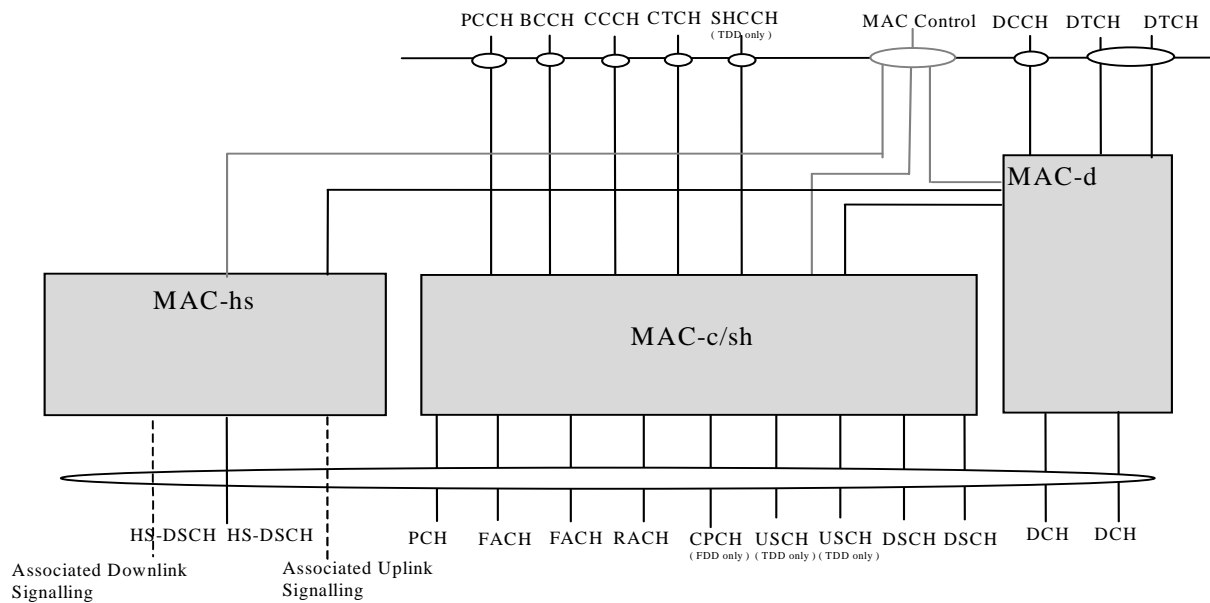

Figure 4.2.3.1: UE side MAC architecture

4.2.3.1 MAC-c/sh entity – UE Side

Figure 4.2.3.1.1 shows the UE side MAC-c/sh entity.

The following functionality is covered:

- TCTF MUX:
 - this function represents the handling (insertion for uplink channels and detection and deletion for downlink channels) of the TCTF field in the MAC header, and the respective mapping between logical and transport channels.
 - The TCTF field indicates the common logical channel type, or if a dedicated logical channel is used;
- add/read UE Id:
 - the UE Id is added for CPCH and RACH transmissions
 - the UE Id, when present, identifies data to this UE.
- UL: TF selection:
 - in the uplink, the possibility of transport format selection exists.
 - In case of CPCH transmission, a TF is selected based on TF availability determined from status information on the CSICH;
- ASC selection:
 - For RACH, MAC indicates the ASC associated with the PDU to the physical layer. For CPCH, MAC may indicate the ASC associated with the PDU to the Physical Layer. This is to ensure that RACH and CPCH messages associated with a given Access Service Class (ASC) are sent on the appropriate signature(s) and time slot(s). MAC also applies the appropriate back-off parameter(s) associated with the given ASC. When sending an RRC CONNECTION REQUEST message, RRC will determine the ASC; in all other cases MAC selects the ASC;
- scheduling /priority handling
 - this functionality is used to transmit the information received from MAC-d on RACH and CPCH based on logical channel priorities. This function is related to TF selection.
- TFC selection

- transport format and transport format combination selection according to the transport format combination set (or transport format combination subset) configured by RRC is performed,

The RLC provides RLC-PDUs to the MAC, which fit into the available transport blocks on the transport channels.

There is one MAC-c/sh entity in each UE.

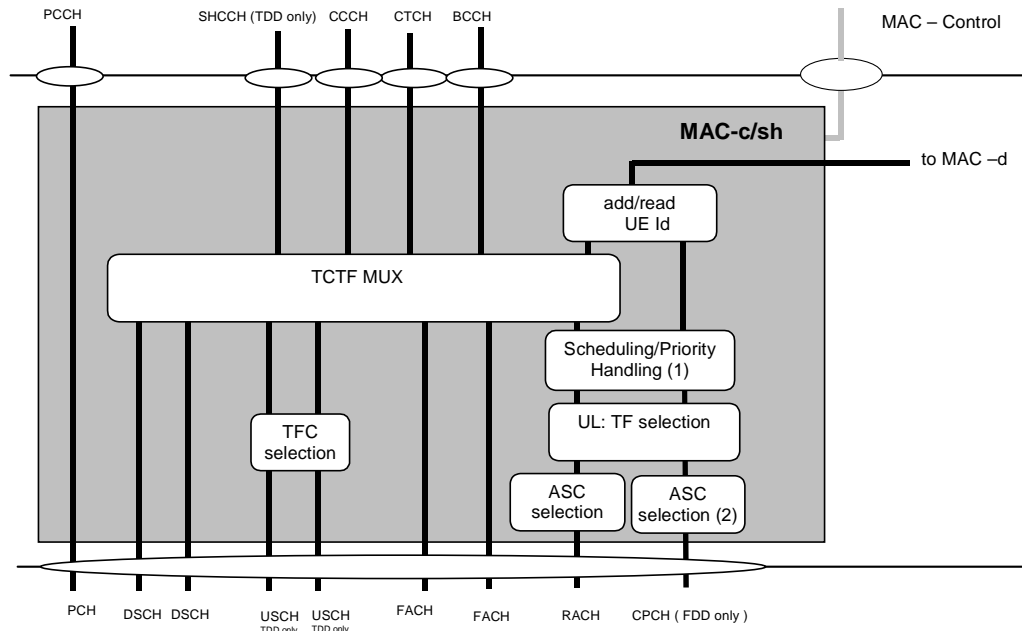

Note 1: Scheduling/Priority handling is applicable for CPCH.

Note 2: In case of CPCH, ASC selection may be applicable for AP preamble.

Figure 4.2.3.1.1: UE side MAC architecture / MAC-c/sh details

4.2.3.2 MAC-d entity – UE Side

Figure 4.2.3.2.1 shows the UE side MAC-d entity.

The following functionality is covered:

- Transport Channel type switching
 - Transport Channel type switching is performed by this entity, based on decision taken by RRC. This is related to a change of radio resources. If requested by RRC, MAC shall switch the mapping of one designated logical channel between common and dedicated transport channels.
- C/T MUX:
 - The C/T MUX is used when multiplexing of several dedicated logical channels onto one transport channel (other than HS-DSCH) or one MAC-d flow (HS-DSCH) is used. An unambiguous identification of the logical channel is included.
- Ciphering:
 - Ciphering for transparent mode data to be ciphered is performed in MAC-d. Details about ciphering can be found in [10].
- Deciphering:
 - Deciphering for ciphered transparent mode data is performed in MAC-d. Details about ciphering can be found in [10].
- UL TFC selection:

- Transport format and transport format combination selection according to the transport format combination set (or transport format combination subset) configured by RRC is performed.

The MAC-d entity is responsible for mapping dedicated logical channels for the uplink either onto dedicated transport channels or to transfer data to MAC-c/sh to be transmitted via common channels.

One dedicated logical channel can be mapped simultaneously onto DCH and DSCH. One dedicated logical channel can be simultaneously mapped onto DCH and HS-DSCH.

The MAC-d entity has a connection to the MAC-c/sh entity. This connection is used to transfer data to the MAC-c/sh to transmit data on transport channels that are handled by MAC-c/sh (uplink) or to receive data from transport channels that are handled by MAC-c/sh (downlink).

The MAC-d entity has a connection to the MAC-hs entity. This connection is used to receive data from the HS-DSCH transport channel which is handled by MAC-hs (downlink).

There is one MAC-d entity in the UE.

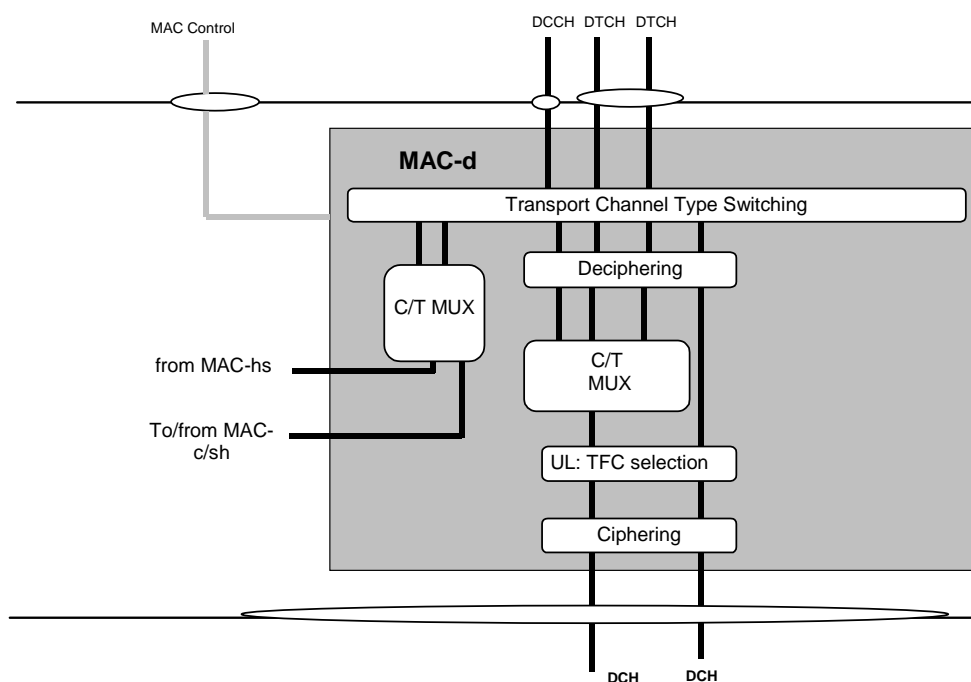

Note 1: For DCH, DSCH and HS-DSCH, different scheduling mechanisms apply.
 Note 2: Cipherring is performed in MAC-d only for transparent RLC mode.

Figure 4.2.3.2.1: UE side MAC architecture / MAC-d details

4.2.3.3 MAC-hs entity – UE Side

The MAC-hs handles the HSDPA specific functions. In the model below the MAC-hs comprises the following entities:

- HARQ:
The HARQ entity is responsible for handling the MAC functions relating to the HARQ protocol. The HARQ functional entity handles all the tasks that are required for hybrid ARQ. It is responsible for generating ACKs or NACKs. The detailed configuration of the hybrid ARQ protocol is provided by RRC over the MAC-Control SAP.
- Reordering Queue distribution:
The reordering queue distribution function routes the MAC-hs PDUs to the correct reordering buffer based on the Queue ID.

- Reordering:
The reordering entity reorders received MAC-hs PDUs according to the received TSN. MAC-hs PDUs with consecutive TSNs are delivered to the disassembly function upon reception. MAC-hs PDUs are not delivered to the disassembly function if MAC-hs PDUs with lower TSN are missing. There is one reordering entity for each Queue ID configured at the UE.
- Disassembly:
The disassembly entity is responsible for the disassembly of MAC-hs PDUs. When a MAC-hs PDU is disassembled the MAC-hs header is removed, the MAC-d PDUs are extracted and any present padding bits are removed. Then the MAC-d PDUs are delivered to higher layer.

The associated signalling shown in the figure illustrates the exchange of information between layer 1 and layer 2 provided by primitives shown in [3].

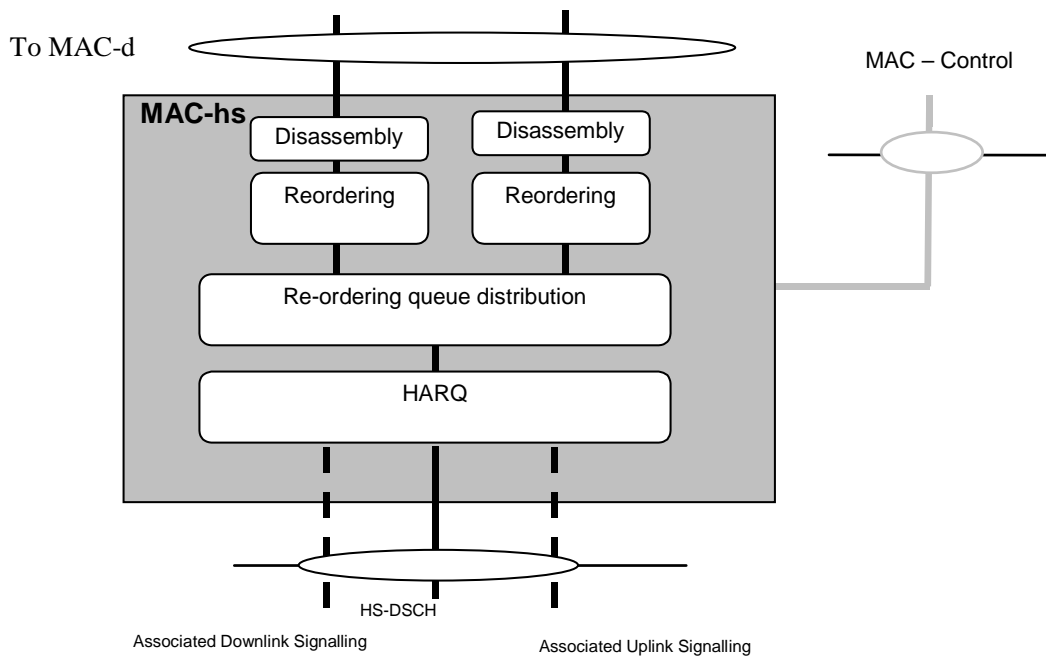

Figure 4.2.3.3.1: UE side MAC architecture / MAC-hs details

4.2.4 Traffic Related Architecture - UTRAN Side

Figure 4.2.4.1 illustrates the connectivity between the MAC entities from the UTRAN side.

It is similar to the UE case with the exception that there will be one MAC-d for each UE and each UE (MAC-d) that is associated with a particular cell may be associated with that cell's MAC-c/sh.

MAC-c/sh is located in the controlling RNC while MAC-d is located in the serving RNC. MAC-hs is located in the Node B. The MAC-d PDUs to be transmitted are transferred from MAC-c/sh to the MAC-hs via the Iub interface in case of configuration with MAC-c/sh, or from the MAC-d via Iur/Iub in case of configuration without MAC-c/sh.

The MAC Control SAP is used to transfer Control information to each MAC entity belonging to one UE.

The associated signalling shown in the figure illustrates the exchange of information between layer 1 and layer 2 provided by primitives shown in [3].

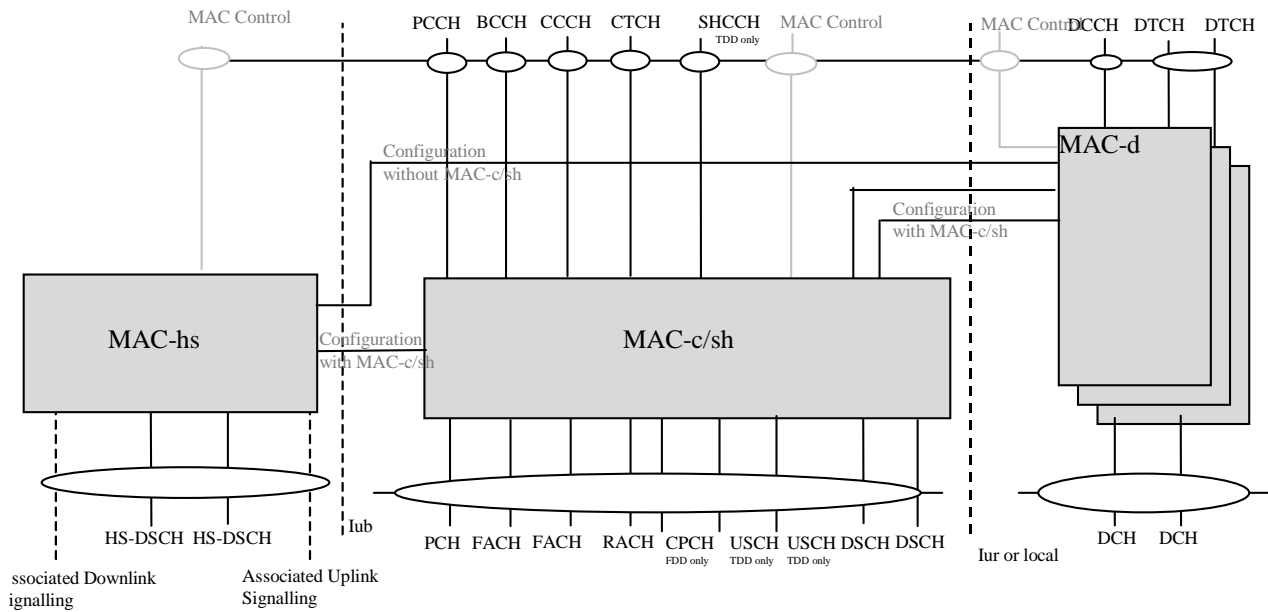

Figure 4.2.4.1: UTRAN side MAC architecture

4.2.4.1 MAC-c/sh entity – UTRAN Side

Figure 4.2.4.1.1 shows the UTRAN side MAC-c/sh entity. The following functionality is covered:

- Scheduling – Priority Handling;
 - this function manages FACH and DSCH resources between the UEs and between data flows according to their priority.
- TCTF MUX
 - this function represents the handling (insertion for downlink channels and detection and deletion for uplink channels) of the TCTF field in the MAC header, and the respective mapping between logical and transport channels. The TCTF field indicates the common logical channel type, or if a dedicated logical channel is used;
- UE Id Mux;
 - for dedicated type logical channels, the UE Id field in the MAC header is used to distinguish between UEs;
- TFC selection:
 - in the downlink, transport format combination selection is done for FACH and PCH and DSCHs;
- Demultiplex;
 - for TDD operation the demultiplex function is used to separate USCH data from different UEs, i.e. to be transferred to different MAC-d entities;
- DL code allocation;
 - this function is used to indicate the code used on the DSCH;
- Flow control;
 - a flow control function exists toward MAC-d to limit buffering between MAC-d and MAC-c/sh entities. a flow control function also exists towards MAC-hs in case of configuration with MAC-c/sh.

The RLC provides RLC-PDUs to the MAC, which fit into the available transport blocks on the transport channels.

There is one MAC-c/sh entity in the UTRAN for each cell;

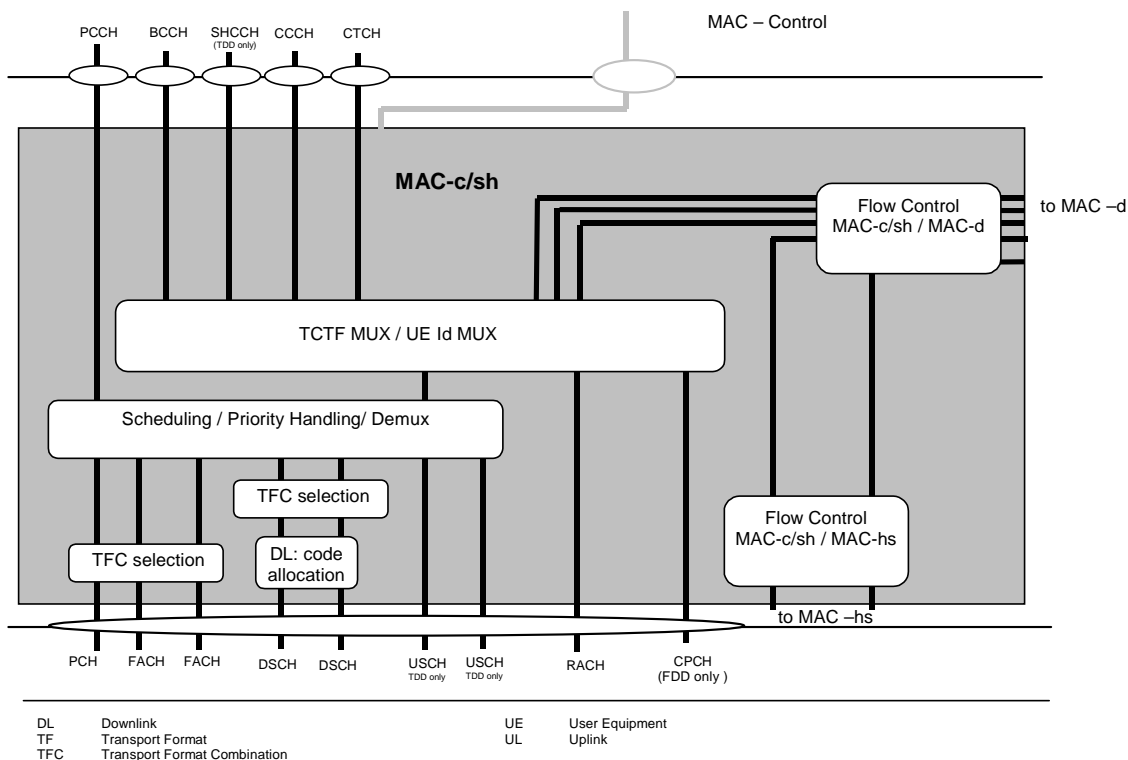

Figure 4.2.4.1.1: UTRAN side MAC architecture / MAC-c/sh details

4.2.4.2 MAC-d entity – UTRAN Side

Figure 4.2.4.2.1 shows the UTRAN side MAC-d entity.

The following functionality is covered:

- Transport Channel type switching:
 - Transport Channel type switching is performed by this entity, based on decision taken by RRC; this is related to a change of radio resources. If requested by RRC, MAC shall switch the mapping of one designated logical channel between common and dedicated transport channels.
- C/T MUX box;
 - the function includes the C/T field when multiplexing of several dedicated logical channels onto one transport channel (other than HS-DSCH) or one MAC-d flow (HS-DSCH) is used.
- Priority setting;
 - This function is responsible for priority setting on data received from DCCH / DTCH;
- Ciphering;
 - Ciphering for transparent mode data to be ciphered is performed in MAC-d. Details about ciphering can be found in [10].
- Deciphering;
 - Deciphering for ciphered transparent mode data is performed in MAC-d. Details about ciphering can be found in [10].
- DL Scheduling/Priority handling;
 - in the downlink, scheduling and priority handling of transport channels is performed within the allowed transport format combinations of the TFCS assigned by the RRC.

- Flow Control;
 - a flow control function exists toward MAC-c/sh to limit buffering between MAC-d and MAC-c/sh entities. This function is intended to limit layer 2 signalling latency and reduce discarded and retransmitted data as a result of FACH or DSCH congestion. For the Iur interface this is specified in [11]. A flow control function also exists towards MAC-hs in case of configuration without MAC-c/sh, see subclause 4.2.4.2.

A MAC-d entity using common channels other than the high speed downlink shared channel is connected to a MAC-c/sh entity that handles the scheduling of the common channels to which the UE is assigned and DL (FACH) priority identification to MAC-c/sh;

A MAC-d entity using downlink shared channel is connected to a MAC-c/sh entity that handles the shared channels to which the UE is assigned and indicates the level of priority of each PDU to MAC-c/sh;

A MAC-d entity using the high speed downlink shared channel may be connected to a MAC-c/sh entity that in turn is connected to the MAC-hs entity in the Node B (configuration with MAC-c/sh); alternately, a MAC-d entity using the high speed downlink shared channel may be connected to the MAC-hs entity in the Node B in case of configuration without MAC-c/sh.

A MAC-d entity is responsible for mapping dedicated logical channels onto the available dedicated transport channels or routing the data received on a DCCH or DTCH to MAC-c/sh or to MAC-hs.

One dedicated logical channel can be mapped simultaneously on DCH and DSCH. Different scheduling mechanisms apply for DCH and DSCH. One dedicated logical channel can be mapped simultaneously on DCH and HS-DSCH.

There is one MAC-d entity in the UTRAN for each UE that has one or more dedicated logical channels to or from the UTRAN.

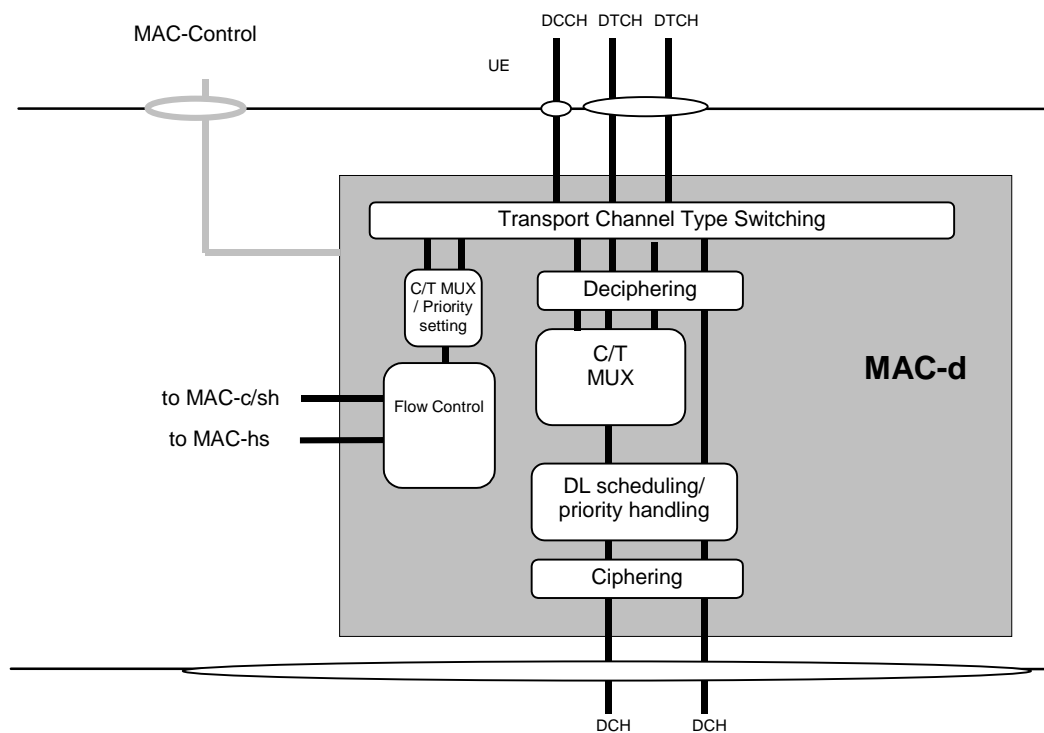

Figure 4.2.4.2.1: UTRAN side MAC architecture / MAC-d details

4.2.4.3 MAC-hs entity – UTRAN Side

There is one MAC-hs entity in the UTRAN for each cell that supports HS-DSCH transmission. The MAC-hs is responsible for handling the data transmitted on the HS-DSCH. Furthermore it is responsible for the management of the physical resources allocated to HSDPA. MAC-hs receives configuration parameters from the RRC layer via the MAC-Control SAP. There should be priority handling per MAC-d PDU in the MAC-hs. The MAC-hs is comprised of four different functional entities:

- Flow Control:
This is the companion flow control function to the flow control function in the MAC-c/sh in case of configuration with MAC-c/sh and MAC-d in case of configuration without MAC-c/sh. Both entities together provide a controlled data flow between the MAC-c/sh and the MAC-hs (Configuration with MAC-c/sh) or the MAC-d and MAC-hs (Configuration without MAC-c/sh) taking the transmission capabilities of the air interface into account in a dynamic manner. This function is intended to limit layer 2 signalling latency and reduce discarded and retransmitted data as a result of HS-DSCH congestion. Flow control is provided independently by MAC-d flow for a given MAC-hs entity.
- Scheduling/Priority Handling:
This function manages HS-DSCH resources between HARQ entities and data flows according to their priority. Based on status reports from associated uplink signalling either new transmission or retransmission is determined. Further it determines the Queue ID and TSN for each new MAC-hs PDU being serviced, and in the case of TDD the HCSN is determined. A new transmission can be initiated instead of a pending retransmission at any time to support the priority handling.
- HARQ:
One HARQ entity handles the hybrid ARQ functionality for one user. One HARQ entity is capable of supporting multiple instances (HARQ process) of stop and wait HARQ protocols. There shall be one HARQ process per HS-DSCH per TTI.
- TFRC selection:
Selection of an appropriate transport format and resource for the data to be transmitted on HS-DSCH.

The associated signalling shown in the figure illustrates the exchange of information between layer 1 and layer 2 provided by primitives shown in [3].

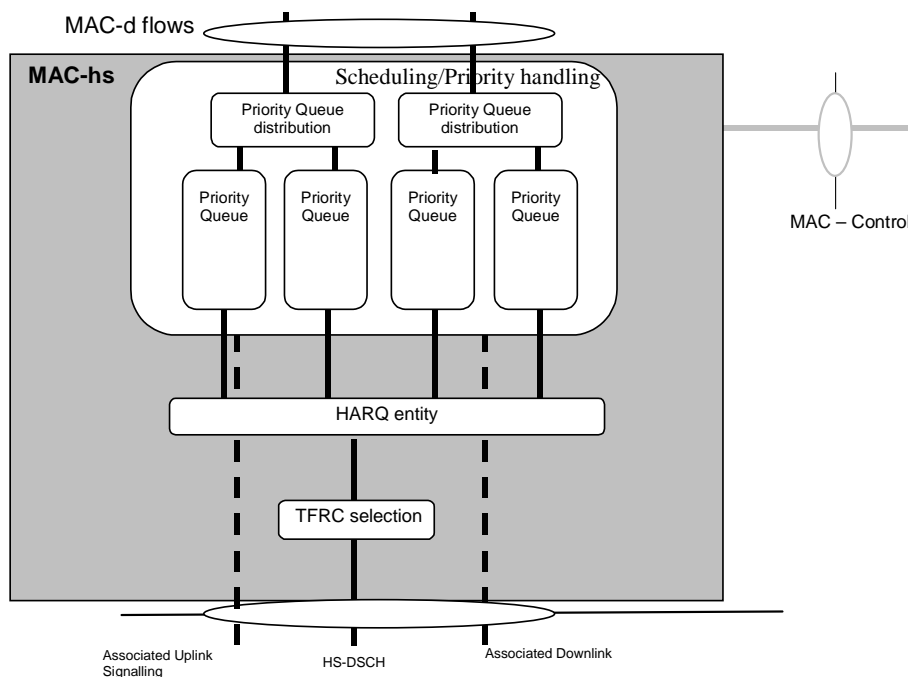

Figure 4.2.4.3.1: UTRAN side MAC architecture / MAC-hs details

4.3 Channel structure

The MAC operates on the channels defined below; the transport channels are described between MAC and Layer 1, the logical channels are described between MAC and RLC.

The following subclauses provide an overview, the normative description can be found in [2] and [3] respectively.

4.3.1 Transport channels

Common transport channel types are:

- Random Access Channel(s) (RACH);
- Forward Access Channel(s) (FACH);
- Downlink Shared Channel(s) (DSCH);
- High Speed Downlink Shared Channel(s) (HS-DSCH);
- Common Packet Channel(s) (CPCH) for UL FDD operation only;
- Uplink Shared Channel(s) (USCH), for TDD operation only;
- Broadcast Channel (BCH);
- Paging Channel (PCH).

Dedicated transport channel types are:

- Dedicated Channel (DCH).

4.3.2 Logical Channels

The MAC layer provides data transfer services on logical channels. A set of logical channel types is defined for different kinds of data transfer services as offered by MAC.

Each logical channel type is defined by what type of information is transferred.

4.3.2.1 Logical channel structure

The configuration of logical channel types is depicted in figure 4.3.2.1.

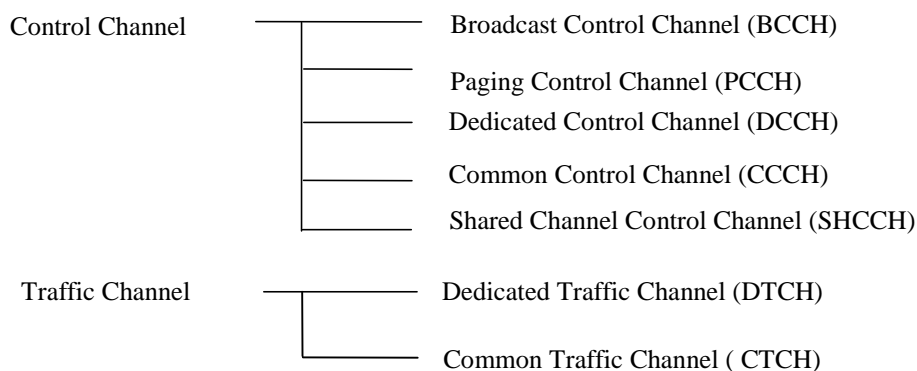

Figure 4.3.2.1: Logical channel structure

4.3.2.2 Control Channels

Following control channels are used for transfer of control plane information only:

- Broadcast Control Channel (BCCH);
- Paging Control Channel (PCCH);
- Common Control Channel (CCCH);
- Dedicated Control Channel (DCCH);

- Shared Channel Control Channel (SHCCH).

4.3.2.3 Traffic Channels

Following traffic channels are used for the transfer of user plane information only:

- Dedicated Traffic Channel (DTCH);
- Common Traffic Channel (CTCH).

5 Services provided to upper layers

This clause describes the different services provided by the MAC to higher layers. For a detailed description of the following functions see [2].

5.1 Description of Services provided to upper layers

- Data transfer: This service provides unacknowledged transfer of MAC SDUs between peer MAC entities without data segmentation.
- Reallocation of radio resources and MAC parameters: This service performs on request of RRC execution of radio resource reallocation and change of MAC parameters.
- Reporting of measurements: Local measurements are reported to RRC.

6 Functions

6.1 Description of the MAC functions

The functions of MAC include:

- mapping between logical channels and transport channels;
- selection of appropriate Transport Format for each Transport Channel depending on instantaneous source rate;
- priority handling between data flows of one UE;
- priority handling between UEs by means of dynamic scheduling;
- identification of UEs on common transport channels;
- multiplexing/demultiplexing of upper layer PDUs into/from transport blocks delivered to/from the physical layer on common transport channels;
- multiplexing/demultiplexing of upper layer PDUs into/from transport block sets delivered to/from the physical layer on dedicated transport channels;
- traffic volume measurement;
- Transport Channel type switching;
- ciphering for transparent mode RLC;
- Access Service Class selection for RACH and CPCH transmission;
- control of HS-DSCH transmission and reception including support of HARQ;
- HS-DSCH Provided Bit Rate measurement.

6.2 Relation between MAC Functions and Transport Channels

6.2.1 Relation between MAC Functions and Transport Channels in UTRAN

Table 6.2.1.1: UTRAN MAC functions corresponding to the transport channel

Associated MAC Functions	Logical Ch	Transport Ch	TF Selection	Priority handling between UEs	Priority handling (one UE)	Scheduling	Identification of UEs	Mux/Demux on common transport channels	Mux/Demux on dedicated transport channels	HARQ support
Uplink (Rx)	CCCH	RACH						X		
	DCCH	RACH					X	X		
	DCCH	CPCH					X	X		
	DCCH	DCH							X	
	DTCH	RACH					X	X		
	DTCH	CPCH					X	X		
	DTCH	DCH							X	
	SHCCH	RACH					X	X		
	SHCCH	USCH						X		
	DTCH	USCH						X		
	DCCH	USCH						X		
Downlink (Tx)	BCCH	BCH				X				
	BCCH	FACH	X			X		X		
	PCCH	PCH	X			X				
	CCCH	FACH	X	X		X		X		
	CTCH	FACH	X			X		X		
	DCCH	FACH	X	X		X	X	X		
	DCCH	DSCH	X	X			X	X		
	DCCH	DCH	X		X				X	
	DCCH	HS-DSCH	X (1)	X	X	X	X	X		X
	DTCH	FACH	X	X		X	X	X		
	DTCH	DSCH	X	X			X	X		
	DTCH	DCH	X		X				X	
	DTCH	HS-DSCH	X (1)	X	X	X	X	X		X
SHCCH	FACH	X	X		X		X			
SHCCH	DSCH	X	X				X			

NOTE 1: In case of HS-DSCH the TF selection is replaced by TFRC selection.

6.2.2 Relation of MAC Functions and Transport Channels in UE

Table 6.2.2.1: UE MAC functions corresponding to the transport channel

Associated MAC Functions	Logical Ch	Transport Ch	TF Selection	Priority handling (one UE)	Identification	Mux/Demux on common transport channels	Mux/Demux on dedicated transport channels	HARQ support
Uplink (Tx)	CCCH	RACH				X		
	DCCH	RACH	X	X	X	X		
	DCCH	CPCH	X	X	X	X		
	DCCH	DCH	X	X			X	
	DTCH	RACH	X	X	X	X		
	DTCH	CPCH	X	X	X	X		
	DTCH	DCH	X	X			X	
	SHCCH	RACH				X		
	SHCCH	USCH	X	X		X		
	DCCH	USCH	X	X		X		
	DTCH	USCH	X	X		X		
Downlink (Rx)	BCCH	BCH						
	BCCH	FACH				X		
	PCCH	PCH						
	CCCH	FACH				X		
	CTCH	FACH				X		
	DCCH	FACH			X	X		
	DCCH	DSCH				X		
	DCCH	DCH					X	
	DCCH	HS-DSCH			X	X		X
	DTCH	FACH			X	X		
	DTCH	DSCH				X		
	DTCH	DCH					X	
	DTCH	HS-DSCH			X	X		X
SHCCH	FACH				X			
SHCCH	DSCH				X			

7 Services expected from physical layer

The physical layer offers information transfer services to MAC. For detailed description, see [3].

8 Elements for layer-to-layer communication

The interaction between the MAC layer and other layers are described in terms of primitives where the primitives represent the logical exchange of information and control between the MAC layer and other layers. The primitives shall not specify or constrain implementations. The MAC is connected to layer 1, RLC and RRC. The following subclauses describe the primitives between these layers.

8.1 Primitives between layers 1 and 2

8.1.1 Primitives

The primitives are described in [3].

8.1.2 Parameters

a) Transport Format Resource Indicator (TFRI) for HS-DSCH:

- For HS-DSCH the Transport Block size is derived from the TFRI value signalled on the HS-SCCH. The mapping between TFRI value and Transport Block size is specified in subclause 9.2.3.

8.2 Primitives between MAC and RLC

8.2.1 Primitives

The primitives between MAC layer and RLC layer are shown in table 8.2.1.1.

Table 8.2.1.1: Primitives between MAC layer and RLC layer

Generic Name	Parameter			
	Request	Indication	Response	Confirm
MAC-DATA	Data, BO, UE-ID type indicator, RLC Entity Info	Data, No_TB, TD (note), Error indication		
MAC-STATUS		No_PDU, PDU_Size, TX status, Status_Report_REQ	BO, RLC Entity Info	
NOTE: TDD only.				

MAC-DATA-Req/Ind:

- MAC-DATA-Req primitive is used to request that an upper layer PDU be sent using the procedures for the information transfer service;
- MAC-DATA-Ind primitive indicates the arrival of upper layer PDUs received within one transmission time interval by means of the information transfer service.

MAC-STATUS-Ind/Resp:

- MAC-STATUS-Ind primitive indicates to RLC for each logical channel the rate at which it may transfer data to MAC. Parameters are the number of PDUs that can be transferred in each transmission time interval and the PDU size; it is possible that MAC would use this primitive to indicate that it expects the current buffer occupancy of the addressed logical channel in order to provide for optimised TFC selection on transport channels with long transmission time interval. At the UE, MAC-STATUS-Ind primitive is also used to indicate from MAC to RLC that MAC has requested data transmission by PHY (i.e. PHY-DATA-REQ has been submitted, see Fig. 11.2.2.1), or that transmission of an RLC PDU on RACH or CPCH has failed due to exceeded preamble ramping cycle counter.
- MAC-STATUS-Resp primitive enables RLC to acknowledge a MAC-STATUS-Ind. It is possible that RLC would use this primitive to indicate that it has nothing to send or that it is in a suspended state or to indicate the current buffer occupancy to MAC.

8.2.2 Parameters

a) Data:

- it contains the RLC layer messages (RLC-PDU) to be transmitted, or the RLC layer messages that have been received by the MAC sub-layer.

b) Number of transmitted transport blocks (No_TB) :

- indicates the number of transport blocks transmitted by the peer entity within the transmission time interval, based on the TFI value.

c) Buffer Occupancy (BO):

- the parameter Buffer Occupancy (BO) indicates for each logical channel the amount of data in number of bytes that is available for transmission and retransmission in RLC layer. When MAC is connected to an AM RLC entity, control PDUs to be transmitted and RLC PDUs outside the RLC Tx window shall also be included in the BO. RLC PDUs that have been transmitted but not negatively acknowledged by the peer entity shall not be included in the BO.
- d) RX Timing Deviation (TD), TDD only:
- it contains the RX Timing Deviation as measured by the physical layer for the physical resources carrying the data of the Message Unit. This parameter is optional and only for Indication. It is needed for the transfer of the RX Timing Deviation measurement of RACH transmissions carrying CCCH data to RRC.
- e) Number of PDU (No_PDU):
- specifies the number of PDUs that the RLC is permitted to transfer to MAC within a transmission time interval.
- f) PDU Size (PDU_Size):
- specifies the size of PDU that can be transferred to MAC within a transmission time interval.
- g) UE-ID Type Indicator:
- indicates the UE-ID type to be included in MAC for a DCCH and DTCH when they are mapped onto a common transport channel (i.e. FACH, RACH, DSCH in FDD or CPCH). On the UE side UE-ID Type Indicator shall always be set to C-RNTI.
- h) TX status:
- when set to value "transmission unsuccessful" this parameter indicates to RLC that transmission of an RLC PDU failed in the previous Transmission Time Interval, when set to value "transmission successful" this parameter indicates to RLC that the requested RLC PDU(s) has been submitted for transmission by the physical layer.
- i) RLC Entity Info
- indicates to MAC the configuration parameters that are critical to TFC selection depending on its mode and the amount of data that could be transmitted at the next TTI. This primitive is meant to insure that MAC can perform TFC selection (see subclause 11.4).
- j) Error indication
- When a MAC SDU is delivered to upper layer, an error indication is given for the SDU to upper layer if an error indication for the SDU has been received from lower layer.
- k) Status_Report_REQ
- indicates to all AM RLC entities mapped on HS-DSCH to generate a status report when the MAC-hs resets.

8.3 Primitives between MAC and RRC

8.3.1 Primitives

The primitives between MAC and RRC are shown in table 8.3.1.1.

Table 8.3.1.1: Primitives between MAC sub-layer and RRC

Generic Name	Parameter			
	Request	Indication	Response	Confirm
CMAC-CONFIG	UE information elements, RB information elements, TrCH information elements, RACH transmission control elements, Ciphering elements, CPCH transmission control elements			
CMAC-MEASUREMENT	Measurement information elements	Measurement result		
CMAC-STATUS		Status info		

CMAC-CONFIG-Req:

- CMAC-CONFIG-Req is used to request for setup, release and configuration of a logical channel, e.g. RNTI allocation, switching the connection between logical channels and transport channels, TFCS update or scheduling priority of logical channel.

CMAC-MEASUREMENT-Req/Ind:

- CMAC-MEASUREMENT-Req is used by RRC to request MAC to perform measurements, e.g. traffic volume measurements;
- CMAC-MEASUREMENT-Ind is used to notify RRC of the measurement result.

CMAC-STATUS-Ind:

- CMAC-STATUS-Ind primitive notifies RRC of status information.

8.3.2 Parameters

See [7] for a detailed description of the UE, RB and TrCH information elements.

- UE information elements
 - S-RNTI
 - SRNC identity
 - C-RNTI
 - Activation time
- RB information elements
 - RB multiplexing info (Transport channel identity, Logical channel identity, MAC logical channel priority)
- TrCH information elements
 - Transport Format Combination Set
 - MAC-hs reset indicator
 - Re-ordering release timer (T1)
- Measurement information elements
 - Reporting Quantity identifiers
 - Time interval to take an average or a variance (applicable when Average or Variance is Reporting Quantity)
- Measurement result
 - Reporting Quantity
- Status info
 - when set to value "transmission unsuccessful" this parameter indicates to RRC that transmission of a TM RLC PDU failed (due to e.g. Maximum number of preamble ramping cycles reached for RACH in FDD), when set to value "transmission successful" this parameter indicates to RRC that the requested TM RLC PDU(s) has been submitted for transmission by the physical layer.
- RACH transmission control elements
 - Set of ASC parameters (identifier for PRACH partitions, persistence values)

Maximum number of preamble ramping cycles (FDD) or synchronisation attempts (1.28 Mcps TDD) M_{\max}
 Minimum and maximum number of time units between two preamble ramping cycles, N_{BO1min} and N_{BO1max} (FDD only)

ASC for RRC CONNECTION REQUEST message

- h) Ciphering elements
 - Ciphering mode
 - Ciphering key
 - Ciphering sequence number
- i) CPCH transmission control elements
 - CPCH persistency value, P for each Transport Format
 - Maximum number of preamble ramping cycles $N_{\text{access_fails}}$
 - NF_max (Maximum number of frames for CPCH transmission for each Transport Format)
 - N_EOT (Number of EOT for release of CPCH transmission)
 - Backoff control timer parameters
 - Transport Format Set
 - Initial Priority Delays
 - Channel Assignment Active indication

9 Elements for peer-to-peer communication

9.1 Protocol data units

9.1.1 General

A MAC PDU is a bit string, with a length not necessarily a multiple of 8 bits. In the drawings in clause 9.1, bit strings are represented by tables in which the first bit is the leftmost one on the first line of the table, the last bit is the rightmost on the last line of the table, and more generally the bit string is to be read from left to right and then in the reading order of the lines.

Depending on the provided service, MAC SDUs are bit strings with any non-null length, or bit strings with an integer number of octets in length. An SDU is included into a MAC PDU from first bit onward.

In the UE for the uplink, all MAC PDUs delivered to the physical layer within one TTI are defined as Transport Block Set (TBS). It consists of one or several Transport Blocks, each containing one MAC PDU. The Transport Blocks, shall be transmitted in the order as delivered from RLC. When multiplexing of RLC PDUs from different logical channels is performed on MAC, the order of all Transport Blocks originating from the same logical channel shall be the same as the order of the sequence delivered from RLC. The order of the different logical channels in a TBS is set by the MAC protocol.

9.1.2 MAC PDU (non-HS-DSCH)

A MAC PDU consists of an optional MAC header and a MAC Service Data Unit (MAC SDU), see figure 9.1.2.1. Both the MAC header and the MAC SDU are of variable size.

The content and the size of the MAC header depends on the type of the logical channel, and in some cases none of the parameters in the MAC header are needed.

The size of the MAC-SDU depends on the size of the RLC-PDU, which is defined during the setup procedure.

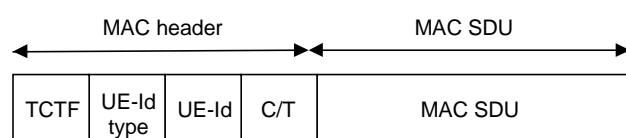

Figure 9.1.2.1: MAC PDU

9.1.3 MAC-d PDU (HS-DSCH)

For HS-DSCH the MAC-d PDU format equals the MAC PDU format for the non HS-DSCH case.

9.1.4 MAC PDU (HS-DSCH)

In case of HS-DSCH a MAC PDU consists of one MAC-hs header and one or more MAC-hs SDUs where each MAC-hs SDU equals a MAC-d PDU. A maximum of one MAC-hs PDU can be transmitted in a TTI per UE. The MAC-hs header is of variable size. The MAC-hs SDUs in one TTI belongs to the same reordering queue.

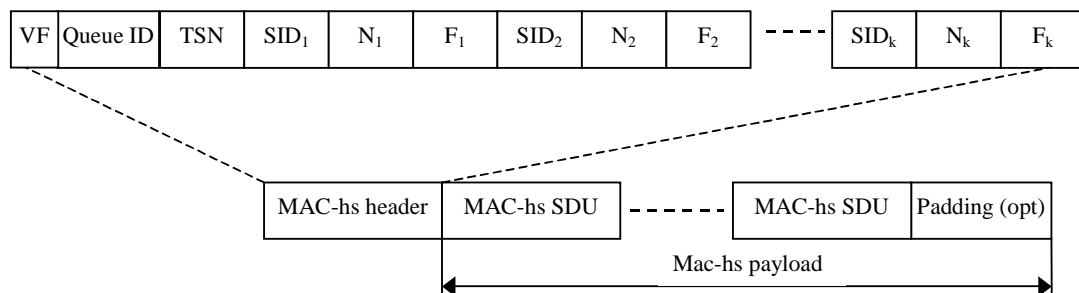

Figure 9.1.4.1: MAC-hs PDU

9.2 Formats and parameters

NOTE: MAC header field encodings as specified in this clause with designation "Reserved" are forbidden to be used by a sender in this version of the protocol.

9.2.1 MAC PDU: Parameters of the MAC PDU header (non HS-DSCH) and MAC-d PDU header (HS-DSCH)

The following fields are defined for the MAC header for transport channels other than HS-DSCH and for the MAC-d PDU header for HS-DSCH:

- Target Channel Type Field

The TCTF field is a flag that provides identification of the logical channel class on FACH and RACH transport channels, i.e. whether it carries BCCH, CCCH, CTCH, SHCCH or dedicated logical channel information. The size and coding of TCTF for FDD and TDD are shown in tables 9.2.1.1, 9.2.1.2, 9.2.1.3, 9.2.1.4 and 9.2.1.5. Note that the size of the TCTF field of FACH for FDD is either 2 or 8 bits depending of the value of the 2 most significant bits and for TDD is either 3 or 5 bits depending on the value of the 3 most significant bits. The TCTF of the RACH for TDD is either 2 or 4 bits depending on the value of the 2 most significant bits.

Table 9.2.1.1: Coding of the Target Channel Type Field on FACH for TDD

TCTF	Designation
000	BCCH
001	CCCH
010	CTCH
01100	DCCH or DTCH over FACH
01101- 01111	Reserved (PDUs with this coding will be discarded by this version of the protocol)
100	SHCCH
101-111	Reserved (PDUs with this coding will be discarded by this version of the protocol)

Table 9.2.1.2: Coding of the Target Channel Type Field on FACH for FDD

TCTF	Designation
00	BCCH
01000000	CCCH
01000001- 01111111	Reserved (PDUs with this coding will be discarded by this version of the protocol)
10000000	CTCH
10000001- 10111111	Reserved (PDUs with this coding will be discarded by this version of the protocol)
11	DCCH or DTCH over FACH

Table 9.2.1.3: Coding of the Target Channel Type Field on USCH or DSCH (TDD only)

TCTF	Designation
0	SHCCH
1	DCCH or DTCH over USCH or DSCH

Table 9.2.1.4: Coding of the Target Channel Type Field on RACH for FDD

TCTF	Designation
00	CCCH
01	DCCH or DTCH over RACH
10-11	Reserved (PDUs with this coding will be discarded by this version of the protocol)

Table 9.2.1.5: Coding of the Target Channel Type Field on RACH for TDD

TCTF	Designation
00	CCCH
0100	DCCH or DTCH Over RACH
0101- 0111	Reserved (PDUs with this coding will be discarded by this version of the protocol)
10	SHCCH
11	Reserved (PDUs with this coding will be discarded by this version of the protocol)

- C/T field

The C/T field provides identification of the logical channel instance when multiple logical channels are carried on the same transport channel (other than HS-DSCH) or same MAC-d flow (HS-DSCH). The C/T field is used also to provide identification of the logical channel type on dedicated transport channels and on FACH and RACH when used for user data transmission. The size of the C/T field is fixed to 4 bits for both common transport channels and dedicated transport channels. Table 9.2.1.5a shows the 4-bit C/T field.

Table 9.2.1.5a: Structure of the C/T field

C/T field	Designation
0000	Logical channel 1
0001	Logical channel 2
...	...
1110	Logical channel 15
1111	Reserved (PDUs with this coding will be discarded by this version of the protocol)

- UE-Id

The UE-Id field provides an identifier of the UE on common transport channels. The following types of UE-Id used on MAC are defined:

- UTRAN Radio Network Temporary Identity (U-RNTI) may be used in the MAC header of DCCH when mapped onto common transport channels in downlink direction; the U-RNTI is never used in uplink direction;
- Cell Radio Network Temporary Identity (C-RNTI) is used on DTCH and DCCH in uplink, and may be used on DCCH in downlink and is used on DTCH in downlink when mapped onto common transport channels, except when mapped onto DSCH transport channel;
- In FDD, DSCH Radio Network Temporary Identity (DSCH-RNTI) is used on DTCH and DCCH in downlink when mapped onto DSCH transport channel;- the UE id to be used by MAC is configured through the MAC control SAP. The lengths of the UE-id field of the MAC header are given in table 9.2.1.6.

Table 9.2.1.6: Lengths of UE Id field

UE Id type	Length of UE Id field
U-RNTI	32 bits
C-RNTI	16 bits
DSCH-RNTI	16 bits

- UE-Id Type

The UE-Id Type field is needed to ensure correct decoding of the UE-Id field in MAC Headers.

Table 9.2.1.7: UE-Id Type field definition

UE-Id Type field 2 bits	UE-Id Type
00	U-RNTI
01	C-RNTI or DSCH-RNTI
10	Reserved (PDUs with this coding will be discarded by this version of the protocol)
11	Reserved (PDUs with this coding will be discarded by this version of the protocol)

9.2.1.1 MAC header for DTCH and DCCH (not mapped on HS-DSCH)

- a) DTCH or DCCH mapped to DCH, no multiplexing of dedicated channels on MAC:
 - no MAC header is required.
- b) DTCH or DCCH mapped to DCH, with multiplexing of dedicated channels on MAC:
 - C/T field is included in MAC header.
- c) DTCH or DCCH mapped to RACH/FACH:
 - TCTF field, C/T field, UE-Id type field and UE-Id are included in the MAC header. For FACH, the UE-Id type field used is the C-RNTI or U-RNTI. For RACH, the UE-Id type field used is the C-RNTI.
- d) DTCH or DCCH mapped to DSCH or USCH:
 - the TCTF field is included in the MAC header for TDD only. The UE-Id type and UE-Id are included in the MAC header for FDD only. The UE-Id type field used is the DSCH-RNTI. The C/T field is included if multiplexing on MAC is applied.
- e) DTCH or DCCH mapped to DSCH or USCH where DTCH or DCCH are the only logical channels:
 - the UE-Id type and UE-Id are included in the MAC header for FDD only. The UE-Id type field used is the DSCH-RNTI. The C/T field is included in the MAC header if multiplexing on MAC is applied.
- f) DTCH or DCCH mapped to CPCH:
 - UE-Id type field and UE-Id are included in the MAC header. The C/T field is included in the MAC header if multiplexing on MAC is applied. The UE-Id type field used is the C-RNTI.

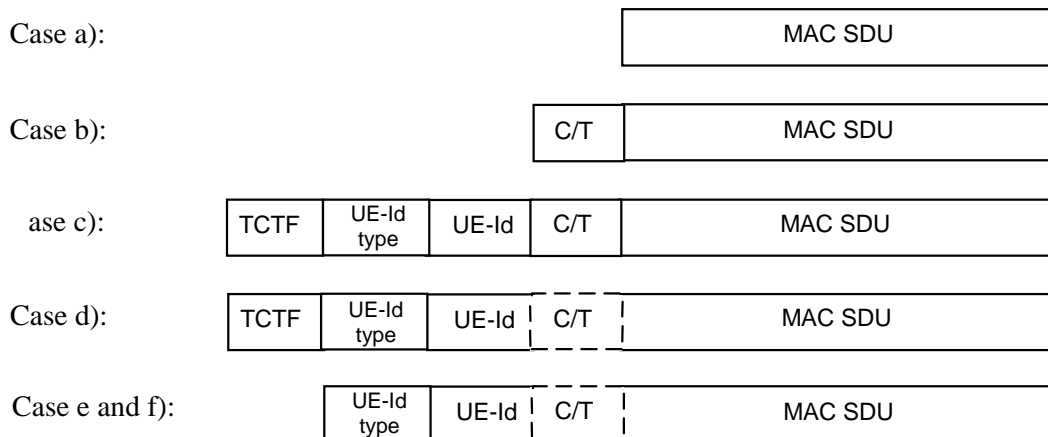

Figure 9.2.1.1.1: MAC PDU formats for DTCH and DCCH

9.2.1.1a MAC-d Header for DTCH and DCCH (mapped on HS-DSCH)

The MAC-d PDU header for DTCH and DCCH mapped on HS-DSCH is as shown in figure 9.2.1.1a.1.

- C/T field is included in the MAC-d PDU header if multiplexing on MAC is applied.

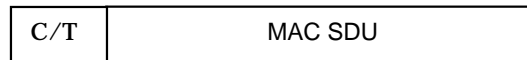
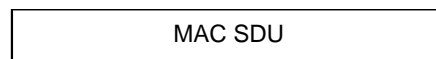

Figure 9.2.1.1a.1 MAC-d PDU format for DTCH and DCCH mapped on HS-DSCH

9.2.1.2 MAC header for BCCH

- BCCH mapped to BCH:
 - no MAC header is included.
- BCCH mapped to FACH:
 - the TCTF field is included in MAC header.

Case a):



Case b):

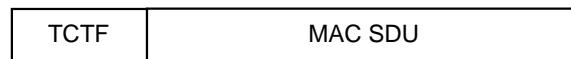

Figure 9.2.1.2.1: MAC PDU formats for BCCH

9.2.1.3 MAC header for PCCH

There is no MAC header for PCCH.

9.2.1.4 MAC header for CCCH

CCCH mapped to RACH/FACH:

- TCTF field is included in MAC header.

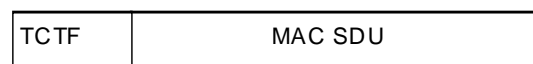

Figure 9.2.1.4.1: MAC PDU formats for CCCH

9.2.1.5 MAC Header for CTCH

The TCTF field is included as MAC header for CTCH as shown in figure 9.2.1.5.1.

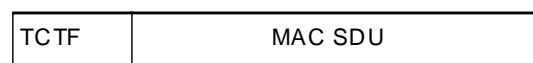

Figure 9.2.1.5.1: MAC PDU format for CTCH

9.2.1.6 MAC Header for SHCCH

The MAC header for SHCCH is as shown in figure 9.2.1.6.1.

- a) SHCCH mapped to RACH and USCH/FACH and DSCH:
 - TCTF has to be included.
- b) SHCCH mapped to RACH and USCH/FACH and DSCH, where SHCCH is the only channel.

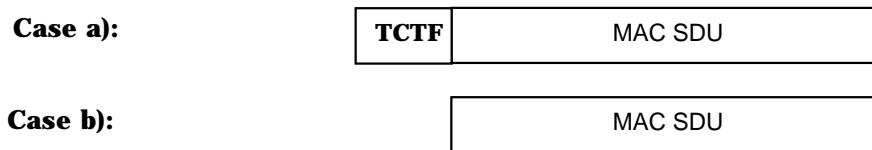

Figure 9.2.1.6.1: MAC PDU format for SHCCH

9.2.2 MAC PDU: Parameters of the MAC header (HS-DSCH)

- Version Flag (VF):
The VF field is a one bit flag providing extension capabilities of the MAC-hs PDU format. The VF field shall be set to zero and the value one is reserved in this version of the protocol.
- Queue identifier (Queue ID):
The Queue ID field provides identification of the reordering queue in the receiver, in order to support independent buffer handling of data belonging to different reordering queues. The length of the Queue ID field is 3 bit.
- Transmission Sequence Number (TSN):
The TSN field provides an identifier for the transmission sequence number on the HS-DSCH. The TSN field is used for reordering purposes to support in-sequence delivery to higher layers. The length of the TSN field is 6 bit.
- Size index identifier (SID):
The SID fields identifies the size of a set of consecutive MAC-d PDUs. The MAC-d PDU size for a given SID is configured by higher layers and is independent for each Queue ID. The length of the SID field is 3 bit.
- Number of MAC-D PDUs (N):
The number of consecutive MAC-d PDUs with equal size is identified with the N field. The length of the N field is 7 bits. In FDD mode, the maximum number of PDUs transmitted in a single TTI shall be assumed to be 70. In 1.28 Mcps TDD mode, the maximum number of PDUs transmitted in a single TTI shall be assumed to be 45. In 3.84 Mcps TDD mode, the maximum number of PDUs transmitted in a single TTI shall be assumed to be 318. If more PDUs than the defined maximum number of PDUs for the corresponding mode are received, the UE behaviour is unspecified.
- Flag (F):
The F field is a flag indicating if more SID fields are present in the MAC-hs header or not. If the F field is set to "0" the F field is followed by a SID field. If the F field is set to "1" the F field is followed by a MAC-d PDU.

9.2.2.1 MAC header for DTCH and DCCH

- a) DTCH or DCCH mapped to HS-DSCH:
 - The Queue ID field and TSN field are always included in the MAC-hs header. One SID field, N field and F field is included for each MAC-d PDU size included in the MAC-hs PDU. Padding is not explicitly indicated but is included in the end of the MAC-hs PDU if the total size of the MAC-hs payload plus the MAC-hs header is smaller than the transport block set size.

9.2.3 Signalling of Transport Block size for HS-DSCH

For HS-DSCH the transport block size is derived from the TFRI value signalled on the HS-SCCH. The mapping between the TFRI value and the transport block size for each mode is specified below:

9.2.3.1 Transport block size for FDD

For all transmissions of a transport block, the transport block size is derived from the TFRI value as specified below, except only in those cases of retransmissions where the Node-B selects a combination for which no mapping exists between the original transport block size and the selected combination of channelisation Code set and modulation type. In such cases, the transport block size index value signalled to the UE shall be set to 111111, i.e., $k_i=63$.

For each combination of channelization code set and modulation scheme $i = 0..31$, a set of $k_i = 0..62$ transport block sizes $L(i, k_i)$ is given by:

If $i = 0$ and $k_i < 39$

$$L(i, k_i) = 137 + 12k_i$$

$$k_i = 0, \dots, 38$$

else

end

The 'if' statement above is true only for a single channelization code using QPSK modulation. The index k_i of the transport block size $L(i, k_i)$ corresponds to the 6 bit transport block size index signalled on the HS-SCCH. The index i corresponds to the combination of channelization code set and modulation scheme as defined in Table 9.2.3.1.

Table 9.2.3.1: Values of $k_{0,i}$ for different numbers of channelization codes and modulation schemes

Combination i	Modulation scheme	Number of channelization codes	$k_{0,i}$
0	QPSK	1	1
1		2	40
2		3	63
3		4	79
4		5	92
5		6	102
6		7	111
7		8	118
8		9	125
9		10	131
10		11	136
11		12	141
12		13	145
13		14	150
14		15	153
15	16QAM	1	40
16		2	79
17		3	102
18		4	118
19		5	131
20		6	141
21		7	150
22		8	157
23		9	164
24		10	169
25		11	175

26		12	180
27		13	184
28		14	188
29		15	192

9.2.3.2 Transport block size for 3.84 Mcps TDD

Let k be the signalled TFRI value, then the corresponding HS-DSCH transport block size L_k is given by :

If $k=1..510$

$$L_k = \lfloor L_{\min} p^k \rfloor$$

$$p = \frac{8313}{8192}$$

$$L_{\min} = 57$$

If $k = 511$

$$L_k = 102000$$

If $k=0$, L_k indicates NULL and shall not be used to signal a transport block size in the TFRI.

9.2.3.3 Transport block size for 1.28 Mcps TDD

The mapping of transport block size, in bits, to TFRI value is dependent upon the UE's HS-DSCH capability class.

If k is the signalled TFRI value then the corresponding HS-DSCH transport block size L_k is given by:

If $k = 1..62$

$$L_k = \lfloor L_{\min} p^{k-1} \rfloor$$

where

$$p = \frac{1340}{1269} \text{ for the 1.4 Mbps user class,}$$

$$p = \frac{1755}{1652} \text{ for the 2.0 Mbps user class,}$$

$$p = \frac{2345}{2196} \text{ for the 2.8 Mbps user class,}$$

and

$$L_{\min} = 240$$

If $k = 63$ then,

$$L_k = 7016 \text{ for the 1.4 Mbps user class,}$$

$$10204 \text{ for the 2.0 Mbps user class,}$$

14056 for the 2.8 Mbps user class.

If $k=0$, L_k indicates NULL and shall not be used to signal a transport block size in the TFRI.

10 Handling of unknown, unforeseen and erroneous protocol data

The list of error cases is reported below:

a) Use of reserved coding in the MAC header

If the MAC entity receives a MAC PDU with a header field using a value marked as reserved for this version of the protocol, it shall discard the PDU, unless explicitly mentioned otherwise.

b) Inconsistent MAC header

If the MAC entity receives a MAC PDU with a header inconsistent with the configuration received from RRC, it shall discard the PDU. E.g.: In case DTCH is mapped to RACH/FACH, the MAC entity shall discard a PDU with a C/T field indicating a logical channel number that is not configured.

c) Erroneous MAC header fields

The MAC PDU shall be discarded if the lower layer gives an error indication for a MAC PDU and a MAC header is included in the MAC PDU.

11 Specific functions

11.1 Traffic volume measurement for dynamic radio bearer control

Dynamic radio bearer control is performed by RRC, based on the traffic volume measurements reported by MAC. Traffic volume information is measured in MAC layer and the results are reported from MAC layer to RRC layer.

At least every TTI, the MAC layer shall receive from each RLC entity the value of its Buffer Occupancy (BO), expressed in bytes. RRC can configure MAC to keep track of statistics (i.e. raw BO, average of BO and variance of BO) on the BO (see [7]) values of all Radio Bearers mapped onto a given transport channel. When the average or variance are requested, an averaging interval duration will also be provided.

Every time the BO values are reported to MAC, the UE shall verify whether an event was triggered or if a periodic report is required (see [7]). If reporting is required (multiple reports may be triggered in a single TTI), the MAC shall deliver to RRC the reporting quantities required for the corresponding RBs. In the case of average and variance of BO, the averaging should be performed for the interval with the configured duration ending at the time when the event was triggered.

RRC requests MAC measurement report with the primitive CMAC-Measure-REQ including following parameters.

Measurement information elements.

- Reporting Quantity identifiers
Indicates what should be reported to RRC layer
For each RB, BO (optional), Average of BO (optional), or Variance of BO(optional)
- Time interval to take an average or a variance (applicable when Average or Variance is Reporting Quantity)
Indicates time interval to take an average or a variance of BO
The calculation of average and variance of BO shall be based on one sample of BO per 10ms during the time interval given in this information element. All samples taken in the time interval shall have equal weight in the calculation.

MAC receives RLC PDUs with the primitive MAC-Data-REQ including following parameters.

- Buffer Occupancy (BO)

The parameter Buffer Occupancy (BO) indicates for each logical channel the amount of data in number of bytes that is available for transmission and retransmission in RLC layer. When MAC is connected to an AM RLC entity, control PDUs to be transmitted and RLC PDUs outside the RLC Tx window shall also be included in the BO. RLC PDUs that have been transmitted but not negatively acknowledged by the peer entity shall not be included in the BO.

11.2 Control of RACH transmissions

The MAC sublayer is in charge of controlling the timing of RACH transmissions on transmission time interval level (the timing on access slot level is controlled by L1). Note that retransmissions in case of erroneously received RACH message part are under control of higher layers, i.e. RLC, or RRC for CCCH (and SHCCH for TDD).

11.2.1 Access Service Class selection

The physical RACH resources (i.e. access slots and preamble signatures for FDD, timeslot and channelisation code for 3.84 Mcps TDD, SYNC1 code for 1.28 Mcps TDD) may be divided between different Access Service Classes in order to provide different priorities of RACH usage. It is possible for more than one ASC or for all ASCs to be assigned to the same access slot/signature space or SYNC1 code.

Access Service Classes are numbered in the range $0 \leq i \leq \text{NumASC} \leq 7$ (i.e. the maximum number of ASCs is 8). An ASC is defined by an identifier i that defines a certain partition of the PRACH resources and an associated persistence value P_i . A set of ASC parameters consists of $\text{NumASC}+1$ such parameters (i, P_i) , $i = 0, \dots, \text{NumASC}$. The PRACH partitions and the persistence values P_i are derived by the RRC protocol from system information (see [7]). The set of ASC parameters is provided to MAC with the CMAC-Config-REQ primitive. The ASC enumeration is such that it corresponds to the order of priority (ASC 0 = highest priority, ASC 7 = lowest priority). ASC 0 shall be used in case of Emergency Call or for reasons with equivalent priority.

At radio bearer setup/reconfiguration each involved logical channel is assigned a MAC Logical channel Priority (MLP) in the range 1, ..., 8. When the MAC sublayer is configured for RACH transmission in the UE, these MLP levels shall be employed for ASC selection on MAC.

The following ASC selection scheme shall be applied, where NumASC is the highest available ASC number and MinMLP the highest logical channel priority assigned to one logical channel:

- in case all TBs in the TB set have the same MLP, select $\text{ASC} = \min(\text{NumASC}, \text{MLP})$;
- in case TBs in a TB set have different priority, determine the highest priority level MinMLP and select $\text{ASC} = \min(\text{NumASC}, \text{MinMLP})$.

When an RRC CONNECTION REQUEST message is sent RRC determines ASC by means of the access class [7]. The ASC to be used in these circumstances is signalled to MAC by means of the CMAC-CONFIG-REQ message.

If MAC has knowledge of a U-RNTI then the ASC is determined in the MAC entity. If no U-RNTI has been indicated to MAC then MAC will use the ASC indicated in the CMAC-CONFIG-REQ primitive.

11.2.2 Control of RACH transmissions for FDD mode

The RACH transmissions are controlled by the UE MAC sublayer as outlined in figure 11.2.2.1.

NOTE: The figure shall illustrate the operation of the transmission control procedure as specified below. It shall not impose restrictions on implementation. MAC controls the timing of each initial preamble ramping cycle as well as successive preamble ramping cycles in case that none or a negative acknowledgement is received on AICH.

NOTE: In Cell-FACH state, the UE should co-ordinate the UL transmission schedule with the measurement schedule in FACH measurement occasions so as to minimise any delays associated with inter-frequency measurements.

MAC receives the following RACH transmission control parameters from RRC with the CMAC-CONFIG-Req primitive:

- a set of Access Service Class (ASC) parameters, which includes for each ASC, $i=0, \dots, \text{NumASC}$ an identification of a PRACH partition and a persistence value P_i (transmission probability);
- maximum number of preamble ramping cycles M_{max} ;
- range of backoff interval for timer T_{BO1} , given in terms of numbers of transmission 10 ms time intervals N_{BO1max} and N_{BO1min} , applicable when negative acknowledgement on AICH is received.

When there is data to be transmitted, MAC selects the ASC from the available set of ASCs, which consists of an identifier i of a certain PRACH partition and an associated persistence value P_i . The procedure to be applied for ASC selection is described in subclause 11.2.1.

Based on the persistence value P_i , the UE decides whether to start the L1 PRACH transmission procedure (see [13]) in the present transmission time interval or not. If transmission is allowed, the PRACH transmission procedure (starting with a preamble power ramping cycle) is initiated by sending of a PHY-ACCESS-REQ primitive. MAC then waits for access information from L1 via PHY-ACCESS-CNF primitive. If transmission is not allowed, a new persistency check is performed in the next transmission time interval. The persistency check is repeated until transmission is permitted.

When the preamble has been acknowledged on AICH, L1 access information with parameter value "ready for data transmission" is indicated to MAC with PHY-ACCESS-CNF primitive. Then data transmission is requested with PHY-DATA-REQ primitive, and the PRACH transmission procedure shall be completed with transmission of the PRACH message part according to L1 specifications. Successful completion (TX status) of the MAC transmission control procedure shall be indicated to higher layer.

When PHY indicates that no acknowledgement on AICH is received while the maximum number of preamble retransmissions is reached (defined by parameter Preamble_Retrans_Max on L1), a new persistency test is performed in the next transmission time interval. The timer T_2 ensures that two successive persistency tests are separated by at least one 10 ms time interval.

In case that a negative acknowledgement has been received on AICH a backoff timer T_{BO1} is started. After expiry of the timer, persistence check is performed again. Backoff timer T_{BO1} is set to an integer number N_{BO1} of 10 ms time intervals, randomly drawn within an interval $0 \leq N_{\text{BO1min}} \leq N_{\text{BO1}} \leq N_{\text{BO1max}}$ (with uniform distribution). N_{BO1min} and N_{BO1max} may be set equal when a fixed delay is desired, and even to zero when no delay other than the one due to persistency is desired.

Before a persistency test is performed it shall be checked whether any new RACH transmission control parameters have been received from RRC with CMAC-CONFIG-Req primitive. The latest set of RACH transmission control parameters shall be applied.

If the maximum number of preamble ramping cycles M_{max} is exceeded, failure of RACH transmission shall be reported to higher layer.

Both, transmission failure and successful completion of the MAC transmission control procedure, shall be indicated individually for each logical channel of which data was included in the transport block set of that access attempt. When transparent mode RLC is employed (i.e. for CCCH), transmission status is reported to RRC with CMAC-STATUS-Ind primitive. For logical channels employing acknowledged or unacknowledged mode RLC, transmission status is reported to RLC with MAC-STATUS-Ind primitive.

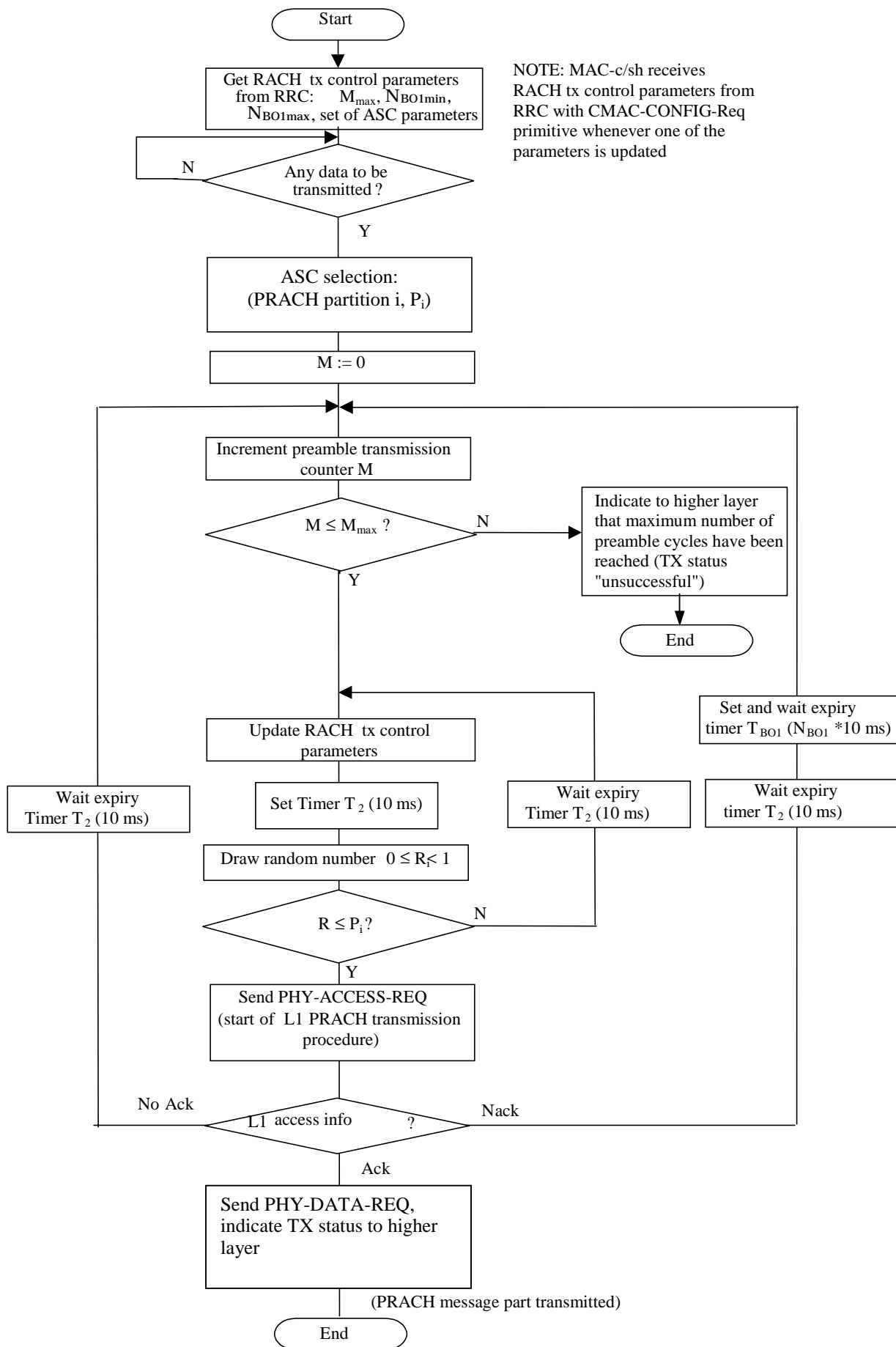

Figure 11.2.2.1: RACH transmission control procedure (UE side, informative)

11.2.3 Control of RACH transmissions for TDD

11.2.3.1 Control of RACH transmissions for 3.84 Mcps TDD

The RACH transmissions are performed by the UE as shown in figure 11.2.3.2.

NOTE: The figure shall illustrate the operation of the transmission control procedure as specified below. It shall not impose restrictions on implementation.

MAC receives the following RACH transmission control parameters from RRC with the CMAC-Config-REQ primitive:

- a set of Access Service Class (ASC) parameters, which includes for each ASC, $i=0, \dots, \text{NumASC}$ an identification of a PRACH partition and a persistence value P_i (transmission probability).

When there is data to be transmitted, MAC selects the ASC from the available set of ASCs, which consists of an identifier i of a certain PRACH partition and an associated persistence value P_i . The procedure to be applied for ASC selection is described in subclause 11.2.1.

In order to separate different ASCs each PRACH has N sub-channels associated with it (numbered from 0 to $N-1$). N may be assigned the value 1,2,4, or 8 by higher layer signalling. Sub-channel i for a PRACH defined in timeslot k is defined as the k :th slot in the frames where $\text{SFN mod } N = i$. Therefore follows the definition:

- Sub-channel i associated to a PRACH defined in timeslot k is defined as the k :th timeslot in the frames where $\text{SFN mod } N = i$.

Figure 11.2.3.1 illustrates the eight possible subchannels for the case, $N=8$. For illustration, the figure assumes that the PRACH is assigned timeslot 3.

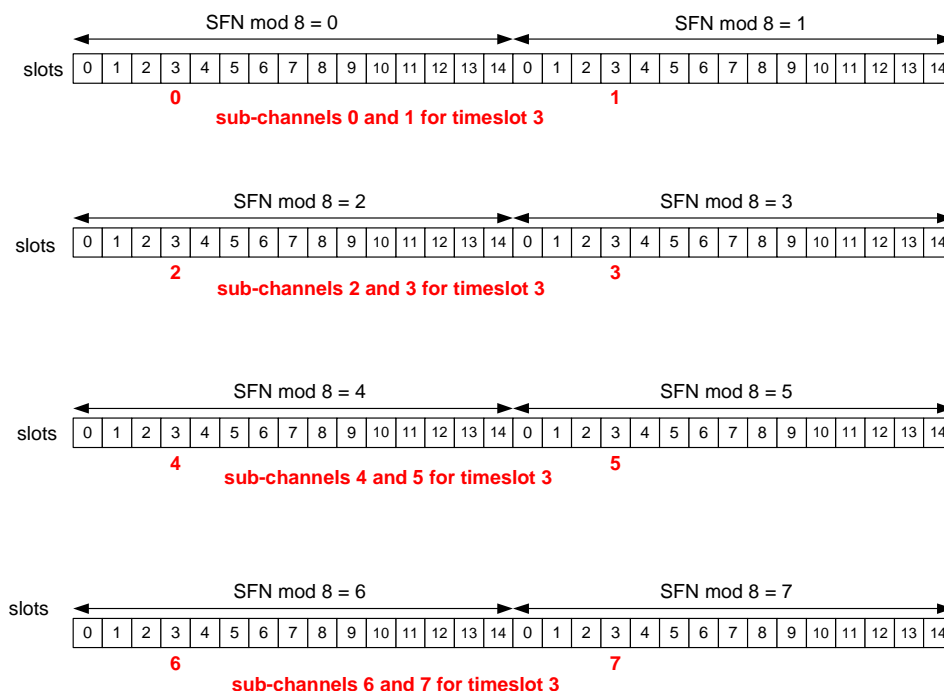

Figure 11.2.3.1 Eight sub-channels for timeslot 3

Based on the persistence value P , the UE decides whether to send the message on the RACH. If transmission is not allowed, a new persistency check is performed in the next transmission time interval. The persistency check is repeated until transmission is permitted. If transmission is allowed, a subchannel is randomly selected from the set of available subchannels for this ASC. The random subchannel selection shall be such that each of the allowed selections is chosen with equal probability. If an available subchannel is not found, the persistency check and subchannel assignment is repeated for the next subchannel period. If an available subchannel is found the PRACH transmission procedure is initiated by sending of a PHY-Data-REQ primitive.

Successful completion (TX status) of the MAC transmission control procedure shall be indicated to higher layer individually for each logical channel of which data was included in the transport block set of that access attempt. When transparent mode RLC is employed (i.e. for CCCH), transmission status is reported to RRC with CMAC-STATUS-Ind primitive. For logical channels employing acknowledged or unacknowledged mode RLC, transmission status is reported to RLC with MAC-STATUS-Ind primitive.

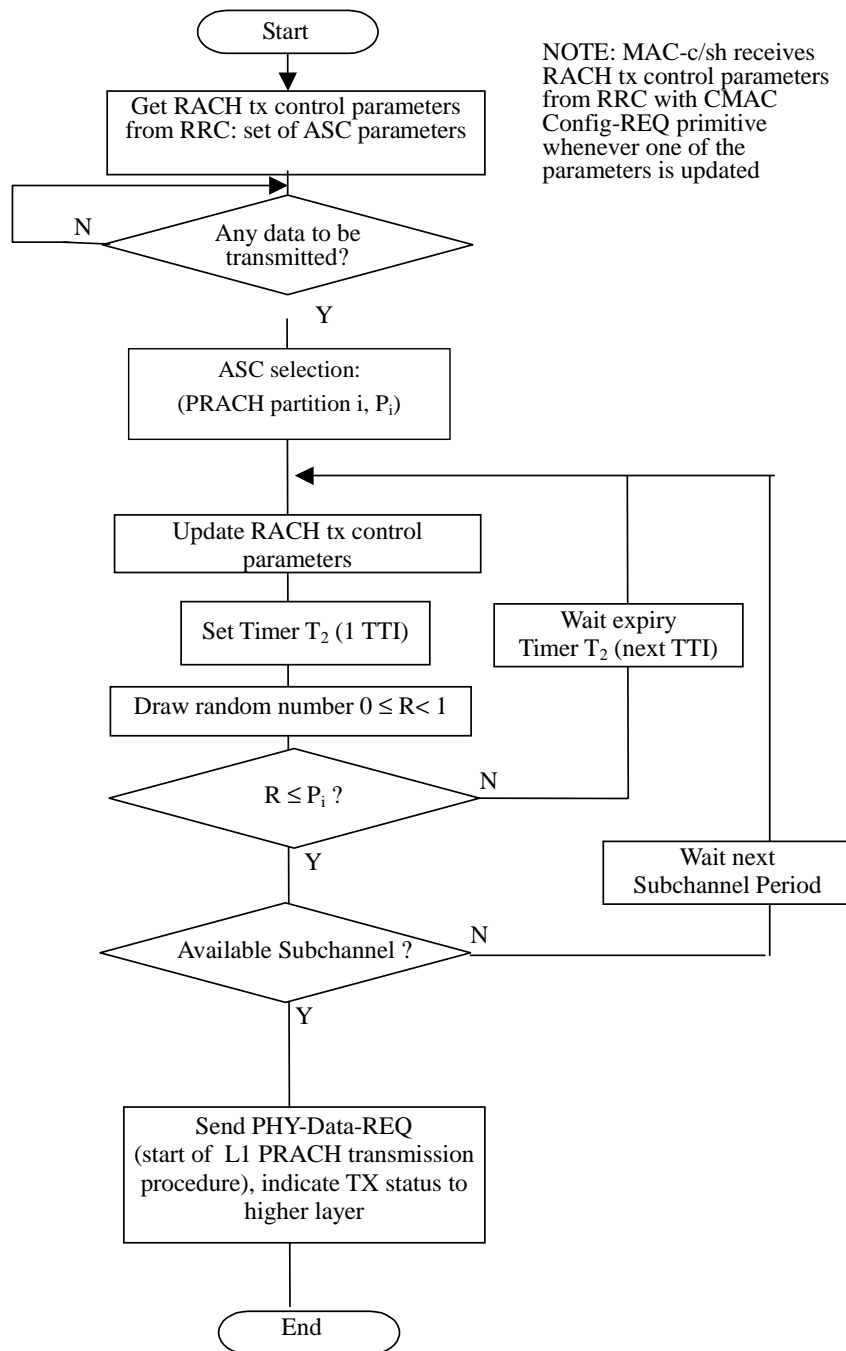

Figure 11.2.3.2: RACH transmission control procedure for TDD (UE side, informative)

11.2.3.2 Control of RACH Transmissions for 1.28 Mcps TDD

The RACH transmissions are performed by the UE as shown in figure 11.2.3.3.

NOTE: The figure shall illustrate the operation of the transmission control procedure as specified below. It shall not impose restrictions on implementation.

UE MAC receives the following RACH transmission control parameters from RRC with the CMAC-Config-REQ primitive:

- a set of Access Service Class (ASC) parameters, which includes for each ASC, $i=0, \dots, \text{NumASC}$ an identification of a PRACH partition and a persistence value P_i (transmission probability),
- maximum number of synchronisation attempts M_{\max} .

When there is data to be transmitted, MAC selects the ASC from the available set of ASCs, which consists of an identifier i of a certain PRACH partition and an associated persistence value P_i .

Based on the persistence value P_i , MAC decides whether to start the L1 PRACH procedure in the present transmission time interval or not. If transmission is allowed, the PRACH transmission procedure (starting with the SYNC_UL/FPACH power ramping sequence) is initiated by the sending of a PHY-ACCESS-REQ primitive. MAC then waits for access information from L1 via the PHY-ACCESS-CNF primitive. If transmission is not allowed, a new persistency check is performed in the next transmission time interval. The persistency check is repeated until transmission is permitted.

If a synchronisation burst has been acknowledged on its associated FPACH, PHY will inform MAC by a PHY-ACCESS-CNF primitive indicating "ready for RACH data transmission". Then MAC requests data transmission with a PHY-DATA-REQ primitive, and the PRACH transmission procedure will be completed with transmission on the PRACH resources associated with the FPACH.

Successful completion of the MAC procedure is indicated to higher layer individually for each logical channel of which data was included in the transport block set of that access attempt. When transparent mode RLC is employed (i.e. for CCCH), transmission status is reported to RRC with CMAC-STATUS-Ind primitive. For logical channels employing acknowledged or unacknowledged mode RLC, transmission status is reported to RLC with MAC-STATUS-Ind primitive.

If no synchronisation burst received an acknowledgement on the FPACH within the maximum number of transmissions permitted in a power ramping cycle, PHY will inform MAC by a PHY-ACCESS-CNF primitive indicating "no response received on FPACH". If the maximum number of synchronisation attempts permitted, M_{\max} , has not been exceeded, then MAC commences a new persistency test sequence in the next transmission time interval and the PHY-ACCESS-REQ procedure is repeated. The timer T_2 ensures that two successive persistency tests are separated by at least one transmission time interval. If the maximum number of synchronisation attempts is exceeded then MAC abandons the RACH procedure. Failure to complete the MAC procedure is indicated to higher layer by the CMAC-STATUS-Ind or MAC-STATUS-Ind primitives.

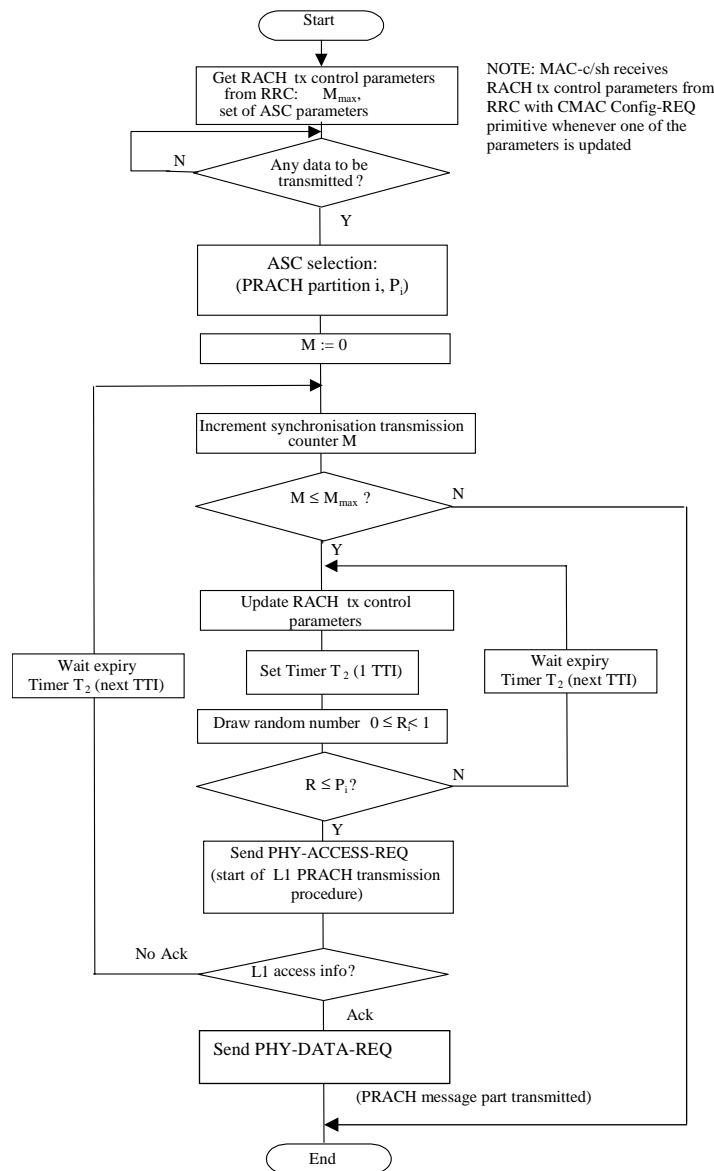

Figure 11.2.3.3: RACH transmission control procedure for 1.28 Mcps TDD (UE side, informative)

11.3 Control of CPCH transmissions for FDD

The MAC layer controls the timing of CPCH transmissions on transmission time interval level (i.e. on 10, 20, 40 or 80 ms level); the timing on access slot level is controlled by L1. MAC controls the timing of each initial preamble ramping cycle as well as successive preamble ramping cycles. Note that retransmissions in case of erroneously received CPCH message part are under control of higher layers. The CPCH transmissions are performed by the UE as illustrated in figures 11.3.1 and 11.3.2. Figure 11.3.1 procedure is used for access to CPCH channel. Figure 11.3.2 procedure is used for CPCH Message transmission on the CPCH channel obtained using the access procedure.

NOTE: In Cell-FACH state, the UE should co-ordinate the UL transmission schedule with the measurement schedule in FACH measurement occasions so as to minimise any delays associated with inter-frequency measurements.

MAC receives the following CPCH transmission control parameters from RRC with the CMAC-Config-REQ primitive:

- persistence values, P (transmission probability for each Transport Format (TF));
- N_access_fails, maximum number of preamble ramping cycles;

- NF_max, maximum number of frames for CPCH transmission for each TF;
- N_EOT (Number of EOT for release of CPCH transmission);
- Backoff control timer parameters;
- Transport Format Set;
- Initial Priority Delays;
- Channel Assignment Active indication.

The MAC procedure for CPCH access shall be invoked when the UE has data to transmit. The steps for this procedure are listed here:

1. the UE shall get all UL transmit parameters (CPCH Set Info, P values, Initial Priority Delays, N_access_fails, NF_max, N_EOT etc) from RRC;
2. the UE shall reset counter M, EOT counter and Frame Count Transmitted (FCT) upon entry to the initial access procedure;
3. if counter M is equal to N_access_fails, the UE shall indicate an access failure error to higher layer and the CPCH access procedure ends. Access failure is reported to RLC with MAC-STATUS-Ind primitive individually for each logical channel of which data was included in the transport block set that could not be transmitted. If counter M is less than N_access_fails, the UE shall send a PHY-CPCH_Status-REQ to Layer 1 to obtain CPCH TF subset status. If Layer 1 returns an error message, the UE shall increment counter M and the procedure shall continue from step 3. If Layer 1 returns a PHY-CPCH_Status-CNF message, which includes a TF subset indicating the currently available TFs of the requested TF subset, the procedure shall continue from step 4;
4. the UE shall initialise the Busy Table with the CPCH TF subset status from Layer 1. Those TFs in the TF subset of the Layer 1 PHY-CPCH_Status-CNF response will be marked available. All other TFs will be marked busy;
5. if all TFs are not marked busy, the procedure shall proceed from step 6. If all TFs are marked busy, the UE shall reset and start timer Tboc1, wait until timer expiry, and increment counter M. The procedure shall continue from step 3;
6. the UE shall update all UL transmit parameters from RRC;
7. UE shall select a TF from the set of available TFs listed in the Busy Table. UE shall use the CPCH channel capacity (transport block set size, NF_max, and TTI interval), and Busy Table information to select one CPCH TF for L1 to access. The UE may select a TF, which uses a lower data rate and a lower UL Tx power than the maximum UL Tx power allowed. UE shall implement a test based on the Persistence value (P) to determine whether to attempt access to the selected CPCH TF. If access is allowed, the procedure shall continue from step 9. If the P test does not allow access, the procedure shall continue from step 8;
8. the selected CPCH TF shall be marked busy in the Busy Table. If all TFs are marked busy, the UE shall reset and start timer Tboc1, wait until timer expiry, increment counter M, and continue from step 3. If all TFs are not marked busy, the UE shall resume the procedure from step 6;
9. the UE may implement an initial delay based on ASC of the data to be transmitted, then shall send a PHY-Access-REQ with the selected TF to L1 for CPCH access. After the UE has sent the access request to L1, L1 shall return a PHY-Access-CNF including one of five access indications to MAC as shown in figure 11.3.1. If the L1 access indication is that access is granted, then UE shall continue from step 14. For the cases of the other Layer 1 responses, the procedure shall continue from step 10, 11, or 12 respectively.
10. if L1 access indication is no AP-AICH received or no CD-AICH received, the UE shall reset and start timer Tboc3, wait until timer expiry, and increment counter M. The UE shall proceed from step 3;
11. if L1 access indication is AP-AICH_nak received, the UE shall reset and start timer Tboc2, wait until timer expiry. If Channel Assignment (CA) is active, the UE shall proceed from step 13. If Channel Assignment (CA) is not active, the procedure shall continue from step 8;
12. if L1 access indication is CD-AICH signature mismatch, the UE shall reset and start timer Tboc4, wait until timer expiry, and increment counter M. The procedure shall continue from step 3;
13. the UE shall increment counter M. The procedure shall continue from step 3.

14. the UE shall build a transport block set for the next TTI;
15. if the sum of the Frame Count Transmitted counter plus N_TTI (the number of frames in the next TTI) is greater than NF_max , the UE shall exit this procedure and start the MAC procedure for CPCH transmission of the first TTI. This shall release the CPCH channel in use and the UE will contend again for a new CPCH channel to continue transmission. If the sum of the Frame Count Transmitted counter plus N_TTI is less than or equal to NF_max , the UE shall send a PHY-Data-REQ with the transport block set to L1 to continue transmission on the CPCH channel which has previously been accessed;
16. if the L1 returns PHY-Status-IND indicating normal transmission, the procedure shall continue from step 17. If L1 returns PHY-Status-IND indicating abnormal situation the UE shall execute an abnormal situation handling procedure and the CPCH message transmission procedure ends. Reasons for abnormal situation may include the following:
- emergency stop was received;
 - start of Message Indicator was not received;
 - L1 hardware failure has occurred;
 - out of synch has occurred;
17. the UE shall increment the Frame Count Transmitted (FCT) counter by N_TTI just transmitted and indicate TX Status "transmission successful" to RLC individually for each logical channel of which data was included in the transport block set. If the UE has more data to transmit, the procedure shall continue from step 14;
18. the UE shall build the next TTI with zero sized transport block set. If the sum of the Frame Count Transmitted counter plus N_TTI is less than or equal to NF_max and if the sum of the EOT counter plus N_TTI is less than or equal to N_EOT , the procedure shall continue from step 19. Otherwise, the procedure ends;
19. UE shall send a PHY-Data-REQ with zero sized transport block set to L1 to stop transmission on the CPCH channel which has previously been accessed, both the EOT and the FCT counters shall be incremented by N_TTI and the procedure shall continue from step 18.

Table 11.3: CPCH Backoff Delay Timer Values

Timer	Based on parameter	Fixed/random
T_{BOC1} (all Busy)	$NF_bo_all_busy$	Random
T_{BOC2} (channel Busy)	NS_bo_busy	Fixed
T_{BOC3} (no AICH)	$NF_bo_no_aich$	Fixed
T_{BOC4} (mismatch)	$NF_bo_mismatch$	Random

For T_{BOC4} , UE shall randomly select a timer value at each execution of the timer. A uniform random draw shall be made to select an integer number of frames within the range [0, $NF_bo_mismatch$]. For T_{BOC1} , UE would randomly select a timer value at each execution of the timer. A uniform random draw shall be made to select an integer number of frames within the range [0, $NF_bo_all_busy$].

NOTE: Backoff parameter range and units are specified in [7], RRC Protocol Specification.

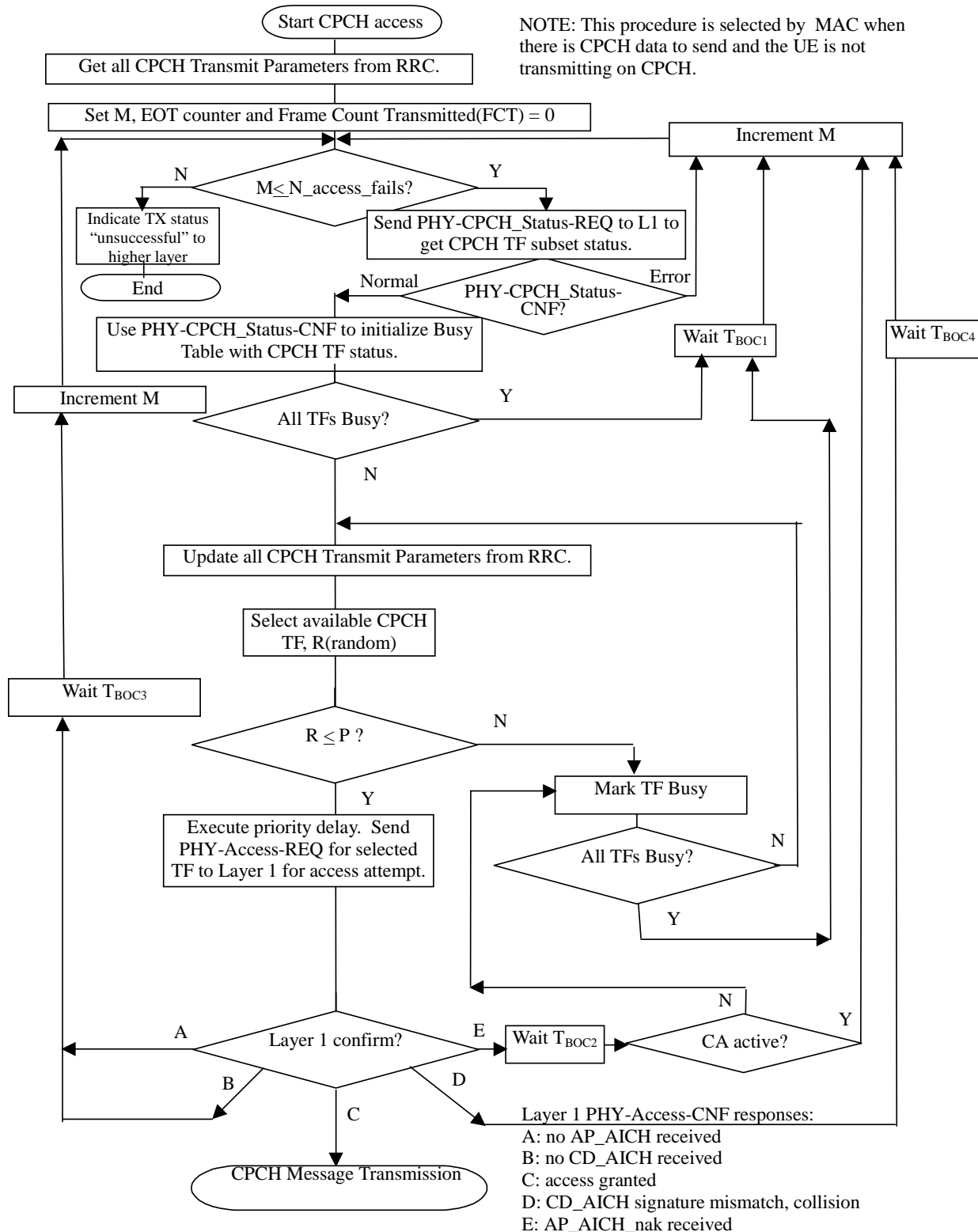

Figure 11.3.1: CPCH transmission control procedure for access (informative)

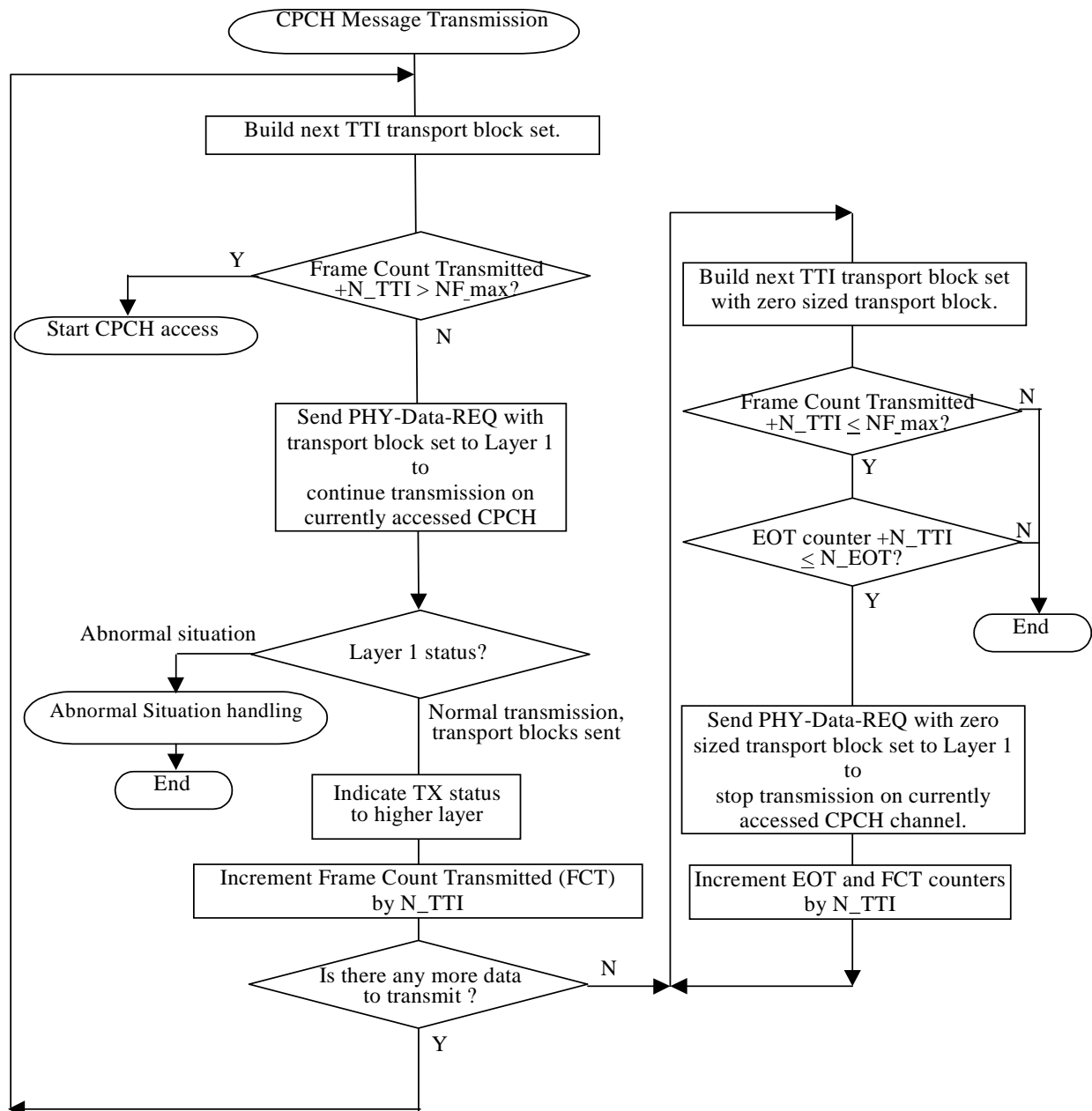

Figure 11.3.2: CPCH transmission control procedure for CPCH Message Transmission (informative)

11.4 Transport format combination selection in UE

RRC can control the scheduling of uplink data by giving each logical channel a priority between 1 and 8, where 1 is the highest priority and 8 the lowest. TFC selection in the UE shall be done in accordance with the priorities indicated by RRC. Logical channels have absolute priority, i.e. the UE shall maximise the transmission of higher priority data.

If the uplink TFCS or TFC Subset configured by UTRAN follows the guidelines described in [7] the UE shall perform the TFC selection according to the rules specified below. If these guidelines are not followed then the UE behaviour is not specified.

A given TFC can be in any of the following states:

- Supported state;
- Excess-power state;
- Blocked state.

TDD mode UEs in CELL_FACH state using the USCH transport channel and UEs in CELL_DCH state shall continuously monitor the state of each TFC based on its required transmit power versus the maximum UE transmit power (see [7]). The state transition criteria and the associated requirements are described in [12, 14]. The UE shall consider that the Blocking criterion is never met for TFCs included in the minimum set of TFCs (see [7]).

The following diagram illustrates the state transitions for the state of a given TFC:

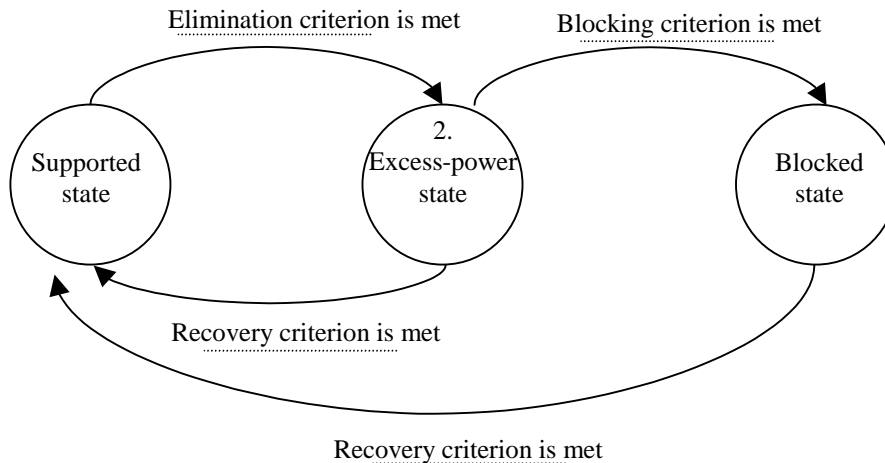

Figure 11.4.1: State transitions for the state of a given TFC

FDD Mode UEs in CELL_FACH state may estimate the channel path loss and set to excess power state all the TFCs requiring more power than the Maximum UE transmitter power (see [7]). All other TFCs shall be set to Supported state.

Every time the set of supported TFCs changes, the available bitrate shall be indicated to upper layers for each logical channel in order to facilitate the adaptation of codec data rates when codecs supporting variable-rate operation are used. The details of the computation of the available bitrate and the interaction with the application layer are not further specified.

Before selecting a TFC, i.e. at every boundary of the shortest TTI, or prior to each transmission on PRACH the set of valid TFCs shall be established. All TFCs in the set of valid TFCs shall:

1. belong to the TFCS.
 - 1a. not be restricted by higher layer signalling (e.g. TFC Control, see [7]).
2. not be in the Blocked state.
3. be compatible with the RLC configuration.
4. not require RLC to produce padding PDUs (see [6] for definition).
5. not carry more bits than can be transmitted in a TTI (e.g. when compressed mode by higher layer scheduling is used and the presence of compressed frames reduces the number of bits that can be transmitted in a TTI using the Minimum SF configured).

The UE may remove from the set of valid TFCs, TFCs in Excess-power state in order to maintain the quality of service for sensitive applications (e.g. speech). However, this shall not apply to TFCs included in the minimum set of TFCs (see [7]). Additionally, if compressed frames are present within the longest configured TTI to which the next transmission belongs, the UE may remove TFCs from the set of valid TFCs in order to account for the higher power requirements.

The chosen TFC shall be selected from within the set of valid TFCs and shall satisfy the following criteria in the order in which they are listed below:

1. No other TFC shall allow the transmission of more highest priority data than the chosen TFC.

2. No other TFC shall allow the transmission of more data from the next lower priority logical channels. Apply this criterion recursively for the remaining priority levels.
3. No other TFC shall have a lower bit rate than the chosen TFC.

In FDD mode the above rules for TFC selection in the UE shall apply to DCH, and the same rules shall apply for TF selection on RACH and CPCH.

In 3.84 Mcps TDD mode the above rules for TFC selection in the UE shall apply to DCH and USCH.

11.5 Ciphering

The ciphering function is performed in MAC (i.e. only in MAC-d) if a radio bearer is using the transparent RLC mode. The part of the MAC PDU that is ciphered is the MAC SDU and this is shown in Figure 11.5.1 below.

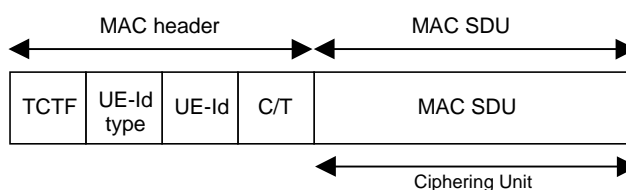

Figure 11.5.1: Ciphered part unit for a MAC PDU

In case a TTI contains multiple MAC PDUs for a given Transparent mode RB, the ciphering unit for this RB is the bitstring concatenation of all the MAC SDUs, resulting in the PLAINTEXT BLOCK, as defined in [15]. In case there is only one MAC PDU for a given Transparent mode RB, the ciphering unit is the MAC SDU, resulting in the PLAINTEXT BLOCK. The concatenation order is the same as the order of transmission of the Transport Blocks between MAC and Physical layer.

The KEYSTREAM BLOCK as defined in [10] is applied to the PLAINTEXT BLOCK, and the end result, CIPHERTEXT BLOCK, becomes the ciphered part for the MAC PDU, in case there is only one MAC PDU per RB. In case there is more than one MAC PDU per RB, the CIPHERTEXT BLOCK is split into the corresponding ciphered parts for each MAC PDU. The split order is the same as the order of transmission of the Transport Blocks between MAC and Physical layer.

The ciphering algorithm and key to be used are configured by upper layers [7] and the ciphering method shall be applied as specified in [10].

The parameters that are required by MAC for ciphering are defined in [10] and are input to the ciphering algorithm. The parameters required by MAC which are provided by upper layers [7] are listed below:

- MAC-d HFN (Hyper frame number for radio bearers that are mapped onto transparent mode RLC)
- BEARER defined as the radio bearer identifier in [10]. It will use the value RB identity -1 as in [7])
- CK (Ciphering Key)

If the TTI consists of more than one 10 ms radio frame, the CFN of the first radio frame in the TTI shall be used as input to the ciphering algorithm for all the data in the TTI.

11.6 Control of HS-DSCH transmission and reception

11.6.1 Network operation

The following are the functions of the various functional entities at the network in support of the HARQ protocol used on HS-DSCH.

11.6.1.1 Scheduler

The scheduler performs the following functions:

- Schedules all UEs within a cell;
- Services priority queues:
 - The scheduler schedules MAC-hs SDUs based on information from upper layers. One UE may be associated with one or more MAC-d flows. Each MAC-d flow contains HS-DSCH MAC-d PDUs for one or more priority queues.
- Determines the HARQ Entity and the queue to be serviced;
- Sets the TSN for new data blocks being transferred from the selected queue;
 - set the TSN to value 0 for the first MAC-hs PDU transmitted for each Queue ID within an HS-DSCH;
 - increment the TSN with one for each transmitted MAC-hs PDU on each Queue ID within an HS-DSCH.

NOTE: The scheduler may re-use TSNs by toggling the NDI bit in order to resume pre-empted transmissions or to force the UE to flush the soft buffer. In this case the content of the payload may be changed but care should be taken to preserve the higher layer data order.

- Indicates the Queue ID and TSN to the HARQ entity for each MAC-hs PDU to be transmitted;
- Schedules new transmissions and retransmissions:
 - Based on the status reports from HARQ Processes the scheduler determines if either a new transmission or a retransmission should be made. A new transmission can however be initiated on a HARQ process at any time. Based on a delay attribute provided by upper layers, the scheduler may decide to discard any 'out-of-date' MAC-hs SDU.
- Determines the redundancy version:
 - The scheduler determines a suitable redundancy version for each transmitted and retransmitted MAC-hs PDU and indicates the redundancy version to lower layer.
- Determines the TDD HCSN;
 - Increment UE specific HCSN for each HS-SCCH transmission.

11.6.1.2 HARQ entity

- There is one HARQ entity per UE in UTRAN.
- The HARQ entity sets the Queue ID in transmitted MAC-hs PDUs to the value indicated by the UTRAN scheduler.
- The HARQ entity sets the transmission sequence number (TSN) in transmitted MAC-hs PDUs to the value indicated by the UTRAN scheduler.
- The HARQ entity sets the HARQ process identifier in transmitted MAC-hs PDUs. UTRAN should:
 - determine a suitable HARQ process to service the MAC-hs PDU and set the HARQ process identifier accordingly.

11.6.1.3 HARQ process

- The HARQ process sets the New data indicator in transmitted MAC-hs PDUs. UTRAN should:
 - set the New Data Indicator to the value "0" for the first MAC-hs PDU transmitted by a HARQ process;

- not increment the New Data Indicator for retransmissions of a MAC-hs PDU;
- increment the New Data Indicator with one for each transmitted MAC-hs PDU containing new data.
- The HARQ process processes received status messages. UTRAN should:
 - deliver received status messages to the scheduler.

11.6.2 UE operation

The UE operation in support of the HARQ protocol used on HS-DSCH is split among the following four functional units with their associated functions.

11.6.2.1 HARQ Entity

- There is one HARQ entity at the UE which processes the HARQ process identifiers in received MAC-hs PDUs on HS-DSCH.
- Each received MAC-hs PDU shall be allocated to the HARQ process indicated by the HARQ process identifier of the MAC-hs PDU.

11.6.2.2 HARQ process

A number of parallel HARQ processes are used in the UE to support the HARQ protocol. The number of HARQ processes is configured by upper layers.

The HARQ process processes the New Data Indicator indicated by lower layers for each received MAC-hs PDU.

The UE shall:

- if the New Data Indicator has been incremented compared to the value in the previous received transmission in this HARQ process or this is the first received transmission in the HARQ process:
 - replace the data currently in the soft buffer for this HARQ process with the received data.
 - if the Transport Block Size index value is equal to 111111 (FDD only):
 - generate a positive acknowledgement (ACK) of the data in this HARQ process;
 - discard the received data;
 - assume that the data has been successfully decoded.
- if the New Data Indicator is identical to the value used in the previous received transmission in the HARQ process:
 - if the Transport Block Size index value is equal to 111111 (FDD only):
 - assume that the transport block size is identical to the last valid transport block size signalled for this HARQ process.
 - if the data has not yet been successfully decoded:
 - combine the received data with the data currently in the soft buffer for this HARQ process.
- if the data in the soft buffer has been successfully decoded and no error was detected:
 - deliver the decoded MAC-hs PDU to the reordering entity;
 - generate a positive acknowledgement (ACK) of the data in this HARQ process.
- else:
 - generate a negative acknowledgement (NAK) of the data in this HARQ process;

- schedule the generated positive or negative acknowledgement for transmission and the time of transmission relative to the reception of data in a HARQ process is configured by upper layer.

The HARQ process processes the Queue ID in the received MAC-hs PDUs. The UE shall:

- arrange the received MAC-hs PDUs in queues based on the Queue ID.

11.6.2.3 Reordering entity

11.6.2.3.1 Definitions

In the functions described in this section the following definitions apply:

Parameters

- Transmitter window size (TRANSMIT_WINDOW_SIZE)
TRANSMIT_WINDOW_SIZE is the size of the transmitter window according to the definition below. This is a parameter in the Node B and the value of the parameter is configured by higher layers.
- Receiver window size (RECEIVE_WINDOW_SIZE)
RECEIVE_WINDOW_SIZE is the size of the receiver window according to the definition below. This is a parameter in the UE and the value of the parameter is configured by higher layers.

State variables

- next_expected_TSN:
The next_expected_TSN is the Transmission sequence number (TSN) following the TSN of the last in-sequence MAC-hs PDU received. It shall be updated upon the receipt of the MAC-hs PDU with TSN equal to next_expected_TSN. The initial value of next_expected_TSN = 0.
- RcvWindow_UpperEdge:
The RcvWindow_UpperEdge represents the TSN, which is at the upper edge of the receiver window. After the first MAC-hs PDU has been received successfully, it also corresponds to the MAC-hs PDU with the highest TSN of all received MAC-hs PDUs. The initial RcvWindow_UpperEdge equals 63. RcvWindow_UpperEdge is updated based on the reception of new payloads according to the procedure given below.
- T1_TSN:
The TSN of the latest MAC-hs PDU that cannot be delivered to the disassembly entity, when the timer T1 is started.

Timers

- Re-ordering release timer (T1):
The Re-ordering release timer T1 controls the stall avoidance in the UE reordering buffer as described below. The value of T1 is configured by upper layers.

Other definitions

- Receiver window:
The receiver window defines TSNs of those MAC-hs PDUs that can be received in the receiver without causing an advancement of the receiver window according to the procedure below. The size of the receiver window equals RECEIVE_WINDOW_SIZE and spans TSNs going from RcvWindow_UpperEdge – RECEIVE_WINDOW_SIZE + 1 to RcvWindow_UpperEdge included.

11.6.2.3.2 Reordering functionality

If no timer T1 is active:

- the timer T1 shall be started when a MAC-hs PDU with TSN > next_expected_TSN is correctly received.

- T1_TSN shall be set to the TSN of this MAC-hs PDU.

If a timer T1 is already active:

- no additional timer shall be started, i.e. only one timer T1 may be active at a given time.

The timer T1 shall be stopped if:

- the MAC-hs PDU with TSN = T1_TSN can be delivered to the disassembly entity before the timer expires.

When the timer T1 expires and $T1_TSN > next_expected_TSN$:

- all correctly received MAC-hs PDUs with TSN $> next_expected_TSN$ up to and including T1_TSN-1 shall be delivered to the disassembly entity;
- all correctly received MAC-hs PDUs up to the next not received MAC-hs PDU shall be delivered to the disassembly entity.
- next_expected_TSN shall be set to the TSN of the next not received MAC-hs PDU.

When the timer T1 is stopped or expires, and there still exist some received MAC-hs PDUs that can not be delivered to higher layer:

- timer T1 is started
- set T1_TSN to the highest TSN among those of the MAC-hs PDUs that can not be delivered.

Transmitter operation:

After the transmitter has transmitted a MAC-hs PDU with TSN=SN, any MAC-hs PDU with TSN $\leq SN - TRANSMIT_WINDOW_SIZE$ should not be retransmitted to avoid sequence number ambiguity in the receiver.

Receiver operation:

When a MAC-hs PDU with TSN = SN is received:

- If SN is within the receiver window:
 - if $SN < next_expected_TSN$, or this MAC-hs PDU has previously been received:
 - the MAC-hs PDU shall be discarded.
 - else:
 - the MAC-hs PDU is placed in the reordering buffer at the place indicated by the TSN.
- If SN is outside the receiver window:
 - the received MAC-hs PDU shall be placed above the highest received TSN in the reordering buffer, at the position indicated by SN;
 - RcvWindow_UpperEdge shall be set to SN thus advancing the receiver window;
 - any MAC-hs PDUs with TSN $\leq RcvWindow_UpperEdge - RECEIVE_WINDOW_SIZE$, i.e. outside the receiver window after its position is updated, shall be removed from the reordering buffer and be delivered to the disassembly entity;
 - next_expected_TSN shall be set to $RcvWindow_UpperEdge - RECEIVE_WINDOW_SIZE + 1$;
 - All received MAC-hs PDUs with consecutive TSNs from next_expected_TSN (included) up to the first not received MAC-hs PDU are delivered to the disassembly entity.
 - next_expected_TSN shall be advanced to the TSN of this first not received MAC-hs PDU.

In case a UE has insufficient memory to process a received MAC-hs PDU, it shall perform the following set of operations:

- select TSN_flush such that: $\text{next_expected_TSN} < \text{TSN_flush} \leq \text{RcvWindow_UpperEdge} + 1$;
- deliver all correctly received MAC-hs PDUs with $\text{TSN} < \text{next_expected_TSN}$ to the disassembly entity;
- set next_expected_TSN to TSN_flush.

11.6.2.4 Disassembly entity

For each MAC-hs PDU that is delivered to the disassembly entity, the UE shall:

- remove any padding bits if present;
- remove the MAC-hs header;
- deliver the MAC-d PDUs in the MAC-hs PDU to MAC-d.

11.6.2.5 MAC-hs Reset

If a reset of the MAC-hs entity is requested by upper layers, the UE shall:

- flush soft buffer for all configured HARQ processes;
- stop all active re-ordering release timer (T1) and set all timer T1 to their initial value;
- start TSN with value 0 for the next transmission on every configured HARQ process;
- initialise the variables RcvWindow_UpperEdge and next_expected_TSN to their initial values;
- disassemble all MAC-hs PDUs in the re-ordering buffer and deliver all MAC-d PDUs to the MAC-d entity;
- flush the re-ordering buffer.

and then:

- indicate to all AM RLC entities mapped on HS-DSCH to generate a status report.

11.6.2.6 Reconfiguration of MAC-hs parameters

The parameters for a MAC-hs entity may be reconfigured (modified) by upper layers.

When a parameter is reconfigured by the upper layer, the UE shall:

- start using the reconfigured value of the parameter.

If the parameter RECEIVE_WINDOW_SIZE is reconfigured, the UE shall:

- set RECEIVE_WINDOW_SIZE to the new value;
- remove any MAC-hs PDUs with $\text{TSN} \leq \text{RcvWindow_UpperEdge} - \text{RECEIVE_WINDOW_SIZE}$ (i.e. outside the receiver window after its size is updated) from the reordering buffer and deliver these MAC-hs PDUs to the disassembly entity;
- if $\text{next_expected_TSN} \leq \text{RcvWindow_UpperEdge} - \text{RECEIVE_WINDOW_SIZE}$:
 - set next_expected_TSN to $\text{RcvWindow_UpperEdge} - \text{RECEIVE_WINDOW_SIZE} + 1$;
 - deliver all received MAC-hs PDUs with consecutive TSNs from next_expected_TSN (included) up to the first not received MAC-hs PDU to the disassembly entity;
 - advance next_expected_TSN to the TSN of this first not received MAC-hs PDU.

11.7 HS-DSCH Provided Bit Rate measurement

The HS-DSCH Provided Bit Rate measurements is defined as follows:

- for each priority class the MAC-hs entity measures the total number of MAC-d PDU bits whose transmission over the radio interface has been considered successful by MAC-hs in Node-B during the last measurement period, divided by the duration of the measurement period;
- the values reported by MAC-hs shall be raw samples;
- the measurement period shall be [100 ms].

Annex A (informative): Change history

Change history								
Date	TSG #	TSG Doc.	CR	Rev	Subject/Comment	Old	New	
06/1999	RP-04	RP-99312	-		Approved at TSG-RAN #4 and placed under Change Control	-	3.0.0	
10/1999	RP-05	RP-99463	001	1	Modified MAC handling of PCH and FACH	3.0.0	3.1.0	
	RP-05	RP-99463	002		Modifications of MAC primitives	3.0.0	3.1.0	
	RP-05	RP-99463	003	2	RACH/FACH MAC header – Channel type identification	3.0.0	3.1.0	
	RP-05	RP-99463	004		Support for USCH/DSCH signalling in TDD	3.0.0	3.1.0	
	RP-05	RP-99463	006		Clarification on RACH partitioning and prioritization via access service class (ASC) and relation to back-off algorithm	3.0.0	3.1.0	
	RP-05	RP-99463	010	1	Modifications on UE-Id formats	3.0.0	3.1.0	
	RP-05	RP-99463	011		CPCH primitives	3.0.0	3.1.0	
	RP-05	RP-99463	012		Timing advance for TDD	3.0.0	3.1.0	
	RP-05	RP-99463	013	1	Traffic volume measurement report procedure	3.0.0	3.1.0	
	RP-05	RP-99463	014		Mapping of BCCH logical channel onto FACH transport channel	3.0.0	3.1.0	
	RP-05	RP-99463	015	1	MAC PDU formats for DCCH/DTCH on DSCH and for PCCH	3.0.0	3.1.0	
	RP-05	RP-99463	016	1	Informative parts that shall not specify or constrain implementations	3.0.0	3.1.0	
	RP-05	RP-99463	017	1	Modification of RACH transmission control procedure	3.0.0	3.1.0	
	RP-05	RP-99463	018		Removal of MAC function for system information and paging scheduling	3.0.0	3.1.0	
	RP-05	RP-99463	019	1	RACH transmission control procedure on MAC for TDD mod	3.0.0	3.1.0	
	RP-05	RP-99463	021	1	Removal of Annex A and B of TS 25.321	3.0.0	3.1.0	
	12/1999	RP-06	RP-99638	022	3	Modified MAC header field sizes	3.1.0	3.2.0
		RP-06	RP-99638	023		MAC: Multiple shared channels (DSCH/USCH)	3.1.0	3.2.0
RP-06		RP-99638	024		Parameters for Status Primitive	3.1.0	3.2.0	
RP-06		RP-99638	025	1	Support of shared channel operation in TDD	3.1.0	3.2.0	
RP-06		RP-99638	028		Modification of Cell Broadcast Service (CBS)	3.1.0	3.2.0	
RP-06		RP-99637	030	1	Editorial changes	3.1.0	3.2.0	
RP-06		RP-99638	031	1	Simultaneous mapping of logical channels on	3.1.0	3.2.0	
03/2000	RP-07	RP-000039	032		Bit Aligned TDD MAC Headers	3.2.0	3.3.0	
	RP-07	RP-000039	035	2	CPCH including Channel Assignment	3.2.0	3.3.0	
	RP-07	RP-000039	036		UE-ID type indication	3.2.0	3.3.0	
	RP-07	RP-000039	037	1	RACH transmission control procedure	3.2.0	3.3.0	
	RP-07	RP-000039	039		CPCH start of message indication	3.2.0	3.3.0	
	RP-07	RP-000039	040		Removal of SCH and SCCH	3.2.0	3.3.0	
	RP-07	RP-000039	041	1	Clarification of bit order	3.2.0	3.3.0	
06/2000	RP-08	RP-000219	042		CPCH correction	3.3.0	3.4.0	
	RP-08	RP-000219	043	1	End of CPCH transmission	3.3.0	3.4.0	
	RP-08	RP-000219	044	2	Clarification of prioritisation of logical channels in UE	3.3.0	3.4.0	
	RP-08	RP-000219	045	1	CPCH MAC procedures	3.3.0	3.4.0	
	RP-08	RP-000219	046		Traffic Volume Measurement for dynamic radio bearer control	3.3.0	3.4.0	
09/2000	RP-09	RP-000357	047		Movement of primitives text to the correct section	3.4.0	3.5.0	
	RP-09	RP-000357	048		Corrections to RACH procedure	3.4.0	3.5.0	
	RP-09	RP-000357	049		Clarification on the parameters of the MAC-RLC primitives	3.4.0	3.5.0	
	RP-09	RP-000357	051	1	Editorial Cleanup	3.4.0	3.5.0	
12/2000	RP-10	RP-000567	053	2	Corrections to logical channel priorities in MAC Protocol	3.5.0	3.6.0	
	RP-10	RP-000567	055	1	Removal of FAUSCH	3.5.0	3.6.0	
	RP-10	RP-000567	056	2	General MAC clarification	3.5.0	3.6.0	
	RP-10	RP-000567	057	1	Error Handling in MAC	3.5.0	3.6.0	
	RP-10	RP-000567	058	1	Error handling for MAC RACH and CPCH transmission control procedure	3.5.0	3.6.0	
	RP-10	RP-000567	059		Inclusion of stage 3 for ciphering	3.5.0	3.6.0	
03/2001	RP-11	RP-010025	061		Removal of FAUSCH	3.6.0	3.7.0	
	RP-11	RP-010025	066	3	TFC selection algorithm correction	3.6.0	3.7.0	
	RP-11	RP-010025	067	3	Miscellaneous corrections	3.6.0	3.7.0	
	RP-11	RP-010025	068	2	Clarification on Traffic Volume Measurement Procedure	3.6.0	3.7.0	
	RP-11	RP-010025	070	1	Clarification on parameters of the primitives	3.6.0	3.7.0	
	RP-11	RP-010037	064		1.28Mcps TDD	3.7.0	4.0.0	
06/2001	RP-12	RP-010308	074		RLC Tr Discard	4.0.0	4.1.0	
	RP-12	RP-010308	076		Clarification on compressed mode	4.0.0	4.1.0	
	RP-12	RP-010308	078		Correction of relation between MAC functions and transport channels	4.0.0	4.1.0	
	RP-12	RP-010308	080		Rate adaptation	4.0.0	4.1.0	
	RP-12	RP-010308	082		Cleanup of MAC services and functions	4.0.0	4.1.0	
	RP-12	RP-010322	083		Correction to control of RACH Transmissions for 1.28Mcps TDD	4.0.0	4.1.0	

Change history							
Date	TSG #	TSG Doc.	CR	Rev	Subject/Comment	Old	New
09/2001	RP-13	RP-010541	085		Setting of UE Id in MAC	4.1.0	4.2.0
	RP-13	RP-010541	087		MAC ASC selection operation when access class is used to determine ASC	4.1.0	4.2.0
	RP-13	RP-010541	089		Addition of neighbour cell BCH to MAC-b model for the UE	4.1.0	4.2.0
	RP-13	RP-010541	093	1	Clarification on TFC selection	4.1.0	4.2.0
12/2001	RP-14	RP-010760	091	1	Cautionary Note for Interfrequency Measurements in Cell-FACH	4.2.0	4.3.0
	RP-14	RP-010760	095		Correction on Control of RACH Transmissions	4.2.0	4.3.0
	RP-14	RP-010760	097		Correction on Traffic Volume Control	4.2.0	4.3.0
	RP-14	RP-010760	099		General correction on Access Service Class selection	4.2.0	4.3.0
	RP-14	RP-010760	101		TFC selection in compressed mode	4.2.0	4.3.0
03/2002	RP-15	RP-020067	103		Clarification on ciphering	4.3.0	4.4.0
	RP-15	RP-020067	106		TDD MAC Layer Subchannel Assignment	4.3.0	4.4.0
	RP-15	RP-020067	110		Missing DTCH channel type in UE-ID Type Indicator	4.3.0	4.4.0
	RP-15	RP-020067	112		Correction on UE Id for DSCH	4.3.0	4.4.0
	RP-15	RP-020067	114		UE undefined behaviour when padding is required	4.3.0	4.4.0
	RP-15	RP-020094	104	2	Introduction of HSDPA	4.4.0	5.0.0
06/2002	RP-16	RP-020326	117		Update References to include 25.123 (TDD)	5.0.0	5.1.0
	RP-16	RP-020326	120		TFCS selection guideline correction	5.0.0	5.1.0
	RP-16	RP-020341	121		HSDPA related MAC corrections	5.0.0	5.1.0
	RP-16	RP-020341	122		Description for MAC-hs reset	5.0.0	5.1.0
09/2002	RP-17	RP-020538	130		MAC TVM Corrections	5.1.0	5.2.0
	RP-17	RP-020538	133		MAC header for DTCH and DCCH	5.1.0	5.2.0
	RP-17	RP-020556	123		Optional use of a maximum transmission delay for MAC-hs SDUs	5.1.0	5.2.0
	RP-17	RP-020556	124		MAC-hs: Scheduler and HARQ entity functions for TSN	5.1.0	5.2.0
	RP-17	RP-020556	125		Correction on C/T field definition for HS-DSCH	5.1.0	5.2.0
	RP-17	RP-020556	126		Corrections to re-ordering protocol description	5.1.0	5.2.0
	RP-17	RP-020556	127		Limiting of number of PDUs per TTI	5.1.0	5.2.0
	RP-17	RP-020556	134		Signaling of Transport Block Sizes for HS-DSCH	5.1.0	5.2.0
	RP-17	RP-020556	135		Transport block size signalling 3.84 Mcps TDD	5.1.0	5.2.0
	RP-17	RP-020556	136		Static HSDPA Transport Block Sizes for 1.28 Mcps TDD	5.1.0	5.2.0
12/2002	RP-18	RP-020718	142	1	TFC selection for RACH transmissions	5.2.0	5.3.0
	RP-18	RP-020718	145		RB id in ciphering	5.2.0	5.3.0
	RP-18	RP-020718	148		Correction to TFC selection for TDD	5.2.0	5.3.0
	RP-18	RP-020718	151		Unblockable TFCs in excess power state	5.2.0	5.3.0
	RP-18	RP-020735	137		Generation of RLC Status Reports to coordinate with MAC-hs reset	5.2.0	5.3.0
	RP-18	RP-020735	138		Re-ordering Mechanism	5.2.0	5.3.0
	RP-18	RP-020735	139		Transport Block Size Signalling for 1.28Mcps TDD	5.2.0	5.3.0
	RP-18	RP-020735	153		Limitation on number of PDUs per single TTI for 1.28 Mcps TDD	5.2.0	5.3.0
	RP-18	RP-020735	154		The Number of mac-d pdu's in a single mac-hs PDU for TDD	5.2.0	5.3.0
	RP-18	RP-020851	155		HSDPA Retransmission block Size	5.2.0	5.3.0
	RP-18	RP-020874	158		Ciphering of multiple PDUs per TTI	5.2.0	5.3.0
	RP-19	RP-030100	166		Setting of ciphering activation time for TM bearers	5.3.0	5.4.0
	RP-19	RP-030100	169	1	TFC Control Implementation	5.3.0	5.4.0
	RP-19	RP-030115	159		TDD HCSN determination in MAC-hs	5.3.0	5.4.0
	RP-19	RP-030115	160		Correction to the use of Transport Block Size index equal to 111111 for TDD	5.3.0	5.4.0
	RP-19	RP-030115	163		Editorial changes to MAC-hs	5.3.0	5.4.0
	RP-19	RP-030115	170		Re-ordering entity corrections	5.3.0	5.4.0
06/2003	RP-20	RP-030302	171		Text clean up of the description of the reordering entity	5.4.0	5.5.0
	RP-20	RP-030302	172		MAC header for DTCH and DCCH mapped to HS-DSCH	5.4.0	5.5.0
09/2003	RP-21	RP-030501	178		TFCS selection guidelines for TFC Subset	5.5.0	5.6.0
	RP-21	RP-030536	174	2	MAC-hs Re-ordering Protocol Correction & MAC-hs window re-ordering	5.5.0	5.6.0
	RP-21	RP-030494	175		Addition of HS-DSCH Provided Bit Rate measurement	5.5.0	5.6.0

History

Document history		
V5.0.0	March 2002	Publication
V5.1.0	June 2002	Publication
V5.2.0	September 2002	Publication
V5.3.0	December 2002	Publication
V5.4.0	March 2003	Publication
V5.5.0	June 2003	Publication
V5.6.0	September 2003	Publication