

ETSI TS 125 321 V7.16.0 (2010-04)

Technical Specification

Universal Mobile Telecommunications System (UMTS); Medium Access Control (MAC) protocol specification (3GPP TS 25.321 version 7.16.0 Release 7)



Reference

RTS/TSGR-0225321v7g0

Keywords

UMTS

ETSI

650 Route des Lucioles
F-06921 Sophia Antipolis Cedex - FRANCE

Tel.: +33 4 92 94 42 00 Fax: +33 4 93 65 47 16

Siret N° 348 623 562 00017 - NAF 742 C
Association à but non lucratif enregistrée à la
Sous-Préfecture de Grasse (06) N° 7803/88

Important notice

Individual copies of the present document can be downloaded from:

<http://www.etsi.org>

The present document may be made available in more than one electronic version or in print. In any case of existing or perceived difference in contents between such versions, the reference version is the Portable Document Format (PDF). In case of dispute, the reference shall be the printing on ETSI printers of the PDF version kept on a specific network drive within ETSI Secretariat.

Users of the present document should be aware that the document may be subject to revision or change of status. Information on the current status of this and other ETSI documents is available at

<http://portal.etsi.org/tb/status/status.asp>

If you find errors in the present document, please send your comment to one of the following services:

http://portal.etsi.org/chaicor/ETSI_support.asp

Copyright Notification

No part may be reproduced except as authorized by written permission.
The copyright and the foregoing restriction extend to reproduction in all media.

© European Telecommunications Standards Institute 2010.
All rights reserved.

DECT™, **PLUGTESTS™**, **UMTS™**, **TIPHON™**, the TIPHON logo and the ETSI logo are Trade Marks of ETSI registered for the benefit of its Members.

3GPP™ is a Trade Mark of ETSI registered for the benefit of its Members and of the 3GPP Organizational Partners.

LTE™ is a Trade Mark of ETSI currently being registered

for the benefit of its Members and of the 3GPP Organizational Partners.

GSM® and the GSM logo are Trade Marks registered and owned by the GSM Association.

Intellectual Property Rights

IPRs essential or potentially essential to the present document may have been declared to ETSI. The information pertaining to these essential IPRs, if any, is publicly available for **ETSI members and non-members**, and can be found in ETSI SR 000 314: *"Intellectual Property Rights (IPRs); Essential, or potentially Essential, IPRs notified to ETSI in respect of ETSI standards"*, which is available from the ETSI Secretariat. Latest updates are available on the ETSI Web server (<http://webapp.etsi.org/IPR/home.asp>).

Pursuant to the ETSI IPR Policy, no investigation, including IPR searches, has been carried out by ETSI. No guarantee can be given as to the existence of other IPRs not referenced in ETSI SR 000 314 (or the updates on the ETSI Web server) which are, or may be, or may become, essential to the present document.

Foreword

This Technical Specification (TS) has been produced by ETSI 3rd Generation Partnership Project (3GPP).

The present document may refer to technical specifications or reports using their 3GPP identities, UMTS identities or GSM identities. These should be interpreted as being references to the corresponding ETSI deliverables.

The cross reference between GSM, UMTS, 3GPP and ETSI identities can be found under <http://webapp.etsi.org/key/queryform.asp>.

Contents

Intellectual Property Rights	2
Foreword.....	2
Foreword.....	7
1 Scope	8
2 References	8
3 Definitions and abbreviations.....	9
3.1 Definitions	9
3.1.1 HS-DSCH Specific Definitions	9
3.1.2 E-DCH Specific Definitions	9
3.1.2.1 General	9
3.1.2.2 FDD.....	10
3.1.3 DTX-DRX and HS-SCCH less Specific definitions (FDD only)	11
3.2 Abbreviations	11
4 General	12
4.1 Objective	12
4.2 MAC architecture	12
4.2.1 MAC Entities	12
4.2.2 MAC-b.....	13
4.2.3 Traffic Related Architecture - UE Side.....	14
4.2.3.1 MAC-c/sh/m entity – UE Side	15
4.2.3.2 MAC-d entity – UE Side	17
4.2.3.3 MAC-hs entity – UE Side	18
4.2.3.4 MAC-e/es entity – UE Side.....	20
4.2.3.5 MAC-ehs entity – UE Side	21
4.2.4 Traffic Related Architecture - UTRAN Side	24
4.2.4.1 MAC-c/sh/m entity – UTRAN Side.....	24
4.2.4.2 MAC-d entity – UTRAN Side	26
4.2.4.3 MAC-hs entity – UTRAN Side.....	27
4.2.4.4 MAC-es entity – UTRAN Side	29
4.2.4.5 MAC-e entity – UTRAN Side.....	31
4.2.4.6 MAC-ehs entity UTRAN Side	32
4.3 Channel structure.....	35
4.3.1 Transport channels	35
4.3.2 Logical Channels	35
4.3.2.1 Logical channel structure	35
4.3.2.2 Control Channels.....	36
4.3.2.3 Traffic Channels.....	36
5 Services provided to upper layers	36
5.1 Description of Services provided to upper layers.....	37
6 Functions	37
6.1 Description of the MAC functions	37
6.2 Relation between MAC Functions and Transport Channels	38
6.2.1 Relation between MAC Functions and Transport Channels in UTRAN	38
6.2.2 Relation of MAC Functions and Transport Channels in UE	39
7 Services expected from physical layer	39
8 Elements for layer-to-layer communication.....	39
8.1 Primitives between layers 1 and 2	40
8.1.1 Primitives.....	40
8.1.2 Parameters.....	40
8.2 Primitives between MAC and RLC.....	40
8.2.1 Primitives.....	40

8.2.2	Parameters.....	41
8.3	Primitives between MAC and RRC	42
8.3.1	Primitives.....	42
8.3.2	Parameters.....	43
9	Elements for peer-to-peer communication	44
9.1	Protocol data units	44
9.1.1	General.....	44
9.1.2	MAC PDU (not HS-DSCH or E-DCH)	45
9.1.3	MAC-d PDU (HS-DSCH)	45
9.1.4	MAC PDU (HS-DSCH).....	45
9.1.5	MAC PDU (E-DCH)	46
9.2	Formats and parameters.....	48
9.2.1	MAC PDU: Parameters of the MAC PDU header (not HS-DSCH or E-DCH) and MAC-d PDU header (HS-DSCH and E-DCH)	48
9.2.1.1	MAC header for DTCH and DCCH (not mapped on HS-DSCH or E-DCH)	51
9.2.1.1a	MAC-d Header for DTCH and DCCH (mapped on HS-DSCH)	51
9.2.1.1b	MAC-d Header for DTCH and DCCH (mapped on E-DCH)	52
9.2.1.1c	MAC Headers for DTCH and DCCH (mapped on HS-DSCH, FDD only)	52
9.2.1.2	MAC header for BCCH	52
9.2.1.3	MAC header for PCCH	53
9.2.1.4	MAC header for CCCH	53
9.2.1.5	MAC Header for CTCH.....	53
9.2.1.6	MAC Header for SHCCH	53
9.2.2	MAC PDU: Parameters of the MAC header (HS-DSCH)	55
9.2.2.1	MAC header for DTCH and DCCH.....	56
9.2.3	Signalling of Transport Block size for HS-DSCH.....	57
9.2.3.1	Transport block size for FDD.....	57
9.2.3.2	Transport block size for 3.84 Mcps TDD.....	59
9.2.3.2a	Transport block size for 7.68 Mcps TDD.....	62
9.2.3.3	Transport block size for 1.28 Mcps TDD.....	65
9.2.4	MAC PDU: Parameters of the MAC header (E-DCH)	71
9.2.4.1	MAC-es header parameters	71
9.2.4.2	MAC-e header parameters	72
9.2.5	Signaling of control information for FDD E-DCH	72
9.2.5.1	HARQ information.....	72
9.2.5.2	DL Scheduling information.....	72
9.2.5.2.1	Relative Grants	72
9.2.5.2.2	Absolute Grant	75
9.2.5.3	UL Scheduling information.....	75
9.2.5.3.1	Happy Bit	75
9.2.5.3.2	Scheduling Information	75
9.2.5.4	Transport block size	77
9.2.6	Signaling of control information for TDD E-DCH.....	79
9.2.6.1	HARQ information.....	79
9.2.6.2	DL Scheduling information.....	79
9.2.6.2.1	Absolute Grant	79
9.2.6.3	UL Scheduling Information	80
9.2.6.4	Transport block size	81
9.2.6.4.1	3.84 Mcps TDD Transport Block Size	81
9.2.6.4.2	7.68 Mcps TDD Transport Block Size	82
9.2.6.4.3	1.28 Mcps TDD Transport Block Size	82
9.2.6.5	Timing Advance and Synchronisation (3.84/7.68 Mcps TDD only).....	83
9.2.6.5.1	Unsynchronised Handover	83
9.2.6.5.2	Synchronisation	83
9.2.6.5.3	Timing Advance Request	83
9.2.6.5.4	Timing Advance Response.....	83
10	Handling of unknown, unforeseen and erroneous protocol data	84
11	Specific functions	84
11.1	Traffic volume measurement for dynamic radio bearer control	84
11.2	Control of RACH transmissions.....	85

11.2.1	Access Service Class selection	85
11.2.2	Control of RACH transmissions for FDD mode.....	85
11.2.3	Control of RACH transmissions for TDD	88
11.2.3.1	Control of RACH transmissions for 3.84 Mcps TDD and 7.68 Mcps TDD	88
11.2.3.1.1	Control of E-RUCCH transmissions	89
11.2.3.1.1.1	Access Service Class selection	90
11.2.3.2	Control of RACH Transmissions for 1.28 Mcps TDD.....	90
11.2.3.2.1	Control of E-RUCCH transmissions	91
11.2.3.2.1.1	Access Service Class selection	92
11.2.3.2.1.2	Void	92
11.3	Void.....	92
11.4	Transport format combination selection in UE (non E-DCH).....	92
11.5	Ciphering.....	94
11.6	Control of HS-DSCH transmission and reception.....	94
11.6.1	Network operation	94
11.6.1.1	Scheduler.....	94
11.6.1.2	HARQ entity	95
11.6.1.3	HARQ process	95
11.6.2	UE operation.....	96
11.6.2.1	HARQ Entity.....	96
11.6.2.2	HARQ process	96
11.6.2.3	Reordering entity.....	97
11.6.2.3.1	Definitions	97
11.6.2.3.2	Reordering functionality.....	98
11.6.2.4	Disassembly entity	99
11.6.2.5	MAC-hs Reset.....	99
11.6.2.6	Reconfiguration of MAC-hs parameters	100
11.6.2.7	HARQ procedure for HS-SCCH less operation (FDD only)	100
11.6.3	Network operation	101
11.6.3.1	Scheduler.....	101
11.6.3.2	HARQ entity	102
11.6.3.3	HARQ process	103
11.6.4	UE operation.....	103
11.6.4.1	HARQ Entity.....	103
11.6.4.2	HARQ process	103
11.6.4.3	Disassembly entity	104
11.6.4.4	Reordering queue distribution entity.....	105
11.6.4.5	Reordering entity.....	105
11.6.4.5.1	Definitions	105
11.6.4.5.2	Reordering functionality.....	106
11.6.4.6	Reassembly unit	107
11.6.4.7	Demultiplexing entity.....	108
11.6.4.8	MAC-ehs Reset	108
11.6.4.9	Reconfiguration of MAC-ehs parameters	109
11.6.4.10	HARQ procedure for HS-SCCH less operation (FDD only)	110
11.7	HS-DSCH Provided Bit Rate measurement	111
11.8	Control of E-DCH transmission and reception (FDD).....	111
11.8.1	UE operation.....	111
11.8.1.1	HARQ Operation.....	111
11.8.1.1.1	HARQ entity.....	111
11.8.1.1.2	HARQ process.....	112
11.8.1.2	Multiplexing and TSN setting entity.....	112
11.8.1.2.1	TSN setting process operation	113
11.8.1.3	Serving Grant Update.....	113
11.8.1.3.1	Baseline Procedure	113
11.8.1.3.2	Handling at start of E-DCH transmission	115
11.8.1.3.3	Handling at serving cell change.....	115
11.8.1.3.4	Handling at TTI change.....	115
11.8.1.3.5	Higher Layer Signalling	116
11.8.1.3.6	Handling in UE DTX Cycle 2.	116
11.8.1.4	E-TFC Selection.....	116
11.8.1.5	Happy Bit Setting.....	119

11.8.1.6	Scheduling Information reporting	120
11.8.1.6.1	Report Triggering when SG = "Zero_Grant" or all processes are deactivated.....	120
11.8.1.6.2	Report Triggering when SG <> "Zero_Grant" and at least one process is activated.....	120
11.8.1.7	MAC-es/e Reset	121
11.8.1.8	Monitoring of Absolute and Relative Grant Channels	121
11.8.2	Node B operation.....	121
11.8.2.1	HARQ Operation	121
11.8.2.1.1	HARQ entity.....	121
11.8.2.1.2	HARQ process.....	122
11.8.2.2	De-multiplexing	122
11.8.2.3	Scheduler.....	122
11.8.2.4	E-DCH Provided Bit Rate measurement.....	122
11.8.3	RNC operation	122
11.8.3.1	Re-ordering entity	122
11.9	Control of E-DCH transmission and reception (TDD).....	123
11.9.1	UE operation.....	123
11.9.1.1	HARQ Operation	123
11.9.1.1.1	HARQ entity.....	124
11.9.1.1.2	HARQ process.....	124
11.9.1.2	Multiplexing and TSN setting entity.....	125
11.9.1.3	Receiving a Grant.....	125
11.9.1.4	E-TFC Selection.....	126
11.9.1.4a	Scheduling Information reporting (3.84/7.68 Mcps TDD only).....	127
11.9.1.5	Scheduling Information reporting (1.28 Mcps TDD only).....	128
11.9.1.6	MAC-es/e Reset (1.28 Mcps TDD only).....	129
11.9.2	Node B operation.....	129
11.9.2.1	HARQ Operation	129
11.9.2.1.1	HARQ entity.....	129
11.9.2.1.2	HARQ process.....	129
11.9.2.2	De-multiplexing	129
11.9.2.3	Scheduler.....	130
11.9.2.4	E-DCH Provided Bit Rate measurement.....	130
11.9.3	RNC operation	130
11.9.3.1	Re-ordering entity	130
Annex A (normative):	HS-DSCH Transport Block Size Table for FDD	131
Annex B (normative):	E-DCH Transport Block Size Tables for FDD.....	135
B.1	2ms TTI E-DCH Transport Block Size Table 0	135
B.2	2ms TTI E-DCH Transport Block Size Table 1	135
B.2a	2ms TTI E-DCH Transport Block Size Table 2	136
B.2b	2ms TTI E-DCH Transport Block Size Table 3	137
B.3	10ms TTI E-DCH Transport Block Size Table 0	138
B.4	10ms TTI E-DCH Transport Block Size Table 1	138
Annex BA (normative):	E-DCH Transport Block Size Tables for 3.84 Mcps TDD	140
BA.1	10ms TTI E-DCH Transport Block Size Table 0	140
Annex BB (normative):	E-DCH Transport Block Size Tables for 7.68 Mcps TDD	143
BB.1	10ms TTI E-DCH Transport Block Size Table 0	143
Annex BC (normative):	E-DCH Transport Block Size Tables for 1.28 Mcps TDD	146
BC.1	5ms TTI E-DCH Transport Block Size Table 0	146
Annex C (informative):	Pseudo-Code for E-TFC Selection (FDD).....	148
Annex CA (informative):	Pseudo-Code for E-TFC Selection (TDD).....	150
Annex D (informative):	Change history	152
History		157

Foreword

This Technical Specification (TS) has been produced by the 3rd Generation Partnership Project (3GPP).

The contents of the present document are subject to continuing work within the TSG and may change following formal TSG approval. Should the TSG modify the contents of the present document, it will be re-released by the TSG with an identifying change of release date and an increase in version number as follows:

Version x.y.z

where:

- x the first digit:
 - 1 presented to TSG for information;
 - 2 presented to TSG for approval;
 - 3 or greater indicates TSG approved document under change control.
- y the second digit is incremented for all changes of substance, i.e. technical enhancements, corrections, updates, etc.
- z the third digit is incremented when editorial only changes have been incorporated in the document.

1 Scope

The present document specifies the MAC protocol.

The specification describes:

- MAC architecture;
- MAC entities;
- channel structure;
- services provided to upper layers;
- MAC functions;
- services expected from the physical layer;
- elements for layer-to-layer communication including primitives between MAC and RLC;
- elements for peer-to-peer communication;
- protocol data units, formats and parameters;
- elementary procedures.

2 References

The following documents contain provisions which, through reference in this text, constitute provisions of the present document.

- References are either specific (identified by date of publication, edition number, version number, etc.) or non-specific.
- For a specific reference, subsequent revisions do not apply.
- For a non-specific reference, the latest version applies. In the case of a reference to a 3GPP document (including a GSM document), a non-specific reference implicitly refers to the latest version of that document *in the same Release as the present document*.

- [1] 3GPP TR 21.905: "Vocabulary for 3GPP Specifications".
- [2] 3GPP TS 25.301: "Radio Interface Protocol Architecture".
- [3] 3GPP TS 25.302: "Services provided by the Physical Layer".
- [4] 3GPP TS 25.303: "Interlayer Procedures in Connected Mode".
- [5] 3GPP TS 25.304: "UE Procedures in Idle Mode and Procedures for Cell Reselection in Connected Mode".
- [6] 3GPP TS 25.322: "RLC Protocol Specification".
- [7] 3GPP TS 25.331: "Radio Resource Control (RRC); protocol specification".
- [8] 3GPP TR 25.921: "Guidelines and Principles for Protocol Description and Error Handling".
- [9] 3GPP TR 25.990: "Vocabulary for the UTRAN".
- [10] 3GPP TS 33.102: "Security architecture".
- [11] 3GPP TS 25.425: "UTRAN Iur Interface User Plane Protocols for Common Transport Channel Data Streams".

- [12] 3GPP TS 25.133: "Requirements for support of radio resource management (FDD)".
- [13] 3GPP TS 25.214: "Physical layer procedures (FDD)".
- [14] 3GPP TS 25.123: "Requirements for support of radio resource management (TDD)".
- [15] 3GPP TS 33.105: "Cryptographic Algorithm Requirements".
- [16] 3GPP TS 25.212: "Multiplexing and Channel Coding (FDD)".
- [17] 3GPP TS 25.215: "Physical layer - Measurements (FDD)".
- [18] 3GPP TS 25.224: "Physical layer procedures (TDD)".
- [19] 3GPP TS 25.222: "Multiplexing and Channel Coding (TDD)".
- [20] 3GPP TS 25.225: "Physical layer – Measurements (TDD)".
- [21] 3GPP TS 25.221 "Physical Channels and Mapping of Transport Channels onto Physical Channels (TDD)"
- [22] 3GPP TS 25.213: "Spreading and modulation (FDD)".
- [23] 3GPP TS 25.306: "UE Radio Access Capabilities".

3 Definitions and abbreviations

3.1 Definitions

For the purposes of the present document, the terms and definitions given below and in [9] and [1] apply.

3.1.1 HS-DSCH Specific Definitions

3.1.2 E-DCH Specific Definitions

3.1.2.1 General

E-DCH: The Enhanced Dedicated Channel (E-DCH) is an uplink transport channel.

HARQ profile: One HARQ profile consists of a power offset attribute and maximum number of transmissions. For 1.28 Mcps TDD, it also includes a retransmission timer attribute.

Power offset attribute (FDD): This represents the power offset between E-DPDCH(s) and reference E-DPDCH power level for a given E-TFC. This power offset attribute is set to achieve the required QoS in this MAC-d flow when carried alone in a MAC-e PDU and subsequently in the corresponding CCTrCh of E-DCH type. Details on the mapping on Beta factors can be found in [13]. The reference E-DPDCH power offset is signalled to the UE for one (or several) reference E-TFC(s) (see details in subclause 11.1).

Power offset attribute (TDD): The power offset attribute is set to achieve the required QoS in this MAC-d flow when carried alone in a MAC-e PDU and subsequently in the corresponding CCTrCh of E-DCH type. Details on the power offset can be found in [18].

Primary Absolute Grant: Absolute Grant received with the primary E-RNTI. Note that the primary E-RNTI is the only E-RNTI for TDD.

Serving E-DCH cell: Cell from which the UE receives Absolute Grants from the Node-B scheduler. A UE has one Serving E-DCH cell.

Serving_Grant (FDD): The state variable `Serving_Grant` indicates the maximum E-DPDCH to DPCCCH power ratio that the UE is allowed to use for scheduled data in the following transmission. The value in the appropriate state variable will be provided to the E-TFC selection function to help in selecting the best format for the upcoming

transmission. Possible values are: "Zero_Grant" and numerical values. The DPCCH power assumed for the Serving_Grant in a compressed frame is the actual DPCCH power in the compressed frame minus $10\log_{10}(N_{\text{pilot,N}}/N_{\text{pilot,C}})$ as defined in [13].

Serving_Grant (TDD): The state variable Serving_Grant indicates the power ratio of maximum E-PUCH power level per TDD resource unit relative to a reference E-PUCH power level $P_{e\text{-ref}}$ that the UE is allowed to use for scheduled data on the physical resources associated with the E-AGCH grant. $P_{e\text{-ref}}$ is defined as the calculated E-PUCH transmit power ($P_{E\text{-PUCH}}$) in [18] with $\beta_e=0$. The value in the appropriate state variable will be provided to the E-TFC selection function to help in selecting the best format for the upcoming transmission. Possible values are: "Zero_Grant" and numerical values.

3.1.2.2 FDD

Active Process: HARQ process for which Scheduling Grant are applicable, i.e. scheduled data can be sent.

AG_Timer: This timer is set to one HARQ RTT (40ms in the case of 10ms TTI, 16ms in the case of 2ms TTI).

E-DCH active set: The set of cells which carry the E-DCH for one UE.

Inactive Process: HARQ process for which Scheduling Grants are not applicable, i.e. scheduled data cannot be sent.

INACTIVE: Absolute Grant value that can be sent by the serving cell's scheduler on the E-AGCH to deactivate a process or to switch the UE to its secondary E-RNTI.

Lowest Configured Serving Grant Value: The serving grant value indicated by index 0 of the SG table in use.

Maximum Serving Grant: The variable Maximum_Serving_Grant indicates the maximum E-DPDCH to DPCCH power ratio that the UE is allowed to use for scheduled data while the timer Non_Serving_RG_Timer has not expired.

Maximum number of re-transmissions, Maximum number of transmissions: Maximum number of re-transmissions = maximum number of transmissions - 1. Both these notations are used.

Minimum Grant: The value Minimum_Grant corresponds to the minimum E-DPDCH to DPCCH power ratio that the UE considers. This value is in index 0 of the configured scheduling grant table described in subclause 9.2.5.2.1.

Non-serving E-DCH RL or Non-serving RL: Cell which belongs to the E-DCH active set but does not belong to the Serving E-DCH RLS and from which the UE can receive one Relative Grant. The UE can have zero, one or several Non-serving E-DCH RL(s).

Non_Serving_RG_Timer: This timer is set to one HARQ RTT (40ms in the case of 10ms TTI, 16ms in the case of 2ms TTI).

Primary Absolute Grant: Absolute Grant received with the primary E-RNTI.

Primary_Grant_Available: This state variable is a Boolean, indicating whether the UE's serving grant is only affected by Primary Absolute Grants and Relative Grants (i.e. not by Secondary Absolute Grants).

reference_ETPR: The state variable reference_ETPR holds the E-DPDCH to DPCCH power ratio used as reference for relative grant commands. This variable is set to the E-DPDCH to DPCCH power ratio used for the E-TFC selected for the previous TTI on this HARQ process, calculated using the amplitude ratios prior to the quantization according to subclause 5.1.2.5B.2.3 or 5.1.2.5B.2.4 of [13], excluding non-scheduled transmissions, excluding any scaling applied according to subclause 5.1.2.6 of [13] and is obtained from the physical layer. In case no scheduled transmission took place on a HARQ process in the previous TTI, reference_ETPR shall be set to Minimum_Grant for this HARQ process.

Secondary Absolute Grant: Absolute Grant received with the secondary E-RNTI.

Serving E-DCH RLS or Serving RLS: Set of cells which contains at least the Serving E-DCH cell and from which the UE can receive and combine one Relative Grant. The UE has only one Serving E-DCH RLS.

Stored_Secondary_Grant: This state variable is used to store the value derived from the last received Secondary Absolute Grant Value. Possible values are: "Zero_Grant" and numerical values.

3.1.3 DTX-DRX and HS-SCCH less Specific definitions (FDD only)

MAC DTX cycle: Defines the pattern of time instances where the start the uplink E-DCH transmission after inactivity is allowed.

MAC Inactivity Threshold: E-DCH inactivity time after which the UE can start E-DCH transmission only at given times.

UE DTX DRX Offset: Uplink DPCCCH burst pattern and HS-SCCH reception pattern offset in subframes.

HS-SCCH less mode of operation: HS-SCCH less mode of operation is enabled when the variable HS_SCCH_LESS_STATUS defined in [7] is set to TRUE.

Inactivity Threshold for UE Grant Monitoring: Determines the number of E-DCH TTIs after an E-DCH scheduled transmission during which the UE is required to monitor the full E-AGCH transmissions from the serving radio link and the full E-RGCH(s) from all the cells in the E-DCH active set.

Inactivity Threshold for UE DTX cycle 2: Defines a number of consecutive E-DCH TTIs without an E-DCH transmission, after which the UE shall immediately move from UE_DTX_cycle_1 to using UE_DTX_cycle_2.

Default-SG-in-DTX-Cycle-2: Defines the default E-DCH Serving Grant used in the case when the UE moves from UE DTX cycle 1 to UE DTX cycle 2 after Inactivity Threshold for UE DTX cycle 2 triggers.

3.2 Abbreviations

For the purposes of the present document, the following abbreviations apply:

AG	Absolute Grant
ASC	Access Service Class
BCCH	Broadcast Control Channel
BCH	Broadcast Channel
C-	Control-
CCCH	Common Control Channel
DCCH	Dedicated Control Channel
DCH	Dedicated Channel
DL	Downlink
DSCH	Downlink Shared Channel
DTCH	Dedicated Traffic Channel
E-AGCH	E-DCH Absolute Grant Channel
E-DCH	Enhanced Dedicated Transport Channel
E-DPCCH	E-DCH Dedicated Physical Control Channel (FDD only)
ENI	E-UCCH Number Indication (1.28Mcps TDD only)
E-HICH	E-DCH HARQ Acknowledgement Indicator Channel
E-PUCH	Enhanced Uplink Physical Channel (TDD only)
E-RGCH	E-DCH Relative Grant Channel
E-RGCH	E-DCH Relative Grant Channel (FDD only)
E-RNTI	E-DCH Radio Network Temporary Identifier
E-RUCCH	E-DCH Random Access Uplink Control Channel (TDD only)
E-TFC	E-DCH Transport Format Combination
E-TFCI	E-DCH Transport Format Combination Indicator
E-UCCH	E-DCH Uplink Control Channel (TDD only)
FACH	Forward Link Access Channel
FDD	Frequency Division Duplex
HARQ	Hybrid Automatic Repeat Request
HCSN	HS-SCCH Cyclic Sequence Number
HSDPA	High Speed Downlink Packet Access
HS-DSCH	High Speed Downlink Shared Channel
L1	Layer 1 (physical layer)
L2	Layer 2 (data link layer)
L3	Layer 3 (network layer)
MAC	Medium Access Control
MBMS	Multimedia Broadcast Multicast Service

MCCH	MBMS point-to-multipoint Control Channel
MTCH	MBMS point-to-multipoint Traffic Channel
MSCH	MBMS point-to-multipoint Scheduling Channel
PCCH	Paging Control Channel
PCH	Paging Channel
PDU	Protocol Data Unit
PHY	Physical layer
PhyCH	Physical Channels
RACH	Random Access Channel
RG	Relative Grant
RLC	Radio Link Control
RLS	Radio Link Set
RNC	Radio Network Controller
RNS	Radio Network Subsystem
RNTI	Radio Network Temporary Identity
RRC	Radio Resource Control
RSN	Retransmission Sequence Number
SAP	Service Access Point
SDU	Service Data Unit
SHCCH	Shared Channel Control Channel
SRNC	Serving Radio Network Controller
SRNS	Serving Radio Network Subsystem
TDD	Time Division Duplex
TFCI	Transport Format Combination Indicator
TFI	Transport Format Indicator
TSN	Transmission Sequence Number
U-	User-
UE	User Equipment
UL	Uplink
UMTS	Universal Mobile Telecommunications System
USCH	Uplink Shared Channel
UTRA	UMTS Terrestrial Radio Access
UTRAN	UMTS Terrestrial Radio Access Network

4 General

4.1 Objective

The objective is to describe the MAC architecture and the different MAC entities from a functional point of view.

4.2 MAC architecture

The description in this subclause is a model and does not specify or restrict implementations.

According to the RRC functions the RRC is generally in control of the internal configuration of the MAC.

Both MAC-hs and MAC-ehs are responsible for handling the data transmitted on the HS-DSCH. Furthermore they are responsible for the management of the physical resources allocated to HS-DSCH. Upper layers configure which of the two entities, MAC-hs or MAC-ehs, is to be applied to handle HS-DSCH functionality.

4.2.1 MAC Entities

The diagrams that describe the MAC architecture are constructed from MAC entities.

The entities are assigned the following names.

- MAC-b is the MAC entity that handles the following transport channels:

- broadcast channel (BCH)
- MAC-c/sh/m, is the MAC entity that handles the following transport channels:
 - paging channel (PCH)
 - forward access channel (FACH)
 - random access channel (RACH)
 - downlink shared channel (DSCH). The DSCH exists only in TDD mode.
 - uplink shared channel (USCH). The USCH exists only in TDD mode.
- MAC-d is the MAC entity that handles the following transport channels:
 - dedicated transport channel (DCH)
- MAC-hs/ehs is the MAC entity that handles the following transport channels:
 - high speed downlink shared channel (HS-DSCH)
- MAC-m is the MAC entity that handles the following transport channels:
 - forward access channel (FACH).
- MAC-e/es are the MAC entities that handle the following transport channels:
 - enhanced dedicated transport channel (E-DCH).

The exact functions completed by the entities are different in the UE from those completed in the UTRAN.

NOTE: When a UE is allocated resources for exclusive use by the bearers that it supports the MAC-d entities dynamically share the resources between the bearers and are responsible for selecting the TFI/ TFCI that is to be used in each transmission time interval.

4.2.2 MAC-b

The following diagram illustrates the connectivity of the MAC-b entity in a UE and in each cell of the UTRAN.

MAC-b represents the control entity for the broadcast channel (BCH).

There is one (current cell) or multiple (current and neighbour cells) MAC-b entities in each UE and one MAC-b in the UTRAN for each cell.

The MAC Control SAP is used to transfer Control information to MAC-b.

The MAC-b entity is located in the Node B.

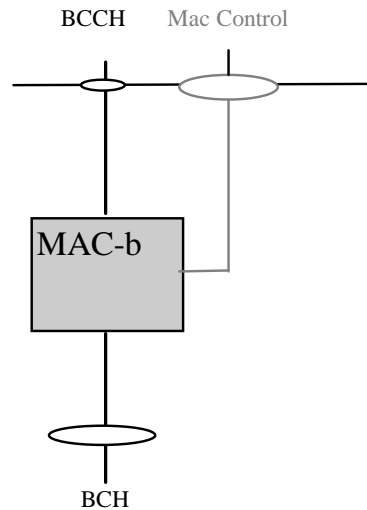

Figure 4.2.2.1: UE side and UTRAN side architecture

4.2.3 Traffic Related Architecture - UE Side

Figure 4.2.3.1 illustrates the connectivity of MAC entities.

The MAC-c/sh/m controls access to all common transport channels, except the HS-DSCH transport channel.

The MAC-d controls access to all dedicated transport channels, to MAC-c/sh/m and MAC-hs/ehs.

The MAC-hs/ehs handles the HSDPA specific functions and controls access to the HS-DSCH transport channel. Upper layers configure which of the two entities, MAC-hs or MAC-ehs, is to be applied to handle HS-DSCH functionality.

The MAC-e/es controls access to the E-DCH transport channel.

In case of selective combining of MTCH channels from multiple cells, the MAC-m controls access to the FACH transport channels used to carry MTCH and MSCH.

In the downlink, if logical channels of dedicated type are mapped to common transport channels then MAC-d receives the data from MAC-c/sh/m or MAC-hs/ehs via the illustrated connection between the functional entities.

In the downlink, if logical channels of common type are mapped to HS-DSCH then MAC-c/sh/m receives the data from MAC-ehs via the illustrated connection between the functional entities (FDD only).

In the uplink, if logical channels of dedicated type are mapped to common transport channels then MAC-d submits the data to MAC-c/sh/m via the illustrated connection between the functional entities.

The mapping of logical channels on transport channels depends on the multiplexing that is configured by RRC.

The MAC Control SAP is used to transfer Control information to each MAC entity.

The associated signalling shown in the figure illustrates the exchange of information between layer 1 and layer 2 provided by primitives shown in [3].

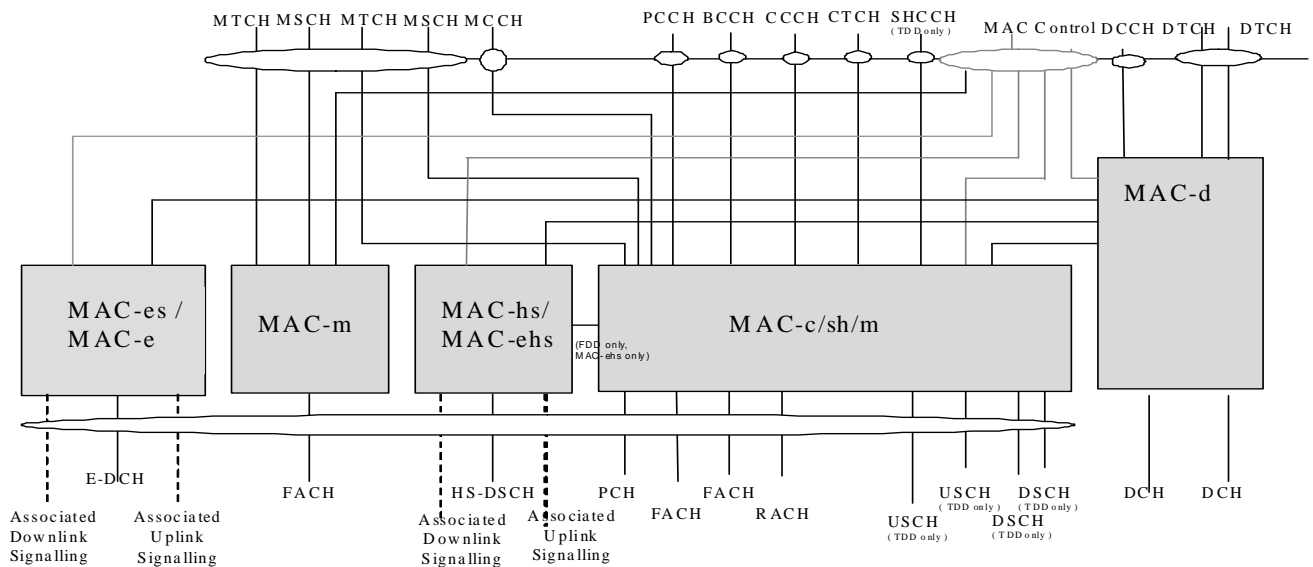

Figure 4.2.3.1: UE side MAC architecture

4.2.3.1 MAC-c/sh/m entity – UE Side

Figure 4.2.3.1.1 shows the UE side MAC-c/sh/m entity.

The following functionality is covered:

- TCTF MUX:
 - this function represents the handling (insertion for uplink channels and detection and deletion for downlink channels) of the TCTF field in the MAC header, and the respective mapping between logical and transport channels.
 - The TCTF field indicates the common logical channel type, or if a dedicated logical channel is used;
- add/read UE Id:
 - the UE Id is added for RACH transmissions;
 - the UE Id, when present, identifies data to this UE.
- read MBMS Id:
 - the MBMS Id is read in case of MTCH reception;
 - the MBMS Id identifies received data to an MBMS service.
- UL: TF selection:
 - in the uplink, the possibility of transport format selection exists.
- ASC selection:
 - For RACH, MAC indicates the ASC associated with the PDU to the physical layer. This is to ensure that RACH messages associated with a given Access Service Class (ASC) are sent on the appropriate signature(s) and time slot(s). MAC also applies the appropriate back-off parameter(s) associated with the given ASC. When sending an RRC CONNECTION REQUEST message, RRC will determine the ASC; in all other cases MAC selects the ASC;
- scheduling /priority handling

- this functionality is used to transmit the information received from MAC-d on RACH based on logical channel priorities. This function is related to TF selection.
- TFC selection
 - transport format and transport format combination selection according to the transport format combination set (or transport format combination subset) configured by RRC is performed,

The RLC provides RLC-PDUs to the MAC, which fit into the available transport blocks on the transport channels.

There is one MAC-c/sh/m entity in each UE.

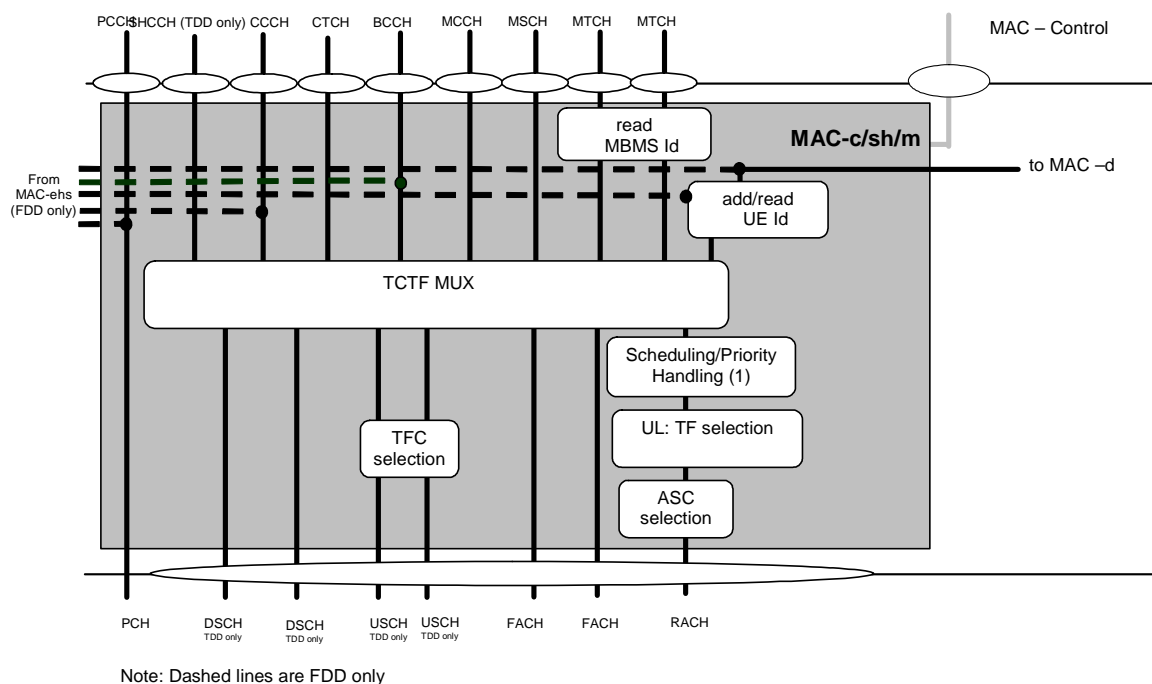

Figure 4.2.3.1.1: UE side MAC architecture / MAC-c/sh/m details

4.2.3.1b MAC-m entity – UE Side

Figure 4.2.3.1b.1 shows the UE side MAC-m entity.

The following functionality is covered:

- TCTF DEMUX:
 - this function represents the handling (detection and deletion for downlink channels) of the TCTF field in the MAC header, and the respective mapping between logical and transport channels. The TCTF field indicates the common logical channel type;
- read MBMS Id
 - the MBMS Id is read in case of MTCH reception;
 - the MBMS Id identifies received data to an MBMS service.

The MAC Control SAP is used to transfer control information to MAC-m.

If MTCH channels are selectively combined, the MAC-m entity exists in the UE. Otherwise, the MAC-m entity does not exist.

In case of selective combining of MTCH channels from multiple cells, there are one MAC-c/sh/m for the current cell and one MAC-m entity for each neighboring cell in the UE.

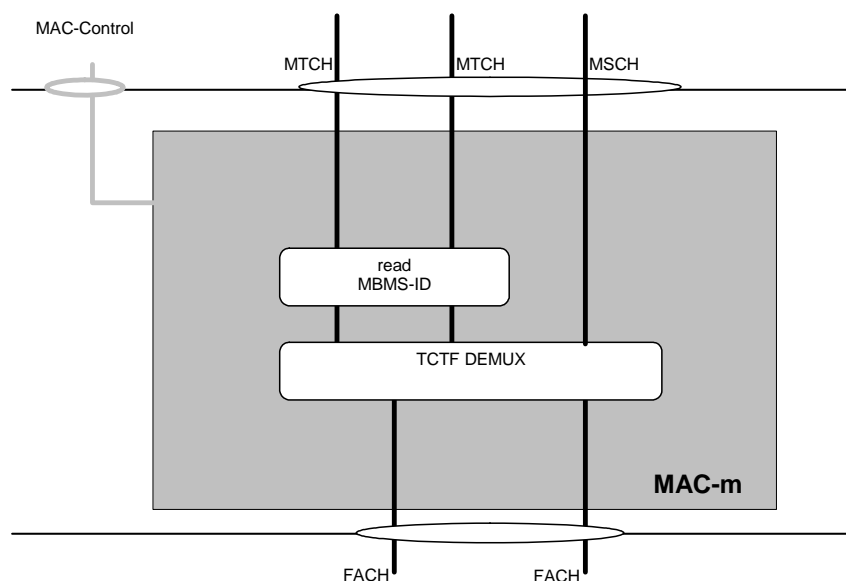

Figure 4.2.3.1b.1: UE side MAC architecture / MAC-m details

4.2.3.2 MAC-d entity – UE Side

Figure 4.2.3.2.1 shows the UE side MAC-d entity.

The following functionality is covered:

- Transport Channel type switching
 - Transport Channel type switching is performed by this entity, based on decision taken by RRC. This is related to a change of radio resources. If requested by RRC, MAC shall switch the mapping of one designated logical channel between common and dedicated transport channels.
- C/T MUX:
 - The C/T MUX is used when multiplexing of several dedicated logical channels onto one transport channel (other than HS-DSCH) or one MAC-d flow (HS-DSCH) is used. An unambiguous identification of the logical channel is included. If MAC-ehs is configured, C/T MUX toward MAC-ehs is not used.
- Ciphering:
 - Ciphering for transparent mode data to be ciphered is performed in MAC-d. Details about ciphering can be found in [10].
- Deciphering:
 - Deciphering for ciphered transparent mode data is performed in MAC-d. Details about ciphering can be found in [10].
- UL TFC selection:
 - Transport format and transport format combination selection according to the transport format combination set (or transport format combination subset) configured by RRC is performed.

The MAC-d entity is responsible for mapping dedicated logical channels for the uplink either onto dedicated transport channels or to transfer data to MAC-c/sh/m to be transmitted via common channels.

One dedicated logical channel can be mapped simultaneously onto DCH and DSCH in TDD mode.

One dedicated logical channel can be simultaneously mapped onto DCH and HS-DSCH.

The MAC-d entity has a connection to the MAC-c/sh/m entity. This connection is used to transfer data to the MAC-c/sh/m to transmit data on transport channels that are handled by MAC-c/sh/m (uplink) or to receive data from transport channels that are handled by MAC-c/sh/m (downlink).

The MAC-d entity has a connection to the MAC-hs or MAC-ehs entity. This connection is used to receive data from the HS-DSCH transport channel which is handled by MAC-hs or MAC-ehs (downlink).

The MAC-d entity has a connection to the MAC-e/es entity. This connection is used to transmit data on the E-DCH transport channel which is handled by the MAC-e/es (uplink).

There is one MAC-d entity in the UE.

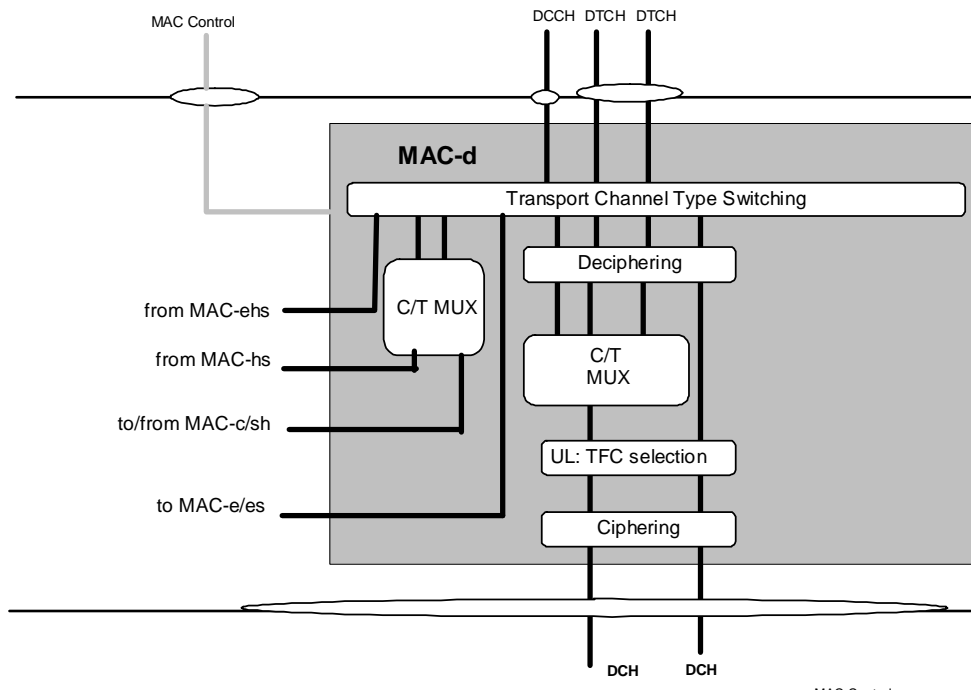

Figure 4.2.3.2.1: UE side MAC architecture / MAC-d details

4.2.3.3 MAC-hs entity – UE Side

In the model below the MAC-hs comprises the following entities. In 1.28 Mcps TDD multi-frequency HS-DSCH cell, the associated downlink control channel and uplink control channel pair controlling the HS-DSCH transmission on the certain carrier shall be allocated on the same carrier. The downlink control channel carries the HS-DSCH operation related info and the uplink control channel carries the feedback info from the UE side.

- HARQ:

The HARQ entity is responsible for handling the MAC functions relating to the HARQ protocol. The HARQ functional entity handles all the tasks that are required for hybrid ARQ. It is responsible for generating ACKs or NACKs. The detailed configuration of the hybrid ARQ protocol is provided by RRC over the MAC-Control SAP. In 1.28 Mcps TDD multi-frequency HS-DSCH cell, multiple HARQ processes are assigned for HS-DSCH operation on every carrier independently, namely HARQ sub-entity; only one HARQ process is allowed to receive HS-DSCH in one TTI for each carrier. The maximum number of HARQ process per HS-DSCH per TTI on which an HS-DSCH transmission can be received is one.
- Reordering Queue distribution:

The reordering queue distribution function routes the MAC-hs PDUs to the correct reordering buffer based on the Queue ID.
- Reordering:

The reordering entity reorders received MAC-hs PDUs according to the received TSN. MAC-hs PDUs with consecutive TSNs are delivered to the disassembly function upon reception. MAC-hs PDUs are not delivered to the disassembly function if MAC-hs PDUs with lower TSN are missing. There is one reordering entity for each Queue ID configured at the UE.
- Disassembly:

The disassembly entity is responsible for the disassembly of MAC-hs PDUs. When a MAC-hs PDU is

disassembled the MAC-hs header is removed, the MAC-d PDUs are extracted and any present padding bits are removed. Then the MAC-d PDUs are delivered to higher layer.

The associated signalling shown in the figure illustrates the exchange of information between layer 1 and layer 2 provided by primitives shown in [3].

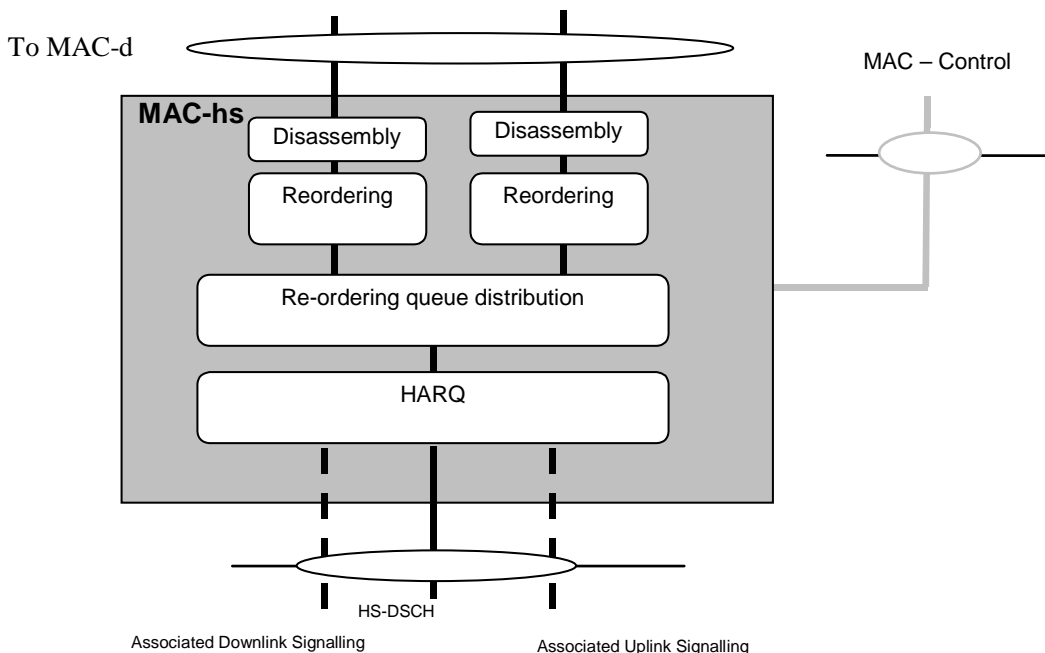

Figure 4.2.3.1: UE side MAC architecture / MAC-hs details

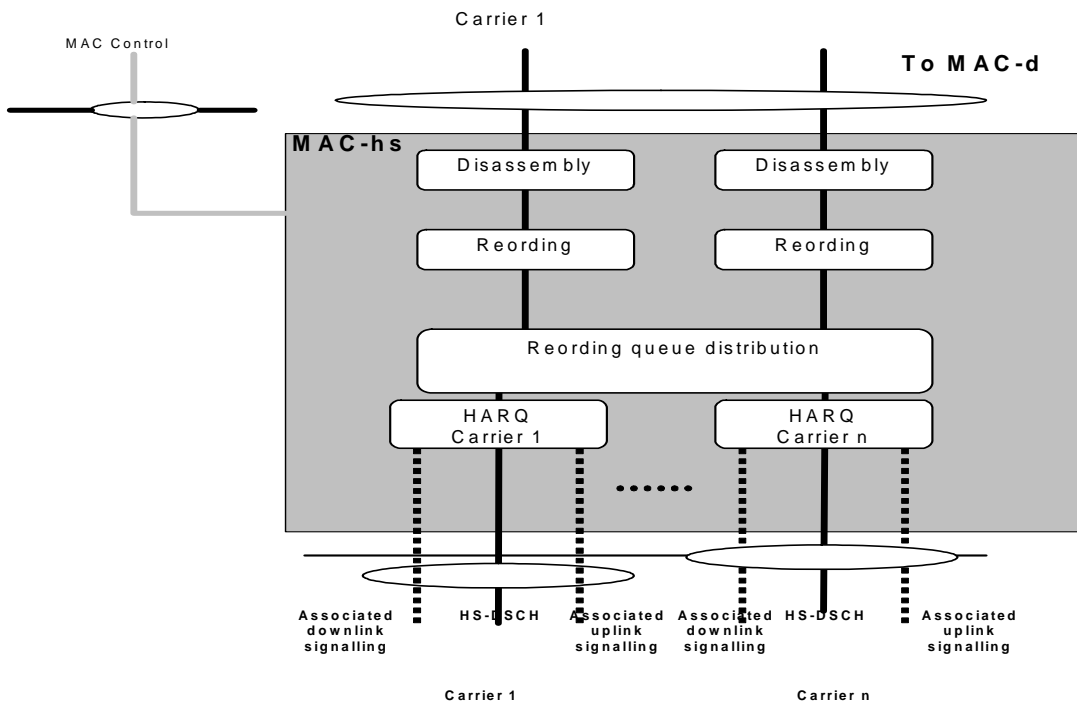

Figure 4.2.3.2: UE side MAC architecture/MAC-hs details (1.28Mcps TDD multi-frequency HS-DSCH operation mode only)

4.2.3.4 MAC-e/es entity – UE Side

The MAC-es/e handles the E-DCH specific functions. The split between MAC-e and MAC-es in the UE is not detailed. In the model below the MAC-e/es comprises the following entities:

- HARQ:
The HARQ entity is responsible for handling the MAC functions relating to the HARQ protocol. It is responsible for storing MAC-e payloads and re-transmitting them. The detailed configuration of the hybrid ARQ protocol is provided by RRC over the MAC-Control SAP.
 - For FDD: The HARQ entity provides the E-TFC, the retransmission sequence number (RSN), and the power offset to be used by L1. Redundancy version (RV) of the HARQ transmission is derived by L1 from RSN, CFN and in case of 2 ms TTI from the sub-frame number.
 - For TDD: The HARQ entity provides the HARQ process identity, the E-TFC, the retransmission sequence number (RSN) and an indication of the power offset to be used by L1. The redundancy version (RV) of the HARQ transmission is derived by L1 from RSN. RRC signalling can also configure the L1 to use RV=0 for every transmission.
- Multiplexing and TSN setting:
The multiplexing and TSN setting entity is responsible for concatenating multiple MAC-d PDUs into MAC-es PDUs, and to multiplex one or multiple MAC-es PDUs into a single MAC-e PDU, to be transmitted in the next TTI, as instructed by the E-TFC selection function. It is also responsible for managing and setting the TSN per logical channel for each MAC-es PDU.
- E-TFC selection:
This entity is responsible for E-TFC selection according to the scheduling information, Relative Grants (FDD only) and Absolute Grants, received from UTRAN via L1 and Serving Grant value signalled through RRC, and for arbitration among the different flows mapped on the E-DCH. The detailed configuration of the E-TFC entity is provided by RRC over the MAC-Control SAP. The E-TFC selection function controls the multiplexing function.
- Scheduling Access Control (TDD only):
The Scheduling Access Control entity is responsible for routing associated uplink signalling via E-UCCH and MAC-e PDU (in the case that E-DCH resources are assigned) or via E-RUCCH (in the case that no E-DCH resources are assigned). It is also responsible for obtaining and formatting the appropriate information to be carried on E-UCCH/E-RUCCH.

NOTE: HARQ process ID and RSN are carried on E-UCCH.

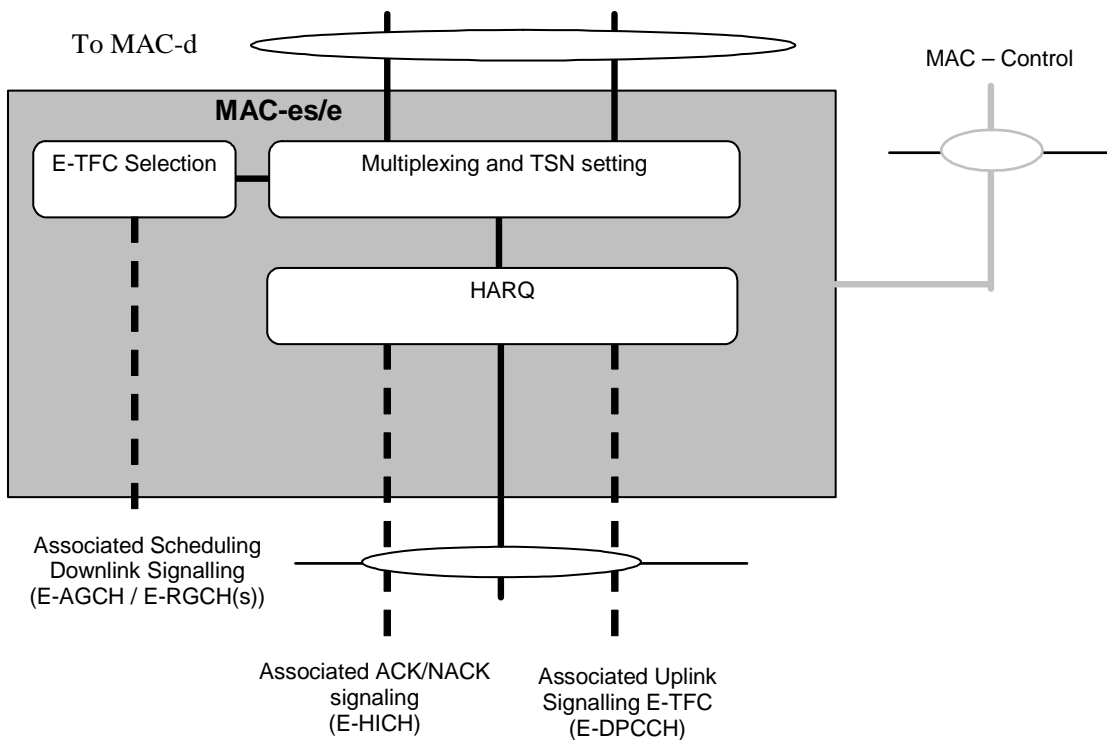

Figure 4.2.3.4.1a: UE side MAC architecture / MAC-e/es details (FDD)

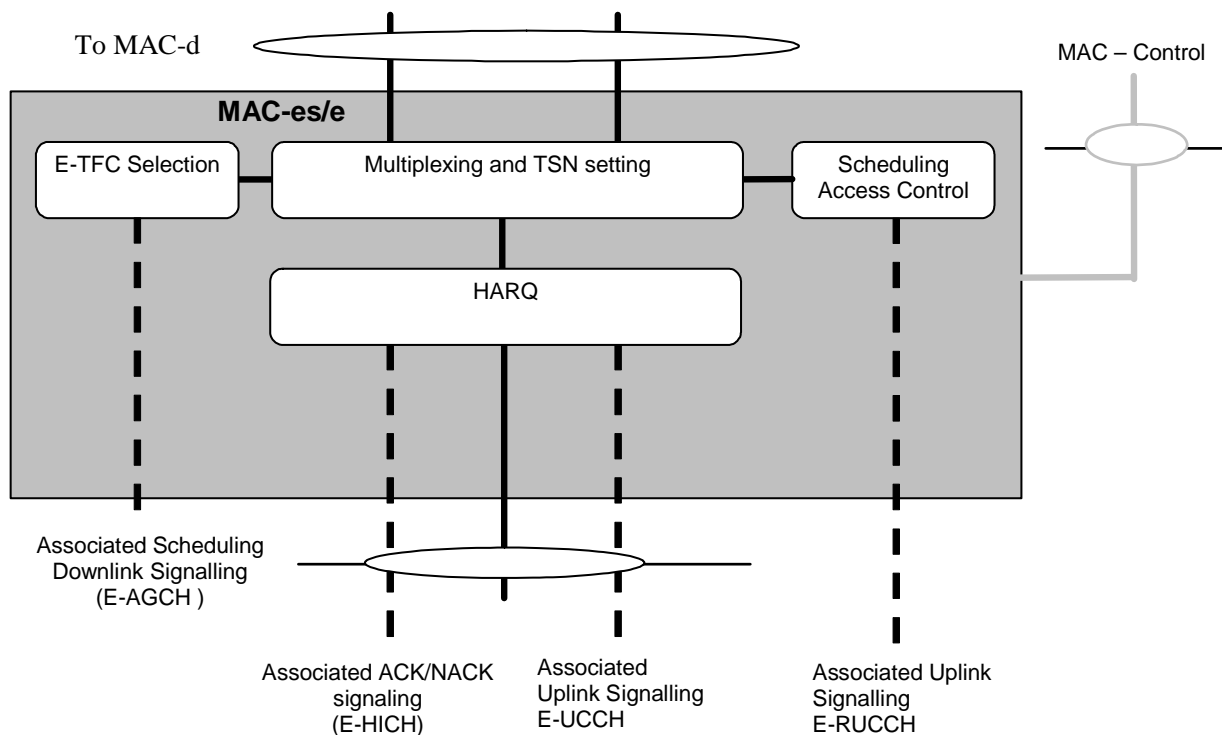

Figure 4.2.3.4.1b: UE side MAC architecture / MAC-e/es details (TDD)

4.2.3.5 MAC-ehs entity – UE Side

In the model below the MAC-ehs comprise the following entities. In 1.28 Mcps TDD multi-frequency HS-DSCH cell, the associated downlink control channel and uplink control channel pair controlling the HS-DSCH transmission on the

certain carrier shall be allocated on the same carrier. The downlink control channel carries the HS-DSCH operation related info and the uplink control channel carries the feedback info from the UE side.

- HARQ:
The HARQ entity is responsible for handling the HARQ protocol. There shall be one HARQ process per HS-DSCH per TTI for single stream transmission and two HARQ processes per HS-DSCH per TTI for dual stream transmission. The HARQ functional entity handles all the tasks that are required for hybrid ARQ. It is for example responsible for generating ACKs or NACKs. The detailed configuration of the hybrid ARQ protocol is provided by RRC over the MAC-Control SAP. In 1.28 Mcps TDD multi-frequency HS-DSCH cell, multiple HARQ processes are assigned for HS-DSCH operation on every carrier independently, namely HARQ sub-entity; only one HARQ process is allowed to receive HS-DSCH in one TTI for each carrier. The maximum number of HARQ process per HS-DSCH per TTI on which an HS-DSCH transmission can be received is one.
- Disassembly
The disassembly entity disassembles the MAC-ehs PDUs by removing the MAC-ehs header and possible padding.
- Reordering queue distribution
The reordering queue distribution function routes the received reordering PDUs to correct reordering queues based on the received logical channel identifier.
- Reordering:
The reordering entity organises received reordering PDUs according to the received TSN. Data blocks with consecutive TSNs are delivered to reassembly entity upon reception. A timer mechanism determines delivery of non-consecutive data blocks to higher layers. There is one reordering entity for each priority class. For the logical channels BCCH and PCCH no re-ordering is applied.
- Reassembly:
The reassembly entity reassembles segmented MAC-ehs SDUs (corresponding to either MAC-c or MAC-d PDUs) and forwards the MAC PDUs to LCH-ID demultiplexing entity.
- LCH-ID demultiplexing:
The demultiplexing entity routes the MAC-ehs SDUs to correct logical channel based on the received logical channel identifier.

The following is allowed:

The MAC-ehs SDUs included in a MAC-ehs PDU can have a different size and a different priority and can be mapped to different priority queues.

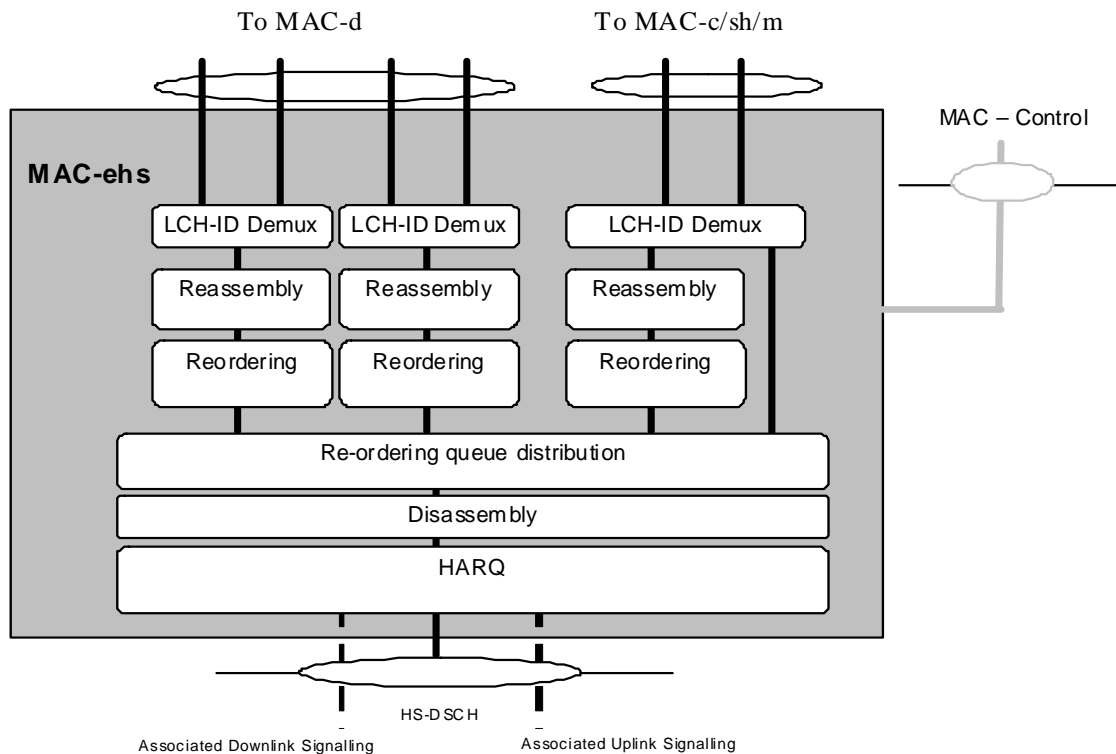

Figure 4.2.3.5-1: UE side MAC architecture/MAC-ehs details.

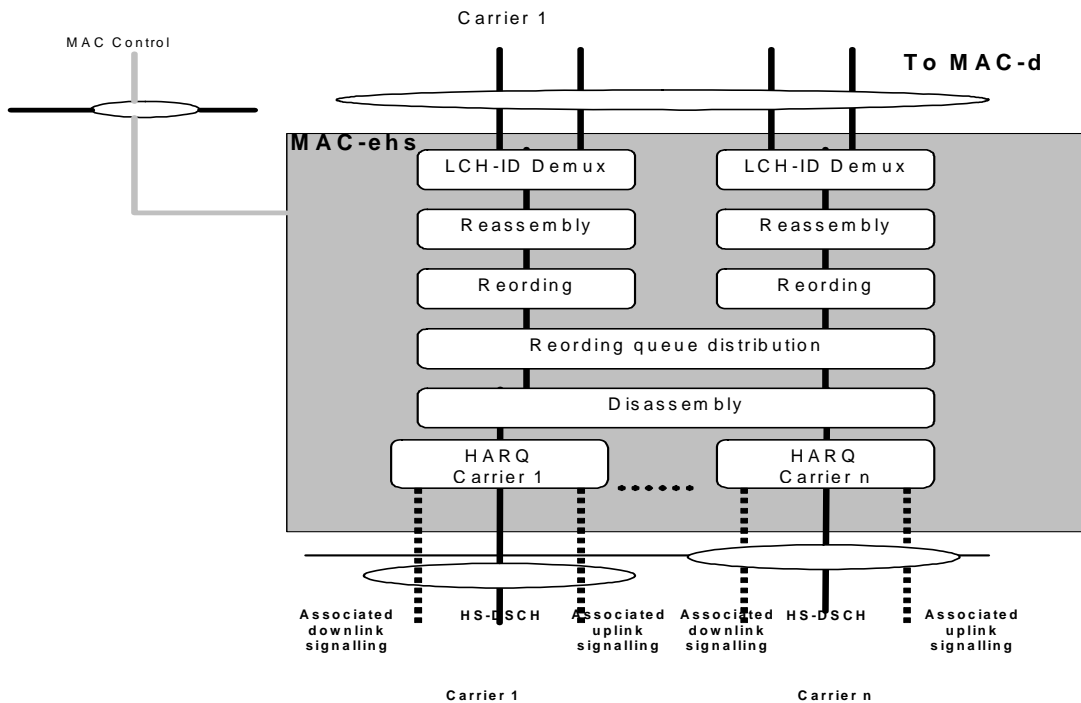

Figure 4.2.3.5-2: UE side MAC architecture/MAC-ehs details (1.28Mcps TDD multi-frequency HS-DSCH operation mode only)

4.2.4 Traffic Related Architecture - UTRAN Side

Figure 4.2.4.1 illustrates the connectivity between the MAC entities from the UTRAN side.

It is similar to the UE case with the exception that there will be one MAC-d for each UE and each UE (MAC-d) that is associated with a particular cell may be associated with that cell's MAC-c/sh/m.

MAC-c/sh/m is located in the controlling RNC while MAC-d is located in the serving RNC. MAC-hs/ehs is located in the Node B. The MAC-d PDUs to be transmitted are transferred from MAC-c/sh/m to the MAC-hs/ehs via the Iub interface in case of configuration with MAC-c/sh/m, or from the MAC-d via Iur/Iub in case of configuration without MAC-c/sh/m.

For each UE that uses E-DCH, one MAC-e entity per Node-B and one MAC-es entity in the SRNC are configured. MAC-e, located in the Node B, controls access to the E-DCH and is connected to MAC-es, located in the SRNC. MAC-es is further connected to MAC-d. There is one transport bearer set up per E-DCH MAC-d flow.

The MAC Control SAP is used to transfer Control information to each MAC entity belonging to one UE.

The associated signalling shown in the figure illustrates the exchange of information between layer 1 and layer 2 provided by primitives shown in [3].

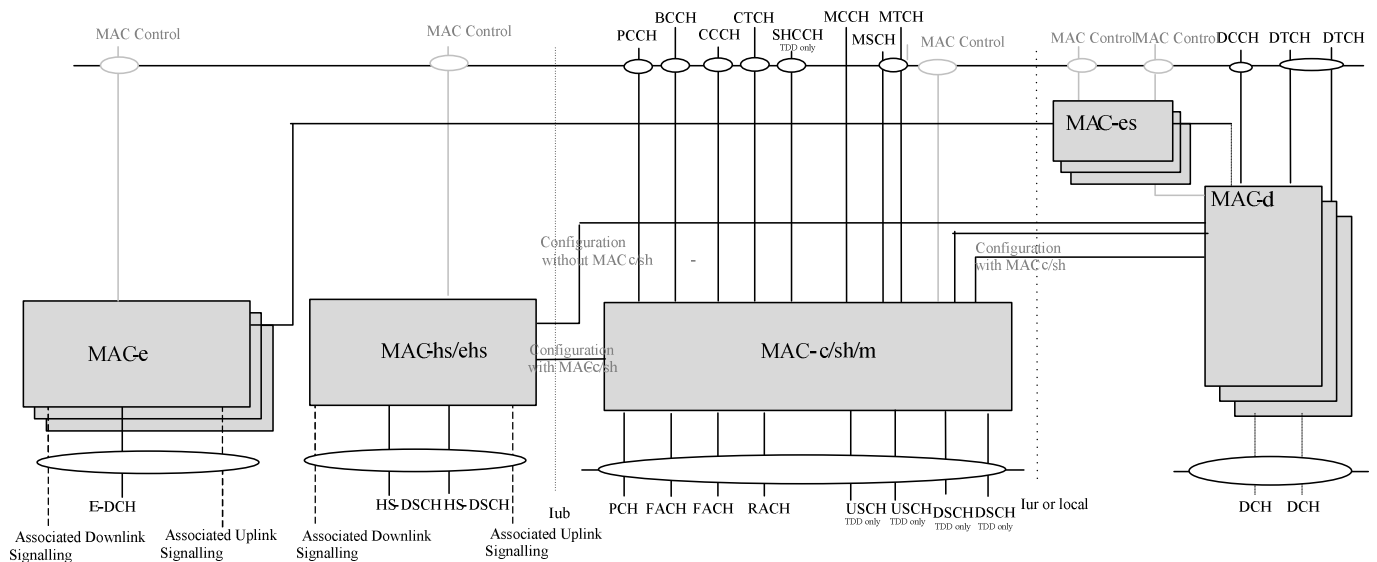

Figure 4.2.4.1: UTRAN side MAC architecture

4.2.4.1 MAC-c/sh/m entity – UTRAN Side

Figure 4.2.4.1.1 shows the UTRAN side MAC-c/sh/m entity. The following functionality is covered:

- Scheduling – Buffering – Priority Handling;
 - this function manages FACH and for TDD DSCH resources between the UEs and between data flows according to their priority and delay requirements set by higher layers.
- TCTF MUX
 - this function represents the handling (insertion for downlink channels and detection and deletion for uplink channels) of the TCTF field in the MAC header, and the respective mapping between logical and transport channels.
 - The TCTF field indicates the common logical channel type, or if a dedicated logical channel is used;
- UE Id Mux;

- for dedicated type logical channels, the UE Id field in the MAC header is used to distinguish between UEs;
- MBMS Id Mux;
- for MTCH channels, the MBMS Id field in the MAC header is used to distinguish between MBMS services;
- TFC selection:
 - in the downlink, transport format combination selection is done for FACH and PCH and for TDD DSCHs;
- Demultiplex;
 - for TDD operation the demultiplex function is used to separate USCH data from different UEs, i.e. to be transferred to different MAC-d entities;
- DL code allocation;
 - for TDD this function is used to indicate the code used on the DSCH;
- Flow control;
 - a flow control function exists toward MAC-d to limit buffering between MAC-d and MAC-c/sh/m entities. a flow control function also exists towards MAC-hs/ehs in case of configuration with MAC-c/sh/m.

The RLC provides RLC-PDUs to the MAC, which fit into the available transport blocks on the transport channels.

There is one MAC-c/sh/m entity in the UTRAN for each cell;

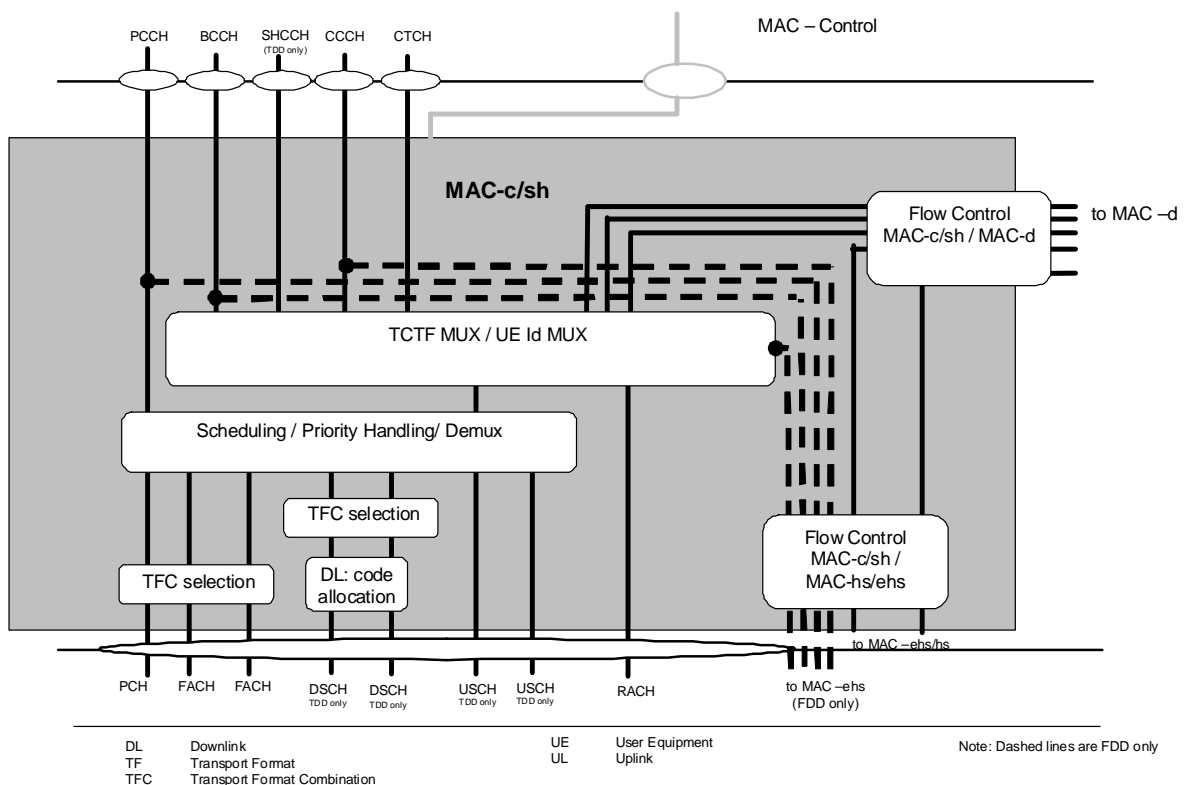

Figure 4.2.4.1.1: UTRAN side MAC architecture / MAC-c/sh/m details

4.2.4.2 MAC-d entity – UTRAN Side

Figure 4.2.4.2.1 shows the UTRAN side MAC-d entity.

The following functionality is covered:

- Transport Channel type switching:
 - Transport Channel type switching is performed by this entity, based on decision taken by RRC; this is related to a change of radio resources. If requested by RRC, MAC shall switch the mapping of one designated logical channel between common and dedicated transport channels.
- C/T MUX box;
 - the function includes the C/T field when multiplexing of several dedicated logical channels onto one transport channel (other than HS-DSCH) or one MAC-d flow (HS-DSCH) is used. If MAC-ehs is configured, C/T MUX toward MAC-ehs is not used.
- LCH MUX box;
 - If MAC-ehs is configured, the LCH MUX function associates each block of MAC-d PDUs of a logical channel with the related LCH-ID, regardless whether one or several logical channels are multiplexed onto one MAC-d flow.
- Priority setting;
 - This function is responsible for priority setting on data received from DCCH / DTCH;
- Ciphering;
 - Ciphering for transparent mode data to be ciphered is performed in MAC-d. Details about ciphering can be found in [10].
- Deciphering;
 - Deciphering for ciphered transparent mode data is performed in MAC-d. Details about ciphering can be found in [10].
- DL Scheduling/Priority handling;
 - in the downlink, scheduling and priority handling of transport channels is performed within the allowed transport format combinations of the TFCS assigned by the RRC.
- Flow Control;
 - a flow control function exists toward MAC-c/sh/m to limit buffering between MAC-d and MAC-c/sh/m entities. This function is intended to limit layer 2 signalling latency and reduce discarded and retransmitted data as a result of FACH or for TDD DSCH congestion. For the Iur interface this is specified in [11]. A flow control function also exists towards MAC-hs/ehs in case of configuration without MAC-c/sh/m, see subclause 4.2.4.2.

A MAC-d entity using common channels other than the high speed downlink shared channel is connected to a MAC-c/sh/m entity that handles the scheduling of the common channels to which the UE is assigned and DL (FACH) priority identification to MAC-c/sh/m;

A MAC-d entity using downlink shared channel is connected to a MAC-c/sh/m entity that handles the shared channels to which the UE is assigned and indicates the level of priority of each PDU to MAC-c/sh/m;

A MAC-d entity using the high speed downlink shared channel may be connected to a MAC-c/sh/m entity that in turn is connected to the MAC-hs/ehs entity in the Node B (configuration with MAC-c/sh/m); alternately, a MAC-d entity using the high speed downlink shared channel may be connected to the MAC-hs/ehs entity in the Node B in case of configuration without MAC-c/sh/m.

A MAC-d entity using the enhanced dedicated transport channel (Uplink only) is connected to a MAC-es entity that handles the re-ordering and combining of data received from different Node Bs. Given that the MAC-es is collocated in

the SRNC, it is not necessary to flow control this connection. The MAC-es indicates the logical channel for which the data is intended, to allow the MAC-d to route it appropriately.

A MAC-d entity is responsible for mapping dedicated logical channels onto the available dedicated transport channels or routing the data received on a DCCH or DTCH to MAC-c/sh/m or to MAC-hs/ehs.

One dedicated logical channel can be mapped simultaneously on DCH and DSCH in TDD mode. Different scheduling mechanisms apply for DCH and DSCH. One dedicated logical channel can be mapped simultaneously on DCH and HS-DSCH.

There is one MAC-d entity in the UTRAN for each UE that has one or more dedicated logical channels to or from the UTRAN.

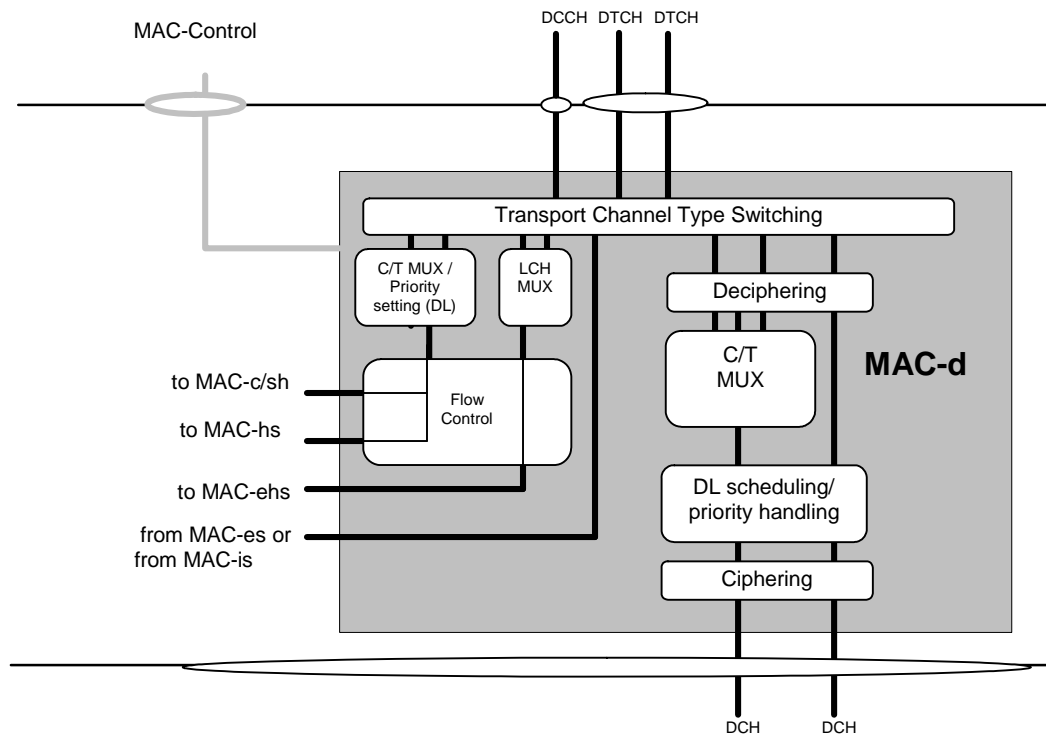

Figure 4.2.4.2.1: UTRAN side MAC architecture / MAC-d details

4.2.4.3 MAC-hs entity – UTRAN Side

There is one MAC-hs entity in the UTRAN for each cell that supports HS-DSCH transmission. The MAC-hs is responsible for handling the data transmitted on the HS-DSCH when configured by upper layers. Furthermore, when configured by upper layers, it is responsible for the management of the physical resources allocated to HSDPA. MAC-hs receives configuration parameters from the RRC layer via the MAC-Control SAP. There should be priority handling per MAC-d PDU in the MAC-hs. The MAC-hs is comprised of four different functional entities:

- Flow Control:
This is the companion flow control function to the flow control function in the MAC-c/sh/m in case of configuration with MAC-c/sh/m and MAC-d in case of configuration without MAC-c/sh/m. Both entities together provide a controlled data flow between the MAC-c/sh/m and the MAC-hs (Configuration with MAC-c/sh/m) or the MAC-d and MAC-hs (Configuration without MAC-c/sh/m) taking the transmission capabilities of the air interface into account in a dynamic manner. This function is intended to limit layer 2 signalling latency and reduce discarded and retransmitted data as a result of HS-DSCH congestion. Flow control is provided independently by MAC-d flow for a given MAC-hs entity.
- Scheduling/Priority Handling:
This function manages HS-DSCH resources between HARQ entities and data flows according to their priority. Based on status reports from associated uplink signalling either new transmission or retransmission is

determined. Further it determines the Queue ID and TSN for each new MAC-hs PDU being serviced, and in the case of TDD the HCSN is determined. A new transmission can be initiated instead of a pending retransmission at any time to support the priority handling.

In 1.28 Mcps TDD multi-frequency HS-DSCH cell:

- multiple HARQ processes are assigned for HS-DSCH operation on every carrier for every user, namely HARQ sub-entity; only one HARQ process in HARQ sub-entity is allowed to receive HS-DSCH in one TTI for each carrier.
- choice of 6bit or 9bit TSN is configured by upper layer signalling
- HARQ:
 - One HARQ entity handles the hybrid ARQ functionality for one user. One HARQ entity is capable of supporting multiple instances (HARQ process) of stop and wait HARQ protocols. There shall be one HARQ process per HS-DSCH per TTI. In 1.28 Mcps TDD multi-frequency HS-DSCH cell, multiple HARQ processes are assigned independently for HS-DSCH operation on every carrier for every user, namely HARQ sub-entity. Only one HARQ process in HARQ sub-entity is allowed to receive HS-DSCH in one TTI for each carrier.
- TFRC selection:
 - Selection of an appropriate transport format and resource for the data to be transmitted on HS-DSCH.

The associated signalling shown in the figure illustrates the exchange of information between layer 1 and layer 2 provided by primitives shown in [3].

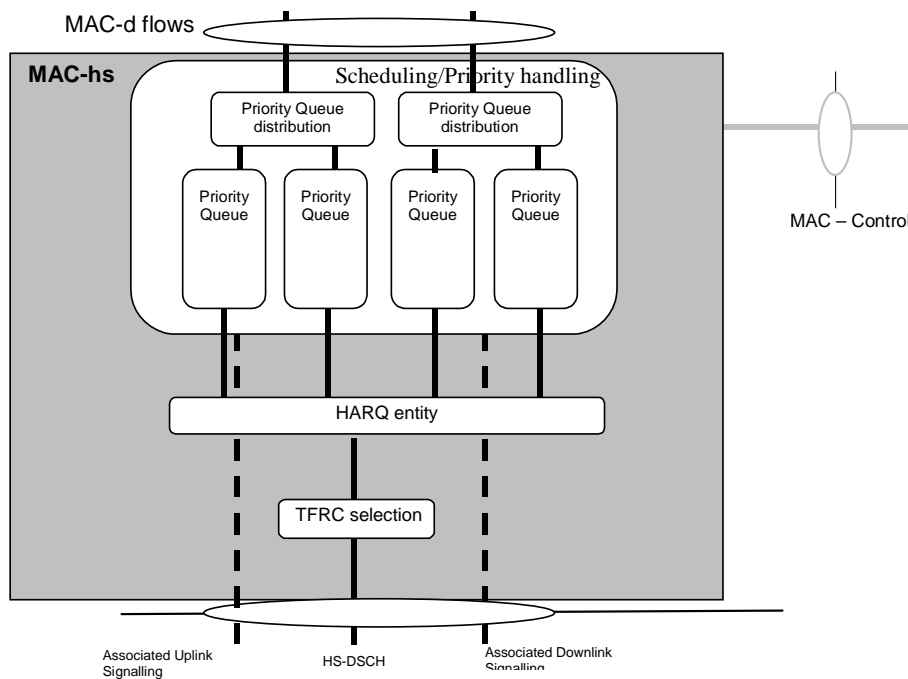

Figure 4.2.4.3.1: UTRAN side MAC architecture / MAC-hs details

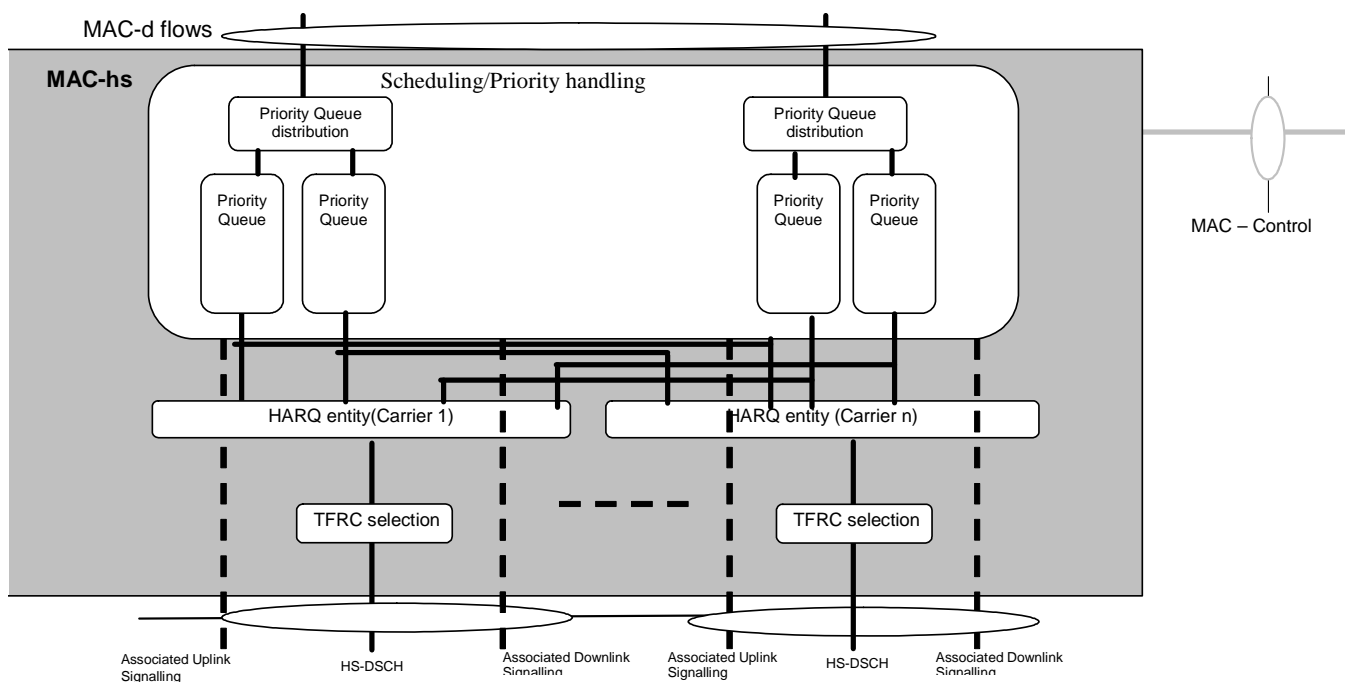

Figure 4.2.4.3.2: UTRAN side MAC architecture/MAC-hs details (1.28Mcps TDD multi-frequency HS-DSCH operation mode only)

4.2.4.4 MAC-es entity – UTRAN Side

For each UE, there is one MAC-es entity in the SRNC. The MAC-es sublayer handles E-DCH specific functionality, which is not covered in the MAC-e entity in Node B. In the model below, the MAC-es comprises the following entities:

- **Reordering Queue Distribution:**
The reordering queue distribution function routes the MAC-es PDUs to the correct reordering buffer based on the SRNC configuration.
- **Reordering:**
This function reorders received MAC-es PDUs according to the received TSN and Node-B tagging i.e. (CFN, subframe number). MAC-es PDUs with consecutive TSNs are delivered to the disassembly function upon reception. Mechanisms for reordering MAC-es PDUs received out-of-order are left up to the implementation. There is one Re-ordering Process per logical channel.
- **Macro diversity selection (FDD only):**
The function is performed in the MAC-es, in case of soft handover with multiple Node-Bs (The soft combining for all the cells of a Node-B takes place in the Node-B). This means that the reordering function receives MAC-es PDUs from each Node-B in the E-DCH active set. The exact implementation is not specified. However the model below is based on one Reordering Queue Distribution entity receiving all the MAC-d flow from all the Node-Bs, and one MAC-es entity per UE.
- **Disassembly:**
The disassembly function is responsible for disassembly of MAC-es PDUs. When a MAC-es PDU is disassembled the MAC-es header is removed, the MAC-d PDU's are extracted and delivered to MAC-d.

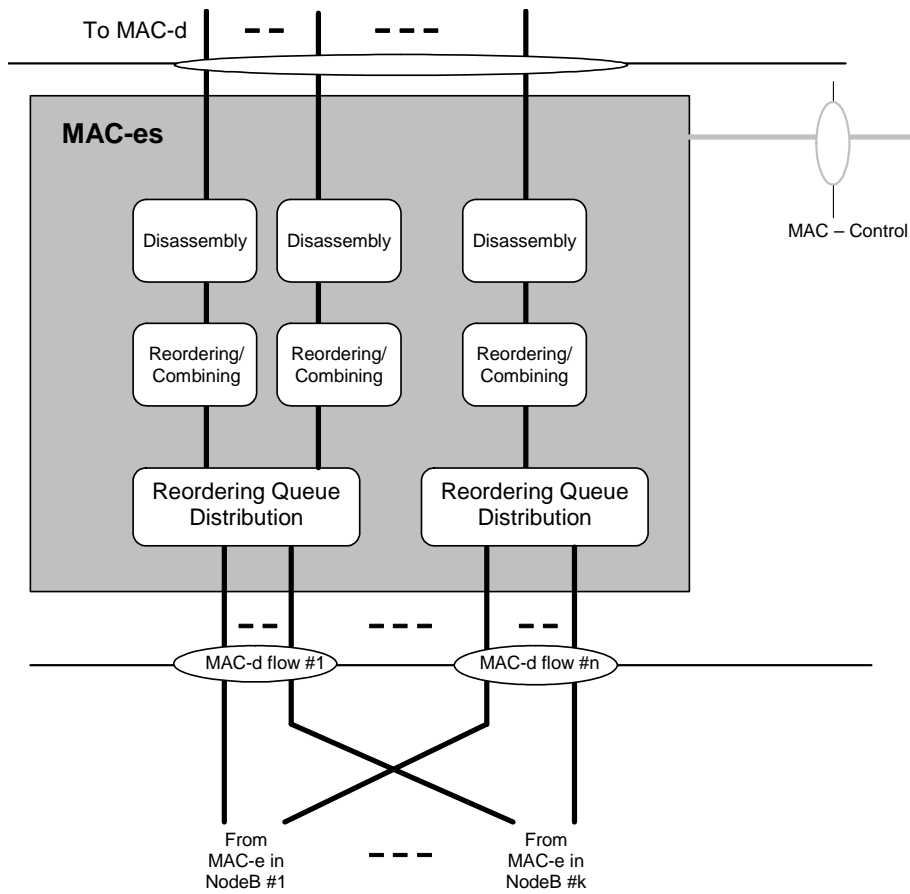

Figure 4.2.4.4-1: UTRAN side MAC architecture / MAC-es details (SHO case, FDD only)

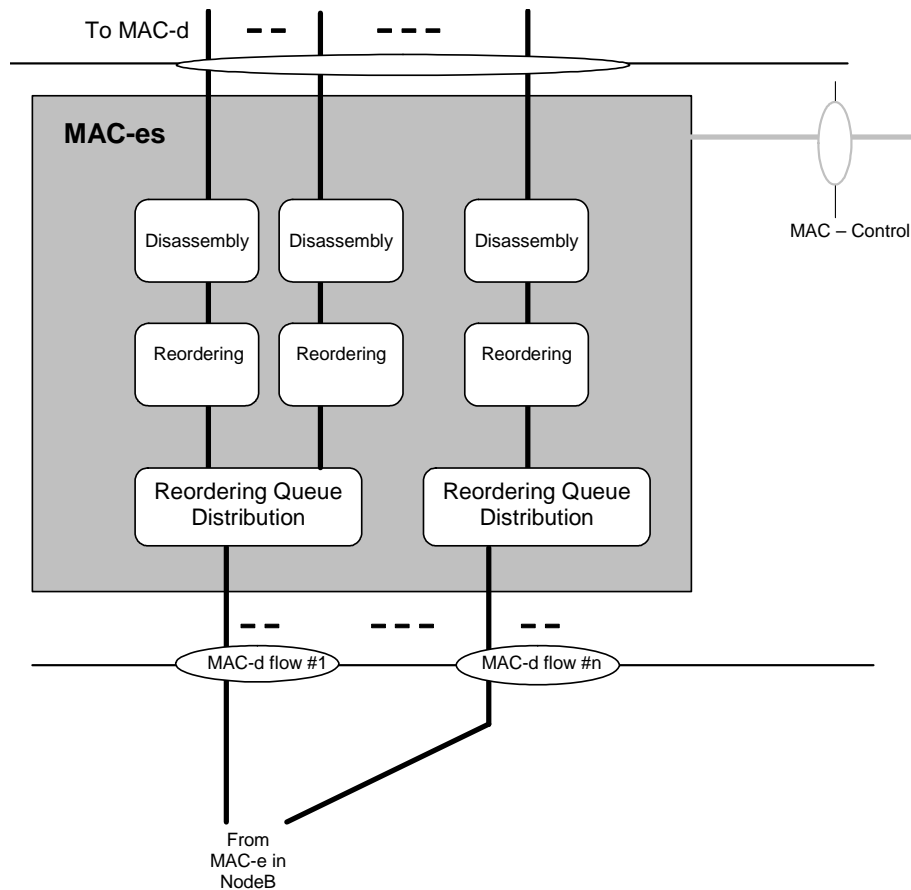

Figure 4.2.4.4-1b: UTRAN side MAC architecture / MAC-es details (TDD)

4.2.4.5 MAC-e entity – UTRAN Side

There is one MAC-e entity in the Node B for each UE and one E-DCH scheduler function in the Node-B. The MAC-e and E-DCH scheduler handle HSUPA specific functions in the Node B. In the model below, the MAC-e and E-DCH scheduler comprises the following entities:

- E-DCH Scheduling:
This function manages E-DCH cell resources between UEs. Based on scheduling requests, Scheduling Grants are determined and transmitted. The general principles of the E-DCH scheduling are described in subclauses 11.8.2.3 and 11.9.2.3 below. However implementation is not specified (i.e. depends on RRM strategy).
- E-DCH Control:
The E-DCH control entity is responsible for reception of scheduling requests and transmission of Scheduling Grants. The general principles of the E-DCH scheduling are described in subclauses 11.8.2.3 and 11.9.2.3 below.
- De-multiplexing:
This function provides de-multiplexing of MAC-e PDUs. MAC-es PDUs are forwarded to the associated MAC-d flow.
- HARQ:
One HARQ entity is capable of supporting multiple instances (HARQ processes) of stop and wait HARQ protocols. Each process is responsible for generating ACKs or NACKs indicating delivery status of E-DCH transmissions. The HARQ entity handles all tasks that are required for the HARQ protocol.

The associated signalling shown in the figures illustrates the exchange of information between layer 1 and layer 2 provided by primitives.

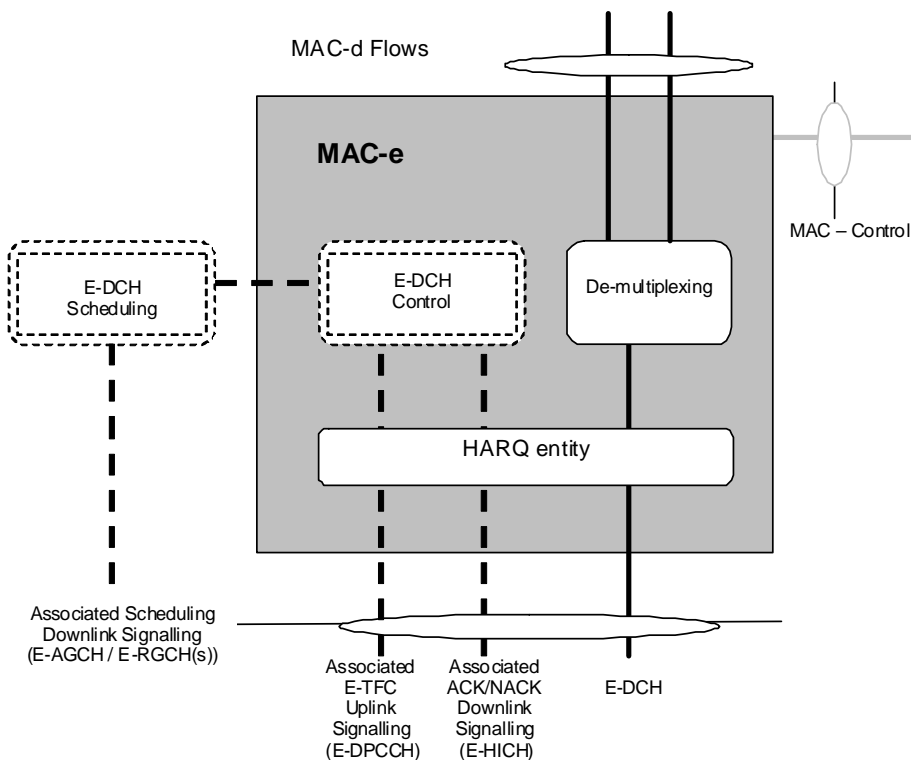

Figure 4.2.4.5-1a: UTRAN side MAC architecture / MAC-e details (FDD)

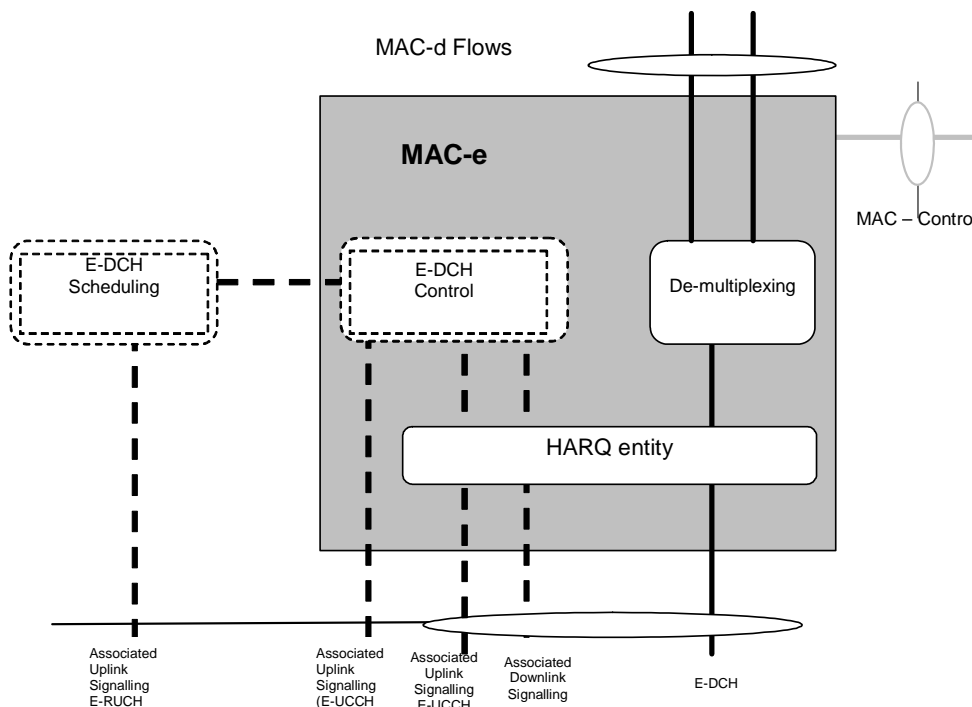

Figure 4.2.4.5-1b: UTRAN side MAC architecture / MAC-e details (TDD)

4.2.4.6 MAC-ehs entity UTRAN Side

There is one MAC-ehs entity in the UTRAN for each cell that supports HS-DSCH transmission. The MAC-ehs is responsible for handling the data transmitted on the HS-DSCH when configured. MAC-ehs receives configuration parameters from the RRC layer via the MAC-Control SAP. There should be priority handling per MAC-ehs SDU in the MAC-ehs. The MAC-ehs is comprised of six different functional entities:

- Flow Control:
The flow control for MAC-ehs is identical to the flow control for MAC-hs.
- Scheduling/Priority Handling:
This function manages HS-DSCH resources between HARQ entities and data flows according to their priority class. In FDD, the scheduler determines for each TTI if single or dual stream transmission should be used. Based on status reports from associated uplink signalling either new transmission or retransmission is determined when operating in CELL_DCH state. In FDD, when operating in CELL_FACH, CELL_PCH and URA_PCH state HS-DSCH reception, the MAC-ehs can perform retransmission without uplink signalling. Further it sets the logical channel identifiers for each new reordering SDU and TSNs for each new reordering PDU being serviced. To maintain proper transmission priority a new transmission can be initiated on a HARQ process at any time. The TSN is unique to each priority class within a HS-DSCH. It is not permitted to schedule new transmissions, including retransmissions originating in the RLC layer, along with retransmissions originating from the HARQ layer within the same TTI and HARQ process.
- HARQ:
One HARQ entity handles the hybrid ARQ functionality for one user. One HARQ entity is capable of supporting multiple instances (HARQ process) of stop and wait HARQ protocols. There shall be one HARQ process per TTI for single stream transmission and two HARQ processes per TTI for dual stream transmission.

In 1.28 Mcps TDD multi-frequency HS-DSCH cell:

- multiple HARQ processes are assigned for HS-DSCH operation on every carrier for every user, namely HARQ sub-entity; only one HARQ process in HARQ sub-entity is allowed to receive HS-DSCH in one TTI for each carrier.
- choice of 6bit or 9bit TSN is configured by upper layer signalling.
- TFRC selection:
The TFRC selection for MAC-ehs is identical to the TFRC selection of the MAC-hs.
- Priority Queue MUX:
This function determinates the number of octets to be included in a MAC-ehs PDU from each priority queue based on the scheduling decision and available TFRC for this function.
- Segmentation:
This function performs necessary segmentation of MAC-ehs SDUs.

The following is allowed:

The MAC-ehs SDUs included in a MAC-ehs PDU can have a different size and a different priority and can be mapped to different logical channels.

The associated signalling shown in the figure illustrates the exchange of information between layer 1 and layer 2 provided by primitives shown in [3].

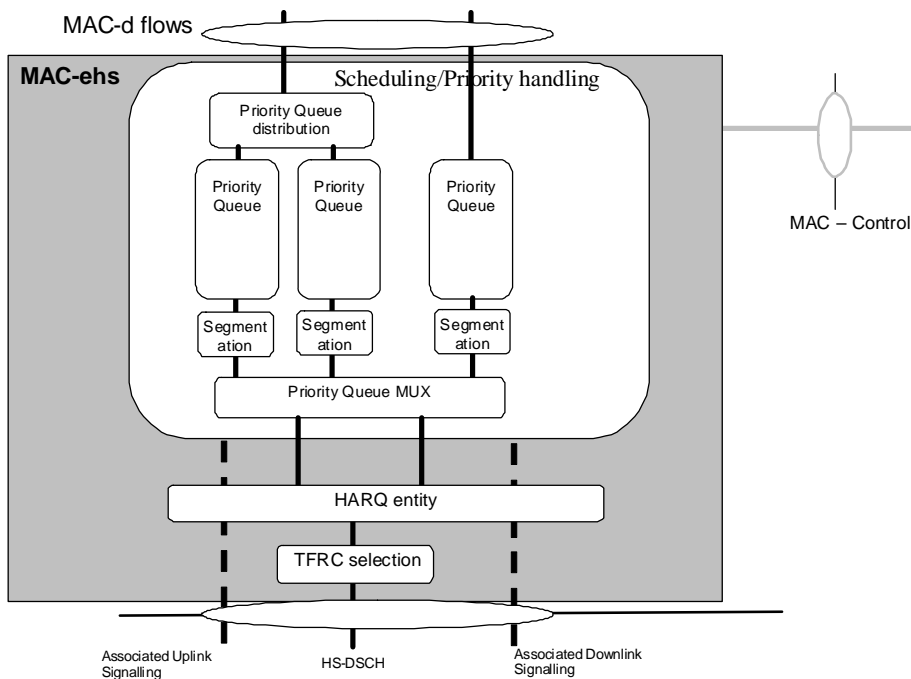

Figure 4.2.4.6-1: UTRAN side MAC architecture / MAC-ehs details

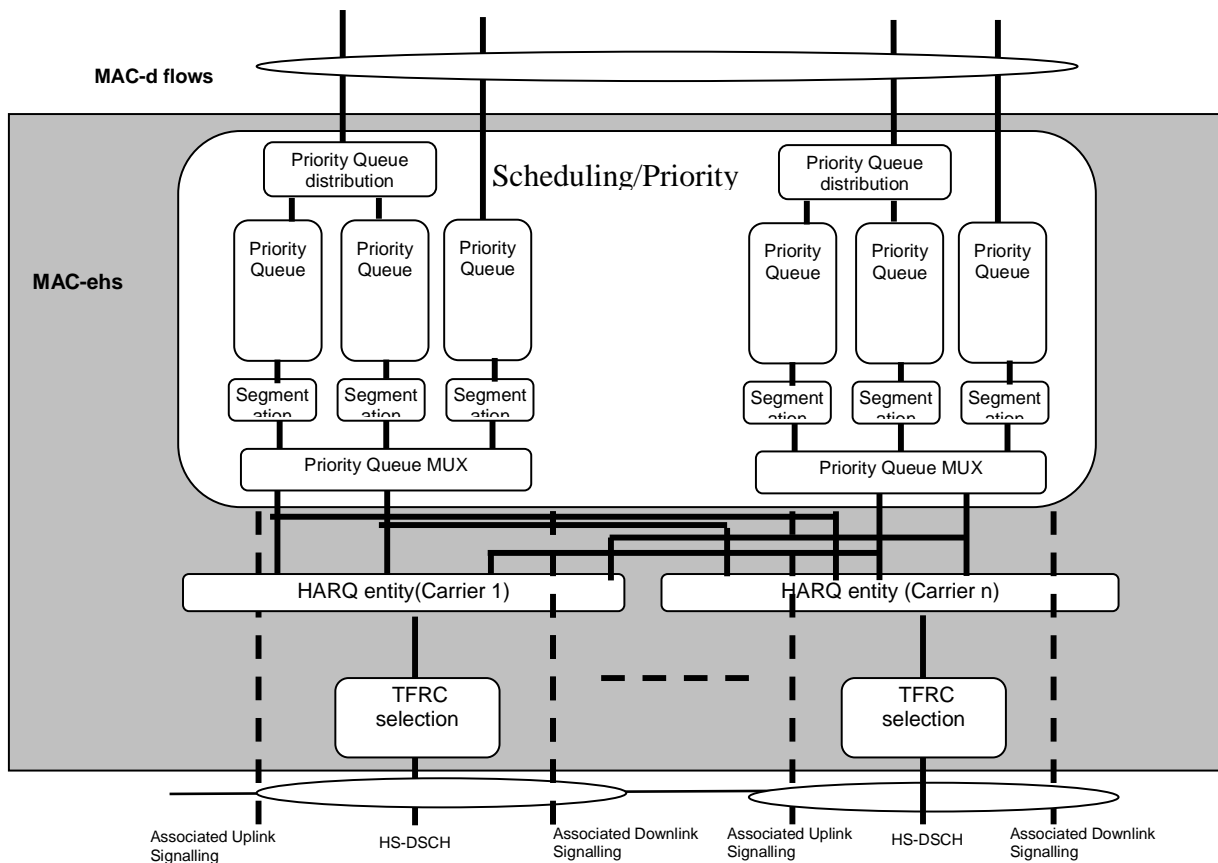

Figure 4.2.4.6-2: UTRAN side MAC architecture/MAC-ehs details (1.28Mcps TDD multi-frequency HS-DSCH operation mode only)

4.3 Channel structure

The MAC operates on the channels defined below; the transport channels are described between MAC and Layer 1, the logical channels are described between MAC and RLC.

The following subclauses provide an overview, the normative description can be found in [2] and [3] respectively.

4.3.1 Transport channels

Common transport channel types are:

- Random Access Channel(s) (RACH);
- Forward Access Channel(s) (FACH);
- Downlink Shared Channel(s) (DSCH), for TDD operation only;
- High Speed Downlink Shared Channel(s) (HS-DSCH);
- Uplink Shared Channel(s) (USCH), for TDD operation only;
- Broadcast Channel (BCH);
- Paging Channel (PCH).

Dedicated transport channel types are:

- Dedicated Channel (DCH);
- Enhanced Dedicated Channel (E-DCH) for UL operation only.

4.3.2 Logical Channels

The MAC layer provides data transfer services on logical channels. A set of logical channel types is defined for different kinds of data transfer services as offered by MAC.

Each logical channel type is defined by what type of information is transferred.

4.3.2.1 Logical channel structure

The configuration of logical channel types is depicted in figure 4.3.2.1.

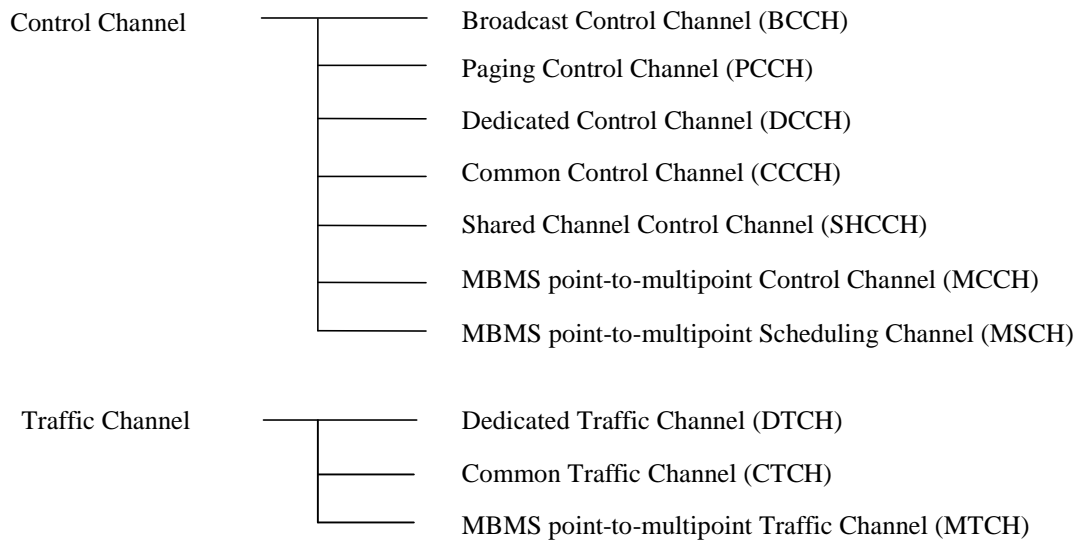

Figure 4.3.2.1: Logical channel structure

4.3.2.2 Control Channels

Following control channels are used for transfer of control plane information only:

- Broadcast Control Channel (BCCH);
- Paging Control Channel (PCCH);
- Common Control Channel (CCCH);
- Dedicated Control Channel (DCCH);
- Shared Channel Control Channel (SHCCH);
- MBMS point-to-multipoint Control Channel (MCCH);
- MBMS point-to-multipoint Scheduling Channel (MSCH)

4.3.2.3 Traffic Channels

Following traffic channels are used for the transfer of user plane information only:

- Dedicated Traffic Channel (DTCH);
- Common Traffic Channel (CTCH);
- MBMS point-to-multipoint Traffic Channel (MTCH).

5 Services provided to upper layers

This clause describes the different services provided by the MAC to higher layers. For a detailed description of the following functions see [2].

5.1 Description of Services provided to upper layers

- Data transfer: This service provides unacknowledged transfer of MAC SDUs between peer MAC entities without data segmentation.
- Reallocation of radio resources and MAC parameters: This service performs on request of RRC execution of radio resource reallocation and change of MAC parameters.
- Reporting of measurements: Local measurements are reported to RRC.

6 Functions

6.1 Description of the MAC functions

The functions of MAC include:

- mapping between logical channels and transport channels;
- selection of appropriate Transport Format for each Transport Channel depending on instantaneous source rate;
- priority handling between data flows of one UE;
- priority handling between UEs by means of dynamic scheduling;
- identification of UEs on common transport channels;
- identification of MBMS services on common transport channels;
- multiplexing/demultiplexing of upper layer PDUs into/from transport blocks delivered to/from the physical layer on common transport channels;
- multiplexing/demultiplexing of upper layer PDUs into/from transport block sets delivered to/from the physical layer on dedicated transport channels;
- segmentation and reassembly of upper layer PDUs
- traffic volume measurement;
- Transport Channel type switching;
- ciphering for transparent mode RLC;
- Access Service Class selection for RACH transmission;
- control of HS-DSCH transmission and reception including support of HARQ;
- HS-DSCH Provided Bit Rate measurement;
- control of E-DCH transmission and reception including support of HARQ;
- generation of uplink scheduling information to assist with E-DCH resource allocation;
- E-DCH Provided Bit-rate measurement.

6.2 Relation between MAC Functions and Transport Channels

6.2.1 Relation between MAC Functions and Transport Channels in UTRAN

Table 6.2.1.1: UTRAN MAC functions corresponding to the transport channel

Associated MAC Functions	Logical Ch	Transport Ch	TF Selection	Priority handling between UEs	Priority handling (one UE)	Scheduling	Identification of UEs or MBMS services	Mux/Demux on common transport channels	Mux/Demux on dedicated transport channels	HARQ support	Segmentation
Uplink (Rx)	CCCH	RACH						X			
	DCCH	RACH					X	X			
	DCCH	DCH							X		
	DTCH	RACH					X	X			
	DTCH	DCH							X		
	SHCCH	RACH					X	X			
	SHCCH	USCH						X			
	DTCH	USCH						X			
	DCCH	USCH						X			
	DTCH	E-DCH				X			X	X	
DCCH	E-DCH				X			X	X		
Downlink (Tx)	BCCH	BCH				X					
	BCCH	FACH	X			X		X			
	BCCH	HS-DSCH	X (1)			X		X		X	(2)
	PCCH	PCH	X			X					
	PCCH	HS-DSCH	X (1)			X		X		X	(2)
	CCCH	FACH	X	X		X		X			
	CCCH	HS-DSCH	X (1)			X		X		X	X
	CTCH	FACH	X			X		X			
	MCCH	FACH	X			X		X			
	MSCH	FACH	X			X		X			
	MTCH	FACH	X			X	X	X			
	CTCH	FACH	X			X		X			
	DCCH	FACH	X	X		X	X	X			
	DCCH	DSCH	X	X			X	X			
	DCCH	DCH	X		X				X		
	DCCH	HS-DSCH	X (1)	X	X	X	X	X		X	X
	DTCH	FACH	X	X		X	X	X			
DTCH	DSCH	X	X			X	X				
DTCH	DCH	X		X				X			
DTCH	HS-DSCH	X (1)	X	X	X	X	X		X	X	
SHCCH	FACH	X	X		X		X				
SHCCH	DSCH	X	X				X				

NOTE 1: In case of HS-DSCH the TF selection is replaced by TFRC selection.

NOTE 2: The UTRAN should not perform MAC-ehs segmentation for MAC-ehs SDUs from BCCH and PCCH logical channels.

6.2.2 Relation of MAC Functions and Transport Channels in UE

Table 6.2.2.1: UE MAC functions corresponding to the transport channel

Associated MAC Functions	Logical Ch	Transport Ch	TF Selection	Priority handling (one UE)	Identification	Mux/Demux on common transport channels	Mux/Demux on dedicated transport channels	HARQ support	Segmentation
Uplink (Tx)	CCCH	RACH				X			
	DCCH	RACH	X	X	X	X			
	DCCH	DCH	X	X			X		
	DTCH	RACH	X	X	X	X			
	DTCH	DCH	X	X			X		
	SHCCH	RACH				X			
	SHCCH	USCH	X	X		X			
	DCCH	USCH	X	X		X			
	DTCH	USCH	X	X		X			
	DCCH	E-DCH	X	X			X	X	
	DTCH	E-DCH	X	X			X	X	
Downlink (Rx)	BCCH	BCH							
	BCCH	FACH				X			
	BCCH	HS-DSCH				X		X	
	PCCH	PCH							
	PCCH	HS-DSCH				X		X	
	CCCH	FACH				X			
	CCCH	HS-DSCH				X		X	X
	CTCH	FACH				X			
	MCCH	FACH				X			
	MSCH	FACH				X			
	MTCH	FACH			X	X			
	DCCH	FACH			X	X			
	DCCH	DSCH				X			
	DCCH	DCH					X		
	DCCH	HS-DSCH			X	X		X	X
	DTCH	FACH			X	X			
	DTCH	DSCH				X			
DTCH	DCH					X			
DTCH	HS-DSCH			X	X		X	X	
SHCCH	FACH				X				
SHCCH	DSCH				X				

7 Services expected from physical layer

The physical layer offers information transfer services to MAC. For detailed description, see [3].

8 Elements for layer-to-layer communication

The interaction between the MAC layer and other layers are described in terms of primitives where the primitives represent the logical exchange of information and control between the MAC layer and other layers. The primitives shall not specify or constrain implementations. The MAC is connected to layer 1, RLC and RRC. The following subclauses describe the primitives between these layers.

8.1 Primitives between layers 1 and 2

8.1.1 Primitives

The primitives are described in [3].

8.1.2 Parameters

a) Transport Format Resource Indicator (TFRI) for HS-DSCH:

- For HS-DSCH the Transport Block size is derived from the TFRI value signalled on the HS-SCCH. The mapping between TFRI value and Transport Block size is specified in subclause 9.2.3.

b) HARQ information for E-DCH:

- ACK/NACK information (details specified in subclause 9.2.5.1).
- RSN information (details specified in subclause 9.2.5.1).
- Power offset (details specified in subclauses 11.8.1.4 and 11.9.1.4).
- E-TFCI (details specified in subclauses 11.8.1.4 and 11.9.1.4).

c) Relative Grant information for E-DCH (FDD only):

- Serving Relative Grant information (details specified in subclause 9.2.5.2.1).
- Non-serving Relative Grant information (details specified in subclause 9.2.5.2.1).

d) Absolute Grant information for E-DCH (details specified in subclause 9.2.5.2.2 for FDD and in 9.2.6.2.1 for TDD).

- Identity Type for E-DCH (FDD only).
- Absolute Grant Value.
- Absolute Grant Scope (FDD only).
- Absolute Grant Code Resource (TDD only)
- Absolute Grant Timeslot Resource (TDD only)
- Absolute Grant Resource Duration (TDD only)
- E-HICH Indicator (1.28 Mcps TDD only)
- E-UCCH Number Indicator (1.28 Mcps TDD only)

e) Happy Bit (FDD only, details specified in subclause 9.2.5.2.2).

8.2 Primitives between MAC and RLC

8.2.1 Primitives

The primitives between MAC layer and RLC layer are shown in table 8.2.1.1.

Table 8.2.1.1: Primitives between MAC layer and RLC layer

Generic Name	Parameter			
	Request	Indication	Response	Confirm
MAC-DATA	Data, BO, UE-ID type indicator, RLC Entity Info	Data, No_TB, TD (note), Error indication		
MAC-STATUS		No_PDU, PDU_Size, TX status	BO, RLC Entity Info	
NOTE: TDD only.				

MAC-DATA-Req/Ind:

- MAC-DATA-Req primitive is used to request that an upper layer PDU be sent using the procedures for the information transfer service;
- MAC-DATA-Ind primitive indicates the arrival of upper layer PDUs received within one transmission time interval by means of the information transfer service.

MAC-STATUS-Ind/Resp:

- MAC-STATUS-Ind primitive indicates to RLC for each logical channel the rate at which it may transfer data to MAC. Parameters are the number of PDUs that can be transferred in each transmission time interval and the PDU size; it is possible that MAC would use this primitive to indicate that it expects the current buffer occupancy of the addressed logical channel in order to provide for optimised TFC selection on transport channels with long transmission time interval. At the UE, MAC-STATUS-Ind primitive is also used to indicate from MAC to RLC that MAC has requested data transmission by PHY (i.e. PHY-DATA-REQ has been submitted, see Fig. 11.2.2.1), or that transmission of an RLC PDU on RACH has failed due to exceeded preamble ramping cycle counter.
- MAC-STATUS-Resp primitive enables RLC to acknowledge a MAC-STATUS-Ind. It is possible that RLC would use this primitive to indicate that it has nothing to send or that it is in a suspended state or to indicate the current buffer occupancy to MAC.

8.2.2 Parameters

a) Data:

- it contains the RLC layer messages (RLC-PDU) to be transmitted, or the RLC layer messages that have been received by the MAC sub-layer.

b) Number of transmitted transport blocks (No_TB) :

- indicates the number of transport blocks transmitted by the peer entity within the transmission time interval, based on the TFI value.

c) Buffer Occupancy (BO):

- the parameter Buffer Occupancy (BO) indicates for each logical channel the amount of data in number of bytes that is available for transmission and retransmission in RLC layer. When MAC is connected to an AM RLC entity, control PDUs to be transmitted and RLC PDUs outside the RLC Tx window shall also be included in the BO. RLC PDUs that have been transmitted but not negatively acknowledged by the peer entity shall not be included in the BO.

d) RX Timing Deviation (TD), TDD only:

- it contains the RX Timing Deviation as measured by the physical layer for the physical resources carrying the data of the Message Unit. This parameter is optional and only for Indication. It is needed for the transfer of the RX Timing Deviation measurement of RACH transmissions carrying CCCH data to RRC.

e) Number of PDU (No_PDU):

- specifies the number of PDUs that the RLC is permitted to transfer to MAC within a transmission time interval.

- f) PDU Size (PDU_Size):
- specifies the size of PDU that can be transferred to MAC within a transmission time interval.
- g) UE-ID Type Indicator:
- indicates the UE-ID type to be included in MAC for a DCCH and DTCH when they are mapped onto a common transport channel (i.e. FACH, RACH in FDD). On the UE side UE-ID Type Indicator shall always be set to C-RNTI.
- h) TX status:
- when set to value "transmission unsuccessful" this parameter indicates to RLC that transmission of an RLC PDU failed in the previous Transmission Time Interval, when set to value "transmission successful" this parameter indicates to RLC that the requested RLC PDU(s) has been submitted for transmission by the physical layer.
- i) RLC Entity Info
- indicates to MAC the configuration parameters that are critical to TFC selection depending on its mode and the amount of data that could be transmitted at the next TTI. This primitive is meant to insure that MAC can perform TFC selection (see subclause 11.4).
- j) Error indication
- When a MAC SDU is delivered to upper layer, an error indication is given for the SDU to upper layer if an error indication for the SDU has been received from lower layer.
- k) (Void)

8.3 Primitives between MAC and RRC

8.3.1 Primitives

The primitives between MAC and RRC are shown in table 8.3.1.1.

Table 8.3.1.1: Primitives between MAC sub-layer and RRC

Generic Name	Parameter			
	Request	Indication	Response	Confirm
CMAC-CONFIG	UE information elements, RB information elements, TrCH information elements, RACH transmission control elements, Ciphering elements, MBMS information elements, E-DCH configuration elements			
CMAC-MEASUREMENT	Measurement information elements	Measurement result		
CMAC-STATUS		Status info, E-RUCCH failure(only for 1.28Mcps TDD)		

CMAC-CONFIG-Req:

- CMAC-CONFIG-Req is used to request for setup, release and configuration of a logical channel, e.g. RNTI allocation, switching the connection between logical channels and transport channels, TFCS update or scheduling priority of logical channel.

CMAC-MEASUREMENT-Req/Ind:

- CMAC-MEASUREMENT-Req is used by RRC to request MAC to perform measurements, e.g. traffic volume measurements;
- CMAC-MEASUREMENT-Ind is used to notify RRC of the measurement result.

CMAC-STATUS-Ind:

- CMAC-STATUS-Ind primitive notifies RRC of status information.

8.3.2 Parameters

See [7] for a detailed description of the UE, RB and TrCH information elements.

- a) UE information elements
 - S-RNTI
 - SRNC identity
 - C-RNTI
 - Activation time
 - Primary E-RNTI configured
 - Secondary E-RNTI configured
- b) RB information elements
 - RB multiplexing info (Transport channel identity, Logical channel identity, MAC logical channel priority)
 - DDI mapping table for E-DCH transmission
 - Indication whether the Logical channel is considered when the Scheduling Information is generated
- c) TrCH information elements
 - Transport Format Combination Set
 - MAC-hs/ehs reset indicator
 - MAC-es/e reset indicator
 - Re-ordering release timer (T1)
 - HARQ Profile parameters (power offset, maximum number of re-transmissions and for 1.28 Mcps TDD retransmission timer)
 - E-DCH TTI duration (FDD only)
 - Allowed combinations for multiplexing of MAC-d flows into MAC-e PDUs
 - E-DCH grant type of MAC-d flows (scheduled or non-scheduled)
 - List of HARQ processes on which non-scheduled grants are allowed (for FDD only, this is if the grant type is non-scheduled and the E-DCH TTI duration is 2ms)
- d) Measurement information elements
 - Reporting Quantity identifiers
 - Time interval to take an average or a variance (applicable when Average or Variance is Reporting Quantity)
- e) Measurement result
 - Reporting Quantity
- f) Status info
 - when set to value "transmission unsuccessful" this parameter indicates to RRC that transmission of a TM RLC PDU failed (due to e.g. Maximum number of preamble ramping cycles reached for RACH in FDD), when set to value "transmission successful" this parameter indicates to RRC that the requested TM RLC PDU(s) has been submitted for transmission by the physical layer.
- g) RACH transmission control elements
 - Set of ASC parameters (identifier for PRACH partitions, persistence values)
 - Maximum number of preamble ramping cycles (FDD) or synchronisation attempts (1.28 Mcps TDD) M_{\max}
 - Minimum and maximum number of time units between two preamble ramping cycles, N_{BO1min} and N_{BO1max} (FDD only)
 - ASC for RRC CONNECTION REQUEST message
 - Type of random access procedure (1.28 Mcps only)

- h) Ciphering elements
 - Ciphering mode
 - Ciphering key
 - Ciphering sequence number
- i) (Void)
- j) MBMS information elements
 - MBMS Id
- k) E-DCH configuration elements
 - E-DPCCH to DPCCH power offset (FDD only)
 - Happy bit delay condition (FDD only)
 - E-TFCI table index
 - minimum set E-TFCI (FDD only)
 - Reference E-TFCI (FDD only)
 - Periodicities for Scheduling Information with and without grant (FDD only)
 - The code, timeslots and maximum power available per TDD resource unit per slot in TTIs designated for non-scheduled use by a given UE (TDD only)
 - The frames designated for non-scheduled use by a given UE (specified by means of a start frame number, repetition period and repetition length) (3.84/7.68 Mcps TDD only)
 - The subframes designated for non-scheduled use by a given UE (specified by means of a start subframe number, repetition period and repetition length) (1.28 Mcps TDD only)
 - Scheduling Information power offset
 - List of HARQ processes on which scheduled grants are allowed (for FDD only, this is if the E-DCH TTI duration is 2ms)
 - Initial Serving Grant value and type (FDD only)
 - E-DCH maximum and minimum allowed coderates (TDD only)
 - A table of paired values, each pair consists of code rate and β normative value (TDD only).
 - Parameters controlling E-RUCCH operation, such as T-RUCCH, T-SCHED, and a set of persistence values (one for each ASC) associated with E-RUCCH (3.84/7.68 Mcps TDD only).
- l) DTX-DRX and HS-SCCH less Information Elements (FDD only)
 - MAC DTX Cycle
 - MAC Inactivity Threshold
 - UE DTX DRX Offset
 - HS-SCCH less mode of operation
 - Inactivity Threshold for UE Grant Monitoring
 - Inactivity Threshold for UE DTX cycle 2
 - Default SG in DTX Cycle 2
- m) E-RUCCH failure(only for 1.28Mcps TDD)

9 Elements for peer-to-peer communication

9.1 Protocol data units

9.1.1 General

A MAC PDU is a bit string, with a length not necessarily a multiple of 8 bits. In the drawings in clause 9.1, bit strings are represented by tables in which the first bit is the leftmost one on the first line of the table, the last bit is the rightmost on the last line of the table, and more generally the bit string is to be read from left to right and then in the reading order of the lines.

Depending on the provided service, MAC SDUs are bit strings with any non-null length, or bit strings with an integer number of octets in length. An SDU is included into a MAC PDU from first bit onward.

In the UE for the uplink, all MAC PDUs delivered to the physical layer within one TTI are defined as Transport Block Set (TBS). It consists of one or several Transport Blocks, each containing one MAC PDU. The Transport Blocks, shall

be transmitted in the order as delivered from RLC. When multiplexing of RLC PDUs from different logical channels is performed on MAC, the order of all Transport Blocks originating from the same logical channel shall be the same as the order of the sequence delivered from RLC. The order of the different logical channels in a TBS is set by the MAC protocol.

9.1.2 MAC PDU (not HS-DSCH or E-DCH)

A MAC PDU consists of an optional MAC header and a MAC Service Data Unit (MAC SDU), see figure 9.1.2.1. Both the MAC header and the MAC SDU are of variable size.

The content and the size of the MAC header depends on the type of the logical channel, and in some cases none of the parameters in the MAC header are needed.

The size of the MAC-SDU depends on the size of the RLC-PDU, which is defined during the setup procedure.

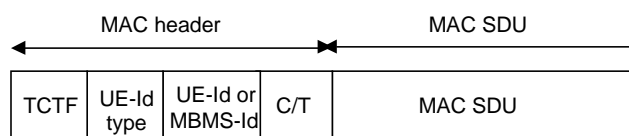

Figure 9.1.2.1: MAC PDU

9.1.3 MAC-d PDU (HS-DSCH)

For HS-DSCH the MAC-d PDU format equals the MAC PDU format for the non HS-DSCH case.

9.1.4 MAC PDU (HS-DSCH)

There are two different MAC PDU formats for HS-DSCH. Depending on configuration by higher layers the format is either MAC-hs or MAC-ehs. The MAC PDU format is determined by upper layer signalling [7].

When MAC-hs is configured, a MAC PDU for HS-DSCH consists of one MAC-hs header and one or more MAC-hs SDUs where each MAC-hs SDU equals a MAC-d PDU. A maximum of one MAC-hs PDU can be transmitted in a TTI per UE. The MAC-hs header is of variable size. The MAC-hs SDUs in one TTI belongs to the same reordering queue. In 1.28 Mcps TDD multi-frequency HS-DSCH cell, TSN can be extended to 9bit as indicated by RRC signalling. When TSN is extended to 9bit, the 3 least significant bits are placed after the last MAC-hs SDU.

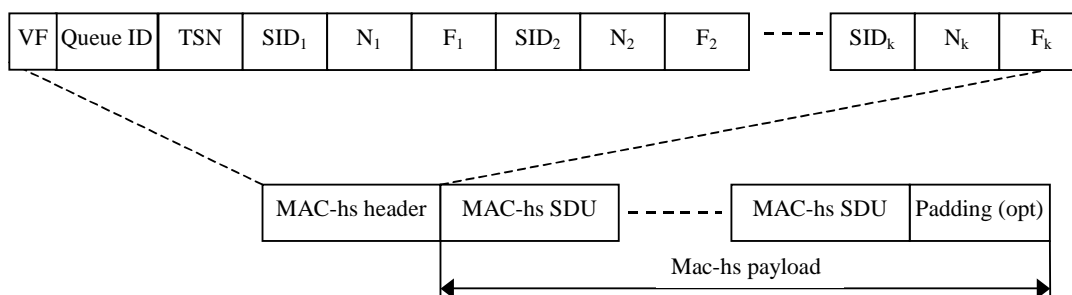

Figure 9.1.4.1: MAC-hs PDU

When MAC-ehs is configured, a MAC PDU for HS-DSCH consists of one MAC-ehs header and one or more reordering PDUs. Each reordering PDU consists of one or more reordering SDUs belonging to the same priority queue. All reordering SDUs belonging to the same priority queue in one TTI shall be mapped to the same reordering PDU. Each reordering SDU equals a complete MAC-ehs SDU or a segment of a MAC-ehs SDU. Each MAC-ehs SDU equals a MAC-d PDU or a MAC-c PDU (FDD only). The LCH-ID and L fields are repeated per reordering SDU. The TSN and SI fields are repeated per reordering PDU. In 1.28 Mcps TDD multi-frequency HS-DSCH cell, TSN can be extended to 9bit as indicated by RRC signalling. When TSN is extended to 9bit, the 3 least significant bits are placed

after the last reordering PDU. If several TSNs is included in MAC-ehs header, the extended bits of TSN should be concatenated in the same order as that of the TSN occurrence in the MAC-ehs header.

The presence of the TSN_i and SI_i fields is based on the value of the $LCH-ID_i$; if the $LCH-ID_i$ is mapped to the same reordering queue as $LCH-ID_{i-1}$ or if the value of $LCH-ID_{i-1}$ is equal to the value of $LCH-ID_i$, there is no TSN_i or SI_i field. The mapping of the LCH-ID to the reordering queue is provided by upper layers [7], except for BCCH or PCCH where no reordering is applied. The TSN_1 and SI_1 fields are always present. For BCCH or PCCH the TSN field, if present, is always set to zero, the SI field, if present, is always set to '00' and the TSN and SI fields shall be ignored by the receiver.

Depending on the HS-DSCH physical layer category, the maximum number of MAC-ehs PDUs that can be transmitted in a TTI per UE is one or two.

The reordering SDUs in one TTI can belong to different priority queues. The reordering SDUs in one TTI can belong to at most 3 priority queues. If reordering SDUs in one TTI belong to more than 3 priority queues or are in greater number than 26, the UE behaviour is unspecified. The MAC-ehs header is of variable size.

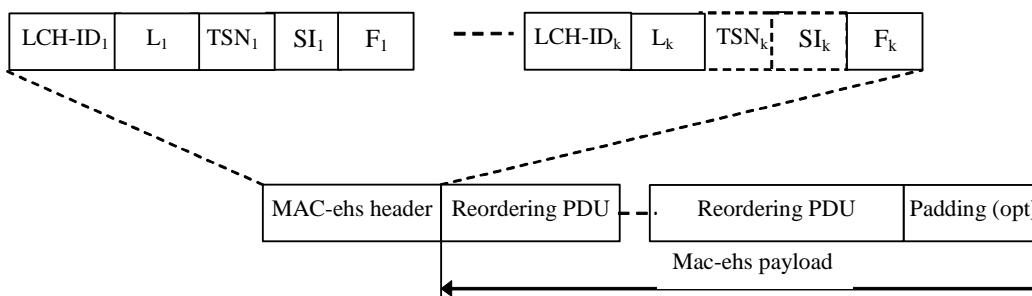

Figure 9.1.4.2: MAC-ehs PDU

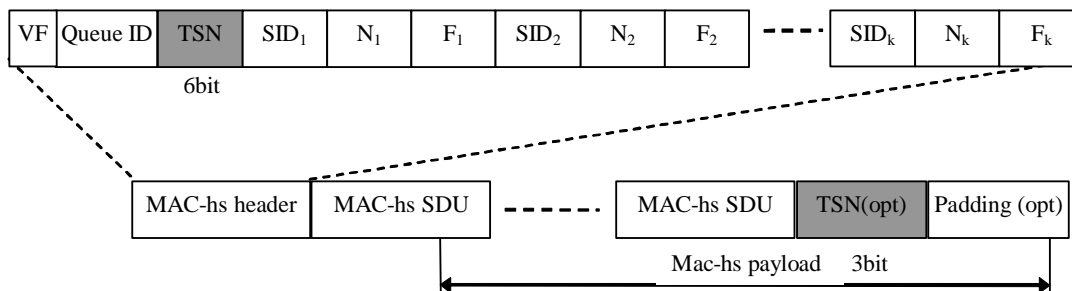

Figure 9.1.4.3: MAC-hs PDU (1.28Mcps TDD multi-frequency HS-DSCH operation mode only)

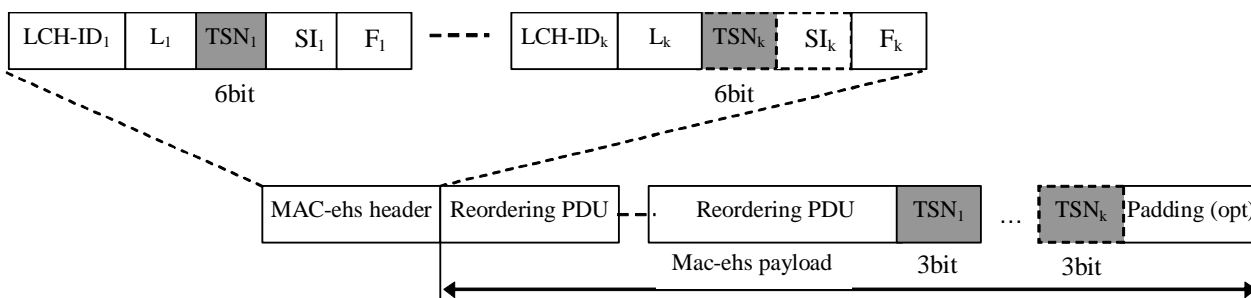

Figure 9.1.4.4: MAC-ehs PDU (1.28Mcps TDD multi-frequency HS-DSCH operation mode only)

9.1.5 MAC PDU (E-DCH)

In the case of E-DCH there are two MAC sublayers, MAC-e and MAC-es. MAC-es sits on top of MAC-e and receives PDUs directly from MAC-d. MAC-es SDUs (i.e. MAC-d PDUs) of the same size, coming from a particular logical channel are multiplexed together into a single MAC-es payload. There is one and only one MAC-es PDU per logical channel per TTI (since only one MAC-d PDU size is allowed per logical channel per TTI). To this payload is prepended the MAC-es header (see subclause 9.2.4.1). The number of PDUs, as well as the one DDI value identifying the logical

channel, the MAC-d flow and the MAC-es SDU size are included as part of the MAC-e header. In case sufficient space is left in the E-DCH transport block or if Scheduling Information needs to be transmitted, an SI will be included at the end of the MAC-e PDU (see subclause 9.2.4.2). Multiple MAC-es PDUs from multiple logical channels, but only one MAC-e PDU can be transmitted in a TTI.

In the example MAC-e PDU shown in figure 9.1.5.2a, the field DDI_0 is referring to the specific DDI value that indicates that there is an SI included in the MAC-e PDU (see subclause 9.2.4.2). This header will not be associated with a new MAC-es payload. Figure 9.1.5.2b shows the MAC-e PDU format when SI is sent alone. In this case DDI_0 is not included in the MAC-e PDU and E-TFCI value 0 is used.

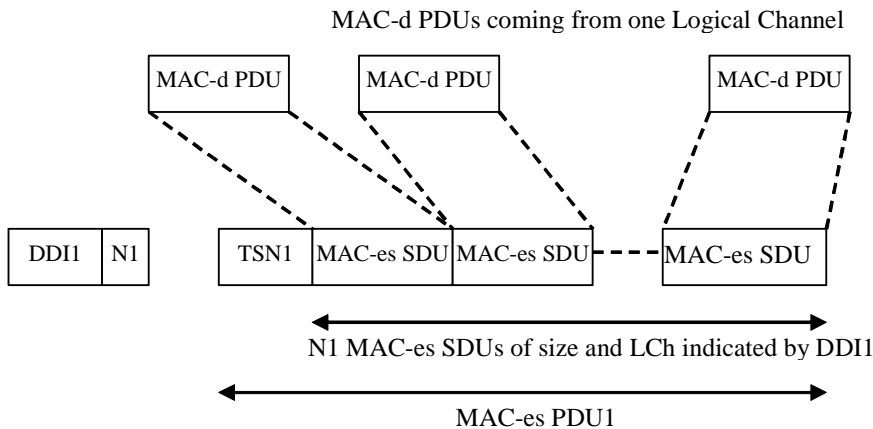

Figure 9.1.5.1 MAC-es PDU

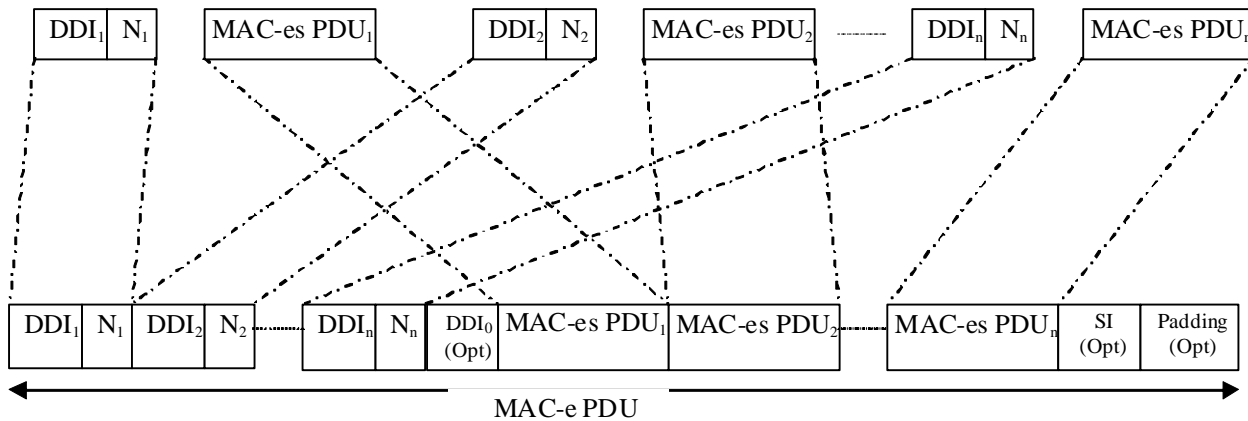

Figure 9.1.5.2a: MAC-e PDU



Figure 9.1.5.2b: MAC-e PDU (SI is sent alone)

9.2 Formats and parameters

NOTE: MAC header field encodings as specified in this clause with designation "Reserved" are forbidden to be used by a sender in this version of the protocol.

9.2.1 MAC PDU: Parameters of the MAC PDU header (not HS-DSCH or E-DCH) and MAC-d PDU header (HS-DSCH and E-DCH)

The following fields are defined for the MAC header for transport channels other than HS-DSCH and for the MAC-d PDU header for HS-DSCH:

- Target Channel Type Field
The TCTF field is a flag that provides identification of the logical channel class on FACH, USCH (TDD only), DSCH (TDD only) and RACH transport channels, i.e. whether it carries BCCH, CCCH, CTCH, SHCCH, MCCH, MTCH, MSCH or dedicated logical channel information. The size and coding of TCTF for FDD and TDD are shown in tables 9.2.1.1, 9.2.1.2, 9.2.1.3, 9.2.1.4 and 9.2.1.5. Note that the size of the TCTF field of FACH for FDD is 2,4 or 8 bits and for TDD is either 3 or 5 bits depending on the value of the 3 most significant bits. The TCTF of the RACH for TDD is either 2 or 4 bits depending on the value of the 2 most significant bits.

Table 9.2.1.1: Coding of the Target Channel Type Field on FACH for TDD

TCTF	Designation
000	BCCH
001	CCCH
010	CTCH
01100	DCCH or DTCH over FACH
01101	MCCH
01110	MTCH
01111	MSCH
100	SHCCH
101-111	Reserved (PDUs with this coding will be discarded by this version of the protocol)

Table 9.2.1.2: Coding of the Target Channel Type Field on FACH for FDD

TCTF	Designation
00	BCCH
01000000	CCCH
01000001- 01001111	Reserved (PDUs with this coding will be discarded by this version of the protocol)
01010000	MCCH
01010001- 01011110	Reserved (PDUs with this coding will be discarded by this version of the protocol)
01011111	MSCH
0110	MTCH
0111	Reserved (PDUs with this coding will be discarded by this version of the protocol)
10000000	CTCH
10000001- 10111111	Reserved (PDUs with this coding will be discarded by this version of the protocol)
11	DCCH or DTCH over FACH

Table 9.2.1.3: Coding of the Target Channel Type Field on USCH or DSCH (TDD only)

TCTF	Designation
0	SHCCH
1	DCCH or DTCH over USCH or DSCH

Table 9.2.1.4: Coding of the Target Channel Type Field on RACH for FDD

TCTF	Designation
00	CCCH
01	DCCH or DTCH over RACH
10-11	Reserved (PDUs with this coding will be discarded by this version of the protocol)

Table 9.2.1.5: Coding of the Target Channel Type Field on RACH for TDD

TCTF	Designation
00	CCCH
0100	DCCH or DTCH Over RACH
0101- 0111	Reserved (PDUs with this coding will be discarded by this version of the protocol)
10	SHCCH
11	Reserved (PDUs with this coding will be discarded by this version of the protocol)

- C/T field

The C/T field provides identification of the logical channel instance when multiple logical channels are carried on the same transport channel (other than HS-DSCH) or same MAC-d flow (HS-DSCH). The C/T field is used also to provide identification of the logical channel type on dedicated transport channels and on FACH and RACH when used for user data transmission. The size of the C/T field is fixed to 4 bits for both common transport channels and dedicated transport channels. Table 9.2.1.5a shows the 4-bit C/T field.

Table 9.2.1.5a: Structure of the C/T field

C/T field	Designation
0000	Logical channel 1
0001	Logical channel 2
...	...
1110	Logical channel 15
1111	Reserved (PDUs with this coding will be discarded by this version of the protocol)

- UE-Id

The UE-Id field provides an identifier of the UE on common transport channels. The following types of UE-Id used on MAC are defined:

- UTRAN Radio Network Temporary Identity (U-RNTI) may be used in the MAC header of DCCH using RLC UM (SRB1), when mapped onto common transport channels in downlink direction; the U-RNTI is never used in uplink direction;
- Cell Radio Network Temporary Identity (C-RNTI) is used on DTCH and DCCH in uplink, and may be used on DCCH in downlink and is used on DTCH in downlink when mapped onto common transport channels, except when mapped onto DSCH transport channel in TDD;

Table 9.2.1.6: Lengths of UE Id field

UE Id type	Length of UE Id field
U-RNTI	32 bits
C-RNTI	16 bits

- UE-Id Type

The UE-Id Type field is needed to ensure correct decoding of the UE-Id field in MAC Headers.

Table 9.2.1.7: UE-Id Type field definition

UE-Id Type field 2 bits	UE-Id Type
00	U-RNTI
01	C-RNTI
10	Reserved (PDUs with this coding will be discarded by this version of the protocol)
11	Reserved (PDUs with this coding will be discarded by this version of the protocol)

- MBMS-Id

The MBMS-Id field provides an identifier of MTCH for an MBMS service carried on FACH. The MBMS-Id is used in the MAC header of MTCH mapped onto FACH in downlink direction; the MBMS-Id is never used in uplink direction. The MBMS Id to be used by MAC is configured through the MAC control SAP. The length of the MBMS-Id field is 4 bits. Table 9.2.1.7a shows the 4-bit MBMS-Id field.

Table 9.2.1.8: Structure of the MBMS-Id field

MBMS-Id field	MBMS logical channel identity [7]
0000	1
0001	2
...	...
1110	15
1111	Reserved (PDUs with this coding will be discarded by this version of the protocol)

9.2.1.1 MAC header for DTCH and DCCH (not mapped on HS-DSCH or E-DCH)

- a) DTCH or DCCH mapped to DCH, no multiplexing of dedicated channels on MAC:
 - no MAC header is required.
- b) DTCH or DCCH mapped to DCH, with multiplexing of dedicated channels on MAC:
 - C/T field is included in MAC header.
- c) DTCH or DCCH mapped to RACH/FACH:
 - TCTF field, C/T field, UE-Id type field and UE-Id are included in the MAC header. For FACH, the UE-Id type field used is the C-RNTI or U-RNTI. For RACH, the UE-Id type field used is the C-RNTI.
- d) DTCH or DCCH mapped to DSCH or USCH:
 - the TCTF field is included in the MAC header. The C/T field is included if multiplexing on MAC is applied.
- e) DTCH or DCCH mapped to DSCH or USCH where DTCH or DCCH are the only logical channels:
 - The C/T field is included in the MAC header if multiplexing on MAC is applied.

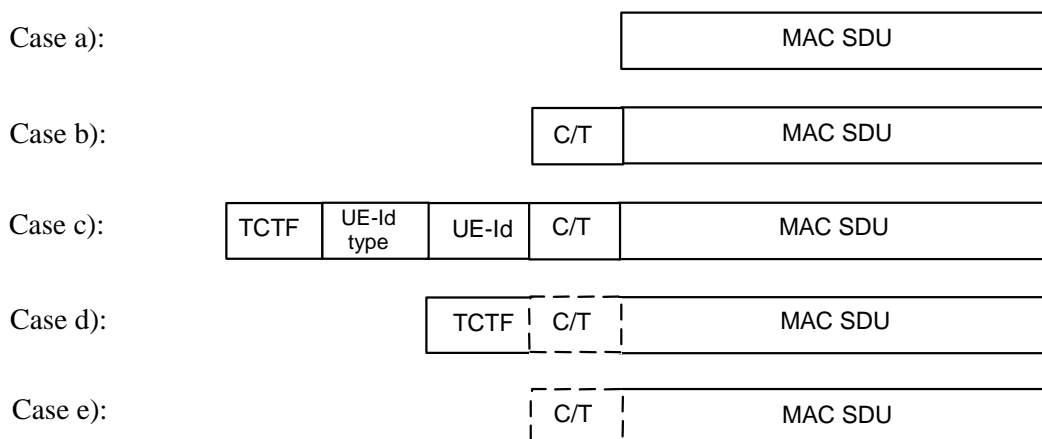

Figure 9.2.1.1.1: MAC PDU formats for DTCH and DCCH

9.2.1.1a MAC-d Header for DTCH and DCCH (mapped on HS-DSCH)

In CELL_DCH state, the MAC-d PDU header for DTCH and DCCH mapped on HS-DSCH is as shown in figure 9.2.1.1a.1.

- C/T field is included in the MAC-d PDU header if multiplexing on MAC is applied.
- If MAC-ehs is configured by upper layers [7], no MAC-d PDU header is required.

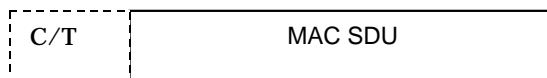

Figure 9.2.1.1a.1 MAC-d PDU format for DTCH and DCCH mapped on HS-DSCH

9.2.1.1b MAC-d Header for DTCH and DCCH (mapped on E-DCH)

For DTCH and DCCH mapped on E-DCH there is no need for a MAC-d header. Therefore, the MAC-d PDU is as shown in figure 9.2.1.1b.1.



Figure 9.2.1.1b.1 MAC-d PDU format for DTCH and DCCH mapped on E-DCH

9.2.1.1c MAC Headers for DTCH and DCCH (mapped on HS-DSCH, FDD only)

In FDD, the MAC PDU header for DTCH and DCCH mapped on HS-DSCH CELL_FACH, CELL_PCH state is as shown in figure 9.2.1.1c-1.

- there is no MAC-d header included for DTCH and DCCH.
- there is no MAC-c header included for DTCH and DCCH when UE dedicated H-RNTI is used.
- the U-RNTI is only included as MAC-c header to MAC-d PDU for DCCH (SRB#1 only) when common H-RNTI is used

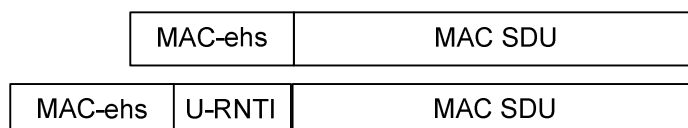

Figure 9.2.1.1c-1: MAC PDU format for DTCH and DCCH mapped on HS-DSCH (FDD only)

9.2.1.2 MAC header for BCCH

- BCCH mapped to BCH:
 - no MAC header is included.
- BCCH mapped to FACH:
 - the TCTF field is included in MAC header.
- in FDD, when BCCH mapped to HS-DSCH
 - the MAC-ehs header is included.

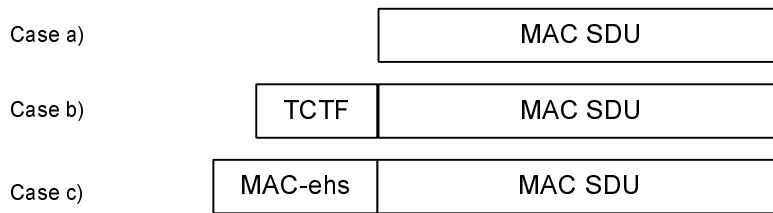

Figure 9.2.1.2.1: MAC PDU formats for BCCH

9.2.1.3 MAC header for PCCH

There is no MAC header for PCCH when mapped on PCH.

In FDD when PCCH is mapped on HS-DSCH:

- the MAC-ehs header is included as depicted in Figure 9.2.1.3-1.

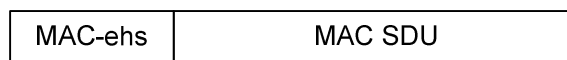

Figure 9.2.1.3-1: MAC PDU format for PCCH (FDD only)

9.2.1.4 MAC header for CCCH

CCCH mapped to RACH/FACH:

- TCTF field is included in MAC header.

In FDD, CCCH mapped to HS-DSCH

- no MAC-c header is included.

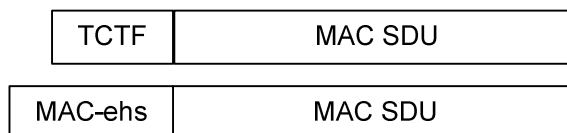

Figure 9.2.1.4.1: MAC PDU formats for CCCH

9.2.1.5 MAC Header for CTCH

The TCTF field is included as MAC header for CTCH as shown in figure 9.2.1.5.1.

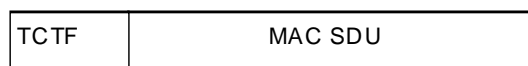

Figure 9.2.1.5.1: MAC PDU format for CTCH

9.2.1.6 MAC Header for SHCCH

The MAC header for SHCCH is as shown in figure 9.2.1.6.1.

- a) SHCCH mapped to RACH and USCH/FACH and DSCH:
 - TCTF has to be included.
- b) SHCCH mapped to RACH and USCH/FACH and DSCH, where SHCCH is the only channel.

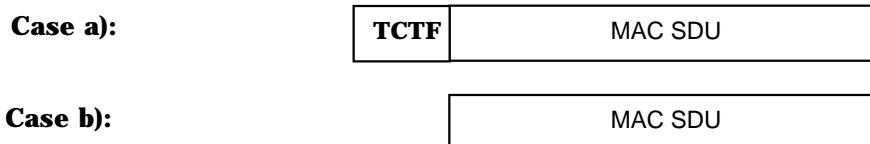

Figure 9.2.1.6.1: MAC PDU format for SHCCH

9.2.1.7 MAC Header for MCCH

The MAC PDU format for MCCH is as shown in figure 9.2.1.7.1.

- a) If the MAC header for MCCH is not configured through the MAC control SAP:
 - there is no MAC header for MCCH.
- b) If the MAC header for MCCH is configured through the MAC control SAP:
 - TCTF field is included in the MAC header for MCCH.

NOTE: If MCCH is not the only channel on the FACH, the MAC header shall be configured for the MCCH.

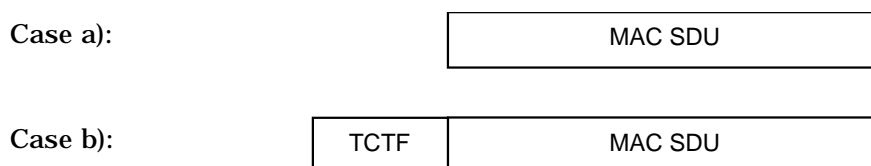

Figure 9.2.1.7.1: MAC PDU format for MCCH

9.2.1.8 MAC Header for MTCH

The TCTF field and MBMS-Id field are included in the MAC header for MTCH as shown in figure 9.2.1.8.1.



Figure 9.2.1.8.1: MAC PDU format for MTCH

9.2.1.9 MAC Header for MSCH

The MAC PDU format for MSCH is as shown in figure 9.2.1.9.1.

- a) If the MAC header for MSCH is not configured through the MAC control SAP:
 - there is no MAC header for MSCH.
- b) If the MAC header for MSCH is configured through the MAC control SAP:
 - TCTF field is included in the MAC header for MSCH.

NOTE: If MSCH is not the only channel on the FACH, the MAC header shall be configured for the MSCH.

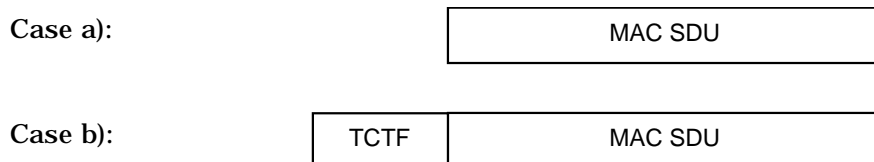

Figure 9.2.1.9.1: MAC PDU format for MSCH

9.2.2 MAC PDU: Parameters of the MAC header (HS-DSCH)

If MAC-hs is configured by upper layers [7], the parameters for the MAC header are:

- Version Flag (VF):
The VF field is a one bit flag providing extension capabilities of the MAC-hs PDU format. The VF field shall be set to zero and the value one is reserved in this version of the protocol.
- Queue identifier (Queue ID):
The Queue ID field provides identification of the reordering queue in the receiver, in order to support independent buffer handling of data belonging to different reordering queues. The length of the Queue ID field is 3 bit.
- Transmission Sequence Number (TSN):
The TSN field provides an identifier for the transmission sequence number on the HS-DSCH. The TSN field is used for reordering purposes to support in-sequence delivery to higher layers. For 1.28 Mcps TDD multi-frequency HS-DSCH operation mode, the length of the TSN field can be 6 bits or 9 bits, which is configured by higher layer. For other operation modes, the length of the TSN field is 6 bit.
- Size index identifier (SID):
The SID fields identifies the size of a set of consecutive MAC-d PDUs. The MAC-d PDU size for a given SID is configured by higher layers and is independent for each Queue ID. The length of the SID field is 3 bit.
- Number of MAC-D PDUs (N):
The number of consecutive MAC-d PDUs with equal size is identified with the N field. The length of the N field is 7 bits. In FDD mode, the maximum number of PDUs transmitted in a single TTI shall be assumed to be 70. In 1.28 Mcps TDD mode, the maximum number of PDUs transmitted in a single TTI shall be assumed to be 45. In 3.84 Mcps TDD mode, the maximum number of PDUs transmitted in a single TTI shall be assumed to be 318. In 7.68 Mcps TDD mode, the maximum number of PDUs transmitted in a single TTI shall be assumed to be 636. If more PDUs than the defined maximum number of PDUs for the corresponding mode are received, the UE behaviour is unspecified.
- Flag (F):
The F field is a flag indicating if more fields are present in the MAC-hs header or not. If the F field is set to "0" the F field is followed by an additional set of SID, N and F fields. If the F field is set to "1" the F field is followed by a MAC-d PDU. The maximum number of MAC-hs header extensions, i.e. number of fields F set to "0", in a single TTI shall be assumed to be 7. If more extensions than the maximum defined for the corresponding mode are included in a TTI, the UE behaviour is unspecified.

If MAC-ehs is configured by upper layers [7], the parameters for the MAC header are:

- Logical channel identifier (LCH-ID):

The LCH-ID field provides identification of the logical channel at the receiver and the re-ordering buffer destination of a reordering SDU.

The length of the LCH-ID is 4 bits.

In FDD, when SDU from BCCH or PCCH logical channel is transmitted on HS-DSCH the LCH-ID field in MAC-ehs header is set to 1111. The identification of the logical channel is done based on H-RNTI value used for broadcast information in or for paging in HS-SCCH. Table 9.2.2-0 shows the 4-bit LCH-ID field.

Table 9.2.2-0: Structure of the LCH-ID field

LCH-ID field	Designation
0000	Logical channel 1
0001	Logical channel 2
...	...
1110	Logical channel 15
1111	Used when SDU from BCCH or PCCH logical channel is transmitted on HS-DSCH

- Transmission Sequence Number (TSN):

The TSN field provides an identifier for the transmission sequence number on the HS-DSCH. The TSN field is used for reordering purposes to support in-sequence delivery to higher layers. The length of the TSN field is 6 bit.

- Segmentation Indication (SI)

The SI field indicates if the MAC-ehs SDU has been segmented. Table 9.2.2-1 shows the 2 bit SI field.

Table 9.2.2-1: Structure of the SI field

SI Field	Segmentation indication
00	The first reordering SDU of the reordering PDU is a complete MAC-ehs SDU. The last reordering SDU of the reordering PDU is a complete MAC-ehs SDU.
01	If there are more than one reordering SDUs in the reordering PDU, the last reordering SDU of the reordering PDU is a complete MAC-ehs SDU. The first reordering SDU of the reordering PDU is the last segment of a MAC-ehs SDU.
10	If there are more than one reordering SDUs in the reordering PDU, the first reordering SDU of the reordering PDU is a complete MAC-ehs SDU. The last reordering SDU of the reordering PDU is the first segment of a MAC-ehs SDU.
11	If there are more than one reordering SDUs in the reordering PDU, the first reordering SDU of the reordering PDU is the last segment of a MAC-ehs SDU and the last reordering SDU of reordering PDU is the first segment of a MAC-ehs SDU. If there is only one reordering SDU in the reordering PDU, the reordering SDU is a middle segment of a MAC-ehs SDU.

- Length (L)

The L field provides the length of the reordering SDU in octets. The reordering SDU size can vary for each reordering SDU in the MAC-ehs PDU, and is set for each reordering SDU individually. The length of the Length field is 11 bits.

- Flag (F)

The F field is a flag indicating if more fields are present in the MAC-ehs header or not. If the F field is set to "0" the F field is followed by an additional set of LCH-ID and L fields and optionally (as described in section 9.1.4) TSN and SI fields. If the F field is set to "1" the F field is followed by a reordering PDU. Each header extension corresponds to one reordering SDU.

9.2.2.1 MAC header for DTCH and DCCH

If MAC-hs is configured by upper layers [7]:

a) DTCH or DCCH mapped to HS-DSCH:

- The Queue ID field and TSN field are always included in the MAC-hs header. One SID field, N field and F field is included for each MAC-d PDU size included in the MAC-hs PDU. Padding is not explicitly indicated but is included in the end of the MAC-hs PDU if the total size of the MAC-hs payload plus the MAC-hs header is smaller than the transport block set size.

If MAC-ehs is configured by upper layers [7]:

a) DTCH or DCCH mapped to HS-DSCH:

- There is always one LCH ID field and L field for each reordering SDU included in the MAC-ehs PDU and one TSN and SI field for each reordering PDU included in the MAC-ehs PDU. Padding is not explicitly indicated but is included in the end of the MAC-ehs PDU if the total size of the MAC-ehs payload plus the MAC-ehs header is smaller than the transport block set size.

9.2.3 Signalling of Transport Block size for HS-DSCH

For HS-DSCH the transport block size is derived from the TFRI value signalled on the HS-SCCH. The mapping between the TFRI value and the transport block size for each mode is specified below:

9.2.3.1 Transport block size for FDD

For all transmissions of a transport block, the transport block size is derived from the TFRI value as specified below, except only in those cases of retransmissions where the Node-B selects a combination for which no mapping exists between the original transport block size and the selected combination of channelisation Code set and modulation type. In such cases, the transport block size index value signalled to the UE shall be set to 111111, i.e., $k_i=63$.

Let k_i be the TFRI signalled on the HS-SCCH value and let $k_{0,i}$ be the value in table 9.2.3.1 or table 9.2.3.2 (as configured by higher layers) corresponding to the modulation and the number of codes signalled on the HS-SCCH. Let k_t be the sum of the two values: $k_t = k_i + k_{0,i}$. The transport block size $L(k_t)$ can be obtained by accessing the position k_t in one of the tables in Annex A (normative) or by using one of the corresponding formulas below (informative).

The use of table 9.2.3.2 requires MAC-ehs.

Formula corresponding to table 9.2.3.1:

If $k_t < 40$

$$L(k_t) = 125 + 12 \cdot k_t$$

else

$$L(k_t) = \lfloor L_{\min} p^{k_t} \rfloor$$

$$p = 2085 / 2048$$

$$L_{\min} = 296$$

end

Table 9.2.3.1: Values of $k_{0,i}$ for different numbers of channelization codes and modulation schemes, bit aligned (QPSK and 16QAM)

Combination i	Modulation scheme	Number of channelization codes	$k_{0,i}$
0	QPSK	1	1
1		2	40
2		3	63
3		4	79
4		5	92
5		6	102

6		7	111
7		8	118
8		9	125
9		10	131
10		11	136
11		12	141
12		13	145
13		14	150
14		15	153
15	16QAM	1	40
16		2	79
17		3	102
18		4	118
19		5	131
20		6	141
21		7	150
22		8	157
23		9	164
24		10	169
25		11	175
26		12	180
27		13	184
28		14	188
29		15	192

NOTE: Some UE categories are only required to support values of K_r up to the value of 52 for the first HARQ transmission, as described in [23].

Formula corresponding to table 9.2.3.2:

If $k_r < 40$

$$L(k_r) = (14 + k_r) * 8$$

else

$$L(k_r) = \lfloor L_{\min} p^{k_r} \rfloor * 8$$

$$p = \left(\frac{5274}{27} \right)^{\frac{1}{296-1}}$$

$$L_{\min} = 27$$

end

Table 9.2.3.2: Values of $k_{0,i}$ for different numbers of channelization codes and modulation schemes, octet aligned (QPSK, 16QAM and 64QAM)

Combination i	Modulation scheme	Number of channelization codes	$k_{0,i}$
0	QPSK	1	1
1		2	58
2		3	81
3		4	97
4		5	109
5		6	119

6		7	128
7		8	136
8		9	142
9		10	148
10		11	153
11		12	158
12		13	163
13		14	167
14		15	171
15	16QAM	1	58
16		2	97
17		3	119
18		4	136
19		5	148
20		6	158
21		7	167
22		8	174
23		9	181
24		10	187
25		11	192
26		12	197
27		13	201
28		14	206
29		15	209
30	64QAM	1	81
31		2	119
32		3	142
33		4	158
34		5	171
35		6	181
36		7	190
37		8	197
38		9	204
39		10	209
40		11	215
41		12	220
42		13	224
43		14	228
44		15	233

NOTE: Some UE categories are only required to support values of K_i up to the value of 52 for the first HARQ transmission, as described in [23].

9.2.3.2 Transport block size for 3.84 Mcps TDD

Let k be the signalled TFRI value, then the corresponding HS-DSCH transport block size L_k is given by :

If $k=1..510$

$$L_k = \left\lfloor L_{\min} P^k \right\rfloor$$

$$P = \frac{8313}{8192}$$

$$L_{\min} = 57$$

If $k = 511$

$$L_k = 102000$$

If $k=0$, L_k indicates NULL and shall not be used to signal a transport block size in the TFRI.

Transport block sizes calculated by this formula shall equal the values indicated in Table 9.2.3.2.1

Table 9.2.3.2.1: HSDPA Transport Block Sizes for 3.84 Mcps TDD

TB index (k)	TB size [bits]	TB index (k)	TB size [bits]	TB index (k)	TB size [bits]	TB index (k)	TB size [bits]
0	NULL	128	372	256	2432	384	15890
1	57	129	377	257	2468	385	16124
2	58	130	383	258	2504	386	16362
3	59	131	389	259	2541	387	16604
4	60	132	394	260	2579	388	16849
5	61	133	400	261	2617	389	17098
6	62	134	406	262	2656	390	17351
7	63	135	412	263	2695	391	17607
8	64	136	418	264	2735	392	17867
9	65	137	424	265	2775	393	18131
10	66	138	431	266	2816	394	18399
11	66	139	437	267	2858	395	18671
12	67	140	443	268	2900	396	18946
13	68	141	450	269	2943	397	19226
14	69	142	457	270	2986	398	19510
15	71	143	463	271	3030	399	19798
16	72	144	470	272	3075	400	20091
17	73	145	477	273	3121	401	20388
18	74	146	484	274	3167	402	20689
19	75	147	491	275	3213	403	20994
20	76	148	499	276	3261	404	21304
21	77	149	506	277	3309	405	21619
22	78	150	514	278	3358	406	21938
23	79	151	521	279	3408	407	22263
24	81	152	529	280	3458	408	22591
25	82	153	537	281	3509	409	22925
26	83	154	545	282	3561	410	23264
27	84	155	553	283	3613	411	23607
28	85	156	561	284	3667	412	23956
29	87	157	569	285	3721	413	24310
30	88	158	578	286	3776	414	24669
31	89	159	586	287	3832	415	25033
32	91	160	595	288	3888	416	25403
33	92	161	604	289	3946	417	25778
34	93	162	613	290	4004	418	26159
35	95	163	622	291	4063	419	26545
36	96	164	631	292	4123	420	26938
37	98	165	640	293	4184	421	27335

38	99	166	650	294	4246	422	27739
39	100	167	659	295	4309	423	28149
40	102	168	669	296	4372	424	28565
41	103	169	679	297	4437	425	28987
42	105	170	689	298	4502	426	29415
43	107	171	699	299	4569	427	29849
44	108	172	709	300	4636	428	30290
45	110	173	720	301	4705	429	30738
46	111	174	730	302	4774	430	31192
47	113	175	741	303	4845	431	31652
48	115	176	752	304	4916	432	32120
49	116	177	763	305	4989	433	32594
50	118	178	775	306	5063	434	33076
51	120	179	786	307	5138	435	33564
52	122	180	798	308	5213	436	34060
53	123	181	809	309	5290	437	34563
54	125	182	821	310	5369	438	35074
55	127	183	834	311	5448	439	35592
56	129	184	846	312	5528	440	36117
57	131	185	858	313	5610	441	36651
58	133	186	871	314	5693	442	37192
59	135	187	884	315	5777	443	37742
60	137	188	897	316	5862	444	38299
61	139	189	910	317	5949	445	38865
62	141	190	924	318	6037	446	39439
63	143	191	937	319	6126	447	40021
64	145	192	951	320	6217	448	40613
65	147	193	965	321	6308	449	41212
66	150	194	980	322	6402	450	41821
67	152	195	994	323	6496	451	42439
68	154	196	1009	324	6592	452	43066
69	156	197	1024	325	6689	453	43702
70	159	198	1039	326	6788	454	44347
71	161	199	1054	327	6889	455	45002
72	163	200	1070	328	6990	456	45667
73	166	201	1085	329	7094	457	46342
74	168	202	1101	330	7198	458	47026
75	171	203	1118	331	7305	459	47721
76	173	204	1134	332	7413	460	48426
77	176	205	1151	333	7522	461	49141
78	178	206	1168	334	7633	462	49867
79	181	207	1185	335	7746	463	50603
80	184	208	1203	336	7860	464	51351
81	186	209	1221	337	7976	465	52109
82	189	210	1239	338	8094	466	52879
83	192	211	1257	339	8214	467	53660
84	195	212	1276	340	8335	468	54453
85	198	213	1294	341	8458	469	55257
86	201	214	1313	342	8583	470	56073
87	204	215	1333	343	8710	471	56901

88	207	216	1353	344	8839	472	57742
89	210	217	1373	345	8969	473	58595
90	213	218	1393	346	9102	474	59460
91	216	219	1413	347	9236	475	60338
92	219	220	1434	348	9373	476	61230
93	222	221	1456	349	9511	477	62134
94	226	222	1477	350	9652	478	63052
95	229	223	1499	351	9794	479	63983
96	232	224	1521	352	9939	480	64928
97	236	225	1543	353	10086	481	65887
98	239	226	1566	354	10235	482	66860
99	243	227	1589	355	10386	483	67848
100	246	228	1613	356	10539	484	68850
101	250	229	1637	357	10695	485	69867
102	254	230	1661	358	10853	486	70899
103	258	231	1685	359	11013	487	71946
104	261	232	1710	360	11176	488	73009
105	265	233	1736	361	11341	489	74087
106	269	234	1761	362	11508	490	75182
107	273	235	1787	363	11678	491	76292
108	277	236	1814	364	11851	492	77419
109	281	237	1840	365	12026	493	78563
110	285	238	1868	366	12204	494	79723
111	290	239	1895	367	12384	495	80901
112	294	240	1923	368	12567	496	82095
113	298	241	1952	369	12752	497	83308
114	303	242	1981	370	12941	498	84539
115	307	243	2010	371	13132	499	85787
116	312	244	2039	372	13326	500	87054
117	316	245	2070	373	13523	501	88340
118	321	246	2100	374	13722	502	89645
119	326	247	2131	375	13925	503	90969
120	331	248	2163	376	14131	504	92313
121	336	249	2195	377	14340	505	93676
122	340	250	2227	378	14551	506	95060
123	346	251	2260	379	14766	507	96464
124	351	252	2293	380	14984	508	97889
125	356	253	2327	381	15206	509	99335
126	361	254	2362	382	15430	510	100802
127	366	255	2397	383	15658	511	102000

9.2.3.2a Transport block size for 7.68 Mcps TDD

Let k be the signalled TFRI value, then the corresponding HS-DSCH transport block size L_k is given by :

If $k=1..510$

$$L_k = \lfloor L_{\min} p^k \rfloor$$

$$p = \frac{33297}{32768}$$

$$L_{\min} = 57$$

If $k = 511$

$$L_k = 204000$$

If $k=0$, L_k indicates NULL and shall not be used to signal a transport block size in the TFRI.

Transport block sizes calculated by this formula shall equal the values indicated in Table 9.2.3.2.1

Table 9.2.3.2a.1: HSDPA Transport Block Sizes for 7.68 Mcps TDD

TB index (k)	TB size [bits]	TB index (k)	TB size [bits]	TB index (k)	TB size [bits]	TB index (k)	TB size [bits]
0	NULL	128	442	256	3438	384	26709
1	57	129	449	257	3494	385	27140
2	58	130	457	258	3550	386	27578
3	59	131	464	259	3607	387	28023
4	60	132	472	260	3666	388	28476
5	61	133	479	261	3725	389	28935
6	62	134	487	262	3785	390	29402
7	63	135	495	263	3846	391	29877
8	64	136	503	264	3908	392	30360
9	65	137	511	265	3971	393	30850
10	66	138	519	266	4035	394	31348
11	67	139	528	267	4101	395	31854
12	69	140	536	268	4167	396	32368
13	70	141	545	269	4234	397	32891
14	71	142	553	270	4302	398	33422
15	72	143	562	271	4372	399	33961
16	73	144	572	272	4443	400	34509
17	74	145	581	273	4514	401	35066
18	76	146	590	274	4587	402	35633
19	77	147	600	275	4661	403	36208
20	78	148	609	276	4736	404	36792
21	79	149	619	277	4813	405	37386
22	81	150	629	278	4891	406	37990
23	82	151	639	279	4970	407	38603
24	83	152	650	280	5050	408	39226
25	85	153	660	281	5131	409	39860
26	86	154	671	282	5214	410	40503
27	87	155	682	283	5298	411	41157
28	89	156	693	284	5384	412	41822
29	90	157	704	285	5471	413	42497
30	92	158	715	286	5559	414	43183
31	93	159	727	287	5649	415	43880
32	95	160	739	288	5740	416	44588
33	96	161	751	289	5833	417	45308
34	98	162	763	290	5927	418	46040
35	99	163	775	291	6023	419	46783
36	101	164	787	292	6120	420	47538
37	103	165	800	293	6219	421	48306

38	104	166	813	294	6319	422	49085
39	106	167	826	295	6421	423	49878
40	108	168	840	296	6525	424	50683
41	109	169	853	297	6630	425	51501
42	111	170	867	298	6737	426	52333
43	113	171	881	299	6846	427	53178
44	115	172	895	300	6957	428	54036
45	117	173	910	301	7069	429	54908
46	119	174	924	302	7183	430	55795
47	120	175	939	303	7299	431	56696
48	122	176	954	304	7417	432	57611
49	124	177	970	305	7537	433	58541
50	126	178	986	306	7658	434	59486
51	128	179	1001	307	7782	435	60446
52	131	180	1018	308	7908	436	61422
53	133	181	1034	309	8035	437	62414
54	135	182	1051	310	8165	438	63421
55	137	183	1068	311	8297	439	64445
56	139	184	1085	312	8431	440	65486
57	142	185	1103	313	8567	441	66543
58	144	186	1120	314	8705	442	67617
59	146	187	1138	315	8846	443	68709
60	148	188	1157	316	8988	444	69818
61	151	189	1175	317	9134	445	70945
62	153	190	1194	318	9281	446	72091
63	156	191	1214	319	9431	447	73254
64	158	192	1233	320	9583	448	74437
65	161	193	1253	321	9738	449	75639
66	164	194	1274	322	9895	450	76860
67	166	195	1294	323	10055	451	78101
68	169	196	1315	324	10217	452	79361
69	172	197	1336	325	10382	453	80643
70	174	198	1358	326	10550	454	81945
71	177	199	1380	327	10720	455	83267
72	180	200	1402	328	10893	456	84612
73	183	201	1425	329	11069	457	85978
74	186	202	1448	330	11248	458	87366
75	189	203	1471	331	11429	459	88776
76	192	204	1495	332	11614	460	90209
77	195	205	1519	333	11801	461	91666
78	198	206	1543	334	11992	462	93145
79	201	207	1568	335	12185	463	94649
80	205	208	1594	336	12382	464	96177
81	208	209	1619	337	12582	465	97730
82	211	210	1646	338	12785	466	99308
83	215	211	1672	339	12992	467	100911
84	218	212	1699	340	13201	468	102540
85	222	213	1727	341	13414	469	104195
86	225	214	1755	342	13631	470	105877
87	229	215	1783	343	13851	471	107587

88	233	216	1812	344	14075	472	109324
89	237	217	1841	345	14302	473	111088
90	240	218	1871	346	14533	474	112882
91	244	219	1901	347	14767	475	114704
92	248	220	1932	348	15006	476	116556
93	252	221	1963	349	15248	477	118438
94	256	222	1994	350	15494	478	120350
95	260	223	2027	351	15744	479	122293
96	265	224	2059	352	15999	480	124267
97	269	225	2093	353	16257	481	126273
98	273	226	2126	354	16519	482	128312
99	278	227	2161	355	16786	483	130383
100	282	228	2196	356	17057	484	132488
101	287	229	2231	357	17332	485	134627
102	291	230	2267	358	17612	486	136800
103	296	231	2304	359	17897	487	139009
104	301	232	2341	360	18185	488	141253
105	306	233	2379	361	18479	489	143533
106	311	234	2417	362	18777	490	145850
107	316	235	2456	363	19081	491	148205
108	321	236	2496	364	19389	492	150597
109	326	237	2536	365	19702	493	153029
110	331	238	2577	366	20020	494	155499
111	337	239	2619	367	20343	495	158010
112	342	240	2661	368	20671	496	160560
113	348	241	2704	369	21005	497	163152
114	353	242	2748	370	21344	498	165786
115	359	243	2792	371	21689	499	168463
116	365	244	2837	372	22039	500	171182
117	371	245	2883	373	22395	501	173946
118	377	246	2929	374	22756	502	176754
119	383	247	2977	375	23124	503	179608
120	389	248	3025	376	23497	504	182507
121	395	249	3074	377	23876	505	185454
122	402	250	3123	378	24262	506	188447
123	408	251	3174	379	24653	507	191490
124	415	252	3225	380	25051	508	194581
125	421	253	3277	381	25456	509	197722
126	428	254	3330	382	25867	510	200914
127	435	255	3384	383	26284	511	204000

9.2.3.3 Transport block size for 1.28 Mcps TDD

The mapping of transport block size, in bits, to TFRI value is dependent upon the UE's HS-DSCH capability class.

When MAC-hs is used, the bit aligned table of transport block size defined as following shall be used.

If k is the signalled TFRI value then the corresponding HS-DSCH transport block size L_k is given by:

If $k = 1..62$

$$L_k = \lfloor L_{\min} p^{k-1} \rfloor$$

where

$$p = \frac{6214}{5973} \text{ if the HS-DSCH physical layer category is between 1 and 3 inclusively,}$$

$$p = \frac{1292}{1228} \text{ if the HS-DSCH physical layer category is between 4 and 6 inclusively,}$$

$$p = \frac{1901}{1795} \text{ if the HS-DSCH physical layer category is between 7 and 9 inclusively,}$$

$$p = \frac{9445}{8877} \text{ if the HS-DSCH physical layer category is between 10 and 12 inclusively,}$$

$$p = \frac{2345}{2196} \text{ if the HS-DSCH physical layer category is between 13 and 15 inclusively,}$$

and

$$L_{\min} = 240$$

If $k = 63$ then,

$L_k = 2788$ if the HS-DSCH physical layer category is between 1 and 3 inclusively,

5600 if the HS-DSCH physical layer category is between 4 and 6 inclusively,

8416 if the HS-DSCH physical layer category is between 7 and 9 inclusively,

11226 if the HS-DSCH physical layer category is between 10 and 12 inclusively,

14043 if the HS-DSCH physical layer category is between 13 and 15 inclusively.

If $k=0$, L_k indicates NULL and shall not be used to signal a transport block size in the TFRI.

Transport block sizes calculated by this formula shall equal the values indicated in the following tables: –

Table 9.2.3.3.1: HSDPA Transport Block Sizes for 1.28 Mcps TDD, for HS-DSCH physical layer category [1, 3], bit aligned

TB index (k)	TB size [bits]	TB index (k)	TB size [bits]	TB index (k)	TB size [bits]	TB index (k)	TB size [bits]
0	NULL	16	434	32	817	48	1540
1	240	17	451	33	851	49	1602
2	249	18	470	34	885	50	1667
3	259	19	489	35	921	51	1734
4	270	20	508	36	958	52	1804
5	281	21	529	37	996	53	1877
6	292	22	550	38	1037	54	1952
7	304	23	572	39	1078	55	2031
8	316	24	596	40	1122	56	2113
9	329	25	620	41	1167	57	2198
10	342	26	645	42	1214	58	2287
11	356	27	671	43	1263	59	2380

12	370	28	698	44	1314	60	2476
13	385	29	726	45	1367	61	2575
14	401	30	755	46	1423	62	2679
15	417	31	786	47	1480	63	2788

Table 9.2.3.3.2: HSDPA Transport Block Sizes for 1.28 Mcps TDD, for HS-DSCH physical layer category [4, 6], bit aligned

TB index (k)	TB size [bits]	TB index (k)	TB size [bits]	TB index (k)	TB size [bits]	TB index (k)	TB size [bits]
0	NULL	16	514	32	1159	48	2613
1	240	17	541	33	1219	49	2749
2	252	18	569	34	1283	50	2893
3	265	19	598	35	1350	51	3043
4	279	20	630	36	1420	52	3202
5	294	21	662	37	1494	53	3369
6	309	22	697	38	1572	54	3544
7	325	23	733	39	1654	55	3729
8	342	24	772	40	1740	56	3924
9	360	25	812	41	1831	57	4128
10	379	26	854	42	1926	58	4343
11	398	27	899	43	2027	59	4570
12	419	28	946	44	2132	60	4808
13	441	29	995	45	2244	61	5058
14	464	30	1047	46	2361	62	5322
15	488	31	1101	47	2484	63	5600

Table 9.2.3.3.3: HSDPA Transport Block Sizes for 1.28 Mcps TDD, for HS-DSCH physical layer category [7, 9], bit aligned

TB index (k)	TB size [bits]	TB index (k)	TB size [bits]	TB index (k)	TB size [bits]	TB index (k)	TB size [bits]
0	NULL	16	567	32	1421	48	3559
1	240	17	601	33	1505	49	3769
2	254	18	636	34	1594	50	3991
3	269	19	674	35	1688	51	4227
4	285	20	713	36	1787	52	4477
5	301	21	756	37	1893	53	4741
6	319	22	800	38	2005	54	5021
7	338	23	848	39	2123	55	5318
8	358	24	898	40	2249	56	5632
9	379	25	951	41	2381	57	5964
10	402	26	1007	42	2522	58	6317
11	425	27	1066	43	2671	59	6690
12	451	28	1129	44	2829	60	7085
13	477	29	1196	45	2996	61	7503
14	505	30	1267	46	3173	62	7946
15	535	31	1341	47	3360	63	8416

Table 9.2.3.3.4: HSDPA Transport Block Sizes for 1.28 Mcps TDD, for HS-DSCH physical layer category [10, 12], bit aligned

TB index (k)	TB size [bits]	TB index (k)	TB size [bits]	TB index (k)	TB size [bits]	TB index (k)	TB size [bits]
0	NULL	16	608	32	1641	48	4427
1	240	17	647	33	1746	49	4711
2	255	18	688	34	1858	50	5012
3	271	19	732	35	1977	51	5333
4	289	20	779	36	2103	52	5674
5	307	21	829	37	2238	53	6037
6	327	22	882	38	2381	54	6424
7	348	23	939	39	2533	55	6835
8	370	24	999	40	2695	56	7272
9	394	25	1063	41	2868	57	7737
10	419	26	1131	42	3051	58	8232
11	446	27	1203	43	3247	59	8759
12	474	28	1280	44	3455	60	9320
13	505	29	1362	45	3676	61	9916
14	537	30	1449	46	3911	62	10550
15	571	31	1542	47	4161	63	11226

Table 9.2.3.3.5 : HSDPA Transport Block Sizes for 1.28 Mcps TDD, for HS-DSCH physical layer category [13,15], bit aligned

TB index (k)	TB size [bits]	TB index (k)	TB size [bits]	TB index (k)	TB size [bits]	TB index (k)	TB size [bits]
0	NULL	16	642	32	1836	48	5250
1	240	17	686	33	1961	49	5606
2	256	18	732	34	2094	50	5987
3	273	19	782	35	2236	51	6393
4	292	20	835	36	2388	52	6827
5	312	21	892	37	2550	53	7290
6	333	22	952	38	2723	54	7785
7	355	23	1017	39	2908	55	8313
8	380	24	1086	40	3105	56	8877
9	405	25	1160	41	3316	57	9479
10	433	26	1238	42	3541	58	10123
11	462	27	1322	43	3781	59	10809
12	494	28	1412	44	4037	60	11543
13	527	29	1508	45	4311	61	12326
14	563	30	1610	46	4604	62	13162
15	601	31	1719	47	4916	63	14043

When MAC-ehs is used, the octet aligned table of transport block size defined as following shall be used.

If k is the signalled TFRI value then the corresponding HS-DSCH transport block size L_k is given by:

If $k = 1..62$

$$L_k = \lfloor L_{\min} p^{k-1} \rfloor * 8$$

where

$$p = \left(\frac{348}{30}\right)^{\frac{1}{63-1}} \text{ if the HS-DSCH physical layer category is between 1 and 3 inclusively,}$$

$$p = \left(\frac{700}{30}\right)^{\frac{1}{63-1}} \text{ if the HS-DSCH physical layer category is between 4 and 6 inclusively,}$$

$$p = \left(\frac{1052}{30}\right)^{\frac{1}{63-1}} \text{ if the HS-DSCH physical layer category is between 7 and 9 inclusively,}$$

$$p = \left(\frac{1403}{30}\right)^{\frac{1}{63-1}} \text{ if the HS-DSCH physical layer category is between 10 and 12 inclusively,}$$

$$p = \left(\frac{1755}{30}\right)^{\frac{1}{63-1}} \text{ if the HS-DSCH physical layer category is between 13 and 15 inclusively,}$$

and

$$L_{\min} = 30$$

If $k = 63$ then,

$L_k = 2784$ if the HS-DSCH physical layer category is between 1 and 3 inclusively,

5600 if the HS-DSCH physical layer category is between 4 and 6 inclusively,

8416 if the HS-DSCH physical layer category is between 7 and 9 inclusively,

11224 if the HS-DSCH physical layer category is between 10 and 12 inclusively,

14040 if the HS-DSCH physical layer category is between 13 and 15 inclusively.

If $k=0$, L_k indicates NULL and shall not be used to signal a transport block size in the TFRI.

Transport block sizes calculated by this formula shall equal the values indicated in the following tables:

Table 9.2.3.3.6: HSDPA Transport Block Sizes for 1.28 Mcps TDD, for HS-DSCH physical layer category [1, 3], octet aligned

TB index (k)	TB size [bits]	TB index (k)	TB size [bits]	TB index (k)	TB size [bits]	TB index (k)	TB size [bits]
0	NULL	16	432	32	816	48	1536
1	240	17	448	33	848	49	1600
2	248	18	464	34	880	50	1664
3	256	19	488	35	920	51	1728
4	264	20	504	36	952	52	1800
5	280	21	528	37	992	53	1872
6	288	22	544	38	1032	54	1944
7	304	23	568	39	1072	55	2024
8	312	24	592	40	1120	56	2104
9	328	25	616	41	1160	57	2192
10	336	26	640	42	1208	58	2280
11	352	27	664	43	1256	59	2376
12	368	28	696	44	1312	60	2472
13	384	29	720	45	1360	61	2568
14	400	30	752	46	1416	62	2672

15	416	31	784	47	1472	63	2784
----	-----	----	-----	----	------	----	------

Table 9.2.3.3.7: HSDPA Transport Block Sizes for 1.28 Mcps TDD, for HS-DSCH physical layer category [4, 6], octet aligned

TB index (k)	TB size [bits]	TB index (k)	TB size [bits]	TB index (k)	TB size [bits]	TB index (k)	TB size [bits]
0	NULL	16	512	32	1152	48	2608
1	240	17	536	33	1216	49	2744
2	248	18	568	34	1280	50	2888
3	264	19	592	35	1344	51	3040
4	272	20	624	36	1416	52	3200
5	288	21	656	37	1488	53	3368
6	304	22	696	38	1568	54	3544
7	320	23	728	39	1648	55	3728
8	336	24	768	40	1736	56	3920
9	360	25	808	41	1824	57	4128
10	376	26	848	42	1920	58	4336
11	392	27	896	43	2024	59	4568
12	416	28	944	44	2128	60	4808
13	440	29	992	45	2240	61	5056
14	464	30	1040	46	2360	62	5320
15	488	31	1096	47	2480	63	5600

Table 9.2.3.3.8: HSDPA Transport Block Sizes for 1.28 Mcps TDD, for HS-DSCH physical layer category [7, 9], octet aligned

TB index (k)	TB size [bits]	TB index (k)	TB size [bits]	TB index (k)	TB size [bits]	TB index (k)	TB size [bits]
0	NULL	16	560	32	1416	48	3552
1	240	17	600	33	1504	49	3768
2	248	18	632	34	1592	50	3984
3	264	19	672	35	1688	51	4224
4	280	20	712	36	1784	52	4472
5	296	21	752	37	1888	53	4736
6	312	22	800	38	2000	54	5016
7	336	23	848	39	2120	55	5312
8	352	24	896	40	2248	56	5632
9	376	25	944	41	2376	57	5960
10	400	26	1000	42	2520	58	6312
11	424	27	1064	43	2664	59	6688
12	448	28	1128	44	2824	60	7080
13	472	29	1192	45	2992	61	7496
14	504	30	1264	46	3168	62	7944
15	528	31	1336	47	3360	63	8416

Table 9.2.3.3.9: HSDPA Transport Block Sizes for 1.28 Mcps TDD, for HS-DSCH physical layer category [10, 12], octet aligned

TB index (k)	TB size [bits]	TB index (k)	TB size [bits]	TB index (k)	TB size [bits]	TB index (k)	TB size [bits]
0	NULL	16	608	32	1640	48	4424
1	240	17	640	33	1744	49	4704
2	248	18	688	34	1856	50	5008
3	264	19	728	35	1976	51	5328
4	288	20	776	36	2096	52	5672
5	304	21	824	37	2232	53	6032
6	320	22	880	38	2376	54	6416
7	344	23	936	39	2528	55	6832
8	368	24	992	40	2688	56	7264
9	392	25	1056	41	2864	57	7736
10	416	26	1128	42	3048	58	8224
11	440	27	1200	43	3240	59	8752
12	472	28	1280	44	3448	60	9312
13	504	29	1360	45	3672	61	9912
14	536	30	1448	46	3904	62	10544
15	568	31	1536	47	4160	63	11224

Table 9.2.3.3.10 : HSDPA Transport Block Sizes for 1.28 Mcps TDD, for HS-DSCH physical layer category [13,15], octet aligned

TB index (k)	TB size [bits]	TB index (k)	TB size [bits]	TB index (k)	TB size [bits]	TB index (k)	TB size [bits]
0	NULL	16	640	32	1832	48	5240
1	240	17	680	33	1960	49	5600
2	256	18	728	34	2088	50	5976
3	272	19	776	35	2232	51	6384
4	288	20	832	36	2384	52	6816
5	312	21	888	37	2544	53	7280
6	328	22	952	38	2720	54	7776
7	352	23	1016	39	2904	55	8304
8	376	24	1080	40	3096	56	8864
9	400	25	1152	41	3312	57	9464
10	432	26	1232	42	3536	58	10112
11	456	27	1320	43	3776	59	10792
12	488	28	1408	44	4032	60	11528
13	520	29	1504	45	4304	61	12312
14	560	30	1608	46	4600	62	13144
15	600	31	1712	47	4912	63	14040

9.2.4 MAC PDU: Parameters of the MAC header (E-DCH)

9.2.4.1 MAC-es header parameters

- Transmission Sequence Number (TSN):

The TSN field provides the transmission sequence number for the MAC-es PDU. This information is used for reordering purposes to support in-sequence delivery to higher layers. The length of the TSN field is 6 bits.

9.2.4.2 MAC-e header parameters

- Data description indicator (DDI):
The DDI field identifies the logical channel, MAC-d flow and size of the MAC-d PDUs concatenated into the associated MAC-es PDU. The mapping between the DDI values and the logical channel ID, MAC-d flow and PDU size is provided by higher layers. The length of the DDI field is 6 bits.
- For FDD: When, due to the quantization in the transport block sizes that can be supported or triggering of the Scheduling Information, the size of the data plus header is less than or equal to the TB size of the E-TFC selected by the UE minus 24 bits, the DDI value [111111] shall be appended at the end of the MAC-e header and a Scheduling Information shall be concatenated into this MAC-e PDU, where DDI value [111111] indicates that there is a Scheduling Information concatenated in this MAC-e PDU. Otherwise, if the size of the data plus header is less than or equal to the TB size of the E-TFC selected by the UE minus 18 bits, a Scheduling Information shall be concatenated into this MAC-e PDU. In any other case it is understood that another MAC-es PDU or Scheduling Information does not fit and it is therefore not necessary to reserve room in the transport block for an additional DDI field.
- For TDD: When, due to the quantization in the transport block sizes that can be supported or triggering of the Scheduling Information (due to timer expiry, see subclauses 11.9.1.4a and 11.9.1.5), the size of the data plus header is less than or equal to the TB size of the E-TFC selected by the UE minus 29bits, the DDI value [111111] shall be appended at the end of the MAC-e header and a Scheduling Information shall be concatenated into this MAC-e PDU, where DDI value [111111] indicates that there is a Scheduling Information concatenated in this MAC-e PDU. Otherwise, if the size of the data plus header is less than or equal to the TB size of the E-TFC selected by the UE minus 23 bits, a Scheduling Information shall be concatenated into this MAC-e PDU. In any other case it is understood that another MAC-es PDU or Scheduling Information does not fit and it is therefore not necessary to reserve room in the transport block for an additional DDI field.
- Number of MAC-d PDUs (N):
The number of consecutive MAC-d PDUs corresponding to the same DDI value. The length of the N field is 6 bits.

9.2.5 Signaling of control information for FDD E-DCH

9.2.5.1 HARQ information

This control information is used in support of the uplink hybrid ARQ functionality.

- ACK/NACK information:
Transmitted on downlink on the E-HICH from each cell in the E-DCH active set, the ACK/NACK information indicates the successful or un-successful decoding of the corresponding uplink transmission. This information allows the UE to know whether to make another transmission for the same MAC-e PDU or to start the transmission of a new one. The length of the ACK/NACK field is 1 bit.
- RSN:
Transmitted on the E-DPCCH, the RSN is used to convey the uplink HARQ transmission number. Because of the limitation in the field size, the RSN saturates to the maximum value once that is reached. The combination of the RSN and the transmission timing allows the receiver to determine the exact transmission number (see [16]). The length of the RSN field is 2 bits.

9.2.5.2 DL Scheduling information

This control information is used by Node-Bs in a UE's E-DCH active set in order to control its use of E-DCH system resources.

9.2.5.2.1 Relative Grants

- Serving Relative Grant:
Transmitted on downlink on the E-RGCH from all cells in the serving E-DCH RLS, the serving relative grant allows the Node B scheduler to incrementally adjust the serving grant of UEs under its control. By definition,

there can only be one serving relative grant command received at any one time. This indication can take three different values, "UP", "DOWN" or "HOLD".

- Non-serving Relative Grant:
Transmitted on downlink on the E-RGCH from a non-serving E-DCH RL, the non-serving relative grant allows neighboring Node Bs to adjust the transmitted rate of UEs that are not under their control in order to avoid overload situations. By definition, there could be multiple non-serving relative grant commands received by MAC at any time. This indication can take two different values, "DOWN" or "HOLD".

The handling of the Relative Grant signalling is based on the Scheduling Grant table configured by higher layers and shown in Tables 9.2.5.2.1.1 and 9.2.5.2.1.2.

Table 9.2.5.2.1.1: Scheduling Grant Table 1 (SG-table)

Index	Scheduled Grant
37	$(168/15)^{2*6}$
36	$(150/15)^{2*6}$
35	$(168/15)^{2*4}$
34	$(150/15)^{2*4}$
33	$(134/15)^{2*4}$
32	$(119/15)^{2*4}$
31	$(150/15)^{2*2}$
30	$(95/15)^{2*4}$
29	$(168/15)^2$
28	$(150/15)^2$
27	$(134/15)^2$
26	$(119/15)^2$
25	$(106/15)^2$
24	$(95/15)^2$
23	$(84/15)^2$
22	$(75/15)^2$
21	$(67/15)^2$
20	$(60/15)^2$
19	$(53/15)^2$
18	$(47/15)^2$
17	$(42/15)^2$
16	$(38/15)^2$
15	$(34/15)^2$
14	$(30/15)^2$
13	$(27/15)^2$
12	$(24/15)^2$
11	$(21/15)^2$
10	$(19/15)^2$
9	$(17/15)^2$
8	$(15/15)^2$
7	$(13/15)^2$
6	$(12/15)^2$
5	$(11/15)^2$
4	$(9/15)^2$
3	$(8/15)^2$
2	$(7/15)^2$
1	$(6/15)^2$
0	$(5/15)^2$

Table 9.2.5.2.1.2: Scheduling Grant Table 2 (SG-table)

Index	Scheduled Grant
-------	-----------------

37	$(377/15)^2 \times 4$
36	$(336/15)^2 \times 4$
35	$(237/15)^2 \times 6$
34	$(212/15)^2 \times 6$
33	$(237/15)^2 \times 4$
32	$(168/15)^2 \times 6$
31	$(150/15)^2 \times 6$
30	$(168/15)^2 \times 4$
29	$(150/15)^2 \times 4$
28	$(134/15)^2 \times 4$
27	$(119/15)^2 \times 4$
26	$(150/15)^2 \times 2$
25	$(95/15)^2 \times 4$
24	$(168/15)^2$
23	$(150/15)^2$
22	$(134/15)^2$
21	$(119/15)^2$
20	$(106/15)^2$
19	$(95/15)^2$
18	$(84/15)^2$
17	$(75/15)^2$
16	$(67/15)^2$
15	$(60/15)^2$
14	$(53/15)^2$
13	$(47/15)^2$
12	$(42/15)^2$
11	$(38/15)^2$
10	$(34/15)^2$
9	$(30/15)^2$
8	$(27/15)^2$
7	$(24/15)^2$
6	$(21/15)^2$
5	$(19/15)^2$
4	$(17/15)^2$
3	$(15/15)^2$
2	$(13/15)^2$
1	$(12/15)^2$
0	$(11/15)^2$

When the Serving_Grant needs to be determined due to E-RGCH signalling (see subclause 11.8.1.3.2), the UE shall:

- Determine the lowest power ratio in the configured SG-table (table 9.2.5.2.1.1 or table 9.2.5.2.1.2) that is equal or higher to the reference_ETPR, and determine the corresponding index in the SG-table: SG_{LUPR} ;
- If the UE received a Serving Relative Grant "UP", based on the thresholds "3-index-step threshold" and "2-index-step threshold" configured by higher layers, determine the Serving_Grant as follows:
 - if $SG_{LUPR} < \text{"3-index-step threshold"}$:
 - Serving_Grant = $SG[\text{MIN}(SG_{LUPR} + 3, 37)]$.
 - if $\text{"3-index-step threshold"} \leq SG_{LUPR} < \text{"2-index-step threshold"}$:
 - Serving_Grant = $SG[\text{MIN}(SG_{LUPR} + 2, 37)]$.
 - if $\text{"2-index-step threshold"} \leq SG_{LUPR}$:
 - Serving_Grant = $SG[\text{MIN}(SG_{LUPR} + 1, 37)]$.
- If the UE received a Serving Relative Grant "DOWN", determine the Serving_Grant:

- $Serving_Grant = SG[\text{MAX}(SG_{LUPR} - 1, 0)]$.
- If the UE received a Non-serving Relative Grant "DOWN", determine the *Serving_Grant*:
 - $Serving_Grant = SG[\text{MAX}(SG_{LUPR} - 1, 0)]$.

9.2.5.2.2 Absolute Grant

The absolute grant message is sent on downlink, on the configured E-AGCH, from the serving E-DCH cell and allows the Node B scheduler to directly adjust the granted rate of UEs under its control.

The E-AGCH is a shared channel that uses an E-RNTI specific CRC in order to address messages to specific users (see [16]). The RRC may configure the MAC-e with two different E-RNTIs, one primary and one secondary. Based on the identity that is used, the following information will be conveyed implicitly when an absolute grant message is received:

- Identity Type:
This variable will take the value "Primary" or "Secondary" respectively based on whether the message was addressed to the primary or the secondary E-RNTI.

The absolute grant message itself includes multiple fields that are multiplexed together into 6 bits inside the MAC-e of the Node B and then submitted to the physical layer for transmission on the E-AGCH. These fields are:

- Absolute Grant Value:
This field is used to determine the maximum E-DCH traffic to pilot ratio (E-DPDCH/DPCCH) that the UE is allowed to use in the next transmission. The length of the Absolute Grant Value field is 5 bits.
- Absolute Grant Scope:
This field indicates the applicability of the Absolute Grant. It can take two different values, "Per HARQ process" or "All HARQ processes", allowing to indicate whether the HARQ process activation/de-activation will affect one or all processes. The Absolute Grant Scope is encoded in 1 bit. When the E-DCH is configured with 10ms TTI, only the value "All HARQ processes" is valid (see subclause 10). In case Identity Type is "Secondary", only the value "All HARQ processes" is valid in this version of the protocol.

9.2.5.3 UL Scheduling information

This control information is used by UEs to indicate to their serving E-DCH Node-B the amount of resources they require.

9.2.5.3.1 Happy Bit

The happy bit is a single bit field that is passed from MAC to the physical layer for inclusion on the E-DPCCH. This field takes two values, "Not Happy" and "Happy" indicating respectively whether the UE could use more resources or not. The setting of the Happy Bit is defined in subclause 11.8.1.5.

9.2.5.3.2 Scheduling Information

The Scheduling Information is located at the end of the MAC-e PDU and is used to provide the serving Node B with a better view of the amount of system resources needed by the UE and the amount of resources it can actually make use of. The transmission of this information will be initiated due to the quantization of the transport block sizes that can be supported or based on the triggers defined in subclause 11.8.1.6. When a Scheduling Information is transmitted, its contents shall always be updated in new transmissions with the buffer status after application of the E-TFC selection procedure described in subclause 11.8.1.4. The logical channels for which a non-scheduled grant is configured shall never be taken into account when putting together this information. In addition, the RRC may restrict applicability for logical channels for which no non-scheduled grant was configured.

This information includes the following fields:

- Highest priority Logical channel ID (HLID):
The HLID field identifies unambiguously the highest priority logical channel with available data. If multiple logical channels exist with the highest priority, the one corresponding to the highest buffer occupancy will be reported. The length of the HLID is 4 bits. In case the TEBS is indicating index 0 (0 byte), the HLID shall indicate the value "0000".

- Fields related to amount of available data:
- Total E-DCH Buffer Status (TEBS):
The TEBS field identifies the total amount of data available across all logical channels for which reporting has been requested by the RRC and indicates the amount of data in number of bytes that is available for transmission and retransmission in RLC layer. When MAC is connected to an AM RLC entity, control PDUs to be transmitted and RLC PDUs outside the RLC Tx window shall also be included in the TEBS. RLC PDUs that have been transmitted but not negatively acknowledged by the peer entity shall not be included in the TEBS.

The length of this field is 5 bits. The values taken by TEBS are shown in Table 9.2.5.3.2.1.

Table 9.2.5.3.2-1: TEBS Values

Index	TEBS Value (bytes)
0	TEBS = 0
1	$0 < \text{TEBS} \leq 10$
2	$10 < \text{TEBS} \leq 14$
3	$14 < \text{TEBS} \leq 18$
4	$18 < \text{TEBS} \leq 24$
5	$24 < \text{TEBS} \leq 32$
6	$32 < \text{TEBS} \leq 42$
7	$42 < \text{TEBS} \leq 55$
8	$55 < \text{TEBS} \leq 73$
9	$73 < \text{TEBS} \leq 97$
10	$97 < \text{TEBS} \leq 129$
11	$129 < \text{TEBS} \leq 171$
12	$171 < \text{TEBS} \leq 228$
13	$228 < \text{TEBS} \leq 302$
14	$302 < \text{TEBS} \leq 401$
15	$401 < \text{TEBS} \leq 533$
16	$533 < \text{TEBS} \leq 708$
17	$708 < \text{TEBS} \leq 940$
18	$940 < \text{TEBS} \leq 1248$
19	$1248 < \text{TEBS} \leq 1658$
20	$1658 < \text{TEBS} \leq 2202$
21	$2202 < \text{TEBS} \leq 2925$
22	$2925 < \text{TEBS} \leq 3884$
23	$3884 < \text{TEBS} \leq 5160$
24	$5160 < \text{TEBS} \leq 6853$
25	$6853 < \text{TEBS} \leq 9103$
26	$9103 < \text{TEBS} \leq 12092$
27	$12092 < \text{TEBS} \leq 16062$
28	$16062 < \text{TEBS} \leq 21335$
29	$21335 < \text{TEBS} \leq 28339$
30	$28339 < \text{TEBS} \leq 37642$
31	$37642 < \text{TEBS}$

- Highest priority Logical channel Buffer Status (HLBS):
The HLBS field indicates the amount of data available from the logical channel identified by HLID, relative to the highest value of the buffer size range reported by TEBS when the reported TEBS index is not 31, and relative to 50000 bytes when the reported TEBS index is 31. The length of HLBS is 4 bits. The values taken by HLBS are shown in table 9.2.5.3.2.2. In case the TEBS field is indicating index 0 (0 byte), the HLBS field shall indicate index 0.

Table 9.2.5.3.2-2: HLBS Values

Index	HLBS values (%)
0	$0 < \text{HLBS} \leq 4$
1	$4 < \text{HLBS} \leq 6$
2	$6 < \text{HLBS} \leq 8$
3	$8 < \text{HLBS} \leq 10$
4	$10 < \text{HLBS} \leq 12$
5	$12 < \text{HLBS} \leq 14$
6	$14 < \text{HLBS} \leq 17$
7	$17 < \text{HLBS} \leq 21$
8	$21 < \text{HLBS} \leq 25$
9	$25 < \text{HLBS} \leq 31$
10	$31 < \text{HLBS} \leq 37$
11	$37 < \text{HLBS} \leq 45$
12	$45 < \text{HLBS} \leq 55$
13	$55 < \text{HLBS} \leq 68$
14	$68 < \text{HLBS} \leq 82$
15	$82 < \text{HLBS}$

- UE Power Headroom (UPH):

The UPH field indicates the ratio of the maximum UE transmission power and the corresponding DPCCCH code power defined in [17]. The length of UPH is 5 bits.

The Scheduling Information message is represented in figure 9.2.5.3.2-1 where for each field, the LSB is the rightmost bit in the figure and the MSB is the leftmost bit.

UPH (5bits)	TEBS (5bits)	HLBS (4bits)	HLID (4bits)
----------------	-----------------	-----------------	-----------------

Figure 9.2.5.3.2-1: Scheduling Information format

9.2.5.4 Transport block size

RRC can configure the MAC-e to use one of two Transport block size sets for the 10ms TTI duration and one of four Transport block size sets for the 2ms TTI duration. The normative description of the mapping between the E-TFCI and the corresponding transport block size is provided in Annex B:

- If the UE is configured with E-TFCI table 0 (see [7]) and 2ms TTI, it shall use the mapping defined in Annex B.1
- If the UE is configured with E-TFCI table 1 (see [7]) and 2ms TTI, it shall use the mapping defined in Annex B.2
- If the UE is configured with E-TFCI table 2 (see [7]) and 2ms TTI, it shall use the mapping defined in Annex B.2a
- If the UE is configured with E-TFCI table 3 (see [7]) and 2ms TTI, it shall use the mapping defined in Annex B.2b
- If the UE is configured with E-TFCI table 0 (see [7]) and 10ms TTI, it shall use the mapping defined in Annex B.3

- If the UE is configured with E-TFCI table 1 (see [7]) and 10ms TTI, it shall use the mapping defined in Annex B.4

The mapping in Transport block size table 0 for 2ms TTI (see table in Annex B.1) can also be obtained using the formula below.

Let k be the chosen E-TFCI, then the corresponding E-DCH transport block size L_k is given by the following formula (informative):

$$L_0 = 18$$

$$\text{if } k = 0..118, 120..126$$

$$L_{k+1} = \lfloor 120 * (\rho)^k \rfloor$$

where

$$\rho = \left(\frac{11484}{120} \right)^{\frac{1}{127-1}}$$

The mapping in Transport block size table 2 for 2ms TTI (see table in Annex B.2a) can also be obtained using the formula below.

Let k be the chosen E-TFCI, then the corresponding E-DCH transport block size L_k is given by the following formula (informative):

$$L_0 = 18$$

$$\text{if } k = 0..119, 121..126$$

$$L_{k+1} = \lfloor 120 * (\rho)^k \rfloor$$

where

$$\rho = \left(\frac{22996}{120} \right)^{\frac{1}{127-1}}$$

The mapping in Transport block size table 0 for 10ms TTI (see table in Annex B.3) can also be obtained using the formula below.

Let k be the chosen E-TFCI, then the corresponding E-DCH transport block size L_k is given by the following formula (informative):

$$L_0 = 18$$

$$\text{if } k = 0..126$$

$$L_{k+1} = \lfloor 120 * (\rho)^k \rfloor$$

where

$$\rho = \left(\frac{20000}{120} \right)^{\frac{1}{127-1}}$$

9.2.6 Signaling of control information for TDD E-DCH

9.2.6.1 HARQ information

This control information is used in support of the uplink hybrid ARQ functionality.

- ACK/NACK information:
Transmitted on the E-HICH in the serving E-DCH cell, the ACK/NACK information indicates the successful or unsuccessful decoding of the corresponding uplink transmission. If NACK is received then the UE may retransmit if appropriate physical resources are available, otherwise it must receive a further Grant before it can retransmit the MAC-e PDU. The length of the ACK/NACK field is 1 bit.
- RSN:
Transmitted on the E-UCCH, the RSN is used to convey the uplink HARQ transmission number. Because of the limitation in the field size, the maximum value that the RSN can represent is equal to 3. Once the RSN reaches this value, the RSN shall alternate between the values of 2 and 3 for any subsequent consecutive retransmissions. Thus, the RSN sequence follows the pattern 0,1,2,3,2,3,2,3,...(see subclause 11.9.1.1.2). The length of the RSN field is 2 bits.
- HARQ Process Identifier
Transmitted on the E-UCCH, the HARQ process identifier is selected by the UE and identifies the HARQ process for which the MAC-e PDU is being transmitted/retransmitted. The length of the HARQ process identifier field is 3 bits. For TDD, the MSB of the HARQ Process Identifier is not transmitted by the physical layer but may be inferred by the Node-B according to the nature of the physical resources used (scheduled or unscheduled). HARQ processes associated with scheduled transmission utilise HARQ Process Identifiers 0 to 3.

9.2.6.2 DL Scheduling information

This control information is used by a Node-B in order to control its use of E-DCH system resources.

9.2.6.2.1 Absolute Grant

The Absolute Grant is sent on downlink on a set of configured E-AGCHs from the serving E-DCH cell and allows the Node B scheduler to directly adjust the granted rate and assigned physical resources for UEs under its control. The physical resource assignment indicates to the UE the maximum amount of uplink resources that it may use for a scheduled transmission.

The E-AGCH is a shared channel that uses an E-RNTI specific CRC in order to address messages to specific UEs (see [19]). For TDD, the RRC shall configure the MAC with a primary E-RNTI only.

A UE is required to monitor a set of E-AGCHs. The RRC signals to the UE details of the set of E-AGCHs that are to be monitored. The UE decodes an Absolute Grant intended for it on the basis of the E-RNTI sent to it by the Node B via the SRNC and by RRC. The following information will be conveyed in an absolute grant message:

- Absolute Grant Value – maximum power granted per resource unit (per slot)
- The physical resources to be used for transmission
 - Channelisation Code
 - Timeslots
 - Resource Duration (optional)

The absolute grant message itself includes multiple fields that are multiplexed together into between 14 and 28 bits for 3.84/7.68 Mcps TDD and between 23 and 26 bits for 1.28 Mcps TDD (depending on the system configuration) inside the MAC-e of the Node B and then submitted to the physical layer for transmission on the E-AGCH. These fields are:

- Absolute Grant Value:
For TDD, this field indicates the maximum E-PUCH transmission power to reference power ratio per TDD resource unit that the UE is allowed to use on the E-DCH resources associated with the Absolute Grant. A TDD resource unit is defined as one sixteenth of the OVFSF codespace in one timeslot. The length of the Absolute Grant Value field for TDD is 5 bits.
- Channelisation Code:
This field describes the code component of the physical resource grant. For 1.28/3.84 Mcps TDD it comprises an enumerated value of length 5 bits indicating which node on the OVFSF code tree has been allocated. For 7.68 Mcps TDD it comprises an enumerated value of length 6 bits indicating which node on the OVFSF tree has been

allocated. The mapping between the allocated OVFSF and the enumerated node 0...30 for 1.28/3.84 Mcps and 0...62 for 7.68 Mcps is as given in [19].

- Timeslot Resource Related Information:
This field describes the timeslot component of the physical resource grant and comprises a bitmap of length n_{TRRI} . For 3.84/7.68 Mcps TDD, the TRRI field indicates which of the timeslots configured for E-DCH use by RRC have been allocated with the LSB corresponding to the lowest numbered E-DCH timeslot and the MSB corresponding to the highest numbered timeslot. The length of the TRRI field (n_{TRRI}) is 5 bits and is configurable by RRC on a per-cell basis between 1 and 12 bits for 3.84/7.68 Mcps TDD. For 1.28 Mcps TDD, the length of the TRRI field (n_{TRRI}) is 5 bits with MSB corresponding to TS1 and LSB corresponding to TS5.
- Resource Duration Indicator:
Optionally, RRC may configure, on a per-cell basis the presence of a resource duration indicator field on E-AGCH for TDD. If configured as present in a cell, 3 bits are used to indicate the number of TTI's allocated and the spacing between the allocated TTIs via a single grant according to table 9.2.6.2.1-2. If the field is configured as not present on E-AGCH in the cell, a value of 0 is implicitly assumed by the UE corresponding to 1 TTI.

Table 9.2.6.2.1-2 – Resource Duration Indicator (RDI) interpretation

Resource Duration Indicator (3 bits)	TTIs allocated	TTI spacing
0	1	1
1	2	1
2	2	2
3	2	4
4	4	1
5	4	2
6	4	4
7	8	1

- E-AGCH Cyclic Sequence Number (ECSN):
The ECSN is a 3-bit field used to assist the UE with outer-loop power control of E-AGCH (cf. HCSN for HS-SCCH).
- E-HICH Indicator(EI) (1.28 Mcps TDD only)
The E-HICH indicator (EI) consists of 2 bits and is used to indicate which E-HICH will convey the acknowledgement indicator for the scheduled UEs.
- E-UCCH Number Indicator (ENI) (1.28 Mcps TDD only)
The E-UCCH Number Indicator (ENI) is a 3-bit field used to indicate the detailed number of E-UCCH.

9.2.6.3 UL Scheduling Information

This control information is used by UEs to indicate to the Node B the amount of resources they require. Scheduling Information is sent via the E-PUCH in the MAC-e header when the UE is granted resource and by the E-RUCCH when no resource has been granted. Scheduling Information consists of three components as defined below.

- Buffer Information: This consists of:
 - Highest priority Logical Channel (HLID)

The HLID field identifies unambiguously the highest priority logical channel with available data. If multiple logical channels exist with the highest priority, the one corresponding to the highest buffer occupancy will be reported. The length of the HLID is 4 bits. In case the TEBS is indicating index 0 (0 byte), the HLID shall indicate the value "0000".

- Total E-DCH Buffer Status (TEBS)

The TEBS field identifies the total amount of data available across all logical channels for which reporting has been requested by the RRC and indicates the amount of data in number of bytes that is available for transmission and retransmission in RLC layer. When MAC is connected to an AM RLC entity, control PDUs

to be transmitted and RLC PDUs outside the RLC Tx window shall also be included in the TEBS. RLC PDUs that have been transmitted but not negatively acknowledged by the peer entity shall not be included in the TEBS.

- Highest priority Logical channel Buffer Status (HLBS)

The HLBS field indicates the amount of data available from the logical channel identified by HLID, relative to the highest value of the buffer size range reported by TEBS when the reported TEBS index is not 31, and relative to 50000 bytes when the reported TEBS index is 31.

- UE Power Headroom (UPH): The UPH field indicates the ratio of the maximum UE transmission power and the calculated UE transmit power defined as in [18] that would result for β_e equal to 0. The length of UPH is 5 bits.
- Serving and Neighbour Cell Pathloss (SNPL): This may be used by the Node-B to assist with its estimation of the degree of intercell interference each UE will generate and hence the absolute grant power value and physical resources to assign. The length of SNPL is 5 bits.

The length of TEBS field is 5 bits, the values taken by TEBS are shown in Table 9.2.5.3.2-1. The length of HLBS is 4 bits, the values taken by HLBS are shown in table 9.2.5.3.2-2.

The Scheduling Information message is represented in figure 9.2.6.3-1 where for each field, the LSB is the rightmost bit in the figure and the MSB is the leftmost bit.

SNPL	UPH	TEBS	HLBS	HLID
(5 bits)	(5 bits)	(5 bits)	(4 bits)	(4 bits)

Figure 9.2.6.3-1: Scheduling Information format

If Scheduling Information is sent via the E-RUCCH then the E-RNTI is also sent via the E-RUCCH, as shown by Figure 9.2.6.3-2 where the LSB is the rightmost bit in the figure and the MSB is the leftmost bit:

Scheduling Information (23 bits)	E-RNTI (16 bits)
---	-------------------------

Figure 9.2.6.3-2: Format of information sent on E-RUCCH

9.2.6.4 Transport block size

For 1.28 Mcps TDD, the normative description of the mapping between the TB index and the corresponding transport block size is provided in Annex BC.

For 3.84 Mcps TDD, the normative description of the mapping between the E-TFC index and the corresponding transport block size is provided in Annex BA.

For 7.68 Mcps TDD, the normative description of the mapping between the E-TFC index and the corresponding transport block size is provided in Annex BB.

9.2.6.4.1 3.84 Mcps TDD Transport Block Size

For 3.84 Mcps TDD, the mapping of transport block size L to signalled index $k_i = \{0,1,\dots,127\}$ (see Annex BA.1) is given by the formula:

$$L = \left\lfloor 60 \times \rho^{k_n + k_i} \right\rfloor$$

In the above formula $\rho = 128^{\frac{1}{127}}$, k_i is the TBS index (0...127) and k_n is an integer selected based upon the number of timeslots allocated (n). Values for k_n are tabulated in Table 9.2.6.4.1.

Table 9.2.6.4.1: k_n tabulated as a function of the number of timeslots (n)

n	k_n
1	0
2	18
3	28
4	36
5	42
6	46
7	50
8	54
9	57
10	60
11	62
12	65

9.2.6.4.2 7.68 Mcps TDD Transport Block Size

For 7.68 Mcps TDD, the mapping of transport block size L to signalled index $k_i = \{0, 1, \dots, 127\}$ (see Annex BB.1) is given by the formula:

$$L = \left\lfloor 60 \times \rho^{k_n + k_i} \right\rfloor$$

In the above formula, $\rho = 256^{\frac{1}{127}}$ k_i is the TBS index (0...127) and k_n is an integer selected based upon the number of timeslots allocated (n). Values for k_n are tabulated in Table 9.2.6.4.2.

Table 9.2.6.4.2: k_n tabulated as a function of the number of timeslots (n)

n	k_n
1	0
2	15
3	25
4	31
5	36
6	41
7	44
8	47
9	50
10	52
11	54
12	56

9.2.6.4.3 1.28 Mcps TDD Transport Block Size

For 1.28 Mcps TDD, the mapping of transport block size L to TB index k ($k = \{0, 1, \dots, 63\}$) (see Annex BC.1) is given by the formula:

Table 9.2.6.4.3: formula used to calculate the Transport Block Size

Category 1-2	Category 3-6
--------------	--------------

1 Timeslot	2 Timeslots	3 Timeslots	1 Timeslot	2 Timeslots	3 Timeslots	4&5 Timeslots
$L_0 = 23, L_1 = 116, L_{\min} = 162, L_k = \lfloor L_{\min} p^{k-2} \rfloor, k \in [2, 62]$						
$L_{63} = 1346,$ $p = \frac{7768}{7503}$	$L_{63} = 2754,$ $p = \frac{2578}{2461}$	$L_{63} = 4162,$ $p = \frac{8934}{8471}$	$L_{63} = 2720,$ $p = \frac{9781}{9339}$	$L_{63} = 5532,$ $p = \frac{2934}{2769}$	$L_{63} = 8348,$ $p = \frac{3052}{2861}$	$L_{63} = 11160,$ $p = \frac{9652}{9005}$

9.2.6.5 Timing Advance and Synchronisation (3.84/7.68 Mcps TDD only)

9.2.6.5.1 Unsynchronised Handover

In the case of unsynchronised handover (e.g. from FDD or from GERAN) and if no uplink DPCH is allocated the UE shall obtain timing advance in the new 3.84/7.68 Mcps TDD cell by transmission of Timing Advance Request on the E-RUCCH and by receiving Timing Advance Response on the E-AGCH.

9.2.6.5.2 Synchronisation

In the case that no uplink DPCH is allocated and after a period T-adv (configured by higher layers [7]) of no uplink transmission on the E-DCH or E-RUCCH and the UE has information to send on the E-DCH or HS-SICH, then the UE shall obtain timing advance and synchronisation by transmission of Timing Advance Request on the E-RUCCH and by receiving Timing Advance Response on the E-AGCH.

9.2.6.5.3 Timing Advance Request

Timing Advance Request is sent on the E-RUCCH using the general message format shown by Figure 9.2.6.3-1 and by having TEBS set to 0.

9.2.6.5.4 Timing Advance Response

Timing Advance Response is sent by the Node B on the E-AGCH in response to a Timing Advance Request and is indicated by Timeslot Resource Related Information (see Section 9.2.6.2.1) being set to 0. The value to be used for timing adjustment is carried by the Absolute Grant Value and Channelisation Code fields in the E-AGCH as shown by tables 9.2.6.5-1 and 9.2.6.5-2:

Table 9.2.6.5-1: 3.84 Mcps TDD

Absolute Grant Value (most significant 3 bits of timing advance)					Channelisation Code (least significant 5 bits of timing advance)				
0	0	X	X	X	X	X	X	X	X

Table 9.2.6.5-2: 7.64 Mcps TDD

Absolute Grant Value (most significant 3 bits of timing advance)					Channelisation Code (least significant 6 bits of timing advance)					
0	0	X	X	X	X	X	X	X	X	X

On receipt of Timing Advance Response the UE shall adjust its transmissions based on the the received timing advance adjustment [18]. If Timing Advance Response is not received within a period T-RUCCH then the UE shall retransmit Timing Advance Request.

10 Handling of unknown, unforeseen and erroneous protocol data

The list of error cases is reported below:

a) Use of reserved coding in the MAC header

If the MAC entity receives a MAC PDU with a header field using a value marked as reserved for this version of the protocol, it shall discard the PDU, unless explicitly mentioned otherwise.

b) Inconsistent MAC header

If the MAC entity receives a MAC PDU with a header inconsistent with the configuration received from RRC, it shall discard the PDU. E.g.: In case DTCH is mapped to RACH/FACH, the MAC entity shall discard a PDU with a C/T field indicating a logical channel number that is not configured.

c) Erroneous MAC header fields

The MAC PDU shall be discarded if the lower layer gives an error indication for a MAC PDU and a MAC header is included in the MAC PDU.

d) Inconsistent information received on MAC control channels

If the MAC entity receives inconsistent information on the E-AGCH, it shall ignore the entire message. The following conditions constitute inconsistent information:

- The Absolute Grant Scope is "Per HARQ process" and the E-DCH TTI is configured to 10ms.
- The Identity Type is "Secondary" and the Absolute Grant Value is "INACTIVE".
- The Identity Type is "Secondary" and the Absolute Grant Scope is "Per HARQ process" in this version of the protocol.
- The Identity type is "Primary", the Absolute Grant value is "INACTIVE", the Absolute Grant Scope is "All HARQ processes", the E-DCH TTI is configured to 10ms and a secondary E-RNTI was not configured.

11 Specific functions

11.1 Traffic volume measurement for dynamic radio bearer control

Dynamic radio bearer control is performed by RRC, based on the traffic volume measurements reported by MAC. Traffic volume information is measured in MAC layer and the results are reported from MAC layer to RRC layer.

At least every TTI, the MAC layer shall receive from each RLC entity the value of its Buffer Occupancy (BO), expressed in bytes. RRC can configure MAC to keep track of statistics (i.e. raw BO, average of BO and variance of BO) on the BO (see [7]) values of all Radio Bearers mapped onto a given transport channel. When the average or variance are requested, an averaging interval duration will also be provided.

Every time the BO values are reported to MAC, the UE shall verify whether an event was triggered or if a periodic report is required (see [7]). If reporting is required (multiple reports may be triggered in a single TTI), the MAC shall deliver to RRC the reporting quantities required for the corresponding RBs. In the case of average and variance of BO, the averaging should be performed for the interval with the configured duration ending at the time when the event was triggered.

RRC requests MAC measurement report with the primitive CMAC-Measure-REQ including following parameters.

Measurement information elements.

- Reporting Quantity identifiers
Indicates what should be reported to RRC layer
For each RB, BO (optional), Average of BO (optional), or Variance of BO(optional)
- Time interval to take an average or a variance (applicable when Average or Variance is Reporting Quantity)
Indicates time interval to take an average or a variance of BO
The calculation of average and variance of BO shall be based on one sample of BO per 10ms during the time interval given in this information element. All samples taken in the time interval shall have equal weight in the calculation.

MAC receives RLC PDUs with the primitive MAC-Data-REQ including following parameters.

- Buffer Occupancy (BO)
The parameter Buffer Occupancy (BO) indicates for each logical channel the amount of data in number of bytes that is available for transmission and retransmission in RLC layer. When MAC is connected to an AM RLC entity, control PDUs to be transmitted and RLC PDUs outside the RLC Tx window shall also be included in the BO. RLC PDUs that have been transmitted but not negatively acknowledged by the peer entity shall not be included in the BO.

11.2 Control of RACH transmissions

The MAC sublayer is in charge of controlling the timing of RACH transmissions on transmission time interval level (the timing on access slot level is controlled by L1). Note that retransmissions in case of erroneously received RACH message part are under control of higher layers, i.e. RLC, or RRC for CCCH (and SHCCH for TDD).

11.2.1 Access Service Class selection

The physical RACH resources (i.e. access slots and preamble signatures for FDD, timeslot and channelisation code for 3.84 Mcps TDD and 7.68 Mcps TDD, SYNC1 code for 1.28 Mcps TDD) may be divided between different Access Service Classes in order to provide different priorities of RACH usage. It is possible for more than one ASC or for all ASCs to be assigned to the same access slot/signature space or SYNC1 code.

Access Service Classes are numbered in the range $0 \leq i \leq \text{NumASC} \leq 7$ (i.e. the maximum number of ASCs is 8). An ASC is defined by an identifier i that defines a certain partition of the PRACH resources and an associated persistence value P_i . A set of ASC parameters consists of $\text{NumASC}+1$ such parameters (i, P_i) , $i = 0, \dots, \text{NumASC}$. The PRACH partitions and the persistence values P_i are derived by the RRC protocol from system information (see [7]). The set of ASC parameters is provided to MAC with the CMAC-Config-REQ primitive. The ASC enumeration is such that it corresponds to the order of priority (ASC 0 = highest priority, ASC 7 = lowest priority). ASC 0 shall be used in case of Emergency Call or for reasons with equivalent priority.

At radio bearer setup/reconfiguration each involved logical channel is assigned a MAC Logical channel Priority (MLP) in the range 1,...,8. When the MAC sublayer is configured for RACH transmission in the UE, these MLP levels shall be employed for ASC selection on MAC.

The following ASC selection scheme shall be applied, where NumASC is the highest available ASC number and MinMLP the highest logical channel priority assigned to one logical channel:

- in case all TBs in the TB set have the same MLP, select $\text{ASC} = \min(\text{NumASC}, \text{MLP})$;
- in case TBs in a TB set have different priority, determine the highest priority level MinMLP and select $\text{ASC} = \min(\text{NumASC}, \text{MinMLP})$.

When an RRC CONNECTION REQUEST message is sent RRC determines ASC by means of the access class [7]. The ASC to be used in these circumstances is signalled to MAC by means of the CMAC-CONFIG-REQ message.

If MAC has knowledge of a U-RNTI then the ASC is determined in the MAC entity. If no U-RNTI has been indicated to MAC then MAC will use the ASC indicated in the CMAC-CONFIG-REQ primitive.

11.2.2 Control of RACH transmissions for FDD mode

The RACH transmissions are controlled by the UE MAC sublayer as outlined in figure 11.2.2.1.

NOTE: The figure shall illustrate the operation of the transmission control procedure as specified below. It shall not impose restrictions on implementation. MAC controls the timing of each initial preamble ramping cycle as well as successive preamble ramping cycles in case that none or a negative acknowledgement is received on AICH.

NOTE: In Cell-FACH state, the UE should co-ordinate the UL transmission schedule with the measurement schedule in FACH measurement occasions so as to minimise any delays associated with inter-frequency measurements.

MAC receives the following RACH transmission control parameters from RRC with the CMAC-CONFIG-Req primitive:

- a set of Access Service Class (ASC) parameters, which includes for each ASC, $i=0, \dots, \text{NumASC}$ an identification of a PRACH partition and a persistence value P_i (transmission probability);
- maximum number of preamble ramping cycles M_{max} ;
- range of backoff interval for timer T_{BO1} , given in terms of numbers of transmission 10 ms time intervals N_{BO1max} and N_{BO1min} , applicable when negative acknowledgement on AICH is received.

When there is data to be transmitted, MAC selects the ASC from the available set of ASCs, which consists of an identifier i of a certain PRACH partition and an associated persistence value P_i . The procedure to be applied for ASC selection is described in subclause 11.2.1.

Based on the persistence value P_i , the UE decides whether to start the L1 PRACH transmission procedure (see [13]) in the present transmission time interval or not. If transmission is allowed, the PRACH transmission procedure (starting with a preamble power ramping cycle) is initiated by sending of a PHY-ACCESS-REQ primitive. MAC then waits for access information from L1 via PHY-ACCESS-CNF primitive. If transmission is not allowed, a new persistency check is performed in the next transmission time interval. The persistency check is repeated until transmission is permitted.

When the preamble has been acknowledged on AICH, L1 access information with parameter value "ready for data transmission" is indicated to MAC with PHY-ACCESS-CNF primitive. Then data transmission is requested with PHY-DATA-REQ primitive, and the PRACH transmission procedure shall be completed with transmission of the PRACH message part according to L1 specifications. Successful completion (TX status) of the MAC transmission control procedure shall be indicated to higher layer.

When PHY indicates that no acknowledgement on AICH is received while the maximum number of preamble retransmissions is reached (defined by parameter `Preamble_Retrans_Max` on L1), a new persistency test is performed in the next transmission time interval. The timer T_2 ensures that two successive persistency tests are separated by at least one 10 ms time interval.

In case that a negative acknowledgement has been received on AICH a backoff timer T_{BO1} is started. After expiry of the timer, persistence check is performed again. Backoff timer T_{BO1} is set to an integer number N_{BO1} of 10 ms time intervals, randomly drawn within an interval $0 \leq N_{\text{BO1min}} \leq N_{\text{BO1}} \leq N_{\text{BO1max}}$ (with uniform distribution). N_{BO1min} and N_{BO1max} may be set equal when a fixed delay is desired, and even to zero when no delay other than the one due to persistency is desired.

Before a persistency test is performed it shall be checked whether any new RACH transmission control parameters have been received from RRC with CMAC-CONFIG-Req primitive. The latest set of RACH transmission control parameters shall be applied.

If the maximum number of preamble ramping cycles M_{max} is exceeded, failure of RACH transmission shall be reported to higher layer.

Both, transmission failure and successful completion of the MAC transmission control procedure, shall be indicated individually for each logical channel of which data was included in the transport block set of that access attempt. When transparent mode RLC is employed (i.e. for CCCH), transmission status is reported to RRC with CMAC-STATUS-Ind primitive. For logical channels employing acknowledged or unacknowledged mode RLC, transmission status is reported to RLC with MAC-STATUS-Ind primitive.

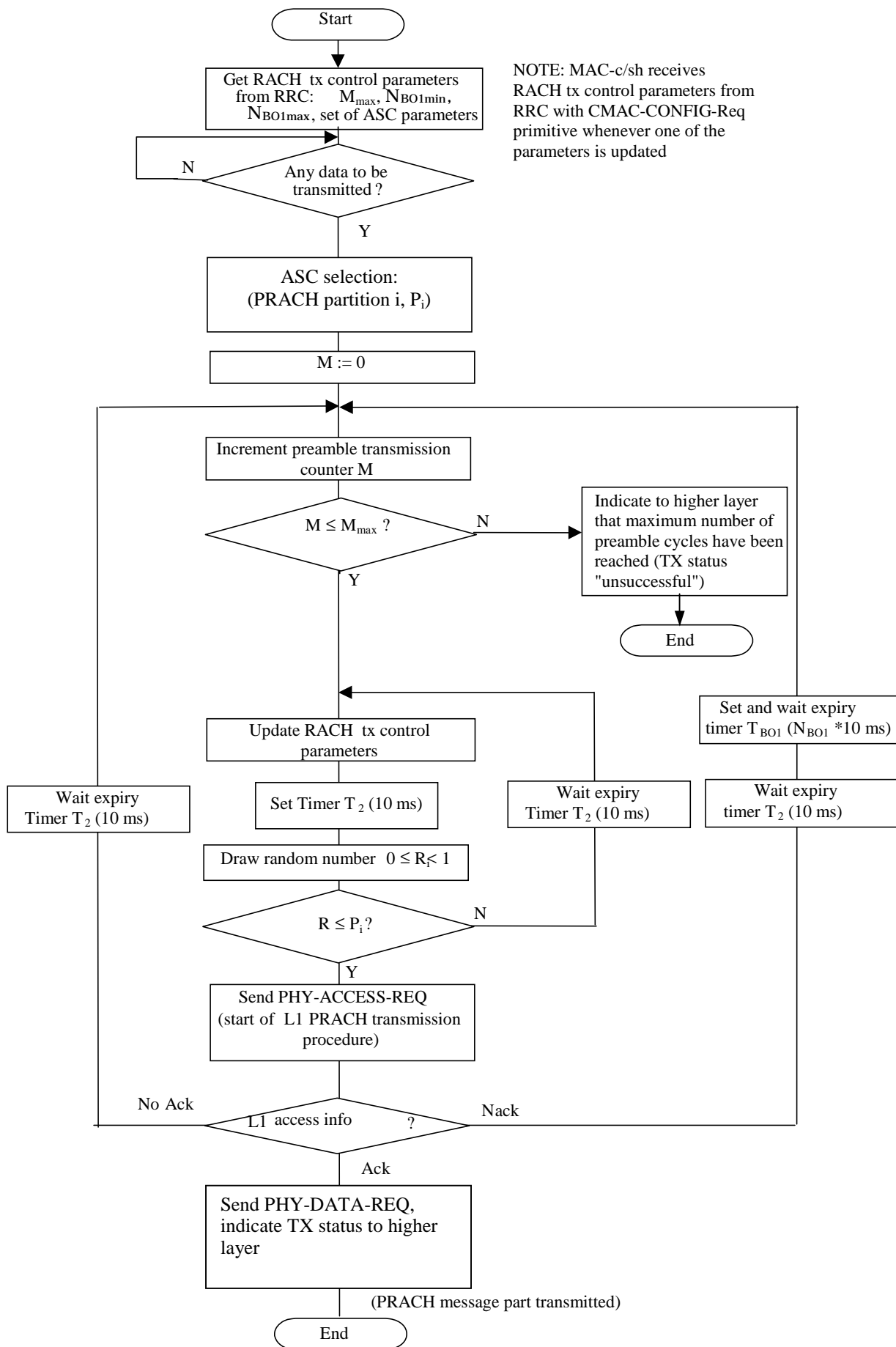

Figure 11.2.2.1: RACH transmission control procedure (UE side, informative)

11.2.3 Control of RACH transmissions for TDD

11.2.3.1 Control of RACH transmissions for 3.84 Mcps TDD and 7.68 Mcps TDD

The RACH transmissions are performed by the UE as shown in figure 11.2.3.2.

NOTE: The figure shall illustrate the operation of the transmission control procedure as specified below. It shall not impose restrictions on implementation.

MAC receives the following RACH transmission control parameters from RRC with the CMAC-Config-REQ primitive:

- a set of Access Service Class (ASC) parameters, which includes for each ASC, $i=0, \dots, \text{NumASC}$ an identification of a PRACH partition and a persistence value P_i (transmission probability).

When there is data to be transmitted, MAC selects the ASC from the available set of ASCs, which consists of an identifier i of a certain PRACH partition and an associated persistence value P_i . The procedure to be applied for ASC selection is described in subclause 11.2.1.

In order to separate different ASCs each PRACH has N sub-channels associated with it (numbered from 0 to $N-1$). N may be assigned the value 1,2,4, or 8 by higher layer signalling. Sub-channel i for a PRACH defined in timeslot k is defined as the k :th slot in the frames where $\text{SFN mod } N = i$. Therefore follows the definition:

- Sub-channel i associated to a PRACH defined in timeslot k is defined as the k :th timeslot in the frames where $\text{SFN mod } N = i$.

Figure 11.2.3.1 illustrates the eight possible subchannels for the case, $N=8$. For illustration, the figure assumes that the PRACH is assigned timeslot 3.

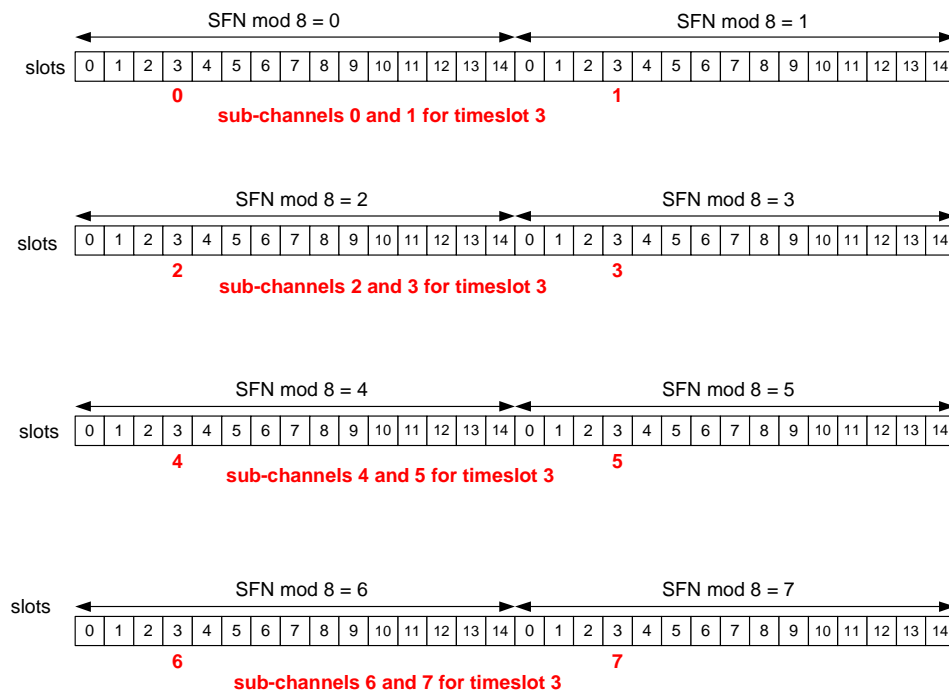

Figure 11.2.3.1 Eight sub-channels for timeslot 3

Based on the persistence value P , the UE decides whether to send the message on the RACH. If transmission is not allowed, a new persistency check is performed in the next transmission time interval. The persistency check is repeated until transmission is permitted. If transmission is allowed, a subchannel is randomly selected from the set of available subchannels for this ASC. The random subchannel selection shall be such that each of the allowed selections is chosen with equal probability. If an available subchannel is not found, the persistency check and subchannel assignment is repeated for the next subchannel period. If an available subchannel is found the PRACH transmission procedure is initiated by sending of a PHY-Data-REQ primitive.

Successful completion (TX status) of the MAC transmission control procedure shall be indicated to higher layer individually for each logical channel of which data was included in the transport block set of that access attempt. When transparent mode RLC is employed (i.e. for CCCH), transmission status is reported to RRC with CMAC-STATUS-Ind primitive. For logical channels employing acknowledged or unacknowledged mode RLC, transmission status is reported to RLC with MAC-STATUS-Ind primitive.

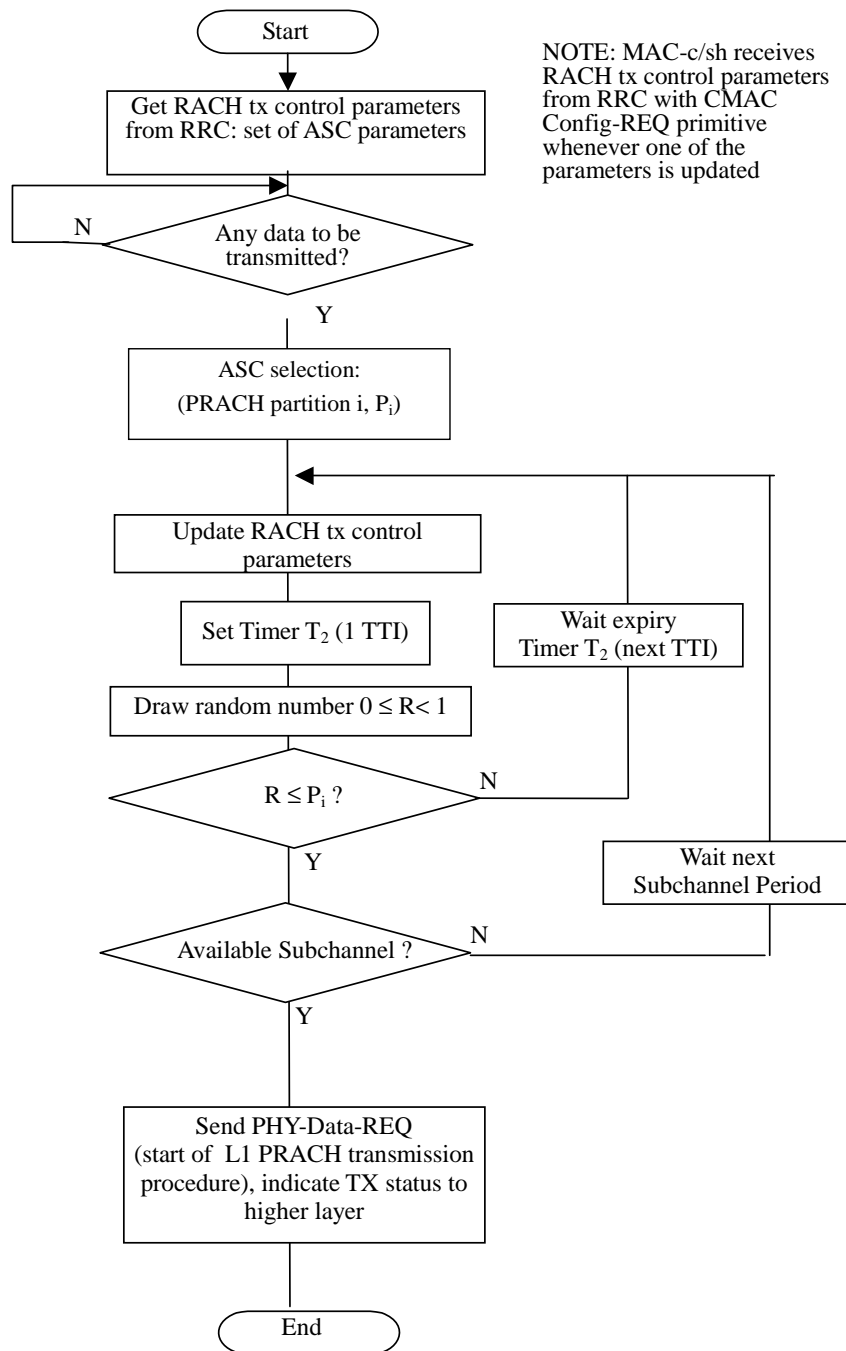

Figure 11.2.3.2: RACH transmission control procedure for TDD (UE side, informative)

11.2.3.1.1 Control of E-RUCCH transmissions

The MAC-e sublayer is in charge of controlling the timing of E-RUCCH transmission.

MAC receives the following E-RUCCH transmission control parameters from RRC with the CMAC-Config-REQ primitive:

- a set of Access Service Class (ASC) parameters, which includes for each ASC, $i=0, \dots, \text{NumASC}$ a persistence value P_i (transmission probability).

When there is data to be transmitted, MAC selects the ASC from the available set of ASCs, which consists of an identifier i of a persistence value P_i . The procedure to be applied for ASC selection is described in subclause 11.2.3.1.1.1.

If this is the first transmission of the E-RUCCH, i.e. timer T-RUCCH (as described in 11.9.1.4a) is not currently running, then the persistence value will be assumed to be 1, otherwise it will be the value associated with the chosen ASC. The persistence value will then be used in the same way as described for RACH transmissions as defined in section 11.2.3.1.

NOTE: Unlike RACH transmissions no partitioning of the E-RUCCH resource based on ASC will be implemented.

11.2.3.1.1.1 Access Service Class selection

For E-RUCCH transmission, the following ASC selection scheme shall be applied:

- select ASC = min (NumASC, MinMLP);

Where NumASC is the highest available ASC number and MinMLP is the highest priority level of the logical channels which have data buffered for transmission.

11.2.3.2 Control of RACH Transmissions for 1.28 Mcps TDD

The RACH transmissions are performed by the UE as shown in figure 11.2.3.3.

NOTE: The figure shall illustrate the operation of the transmission control procedure as specified below. It shall not impose restrictions on implementation.

UE MAC receives the following RACH transmission control parameters from RRC with the CMAC-Config-REQ primitive:

- a set of Access Service Class (ASC) parameters, which includes for each ASC, $i=0, \dots, \text{NumASC}$ an identification of a PRACH partition and a persistence value P_i (transmission probability),
- maximum number of synchronisation attempts M_{max} .

When there is data to be transmitted, MAC selects the ASC from the available set of ASCs, which consists of an identifier i of a certain PRACH partition and an associated persistence value P_i .

Based on the persistence value P_i , MAC decides whether to start the L1 PRACH procedure in the present transmission time interval or not. If transmission is allowed, the PRACH transmission procedure (starting with the SYNC_UL/FPACH power ramping sequence) is initiated by the sending of a PHY-ACCESS-REQ primitive. MAC then waits for access information from L1 via the PHY-ACCESS-CNF primitive. If transmission is not allowed, a new persistency check is performed in the next transmission time interval. The persistency check is repeated until transmission is permitted.

If a synchronisation burst has been acknowledged on its associated FPACH, PHY will inform MAC by a PHY-ACCESS-CNF primitive indicating "ready for RACH data transmission". Then MAC requests data transmission with a PHY-DATA-REQ primitive, and the PRACH transmission procedure will be completed with transmission on the PRACH resources associated with the FPACH.

Successful completion of the MAC procedure is indicated to higher layer individually for each logical channel of which data was included in the transport block set of that access attempt. When transparent mode RLC is employed (i.e. for CCCH), transmission status is reported to RRC with CMAC-STATUS-Ind primitive. For logical channels employing acknowledged or unacknowledged mode RLC, transmission status is reported to RLC with MAC-STATUS-Ind primitive.

If no synchronisation burst received an acknowledgement on the FPACH within the maximum number of transmissions permitted in a power ramping cycle, PHY will inform MAC by a PHY-ACCESS-CNF primitive indicating "no response received on FPACH". If the maximum number of synchronisation attempts permitted, M_{max} , has not been exceeded, then MAC commences a new persistency test sequence in the next transmission time interval and the PHY-ACCESS-REQ procedure is repeated. The timer T_2 ensures that two successive persistency tests are separated by at least one transmission time interval. If the maximum number of synchronisation attempts is exceeded then MAC

abandons the RACH procedure. Failure to complete the MAC procedure is indicated to higher layer by the CMAC-STATUS-Ind or MAC-STATUS-Ind primitives.

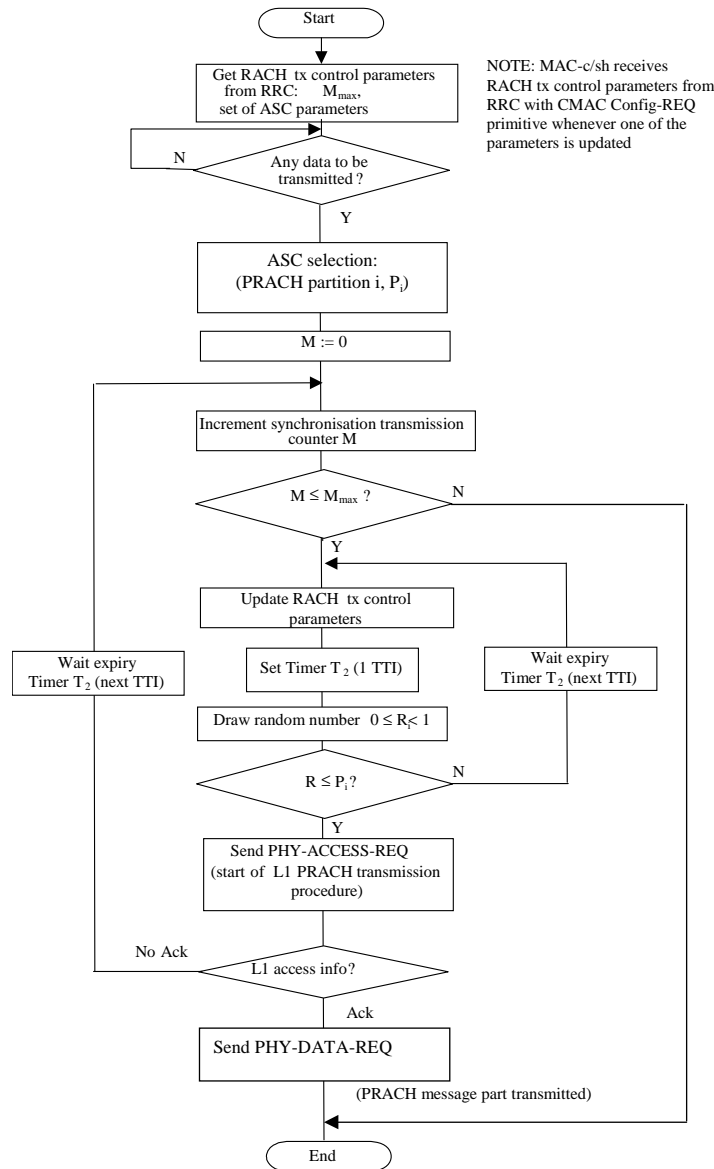

Figure 11.2.3.3: RACH transmission control procedure for 1.28 Mcps TDD (UE side, informative)

11.2.3.2.1 Control of E-RUCCH transmissions

The MAC-e sublayer is in charge of controlling the timing of E-RUCCH transmission.

MAC receives the following E-RUCCH transmission control parameters from RRC with the CMAC-Config-REQ primitive:

- a set of Access Service Class (ASC) parameters, which includes for each ASC, $i=0, \dots, \text{NumASC}$ a persistence value P_i (transmission probability).
- maximum number of synchronisation attempts M_{max} .

When there is data to be transmitted, MAC selects the ASC from the available set of ASCs, which consists of an identifier i of a persistence value P_i . The procedure to be applied for ASC selection is described in subclause 11.2.3.2.1.1.

The persistence value will be the value associated with the chosen ASC. The persistence value will then be used in the same way as described for RACH transmissions as defined in section 11.2.3.2.

If one of the following criteria for E-RUCCH transmission are met, failure indication of the E-RUCCH transmission is sent to RRC by the CMAC-STATUS-Ind primitive with E-RUCCH failure:

- The maximum number Mmax of synchronisation attempts is reached;
- When the hysteresis timer with the value of N-RUCCH times of T-RUCCH period, which is started when the the E-RUCCH transmission counter is reached to N_RUCCH, is expired.

11.2.3.2.1.1 Access Service Class selection

For E-RUCCH transmission, the following ASC selection scheme shall be applied:

- select ASC = min (NumASC, MinMLP);

Where NumASC is the highest available ASC number and MinMLP is the highest logical channel priority of the logical channel which has data buffered for transmission.

11.2.3.2.1.2 Void

11.3 Void

11.4 Transport format combination selection in UE (non E-DCH)

RRC can control the scheduling of uplink data by giving each logical channel a priority between 1 and 8, where 1 is the highest priority and 8 the lowest. TFC selection in the UE shall be done in accordance with the priorities indicated by RRC. Logical channels have absolute priority, i.e. the UE shall maximise the transmission of higher priority data.

If the uplink TFCS or TFC Subset configured by UTRAN follows the guidelines described in [7] the UE shall perform the TFC selection according to the rules specified below. If these guidelines are not followed then the UE behaviour is not specified.

A given TFC can be in any of the following states:

- Supported state;
- Excess-power state;
- Blocked state.

TDD mode UEs in CELL_FACH state using the USCH transport channel and UEs in CELL_DCH state using a DCH shall continuously monitor the state of each TFC based on its required transmit power versus the maximum UE transmit power (see [7]). The state transition criteria and the associated requirements are described in [12, 14]. The UE shall consider that the Blocking criterion is never met for TFCs included in the minimum set of TFCs (see [7]).

The following diagram illustrates the state transitions for the state of a given TFC:

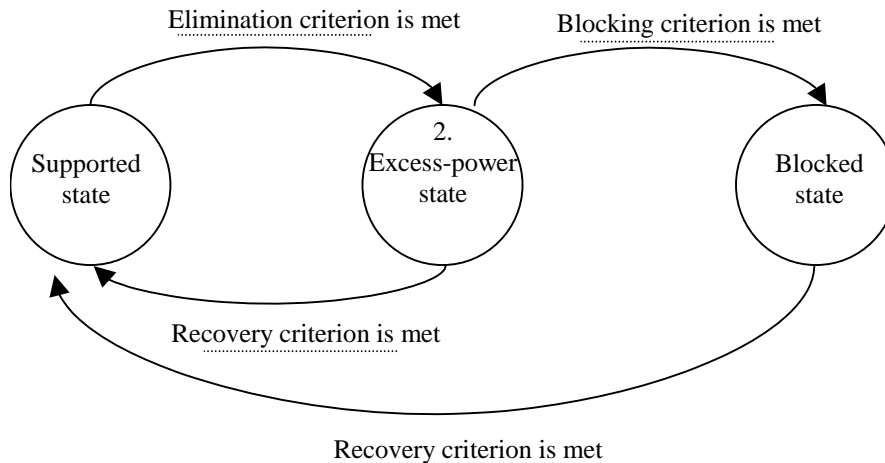

Figure 11.4.1: State transitions for the state of a given TFC

FDD Mode UEs in CELL_FACH state may estimate the channel path loss and set to excess power state all the TFCs requiring more power than the Maximum UE transmitter power (see [7]). All other TFCs shall be set to Supported state.

Every time the set of supported TFCs changes, the available bitrate shall be indicated to upper layers for each logical channel in order to facilitate the adaptation of codec data rates when codecs supporting variable-rate operation are used. The details of the computation of the available bitrate and the interaction with the application layer are not further specified.

Before selecting a TFC, i.e. at every boundary of the shortest TTI, or prior to each transmission on PRACH the set of valid TFCs shall be established. All TFCs in the set of valid TFCs shall:

1. belong to the TFCS.
- 1a. not be restricted by higher layer signalling (e.g. TFC Control, see [7]).
2. not be in the Blocked state.
3. be compatible with the RLC configuration.
4. not require RLC to produce padding PDUs (see [6] for definition).
5. not carry more bits than can be transmitted in a TTI (e.g. when compressed mode by higher layer scheduling is used and the presence of compressed frames reduces the number of bits that can be transmitted in a TTI using the Minimum SF configured).

The UE may remove from the set of valid TFCs, TFCs in Excess-power state in order to maintain the quality of service for sensitive applications (e.g. speech). However, this shall not apply to TFCs included in the minimum set of TFCs (see [7]). Additionally, if compressed frames are present within the longest configured TTI to which the next transmission belongs, the UE may remove TFCs from the set of valid TFCs in order to account for the higher power requirements.

The chosen TFC shall be selected from within the set of valid TFCs and shall satisfy the following criteria in the order in which they are listed below:

1. No other TFC shall allow the transmission of more highest priority data than the chosen TFC.
2. No other TFC shall allow the transmission of more data from the next lower priority logical channels. Apply this criterion recursively for the remaining priority levels.
3. No other TFC shall have a lower bit rate than the chosen TFC.

In FDD mode the above rules for TFC selection in the UE shall apply to DCH, and the same rules shall apply for TF selection on RACH.

In 3.84 Mcps TDD mode and in 7.68 Mcps TDD mode the above rules for TFC selection in the UE shall apply to DCH and USCH.

11.5 Ciphering

The ciphering function is performed in MAC (i.e. only in MAC-d) if a radio bearer is using the transparent RLC mode. The part of the MAC PDU that is ciphered is the MAC SDU and this is shown in Figure 11.5.1 below.

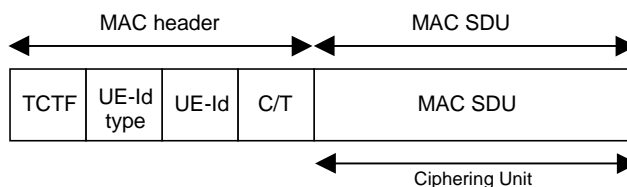

Figure 11.5.1: Ciphered part unit for a MAC PDU

In case a TTI contains multiple MAC PDUs for a given Transparent mode RB, the ciphering unit for this RB is the bitstring concatenation of all the MAC SDUs, resulting in the PLAINTEXT BLOCK, as defined in [15]. In case there is only one MAC PDU for a given Transparent mode RB, the ciphering unit is the MAC SDU, resulting in the PLAINTEXT BLOCK. The concatenation order is the same as the order of transmission of the Transport Blocks between MAC and Physical layer.

The KEYSTREAM BLOCK as defined in [10] is applied to the PLAINTEXT BLOCK, and the end result, CIPHERTEXT BLOCK, becomes the ciphered part for the MAC PDU, in case there is only one MAC PDU per RB. In case there is more than one MAC PDU per RB, the CIPHERTEXT BLOCK is split into the corresponding ciphered parts for each MAC PDU. The split order is the same as the order of transmission of the Transport Blocks between MAC and Physical layer.

The ciphering algorithm and key to be used are configured by upper layers [7] and the ciphering method shall be applied as specified in [10].

The parameters that are required by MAC for ciphering are defined in [10] and are input to the ciphering algorithm. The parameters required by MAC which are provided by upper layers [7] are listed below:

- MAC-d HFN (Hyper frame number for radio bearers that are mapped onto transparent mode RLC)
- BEARER defined as the radio bearer identifier in [10]. It will use the value RB identity -1 as in [7])
- CK (Ciphering Key)

If the TTI consists of more than one 10 ms radio frame, the CFN of the first radio frame in the TTI shall be used as input to the ciphering algorithm for all the data in the TTI.

11.6 Control of HS-DSCH transmission and reception

If MAC-hs is configured by upper layers [7], the control of HS-DSCH transmission and reception is defined in subclauses 11.6.1 and 11.6.2.

If MAC-ehs version is configured by upper layers [7], the control of HS-DSCH transmission and reception is defined in subclauses 11.6.3 and 11.6.4.

11.6.1 Network operation

The following are the functions of the various functional entities at the network in support of the HARQ protocol used on HS-DSCH when MAC-hs is configured by upper layers [7].

11.6.1.1 Scheduler

The scheduler performs the following functions:

- Schedules all UEs within a cell;

- Services priority queues:
 - The scheduler schedules MAC-hs SDUs based on information from upper layers. One UE may be associated with one or more MAC-d flows. Each MAC-d flow contains HS-DSCH MAC-d PDUs for one or more priority queues.
- Determines the HARQ Entity and the queue to be serviced;
- Sets the TSN for new data blocks being transferred from the selected queue;
 - set the TSN to value 0 for the first MAC-hs PDU transmitted for each Queue ID within an HS-DSCH;
 - increment the TSN with one for each transmitted MAC-hs PDU on each Queue ID within an HS-DSCH.

NOTE: In 1.28 Mcps TDD multi-frequency HS-DSCH cell, the length of TSN can be 6 bits or 9 bits based on the configuration of higher layer.

NOTE: The scheduler may re-use TSNs by toggling the NDI bit in order to resume pre-empted transmissions or to force the UE to flush the soft buffer. In this case the content of the payload may be changed but care should be taken to preserve the higher layer data order.

- Indicates the Queue ID and TSN to the HARQ entity for each MAC-hs PDU to be transmitted;
- Schedules new transmissions and retransmissions:
 - Based on the status reports from HARQ Processes the scheduler determines if either a new transmission or a retransmission should be made. A new transmission can however be initiated on a HARQ process at any time. Based on a delay attribute provided by upper layers, the scheduler may decide to discard any 'out-of-date' MAC-hs SDU.
- Determines the redundancy version:
 - The scheduler determines a suitable redundancy version for each transmitted and retransmitted MAC-hs PDU and indicates the redundancy version to lower layer.
 - Determines the TDD HCSN;
 - Increment UE specific HCSN for each HS-SCCH transmission. In 1.28Mcps TDD multi-frequency HS-DSCH cell, UE maintains the respective HCSN for each carrier independently.

11.6.1.2 HARQ entity

- There is one HARQ entity per UE in UTRAN. In 1.28 Mcps TDD multi-frequency HS-DSCH cell, HARQ entity consists of some HARQ sub-entities, each sub-entity is associated with one carrier.
- The HARQ entity sets the Queue ID in transmitted MAC-hs PDUs to the value indicated by the UTRAN scheduler.
- The HARQ entity sets the transmission sequence number (TSN) in transmitted MAC-hs PDUs to the value indicated by the UTRAN scheduler.
- The HARQ entity sets the HARQ process identifier in transmitted MAC-hs PDUs. UTRAN should:
 - determine a suitable HARQ process to service the MAC-hs PDU and set the HARQ process identifier accordingly.

11.6.1.3 HARQ process

- The HARQ process sets the New data indicator in transmitted MAC-hs PDUs. UTRAN should:
 - set the New Data Indicator to the value "0" for the first MAC-hs PDU transmitted by a HARQ process;
 - not increment the New Data Indicator for retransmissions of a MAC-hs PDU;
 - increment the New Data Indicator with one for each transmitted MAC-hs PDU containing new data.

- The HARQ process processes received status messages. UTRAN should:
 - deliver received status messages to the scheduler.

11.6.2 UE operation

The UE operation in support of the HARQ protocol used on HS-DSCH is split among the following four functional units with their associated functions.

11.6.2.1 HARQ Entity

There is one HARQ entity at the UE which processes the HARQ process identifiers received on the HS-SCCH transmissions associated with MAC-hs PDUs received on the HS-DSCH.

In 1.28 Mcps TDD multi-frequency HS-DSCH cell, HARQ sub-entity is configured at UE per carrier where HS-DSCH is configured. The associated downlink control channel and uplink control channel pair controlling the HS-DSCH transmission on the certain carrier shall be allocated on the same carrier. The downlink control channel carries the HS-DSCH operation related info and the uplink control channel carries the feedback info from the UE side. In 1.28 Mcps TDD single frequency or multi-frequency HS-DSCH cell, HARQ entity or HARQ sub-entity is configured to handle the HARQ identity associated with the received MAC-hs PDU from every carrier where HS-DSCH is configured at UE side.

A number of parallel HARQ processes are used in the UE to support the HARQ entity. The number of HARQ processes is configured by upper layers:

- Each received MAC-hs PDU shall be allocated to the HARQ process indicated by the HARQ process identifier of the MAC-hs PDU.

11.6.2.2 HARQ process

The HARQ process processes the New Data Indicator indicated by lower layers for each received MAC-hs PDU.

The UE may:

- for FDD, if the MAC-hs PDU is received within 5 sub-frames from the reception of the previous MAC-hs PDU intended for this HARQ process; or
- for TDD, if the MAC-hs PDU is received before generation of feedback resulting from reception of a previous MAC-hs PDU for the same HARQ process:
 - discard the MAC-hs PDU.

The UE shall:

- if the New Data Indicator has been incremented compared to the value in the previous received transmission in this HARQ process or this is the first received transmission in the HARQ process:
 - replace the data currently in the soft buffer for this HARQ process with the received data.
- if the Transport Block Size index value is equal to 111111 (FDD only):
 - generate a positive acknowledgement (ACK) of the data in this HARQ process;
 - discard the received data;
 - assume that the data has been successfully decoded.
- if the New Data Indicator is identical to the value used in the previous received transmission in the HARQ process:
 - if the Transport Block Size index value is equal to 111111 (FDD only):
 - assume that the transport block size is identical to the last valid transport block size signalled for this HARQ process.

- if the data has not yet been successfully decoded:
 - combine the received data with the data currently in the soft buffer for this HARQ process.
- if the transport block size is different from the last valid transport block size signalled for this HARQ process:
 - the UE may replace the data currently in the soft buffer for this HARQ process with the received data.
- if the data in the soft buffer has been successfully decoded and no error was detected:
 - deliver the decoded MAC-hs PDU to the reordering entity;
 - generate a positive acknowledgement (ACK) of the data in this HARQ process.
- else:
 - generate a negative acknowledgement (NAK) of the data in this HARQ process;
- schedule the generated positive or negative acknowledgement for transmission and the time of transmission relative to the reception of data in a HARQ process is configured by upper layer.

The HARQ process processes the Queue ID in the received MAC-hs PDUs. The UE shall:

- arrange the received MAC-hs PDUs in queues based on the Queue ID.

11.6.2.3 Reordering entity

11.6.2.3.1 Definitions

In the functions described in this section the following definitions apply:

Parameters

- Transmitter window size (TRANSMIT_WINDOW_SIZE)
TRANSMIT_WINDOW_SIZE is the size of the transmitter window according to the definition below. This is a parameter in the Node B and the value of the parameter is configured by higher layers.
- Receiver window size (RECEIVE_WINDOW_SIZE)
RECEIVE_WINDOW_SIZE is the size of the receiver window according to the definition below. This is a parameter in the UE and the value of the parameter is configured by higher layers.

State variables

All state variables are non-negative integers. MAC-hs PDUs are numbered by modulo integer Transmission sequence numbers (TSN) cycling through the field 0 to 63. All arithmetic operations contained in the present document on next_expected_TSN, RcvWindow_UpperEdge, T1_TSN and TSN_flush are affected by the 64 modulus. When performing arithmetic comparisons of state variables or Transmission sequence number values a 64 modulus base shall be used. This modulus base is subtracted (within the appropriate field) from all the values involved and then an absolute comparison is performed. RcvWindow_UpperEdge – RECEIVE_WINDOW_SIZE + 1 shall be assumed to be the modulus base. For 1.28 Mcps TDD multi-frequency HS-DSCH operation operation mode, TSN_MAX represents period length of TSN; the arithmetic operations and comparisons of state variables in multi-frequency mode are performed on TSN_MAX modulus base.

- next_expected_TSN:
The next_expected_TSN is the Transmission sequence number (TSN) following the TSN of the last in-sequence MAC-hs PDU received. It shall be updated according to the procedures given in subclauses 11.6.2.3.2, 11.6.2.5 and 11.6.2.6. The initial value of next_expected_TSN =0.
- RcvWindow_UpperEdge:
The RcvWindow_UpperEdge represents the TSN, which is at the upper edge of the receiver window. After the first MAC-hs PDU has been received successfully, it also corresponds to the MAC-hs PDU with the highest TSN of all received MAC-hs PDUs. The initial RcvWindow_UpperEdge equals 63. RcvWindow_UpperEdge is updated based on the reception of new MAC-hs PDU according to the procedure given below.

- T1_TSN:
The TSN of the latest MAC-hs PDU that cannot be delivered to the disassembly entity, when the timer T1 is started.
- TSN_MAX (1.28Mcps TDD multi-frequency HS-DSCH operation mode only):
TSN_MAX represents the periodicity of TSN for 1.28Mcps TDD multi-frequency HS-DSCH operation mode, the possible value is 64 or 512.

Timers

- Re-ordering release timer (T1):
The Re-ordering release timer T1 controls the stall avoidance in the UE reordering buffer as described below. The value of T1 is configured by upper layers.

Other definitions

- Receiver window:
The receiver window defines TSNs of those MAC-hs PDUs that can be received in the receiver without causing an advancement of the receiver window according to the procedure below. The size of the receiver window equals RECEIVE_WINDOW_SIZE and spans TSNs going from RcvWindow_UpperEdge – RECEIVE_WINDOW_SIZE + 1 to RcvWindow_UpperEdge included.

11.6.2.3.2 Reordering functionality

If no timer T1 is active:

- the timer T1 shall be started when a MAC-hs PDU with $TSN > next_expected_TSN$ is correctly received.
- T1_TSN shall be set to the TSN of this MAC-hs PDU.

If a timer T1 is already active:

- no additional timer shall be started, i.e. only one timer T1 may be active at a given time.

The timer T1 shall be stopped if:

- the MAC-hs PDU with $TSN = T1_TSN$ can be delivered to the disassembly entity before the timer expires.

When the timer T1 expires and $T1_TSN > next_expected_TSN$:

- all correctly received MAC-hs PDUs with $TSN > next_expected_TSN$ up to and including $T1_TSN-1$ shall be delivered to the disassembly entity;
- all correctly received MAC-hs PDUs up to the next not received MAC-hs PDU shall be delivered to the disassembly entity.
- $next_expected_TSN$ shall be set to the TSN of the next not received MAC-hs PDU.

When the timer T1 is stopped or expires, and there still exist some received MAC-hs PDUs that can not be delivered to higher layer:

- timer T1 is started
- set T1_TSN to the highest TSN among those of the MAC-hs PDUs that can not be delivered.

Transmitter operation:

After the transmitter has transmitted a MAC-hs PDU with $TSN=SN$, any MAC-hs PDU with $TSN \leq SN - TRANSMIT_WINDOW_SIZE$ should not be retransmitted to avoid sequence number ambiguity in the receiver.

Receiver operation:

When a MAC-hs PDU with $TSN = SN$ is received:

- if SN is within the receiver window:

- if SN < next_expected_TSN, or this MAC-hs PDU has previously been received:
 - the MAC-hs PDU shall be discarded;
- else:
 - the MAC-hs PDU shall be placed in the reordering buffer at the place indicated by the TSN.
- if SN is outside the receiver window:
 - the received MAC-hs PDU shall be placed above the highest received TSN in the reordering buffer, at the position indicated by SN;
 - RcvWindow_UpperEdge shall be set to SN thus advancing the receiver window;
 - any MAC-hs PDUs with $TSN \leq RcvWindow_UpperEdge - RECEIVE_WINDOW_SIZE$, i.e. outside the receiver window after its position is updated, shall be removed from the reordering buffer and be delivered to the disassembly entity;
 - if next_expected_TSN is below the updated receiver window:
 - next_expected_TSN shall be set to $RcvWindow_UpperEdge - RECEIVE_WINDOW_SIZE + 1$;
- if the MAC-hs PDU with $TSN = next_expected_TSN$ is stored in the reordering buffer:
 - all received MAC-hs PDUs with consecutive TSNs from next_expected_TSN (included) up to the first not received MAC-hs PDU shall be delivered to the disassembly entity;
 - next_expected_TSN shall be advanced to the TSN of this first not received MAC-hs PDU.

In case a UE has insufficient memory to process a received MAC-hs PDU, it shall perform the following set of operations:

- select TSN_flush such that: $next_expected_TSN < TSN_flush \leq RcvWindow_UpperEdge + 1$;
- deliver all correctly received MAC-hs PDUs with $TSN < TSN_flush$ to the disassembly entity;
- if the MAC-hs PDU with $TSN=TSN_flush$ has previously been received:
 - deliver all received MAC-hs PDUs with consecutive TSNs from TSN_flush (included) up to the first not received MAC-hs PDU to the disassembly entity;
 - advance next_expected_TSN to the TSN of this first not received MAC-hs PDU.
- else:
 - set next_expected_TSN to TSN_flush.

11.6.2.4 Disassembly entity

For each MAC-hs PDU that is delivered to the disassembly entity, the UE shall:

- remove any padding bits if present;
- remove the MAC-hs header;
- deliver the MAC-d PDUs in the MAC-hs PDU to MAC-d.

11.6.2.5 MAC-hs Reset

If a reset of the MAC-hs entity is requested by upper layers, the UE shall at the activation time indicated by higher layers:

- flush soft buffer for all configured HARQ processes;
- stop all active re-ordering release timer (T1) and set all timer T1 to their initial value;

- start TSN with value 0 for the next transmission on every configured HARQ process;
- initialise the variables RcvWindow_UpperEdge and next_expected_TSN to their initial values;
- disassemble all MAC-hs PDUs in the re-ordering buffer and deliver all MAC-d PDUs to the MAC-d entity;
- flush the re-ordering buffer;
- treat next received Transport Block as new data.

11.6.2.6 Reconfiguration of MAC-hs parameters

The parameters for a MAC-hs entity may be reconfigured (modified) by upper layers.

When a parameter is reconfigured by the upper layer, the UE shall:

- start using the reconfigured value of the parameter at the activation time indicated by higher layers.

If the parameter T1 is reconfigured for an already existing re-ordering queue, the UE shall:

- start to use the new value of T1 the next time T1 is started.

If the MAC-d PDU size info (i.e. mapping of MAC-d PDU size index to MAC-d PDU size) is reconfigured for an already existing re-ordering queue, at the activation time indicated by higher layers, the UE shall:

- stop timer T1 if running;
- set next_expected_TSN to (highest TSN of received MAC-hs PDU of this re-ordering queue + 1);
- deliver all correctly received MAC-hs PDUs in this re-ordering queue to the disassembly entity and use the old MAC-d PDU size info for these MAC-hs PDUs.

If the parameter RECEIVE_WINDOW_SIZE is reconfigured for a re-ordering queue, the UE shall:

- set RECEIVE_WINDOW_SIZE to the new value;
- remove any MAC-hs PDUs in this re-ordering queue with $TSN \leq RcvWindow_UpperEdge - RECEIVE_WINDOW_SIZE$ (i.e. outside the receiver window after its size is updated) from the reordering buffer and deliver these MAC-hs PDUs to the disassembly entity;
- if next_expected_TSN is below the receiver window after its size is updated:
 - set next_expected_TSN to $RcvWindow_UpperEdge - RECEIVE_WINDOW_SIZE + 1$;
 - deliver all received MAC-hs PDUs in this re-ordering queue with consecutive TSNs from next_expected_TSN (included) up to the first not received MAC-hs PDU to the disassembly entity;
 - advance next_expected_TSN to the TSN of this first not received MAC-hs PDU.

If the "Memory Partitioning" (see [7]) for soft buffer is reconfigured, the UE shall:

- flush soft buffer for all configured HARQ processes.

If the "TSN-Length" is reconfigured, the UE shall:

- perform the operation as per subclause 11.6.2.5.

11.6.2.7 HARQ procedure for HS-SCCH less operation (FDD only)

When the HS-SCCH less mode of operation is enabled, the UE shall be able to store 13 TTIs in a cyclic soft buffer.

For each received MAC-hs PDU provided by the lower layers the UE shall:

- If the associated HS-SCCH corresponds to an HS-SCCH less retransmission as defined in subclause 4.6A.2.2.1 of [16]:

- If the data in the soft buffer identified by the TTI $[5 \cdot \text{CFN} + \text{subframe number} - 6 - \text{PTR}] \bmod 13$ has been decoded successfully:
 - generate a positive acknowledgement (ACK) of the data corresponding to this TTI;
 - consider the data in the soft buffer identified by the TTI $[5 \cdot \text{CFN} + \text{subframe number}] \bmod 13$ has been decoded successfully.
- Else:
 - combine the received data with the data currently in the soft buffer identified by $[5 \cdot \text{CFN} + \text{subframe number} - 6 - \text{PTR}] \bmod 13$ where PTR is the value of the pointer to the previous transmission as defined in subclause 4.6A.2.2.1.2 of [16];
 - If the combined data in the soft buffer has been successfully decoded and no error was detected:
 - deliver the decoded MAC-hs PDU to the reordering entity;
 - generate a positive acknowledgement (ACK) of the data corresponding to this TTI;
 - consider the data in the soft buffer identified by the TTI $[5 \cdot \text{CFN} + \text{subframe number}] \bmod 13$ has been decoded successfully.
 - Else:
 - place the combined data for the HS-SCCH less TTI in the soft buffer identified by $[5 \cdot \text{CFN} + \text{subframe number}] \bmod 13$, replacing any data previously stored in that buffer.
 - generate a negative acknowledgement (NACK) of the data corresponding to this TTI.
- Else if the associated HS-SCCH corresponds to a HS-SCCH type 1 as defined in subclause 4.6 of [16];
 - process the received MAC-hs PDU provided by the lower layers as per subclause 11.6.2.2.
- Else;
 - If the data has been successfully decoded and no error was detected;
 - deliver the decoded MAC-hs PDU to the reordering entity;
 - generate a positive acknowledgement (ACK) of the data corresponding to this TTI;
 - consider the data in the soft buffer identified by the TTI $[5 \cdot \text{CFN} + \text{subframe number}] \bmod 13$ has been decoded successfully.
 - Else:
 - place the data for the HS-SCCH less TTI in the soft buffer identified by $[5 \cdot \text{CFN} + \text{subframe number}] \bmod 13$, replacing any data previously stored in that buffer.

11.6.3 Network operation

The following are the functions of the various functional entities at the network in support of the HARQ protocol used on HS-DSCH when MAC-ehs is configured by upper layers [7].

11.6.3.1 Scheduler

The scheduler performs the following functions:

- Schedules all UEs within a cell;
- Services priority queues:
 - The scheduler schedules reordering PDUs (see subsection 9.1.4) based on information from upper layers. One UE operating in CELL_DCH may be associated with one or more priority queues.

- In FDD, when transmitting to the UE in CELL_FACH or CELL_PCH or URA_PCH state there can be multiple service priority queues. One service priority queue can be associated to multiple H-RNTIs.
- Determines the HARQ Entity and the queues to be serviced;
- Sets the TSN values for new data blocks being transferred from the selected queue;
 - set the TSN to value 0 for the first reordering PDU transmitted from the selected queue;
 - increment the TSN with one for each subsequent reordering PDU transmitted from the selected queue.
 - increment the TSN with one for each subsequent reordering PDU transmitted from the selected queue per H-RNTI within an HS-DSCH, when transmitting to the UEs in CELL_FACH, CELL_PCH or URA_PCH state.

NOTE: In 1.28 Mcps TDD multi-frequency HS-DSCH cell, the length of TSN can be 6 bits or 9 bits based on the configuration of higher layer.

NOTE: The scheduler may re-use TSNs by toggling the NDI bit in order to resume pre-empted transmissions or to force the UE to flush the soft buffer. In this case the content of the payload may be changed but care should be taken to preserve the higher layer data order.

- Indicates the LCH ID and L field values for each reordering SDU to be transmitted and the TSN field and SI field values for each reordering PDU to be transmitted to the HARQ entity;
- Schedules new transmissions and retransmissions:
 - When transmitting for a UE in CELL_DCH state the scheduler determines based on the status reports from HARQ Processes if either a new transmission or a retransmission should be made. A new transmission can however be initiated on a HARQ process at any time. Based on a delay attribute provided by upper layers, the scheduler may decide to discard any 'out-of-date' MAC-ehs SDU.
 - In FDD when transmitting for a UE in CELL_FACH state the scheduler determines based on RRM and IE "Transmitted Power Level" received on Iub FP the number of retransmission that should be made after new transmission. A new transmission can however be initiated on a HARQ process at any time. Based on a delay attribute provided by upper layers, the scheduler may decide to discard any 'out-of-date' MAC-hs SDU.

NOTE: When operating in MIMO mode, the scheduler uses the redundancy version coding to indicate whether a transmission is a new transmission or a retransmission, otherwise, the New Data Indicator field is used.

- Determines the redundancy version:
 - The scheduler determines a suitable redundancy version for each transmitted and retransmitted MAC-ehs PDU and indicates the redundancy version to lower layer.
- Determines the TDD HCSN;
- Increment UE specific HCSN for each HS-SCCH transmission. In 1.28Mcps TDD multi-frequency HS-DSCH cell, UE maintains the respective HCSN for each carrier independently.

11.6.3.2 HARQ entity

- There is one HARQ entity per UE operating in CELL_DCH state in UTRAN. In 1.28 Mcps TDD multi-frequency HS-DSCH cell, HARQ entity consists of some HARQ sub-entities, each sub-entity is associated with one carrier.
- In FDD, there is one HARQ entity per H-RNTI in UTRAN used for transmitting data for UE(s) in CELL_FACH state.
- The HARQ entity sets the logical channel ID (LCH ID) fields in transmitted MAC-ehs PDUs to the values indicated by the UTRAN scheduler.
- The HARQ entity sets the Length (L) fields in transmitted MAC-ehs PDUs to the values indicated by the UTRAN scheduler.

- The HARQ entity sets the Segmentation Indication (SI) fields in transmitted MAC-ehs PDUs to the values indicated by the UTRAN scheduler.
- The HARQ entity sets the transmission sequence number (TSN) fields in transmitted MAC-ehs PDUs to the values indicated by the UTRAN scheduler.
- The HARQ entity sets the HARQ process identifier in transmitted MAC-ehs PDUs. UTRAN should:
 - determine a suitable HARQ process to service the MAC-ehs PDU and set the HARQ process identifier accordingly.

11.6.3.3 HARQ process

- If the New Data Indicator field exists, the HARQ process sets the New Data indicator in transmitted MAC-ehs PDUs. UTRAN should:
 - set the New Data Indicator to the value "0" for the first MAC-ehs PDU transmitted by a HARQ process;
 - not increment the New Data Indicator for retransmissions of a MAC-ehs PDU;
 - increment the New Data Indicator with one for each transmitted MAC-ehs PDU containing new data.
- If the New Data Indicator field doesn't exist, UTRAN should:
 - instruct the physical layer to set the appropriate redundancy version coding when indicating the MAC-ehs PDU is either an initial transmission or a retransmission.
- The HARQ process processes received status messages. UTRAN should:
 - deliver received status messages to the scheduler.

11.6.4 UE operation

The UE operation in support of the HARQ protocol used on HS-DSCH is split among the following five functional units with their associated functions.

11.6.4.1 HARQ Entity

There is one HARQ entity at the UE which processes the HARQ process identifiers received on the HS-SCCH transmissions associated with MAC-ehs PDUs received on the HS-DSCH.

In 1.28 Mcps TDD multi-frequency HS-DSCH cell, HARQ sub-entity is configured at UE per carrier where HS-DSCH is configured. The associated downlink control channel and uplink control channel pair controlling the HS-DSCH transmission on the certain carrier shall be allocated on the same carrier. The downlink control channel carries the HS-DSCH operation related info and the uplink control channel carries the feedback info from the UE side. In 1.28 Mcps TDD single frequency or multi-frequency HS-DSCH cell, HARQ entity or HARQ sub-entity is configured to handle the HARQ identity associated with the received MAC-ehs PDU from every carrier where HS-DSCH is configured at UE side.

A number of parallel HARQ processes are used in the UE to support the HARQ entity. The number of HARQ processes is configured by upper layers:

- Each received MAC-ehs PDU shall be allocated to the HARQ process indicated by the HARQ process identifier of the MAC-ehs PDU.

11.6.4.2 HARQ process

The HARQ process processes the New Data Indicator (if any) indicated by lower layers for each received MAC-ehs PDU.

The UE may:

- for FDD, when operating in CELL_DCH state, or in CELL_FACH state with a dedicated H-RNTI, if the MAC-ehs PDU is received within 5 sub-frames from the reception of the previous MAC-ehs PDU intended for this HARQ process; or
- for TDD, if the MAC-ehs PDU is received before generation of feedback resulting from reception of a previous MAC-ehs PDU for the same H-ARQ process:
 - discard the MAC-ehs PDU.

The UE shall:

- if the New Data Indicator (if any) has been incremented compared to the value in the previous received transmission in this HARQ process or in absence of a New Data Indicator field, the physical layer redundancy version coding indicates it is an initial transmission:
 - replace the data currently in the soft buffer for this HARQ process with the received data.
 - if the Transport Block Size index value is equal to 111111 (FDD only):
 - generate a positive acknowledgement (ACK) of the data in this HARQ process;
 - discard the received data;
 - assume that the data has been successfully decoded.
 - if the New Data Indicator is not present and the physical layer redundancy version coding indicates it is a retransmission and the UE had positively acknowledged the earlier transmission:
 - discard received data and generate a positive acknowledgement (ACK).
 - if the New Data Indicator (if any) is identical to the value used in the previous received transmission in the HARQ process or in absence of a New Data Indicator field, the physical layer redundancy version coding indicates it is a retransmission and the UE had negatively acknowledged the earlier transmission:
 - if the Transport Block Size index value is equal to 111111 (FDD only):
 - assume that the transport block size is identical to the last valid transport block size signalled for this HARQ process.
 - if the data has not yet been successfully decoded:
 - combine the received data with the data currently in the soft buffer for this HARQ process.
 - if the transport block size is different from the last valid transport block size signalled for this HARQ process:
 - the UE may replace the data currently in the soft buffer for this HARQ process with the received data.
 - if the data in the soft buffer has been successfully decoded and no error was detected:
 - deliver the decoded MAC-ehs PDU to the disassembly entity;
 - when operating in CELL_DCH state generate a positive acknowledgement (ACK) of the data in this HARQ process.
 - else:
 - when operating in CELL_DCH state generate a negative acknowledgement (NAK) of the data in this HARQ process;
 - schedule the generated positive or negative acknowledgement for transmission and the time of transmission relative to the reception of data in a HARQ process is configured by upper layer.

11.6.4.3 Disassembly entity

For each MAC-ehs PDU that is delivered to the disassembly entity, the UE shall:

- remove any padding bits if present;
- remove the MAC-ehs header;
- deliver the reordering PDUs in the MAC-ehs PDU to reordering distribution entity.

11.6.4.4 Reordering queue distribution entity

Reordering shall be applied to all logical channels except for BCCH and PCCH.

For each reordering PDU in the MAC-ehs PDU, except for BCCH and PCCH, the UE shall:

- route the reordering PDU to the correct reordering queue based on the received LCH ID. The mapping of the LCH ID to queue is provided by upper layers [7].

11.6.4.5 Reordering entity

11.6.4.5.1 Definitions

In the functions described in this section the following definitions apply:

Parameters

- Transmitter window size (TRANSMIT_WINDOW_SIZE)
TRANSMIT_WINDOW_SIZE is the size of the transmitter window according to the definition below. This is a parameter in the Node B and the value of the parameter is configured by higher layers.
- Receiver window size (RECEIVE_WINDOW_SIZE)
RECEIVE_WINDOW_SIZE is the size of the receiver window according to the definition below. This is a parameter in the UE and the value of the parameter is configured by higher layers.

State variables

All state variables are non-negative integers. Reordering PDUs are numbered by modulo integer Transmission sequence numbers (TSN) cycling through the field 0 to 63. All arithmetic operations contained in the present document on next_expected_TSN, RcvWindow_UpperEdge, T1_TSN and TSN_flush are affected by the 64 modulus. When performing arithmetic comparisons of state variables or Transmission sequence number values a 64 modulus base shall be used. This modulus base is subtracted (within the appropriate field) from all the values involved and then an absolute comparison is performed. $RcvWindow_UpperEdge - RECEIVE_WINDOW_SIZE + 1$ shall be assumed to be the modulus base. For 1.28 Mcps TDD multi-frequency HS-DSCH operation mode, TSN_MAX represents period length of TSN; the arithmetic operations and comparisons of state variables in multi-frequency mode are performed on TSN_MAX modulus base.

- next_expected_TSN:
The next_expected_TSN is the Transmission sequence number (TSN) following the TSN of the last in-sequence reordering PDU received. It shall be updated according to the procedures given in subclauses 11.6.4.5.2, 11.6.4.8 and 11.6.4.9. For CELL_DCH, the initial value of next_expected_TSN = 0. For states other than CELL_DCH the initial value of the next_expected_TSN = $RcvWindow_UpperEdge - RECEIVE_WINDOW_SIZE + 1$.
- RcvWindow_UpperEdge:
The RcvWindow_UpperEdge represents the TSN, which is at the upper edge of the receiver window. After the first reordering PDU has been received successfully, it also corresponds to the reordering PDU with the highest TSN of all received reordering PDUs. The initial RcvWindow_UpperEdge equals 63. RcvWindow_UpperEdge is updated based on the reception of new reordering PDU according to the procedure given below.
- T1_TSN:
The TSN of the latest reordering PDU that cannot be delivered to the reassembly entity, when the timer T1 is started.

Timers

- Re-ordering release timer (T1):
The Re-ordering release timer T1 controls the stall avoidance in the UE reordering buffer as described below. The value of T1 is configured by upper layers.

- Reset timer (Treset) (FDD only)
Treset controls the reset of the MAC-ehs reordering functionality. This timer is not used when the UE is in CELL_DCH state.

Other definitions

- Receiver window:
The receiver window defines TSNs of those reordering PDUs that can be received in the receiver without causing an advancement of the receiver window according to the procedure below. The size of the receiver window equals RECEIVE_WINDOW_SIZE and spans TSNs going from RcvWindow_UpperEdge – RECEIVE_WINDOW_SIZE + 1 to RcvWindow_UpperEdge included.

11.6.4.5.2 Reordering functionality

If no timer T1 is active:

- the timer T1 shall be started when a reordering PDU with $TSN > next_expected_TSN$ is correctly received.
- T1_TSN shall be set to the TSN of this reordering PDU.

If a timer T1 is already active:

- no additional timer shall be started, i.e. only one timer T1 may be active at a given time.

The timer T1 shall be stopped if:

- the reordering PDU with $TSN = T1_TSN$ can be delivered to the reassembly entity before the timer expires.

When the timer T1 expires and $T1_TSN > next_expected_TSN$:

- all correctly received reordering PDUs with $TSN > next_expected_TSN$ up to and including T1_TSN-1 shall be delivered to the reassembly entity;
- all correctly received reordering PDUs up to the next not received reordering PDU shall be delivered to the reassembly entity.
- next_expected_TSN shall be set to the TSN of the next not received reordering PDU.

When the timer T1 is stopped or expires, and there still exist some received reordering PDUs that can not be delivered to higher layer:

- timer T1 is started
- set T1_TSN to the highest TSN among those of the reordering PDUs that can not be delivered.

For FDD only, if the UE is not in CELL_DCH state and if the timer Treset is not active:

- the timer Treset shall be started when a reordering PDU is correctly received.

For FDD only, if the UE is in any state other than CELL_DCH state and if a timer Treset is already active:

- the timer Treset shall be restarted when a reordering PDU is correctly received.
- no additional timer shall be started, i.e. only one timer Treset may be active at a given time.

When the timer Treset expires:

- perform a MAC-ehs reset.

For FDD only, if the UE enters CELL_DCH state:

- stop all configured Treset timers.

Transmitter operation:

After the transmitter has transmitted a reordering PDU with $TSN=SN$, any reordering PDU with $TSN \leq SN - TRANSMIT_WINDOW_SIZE$ should not be retransmitted to avoid sequence number ambiguity in the receiver.

Receiver operation:

When a reordering PDU with TSN = SN is received:

- if SN is within the receiver window:
 - if SN < next_expected_TSN, or this reordering PDU has previously been received:
 - the reordering PDU shall be discarded;
 - else:
 - the reordering PDU shall be placed in the reordering buffer at the place indicated by the TSN.
- if SN is outside the receiver window:
 - the received reordering PDU shall be placed above the highest received TSN in the reordering buffer, at the position indicated by SN;
 - RcvWindow_UpperEdge shall be set to SN thus advancing the receiver window;
 - any reordering PDU with TSN \leq RcvWindow_UpperEdge – RECEIVE_WINDOW_SIZE, i.e. outside the receiver window after its position is updated, shall be removed from the reordering buffer and be delivered to the reassembly entity;
 - if next_expected_TSN is below the updated receiver window:
 - next_expected_TSN shall be set to RcvWindow_UpperEdge – RECEIVE_WINDOW_SIZE + 1;
 - if the reordering PDU with TSN = next_expected_TSN is stored in the reordering buffer:
 - all received reordering PDUs with consecutive TSNs from next_expected_TSN (included) up to the first not received reordering PDU shall be delivered to the reassembly entity;
 - next_expected_TSN shall be advanced to the TSN of this first not received reordering PDU.

In case a UE has insufficient memory to process a received reordering PDU, it shall perform the following set of operations:

- select TSN_flush such that: next_expected_TSN < TSN_flush \leq RcvWindow_UpperEdge + 1;
- deliver all correctly received reordering PDUs with TSN < TSN_flush to the reassembly entity;
- if the reordering PDU with TSN=TSN_flush has previously been received:
 - deliver all received reordering PDUs with consecutive TSNs from TSN_flush (included) up to the first not received reordering PDU to the reassembly entity;
 - advance next_expected_TSN to the TSN of this first not received reordering PDU.
- else:
- set next_expected_TSN to TSN_flush.

11.6.4.6 Reassembly unit

The reassembly unit processes the SI field associated with a reordering PDU. The UE shall:

- if SI field is set to "00":
 - deliver all MAC-d or MAC-c PDUs corresponding to MAC-ehs SDUs in the reordering PDU to demultiplexing entity;
 - discard any previously stored segment of MAC-ehs SDU.
- if SI field is set to "01":

- if the received and stored segments of a MAC-ehs SDU are consecutive:
 - combine the first reordering SDU with the stored segment of MAC-ehs SDU;
 - deliver the MAC-d or MAC-c PDU corresponding to the combined MAC-ehs SDU to demultiplexing entity.
- if the received and stored segments of MAC-ehs SDU are not consecutive
 - discard the first received reordering SDU and the stored segment of MAC-ehs SDU.
 - deliver all MAC-d or MAC-c PDUs corresponding to subsequent MAC-ehs SDUs in the reordering queue to demultiplexing entity;
- if SI field is set to "10":
 - deliver all MAC-d or MAC-c PDUs corresponding to all but last reordering SDU in the reordering PDU to the demultiplexing entity;
 - discard any previously stored segment of MAC-ehs SDU and store the last reordering SDU of the received reordering PDU
- if SI field is set to "11":
 - if the received and stored MAC-ehs SDUs are consecutive:
 - if there is only one reordering SDU in the reordering PDU:
 - combine the received reordering SDU with the stored segment of MAC-ehs SDU:
 - if there is more than one reordering SDU in the reordering PDU:
 - combine the first received reordering SDU with the stored segment MAC-ehs SDU;
 - deliver the MAC-d or MAC-c PDU corresponding to the combined MAC-ehs SDU to demultiplexing entity.
 - deliver all MAC-d or MAC-c PDUs corresponding to all but last reordering SDU in the reordering PDU to demultiplexing entity;
 - discard any previously stored segment of MAC-ehs SDU and store the last reordering SDU of the received reordering PDU.
 - if the received and stored segments of the MAC-ehs SDU are not consecutive:
 - discard the first received reordering SDU and the stored segment of MAC-ehs SDU;
 - if there is more than one reordering SDU in the reordering PDU:
 - deliver all MAC-d or MAC-c PDUs corresponding to all but first and last reordering SDUs in the reordering PDU to demultiplexing entity and store the last reordering SDU of the received reordering PDU.

11.6.4.7 Demultiplexing entity

For each MAC-d or MAC-c PDU that is delivered to the demultiplexing entity, the UE shall:

- route MAC-d or MAC-c PDU to the correct logical channel based on the corresponding LCH ID field.

11.6.4.8 MAC-ehs Reset

If a reset of the MAC-ehs entity is requested by upper layers, the UE shall at the activation time indicated by higher layers:

- flush soft buffer for all configured HARQ processes;

- stop all active re-ordering release timer (T1) and set all timer T1 to their initial value;
- stop all active reset timers (Treset) and set all timers Treset to their initial value;
- start TSN with value 0 for the next transmission on every configured HARQ process;
 - initialise the variables RcvWindow_UpperEdge and next_expected_TSN to their initial value;
- deliver all reordering PDUs in the re-ordering buffer to the reassembly entity;
- deliver any successfully reassembled MAC-ehs SDUs to logical channel demultiplexing entity;
- route any MAC-d or MAC-c PDUs delivered to the demultiplexing entity to the correct logical channel;
- flush the re-ordering buffer;
- discard any stored segment in the reassembly entity;
- treat next received Transport Block as new data.

If a reset of the MAC-ehs entity is required by the expiry of Treset, the UE shall:

- if the Treset has expired for all the configured reordering queues:
 - flush soft buffer for all configured HARQ processes;
 - treat the next received Transport Block as new data.
- for each reordering queue where Treset has expired:
 - stop the active re-ordering release timer (T1) and set the timer T1 to its initial value;
 - start TSN with value 0 for the next transmission on every configured HARQ process;
 - initialise the variable RcvWindow_UpperEdge to its initial value;
 - initialise the variable next_expected_TSN to its initial value;
 - deliver all reordering PDUs in the re-ordering buffer to the reassembly entity;
 - deliver any successfully reassembled MAC-ehs SDUs to logical channel demultiplexing entity;
 - route any MAC-d or MAC-c PDUs delivered to the demultiplexing entity to the correct logical channel;
 - flush the re-ordering buffer;
 - discard any stored segment in the reassembly entity;

11.6.4.9 Reconfiguration of MAC-ehs parameters

The parameters for a MAC-ehs entity may be reconfigured (modified) by upper layers.

When a parameter is reconfigured by the upper layer, the UE shall:

- start using the reconfigured value of the parameter at the activation time indicated by higher layers.

If the parameter T1 is reconfigured for an already existing re-ordering queue, the UE shall:

- start to use the new value of T1 the next time T1 is started.

If the parameter RECEIVE_WINDOW_SIZE is reconfigured for a re-ordering queue, the UE shall:

- set RECEIVE_WINDOW_SIZE to the new value;
- remove any reordering PDUs in this re-ordering queue with $TSN \leq RcvWindow_UpperEdge - RECEIVE_WINDOW_SIZE$ (i.e. outside the receiver window after its size is updated) from the reordering buffer and deliver these reordering PDUs to the reassembly entity;

- if next_expected_TSN is below the receiver window after its size is updated:
 - set next_expected_TSN to $RcvWindow_UpperEdge - RECEIVE_WINDOW_SIZE + 1$;
 - deliver all received reordering PDUs in this re-ordering queue with consecutive TSNs from next_expected_TSN (included) up to the first not received reordering PDU to the reassembly entity;
 - advance next_expected_TSN to the TSN of this first not received reordering PDU.

If the "Memory Partitioning" (see [7]) for soft buffer is reconfigured, the UE shall:

- flush soft buffer for all configured HARQ processes.

For 1.28Mcps TDD, if the "TSN-Length" is reconfigured, the UE shall:

- perform the operation as per subclause 11.6.4.8.

11.6.4.10 HARQ procedure for HS-SCCH less operation (FDD only)

When the HS-SCCH less mode of operation is enabled, the UE shall be able to store 13 TTIs in a cyclic soft buffer.

For each received MAC-ehs PDU provided by the lower layers the UE shall:

- If the associated HS-SCCH corresponds to an HS-SCCH less retransmission as defined in subclause 4.6A.2.2.1 of [16]:
 - If the data in the soft buffer identified by the TTI $[5*CFN + \text{subframe number} - 6 - PTR] \bmod 13$ has been decoded successfully:
 - generate a positive acknowledgement (ACK) of the data corresponding to this TTI;
 - consider the data in the soft buffer identified by the TTI $[5*CFN + \text{subframe number}] \bmod 13$ has been decoded successfully.
 - Else:
 - combine the received data with the data currently in the soft buffer identified by $[5*CFN + \text{subframe number} - 6 - PTR] \bmod 13$ where PTR is the value of the pointer to the previous transmission as defined in subclause 4.6A.2.2.1.2 of [16].
 - If the combined data in the soft buffer has been successfully decoded and no error was detected;
 - deliver the decoded MAC-ehs PDU to the disassembly entity;
 - generate a positive acknowledgement (ACK) of the data corresponding to this TTI.
 - consider the data in the soft buffer identified by the TTI $[5*CFN + \text{subframe number}] \bmod 13$ has been decoded successfully.
 - Else:
 - place the combined data for the HS-SCCH less TTI in the soft buffer identified by $[5*CFN + \text{subframe number}] \bmod 13$, replacing any data previously stored in that buffer.
 - generate a negative acknowledgement (NACK) of the data corresponding to this TTI.
- Else if the associated HS-SCCH corresponds to a HS-SCCH type 1 as defined in subclause 4.6 of [16];
 - process the received MAC-ehs PDU provided by the lower layers as per subclause 11.6.4.2.
- Else:
 - If the data has been successfully decoded and no error was detected;
 - deliver the decoded MAC-ehs PDU to the disassembly entity;
 - generate a positive acknowledgement (ACK) of the data corresponding to this TTI;

- consider the data in the soft buffer identified by the TTI $[5 \cdot \text{CFN} + \text{subframe number}] \bmod 13$ has been decoded successfully.
- Else:
 - place the data for the HS-SCCH less TTI in the soft buffer identified by $[5 \cdot \text{CFN} + \text{subframe number}] \bmod 13$, replacing any data previously stored in that buffer.

11.7 HS-DSCH Provided Bit Rate measurement

The HS-DSCH Provided Bit Rate measurements is defined as follows:

- for each priority class the MAC-hs/ehs entity measures the total number of MAC-d PDU bits whose transmission over the radio interface has been considered successful by MAC-hs in Node-B during the last measurement period, divided by the duration of the measurement period;
- the values reported by MAC-hs/ehs shall be raw samples;
- the measurement period shall be [100 ms];
- when the cell portions are defined in a cell, the HS-DSCH Provided Bit Rate shall be measured for each cell portion.

11.8 Control of E-DCH transmission and reception (FDD)

11.8.1 UE operation

11.8.1.1 HARQ Operation

11.8.1.1.1 HARQ entity

There is one HARQ entity at the UE. A number of parallel HARQ processes are used in the UE to support the HARQ entity, allowing transmissions to take place continuously while waiting for the feedback on the successful or unsuccessful reception of previous transmissions.

At a given TTI, the HARQ entity identifies the HARQ process for which a transmission should take place. Also, based on the timing, it routes the receiver feedback (ACK/NACK information), relayed by the physical layer, to the appropriate HARQ process.

The number of HARQ processes is equal to the HARQ round-trip-time (HARQ_RTT). The HARQ_RTT is equal to 4 for 10ms TTI and 8 for 2ms TTI. The TTI duration shall be configured by the higher layers. Each process is associated with a number from 0 to HARQ_RTT-1.

After each TTI, the HARQ entity shall:

- if the buffer of the HARQ process corresponding to the next TTI is empty:
 - notify the E-TFC selection entity that the next TTI is available for a new transmission;
 - if the "E-TFC Selection" entity indicates the need for a new transmission:
 - obtain the transmission information (i.e. HARQ profile, whether triggered Scheduling Information is included and whether it is sent alone) from the "E-TFC Selection" entity;
 - obtain the MAC-e PDU to transmit from the "Multiplexing and TSN setting" entity;
 - instruct the HARQ process corresponding to this TTI to trigger the transmission of this new payload using the identified HARQ profile parameters.
- else:
 - instruct the HARQ process to generate a re-transmission.

11.8.1.1.2 HARQ process

Each HARQ process is associated with a physical buffer (HARQ buffer).

Each HARQ process maintains the state variable `CURRENT_TX_NB`, which indicates the number of transmissions that have taken place for the MAC-e PDU currently in the buffer. When the HARQ process is established, `CURRENT_TX_NB` shall be initialized to 0.

At the time of a new transmission, the HARQ entity provides the HARQ profile to use for all transmissions and re-transmissions of this MAC-e PDU. This HARQ profile includes information on the maximum number of transmissions to perform, and the power offset with which to configure the physical layer.

If the HARQ entity provides a new PDU, the HARQ process shall:

- set `CURRENT_TX_NB` to 0;
- set `CURRENT_RSN` to 0;
- store the MAC-e PDU in the associated HARQ buffer;
- generate a transmission as described below.

If the HARQ entity requests a re-transmission, the HARQ process shall:

- generate a transmission as described below.

To generate a transmission, the HARQ process shall, regardless of any overlapping with a compressed mode gap:

- instruct the physical layer to set the RSN field on the E-DPCCH to `CURRENT_RSN`;
- instruct the physical layer to generate a transmission with the power offset corresponding to the HARQ profile and the redundancy version corresponding to the RSN value and the transmission timing (i.e. the CFN and in the case of 2ms TTI, sub-frame number as described in [16]);
- if `CURRENT_RSN < 3`:
 - increment `CURRENT_RSN` by 1;
 - increment `CURRENT_TX_NB` by 1;

The HARQ process shall:

- if an ACK is received from the RLS containing the serving cell; or
- if an ACK is received from any RLS and the transmission included higher layer data (i.e. not only included Scheduling Information); or
- if `CURRENT_TX_NB ≥` maximum number of transmissions indicated in the transmission HARQ profile:
 - flush the HARQ buffer;
 - if the transmission included Scheduling Information which was triggered per subclause 11.8.1.6 and if no ACK for that transmission was received from the RLS containing the serving cell:
 - notify the Scheduling Information Reporting function that the HARQ process failed to deliver the triggered Scheduling Information to the RLS containing the serving cell (see subclause 11.8.1.6.3).

NOTE: In the case where the Scheduling Information is transmitted alone, without any higher layer data the UE will keep re-transmitting the Scheduling Information until an ACK is received from the RLS containing the serving cell or the maximum number of re-transmissions is reached. In the latter case, periodic triggering will be relied upon for reliability.

11.8.1.2 Multiplexing and TSN setting entity

There is one Multiplexing and TSN setting entity at the UE. A number of TSN setting processes are used to support independent numbering of transmissions from different logical channels.

11.8.1.2.1 TSN setting process operation

There is one TSN setting process at the UE for each logical channel. When a MAC-es PDU is transmitted, the UE operation in support of the re-ordering functionality consists in generating an explicit sequence number (TSN) for the MAC-es PDU intended for the associated re-ordering queue. In one TTI, there is only one TSN per logical channel: one for the MAC-es PDU that is transmitted.

Each TSN setting process maintains the state variable `CURRENT_TSN`, which indicates the sequence number to be included in the header of the following MAC-es PDU to be generated. When the TSN setting process is established, `CURRENT_TSN` shall be initialized to 0.

When a new payload needs to be generated for the associated re-ordering queue, the Multiplexing and TSN setting entity shall:

- set the TSN of the transmission to `CURRENT_TSN`;

After each MAC-es PDU is multiplexed:

- increment `CURRENT_TSN` by 1;
- if `CURRENT_TSN > 63`:
 - set `CURRENT_TSN = 0`.

11.8.1.3 Serving Grant Update

UEs in `CELL_DCH` state, configured with an E-DCH transport channel shall maintain a Serving Grant and the list of active HARQ processes based on the absolute and relative grant commands decoded on the configured E-AGCH and E-RGCH(s).

Each Absolute Grant or Relative Grant command is applied at a specific TTI. This association is implicit based on the timing of the E-AGCH and E-RGCH (see [13]). The timing is tight enough that this relationship is un-ambiguous.

The activation/deactivation of one or all processes is only applicable to processes for which transmission of scheduled data is allowed according to RRC signalling

Process activation of an active process does not result in any action taken by the UE.

11.8.1.3.1 Baseline Procedure

The Serving Grant Update procedure shall be applied at every TTI boundary and shall take into account the Absolute Grant message, Serving Relative Grant and non-serving Relative Grants that apply to the TTI.

The UE shall:

- 1> set `reference_ETPR` to the E-DPDCH to DPCCH power ratio as defined in subclause 3.1.2;
- 1> if an Absolute Grant was received for this TTI:
 - 2> if the Identity type is "Primary", and the Absolute Grant value is set to "INACTIVE":
 - 3> if Absolute Grant Scope indicates "Per HARQ process" and a 2ms TTI is configured:
 - 4> de-activate the process given by the value of `CURRENT_HARQ_PROCESS`.
 - 3> if Absolute Grant Scope indicates "All HARQ processes" and a secondary E-RNTI was configured by higher layers:
 - 4> activate all HARQ processes;
 - 4> set `Serving_Grant = Stored_Secondary_Grant`;
 - 4> set `Primary_Grant_Available` to "False".
 - 3> if Absolute Grant Scope indicates "All HARQ processes", a 2ms TTI is configured and a secondary E-RNTI was not configured by higher layers:

- 4> deactivate all HARQ processes (if a process was inactive it remains inactive, if a process was active it becomes inactive).
- 2> else if the Absolute Grant Value is different from "INACTIVE":
 - 3> if the Identity Type is "Secondary":
 - 4> set Stored_Secondary_Grant = MAX(Absolute Grant Value, Lowest Configured Serving Grant Value).
 - 3> if the Identity Type is "Primary" or Primary_Grant_Available is set to "False":
 - 4> set Serving_Grant = MAX(Absolute Grant Value, Lowest Configured Serving Grant Value).
 - 4> if the Identity Type is "Primary":
 - 5> set Primary_Grant_Available to "True";
 - 5> if Absolute Grant Scope indicates "Per HARQ process":
 - 6> activate the process given by the value of CURRENT_HARQ_PROCESS.
 - 5> if Absolute Grant Scope indicates "All HARQ processes":
 - 6> activate all HARQ processes.
 - 5> if AG_Timer is not active, it shall be started, otherwise it shall be restarted.
- 1> else (no Absolute Grant received):
 - 2> if the HARQ process given by the value of CURRENT_HARQ_PROCESS is active; and
 - 2> if Primary_Grant_Available is equal to "True"; and
 - 2> if Serving_Grant <> "Zero_Grant" ; and
 - 2> if AG_Timer has expired; and
 - 2> if there was a scheduled transmission (see NOTE) in the previous TTI of the HARQ process given by the value of CURRENT_HARQ_PROCESS:
 - 3> if the Serving Relative Grant indicates "UP":
 - 4> determine the Serving_Grant in accordance with subclause 9.2.5.2.1.
 - 3> else, if the Serving Relative Grant indicates "DOWN":
 - 4> determine the Serving_Grant in accordance with subclause 9.2.5.2.1.
 - 3> else:
 - 4> the Serving_Grant is unchanged (i.e. kept from previous TTI).
- 1> if any Non-Serving Relative Grants indicate "DOWN" for this TTI and Serving_Grant <> "Zero_Grant":
 - 2> Serving_Grant = MIN(Serving_Grant, Maximum_Serving_Grant, Serving_Grant determined in accordance with subclause 9.2.5.2.1);
 - 2> Maximum_Serving_Grant = Serving_Grant.
 - 2> if Non_Serving_RG_Timer is not active it shall be started, otherwise it shall be restarted;
- 1> else if no Non-Serving Relative Grants indicate "DOWN" for this TTI:
 - 2> if Non_Serving_RG_Timer has not expired:
 - 3> Serving_Grant = MIN(Maximum_Serving_Grant, Serving_Grant).
- 1> if Non_Serving_RG_Timer expires:

- 2> set the Maximum_Serving_Grant to the highest possible value (i.e. index 37 in table 9.2.5.2.1.1 or 9.2.5.2.1.2 as configured by higher layers).

NOTE 1: MIN("Zero_Grant", any numerical value) = "Zero_Grant".

NOTE 2: Scheduling Information sent alone is not considered as a scheduled transmission.

11.8.1.3.2 Handling at start of E-DCH transmission

When E-DCH transmission is started (i.e. the RRC variable E_DCH_TRANSMISSION is changed from "false" to "true"), the UE shall:

- activate all HARQ processes;
- if the IE's "Serving Grant value" and "Primary/Secondary Grant Selector" are provided by higher layers:
 - update the state variables and timers according to subclause 11.8.1.3.5.
- else:
 - initialise the state variable Serving_Grant to Zero_Grant;
 - initialise the state variable Primary_Grant_Available to "False";
 - initialise the state variable Stored_Secondary_Grant to "Zero_Grant".
- initialise the state variables reference_ETPR to "Minimum_Grant";
- initialise the state variable Maximum_Serving_Grant to the highest possible value (i.e. index 37 in table 9.2.5.2.1.1 or 9.2.5.2.1.2 as configured by higher layers).

11.8.1.3.3 Handling at serving cell change

At E-DCH serving cell change, the UTRAN may configure the UE with the grant value to use in the new cell and shall indicate whether the UE should monitor Absolute Grant Messages with the secondary E-RNTI.

The UE shall:

- activate all HARQ processes;
- if the IE's "Serving Grant value" and "Primary/Secondary Grant Selector" are provided by higher layers:
 - update the state variables and timers according to subclause 11.8.1.3.5.
- else:
 - continue to use the current values of state variables Serving_Grant and Primary_Grant_Available;
 - initialise the state variable Stored_Secondary_Grant to "Zero_Grant".

11.8.1.3.4 Handling at TTI change

At E-DCH TTI change, the UE shall:

- activate all HARQ processes;
- initialise the state variables reference_ETPR to "Minimum_Grant";
- reset Non_Serving_RG_Timer and AG_Timer;
- set the state variable Maximum_Serving_Grant to the highest possible value (i.e. index 37 in table 9.2.5.2.1.1 or 9.2.5.2.1.2 as configured by higher layers).
- if the IE's "Serving Grant value" and "Primary/Secondary Grant Selector" are provided by higher layers:
 - update the state variables and timers according to subclause 11.8.1.3.5.

- else:
 - continue to use the current values of state variables `Serving_Grant` and `Primary_Grant_Available`;
 - initialise the state variable `Stored_Secondary_Grant` to "Zero_Grant".

11.8.1.3.5 Higher Layer Signalling

When the IE's "Serving Grant value" and "Primary/Secondary Grant Selector" are provided by higher layers:

- set the state variable `Serving_Grant` to the value of the IE's "Serving Grant value" provided by higher layers;
- if the IE's "Primary/Secondary Grant Selector" is provided by higher layers as "Primary":
 - if `AG_Timer` is not active, it shall be started, otherwise it shall be restarted;
 - set the state variable `Primary_Grant_Available` to "True";
 - set the state variable `Stored_Secondary_Grant` to "Zero_Grant".
- if the IE's "Primary/Secondary Grant Selector" is provided by higher layers as "Secondary":
 - set the state variable `Primary_Grant_Available` to "False";
 - set the state variable `Stored_Secondary_Grant` to the value of the IE's "Serving Grant value" provided by higher layers.

11.8.1.3.6 Handling in UE DTX Cycle 2.

In FDD, in case the DTX feature is configured by higher layers, and there has not been any E-DCH transmission for the last "Inactivity Threshold for UE DTX cycle 2" E-DCH TTIs:

- If `Default-SG-in-DTX-Cycle-2` has been signalled by higher layers:
 - set the state variable `Serving_Grant` to the value of `Default-SG-in-DTX-Cycle-2`.

11.8.1.4 E-TFC Selection

In FDD mode, the rules for E-TFC selection provided below shall apply to UEs in `CELL_DCH` state with an E-DCH transport channel configured. These UEs shall apply the E-TFC selection procedure when invoked by the HARQ entity (see subclause 11.8.1.1.1). In the case where a 2ms TTI is configured, E-TFC selection shall not be performed for TTIs that overlap with an uplink compressed mode gap. The E-TFC restriction procedure described in [12] shall always be applied before the E-TFC selection process below. E-TFCs which (according to calculations in [16]) require channelisation codes which are not allowed by the value given by the Maximum channelisation codes for E-DPDCH or are not supported by the UE capability shall be considered as blocked. Furthermore, for UEs that are also configured with a DCH transport channel on uplink, the TFC selection procedure shall be applied before either of these.

For each MAC-d flow, RRC configures MAC with a HARQ profile and a multiplexing list. Additionally, RRC configures MAC with a power offset for "Control-only" transmissions. This power offset and a maximum number of HARQ transmissions of 8 will be used to define a HARQ profile for "Control-only" transmissions which will be used, in case the Scheduling Information needs to be transmitted without any higher-layer data. The HARQ profile includes the power offset and maximum number of HARQ transmissions to use for this MAC-d flow. The multiplexing list identifies for each MAC-d flow(s), the other MAC-d flows from which data can be multiplexed in a transmission that uses the power offset included in its HARQ profile.

RRC can control the scheduling of uplink data by giving each logical channel a priority between 1 and 8, where 1 is the highest priority and 8 the lowest. E-TFC selection in the UE shall be done in accordance with the priorities indicated by RRC. Logical channels have absolute priority, i.e. the UE shall maximise the transmission of higher priority data.

RRC can allocate non-scheduled transmission grants to individual MAC-d flows in order to reduce the transmission delays. When a 2ms TTI is configured each non-scheduled grant is applicable to the specific set of HARQ processes indicated by RRC. The applicability of scheduled grants can be also restricted to a specific set of HARQ processes when a 2ms TTI is configured. HARQ process restriction and reservation is under the control of the serving cell Node B and indicated to the UE by RRC.

For each configured MAC-d flow, a given E-TFC can be in any of the following states:

- Supported state;
- Blocked state.

At each TTI boundary, UEs in CELL_DCH state with an E-DCH transport channel configured shall determine the state of each E-TFC for every MAC-d flow configured based on its required transmit power versus the maximum UE transmit power (see [7] and [12]). The UE shall consider that E-TFCs included in the minimum set of E-TFCs are always in supported state (see [7]).

At every TTI boundary for which a new transmission is requested by the HARQ entity (see subclause 11.8.1.1.1), the UE shall perform the operations described below. UEs configured both with DCH and E-DCH transport channels shall perform TFC selection before performing E-TFC selection.

The Serving Grant Update function provides the E-TFC selection function with the maximum E-DPDCH to DPCCH power ratio that the UE is allowed to allocate for the upcoming transmission for scheduled data (held in the Serving Grant state variable – see subclause 11.8.1.3). This power ratio shall be used to determine a maximum number of bits of scheduled data with a 1 bit granularity for the upcoming transmission, calculated from number of bits corresponding to the reference E-TFCs (E-TFC_{ref,m}), and that the highest value is lower or equal to:

If E-DPDCH power extrapolation formula is configured:

$$\left\lfloor K_{e,ref,m} \cdot \frac{\text{Serving_Grant}}{L_{e,ref,m} \cdot A_{ed,m}^2 \cdot 10^{\Delta_{harq}/10}} \right\rfloor$$

This maximum number of bits shall be lower than $K_{e,ref,n}$ bits, where $K_{e,ref,n}$ corresponds to any higher n^{th} reference E-TFC (E-TFC_{ref,n}) and shall be higher or equal to $K_{e,ref,m}$ of E-TFC_{ref,m} except if $m=1$.

Else if E-DPDCH power interpolation formula is configured:

$$\left\lfloor K_{e,ref,m} + \frac{\left(\frac{\text{Serving_Grant}}{10^{\Delta_{harq}/10}} - L_{e,ref,m} \cdot A_{ed,m}^2 \right) (K_{e,ref,m+1} - K_{e,ref,m})}{L_{e,ref,m+1} \cdot A_{ed,m+1}^2 - L_{e,ref,m} \cdot A_{ed,m}^2} \right\rfloor$$

This maximum number of bits shall be lower than $K_{e,ref,m+1}$ bits except if $K_{e,ref,m+1}$ corresponds to the number of bits of the highest reference E-TFC (E-TFC_{ref,M}) and shall be higher or equal to $K_{e,ref,m}$ of E-TFC_{ref,m} except if $m=1$.

$K_{e,ref,m}$ and $L_{e,ref,m}$ above are given in [13]. $A_{ed,m}$ denotes the quantized amplitude ratio assigned to E-TFC_{ref,m} and is defined in [22].

The HARQ process ID for the upcoming transmission is determined using the following formulae:

- For 2ms TTI: $\text{CURRENT_HARQ_PROCESS_ID} = [5 * \text{CFN} + \text{subframe number}] \bmod \text{HARQ_RTT}$
- For 10ms TTI: $\text{CURRENT_HARQ_PROCESS_ID} = [\text{CFN}] \bmod \text{HARQ_RTT}$

Based on this current HARQ process ID and the RRC configuration, the UE shall determine whether to take the scheduled and non-scheduled grants into account in the upcoming transmission. If they are not supposed to be taken into account, then the corresponding grant shall be assumed to not exist. If the variable Serving_Grant has the value "Zero_Grant" after the Serving Grant Update, then the Serving Grant shall not be taken into account in the upcoming transmission.

When Scheduling Information is triggered per subclause 11.8.1.6, the E-TFC selection and data-allocation process shall assume that a non-scheduled grant is available for its transmission and that Scheduling Information has a priority higher

then any other logical channel. Furthermore the HARQ process used for the upcoming transmission shall be assumed to be active and not L3 restricted for the transmission of the Scheduling Information, i.e. transmission of Scheduling Information can take place on this process.

The transmission format and data allocation shall follow the requirements below:

- Only E-TFCs from the configured E-TFCS shall be considered for the transmission;
- For all logical channels, if the logical channel belongs to a non-scheduled MAC-d flow, its data shall be considered as available up to the corresponding non-scheduled grant, if the logical channel does not belong to a non-scheduled MAC-d flow, its data shall be considered as available up to the Serving Grant;
- The power offset for the transmission is the one from the HARQ profile of the MAC-d flow that allows highest-priority data to be transmitted. If more than one MAC-d flow allows data of the same highest priority to be transmitted, it is left to implementation to select which MAC-d flow to prefer);
- In case the variable `Serving_Grant` has the value "Zero_Grant" after the Serving Grant Update function and there is no data available for MAC-d flows for which non-scheduled grants were configured and the transmission of Scheduling Information has been triggered, the "Control-only" HARQ profile configured by the higher layers shall be used.
- The Nominal Power Offset shall be set to the power offset included in the transmission HARQ profile;
- The UE shall not use the following E-TFCIs:
 - If the UE is configured with E-TFCI table 0 (see [7]) and 2ms TTI, it shall not use E-TFCI 120 in the mapping defined in Annex B.1;
 - If the UE is configured with E-TFCI table 1 (see [7]) and 2ms TTI, it shall not use E-TFCI 115 in the mapping defined in Annex B.2;
 - If the UE is configured with E-TFCI table 2 (see [7]) and 2ms TTI, it shall not use E-TFCI 121 in the mapping defined in Annex B.2a;
 - If the UE is configured with E-TFCI table 3 (see [7]) and 2ms TTI, it shall not use E-TFCIs 101 and 102 in the mapping defined in Annex B.2b;
- The data allocation shall maximize the transmission of higher priority data. When scheduled and non-scheduled grants are taken into account for the upcoming transmission:
 - Data of a given priority belonging to a scheduled MAC-d flow shall have precedence over any lower priority data, whether they belong to a scheduled or a non-scheduled MAC-d flow;
 - Data of a given priority belonging to a non-scheduled MAC-d flow shall have precedence over any lower priority data, whether they belong to a scheduled or a non-scheduled MAC-d flow;
- The amount of data and corresponding MAC-e/es headers from MAC-d flows for which non-scheduled grants were configured shall not exceed the value of the non-scheduled grant.
- If a 10ms TTI is configured and the TTI for the upcoming transmission overlaps with a compressed mode gap, the `Serving_Grant` provided by the Serving Grant Update function shall be scaled back as follows:

$$SG' = SG * \left(\frac{N_C}{15}\right)$$

where SG' represents the modified serving grant considered by the E-TFC selection algorithm and N_C represents the number of non DTX slots in the compressed TTI;

- If the transmission contains any scheduled data, the size of the selected MAC-e PDU shall not exceed the total of:
 - all non-scheduled grants which are applicable for transmission in this TTI;
 - the maximum number of scheduled bits based on the Serving Grant (after adjustment for compressed frames) and the power offset from the selected HARQ profile;

- the size of the triggered scheduling information (if any).
- In the case a 2ms TTI is configured and the HARQ process is inactive, the UE shall not include in the transmission any data from MAC-d flows for which no non-scheduled grants were configured;
- The Scheduling Information is always sent when triggered (see subclause 11.8.1.6);
- Only E-TFCs in supported state shall be considered;
- Once all other requirements have been fulfilled, the E-TFC resulting in the smallest amount of padding for the selected MAC-es PDUs and corresponding MAC-e/es headers, shall be selected including the case when the Scheduling Information needs to be transmitted.

While respecting all the above listed requirements, for each logical channel using RLC-UM, at every TTI, the UE may select the RLC PDU size so as to maximise the amount of data of this logical channel that can be transmitted.

Once an appropriate E-TFC and data allocation are found according to the rules above, the "Multiplexing and TSN Setting" entity shall generate the corresponding MAC-e PDU.

The E-TFC selection function shall provide this MAC-e PDU and transmission HARQ profile to the HARQ entity. The maximum number of HARQ transmissions and the power offset in this profile, shall be set respectively to the maximum of the Max Number of HARQ Transmissions of the HARQ profiles from all the MAC-d flows from which data is multiplexed into the transmission and to the Nominal Power Offset. The HARQ entity shall also be informed of whether the transmission includes Scheduling Information and whether this information is sent by itself or with higher-layer data. The E-TFC selection function shall provide the E-TFCI for the selected E-TFC to the HARQ entity.

In FDD, in case the DTX feature is configured by higher layers and no E-DCH transmission is performed in this TTI:

- if *MAC Inactivity Threshold* > 1 and no E-DCH transmission has been performed for *MAC Inactivity Threshold* - 1 previous TTIs or,
- if *MAC Inactivity Threshold* = 1:
 - E-TFC selection shall only be performed for the TTIs where the following conditions are fulfilled:
 - For 2ms TTI: $[5 * CFN + \text{subframe number} - \text{UE DTX DRX Offset}] \bmod \text{MAC DTX Cycle} = 0$;
 - For 10ms TTI: $[5 * CFN - \text{UE DTX DRX Offset}] \bmod \text{MAC DTX Cycle} = 0$.

In 2ms TTI case, if the TTI that fulfilled $[5 * CFN + \text{subframe number} - \text{UE DTX DRX Offset}] \bmod \text{MAC DTX Cycle} = 0$ overlapped with an uplink compressed mode transmission gap, the E-TFC selection shall be performed for the first TTI not overlapping with an uplink compressed mode transmission gap.

11.8.1.5 Happy Bit Setting

The Happy Bit is included on the E-DPCCH for every E-DCH transmission. E-DCH transmissions shall not be triggered specifically to allow the transmission of the happy bit.

RRC configures MAC with the duration *Happy_Bit_Delay_Condition*, over which to evaluate the current grant relative to the TEBS after application of the E-TFC selection procedure described in subclause 11.8.1.4.

For every E-DCH transmission, the Happy Bit shall be set to "unhappy" if the three following criteria are met:

- 1) UE is transmitting as much scheduled data as allowed by the current *Serving_Grant* in E-TFC selection; and
- 2) UE has enough power available to transmit at higher data rate; and
- 3) Based on the same power offset as the one selected in E-TFC selection to transmit data in the same TTI as the Happy Bit, TEBS would require more than *Happy_Bit_Delay_Condition* ms to be transmitted with the current *Serving_Grant* × the ratio of active processes to the total number of processes.

The first criteria is always true for a deactivated process and the ratio of the third criteria is always 1 for 10ms TTI..

Otherwise, the Happy Bit shall be set to "happy".

In order to assess if it has enough power available to transmit at higher data rate the UE shall:

- 1) Identify the E-TFC that has a transport block size at least x bits larger than the transport block size of the E-TFC selected for transmission in the same TTI as the Happy Bit, where x is the smallest RLC PDU size configured among all the logical channels that do not belong to non-scheduled MAC-d flows and which have data in the buffer; and
- 2) Based on the same power offset as the one selected in E-TFC selection to transmit data in the same TTI as the Happy Bit, check that the identified E-TFC is supported i.e. not blocked.

11.8.1.6 Scheduling Information reporting

Scheduling information reports will be triggered differently depending on the value of the variable `Serving_Grant` after the `Serving Grant Update` function. The triggering of a report shall be indicated to the E-TFC selection function at the first new transmission opportunity.

Even if multiple events are triggered by the time a new transmission can take place, only a single scheduling information header will be included in the payload.

The Scheduling Information shall not be transmitted if the TEBS is zero, even if it was triggered by one of the configured triggering mechanisms. If the Scheduling Information needs to be included in the MAC-e PDU according to subclause 9.2.4.2, it shall be transmitted regardless of TEBS status.

The transmission of Scheduling Information can take place on every HARQ process, even on those processes for which transmission is restricted according to RRC or deactivated by absolute grants, i.e. processes on which scheduled and/or non-scheduled transmission can not take place.

The description of the behaviour in the two cases is provided below.

11.8.1.6.1 Report Triggering when SG = "Zero_Grant" or all processes are deactivated

If the `Serving_Grant` has the value "Zero_Grant" or all processes are deactivated, and the TEBS becomes larger than zero, the transmission of Scheduling Information shall be triggered.

If data with higher priority than the data already in the transmission buffer arrives, the transmission of a Scheduling Information shall be triggered.

RRC can also configure MAC with periodic Scheduling Information triggering. The periodic trigger timer `T_SING` (Timer Scheduling Information – "Zero_Grant") shall be started once the `Serving_Grant` variable becomes "Zero_Grant" or all processes are deactivated and TEBS is larger than zero.

When `T_SING` expires, the transmission of a Scheduling Information shall be triggered.

`T_SING` shall be restarted when the transmission of a Scheduling Information is triggered.

`T_SING` shall be stopped and reset once the `Serving_Grant` variable in the `Serving Grant Update` function takes a value other than "Zero_Grant" and at least one process is activated.

11.8.1.6.2 Report Triggering when SG \neq "Zero_Grant" and at least one process is activated

If SG becomes too small to allow transmission of a single PDU from any scheduled MAC-d flow or if the SG is too small to allow transmission of a single PDU from any scheduled MAC-d flow and TEBS becomes larger than zero, the transmission of Scheduling Information should be triggered.

If an E-DCH serving cell change occurs and if the new E-DCH serving cell was not part of the previous `Serving E-DCH RLS`, the transmission of a Scheduling Information shall be triggered.

RRC can configure MAC with periodic triggering also for the case when the variable `Serving_Grant` \neq "Zero_Grant" and at least one process is activated. The periodic trigger timer `T_SIG` (Timer Scheduling Information – different from "Zero_Grant") can be configured to a different value than `T_SING`.

`T_SIG` shall be started once the `Serving_Grant` variable becomes \neq "Zero_Grant" and at least one process is activated.

When `T_SIG` expires, the transmission of a new Scheduling Information shall be triggered.

T_SIG shall be stopped and reset once the Serving_Grant variable in the Serving Grant Update function becomes equal to "Zero_Grant" or all processes are deactivated.

T_SIG shall be restarted when the transmission of a Scheduling Information is triggered.

Once the Serving_Grant variable in the Serving Grant Update function becomes equal to "Zero_Grant" or all processes are deactivated and TEBS is larger than zero, the transmission of a Scheduling Information shall be triggered.

11.8.1.6.3 HARQ delivery failure for triggered Scheduling Information

If the HARQ process fails to deliver a MAC-e PDU containing a triggered Scheduling Information to the RLS containing the serving cell:

- if the Scheduling Information was transmitted without any higher layer data multiplexed in the same MAC-e PDU:
 - no further action is required (rely on periodic triggering).
- else (Scheduling Information was transmitted together with higher layer data multiplexed in the same MAC-e PDU):
 - the transmission of a new Scheduling Information shall be triggered.

11.8.1.7 MAC-es/e Reset

If a reset of the MAC-es/e entity is requested by upper layers, the UE shall at the activation time indicated by higher layers:

- flush all HARQ processes;
- set CURRENT_TSN to 0 for all the logical channels mapped to E-DCH.

NOTE: In this case, the HARQ entity will not notify the Scheduling Information Reporting function if a flushed MAC-e PDU contained a triggered Scheduling Information (rely on periodic triggering).

11.8.1.8 Monitoring of Absolute and Relative Grant Channels

When the DRX feature is enabled by higher layers, and in addition to the conditions defined in subclause 6C.3 of [13] the downlink monitoring of E-AGCH and E-RGCH sets is required in the following conditions:

- At least one MAC-d flow is configured with a scheduled transmission and TEBS > 0 or;
- a scheduled E-DCH transmission has been performed in any of the *Inactivity Threshold for UE Grant Monitoring* previous uplink TTIs or;
- the start of E-AGCH or E-RGCH commands overlap in time with an E-HICH corresponding to a scheduled E-DCH transmission.

11.8.2 Node B operation

11.8.2.1 HARQ Operation

11.8.2.1.1 HARQ entity

There is one HARQ entity per UE in each Node-B in its E-DCH active set. The HARQ entity routes the payload and the associated RSN value to the appropriate HARQ process based on the transmission timing. Based on the outcome of the decoding, the HARQ entity transmits an ACK or a NACK in return.

11.8.2.1.2 HARQ process

The HARQ process uses the RSN and the transmission timing (CFN, sub-frame) to establish the transmission number. Based on this it identifies the transmission redundancy version and attempts to decode the transmission. The outcome of the decoding is reported to the HARQ entity, so that it may be fed back to the UE.

11.8.2.2 De-multiplexing

There is one de-multiplexing entity per UE in the Node B. The SRNC configures the Node B with the mapping between the active DDI values and the corresponding MAC-d flow and PDU size. Also, it provides it with the mapping between MAC-d flow IDs and the corresponding Iub bearer.

The de-multiplexing entity uses the MAC-e header information (DDI, N) to determine the size of each MAC-es PDU and based on this it segments the MAC-e payload into MAC-es PDUs. These are then routed onto the Iub bearer indicated by the DDI value.

With each MAC-es PDU, the Node B will send to the SRNC:

- the associated DDI and N values;
- the CFN and sub-frame number when the payload including the MAC-es PDU was decoded correctly;
- the total number of transmissions that were needed for the MAC-e PDU to be decoded correctly.

11.8.2.3 Scheduler

There is one E-DCH Node B scheduler per Node B. The Node B scheduler is responsible for the following functions:

- Allocating uplink resources to UEs for which it acts as the serving Node B;
- Monitoring other-cell interference and accordingly sending relative grants to UEs for which it does not act as the serving Node B;
- Reporting to the SRNC on the lack of processing resources;

11.8.2.4 E-DCH Provided Bit Rate measurement

The E-DCH Provided Bit Rate measurement is defined as follows:

- for each priority class the MAC-e function in the Node B measures the total number of MAC-d PDU bits whose transmission over the radio interface has been considered successful by MAC-e in Node-B during the last measurement period, divided by the duration of the measurement period;
- the number of MAC-d PDU bits from UEs in softer handover shall be considered after soft combining;
- the Node-B shall allocate the bit rate received over an RLS equally divided among all cells in the RLS regardless of whether the RLS contains the E-DCH serving cell or not;
- the values reported shall be raw samples;
- the measurement period shall be 100 ms.

11.8.3 RNC operation

11.8.3.1 Re-ordering entity

The re-ordering entity is part of the MAC-es sublayer in the SRNC. There is one re-ordering entity per UE. Each re-ordering entity will support one re-ordering process per logical channel. The DDI value is used to determine the logical channel for which each MAC-es PDU is meant. Based on this information, the MAC-es PDUs are routed to the proper re-ordering process. The re-ordering process may use the explicit TSN indication as well as the timing information provided by the Node B in order to eliminate duplicates and deliver the packets in order to RLC. The details of the re-ordering mechanism are left up to the implementation.

11.9 Control of E-DCH transmission and reception (TDD)

11.9.1 UE operation

11.9.1.1 HARQ Operation

The TDD HARQ protocol is a stop and wait protocol based on synchronous downlink ACK/NACKs with asynchronous retransmissions in the uplink. If NACK is received then the UE may only retransmit the previously transmitted MAC-e PDU if suitable physical resources are available, otherwise it must wait until it receives an appropriate Absolute Grant (or in the case of non-scheduled transmission, the UE must wait until resource is next designated as available for non-scheduled transmission/retransmission). There are a maximum of 8 HARQ processes (instances of the HARQ entity). Operation of the HARQ protocol is as follows:

- If an Absolute Grant is received in Frame (i) then the UE transmits a data block (MAC-e PDU) in Frame (i+T1)
- For a MAC-e PDU transmitted in Frame (i+T1) the UE receives an ACK/NACK in Frame (i+T1+T2)
- If NACK is received in Frame (i+T1+T2) then the UE cannot retransmit the MAC-e PDU previously transmitted in Frame (i+T1) (now stored for potential retransmission) until suitable physical resources are available (e.g. until Absolute Grant received)
- The interval T3 between reception of NACK and the availability of suitable resources via reception of a Grant for a subsequent retransmission is variable and depends on Node B scheduling decisions
- If an ACK is received in Frame (i+T1+T2) then the MAC-e PDU previously transmitted in Frame (i+T1) (stored for potential retransmission) is discarded and the HARQ process identity associated with the previously transmitted data block can now be reassigned.

NOTE: For 1.28 Mcps TDD, "subframe" should be used to describe the above timing relation. T1 and T2 may be derived from the physical layer timings given in [21].

Operation of the TDD HARQ protocol is illustrated by Figure 11.9.1.1.

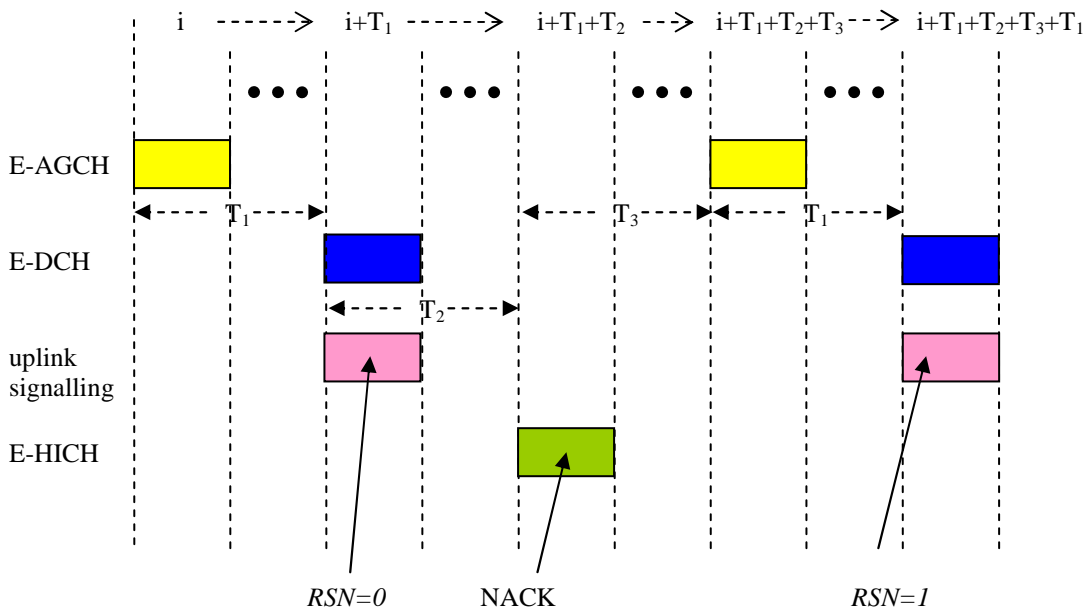

Figure 11.9.1.1: TDD E-DCH HARQ Operation

11.9.1.1.1 HARQ entity

There is one HARQ entity in the UE. A number of parallel HARQ processes (identified by a HARQ process identifier) are used in the UE to support the HARQ entity, allowing transmissions to take place continuously while the UE is granted resources. The HARQ entity identifies the HARQ process for which transmission should take place if resources are available. Also, based on timing with respect to a previously-transmitted MAC-e PDU it routes the receiver feedback (ACK/NACK information), relayed by the physical layer, to the appropriate HARQ process.

The minimum number of HARQ processes is a function of T1 and T2 (see subclause 11.9.1.1). The maximum number of HARQ process identifiers is 8. Each process is associated with a HARQ process identifier numbered from 0 to 7.

The HARQ entity is responsible for determining which HARQ process will use the assigned resources in a given TTI (for both scheduled and non-scheduled resource types). It is further responsible for determining for each HARQ process whether new data or existing data should be transmitted from the HARQ process buffer, including the case in which new data is transmitted before successful delivery of the existing data.

For transmission in a given TTI, the HARQ entity shall only consider those HARQ processes associated with the resource grant type (scheduled / non-scheduled). HARQ processes 0 to 3 are associated with scheduled transmission whilst HARQ processes 4 to 7 are associated with non-scheduled transmission. In the following, the set of HARQ processes associated with the resource grant type is denoted the "associated set".

The following rules control the operation of the HARQ entity:

- If retransmissions are pending for any of the HARQ processes of the associated set:
 - the HARQ entity shall determine for each HARQ process of the associated set whether the current resource grant is sufficient to allow retransmission of the data. The grant is deemed to be sufficient if the corresponding transport block size is supportable within the allocated resources as determined by the E-TFC selection entity (see subclause 11.9.1.4);
 - if the grant is sufficient for retransmission by at least one of the HARQ processes of the associated set, select the HARQ process containing the oldest MAC-e PDU for retransmission and notify the E-TFC selection entity that the TTI shall be used for retransmission;
 - if the grant is not sufficient for retransmission by any of the HARQ processes of the associated set, the HARQ entity shall select an available HARQ process from the associated set for transmission of new data. In the case that none of the HARQ processes in the associated set are available (all contain data for retransmission) the HARQ entity shall discard the data from the HARQ process in the associated set containing the oldest MAC-e PDU and shall select that HARQ process for transmission of new data. In either case, the HARQ entity shall notify the E-TFC selection entity that the TTI shall be used for a new transmission.
- else:
 - the HARQ entity shall select an available HARQ process from the associated set for transmission of new data and shall notify the E-TFC selection entity that the TTI shall be used for a new transmission of scheduled data.

11.9.1.1.2 HARQ process

Each HARQ process is associated with a physical buffer (HARQ buffer).

Each HARQ process maintains the state variable CURRENT_TX_NB, which indicates the number of transmissions that have taken place for the MAC-e PDU currently in the buffer. For 1.28 Mcps TDD, each HARQ process also maintains the timer RTX_TIMER used to determine whether a pending retransmission should be discarded. When the HARQ process is established, CURRENT_TX_NB shall be initialized to 0.

At the time of a new transmission, the HARQ entity provides the HARQ profile to use for all transmissions and re-transmissions of this MAC-e PDU. This HARQ profile includes information on the maximum number of transmissions to perform, and the power offset with which to configure the physical layer. For 1.28 Mcps TDD, the HARQ profile also includes a retransmission timer attribute.

If the HARQ entity provides a new PDU, the HARQ process shall:

- set CURRENT_TX_NB to 0;

- set CURRENT_RSN to 0;
- store the MAC-e PDU in the associated HARQ buffer;
- for 1.28 Mcps TDD, if RTX_TIMER is active, it shall be stopped;
- generate a transmission as described below.

If the HARQ entity requests a re-transmission, the HARQ process shall:

- generate a transmission as described below.
- for 1.28 Mcps TDD, start RTX_TIMER for this MAC-e PDU if NACK is received for the initial transmission.

To generate a transmission, the HARQ process shall:

- instruct the physical layer to set the RSN field on the E-UCCH to CURRENT_RSN;
- instruct the physical layer to generate a transmission with the power offset corresponding to the HARQ profile and the redundancy version corresponding to the RSN value
- if CURRENT_RSN < 3
 - increment CURRENT_RSN by 1;
- else
 - decrement CURRENT_RSN by 1;
- increment CURRENT_TX_NB by 1;
- if CURRENT_TX_NB \geq maximum number of transmissions indicated in the transmission HARQ profile:
 - flush the HARQ buffer;
 - set CURRENT_TX_NB to 0;
 - set CURRENT_RSN to 0.
 - for 1.28 Mcps TDD, if RTX_TIMER is active, it shall be stopped
- for 1.28 Mcps TDD, if RTX_TIMER expires which value indicated in the transmission HARQ profile:
 - flush the HARQ buffer;
 - set CURRENT_TX_NB to 0;
 - set CURRENT_RSN to 0.

If an ACK is received, the HARQ process shall:

- flush the HARQ buffer;
- set CURRENT_TX_NB to 0;
- set CURRENT_RSN to 0.
- for 1.28 Mcps TDD, if RTX_TIMER is active, it shall be stopped.

11.9.1.2 Multiplexing and TSN setting entity

As subclause 11.8.1.2.

11.9.1.3 Receiving a Grant

The UE determines whether each TTI is available for scheduled or non-scheduled transmissions.

The parameters applicable to a transmission are timeslots, code and maximum power. In the case of non-scheduled transmission, these parameters are set by RRC and retransmissions and/or new transmissions may occur in frames at intervals set by RRC. For scheduled transmission, the parameters are received via the E-AGCH.

For given grant, the HARQ entity determines which HARQ process to use in the TTI (see subclause 11.9.1.1.1).

11.9.1.4 E-TFC Selection

In TDD, rules for E-TFC selection shall be applied as provided below.

UEs shall apply E-TFC selection when invoked by the HARQ entity (see subclause 11.9.1.1.1).

For each MAC-d flow, RRC configures MAC-e with a HARQ profile and multiplexing list. Additionally, for 3.84/7.68 Mcps TDD, RRC configures MAC with a power offset in case the Scheduling Information needs to be transmitted without any higher-layer data. For 1.28 Mcps TDD, RRC also configures MAC with a retransmission timer and the maximum number of HARQ transmissions in case the Scheduling Information needs to be transmitted without any higher-layer data. The HARQ profile includes the power offset and maximum number of HARQ transmissions to use for this MAC-d flow. For 1.28 Mcps TDD, the HARQ profile also includes a retransmission timer attribute. The multiplexing list identifies for each MAC-d flow(s), the other MAC-d flows for which data can be multiplexed in a transmission that uses the power offset included in its HARQ profile.

RRC can control the scheduling of uplink data by giving each logical channel a priority between 1 and 8, where 1 is the highest priority and 8 the lowest. E-TFC selection in the UE shall be done in accordance with the priorities indicated by RRC. Logical channels have absolute priority, i.e. the UE shall maximise the transmission of higher priority data.

RRC can allocate non-scheduled transmission grants to individual MAC-d flows in order to reduce the transmission delays.

The UE shall determine whether to take scheduled or non-scheduled grants into account in the upcoming transmission. If neither are supposed to be taken into account (i.e. the TTI is not available for non-scheduled transmission and no Grant for scheduled transmission has been received) then no grant shall be assumed to exist. If a grant exists then the transmission format and data allocation shall follow the requirements below.

For each configured MAC-d flow, a given E-TFC can be in any of the following states:

- Supported state;
- Blocked state.

The E-TFC states are derived according to the following:

- If the transmission is a retransmission then only the E-TFC with the same block size as the original transmission may be in the supported state.
- For 1.28Mcps TDD, only E-TFCs from the E-TFCS (the table of TB sizes) which are consistent with the UE's E-DCH capability category shall be considered for the transmission;
- Only E-TFCs from the E-TFCS (the table of TB sizes) which can be supported by (exactly) the number of slots assigned by the grant shall be considered for the transmission;
- Only E-TFCs which result (for the granted timeslot and code physical resources) in a coderate lying between the maximum and minimum (inclusive) allowable coderates set by RRC [7] shall be considered for the transmission {note: the definition of the term "coderate" as used here is the same as that provided by [18]}. This shall be evaluated for both QPSK and 16-QAM modulation;
- P_{HARQ} , the HARQ profile power offset is selected (for 3.84/7.68Mcps TDD the HARQ profile for the transmission shall be selected among the HARQ profiles of MAC-d flows on which the highest priority logical channels with available data are mapped, for 1.28Mcps TDD the HARQ power offset shall be set to the maximum of HARQ power offset of all the MAC-d flows mapped to the same type of resource (scheduled or non-scheduled resource); Scheduling Information power offset shall be used when Scheduling Information is transmitted without any higher-layer data.)
- Only E-TFCs whose calculated transmission power requirement $P_{\text{E-PUCH}}$ (see [18]) is less than or equal to both the available and the granted power shall be considered for the transmission (note: this requirement does not apply in the case of a retransmission on non-scheduled resources). For TDD, the smallest E-TFC is considered

always in the supported state. The granted power is defined as the calculated E-PUCH transmission power of [18] with $\beta_e = (\text{Absolute Grant Value} + \alpha_e)$. The available power is the maximum UE transmission power.

- For 1.28Mcps TDD, if the E-PUCH coexists with other physical channel within one timeslot, the sum of calculated transmission power requirement P_{E-PUCH} and the transmission power requirement for the other physical channel shall be less than or equal to the available power.
- If only scheduling information is included in MAC-e PDU, the smallest E-TFC shall be chosen and the transmission power shall be equal to the granted power (the available maximum E-PUCH power shall be considered too). And the UE shall select QPSK modulation. (1.28 Mcps TDD only);

From those E-TFCs in the supported state the UE determines the largest block size that it is permitted to transmit within the given constraints.

The UE shall select the modulation type associated with the determined E-TFC (note: if an E-TFC is supported by both QPSK and 16-QAM then 16-QAM modulation shall be used if its power requirement (P_{E-PUCH}) is lower than the power requirement for QPSK, otherwise QPSK modulation shall be used).

Data allocation shall then be performed in accordance with the following:

- For all logical channels, if the logical channel belongs to a non-scheduled MAC-d flow, its data shall be considered as available up to the largest block size determined for the corresponding non-scheduled grant. If the logical channel does not belong to a non-scheduled MAC-d flow, its data shall be considered as available up to the largest block size determined for the Serving Grant;
- The data allocation shall maximise the transmission of higher priority data;
- The UE shall select the E-TFC, SF and modulation which minimises the power used (3.84/7.68 Mcps TDD only);
- The UE shall select the E-TFC and modulation. QPSK shall be used in the case of E-PUCH allocated with other physical channel in the same timeslot of one TTI for one UE, otherwise modulation shall be selected, which minimises the power used (1.28 Mcps TDD only);

While respecting all the above listed requirements, for each logical channel using RLC-UM, at every TTI, the UE may select the RLC PDU size so as to maximise the amount of data of this logical channel that can be transmitted.

Once an appropriate E-TFC and data allocation are found according to the rules above, the "Multiplexing and TSN Setting" entity shall generate the corresponding MAC-e PDU.

In 1.28Mcps TDD, when Scheduling Information is triggered by timer per subclause 11.9.1.5, the E-TFC selection and data-allocation process shall assume that Scheduling Information has a priority higher than any other logical channel.

The E-TFC selection function shall provide this MAC-e PDU and transmission HARQ profile to the HARQ entity. The selected E-TFC is also provided. For 3.84Mcps TDD and 7.68Mcps TDD the maximum number of HARQ transmissions and the power offset in this profile shall be set respectively to the maximum of both the Max Number of HARQ Transmissions and of the power offset of the HARQ profiles from all the MAC-d flows from which data is multiplexed into the transmission. For 1.28 Mcps TDD, the maximum number of HARQ transmissions shall be set to the maximum of the Max Number of HARQ Transmissions of the HARQ profiles from all the MAC-d flows from which data is multiplexed into the transmission, the HARQ power offset shall be set to the maximum of HARQ power offset of all the MAC-d flows mapped to the same type of resource (scheduled or non-scheduled resource), and the retransmission timer shall be set to the maximum of the retransmission timer value of the HARQ profiles that are permitted to be multiplexed into the transmission. For 1.28Mcps TDD, when the Scheduling Information needs to be transmitted without any higher-layer data, the specific HARQ profile should be applied. Each HARQ process which is associated with a buffer holding a MAC-e PDU for potential retransmission shall maintain the HARQ profile and the number of re-transmissions that have occurred. For 1.28 Mcps TDD, the HARQ process shall also maintain the value of `RTX_TIMER`.

Further information on E-TFC selection is provided in Annex CA.

11.9.1.4a Scheduling Information reporting (3.84/7.68 Mcps TDD only)

The UE shall implement a scheduling information delay time mechanism. The period T-SCHED governing the periodicity of sending scheduling information and the period T-RUCCH governing E-RUCCH retransmissions is set by

RRC. The delay timer shall be reset whenever Scheduling Information is included in the MAC-e PDU.

If a UE has no Grant and the TEBS becomes larger than zero, the transmission of Scheduling Information shall be sent via E-RUCCH.

When the UE sends scheduling information via E-RUCCH it will start a timer T_R which will be stopped and reset if the UE receives a subsequent grant. However if this timer reaches T-RUCCH (the value T-RUCCH is set via RRC) the UE will resend the Scheduling information via E-RUCCH.

If the UE has a Grant then Scheduling Information may be included in the MAC-e PDU according to subclause 9.2.4.2. If the UE has a Grant and scheduling information delay timer $\geq T\text{-SCHEd}$ then the UE shall include Scheduling Information in the next MAC-e PDU sent and the scheduling information delay timer shall be restarted. If the UE does not receive any Grant before the scheduling information delay timer $> T\text{-SCHEd} + T\text{-RUCCH} / 2$ then the UE shall send scheduling information via the E-RUCCH and shall stop and reset the scheduling information delay timer.

11.9.1.5 Scheduling Information reporting (1.28 Mcps TDD only)

A "Grant Request" type Scheduling Information can be triggered if any of the following events occur:

- The TEBS becomes larger than zero;
- An E-DCH serving cell change occurs and the TEBS is larger than zero;
- An E-DCH working frequency change occurs in the serving cell and the TEBS is larger than zero;

An optional Extended Estimation Window (defined by RRC in TTIs) may be used to prevent the UE from triggering unnecessary E-RUCCH transmission in case the UE potentially has an available Grant a short time in the future. The UE may perform a persistent check through the Extended Estimation Window to evaluate whether there is a Grant available for new data transmission when the UE can not take the decision just according to the related HARQ information, e.g. HARQ timing, HARQ retransmission numbers and so on.

If a UE has no Grant (including scheduled grant or non-scheduled grant) available for a new MAC-e PDU transmission in current TTI or in the Extended Estimation Window (if configured by RRC), as the "Grant Request" type Scheduling Information is triggered, the transmission of Scheduling Information shall be triggered via E-RUCCH.

Else if the UE has a Grant (including scheduled grant or non-scheduled grant) available for a new MAC-e PDU transmission in current TTI or in Extended Estimation Window (if configured by RRC), as the "Grant Request" type Scheduling Information is triggered, the scheduling information should be included in a MAC-e PDU via the Grant. If the HARQ process fails to deliver the MAC-e PDU containing the triggered the "Grant Request" type Scheduling Information, another "Grant Request" type Scheduling Information shall be triggered.

When assembling a MAC-e PDU, if the scheduling information needs to be included in the MAC-e PDU according to subclause 9.2.4.2 and it shall be transmitted regardless of TEBS status.

Additional periodic timer T-SI is used to avoid long pause duration of scheduling information reporting (defined by RRC). Once the grant is designated, T-SI shall be started. When the scheduling information is included in MAC-e PDU and sent, the timer shall be restarted immediately. When the timer expires, if there is a grant to send a new MAC-e PDU, it should include scheduling information, otherwise the UE shall wait a grant to send scheduling information in a new MAC-e PDU.

Additionally if data with higher priority than the data already in the transmission buffer arrives, the Scheduling Information shall be triggered and included in next available MAC-e PDU, i.e. higher priority data arrival event shall not trigger a E-RUCCH procedure.

RRC can configure MAC with a delay timer to be used when the UE transits from having a Grant to not having a Grant and the TEBS is still larger than zero. The delay timer T_WAIT shall be started once the Grant expires and shall be stopped and reset when a Grant is received. When T_WAIT expires, the transmission of a Scheduling Information shall be triggered via E-RUCCH (T_WAIT shall be stopped and reset).

Even if multiple events are triggered by the time a new Scheduling Information reporting can take place, only single scheduling information with newly updated content shall be sent via E-RUCCH or included in a MAC-e PDU.

In the case that only non-scheduled transmission is configured without scheduled transmission, the Scheduling Information reporting mechanism above is not applicable, and Scheduling Information reporting procedure is defined as below:

- The Scheduling Information shall be included in the MAC-e PDU due to the quantization of the transport block sizes that can be supported as defined in subclause 9.2.4.2;
- If the periodic timer T-SI-NST is configured by RRC, the Scheduling Information shall be triggered upon the expiration of the periodic timer T-SI-NST, and the triggered Scheduling Information shall be included in the next new MAC-e PDU, the maintenance of timer T-SI-NST is the same as T-SI;
- If both events are triggered by the time a new Scheduling Information reporting can take place, only single scheduling information with newly updated content shall be included in a MAC-e PDU.
- E-RUCCH procedure shall not be initiated for non-scheduled transmission only case.

11.9.1.6 MAC-es/e Reset (1.28 Mcps TDD only)

If a reset of MAC-es/e entity is requested by upper layers, the UE shall at the activation time indicated by higher layer:

- flush all HARQ processes;
- set CURRENT_TSN to 0 for all the logical channels mapped to E-DCH;
- stop all active timers (the timers include Retransmission timer, T_SI, T_WAIT, T_RUCCH);
- set CURRENT_RUCCH to 0.

11.9.2 Node B operation

11.9.2.1 HARQ Operation

11.9.2.1.1 HARQ entity

There is one HARQ entity per UE in the Node-B. The HARQ entity routes the payload and the associated RSN value to the indicated HARQ process (the HARQ process identifier is signalled to the Node B via the E-UCCH). Based on the outcome of the decoding, the HARQ entity transmits an ACK or a NACK in return.

11.9.2.1.2 HARQ process

The HARQ process uses the RSN to identify the redundancy version, The Node B uses the identified redundancy version to attempt to decode the transmission. The outcome of the decoding is reported to the HARQ entity, so that it may be fed back to the UE as ACK or NACK.

11.9.2.2 De-multiplexing

There is one de-multiplexing entity per UE in the Node B. The SRNC configures the Node B with the mapping between the active DDI values and the corresponding MAC-d flow and PDU size. Also, it provides it with the mapping between MAC-d flow IDs and the corresponding Iub bearer.

The de-multiplexing entity uses the MAC-e header information (DDI, N) to determine the size of each MAC-es PDU and based on this it segments the MAC-e payload into MAC-es PDUs. These are then routed onto the Iub bearer indicated by the DDI value.

With each MAC-es PDU, the Node B will send to the SRNC:

- the associated DDI and N values;
- the CFN when the payload including the MAC-es PDU was decoded correctly (3.84/7.68 Mcps only);
- the CFN and sub-frame number when the payload including the MAC-es PDU was decoded correctly (1.28 Mcps TDD only);

- the total number of transmissions that were needed for the MAC-e PDU to be decoded correctly.

11.9.2.3 Scheduler

There is one E-DCH Node B scheduler per Node B. The Node B scheduler is responsible for the following functions:

- Allocating uplink resources to UEs and signalling these to UEs via Absolute Grants;
- Reporting uplink interference measurements to the SRNC
- Reporting to the SRNC on the lack of processing resources
- Determining the TDD ECSN (the UE specific ECSN is incremented for each E-AGCH transmission)
- Determining which E-HICH will be used for the incoming transmission and the value of the associated E-HICH Indicator (1.28 Mcps TDD only)
- Determining how many E-UCCHs should be carried on the incoming E-PUCHs and the value of the associated E-UCCH Number Indicator (1.28 Mcps TDD only).

11.9.2.4 E-DCH Provided Bit Rate measurement

The E-DCH Provided Bit Rate measurement is defined as follows:

- for each priority class the MAC-e function in the Node B measures the total number of MAC-d PDU bits whose transmission over the radio interface has been considered successful by MAC-e in Node-B during the last measurement period, divided by the duration of the measurement period;
- the measurement period shall be [100 ms].

11.9.3 RNC operation

11.9.3.1 Re-ordering entity

The re-ordering entity is part of the MAC-es sublayer in the SRNC. There is one re-ordering entity per UE. Each re-ordering entity will support one re-ordering process per logical channel. The DDI value is used to determine the logical channel for which each MAC-es PDU is meant. Based on this information, the MAC-es PDUs are routed to the proper re-ordering process. The re-ordering process may use the explicit TSN indication as well as the timing information provided by the Node B in order to eliminate duplicates and deliver the packets in order to RLC. The details of the re-ordering mechanism are left up to the implementation.

Annex A (normative): HS-DSCH Transport Block Size Table for FDD

The following table provides the mapping between k_t (as per the definition in subclause 9.2.3.1) and the HS-DSCH Transport Block Size ($L(k_t)$) corresponding to table 9.2.3.1:

Index	TB Size	Index	TB Size	Index	TB Size
1	137	86	1380	171	6324
2	149	87	1405	172	6438
3	161	88	1430	173	6554
4	173	89	1456	174	6673
5	185	90	1483	175	6793
6	197	91	1509	176	6916
7	209	92	1537	177	7041
8	221	93	1564	178	7168
9	233	94	1593	179	7298
10	245	95	1621	180	7430
11	257	96	1651	181	7564
12	269	97	1681	182	7700
13	281	98	1711	183	7840
14	293	99	1742	184	7981
15	305	100	1773	185	8125
16	317	101	1805	186	8272
17	329	102	1838	187	8422
18	341	103	1871	188	8574
19	353	104	1905	189	8729
20	365	105	1939	190	8886
21	377	106	1974	191	9047
22	389	107	2010	192	9210
23	401	108	2046	193	9377
24	413	109	2083	194	9546
25	425	110	2121	195	9719
26	437	111	2159	196	9894
27	449	112	2198	197	10073
28	461	113	2238	198	10255
29	473	114	2279	199	10440
30	485	115	2320	200	10629
31	497	116	2362	201	10821
32	509	117	2404	202	11017
33	521	118	2448	203	11216
34	533	119	2492	204	11418
35	545	120	2537	205	11625
36	557	121	2583	206	11835
37	569	122	2630	207	12048
38	581	123	2677	208	12266
39	593	124	2726	209	12488
40	605	125	2775	210	12713
41	616	126	2825	211	12943
42	627	127	2876	212	13177
43	639	128	2928	213	13415
44	650	129	2981	214	13657
45	662	130	3035	215	13904

46	674	131	3090	216	14155
47	686	132	3145	217	14411
48	699	133	3202	218	14671
49	711	134	3260	219	14936
50	724	135	3319	220	15206
51	737	136	3379	221	15481
52	751	137	3440	222	15761
53	764	138	3502	223	16045
54	778	139	3565	224	16335
55	792	140	3630	225	16630
56	806	141	3695	226	16931
57	821	142	3762	227	17237
58	836	143	3830	228	17548
59	851	144	3899	229	17865
60	866	145	3970	230	18188
61	882	146	4042	231	18517
62	898	147	4115	232	18851
63	914	148	4189	233	19192
64	931	149	4265	234	19538
65	947	150	4342	235	19891
66	964	151	4420	236	20251
67	982	152	4500	237	20617
68	1000	153	4581	238	20989
69	1018	154	4664	239	21368
70	1036	155	4748	240	21754
71	1055	156	4834	241	22147
72	1074	157	4921	242	22548
73	1093	158	5010	243	22955
74	1113	159	5101	244	23370
75	1133	160	5193	245	23792
76	1154	161	5287	246	24222
77	1175	162	5382	247	24659
78	1196	163	5480	248	25105
79	1217	164	5579	249	25558
80	1239	165	5680	250	26020
81	1262	166	5782	251	26490
82	1285	167	5887	252	26969
83	1308	168	5993	253	27456
84	1331	169	6101	254	27952
85	1356	170	6211		

The following table provides the mapping between k_t (as per the definition in subclause 9.2.3.1) and the HS-DSCH Transport Block Size ($L(k_t)$) corresponding to table 9.2.3.2:

Index	TB Size	Index	TB Size	Index	TB Size	Index	TB Size
1	120	86	1000	171	4592	256	21000
2	128	87	1016	172	4672	257	21384
3	136	88	1040	173	4760	258	21768
4	144	89	1056	174	4848	259	22160
5	152	90	1072	175	4936	260	22560
6	160	91	1096	176	5024	261	22968
7	168	92	1112	177	5112	262	23384
8	176	93	1136	178	5208	263	23808
9	184	94	1152	179	5296	264	24232
10	192	95	1176	180	5392	265	24672
11	200	96	1200	181	5488	266	25120
12	208	97	1216	182	5592	267	25568
13	216	98	1240	183	5688	268	26032
14	224	99	1264	184	5792	269	26504
15	232	100	1288	185	5896	270	26976
16	240	101	1312	186	6008	271	27464
17	248	102	1336	187	6112	272	27960
18	256	103	1360	188	6224	273	28464
19	264	104	1384	189	6336	274	28976
20	272	105	1408	190	6448	275	29504
21	280	106	1432	191	6568	276	30032
22	288	107	1456	192	6688	277	30576
23	296	108	1488	193	6808	278	31128
24	304	109	1512	194	6928	279	31688
25	312	110	1536	195	7056	280	32264
26	320	111	1568	196	7184	281	32848
27	328	112	1600	197	7312	282	33440
28	336	113	1624	198	7440	283	34040
29	344	114	1656	199	7576	284	34656
30	352	115	1688	200	7712	285	35280
31	360	116	1712	201	7856	286	35920
32	368	117	1744	202	7992	287	36568
33	376	118	1776	203	8136	288	37224
34	384	119	1808	204	8288	289	37896
35	392	120	1840	205	8440	290	38576
36	400	121	1872	206	8592	291	39272
37	408	122	1912	207	8744	292	39984
38	416	123	1944	208	8904	293	40704
39	424	124	1976	209	9064	294	41440
40	440	125	2016	210	9224	295	42192
41	448	126	2048	211	9392		
42	456	127	2088	212	9560		
43	464	128	2128	213	9736		
44	472	129	2168	214	9912		
45	480	130	2200	215	10088		
46	488	131	2240	216	10272		
47	496	132	2288	217	10456		
48	504	133	2328	218	10648		
49	512	134	2368	219	10840		
50	528	135	2408	220	11032		
51	536	136	2456	221	11232		
52	544	137	2496	222	11432		

53	552	138	2544	223	11640
54	560	139	2592	224	11848
55	576	140	2632	225	12064
56	584	141	2680	226	12280
57	592	142	2736	227	12504
58	608	143	2784	228	12728
59	616	144	2832	229	12960
60	624	145	2880	230	13192
61	640	146	2936	231	13432
62	648	147	2984	232	13672
63	664	148	3040	233	13920
64	672	149	3096	234	14168
65	688	150	3152	235	14424
66	696	151	3208	236	14688
67	712	152	3264	237	14952
68	728	153	3328	238	15224
69	736	154	3384	239	15496
70	752	155	3448	240	15776
71	768	156	3512	241	16064
72	776	157	3576	242	16352
73	792	158	3640	243	16648
74	808	159	3704	244	16944
75	824	160	3768	245	17256
76	840	161	3840	246	17568
77	848	162	3912	247	17880
78	864	163	3976	248	18200
79	880	164	4048	249	18536
80	896	165	4120	250	18864
81	912	166	4200	251	19208
82	928	167	4272	252	19552
83	952	168	4352	253	19904
84	968	169	4432	254	20264
85	984	170	4512	255	20632

Annex B (normative): E-DCH Transport Block Size Tables for FDD

The mapping between the chosen E-TFCI and the corresponding E-DCH transport block size is given in the following tables:

B.1 2ms TTI E-DCH Transport Block Size Table 0

E-TFCI	TB Size (bits)	E-TFCI	TB Size (bits)	E-TFCI	TB Size (bits)	E-TFCI	TB Size (bits)	E-TFCI	TB Size (bits)
0	18	30	342	60	1015	90	3008	120	N/A
1	120	31	355	61	1053	91	3119	121	9241
2	124	32	368	62	1091	92	3234	122	9582
3	129	33	382	63	1132	93	3353	123	9935
4	133	34	396	64	1173	94	3477	124	10302
5	138	35	410	65	1217	95	3605	125	10681
6	143	36	426	66	1262	96	3738	126	11075
7	149	37	441	67	1308	97	3876	127	11484
8	154	38	458	68	1356	98	4019		
9	160	39	474	69	1406	99	4167		
10	166	40	492	70	1458	100	4321		
11	172	41	510	71	1512	101	4480		
12	178	42	529	72	1568	102	4645		
13	185	43	548	73	1626	103	4816		
14	192	44	569	74	1685	104	4994		
15	199	45	590	75	1748	105	5178		
16	206	46	611	76	1812	106	5369		
17	214	47	634	77	1879	107	5567		
18	222	48	657	78	1948	108	5772		
19	230	49	682	79	2020	109	5985		
20	238	50	707	80	2094	110	6206		
21	247	51	733	81	2172	111	6435		
22	256	52	760	82	2252	112	6672		
23	266	53	788	83	2335	113	6918		
24	275	54	817	84	2421	114	7173		
25	286	55	847	85	2510	115	7437		
26	296	56	878	86	2603	116	7711		
27	307	57	911	87	2699	117	7996		
28	318	58	944	88	2798	118	8290		
29	330	59	979	89	2901	119	8596		

NOTE: Non applicable E-TFCI values are marked as N/A.

B.2 2ms TTI E-DCH Transport Block Size Table 1

E-TFCI	TB Size (bits)	E-TFCI	TB Size (bits)	E-TFCI	TB Size (bits)
0	18	43	2724	86	7252
1	186	44	2742	87	7288

2	204	45	3042	88	7428
3	354	46	3060	89	7464
4	372	47	3078	90	7764
5	522	48	3298	91	7800
6	540	49	3316	92	7908
7	674	50	3334	93	7944
8	690	51	3378	94	8100
9	708	52	3396	95	8136
10	726	53	3414	96	8436
11	858	54	3732	97	8472
12	876	55	3750	98	8564
13	1026	56	3972	99	8600
14	1044	57	3990	100	8772
15	1062	58	4068	101	8808
16	1194	59	4086	102	9108
17	1212	60	4404	103	9144
18	1330	61	4422	104	9220
19	1348	62	4628	105	9256
20	1362	63	4646	106	9444
21	1380	64	4740	107	9480
22	1398	65	4758	108	9780
23	1530	66	5076	109	9816
24	1548	67	5094	110	9876
25	1698	68	5284	111	9912
26	1716	69	5302	112	10116
27	1734	70	5412	113	10152
28	1866	71	5430	114	10452
29	1884	72	5748	115	N/A
30	1986	73	5766	116	10532
31	2004	74	5940	117	10568
32	2022	75	5958	118	10788
33	2034	76	6084	119	10824
34	2052	77	6102	120	11124
35	2070	78	6420	121	11178
36	2370	79	6438	122	11188
37	2388	80	6596	123	11242
38	2406	81	6614	124	11460
39	2642	82	6756	125	11478
40	2660	83	6774		
41	2678	84	7092		
42	2706	85	7110		

NOTE: Non applicable E-TFCI values are marked as N/A.

B.2a 2ms TTI E-DCH Transport Block Size Table 2

E-TFCI	TB Size (bits)	E-TFCI	TB Size (bits)	E-TFCI	TB Size (bits)	E-TFCI	TB Size (bits)	E-TFCI	TB Size (bits)
0	18	30	402	60	1405	90	4913	120	17173
1	120	31	419	61	1465	91	5122	121	N/A
2	125	32	437	62	1528	92	5341	122	18667
3	130	33	455	63	1593	93	5568	123	19462
4	135	34	475	64	1661	94	5805	124	20291
5	141	35	495	65	1731	95	6053	125	21155

6	147	36	516	66	1805	96	6310	126	22056
7	154	37	538	67	1882	97	6579	127	22995
8	160	38	561	68	1962	98	6859		
9	167	39	585	69	2046	99	7152		
10	174	40	610	70	2133	100	7456		
11	182	41	636	71	2224	101	7774		
12	189	42	663	72	2319	102	8105		
13	197	43	691	73	2417	103	8450		
14	206	44	721	74	2520	104	8810		
15	215	45	752	75	2628	105	9185		
16	224	46	784	76	2740	106	9577		
17	233	47	817	77	2856	107	9985		
18	243	48	852	78	2978	108	10410		
19	254	49	888	79	3105	109	10853		
20	265	50	926	80	3237	110	11316		
21	276	51	965	81	3375	111	11798		
22	288	52	1007	82	3519	112	12300		
23	300	53	1049	83	3669	113	12824		
24	313	54	1094	84	3825	114	13370		
25	326	55	1141	85	3988	115	13940		
26	340	56	1189	86	4158	116	14534		
27	354	57	1240	87	4335	117	15153		
28	370	58	1293	88	4520	118	15798		
29	385	59	1348	89	4712	119	16471		

NOTE: Non applicable E-TFCI values are marked as N/A.

B.2b 2ms TTI E-DCH Transport Block Size Table 3

E-TFCI	TB Size (bits)	E-TFCI	TB Size (bits)	E-TFCI	TB Size (bits)	E-TFCI	TB Size (bits)	E-TFCI	TB Size (bits)
0	18	30	1902	60	6614	90	14184	120	21966
1	186	31	1986	61	6774	91	14538	121	22302
2	204	32	2004	62	7110	92	14874	122	22430
3	354	33	2034	63	7270	93	15210	123	22638
4	372	34	2052	64	7446	94	15546	124	22996
5	522	35	2370	65	7782	95	15882		
6	540	36	2388	66	7926	96	16218		
7	558	37	2642	67	8118	97	16554		
8	674	38	2660	68	8454	98	16890		
9	692	39	2706	69	8582	99	17226		
10	708	40	2724	70	8790	100	17562		
11	858	41	3042	71	9126	101	N/A		
12	876	42	3060	72	9238	102	N/A		
13	894	43	3298	73	9462	103	18252		
14	1026	44	3316	74	9798	104	18476		
15	1044	45	3378	75	9894	105	18588		
16	1194	46	3396	76	10134	106	18924		
17	1212	47	3750	77	10470	107	19132		
18	1230	48	3990	78	10550	108	19260		
19	1330	49	4086	79	10806	109	19596		
20	1348	50	4422	80	11160	110	19788		
21	1362	51	4646	81	11224	111	19932		
22	1380	52	4758	82	11496	112	20268		
23	1530	53	5094	83	11880	113	20444		

24	1548	54	5302	84	12168	114	20604
25	1566	55	5430	85	12536	115	20940
26	1698	56	5766	86	12840	116	21100
27	1716	57	5958	87	13192	117	21276
28	1866	58	6102	88	13512	118	21612
29	1884	59	6438	89	13848	119	21774

NOTE: Non applicable E-TFCI values are marked as N/A.

B.3 10ms TTI E-DCH Transport Block Size Table 0

E-TFCI	TB Size (bits)	E-TFCI	TB Size (bits)	E-TFCI	TB Size (bits)	E-TFCI	TB Size (bits)	E-TFCI	TB Size (bits)
0	18	30	389	60	1316	90	4452	120	15051
1	120	31	405	61	1371	91	4636	121	15675
2	124	32	422	62	1428	92	4828	122	16325
3	130	33	440	63	1487	93	5029	123	17001
4	135	34	458	64	1549	94	5237	124	17706
5	141	35	477	65	1613	95	5454	125	18440
6	147	36	497	66	1680	96	5680	126	19204
7	153	37	517	67	1749	97	5915	127	20000
8	159	38	539	68	1822	98	6161		
9	166	39	561	69	1897	99	6416		
10	172	40	584	70	1976	100	6682		
11	180	41	608	71	2058	101	6959		
12	187	42	634	72	2143	102	7247		
13	195	43	660	73	2232	103	7547		
14	203	44	687	74	2325	104	7860		
15	211	45	716	75	2421	105	8186		
16	220	46	745	76	2521	106	8525		
17	229	47	776	77	2626	107	8878		
18	239	48	809	78	2735	108	9246		
19	249	49	842	79	2848	109	9629		
20	259	50	877	80	2966	110	10028		
21	270	51	913	81	3089	111	10444		
22	281	52	951	82	3217	112	10877		
23	293	53	991	83	3350	113	11328		
24	305	54	1032	84	3489	114	11797		
25	317	55	1074	85	3634	115	12286		
26	331	56	1119	86	3784	116	12795		
27	344	57	1165	87	3941	117	13325		
28	359	58	1214	88	4105	118	13877		
29	374	59	1264	89	4275	119	14453		

B.4 10ms TTI E-DCH Transport Block Size Table 1

E-TFCI	TB Size (bits)	E-TFCI	TB Size (bits)	E-TFCI	TB Size (bits)
0	18	41	5076	82	11850
1	186	42	5094	83	12132
2	204	43	5412	84	12186
3	354	44	5430	85	12468

4	372	45	5748	86	12522
5	522	46	5766	87	12804
6	540	47	6084	88	12858
7	690	48	6102	89	13140
8	708	49	6420	90	13194
9	858	50	6438	91	13476
10	876	51	6756	92	13530
11	1026	52	6774	93	13812
12	1044	53	7092	94	13866
13	1194	54	7110	95	14148
14	1212	55	7428	96	14202
15	1362	56	7464	97	14484
16	1380	57	7764	98	14556
17	1530	58	7800	99	14820
18	1548	59	8100	100	14892
19	1698	60	8136	101	15156
20	1716	61	8436	102	15228
21	1866	62	8472	103	15492
22	1884	63	8772	104	15564
23	2034	64	8808	105	15828
24	2052	65	9108	106	15900
25	2370	66	9144	107	16164
26	2388	67	9444	108	16236
27	2706	68	9480	109	16500
28	2724	69	9780	110	16572
29	3042	70	9816	111	17172
30	3060	71	10116	112	17244
31	3378	72	10152	113	17844
32	3396	73	10452	114	17916
33	3732	74	10488	115	18516
34	3750	75	10788	116	18606
35	4068	76	10824	117	19188
36	4086	77	11124	118	19278
37	4404	78	11178	119	19860
38	4422	79	11460	120	19950
39	4740	80	11514		
40	4758	81	11796		

Annex BA (normative): E-DCH Transport Block Size Tables for 3.84 Mcps TDD

The mapping between the chosen E-TFC index and the corresponding E-DCH transport block size is given in the following tables:

BA.1 10ms TTI E-DCH Transport Block Size Table 0

N_{slots}	1	2	3	4	5	6	7	8	9	10	11	12
K_n	0	18	28	36	42	46	50	54	57	60	62	65
TBS index	/											
0	60	119	174	237	298	347	405	472	529	593	641	718
1	62	123	181	246	310	361	421	490	550	616	665	746
2	64	128	188	256	322	375	437	509	571	641	691	775
3	67	133	196	266	334	390	454	529	593	665	718	806
4	69	139	203	276	347	405	472	550	616	691	746	837
5	72	144	211	287	361	421	490	571	641	718	775	870
6	75	150	219	298	375	437	509	593	665	746	806	904
7	78	155	228	310	390	454	529	616	691	775	837	939
8	81	162	237	322	405	472	550	641	718	806	870	975
9	84	168	246	334	421	490	571	665	746	837	904	1013
10	87	174	256	347	437	509	593	691	775	870	939	1053
11	91	181	266	361	454	529	616	718	806	904	975	1094
12	94	188	276	375	472	550	641	746	837	939	1013	1136
13	98	196	287	390	490	571	665	775	870	975	1053	1181
14	102	203	298	405	509	593	691	806	904	1013	1094	1227
15	106	211	310	421	529	616	718	837	939	1053	1136	1275
16	110	219	322	437	550	641	746	870	975	1094	1181	1324
17	114	228	334	454	571	665	775	904	1013	1136	1227	1376
18	119	237	347	472	593	691	806	939	1053	1181	1275	1429
19	123	246	361	490	616	718	837	975	1094	1227	1324	1485
20	128	256	375	509	641	746	870	1013	1136	1275	1376	1543
21	133	266	390	529	665	775	904	1053	1181	1324	1429	1603
22	139	276	405	550	691	806	939	1094	1227	1376	1485	1665
23	144	287	421	571	718	837	975	1136	1275	1429	1543	1730
24	150	298	437	593	746	870	1013	1181	1324	1485	1603	1798
25	155	310	454	616	775	904	1053	1227	1376	1543	1665	1868
26	162	322	472	641	806	939	1094	1275	1429	1603	1730	1941
27	168	334	490	665	837	975	1136	1324	1485	1665	1798	2016
28	174	347	509	691	870	1013	1181	1376	1543	1730	1868	2095
29	181	361	529	718	904	1053	1227	1429	1603	1798	1941	2176
30	188	375	550	746	939	1094	1275	1485	1665	1868	2016	2261
31	196	390	571	775	975	1136	1324	1543	1730	1941	2095	2349
32	203	405	593	806	1013	1181	1376	1603	1798	2016	2176	2441
33	211	421	616	837	1053	1227	1429	1665	1868	2095	2261	2536
34	219	437	641	870	1094	1275	1485	1730	1941	2176	2349	2634
35	228	454	665	904	1136	1324	1543	1798	2016	2261	2441	2737
36	237	472	691	939	1181	1376	1603	1868	2095	2349	2536	2844
37	246	490	718	975	1227	1429	1665	1941	2176	2441	2634	2954
38	256	509	746	1013	1275	1485	1730	2016	2261	2536	2737	3070
39	266	529	775	1053	1324	1543	1798	2095	2349	2634	2844	3189

40	276	550	806	1094	1376	1603	1868	2176	2441	2737	2954	3313
41	287	571	837	1136	1429	1665	1941	2261	2536	2844	3070	3442
42	298	593	870	1181	1485	1730	2016	2349	2634	2954	3189	3576
43	310	616	904	1227	1543	1798	2095	2441	2737	3070	3313	3716
44	322	641	939	1275	1603	1868	2176	2536	2844	3189	3442	3861
45	334	665	975	1324	1665	1941	2261	2634	2954	3313	3576	4011
46	347	691	1013	1376	1730	2016	2349	2737	3070	3442	3716	4167
47	361	718	1053	1429	1798	2095	2441	2844	3189	3576	3861	4329
48	375	746	1094	1485	1868	2176	2536	2954	3313	3716	4011	4498
49	390	775	1136	1543	1941	2261	2634	3070	3442	3861	4167	4673
50	405	806	1181	1603	2016	2349	2737	3189	3576	4011	4329	4855
51	421	837	1227	1665	2095	2441	2844	3313	3716	4167	4498	5044
52	437	870	1275	1730	2176	2536	2954	3442	3861	4329	4673	5241
53	454	904	1324	1798	2261	2634	3070	3576	4011	4498	4855	5445
54	472	939	1376	1868	2349	2737	3189	3716	4167	4673	5044	5657
55	490	975	1429	1941	2441	2844	3313	3861	4329	4855	5241	5877
56	509	1013	1485	2016	2536	2954	3442	4011	4498	5044	5445	6106
57	529	1053	1543	2095	2634	3070	3576	4167	4673	5241	5657	6344
58	550	1094	1603	2176	2737	3189	3716	4329	4855	5445	5877	6591
59	571	1136	1665	2261	2844	3313	3861	4498	5044	5657	6106	6848
60	593	1181	1730	2349	2954	3442	4011	4673	5241	5877	6344	7115
61	616	1227	1798	2441	3070	3576	4167	4855	5445	6106	6591	7392
62	641	1275	1868	2536	3189	3716	4329	5044	5657	6344	6848	7680
63	665	1324	1941	2634	3313	3861	4498	5241	5877	6591	7115	7979
64	691	1376	2016	2737	3442	4011	4673	5445	6106	6848	7392	8289
65	718	1429	2095	2844	3576	4167	4855	5657	6344	7115	7680	8612
66	746	1485	2176	2954	3716	4329	5044	5877	6591	7392	7979	8948
67	775	1543	2261	3070	3861	4498	5241	6106	6848	7680	8289	9296
68	806	1603	2349	3189	4011	4673	5445	6344	7115	7979	8612	9658
69	837	1665	2441	3313	4167	4855	5657	6591	7392	8289	8948	10034
70	870	1730	2536	3442	4329	5044	5877	6848	7680	8612	9296	10425
71	904	1798	2634	3576	4498	5241	6106	7115	7979	8948	9658	10831
72	939	1868	2737	3716	4673	5445	6344	7392	8289	9296	10034	11253
73	975	1941	2844	3861	4855	5657	6591	7680	8612	9658	10425	11691
74	1013	2016	2954	4011	5044	5877	6848	7979	8948	10034	10831	12146
75	1053	2095	3070	4167	5241	6106	7115	8289	9296	10425	11253	12620
76	1094	2176	3189	4329	5445	6344	7392	8612	9658	10831	11691	13111
77	1136	2261	3313	4498	5657	6591	7680	8948	10034	11253	12146	13622
78	1181	2349	3442	4673	5877	6848	7979	9296	10425	11691	12620	14152
79	1227	2441	3576	4855	6106	7115	8289	9658	10831	12146	13111	14703
80	1275	2536	3716	5044	6344	7392	8612	10034	11253	12620	13622	15276
81	1324	2634	3861	5241	6591	7680	8948	10425	11691	13111	14152	15871
82	1376	2737	4011	5445	6848	7979	9296	10831	12146	13622	14703	16489
83	1429	2844	4167	5657	7115	8289	9658	11253	12620	14152	15276	17131
84	1485	2954	4329	5877	7392	8612	10034	11691	13111	14703	15871	17798
85	1543	3070	4498	6106	7680	8948	10425	12146	13622	15276	16489	18491
86	1603	3189	4673	6344	7979	9296	10831	12620	14152	15871	17131	19212
87	1665	3313	4855	6591	8289	9658	11253	13111	14703	16489	17798	19960
88	1730	3442	5044	6848	8612	10034	11691	13622	15276	17131	18491	20737
89	1798	3576	5241	7115	8948	10425	12146	14152	15871	17798	19212	21545
90	1868	3716	5445	7392	9296	10831	12620	14703	16489	18491	19960	22384
91	1941	3861	5657	7680	9658	11253	13111	15276	17131	19212	20737	23256
92	2016	4011	5877	7979	10034	11691	13622	15871	17798	19960	21545	24161

93	2095	4167	6106	8289	10425	12146	14152	16489	18491	20737	22384	25102
94	2176	4329	6344	8612	10831	12620	14703	17131	19212	21545	23256	26080
95	2261	4498	6591	8948	11253	13111	15276	17798	19960	22384	24161	27095
96	2349	4673	6848	9296	11691	13622	15871	18491	20737	23256	25102	28151
97	2441	4855	7115	9658	12146	14152	16489	19212	21545	24161	26080	29247
98	2536	5044	7392	10034	12620	14703	17131	19960	22384	25102	27095	30386
99	2634	5241	7680	10425	13111	15276	17798	20737	23256	26080	28151	31569
100	2737	5445	7979	10831	13622	15871	18491	21545	24161	27095	29247	32799
101	2844	5657	8289	11253	14152	16489	19212	22384	25102	28151	30386	34076
102	2954	5877	8612	11691	14703	17131	19960	23256	26080	29247	31569	35403
103	3070	6106	8948	12146	15276	17798	20737	24161	27095	30386	32799	36782
104	3189	6344	9296	12620	15871	18491	21545	25102	28151	31569	34076	38214
105	3313	6591	9658	13111	16489	19212	22384	26080	29247	32799	35403	39703
106	3442	6848	10034	13622	17131	19960	23256	27095	30386	34076	36782	41249
107	3576	7115	10425	14152	17798	20737	24161	28151	31569	35403	38214	42855
108	3716	7392	10831	14703	18491	21545	25102	29247	32799	36782	39703	44524
109	3861	7680	11253	15276	19212	22384	26080	30386	34076	38214	41249	46258
110	4011	7979	11691	15871	19960	23256	27095	31569	35403	39703	42855	48060
111	4167	8289	12146	16489	20737	24161	28151	32799	36782	41249	44524	49932
112	4329	8612	12620	17131	21545	25102	29247	34076	38214	42855	46258	51876
113	4498	8948	13111	17798	22384	26080	30386	35403	39703	44524	48060	53896
114	4673	9296	13622	18491	23256	27095	31569	36782	41249	46258	49932	55995
115	4855	9658	14152	19212	24161	28151	32799	38214	42855	48060	51876	58176
116	5044	10034	14703	19960	25102	29247	34076	39703	44524	49932	53896	60442
117	5241	10425	15276	20737	26080	30386	35403	41249	46258	51876	55995	62796
118	5445	10831	15871	21545	27095	31569	36782	42855	48060	53896	58176	65241
119	5657	11253	16489	22384	28151	32799	38214	44524	49932	55995	60442	67782
120	5877	11691	17131	23256	29247	34076	39703	46258	51876	58176	62796	70422
121	6106	12146	17798	24161	30386	35403	41249	48060	53896	60442	65241	73164
122	6344	12620	18491	25102	31569	36782	42855	49932	55995	62796	67782	76013
123	6591	13111	19212	26080	32799	38214	44524	51876	58176	65241	70422	78974
124	6848	13622	19960	27095	34076	39703	46258	53896	60442	67782	73164	82049
125	7115	14152	20737	28151	35403	41249	48060	55995	62796	70422	76013	85245
126	7392	14703	21545	29247	36782	42855	49932	58176	65241	73164	78974	88565
127	7680	15276	22384	30386	38214	44524	51876	60442	67782	76013	82049	92014

Annex BB (normative): E-DCH Transport Block Size Tables for 7.68 Mcps TDD

The mapping between the chosen E-TFC index and the corresponding E-DCH transport block size is given in the following tables:

BB.1 10ms TTI E-DCH Transport Block Size Table 0

Nslots	1	2	3	4	5	6	7	8	9	10	11	12
kn	0	15	25	31	36	41	44	47	50	52	54	56
TBS index												
0	60	115	178	232	288	359	409	467	532	581	634	691
1	62	120	186	242	301	375	428	487	556	606	662	722
2	65	126	195	253	315	392	447	509	581	634	691	755
3	68	131	203	264	329	409	467	532	606	662	722	788
4	71	137	212	276	344	428	487	556	634	691	755	823
5	74	143	222	288	359	447	509	581	662	722	788	860
6	77	150	232	301	375	467	532	606	691	755	823	899
7	81	156	242	315	392	487	556	634	722	788	860	939
8	85	163	253	329	409	509	581	662	755	823	899	981
9	88	171	264	344	428	532	606	691	788	860	939	1024
10	92	178	276	359	447	556	634	722	823	899	981	1070
11	96	186	288	375	467	581	662	755	860	939	1024	1118
12	101	195	301	392	487	606	691	788	899	981	1070	1168
13	105	203	315	409	509	634	722	823	939	1024	1118	1220
14	110	212	329	428	532	662	755	860	981	1070	1168	1275
15	115	222	344	447	556	691	788	899	1024	1118	1220	1331
16	120	232	359	467	581	722	823	939	1070	1168	1275	1391
17	126	242	375	487	606	755	860	981	1118	1220	1331	1453
18	131	253	392	509	634	788	899	1024	1168	1275	1391	1518
19	137	264	409	532	662	823	939	1070	1220	1331	1453	1586
20	143	276	428	556	691	860	981	1118	1275	1391	1518	1656
21	150	288	447	581	722	899	1024	1168	1331	1453	1586	1730
22	156	301	467	606	755	939	1070	1220	1391	1518	1656	1808
23	163	315	487	634	788	981	1118	1275	1453	1586	1730	1888
24	171	329	509	662	823	1024	1168	1331	1518	1656	1808	1973
25	178	344	532	691	860	1070	1220	1391	1586	1730	1888	2061
26	186	359	556	722	899	1118	1275	1453	1656	1808	1973	2153
27	195	375	581	755	939	1168	1331	1518	1730	1888	2061	2249
28	203	392	606	788	981	1220	1391	1586	1808	1973	2153	2349
29	212	409	634	823	1024	1275	1453	1656	1888	2061	2249	2454
30	222	428	662	860	1070	1331	1518	1730	1973	2153	2349	2564
31	232	447	691	899	1118	1391	1586	1808	2061	2249	2454	2678
32	242	467	722	939	1168	1453	1656	1888	2153	2349	2564	2798
33	253	487	755	981	1220	1518	1730	1973	2249	2454	2678	2922
34	264	509	788	1024	1275	1586	1808	2061	2349	2564	2798	3053
35	276	532	823	1070	1331	1656	1888	2153	2454	2678	2922	3189
36	288	556	860	1118	1391	1730	1973	2249	2564	2798	3053	3331
37	301	581	899	1168	1453	1808	2061	2349	2678	2922	3189	3480
38	315	606	939	1220	1518	1888	2153	2454	2798	3053	3331	3636

39	329	634	981	1275	1586	1973	2249	2564	2922	3189	3480	3798
40	344	662	1024	1331	1656	2061	2349	2678	3053	3331	3636	3967
41	359	691	1070	1391	1730	2153	2454	2798	3189	3480	3798	4144
42	375	722	1118	1453	1808	2249	2564	2922	3331	3636	3967	4329
43	392	755	1168	1518	1888	2349	2678	3053	3480	3798	4144	4523
44	409	788	1220	1586	1973	2454	2798	3189	3636	3967	4329	4725
45	428	823	1275	1656	2061	2564	2922	3331	3798	4144	4523	4935
46	447	860	1331	1730	2153	2678	3053	3480	3967	4329	4725	5156
47	467	899	1391	1808	2249	2798	3189	3636	4144	4523	4935	5386
48	487	939	1453	1888	2349	2922	3331	3798	4329	4725	5156	5626
49	509	981	1518	1973	2454	3053	3480	3967	4523	4935	5386	5877
50	532	1024	1586	2061	2564	3189	3636	4144	4725	5156	5626	6140
51	556	1070	1656	2153	2678	3331	3798	4329	4935	5386	5877	6414
52	581	1118	1730	2249	2798	3480	3967	4523	5156	5626	6140	6700
53	606	1168	1808	2349	2922	3636	4144	4725	5386	5877	6414	6999
54	634	1220	1888	2454	3053	3798	4329	4935	5626	6140	6700	7311
55	662	1275	1973	2564	3189	3967	4523	5156	5877	6414	6999	7638
56	691	1331	2061	2678	3331	4144	4725	5386	6140	6700	7311	7979
57	722	1391	2153	2798	3480	4329	4935	5626	6414	6999	7638	8335
58	755	1453	2249	2922	3636	4523	5156	5877	6700	7311	7979	8707
59	788	1518	2349	3053	3798	4725	5386	6140	6999	7638	8335	9095
60	823	1586	2454	3189	3967	4935	5626	6414	7311	7979	8707	9501
61	860	1656	2564	3331	4144	5156	5877	6700	7638	8335	9095	9925
62	899	1730	2678	3480	4329	5386	6140	6999	7979	8707	9501	10368
63	939	1808	2798	3636	4523	5626	6414	7311	8335	9095	9925	10831
64	981	1888	2922	3798	4725	5877	6700	7638	8707	9501	10368	11314
65	1024	1973	3053	3967	4935	6140	6999	7979	9095	9925	10831	11819
66	1070	2061	3189	4144	5156	6414	7311	8335	9501	10368	11314	12347
67	1118	2153	3331	4329	5386	6700	7638	8707	9925	10831	11819	12898
68	1168	2249	3480	4523	5626	6999	7979	9095	10368	11314	12347	13474
69	1220	2349	3636	4725	5877	7311	8335	9501	10831	11819	12898	14075
70	1275	2454	3798	4935	6140	7638	8707	9925	11314	12347	13474	14703
71	1331	2564	3967	5156	6414	7979	9095	10368	11819	12898	14075	15360
72	1391	2678	4144	5386	6700	8335	9501	10831	12347	13474	14703	16045
73	1453	2798	4329	5626	6999	8707	9925	11314	12898	14075	15360	16761
74	1518	2922	4523	5877	7311	9095	10368	11819	13474	14703	16045	17509
75	1586	3053	4725	6140	7638	9501	10831	12347	14075	15360	16761	18291
76	1656	3189	4935	6414	7979	9925	11314	12898	14703	16045	17509	19107
77	1730	3331	5156	6700	8335	10368	11819	13474	15360	16761	18291	19960
78	1808	3480	5386	6999	8707	10831	12347	14075	16045	17509	19107	20851
79	1888	3636	5626	7311	9095	11314	12898	14703	16761	18291	19960	21781
80	1973	3798	5877	7638	9501	11819	13474	15360	17509	19107	20851	22753
81	2061	3967	6140	7979	9925	12347	14075	16045	18291	19960	21781	23769
82	2153	4144	6414	8335	10368	12898	14703	16761	19107	20851	22753	24830
83	2249	4329	6700	8707	10831	13474	15360	17509	19960	21781	23769	25938
84	2349	4523	6999	9095	11314	14075	16045	18291	20851	22753	24830	27095
85	2454	4725	7311	9501	11819	14703	16761	19107	21781	23769	25938	28305
86	2564	4935	7638	9925	12347	15360	17509	19960	22753	24830	27095	29568
87	2678	5156	7979	10368	12898	16045	18291	20851	23769	25938	28305	30888
88	2798	5386	8335	10831	13474	16761	19107	21781	24830	27095	29568	32266
89	2922	5626	8707	11314	14075	17509	19960	22753	25938	28305	30888	33706
90	3053	5877	9095	11819	14703	18291	20851	23769	27095	29568	32266	35211
91	3189	6140	9501	12347	15360	19107	21781	24830	28305	30888	33706	36782
92	3331	6414	9925	12898	16045	19960	22753	25938	29568	32266	35211	38424
93	3480	6700	10368	13474	16761	20851	23769	27095	30888	33706	36782	40139
94	3636	6999	10831	14075	17509	21781	24830	28305	32266	35211	38424	41930

95	3798	7311	11314	14703	18291	22753	25938	29568	33706	36782	40139	43801
96	3967	7638	11819	15360	19107	23769	27095	30888	35211	38424	41930	45756
97	4144	7979	12347	16045	19960	24830	28305	32266	36782	40139	43801	47798
98	4329	8335	12898	16761	20851	25938	29568	33706	38424	41930	45756	49932
99	4523	8707	13474	17509	21781	27095	30888	35211	40139	43801	47798	52160
100	4725	9095	14075	18291	22753	28305	32266	36782	41930	45756	49932	54488
101	4935	9501	14703	19107	23769	29568	33706	38424	43801	47798	52160	56920
102	5156	9925	15360	19960	24830	30888	35211	40139	45756	49932	54488	59460
103	5386	10368	16045	20851	25938	32266	36782	41930	47798	52160	56920	62114
104	5626	10831	16761	21781	27095	33706	38424	43801	49932	54488	59460	64886
105	5877	11314	17509	22753	28305	35211	40139	45756	52160	56920	62114	67782
106	6140	11819	18291	23769	29568	36782	41930	47798	54488	59460	64886	70807
107	6414	12347	19107	24830	30888	38424	43801	49932	56920	62114	67782	73967
108	6700	12898	19960	25938	32266	40139	45756	52160	59460	64886	70807	77268
109	6999	13474	20851	27095	33706	41930	47798	54488	62114	67782	73967	80717
110	7311	14075	21781	28305	35211	43801	49932	56920	64886	70807	77268	84319
111	7638	14703	22753	29568	36782	45756	52160	59460	67782	73967	80717	88082
112	7979	15360	23769	30888	38424	47798	54488	62114	70807	77268	84319	92014
113	8335	16045	24830	32266	40139	49932	56920	64886	73967	80717	88082	96120
114	8707	16761	25938	33706	41930	52160	59460	67782	77268	84319	92014	100410
115	9095	17509	27095	35211	43801	54488	62114	70807	80717	88082	96120	104891
116	9501	18291	28305	36782	45756	56920	64886	73967	84319	92014	100410	109573
117	9925	19107	29568	38424	47798	59460	67782	77268	88082	96120	104891	114463
118	10368	19960	30888	40139	49932	62114	70807	80717	92014	100410	109573	119572
119	10831	20851	32266	41930	52160	64886	73967	84319	96120	104891	114463	124908
120	11314	21781	33706	43801	54488	67782	77268	88082	100410	109573	119572	130483
121	11819	22753	35211	45756	56920	70807	80717	92014	104891	114463	124908	136306
122	12347	23769	36782	47798	59460	73967	84319	96120	109573	119572	130483	142390
123	12898	24830	38424	49932	62114	77268	88082	100410	114463	124908	136306	148744
124	13474	25938	40139	52160	64886	80717	92014	104891	119572	130483	142390	155383
125	14075	27095	41930	54488	67782	84319	96120	109573	124908	136306	148744	162318
126	14703	28305	43801	56920	70807	88082	100410	114463	130483	142390	155383	169562
127	15360	29568	45756	59460	73967	92014	104891	119572	136306	148744	162318	177130

Annex BC (normative): E-DCH Transport Block Size Tables for 1.28 Mcps TDD

The mapping between the TB index k ($k = \{0,1,\dots,63\}$) and the corresponding E-DCH transport block size is given in the following tables.

BC.1 5ms TTI E-DCH Transport Block Size Table 0

TB index	Category 1-2			Category 3-6				
	1 Timeslot TBS	2 Timeslots TBS	3 Timeslots TBS	1 Timeslot TBS	2 Timeslots TBS	3 Timeslots TBS	4 Timeslots TBS	5 Timeslots TBS
0	23	23	23	23	23	23	23	23
1	116	116	116	116	116	116	116	116
2	162	162	162	162	162	162	162	162
3	167	169	170	169	171	172	173	173
4	173	177	180	177	181	184	186	186
5	179	186	190	186	192	196	199	199
6	186	195	200	194	204	209	213	213
7	192	204	211	204	216	223	229	229
8	199	214	222	213	229	238	245	245
9	206	224	235	223	242	254	263	263
10	213	234	247	234	257	271	282	282
11	221	246	261	245	272	289	302	302
12	229	257	275	257	288	309	324	324
13	237	270	290	269	306	329	347	347
14	245	282	306	282	324	351	372	372
15	254	296	323	295	343	375	399	399
16	263	310	341	309	364	400	427	427
17	272	325	359	324	385	427	458	458
18	282	340	379	339	408	455	491	491
19	292	356	400	355	433	486	526	526
20	302	373	422	372	459	518	564	564
21	313	391	445	390	486	553	605	605
22	324	410	469	408	515	589	648	648
23	335	429	495	427	546	629	695	695
24	347	450	522	448	578	671	745	745
25	359	471	550	469	613	716	799	799
26	372	493	581	491	649	764	856	856
27	385	517	612	514	688	815	918	918
28	399	541	646	539	729	869	983	983
29	413	567	681	564	773	927	1054	1054
30	428	594	718	591	819	989	1130	1130
31	443	622	758	619	867	1055	1211	1211

32	458	652	799	648	919	1125	1298	1298
33	475	683	843	679	974	1201	1392	1392
34	491	716	889	711	1032	1281	1492	1492
35	509	750	937	745	1094	1366	1599	1599
36	527	785	989	780	1159	1458	1714	1714
37	545	823	1043	817	1228	1555	1837	1837
38	565	862	1100	856	1301	1659	1969	1969
39	585	903	1160	896	1379	1770	2110	2110
40	605	946	1223	938	1461	1888	2262	2262
41	627	991	1290	983	1548	2014	2425	2425
42	649	1038	1361	1029	1640	2148	2599	2599
43	672	1087	1435	1078	1738	2292	2786	2786
44	696	1139	1514	1129	1841	2445	2986	2986
45	720	1193	1596	1183	1951	2608	3200	3200
46	746	1250	1684	1239	2067	2782	3430	3430
47	772	1309	1776	1297	2191	2968	3677	3677
48	799	1372	1873	1359	2321	3166	3941	3941
49	827	1437	1975	1423	2460	3377	4224	4224
50	857	1505	2083	1491	2606	3603	4528	4528
51	887	1577	2197	1561	2762	3843	4853	4853
52	918	1652	2317	1635	2926	4100	5202	5202
53	951	1730	2444	1712	3101	4374	5576	5576
54	984	1813	2578	1794	3285	4666	5976	5976
55	1019	1899	2719	1878	3481	4977	6406	6406
56	1055	1989	2867	1967	3689	5310	6866	6866
57	1092	2084	3024	2060	3908	5664	7359	7359
58	1131	2183	3189	2158	4141	6042	7888	7888
59	1171	2287	3364	2260	4388	6446	8455	8455
60	1212	2395	3547	2367	4650	6876	9062	9062
61	1255	2509	3741	2479	4927	7335	9713	9713
62	1300	2629	3946	2597	5220	7825	10411	10411
63	1346	2754	4162	2720	5532	8348	11160	11160

Annex C (informative): Pseudo-Code for E-TFC Selection (FDD)

The pseudo-code below describes one possible implementation of the E-TFC Selection as described in subclause 11.8.1.4:

- 1> determine whether to take the scheduled and non-scheduled grants into account in the upcoming transmission.
- 1> if scheduled and/or non-scheduled data can be transmitted:
 - 2> select a MAC-d flow that allows highest-priority data to be transmitted (when more than one MAC-d flow allows data of the same highest priority to be transmitted, it is left to implementation to select which MAC-d flow to prefer);
 - 2> identify the MAC-d flow(s) whose multiplexing lists allow them to be transmitted in the same TTI as this MAC-d flow, and whose grants allow them to transmit in this TTI and ignore the one(s) that cannot.
 - 2> based on the HARQ profile of this MAC-d flow, identify the power offset to use;
 - 2> based on this power offset and the E-TFC restriction procedure, determine the "Maximum Supported Payload" (i.e. maximum MAC-e PDU size or E-TFC that can be sent by the UE during the upcoming transmission);
 - 2> if the upcoming transmission overlaps with a compressed mode gap on 10ms TTI, scale down the current serving grant (SG);
 - 2> set "Remaining Scheduled Grant Payload" to the highest payload that could be transmitted according to SG and selected power offset;
 - 2> for each MAC-d flow with a non-scheduled grant, set the "Remaining Non-scheduled Payload" to the value of the grant;
 - 2> if Scheduling Information needs to be transmitted:
 - 3> set "Total Granted Payload" to the sum of "Remaining Non Scheduled Payload" for all non-scheduled MAC-d flows + "Remaining Scheduled Grant Payload" + size of the scheduling information.
 - 2> else:
 - 3> set "Total Granted Payload" to the sum of "Remaining Non Scheduled Payload" for all non-scheduled MAC-d flows + "Remaining Scheduled Grant Payload".
 - 2> set "Remaining Available Payload" to MIN ("Max Supported Payload", "Total Granted Payload");
 - 2> if "Remaining Available Payload" = an ETFC size:
 - 3> set "Quantisation Loss" to zero.
 - 2> else:
 - 3> set "Quantization Loss" to the value of "Remaining Available Payload" – ("Remaining Available Payload" rounded down to the next smaller E-TFC).
 - 2> if scheduling information needs to be transmitted:
 - 3> subtract the size of scheduling information from "Remaining Available Payload".
 - 2> set "Quantisation Applied" to FALSE;
 - 2> perform the following loop for each logical channel, in the order of their priorities:
 - 3> if this logical channel belongs to a MAC-d flow with a non-scheduled grant, then:

- 4> consider the "Remaining Non-scheduled Payload" corresponding to the MAC-d flow on which this logical channel is mapped;
 - 4> fill the MAC-e PDU with SDU(s) from this logical channel up to MIN ("Remaining Non-scheduled Payload" taking into account the MAC-e/es headers, Available Data for this logical channel, "Remaining Available Payload" taking into account the MAC-e/es headers);
 - 4> subtract the corresponding bits if any from "Remaining Available Payload" and "Remaining Non-scheduled Payload" taking into account the MAC-e/es headers.
- 3> else:
- 4> If "Quantisation Applied" is TRUE:
 - 5> fill the MACe PDU with SDU(s) from this logical channel up to MIN ("Remaining Scheduled Grant Payload" taking into account the MAC-e/es headers, Available Data for this logical channel, "Remaining Available Payload" taking into account the MAC-e/es headers);
 - 5> subtract the corresponding bits if any from "Remaining Available Payload" and "Remaining Scheduled Grant Payload" taking into account the MAC-e/es headers.
 - 4> else:
 - 5> fill the MAC-e PDU with SDU(s) from this logical channel up to MIN ("Remaining Scheduled Grant Payload" taking into account the MAC-e/es headers, Available Data for this logical channel, "Remaining Available Payload" – "Quantisation Loss" taking into account the MAC-e/es headers);
 - 5> if bits can be transmitted on this logical channel:
 - 6> set "Remaining Available Payload" to ("Remaining Available Payload" – "Quantisation Loss");
 - 6> subtract the corresponding bits from "Remaining Available Payload" and "Remaining Scheduled Grant Payload" taking into account the MAC-e/es headers;
 - 6> set "Quantisation Applied" to TRUE.
- 2> if Scheduling Information needs to be transmitted:
- 3> add Scheduling Information to the MAC-e PDU;
 - 3> determine the smallest E-TFC that can carry the resulting MAC-e PDU;
 - 3> if the padding allows a DDI_0 to be sent, add it to the end of the MAC-e header.
- 2> else:
- 3> determine the smallest E-TFC that can carry the resulting MAC-e PDU;
 - 3> if the padding allows a Scheduling Information to be sent, add it to the MAC-e PDU;
 - 3> if a Scheduling Information was added to the PDU and if the padding allows a DDI_0 to be sent, add it to the end of the MAC-e header.
- 2> set the maximum number of HARQ transmissions to the maximum among the maximum number of HARQ transmissions of the HARQ profiles of the MAC-d flows selected for transmissions.
- 1> else if Scheduling Information needs to be transmitted:
- 2> select the "control-only" HARQ profile;
 - 2> fill the MAC-e PDU with the scheduling information;
 - 2> select the smallest E-TFC.

Annex CA (informative): Pseudo-Code for E-TFC Selection (TDD)

The pseudo-code below describes one possible implementation of UE E-TFC Selection as described in subclause 11.9.1.4. It consists of three separate procedures which are normally executed Procedure 1, 2 and then 3:

Procedure 1:

- 1> Determine set B, the set of logical channels which consist of a) the highest priority logical channel which has data buffered for transmission b) the set of logical channels which have data buffered for transmission and which may be multiplexed with the highest priority channel. The detailed steps involved are as follows:
 - 2> Determine whether or not a TTI is designated for scheduled or non scheduled transmission.
 - 2> Determine the set A of logical channels which have data buffered for transmission and which are consistent with the TTI designation (scheduled or non-scheduled).
 - 2> Determine X, the highest priority logical channel in set A.
 - 2> For 3.84 and 7.68Mcps TDD, select the HARQ profile of the MAC-d flow, flow Y, to which logical channel X belongs. (*Note: A logical channel can only belong to one MAC-d flow and can therefore only have one HARQ profile*). For 1.28Mcps TDD, the HARQ power offset shall be set to the maximum of HARQ power offset of all the MAC-d flows mapped to the same type of resource (scheduled or non-scheduled resource).
 - 2> Determine set B, the set of logical channels which are in set A and which belong to flow Y or to a flow which may be multiplexed with flow Y

Procedure 2:

- 1> Generate the largest block size that can be supported by the resources granted. The detailed steps involved are as follows:
 - 2> Determine the sets of TFCs C_1 (QPSK) and C_2 (16-QAM) whose code rates fall within the allowed maximum and minimum (inclusive) coderates specified by RRC for the assigned number of time slots and the assigned channelisation code (the UE is not allowed to use more or less slots than are assigned nor to use a code associated with a lower spreading factor). For 1.28 Mcps TDD, the spreading factor can not be changed by the UE and the current value of ENI should be considered when choosing the allowed maximum and minimum code rates if a scheduled transmission is designated.
 - 2> Determine the subsets D_1 and D_2 of C_1 and C_2 respectively which require transmit power that is less than or equal to the power available taking into account of the power offset of the HARQ profile (the power offset is determined in procedure 1), P_{e-base} , Pathloss and beta values (see [18]) associated with TFCs for QPSK and 16QAM.
 - 2> For 1.28Mcps TDD,
 - If the data of other type physical channel within the E-PUCH timeslots in the TTI shall be transmitted, the UE selects QPSK modulation. Determine k, the largest MAC-e PDU block size that can be supported from the set D_1 , which require transmit power that is less than or equal to the power that consider other type physical channel transmit power.
 - Otherwise determine K, the largest MAC-e PDU block size that can be supported, from the sets D_1 and D_2 .
 - 2> For 3.84Mcps and 7.68Mcps TDD, determine k, the largest MAC-e PDU block size that can be supported, from the sets D_1 and D_2
 - 2> If k belongs exclusively to set D_1 , select QPSK modulation. If k belongs exclusively to set D_2 , select 16-QAM modulation. If k appears in both sets D_1 and D_2 , select 16-QAM modulation only if it offers a lower power requirement than QPSK, otherwise select QPSK modulation.

Procedure 3:

- 1> Generate the largest MAC-e PDU, having a size $\leq k$, by taking MAC-d PDUs from logical channels in set B (in order of priority) and select SF (for 1.28 Mcps TDD, the SF can not be changed) and modulation so as to minimise the power used . The detailed steps are as follows:
 - 2> For 3.84Mcps and 7.68Mcps TDD, generate the largest MAC-e PDU $\leq k$, taking MAC-d PDUs from logical channels belonging to set B (in priority order);
For 1.28Mcps TDD, generate the largest MAC-e PDU $=k$, taking MAC-d PDUs from logical channels belonging to set B(in priority order), Padding is included in the end of the MAC-e PDU if the total size of the MAC-e payload plus the MAC-e header is smaller than k;
 - 2> If this is successful (i.e. sufficient resources granted):
 - 3> select the SF (for 1.28 Mcps TDD, the SF cannot be changed) and modulation according to the result of Procedure 2 to use.
 - 2> If this is not successful (i.e. the MAC-e PDU is empty due to insufficient resources granted):
 - 3> $A := A - B$;
 - 3> if A is not empty (i.e. other logical channels have data buffered for transmission):
 - 4> determine a new set B (repeat Procedure 1 and then Procudure 3).
 - 3> if A is empty (i.e. no other logical channels have data buffered for transmission):
 - 4> transmit scheduling information only in the MAC-e PDU. For 1.28Mcps TDD, select the QPSK modulation and the transmit power uses the lower power of the granted power and the available maximum E-PUCH power.

Annex D (informative): Change history

Change history								
Date	TSG #	TSG Doc.	CR	Rev	Subject/Comment	Old	New	
06/1999	RP-04	RP-99312	-		Approved at TSG-RAN #4 and placed under Change Control	-	3.0.0	
10/1999	RP-05	RP-99463	001	1	Modified MAC handling of PCH and FACH	3.0.0	3.1.0	
	RP-05	RP-99463	002		Modifications of MAC primitives	3.0.0	3.1.0	
	RP-05	RP-99463	003	2	RACH/FACH MAC header – Channel type identification	3.0.0	3.1.0	
	RP-05	RP-99463	004		Support for USCH/DSCH signalling in TDD	3.0.0	3.1.0	
	RP-05	RP-99463	006		Clarification on RACH partitioning and prioritization via access service class (ASC) and relation to back-off algorithm	3.0.0	3.1.0	
	RP-05	RP-99463	010	1	Modifications on UE-Id formats	3.0.0	3.1.0	
	RP-05	RP-99463	011		CPCH primitives	3.0.0	3.1.0	
	RP-05	RP-99463	012		Timing advance for TDD	3.0.0	3.1.0	
	RP-05	RP-99463	013	1	Traffic volume measurement report procedure	3.0.0	3.1.0	
	RP-05	RP-99463	014		Mapping of BCCH logical channel onto FACH transport channel	3.0.0	3.1.0	
	RP-05	RP-99463	015	1	MAC PDU formats for DCCH/DTCH on DSCH and for PCCH	3.0.0	3.1.0	
	RP-05	RP-99463	016	1	Informative parts that shall not specify or constrain implementations	3.0.0	3.1.0	
	RP-05	RP-99463	017	1	Modification of RACH transmission control procedure	3.0.0	3.1.0	
	RP-05	RP-99463	018		Removal of MAC function for system information and paging scheduling	3.0.0	3.1.0	
	RP-05	RP-99463	019	1	RACH transmission control procedure on MAC for TDD mod	3.0.0	3.1.0	
	RP-05	RP-99463	021	1	Removal of Annex A and B of TS 25.321	3.0.0	3.1.0	
	12/1999	RP-06	RP-99638	022	3	Modified MAC header field sizes	3.1.0	3.2.0
		RP-06	RP-99638	023		MAC: Multiple shared channels (DSCH/USCH)	3.1.0	3.2.0
RP-06		RP-99638	024		Parameters for Status Primitive	3.1.0	3.2.0	
RP-06		RP-99638	025	1	Support of shared channel operation in TDD	3.1.0	3.2.0	
RP-06		RP-99638	028		Modification of Cell Broadcast Service (CBS)	3.1.0	3.2.0	
RP-06		RP-99637	030	1	Editorial changes	3.1.0	3.2.0	
RP-06	RP-99638	031	1	Simultaneous mapping of logical channels on	3.1.0	3.2.0		
03/2000	RP-07	RP-000039	032		Bit Aligned TDD MAC Headers	3.2.0	3.3.0	
	RP-07	RP-000039	035	2	CPCH including Channel Assignment	3.2.0	3.3.0	
	RP-07	RP-000039	036		UE-ID type indication	3.2.0	3.3.0	
	RP-07	RP-000039	037	1	RACH transmission control procedure	3.2.0	3.3.0	
	RP-07	RP-000039	039		CPCH start of message indication	3.2.0	3.3.0	
	RP-07	RP-000039	040		Removal of SCH and SCCH	3.2.0	3.3.0	
	RP-07	RP-000039	041	1	Clarification of bit order	3.2.0	3.3.0	
06/2000	RP-08	RP-000219	042		CPCH correction	3.3.0	3.4.0	
	RP-08	RP-000219	043	1	End of CPCH transmission	3.3.0	3.4.0	
	RP-08	RP-000219	044	2	Clarification of prioritisation of logical channels in UE	3.3.0	3.4.0	
	RP-08	RP-000219	045	1	CPCH MAC procedures	3.3.0	3.4.0	
	RP-08	RP-000219	046		Traffic Volume Measurement for dynamic radio bearer control	3.3.0	3.4.0	
09/2000	RP-09	RP-000357	047		Movement of primitives text to the correct section	3.4.0	3.5.0	
	RP-09	RP-000357	048		Corrections to RACH procedure	3.4.0	3.5.0	
	RP-09	RP-000357	049		Clarification on the parameters of the MAC-RLC primitives	3.4.0	3.5.0	
	RP-09	RP-000357	051	1	Editorial Cleanup	3.4.0	3.5.0	
12/2000	RP-10	RP-000567	053	2	Corrections to logical channel priorities in MAC Protocol	3.5.0	3.6.0	
	RP-10	RP-000567	055	1	Removal of FAUSCH	3.5.0	3.6.0	
	RP-10	RP-000567	056	2	General MAC clarification	3.5.0	3.6.0	
	RP-10	RP-000567	057	1	Error Handling in MAC	3.5.0	3.6.0	
	RP-10	RP-000567	058	1	Error handling for MAC RACH and CPCH transmission control procedure	3.5.0	3.6.0	
	RP-10	RP-000567	059		Inclusion of stage 3 for ciphering	3.5.0	3.6.0	
03/2001	RP-11	RP-010025	061		Removal of FAUSCH	3.6.0	3.7.0	
	RP-11	RP-010025	066	3	TFC selection algorithm correction	3.6.0	3.7.0	
	RP-11	RP-010025	067	3	Miscellaneous corrections	3.6.0	3.7.0	
	RP-11	RP-010025	068	2	Clarification on Traffic Volume Measurement Procedure	3.6.0	3.7.0	
	RP-11	RP-010025	070	1	Clarification on parameters of the primitives	3.6.0	3.7.0	
	RP-11	RP-010037	064		1.28Mcps TDD	3.7.0	4.0.0	
06/2001	RP-12	RP-010308	074		RLC Tr Discard	4.0.0	4.1.0	
	RP-12	RP-010308	076		Clarification on compressed mode	4.0.0	4.1.0	
	RP-12	RP-010308	078		Correction of relation between MAC functions and transport channels	4.0.0	4.1.0	
	RP-12	RP-010308	080		Rate adaptation	4.0.0	4.1.0	
	RP-12	RP-010308	082		Cleanup of MAC services and functions	4.0.0	4.1.0	
	RP-12	RP-010322	083		Correction to control of RACH Transmissions for 1.28Mcps TDD	4.0.0	4.1.0	

Change history							
Date	TSG #	TSG Doc.	CR	Rev	Subject/Comment	Old	New
09/2001	RP-13	RP-010541	085		Setting of UE Id in MAC	4.1.0	4.2.0
	RP-13	RP-010541	087		MAC ASC selection operation when access class is used to determine ASC	4.1.0	4.2.0
	RP-13	RP-010541	089		Addition of neighbour cell BCH to MAC-b model for the UE	4.1.0	4.2.0
	RP-13	RP-010541	093	1	Clarification on TFC selection	4.1.0	4.2.0
12/2001	RP-14	RP-010760	091	1	Cautionary Note for Interfrequency Measurements in Cell-FACH	4.2.0	4.3.0
	RP-14	RP-010760	095		Correction on Control of RACH Transmissions	4.2.0	4.3.0
	RP-14	RP-010760	097		Correction on Traffic Volume Control	4.2.0	4.3.0
	RP-14	RP-010760	099		General correction on Access Service Class selection	4.2.0	4.3.0
	RP-14	RP-010760	101		TFC selection in compressed mode	4.2.0	4.3.0
03/2002	RP-15	RP-020067	103		Clarification on ciphering	4.3.0	4.4.0
	RP-15	RP-020067	106		TDD MAC Layer Subchannel Assignment	4.3.0	4.4.0
	RP-15	RP-020067	110		Missing DTCH channel type in UE-ID Type Indicator	4.3.0	4.4.0
	RP-15	RP-020067	112		Correction on UE Id for DSCH	4.3.0	4.4.0
	RP-15	RP-020067	114		UE undefined behaviour when padding is required	4.3.0	4.4.0
	RP-15	RP-020094	104	2	Introduction of HSDPA	4.4.0	5.0.0
06/2002	RP-16	RP-020326	117		Update References to include 25.123 (TDD)	5.0.0	5.1.0
	RP-16	RP-020326	120		TFCS selection guideline correction	5.0.0	5.1.0
	RP-16	RP-020341	121		HSDPA related MAC corrections	5.0.0	5.1.0
	RP-16	RP-020341	122		Description for MAC-hs reset	5.0.0	5.1.0
09/2002	RP-17	RP-020538	130		MAC TVM Corrections	5.1.0	5.2.0
	RP-17	RP-020538	133		MAC header for DTCH and DCCH	5.1.0	5.2.0
	RP-17	RP-020556	123		Optional use of a maximum transmission delay for MAC-hs SDUs	5.1.0	5.2.0
	RP-17	RP-020556	124		MAC-hs: Scheduler and HARQ entity functions for TSN	5.1.0	5.2.0
	RP-17	RP-020556	125		Correction on C/T field definition for HS-DSCH	5.1.0	5.2.0
	RP-17	RP-020556	126		Corrections to re-ordering protocol description	5.1.0	5.2.0
	RP-17	RP-020556	127		Limiting of number of PDUs per TTI	5.1.0	5.2.0
	RP-17	RP-020556	134		Signaling of Transport Block Sizes for HS-DSCH	5.1.0	5.2.0
	RP-17	RP-020556	135		Transport block size signalling 3.84 Mcps TDD	5.1.0	5.2.0
	RP-17	RP-020556	136		Static HSDPA Transport Block Sizes for 1.28 Mcps TDD	5.1.0	5.2.0
12/2002	RP-18	RP-020718	142	1	TFC selection for RACH transmissions	5.2.0	5.3.0
	RP-18	RP-020718	145		RB id in ciphering	5.2.0	5.3.0
	RP-18	RP-020718	148		Correction to TFC selection for TDD	5.2.0	5.3.0
	RP-18	RP-020718	151		Unblockable TFCs in excess power state	5.2.0	5.3.0
	RP-18	RP-020735	137		Generation of RLC Status Reports to coordinate with MAC-hs reset	5.2.0	5.3.0
	RP-18	RP-020735	138		Re-ordering Mechanism	5.2.0	5.3.0
	RP-18	RP-020735	139		Transport Block Size Signalling for 1.28Mcps TDD	5.2.0	5.3.0
	RP-18	RP-020735	153		Limitation on number of PDUs per single TTI for 1.28 Mcps TDD	5.2.0	5.3.0
	RP-18	RP-020735	154		The Number of mac-d pdu's in a single mac-hs PDU for TDD	5.2.0	5.3.0
	RP-18	RP-020851	155		HSDPA Retransmission block Size	5.2.0	5.3.0
	RP-18	RP-020874	158		Ciphering of multiple PDUs per TTI	5.2.0	5.3.0
	RP-19	RP-030100	166		Setting of ciphering activation time for TM bearers	5.3.0	5.4.0
	RP-19	RP-030100	169	1	TFC Control Implementation	5.3.0	5.4.0
	RP-19	RP-030115	159		TDD HCSN determination in MAC-hs	5.3.0	5.4.0
	RP-19	RP-030115	160		Correction to the use of Transport Block Size index equal to 111111 for TDD	5.3.0	5.4.0
	RP-19	RP-030115	163		Editorial changes to MAC-hs	5.3.0	5.4.0
	RP-19	RP-030115	170		Re-ordering entity corrections	5.3.0	5.4.0
06/2003	RP-20	RP-030302	171		Text clean up of the description of the reordering entity	5.4.0	5.5.0
	RP-20	RP-030302	172		MAC header for DTCH and DCCH mapped to HS-DSCH	5.4.0	5.5.0
09/2003	RP-21	RP-030501	178		TFCS selection guidelines for TFC Subset	5.5.0	5.6.0
	RP-21	RP-030536	174	2	MAC-hs Re-ordering Protocol Correction & MAC-hs window re-ordering	5.5.0	5.6.0
	RP-21	RP-030494	175		Addition of HS-DSCH Provided Bit Rate measurement	5.5.0	5.6.0
12/2003	RP-22	RP-030624	179		Corrections Relating to HSDPA TB Sizes for 1.28Mcps TDD	5.6.0	5.7.0
	RP-22	RP-030624	180		HSDPA Transport block size table for 3.84Mcps TDD	5.6.0	5.7.0
	RP-22	RP-030624	181		HSDPA TB size table	5.6.0	5.7.0
	RP-22	RP-030624	182		Unwarranted HARQ re-transmissions	5.6.0	5.7.0
	RP-22	RP-030624	183		MAC-hs Re-ordering Protocol Flushing correction	5.6.0	5.7.0
	RP-22	RP-030624	184		Correction to window based stall avoidance mechanism	5.6.0	5.7.0
	RP-22	-	-		Upgrade to Release 6 - no technical change	5.7.0	6.0.0
03/2004	RP-23	RP-040104	186	1	UE handling of NDI and TBS for HSDPA	6.0.0	6.1.0
	RP-23	RP-040104	188		HSDPA related corrections on MAC-hs reconfiguration	6.0.0	6.1.0
	RP-23	RP-040104	190		Reconfiguration of soft memory buffer partitioning	6.0.0	6.1.0
06/2004	RP-24	RP-040200	194		Use of U-RNTI in downlink	6.1.0	6.2.0
	RP-24	RP-040234	196		State variables arithmetic comparison	6.1.0	6.2.0
12/2004	RP-26	RP-040480	198		MAC-hs header extension	6.2.0	6.3.0
	RP-26	RP-040480	200		Clarification on the C/T field use in the HSDPA Mac-d header	6.2.0	6.3.0
	RP-26	RP-040489	201	1	Introduction of MBMS MAC header	6.2.0	6.3.0

Change history							
Date	TSG #	TSG Doc.	CR	Rev	Subject/Comment	Old	New
	RP-26	RP-040489	202		Introduction of MBMS	6.2.0	6.3.0
	RP-26	RP-040497	203		Introduction of EUL in MAC specification	6.2.0	6.3.0
03/2005	RP-27	RP-050078	204		Correction to MBMS header for MBMS	6.3.0	6.4.0
06/2005	RP-28	RP-050301	0207		Correction of HSDPA state variable	6.4.0	6.5.0
	RP-28	RP-050319	0208		Corrections to the description of TCTF field	6.4.0	6.5.0
	RP-28	RP-050301	0210		Reconfiguration of MAC-hs parameters	6.4.0	6.5.0
	RP-28	RP-050308	0212		Feature Clean-up: Removal of DSCH (FDD)	6.4.0	6.5.0
	RP-28	RP-050309	0214		Feature Clean Up: Removal of CPCH	6.4.0	6.5.0
	RP-28	RP-050323	0215		HS-DSCH Provided Bit Rate measurement per Cell Portion	6.4.0	6.5.0
	RP-28	RP-050375	0216	2	Additional text on EUL in MAC specification	6.4.0	6.5.0
09/2005	RP-29	RP-050462	0218		Correction of TB size for 1.28 Mcps TDD	6.5.0	6.6.0
	RP-29	RP-050602	0219	5	Additional text on EUL in MAC specification	6.5.0	6.6.0
	RP-29	RP-050452	0220		Definition of UE power Headroom	6.5.0	6.6.0
	RP-29	RP-050457	0222		Feature Clean Up: Removal of CPCH	6.5.0	6.6.0
12/2005	RP-30	RP-050791	0223		Multi-step handling for E-RGCH	6.6.0	6.7.0
	RP-30	RP-050791	0224		Clarifications and Corrections of E-TFC Selection	6.6.0	6.7.0
	RP-30	RP-050791	0225	1	Criteria for the Happy Bit	6.6.0	6.7.0
	RP-30	RP-050791	0226	1	Correction to definition of reference_ETPR	6.6.0	6.7.0
	RP-30	RP-050791	0227		TEBS and HLBS Coding	6.6.0	6.7.0
	RP-30	RP-050791	0228		Correction on MAC-e PDU format	6.6.0	6.7.0
	RP-30	RP-050791	0229		SI Triggering Timer	6.6.0	6.7.0
	RP-30	RP-050791	0230		Maximum number of transmissions for control-only information	6.6.0	6.7.0
	RP-30	RP-050791	0231		Additional error case on the Absolute Grant channel	6.6.0	6.7.0
	RP-30	RP-050791	0232		HARQ process restriction/reservation	6.6.0	6.7.0
	RP-30	RP-050791	0233		Behavior at E-DCH TTI change	6.6.0	6.7.0
	RP-30	RP-050792	0234		Buffer status for Scheduling Information	6.6.0	6.7.0
	RP-30	RP-050792	0235		Buffer definition for Happy Bit setting	6.6.0	6.7.0
	RP-30	RP-050792	0236		Specification of rate control combining rules in baseline procedure for Serving Grant update	6.6.0	6.7.0
	RP-30	RP-050792	0237		Definition of sample for E-DCH bit rate measurement	6.6.0	6.7.0
	RP-30	RP-050792	0238		Size of Absolute Grant field	6.6.0	6.7.0
	RP-30	RP-050792	0239		Transmission of Scheduling Information without higher layer data	6.6.0	6.7.0
	RP-30	RP-050792	0241		Size of UPH field and assembly of Scheduling Information message	6.6.0	6.7.0
	RP-30	RP-050792	0242		E-DCH SI MAC-e PDU and SI timers	6.6.0	6.7.0
	RP-30	RP-050792	0243		MAC es/e reset indicator	6.6.0	6.7.0
	RP-30	RP-050792	0244		E-DCH handling at serving cell change	6.6.0	6.7.0
	RP-30	RP-050792	0245		RSN sequence in the presence of compressed mode transmission gaps	6.6.0	6.7.0
03/2006	RP-31	RP-060085	0246		Definition of reference_ETPR	6.7.0	6.8.0
	RP-31	RP-060085	0247	1	AG_Timer for IE "Serving Grant"	6.7.0	6.8.0
	RP-31	RP-060085	0248		TEBS and HLBS Coding	6.7.0	6.8.0
	RP-31	RP-060194	0249	1	Correction related to automatic triggering of SI retransmissions	6.7.0	6.8.0
	RP-31	RP-060085	0250		Clarifications at TTI Change	6.7.0	6.8.0
	RP-31	RP-060085	0251	2	MAC-es/e and MAC-hs reset procedure	6.7.0	6.8.0
	RP-31	RP-060085	0254		Enhanced Uplink Corrections	6.7.0	6.8.0
	RP-31	RP-060085	0255		E-TFC Selection Pseudo Code Correction	6.7.0	6.8.0
	RP-31	RP-060088	0256		Correction of MBMS-Id field (MAC header of MTCH)	6.7.0	6.8.0
	RP-31	RP-060085	0257		E-DCH Serving Grant Update	6.7.0	6.8.0
	RP-31	RP-060085	0258		One PDU size per logical channel per TTI	6.7.0	6.8.0
	RP-31	RP-060098	0253		7.68 Mcps TDD Option (Release 7)	6.8.0	7.0.0
06/2006	RP-32	RP-060352	0260		Buffer Status for the Happy Bit and Scheduling Information Reporting	7.0.0	7.1.0
	RP-32	RP-060352	0262		Serving RG and Scheduling Information	7.0.0	7.1.0
	RP-32	RP-060352	0264		Definition of RG_step_size	7.0.0	7.1.0
	RP-32	RP-060352	0266		Correction to AG_Timer Start	7.0.0	7.1.0
	RP-32	RP-060352	0268		Miscellaneous corrections for E-DCH	7.0.0	7.1.0
	RP-32	RP-060353	0270		Correction to Notification of SI transmission failure and variable resets	7.0.0	7.1.0
	RP-32	RP-060353	0272		Correction to Handling at Start of E-DCH Transmission	7.0.0	7.1.0
	RP-32	RP-060353	0274		Additional inconsistent information on E-AGCH	7.0.0	7.1.0
	RP-32	RP-060370	0276		Clarifications on E-TFCI	7.0.0	7.1.0
	RP-32	RP-060353	0282		Transmission of SI if TEBS is zero	7.0.0	7.1.0
	RP-32	RP-060419	0284	1	Serving_Grant and Unquantized E-DPDCH to DPCCH power ratios	7.0.0	7.1.0
09/2006	RP-33	RP-060625	0286	2	Maximum number of transmissions	7.1.0	7.2.0
	RP-33	RP-060574	0289		HLBS values in Scheduling Information message	7.1.0	7.2.0
	RP-33	RP-060580	0290	1	Note on Serving Grant Update with Zero Grant	7.1.0	7.2.0
	RP-33	RP-060586	0291		Introduction of 3.84 Mcps and 7.68 Mcps TDD E-DCH	7.1.0	7.2.0

Change history							
Date	TSG #	TSG Doc.	CR	Rev	Subject/Comment	Old	New
	RP-33	RP-060578	0293		MAC-hs reset	7.1.0	7.2.0
12/2006	RP-34	RP-060716	0301		Grant and MAC-e/es headers for E-DCH	7.2.0	7.3.0
	RP-34	RP-060716	0303		Clarification to Maximum channelisation codes and E-TFC selection	7.2.0	7.3.0
	RP-34	RP-060716	0305	1	Correction for E-DCH SG and compressed mode	7.2.0	7.3.0
	RP-34	RP-060716	0307		SG update procedure correction	7.2.0	7.3.0
03/2007	RP-35	RP-070150	0310		Modification of HS-DSCH TB size for LCR TDD	7.3.0	7.4.0
	RP-35	RP-070163	0312	1	Introduction of 64QAM in MAC specification	7.3.0	7.4.0
	RP-35	RP-070157	0313		Introduction of 1.28 Mcps TDD E-DCH	7.3.0	7.4.0
	RP-35	RP-070160	0314		Editorial Corrections for 3.84/7.68 Mcps TDD E-DCH	7.3.0	7.4.0
	RP-35	RP-070158	0315		Introduction of DTX-DRX and HS-SCCH less in MAC	7.3.0	7.4.0
	RP-35	RP-070161	0316		Introducing MIMO in MAC specification	7.3.0	7.4.0
06/2007	RP-36	RP-070402	0311	2	Introducing 16QAM uplink support	7.4.0	7.5.0
	RP-36	RP-070393	0317	-	"Maximum_Serving_Grant" setting at TTI change	7.4.0	7.5.0
	RP-36	RP-070405	0318	3	Introduction of Improved L2 support for high data rates and Enhanced CELL_FACH state	7.4.0	7.5.0
	RP-36	RP-070407	0319	-	Removing an incomplete optimization for RLC operations during HSDPA cell change	7.4.0	7.5.0
	RP-36	RP-070397	0321	-	Clarification for control of E-RUCCH transmission in LCR TDD	7.4.0	7.5.0
	RP-36	RP-070397	0322	-	Some Small Editorial Corrections to TS 25.321	7.4.0	7.5.0
	RP-36	RP-070397	0323	-	Introduction of E-TFC Selection for 1.28Mcps TDD	7.4.0	7.5.0
	RP-36	RP-070397	0324	-	Some clarifications related to E-DCH Scheduling Information in TDD mode	7.4.0	7.5.0
	RP-36	RP-070393	0326	-	Clarification on calculation of "Scheduled Grant Payload"	7.4.0	7.5.0
	RP-36	RP-070393	0327	-	Recommandation on RLC PDU size selection on E-DCH	7.4.0	7.5.0
	RP-36	RP-070491	0329		Clarifications on priority of requirements in E-TFC selection	7.4.0	7.5.0
09/2007	RP-37	RP-070623	0333		Correction on E-DCH compress mode	7.5.0	7.6.0
	RP-37	RP-070670	0337		Correction to HS-DSCH transport block size table	7.5.0	7.6.0
	RP-37	RP-070626	0338		Correction to operation of SI field in reassembly entity	7.5.0	7.6.0
	RP-37	RP-070627	0339		MAC DTX timing start restrictions & compressed mode	7.5.0	7.6.0
	RP-37	RP-070627	0340	1	Handling of long preambles in CPC	7.5.0	7.6.0
	RP-37	RP-070627	0341		L1 parameter name changes	7.5.0	7.6.0
	RP-37	RP-070670	0343	1	Removing MIMO requirements from MAC-hs	7.5.0	7.6.0
	RP-37	RP-070623	0345		Serving grant 'HOLD'	7.5.0	7.6.0
	RP-37	RP-070623	0347		Correction to quantisation requirements in E-TFC selection	7.5.0	7.6.0
	RP-37	RP-070671	0348		Periodic MAC-ehs reset and setting of the expected TSN	7.5.0	7.6.0
	RP-37	RP-070626	0349		Enhanced L2 processing	7.5.0	7.6.0
	RP-37	RP-070626	0350		Correction to MAC-ehs PDU definition	7.5.0	7.6.0
	RP-37	RP-070626	0351	1	Defining of reordering SDU and correction to the definition of the SI field	7.5.0	7.6.0
	RP-37	RP-070627	0352	1	Clarification on the HARQ procedure for HS-SCCH less operation	7.5.0	7.6.0
	RP-37	RP-070627	0354		Clarifications of CPC Grant Channel Monitoring	7.5.0	7.6.0
	RP-37	RP-070627	0355		Avoid unnecessarily decreasing UE DRX possibility	7.5.0	7.6.0
	RP-37	RP-070629	0356		Timing Advance Corrections for 3.84/7.68 Mcps TDD EDCH	7.5.0	7.6.0
	RP-37	RP-070631	0357		3.84/7.68 Mcps TDD EDCH: Sending Scheduling Information Periodically	7.5.0	7.6.0
	RP-37	RP-070670	0358	1	Correction to HARQ operation in MIMO	7.5.0	7.6.0
	RP-37	RP-070670	0360		Calculation of 'Scheduled Grant Payload' in Rel-7	7.5.0	7.6.0
	RP-37	RP-070650	0361		Introduction of multi-frequency operation for 1.28Mcps TDD	7.5.0	7.6.0
	RP-37	RP-070636	0362		Addition of an SI trigger when UE grant <> 0 and at least one process is activated	7.5.0	7.6.0
	RP-37	RP-070623	0364		Reference_ETPR definition alignment	7.5.0	7.6.0
12/2007	RP-38	RP-070903	0365		Introduction of an additional UE category for 1.28Mcps TDD E-DCH	7.6.0	7.7.0
	RP-38	RP-070903	0366		Clarification on E-TFC selection for 1.28Mcps TDD	7.6.0	7.7.0
	RP-38	RP-070903	0367		Clarification of TEBS and HLBS in Scheduling Information for TDD mode	7.6.0	7.7.0
	RP-38	RP-070938	0368		Scheduled Grant setting in DTX Cycle 2 during CPC operation	7.6.0	7.7.0
	RP-38	RP-070901	0369		Clarification on SG table for 16QAM	7.6.0	7.7.0
	RP-38	RP-070900	0370		Correction to the UE behaviour when receiving RV=0	7.6.0	7.7.0
	RP-38	RP-070905	0371		Reassembly Unit	7.6.0	7.7.0
	RP-38	RP-070911	0372		Clarification on E-DPDCH power extrapolation/interpolation	7.6.0	7.7.0
03/2008	RP-39	RP-080189	0373	-	Inconsistency of MAC header when BCCH mapped to HS-DSCH	7.7.0	7.8.0
	RP-39	RP-080189	0375	-	Correction to the operation of the timer Treset	7.7.0	7.8.0
	RP-39	RP-080176	0383	-	Correction to UTRAN side MAC-e depiction	7.7.0	7.8.0
	RP-39	RP-080190	0385	-	Support of octet aligned HS-DSCH transport block sizes for non-64QAM	7.7.0	7.8.0
	RP-39	RP-080190	0387	-	transmission scheduling in MAC-ehs entity	7.7.0	7.8.0
	RP-39	RP-080185	0389	-	Clarification of Scheduling Information Fields for TDD E-DCH	7.7.0	7.8.0

Change history							
Date	TSG #	TSG Doc.	CR	Rev	Subject/Comment	Old	New
	RP-39	RP-080184	0391	-	Persistence scaling values and scheduling information for 3.84/7.68 Mcps TDD E-DCH	7.7.0	7.8.0
	RP-39	RP-080190	0393	-	Editorial corrections to MAC-ehs	7.7.0	7.8.0
	RP-39	RP-080187	0395	-	Definition of Default-SG-in-DTX-Cycle-2	7.7.0	7.8.0
	RP-39	RP-080185	0398	-	Clarification of SI transmission priority over Non-scheduled MAC-e PDU	7.7.0	7.8.0
05/2008	RP-40	RP-080400	0401	-	Correction on the Mapping of TRRI field and MSB/LSB for 1.28Mcps TDD EUL	7.8.0	7.9.0
	RP-40	RP-080404	0403	-	Completion of the mechanism for Scheduling Information transmission on MAC-e PDU alone for 1.28 Mcps TDD in EUL	7.8.0	7.9.0
	RP-40	RP-080395	0406	-	Change of MAC-d flow definition for MAC-ehs	7.8.0	7.9.0
	RP-40	RP-080400	0408	1	Clarification of method in determining State of a E-TFC for TDD	7.8.0	7.9.0
	RP-40	RP-080397	0410	-	Modification of TBS tables and E-TFC selection for LCR TDD	7.8.0	7.9.0
	RP-40	RP-080398	0414	-	Clarification of the definition of PRRI for TDD	7.8.0	7.9.0
	RP-40	RP-080400	0416	-	HARQ power offset selection during multiplexing of multiple MAC-d flows	7.8.0	7.9.0
09/2008	RP-41	RP-080677	0422	-	HSDPA TBS Table correction for LCR TDD	7.9.0	7.10.0
	RP-41	RP-080682	0424	-	Ki restriction for FDD UE HS-DSCH categories 13 and 15	7.9.0	7.10.0
	RP-41	RP-080683	0426	1	LCH-ID field structure and mapping to logical channel identity	7.9.0	7.10.0
	RP-41	RP-080679	0428	-	MAC-es/e RESET for LCR TDD	7.9.0	7.10.0
	RP-41	RP-080679	0433	-	Modification of TBS tables and E-TFC selection for LCR TDD	7.9.0	7.10.0
	RP-41	RP-080679	0435	1	Triggers and transmission of Scheduling Information for LCR TDD	7.9.0	7.10.0
	RP-41	RP-080685	0437	1	The number of reordering PDUs belonging to the same reordering queue	7.9.0	7.10.0
	RP-41	RP-080679	0441	1	Clarifications and Corrections of HARQ process for TDD	7.9.0	7.10.0
	RP-41	RP-080679	0443	-	Recommendation on RLC PDU size selection on E-DCH for TDD	7.9.0	7.10.0
	RP-41	RP-080683	0445	-	Editorial correction to MAC-ehs entity UTRAN Side	7.9.0	7.10.0
12/2008	RP-42	RP-081002	0447	-	Removal of the reference to E-TFCl threshold	7.10.0	7.11.0
	RP-42	RP-081002	0453	1	Correcting E-TFC minimum set behaviour when DCH is configured	7.10.0	7.11.0
	RP-42	RP-081007	0456	1	Clarification of E-RUCCH transmission in 25.321	7.10.0	7.11.0
	RP-42	RP-081001	0462	2	UE restrictions on E-TFCIs	7.10.0	7.11.0
	RP-42	RP-081008	0464	-	Setting of NDI after MIMO to non-MIMO configuration	7.10.0	7.11.0
	RP-42	RP-081007	0474	-	Clarification of RX-TIMER reset in 25.321 for 1.28Mcps TDD	7.10.0	7.11.0
	RP-42	RP-081007	0479	-	Modification of E-RUCCH uplink sync transmission for 1.28Mcps TDD	7.10.0	7.11.0
03/2009	RP-43	RP-090116	0481	-	Corrections to E-TFC selection in case of E-DPDCH extrapolation	7.11.0	7.12.0
	RP-43	RP-090116	0484	-	SI reporting and compressed mode	7.11.0	7.12.0
	RP-43	RP-090121	0486	1	Corrections to E-TFC selection in case of E-DPDCH interpolation	7.11.0	7.12.0
	RP-43	RP-090118	0490	-	Addition of HARQ procedure for HS-SCCH less operation when MAC-ehs is configured	7.11.0	7.12.0
	RP-43	RP-090120	0493	-	Correction on Absolute Grant Value for LCR TDD	7.11.0	7.12.0
	RP-43	RP-090121	0499	1	Correction to MAC handling of AG and SG tables when 16QAM UL is configured	7.11.0	7.12.0
	RP-43	RP-090118	0501	2	Correction to HARQ operation for HS-SCCH less operation	7.11.0	7.12.0
	RP-43	RP-090120	0506	-	25.321(R7,F) on correction of E-TFC selection procedure for LCR TDD	7.11.0	7.12.0
06/2009	RP-44	RP-090504	0513	1	Reordering configuration for BCCH and paging	7.12.0	7.13.0
	RP-44	RP-090501	0518	1	Correction to non-scheduled transmission for 1.28 Mcps TDD	7.12.0	7.13.0
	RP-44	RP-090503	0520	-	Correction to Improved L2 for 1.28Mcps TDD	7.12.0	7.13.0
	RP-44	RP-090503	0522	1	Correction to TBS tables for Improved L2 for 1.28Mcps TDD	7.12.0	7.13.0
	RP-44	RP-090505	0524	1	Clarification to grant monitoring	7.12.0	7.13.0
09/2009	RP-45	RP-090903	0542	1	Modification of E-DCH configuration elements for LCR TDD	7.13.0	7.14.0
	RP-45	RP-090902	0545	-	25.321 Feature to be made optional in release 7: SI trigger when grant <> 0	7.13.0	7.14.0
	RP-45	RP-090901	0555	1	Correction to MAC-c/sh/m details	7.13.0	7.14.0
12/2009	RP-46	RP-091310	0561	-	Clarification of the transmission power of SI-only MAC-e PDU for 1.28Mcps TDD	7.14.0	7.15.0
	RP-46	RP-091311	0570	-	TSN or SI field presences in case of consecutive BCCH/PCCH re-ordering PDUs	7.14.0	7.15.0
	RP-46	RP-091310	0574	-	Clarification for scheduling information reporting for 1.28Mcps TDD	7.14.0	7.15.0
	RP-46	RP-091313	0581	-	Corrections to MAC-ehs reset	7.14.0	7.15.0
03/2010	RP-47	RP-100284	0621	-	Correction to MAC-ehs reset at Treset expiry	7.15.0	7.16.0

NOTE: CR0412r1 to 25.321 v7.8.0 "Triggers and transmission of Scheduling Information for LCR TDD" was approved in RP-080443 at RAN #40 but it but could not be implemented in the specification as CR was based on an older specification version. See therefore CR0435r1 of RAN #41.

History

Document history		
V7.0.0	March 2006	Publication
V7.1.0	June 2006	Publication
V7.2.0	September 2006	Publication
V7.3.0	December 2006	Publication
V7.4.0	March 2007	Publication
V7.5.0	June 2007	Publication
V7.6.0	October 2007	Publication
V7.7.0	January 2008	Publication
V7.8.0	April 2008	Publication
V7.9.0	July 2008	Publication
V7.10.0	October 2008	Publication
V7.11.0	January 2009	Publication
V7.12.0	April 2009	Publication
V7.13.0	July 2009	Publication
V7.14.0	September 2009	Publication
V7.15.0	February 2010	Publication
V7.16.0	April 2010	Publication