

ETSI TS 125 331 V4.9.0 (2003-03)

Technical Specification

Universal Mobile Telecommunications System (UMTS); Radio Resource Control (RRC) protocol specification (3GPP TS 25.331 version 4.9.0 Release 4)



Reference

RTS/TSGR-0225331v490

Keywords

UMTS

ETSI

650 Route des Lucioles
F-06921 Sophia Antipolis Cedex - FRANCE

Tel.: +33 4 92 94 42 00 Fax: +33 4 93 65 47 16

Siret N° 348 623 562 00017 - NAF 742 C
Association à but non lucratif enregistrée à la
Sous-Préfecture de Grasse (06) N° 7803/88

Important notice

Individual copies of the present document can be downloaded from:

<http://www.etsi.org>

The present document may be made available in more than one electronic version or in print. In any case of existing or perceived difference in contents between such versions, the reference version is the Portable Document Format (PDF). In case of dispute, the reference shall be the printing on ETSI printers of the PDF version kept on a specific network drive within ETSI Secretariat.

Users of the present document should be aware that the document may be subject to revision or change of status. Information on the current status of this and other ETSI documents is available at

<http://portal.etsi.org/tb/status/status.asp>

If you find errors in the present document, send your comment to:

editor@etsi.org

Copyright Notification

No part may be reproduced except as authorized by written permission.
The copyright and the foregoing restriction extend to reproduction in all media.

© European Telecommunications Standards Institute 2003.
All rights reserved.

DECT™, PLUGTESTS™ and UMTS™ are Trade Marks of ETSI registered for the benefit of its Members.
TIPHON™ and the TIPHON logo are Trade Marks currently being registered by ETSI for the benefit of its Members.
3GPP™ is a Trade Mark of ETSI registered for the benefit of its Members and of the 3GPP Organizational Partners.

Intellectual Property Rights

IPRs essential or potentially essential to the present document may have been declared to ETSI. The information pertaining to these essential IPRs, if any, is publicly available for **ETSI members and non-members**, and can be found in ETSI SR 000 314: "*Intellectual Property Rights (IPRs); Essential, or potentially Essential, IPRs notified to ETSI in respect of ETSI standards*", which is available from the ETSI Secretariat. Latest updates are available on the ETSI Web server (<http://webapp.etsi.org/IPR/home.asp>).

All published ETSI deliverables shall include information which directs the reader to the above source of information.

Foreword

This Technical Specification (TS) has been produced by ETSI 3rd Generation Partnership Project (3GPP).

The present document may refer to technical specifications or reports using their 3GPP identities, UMTS identities or GSM identities. These should be interpreted as being references to the corresponding ETSI deliverables.

The cross reference between GSM, UMTS, 3GPP and ETSI identities can be found under <http://webapp.etsi.org/key/queryform.asp> .

Contents

Intellectual Property Rights	2
Foreword.....	2
Foreword.....	25
1 Scope	26
2 References	26
3 Definitions and abbreviations.....	28
3.1 Definitions	28
3.2 Abbreviations	28
4 General	30
4.1 Overview of the specification.....	30
4.2 RRC Layer Model	31
4.3 Protocol specification principles	34
5 RRC Functions and Services provided to upper layers	34
5.1 RRC Functions	34
5.2 RRC Services provided to upper layers.....	35
5.3 Primitives between RRC and upper layers	35
6 Services expected from lower layers.....	35
6.1 Services expected from Layer 2	35
6.2 Services expected from Layer 1	35
6.3 Signalling Radio Bearers.....	35
7 Protocol states	36
7.1 Overview of RRC States and State Transitions including GSM	36
7.2 Processes in UE modes/states.....	36
7.2.1 UE Idle mode.....	37
7.2.2 UTRA RRC Connected mode.....	37
7.2.2.1 URA_PCH or CELL_PCH state	37
7.2.2.2 CELL_FACH state.....	37
7.2.2.3 CELL_DCH state.....	38
8 RRC procedures	38
8.1 RRC Connection Management Procedures	39
8.1.1 Broadcast of system information	39
8.1.1.1 General	39
8.1.1.1.1 System information structure.....	39
8.1.1.1.2 System information blocks	40
8.1.1.1.3 Segmentation and concatenation of system information blocks	44
8.1.1.1.4 Re-assembly of segments	45
8.1.1.1.5 Scheduling of system information	46
8.1.1.2 Initiation.....	47
8.1.1.3 Reception of SYSTEM INFORMATION messages by the UE.....	47
8.1.1.4 Reception of SYSTEM INFORMATION messages broadcast on a FACH transport channel.....	47
8.1.1.5 Actions upon reception of the Master Information Block and Scheduling Block(s).....	47
8.1.1.6 Actions upon reception of system information blocks	50
8.1.1.6.1 System Information Block type 1	51
8.1.1.6.2 System Information Block type 2.....	52
8.1.1.6.3 System Information Block type 3.....	52
8.1.1.6.4 System Information Block type 4.....	52
8.1.1.6.5 System Information Block type 5.....	52
8.1.1.6.6 System Information Block type 6.....	53
8.1.1.6.7 System Information Block type 7.....	54
8.1.1.6.8 System Information Block type 8.....	54
8.1.1.6.9 System Information Block type 9.....	54

8.1.1.6.10	System Information Block type 10	54
8.1.1.6.11	System Information Block type 11	54
8.1.1.6.12	System Information Block type 12	55
8.1.1.6.13	System Information Block type 13	57
8.1.1.6.14	System Information Block type 14	57
8.1.1.6.15	System Information Block type 15	57
8.1.1.6.16	System Information Block type 16	59
8.1.1.6.17	System Information Block type 17	60
8.1.1.6.18	System Information Block type 18	60
8.1.1.7	Modification of system information	60
8.1.1.7.1	Modification of system information blocks using a value tag	60
8.1.1.7.2	Synchronised modification of system information blocks	61
8.1.1.7.3	Actions upon system information change	61
8.1.1.7.4	Actions upon expiry of a system information expiry timer	62
8.1.2	Paging	62
8.1.2.1	General	62
8.1.2.2	Initiation	62
8.1.2.3	Reception of a PAGING TYPE 1 message by the UE	63
8.1.3	RRC connection establishment	64
8.1.3.1	General	64
8.1.3.2	Initiation	64
8.1.3.3	RRC CONNECTION REQUEST message contents to set	65
8.1.3.4	Reception of an RRC CONNECTION REQUEST message by the UTRAN	65
8.1.3.5	Cell re-selection or T300 timeout	65
8.1.3.5a	Abortion of RRC connection establishment	66
8.1.3.6	Reception of an RRC CONNECTION SETUP message by the UE	66
8.1.3.7	Physical channel failure or cell re-selection	67
8.1.3.8	Invalid RRC CONNECTION SETUP message, unsupported configuration or invalid configuration	68
8.1.3.9	Reception of an RRC CONNECTION REJECT message by the UE	69
8.1.3.10	Invalid RRC CONNECTION REJECT message	71
8.1.4	RRC connection release	72
8.1.4.1	General	72
8.1.4.2	Initiation	72
8.1.4.3	Reception of an RRC CONNECTION RELEASE message by the UE	72
8.1.4.4	Invalid RRC CONNECTION RELEASE message	74
8.1.4.5	Cell re-selection or radio link failure	74
8.1.4.6	Expiry of timer T308, unacknowledged mode transmission	75
8.1.4.7	Void	75
8.1.4.8	Reception of an RRC CONNECTION RELEASE COMPLETE message by UTRAN	75
8.1.4.9	Unsuccessful transmission of the RRC CONNECTION RELEASE COMPLETE message, acknowledged mode transmission	76
8.1.4.10	Detection of loss of dedicated physical channel by UTRAN in CELL_DCH state	76
8.1.4.11	Failure to receive RRC CONNECTION RELEASE COMPLETE message by UTRAN	76
8.1.4a	RRC connection release requested by upper layers	76
8.1.4a.1	General	76
8.1.4a.2	Initiation	76
8.1.5	Void	77
8.1.6	Transmission of UE capability information	77
8.1.6.1	General	77
8.1.6.2	Initiation	77
8.1.6.3	Reception of a UE CAPABILITY INFORMATION message by the UTRAN	78
8.1.6.4	Reception of the UE CAPABILITY INFORMATION CONFIRM message by the UE	78
8.1.6.5	Invalid UE CAPABILITY INFORMATION CONFIRM message	78
8.1.6.6	T304 timeout	78
8.1.7	UE capability enquiry	79
8.1.7.1	General	79
8.1.7.2	Initiation	79
8.1.7.3	Reception of a UE CAPABILITY ENQUIRY message by the UE	79
8.1.7.4	Invalid UE CAPABILITY ENQUIRY message	79
8.1.8	Initial Direct transfer	80
8.1.8.1	General	80

8.1.8.2	Initiation of Initial direct transfer procedure in the UE	80
8.1.8.2a	RLC re-establishment or inter-RAT change	81
8.1.8.2b	Abortion of signalling connection establishment	82
8.1.8.3	Reception of INITIAL DIRECT TRANSFER message by the UTRAN	82
8.1.9	Downlink Direct transfer	82
8.1.9.1	General	82
8.1.9.2	Initiation of downlink direct transfer procedure in the UTRAN	82
8.1.9.3	Reception of a DOWNLINK DIRECT TRANSFER message by the UE	83
8.1.9.3a	No signalling connection exists	83
8.1.9.4	Invalid DOWNLINK DIRECT TRANSFER message	83
8.1.10	Uplink Direct transfer	84
8.1.10.1	General	84
8.1.10.2	Initiation of uplink direct transfer procedure in the UE	84
8.1.10.2a	RLC re-establishment or inter-RAT change	85
8.1.10.3	Reception of UPLINK DIRECT TRANSFER message by the UTRAN	85
8.1.11	UE dedicated paging	85
8.1.11.1	General	85
8.1.11.2	Initiation	86
8.1.11.3	Reception of a PAGING TYPE 2 message by the UE	86
8.1.11.4	Invalid PAGING TYPE 2 message	86
8.1.12	Security mode control	87
8.1.12.1	General	87
8.1.12.2	Initiation	87
8.1.12.2.1	Ciphering configuration change	87
8.1.12.2.2	Integrity protection configuration change	88
8.1.12.3	Reception of SECURITY MODE COMMAND message by the UE	90
8.1.12.3.1	New ciphering and integrity protection keys	93
8.1.12.4	Void	95
8.1.12.4a	Incompatible simultaneous security reconfiguration	95
8.1.12.4b	Cell update procedure during security reconfiguration	95
8.1.12.4c	Invalid configuration	96
8.1.12.5	Reception of SECURITY MODE COMPLETE message by the UTRAN	96
8.1.12.6	Invalid SECURITY MODE COMMAND message	98
8.1.13	Signalling connection release procedure	99
8.1.13.1	General	99
8.1.13.2	Initiation of SIGNALLING CONNECTION RELEASE by the UTRAN	99
8.1.13.3	Reception of SIGNALLING CONNECTION RELEASE by the UE	99
8.1.13.4	Invalid SIGNALLING CONNECTION RELEASE message	99
8.1.13.5	Invalid configuration	100
8.1.14	Signalling connection release indication procedure	100
8.1.14.1	General	100
8.1.14.2	Initiation	100
8.1.14.2a	RLC re-establishment or inter-RAT change	101
8.1.14.3	Reception of SIGNALLING CONNECTION RELEASE INDICATION by the UTRAN	101
8.1.15	Counter check procedure	101
8.1.15.1	General	101
8.1.15.2	Initiation	102
8.1.15.3	Reception of a COUNTER CHECK message by the UE	102
8.1.15.4	Reception of the COUNTER CHECK RESPONSE message by UTRAN	103
8.1.15.5	Cell re-selection	103
8.1.15.6	Invalid COUNTER CHECK message	103
8.1.16	Inter RAT handover information transfer	103
8.1.16.1	General	103
8.1.16.2	Initiation	103
8.1.16.3	INTER RAT HANDOVER INFO message contents to set	104
8.2	Radio Bearer control procedures	105
8.2.1	Radio bearer establishment	105
8.2.2	Reconfiguration procedures	105
8.2.2.1	General	107
8.2.2.2	Initiation	107

8.2.2.3	Reception of RADIO BEARER SETUP or RADIO BEARER RECONFIGURATION or RADIO BEARER RELEASE or TRANSPORT CHANNEL RECONFIGURATION or PHYSICAL CHANNEL RECONFIGURATION message by the UE	109
8.2.2.4	Transmission of a response message by the UE, normal case.....	114
8.2.2.5	Reception of a response message by the UTRAN, normal case.....	115
8.2.2.6	Unsupported configuration in the UE	116
8.2.2.7	Physical channel failure	117
8.2.2.8	Cell re-selection	117
8.2.2.9	Transmission of a response message by the UE, failure case	117
8.2.2.10	Reception of a response message by the UTRAN, failure case	118
8.2.2.11	Invalid configuration.....	118
8.2.2.12	Incompatible simultaneous reconfiguration	119
8.2.2.12a	Incompatible simultaneous security reconfiguration.....	119
8.2.2.12b	Cell update procedure during security reconfiguration	119
8.2.2.13	Invalid received message	120
8.2.3	Radio bearer release.....	121
8.2.4	Transport channel reconfiguration.....	121
8.2.5	Transport format combination control.....	121
8.2.5.1	General.....	121
8.2.5.2	Initiation.....	121
8.2.5.3	Reception of a TRANSPORT FORMAT COMBINATION CONTROL message by the UE	122
8.2.5.4	Invalid configuration.....	123
8.2.5.5	Invalid TRANSPORT FORMAT COMBINATION CONTROL message	123
8.2.6	Physical channel reconfiguration.....	124
8.2.7	Physical Shared Channel Allocation [TDD only].....	124
8.2.7.1	General.....	124
8.2.7.2	Initiation.....	124
8.2.7.3	Reception of a PHYSICAL SHARED CHANNEL ALLOCATION message by the UE	124
8.2.7.4	Invalid PHYSICAL SHARED CHANNEL ALLOCATION message.....	126
8.2.8	PUSCH capacity request [TDD only].....	127
8.2.8.1	General.....	127
8.2.8.2	Initiation.....	127
8.2.8.3	PUSCH CAPACITY REQUEST message contents to set.....	128
8.2.8.4	Reception of a PUSCH CAPACITY REQUEST message by the UTRAN	129
8.2.8.5	T310 expiry	129
8.2.9	Void	129
8.2.10	Uplink Physical Channel Control [TDD only].....	129
8.2.10.1	General.....	129
8.2.10.2	Initiation.....	129
8.2.10.3	Reception of UPLINK PHYSICAL CHANNEL CONTROL message by the UE	129
8.2.10.4	Invalid UPLINK PHYSICAL CHANNEL CONTROL message	130
8.2.11	Physical channel reconfiguration failure.....	130
8.2.11.1	General.....	131
8.2.11.2	Runtime error due to overlapping compressed mode configurations.....	131
8.2.11.3	Runtime error due to overlapping compressed mode configuration and PDSCH reception	131
8.3	RRC connection mobility procedures.....	131
8.3.1	Cell and URA update procedures	131
8.3.1.1	General.....	134
8.3.1.2	Initiation.....	134
8.3.1.3	CELL UPDATE / URA UPDATE message contents to set.....	138
8.3.1.4	T305 expiry and the UE detects "out of service area".....	139
8.3.1.4.1	Re-entering "in service area"	139
8.3.1.4.2	Expiry of timer T307	140
8.3.1.5	Reception of an CELL UPDATE/URA UPDATE message by the UTRAN.....	141
8.3.1.6	Reception of the CELL UPDATE CONFIRM/URA UPDATE CONFIRM message by the UE	141
8.3.1.7	Transmission of a response message to UTRAN	146
8.3.1.7a	Physical channel failure	149
8.3.1.8	Unsupported configuration by the UE	150
8.3.1.9	Invalid configuration.....	151
8.3.1.9a	Incompatible simultaneous reconfiguration	153
8.3.1.9b	Security reconfiguration during Cell update procedure	154
8.3.1.10	Confirmation error of URA ID list.....	154

8.3.1.11	Invalid CELL UPDATE CONFIRM/URA UPDATE CONFIRM message	155
8.3.1.12	T302 expiry or cell reselection	156
8.3.1.13	T314 expiry	158
8.3.1.14	T315 expiry	159
8.3.1.15	Reception of the UTRAN MOBILITY INFORMATION CONFIRM message by the UTRAN	160
8.3.2	URA update	160
8.3.3	UTRAN mobility information	160
8.3.3.1	General	160
8.3.3.2	Initiation	160
8.3.3.3	Reception of UTRAN MOBILITY INFORMATION message by the UE	160
8.3.3.4	Reception of an UTRAN MOBILITY INFORMATION CONFIRM message by the UTRAN	163
8.3.3.5	Cell re-selection	163
8.3.3.5a	Incompatible simultaneous security reconfiguration	163
8.3.3.6	Invalid UTRAN MOBILITY INFORMATION message	164
8.3.4	Active set update	164
8.3.4.1	General	165
8.3.4.2	Initiation	165
8.3.4.3	Reception of an ACTIVE SET UPDATE message by the UE	165
8.3.4.4	Unsupported configuration in the UE	166
8.3.4.5	Invalid configuration	166
8.3.4.5a	Void	167
8.3.4.5b	Incompatible simultaneous reconfiguration	167
8.3.4.6	Reception of the ACTIVE SET UPDATE COMPLETE message by the UTRAN	167
8.3.4.7	Reception of the ACTIVE SET UPDATE FAILURE message by the UTRAN	167
8.3.4.8	Invalid ACTIVE SET UPDATE message	167
8.3.4.9	Reception of an ACTIVE SET UPDATE message in wrong state	168
8.3.5	Hard handover	168
8.3.5.1	Timing re-initialised hard handover	168
8.3.5.1.1	General	168
8.3.5.1.2	Initiation	169
8.3.5.2	Timing-maintained hard handover	169
8.3.5.2.1	General	169
8.3.5.2.2	Initiation	169
8.3.6	Inter-RAT handover to UTRAN	170
8.3.6.1	General	170
8.3.6.2	Initiation	170
8.3.6.3	Reception of HANDOVER TO UTRAN COMMAND message by the UE	171
8.3.6.4	Invalid Handover to UTRAN command message	174
8.3.6.4a	Unsupported configuration in HANDOVER TO UTRAN COMMAND message	174
8.3.6.5	UE fails to perform handover	174
8.3.6.6	Reception of message HANDOVER TO UTRAN COMPLETE by the UTRAN	174
8.3.7	Inter-RAT handover from UTRAN	174
8.3.7.1	General	175
8.3.7.2	Initiation	175
8.3.7.3	Reception of a HANDOVER FROM UTRAN COMMAND message by the UE	175
8.3.7.4	Successful completion of the inter-RAT handover	176
8.3.7.5	UE fails to complete requested handover	176
8.3.7.6	Invalid HANDOVER FROM UTRAN COMMAND message	177
8.3.7.7	Reception of an HANDOVER FROM UTRAN FAILURE message by UTRAN	177
8.3.7.8	Unsupported configuration in HANDOVER FROM UTRAN COMMAND message	177
8.3.7.8a	Reception of HANDOVER FROM UTRAN COMMAND message by UE in CELL_FACH	178
8.3.8	Inter-RAT cell reselection to UTRAN	178
8.3.8.1	General	178
8.3.8.2	Initiation	178
8.3.8.3	UE fails to complete an inter-RAT cell reselection	179
8.3.9	Inter-RAT cell reselection from UTRAN	179
8.3.9.1	General	179
8.3.9.2	Initiation	179
8.3.9.3	Successful cell reselection	179
8.3.9.4	UE fails to complete an inter-RAT cell reselection	179
8.3.10	Inter-RAT cell change order to UTRAN	180
8.3.10.1	General	180

8.3.10.2	Initiation	180
8.3.10.3	UE fails to complete an inter-RAT cell change order	180
8.3.11	Inter-RAT cell change order from UTRAN	180
8.3.11.1	General	181
8.3.11.2	Initiation	181
8.3.11.3	Reception of an CELL CHANGE ORDER FROM UTRAN message by the UE	181
8.3.11.4	Successful completion of the cell change order	181
8.3.11.5	Expiry of timer T309 or UE fails to complete requested cell change order	182
8.3.11.6	Unsupported configuration in CELL CHANGE ORDER FROM UTRAN message	183
8.3.11.7	Invalid CELL CHANGE ORDER FROM UTRAN message	183
8.4	Measurement procedures	184
8.4.0	Measurement related definitions	184
8.4.1	Measurement control	185
8.4.1.1	General	186
8.4.1.2	Initiation	186
8.4.1.3	Reception of MEASUREMENT CONTROL by the UE	186
8.4.1.4	Unsupported measurement in the UE	190
8.4.1.4a	Configuration Incomplete	191
8.4.1.5	Invalid MEASUREMENT CONTROL message	191
8.4.1.6	Measurements after transition from CELL_DCH to CELL_FACH/CELL_PCH/URA_PCH state ...	191
8.4.1.6.1	Intra-frequency measurement	191
8.4.1.6.2	Inter-frequency measurement	192
8.4.1.6.3	Inter-RAT measurement	192
8.4.1.6.4	Quality measurement	192
8.4.1.6.5	UE internal measurement	193
8.4.1.6.6	Traffic volume measurement	193
8.4.1.6.7	UE positioning measurement	193
8.4.1.6a	Actions in CELL_FACH/CELL_PCH/URA_PCH state upon cell re-selection	195
8.4.1.7	Measurements after transition from CELL_FACH to CELL_DCH state	195
8.4.1.7.1	Intra-frequency measurement	195
8.4.1.7.2	Inter-frequency measurement	195
8.4.1.7.3	Inter-RAT measurement	196
8.4.1.7.4	Traffic volume measurement	196
8.4.1.7.5	UE positioning measurement	196
8.4.1.8	Measurements after transition from idle mode to CELL_DCH state	197
8.4.1.8.1	Intra-frequency measurement	197
8.4.1.8.2	Inter-frequency measurement	197
8.4.1.8.3	Inter-RAT measurement	197
8.4.1.8.4	Traffic volume measurement	198
8.4.1.8.5	UE positioning measurement	198
8.4.1.9	Measurements after transition from idle mode to CELL_FACH state	198
8.4.1.9.1	Intra-frequency measurement	198
8.4.1.9.2	Inter-frequency measurement	198
8.4.1.9.3	Inter-RAT measurement	198
8.4.1.9.4	Traffic volume measurement	198
8.4.1.9.5	UE positioning measurement	198
8.4.1.9a	Measurements after transition from connected mode to idle mode	199
8.4.1.9a.1	Intra-frequency measurement	199
8.4.1.9a.2	Inter-frequency measurement	199
8.4.1.9a.3	Inter-RAT measurement	199
8.4.1.9a.4	UE positioning measurement	199
8.4.1.10	Changes in measurement objects	200
8.4.1.10.1	Traffic volume measurement	200
8.4.1.10.2	Quality measurement	200
8.4.1.10.3	Intra-frequency, Inter-frequency and Inter-RAT measurements	201
8.4.2	Measurement report	201
8.4.2.1	General	201
8.4.2.2	Initiation	201
8.4.3	Assistance Data Delivery	203
8.4.3.1	General	203
8.4.3.2	Initiation	203
8.4.3.3	Reception of ASSISTANCE DATA DELIVERY message by the UE	203

8.4.3.4	Invalid ASSISTANCE DATA DELIVERY message	203
8.5	General procedures	204
8.5.1	Selection of initial UE identity	204
8.5.2	Actions when entering idle mode from connected mode	204
8.5.3	Open loop power control upon establishment of DPCH	205
8.5.4	Physical channel establishment criteria	205
8.5.5	Actions in "out of service area" and "in service area"	206
8.5.5.1	Detection of "out of service" area	206
8.5.5.1.1	Actions following detection of "out of service" area in URA_PCH or CELL_PCH state	206
8.5.5.1.2	Actions following detection of "out of service" area in CELL_FACH state	206
8.5.5.2	Detection of "in service" area	206
8.5.5.2.1	Actions following Re-entry into "in service area" in URA_PCH or CELL_PCH state	206
8.5.5.2.2	Actions following re-entry into "in service area" in CELL_FACH state	206
8.5.5.3	T316 expiry	207
8.5.5.4	T317 expiry	207
8.5.6	Radio link failure criteria and actions upon radio link failure	207
8.5.7	Open loop power control	208
8.5.8	Maintenance of Hyper Frame Numbers	210
8.5.9	START value calculation	211
8.5.10	Integrity protection	211
8.5.10.1	Integrity protection in downlink	212
8.5.10.2	Integrity protection in uplink	213
8.5.10.3	Calculation of message authentication code	214
8.5.11	FACH measurement occasion calculation	214
8.5.12	Establishment of Access Service Classes	215
8.5.13	Mapping of Access Classes to Access Service Classes	215
8.5.14	PLMN Type Selection	216
8.5.14a	Neighbour cells list narrowing for cell reselection	216
8.5.15	CFN calculation	216
8.5.15.1	Initialisation for CELL_DCH state after state transition	216
8.5.15.2	Initialisation in CELL_DCH state at hard handover	216
8.5.15.3	Initialisation for CELL_FACH	217
8.5.15.4	Initialisation after intersystem handover to UTRAN	217
8.5.16	Configuration of CTCH occasions	217
8.5.17	PRACH selection	218
8.5.18	Selection of RACH TTI	219
8.5.18.1	FDD	219
8.5.18.2	1.28 Mcps TDD	219
8.5.19	Secondary CCPCH selection	220
8.5.20	Unsupported configuration	220
8.5.21	Actions related to Radio Bearer mapping	220
8.5.22	Actions when entering another RAT from connected mode	222
8.6	Generic actions on receipt and absence of an information element	223
8.6.1	CN information elements	223
8.6.1.1	Void	223
8.6.1.2	CN information info	223
8.6.1.3	Signalling connection release indication	223
8.6.2	UTRAN mobility information elements	223
8.6.2.1	URA identity	223
8.6.2.2	Mapping info	224
8.6.3	UE information elements	224
8.6.3.1	Activation time	224
8.6.3.1a	CN domain specific DRX cycle length coefficient	225
8.6.3.2	UTRAN DRX Cycle length coefficient	225
8.6.3.3	Generic state transition rules depending on received information elements	225
8.6.3.4	Ciphering mode info	226
8.6.3.5	Integrity protection mode info	229
8.6.3.5.1	Initialisation of Integrity Protection	229
8.6.3.5.2	Integrity Protection Re-configuration for SRNS Relocation	230
8.6.3.5.3	Integrity Protection modification in case of new keys or initialisation of signalling connection	231
8.6.3.6	Void	232
8.6.3.7	Void	232

8.6.3.8	Integrity check info	232
8.6.3.9	New C-RNTI.....	232
8.6.3.9a	New DSCH-RNTI.....	233
8.6.3.10	New U-RNTI.....	233
8.6.3.11	RRC transaction identifier.....	233
8.6.3.12	Capability Update Requirement	236
8.6.4	Radio bearer information elements	237
8.6.4.1	Signalling RB information to setup list.....	237
8.6.4.2	RAB information for setup.....	238
8.6.4.2a	RAB information to reconfigure	239
8.6.4.3	RB information to setup	239
8.6.4.4	RB information to be affected	241
8.6.4.5	RB information to reconfigure	241
8.6.4.6	RB information to release	242
8.6.4.7	RB with PDCP information	242
8.6.4.8	RB mapping info	243
8.6.4.9	RLC Info	245
8.6.4.10	PDCP Info	245
8.6.4.11	PDCP SN Info	246
8.6.4.12	NAS Synchronisation Indicator	246
8.6.5	Transport channel information elements.....	246
8.6.5.1	Transport Format Set.....	246
8.6.5.2	Transport format combination set	248
8.6.5.3	Transport format combination subset.....	249
8.6.5.4	DCH quality target	250
8.6.5.5	Added or Reconfigured UL TrCH information.....	251
8.6.5.6	Added or Reconfigured DL TrCH information.....	251
8.6.5.7	Deleted UL TrCH information.....	251
8.6.5.8	Deleted DL TrCH information.....	251
8.6.5.9	UL Transport channel information common for all transport channels	251
8.6.5.10	DL Transport channel information common for all transport channels	252
8.6.5.11	DRAC static information	253
8.6.5.12	TFCS Reconfiguration/Addition Information	253
8.6.5.13	TFCS Removal Information.....	253
8.6.5.14	TFCI Field 2 Information.....	253
8.6.5.15	TFCS Explicit Configuration	254
8.6.6	Physical channel information elements.....	254
8.6.6.1	Frequency info	254
8.6.6.2	Void.....	255
8.6.6.2a	PNBSCH allocation	255
8.6.6.3	Void.....	255
8.6.6.3a	Downlink information per radio link list.....	255
8.6.6.4	Downlink information for each radio link.....	256
8.6.6.5	Void.....	256
8.6.6.6	Uplink DPCH info	256
8.6.6.7	Void.....	257
8.6.6.8	Maximum allowed UL TX power	257
8.6.6.9	PDSCH with SHO DCH Info (FDD only)	257
8.6.6.10	PDSCH code mapping (FDD only).....	257
8.6.6.11	Uplink DPCH power control info	259
8.6.6.12	Secondary CPICH info.....	260
8.6.6.13	Primary CPICH usage for channel estimation	260
8.6.6.14	DPCH frame offset.....	261
8.6.6.15	DPCH Compressed mode info	261
8.6.6.16	Repetition period, Repetition length, Offset (TDD only).....	263
8.6.6.17	Primary CCPCH info	264
8.6.6.18	Primary CPICH info.....	264
8.6.6.19	CPCH SET Info (FDD only).....	264
8.6.6.20	CPCH set ID (FDD only).....	265
8.6.6.21	Default DPCH Offset Value.....	265
8.6.6.22	Secondary Scrambling Code, Code Number.....	265
8.6.6.23	PDSCH Power Control info	265

8.6.6.24	Tx Diversity Mode	266
8.6.6.25	SSDT Information	266
8.6.6.26	UL Timing Advance Control (TDD only)	266
8.6.6.26a	Uplink synchronisation parameters	267
8.6.6.27	Downlink information common for all radio links	267
8.6.6.28	Downlink DPCH info common for all radio links	268
8.6.6.29	ASC setting	269
8.6.6.30	SRB delay, PC preamble (FDD only)	271
8.6.6.31	FPACH/PRACH Selection (1.28 Mcps TDD only)	271
8.6.7	Measurement information elements	271
8.6.7.1	Measurement validity	272
8.6.7.2	Filter coefficient	272
8.6.7.3	Intra-frequency/Inter-frequency/Inter-RAT cell info list	273
8.6.7.4	Intra-frequency measurement quantity	279
8.6.7.5	Inter-RAT measurement quantity	279
8.6.7.6	Inter-RAT reporting quantity	280
8.6.7.7	Cell Reporting Quantities	281
8.6.7.8	Periodical Reporting Criteria	282
8.6.7.9	Reporting Cell Status	282
8.6.7.10	Traffic Volume Measurement	283
8.6.7.11	Traffic Volume Measurement Reporting Criteria	283
8.6.7.12	FACH measurement occasion info	283
8.6.7.13	Measurement Reporting Mode	284
8.6.7.14	Inter-frequency measurement	284
8.6.7.15	Inter-RAT measurement	285
8.6.7.16	Intra-frequency measurement	286
8.6.7.17	Quality measurement	286
8.6.7.18	UE internal measurement	286
8.6.7.18a	UE positioning measurement	286
8.6.7.19	UE positioning	287
8.6.7.19.0	UE positioning reporting criteria	287
8.6.7.19.1	UE positioning reporting quantity	287
8.6.7.19.1a	UE positioning reporting for UE assisted methods	288
8.6.7.19.1b	UE positioning reporting for UE based methods	290
8.6.7.19.2	UE positioning OTDOA assistance data for UE-assisted	291
8.6.7.19.2a	UE positioning OTDOA assistance data for UE-based	291
8.6.7.19.3	UE positioning GPS assistance data	293
8.6.7.19.4	UE positioning Ciphering info	296
8.6.7.19.5	UE positioning Error	297
8.6.7.19.6	Void	297
8.6.7.20	Void	297
8.6.7.21	Intra-frequency reporting quantity for RACH reporting	297
8.6.7.22	Additional Measurement List	297
8.6.8	Void	298
9	Handling of unknown, unforeseen and erroneous protocol data	298
9.1	General	298
9.2	ASN.1 violation or encoding error	298
9.3	Unknown or unforeseen message type	299
9.3a	Unsolicited received message	299
9.3b	Unexpected critical message extension	300
9.4	Unknown or unforeseen information element value, mandatory information element	300
9.5	Conditional information element error	301
9.6	Unknown or unforeseen information element value, conditional information element	301
9.7	Unknown or unforeseen information element value, optional information element	302
9.8	Unexpected non-critical message extension	302
9.9	Handling of errors in nested information elements	303
10	Message and information element functional definition and content	303
10.1	General	303
10.1.1	Protocol extensions	304
10.1.1.1	Non-critical extensions	306

10.1.1.1.1	Extension of an information element with additional values or choices	306
10.1.1.1.2	Extension of a message with additional information elements	306
10.1.1.2	Critical extensions	307
10.1.1.2.1	Extension of an information element with additional values or choices	307
10.1.1.2.2	Extension of a message with additional information elements	307
10.2	Radio Resource Control messages	307
10.2.1	ACTIVE SET UPDATE	307
10.2.2	ACTIVE SET UPDATE COMPLETE	308
10.2.3	ACTIVE SET UPDATE FAILURE	308
10.2.4	ASSISTANCE DATA DELIVERY	309
10.2.5	CELL CHANGE ORDER FROM UTRAN	310
10.2.6	CELL CHANGE ORDER FROM UTRAN FAILURE	310
10.2.7	CELL UPDATE	311
10.2.8	CELL UPDATE CONFIRM	312
10.2.9	COUNTER CHECK	315
10.2.10	COUNTER CHECK RESPONSE	315
10.2.11	DOWNLINK DIRECT TRANSFER	316
10.2.12	Void	316
10.2.13	Void	316
10.2.14	Void	317
10.2.15	HANDOVER FROM UTRAN COMMAND	317
10.2.16	HANDOVER FROM UTRAN FAILURE	318
10.2.16a	HANDOVER TO UTRAN COMMAND	319
10.2.16b	HANDOVER TO UTRAN COMPLETE	321
10.2.16c	INITIAL DIRECT TRANSFER	322
10.2.16d	INTER RAT HANDOVER INFO	322
10.2.17	MEASUREMENT CONTROL	323
10.2.18	MEASUREMENT CONTROL FAILURE	324
10.2.19	MEASUREMENT REPORT	325
10.2.20	PAGING TYPE 1	325
10.2.21	PAGING TYPE 2	326
10.2.22	PHYSICAL CHANNEL RECONFIGURATION	326
10.2.23	PHYSICAL CHANNEL RECONFIGURATION COMPLETE	328
10.2.24	PHYSICAL CHANNEL RECONFIGURATION FAILURE	329
10.2.25	PHYSICAL SHARED CHANNEL ALLOCATION	329
10.2.26	PUSCH CAPACITY REQUEST	330
10.2.27	RADIO BEARER RECONFIGURATION	331
10.2.28	RADIO BEARER RECONFIGURATION COMPLETE	334
10.2.29	RADIO BEARER RECONFIGURATION FAILURE	335
10.2.30	RADIO BEARER RELEASE	336
10.2.31	RADIO BEARER RELEASE COMPLETE	339
10.2.32	RADIO BEARER RELEASE FAILURE	340
10.2.33	RADIO BEARER SETUP	341
10.2.34	RADIO BEARER SETUP COMPLETE	344
10.2.35	RADIO BEARER SETUP FAILURE	346
10.2.36	RRC CONNECTION REJECT	346
10.2.37	RRC CONNECTION RELEASE	347
10.2.38	RRC CONNECTION RELEASE COMPLETE	348
10.2.39	RRC CONNECTION REQUEST	348
10.2.40	RRC CONNECTION SETUP	349
10.2.41	RRC CONNECTION SETUP COMPLETE	351
10.2.41a	RRC FAILURE INFO	352
10.2.42	RRC STATUS	352
10.2.43	SECURITY MODE COMMAND	353
10.2.44	SECURITY MODE COMPLETE	354
10.2.45	SECURITY MODE FAILURE	355
10.2.46	SIGNALLING CONNECTION RELEASE	355
10.2.47	SIGNALLING CONNECTION RELEASE INDICATION	356
10.2.48	SYSTEM INFORMATION	356
10.2.48.1	First Segment	358
10.2.48.2	First Segment (short)	358
10.2.48.3	Subsequent Segment	358

10.2.48.4	Last Segment.....	359
10.2.48.5	Last Segment (short)	359
10.2.48.6	Complete SIB	359
10.2.48.7	Complete SIB (short)	360
10.2.48.8	System Information Blocks.....	360
10.2.48.8.1	Master Information Block	360
10.2.48.8.2	Scheduling Block 1.....	361
10.2.48.8.3	Scheduling Block 2.....	361
10.2.48.8.4	System Information Block type 1	361
10.2.48.8.5	System Information Block type 2.....	362
10.2.48.8.6	System Information Block type 3.....	362
10.2.48.8.7	System Information Block type 4.....	362
10.2.48.8.8	System Information Block type 5.....	363
10.2.48.8.9	System Information Block type 6.....	363
10.2.48.8.10	System Information Block type 7.....	365
10.2.48.8.11	System Information Block type 8.....	365
10.2.48.8.12	System Information Block type 9.....	366
10.2.48.8.13	System Information Block type 10.....	366
10.2.48.8.14	System Information Block type 11.....	366
10.2.48.8.15	System Information Block type 12.....	367
10.2.48.8.16	System Information Block type 13.....	367
10.2.48.8.16.1	System Information Block type 13.1	367
10.2.48.8.16.2	System Information Block type 13.2	368
10.2.48.8.16.3	System Information Block type 13.3	368
10.2.48.8.16.4	System Information Block type 13.4	368
10.2.48.8.17	System Information Block type 14.....	368
10.2.48.8.18	System Information Block type 15.....	369
10.2.48.8.18.1	System Information Block type 15.1	369
10.2.48.8.18.2	System Information Block type 15.2	369
10.2.48.8.18.3	System Information Block type 15.3	370
10.2.48.8.18.4	System Information Block type 15.4	370
10.2.48.8.19	System Information Block type 16.....	371
10.2.48.8.20	System Information Block type 17.....	371
10.2.48.8.21	System Information Block type 18.....	372
10.2.49	SYSTEM INFORMATION CHANGE INDICATION	372
10.2.50	TRANSPORT CHANNEL RECONFIGURATION	372
10.2.51	TRANSPORT CHANNEL RECONFIGURATION COMPLETE	374
10.2.52	TRANSPORT CHANNEL RECONFIGURATION FAILURE.....	376
10.2.53	TRANSPORT FORMAT COMBINATION CONTROL.....	376
10.2.54	TRANSPORT FORMAT COMBINATION CONTROL FAILURE.....	377
10.2.55	UE CAPABILITY ENQUIRY	378
10.2.56	UE CAPABILITY INFORMATION.....	378
10.2.57	UE CAPABILITY INFORMATION CONFIRM	379
10.2.58	UPLINK DIRECT TRANSFER	379
10.2.59	UPLINK PHYSICAL CHANNEL CONTROL.....	380
10.2.60	URA UPDATE	381
10.2.61	URA UPDATE CONFIRM	382
10.2.62	UTRAN MOBILITY INFORMATION	383
10.2.63	UTRAN MOBILITY INFORMATION CONFIRM	384
10.2.64	UTRAN MOBILITY INFORMATION FAILURE.....	385
10.3	Information element functional definitions	385
10.3.1	CN Information elements.....	385
10.3.1.1	CN domain identity	385
10.3.1.2	CN Domain System Information.....	385
10.3.1.3	CN Information info.....	386
10.3.1.3a	CN Information info full	387
10.3.1.4	IMEI.....	387
10.3.1.5	IMSI (GSM-MAP)	387
10.3.1.6	Intra Domain NAS Node Selector.....	388
10.3.1.7	Location Area Identification	389
10.3.1.8	NAS message	389
10.3.1.9	NAS system information (GSM-MAP).....	390

10.3.1.10	Paging record type identifier	390
10.3.1.11	PLMN identity	390
10.3.1.12	PLMN Type	390
10.3.1.13	P-TMSI (GSM-MAP)	391
10.3.1.14	RAB identity	391
10.3.1.15	Routing Area Code.....	391
10.3.1.16	Routing Area Identification.....	391
10.3.1.17	TMSI (GSM-MAP).....	392
10.3.2	UTRAN mobility Information elements	392
10.3.2.1	Cell Access Restriction	392
10.3.2.2	Cell identity.....	393
10.3.2.3	Cell selection and re-selection info for SIB3/4	393
10.3.2.4	Cell selection and re-selection info for SIB11/12	395
10.3.2.5	Mapping Info.....	396
10.3.2.6	URA identity.....	397
10.3.3	UE Information elements.....	397
10.3.3.1	Activation time.....	397
10.3.3.2	Capability Update Requirement	397
10.3.3.3	Cell update cause	398
10.3.3.4	Ciphering Algorithm	398
10.3.3.5	Ciphering mode info	398
10.3.3.6	CN domain specific DRX cycle length coefficient	399
10.3.3.7	CPCH Parameters	399
10.3.3.8	C-RNTI	400
10.3.3.9	DRAC system information.....	401
10.3.3.9a	DSCH-RNTI	401
10.3.3.10	Void.....	401
10.3.3.11	Establishment cause	402
10.3.3.12	Expiration Time Factor	403
10.3.3.13	Failure cause	403
10.3.3.14	Failure cause and error information	403
10.3.3.15	Initial UE identity.....	404
10.3.3.16	Integrity check info	404
10.3.3.17	Integrity protection activation info.....	405
10.3.3.18	Integrity protection Algorithm	405
10.3.3.19	Integrity protection mode info.....	406
10.3.3.20	Maximum bit rate.....	406
10.3.3.21	Measurement capability	406
10.3.3.21a	Measurement capability extension	408
10.3.3.22	Paging cause.....	410
10.3.3.23	Paging record	410
10.3.3.24	PDCP capability.....	411
10.3.3.25	Physical channel capability	411
10.3.3.26	Protocol error cause.....	414
10.3.3.27	Protocol error indicator	415
10.3.3.28	RB timer indicator.....	415
10.3.3.29	Redirection info.....	415
10.3.3.30	Re-establishment timer.....	415
10.3.3.31	Rejection cause	416
10.3.3.32	Release cause	416
10.3.3.33	RF capability FDD	416
10.3.3.33a	RF capability FDD extension	417
10.3.3.33b	RF capability TDD.....	417
10.3.3.34	RLC capability	417
10.3.3.35	RLC re-establish indicator	417
10.3.3.35a	RRC State Indicator	417
10.3.3.36	RRC transaction identifier.....	418
10.3.3.37	Security capability.....	418
10.3.3.38	START	418
10.3.3.39	Transmission probability.....	418
10.3.3.40	Transport channel capability	419
10.3.3.41	UE multi-mode/multi-RAT capability	420

10.3.3.42	UE radio access capability	421
10.3.3.42a	UE radio access capability extension	422
10.3.3.42b	UE security information	422
10.3.3.43	UE Timers and Constants in connected mode	422
10.3.3.44	UE Timers and Constants in idle mode	423
10.3.3.45	UE positioning capability	424
10.3.3.46	URA update cause	424
10.3.3.47	U-RNTI	425
10.3.3.48	U-RNTI Short	425
10.3.3.49	UTRAN DRX cycle length coefficient	425
10.3.3.50	Wait time	425
10.3.3.51	UE Specific Behaviour Information 1 idle	425
10.3.3.52	UE Specific Behaviour Information 1 interRAT	426
10.3.4	Radio Bearer Information elements	426
10.3.4.0	Default configuration identity	426
10.3.4.1	Downlink RLC STATUS info	426
10.3.4.2	PDCP info	426
10.3.4.3	PDCP SN info	429
10.3.4.4	Polling info	429
10.3.4.5	Predefined configuration identity	429
10.3.4.5a	Predefined configuration status information	430
10.3.4.6	Predefined configuration value tag	430
10.3.4.7	Predefined RB configuration	431
10.3.4.8	RAB info	431
10.3.4.9	RAB info Post	432
10.3.4.10	RAB information for setup	432
10.3.4.11	RAB information to reconfigure	432
10.3.4.12	NAS Synchronization indicator	432
10.3.4.13	RB activation time info	433
10.3.4.14	RB COUNT-C MSB information	433
10.3.4.15	RB COUNT-C information	433
10.3.4.16	RB identity	433
10.3.4.17	RB information to be affected	434
10.3.4.18	RB information to reconfigure	434
10.3.4.19	RB information to release	434
10.3.4.20	RB information to setup	434
10.3.4.21	RB mapping info	435
10.3.4.22	RB with PDCP information	436
10.3.4.23	RLC info	437
10.3.4.24	Signalling RB information to setup	438
10.3.4.25	Transmission RLC Discard	438
10.3.5	Transport CH Information elements	440
10.3.5.1	Added or Reconfigured DL TrCH information	440
10.3.5.2	Added or Reconfigured UL TrCH information	440
10.3.5.3	CPCH set ID	440
10.3.5.4	Deleted DL TrCH information	441
10.3.5.5	Deleted UL TrCH information	441
10.3.5.6	DL Transport channel information common for all transport channels	441
10.3.5.7	DRAC Static Information	442
10.3.5.8	Power Offset Information	442
10.3.5.9	Predefined TrCH configuration	443
10.3.5.10	Quality Target	444
10.3.5.11	Semi-static Transport Format Information	444
10.3.5.12	TFCI Field 2 Information	444
10.3.5.13	TFCS Explicit Configuration	445
10.3.5.14	TFCS Information for DSCH (TFCI range method)	445
10.3.5.15	TFCS Reconfiguration/Addition Information	447
10.3.5.16	TFCS Removal Information	448
10.3.5.17	Void	448
10.3.5.18	Transport channel identity	448
10.3.5.19	Transport Format Combination (TFC)	448
10.3.5.20	Transport Format Combination Set	448

10.3.5.21	Transport Format Combination Set Identity	449
10.3.5.22	Transport Format Combination Subset	449
10.3.5.23	Transport Format Set.....	450
10.3.5.24	UL Transport channel information common for all transport channels	452
10.3.6	Physical CH Information elements	453
10.3.6.1	AC-to-ASC mapping.....	453
10.3.6.2	AICH Info	454
10.3.6.3	AICH Power offset.....	454
10.3.6.4	Allocation period info	454
10.3.6.5	Alpha.....	454
10.3.6.6	ASC setting	454
10.3.6.7	Void.....	456
10.3.6.8	CCTrCH power control info	456
10.3.6.8a	Cell and Channel Identity info	456
10.3.6.9	Cell parameters Id	457
10.3.6.10	Common timeslot info.....	457
10.3.6.11	Constant value.....	457
10.3.6.11a	Constant value TDD.....	458
10.3.6.12	CPCH persistence levels	458
10.3.6.13	CPCH set info	458
10.3.6.14	CPCH Status Indication mode.....	460
10.3.6.15	CSICH Power offset.....	461
10.3.6.16	Default DPCH Offset Value.....	461
10.3.6.17	Downlink channelisation codes.....	461
10.3.6.18	Downlink DPCH info common for all RL	462
10.3.6.19	Downlink DPCH info common for all RL Post	463
10.3.6.20	Downlink DPCH info common for all RL Pre	463
10.3.6.21	Downlink DPCH info for each RL.....	464
10.3.6.22	Downlink DPCH info for each RL Post.....	466
10.3.6.23	Downlink DPCH power control information	467
10.3.6.24	Downlink information common for all radio links.....	467
10.3.6.25	Downlink information common for all radio links Post.....	467
10.3.6.26	Downlink information common for all radio links Pre	468
10.3.6.27	Downlink information for each radio link.....	468
10.3.6.28	Downlink information for each radio link Post.....	468
10.3.6.29	Void.....	469
10.3.6.30	Downlink PDSCH information	469
10.3.6.31	Downlink rate matching restriction information	469
10.3.6.32	Downlink Timeslots and Codes	469
10.3.6.33	DPCH compressed mode info	470
10.3.6.34	DPCH Compressed Mode Status Info.....	473
10.3.6.35	Dynamic persistence level.....	474
10.3.6.35a	FPACH info	474
10.3.6.36	Frequency info	474
10.3.6.37	Individual timeslot info	474
10.3.6.38	Individual Timeslot interference	475
10.3.6.39	Maximum allowed UL TX power.....	475
10.3.6.40	Void.....	475
10.3.6.41	Midamble shift and burst type.....	475
10.3.6.42	PDSCH Capacity Allocation info	477
10.3.6.43	PDSCH code mapping	477
10.3.6.44	PDSCH info	479
10.3.6.45	PDSCH Power Control info	479
10.3.6.46	PDSCH system information	479
10.3.6.47	PDSCH with SHO DCH Info.....	480
10.3.6.48	Persistence scaling factors.....	480
10.3.6.49	PICH Info.....	480
10.3.6.50	PICH Power offset	481
10.3.6.51	PRACH Channelisation Code List.....	481
10.3.6.51a	PRACH Channelisation Code 1.28 Mcps TDD	482
10.3.6.52	PRACH info (for RACH).....	482
10.3.6.53	PRACH partitioning.....	484

10.3.6.54	PRACH power offset	484
10.3.6.55	PRACH system information list.....	484
10.3.6.56	Predefined PhyCH configuration	486
10.3.6.57	Primary CCPCH info	486
10.3.6.58	Primary CCPCH info post.....	486
10.3.6.59	Primary CCPCH TX Power	487
10.3.6.60	Primary CPICH info.....	487
10.3.6.61	Primary CPICH Tx power.....	487
10.3.6.62	Primary CPICH usage for channel estimation	487
10.3.6.63	PUSCH info	487
10.3.6.64	PUSCH Capacity Allocation info	488
10.3.6.65	PUSCH power control info	488
10.3.6.66	PUSCH system information	489
10.3.6.67	RACH transmission parameters	489
10.3.6.68	Radio link addition information	489
10.3.6.69	Radio link removal information	490
10.3.6.70	SCCPCH Information for FACH	490
10.3.6.70a	SCTD indicator	490
10.3.6.71	Secondary CCPCH info	491
10.3.6.72	Secondary CCPCH system information.....	492
10.3.6.73	Secondary CPICH info.....	492
10.3.6.74	Secondary scrambling code.....	492
10.3.6.75	SFN Time info	493
10.3.6.75a	Special Burst Scheduling	493
10.3.6.76	SSDT cell identity	493
10.3.6.77	SSDT information	493
10.3.6.78	STTD indicator	493
10.3.6.78a	SYNC_UL info	494
10.3.6.79	TDD open loop power control	494
10.3.6.80	TFC Control duration	495
10.3.6.81	TFCI Combining Indicator.....	495
10.3.6.82	TGPSI	495
10.3.6.83	Time info.....	496
10.3.6.84	Timeslot number	496
10.3.6.85	TPC combination index.....	496
10.3.6.85a	TSTD indicator	496
10.3.6.86	TX Diversity Mode	496
10.3.6.87	UL interference	497
10.3.6.87a	UL interference TDD	497
10.3.6.88	Uplink DPCH info	498
10.3.6.89	Uplink DPCH info Post.....	499
10.3.6.90	Uplink DPCH info Pre	499
10.3.6.91	Uplink DPCH power control info	499
10.3.6.92	Uplink DPCH power control info Post	500
10.3.6.93	Uplink DPCH power control info Pre	501
10.3.6.94	Uplink Timeslots and Codes	501
10.3.6.95	Uplink Timing Advance.....	502
10.3.6.96	Uplink Timing Advance Control.....	503
10.3.7	Measurement Information elements.....	504
10.3.7.1	Additional measurements list	504
10.3.7.2	Cell info	504
10.3.7.3	Cell measured results	506
10.3.7.4	Cell measurement event results.....	506
10.3.7.5	Cell reporting quantities	507
10.3.7.6	Cell synchronisation information	507
10.3.7.7	Event results	507
10.3.7.8	FACH measurement occasion info	508
10.3.7.9	Filter coefficient.....	509
10.3.7.10	HCS Cell re-selection information.....	509
10.3.7.11	HCS neighbouring cell information	509
10.3.7.12	HCS Serving cell information.....	510
10.3.7.13	Inter-frequency cell info list.....	510

10.3.7.14	Inter-frequency event identity	511
10.3.7.15	Inter-frequency measured results list	511
10.3.7.16	Inter-frequency measurement.....	511
10.3.7.17	Inter-frequency measurement event results.....	512
10.3.7.18	Inter-frequency measurement quantity.....	512
10.3.7.19	Inter-frequency measurement reporting criteria.....	513
10.3.7.20	Inter-frequency measurement system information.....	515
10.3.7.21	Inter-frequency reporting quantity	515
10.3.7.22	Inter-frequency SET UPDATE	515
10.3.7.23	Inter-RAT cell info list.....	516
10.3.7.24	Inter-RAT event identity	517
10.3.7.25	Inter-RAT info	517
10.3.7.26	Inter-RAT measured results list	518
10.3.7.27	Inter-RAT measurement.....	519
10.3.7.28	Inter-RAT measurement event results.....	519
10.3.7.29	Inter-RAT measurement quantity.....	520
10.3.7.30	Inter-RAT measurement reporting criteria.....	520
10.3.7.31	Inter-RAT measurement system information.....	521
10.3.7.32	Inter-RAT reporting quantity	521
10.3.7.33	Intra-frequency cell info list.....	522
10.3.7.34	Intra-frequency event identity	522
10.3.7.35	Intra-frequency measured results list	523
10.3.7.36	Intra-frequency measurement.....	523
10.3.7.37	Intra-frequency measurement event results.....	523
10.3.7.38	Intra-frequency measurement quantity.....	524
10.3.7.39	Intra-frequency measurement reporting criteria.....	524
10.3.7.40	Intra-frequency measurement system information.....	526
10.3.7.41	Intra-frequency reporting quantity	527
10.3.7.42	Intra-frequency reporting quantity for RACH reporting	527
10.3.7.43	Maximum number of reported cells on RACH.....	528
10.3.7.44	Measured results	528
10.3.7.45	Measured results on RACH	529
10.3.7.46	Measurement Command	530
10.3.7.47	Measurement control system information.....	531
10.3.7.48	Measurement Identity.....	531
10.3.7.49	Measurement reporting mode.....	532
10.3.7.50	Measurement Type.....	532
10.3.7.51	Measurement validity.....	532
10.3.7.52	Observed time difference to GSM cell.....	532
10.3.7.53	Periodical reporting criteria.....	533
10.3.7.53a	PLMN identities of neighbour cells	533
10.3.7.54	Primary CCPCH RSCP info.....	534
10.3.7.54a	Qhcs	534
10.3.7.55	Quality measured results list	535
10.3.7.56	Quality measurement	536
10.3.7.57	Quality measurement event results	536
10.3.7.58	Quality measurement reporting criteria.....	536
10.3.7.59	Quality reporting quantity	537
10.3.7.60	Reference time difference to cell	537
10.3.7.61	Reporting Cell Status	537
10.3.7.62	Reporting information for state CELL_DCH.....	540
10.3.7.63	SFN-SFN observed time difference	540
10.3.7.64	Time to trigger	540
10.3.7.65	Timeslot ISCP info.....	540
10.3.7.66	Traffic volume event identity	541
10.3.7.67	Traffic volume measured results list	541
10.3.7.68	Traffic volume measurement	542
10.3.7.69	Traffic volume measurement event results	542
10.3.7.70	Traffic volume measurement object.....	543
10.3.7.71	Traffic volume measurement quantity	543
10.3.7.72	Traffic volume measurement reporting criteria.....	544
10.3.7.73	Traffic volume measurement system information.....	545

10.3.7.74	Traffic volume reporting quantity	545
10.3.7.75	UE internal event identity	545
10.3.7.76	UE internal measured results.....	546
10.3.7.77	UE internal measurement.....	547
10.3.7.78	UE internal measurement event results.....	547
10.3.7.79	UE internal measurement quantity.....	547
10.3.7.80	UE internal measurement reporting criteria	548
10.3.7.81	Void.....	549
10.3.7.82	UE Internal reporting quantity	549
10.3.7.83	UE Rx-Tx time difference type 1	549
10.3.7.84	UE Rx-Tx time difference type 2.....	550
10.3.7.85	UE Transmitted Power info.....	550
10.3.7.86	UE positioning Ciphering info	550
10.3.7.87	UE positioning Error	550
10.3.7.88	UE positioning GPS acquisition assistance.....	551
10.3.7.88a	UE positioning GPS Additional Assistance Data Request.....	551
10.3.7.89	UE positioning GPS almanac	553
10.3.7.90	UE positioning GPS assistance data.....	553
10.3.7.90a	Void.....	554
10.3.7.91	UE positioning GPS DGPS corrections	554
10.3.7.91a	UE positioning GPS Ephemeris and Clock Correction parameters.....	555
10.3.7.92	UE positioning GPS ionospheric model.....	557
10.3.7.93	UE positioning GPS measured results.....	557
10.3.7.94	UE positioning GPS navigation model	558
10.3.7.95	UE positioning GPS real-time integrity	559
10.3.7.95a	Void.....	559
10.3.7.96	UE positioning GPS reference time	559
10.3.7.97	UE positioning GPS UTC model	560
10.3.7.98	UE positioning IPDL parameters	560
10.3.7.99	UE positioning measured results	561
10.3.7.100	UE positioning measurement	561
10.3.7.101	UE positioning measurement event results	562
10.3.7.102	Void.....	562
10.3.7.103	UE positioning OTDOA assistance data for UE-assisted	562
10.3.7.103a	UE positioning OTDOA assistance data for UE-based.....	563
10.3.7.104	Void.....	563
10.3.7.105	UE positioning OTDOA measured results.....	563
10.3.7.106	UE positioning OTDOA neighbour cell info	564
10.3.7.106a	UE positioning OTDOA neighbour cell info for UE-based	566
10.3.7.107	UE positioning OTDOA quality	566
10.3.7.108	UE positioning OTDOA reference cell info.....	567
10.3.7.108a	UE positioning OTDOA reference cell info for UE-based	568
10.3.7.109	UE positioning position estimate info	568
10.3.7.109a	UE positioning Relative Time Difference quality.....	570
10.3.7.110	UE positioning reporting criteria.....	570
10.3.7.111	UE positioning reporting quantity.....	571
10.3.7.112	TADV info	572
10.3.8	Other Information elements	573
10.3.8.1	BCCH modification info	573
10.3.8.2	BSIC.....	573
10.3.8.3	CBS DRX Level 1 information.....	573
10.3.8.4	Cell Value tag.....	573
10.3.8.4a	Ellipsoid point.....	574
10.3.8.4b	Ellipsoid point with Altitude	574
10.3.8.4c	Ellipsoid point with Altitude and uncertainty ellipsoid.....	574
10.3.8.4d	Ellipsoid point with uncertainty Circle	575
10.3.8.4e	Ellipsoid point with uncertainty Ellipse	576
10.3.8.5	Inter-RAT change failure	576
10.3.8.6	Inter-RAT handover failure.....	577
10.3.8.7	Inter-RAT UE radio access capability.....	577
10.3.8.8	Void.....	578

10.3.8.8a	Inter-RAT UE security capability	578
10.3.8.9	MIB Value tag.....	579
10.3.8.10	PLMN Value tag	579
10.3.8.10a	PNBSCH allocation	579
10.3.8.11	Predefined configuration identity and value tag.....	579
10.3.8.12	Protocol error information.....	579
10.3.8.13	References to other system information blocks.....	580
10.3.8.14	References to other system information blocks and scheduling blocks	580
10.3.8.15	Rplmn information.....	580
10.3.8.16	Scheduling information.....	581
10.3.8.17	SEG COUNT	582
10.3.8.18	Segment index.....	582
10.3.8.18a	SIB and SB type.....	582
10.3.8.19	SIB data fixed.....	583
10.3.8.20	SIB data variable.....	583
10.3.8.20a	SIB occurrence identity.....	584
10.3.8.20b	SIB occurrence identity and value tag.....	584
10.3.8.20c	SIB occurrence value tag	584
10.3.8.21	SIB type	584
10.3.8.22	SIB type SIBs only.....	585
10.3.9	ANSI-41 Information elements.....	586
10.3.9.1	ANSI 41 Core Network Information.....	586
10.3.9.2	ANSI-41 Global Service Redirection information	587
10.3.9.3	ANSI-41 NAS parameter	587
10.3.9.4	ANSI-41 NAS system information	587
10.3.9.5	ANSI-41 Private Neighbour List information.....	587
10.3.9.6	ANSI-41 RAND information	587
10.3.9.7	ANSI-41 User Zone Identification information	587
10.3.9.8	MIN_P_REV.....	588
10.3.9.9	NID	588
10.3.9.10	P_REV	588
10.3.9.11	SID	588
10.3.10	Multiplicity values and type constraint values.....	588
11	Message and Information element abstract syntax (with ASN.1).....	591
11.0	General	591
11.1	General message structure.....	591
11.2	PDU definitions.....	595
11.3	Information element definitions	638
11.4	Constant definitions.....	755
11.5	RRC information between network nodes.....	756
12	Message transfer syntax	765
12.1	Structure of encoded RRC messages.....	765
12.1.1	Basic production	765
12.1.2	Extension	765
12.1.3	Padding	765
12.2	ECN link module for RRC	768
12.3	ECN modules for RRC.....	769
12.4	RRC messages encoded otherwise	769
12.4.1	Messages using tabular encoding specification	769
12.4.1.1	TRANSPORT FORMAT COMBINATION CONTROL using transparent DCCH.....	770
12.4.1.1.1	TRANSPORT FORMAT COMBINATION CONTROL, 3 bit format.....	770
12.4.1.1.2	TRANSPORT FORMAT COMBINATION CONTROL, 5 bit format.....	770
12.4.1.1.3	TRANSPORT FORMAT COMBINATION CONTROL, 10 bit format.....	770
13	Protocol timers, counters, other parameters and default configurations	771
13.1	Timers for UE.....	771
13.2	Counters for UE	772
13.3	UE constants and parameters.....	772
13.4	UE variables	772
13.4.0	CELL_INFO_LIST.....	772
13.4.00	Void	773

13.4.0a	CELL_UPDATE_STARTED	774
13.4.1	CIPHERING_STATUS	774
13.4.2	Void	774
13.4.2a	CONFIGURATION_INCOMPLETE	774
13.4.3	C_RNTI	775
13.4.3a	DSCH_RNTI	775
13.4.4	Void	775
13.4.5	ESTABLISHED_RABS	775
13.4.5a	ESTABLISHED_SIGNALLING_CONNECTIONS	776
13.4.6	ESTABLISHMENT_CAUSE	776
13.4.7	FAILURE_CAUSE	776
13.4.8	FAILURE_INDICATOR	776
13.4.8a	INCOMPATIBLE_SECURITY_RECONFIGURATION	777
13.4.9	INITIAL_UE_IDENTITY	777
13.4.9a	INTEGRITY_PROTECTION_ACTIVATION_INFO	777
13.4.10	INTEGRITY_PROTECTION_INFO	777
13.4.10a	INTER_RAT_HANDOVER_INFO_TRANSFERRED	778
13.4.11	INVALID_CONFIGURATION	778
13.4.11a	LATEST_CONFIGURED_CN_DOMAIN	779
13.4.12	MEASUREMENT_IDENTITY	779
13.4.13	Void	779
13.4.14	ORDERED_RECONFIGURATION	779
13.4.15	PDCP_SN_INFO	779
13.4.15a	PHYSICAL_SHARED_CHANNEL_CONFIGURATION	780
13.4.16	PROTOCOL_ERROR_INDICATOR	780
13.4.17	PROTOCOL_ERROR_INFORMATION	781
13.4.18	PROTOCOL_ERROR_REJECT	781
13.4.19	RB_TIMER_INDICATOR	781
13.4.20	RB_UPLINK_CIPHERING_ACTIVATION_TIME_INFO	781
13.4.20a	SECURITY_MODIFICATION	781
13.4.21	SELECTED_PLMN	782
13.4.22	START_THRESHOLD	782
13.4.23	START_VALUE_TO_TRANSMIT	782
13.4.24	TFC_SUBSET	782
13.4.25	TGPS_IDENTITY	784
13.4.26	TGSN_REPORTED	784
13.4.26a	TIMERS_AND_CONSTANTS	785
13.4.27	TRANSACTIONS	785
13.4.27a	TRIGGERED_1A_EVENT	785
13.4.27b	TRIGGERED_1B_EVENT	786
13.4.27c	TRIGGERED_1C_EVENT	787
13.4.27d	BEST_CELL_1D_EVENT	787
13.4.27e	TRIGGERED_1E_EVENT	787
13.4.27f	TRIGGERED_1F_EVENT	788
13.4.27f1	TRIGGERED_1G_EVENT	788
13.4.27f2	TRIGGERED_1H_EVENT	788
13.4.27f3	TRIGGERED_1I_EVENT	788
13.4.27f4	BEST_FREQUENCY_2A_EVENT	789
13.4.27f5	TRIGGERED_2B_EVENT	789
13.4.27f6	TRIGGERED_2C_EVENT	789
13.4.27f7	TRIGGERED_2D_EVENT	789
13.4.27f8	TRIGGERED_2E_EVENT	790
13.4.27f9	TRIGGERED_2F_EVENT	790
13.4.27f10	TRIGGERED_3A_EVENT	790
13.4.27f11	TRIGGERED_3B_EVENT	791
13.4.27f12	TRIGGERED_3C_EVENT	791
13.4.27f13	BEST_CELL_3D_EVENT	791
13.4.27f14	TRIGGERED_6A_EVENT	792
13.4.27f15	TRIGGERED_6B_EVENT	792
13.4.27f16	TRIGGERED_6C_EVENT	792
13.4.27f17	TRIGGERED_6D_EVENT	792
13.4.27f18	TRIGGERED_6E_EVENT	792

13.4.27f19	TRIGGERED_6F_EVENT	792
13.4.27f20	TRIGGERED_6G_EVENT	793
13.4.27g	UE_CAPABILITY_REQUESTED	793
13.4.28	UE_CAPABILITY_TRANSFERRED	793
13.4.28a	UE_POSITIONING_GPS_DATA	794
13.4.28b	UE_POSITIONING_OTDOA_DATA_UE_ASSISTED	795
13.4.28c	UE_POSITIONING_OTDOA_DATA_UE_BASED.....	796
13.4.29	UNSUPPORTED_CONFIGURATION	796
13.4.30	URA_IDENTITY	796
13.4.31	U_RNTI.....	796
13.4.32	VALUE_TAG.....	797
13.5	UE RRC Procedure Performance	798
13.5.1	Definitions	798
13.5.2	RRC procedure performance values	799
13.6	RB information parameters for signalling radio bearer RB 0.....	804
13.6a	RB information parameters for SHCCH	804
13.6b	RB information parameters for BCCH mapped to FACH.....	804
13.6c	RB information parameters for PCCH mapped to PCH.....	805
13.6d	Parameters for BCCH mapped to BCH.....	805
13.7	Parameter values for default radio configurations.....	805
14	Specific functions.....	829
14.1	Intra-frequency measurements	829
14.1.1	Intra-frequency measurement quantities	829
14.1.2	Intra-frequency reporting events for FDD	830
14.1.2.1	Reporting event 1A: A Primary CPICH enters the reporting range	830
14.1.2.2	Reporting event 1B: A primary CPICH leaves the reporting range	832
14.1.2.3	Reporting event 1C: A non-active primary CPICH becomes better than an active primary CPICH ..	834
14.1.2.4	Reporting event 1D: Change of best cell.....	837
14.1.2.5	Reporting event 1E: A Primary CPICH becomes better than an absolute threshold.....	838
14.1.2.6	Reporting event 1F: A Primary CPICH becomes worse than an absolute threshold	840
14.1.3	Intra-frequency reporting events for TDD	842
14.1.3.1	Reporting event 1G: Change of best cell (TDD).....	842
14.1.3.2	Reporting event 1H: Timeslot ISCP below a certain threshold (TDD).....	843
14.1.3.3	Reporting event 1I: Timeslot ISCP above a certain threshold (TDD).....	844
14.1.4	Event-triggered periodic intra-frequency measurement reports (informative)	846
14.1.4.1	Cell addition failure (FDD only).....	846
14.1.4.2	Cell replacement failure (FDD only)	847
14.1.5	Mechanisms available for modifying intra-frequency measurement reporting behaviour (informative)	847
14.1.5.1	Hysteresis.....	847
14.1.5.2	Time-to-trigger.....	848
14.1.5.3	Cell individual offsets	849
14.1.5.4	Forbid a Primary CPICH to affect the reporting range (FDD only).....	850
14.1.6	Report quantities in intra-frequency measurements.....	851
14.2	Inter-frequency measurements	852
14.2.0a	Inter-frequency measurement quantities	852
14.2.0b	Frequency quality estimate	852
14.2.0b.1	FDD cells	852
14.2.0b.2	TDD cells	853
14.2.0c	Inter-frequency reporting quantities	853
14.2.1	Inter-frequency reporting events.....	854
14.2.1.1	Event 2a: Change of best frequency.....	854
14.2.1.2	Event 2b: The estimated quality of the currently used frequency is below a certain threshold and the estimated quality of a non-used frequency is above a certain threshold.....	855
14.2.1.3	Event 2c: The estimated quality of a non-used frequency is above a certain threshold	856
14.2.1.4	Event 2d: The estimated quality of the currently used frequency is below a certain threshold.....	857
14.2.1.5	Event 2e: The estimated quality of a non-used frequency is below a certain threshold.....	858
14.2.1.6	Event 2 f: The estimated quality of the currently used frequency is above a certain threshold	859
14.3	Inter-RAT measurements	860
14.3.0a	Inter-RAT measurement quantities.....	860
14.3.0b	Frequency quality estimate of the UTRAN frequency	861

14.3.0c	Inter-RAT reporting quantities	861
14.3.1	Inter-RAT reporting events.....	861
14.3.1.1	Event 3a: The estimated quality of the currently used UTRAN frequency is below a certain threshold and the estimated quality of the other system is above a certain threshold.....	862
14.3.1.2	Event 3b: The estimated quality of other system is below a certain threshold.....	864
14.3.1.3	Event 3c: The estimated quality of other system is above a certain threshold	865
14.3.1.4	Event 3d: Change of best cell in other system	866
14.3.2	GSM measurements in compressed mode	868
14.3.2.1	GSM RSSI measurements.....	868
14.3.2.2	Initial BSIC identification.....	868
14.3.2.3	BSIC re-confirmation.....	868
14.4	Traffic Volume Measurements.....	868
14.4.1	Traffic Volume Measurement Quantity.....	868
14.4.2	Traffic Volume reporting triggers.....	869
14.4.2.1	Reporting event 4 A: Transport Channel Traffic Volume becomes larger than an absolute threshold.....	873
14.4.2.2	Reporting event 4 B: Transport Channel Traffic Volume becomes smaller than an absolute threshold.....	873
14.4.3	Traffic volume reporting mechanisms	874
14.4.3.1	Pending time after trigger.....	874
14.4.3.2	Time-to-trigger.....	874
14.4.4	Interruption of user data transmission.....	875
14.5	Quality Measurements.....	875
14.5.1	Quality reporting measurement quantities	875
14.5.2	Quality reporting events.....	875
14.5.2.1	Reporting event 5A: A predefined number of bad CRCs is exceeded	875
14.6	UE internal measurements.....	876
14.6.1	UE internal measurement quantities	876
14.6.2	UE internal measurement reporting events.....	876
14.6.2.1	Reporting event 6A: The UE Tx power becomes larger than an absolute threshold.....	876
14.6.2.2	Reporting event 6B: The UE Tx power becomes less than an absolute threshold	877
14.6.2.3	Reporting event 6C: The UE Tx power reaches its minimum value	878
14.6.2.4	Reporting event 6D: The UE Tx power reaches its maximum value	879
14.6.2.5	Reporting event 6E: The UE RSSI reaches the UE's dynamic receiver range	880
14.6.2.6	Reporting event 6F (FDD): The UE Rx-Tx time difference for a RL included in the active set becomes larger than an absolute threshold.....	880
14.6.2.6a	Reporting event 6F (1.28 Mcps TDD): The time difference indicated by T _{ADV} becomes larger than an absolute threshold.....	881
14.6.2.7	Reporting event 6G: The UE Rx-Tx time difference for a RL included in the active set becomes less than an absolute threshold	881
14.7	UE positioning measurements	882
14.7.1	UE positioning measurement quantities	882
14.7.2	Void	882
14.7.3	UE positioning reporting events	882
14.7.3.1	Reporting Event 7a: The UE position changes more than an absolute threshold.....	882
14.7.3.2	Reporting Event 7b: SFN-SFN measurement changes more than an absolute threshold.....	882
14.7.3.3	Reporting Event 7c: GPS time and SFN time have drifted apart more than an absolute threshold	883
14.8	Dynamic Resource Allocation Control of Uplink DCH (FDD only)	884
14.9	Downlink power control.....	884
14.9.1	Generalities	884
14.9.2	Downlink power control in compressed mode	885
14.10	Calculated Transport Format Combination	885
14.11	UE autonomous update of virtual active set on non-used frequency (FDD only).....	886
14.11.1	Initial virtual active set	886
14.11.2	Virtual active set update during an inter-frequency measurement.....	889
14.12	Provision and reception of RRC information between network nodes.....	892
14.12.0	General.....	892
14.12.0a	General error handling for RRC messages exchanged between network nodes	892
14.12.1	RRC Information to target RNC	893
14.12.2	RRC information, target RNC to source RNC.....	894
14.12.3	Void	895
14.12.4	RRC messages exchanged between network nodes.....	895

14.12.4.0	HANDOVER TO UTRAN COMMAND	895
14.12.4.0a	INTER RAT HANDOVER INFO	895
14.12.4.1	INTER RAT HANDOVER INFO WITH INTER RAT CAPABILITIES	895
14.12.4.2	SRNS RELOCATION INFO	896
14.12.4.3	Void.....	905
14.13	Void.....	905
14.14	Versatile Channel Assignment Mode (VCAM) mapping rule (FDD only).....	905
Annex A (informative): USIM parameters		906
A.1	Introduction	906
A.2	Ciphering information	906
A.3	Frequency information	906
A.4	Multiplicity values and type constraint values	907
Annex B (informative): Description of RRC state transitions.....		908
B.1	RRC states and state transitions including GSM.....	908
B.2	Transition from Idle Mode to UTRA RRC Connected Mode	908
B.2.1	Transitions for Emergency Calls	908
B.3	UTRA RRC Connected Mode States and Transitions.....	908
B.3.1	CELL_DCH state.....	908
B.3.1.1	Transition from CELL_DCH to Idle Mode.....	909
B.3.1.2	Transition from CELL_DCH to CELL_FACH state	909
B.3.1.3	Transition from CELL_DCH to CELL_PCH state	909
B.3.1.4	Transition from CELL_DCH to URA_PCH state.....	909
B.3.1.5	Radio Resource Allocation tasks (CELL_DCH).....	909
B.3.1.6	RRC Connection mobility tasks (CELL_DCH).....	909
B.3.1.7	UE Measurements (CELL_DCH)	910
B.3.1.8	Acquisition of system information (CELL_DCH).....	910
B.3.2	CELL_FACH state	910
B.3.2.1	Transition from CELL_FACH to CELL_DCH state	910
B.3.2.2	Transition from CELL_FACH to CELL_PCH state	910
B.3.2.3	Transition from CELL_FACH to Idle Mode	910
B.3.2.4	Transition from CELL_FACH to URA_PCH State.....	910
B.3.2.5	Radio Resource Allocation Tasks (CELL_FACH)	910
B.3.2.6	RRC Connection mobility tasks (CELL_FACH).....	911
B.3.2.7	UE Measurements (CELL_FACH)	911
B.3.2.8	Transfer and update of system information (CELL_FACH).....	911
B.3.3	CELL_PCH state	912
B.3.3.1	Transition from CELL_PCH to CELL_FACH state	912
B.3.3.2	Radio Resource Allocation Tasks (CELL_PCH).....	912
B.3.3.3	RRC Connection mobility tasks (CELL_PCH).....	912
B.3.3.4	UE Measurements (CELL_PCH).....	912
B.3.3.5	Transfer and update of system information (CELL_PCH)	912
B.3.4	URA_PCH State	913
B.3.4.1	Transition from URA_PCH State to CELL_FACH State (URA_PCH)	913
B.3.4.2	Radio Resource Allocation Tasks (URA_PCH).....	913
B.3.4.3	RRC Connection mobility tasks (URA_PCH)	913
B.3.4.4	UE Measurements (URA_PCH)	913
B.3.4.5	Transfer and update of system information (URA_PCH).....	914
B.3.5	States and Transitions for Cell Reselection in URA_PCH, CELL_PCH, and CELL_FACH	914
B.4	Inter-RAT handover with CS domain services.....	914
B.5	Inter-RAT handover with PS domain services	915
B.6	Inter-RAT handover with simultaneous PS and CS domain services.....	915
B.6.1	Inter-RAT handover UTRAN to GSM / BSS	915
B.6.2	Inter-RAT handover GSM / BSS to UTRAN	915
Annex C (informative): Change history		916
History		935

Foreword

This Technical Specification has been produced by the 3rd Generation Partnership Project (3GPP).

The contents of the present document are subject to continuing work within the TSG and may change following formal TSG approval. Should the TSG modify the contents of the present document, it will be re-released by the TSG with an identifying change of release date and an increase in version number as follows:

Version x.y.z

where:

- x the first digit:
 - 1 presented to TSG for information;
 - 2 presented to TSG for approval;
 - 3 or greater indicates TSG approved document under change control.
- y the second digit is incremented for all changes of substance, i.e. technical enhancements, corrections, updates, etc.
- z the third digit is incremented when editorial only changes have been incorporated in the document.

1 Scope

The present document specifies the Radio Resource Control protocol for the UE-UTRAN radio interface.

The scope of the present document also includes:

- the information to be transported in a transparent container between source RNC and target RNC in connection with SRNC relocation;
- the information to be transported in a transparent container between a target RNC and another system.

2 References

The following documents contain provisions which, through reference in this text, constitute provisions of the present document.

- References are either specific (identified by date of publication, edition number, version number, etc.) or non-specific.
- For a specific reference, subsequent revisions do not apply.
- For a non-specific reference, the latest version applies. In the case of a reference to a 3GPP document (including a GSM document), a non-specific reference implicitly refers to the latest version of that document *in the same Release as the present document*.

- [1] 3GPP TR 21.905: "Vocabulary for 3GPP Specifications".
- [2] 3GPP TS 25.301: "Radio Interface Protocol Architecture".
- [3] 3GPP TS 25.303: "Interlayer Procedures in Connected Mode".
- [4] 3GPP TS 25.304: "UE Procedures in Idle Mode and Procedures for Cell Reselection in Connected Mode".
- [5] 3GPP TS 24.008: "Mobile radio interface layer 3 specification; Core Network Protocols; Stage 3".
- [6] 3GPP TS 25.103: "RF parameters in support of RRM".
- [7] 3GPP TS 25.215: "Physical layer – Measurements (FDD)".
- [8] 3GPP TS 25.225: "Physical layer – Measurements (TDD)".
- [9] 3GPP TS 25.401: "UTRAN overall description".
- [10] 3GPP TS 25.402: "Synchronization in UTRAN; Stage 2".
- [11] 3GPP TS 23.003: "Numbering, addressing and identification".
- [12] ICD-GPS-200: "Navstar GPS Space Segment/Navigation User Interface".
- [13] RTCM-SC104: "RTCM Recommended Standards for Differential GNSS Service (v.2.2)".
- [14] 3GPP TR 25.921: "Guidelines and principles for protocol description and error handling".
- [15] 3GPP TS 25.321: "Medium Access Control (MAC) protocol specification".
- [16] 3GPP TS 25.322: "Radio Link Control (RLC) protocol specification".
- [17] 3GPP TS 24.007: "Mobile radio interface signalling layer 3; General aspects".
- [18] 3GPP TS 25.305: "Stage 2 Functional Specification of UE Positioning in UTRAN".
- [19] 3GPP TS 25.133: "Requirements for Support of Radio Resource Management (FDD)".

- [20] 3GPP TS 25.123: "Requirements for Support of Radio Resource Management (TDD)".
- [21] 3GPP TS 25.101: "UE Radio Transmission and Reception (FDD)".
- [22] 3GPP TS 25.102: "UE Radio Transmission and Reception (TDD)".
- [23] 3GPP TS 23.060: "General Packet Radio Service (GPRS); Service description; Stage 2".
- [24] 3GPP TS 23.032: "Universal Geographical Area Description (GAD)".
- [25] 3GPP TS 23.122: "Non-Access-Stratum functions related to Mobile Station (MS) in idle mode".
- [26] 3GPP TS 25.211: "Physical channels and mapping of transport channels onto physical channels (FDD)".
- [27] 3GPP TS 25.212: "Multiplexing and channel coding (FDD)".
- [28] 3GPP TS 25.213: "Spreading and modulation (FDD)".
- [29] 3GPP TS 25.214: "Physical layer procedures (FDD)".
- [30] 3GPP TS 25.221: "Physical channels and mapping of transport channels onto physical channels (TDD)".
- [31] 3GPP TS 25.222: "Multiplexing and channel coding (TDD)".
- [32] 3GPP TS 25.223: "Spreading and modulation (TDD)".
- [33] 3GPP TS 25.224: "Physical Layer Procedures (TDD)".
- [34] 3GPP TS 25.302: "Services provided by the physical layer".
- [35] 3GPP TS 25.306 "UE Radio Access Capabilities".
- [36] 3GPP TS 25.323: "Packet Data Convergence Protocol (PDCP) Specification".
- [37] 3GPP TS 25.324: "Broadcast/Multicast Control BMC".
- [38] 3GPP TR 25.922: "Radio resource management strategies".
- [39] 3GPP TR 25.925: "Radio interface for broadcast/multicast services".
- [40] 3GPP TS 33.102: "3G Security; Security Architecture".
- [41] 3GPP TS 34.108: "Common Test Environments for User Equipment (UE) Conformance Testing".
- [42] 3GPP TS 34.123-2: "User Equipment (UE) conformance specification; Part 2: Implementation Conformance Statement (ICS) proforma specification".
- [43] 3GPP TS 44.018: "Mobile radio interface layer 3 specification; Radio Resource Control Protocol".
- [44] 3GPP TS 44.060: "General Packet Radio Service (GPRS); Mobile Station (MS) - Base Station System (BSS) interface; Radio Link Control/Medium Access Control (RLC/MAC) protocol".
- [45] 3GPP TS 45.005: "Radio transmission and reception".
- [46] 3GPP TS 45.008: "Radio subsystem link control".
- [47] ITU-T Recommendation X.680 (12/97) "Information Technology - Abstract Syntax Notation One (ASN.1): Specification of basic notation".
- [48] ITU-T Recommendation X.681 (12/97) "Information Technology - Abstract Syntax Notation One (ASN.1): Information object specification".
- [49] ITU-T Recommendation X.691 (12/97) "Information technology - ASN.1 encoding rules: Specification of Packed Encoding Rules (PER)".
- [50] 3GPP TS 31.102: "Characteristics of the USIM Application".

3 Definitions and abbreviations

3.1 Definitions

For the purposes of the present document, the terms and definitions given in [1] apply.

3.2 Abbreviations

For the purposes of the present document, the following abbreviations apply:

ACK	Acknowledgement
AICH	Acquisition Indicator CHannel
AM	Acknowledged Mode
AS	Access Stratum
ASC	Access Service Class
ASN.1	Abstract Syntax Notation.1
BCCH	Broadcast Control Channel
BCFE	Broadcast Control Functional Entity
BER	Bit Error Rate
BLER	BLock Error Rate
BSS	Base Station Sub-system
CCCH	Common Control Channel
CCPCH	Common Control Physical CHannel
CH	Conditional on history
CM	Connection Management
CN	Core Network
CPCH	Common Packet CHannel
C-RNTI	Cell RNTI
CTCH	Common Traffic CHannel
CTFC	Calculated Transport Format Combination
CV	Conditional on value
DCA	Dynamic Channel Allocation
DCCH	Dedicated Control Channel
DCFE	Dedicated Control Functional Entity
DCH	Dedicated Channel
DC-SAP	Dedicated Control SAP
DGPS	Differential Global Positioning System
DL	Downlink
DRAC	Dynamic Resource Allocation Control
DSCH	Downlink Shared Channel
DTCH	Dedicated Traffic Channel
FACH	Forward Access Channel
FDD	Frequency Division Duplex
FFS	For Further Study
GC-SAP	General Control SAP
HCS	Hierarchical Cell Structure
HFN	Hyper Frame Number
ID	Identifier
IDNNS	Intra Domain NAS Node Selector
IE	Information element
IETF	Internet Engineering Task Force
IMEI	International Mobile Equipment Identity
IMSI	International Mobile Subscriber Identity
IP	Internet Protocol
ISCP	Interference on Signal Code Power
L1	Layer 1
L2	Layer 2
L3	Layer 3
LAI	Location Area Identity

MAC	Media Access Control
MCC	Mobile Country Code
MD	Mandatory default
MM	Mobility Management
MNC	Mobile Network Code
MP	Mandatory present
NAS	Non Access Stratum
Nt-SAP	Notification SAP
NW	Network
OP	Optional
PCCH	Paging Control Channel
PCH	Paging Channel
PDCP	Packet Data Convergence Protocol
PDSCH	Physical Downlink Shared Channel
PDU	Protocol Data Unit
PLMN	Public Land Mobile Network
PNFE	Paging and Notification Control Functional Entity
PRACH	Physical Random Access Channel
P-TMSI	Packet Temporary Mobile Subscriber Identity
PUSCH	Physical Uplink Shared Channel
QoS	Quality of Service
RAB	Radio access bearer
RACH	Random Access Channel
RAI	Routing Area Identity
RAT	Radio Access Technology
RB	Radio Bearer
RFE	Routing Functional Entity
RL	Radio Link
RLC	Radio Link Control
RNC	Radio Network Controller
RNTI	Radio Network Temporary Identifier
RRC	Radio Resource Control
RSCP	Received Signal Code Power
RSSI	Received Signal Strength Indicator
SAP	Service Access Point
SCFE	Shared Control Function Entity
SCTD	Space Code Transmit Diversity
SF	Spreading Factor
SHCCH	Shared Control Channel
SIR	Signal to Interference Ratio
S-RNTI	SRNC - RNTI
SSDT	Site Selection Diversity Transmission
TDD	Time Division Duplex
TF	Transport Format
TFCS	Transport Format Combination Set
TFS	Transport Format Set
TM	Transparent Mode
TME	Transfer Mode Entity
TMSI	Temporary Mobile Subscriber Identity
Tr	Transparent
Tx	Transmission
UE	User Equipment
UL	Uplink
UM	Unacknowledged Mode
URA	UTRAN Registration Area
U-RNTI	UTRAN-RNTI
USCH	Uplink Shared Channel
UTRAN	Universal Terrestrial Radio Access Network

4 General

If not specified differently, descriptions are relevant for both FDD and TDD. Descriptions for TDD only are relevant for both 1.28 Mcps TDD and 3.84 Mcps TDD if not specified differently.

4.1 Overview of the specification

This specification is organised as follows:

- subclause 4.2 contains the description of the model of the RRC protocol layer;
- clause 5 lists the RRC functions and the services provided to upper layers;
- clause 6 lists the services expected from the lower layers and specifies the radio bearers available for usage by the RRC messages;
- clause 7 specifies the UE states for the Access Stratum, and also specifies the processes running in the UE in the respective states;
- clause 8 specifies RRC procedures, including UE state transitions;
- clause 9 specifies the procedures for the handling of unknown, unforeseen, and erroneous protocol data by the receiving entity;
- clause 10 describes the message in a Tabular format; these messages descriptions are referenced in clause 8;
- clause 11 specifies the encoding of the messages of the RRC protocol. This is based on the Tabular description in clause 10.
- clause 12 specifies the transfer syntax for RRC PDUs derived from the encoding definition;
- clause 13 lists the protocol timers, counters, constants and variables to be used by the UE;
- clause 14 specifies some of the processes applicable in UTRA RRC connected mode e.g. measurement processes, and also the RRC information to be transferred between network nodes. Note that not all the processes applicable in UTRA RRC connected mode are specified here i.e. some UTRA RRC connected mode processes are described in [4] e.g. cell re-selection;
- Annex A contains recommendations about the network parameters to be stored on the USIM;
- Annex B contains informative Stage 2 description of the RRC protocol states and state transitions.

The following figure summarises the mapping of UE states, including states in GSM, to the appropriate UTRA and GSM specifications that specify the UE behaviour.

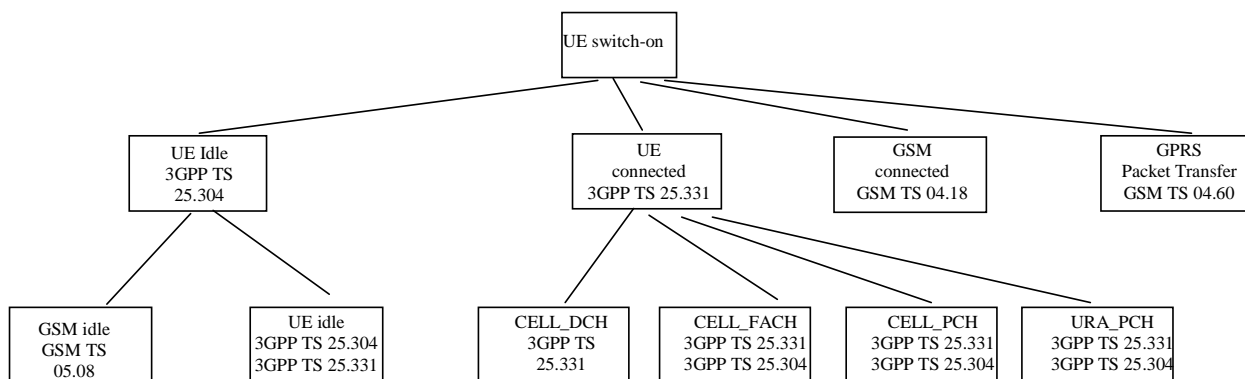

Figure 4.1-1: Mapping of UE state to 3GPP Specifications

4.2 RRC Layer Model

The functional entities of the RRC layer are described below:

- Routing of higher layer messages to different MM/CM entities (UE side) or different core network domains (UTRAN side) is handled by the Routing Function Entity (**RFE**).
- Broadcast functions are handled in the broadcast control function entity (**BCFE**). The BCFE is used to deliver the RRC services, which are required at the GC-SAP. The BCFE can use the lower layer services provided by the Tr-SAP and UM-SAP.
- Paging of UEs that do not have an RRC connection is controlled by the paging and notification control function entity (**PNFE**). The PNFE is used to deliver the RRC services that are required at the Nt-SAP. The PNFE can use the lower layer services provided by the Tr-SAP and UM-SAP.
- The Dedicated Control Function Entity (**DCFE**) handles all functions specific to one UE. The DCFE is used to deliver the RRC services that are required at the DC-SAP and can use lower layer services of UM/AM-SAP and Tr-SAP depending on the message to be sent and on the current UE service state.
- In TDD mode, the DCFE is assisted by the Shared Control Function Entity (SCFE) location in the C-RNC, which controls the allocation of the PDSCH and PUSCH using lower layers services of UM-SAP and Tr-SAP.
- The Transfer Mode Entity (TME) handles the mapping between the different entities inside the RRC layer and the SAPs provided by RLC.

NOTE 1: Logical information exchange is necessary also between the RRC sublayer functional entities. Most of that is implementation dependent and not necessary to present in detail in a specification.

Figure 4.2-1 shows the RRC model for the UE and Figure 4.2-2 and Figure 4.2-3 show the RRC model for the UTRAN.

NOTE 2: The figure shows only the types of SAPs that are used. Multiple instances of Tr-SAP, UM-SAP and AM-SAP are possible. Especially, different functional entities usually use different instances of SAP types.

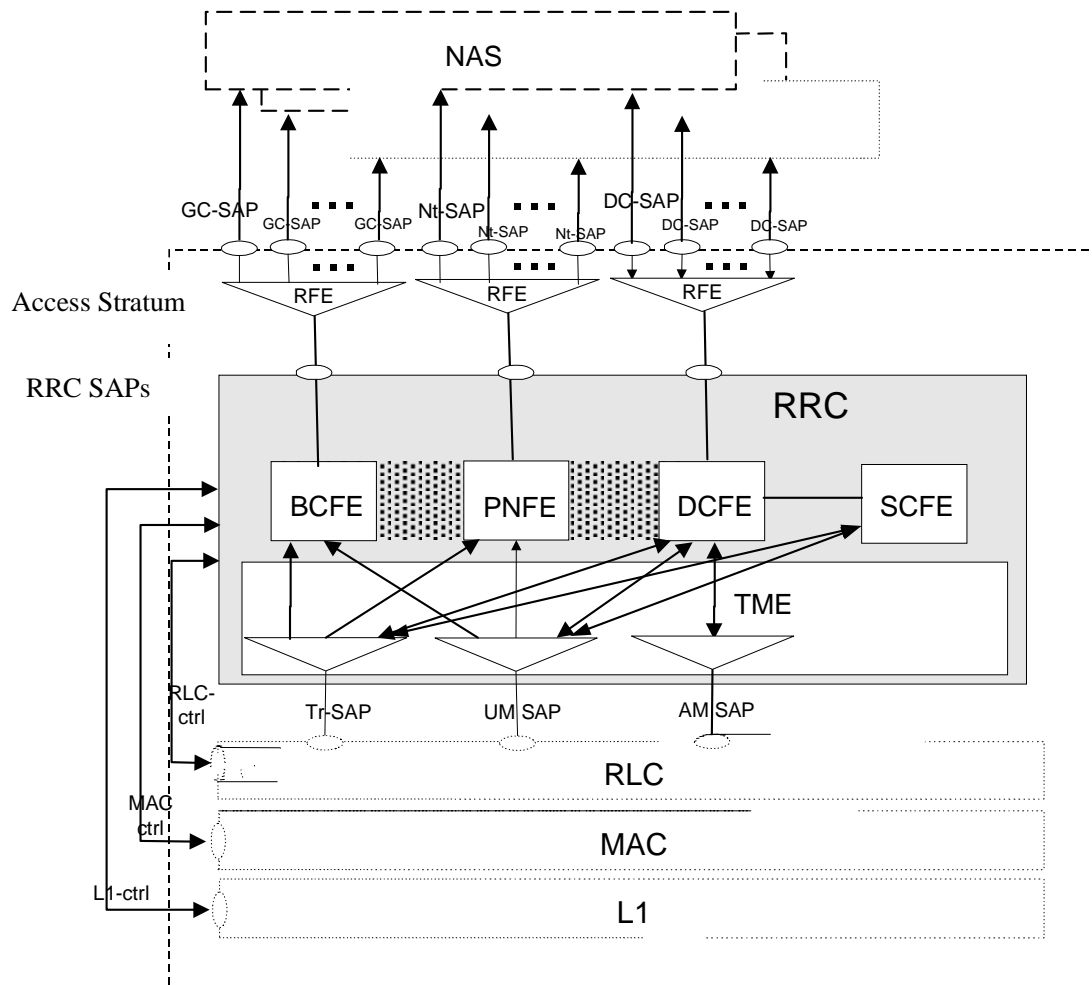

Figure 4.2-1: UE side model of RRC

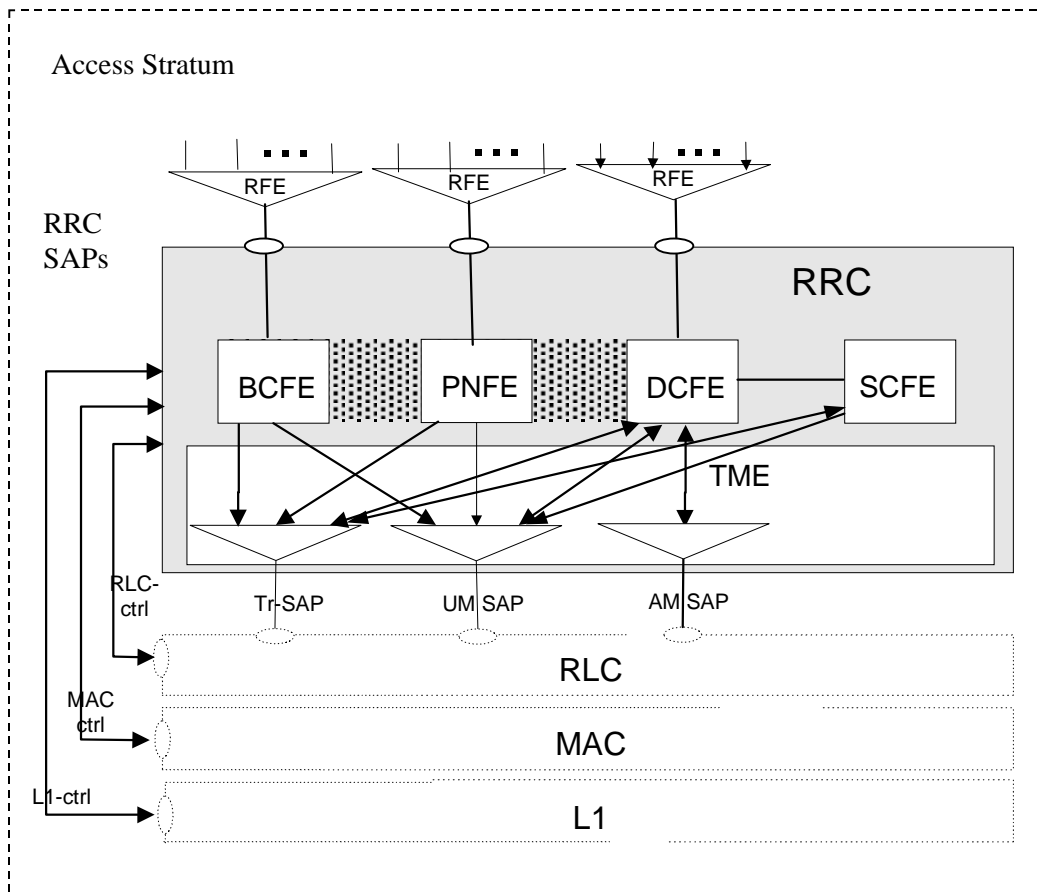

Figure 4.2-2: UTRAN side RRC model (DS-MAP system)

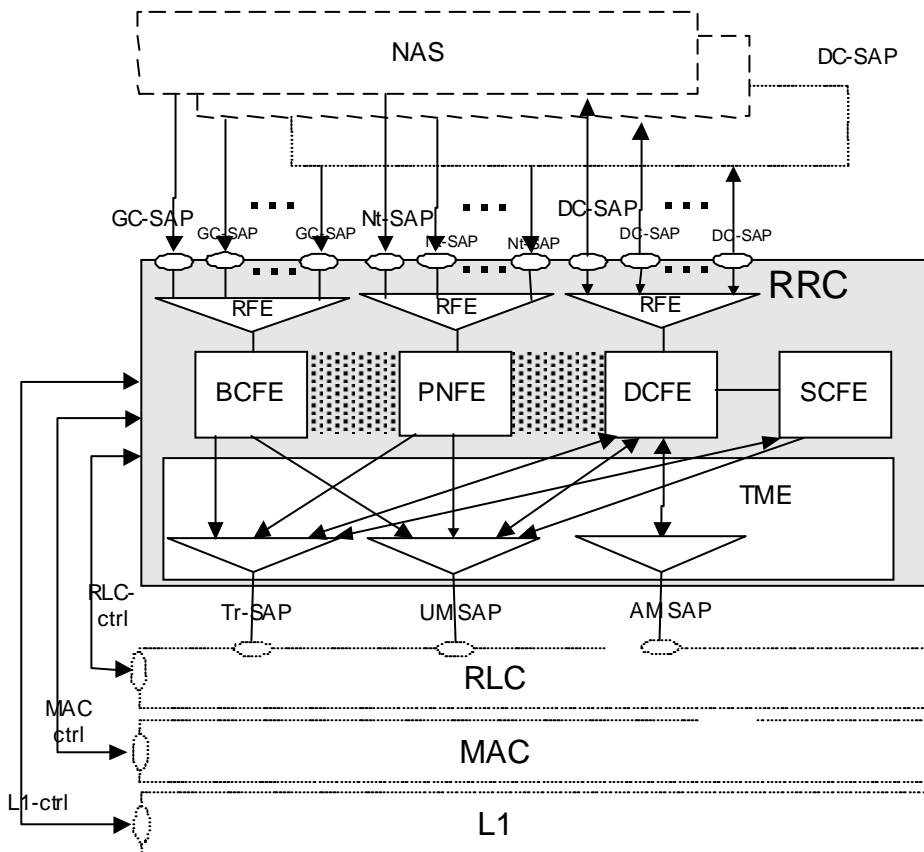

Figure 4.2-3: UTRAN side RRC model (DS-41 System)

4.3 Protocol specification principles

This protocol specification is based on the applicable general guidelines given in [14].

In this specification, a notation of variables is used. The variables are defined in subclause 13.4. Variables are typically used to represent a status or a result of an action, such as reception of an information element in a message, which is used to specify a behaviour somewhere else in the specification, such as when setting the value of an information element in a transmitted message. The variables only serve the purpose of specifying the protocol, and do not therefore impose any particular implementation.

When specifying the UE behaviour at reception of messages, the behaviour that is tied to reception or non-reception of individual information elements, and in some cases combinations of information elements, is specified in one location (subclause 8.6).

5 RRC Functions and Services provided to upper layers

5.1 RRC Functions

The RRC performs the functions listed below. A more detailed description of these functions is provided in [2]:

- Broadcast of information related to the non-access stratum (Core Network);
- Broadcast of information related to the access stratum;
- Establishment, maintenance and release of an RRC connection between the UE and UTRAN;
- Establishment, reconfiguration and release of Radio Bearers;
- Assignment, reconfiguration and release of radio resources for the RRC connection;
- RRC connection mobility functions;
- Control of requested QoS;
- UE measurement reporting and control of the reporting;
- Outer loop power control;
- Control of ciphering;
- Slow DCA (TDD mode);
- Paging;
- Initial cell selection and cell re-selection;
- Arbitration of radio resources on uplink DCH;
- RRC message integrity protection;
- Timing advance (TDD mode);
- CBS control.

5.2 RRC Services provided to upper layers

The RRC offers the following services to upper layers, a description and primitives of these services are provided in [2] and [17].

- General Control;
- Notification;
- Dedicated control.

The RRC layer provides the UE-UTRAN portion of signalling connections to the upper layers to support the exchange of upper layer's information flow. The signalling connection is used between the user equipment and the core network to transfer upper layer information. For each core network domain, at most one signalling connection may exist at the same time. The RRC layer maps the signalling connections for one UE on a single RRC connection. For the upper layer data transfer on signalling connections, the RRC layer supports the discrimination between two different classes, named "High priority" (corresponding to "SAPI 0" for a GSM-MAP based core network) and "Low priority" (corresponding to "SAPI 3" for a GSM-MAP based core network).

5.3 Primitives between RRC and upper layers

The primitives between RRC and the upper layers are described in [17].

6 Services expected from lower layers

6.1 Services expected from Layer 2

The services provided by layer 2 are described in [2], [15] and [16].

6.2 Services expected from Layer 1

The services provided by layer 1 are described in [2].

6.3 Signalling Radio Bearers

The Radio Bearers (RB) available for transmission of RRC messages are defined as "signalling radio bearers" and are specified in the following. The UE and UTRAN shall select the signalling radio bearers for RRC messages using RLC-TM, RLC-UM or RLC-AM on the DCCH and CCCH, according to the following:

- Signalling radio bearer RB0 shall be used for all messages sent on the CCCH (UL: RLC-TM, DL: RLC-UM).
- Signalling radio bearer RB1 shall be used for all messages sent on the DCCH, when using RLC unacknowledged mode (RLC-UM).
- Signalling radio bearer RB2 shall be used for all messages sent on the DCCH, when using RLC acknowledged mode (RLC-AM), except for the RRC messages carrying higher layer (NAS) signalling.
- Signalling radio bearer RB3 and optionally Signalling radio bearer RB4 shall be used for the RRC messages carrying higher layer (NAS) signalling and sent on the DCCH in RLC acknowledged mode (RLC-AM), as specified in subclauses 8.1.8., 8.1.9 and 8.1.10.
- Additionally, RBs whose identities shall be set between 5 and 32 may be used as signalling radio bearer for the RRC messages on the DCCH sent in RLC transparent mode (RLC-TM).
- RRC messages on the SHCCH are mapped either on RACH or on the USCH in the uplink using TM and either on FACH or on the DSCH using RLC-UM. These messages are only specified for TDD mode.

The Radio Bearer configuration for signalling radio bearer RB0, SHCCH, BCCH on FACH and PCCH on PCH are specified in subclauses 13.6, 13.6a, 13.6b and 13.6c.

Ciphering is never applied to signalling radio bearer RB0.

7 Protocol states

7.1 Overview of RRC States and State Transitions including GSM

Figure 7.1-1 shows the RRC states in UTRA RRC Connected Mode, including transitions between UTRA RRC connected mode and GSM connected mode for CS domain services, and between UTRA RRC connected mode and GSM/GPRS packet modes for PS domain services. It also shows the transitions between Idle Mode and UTRA RRC Connected Mode and furthermore the transitions within UTRA RRC connected mode.

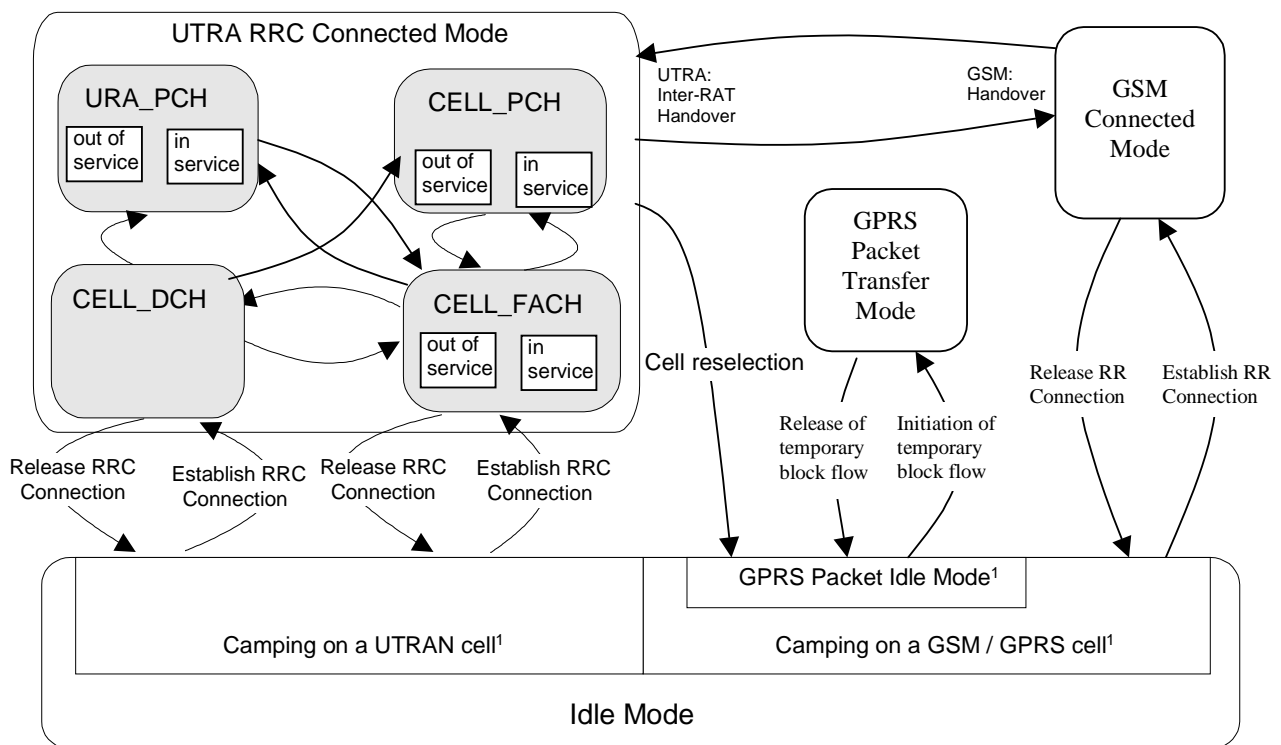

NOTE: ¹: The indicated division within Idle Mode is only included for clarification and shall not be interpreted as states.

Figure 7.1-1: RRC States and State Transitions including GSM

The RRC connection is defined as a point-to-point bi-directional connection between RRC peer entities in the UE and the UTRAN characterised by the allocation of a U-RNTI. A UE has either zero or one RRC connection.

NOTE: The state transitions are specified in clause 8.

7.2 Processes in UE modes/states

NOTE: This subclause specifies what processes shall be active in the UE in the different RRC modes/states. The related procedures and the conditions on which they are triggered are specified either in clause 8 or elsewhere in the relevant process definition.

7.2.1 UE Idle mode

UE processes that are active in UE Idle mode are specified in [4].

The UE shall perform a periodic search for higher priority PLMNs as specified in [25].

7.2.2 UTRA RRC Connected mode

In this specification unless otherwise mentioned "connected mode" shall refer to "UTRA RRC connected mode".

7.2.2.1 URA_PCH or CELL_PCH state

In the URA_PCH or CELL_PCH state the UE shall perform the following actions:

NOTE: Neither DCCH nor DTCH are available in these states.

1> if the UE is "in service area":

- 2> maintain up-to-date system information as broadcast by the serving cell as specified in the subclause 8.1.1;
- 2> perform cell reselection process as specified in [4];
- 2> perform a periodic search for higher priority PLMNs as specified in [25];

NOTE: If the DRX cycle length is 80ms, then a search for higher priority PLMNs may not identify all the available PLMNs due to the paging occasion on the current serving cell coinciding with the MIB of the cell of interest.

- 2> monitor the paging occasions and PICH monitoring occasions determined according to subclauses 8.6.3.1a and 8.6.3.2 and receive paging information on the PCH mapped on the S-CCPCH selected by the UE according to the procedure in subclause 8.5.19;
- 2> act on RRC messages received on PCCH and BCCH;
- 2> perform measurements process according to measurement control information as specified in subclause 8.4 and in subclause 14.4;
- 2> maintain up-to-date BMC data if it supports Cell Broadcast Service (CBS) as specified in [37];
- 2> run timer T305 for periodical URA update if the UE is in URA_PCH or for periodical cell update if the UE is in CELL_PCH.

1> if the UE is "out of service area":

- 2> perform cell selection process as specified in [4];
- 2> run timer T316;
- 2> run timer T305.

7.2.2.2 CELL_FACH state

In the CELL_FACH state the UE shall perform the following actions:

NOTE: DCCH and, if configured, DTCH are available in this state.

1> if the UE is "in service area":

- 2> maintain up-to-date system information as broadcast by the serving cell as specified in subclause 8.1.1;
- 2> perform cell reselection process as specified in [4];
- 2> perform measurements process according to measurement control information as specified in subclause 8.4 and in subclause 14.4;

- 2> run timer T305 (periodical cell update);
 - 2> select and configure the RB multiplexing options applicable for the transport channels to be used in this RRC state;
 - 2> listen to all FACH transport channels mapped on the S-CCPCH selected by the UE according to the procedure in subclause 8.5.19;
 - 2> act on RRC messages received on BCCH, CCCH and DCCH;
 - 2> act on RRC messages received on, if available, SHCCH (TDD only).
- 1> if the UE is "out of service area":
- 2> perform cell selection process as specified in [4];
 - 2> run timers T305 (periodical cell update), and T317 (cell update when re-entering "in service") or T307 (transition to Idle mode).

7.2.2.3 CELL_DCH state

In the CELL_DCH state the UE shall perform the following actions:

NOTE: DCCH and, if configured, DTCH are available in this state.

- 1> read system information broadcast on FACH as specified in subclause 8.1.1.3 (applicable only to UEs with certain capabilities and in FDD mode);
- 1> read the system information as specified in subclause 8.1.1 (for UEs in TDD mode);
- 1> perform measurements process according to measurement control information as specified in subclause 8.4 and in clause 14;
- 1> select and configure the RB multiplexing options applicable for the transport channels to be used in this RRC state;
- 1> act on RRC messages received on DCCH;
- 1> act on RRC messages received on BCCH (applicable only to UEs with certain capabilities and in FDD mode);
- 1> act on RRC messages received on BCCH (TDD only) and, if available, SHCCH (TDD only).

8 RRC procedures

The UE shall be able to process several simultaneous RRC procedures. After the reception of a message which invoked a procedure, the UE shall be prepared to receive and act on another message which may invoke a second procedure. Whether this second invocation of a procedure (transaction) is accepted or rejected by the UE is specified in the subclauses of this clause, and in particular in subclause 8.6.3.11 (RRC transaction identifier).

On receiving a message the UE shall:

- 1> check that the message is addressed to the UE (e.g. by checking the IE "Initial UE identity" or the IE "U-RNTI" for messages on CCCH);
- 1> discard the messages addressed to other UEs.

and then the UE shall:

- 1> apply integrity check as appropriate;
- 1> proceed with error handling as specified in clause 9;
- 1> act upon the IE "RRC transaction identifier";
- 1> continue with the procedure as specified in the relevant subclause.

The RRC entity in the UE shall consider PDUs to have been transmitted when they are submitted to the lower layers. If the RRC entity in the UE submits a message for transmission using AM RLC, it shall consider the message successfully transmitted when UTRAN reception of all relevant PDUs is acknowledged by RLC. In the UE, timers are started when the PDUs are sent on the radio interface in the case of the transmission using the CCCH.

8.1 RRC Connection Management Procedures

8.1.1 Broadcast of system information

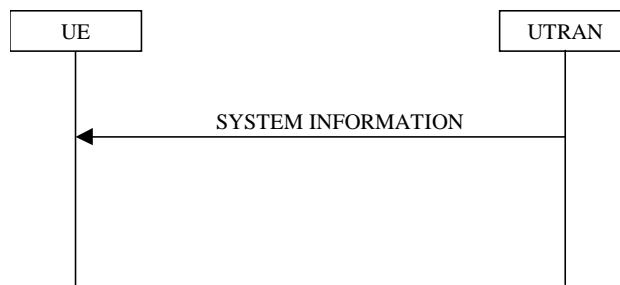

Figure 8.1.1-1: Broadcast of system information

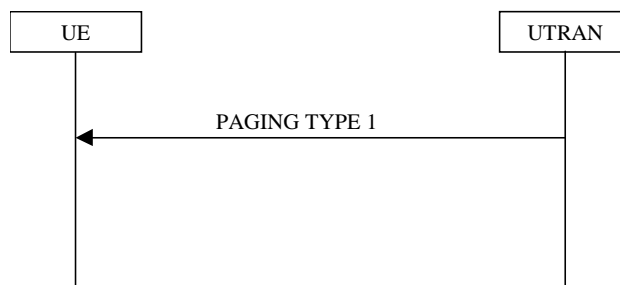

Figure 8.1.1-2: Notification of system information modification for UEs in idle mode, CELL_PCH state and URA_PCH state

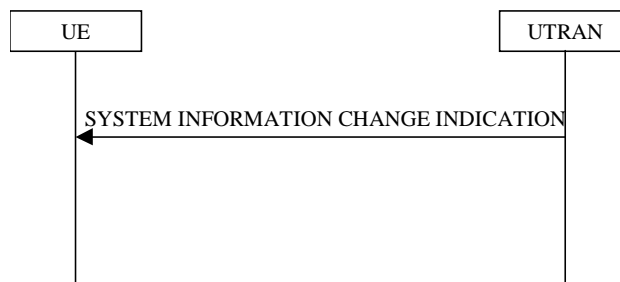

Figure 8.1.1-3: Notification of system information modification for UEs in CELL_FACH state

8.1.1.1 General

The purpose of this procedure is to broadcast system information from the UTRAN to UEs in a cell.

8.1.1.1.1 System information structure

The system information elements are broadcast in *system information blocks*. A system information block groups together system information elements of the same nature. Different system information blocks may have different characteristics, e.g. regarding their repetition rate and the requirements on UEs to re-read the system information blocks.

The system information is organised as a tree. A *master information block* gives references and scheduling information to a number of system information blocks in a cell. The system information blocks contain the actual system

information. The master information block may optionally also contain reference and scheduling information to one or two *scheduling blocks*, which give references and scheduling information for additional system information blocks. Scheduling information for a system information block may only be included in either the master information block or one of the scheduling blocks.

For all system information blocks except System Information Block types 15.2, 15.3 and 16, the content is the same in each occurrence for system information blocks using value tag. System Information Block types 15.2, 15.3 and 16 may occur more than once with different content. In this case scheduling information is provided for each such occurrence of the system information block. System information blocks that do not use value tag may have different content for each occurrence.

8.1.1.1.2 System information blocks

Table 8.1.1 specifies all system information blocks and their characteristics.

The *area scope column* in table 8.1.1 specifies the area where a system information block's value tag is valid. If the area scope is *cell*, the UE shall consider the system information block to be valid only in the cell in which it was read. If system information blocks have been previously stored for this cell, the UE shall check whether the value tag for the system information block in the entered cell is different compared to the stored value tag. If the area scope is *PLMN* or *Equivalent PLMN*, the UE shall check the value tag for the system information block when a new cell is selected. If the value tag for the system information block in the new cell is different compared to the value tag for the system information block stored in the UE, the UE shall re-read the system information block. If the area scope is *PLMN*, the UE shall consider the system information block to be valid only within the PLMN in which it was read. If the area scope is *Equivalent PLMN*, the UE shall consider the system information block to be valid within the PLMN in which it was received and all PLMNs which are indicated by higher layers to be equivalent.

For System information block types 15.2, 15.3 and 16, which may have multiple occurrences, each occurrence has its own independent value tag. The UE shall re-read a particular occurrence if the value tag of this occurrence has changed compared to that stored in the UE.

The *UE mode/state column when block is valid* in Table 8.1.1 specifies in which UE mode or UE state the IEs in a system information block shall be regarded as valid by the UE. In other words, the indicated system information block becomes invalid upon change to a mode/state that is not included in this column. System Information Block Type 16 remains also valid upon transition to or from GSM/GPRS. In some cases, the states are inserted in brackets to indicate that the validity is dependent on the broadcast of the associated System Information Blocks by the network as explained in the relevant procedure subclause.

The *UE mode/state column when block is read* in Table 8.1.1 specifies in which UE mode or UE state the IEs in a system information block may be read by the UE. The UE shall have the necessary information prior to execution of any procedure requiring information to be obtained from the appropriate system information block. The requirements on the UE in terms of when to read the system information may therefore be derived from the procedure specifications that specify which IEs are required in the different UE modes/states in conjunction with the different performance requirements that are specified. System Information Block type 10 shall only be read by the UE while in CELL_DCH.

NOTE 1: There are a number of system information blocks that include the same IEs while the UE mode/state in which the information is valid differs. This approach is intended to allow the use of different IE values in different UE mode/states.

NOTE 2: System Information Block Type 16 is also obtained by a UE while in GSM/GPRS. The details of this are not within the scope of this specification.

The *Scheduling information* column in table 8.1.1 specifies the position and repetition period for the SIB.

The *modification of system information* column in table 8.1.1 specifies the update mechanisms applicable for a certain system information block. For system information blocks with a value tag, the UE shall update the information according to subclause 8.1.1.7.1 or 8.1.1.7.2. For system information blocks with an expiration timer, the UE shall, when the timer expires, perform an update of the information according to subclause 8.1.1.7.4.

Table 8.1.1: Specification of system information block characteristics

System information block	Area scope	UE mode/state when block is valid	UE mode/state when block is read	Scheduling information	Modification of system information	Additional comment
--------------------------	------------	-----------------------------------	----------------------------------	------------------------	------------------------------------	--------------------

System information block	Area scope	UE mode/state when block is valid	UE mode/state when block is read	Scheduling information	Modification of system information	Additional comment
Master information block	Cell	Idle mode, CELL_FACH, CELL_PCH, URA_PCH	Idle mode, CELL_FACH, CELL_PCH, URA_PCH	SIB_POS = 0 SIB_REP = 8 (FDD) SIB_REP = 8, 16, 32 (TDD) SIB_OFF=2	Value tag	
Scheduling block 1	Cell	Idle mode, CELL_FACH, CELL_PCH, URA_PCH	Idle mode, CELL_FACH, CELL_PCH, URA_PCH	Specified by the IE "Scheduling information" in MIB	Value tag	
Scheduling block 2	Cell	Idle mode, CELL_FACH, CELL_PCH, URA_PCH	Idle mode, CELL_FACH, CELL_PCH, URA_PCH	Specified by the IE "Scheduling information" in MIB	Value tag	
System information block type 1	PLMN	Idle mode, CELL_FACH, CELL_PCH, URA_PCH, CELL_DCH	Idle, CELL_FACH, CELL_PCH, URA_PCH	Specified by the IE "Scheduling information"	Value tag	
System information block type 2	Cell	URA_PCH	URA_PCH	Specified by the IE "Scheduling information"	Value tag	
System information block type 3	Cell	Idle mode, (CELL_FACH, CELL_PCH, URA_PCH)	Idle mode, (CELL_FACH, CELL_PCH, URA_PCH)	Specified by the IE "Scheduling information"	Value tag	
System information block type 4	Cell	CELL_FACH, CELL_PCH, URA_PCH	CELL_FACH, CELL_PCH, URA_PCH	Specified by the IE "Scheduling information"	Value tag	If System information block type 4 is not broadcast in a cell, the connected mode UE shall apply information in System information block type 3 in connected mode.
System information block type 5	Cell	Idle mode, (CELL_FACH, CELL_PCH, URA_PCH, CELL_DCH (TDD only))	Idle mode, (CELL_FACH, CELL_PCH, URA_PCH, CELL_DCH (TDD only))	Specified by the IE "Scheduling information"	Value tag	

System information block	Area scope	UE mode/state when block is valid	UE mode/state when block is read	Scheduling information	Modification of system information	Additional comment
System information block type 6	Cell	CELL_FACH, CELL_PCH, URA_PCH, CELL_DCH (TDD only)	CELL_FACH, CELL_PCH, URA_PCH, CELL_DCH (TDD only)	Specified by the IE "Scheduling information"	Value tag	<p>If system information block type 6 is not broadcast in a cell, the connected mode UE shall read System information block type 5.</p> <p>If some of the optional IEs are not included in System information block type 6, the UE shall read the corresponding IEs in System information block type 5</p> <p>In TDD mode system information block 6 shall only be read in CELL_DCH if required for open loop power control as specified in subclause 8.5.7 and/or if shared transport channels are assigned to the UE. If in these cases system information block type 6 is not broadcast the UE shall read system information block type 5.</p>
System information block type 7	Cell	Idle mode, CELL_FACH, CELL_PCH, URA_PCH, CELL_DCH (TDD only)	Idle mode, CELL_FACH, CELL_PCH, URA_PCH, CELL_DCH (TDD only)	Specified by the IE "Scheduling information"	Expiration timer = MAX(32 , SIB_REP * ExpirationTimeFactor)	In TDD mode system information block type 7 shall only be read in CELL_DCH if shared transport channels are assigned to the UE.
System information block type 8	Cell	CELL_FACH, CELL_PCH, URA_PCH	CELL_FACH, CELL_PCH, URA_PCH	Specified by the IE "Scheduling information"	Value tag	
System information block type 9	Cell	CELL_FACH, CELL_PCH, URA_PCH	CELL_FACH, CELL_PCH, URA_PCH	Specified by the IE "Scheduling information"	Expiration timer = SIB_REP	
System information block type 10	Cell	CELL_DCH	CELL_DCH	Specified by the IE "Scheduling information"	Expiration timer = SIB_REP	
System information block type 11	Cell	Idle mode (CELL_FACH, CELL_PCH, URA_PCH, CELL_DCH)	Idle mode (CELL_FACH, CELL_PCH, URA_PCH)	Specified by the IE "Scheduling information"	Value tag	

System information block	Area scope	UE mode/state when block is valid	UE mode/state when block is read	Scheduling information	Modification of system information	Additional comment
System information block type 12	Cell	CELL_FACH, CELL_PCH, URA_PCH, CELL_DCH	CELL_FACH, CELL_PCH, URA_PCH	Specified by the IE "Scheduling information"	Value tag	If system information block type 12 is not broadcast in a cell, the connected mode UE shall read System information block type 11. If some of the optional IEs are not included in System information block type 12, the UE shall read the corresponding IEs in System information block type 11.
System information block type 13	Cell	Idle Mode, CELL_FACH, CELL_PCH, URA_PCH	Idle Mode, CELL_FACH, CELL_PCH, URA_PCH	Specified by the IE "Scheduling information"	Value tag	
System information block type 13.1	Cell	Idle Mode, CELL_FACH, CELL_PCH, URA_PCH	Idle Mode, CELL_FACH, CELL_PCH, URA_PCH	Specified by the IE "Scheduling information"	Value tag	
System information block type 13.2	Cell	Idle Mode, CELL_FACH, CELL_PCH, URA_PCH	Idle Mode, CELL_FACH, CELL_PCH, URA_PCH	Specified by the IE "Scheduling information"	Value tag	
System information block type 13.3	Cell	Idle Mode, CELL_FACH, CELL_PCH, URA_PCH	Idle Mode, CELL_FACH, CELL_PCH, URA_PCH	Specified by the IE "Scheduling information"	Value tag	
System information block type 13.4	Cell	Idle Mode, CELL_FACH, CELL_PCH, URA_PCH	Idle Mode, CELL_FACH, CELL_PCH, URA_PCH	Specified by the IE "Scheduling information"	Value tag	
System information block type 14	Cell	Idle Mode, CELL_FACH, CELL_PCH, URA_PCH, CELL_DCH	Idle Mode, CELL_FACH, CELL_PCH, URA_PCH, CELL_DCH	Specified by the IE "Scheduling information"	Expiration timer = MAX(32 , SIB_REP * ExpirationTimeFactor)	This system information block is used in 3.84 Mcps TDD mode only. System information block type 14 shall only be read in CELL_DCH if required for open loop power control as specified in subclause 8.5.7.
System information block type 15	Cell	Idle Mode, CELL_FACH, CELL_PCH, URA_PCH	Idle Mode, CELL_FACH, CELL_PCH, URA_PCH	Specified by the IE "Scheduling information"	Value tag	
System information block type 15.1	Cell	Idle Mode, CELL_FACH, CELL_PCH, URA_PCH	Idle Mode, CELL_FACH, CELL_PCH, URA_PCH	Specified by the IE "Scheduling information"	Value tag	
System information block type 15.2	Cell	Idle Mode, CELL_FACH, CELL_PCH, URA_PCH	Idle Mode, CELL_FACH, CELL_PCH, URA_PCH	Specified by the IE "Scheduling information"	Value tag	For this system information block there may be multiple occurrences
System information block type 15.3	PLMN	Idle Mode, CELL_FACH, CELL_PCH, URA_PCH	Idle Mode, CELL_FACH, CELL_PCH, URA_PCH	Specified by the IE "Scheduling information"	Value tag	For this system information block there may be multiple occurrences

System information block	Area scope	UE mode/state when block is valid	UE mode/state when block is read	Scheduling information	Modification of system information	Additional comment
System information block type 15.4	Cell	Idle Mode, CELL_FACH, CELL_PCH, URA_PCH	Idle Mode, CELL_FACH, CELL_PCH, URA_PCH	Specified by the IE "Scheduling information"	Value tag	
System information block type 15.5	Cell	Idle Mode, CELL_FACH, CELL_PCH, URA_PCH	Idle Mode, CELL_FACH, CELL_PCH, URA_PCH	Specified by the IE "Scheduling information"	Value tag	
System information block type 16	Equivalent PLMN	Idle Mode, CELL_FACH, CELL_PCH, URA_PCH, CELL_DCH	Idle Mode, CELL_FACH, CELL_PCH, URA_PCH	Specified by the IE "Scheduling information"	Value tag	For this system information block there may be multiple occurrences. This system information block is also valid while in GSM/GPRS.
System information block type 17	Cell	CELL_FACH, CELL_PCH, URA_PCH, CELL_DCH	CELL_FACH, CELL_PCH, URA_PCH, CELL_DCH	Specified by the IE "Scheduling information"	Expiration timer = SIB_REP	This system information block is used in TDD mode only. System information block type 17 shall only be read if shared transport channels are assigned to the UE.
System Information Block type 18	Cell	Idle mode, CELL_FACH, CELL_PCH, URA_PCH, CELL_DCH	Idle mode, CELL_FACH, CELL_PCH, URA_PCH	Specified by the IE "Scheduling information"	Value tag	

The UE shall acquire all system information blocks except system information block type 10 on BCH. System Information Block type 10 shall be acquired on the FACH and only by UEs with support for simultaneous reception of one SCCPCH and one DPCH. If System Information Block type 10 is not broadcast in a cell, the DRAC procedures do not apply in this cell. System Information Block type 10 is used in FDD mode only.

8.1.1.1.3 Segmentation and concatenation of system information blocks

A generic SYSTEM INFORMATION message is used to convey the system information blocks on the BCCH. A given BCCH may be mapped onto either a BCH or a FACH transport channel according to subclause 8.1.1.1.2. The size of the SYSTEM INFORMATION message shall fit the size of a BCH or a FACH transport block.

The RRC layer in UTRAN performs segmentation and concatenation of encoded system information blocks. If the encoded system information block is larger than the size of a SYSTEM INFORMATION message, it will be segmented and transmitted in several messages. If the encoded system information block is smaller than a SYSTEM INFORMATION message, UTRAN may concatenate several system information blocks, or the first segment or the last segment into the same message as specified in the remainder of this clause.

Four different segment types are defined:

- First segment;
- Subsequent segment;
- Last segment;
- Complete.

Each of the types - *First*, *Subsequent* and *Last segment* - is used to transfer segments of a master information block, scheduling block or a system information block. The segment type, *Complete*, is used to transfer a complete master information block, complete scheduling block or a complete system information block.

Each segment consists of a header and a data field. The data field carries the encoded system information elements. The header contains the following parameters:

- The number of segments in the system information block (SEG_COUNT). This parameter is only included in the header if the segment type is "First segment".
- SIB type. The SIB type uniquely identifies the master information block, scheduling block or a system information block.
- Segment index. This parameter is only included in the header if the segment type is "Subsequent segment" or "Last segment".

UTRAN may combine one or several segments of variable length in the same SYSTEM INFORMATION message. The following combinations are allowed:

1. No segment;
2. First segment;
3. Subsequent segment;
4. Last segment;
5. Last segment + First segment;
6. Last segment + one or several Complete;
7. Last segment + one or several Complete + First segment;
8. One or several Complete;
9. One or several Complete + First segment;
10. One Complete of size 215 to 226;
11. Last segment of size 215 to 222.

The "No segment" combination is used when there is no master information block, scheduling block or system information block scheduled for a specific BCH transport block.

UEs are not required to support the reception of multiple occurrences of the same system information block type within one SYSTEM INFORMATION message.

NOTE: Since the SIB type is the same for each occurrence of the system information block, the UE does not know the order in which the occurrences, scheduled for this SYSTEM INFORMATION message, appear. Therefore, the UE is unable to determine which scheduling information, e.g., value tag relates to which occurrence of the system information block.

8.1.1.1.4 Re-assembly of segments

The RRC layer in the UE shall perform re-assembly of segments. All segments belonging to the same master information block, scheduling block or system information block shall be assembled in ascending order with respect to the segment index. When all segments of the master information block, scheduling block or a system information block have been received, the UE shall perform decoding of the complete master information block, scheduling block or system information block. For System Information Block types 15.2, 15.3 and 16, which may have multiple occurrences, each occurrence shall be re-assembled independently.

The UE shall discard system information blocks of which segments were missing, of which segments were received out of sequence and/or for which duplicate segments were received. The only valid sequence is an ascending one with the sequence starting with the First Segment of the associated System Information Block.

If the UE receives a Subsequent segment or Last segment where the index in IE "Segment index" is equal to or larger than the number of segments stated in IE "SEG_COUNT" in the scheduling information for that scheduling block or system information block:

- 1> the UE may:
 - 2> read all the segments to create a system information block as defined by the scheduling information read by the UE;
 - 2> store the content of the system information block with a value tag set to the value NULL; and
 - 2> consider the content of the scheduling block or system information block as valid:
 - 3> until it receives the same type of scheduling block or system information block in a position according to its scheduling information; or
 - 3> at most for 6 hours after reception.
- 1> and the UE shall:
 - 2> re-read scheduling information for that scheduling block or system information block.

If the UE receives a Subsequent segment or Last segment where the index in IE "Segment index" is equal to or larger than the number of segments stated in IE "SEG_COUNT" in the First segment, the UE shall

- 1> discard all segments for that master information block, scheduling block or system information block; and
- 1> re-read the scheduling information for that system information block;
- 1> then re-read all segments for that system information block.

8.1.1.1.5 Scheduling of system information

Scheduling of system information blocks is performed by the RRC layer in UTRAN. If segmentation is used, it should be possible to schedule each segment separately.

To allow the mixing of system information blocks with short repetition period and system information blocks with segmentation over many frames, UTRAN may multiplex segments from different system information blocks. Multiplexing and de-multiplexing is performed by the RRC layer.

The scheduling of each system information block broadcast on a BCH transport channel is defined by the following parameters:

- the number of segments (SEG_COUNT);
- the repetition period (SIB_REP). The same value applies to all segments;
- the position (phase) of the first segment within one cycle of the Cell System Frame Number (SIB_POS(0)). Since system information blocks are repeated with period SIB_REP, the value of SIB_POS(i), $i = 0, 1, 2, \dots, \text{SEG_COUNT}-1$ must be less than SIB_REP for all segments;
- the offset of the subsequent segments in ascending index order (SIB_OFF(i), $i = 1, 2, \dots, \text{SEG_COUNT}-1$)
The position of the subsequent segments is calculated using the following: $\text{SIB_POS}(i) = \text{SIB_POS}(i-1) + \text{SIB_OFF}(i)$.

The scheduling is based on the Cell System Frame Number (SFN). The SFN of a frame at which a particular segment, i , with $i = 0, 1, 2, \dots, \text{SEG_COUNT}-1$ of a system information block occurs, fulfils the following relation:

$$\text{SFN mod SIB_REP} = \text{SIB_POS}(i)$$

In FDD and TDD the scheduling of the master information block is fixed as defined in table 8.1.1. For TDD, UTRAN may apply one of the values allowed for the master information block's repetition period. The value that UTRAN is using in TDD is not signalled; UEs have to determine it by trial and error.

8.1.1.2 Initiation

The system information is continuously broadcast on a regular basis in accordance with the scheduling defined for each system information block.

8.1.1.3 Reception of SYSTEM INFORMATION messages by the UE

The UE shall read SYSTEM INFORMATION messages broadcast on a BCH transport channel in idle mode and in the connected mode in states CELL_FACH, CELL_PCH, URA_PCH and CELL_DCH (TDD only). In addition, UEs in FDD mode which support simultaneous reception of one SCCPCH and one DPCH shall read system information on a FACH transport channel when in CELL_DCH state.

In idle mode and connected mode different combinations of system information blocks are valid. The UE shall acquire the system information blocks that are needed according to table 8.1.1.

The UE may store system information blocks with *cell*, *PLMN* or *Equivalent PLMN* area scope (including their value tag if applicable) for different cells and different PLMNs, to be used if the UE returns to these cells.

The UE shall consider all stored system information blocks as invalid after it has been switched off. Some information obtained from system information may be stored by the UE or in the USIM for use in a stored information cell selection.

When selecting a new cell within the currently used PLMN, the UE shall consider all current system information blocks with area scope *cell* to be invalid. If the UE has stored valid system information blocks for the newly selected cell, the UE may set those as current system information blocks.

After selecting a new PLMN, the UE shall consider all current system information blocks with area scope *cell* and *PLMN* to be invalid. If the UE has previously stored valid system information blocks for the selected cell of the new PLMN, the UE may set those as current system information blocks. Upon selection of a new PLMN the UE shall store all information elements specified within variable SELECTED_PLMN for the new PLMN within this variable.

After selecting a new PLMN which is not indicated by higher layers to be equivalent to the identity of the previously selected PLMN, the UE shall consider all system information blocks with area scope *Equivalent PLMN* to be invalid.

8.1.1.4 Reception of SYSTEM INFORMATION messages broadcast on a FACH transport channel

System information block type 10 may be broadcast on FACH, as specified in subclause 8.1.1.1.2.

When reading system information blocks on FACH, the UE shall perform the actions as defined in subclause 8.1.1.6.

8.1.1.5 Actions upon reception of the Master Information Block and Scheduling Block(s)

When selecting a new cell, the UE shall read the master information block. The UE may use the pre-defined scheduling information to locate the master information block in the cell.

Upon reception of the master information block, the UE shall:

- 1> if the "PLMN type" in the variable SELECTED_PLMN has the value "GSM-MAP" and the IE "PLMN Type" has the value "GSM-MAP" or "GSM-MAP and ANSI-41":
 - 2> check the IE "PLMN identity" in the master information block and verify that it is the selected PLMN, stored as "PLMN identity" in the variable SELECTED_PLMN.
- 1> if the "PLMN type" in the variable SELECTED_PLMN has the value "ANSI-41" and the IE "PLMN Type" has the value "ANSI-41" or "GSM-MAP and ANSI-41":
 - 2> store the ANSI-41 Information elements contained in the master information block and perform initial process for ANSI-41.
- 1> compare the value tag in the master information block with the value tag stored for this cell and this PLMN in the variable VALUE_TAG;

- 1> if the value tags differ, or if no IEs for the master information block are stored:
 - 2> store the value tag into the variable VALUE_TAG for the master information block;
 - 2> read and store scheduling information included in the master information block.
- 1> if the value tags are the same the UE may use stored system information blocks and scheduling blocks using value tag that were stored for this cell and this PLMN as valid system information.

For all system information blocks or scheduling blocks that are supported by the UE referenced in the master information block or the scheduling blocks, the UE shall perform the following actions:

- 1> for all system information blocks with area scope "PLMN" or "Equivalent PLMN" that use value tags:
 - 2> compare the value tag read in scheduling information for that system information block with the value stored within the variable VALUE_TAG for that system information block;
 - 2> if the value tags differ, or if no IEs for the corresponding system information block are stored:
 - 3> store the value tag read in scheduling information for that system information block into the variable VALUE_TAG;
 - 3> read and store the IEs of that system information block.
 - 2> if the value tags are the same the UE may use stored system information blocks using value tag that were stored in this PLMN as valid system information.
- 1> for all system information blocks or scheduling blocks with area scope cell that use value tags:
 - 2> compare the value tag read in scheduling information for that system information block or scheduling block with the value stored within the variable VALUE_TAG for that system information block or scheduling block;
 - 2> if the value tags differ, or if no IEs for the corresponding system information block or scheduling block are stored:
 - 3> store the value tag read in scheduling information for that system information block or scheduling block into the variable VALUE_TAG;
 - 3> read and store the IEs of that system information block or scheduling block.
 - 2> if the value tags are the same the UE may use stored system information blocks using value tags that were stored for this cell and this PLMN as valid system information.
- 1> for system information blocks which may have multiple occurrences:
 - 2> compare the value tag and the configuration or multiple occurrence identity for the occurrence of the system information blocks read in scheduling information with the value tag and configuration or multiple occurrence identity stored within the variable VALUE_TAG:
 - 3> if the value tags differ, or if no IEs from the occurrence with that configuration or multiple occurrence identity of the system information block are stored:
 - 4> store the value tag read in scheduling information for that system information block and the occurrence with that configuration or multiple occurrence identity into the variable VALUE_TAG;
 - 4> read and store the IEs of that system information block.
 - 3> if the value tags and the configuration or multiple occurrence identity are identical to those stored, the UE may use stored occurrences of system information blocks that were stored for this cell and this PLMN as valid system information.

For system information blocks, not supported by the UE, but referenced either in the master information block or in the scheduling blocks, the UE may:

- 1> skip reading this system information block;

1> skip monitoring changes to this system information block.

If the UE:

- 1> receives a scheduling block at a position different from its position according to the scheduling information for the scheduling block; or
- 1> receives a scheduling block for which scheduling information has not been received:

the UE may:

- 1> store the content of the scheduling block with a value tag set to the value NULL; and
- 1> consider the content of the scheduling block as valid until it receives the same type of scheduling block in a position according to its scheduling information or at most for 6 hours after reception.

If the UE does not find a scheduling block in a position where it should be according to its scheduling information, but a transport block with correct CRC was found at that position, the UE shall:

- 1> read the scheduling information for this scheduling block.

If the UE does not find the master information block in a position fulfilling:

$$\text{SFN mod } 32 = 0$$

but a transport block with correct CRC was found at that position), the UE shall:

- 1> consider the master information block as not found; and
- 1> consider the cell to be barred according to [4]; and
- 1> consider the barred cell as using the value "allowed" in the IE "Intra-frequency cell re-selection indicator", and the maximum value in the IE " T_{barred} ".

NOTE: This permits a different repetition for the MIB in later versions for FDD. In TDD it allows for a variable SIB_REP in this and future releases.

If system information block type 1 is not scheduled on BCH, and system information block type 13 is not scheduled on BCH, the UE shall:

- 1> consider the cell to be barred according to [4]; and
- 1> consider the barred cell as using the value "allowed" in the IE "Intra-frequency cell re-selection indicator", and the maximum value in the IE " T_{barred} ".

If the UE only supports GSM-MAP but finds a cell that broadcasts System Information Block type 13 but not System Information Block type 1, the UE shall:

- 1> consider the cell barred.

If:

- system information block type 1 is not scheduled on BCH; and
- the "PLMN Type" in the variable SELECTED_PLMN has the value "GSM-MAP"; and
- the IE "PLMN type" in the Master Information Block has the value "GSM-MAP" or "GSM-MAP and ANSI-41":

the UE shall:

- 1> indicate to upper layers that no CN system information is available.

If in idle mode and System Information Block type 3 is not scheduled on BCH, the UE shall:

- 1> consider the cell to be barred according to [4]; and
- 1> consider the barred cell as using the value "allowed" in the IE "Intra-frequency cell re-selection indicator", and the maximum value in the IE " T_{barred} ".

If in connected mode and System Information Block type 3 is not scheduled on BCH, and System Information Block type 4 is not scheduled on BCH, the UE shall:

- 1> consider the cell to be barred according to [4]; and
- 1> consider the barred cell as using the value "allowed" in the IE "Intra-frequency cell re-selection indicator", and the maximum value in the IE " T_{barred} ".

If in idle mode and System Information Block type 5 is not scheduled on BCH or System Information Block type 5 is scheduled but IE "AICH info" (FDD) or IE "PICH info" is not present, the UE shall:

- 1> consider the cell to be barred according to [4]; and
- 1> consider the barred cell as using the value "allowed" in the IE "Intra-frequency cell re-selection indicator", and the maximum value in the IE " T_{barred} ".

If in connected mode and System Information Block type 5 is not scheduled on BCH, and System Information Block type 6 is not scheduled on BCH, or any of System Information Block type 5 or type 6 is scheduled but IE "AICH info" (FDD) or IE "PICH info" is not present, the UE shall:

- 1> consider the cell to be barred according to [4]; and
- 1> consider the barred cell as using the value "allowed" in the IE "Intra-frequency cell re-selection indicator", and the maximum value in the IE " T_{barred} ".

If System Information Block type 7 is not scheduled on BCH, the UE shall:

- 1> consider the cell to be barred according to [4]; and
- 1> consider the barred cell as using the value "allowed" in the IE "Intra-frequency cell re-selection indicator", and the maximum value in the IE " T_{barred} ".

In 3.84 Mcps TDD, if System Information Block type 14 is not scheduled on BCH, the UE shall:

- 1> consider the cell to be barred according to [4]; and
- 1> consider the barred cell as using the value "allowed" in the IE "Intra-frequency cell re-selection indicator", and the maximum value in the IE " T_{barred} ".

8.1.1.6 Actions upon reception of system information blocks

The UE may use the scheduling information included within the master information block and the scheduling blocks to locate each system information block to be acquired.

The UE should only expect one occurrence of the scheduling information for a system information block in the master information block and any of the scheduling blocks except for System Information Block type 16, System Information Block type 15.2 and System Information Block type 15.3, which may have multiple occurrences. However, to enable future introduction of new system information blocks, the UE shall also be able to receive system information blocks other than the ones indicated within the scheduling information. The UE may ignore contents of such system information block.

If the UE:

- 1> receives a system information block in a position according to the scheduling information for the system information block; and
- 1> this system information block uses a value tag; or
- 1> this system information block uses a value tag and configuration or multiple occurrence identity:

the UE shall:

- 1> store the content of the system information block together with the value of its value tag or the values of configuration and multiple occurrence identity and the associated value tag in the scheduling information for the system information block; and

- 1> consider the content of the system information block valid until, if used, the value tag in the scheduling information for the system information block is changed or at most for 6 hours after reception.

If the UE:

- 1> receives a system information block in a position according to the scheduling information for the system information block; and
- 1> this system information block does not use a value tag according to the system information block type:

the UE shall:

- 1> store the content of the system information block; and
- 1> start an expiration timer using a value as defined in Table 8.1.1 for that system information block type; and
- 1> consider the content of the system information block valid until, the expiration timer expires.

If the UE:

- 1> receives a system information block at a position different from its position according to the scheduling information for the system information block; or
- 1> receives a system information block for which scheduling information has not been received; and
- 1> this system information block uses a value tag:

the UE may:

- 1> store the content of the system information block with a value tag set to the value NULL; and
- 1> consider the content of the system information block as valid until it receives the same type of system information block in a position according to its scheduling information or at most for 6 hours after reception.

If the UE:

- 1> receives a system information block with multiple occurrences at a position different from its position according to the scheduling information for the system information block; or
- 1> receives a system information block with multiple occurrences for which scheduling information has not been received; and
- 1> this system information block uses a value tag and configuration or multiple occurrence identity:

the UE shall:

- 1> ignore this information.

If the UE does not find a system information block in a position where it should be according to its scheduling information, but a transport block with correct CRC was found at that position, the UE shall read the scheduling information for this system information block.

The UE shall act upon all received information elements as specified in subclause 8.6 unless specified otherwise in the following subclauses.

8.1.1.6.1 System Information Block type 1

The UE should store all relevant IEs included in this system information block if the "PLMN Type" in the variable SELECTED_PLMN has the value "GSM-MAP" and the IE "PLMN type" in the Master Information Block has the value "GSM-MAP" or "GSM-MAP and ANSI-41". The UE shall also:

- 1> check that the cell, according to information included in IE "CN common GSM-MAP NAS system information", is suitable [4];
- 1> if in connected mode:
 - 2> not forward the content of the IE "CN common GSM-MAP NAS system information" to upper layers.

1> if in idle mode:

2> forward the content of the IE "CN common GSM-MAP NAS system information" to upper layers.

1> for the IE "CN domain system information list":

2> for each IE "CN domain system information" that is present:

3> check that the cell, according to information included in IE "CN domain specific NAS system information", is suitable [4];

3> if in connected mode:

4> not forward the content of the IE "CN common GSM-MAP NAS system information" to upper layers.

3> if in idle mode:

4> forward the content of the IE "CN domain specific NAS system information" and the IE "CN domain identity" to upper layers;

4> use the IE "CN domain specific DRX cycle length coefficient" to calculate frame number for the Paging Occasions as specified in [4];

4> store the value of the IE "CN domain specific DRX cycle length coefficient" for use in connected mode.

2> if an IE "CN domain system information" is not present for a particular CN domain:

3> indicate to upper layers that no CN system information is available for that CN domain.

1> if the UE has not yet entered UTRA RRC connected mode:

2> store the values of the IE "UE Timers and constants in connected mode" in the variable TIMERS_AND_CONSTANTS.

1> use the values stored in the variable TIMERS_AND_CONSTANTS for the relevant timers and constants.

8.1.1.6.2 System Information Block type 2

If in connected mode the UE should store all relevant IEs included in this system information block. The UE shall:

1> if in state URA_PCH, start to perform URA updates using the information in the IE "URA identity".

If in idle mode, the UE shall not use the values of the IEs in this system information block.

8.1.1.6.3 System Information Block type 3

The UE should store all relevant IEs included in this system information block. The UE shall:

1> if in connected mode, and System Information Block 4 is indicated as used in the cell:

2> read and act on information sent in that block.

8.1.1.6.4 System Information Block type 4

If in connected mode, the UE should store all relevant IEs included in this system information block.

If in idle mode, the UE shall not use the values of the IEs included in this system information block.

8.1.1.6.5 System Information Block type 5

The UE should store all relevant IEs included in this system information block. The UE shall:

1> if in connected mode, and System Information Block type 6 is indicated as used in the cell:

2> read and act on information sent in System Information Block type 6.

- 1> replace the TFS of the RACH with the one stored in the UE if any;
- 1> let the physical channel(s) of type PRACH given by the IE(s) "PRACH info" be the default in uplink for the PRACH if UE is in CELL_FACH state;
- 1> start to receive the physical channel of type AICH using the parameters given by the IE "AICH info" (FDD only) when given allocated PRACH is used;
- 1> use the first instance of the list of transport formats as in the IE "RACH TFS" for the used RACH received in the IE "PRACH system information list" when using the CCCH;
- 1> replace the TFS of the FACH/PCH with the one stored in the UE if any;
- 1> select a Secondary CCPCH as specified in [4] and in subclause 8.5.19, and start to receive the physical channel of type PICH associated with the PCH carried by the selected Secondary CCPCH using the parameters given by the IE "PICH info" if UE is in Idle mode or in CELL_PCH or URA_PCH state;
- 1> start to monitor its paging occasions on the selected PICH if UE is in Idle mode or in CELL_PCH or URA_PCH state;
- 1> start to receive the selected physical channel of type Secondary CCPCH using the parameters given by the IE(s) "Secondary CCPCH info" if UE is in CELL_FACH state;
- 1> in 3.84 Mcps TDD:
 - 2> use the IE "TDD open loop power control" as defined in subclause 8.5.7 when allocated PRACH is used.
- 1> in TDD:
 - 2> if the IE "PDSCH system information" and/or the IE "PUSCH system information" is included:
 - 3> store each of the configurations given there with the associated identity given in the IE "PDSCH Identity" and/or "PUSCH Identity" respectively. For every configuration, for which the IE "SFN Time info" is included, the information shall be stored for the duration given there.

8.1.1.6.6 System Information Block type 6

If in connected mode, the UE should store all relevant IEs included in this system information block. The UE shall:

- 1> replace the TFS of the RACH with the one stored in the UE if any;
- 1> let the physical channel(s) of type PRACH given by the IE(s) "PRACH info" be the default in uplink if UE is in CELL_FACH state. If the IE "PRACH info" is not included, the UE shall read the corresponding IE(s) in System Information Block type 5 and use that information to configure the PRACH;
- 1> start to receive the physical channel of type AICH using the parameters given by the IE "AICH info" when associated PRACH is used. If the IE "AICH info" is not included, the UE shall read the corresponding IE in System Information Block type 5 and use that information (FDD only);
- 1> replace the TFS of the FACH/PCH with the one stored in the UE if any;
- 1> select a Secondary CCPCH as specified in [4] and in subclause 8.5.19, and start to receive the physical channel of type PICH associated with the PCH carried by the selected Secondary CCPCH using the parameters given by the IE "PICH info" if the UE is in CELL_PCH or URA_PCH state. If the IE "PICH info" is not included, the UE shall read the corresponding IE in System Information Block type 5 and use that information;
- 1> start to monitor its paging occasions on the selected PICH if the UE is in CELL_PCH or URA_PCH state;
- 1> start to receive the selected physical channel of type Secondary CCPCH using the parameters given by the IE(s) "Secondary CCPCH info" if the UE is in CELL_FACH state. If the IE "Secondary CCPCH info" is not included, the UE shall read the corresponding IE(s) in System Information Block type 5 and use that information;
- 1> in 3.84 Mcps TDD: use the IE "TDD open loop power control" as defined in subclause 8.5.7;
- 1> in TDD: if the IE "PDSCH system information" and/or the IE "PUSCH system information" is included, store each of the configurations given there with the associated identity given in the IE "PDSCH Identity" and/or

"PUSCH Identity" respectively. For every configuration, for which the IE "SFN Time info" is included, the information shall be stored for the duration given there.

If in idle mode, the UE shall not use the values of the IEs in this system information block.

8.1.1.6.7 System Information Block type 7

The UE should store all relevant IEs included in this system information block.

8.1.1.6.8 System Information Block type 8

This system information block type is used only in FDD.

If in connected mode, the UE should store all relevant IEs included in this system information block.

If in idle mode, the UE shall not use the values of the IEs in this system information block.

8.1.1.6.9 System Information Block type 9

This system information block type is used only in FDD.

If in connected mode, the UE should store all relevant IEs included in the system information block. The UE shall:

- 1> start a timer set to the value given by the repetition period (SIB_REP) for that system information block.

If in idle mode, the UE shall not use the values of the IEs in this system information block.

8.1.1.6.10 System Information Block type 10

This system information block type is used only in FDD.

If in state CELL_DCH, the UE should store all relevant IEs included in this system information block. The UE shall:

- 1> start a timer set to the value given by the repetition period (SIB_REP) for that system information block;
- 1> perform actions defined in subclause 14.8.

If in idle mode, state CELL_FACH, state CELL_PCH or state URA_PCH, the UE shall not use the values of the IEs in this system information block.

8.1.1.6.11 System Information Block type 11

The UE should store all relevant IEs included in this system information block. The UE shall:

- 1> if in idle mode:

- 2> clear the variable MEASUREMENT_IDENTITY.

- 1> if IE "FACH measurement occasion info" is included:

- 2> act as specified in subclause 8.6.7.

- 1> else:

- 2> may perform inter-frequency/inter-RAT measurements or inter-frequency/inter-RAT cell re-selection evaluation, if the UE capabilities permit such measurements while simultaneously receiving the S-CCPCH of the serving cell.

- 1> clear the variable CELL_INFO_LIST;

- 1> act upon the received IE "Intra-frequency cell info list"/"Inter-frequency cell info list"/"Inter-RAT cell info list" as described in subclause 8.6.7.3;

- 1> if in idle mode; or

- 1> if in connected mode and if System Information Block type 12 is not broadcast in the cell:
 - 2> if no intra-frequency measurement was set up or modified through a MEASUREMENT CONTROL message:
 - 3> if included, store the IE "Intra-frequency reporting quantity" and the IE "Intra-frequency measurement reporting criteria" or "Periodical reporting criteria" in order to activate reporting when state CELL_DCH is entered in the variable MEASUREMENT_IDENTITY. The IE "Cells for measurement" is absent for this measurement. The IE "Measurement Validity" is absent for this measurement after a state transition to CELL_DCH;
- 1> if in connected mode and if System Information Block type 12 is not broadcast in the cell:
 - 2> read the IE "Traffic volume measurement information";
 - 2> if no traffic volume measurement with the measurement identity indicated in the IE "Traffic volume measurement system information" was set up or modified through a MEASUREMENT CONTROL message:
 - 3> update the variable MEASUREMENT_IDENTITY with the measurement information received in that IE.
- 1> if the IE "Cell selection and reselection info" is not included for a new neighbouring cell in the IE "intra-frequency cell info list", the IE "inter-frequency cell info list" or the IE "inter-RAT cell info list" in System Information Block type 11:
 - 2> use the default values specified for the IE "Cell selection and reselection info" for that cell except for the IE "HCS neighbouring cell information".
- 1> if the IE "Use of HCS" is set to "used", indicating that HCS is used, do the following:
 - 2> if IE "HCS neighbouring cell information" is not included for the first new cell in the IE "Intra-frequency cell info list", the IE "Inter-frequency cell info list" or the IE "Inter-RAT cell info list" in System Information Block type 11:
 - 3> use the default values specified for the IE "HCS neighbouring cell information" for that cell.
 - 2> if IE "HCS neighbouring cell information" is not included for any other new cell in the IE "Intra-frequency cell info list", the IE "Inter-frequency cell info list" or the IE "Inter-RAT cell info list" in System Information Block type 11:
 - 3> for that cell use the same parameter values as used for the preceding cell in the same cell info list in System Information Block type 11.
- 1> if the value of the IE "Cell selection and reselection quality measure" is different from the value of the IE "Cell selection and reselection quality measure" obtained from System Information Block type 3 or System Information Block type 4:
 - 2> use the value of the IE from this System Information Block and ignore the value obtained from System Information Block type 3 or System Information Block type 4.
- 1> if in connected mode, and System Information Block type 12 is indicated as used in the cell:
 - 2> read and act on information sent in System Information Block type 12 as indicated in subclause 8.1.1.6.12.

8.1.1.6.12 System Information Block type 12

If in connected mode, the UE should store all relevant IEs included in this system information block. The UE shall:

- 1> after reception of System Information Block type 11:
 - 2> update the variable MEASUREMENT_IDENTITY with the measurement information in the received IEs unless specified otherwise.
- 1> if IE "FACH measurement occasion info" is included:
 - 2> act as specified in subclause 8.6.7.

- 1> else:
 - 2> may perform inter-frequency/inter-RAT measurements or inter-frequency/inter-RAT cell re-selection evaluation, if the UE capabilities permit such measurements while simultaneously receiving the S-CCPCH of the serving cell.
- 1> act upon the received IE "Intra-frequency cell info list"/"Inter-frequency cell info list"/"Inter-RAT cell info list" as described in subclause 8.6.7.3;
- 1> if any of the IEs "Intra-frequency measurement quantity", "Intra-frequency reporting quantity for RACH reporting", "Maximum number of reported cells on RACH" or "Reporting information for state CELL_DCH" are not included in the system information block:
 - 2> read the corresponding IE(s) in system information block type 11 and use that information for the intra-frequency measurement.
- 1> if included in this system information block or in System Information Block type 11:
 - 2> if no intra-frequency measurement in the variable MEASUREMENT_IDENTITY was set up or modified through a MEASUREMENT CONTROL message:
 - 3> store the IE "Intra-frequency reporting quantity" and the IE "Intra-frequency measurement reporting criteria" or "Periodical reporting criteria" in order to activate reporting when state CELL_DCH is entered in the variable MEASUREMENT_IDENTITY. The IE "Cells for measurement" is absent for this measurement. The IE "Measurement Validity" is absent for this measurement after a state transition to CELL_DCH;
- 1> if the IE "Traffic volume measurement system information" is not included in this system information block:
 - 2> read the corresponding IE in System Information Block type 11.
- 1> if the IE "Traffic volume measurement system information" was received either in this system information block or in System Information Block type 11:
 - 2> if no traffic volume measurement with the measurement identity indicated in the IE "Traffic volume measurement system information" was set up or modified through a MEASUREMENT CONTROL message:
 - 3> update the variable MEASUREMENT_IDENTITY with the measurement information received in that IE.
- 1> if in CELL_FACH state:
 - 2> start or continue the traffic volume measurements stored in the variable MEASUREMENT_IDENTITY that are valid in CELL_FACH state.
- 1> if the IE "Cell selection and reselection info" is not included for a new neighbouring cell in the IE "Intra-frequency cell info list", the IE "Inter-frequency cell info list" or the IE "Inter-RAT cell info list" in System Information Block type 12:
 - 2> use the default values specified for the IE "Cell selection and reselection info" for that cell except for the IE "HCS neighbouring cell information".
- 1> if the IE "Use of HCS" is set to "used", indicating that HCS is used, do the following:
 - 2> if IE "HCS neighbouring cell information" is not included for the first new cell in the IE "Intra-frequency cell info list", the IE "Inter-frequency cell info list" or the IE "Inter-RAT cell info list" in System Information Block type 12:
 - 3> use the default values specified for the IE "HCS neighbouring cell information" for that cell.
 - 2> if IE "HCS neighbouring cell information" is not included for any other new cell in the IE "Intra-frequency cell info list", the IE "Inter-frequency cell info list" or the IE "Inter-RAT cell info list" in System Information Block type 12:
 - 3> for that cell use the same parameter values as used for the preceding cell in the same cell info list in System Information Block type 12.

- 1> if the value of the IE "Cell selection and reselection quality measure" is different from the value of the IE "Cell selection and reselection quality measure" obtained from System Information Block type 3 or System Information Block type 4:
- 2> use the value of the IE from this System Information Block and ignore the value obtained from System Information Block type 3 or System Information Block type 4.

If in idle mode, the UE shall not use the values of the IEs in this system information block.

8.1.1.6.13 System Information Block type 13

If in idle or connected mode, the UE should store all relevant IEs included in this system information block except for the IEs "CN domain specific DRX cycle length coefficient", "UE timers and constants in idle mode" and "Capability update requirement" which shall be stored only in the idle mode case. The UE shall read System Information Block type 13 and the associated System Information Block types 13.1, 13.2, 13.3 and 13.4 only when the "PLMN Type" in the variable SELECTED_PLMN has the value "ANSI-41" and the IE "PLMN type" in the Master Information Block has the value "ANSI-41" or "GSM-MAP and ANSI-41". The UE shall also:

- 1> forward the content of the IE "CN domain specific NAS system information" to the non-access stratum entity indicated by the IE "CN domain identity";
- 1> use the IE "CN domain specific DRX cycle length coefficient" to calculate frame number for the Paging Occasions and Page indicator as specified in [4].

Refer to TIA/EIA/IS-2000.5-A for actions on information contained in System Information Block types 13.1, 13.2, 13.3 and 13.4.

8.1.1.6.14 System Information Block type 14

This system information block type is used only in 3.84 Mcps TDD.

The UE should store all relevant IEs included in this system information block. The UE shall:

- 1> use the IE "UL Timeslot Interference" to calculate PRACH, DPCH and PUSCH transmit power for TDD uplink open loop power control as defined in subclause 8.5.7.

8.1.1.6.15 System Information Block type 15

If the UE is in idle or connected mode, and supports GPS location services it should store all relevant IEs included in this system information block. The UE shall:

- 1> if the IE "GPS Data ciphering info" is included:
 - 1> act as specified in the subclause 8.6.7.19.4.- act upon the received IE "Reference position" as specified in subclause 8.6.7.19.3.8;
 - 1> act upon the received IE "GPS reference time" as specified in subclause 8.6.7.19.3.7;
- 1> if IE "Satellite information" is included:
 - 2> act upon this list of bad satellites as specified in subclause 8.6.7.19.3.6.

NOTE: For efficiency purposes, the UTRAN should broadcast System Information Block type 15 if it is broadcasting System Information Block type 15.2.

8.1.1.6.15.1 System Information Block type 15.1

The UE should store all the relevant IEs included in this system information block in variable UE_POSITIONING_GPS_DATA. The UE shall:

- 1> act on "DGPS information" in the IE "DGPS Corrections" in a similar manner as specified in [13] except that the scale factors for PRC and RRC are different;
- 1> act upon the received IE " UE Positioning GPS DGPS corrections" as specified in subclause 8.6.7.19.3.3.

In this version of the specification, the UE shall:

- 1> ignore the following IEs: "Delta PRC2", "Delta RRC2", "Delta PRC3" and "Delta RRC3".

8.1.1.6.15.2 System Information Block type 15.2

For System Information Block type 15.2 multiple occurrences may be used; one occurrence for one satellite. To identify the different occurrences, the scheduling information for System Information Block type 15.2 includes IE "SIB occurrence identity and value tag". The UE should store all the relevant IEs included in this system information block in variable UE_POSITIONING_GPS_DATA. The UE shall:

- 1> compare for each occurrence the value tag of the stored occurrence, if any, with the occurrence value tag included in the IE "SIB occurrence identity and value tag" for the occurrence of the SIB with the same occurrence identity;
- 1> in case the UE has no SIB occurrence stored with the same identity or in case the occurrence value tag is different:
 - 2> store the occurrence information together with its identity and value tag for later use.
- 1> in case an occurrence with the same identity but different value tag was stored:
 - 2> overwrite this one with the new occurrence read via system information for later use.
- 1> interpret IE "Transmission TOW" as a very coarse estimate of the current time, i.e., the approximate GPS time-of-week when the message is broadcast;
- 1> interpret IE "SatID" as the satellite ID of the data from which this message was obtained;
- 1> act upon the received IEs "Sat ID" and "GPS Ephemeris and Clock Corrections Parameter" as specified in subclause 8.6.7.19.3.4.

The IE "Transmission TOW" may be different each time a particular SIB occurrence is transmitted. The UTRAN should not increment the value tag of the SIB occurrence if the IE "Transmission TOW" is the only IE that is changed.

The UE may not need to receive all occurrences before it can use the information from any one occurrence.

8.1.1.6.15.3 System Information Block type 15.3

For System Information Block type 15.3 multiple occurrences may be used; one occurrence for each set of satellite data. To identify the different occurrences, the scheduling information for System Information Block type 15.3 includes IE "SIB occurrence identity and value tag". The UE should store all the relevant IEs included in this system information block in variable UE_POSITIONING_GPS_DATA. The UE shall:

- 1> compare for each occurrence the value tag of the stored occurrence, if any, with the occurrence value tag included in the IE "SIB occurrence identity and value tag" for the occurrence of the SIB with the same occurrence identity;
- 1> in case the UE has no SIB occurrence stored with the same identity or in case the occurrence value tag is different:
 - 2> store the occurrence information together with its identity and value tag for later use.
- 1> in case an occurrence with the same identity but different value tag was stored:
 - 2> overwrite this one with the new occurrence read via system information for later use.
- 1> interpret IE "Transmission TOW" as a very coarse estimate of the current time, i.e., the approximate GPS time-of-week when the message is broadcast;
- 1> if the IE "GPS Almanac and Satellite Health" is included:
 - 2> interpret IE "SatMask" as the satellites that contain the pages being broadcast in this message;
 - 2> interpret IE "LSB TOW" as the least significant 8 bits of the TOW ([12]);

2> act upon the received IE "GPS Almanac and Satellite Health" as specified in subclause 8.6.7.19.3.2.

1> if the IE "GPS ionospheric model" is included:

2> act upon the received IE "GPS ionospheric model" as specified in subclause 8.6.7.19.3.5.

1> if the IE "GPS UTC model" is included:

2> act upon the received IE "GPS UTC model" as specified in subclause 8.6.7.19.3.9.

The IE "Transmission TOW" may be different each time a particular SIB occurrence is transmitted. The UTRAN should not increment the value tag of the SIB occurrence if the IE "Transmission TOW" is the only IE that is changed. One SIB occurrence value tag is assigned to the table of subclause 10.2.48.8.18.3.

The UE may not need to receive all occurrences before it can use the information for any one occurrence.

8.1.1.6.15.4 System Information Block type 15.4

If the UE is in idle mode or connected mode, the UE shall:

1> if the IE "OTDOA Data ciphering info" is included:

2> act as specified in subclause 8.6.7.19.4.

If the UE is in connected mode, the UE shall:

1> act as specified in subclause 8.6.7.19.2.

8.1.1.6.15.5 System Information Block type 15.5

If the UE is in idle or connected mode, the UE shall:

1> if the UE supports UE-based OTDOA positioning:

2> act as specified in subclause 8.6.7.19.2a.

8.1.1.6.16 System Information Block type 16

For System Information Block type 16 multiple occurrences may be used; one occurrence for each predefined configuration. To identify the different predefined configurations, the scheduling information for System Information Block type 16 includes IE "Predefined configuration identity and value tag".

The UE should store all relevant IEs included in this system information block. The UE shall:

1> compare for each predefined configuration the value tag of the stored predefined configuration with the preconfiguration value tag included in the IE "Predefined configuration identity and value tag" for the occurrence of the SIB with the same predefined configuration identity;

1> in case the UE has no predefined configuration stored with the same identity or in case the predefined configuration value tag is different:

2> store the predefined configuration information together with its identity and value tag for later use e.g. during handover to UTRAN.

1> in case a predefined configuration with the same identity but different value tag was stored:

2> overwrite this one with the new configuration read via system information for later use e.g. during handover to UTRAN.

The above handling applies regardless of whether the previously stored predefined configuration information has been obtained via UTRA or via another RAT.

The UE is not required to complete reading of all occurrences of System Information Block type 16 before initiating RRC connection establishment.

The UE is not required to store more than maxPredefConfig preconfigurations even in the case of multiple equivalent PLMNs.

8.1.1.6.17 System Information Block type 17

This system information block type is used only for TDD.

If in connected mode, the UE should store all relevant IEs included in this system information block. The UE shall:

- 1> if the IE "PDSCH system information" and/or the IE "PUSCH system information" is included, store each of the configurations given there with the associated identity given in the IE "PDSCH Identity" and/or "PUSCH Identity" respectively. This information shall become invalid after the time specified by the repetition period (SIB_REP) for this system information block.

If in idle mode, the UE shall not use the values of the IEs in this system information block.

8.1.1.6.18 System Information Block type 18

If the System Information Block type 18 is present, a UE shall obtain knowledge of the PLMN identity of the neighbour cells to be considered for cell reselection, and shall behave as specified in this subclause and in subclause 8.5.14a.

The UE should store all the relevant IEs included in this system information block.

A UE in idle mode shall act according to the following rules:

- 1> any PLMN list of a given type (IEs "PLMNs of intra-frequency cells list", "PLMNs of inter-frequency cells list", "PLMNs of inter-RAT cell lists") included in the IE "Idle mode PLMN identities" is paired with the list of cells of the same type derived from System Information Block type 11;
- 1> the PLMN identity located at a given rank in the PLMN list is that of the cell with the same ranking in the paired list of cells, the cells being considered in the increasing order of their associated identities ("Intra-frequency cell id", "Inter-frequency cell id", "Inter-RAT cell id");
- 1> if the number of identities in a PLMN list exceeds the number of neighbour cells in the paired list (if any), the extra PLMN identities are considered as unnecessary and ignored;
- 1> if the number of identities in a PLMN list (if any) is lower than the number of neighbour cells in the paired list, the missing PLMN identities are replaced by the last PLMN identity in the list if present, otherwise by the identity of the selected PLMN.

A UE in connected mode shall act in the same manner as a UE in idle mode with the following modifications:

- 1> the PLMN lists to be considered are the ones included, when present, in the IE "Connected mode PLMN identities"; otherwise, the UE shall use, in place of any missing list, the corresponding one in the IE "Idle mode PLMN identities";
- 1> the paired lists of cells are the ones derived from System Information Block type 11, and System Information Block type 12 if present.

8.1.1.7 Modification of system information

For System Information Block type 15.2, 15.3 and 16 that may have multiple occurrences, the UE shall handle each occurrence independently as specified in the previous; that is each occurrence is handled as a separate system information block.

NOTE: It should be noted that for the proper operation of the BCCH Modification Information sent on a PCH, the System Information should not be changed more frequently than can be accommodated by mobile stations operating at the maximum DRX cycle length supported by the UTRAN.

8.1.1.7.1 Modification of system information blocks using a value tag

Upon modifications of system information blocks using value tags, UTRAN should notify the new value tag for the master information block in the IE "BCCH modification info", transmitted in the following way:

1> to reach UEs in idle mode, CELL_PCH state and URA_PCH state, the IE "BCCH modification info" is contained in a PAGING TYPE 1 message transmitted on the PCCH in all paging occasions in the cell;

1> to reach UEs in CELL_FACH state or TDD UEs in CELL_DCH with S-CCPCH assigned, the IE "BCCH modification info" is contained in a SYSTEM INFORMATION CHANGE INDICATION message transmitted on the BCCH mapped on at least one FACH on every Secondary CCPCH in the cell.

Upon reception of a PAGING TYPE 1 message or a SYSTEM INFORMATION CHANGE INDICATION message containing the IE "BCCH modification info" containing the IE "MIB value tag" but not containing the IE "BCCH modification time", the UE shall perform actions as specified in subclause 8.1.1.7.3.

If the IE "BCCH modification time" is included the UE shall perform actions as specified in subclause 8.1.1.7.2.

8.1.1.7.2 Synchronised modification of system information blocks

For modification of some system information elements, e.g. reconfiguration of the channels, it is important for the UE to know exactly when a change occurs. In such cases, the UTRAN should notify the SFN when the change will occur as well as the new value tag for the master information block in the IE "BCCH modification info" transmitted in the following way:

1> To reach UEs in idle mode, CELL_PCH state and URA_PCH state, the IE "BCCH modification info" is contained in a PAGING TYPE 1 message transmitted on the PCCH in all paging occasions in the cell;

1> To reach UEs in CELL_FACH state, the IE "BCCH modification info" is contained in a SYSTEM INFORMATION CHANGE INDICATION message transmitted on the BCCH mapped on at least one FACH on every Secondary CCPCH in the cell.

Upon reception of a PAGING TYPE 1 message or a SYSTEM INFORMATION CHANGE INDICATION message containing the IE "BCCH modification info" containing the IE "MIB value tag" and containing the IE "BCCH modification time", the UE shall:

1> perform the actions as specified in subclause 8.1.1.7.3 at the time, indicated in the IE "BCCH Modification Info".

8.1.1.7.3 Actions upon system information change

The UE shall:

1> compare the value of IE "MIB value tag" in the IE "BCCH modification info" with the value tag stored for the master information block in variable VALUE_TAG.

1> if the value tags differ:

2> read the master information block on BCH;

2> if the value tag of the master information block in the system information is the same as the value in IE "MIB value tag" in "BCCH modification info" but different from the value tag stored in the variable VALUE_TAG:

3> perform actions as specified in subclause 8.1.1.5.

2> if the value tag of the master information block in the system information is the same as the value tag stored in the variable VALUE_TAG:

3> for the next occurrence of the master information block:

4> perform actions as specified in subclause 8.1.1.7.3 again.

2> if the value tag of the master information block in the system information is different from the value tag stored in the variable VALUE_TAG, and is different from the value in IE "MIB value tag" in "BCCH modification info":

3> perform actions as specified in subclause 8.1.1.5;

3> if $(VTCI - VTMIB) \bmod 8 < 4$, where VTCI is the value tag in the IE "MIB value tag" in "BCCH modification info" and VTMIB is the value tag of the master information block in the system information:

4> for the next occurrence of the master information block:

5> perform actions as specified in subclause 8.1.1.7.3 again.

8.1.1.7.4 Actions upon expiry of a system information expiry timer

When the expiry timer of a system information block not using a value tag expires

the UE shall:

1> consider the content of the system information block invalid;

1> re-acquire the system information block again before the content can be used;

the UE may:

1> postpone reading the system information block until the content is needed.

8.1.2 Paging

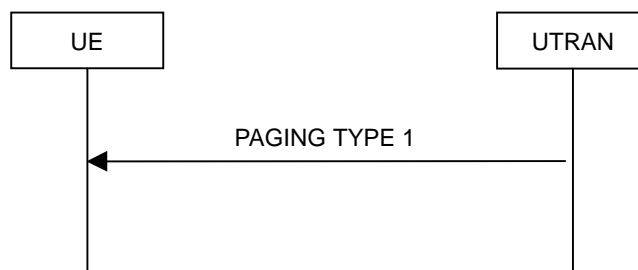

Figure 8.1.2-1: Paging

8.1.2.1 General

This procedure is used to transmit paging information to selected UEs in idle mode, CELL_PCH or URA_PCH state using the paging control channel (PCCH). Upper layers in the network may request paging, to e.g. establish a signalling connection. UTRAN may initiate paging for UEs in CELL_PCH or URA_PCH state to trigger a cell update procedure. In addition, UTRAN may initiate paging for UEs in idle mode, CELL_PCH and URA_PCH state to trigger reading of updated system information.

8.1.2.2 Initiation

UTRAN initiates the paging procedure by transmitting a PAGING TYPE 1 message on an appropriate paging occasion on the PCCH.

UTRAN may repeat transmission of a PAGING TYPE 1 message to a UE in several paging occasions to increase the probability of proper reception of a page.

UTRAN may page several UEs in the same paging occasion by including one IE "Paging record" for each UE in the PAGING TYPE 1 message.

For CN originated paging, UTRAN should set the IE "Paging cause" to the cause for paging received from upper layers. If no cause for paging is received from upper layers, UTRAN should set the value "Terminating – cause unknown".

UTRAN may also indicate that system information has been updated, by including the value tag of the master information block in the IE "BCCH modification info" in the PAGING TYPE 1 message. In this case, UTRAN may omit the IEs "Paging record".

8.1.2.3 Reception of a PAGING TYPE 1 message by the UE

A UE in idle mode, CELL_PCH state or URA_PCH state shall receive the paging information for all its monitored paging occasions. For a UE in idle mode, the paging occasions are specified in [4] and depend on the IE "CN domain specific DRX cycle length coefficient", as specified in subclause 8.6.3.1a. For a UE in CELL_PCH state or URA_PCH state, the paging occasions depend also on the IE "UTRAN DRX cycle length coefficient" and the IE "RRC State Indicator", as specified in subclauses 8.6.3.2 and 8.6.3.3 respectively.

When the UE receives a PAGING TYPE 1 message, it shall perform the actions as specified below.

If the UE is in idle mode, for each occurrence of the IE "Paging record" included in the message the UE shall:

- 1> if the IE "Used paging identity" is a CN identity:
 - 2> compare the IE "UE identity" with all of its allocated CN UE identities:
 - 2> if one match is found:
 - 3> indicate reception of paging; and
 - 3> forward the IE "CN domain identity", the IE "UE identity" and the IE "Paging cause" to the upper layers.
 - 2> otherwise:
 - 2> ignore that paging record.

If the UE is in connected mode, for each occurrence of the IE "Paging record" included in the message the UE shall:

- 1> if the IE "Used paging identity" is a UTRAN identity and if this U-RNTI is the same as the U-RNTI allocated to the UE:
 - 2> if the optional IE "CN originated page to connected mode UE" is included:
 - 3> indicate reception of paging; and
 - 3> forward the IE "CN domain identity", the IE "Paging cause" and the IE "Paging record type identifier" to the upper layers.
 - 2> otherwise:
 - 3> perform a cell update procedure with cause "paging response" as specified in subclause 8.3.1.2.
 - 2> ignore any other remaining IE "Paging record" that may be present in the message.
- 1> otherwise:
 - 2> ignore that paging record.

If the IE "BCCH modification info" is included, any UE in idle mode, CELL_PCH or URA_PCH state shall perform the actions as specified in subclause 8.1.1 in addition to any actions caused by the IE "Paging record" occurrences in the message as specified above.

8.1.3 RRC connection establishment

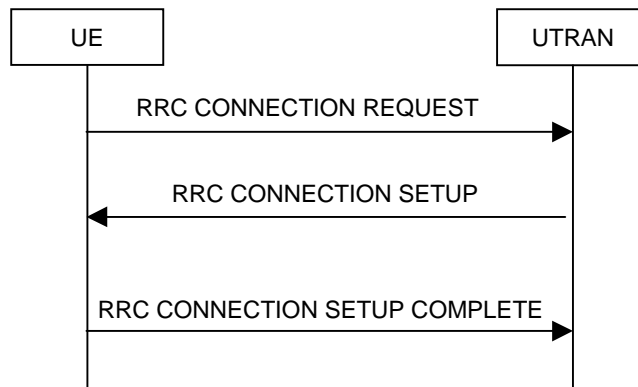

Figure 8.1.3-1: RRC Connection Establishment, network accepts RRC connection

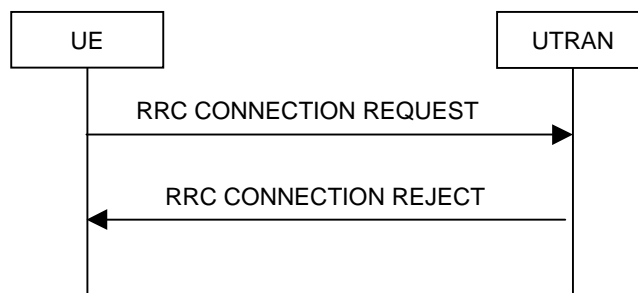

Figure 8.1.3-2: RRC Connection Establishment, network rejects RRC connection

8.1.3.1 General

The purpose of this procedure is to establish an RRC connection.

8.1.3.2 Initiation

The UE shall initiate the procedure when upper layers in the UE requests the establishment of a signalling connection and the UE is in idle mode (no RRC connection exists), as specified in subclause 8.1.8.

Upon initiation of the procedure, the UE shall:

- 1> set the variable `PROTOCOL_ERROR_INDICATOR` to `FALSE`;
- 1> if the USIM is present:
 - 1> set the value of "THRESHOLD" in the variable "START_THRESHOLD" to the 20 MSBs of the value stored in the USIM [50] for the maximum value of `START` for each CN Domain.
- 1> set the IE "Initial UE identity" in the variable `INITIAL_UE_IDENTITY` according to subclause 8.5.1;
- 1> set the contents of the RRC CONNECTION REQUEST message according to subclause 8.1.3.3;
- 1> set CFN in relation to SFN of current cell according to subclause 8.5.15;
- 1> perform the mapping of the Access Class to an Access Service Class as specified in subclause 8.5.13, and apply the given Access Service Class when accessing the RACH;
- 1> submit the RRC CONNECTION REQUEST message for transmission on the uplink CCCH;
- 1> set counter `V300` to 1; and
- 1> start timer `T300` when the MAC layer indicates success or failure to transmit the message;

- 1> select a Secondary CCPCH according to [4];
- 1> start receiving all FACH transport channels mapped on the selected Secondary CCPCH.

8.1.3.3 RRC CONNECTION REQUEST message contents to set

The UE shall, in the transmitted RRC CONNECTION REQUEST message:

- 1> set the IE "Establishment cause" to the value of the variable ESTABLISHMENT_CAUSE;
- 1> set the IE "Initial UE identity" to the value of the variable INITIAL_UE_IDENTITY;
- 1> set the IE "Protocol error indicator" to the value of the variable PROTOCOL_ERROR_INDICATOR;
- 1> include a measurement report in the IE "Measured results on RACH", as specified in the IE "Intra-frequency reporting quantity for RACH reporting" and the IE "Maximum number of reported cells on RACH" in System Information Block type 11; and
- 1> include in the IE "Measured results on RACH" all requested reporting quantities for cells for which measurements are reported; and
- 1> take care that the maximum allowed message size is not exceeded when forming the IE "Measured results on RACH".

The UE shall not include the IE "UE Specific Behaviour Information 1 idle".

8.1.3.4 Reception of an RRC CONNECTION REQUEST message by the UTRAN

Upon receiving an RRC CONNECTION REQUEST message, UTRAN should either:

- 1> submit an RRC CONNECTION SETUP message to the lower layers for transmission on the downlink CCCH; or

NOTE: The RRC CONNECTION SETUP message always includes the IEs "Added or Reconfigured TrCH information list", both for uplink and downlink transport channels, even if UTRAN orders the UE to move to CELL_FACH and hence need not configure any transport channels. In these cases, UTRAN may include a configuration that adds little to the encoded message size e.g. a DCH with a single zero size transport format. At a later stage, UTRAN may either remove or reconfigure this configuration.

- 1> submit an RRC CONNECTION REJECT message on the downlink CCCH. In the RRC CONNECTION REJECT message, the UTRAN may direct the UE to another UTRA carrier or to another system. After the RRC CONNECTION REJECT message has been sent, all context information for the UE may be deleted in UTRAN.

8.1.3.5 Cell re-selection or T300 timeout

- 1> if the UE has not yet received an RRC CONNECTION SETUP message with the value of the IE "Initial UE identity" equal to the value of the variable INITIAL_UE_IDENTITY; and
- 1> if cell re-selection or expiry of timer T300 occurs:

the UE shall:

- 1> check the value of V300; and
 - 2> if V300 is equal to or smaller than N300:
 - 3> if cell re-selection occurred:
 - 4> set CFN in relation to SFN of current cell according to subclause 8.5.15.
 - 3> set the IEs in the RRC CONNECTION REQUEST message according to subclause 8.1.3.3;
 - 3> perform the mapping of the Access Class to an Access Service Class as specified in subclause 8.5.13; and
 - 3> apply the given Access Service Class when accessing the RACH;

- 3> submit a new RRC CONNECTION REQUEST message to lower layers for transmission on the uplink CCCH;
- 3> increment counter V300;
- 3> restart timer T300 when the MAC layer indicates success or failure to transmit the message.
- 2> if V300 is greater than N300:
 - 3> enter idle mode.
 - 3> consider the procedure to be unsuccessful;
 - 3> Other actions the UE shall perform when entering idle mode from connected mode are specified in subclause 8.5.2;
 - 3> the procedure ends.

8.1.3.5a Abortion of RRC connection establishment

If the UE has not yet entered UTRA RRC Connected mode and the RRC connection establishment is to be aborted as specified in subclause 8.1.8, the UE shall:

- 1> consider the procedure to be unsuccessful;
- 1> perform the actions when entering idle mode as specified in subclause 8.5.2.

The procedure ends.

8.1.3.6 Reception of an RRC CONNECTION SETUP message by the UE

The UE shall compare the value of the IE "Initial UE identity" in the received RRC CONNECTION SETUP message with the value of the variable INITIAL_UE_IDENTITY.

If the values are different, the UE shall:

- 1> ignore the rest of the message.

If the values are identical, the UE shall:

- 1> stop timer T300, and act upon all received information elements as specified in subclause 8.6, unless specified otherwise in the following:
 - 2> if the UE, according to subclause 8.6.3.3, will be in the CELL_FACH state at the conclusion of this procedure:
 - 3> if the IE "Frequency info" is included:
 - 4> select a suitable UTRA cell according to [4] on that frequency;
 - 3> enter UTRA RRC connected mode;
 - 3> select PRACH according to subclause 8.5.17;
 - 3> select Secondary CCPCH according to subclause 8.5.19;
 - 3> ignore the IE "UTRAN DRX cycle length coefficient" and stop using DRX.
 - 1> if the UE, according to subclause 8.6.3.3, will be in the CELL_DCH state at the conclusion of this procedure:
 - 2> perform the physical layer synchronisation procedure A as specified in [29] (FDD only).
 - 2> enter UTRA RRC connected mode;
- 1> submit an RRC CONNECTION SETUP COMPLETE message to the lower layers on the uplink DCCH after successful state transition per subclause 8.6.3.3, with the contents set as specified below:

- 2> set the IE "RRC transaction identifier" to:
 - 3> the value of "RRC transaction identifier" in the entry for the RRC CONNECTION SETUP message in the table "Accepted transactions" in the variable TRANSACTIONS; and
 - 3> clear that entry.
- 2> if the USIM or SIM is present:
 - 3> set the "START" for each CN domain in the IE "START list" in the RRC CONNECTION SETUP COMPLETE message with the corresponding START value that is stored in the USIM [50] if present, or as stored in the UE if the SIM is present; and then
 - 3> set the START value stored in the USIM [50] if present, and as stored in the UE if the SIM is present for any CN domain to the value "THRESHOLD" of the variable START_THRESHOLD.
- 2> if neither the USIM nor SIM is present:
 - 3> set the "START" for each CN domain in the IE "START list" in the RRC CONNECTION SETUP COMPLETE message to zero;
 - 3> set the value of "THRESHOLD" in the variable "START_THRESHOLD" to the default value [40].
- 2> retrieve its UTRA UE radio access capability information elements from variable UE_CAPABILITY_REQUESTED; and then
- 2> include this in IE "UE radio access capability" and IE "UE radio access capability extension", provided this IE is included in variable UE_CAPABILITY_REQUESTED;
- 2> retrieve its inter-RAT-specific UE radio access capability information elements from variable UE_CAPABILITY_REQUESTED; and then
- 2> include this in IE "UE system specific capability".

When the RRC CONNECTION SETUP COMPLETE message has been submitted to lower layers for transmission the UE shall:

- 1> if the UE has entered CELL_FACH state:
 - 2> start timer T305 using its initial value if periodical update has been configured by T305 in the IE "UE Timers and constants in connected mode" set to any other value than "infinity" in the variable TIMERS_AND_CONSTANTS.
- 1> store the contents of the variable UE_CAPABILITY_REQUESTED in the variable UE_CAPABILITY_TRANSFERRED;
- 1> initialise variables upon entering UTRA RRC connected mode as specified in subclause 13.4;
- 1> consider the procedure to be successful;

And the procedure ends.

8.1.3.7 Physical channel failure or cell re-selection

- 1> If the UE failed to establish, per subclause 8.5.4, the physical channel(s) indicated in the RRC CONNECTION SETUP message; or
- 1> if the UE performs cell re-selection; or
- 1> if the UE will be in the CELL_FACH state at the conclusion of this procedure; and
- 1> if the received RRC CONNECTION SETUP message included the IE "Primary CPICH info" (for FDD) or "Primary CCPCH info" (for TDD), and the UE selected another cell than indicated by this IE; or
- 1> if the contents of the variable C_RNTI is empty;

1> after having received an RRC CONNECTION SETUP message with the value of the IE "Initial UE identity" equal to the value of the variable INITIAL_UE_IDENTITY; and

1> before the RRC CONNECTION SETUP COMPLETE message is delivered to lower layers for transmission:

the UE shall:

1> clear the entry for the RRC CONNECTION SETUP message in the table "Accepted transactions" in the variable TRANSACTIONS;

1> check the value of V300, and:

2> if V300 is equal to or smaller than N300:

3> set CFN in relation to SFN of current cell according to subclause 8.5.15;

3> set the IEs in the RRC CONNECTION REQUEST message according to subclause 8.1.3.3;

3> perform the mapping of the Access Class to an Access Service Class as specified in subclause 8.5.13, and apply the given Access Service Class when accessing the RACH;

3> submit a new RRC CONNECTION REQUEST message to the lower layers for transmission on the uplink CCCH;

3> increment counter V300; and

3> restart timer T300 when the MAC layer indicates success or failure in transmitting the message.

2> if V300 is greater than N300:

3> enter idle mode;

3> perform the actions specified in subclause 8.5.2 when entering idle mode from connected mode;

3> consider the RRC establishment procedure to be unsuccessful;

3> the procedure ends.

8.1.3.8 Invalid RRC CONNECTION SETUP message, unsupported configuration or invalid configuration

If the UE receives an RRC CONNECTION SETUP message which contains an IE "Initial UE identity" with a value which is identical to the value of the variable INITIAL_UE_IDENTITY, but the RRC CONNECTION SETUP message contains a protocol error causing the variable PROTOCOL_ERROR_REJECT to be set to TRUE according to clause 9, the UE shall perform procedure specific error handling as follows. The UE shall:

1> clear the entry for the RRC CONNECTION SETUP message in the table "Rejected transactions" in the variable TRANSACTIONS and proceed as below.

If the UE receives an RRC CONNECTION SETUP message which contains an IE "Initial UE identity" with a value which is identical to the value of the variable INITIAL_UE_IDENTITY:

1> if the RRC CONNECTION SETUP message contained a configuration the UE does not support; and/or

1> if the variable UNSUPPORTED_CONFIGURATION becomes set to TRUE due to the received RRC CONNECTION SETUP message; and/or

1> if the variable INVALID_CONFIGURATION becomes set to TRUE due to the received RRC CONNECTION SETUP message:

the UE shall:

1> clear the entry for the RRC CONNECTION SETUP message in the table "Accepted transactions" in the variable TRANSACTIONS and proceed as below.

If V300 is equal to or smaller than N300, the UE shall:

- 1> set the variable `PROTOCOL_ERROR_INDICATOR` to `TRUE`;
- 1> set the IEs in the `RRC CONNECTION REQUEST` message according to subclause 8.1.3.3;
- 1> perform the mapping of the Access Class to an Access Service Class as specified in subclause 8.5.13; and
- 1> apply the given Access Service Class when accessing the RACH;
- 1> submit a new `RRC CONNECTION REQUEST` message to the lower layers for transmission on the uplink CCCH;
- 1> increment counter `V300`; and
- 1> restart timer `T300` when the MAC layer indicates success or failure in transmitting the message.

If `V300` is greater than `N300`, the UE shall:

- 1> enter idle mode;
- 1> perform the actions specified in subclause 8.5.2 when entering idle mode from connected mode;
- 1> consider the RRC establishment procedure to be unsuccessful;
- 1> the procedure ends.

8.1.3.9 Reception of an RRC CONNECTION REJECT message by the UE

When the UE receives an `RRC CONNECTION REJECT` message on the downlink CCCH, it shall compare the value of the IE "Initial UE identity" in the received `RRC CONNECTION REJECT` message with the value of the variable `INITIAL_UE_IDENTITY`:

If the values are different, the UE shall ignore the rest of the message;

If the values are identical, the UE shall:

- 1> stop timer `T300`; and
- 1> clear the entry for the `RRC CONNECTION REJECT` message in the table "Accepted transactions" in the variable `TRANSACTIONS`;
- 1> if the IE "wait time" \neq '0'; and
- 1> if the IE "frequency info" is present and:
 - 2> if `V300` is equal to or smaller than `N300`:
 - 3> initiate cell selection on the designated UTRA carrier;
 - 3> after having selected and camped on a cell:
 - 4> set CFN in relation to SFN of current cell according to subclause 8.5.15;
 - 4> set the contents of the `RRC CONNECTION REQUEST` message according to subclause 8.1.3.3;
 - 4> perform the mapping of the Access Class to an Access Service Class as specified in subclause 8.5.13, and apply the given Access Service Class when accessing the RACH;
 - 4> transmit an `RRC CONNECTION REQUEST` message on the uplink CCCH;
 - 4> reset counter `V300`;
 - 4> start timer `T300` when the MAC layer indicates success or failure in transmitting the message;
 - 4> disable cell reselection to original carrier until the time stated in the IE "wait time" has elapsed;

- 3> if a cell selection on the designated carrier fails:
 - 4> wait for the time stated in the IE "wait time";
 - 4> set CFN in relation to SFN of current cell according to subclause 8.5.15;
 - 4> set the IEs in the RRC CONNECTION REQUEST message according to subclause 8.1.3.3;
 - 4> perform the mapping of the Access Class to an Access Service Class as specified in subclause 8.5.13, and apply the given Access Service Class when accessing the RACH;
 - 4> then submit a new RRC CONNECTION REQUEST message to the lower layers for transmission on the uplink CCCH of the original serving cell;
 - 4> increment counter V300;
 - 4> restart timer T300 when the MAC layer indicates success or failure to transmit the message;
- 2> if V300 is greater than N300:
 - 3> enter idle mode;
 - 3> perform the actions specified in subclause 8.5.2 when entering idle mode from connected mode;
 - 3> consider the RRC establishment procedure to be unsuccessful;
 - 3> the procedure ends.
- 1> if the IE "inter-RAT info" is present and:
 - 2> if V300 is equal to or smaller than N300:
 - 3> perform cell selection in the designated system;
 - 3> delay cell reselection to the original system until the time stated in the IE " wait time" has elapsed.
 - 3> if cell selection in the designated system fails:
 - 4> wait at least the time stated in the IE "wait time";
 - 4> set CFN in relation to SFN of current cell according to subclause 8.5.15;
 - 4> set the IEs in the RRC CONNECTION REQUEST message according to subclause 8.1.3.2.
 - 4> perform the mapping of the Access Class to an Access Service Class as specified in subclause 8.5.13, and apply the given Access Service Class when accessing the RACH;
 - 4> then submit a new RRC CONNECTION REQUEST message to the lower layers for transmission on the uplink CCCH;
 - 4> increment counter V300;
 - 4> restart timer T300 when the MAC layer indicates success or failure to transmit the message;
- 2> if V300 is greater than N300:
 - 3> enter idle mode;
 - 3> perform the actions specified in subclause 8.5.2 when entering idle mode from connected mode;
 - 3> consider the RRC establishment procedure to be unsuccessful;
 - 3> the procedure ends.
- 1> If neither the IEs "frequency info" nor "inter-RAT info" are present and:
 - 2> if V300 is equal to or smaller than N300:
 - 3> wait at least the time stated in the IE "wait time";

- 3> set the IEs in the RRC CONNECTION REQUEST message according to subclause 8.1.3.2;
- 3> perform the mapping of the Access Class to an Access Service Class as specified in subclause 8.5.13, and apply the given Access Service Class when accessing the RACH;
- 3> submit a new RRC CONNECTION REQUEST message to the lower layers for transmission on the uplink CCCH;
- 3> increment counter V300;
- 3> restart timer T300 when the MAC layer indicates success or failure to transmit the message;
- 2> if V300 is greater than N300:
 - 3> enter idle mode;
 - 3> perform the actions specified in subclause 8.5.2 when entering idle mode from connected mode;
 - 3> consider the RRC establishment procedure to be unsuccessful;
 - 3> the procedure ends.
- 1> if the IE "wait time" = '0':
 - 2> enter idle mode;
 - 2> perform the actions specified in subclause 8.5.2 when entering idle mode from connected mode;
 - 2> consider the RRC establishment procedure to be unsuccessful;
 - 2> the procedure ends.

8.1.3.10 Invalid RRC CONNECTION REJECT message

If the UE receives an RRC CONNECTION REJECT message which contains an IE "Initial UE identity" with a value which is identical to the value of the IE "Initial UE identity" in the most recent RRC CONNECTION REQUEST message sent by the UE; but the RRC CONNECTION REJECT message contains a protocol error causing the variable `PROTOCOL_ERROR_REJECT` to be set to TRUE according to clause 9, the UE shall perform procedure specific error handling as follows:

The UE shall:

- 1> clear the entry for the RRC CONNECTION REJECT message in the table "Rejected transactions" in the variable `TRANSACTIONS`;
- 1> if V300 is equal to or smaller than N300:
 - 2> set the variable `PROTOCOL_ERROR_INDICATOR` to TRUE;
 - 2> set the IEs in the RRC CONNECTION REQUEST message according to subclause 8.1.3.3;
 - 2> perform the mapping of the Access Class to an Access Service Class as specified in subclause 8.5.13, and apply the given Access Service Class when accessing the RACH;
 - 2> submit a new RRC CONNECTION REQUEST message to the lower layers for transmission on the uplink CCCH;
 - 2> increment counter V300;
 - 2> restart timer T300 when the MAC layer indicates success or failure to transmit the message.
- 1> if V300 is greater than N300:
 - 2> enter idle mode;
 - 2> perform the actions specified in subclause 8.5.2 when entering idle mode from connected mode;

- 2> consider the procedure to be successful;
- 2> the procedure ends.

8.1.4 RRC connection release

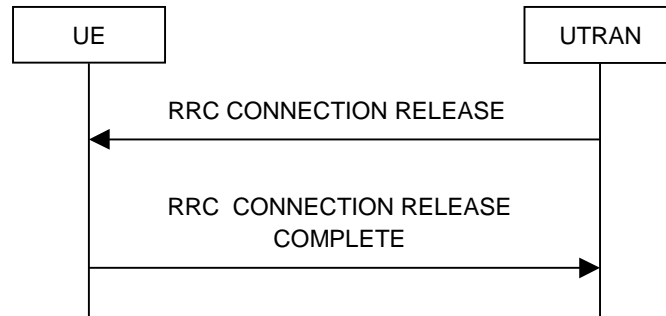

Figure 8.1.4-1: RRC Connection Release procedure on the DCCH



Figure 8.1.4-2: RRC Connection Release procedure on the CCCH

8.1.4.1 General

The purpose of this procedure is to release the RRC connection including all radio bearers and all signalling radio bearers between the UE and the UTRAN. By doing so, all established signalling connections will be released.

8.1.4.2 Initiation

When the UE is in state CELL_DCH or CELL_FACH, the UTRAN may at anytime initiate an RRC connection release by transmitting an RRC CONNECTION RELEASE message using UM RLC.

When UTRAN transmits an RRC CONNECTION RELEASE message the downlink DCCH should be used, if available. If the downlink DCCH is not available in UTRAN and the UE is in CELL_FACH state, the downlink CCCH may be used.

UTRAN may transmit several RRC CONNECTION RELEASE messages to increase the probability of proper reception of the message by the UE. In such a case, the RRC SN for these repeated messages should be the same. The number of repeated messages and the interval between the messages is a network option.

8.1.4.3 Reception of an RRC CONNECTION RELEASE message by the UE

The UE shall receive and act on an RRC CONNECTION RELEASE message in states CELL_DCH and CELL_FACH. Furthermore this procedure can interrupt any ongoing procedures with the UE in the above listed states.

When the UE receives the first RRC CONNECTION RELEASE message; and

- 1> if the message is received on the CCCH, and IE "U-RNTI" is present and has the same value as the variable U_RNTI; or
- 1> if the message is received on DCCH:

the UE shall:

1> in state CELL_DCH:

- 2> initialise the counter V308 to zero;
- 2> set the IE "RRC transaction identifier" in the RRC CONNECTION RELEASE COMPLETE message to the value of "RRC transaction identifier" in the entry for the RRC CONNECTION RELEASE message in the table "Accepted transactions" in the variable TRANSACTIONS;
- 2> submit an RRC CONNECTION RELEASE COMPLETE message to the lower layers for transmission using UM RLC on the DCCH to the UTRAN;
- 2> if the IE "Rplmn information" is present:
 - 3> the UE may:
 - 4> store the IE on the ME together with the PLMN id for which it applies;
 - 3> the UE may then:
 - 4> utilise this information, typically indicating where a number of BCCH frequency ranges of a RAT may be expected to be found, during subsequent Rplmn selections of the indicated PLMN.
- 2> start timer T308 when the RRC CONNECTION RELEASE COMPLETE message is sent on the radio interface.

1> in state CELL_FACH:

- 2> if the RRC CONNECTION RELEASE message was received on the DCCH:
 - 3> set the IE "RRC transaction identifier" in the RRC CONNECTION RELEASE COMPLETE message to the value of "RRC transaction identifier" in the entry for the RRC CONNECTION RELEASE message in the table "Accepted transactions" in the variable TRANSACTIONS;
 - 3> submit an RRC CONNECTION RELEASE COMPLETE message to the lower layers for transmission using AM RLC on the DCCH to the UTRAN.
 - 3> when the successful transmission of the RRC CONNECTION RELEASE COMPLETE message has been confirmed by the lower layers:
 - 4> release all its radio resources; and
 - 4> indicate the release of the established signalling connections (as stored in the variable ESTABLISHED_SIGNALLING_CONNECTIONS) and established radio access bearers (as stored in the variable ESTABLISHED_RABS) to upper layers; and
 - 4> clear any entry for the RRC CONNECTION RELEASE message in the tables "Accepted transactions" and "Rejected transactions" in the variable TRANSACTIONS;
 - 4> clear the variable ESTABLISHED_SIGNALLING_CONNECTIONS;
 - 4> clear the variable ESTABLISHED_RABS;
 - 4> pass the value of the IE "Release cause" received in the RRC CONNECTION RELEASE message to upper layers;
 - 4> enter idle mode;
 - 4> perform the actions specified in subclause 8.5.2 when entering idle mode.
 - 3> and the procedure ends.
- 2> if the RRC CONNECTION RELEASE message was received on the CCCH:
 - 3> release all its radio resources;

- 3> indicate the release of the established signalling connections (as stored in the variable ESTABLISHED_SIGNALLING_CONNECTIONS) and established radio access bearers (as stored in the variable ESTABLISHED_RABS) to the upper layers;
- 3> clear any entry for the RRC CONNECTION RELEASE message in the tables "Accepted transactions" and "Rejected transactions" in the variable TRANSACTIONS;
- 3> clear the variable ESTABLISHED_SIGNALLING_CONNECTIONS;
- 3> clear the variable ESTABLISHED_RABS;
- 3> pass the value of the IE "Release cause" received in the RRC CONNECTION RELEASE message to upper layers;
- 3> enter idle mode;
- 3> perform the actions specified in subclause 8.5.2 when entering idle mode;
- 3> and the procedure ends.

8.1.4.4 Invalid RRC CONNECTION RELEASE message

If the RRC CONNECTION RELEASE message contains a protocol error causing the variable PROTOCOL_ERROR_REJECT to be set to TRUE according to clause 9, and if the "protocol error cause" in PROTOCOL_ERROR_INFORMATION is set to any cause value except "ASN.1 violation or encoding error", the UE shall perform procedure specific error handling as follows:

The UE shall:

- 1> ignore any IE(s) causing the error but treat the rest of the RRC CONNECTION RELEASE message as normal according to subclause 8.1.4.3, with an addition of the following actions:
 - 2> if the RRC CONNECTION RELEASE message was received on the DCCH:
 - 3> set the IE "RRC transaction identifier" in the RRC CONNECTION RELEASE COMPLETE message to the value of "RRC transaction identifier" in the entry for the RRC CONNECTION RELEASE message in the table "Rejected transactions" in the variable TRANSACTIONS;
 - 3> include the IE "Error indication" in the RRC CONNECTION RELEASE COMPLETE message with:
 - 4> the IE "Failure cause" set to the cause value "Protocol error"; and
 - 4> the IE "Protocol error information" set to the value of the variable PROTOCOL_ERROR_INFORMATION.

8.1.4.5 Cell re-selection or radio link failure

If the UE performs cell re-selection or the radio link failure criteria in subclause 8.5.6 is met at any time during the RRC connection release procedure and the UE has not yet entered idle mode, the UE shall:

- 1> if cell re-selection occurred (CELL_FACH state):
 - 2> perform a cell update procedure according to subclause 8.3.1 using the cause "Cell reselection".
- 1> if radio link failure occurred (CELL_DCH state):
 - 2> release all its radio resources;
 - 2> indicate the release of the established signalling connections (as stored in the variable ESTABLISHED_SIGNALLING_CONNECTIONS) and established radio access bearers (as stored in the variable ESTABLISHED_RABS) to upper layers;
 - 2> clear the variable ESTABLISHED_SIGNALLING_CONNECTIONS;
 - 2> clear the variable ESTABLISHED_RABS;

- 2> enter idle mode;
- 2> perform the actions specified in subclause 8.5.2 when entering idle mode;
- 2> and the procedure ends.

8.1.4.6 Expiry of timer T308, unacknowledged mode transmission

When in state CELL_DCH and the timer T308 expires, the UE shall:

- 1> increment V308 by one;
- 1> if V308 is equal to or smaller than N308:
 - 2> prior to retransmitting the RRC CONNECTION RELEASE COMPLETE message:
 - 3> if the IE "Status" in the variable INTEGRITY_PROTECTION_INFO has the value "Started":
 - 4> include the same IEs as in the last unsuccessful attempt of this message, except for the IE "Integrity check info", which is set as specified in subclause 8.5.10.
 - 3> else:
 - 4> include the same IEs as in the last unsuccessful attempt of this message.
 - 2> set the IE "RRC transaction identifier" in the RRC CONNECTION RELEASE COMPLETE message retransmitted below to the value of "RRC transaction identifier" in the entry for the RRC CONNECTION RELEASE message in the table "Accepted transactions" in the variable TRANSACTIONS;
 - 2> send the RRC CONNECTION RELEASE COMPLETE message on signalling radio bearer RB1;
 - 2> start timer T308 when the RRC CONNECTION RELEASE COMPLETE message is sent on the radio interface.
- 1> if V308 is greater than N308:
 - 2> release all its radio resources;
 - 2> indicate the release of the established signalling connections (as stored in the variable ESTABLISHED_SIGNALLING_CONNECTIONS) and established radio access bearers (as stored in the variable ESTABLISHED_RABS) to upper layers;
 - 2> clear any entry for the RRC CONNECTION RELEASE message in the tables "Accepted transactions" and "Rejected transactions" in the variable TRANSACTIONS;
 - 2> clear the variable ESTABLISHED_SIGNALLING_CONNECTIONS;
 - 2> clear the variable ESTABLISHED_RABS;
 - 2> enter idle mode;
 - 2> perform the actions specified in subclause 8.5.2 when entering idle mode;
 - 2> and the procedure ends.

8.1.4.7 Void

8.1.4.8 Reception of an RRC CONNECTION RELEASE COMPLETE message by UTRAN

When UTRAN receives an RRC CONNECTION RELEASE COMPLETE message from the UE, it should:

- 1> release all UE dedicated resources and the procedure ends on the UTRAN side.

8.1.4.9 Unsuccessful transmission of the RRC CONNECTION RELEASE COMPLETE message, acknowledged mode transmission

When acknowledged mode was used and RLC does not succeed in transmitting the RRC CONNECTION RELEASE COMPLETE message, the UE shall:

- 1> release all its radio resources;
- 1> indicate the release of the established signalling connections (as stored in the variable ESTABLISHED_SIGNALLING_CONNECTIONS) and established radio access bearers (as stored in the variable ESTABLISHED_RABS) to upper layers;
- 1> clear the variable ESTABLISHED_SIGNALLING_CONNECTIONS;
- 1> clear the variable ESTABLISHED_RABS;
- 1> enter idle mode;
- 1> perform the actions specified in subclause 8.5.2 when entering idle mode;
- 1> and the procedure ends.

8.1.4.10 Detection of loss of dedicated physical channel by UTRAN in CELL_DCH state

If the release is performed from the state CELL_DCH, and UTRAN detects loss of the dedicated physical channel according to subclause 8.5.6, UTRAN may release all UE dedicated resources, even if no RRC CONNECTION RELEASE COMPLETE message has been received.

8.1.4.11 Failure to receive RRC CONNECTION RELEASE COMPLETE message by UTRAN

If UTRAN does not receive any RRC CONNECTION RELEASE COMPLETE message, it should release all UE dedicated resources.

8.1.4a RRC connection release requested by upper layers

8.1.4a.1 General

The purpose of this procedure is to release the RRC connection and bar the current cell or cells. The procedure is requested by upper layers when they determine that the network has failed an authentication check [5].

8.1.4a.2 Initiation

If the upper layers request the release of the RRC connection, the UE shall:

- 1> release all its radio resources;
- 1> enter idle mode;
- 1> perform other actions when entering idle mode from connected mode as specified in subclause 8.5.2;
- 1> if the UE was in CELL_DCH state prior to entering idle mode:
 - 2> consider all cells that were in the active set prior to entering idle mode to be barred according to [4]; and
 - 2> consider the barred cells as using the value "allowed" in the IE "Intra-frequency cell re-selection indicator", and the maximum value in the IE "T_{barred}".
- 1> if the UE was in CELL_FACH or CELL_PCH or URA_PCH state prior to entering idle mode:
 - 2> consider the cell on which the UE was camped prior to entering idle mode to be barred according to [4]; and

- 2> consider the barred cell as using the value "allowed" in the IE "Intra-frequency cell re-selection indicator", and the maximum value in the IE "T_{barred}".

8.1.5 Void

8.1.6 Transmission of UE capability information

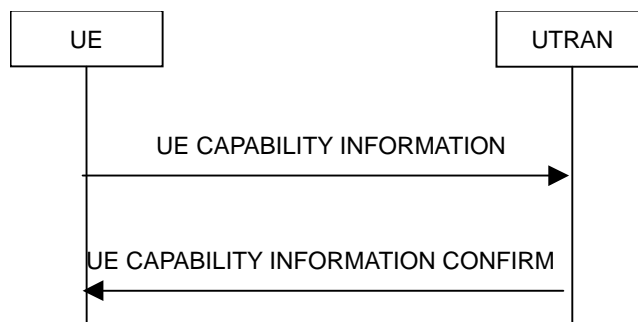

Figure 8.1.6-1: Transmission of UE capability information, normal flow

8.1.6.1 General

The UE capability update procedure is used by the UE to convey UE specific capability information to the UTRAN.

8.1.6.2 Initiation

The UE shall initiate the UE capability update procedure in the following situations:

- 1> the UE receives a UE CAPABILITY ENQUIRY message from the UTRAN;
- 1> while in connected mode the UE capabilities change compared to those stored in the variable UE_CAPABILITY_TRANSFERRED.

If the UE CAPABILITY INFORMATION message is sent in response to a UE CAPABILITY ENQUIRY message, the UE shall:

- 1> include the IE "RRC transaction identifier"; and
- 1> set it to the value of "RRC transaction identifier" in the entry for the UE CAPABILITY ENQUIRY message in the table "Accepted transactions" in the variable TRANSACTIONS;
- 1> retrieve its UTRA UE radio access capability information elements from variable UE_CAPABILITY_REQUESTED; and
- 1> include this in IE "UE radio access capability" and in IE "UE radio access capability extension", provided this IE is included in variable UE_CAPABILITY_REQUESTED;
- 1> retrieve its inter-RAT-specific UE radio access capability information elements from variable UE_CAPABILITY_REQUESTED; and
- 1> include this in IE "UE system specific capability".

If the UE CAPABILITY INFORMATION message is sent because one or more of the UE capabilities change compared to those stored in the variable UE_CAPABILITY_TRANSFERRED while in connected state, the UE shall include the information elements associated with the capabilities that have changed in the UE CAPABILITY INFORMATION message.

If the UE is in CELL_PCH or URA_PCH state, it shall first perform a cell update procedure using the cause "uplink data transmission", see subclause 8.3.1.

The UE RRC shall submit the UE CAPABILITY INFORMATION message to the lower layers for transmission on the uplink DCCH using AM RLC. When the message has been delivered to lower layers for transmission the UE RRC shall start timer T304 and set counter V304 to 1.

8.1.6.3 Reception of a UE CAPABILITY INFORMATION message by the UTRAN

Upon reception of a UE CAPABILITY INFORMATION message, the UTRAN should transmit a UE CAPABILITY INFORMATION CONFIRM message on the downlink DCCH using UM or AM RLC. After the UE CAPABILITY INFORMATION CONFIRM message has been submitted to the lower layers for transmission, the procedure is complete.

8.1.6.4 Reception of the UE CAPABILITY INFORMATION CONFIRM message by the UE

Upon reception of a UE CAPABILITY INFORMATION CONFIRM message, the UE shall:

- 1> stop timer T304;
- 1> if there is an entry for the UE CAPABILITY ENQUIRY message is present in the table "Accepted transactions" in the variable TRANSACTIONS:
 - 2> clear that entry.
- 1> update its variable UE_CAPABILITY_TRANSFERRED with the UE capabilities it has last transmitted to the UTRAN during the current RRC connection;
- 1> clear the variable UE_CAPABILITY_REQUESTED;
- 1> and the procedure ends.

8.1.6.5 Invalid UE CAPABILITY INFORMATION CONFIRM message

If the UE receives a UE CAPABILITY INFORMATION CONFIRM message, which contains a protocol error causing the variable PROTOCOL_ERROR_REJECT to be set to TRUE according to clause 9, the UE shall perform procedure specific error handling as follows:

- 1> stop timer T304;
- 1> transmit an RRC STATUS message on the uplink DCCH using AM RLC;
- 1> include the IE "Identification of received message"; and
- 1> set the IE "Received message type" to UE CAPABILITY INFORMATION CONFIRM; and
- 1> set the IE "RRC transaction identifier" to the value of "RRC transaction identifier" in the entry for the UE CAPABILITY INFORMATION CONFIRM message in the table "Rejected transactions" in the variable TRANSACTIONS; and
- 1> clear that entry;
- 1> include the IE "Protocol error information" with contents set to the value of the variable PROTOCOL_ERROR_INFORMATION;
- 1> when the RRC STATUS message has been submitted to lower layers for transmission:
 - 2> restart timer T304 and continue with any ongoing procedures or processes as if the invalid UE CAPABILITY INFORMATION CONFIRM message has not been received.

8.1.6.6 T304 timeout

Upon expiry of timer T304, the UE shall check the value of V304 and:

- 1> if V304 is smaller than or equal to N304:

- 2> prior to retransmitting the UE CAPABILITY INFORMATION message:
 - 3> if the IE "Status" in the variable INTEGRITY_PROTECTION_INFO has the value "Started":
 - 4> include the same IEs as in the last unsuccessful attempt of this message, except for the IE "Integrity check info", which is set as specified in subclause 8.5.10.
 - 3> else:
 - 4> include the same IEs as in the last unsuccessful attempt of this message.
- 2> send the UE CAPABILITY INFORMATION message on signalling radio bearer RB2;
- 2> restart timer T304;
- 2> increment counter V304.
- 1> if V304 is greater than N304:
 - 2> initiate the Cell update procedure as specified in subclause 8.3.1, using the cause "Radio link failure".

8.1.7 UE capability enquiry

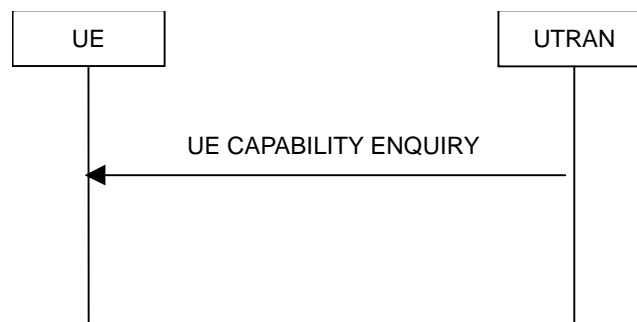

Figure 8.1.7-1: UE capability enquiry procedure, normal flow

8.1.7.1 General

The UE capability enquiry can be used to request the UE to transmit its capability information related to any radio access network that is supported by the UE.

8.1.7.2 Initiation

The UE capability enquiry procedure is initiated by the UTRAN by transmitting a UE CAPABILITY ENQUIRY message on the DCCH using UM or AM RLC.

8.1.7.3 Reception of a UE CAPABILITY ENQUIRY message by the UE

Upon reception of a UE CAPABILITY ENQUIRY message, the UE shall act on the received information elements as specified in subclause 8.6 and initiate the transmission of UE capability information procedure, which is specified in subclause 8.1.6.

8.1.7.4 Invalid UE CAPABILITY ENQUIRY message

If the UE receives a UE CAPABILITY ENQUIRY message, which contains a protocol error causing the variable `PROTOCOL_ERROR_REJECT` to be set to `TRUE` according to clause 9, the UE shall perform procedure specific error handling as follows:

- 1> transmit an RRC STATUS message on the uplink DCCH using AM RLC;
- 1> include the IE "Identification of received message"; and

- 1> set the IE "Received message type" to UE CAPABILITY ENQUIRY; and
- 1> set the IE "RRC transaction identifier" to the value of "RRC transaction identifier" in the entry for the UE CAPABILITY ENQUIRY message in the table "Rejected transactions" in the variable TRANSACTIONS; and
- 1> clear that entry;
- 1> include the IE "Protocol error information" with contents set to the value of the variable PROTOCOL_ERROR_INFORMATION;
- 1> when the RRC STATUS message has been submitted to lower layers for transmission:
 - 2> continue with the ongoing processes and procedures as if the invalid UE CAPABILITY ENQUIRY message has not been received.

8.1.8 Initial Direct transfer

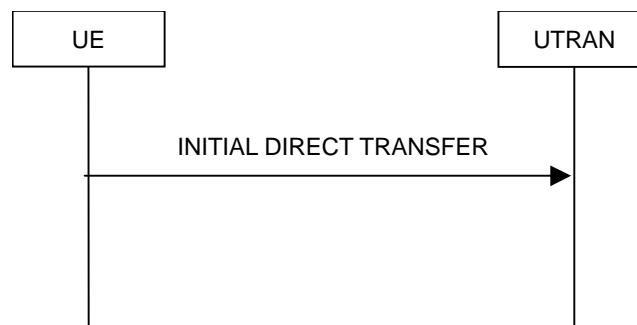

Figure 8.1.8-1: Initial Direct transfer in the uplink, normal flow

8.1.8.1 General

The initial direct transfer procedure is used in the uplink to establish a signalling connection. It is also used to carry an initial upper layer (NAS) message over the radio interface.

8.1.8.2 Initiation of Initial direct transfer procedure in the UE

In the UE, the initial direct transfer procedure shall be initiated, when the upper layers request establishment of a signalling connection. This request also includes a request for the transfer of a NAS message.

Upon initiation of the initial direct transfer procedure when the UE is in idle mode, the UE shall:

- 1> set the variable ESTABLISHMENT_CAUSE to the cause for establishment indicated by upper layers;
- 1> perform an RRC connection establishment procedure, according to subclause 8.1.3;
- 1> if the RRC connection establishment procedure was not successful:
 - 2> indicate failure to establish the signalling connection to upper layers and end the procedure.
- 1> when the RRC connection establishment procedure is completed successfully:
 - 2> continue with the initial direct transfer procedure as below.

Upon initiation of the initial direct transfer procedure when the UE is in CELL_PCH or URA_PCH state, the UE shall:

- 1> perform a cell update procedure, according to subclause 8.3.1, using the cause "uplink data transmission";
- 1> when the cell update procedure completed successfully:
 - 2> continue with the initial direct transfer procedure as below.

The UE shall, in the INITIAL DIRECT TRANSFER message:

- 1> set the IE "NAS message" as received from upper layers; and
- 1> set the IE "CN domain identity" as indicated by the upper layers; and
- 1> set the IE "Intra Domain NAS Node Selector" as follows:
 - 2> derive the IE "Intra Domain NAS Node Selector" from TMSI/PMTSI, IMSI, or IMEI; and
 - 2> provide the coding of the IE "Intra Domain NAS Node Selector" according to the following priorities:
 1. derive the routing parameter for IDNNS from TMSI (CS domain) or PTMSI (PS domain) whenever a valid TMSI/PTMSI is available;
 2. base the routing parameter for IDNNS on IMSI when no valid TMSI/PTMSI is available;
 3. base the routing parameter for IDNNS on IMEI only if no (U)SIM is inserted in the UE.
- 1> calculate the START according to subclause 8.5.9 for the CN domain as set in the IE "CN Domain Identity"; and
- 1> include the calculated START value for that CN domain in the IE "START".

In CELL_FACH state, the UE shall:

- 1> include a measurement report in the IE "Measured results on RACH", as specified in the IE "Intra-frequency reporting quantity for RACH reporting" and the IE "Maximum number of reported cells on RACH" in System Information Block type 12 (or "System Information Block Type 11" if "System Information Block Type 12" is not being broadcast);
- 1> include in the IE "Measured results on RACH" all requested reporting quantities for cells for which measurements are reported.

The UE shall:

- 1> transmit the INITIAL DIRECT TRANSFER message on the uplink DCCH using AM RLC on signalling radio bearer RB3;
- 1> when the INITIAL DIRECT TRANSFER message has been submitted to lower layers for transmission:
 - 2> confirm the establishment of a signalling connection to upper layers; and
 - 2> add the signalling connection with the identity indicated by the IE "CN domain identity" in the variable ESTABLISHED_SIGNALLING_CONNECTIONS.
- 1> when the successful delivery of the INITIAL DIRECT TRANSFER message has been confirmed by RLC:
 - 2> the procedure ends.

When not stated otherwise elsewhere, the UE may also initiate the initial direct transfer procedure when another procedure is ongoing, and in that case the state of the latter procedure shall not be affected.

A new signalling connection request may be received from upper layers during transition to idle mode. In those cases, from the time of the indication of release to upper layers until the UE has entered idle mode, any such upper layer request to establish a new signalling connection shall be queued. This request shall be processed after the UE has entered idle mode.

8.1.8.2a RLC re-establishment or inter-RAT change

If a re-establishment of RLC on signalling radio bearer RB3 occurs before the successful delivery of the INITIAL DIRECT TRANSFER message has been confirmed by RLC, the UE shall:

- 1> retransmit the INITIAL DIRECT TRANSFER message on the uplink DCCH using AM RLC on signalling radio bearer RB3.

If an Inter-RAT handover from UTRAN procedure occurs before the successful delivery of the INITIAL DIRECT TRANSFER message has been confirmed by RLC, for messages with the IE "CN domain identity" set to "CS domain", the UE shall:

1> retransmit the NAS message as specified in subclause 8.3.7.4.

8.1.8.2b Abortion of signalling connection establishment

If the UE receives a request from upper layers to release (abort) the signalling connection for the CN domain for which the initial direct transfer procedure is ongoing, the UE shall:

1> if the UE has not yet entered UTRA RRC connected mode:

2> abort the RRC connection establishment procedure as specified in subclause 8.1.3;

the procedure ends.

8.1.8.3 Reception of INITIAL DIRECT TRANSFER message by the UTRAN

On reception of the INITIAL DIRECT TRANSFER message the NAS message should be routed using the IE "CN Domain Identity". UTRAN may also use the IE "Intra Domain NAS Node Selector" for routing among the CN nodes for the addressed CN domain.

If no signalling connection exists towards the chosen node, then a signalling connection is established.

If the IE "Measured results on RACH" is present in the message, the UTRAN should extract the contents to be used for radio resource control.

When the UTRAN receives an INITIAL DIRECT TRANSFER message, it shall not affect the state of any other ongoing RRC procedures, when not stated otherwise elsewhere.

The UTRAN should:

1> set the START value for the CN domain indicated in the IE "CN domain identity" to the value of the IE "START".

8.1.9 Downlink Direct transfer



Figure 8.1.9-1: Downlink Direct transfer, normal flow

8.1.9.1 General

The downlink direct transfer procedure is used in the downlink direction to carry upper layer (NAS) messages over the radio interface.

8.1.9.2 Initiation of downlink direct transfer procedure in the UTRAN

In the UTRAN, the direct transfer procedure is initiated when the upper layers request the transfer of a NAS message after the initial signalling connection is established. The UTRAN may also initiate the downlink direct transfer procedure when another RRC procedure is ongoing, and in that case the state of the latter procedure shall not be affected. The UTRAN shall transmit the DOWNLINK DIRECT TRANSFER message on the downlink DCCH using AM RLC on signalling radio bearer RB3 or signalling radio bearer RB4. The UTRAN should:

1> if upper layers indicate "low priority" for this message:

- 2> select signalling radio bearer RB4, if available. Specifically, for a GSM-MAP based CN, signalling radio bearer RB4 should, if available, be selected when "SAPI 3" is requested;
 - 2> select signalling radio bearer RB3 when signalling radio bearer RB4 is not available.
- 1> if upper layers indicate "high priority" for this message:
- 2> select signalling radio bearer RB3. Specifically, for a GSM-MAP based CN, signalling radio bearer RB3 should be selected when "SAPI 0" is requested.

The UTRAN sets the IE "CN Domain Identity" to indicate, which CN domain the NAS message is originated from.

8.1.9.3 Reception of a DOWNLINK DIRECT TRANSFER message by the UE

Upon reception of the DOWNLINK DIRECT TRANSFER message, the UE RRC shall, using the IE "CN Domain Identity", route the contents of the IE "NAS message" and the value of the IE "CN Domain Identity" to upper layers.

The UE shall clear the entry for the DOWNLINK DIRECT TRANSFER message in the table "Accepted transactions" in the variable TRANSACTIONS.

When the UE receives a DOWNLINK DIRECT TRANSFER message, it shall not affect the state of any other ongoing RRC procedures when not stated otherwise elsewhere.

8.1.9.3a No signalling connection exists

If the UE receives a DOWNLINK DIRECT TRANSFER message, and the signalling connection identified with the IE "CN domain identity" does not exist according to the variable ESTABLISHED_SIGNALLING_CONNECTIONS, the UE shall:

- 1> ignore the content of the DOWNLINK DIRECT TRANSFER message;
- 1> transmit an RRC STATUS message on the uplink DCCH using AM RLC;
- 1> include the IE "Identification of received message"; and
- 1> set the IE "Received message type" to DOWNLINK DIRECT TRANSFER; and
- 1> set the IE "RRC transaction identifier" to the value of "RRC transaction identifier" in the entry for the DOWNLINK DIRECT TRANSFER message in the table "Accepted transactions" in the variable TRANSACTIONS; and
- 1> clear that entry;
- 1> include the IE "Protocol error information" with the IE "Protocol error cause" set to "Message not compatible with receiver state".

When the RRC STATUS message has been submitted to lower layers for transmission, the UE shall:

- 1> continue with any ongoing processes and procedures as if the DOWNLINK DIRECT TRANSFER message has not been received.

8.1.9.4 Invalid DOWNLINK DIRECT TRANSFER message

If the UE receives a DOWNLINK DIRECT TRANSFER message, which contains a protocol error causing the variable PROTOCOL_ERROR_REJECT to be set to TRUE according to clause 9, the UE shall perform procedure specific error handling as follows:

- 1> transmit an RRC STATUS message on the uplink DCCH using AM RLC;
- 1> include the IE "Identification of received message"; and
- 1> set the IE "Received message type" to DOWNLINK DIRECT TRANSFER; and

- 1> set the IE "RRC transaction identifier" to the value of "RRC transaction identifier" in the entry for the DOWNLINK DIRECT TRANSFER message in the table "Rejected transactions" in the variable TRANSACTIONS; and
- 1> clear that entry;
- 1> include the IE "Protocol error information" with contents set to the value of the variable PROTOCOL_ERROR_INFORMATION.

When the RRC STATUS message has been submitted to lower layers for transmission, the UE shall:

- 1> continue with any ongoing processes and procedures as if the invalid DOWNLINK DIRECT TRANSFER message has not been received.

8.1.10 Uplink Direct transfer

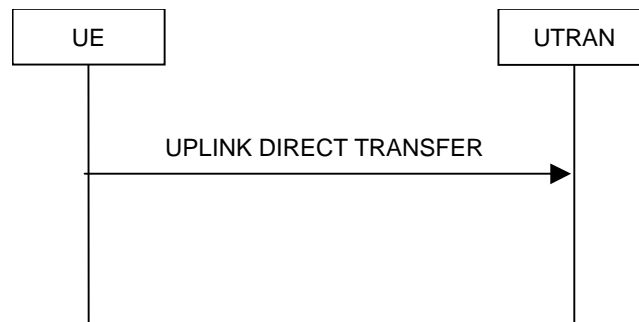

Figure 8.1.10-1: Uplink Direct transfer, normal flow

8.1.10.1 General

The uplink direct transfer procedure is used in the uplink direction to carry all subsequent upper layer (NAS) messages over the radio interface belonging to a signalling connection.

8.1.10.2 Initiation of uplink direct transfer procedure in the UE

In the UE, the uplink direct transfer procedure shall be initiated when the upper layers request a transfer of a NAS message on an existing signalling connection. When not stated otherwise elsewhere, the UE may initiate the uplink direct transfer procedure when another procedure is ongoing, and in that case the state of the latter procedure shall not be affected.

Upon initiation of the uplink direct transfer procedure in CELL_PCH or URA_PCH state, the UE shall:

- 1> perform a cell update procedure, according to subclause 8.3.1, using the cause "uplink data transmission";
- 1> when the cell update procedure has been completed successfully:
 - 2> continue with the uplink direct transfer procedure as below.

The UE shall transmit the UPLINK DIRECT TRANSFER message on the uplink DCCH using AM RLC on signalling radio bearer RB3 or signalling radio bearer RB4. The UE shall:

- 1> if upper layers indicate "low priority" for this message:
 - 2> select signalling radio bearer RB4, if available. Specifically, for a GSM-MAP based CN, signalling radio bearer RB4 shall, if available, be selected when "SAPI 3" is requested;
 - 2> select signalling radio bearer RB3 when signalling radio bearer RB4 is not available;
- 1> if upper layers indicate "high priority" for this message:
 - 2> select signalling radio bearer RB3. Specifically, for a GSM-MAP based CN, signalling radio bearer RB3 shall be selected when "SAPI 0" is requested.

In CELL_FACH state, the UE shall:

- 1> include a measurement report in the IE "Measured results on RACH", as specified in the IE "Intra-frequency reporting quantity for RACH reporting" and the IE "Maximum number of reported cells on RACH" in System Information Block type 12 (or "System Information Block Type 11" if "System Information Block Type 12" is not being broadcast);
- 1> include in the IE "Measured results on RACH" all requested reporting quantities for cells for which measurements are reported.

The UE shall set the IE "NAS message" as received from upper layers and set the IE "CN domain identity" as indicated by the upper layers.

When the successful delivery of the UPLINK DIRECT TRANSFER message has been confirmed by RLC the procedure ends.

8.1.10.2a RLC re-establishment or inter-RAT change

If signalling radio bearer RB n (where n equals to 3 or 4) was used when transmitting the UPLINK DIRECT TRANSFER message and a re-establishment of RLC on the same signalling radio bearer RB n occurs before the successful delivery of the UPLINK DIRECT TRANSFER message has been confirmed by RLC, the UE shall:

- 1> retransmit the UPLINK DIRECT TRANSFER message on the uplink DCCH using AM RLC on signalling radio bearer RB n.

If an Inter-RAT handover from UTRAN procedure occurs before the successful delivery of the UPLINK DIRECT TRANSFER message has been confirmed by RLC, for messages with the IE "CN domain identity" set to "CS domain", the UE shall:

- 1> retransmit the NAS message as specified in subclause 8.3.7.4.

8.1.10.3 Reception of UPLINK DIRECT TRANSFER message by the UTRAN

On reception of the UPLINK DIRECT TRANSFER message the NAS message should be routed using the value indicated in the IE "CN domain identity".

If the IE "Measured results on RACH" is present in the message, the UTRAN should extract the contents to be used for radio resource control.

When the UTRAN receives an UPLINK DIRECT TRANSFER message, it shall not affect the state of any other ongoing RRC procedures, when not stated otherwise elsewhere.

8.1.11 UE dedicated paging

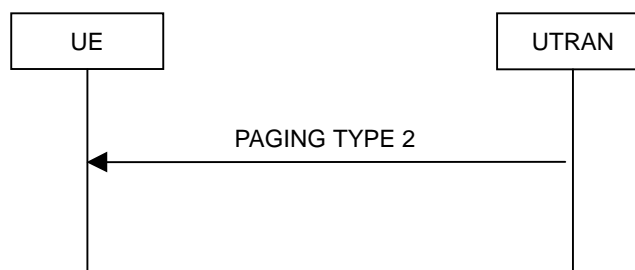

Figure 8.1.11-1: UE dedicated paging

8.1.11.1 General

This procedure is used to transmit dedicated paging information to one UE in connected mode in CELL_DCH or CELL_FACH state. Upper layers in the network may request initiation of paging.

8.1.11.2 Initiation

For a UE in CELL_DCH or CELL_FACH state, UTRAN initiates the procedure by transmitting a PAGING TYPE 2 message on the DCCH using AM RLC. When not stated otherwise elsewhere, the UTRAN may initiate the UE dedicated paging procedure also when another RRC procedure is ongoing, and in that case the state of the latter procedure shall not be affected.

UTRAN should set the IE "Paging cause" to the cause for paging received from upper layers. If no cause for paging is received from upper layers, UTRAN should set the value "Terminating – cause unknown".

8.1.11.3 Reception of a PAGING TYPE 2 message by the UE

When the UE receives a PAGING TYPE 2 message, it shall not affect the state of any other ongoing RRC procedures, when not stated otherwise elsewhere.

The UE shall:

- 1> indicate reception of paging; and
- 1> forward the IE "Paging cause" and the IE "Paging record type identifier" to upper layers.

The UE shall:

- 1> clear the entry for the PAGING TYPE 2 message in the table "Accepted transactions" in the variable TRANSACTIONS.

8.1.11.4 Invalid PAGING TYPE 2 message

If the UE receives a PAGING TYPE 2 message, which contains a protocol error causing the variable PROTOCOL_ERROR_REJECT to be set to TRUE according to clause 9, the UE shall perform procedure specific error handling as follows:

- 1> transmit an RRC STATUS message on the uplink DCCH using AM RLC;
- 1> include the IE "Identification of received message"; and
- 1> set the IE "Received message type" to PAGING TYPE 2; and
- 1> set the IE "RRC transaction identifier" to the value of "RRC transaction identifier" in the entry for the PAGING TYPE 2 message in the table "Rejected transactions" in the variable TRANSACTIONS; and
- 1> clear that entry;
- 1> include the IE "Protocol error information" with contents set to the value of the variable PROTOCOL_ERROR_INFORMATION;
- 1> when the RRC STATUS message has been submitted to lower layers for transmission:
 - 2> continue with any ongoing processes and procedures as if the invalid PAGING TYPE 2 message has not been received.

8.1.12 Security mode control

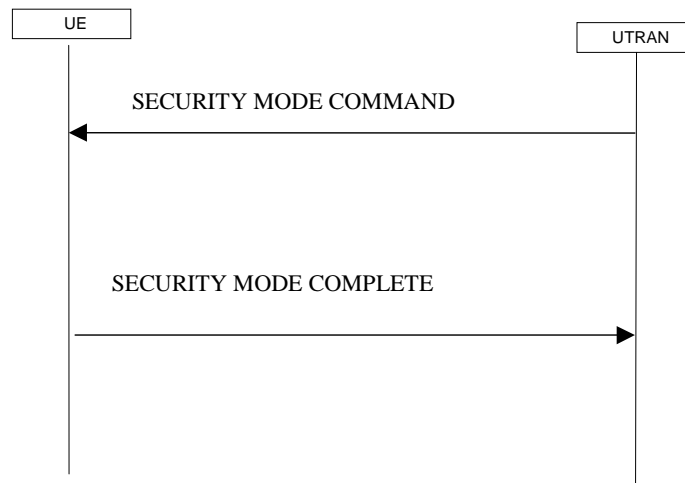

Figure 8.1.12-1: Security mode control procedure

8.1.12.1 General

The purpose of this procedure is to trigger the start of ciphering or to command the restart of the ciphering with a new ciphering configuration, for the radio bearers of one CN domain and for all signalling radio bearers.

It is also used to start integrity protection or to modify the integrity protection configuration for all signalling radio bearers.

8.1.12.2 Initiation

8.1.12.2.1 Ciphering configuration change

To start/restart ciphering, UTRAN sends a SECURITY MODE COMMAND message on the downlink DCCH in AM RLC using the most recent ciphering configuration. If no such ciphering configuration exists then the SECURITY MODE COMMAND is not ciphered. UTRAN should not transmit a SECURITY MODE COMMAND to signal a change in ciphering algorithm.

When configuring ciphering, UTRAN should ensure that the UE needs to store at most two different ciphering configurations (keyset and algorithm) per CN domain, in total over all radio bearers at any given time. For signalling radio bearers the total number of ciphering configurations that need to be stored is at most three. Prior to sending the SECURITY MODE COMMAND, for the CN domain indicated in the IE "CN domain identity" in the SECURITY MODE COMMAND, UTRAN should:

- 1> suspend all radio bearers using RLC-AM or RLC-UM and all signalling radio bearers using RLC-AM or RLC-UM, except the signalling radio bearer used to send the SECURITY MODE COMMAND message on the downlink DCCH in RLC-AM, and except signalling radio bearer RB0, according to the following:
 - 2> not transmit RLC PDUs with sequence number greater than or equal to the number in IE "Radio bearer downlink ciphering activation time info" on all suspended radio bearers and all suspended signalling radio bearers.
- 1> set, for the signalling radio bearer used to send the SECURITY MODE COMMAND, the "RLC sequence number" in IE "Radio bearer downlink ciphering activation time info" in the IE "Ciphering mode info", at which time the new ciphering configuration shall be applied;
- 1> if a transparent mode radio bearer for this CN domain exists:
 - 2> include the IE "Ciphering activation time for DPCH" in IE "Ciphering mode info", at which time the new ciphering configuration shall be applied and specify a CFN value for this IE that is a **multiple of 8 frames** (CFN mod 8 = 0);

- 1> consider a ciphering activation time in downlink to be pending until the RLC sequence number of the next RLC PDU to be transmitted for the first time is equal to or larger than the selected activation time;
- 1> set, for each suspended radio bearer and signalling radio bearer that has no pending ciphering activation time set by a previous security mode control procedure, an "RLC sequence number" in IE "Radio bearer downlink ciphering activation time info" in the IE "Ciphering mode info", at which time the new ciphering configuration shall be applied;
- 1> set, for each suspended radio bearer and signalling radio bearer that has a pending ciphering activation time set by a previous security mode control procedure, the "RLC sequence number" in IE "Radio bearer downlink ciphering activation time info" in the IE "Ciphering mode info" to the value used in the previous security mode control procedure, at which time the latest ciphering configuration shall be applied;
- 1> if Integrity protection has already been started for the UE:
 - 2> if for the CN domain indicated in the IE "CN domain identity" in the SECURITY MODE COMMAND, a new security key set (new ciphering and integrity protection keys) has been received from upper layers since the transmission of the last SECURITY MODE COMMAND message for that CN domain:
 - 3> include the IE "Integrity protection mode info" in the SECURITY MODE COMMAND.
 - 2> if the IE "CN domain identity" in the SECURITY MODE COMMAND is different from the IE "CN domain identity" that was sent in the previous SECURITY MODE COMMAND message to the UE:
 - 3> include the IE "Integrity protection mode info" in the SECURITY MODE COMMAND.
- 1> transmit the SECURITY MODE COMMAND message on RB2.

8.1.12.2.2 Integrity protection configuration change

To start or modify integrity protection, UTRAN sends a SECURITY MODE COMMAND message on the downlink DCCCH in AM RLC using the new integrity protection configuration. UTRAN should not "modify" integrity protection for a CN domain to which a SECURITY MODE COMMAND configuring integrity protection has been previously sent for an ongoing signalling connection unless the application of new integrity keys needs to be signalled to the UE. UTRAN should not transmit a SECURITY MODE COMMAND to signal a change in integrity protection algorithm.

When configuring Integrity protection, UTRAN should:

- 1> ensure that the UE needs to store at most three different Integrity protection configurations (keysets) at any given time. This includes the total number of Integrity protection configurations for all signalling radio bearers;
- 1> if Ciphering has already been started for the UE for the CN domain to be set in the IE "CN domain identity" in the SECURITY MODE COMMAND:
 - 2> if for the CN domain indicated in the IE "CN domain identity" in the SECURITY MODE COMMAND, a new security key set (new ciphering and integrity protection keys) has been received from upper layers since the transmission of the last SECURITY MODE COMMAND message for that CN domain:
 - 3> include the IE "Ciphering mode info" in the SECURITY MODE COMMAND.
- 1> if Ciphering has already been configured for the UE for a CN domain different from the CN domain to be set in the IE "CN domain identity" in the SECURITY MODE COMMAND:
 - 2> include the IE "Ciphering mode info" in the SECURITY MODE COMMAND.

Prior to sending the SECURITY MODE COMMAND, for the CN domain indicated in the IE "CN domain identity" in the SECURITY MODE COMMAND, UTRAN should:

- 1> if this is the first SECURITY MODE COMMAND sent for this RRC connection:
 - 2> if new keys have been received:
 - 3> initialise the hyper frame numbers as follows:
 - 4> set all bits of the hyper frame numbers of the COUNT-I values for all signalling radio bearers to zero.

- 2> else (if new keys have not been received):
 - 3> use the value "START" in the most recently received IE "START list" or IE "START" that belongs to the CN domain indicated in the IE "CN domain identity" to initialise all hyper frame numbers of COUNT-I for all the signalling radio bearers by:
 - 4> setting the 20 most significant bits of the hyper frame numbers for all signalling radio bearers to the value "START" in the most recently received IE "START list" or IE "START" for that CN domain;
 - 4> setting the remaining bits of the hyper frame numbers equal to zero.
 - 1> else (this is not the first SECURITY MODE COMMAND sent for this RRC connection):
 - 2> if new keys have been received:
 - 3> initialise the hyper frame number for COUNT-I for RB2 as follows:
 - 4> set all bits of the HFN of the COUNT-I value for RB2 to zero.
 - 2> if new keys have not been received:
 - 3> initialise the hyper frame number for COUNT-I for RB2 as follows:
 - 4> set the 20 most significant bits of the HFN of the downlink and uplink COUNT-I to the value of the most recently received IE "START" or IE "START list" for the CN domain to be set in the IE "CN Domain Identity";
 - 4> set the remaining bits of the HFN of the downlink and uplink COUNT-I to zero.
 - 1> if the IE "Integrity protection mode command" has the value "Start":
 - 2> prohibit the transmission of signalling messages with any RRC SN on all signalling radio bearers, except RB2;
 - 2> set the FRESH value in the IE "Integrity protection initialisation number", included in the IE "Integrity protection mode info".
 - 1> if the IE "Integrity protection mode command" has the value "Modify":
 - 2> for each signalling radio bearer RBn, except RB2:
 - 3> prohibit the transmission of signalling messages with RRC SN greater or equal to the RRC sequence number in entry for signalling radio bearer n in the "RRC message sequence number list" in the IE "Downlink integrity protection activation info", included in the IE "Integrity protection mode info".
 - 2> consider an integrity protection activation time in downlink to be pending until the selected activation time is equal to the next RRC sequence number to be used, which means that the last RRC message using the old integrity protection configuration has been submitted to lower layers;
 - 2> set, for each signalling radio bearer RBn, that has no pending integrity protection activation time set by a previous security mode control procedure, an RRC sequence number in entry for signalling radio bearer n in the "RRC message sequence number list" in the IE "Downlink integrity protection activation info", included in the IE "Integrity protection mode info", at which time the new integrity protection configuration shall be applied;
 - 2> set, for each signalling radio bearer RBn, that has a pending integrity protection activation time set by a previous security mode control procedure, the RRC sequence number in entry for signalling radio bearer n in the "RRC message sequence number list" in the IE "Downlink integrity protection activation info", included in the IE "Integrity protection mode info", to the value used in the previous security mode control procedure, at which time the latest integrity protection configuration shall be applied.
- 1> transmit the SECURITY MODE COMMAND message on RB2 using the new integrity protection configuration.

NOTE: In the case of re-initialisation of Integrity Protection at HFN wrap around, the network should take into account the UE actions as described in subclauses 8.5.10.1 and 8.5.10.2.

8.1.12.3 Reception of SECURITY MODE COMMAND message by the UE

Upon reception of the SECURITY MODE COMMAND message, the UE shall:

- 1> if neither IE "Ciphering mode info" nor IE "Integrity protection mode info" is included in the SECURITY MODE COMMAND:
 - 2> set the variable INVALID_CONFIGURATION to TRUE.
- 1> if the IE "Security capability" is the same as indicated by variable UE_CAPABILITY_TRANSFERRED, and the IE "GSM security capability" (if included in the SECURITY MODE COMMAND) is the same as indicated by the variable UE_CAPABILITY_TRANSFERRED:
 - 2> set the variable LATEST_CONFIGURED_CN_DOMAIN equal to the IE "CN domain identity";
 - 2> set the IE "Status" in the variable SECURITY_MODIFICATION for the CN domain indicated in the IE "CN domain identity" in the received SECURITY MODE COMMAND to the value "Affected";
 - 2> set the IE "Status" in the variable SECURITY_MODIFICATION for all CN domains other than the CN domain indicated in the IE "CN domain identity" to "Not affected";
 - 2> set the IE "RRC transaction identifier" in the SECURITY MODE COMPLETE message to the value of "RRC transaction identifier" in the entry for the SECURITY MODE COMMAND message in the table "Accepted transactions" in the variable TRANSACTIONS; and
 - 2> clear that entry;
 - 2> if the SECURITY MODE COMMAND message contained the IE "Ciphering mode info":
 - 3> perform the actions as specified in subclause 8.6.3.4.
 - 2> if the SECURITY MODE COMMAND message contained the IE "Integrity protection mode info":
 - 3> perform the actions as specified in subclause 8.6.3.5.
- 1> prior to sending the SECURITY MODE COMPLETE message:
 - 2> use the old ciphering configuration for this message;
 - 2> if the SECURITY MODE COMMAND message contained the IE "Ciphering mode info":
 - 3> include and set the IE "Radio bearer uplink ciphering activation time info" to the value of the variable RB_UPLINK_CIPHERING_ACTIVATION_TIME_INFO;
 - 3> for each radio bearer and signalling radio bearer that belongs to the CN domain as indicated in the variable LATEST_CONFIGURED_CN_DOMAIN:
 - 4> start or continue incrementing the COUNT-C values for all RLC-AM and RLC-UM signalling radio bearers at the ciphering activation time as specified in the procedure;
 - 4> start or continue incrementing the COUNT-C values common for all transparent mode radio bearers for this CN domain at the ciphering activation time as specified in the procedure;
 - 4> continue incrementing the COUNT-C values for all RLC-AM and RLC-UM radio bearers.
 - 3> if no new security key set (new ciphering and integrity protection keys) has been received from the upper layers [40] for the CN domain as indicated in the variable LATEST_CONFIGURED_CN_DOMAIN:
 - 4> for ciphering on signalling radio bearers using RLC-AM and RLC-UM in the downlink, at the RLC sequence number indicated in IE "Radio bearer downlink ciphering activation time info" in the IE "Ciphering mode info" included in the SECURITY MODE COMMAND, for each signalling radio bearer:
 - 5> set the 20 most significant bits of the HFN component of the downlink COUNT-C to the value "START" in the most recently transmitted IE "START list" or IE "START", at the reception of the SECURITY MODE COMMAND, that belongs to the CN domain as indicated in the variable LATEST_CONFIGURED_CN_DOMAIN;

- 5> set the remaining bits of the hyper frame numbers to zero.
- 3> if new keys have been received:
 - 4> perform the actions in subclause 8.1.12.3.1.
- 2> if the SECURITY MODE COMMAND message contained the IE "Integrity protection mode info":
 - 3> include and set the IE "Uplink integrity protection activation info" to the value of the variable INTEGRITY_PROTECTION_ACTIVATION_INFO for each signalling radio bearer;
 - 3> if no new security key set (new ciphering and integrity protection keys) has been received from the upper layers [40] for the CN domain as indicated in the variable LATEST_CONFIGURED_CN_DOMAIN, for RB2:
 - 4> in the downlink, for the received SECURITY MODE COMMAND message:
 - 5> set the 20 most significant bits of the IE "Downlink RRC HFN" in the variable INTEGRITY_PROTECTION_INFO of the downlink COUNT-I to the value "START" in the most recently transmitted IE "START list" or IE "START", at the reception of the SECURITY MODE COMMAND, that belongs to the CN domain as indicated in the variable LATEST_CONFIGURED_CN_DOMAIN;
 - 5> set the remaining bits of the IE "Downlink RRC HFN" to zero.
 - 4> in the uplink, for the transmitted response message, SECURITY MODE COMPLETE:
 - 5> set the 20 most significant bits of the IE "Uplink RRC HFN" in the variable INTEGRITY_PROTECTION_INFO of the uplink COUNT-I to the value "START" in the most recently transmitted IE "START list" or IE "START", at the reception of the SECURITY MODE COMMAND, that belongs to the CN domain as indicated in the variable LATEST_CONFIGURED_CN_DOMAIN;
 - 5> set the remaining bits of the IE "Uplink RRC HFN" to zero.
 - 3> if no new security key set (new ciphering and integrity protection keys) has been received from the upper layers [40] for the CN domain indicated in the variable LATEST_CONFIGURED_CN_DOMAIN, for each signalling radio bearer other than RB2:
 - 4> if the IE "Integrity protection mode command" has the value "start":
 - 5> in the downlink, for this signalling radio bearer:
 - 6> set the 20 most significant bits of IE "Downlink RRC HFN" in the variable INTEGRITY_PROTECTION_INFO of the downlink COUNT-I to the value START transmitted in the most recently transmitted IE "START list" or IE "START", at the reception of the SECURITY MODE COMMAND, that belongs to the CN domain as indicated in the variable LATEST_CONFIGURED_CN_DOMAIN;
 - 6> set the remaining bits of the IE "Downlink RRC HFN" in the variable INTEGRITY_PROTECTION_INFO of the downlink COUNT-I to zero;
 - 4> else:
 - 5> in the downlink, for the first message for which the RRC sequence number in a received RRC message for this signalling radio bearer is equal to or greater than the activation time as indicated in IE "Downlink integrity protection activation info" as included in the IE "Integrity protection mode info", for this signalling radio bearer:
 - 6> set the 20 most significant bits of the IE "Downlink RRC HFN" in the variable INTEGRITY_PROTECTION_INFO of the downlink COUNT-I to the value "START" in the most recently transmitted IE "START list" or IE "START", at the reception of the SECURITY MODE COMMAND, that belongs to the CN domain as indicated in the variable LATEST_CONFIGURED_CN_DOMAIN;
 - 6> set the remaining bits of the IE "Downlink RRC HFN" to zero.

3> if new keys have been received:

4> perform the actions in subclause 8.1.12.3.1.

2> start applying the new integrity protection configuration in the uplink for signalling radio bearer RB2 from and including the transmitted SECURITY MODE COMPLETE message;

2> transmit the SECURITY MODE COMPLETE message on the uplink DCCH in AM RLC;

NOTE: After submission of the SECURITY MODE COMPLETE message to the lower layers, the UE should accept messages received in the DL which require the new security configuration to be applied on them. If the received message is successfully integrity checked, the UE should not discard the message due to lack of completion of the security procedure, caused by the successful delivery of the SECURITY MODE COMPLETE not having yet been confirmed by lower layers, unless the security configuration to be applied has been aborted and the message received requires integrity protection [5].

1> when the successful delivery of the SECURITY MODE COMPLETE message has been confirmed by RLC:

2> if the SECURITY MODE COMMAND message contained the IE "Ciphering mode info":

3> if no new security key set (new ciphering and integrity protection keys) has been received from the upper layers [40] for the CN domain as indicated in the variable LATEST_CONFIGURED_CN_DOMAIN:

4> for ciphering on signalling radio bearers using RLC-AM and RLC-UM in the uplink, at the RLC sequence number indicated in IE "Radio bearer uplink ciphering activation time info" included in the SECURITY MODE COMPLETE, for each signalling radio bearer:

5> set the HFN component of the uplink COUNT-C to the value "START" in the most recently transmitted IE "START list" or IE "START", at the reception of the SECURITY MODE COMMAND, that belongs to the CN domain as indicated in the variable LATEST_CONFIGURED_CN_DOMAIN;

5> set the remaining bits of the hyper frame numbers to zero.

3> if new keys have been received:

4> perform the actions in subclause 8.1.12.3.1.

3> resume data transmission on any suspended radio bearer and signalling radio bearer mapped on RLC-AM or RLC-UM;

3> set the IE "Reconfiguration" in the variable CIPHERING_STATUS to FALSE; and

3> clear the variable RB_UPLINK_CIPHERING_ACTIVATION_TIME_INFO.

2> if the SECURITY MODE COMMAND message contained the IE "Integrity protection mode info":

3> if no new security key set (new ciphering and integrity protection keys) has been received from the upper layers [40] for the CN domain indicated in the variable LATEST_CONFIGURED_CN_DOMAIN, for each signalling radio bearer other than RB2:

4> if the IE "Integrity protection mode command" has the value "start":

5> in the uplink, for this signalling radio bearer:

6> set the 20 most significant bits of IE "Uplink RRC HFN" in the variable INTEGRITY_PROTECTION_INFO of the uplink COUNT-I to the value START transmitted in the most recently transmitted IE "START list" or IE "START", at the reception of the SECURITY MODE COMMAND, that belongs to the CN domain as indicated in the variable LATEST_CONFIGURED_CN_DOMAIN;

6> set the remaining bits of the IE "Uplink RRC HFN" in the variable INTEGRITY_PROTECTION_INFO of the uplink COUNT-I to zero.

4> else:

- 5> in the uplink, for the first transmitted RRC message for this signalling radio bearer with RRC sequence number equal to the activation time as indicated in IE "Uplink integrity protection activation info" included in the transmitted SECURITY MODE COMPLETE, for this signalling radio bearer:
 - 6> set the 20 most significant bits of the IE "Uplink RRC HFN" in the variable INTEGRITY_PROTECTION_INFO of the uplink COUNT-I to the value "START" in the most recently transmitted IE "START list" or IE "START", at the reception of the SECURITY MODE COMMAND, that belongs to the CN domain as indicated in the variable LATEST_CONFIGURED_CN_DOMAIN;
 - 6> set the remaining bits of the IE "Uplink RRC HFN" to zero.
- 3> if new keys have been received:
 - 4> perform the actions in subclause 8.1.12.3.1.
 - 3> allow the transmission of RRC messages on all signalling radio bearers with any RRC SN;
 - 3> set "Uplink RRC Message sequence number" for signalling radio bearer RB0 in the variable INTEGRITY_PROTECTION_INFO to a value such that next RRC message to be sent on uplink RB0 will use the new integrity protection configuration;
 - 3> set the IE "Reconfiguration" in the variable INTEGRITY_PROTECTION_INFO to FALSE; and
 - 3> clear the variable INTEGRITY_PROTECTION_ACTIVATION_INFO.
- 2> clear the variable SECURITY_MODIFICATION;
- 2> notify upper layers upon change of the security configuration;
- 2> and the procedure ends.
- 1> if the IE "Security capability" is not the same as indicated by the variable UE_CAPABILITY_TRANSFERRED, or the IE "GSM security capability" (if included in the SECURITY MODE COMMAND) is not the same as indicated by the variable UE_CAPABILITY_TRANSFERRED, or if the IE "GSM security capability" is not included in the SECURITY MODE COMMAND and is included in the variable UE_CAPABILITY_TRANSFERRED:
 - 2> release all its radio resources;
 - 2> indicate the release of the established signalling connections (as stored in the variable ESTABLISHED_SIGNALLING_CONNECTIONS) and established radio access bearers (as stored in the variable ESTABLISHED_RABS) to upper layers;
 - 2> clear the variable ESTABLISHED_SIGNALLING_CONNECTIONS;
 - 2> clear the variable ESTABLISHED_RABS;
 - 2> clear the variable SECURITY_MODIFICATION;
 - 2> enter idle mode;
 - 2> perform actions when entering idle mode as specified in subclause 8.5.2;
 - 2> and the procedure ends.

8.1.12.3.1 New ciphering and integrity protection keys

If a new security key set (new ciphering and integrity protection keys) has been received from the upper layers [40] for the CN domain as indicated in the variable LATEST_CONFIGURED_CN_DOMAIN, the UE shall:

- 1> set the START value for the CN domain indicated in the variable LATEST_CONFIGURED_CN_DOMAIN to zero;
- 1> if the SECURITY MODE COMMAND message contained the IE "Integrity protection mode info":

- 2> for integrity protection in the downlink on each signalling radio bearer except RB2:
 - 3> if IE "Integrity protection mode command" has the value "start":
 - 4> for the first received message on this signalling radio bearer:
 - 5> start using the new integrity key;
 - 5> for this signalling radio bearer:
 - 6> set the IE "Downlink RRC HFN" in the variable INTEGRITY_PROTECTION_INFO of the downlink COUNT-I to zero.
 - 3> else:
 - 4> for the first message for which the RRC sequence number in a received RRC message for this signalling radio bearer is equal to or greater than the activation time as indicated in IE "Downlink integrity protection activation info" as included in the IE "Integrity protection mode info":
 - 5> start using the new integrity key;
 - 5> for this signalling radio bearer:
 - 6> set the IE "Downlink RRC HFN" in the variable INTEGRITY_PROTECTION_INFO of the downlink COUNT-I to zero.
 - 2> for integrity protection in the uplink on each signalling radio bearer except RB2:
 - 3> for the first message for which the RRC sequence number in a to be transmitted RRC message for this signalling radio bearer is equal to the activation time as indicated in IE "Uplink integrity protection activation info" included in the transmitted SECURITY MODE COMPLETE message:
 - 4> start using the new integrity key;
 - 4> for this signalling radio bearer:
 - 5> set the IE "Uplink RRC HFN" in the variable INTEGRITY_PROTECTION_INFO of the uplink COUNT-I to zero.
 - 2> for integrity protection in the downlink on signalling radio bearer RB2:
 - 3> at the received SECURITY MODECOMMAND:
 - 4> start using the new integrity key;
 - 4> set the IE "Downlink RRC HFN" in the variable INTEGRITY_PROTECTION_INFO of the downlink COUNT-I to zero.
 - 2> for integrity protection in the uplink on signalling radio bearer RB2 :
 - 3> at the transmitted SECURITY MODE COMPLETE:
 - 4> start using the new integrity key;
 - 4> set the IE "Uplink RRC HFN" in the variable INTEGRITY_PROTECTION_INFO of the uplink COUNT-I to zero.
 - 1> if the SECURITY MODE COMMAND message contained the IE "Ciphering mode info":
 - 2> for each signalling radio bearer and for each radio bearer for the CN domain indicated in the variable LATEST_CONFIGURED_CN_DOMAIN:
 - 3> if the IE "Status" in the variable CIPHERING_STATUS has the value "Started" for this CN domain, then for ciphering on radio bearers using RLC-TM:
 - 4> at the CFN as indicated in the IE "Ciphering activation time for DPCH" in the IE "Ciphering mode info":

- 5> start using the new key in uplink and downlink;
- 5> set the HFN component of the COUNT-C to zero.
- 3> if the IE "Status" in the variable CIPHERING_STATUS has the value "Started" for this CN domain, then for ciphering on radio bearers and signalling radio bearers using RLC-AM and RLC-UM:
 - 4> in the downlink, at the RLC sequence number indicated in IE "Radio bearer downlink ciphering activation time info" in the IE "Ciphering mode info":
 - 5> start using the new key;
 - 5> set the HFN component of the downlink COUNT-C to zero.
 - 4> in the uplink, at the RLC sequence number indicated in IE "Radio bearer uplink ciphering activation time info":
 - 5> start using the new key;
 - 5> set the HFN component of the uplink COUNT-C to zero.
- 1> consider the value of the latest transmitted START value to be zero.

8.1.12.4 Void

8.1.12.4a Incompatible simultaneous security reconfiguration

If the variable INCOMPATIBLE_SECURITY_RECONFIGURATION becomes set to TRUE of the received SECURITY MODE COMMAND message, the UE shall:

- 1> transmit a SECURITY MODE FAILURE message on the uplink DCCH using AM RLC, using the ciphering and integrity protection configurations prior to the reception of this SECURITY MODE COMMAND;
- 1> set the IE "RRC transaction identifier" in the SECURITY MODE FAILURE message to the value of "RRC transaction identifier" in the entry for the SECURITY MODE COMMAND message in the table "Accepted transactions" in the variable TRANSACTIONS; and
- 1> clear that entry;
- 1> set the IE "failure cause" to the cause value "incompatible simultaneous reconfiguration";
- 1> when the response message has been submitted to lower layers for transmission:
 - 2> set the variable INCOMPATIBLE_SECURITY_RECONFIGURATION to FALSE;
 - 2> continue with any ongoing processes and procedures as if the invalid SECURITY MODE COMMAND message has not been received;
 - 2> and the procedure ends.

8.1.12.4b Cell update procedure during security reconfiguration

If:

- a cell update procedure according to subclause 8.3.1 is initiated; and
- the received SECURITY MODE COMMAND message causes either,
 - the IE "Reconfiguration" in the variable CIPHERING_STATUS to be set to TRUE; and/or
 - the IE "Reconfiguration" in the variable INTEGRITY_PROTECTION_INFO to be set to TRUE:

the UE shall:

- 1> abort the ongoing integrity and/or ciphering reconfiguration;
- 1> resume data transmission on any suspended radio bearer and signalling radio bearer mapped on RLC-AM or RLC-UM;
- 1> allow the transmission of RRC messages on all signalling radio bearers with any RRC SN;
- 1> when the CELL UPDATE message has been submitted to lower layers for transmission:
 - 2> if the SECURITY MODE COMMAND message contained the IE "Ciphering mode info":
 - 3> set the IE "Reconfiguration" in the variable CIPHERING_STATUS to FALSE; and
 - 3> clear the variable RB_UPLINK_CIPHERING_ACTIVATION_TIME_INFO;
 - 2> if the SECURITY MODE COMMAND message contained the IE "Integrity protection mode info":
 - 3> set the IE "Reconfiguration" in the variable INTEGRITY_PROTECTION_INFO to FALSE; and
 - 3> clear the variable INTEGRITY_PROTECTION_ACTIVATION_INFO.
 - 2> continue with any ongoing processes and procedures as if the invalid SECURITY MODE COMMAND message has not been received; and
 - 2> clear the variable SECURITY_MODIFICATION;
 - 2> the procedure ends.

8.1.12.4c Invalid configuration

If the variable INVALID_CONFIGURATION is set to TRUE due to the received SECURITY MODE COMMAND message, the UE shall:

- 1> transmit a SECURITY MODE FAILURE message on the DCCH using AM RLC after setting the IEs as specified below:
 - 2> set the IE "RRC transaction identifier" in the SECURITY MODE FAILURE message to the value of "RRC transaction identifier" in the entry for the SECURITY MODE COMMAND message in the table "Accepted transactions" in the variable TRANSACTIONS; and
 - 2> clear that entry;
 - 2> set the IE "failure cause" to the cause value "invalid configuration".
- 1> when the response message has been submitted to lower layers for transmission:
 - 2> set the variable INVALID_CONFIGURATION to FALSE;
 - 2> set the IE "Reconfiguration" in the variable CIPHERING_STATUS to FALSE;
 - 2> continue with any ongoing processes and procedures as if the invalid SECURITY MODE COMMAND message has not been received;
 - 2> and the procedure ends.

8.1.12.5 Reception of SECURITY MODE COMPLETE message by the UTRAN

UTRAN should apply integrity protection on the received SECURITY MODE COMPLETE message and all subsequent messages with the new integrity protection configuration, if changed. When UTRAN has received a SECURITY MODE COMPLETE message and the integrity protection has successfully been applied, UTRAN should:

- 1> if the IE "Ciphering mode info" was included in the SECURITY MODE COMMAND message:
 - 2> if new keys were received for the CN domain set in the IE "CN Domain Identity" in the SECURITY MODE COMMAND:

- 3> set, at the downlink and uplink activation time, all the bits of the hyper frame numbers of the downlink and uplink COUNT-C values respectively for all radio bearers for this CN domain and all signalling radio bearers to zero.
- 2> else (if new keys were not received):
 - 3> use, at the downlink and uplink activation time, the value "START" in the most recently received IE "START list" or IE "START" that belongs to the CN domain as indicated in the IE "CN domain identity" to initialise all hyper frame numbers of the downlink and uplink COUNT-C values respectively for all the signalling radio bearers as follows:
 - 4> set the 20 most significant bits of the hyper frame numbers of the COUNT-C for all signalling radio bearers to the value "START" in the most recently received IE "START list" or IE "START" for that CN domain;
 - 4> set the remaining bits of the hyper frame numbers equal to zero.
- 1> if the IE "Integrity protection mode info" was included in the SECURITY MODE COMMAND message:
 - 2> if this was not the first SECURITY MODE COMMAND message for this RRC connection:
 - 3> if new keys have been received for the CN domain set in the IE "CN Domain Identity" included in the transmitted SECURITY MODE COMMAND message:
 - 4> initialise, at the downlink and uplink activation time, all hyper frame numbers of the downlink and uplink COUNT-I values respectively for all the signalling radio bearers other than RB2 as follows:
 - 5> set all bits of the hyper frame numbers of the uplink and downlink COUNT-I to zero.
 - 3> if no new keys have been received for the CN domain set in the IE "CN Domain Identity" included in the transmitted SECURITY MODE COMMAND message:
 - 4> use, at the downlink and uplink activation time, the value "START" in the most recently received IE "START list" or IE "START" that belongs to the CN domain as indicated in the IE "CN domain identity" to initialise all hyper frame numbers of the downlink and uplink COUNT-I values respectively for all the signalling radio bearers other than RB2 as follows:
 - 5> set the 20 most significant bits of the hyper frame numbers of the downlink and uplink COUNT-I respectively for all signalling radio bearers to the value "START" in the most recently received IE "START list" or IE "START" for that CN domain;
 - 5> set the remaining bits of the hyper frame numbers equal to zero.
 - 1> send an indication to upper layers that the new security configuration has been activated;
 - 1> resume, in the downlink, all suspended radio bearers and all signalling radio bearers;
 - 1> allow the transmission of RRC messages on all signalling radio bearers with any RRC SN;
 - 1> if the IE "Integrity protection mode command" included in the SECURITY MODE COMMAND had the value "Start":
 - 2> start applying integrity protection in the downlink for all signalling radio bearers.
 - 1> if the IE "Integrity protection mode command" included in the SECURITY MODE COMMAND had the value "Modify":
 - 2> start applying the new integrity protection configuration in the downlink at the RRC sequence number, for each signalling radio bearers RBn, except for signalling radio bearer RB2, indicated by the entry for signalling radio bearer n in the "RRC message sequence number list" in the IE "Downlink integrity protection activation info";
 - 2> continue applying the new integrity configuration for signalling radio bearer RB2;

- 2> apply the new integrity protection configuration on the received signalling messages with RRC SN greater than or equal to the number associated with the signalling radio bearer in IE "Uplink integrity protection activation info".
- 1> apply the old ciphering configuration for the transmission of RLC PDUs with RLC sequence number less than the number indicated in the IE "Radio bearer downlink ciphering activation time info" included in the IE "Ciphering mode info";
- 1> apply the new ciphering configuration for the transmission of RLC PDUs with RLC sequence number greater than or equal to the number indicated in IE "Radio bearer downlink ciphering activation time info" included in the IE "Ciphering mode info";
- 1> apply the old integrity protection configuration on the received signalling messages with RRC SN smaller than the number associated with the signalling radio bearer in IE "Uplink integrity protection activation info";
- 1> for radio bearers using RLC-AM or RLC-UM:
 - 2> use the old ciphering configuration for received RLC PDUs with RLC sequence number less than the RLC sequence number indicated in the IE "Radio bearer uplink ciphering activation time info" sent by the UE;
 - 2> use the new ciphering configuration for received RLC PDUs with RLC sequence number greater than or equal to the RLC sequence number indicated in the IE "Radio bearer uplink ciphering activation time info" sent by the UE;
 - 2> if an RLC reset or re-establishment occurs after the SECURITY MODE COMPLETE message has been received by UTRAN before the activation time for the new ciphering configuration has been reached, ignore the activation time and apply the new ciphering configuration immediately after the RLC reset or RLC re-establishment.
- 1> for radio bearers using RLC-TM:
 - 2> use the old ciphering configuration for the received RLC PDUs before the CFN as indicated in the IE "Ciphering activation time for DPCH" in the IE "Ciphering mode info" as included in the SECURITY MODE COMMAND;
 - 2> use the new ciphering configuration for the received RLC PDUs at the CFN as indicated in the IE "Ciphering activation time for DPCH" in the IE "Ciphering mode info" as included in the SECURITY MODE COMMAND.
- 1> and the procedure ends.

8.1.12.6 Invalid SECURITY MODE COMMAND message

If the SECURITY MODE COMMAND message contains a protocol error causing the variable PROTOCOL_ERROR_REJECT to be set to TRUE according to clause 9, the UE shall perform procedure specific error handling as follows:

- 1> transmit a SECURITY MODE FAILURE message on the uplink DCCH using AM RLC;
- 1> set the IE "RRC transaction identifier" in the SECURITY MODE FAILURE message to the value of "RRC transaction identifier" in the entry for the SECURITY MODE COMMAND message in the table "Rejected transactions" in the variable TRANSACTIONS; and
- 1> clear that entry;
- 1> set the IE "failure cause" to the cause value "protocol error";
- 1> include the IE "Protocol error information" with contents set to the value of the variable PROTOCOL_ERROR_INFORMATION;
- 1> when the response message has been submitted to lower layers for transmission:
 - 2> continue with any ongoing processes and procedures as if the invalid SECURITY MODE COMMAND message has not been received;

2> and the procedure ends.

8.1.13 Signalling connection release procedure

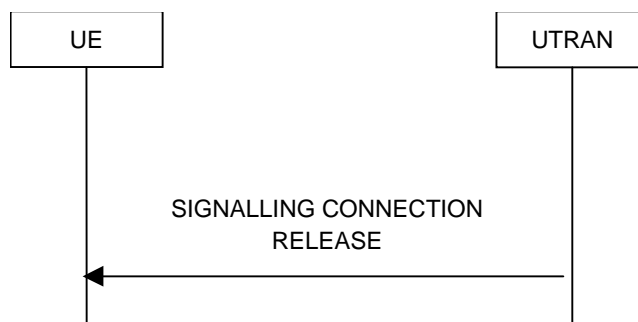

Figure 8.1.13-1: Signalling connection release procedure, normal case

8.1.13.1 General

The signalling connection release procedure is used to notify to the UE that one of its ongoing signalling connections has been released. The procedure does not initiate the release of the RRC connection.

8.1.13.2 Initiation of SIGNALLING CONNECTION RELEASE by the UTRAN

To initiate the procedure, the UTRAN transmits a SIGNALLING CONNECTION RELEASE message on DCCH using AM RLC.

8.1.13.3 Reception of SIGNALLING CONNECTION RELEASE by the UE

Upon reception of a SIGNALLING CONNECTION RELEASE message, the UE shall:

- 1> indicate the release of the signalling connection and pass the value of the IE "CN domain identity" to upper layers;
- 1> remove the signalling connection with the identity indicated by the IE "CN domain identity" from the variable ESTABLISHED_SIGNALLING_CONNECTIONS;
- 1> clear the entry for the SIGNALLING CONNECTION RELEASE message in the table "Accepted transactions" in the variable TRANSACTIONS;
- 1> the procedure ends.

8.1.13.4 Invalid SIGNALLING CONNECTION RELEASE message

If the UE receives a SIGNALLING CONNECTION RELEASE message, which contains a protocol error causing the variable `PROTOCOL_ERROR_REJECT` to be set to `TRUE` according to clause 9, the UE shall perform procedure specific error handling as follows:

- 1> include the IE "Identification of received message"; and
 - 2> set the IE "Received message type" to SIGNALLING CONNECTION RELEASE;
 - 2> set the IE "RRC transaction identifier" to the value of "RRC transaction identifier" in the entry for the SIGNALLING CONNECTION RELEASE message in the table "Rejected transactions" in the variable TRANSACTIONS; and
 - 2> clear that entry.
- 1> include the IE "Protocol error information" with contents set to the value of the variable `PROTOCOL_ERROR_INFORMATION`;
- 1> transmit an RRC STATUS message on the uplink DCCH using AM RLC

- 1> when the RRC STATUS message has been submitted to lower layers for transmission:
 - 2> continue with any ongoing processes and procedures as if the invalid SIGNALLING CONNECTION RELEASE message has not been received.

8.1.13.5 Invalid configuration

If radio access bearers for the CN domain indicated by the IE "CN domain identity" exist in the variable ESTABLISHED_RABS, the UE shall:

- 1> transmit an RRC STATUS message on the uplink DCCH using AM RLC;
- 1> include the IE "Identification of received message"; and
- 1> set the IE "Received message type" to SIGNALLING CONNECTION RELEASE; and
- 1> set the IE "RRC transaction identifier" to the value of "RRC transaction identifier" in the entry for the SIGNALLING CONNECTION RELEASE message in the table "Accepted transactions" in the variable TRANSACTIONS and clear that entry;
- 1> include the IE "Protocol error information" with contents set to the value "Message not compatible with receiver state";
- 1> when the RRC STATUS message has been submitted to lower layers for transmission:
 - 2> continue with any ongoing processes and procedures as if the invalid SIGNALLING CONNECTION RELEASE message has not been received.

8.1.14 Signalling connection release indication procedure

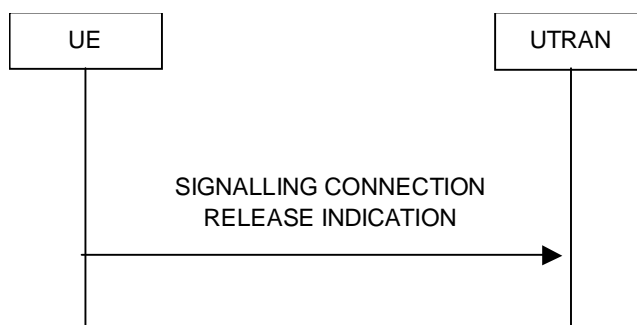

Figure 8.1.14-1: Signalling connection release indication procedure, normal case

8.1.14.1 General

The signalling connection release indication procedure is used by the UE to indicate to the UTRAN that one of its signalling connections has been released. The procedure may in turn initiate the RRC connection release procedure.

8.1.14.2 Initiation

The UE shall, on receiving a request to release (abort) the signalling connection from upper layers for a specific CN domain:

- 1> if a signalling connection in the variable ESTABLISHED_SIGNALLING_CONNECTIONS for the specific CN domain identified with the IE "CN domain identity" exists:
 - 2> initiate the signalling connection release indication procedure.
- 1> otherwise:
 - 2> abort any ongoing establishment of signalling connection for that specific CN domain as specified in 8.1.3.5a.

Upon initiation of the signalling connection release indication procedure in CELL_PCH or URA_PCH state, the UE shall:

- 1> perform a cell update procedure, according to subclause 8.3.1, using the cause "uplink data transmission";
- 1> when the cell update procedure completed successfully:
 - 2> continue with the signalling connection release indication procedure as below.

The UE shall:

- 1> set the IE "CN Domain Identity" to the value indicated by the upper layers. The value of the IE indicates the CN domain whose associated signalling connection the upper layers are indicating to be released;
- 1> remove the signalling connection with the identity indicated by upper layers from the variable ESTABLISHED_SIGNALLING_CONNECTIONS;
- 1> transmit a SIGNALLING CONNECTION RELEASE INDICATION message on DCCH using AM RLC.

When the successful delivery of the SIGNALLING CONNECTION RELEASE INDICATION message has been confirmed by RLC the procedure ends.

8.1.14.2a RLC re-establishment or inter-RAT change

If a re-establishment of RLC on signalling radio bearer RB2 occurs before the successful delivery of the SIGNALLING CONNECTION RELEASE INDICATION message has been confirmed by RLC, the UE shall:

- 1> retransmit the SIGNALLING CONNECTION RELEASE INDICATION message on the uplink DCCH using AM RLC on signalling radio bearer RB2.

If an Inter-RAT handover from UTRAN procedure occurs before the successful delivery of the SIGNALLING CONNECTION RELEASE INDICATION message has been confirmed by RLC, the UE shall:

- 1> abort the signalling connection while in the new RAT.

8.1.14.3 Reception of SIGNALLING CONNECTION RELEASE INDICATION by the UTRAN

Upon reception of a SIGNALLING CONNECTION RELEASE INDICATION message, the UTRAN requests the release of the signalling connection from upper layers. Upper layers may then initiate the release of the signalling connection.

8.1.15 Counter check procedure

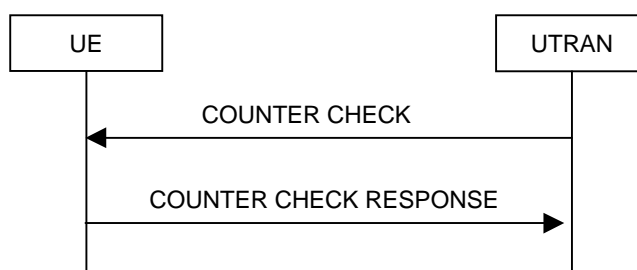

Figure 8.1.15-1: Counter check procedure

8.1.15.1 General

The counter check procedure is used by the UTRAN to perform a local authentication. The purpose of the procedure is to check that the amount of data sent in both directions (uplink and downlink) over the duration of the RRC connection is identical at the UTRAN and at the UE (to detect a possible intruder – a 'man-in-the-middle' – from operating).

This procedure is only applicable to radio bearers, and only to radio bearers using RLC-AM or RLC-UM. It should be noted that this requires that the COUNT-C values for each UL and DL radio bearers using RLC-AM or RLC-UM continue to be incremented even if ciphering is not used. This procedure is not applicable to signalling radio bearers.

8.1.15.2 Initiation

The UTRAN monitors the COUNT-C value associated with each radio bearer using UM or AM RLC. The procedure is triggered whenever any of these values reaches a critical checking value. The granularity of these checking values and the values themselves are defined to the UTRAN by the visited network. The UTRAN initiates the procedure by sending a COUNTER CHECK message on the downlink DCCH.

8.1.15.3 Reception of a COUNTER CHECK message by the UE

When the UE receives a COUNTER CHECK message it shall compare the COUNT-C MSB values received in the IE "RB COUNT-C MSB information" in the COUNTER CHECK message to the COUNT-C MSB values of the corresponding radio bearers.

The UE shall:

- 1> set the IE "RRC transaction identifier" in the COUNTER CHECK RESPONSE message to the value of "RRC transaction identifier" in the entry for the COUNTER CHECK message in the table "Accepted transactions" in the variable TRANSACTIONS; and
- 1> clear that entry.

If:

- there is one or more radio bearer(s) using UM or AM RLC mode stored in the variable ESTABLISHED_RABS, which is (are) not included in the IE "RB COUNT-C MSB information"; or
- there is one or more radio bearer(s) included in the IE "RB COUNT-C MSB information", which is (are) not stored in the variable ESTABLISHED_RABS; or
- for any radio bearer (excluding signalling radio bearers) using UM or AM RLC mode stored in the variable ESTABLISHED_RABS and included in the IE "RB COUNT-C MSB information" with COUNT-C MSB values different from the MSB part of the COUNT-C values in the UE:

the UE shall:

- 1> include these radio bearers in the IE "RB COUNT-C information" in the COUNTER CHECK RESPONSE message. For any RB which is included in the IE "RB COUNT-C MSB information" in the COUNTER CHECK message but not stored in the variable ESTABLISHED_RABS in the UE, the MSB part of COUNT-C values in the COUNTER CHECK RESPONSE message shall be set identical to COUNT-C-MSB values in the COUNTER CHECK message. The LSB part shall be filled with zeroes.

The UE shall:

- 1> if no COUNT-C exists for a radio bearer for a given direction (uplink or downlink) because:
 - 2> it is a uni-directional radio bearer configured only for the other direction (downlink or uplink respectively); or
 - 2> it has been configured to RLC-TM mode in one direction (uplink or downlink) and RLC-UM in the other (downlink or uplink respectively):
 - 3> set the COUNT-C in the IE "RB COUNT-C information" in the COUNTER CHECK RESPONSE message, to any value.
- 1> submit a COUNTER CHECK RESPONSE message to lower layers for transmission on the uplink DCCH using AM RLC.

When the COUNTER CHECK RESPONSE message has been submitted to lower layers for transmission the procedure ends.

8.1.15.4 Reception of the COUNTER CHECK RESPONSE message by UTRAN

If the UTRAN receives a COUNTER CHECK RESPONSE message that does not contain any COUNT-C values, the procedure ends.

If the UTRAN receives a COUNTER CHECK RESPONSE message that contains one or several COUNT-C values the UTRAN may release the RRC connection.

8.1.15.5 Cell re-selection

If the UE performs cell re-selection anytime during this procedure it shall, without interrupting the procedure:

- 1> initiate the cell update procedure according to subclause 8.3.1.

8.1.15.6 Invalid COUNTER CHECK message

If the UE receives a COUNTER CHECK message, which contains a protocol error causing the variable `PROTOCOL_ERROR_REJECT` to be set to TRUE according to clause 9, the UE shall perform procedure specific error handling as follows. The UE shall:

- 1> transmit an RRC STATUS message on the uplink DCCH using AM RLC;
- 1> include the IE "Identification of received message"; and
- 1> set the IE "Received message type" to COUNTER CHECK; and
- 1> set the IE "RRC transaction identifier" to the value of "RRC transaction identifier" in the entry for the UE COUNTER CHECK message in the table "Rejected transactions" in the variable TRANSACTIONS; and
- 1> clear that entry;
- 1> include the IE "Protocol error information" with contents set to the value of the variable `PROTOCOL_ERROR_INFORMATION`;
- 1> when the RRC STATUS message has been submitted to lower layers for transmission:
 - 2> continue with any ongoing processes and procedures as if the invalid COUNTER CHECK message has not been received.

8.1.16 Inter RAT handover information transfer



Figure 8.1.16-1: Inter RAT handover information transfer, normal flow

8.1.16.1 General

The inter RAT handover information transfer procedure is used by the UE to convey RRC information needed for inter RAT handover to UTRAN.

8.1.16.2 Initiation

If:

- a radio access technology other than UTRA, e.g. GSM, using radio access technology-specific procedures, orders the UE to provide the INTER RAT HANDOVER INFO message; or
- a radio access technology other than UTRA, e.g. GSM, using radio access technology-specific procedures, configures the UE to send the INTER RAT HANDOVER INFO message upon system specific conditions not involving an explicit order e.g. early classmark sending upon entering connected mode; or
- while in connected mode using another radio access technology, the inter RAT handover info changes compared to what has previously been sent via the other radio access technology:

the UE shall:

- 1> initiate the inter RAT handover information transfer procedure.

To determine if the inter RAT handover info has changed compared to what has previously been sent, the UE shall:

- 1> store the information last sent in the variable INTER_RAT_HANDOVER_INFO_TRANSFERRED;
- 1> if this variable has not yet been set:
 - 2> not initiate the inter RAT handover information transfer procedure due to change of inter RAT handover info.

NOTE: Currently neither the UE security information nor the predefined configuration status information change while in connected mode using GSM radio access technology.

8.1.16.3 INTER RAT HANDOVER INFO message contents to set

The UE shall:

- 1> include the IE "Predefined configuration status information" and the IE "UE security information";
- 1> include the IE "UE capability container", containing the IE "UE radio access capability" and the IE "UE radio access capability extension", in accordance with the following:
 - 2> if the UE supports multiple UTRA FDD Frequency Bands; or
 - 2> if the UE supports a single UTRA FDD Frequency Band different from 2100 MHz:
 - 3> include the IE "UE radio access capability", excluding IEs "RF capability FDD" and "Measurement capability";
 - 3> include the IE "UE radio access capability extension", including the IEs "RF capability FDD extension" and the "Measurement capability extension" associated with each supported UTRA FDD frequency band indicated in the IE "Frequency band".
 - 2> else:
 - 3> include the IE "UE radio access capability", including the IEs "RF capability FDD" and "Measurement capability" associated with the 2100 MHz UTRA FDD frequency band;
 - 3> include the IE "UE radio access capability extension", including the IEs "RF capability FDD extension" and the "Measurement capability extension" associated with each supported UTRA FDD frequency band indicated in the IE "Frequency band".
- 1> not include the IE "UE Specific Behaviour Information 1 interRAT";
- 1> initiate the transfer of the INTER RAT HANDOVER INFO message via the other radio access technology, using radio access technology-specific procedures;
- 1> store the IE "Predefined configuration status information", the IE "UE security information", the IE "UE radio access capability" and the IE "UE radio access capability extension", if included in the INTER RAT HANDOVER MESSAGE, in variable INTER_RAT_HANDOVER_INFO_TRANSFERRED;
- 1> and the procedure ends.

8.2 Radio Bearer control procedures

8.2.1 Radio bearer establishment

See subclause 8.2.2 Reconfiguration procedures.

8.2.2 Reconfiguration procedures

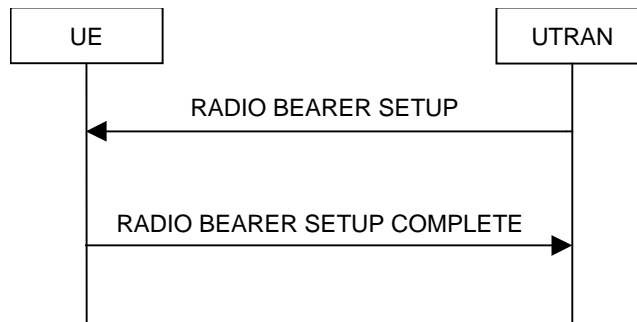

Figure 8.2.2-1: Radio Bearer Establishment, normal case

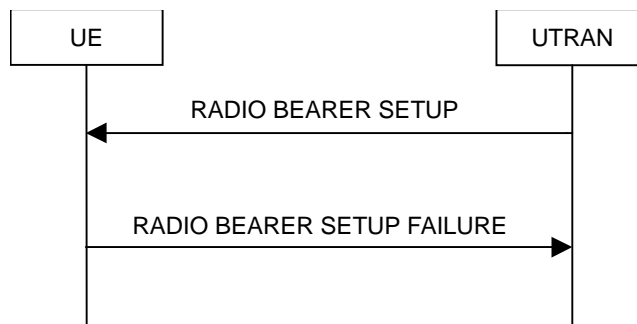

Figure 8.2.2-2: Radio Bearer Establishment, failure case

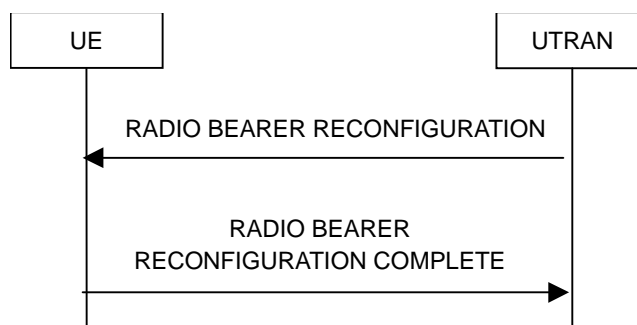

Figure 8.2.2-3: Radio bearer reconfiguration, normal flow

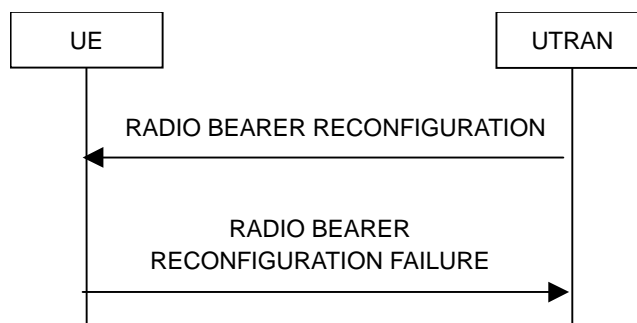

Figure 8.2.2-4: Radio bearer reconfiguration, failure case

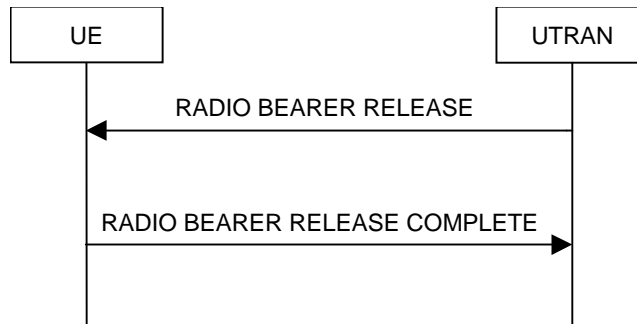

Figure 8.2.2-5: Radio Bearer Release, normal case

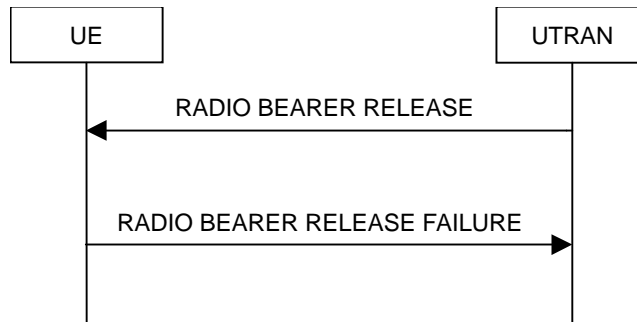

Figure 8.2.2-6: Radio Bearer Release, failure case

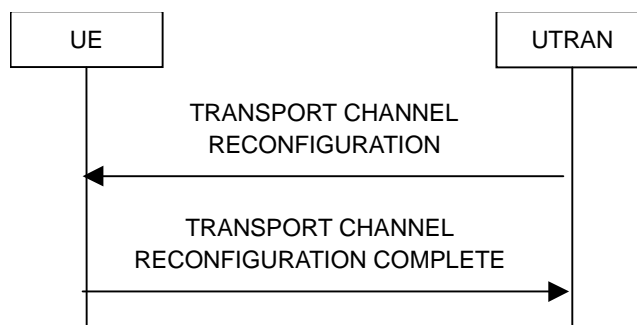

Figure 8.2.2-7: Transport channel reconfiguration, normal flow

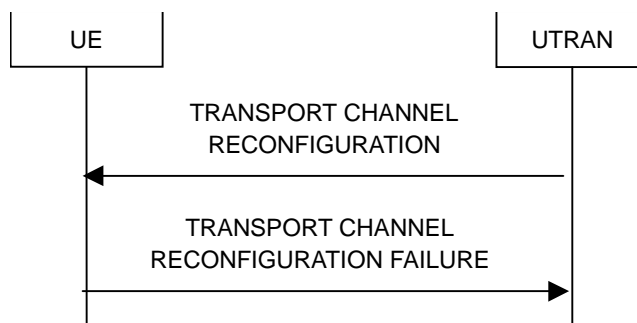

Figure 8.2.2-8: Transport channel reconfiguration, failure case

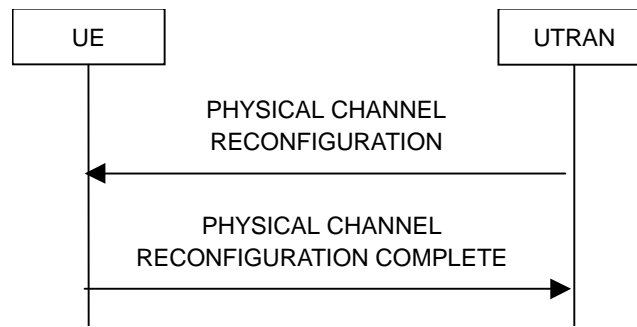

Figure 8.2.2-9: Physical channel reconfiguration, normal flow

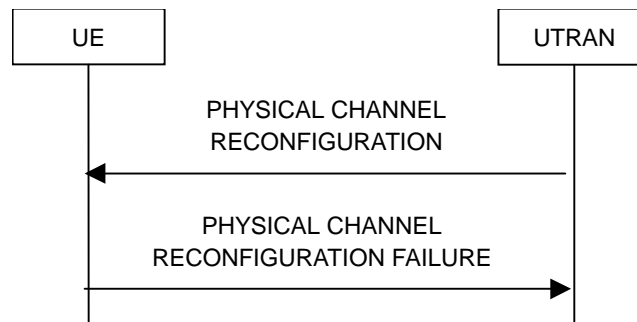

Figure 8.2.2-10: Physical channel reconfiguration, failure case

8.2.2.1 General

Reconfiguration procedures include the following procedures:

- the radio bearer establishment procedure;
- radio bearer reconfiguration procedure;
- the radio bearer release procedure;
- the transport channel reconfiguration procedure; and
- the physical channel reconfiguration procedure.

The radio bearer establishment procedure is used to establish new radio bearer(s).

The radio bearer reconfiguration procedure is used to reconfigure parameters for a radio bearer.

The radio bearer release procedure is used to release radio bearer(s).

The transport channel reconfiguration procedure is used to reconfigure transport channel parameters.

The physical channel reconfiguration procedure is used to establish, reconfigure and release physical channels.

While performing any of the above procedures, these procedures may perform a hard handover - see subclause 8.3.5.

8.2.2.2 Initiation

To initiate any one of the reconfiguration procedures, UTRAN should:

- 1> configure new radio links in any new physical channel configuration;
- 1> start transmission and reception on the new radio links;
- 1> for a radio bearer establishment procedure:
 - 2> transmit a RADIO BEARER SETUP message on the downlink DCCH using AM or UM RLC;

- 2> if signalling radio bearer RB4 is setup with this procedure and signalling radio bearers RB1-RB3 were already established prior to the procedure:
 - 3> if the variable "LATEST_CONFIGURED_CN_DOMAIN" has been initialised:
 - 4> connect any radio bearers setup by the same message as signalling radio bearer RB4 to the CN domain indicated in the variable "LATEST_CONFIGURED_CN_DOMAIN".
- 1> for a radio bearer reconfiguration procedure:
 - 2> transmit a RADIO BEARER RECONFIGURATION message on the downlink DCCH using AM or UM RLC.
- 1> for a radio bearer release procedure:
 - 2> transmit a RADIO BEARER RELEASE message on the downlink DCCH using AM or UM RLC.
- 1> for a transport channel reconfiguration procedure:
 - 2> transmit a TRANSPORT CHANNEL RECONFIGURATION message on the downlink DCCH using AM or UM RLC.
- 1> for a physical channel reconfiguration procedure:
 - 2> transmit a PHYSICAL CHANNEL RECONFIGURATION message on the downlink DCCH using AM or UM RLC.
- 1> if the reconfiguration procedure is simultaneous with SRNS relocation procedure:
 - 2> if the transmitted message is a RADIO BEARER RECONFIGURATION:
 - 3> include the IE "New U-RNTI".
 - 2> else:
 - 3> include the IE "Downlink counter synchronisation info".
 - 2> if ciphering and/or integrity protection are activated:
 - 3> include new ciphering and/or integrity protection configuration information to be used after reconfiguration.
 - 2> use the downlink DCCH using AM RLC.
- 1> if transport channels are added, reconfigured or deleted in uplink and/or downlink:
 - 2> set TFCS according to the new transport channel(s).
- 1> if transport channels are added or deleted in uplink and/or downlink, and RB Mapping Info applicable to the new configuration has not been previously provided to the UE, the UTRAN should:
 - 2> send the RB Mapping Info for the new configuration.

In the Radio Bearer Reconfiguration procedure UTRAN may indicate that uplink transmission shall be stopped or continued on certain radio bearers. Uplink transmission on a signalling radio bearer used by the RRC signalling (signalling radio bearer RB1 or signalling radio bearer RB2) should not be stopped.

NOTE 1: The Release '99 RADIO BEARER RECONFIGURATION message always includes the IE "RB information to reconfigure", even if UTRAN does not require the reconfiguration of any RB. In these cases, UTRAN may include only the IE "RB identity" within the IE "RB information to reconfigure".

NOTE 2: The Release '99 RADIO BEARER RECONFIGURATION message always includes the IE "Downlink information per radio link list", even if UTRAN does not require the reconfiguration of any RL. In these cases, UTRAN may re-send the currently assigned values for the mandatory IEs included within the IE "Downlink information per radio link list".

NOTE 3: The Release '99 RADIO BEARER RECONFIGURATION message always includes the IE "Primary CPICH Info" (FDD) or IE "Primary CCPCH Info" (TDD) within IE "Downlink information per radio link list". This implies that in case UTRAN applies the RADIO BEARER RECONFIGURATION message to move the UE to CELL_FACH state, it has to indicate a cell. However, UTRAN may indicate any cell; the UE anyhow performs cell selection and notifies UTRAN if it selects another cell than indicated by UTRAN.

If the IE "Activation Time" is included, UTRAN should set it to a value taking the UE performance requirements into account.

UTRAN should take the UE capabilities into account when setting the new configuration.

If the message is used to initiate a transition from CELL_DCH to CELL_FACH state, the UTRAN may assign a CPCH configuration to be used in that cell by the UE. UTRAN may also assign a C-RNTI to be used in that cell by the UE.

8.2.2.3 Reception of RADIO BEARER SETUP or RADIO BEARER RECONFIGURATION or RADIO BEARER RELEASE or TRANSPORT CHANNEL RECONFIGURATION or PHYSICAL CHANNEL RECONFIGURATION message by the UE

The UE shall be able to receive any of the following messages:

- RADIO BEARER SETUP message; or
- RADIO BEARER RECONFIGURATION message; or
- RADIO BEARER RELEASE message; or
- TRANSPORT CHANNEL RECONFIGURATION message; or
- PHYSICAL CHANNEL RECONFIGURATION message;

In case the reconfiguration procedure is used to remove all existing RL(s) in the active set while new RL(s) are established the UE shall:

- 1> perform the physical layer synchronisation procedure A as specified in [29] (FDD only);
- 1> apply the hard handover procedure as specified in subclause 8.3.5;
- 1> be able to perform this procedure even if no prior UE measurements have been performed on the target cell and/or frequency.

If the UE receives:

- a RADIO BEARER SETUP message; or
- a RADIO BEARER RECONFIGURATION message; or
- a RADIO BEARER RELEASE message; or
- a TRANSPORT CHANNEL RECONFIGURATION message; or
- a PHYSICAL CHANNEL RECONFIGURATION message;

it shall:

- 1> set the variable ORDERED_RECONFIGURATION to TRUE;
- 1> if the UE will enter the CELL_DCH state from any state other than CELL_DCH state at the conclusion of this procedure:
 - 2> perform the physical layer synchronisation procedure A as specified in [29] (FDD only).
- 1> act upon all received information elements as specified in subclause 8.6, unless specified in the following and perform the actions below.

The UE may:

- 1> maintain a list of the set of cells to which the UE has Radio Links if the IE "Cell ID" is present.

The UE may first release the physical channel configuration used at reception of the reconfiguration message. The UE shall then:

- 1> in FDD, if the IE "PDSCH code mapping" is included but the IE "PDSCH with SHO DCH Info" is not included and if the DCH has only one link in its active set:
 - 2> act upon the IE "PDSCH code mapping" as specified in subclause 8.6; and
 - 2> infer that the PDSCH will be transmitted from the cell from which the downlink DPCH is transmitted.
- 1> enter a state according to subclause 8.6.3.3.

In case the UE receives a RADIO BEARER RECONFIGURATION message including the IE "RB information to reconfigure" that only includes the IE "RB identity", the UE shall:

- 1> handle the message as if IE "RB information to reconfigure" was absent.

NOTE: The Release '99 RADIO BEARER RECONFIGURATION message always includes the IE "RB information to reconfigure". UTRAN has to include it even if it does not require the reconfiguration of any RB.

If after state transition the UE enters CELL_DCH state, the UE shall, after the state transition:

- 1> in FDD; or
- 1> in TDD when "Primary CCPCH Info" is included indicating a new target cell and "New C-RNTI" is not specified:
 - 2> remove any C-RNTI from MAC;
 - 2> clear the variable C_RNTI.

In FDD, if after state transition the UE leaves CELL_DCH state, the UE shall, after the state transition:

- 1> remove any DSCH-RNTI from MAC;
- 1> clear the variable DSCH_RNTI.

If the UE was in CELL_DCH state upon reception of the reconfiguration message and remains in CELL_DCH state, the UE shall:

- 1> if the IE "Uplink DPCH Info" is absent, not change its current UL Physical channel configuration.
- 1> in TDD:
 - 2> if "Primary CCPCH Info" is included indicating a new target cell and "New C-RNTI" is not specified:
 - 3> remove any C-RNTI from MAC;

3> clear the variable C_RNTI. If after state transition the UE enters CELL_FACH state, the UE shall, after the state transition:

- 1> if the IE "Frequency info" is included in the received reconfiguration message:
 - 2> select a suitable UTRA cell according to [4] on that frequency.
- 1> if the IE "Frequency info" is not included in the received reconfiguration message:
 - 2> select a suitable UTRA cell according to [4].
- 1> if the received reconfiguration message included the IE "Primary CPICH info" (for FDD) or "Primary CCPCH info" (for TDD), and the UE selects another cell than indicated by this IE or the received reconfiguration message did not include the IE "Primary CPICH info" (for FDD) or "Primary CCPCH info" (for TDD):

- 2> initiate a cell update procedure according to subclause 8.3.1 using the cause "Cell reselection";
- 2> when the cell update procedure completed successfully:
 - 3> if the UE is in CELL_PCH or URA_PCH state:
 - 4> initiate a cell update procedure according to subclause 8.3.1 using the cause "Uplink data transmission";
 - 4> proceed as below.
- 1> start timer T305 using its initial value if timer T305 is not running and if periodical update has been configured by T305 in the IE "UE Timers and constants in connected mode" set to any other value than "infinity" in the variable TIMERS_AND_CONSTANTS;
- 1> select PRACH according to subclause 8.5.17;
- 1> select Secondary CCPCH according to subclause 8.5.19;
- 1> use the transport format set given in system information;
- 1> if the IE "UTRAN DRX cycle length coefficient" is included in the same message:
 - 2> ignore that IE and stop using DRX.
- 1> if the contents of the variable C_RNTI is empty:
 - 2> perform a cell update procedure according to subclause 8.3.1 using the cause "Cell reselection";
 - 2> when the cell update procedure completed successfully:
 - 3> if the UE is in CELL_PCH or URA_PCH state:
 - 4> initiate a cell update procedure according to subclause 8.3.1 using the cause "Uplink data transmission";
 - 4> proceed as below.

If the UE was in CELL_FACH state upon reception of the reconfiguration message and remains in CELL_FACH state, the UE shall:

- 1> if the IE "Frequency info" is included in the received reconfiguration message:
 - 2> select a suitable UTRA cell according to [4] on that frequency;
 - 2> if the received reconfiguration message included the IE "Primary CPICH info" (for FDD) or "Primary CCPCH info" (for TDD), and the UE selected another cell than indicated by this IE or the received reconfiguration message did not include the IE "Primary CPICH info" (for FDD) or "Primary CCPCH info" (for TDD):
 - 3> initiate a cell update procedure according to subclause 8.3.1 using the cause "cell reselection";
 - 3> when the cell update procedure completed successfully:
 - 4> proceed as below.

The UE shall transmit a response message as specified in subclause 8.2.2.4, setting the information elements as specified below. The UE shall:

- 1> if the received reconfiguration message included the IE "Downlink counter synchronisation info"; or
- 1> if the received reconfiguration message is a RADIO BEARER RECONFIGURATION and the IE "New U-RNTI" is included:
 - 2> re-establish RB2;
 - 2> set the new uplink and downlink HFN component of COUNT-C of RB2 to MAX(uplink HFN component of COUNT-C of RB2, downlink HFN component of COUNT-C of RB2);

- 2> increment by one the downlink and uplink values of the HFN component of COUNT-C for RB2;
 - 2> calculate the START value according to subclause 8.5.9;
 - 2> include the calculated START values for each CN domain in the IE "START list" in the IE "Uplink counter synchronisation info".
- 1> if the received reconfiguration message did not include the IE "Downlink counter synchronisation info":
- 2> if the variable START_VALUE_TO_TRANSMIT is set:
 - 3> include and set the IE "START" to the value of that variable.
 - 2> if the variable START_VALUE_TO_TRANSMIT is not set and the IE "New U-RNTI" is included:
 - 3> calculate the START value according to subclause 8.5.9;
 - 3> include the calculated START values for each CN domain in the IE "START list" in the IE "Uplink counter synchronisation info".
 - 2> if the received reconfiguration message caused a change in the RLC size for any RB using RLC-AM:
 - 3> calculate the START value according to subclause 8.5.9;
 - 3> include the calculated START values for the CN domain associated with the corresponding RB identity in the IE "START list" in the IE "Uplink counter synchronisation info".
- 1> if the received reconfiguration message contained the IE "Ciphering mode info" or contained the IE "Integrity protection mode info":
- 2> set the IE "Status" in the variable SECURITY_MODIFICATION for all the CN domains in the variable SECURITY_MODIFICATION to "Affected".
- 1> if the received reconfiguration message contained the IE "Ciphering mode info":
- 2> include and set the IE "Radio bearer uplink ciphering activation time info" to the value of the variable RB_UPLINK_CIPHERING_ACTIVATION_TIME_INFO.
- 1> if the received reconfiguration message did not contain the IE "Ciphering activation time for DPCH":
- 2> if prior to this procedure there exist no transparent mode RLC radio bearers for the CN domain indicated in the IE "CN domain identity" in the IE "RAB info":
 - 3> if, at the conclusion of this procedure, the UE will be in CELL_DCH state; and
 - 3> if, at the conclusion of this procedure, at least one transparent mode RLC radio bearer exists for the CN domain indicated in the IE "CN domain identity" in the IE "RAB info":
 - 4> include the IE "COUNT-C activation time" and specify a CFN value for this IE that is a multiple of 8 frames ($CFN \bmod 8 = 0$) and lies at least 200 frames ahead of the CFN in which the response message is first transmitted.
- NOTE: UTRAN should not include the IE "Ciphering mode info" in any reconfiguration message unless it is also used to perform an SRNS relocation with change of ciphering algorithm.
- 1> set the IE "RRC transaction identifier" to the value of "RRC transaction identifier" in the entry for the received message in the table "Accepted transactions" in the variable TRANSACTIONS; and
- 1> clear that entry;
- 1> if the variable PDCP_SN_INFO is not empty:
- 2> include the IE "RB with PDCP information list" and set it to the value of the variable PDCP_SN_INFO.
- 1> in TDD, if the procedure is used to perform a handover to a cell where timing advance is enabled, and the UE can calculate the timing advance value in the new cell (i.e. in a synchronous TDD network):

2> set the IE "Uplink Timing Advance" according to subclause 8.6.6.26.

1> if the IE "Integrity protection mode info" was present in the received reconfiguration message:

2> start applying the new integrity protection configuration in the uplink for signalling radio bearer RB2 from and including the transmitted response message.

If after state transition the UE enters CELL_PCH or URA_PCH state, the UE shall, after the state transition and transmission of the response message:

1> if the IE "Frequency info" is included in the received reconfiguration message:

2> select a suitable UTRA cell according to [4] on that frequency.

1> if the IE "Frequency info" is not included in the received reconfiguration message:

2> select a suitable UTRA cell according to [4].

1> prohibit periodical status transmission in RLC;

1> remove any C-RNTI from MAC;

1> clear the variable C_RNTI;

1> start timer T305 using its initial value if timer T305 is not running and if periodical update has been configured by T305 in the IE "UE Timers and constants in connected mode" set to any other value than "infinity" in the variable TIMERS_AND_CONSTANTS;

1> select Secondary CCPCH according to subclause 8.5.19;

1> if the IE "UTRAN DRX cycle length coefficient" is included in the same message:

2> use the value in the IE "UTRAN DRX Cycle length coefficient" for calculating Paging occasion and PICH Monitoring Occasion as specified in subclause 8.6.3.2.

1> if the IE "UTRAN DRX cycle length coefficient" is not included in the same message:

2> set the variable INVALID_CONFIGURATION to TRUE.

1> if the UE enters CELL_PCH state from CELL_DCH state, and the received reconfiguration message included the IE "Primary CPICH info" (for FDD) or "Primary CCPCH info" (for TDD), and the UE selected another cell than indicated by this IE or the received reconfiguration message did not include the IE "Primary CPICH info" (for FDD) or "Primary CCPCH info" (for TDD):

2> initiate a cell update procedure according to subclause 8.3.1 using the cause "cell reselection";

2> when the cell update procedure completed successfully:

3> the procedure ends.

1> if the UE enters CELL_PCH state from CELL_FACH state, and the received reconfiguration message included the IE "Primary CPICH info" (for FDD) or "Primary CCPCH info" (for TDD), and the UE selected another cell than indicated by this IE:

2> initiate a cell update procedure according to subclause 8.3.1 using the cause "cell reselection";

2> when the cell update procedure is successfully completed:

3> the procedure ends.

1> if the UE enters URA_PCH state, and after cell selection the criteria for URA update caused by "URA reselection" according to subclause 8.3.1 is fulfilled:

2> initiate a URA update procedure according to subclause 8.3.1 using the cause "URA reselection";

2> when the URA update procedure is successfully completed:

3> the procedure ends.

8.2.2.4 Transmission of a response message by the UE, normal case

In case the procedure was triggered by reception of a RADIO BEARER SETUP message, the UE shall:

- 1> transmit a RADIO BEARER SETUP COMPLETE as response message on the uplink DCCH using AM RLC.

In case the procedure was triggered by reception of a RADIO BEARER RECONFIGURATION message, the UE shall:

- 1> transmit a RADIO BEARER RECONFIGURATION COMPLETE as response message on the uplink DCCH using AM RLC.

In case the procedure was triggered by reception of a RADIO BEARER RELEASE message, the UE shall:

- 1> transmit a RADIO BEARER RELEASE COMPLETE as response message on the uplink DCCH using AM RLC.

In case the procedure was triggered by reception of a TRANSPORT CHANNEL RECONFIGURATION message, the UE shall:

- 1> transmit a TRANSPORT CHANNEL RECONFIGURATION COMPLETE as response message on the uplink DCCH using AM RLC.

In case the procedure was triggered by reception of a PHYSICAL CHANNEL RECONFIGURATION message, the UE shall:

- 1> transmit a PHYSICAL CHANNEL RECONFIGURATION COMPLETE as response message on the uplink DCCH using AM RLC.

If the new state is CELL_DCH or CELL_FACH, the response message shall be transmitted using the new configuration after the state transition, and the UE shall:

- 1> if the IE "Downlink counter synchronisation info" was included in the reconfiguration message; or
- 1> if the received reconfiguration message is a RADIO BEARER RECONFIGURATION and the IE "New U-RNTI" is included:
 - 2> when RLC has confirmed the successful transmission of the response message:
 - 3> re-establish all AM and UM RLC entities with RB identities larger than 4 and set the first 20 bits of all the HFN component of the respective COUNT-C values to the START value included in the response message for the corresponding CN domain;
 - 3> re-establish the RLC entities with RB identities 1, 3 and 4 and set the first 20 bits of all the HFN component of the respective COUNT-C values to the START value included in the response message for the CN domain stored in the variable LATEST_CONFIGURED_CN_DOMAIN;
 - 3> set the remaining bits of the HFN component of COUNT-C values of all UM RLC entities to zero;
 - 3> re-initialise the PDCP header compression entities of each radio bearer in the variable ESTABLISHED_RABS as specified in [36].
 - 1> if the variable PDCP_SN_INFO is empty:
 - 2> if the received reconfiguration message contained the IE "Ciphering mode info":
 - 3> when RLC has confirmed the successful transmission of the response message:
 - 4> notify upper layers upon change of the security configuration;
 - 4> perform the actions below.
 - 2> if the received reconfiguration message did not contain the IE "Ciphering mode info":
 - 3> when RLC has been requested to transmit the response message:
 - 4> perform the actions below.

- 1> if the variable PDCP_SN_INFO is non-empty:
 - 2> when RLC has confirmed the successful transmission of the response message:
 - 3> for each radio bearer in the variable PDCP_SN_INFO:
 - 4> if the IE "RB started" in the variable ESTABLISHED_RABS is set to "started":
 - 5> configure the RLC entity for that radio bearer to "continue".
 - 3> perform the actions below.

If the new state is CELL_PCH or URA_PCH, the response message shall be transmitted using the old configuration before the state transition, but the new C-RNTI shall be used if the IE "New C-RNTI" was included in the received reconfiguration message, and the UE shall:

- 1> when RLC has confirmed the successful transmission of the response message:
 - 2> for each radio bearer in the variable PDCP_SN_INFO:
 - 3> if the IE "RB started" in the variable ESTABLISHED_RABS is set to "started":
 - 4> configure the RLC entity for that radio bearer to "continue".
 - 2> enter the new state (CELL_PCH or URA_PCH, respectively);
 - 2> perform the actions below.

The UE shall:

- 1> set the variable ORDERED_RECONFIGURATION to FALSE;
- 1> if the received reconfiguration message contained the IE "Ciphering mode info":
 - 2> resume data transmission on any suspended radio bearer and signalling radio bearer mapped on RLC-AM or RLC-UM;
 - 2> set the IE "Reconfiguration" in the variable CIPHERING_STATUS to FALSE; and
 - 2> clear the variable RB_UPLINK_CIPHERING_ACTIVATION_TIME_INFO.
- 1> if the received reconfiguration message contained the IE "Integrity protection mode info":
 - 2> allow the transmission of RRC messages on all signalling radio bearers with any RRC SN;
 - 2> set "Uplink RRC Message sequence number" for signalling radio bearer RB0 in the variable INTEGRITY_PROTECTION_INFO to a value such that next RRC message to be sent on uplink RB0 will use the new integrity protection configuration;
 - 2> set the IE "Reconfiguration" in the variable INTEGRITY_PROTECTION_INFO to FALSE; and
 - 2> clear the variable INTEGRITY_PROTECTION_ACTIVATION_INFO.
- 1> clear the variable PDCP_SN_INFO;
- 1> clear the variable START_VALUE_TO_TRANSMIT;
- 1> clear the variable SECURITY_MODIFICATION.

8.2.2.5 Reception of a response message by the UTRAN, normal case

When UTRAN has received

- the RADIO BEARER SETUP COMPLETE message; or
- the RADIO BEARER RECONFIGURATION COMPLETE message; or
- the RADIO BEARER RELEASE COMPLETE message; or

- the TRANSPORT CHANNEL RECONFIGURATION COMPLETE message; or
- the PHYSICAL CHANNEL RECONFIGURATION COMPLETE message.

UTRAN may:

- 1> delete the old configuration.

If the procedure caused the UE to leave the CELL_FACH state, UTRAN may:

- 1> delete the C-RNTI of the UE.

If the IE "UL Timing Advance" is included in TDD, UTRAN should:

- 1> evaluate the timing advance value that the UE has to use in the new cell after handover.

If the IE "START" or the IE "START list " is included, UTRAN should:

- 1> set the START value for each CN domain with the corresponding values as received in this response message;
- 1> consequently, then use the START values to initialise the hyper frame numbers, in the same way as specified for the UE in subclause 8.2.2.3, for any new radio bearers that are established.

If UTRAN has ordered a ciphering reconfiguration by including the IE "Ciphering mode info", UTRAN should:

- 1> for radio bearers using RLC-AM or RLC-UM:
 - 2> use the old ciphering configuration for received RLC PDUs with RLC sequence number less than the RLC sequence number indicated in the IE "Radio bearer uplink ciphering activation time info" sent by the UE;
 - 2> use the new ciphering configuration for received RLC PDUs with RLC sequence number greater than or equal to the RLC sequence number indicated in the IE "Radio bearer uplink ciphering activation time info" sent by the UE;
 - 2> if an RLC reset or re-establishment occurs after this response message has been received by UTRAN before the activation time for the new ciphering configuration has been reached:
 - 3> ignore the activation time; and
 - 3> apply the new ciphering configuration immediately after the RLC reset or RLC re-establishment.
- 1> for radio bearers using RLC-TM:
 - 2> begin incrementing the COUNT-C at the CFN only as indicated in:
 - 3> the IE "Ciphering activation time for DPCH" in the IE "Ciphering mode info", if included in the message that triggered the radio bearer control procedure; or
 - 3> the IE "COUNT-C activation time", if included in the response message for this procedure.
- 1> and the procedure ends on the UTRAN side.

8.2.2.6 Unsupported configuration in the UE

If the UTRAN instructs the UE to use a configuration, which it does not support and/or if the received message causes the variable UNSUPPORTED_CONFIGURATION to be set to TRUE, the UE shall:

- 1> transmit a failure response as specified in subclause 8.2.2.9, setting the information elements as specified below:
 - 2> include the IE "RRC transaction identifier"; and
 - 2> set it to the value of "RRC transaction identifier" in the entry for the received message in the table "Accepted transactions" in the variable TRANSACTIONS; and
 - 2> clear that entry;
 - 2> set the IE "failure cause" to "configuration unsupported".

1> set the variable UNSUPPORTED_CONFIGURATION to FALSE;

1> continue with any ongoing processes and procedures as if the reconfiguration message was not received.

The procedure ends.

8.2.2.7 Physical channel failure

If the received message caused the UE to be in CELL_DCH state and the UE according to subclause 8.5.4 failed to establish the dedicated physical channel(s) indicated in the received message the UE shall:

1> revert to the configuration prior to the reception of the message (old configuration);

1> if the old configuration includes dedicated physical channels (CELL_DCH state) and the UE is unable to revert to the old configuration:

2> initiate a cell update procedure according to subclause 8.3.1, using the cause "radio link failure";

2> after the cell update procedure has completed successfully:

3> proceed as below.

1> if the old configuration does not include dedicated physical channels (CELL_FACH state):

2> select a suitable UTRA cell according to [4];

2> if the UE selects another cell than the cell the UE camped on upon reception of the reconfiguration message:

3> initiate a cell update procedure according to subclause 8.3.1, using the cause "Cell reselection";

3> after the cell update procedure has completed successfully:

4> proceed as below.

1> transmit a failure response message as specified in subclause 8.2.2.9, setting the information elements as specified below:

2> include the IE "RRC transaction identifier"; and

2> set it to the value of "RRC transaction identifier" in the entry for the received message in the table "Accepted transactions" in the variable TRANSACTIONS; and

2> clear that entry;

2> set the IE "failure cause" to "physical channel failure".

1> set the variable ORDERED_RECONFIGURATION to FALSE;

1> continue with any ongoing processes and procedures as if the reconfiguration message was not received.

The procedure ends.

8.2.2.8 Cell re-selection

If the UE performs cell re-selection during the reconfiguration procedure, the UE shall:

1> initiate a cell update procedure, as specified in subclause 8.3.1;

1> continue with the reconfiguration procedure.

8.2.2.9 Transmission of a response message by the UE, failure case

The UE shall:

1> in case of reception of a RADIO BEARER SETUP message:

- 2> if the radio bearer establishment procedure affects several radio bearers:
 - 3> (may) include the identities of the radio bearers for which the procedure would have been successful into the RADIO BEARER SETUP FAILURE message.
 - 2> transmit a RADIO BEARER SETUP FAILURE as response message on the DCCH using AM RLC.
- 1> in case of reception of a RADIO BEARER RECONFIGURATION message:
 - 2> if the radio bearer reconfiguration procedure affects several radio bearers:
 - 3> (may) include the identities of the radio bearers for which the procedure would have been successful into the RADIO BEARER RECONFIGURATION FAILURE message.
 - 2> transmit a RADIO BEARER RECONFIGURATION FAILURE as response message on the DCCH using AM RLC.
- 1> in case of reception of a RADIO BEARER RELEASE message:
 - 2> if the radio bearer release procedure affects several radio bearers:
 - 3> (may) include the identities of the radio bearers for which the procedure would have been successful into the RADIO BEARER RELEASE FAILURE message.
 - 2> transmit a RADIO BEARER RELEASE FAILURE as response message on the DCCH using AM RLC.
- 1> in case of reception of a TRANSPORT CHANNEL RECONFIGURATION message:
 - 2> transmit a TRANSPORT CHANNEL RECONFIGURATION FAILURE as response message on the DCCH using AM RLC.
- 1> in case of reception of a PHYSICAL CHANNEL RECONFIGURATION message:
 - 2> transmit a PHYSICAL CHANNEL RECONFIGURATION FAILURE as response message on the DCCH using AM RLC.
- 1> when the response message has been submitted to lower layers for transmission:
 - 2> continue with any ongoing processes and procedures as if no reconfiguration attempt had occurred.

8.2.2.10 Reception of a response message by the UTRAN, failure case

When the UTRAN has received:

- the RADIO BEARER SETUP FAILURE message; or
- the RADIO BEARER RECONFIGURATION FAILURE message; or
- the RADIO BEARER RELEASE FAILURE message; or
- the TRANSPORT CHANNEL RECONFIGURATION FAILURE message; or
- the PHYSICAL CHANNEL RECONFIGURATION FAILURE message;

the UTRAN may restore the old and delete the new configuration. Upper layers should be notified of the failure.

The procedure ends on the UTRAN side.

8.2.2.11 Invalid configuration

If the variable INVALID_CONFIGURATION is set to TRUE the UE shall:

- 1> keep the configuration existing before the reception of the message;
- 1> transmit a failure response message as specified in subclause 8.2.2.9, setting the information elements as specified below:

- 2> include the IE "RRC transaction identifier"; and
- 3> set it to the value of "RRC transaction identifier" in the entry for the received message in the table "Accepted transactions" in the variable TRANSACTIONS; and
- 3> clear that entry.
- 2> set the IE "failure cause" to "invalid configuration".
- 1> set the variable INVALID_CONFIGURATION to FALSE;
- 1> continue with any ongoing processes and procedures as if the reconfiguration message was not received.

The procedure ends.

8.2.2.12 Incompatible simultaneous reconfiguration

If the table "Rejected transactions" in the variable TRANSACTIONS is set due to the received message and the variable PROTOCOL_ERROR_REJECT is set to FALSE, the UE shall:

- 1> not apply the configuration contained in the received reconfiguration message;
- 1> transmit a failure response message as specified in subclause 8.2.2.9, setting the information elements as specified below:
 - 2> include the IE "RRC transaction identifier"; and
 - 2> set it to the value of "RRC transaction identifier" in the entry for the received message in the table "Rejected transactions" in the variable TRANSACTIONS; and
 - 2> clear that entry;
 - 2> set the IE "failure cause" to "incompatible simultaneous reconfiguration".
- 1> continue with any ongoing processes and procedures as if the reconfiguration message was not received.

The procedure ends.

8.2.2.12a Incompatible simultaneous security reconfiguration

If the variable INCOMPATIBLE_SECURITY_RECONFIGURATION is set to TRUE due to the received reconfiguration message, the UE shall:

- 1> transmit a failure response message as specified in subclause 8.2.2.9, setting the information elements as specified below:
 - 2> include the IE "RRC transaction identifier"; and
 - 2> set it to the value of "RRC transaction identifier" in the entry for the received message in the table "Accepted transactions" in the variable TRANSACTIONS; and
 - 2> clear that entry;
 - 2> set the IE "failure cause" to the cause value "incompatible simultaneous reconfiguration".
- 1> set the variable INCOMPATIBLE_SECURITY_RECONFIGURATION to FALSE;
- 1> continue with any ongoing processes and procedures as if the reconfiguration message was not received.

The procedure ends.

8.2.2.12b Cell update procedure during security reconfiguration

If:

- a cell update procedure according to subclause 8.3.1 is initiated; and

- the received reconfiguration message causes either:
 - the IE "Reconfiguration" in the variable CIPHERING_STATUS to be set to TRUE; and/or
 - the IE "Reconfiguration" in the variable INTEGRITY_PROTECTION_INFO to be set to TRUE:

the UE shall:

- 1> release all radio resources;
- 1> indicate the release of the established signalling connections (as stored in the variable ESTABLISHED_SIGNALLING_CONNECTIONS) and established radio access bearers (as stored in the variable ESTABLISHED_RABS) to upper layers; and
- 1> clear any entry for the RRC CONNECTION RELEASE message in the tables "Accepted transactions" and "Rejected transactions" in the variable TRANSACTIONS;
- 1> clear the variable ESTABLISHED_SIGNALLING_CONNECTIONS;
- 1> clear the variable ESTABLISHED_RABS;
- 1> if the received reconfiguration message contained the IE "Ciphering mode info":
 - 2> set the IE "Reconfiguration" in the variable CIPHERING_STATUS to FALSE; and
 - 2> clear the variable RB_UPLINK_CIPHERING_ACTIVATION_TIME_INFO;
 - 2> clear the variable SECURITY_MODIFICATION.
- 1> if the received reconfiguration message contained the IE "Integrity protection mode info":
 - 2> set the IE "Reconfiguration" in the variable INTEGRITY_PROTECTION_INFO to FALSE; and
 - 2> clear the variable INTEGRITY_PROTECTION_ACTIVATION_INFO.
- 1> enter idle mode;
- 1> perform the actions specified in subclause 8.5.2 when entering idle mode;
- 1> and the procedure ends.

NOTE: UTRAN should use RB Control messages to perform an SRNS relocation only in case of state transitions from CELL_DCH to CELL_DCH.

8.2.2.13 Invalid received message

If the received reconfiguration message contains a protocol error causing the variable PROTOCOL_ERROR_REJECT to be set to TRUE according to clause 9, the UE shall perform procedure specific error handling as follows. The UE shall:

- 1> transmit a failure response message as specified in subclause 8.2.2.9, setting the information elements as specified below:
 - 2> include the IE "RRC transaction identifier"; and
 - 2> set it to the value of "RRC transaction identifier" in the entry for the received message in the table "Rejected transactions" in the variable TRANSACTIONS; and
 - 2> clear that entry;
 - 2> set the IE "failure cause" to the cause value "protocol error";
 - 2> include the IE "Protocol error information" with contents set to the value of the variable PROTOCOL_ERROR_INFORMATION.

The procedure ends.

8.2.3 Radio bearer release

See subclause 8.2.2 (Reconfiguration procedures).

8.2.4 Transport channel reconfiguration

See subclause 8.2.2 (Reconfiguration procedures).

8.2.5 Transport format combination control

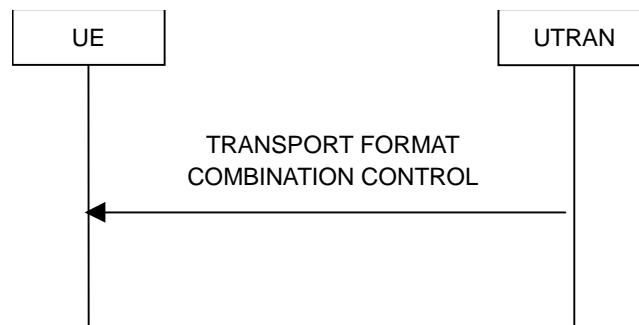

Figure 8.2.5-1: Transport format combination control, normal flow

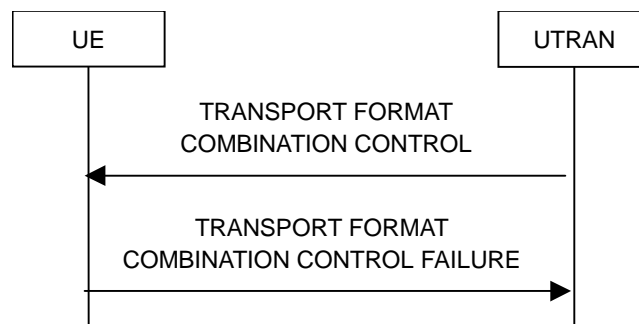

Figure 8.2.5-2: Transport format combination control, failure case

8.2.5.1 General

The transport format combination control procedure is used to control the allowed uplink transport format combinations within the transport format combination set.

8.2.5.2 Initiation

To initiate the transport format combination control procedure, the UTRAN transmits the TRANSPORT FORMAT COMBINATION CONTROL message on the downlink DCCH using AM, UM or TM RLC. When not stated otherwise elsewhere, the UE may initiate the transport format combination control procedure also when another procedure is ongoing, and in that case the state of the latter procedure shall not be affected.

To change the sub-set of allowed transport format combinations, the UTRAN should:

- 1> set the allowed TFCs in the IE "TFC subset". The UTRAN may specify the duration for which a new TFC sub-set applies by using the IE "TFC Control duration" and independently may specify the time at which a new TFC sub-set shall be applied using the IE "Activation Time".

To remove completely the previous restrictions of allowed transport format combinations, the UTRAN should:

- 1> set the "full transport format combination" in the IE "TFC subset".

8.2.5.3 Reception of a TRANSPORT FORMAT COMBINATION CONTROL message by the UE

If the TRANSPORT FORMAT COMBINATION CONTROL message was received on AM RLC or UM RLC, the UE shall:

- 1> act upon all received information elements as specified in 8.6, unless specified otherwise in the following;
- 1> perform the actions for the transport format combination subset specified in the IE "DPCH/PUSCH TFCS in uplink" according to subclause 8.6.5.3;
- 1> if the variable INVALID_CONFIGURATION is set to FALSE:
 - 2> if the IE "TFC Control duration" is included in the message:
 - 3> store the value of the IE "TFC Control duration" in the IE "Duration" in the variable TFC_SUBSET;
 - 3> set the IE "Current TFC subset" (for the CCTrCH indicated by the IE "TFCS Id" in case of TDD) in the variable TFC_SUBSET to the value of the IE "Transport format combination subset";
 - 3> apply the transport format combination subset in the IE "Current TFC subset" stored in the variable TFC_SUBSET for the number of (10 ms) frames specified in the IE "TFC Control duration";
 - 3> at the end of the time period defined by the IE "TFC control duration":
 - 4> if the variable TFC_SUBSET has not subsequently been reset by another message:
 - 5> go back to any previous restriction of the transport format combination set defined by the content of the IE "Default TFC subset" in the variable TFC_SUBSET;
 - 5> set the value of the IE "Current TFC subset" in the variable TFC_SUBSET to the value of the IE "Default TFC subset" in the variable TFC_SUBSET;
 - 5> clear the IE "Duration" in the variable TFC_SUBSET.
 - 2> if the IE "TFC Control duration" is not included in the message:
 - 3> set both the IE "Current TFC subset" and the IE "Default TFC subset" (for the CCTrCH indicated by the IE "TFCS Id" in case of TDD) in the variable TFC_SUBSET to the value of the IE "Transport format combination subset".
 - 1> if the UE is unable to comply with the reconfiguration due to an invalid activation time:
 - 2> set the variable INVALID_CONFIGURATION to TRUE.

If the TRANSPORT FORMAT COMBINATION CONTROL message was received on TM RLC, the UE shall:

- 1> consider the size of the transport block of the downlink transport channel where this message was received to select the format for the transparent format combination control mode as specified in subclause 12.4.1.1;
- 1> if the IE "TFC subset identity" identifies one of the TFC subsets stored in the IE "TFC subset list" in the variable TFC_SUBSET:
 - 2> perform the actions as specified in subclause 8.6.5.3;
 - 2> if the variable INVALID_CONFIGURATION is set to FALSE:
 - 3> in the variable TFC_SUBSET, set the IE "Current TFC subset" to the value of the IE "TFC subset" in "TFC subset list" which is identified by the IE "TFC subset identity".
- 1> if the IE "TFC subset identity" is greater than the maximum number of TFC subsets stored in the IE "TFC subset list" in the variable TFC_SUBSET:
 - 2> set the variable INVALID_CONFIGURATION to TRUE.

The UE shall:

- 1> clear the entry for the TRANSPORT FORMAT COMBINATION CONTROL message in the table "Accepted transactions" in the variable TRANSACTIONS;
- 1> and the procedure ends.

8.2.5.4 Invalid configuration

If the variable INVALID_CONFIGURATION is set to TRUE due to the received TRANSPORT FORMAT COMBINATION CONTROL message the UE shall:

- 1> if the TRANSPORT FORMAT COMBINATION CONTROL message was received on AM RLC:
 - 2> keep the TFC subset existing before the TRANSPORT FORMAT COMBINATION CONTROL message was received;
 - 2> transmit a TRANSPORT FORMAT COMBINATION CONTROL FAILURE message on the DCCH using AM RLC;
 - 2> set the IE "RRC transaction identifier" in the TRANSPORT FORMAT COMBINATION CONTROL FAILURE message to the value of "RRC transaction identifier" in the entry for the TRANSPORT FORMAT COMBINATION CONTROL message in the table "Accepted transactions" in the variable TRANSACTIONS; and
 - 2> clear that entry;
 - 2> set the IE "failure cause" to "invalid configuration";
 - 2> when the TRANSPORT FORMAT COMBINATION CONTROL FAILURE message has been submitted to lower layers for transmission the procedure ends.
- 1> if the TRANSPORT FORMAT COMBINATION CONTROL message was received on UM RLC or TM RLC:
 - 2> ignore the TRANSPORT FORMAT COMBINATION CONTROL message;
 - 2> clear the entry for the TRANSPORT FORMAT COMBINATION CONTROL message in the table "Accepted transactions" in the variable TRANSACTIONS.

8.2.5.5 Invalid TRANSPORT FORMAT COMBINATION CONTROL message

If the TRANSPORT FORMAT COMBINATION CONTROL message was received on AM RLC or UM RLC and contains a protocol error causing the variable PROTOCOL_ERROR_REJECT to be set to TRUE according to clause 9, the UE shall perform procedure specific error handling as follows. The UE shall:

- 1> transmit a TRANSPORT FORMAT COMBINATION CONTROL FAILURE message on the uplink DCCH using AM RLC setting the information elements as specified below:
 - 2> set the IE "RRC transaction identifier" in the TRANSPORT FORMAT COMBINATION CONTROL FAILURE message to the value of "RRC transaction identifier" in the entry for the TRANSPORT FORMAT COMBINATION CONTROL message in the table "Rejected transactions" in the variable TRANSACTIONS; and
 - 2> clear that entry;
 - 2> set the IE "failure cause" to the cause value "protocol error";
 - 2> include the IE "Protocol error information" with contents set to the value of the variable PROTOCOL_ERROR_INFORMATION.
- 1> when the TRANSPORT FORMAT COMBINATION CONTROL FAILURE message has been submitted to lower layers for transmission:
 - 2> continue with any ongoing processes and procedures as if the invalid TRANSPORT FORMAT COMBINATION CONTROL message has not been received;
 - 2> and the procedure ends.

If the TRANSPORT FORMAT COMBINATION CONTROL message was received on TM RLC and contains a protocol error causing the variable `PROTOCOL_ERROR_REJECT` to be set to `TRUE` according to clause 9, the UE shall perform procedure specific error handling as follows. The UE shall:

- 1> ignore the invalid TRANSPORT FORMAT COMBINATION CONTROL message as if it has not been received;
- 1> the procedure ends.

8.2.6 Physical channel reconfiguration

See subclause 8.2.2 Reconfiguration procedures.

8.2.7 Physical Shared Channel Allocation [TDD only]



Figure 8.2.7-1: Physical Shared Channel Allocation

8.2.7.1 General

The purpose of this procedure is to allocate radio resources to USCH and/or DSCH transport channels in TDD mode, for use by a UE. This procedure can also be used to indicate to the UE, that a PUSCH allocation is pending, in order to prevent further capacity requests from the UE.

UEs are not required to receive FACH and DSCH simultaneously, i.e. if resources are allocated to DSCH the FACH reception may be suspended.

8.2.7.2 Initiation

To initiate the Physical Shared Channel Allocation procedure, the UTRAN sends the "PHYSICAL SHARED CHANNEL ALLOCATION" message on the downlink SHCCH or on the downlink DCCH using UM RLC. The DSCH-RNTI shall be included for UE identification, if the message is sent on the SHCCH.

8.2.7.3 Reception of a PHYSICAL SHARED CHANNEL ALLOCATION message by the UE

Upon reception of a "PHYSICAL SHARED CHANNEL ALLOCATION" message, if the message is received on the downlink SHCCH the UE shall:

- 1> check the DSCH-RNTI to see if the UE is addressed by the message;
- 1> if the UE is addressed by the message, or if the message is received on the downlink DCCH:
 - 2> perform the following actions.
- 1> otherwise:
 - 2> ignore the message.
- 1> act upon all received information elements as specified in subclause 8.6, unless specified otherwise in the following:
 - 1> if the IE "ISCP Timeslot list" is included:

- 2> store the timeslot numbers given there for future Timeslot ISCP measurements and reports in the variable PHYSICAL_SHARED_CHANNEL_CONFIGURATION.
- 1> if the IE "PDSCH capacity allocation info" is included:
 - 2> configure the physical resources used for the downlink CCTrCH given by the IE "TFCS ID" according to the following:
 - 3> if the CHOICE "Configuration" has the value "Old configuration":
 - 4> if the UE has stored a PDSCH configuration in the variable PHYSICAL_SHARED_CHANNEL_CONFIGURATION with the identity given by the IE "PDSCH Identity":
 - 5> configure the physical resources according to that configuration.
 - 4> otherwise:
 - 5> ignore the IE "PDSCH capacity allocation info".
 - 3> if the CHOICE "Configuration" has the value "New configuration":
 - 4> configure the physical resources according to the information given in IE "PDSCH Info". If IE "Common timeslot info" or IE "PDSCH timeslots and codes" IE are not present in IE "PDSCH Info":
 - 5> reuse the configuration stored in the variable PHYSICAL_SHARED_CHANNEL_CONFIGURATION for this CCTrCH.
 - 4> if the IE "PDSCH Identity" is included:
 - 5> store the new configuration in the variable PHYSICAL_SHARED_CHANNEL_CONFIGURATION using that identity.
 - 2> start using the new configuration at the CFN specified by the IE "Allocation activation time", and use that for the duration given by the IE "Allocation duration";
 - 2> if the IE "Confirm request" has the value "Confirm PDSCH" and IE "PDSCH Identity" is included in IE "PDSCH capacity allocation info":
 - 3> initiate the PUSCH CAPACITY REQUEST procedure as described in subclause 8.2.8.
 - 1> if the IE "PUSCH capacity allocation info" is included:
 - 2> stop the timer T310, if running;
 - 2> if the CHOICE "PUSCH allocation" has the value "PUSCH allocation pending":
 - 3> start the timer T311.
 - 2> if the CHOICE "PUSCH allocation" has the value "PUSCH allocation assignment":
 - 3> stop the timer T311, if running;
 - 3> configure the physical resources used for the uplink CCTrCH given by the IE "TFCS ID" according to the following:
 - 4> if the CHOICE "Configuration" has the value "Old configuration":
 - 5> if the UE has stored a PUSCH configuration with the identity given by the IE "PUSCH Identity" in the variable PHYSICAL_SHARED_CHANNEL_CONFIGURATION:
 - 6> configure the physical resources according to that configuration.
 - 5> otherwise:
 - 6> ignore the IE "PUSCH capacity allocation info".

- 4> if the CHOICE "Configuration" has the value "New configuration", the UE shall:
 - 5> configure the physical resources according to the information given in IE "PUSCH Info". If IE "Common timeslot info" or IE "PUSCH timeslots and codes" is not present in IE "PUSCH Info":
 - 6> reuse the configuration stored in the variable PHYSICAL_SHARED_CHANNEL_CONFIGURATION for this CCTrCH.
 - 5> if the IE "PUSCH Identity" is included:
 - 6> store the new configuration in the variable PHYSICAL_SHARED_CHANNEL_CONFIGURATION using that identity.
- 3> start using the new configuration at the CFN specified by the IE "Allocation activation time", and use that for the duration given by the IE "Allocation duration";
- 3> if the "UL target SIR" is included:
 - 4> replace the SIR target for this CCTrCH with the signalled value.
- 3> if the IE "Traffic volume report request " is included:
 - 4> initiate the PUSCH CAPACITY REQUEST procedure as described in subclause 8.2.8 at the time indicated by the IE "Traffic volume report request".
- 3> if the IE "Confirm request" has the value "Confirm PUSCH" and IE "PUSCH Identity" is included in IE "PUSCH capacity allocation info":
 - 4> initiate the PUSCH CAPACITY REQUEST procedure as described in subclause 8.2.8.
- 3> determine the TFCS subset and hence the TFCI values which are possible given the PUSCH allocation for that CCTrCH;
- 3> configure the MAC-c/sh in the UE with this TFCS restriction if necessary;
- 3> transmit USCH Transport Block Sets as required, within the TFCS limits given by the PUSCH allocation.

NOTE: If the UE has just entered a new cell and System Information Block Type 6 has not yet been scheduled, PUSCH/PDSCH information should be specified in the allocation message.

The UE shall:

- 1> clear the entry for the PHYSICAL SHARED CHANNEL ALLOCATION message in the table "Accepted transactions" in the variable TRANSACTIONS;
- 1> and the procedure ends.

8.2.7.4 Invalid PHYSICAL SHARED CHANNEL ALLOCATION message

If the UE receives a PHYSICAL SHARED CHANNEL ALLOCATION message, which contains a protocol error causing the variable PROTOCOL_ERROR_REJECT to be set to TRUE according to clause 9, the UE shall perform procedure specific error handling as follows. The UE shall:

- 1> ignore the invalid PHYSICAL SHARED CHANNEL ALLOCATION message;
- 1> submit the PUSCH CAPACITY REQUEST message for transmission on the uplink SHCCH, setting the information elements in the message as specified in subclause 8.2.8.3;
- 1> reset counter V310;
- 1> start timer T310;
- 1> proceed as described in subclause 8.2.8.

8.2.8 PUSCH capacity request [TDD only]

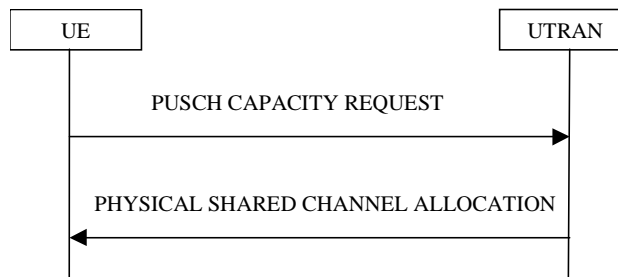

Figure 8.2.8-1: PUSCH Capacity request procedure

8.2.8.1 General

With this procedure, the UE transmits its request for PUSCH resources to the UTRAN. In the normal case, the UTRAN responds with a PHYSICAL SHARED CHANNEL ALLOCATION message, which either allocates the requested PUSCH resources, and/or allocates a PDSCH resource, or may just serve as an acknowledgement, indicating that PUSCH allocation is pending.

This procedure can also be used to acknowledge the reception of a PHYSICAL SHARED CHANNEL ALLOCATION message, or to indicate a protocol error in that message.

With the PUSCH CAPACITY REQUEST message, the UE can request capacity for one or more USCH.

8.2.8.2 Initiation

This procedure is initiated:

- 1> in the CELL_FACH or CELL_DCH state;
- 1> and when at least one RB using USCH has been established;
- 1> and when the UE sees the requirement to request physical resources (PUSCH) for an USCH channel or there is the need to reply to a PHYSICAL SHARED CHANNEL ALLOCATION message as described in clause 8.2.7 (i.e. to confirm the reception of a message, if requested to do so, or to indicate a protocol error).

The procedure can be initiated if:

- Timer T311 is not running.
- The timer T310 (capacity request repetition timer) is not running.

The UE shall:

- 1> set the IEs in the PUSCH CAPACITY REQUEST message according to subclause 8.2.8.3;
- 1> if the procedure is triggered to reply to a previous PHYSICAL SHARED CHANNEL ALLOCATION message by the IE "Confirm request" set to "Confirm PUSCH" and the IE "PUSCH capacity allocation info" is not present:
 - 2> transmit the PUSCH CAPACITY REQUEST message on RACH.
- 1> else:
 - 2> transmit the PUSCH CAPACITY REQUEST message on the uplink SHCCH.
- 1> set counter V310 to 1;
- 1> start timer T310.

8.2.8.3 PUSCH CAPACITY REQUEST message contents to set

With one PUSCH CAPACITY REQUEST message, capacity for one or more USCH can be requested. It shall include these information elements:

- 1> DSCH-RNTI to be used as UE identity if the message is sent on RACH;
- 1> Traffic volume measured results for each radio bearer satisfying the reporting criteria as specified in the MEASUREMENT CONTROL procedure (if no radio bearer satisfies the reporting criteria, traffic volume measured results shall not be included). These results shall include:
 - 2> Radio Bearer ID of the Radio Bearer being reported;
 - 2> RLC buffer payload for these radio bearers, as specified by the MEASUREMENT CONTROL procedure.

The UE shall:

- 1> if the initiation of the procedure is triggered by the IE "Traffic volume report request" in a previously received PHYSICAL SHARED CHANNEL ALLOCATION message:
 - 2> report the traffic volume measurement result for the radio bearer mapped on USCH transport channel specified in the received message. These results shall include:
 - 3> Radio Bearer ID of the Radio Bearer being reported;
 - 3> RLC buffer payload for this radio bearer.
- 1> if the initiation of the procedure is triggered by the IE "Confirm request" set to "Confirm PDSCH" in a previously received PHYSICAL SHARED CHANNEL ALLOCATION message and the IE "PUSCH capacity allocation info" is present in this message:
 - 2> set the CHOICE "Allocation confirmation" to "PDSCH Confirmation" with the value given in the IE "PDSCH Identity" stored in the variable PHYSICAL_SHARED_CHANNEL_CONFIGURATION.
- 1> if the initiation of the procedure is triggered by the IE "Confirm request" set to "Confirm PUSCH" in a previously received PHYSICAL SHARED CHANNEL ALLOCATION message:
 - 2> set the CHOICE "Allocation confirmation" to "PUSCH Confirmation" with the value given in the IE "PUSCH Identity" stored in the variable PHYSICAL_SHARED_CHANNEL_CONFIGURATION.
- 1> if the variable PROTOCOL_ERROR_REJECT is set to TRUE:
 - 2> include the IE "RRC transaction identifier" in the response message transmitted below; and
 - 2> set it to the value of "RRC transaction identifier" in the entry for the PHYSICAL SHARED CHANNEL ALLOCATION message in the table "Rejected transactions" in the variable TRANSACTIONS; and
 - 2> clear that entry;
 - 2> set the IE "protocol error indicator" to TRUE;
 - 2> include the IE "Protocol error information" with contents set to the value of the variable PROTOCOL_ERROR_INFORMATION.
- 1> if the value of the variable PROTOCOL_ERROR_REJECT is FALSE:
 - 2> set the IE "Protocol error indicator" to FALSE.

As an option, the message may include IE "Timeslot ISCP" and IE "Primary CCPCH RSCP".

The timeslots for which "Timeslot ISCP" may be reported shall have been configured with a previous PHYSICAL SHARED CHANNEL ALLOCATION message and stored in the variable PHYSICAL_SHARED_CHANNEL_CONFIGURATION.

"Primary CCPCH RSCP" is reported when requested with a previous PHYSICAL SHARED CHANNEL ALLOCATION message.

8.2.8.4 Reception of a PUSCH CAPACITY REQUEST message by the UTRAN

Upon receiving a PUSCH CAPACITY REQUEST message with traffic volume measurement included for at least one radio bearer, the UTRAN should initiate the PHYSICAL SHARED CHANNEL ALLOCATION procedure, either for allocating PUSCH or PDSCH resources as required, or just as an acknowledgement, indicating a pending PUSCH allocation, as described in subclause 8.2.7.

8.2.8.5 T310 expiry

Upon expiry of timer T310, the UE shall:

- 1> if V310 is smaller than N310:
 - 2> transmit a new PUSCH CAPACITY REQUEST message on the Uplink SHCCH;
 - 2> restart timer T310;
 - 2> increment counter V310;
 - 2> set the IEs in the PUSCH CAPACITY REQUEST message as specified in subclause 8.2.8.3.
- 1> if V310 is greater than or equal to N310:
 - 2> the procedure ends.

8.2.9 Void

8.2.10 Uplink Physical Channel Control [TDD only]

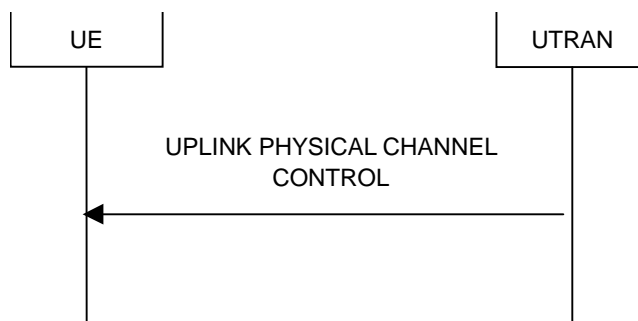

Figure 8.2.10-1: Uplink Physical Channel Control

8.2.10.1 General

The uplink physical channel control procedure is used in TDD to control the uplink outer loop power control and timing advance running in the UE.

8.2.10.2 Initiation

The UTRAN initiates the procedure by transmitting the UPLINK PHYSICAL CHANNEL CONTROL message on the downlink DCCH using AM or UM RLC in order to update parameters for uplink open loop power control in the UE for one CCTrCH or to inform the UE about a new timing advance value to be applied. Especially, uplink interference information measured by the UTRAN can be included for the uplink timeslots used for the CCTrCH.

8.2.10.3 Reception of UPLINK PHYSICAL CHANNEL CONTROL message by the UE

Upon reception of the UPLINK PHYSICAL CHANNEL CONTROL message, the UE shall:

- 1> act upon all received information elements as specified in subclause 8.6.

In 1.28 Mcps TDD, if the IE "Uplink DPCH Power Control Info" is transmitted, this information shall be taken into account by the UE for uplink open loop power control as specified in subclause 8.5.7 and for uplink closed loop power control.

In 3.84 Mcps TDD, if the IEs "Uplink DPCH Power Control Info", "PRACH Constant Value", "PUSCH Constant Value", "Alpha" or IE group "list of UL Timeslot Interference" are transmitted, this information shall be taken into account by the UE for uplink open loop power control as specified in subclause 8.5.7. If the UE is capable of using IPDLs for UE positioning, the IE "IPDL-Alpha" shall be used instead of the IE "Alpha". If the IE "IPDL-Alpha" parameter is not present, the UE shall use IE "Alpha".

If the IE Special Burst Scheduling is transmitted the UE shall:

- 1> use the new value for the "Special Burst Generation Period".

The UE shall:

- 1> clear the entry for the UPLINK PHYSICAL CHANNEL CONTROL message in the table "Accepted transactions" in the variable TRANSACTIONS;
- 1> and the procedure ends.

8.2.10.4 Invalid UPLINK PHYSICAL CHANNEL CONTROL message

If the UE receives a UPLINK PHYSICAL CHANNEL CONTROL message, which contains a protocol error causing the variable `PROTOCOL_ERROR_REJECT` to be set to `TRUE` according to clause 9, the UE shall perform procedure specific error handling as follows. The UE shall:

- 1> transmit an RRC STATUS message on the uplink DCCH using AM RLC, setting the information elements as specified below:
 - 2> include the IE "Identification of received message"; and
 - 2> set the IE "Received message type" to UPLINK PHYSICAL CHANNEL CONTROL; and
 - 2> set the IE "RRC transaction identifier" to the value of "RRC transaction identifier" in the entry for the UPLINK PHYSICAL CHANNEL CONTROL message in the table "Rejected transactions" in the variable TRANSACTIONS; and
 - 2> clear that entry;
 - 2> include the IE "Protocol error information" with contents set to the value of the variable `PROTOCOL_ERROR_INFORMATION`.
- 1> when the RRC STATUS message has been submitted to lower layers for transmission:
 - 2> continue with any ongoing processes and procedures as if the invalid UPLINK PHYSICAL CHANNEL CONTROL message has not been received.

8.2.11 Physical channel reconfiguration failure

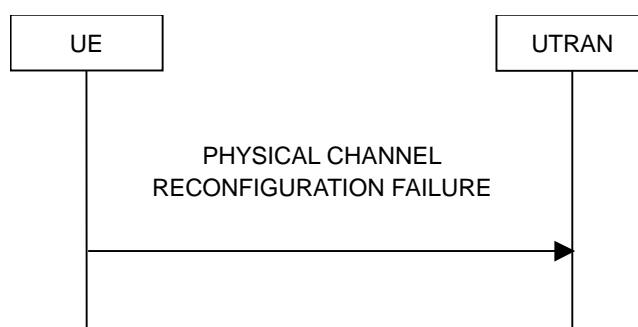

Figure 8.2.11-1: Physical channel reconfiguration failure in case of runtime configuration error

8.2.11.1 General

The physical channel reconfiguration failure procedure is used to indicate to the network a runtime configuration error in the UE.

8.2.11.2 Runtime error due to overlapping compressed mode configurations

When the UE has received from the UTRAN the configurations of several compressed mode transmission gap pattern sequences, and if several of these patterns are to be simultaneously active, the UE shall check to see if these simultaneously active transmission gap pattern sequences create transmission gaps in the same frame. An illegal overlap is created if two or more transmission gap pattern sequences create transmission gaps in the same frame, irrespective of the gaps are created in uplink or downlink.

If the parallel transmission gap pattern sequences create an illegal overlap, the UE shall:

- 1> delete the overlapping transmission gap pattern sequence configuration stored in the variable TGPS_IDENTITY, which is associated with the highest value of IE "TGPSI";
- 1> transmit a PHYSICAL CHANNEL RECONFIGURATION FAILURE message on the DCCH using AM RLC, setting the information elements as specified below:
 - 2> not include the IE "RRC transaction identifier";
 - 2> set the cause value in IE "failure cause" to value "compressed mode runtime error".
- 1> terminate the inter-frequency and/or inter-RAT measurements corresponding to the deleted transmission gap pattern sequence;
- 1> when the PHYSICAL CHANNEL RECONFIGURATION FAILURE message has been submitted to lower layers for transmission:
 - 2> the procedure ends.

8.2.11.3 Runtime error due to overlapping compressed mode configuration and PDSCH reception

If UE is scheduled to receive a PDSCH frame at the same time instant as a compressed mode gap, UE shall perform the measurements according to the measurement purpose of the pattern sequence.

8.3 RRC connection mobility procedures

8.3.1 Cell and URA update procedures

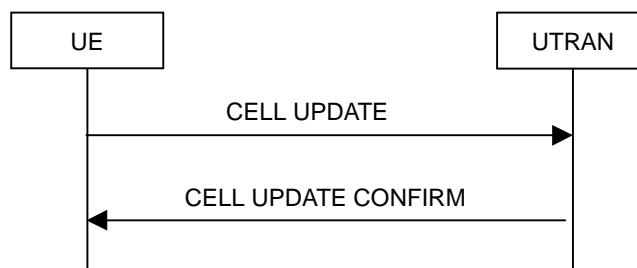

Figure 8.3.1-1: Cell update procedure, basic flow

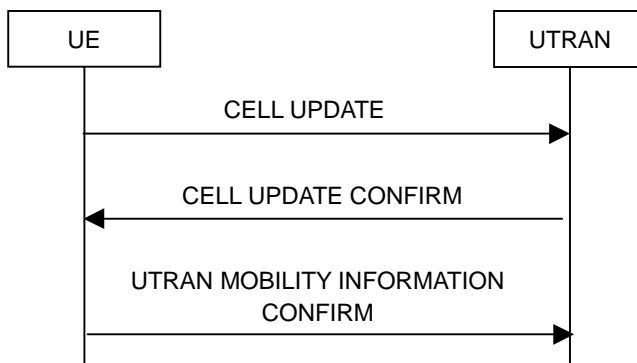

Figure 8.3.1-2: Cell update procedure with update of UTRAN mobility information

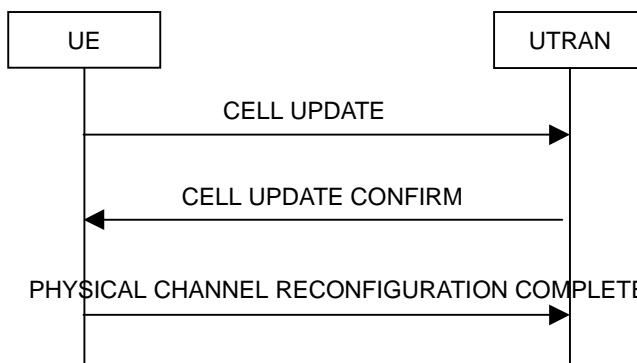

Figure 8.3.1-3: Cell update procedure with physical channel reconfiguration

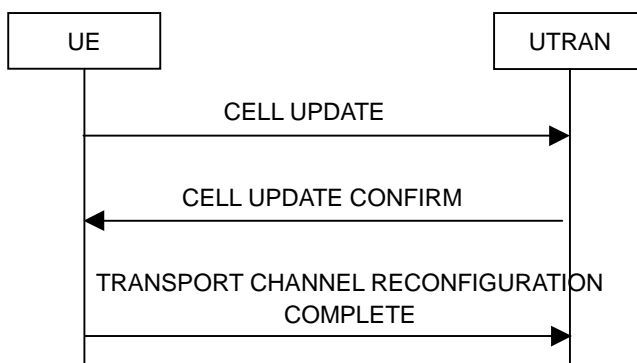

Figure 8.3.1-4: Cell update procedure with transport channel reconfiguration

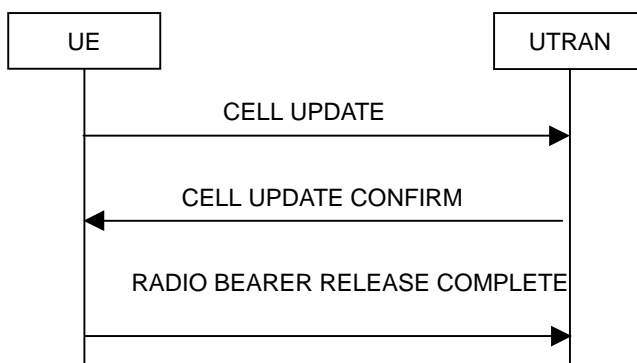

Figure 8.3.1-5: Cell update procedure with radio bearer release

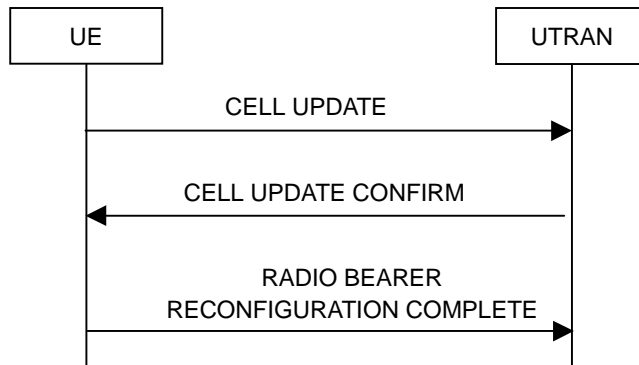

Figure 8.3.1-6: Cell update procedure with radio bearer reconfiguration

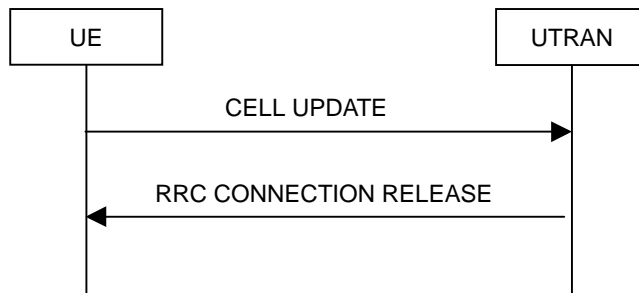

Figure 8.3.1-7: Cell update procedure, failure case

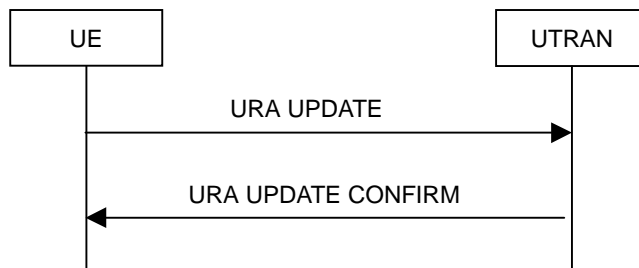

Figure 8.3.1-8: URA update procedure, basic flow

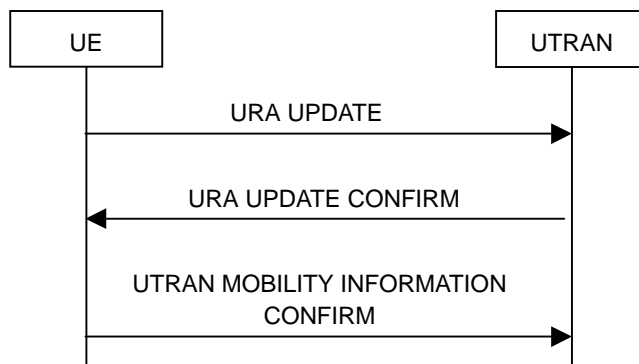

Figure 8.3.1-9: URA update procedure with update of UTRAN mobility information

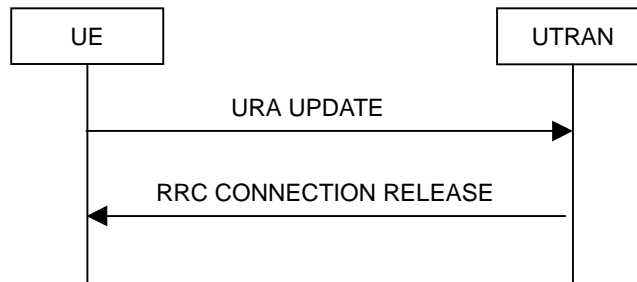

Figure 8.3.1-10: URA update procedure, failure case

8.3.1.1 General

The URA update and cell update procedures serve several main purposes:

- to notify UTRAN after re-entering service area in the URA_PCH or CELL_PCH state;
- to notify UTRAN of an RLC unrecoverable error [16] on an AM RLC entity;
- to be used as a supervision mechanism in the CELL_FACH, CELL_PCH, or URA_PCH state by means of periodical update.

In addition, the URA update procedure also serves the following purpose:

- to retrieve a new URA identity after cell re-selection to a cell not belonging to the current URA assigned to the UE in URA_PCH state.

In addition, the cell update procedure also serves the following purposes:

- to update UTRAN with the current cell the UE is camping on after cell reselection;
- to act on a radio link failure in the CELL_DCH state;
- to act on the transmission failure of the UE CAPABILITY INFORMATION message;
- when triggered in the URA_PCH or CELL_PCH state, to notify UTRAN of a transition to the CELL_FACH state due to the reception of UTRAN originated paging or due to a request to transmit uplink data.

The URA update and cell update procedures may:

- 1> include an update of mobility related information in the UE;
- 1> cause a state transition from the CELL_FACH state to the CELL_DCH, CELL_PCH or URA_PCH states or idle mode.

The cell update procedure may also include:

- a re-establish of AM RLC entities;
- a radio bearer release, radio bearer reconfiguration, transport channel reconfiguration or physical channel reconfiguration.

8.3.1.2 Initiation

A UE shall initiate the cell update procedure in the following cases:

- 1> Uplink data transmission:
 - 2> if the UE is in URA_PCH or CELL_PCH state; and
 - 2> if the UE has uplink RLC data PDU or uplink RLC control PDU on RB1 or upwards to transmit;
 - 3> perform cell update using the cause "uplink data transmission".

1> Paging response:

- 2> if the criteria for performing cell update with the cause specified above in the current subclause is not met; and
- 2> if the UE in URA_PCH or CELL_PCH state, receives a PAGING TYPE 1 message fulfilling the conditions for initiating a cell update procedure specified in subclause 8.1.2.3:
- 3> perform cell update using the cause "paging response".

1> Radio link failure:

- 2> if none of the criteria for performing cell update with the causes specified above in the current subclause is met:
- 3> if the UE is in CELL_DCH state and the criteria for radio link failure is met as specified in subclause 8.5.6; or
- 3> if the transmission of the UE CAPABILITY INFORMATION message fails as specified in subclause 8.1.6.6:
- 4> perform cell update using the cause "radio link failure".

1> Re-entering service area:

- 2> if none of the criteria for performing cell update with the causes specified above in the current subclause is met; and
- 2> if the UE is in CELL_FACH or CELL_PCH state; and
- 2> if the UE has been out of service area and re-enters service area before T307 or T317 expires:
- 3> perform cell update using the cause "re-entering service area".

1> RLC unrecoverable error:

- 2> if none of the criteria for performing cell update with the causes specified above in the current subclause is met; and
- 2> if the UE detects RLC unrecoverable error [16] in an AM RLC entity:
- 3> perform cell update using the cause "RLC unrecoverable error".

1> Cell reselection:

- 2> if none of the criteria for performing cell update with the causes specified above in the current subclause is met:
- 3> if the UE is in CELL_FACH or CELL_PCH state and the UE performs cell re-selection; or
- 3> if the UE is in CELL_FACH state and the variable C_RNTI is empty:
- 4> perform cell update using the cause "cell reselection".

1> Periodical cell update:

- 2> if none of the criteria for performing cell update with the causes specified above in the current subclause is met; and
- 2> if the UE is in CELL_FACH or CELL_PCH state; and
- 2> if the timer T305 expires; and
- 2> if the criteria for "in service area" as specified in subclause 8.5.5.2 is fulfilled; and
- 2> if periodic updating has been configured by T305 in the IE "UE Timers and constants in connected mode" set to any other value than "infinity":

3> perform cell update using the cause "periodical cell update".

A UE in URA_PCH state shall initiate the URA update procedure in the following cases:

1> URA reselection:

- 2> if the UE detects that the current URA assigned to the UE, stored in the variable URA_IDENTITY, is not present in the list of URA identities in system information block type 2; or
- 2> if the list of URA identities in system information block type 2 is empty; or
- 2> if the system information block type 2 can not be found:
 - 3> perform URA update using the cause "change of URA".

1> Periodic URA update:

- 2> if the criteria for performing URA update with the causes as specified above in the current subclause are not met; and
- 2> if the timer T305 expires while the UE is in the service area; and
- 2> if periodic updating has been configured by T305 in the IE "UE Timers and constants in connected mode" set to any other value than "infinity":
 - 3> perform URA update using the cause "periodic URA update".

When initiating the URA update or cell update procedure, the UE shall:

1> stop timer T305;

1> if the UE is in CELL_DCH state:

- 2> in the variable RB_TIMER_INDICATOR, set the IE "T314 expired" and the IE "T315 expired" to FALSE;
- 2> if the stored values of the timer T314 and timer T315 are both equal to zero; or
- 2> if the stored value of the timer T314 is equal to zero and there are no radio bearers associated with any radio access bearers for which in the variable ESTABLISHED_RABS the value of the IE "Re-establishment timer" is set to "useT315":
 - 3> release all its radio resources;
 - 3> indicate release (abort) of the established signalling connections (as stored in the variable ESTABLISHED_SIGNALLING_CONNECTIONS) and established radio access bearers (as stored in the variable ESTABLISHED_RABS) to upper layers;
 - 3> clear the variable ESTABLISHED_SIGNALLING_CONNECTIONS;
 - 3> clear the variable ESTABLISHED_RABS;
 - 3> enter idle mode;
 - 3> perform other actions when entering idle mode from connected mode as specified in subclause 8.5.2;
 - 3> and the procedure ends.
- 2> if the stored value of the timer T314 is equal to zero:
 - 3> release all radio bearers, associated with any radio access bearers for which in the variable ESTABLISHED_RABS the value of the IE "Re-establishment timer" is set to "useT314";
 - 3> in the variable RB_TIMER_INDICATOR set the IE "T314 expired" to TRUE.
- 2> if the stored value of the timer T315 is equal to zero:
 - 3> release all radio bearers associated with any radio access bearers for which in the variable ESTABLISHED_RABS the value of the IE "Re-establishment timer" is set to "useT315";

- 3> in the variable RB_TIMER_INDICATOR set the IE "T315 expired" to TRUE.
- 2> if the stored value of the timer T314 is greater than zero:
 - 3> if there are radio bearers associated with any radio access bearers for which in the variable ESTABLISHED_RABS the value of the IE "Re-establishment timer" is set to "useT314":
 - 4> start timer T314.
 - 3> if there are no radio bearers associated with any radio access bearers for which in the variable ESTABLISHED_RABS the value of the IE "Re-establishment timer" is set to "useT314" or "useT315":
 - 4> start timer T314.
- 2> if the stored value of the timer T315 is greater than zero:
 - 3> if there are radio bearers associated with any radio access bearers for which in the variable ESTABLISHED_RABS the value of the IE "Re-establishment timer" is set to "useT315":
 - 4> start timer T315.
- 2> for the released radio bearer(s):
 - 3> delete the information about the radio bearer from the variable ESTABLISHED_RABS;
 - 3> when all radio bearers belonging to the same radio access bearer have been released:
 - 4> indicate local end release of the radio access bearer to upper layers using the CN domain identity together with the RAB identity stored in the variable ESTABLISHED_RABS;
 - 4> delete all information about the radio access bearer from the variable ESTABLISHED_RABS.
- 2> select a suitable UTRA cell according to [4];
- 2> set the variable ORDERED_RECONFIGURATION to FALSE.
- 1> set the variables PROTOCOL_ERROR_INDICATOR, FAILURE_INDICATOR, UNSUPPORTED_CONFIGURATION and INVALID_CONFIGURATION to FALSE;
- 1> set the variable CELL_UPDATE_STARTED to TRUE;
- 1> if the UE is not already in CELL_FACH state:
 - 2> move to CELL_FACH state;
 - 2> select PRACH according to subclause 8.5.17;
 - 2> select Secondary CCPCH according to subclause 8.5.19;
 - 2> use the transport format set given in system information as specified in subclause 8.6.5.1.
- 1> if the UE performs cell re-selection:
 - 2> clear the variable C_RNTI; and
 - 2> stop using that C_RNTI just cleared from the variable C_RNTI in MAC.
- 1> set CFN in relation to SFN of current cell according to subclause 8.5.15;
- 1> in case of a cell update procedure:
 - 2> set the contents of the CELL UPDATE message according to subclause 8.3.1.3;
 - 2> submit the CELL UPDATE message for transmission on the uplink CCCH.
- 1> in case of a URA update procedure:
 - 2> set the contents of the URA UPDATE message according to subclause 8.3.1.3;

- 2> submit the URA UPDATE message for transmission on the uplink CCCH.
- 1> set counter V302 to 1;
- 1> start timer T302 when the MAC layer indicates success or failure in transmitting the message.

8.3.1.3 CELL UPDATE / URA UPDATE message contents to set

In case of cell update procedure the UE shall transmit a CELL UPDATE message.

In case of URA update procedure the UE shall transmit a URA UPDATE message.

The UE shall set the IEs in the CELL UPDATE message as follows:

- 1> set the IE "Cell update cause" corresponding to the cause specified in subclause 8.3.1.2 that is valid when the CELL UPDATE message is submitted to lower layers for transmission;

NOTE: During the time period starting from when a cell update procedure is initiated by the UE until when the procedure ends, additional CELL UPDATE messages may be transmitted by the UE with different causes.

- 1> set the IE "U-RNTI" to the value of the variable U_RNTI;
- 1> if the value of the variable PROTOCOL_ERROR_INDICATOR is TRUE:
 - 2> include the IE "RRC transaction identifier"; and
 - 3> set it to the value of "RRC transaction identifier" in the entry for the CELL UPDATE CONFIRM message in the table "Rejected transactions" in the variable TRANSACTIONS.
 - 2> include and set the IE "failure cause" to the cause value "protocol error";
 - 2> set the IE "Protocol error information" set to the value of the variable PROTOCOL_ERROR_INFORMATION.
- 1> if the value of the variable FAILURE_INDICATOR is TRUE:
 - 2> include the IE "RRC transaction identifier"; and
 - 3> set it to the value of "RRC transaction identifier" in the entry for the CELL UPDATE CONFIRM message in the table "Accepted transactions" in the variable TRANSACTIONS.
 - 2> include and set the IE "failure cause" to the value of the variable FAILURE_CAUSE.
- 1> include the START values for each CN domain, calculated according to subclause 8.5.9;
- 1> if an unrecoverable error [16] in any of the AM RLC entities for the signalling radio bearers RB2, RB3 or RB4 is detected:
 - 2> set the IE "AM_RLC error indication (RB2, RB3 or RB4)" to TRUE.
- 1> otherwise:
 - 2> set the IE "AM_RLC error indication (RB2, RB3 or RB4)" to FALSE.
- 1> if an unrecoverable error [16] in any of the AM RLC entities for the RB5 or upward is detected:
 - 2> set the IE "AM_RLC error indication (RB>4)" to TRUE.
- 1> otherwise:
 - 2> set the IE "AM_RLC error indication (RB>4)" to FALSE.
- 1> set the IE "RB Timer indicator" to the value of the variable RB_TIMER_INDICATOR;
- 1> include an intra-frequency measurement report in the IE "Measured results on RACH", as specified in the IE "Intra-frequency reporting quantity for RACH reporting" and the IE "Maximum number of reported cells on

RACH" in system information block type 12 (or System Information Block type 11, if System Information Block type 12 is not being broadcast); and

- 1> include in the IE "Measured results on RACH" all requested reporting quantities for all included measurement objects; and
- 1> take care that the maximum allowed message size is not exceeded when forming the IE "Measured results on RACH".

The UE shall set the IEs in the URA UPDATE message as follows:

- 1> set the IE "U-RNTI" to the value of the variable U_RNTI;
- 1> set the IE "URA update cause" corresponding to which cause as specified in subclause 8.3.1.2 that is valid when the URA UPDATE message is submitted to lower layers for transmission;

NOTE: During the time period starting from when a URA update procedure is initiated by the UE until when the procedure ends, additional URA UPDATE messages may be transmitted by the UE with different causes, depending on which causes are valid for the respective URA UPDATE message.

- 2> if the value of the variable `PROTOCOL_ERROR_INDICATOR` is TRUE:
 - 3> include the IE "RRC transaction identifier"; and
 - 4> set it to the value of "RRC transaction identifier" in the entry for the URA UPDATE CONFIRM message in the table "Rejected transactions" in the variable `TRANSACTIONS`;
 - 3> set the IE "Protocol error indicator" to TRUE;
 - 3> include the IE "Protocol error information" set to the value of the variable `PROTOCOL_ERROR_INFORMATION`.
- 2> if the value of the variable `PROTOCOL_ERROR_INDICATOR` is FALSE:
 - 3> if the value of the variable `INVALID_CONFIGURATION` is TRUE:
 - 4> include the IE "RRC transaction identifier"; and
 - 4> set it to the value of "RRC transaction identifier" in the entry for the URA UPDATE CONFIRM message in the table "Accepted transactions" in the variable `TRANSACTIONS`;
 - 4> set the IE "Protocol error indicator" to TRUE;
 - 4> include the IE "Protocol error information" set to "Information element value not comprehended";
 - 3> if the value of the variable `INVALID_CONFIGURATION` is FALSE:
 - 4> set the IE "Protocol error indicator" to FALSE.

8.3.1.4 T305 expiry and the UE detects "out of service area"

When the T305 expires and the UE detects that it is "out of service area" as specified in subclause 8.5.5.1, the UE shall

- 1> start timer T307;
- 1> re-select to a new cell, as described in [4].

8.3.1.4.1 Re-entering "in service area"

If the UE detects "in service area" according to subclause 8.5.5.2 and timer T307 or T317 is running, the UE shall:

- 1> check the value of V302; and
- 1> if V302 is equal to or smaller than N302:
 - 2> in case of a cell update procedure:

- 3> set the contents of the CELL UPDATE message according to subclause 8.3.1.3;
- 3> submit the CELL UPDATE message for transmission on the uplink CCCH.
- 2> in case of a URA update procedure:
 - 3> set the contents of the URA UPDATE message according to subclause 8.3.1.3;
 - 3> submit the URA UPDATE message for transmission on the uplink CCCH.
- 2> increment counter V302;
- 2> restart timer T302 when the MAC layer indicates success or failure to transmit the message.
- 1> if V302 is greater than N302:
 - 2> clear the variable RB_UPLINK_CIPHERING_ACTIVATION_TIME_INFO;
 - 2> clear the variable INTEGRITY_PROTECTION_ACTIVATION_INFO;
 - 2> in case of a cell update procedure:
 - 3> clear the entry for the CELL UPDATE CONFIRM message in the table "Rejected transactions" in the variable TRANSACTIONS.
 - 2> in case of a URA update procedure:
 - 3> clear the entry for the URA UPDATE CONFIRM message in the table "Rejected transactions" in the variable TRANSACTIONS.
 - 2> release all its radio resources;
 - 2> indicate release (abort) of the established signalling connections (as stored in the variable ESTABLISHED_SIGNALLING_CONNECTIONS) and established radio access bearers (as stored in the variable ESTABLISHED_RABS) to upper layers;
 - 2> clear the variable ESTABLISHED_SIGNALLING_CONNECTIONS;
 - 2> clear the variable ESTABLISHED_RABS;
 - 2> enter idle mode;
 - 2> perform other actions when entering idle mode from connected mode as specified in subclause 8.5.2;
 - 2> and the procedure ends.

8.3.1.4.2 Expiry of timer T307

When the T307 expires, the UE shall:

- 1> move to idle mode;
- 1> release all dedicated resources;
- 1> indicate release (abort) of the established signalling connections (as stored in the variable ESTABLISHED_SIGNALLING_CONNECTIONS) and established radio access bearers (as stored in the variable ESTABLISHED_RABS) to upper layers;
- 1> clear the variable ESTABLISHED_SIGNALLING_CONNECTIONS;
- 1> clear the variable ESTABLISHED_RABS;
- 1> perform other actions when entering idle mode from connected mode as specified in subclause 8.5.2;
- 1> and the procedure ends.

8.3.1.5 Reception of an CELL UPDATE/URA UPDATE message by the UTRAN

When the UTRAN receives a CELL UPDATE/URA UPDATE message, the UTRAN should:

- 1> in case the procedure was triggered by reception of a CELL UPDATE:
 - 2> if SRNS relocation was performed:
 - 3> transmit a CELL UPDATE CONFIRM message on the downlink DCCH.
 - 2> otherwise:
 - 3> update the START value for each CN domain as maintained in UTRAN (refer to subclause 8.5.9) with "START" in the IE "START list" for the CN domain as indicated by "CN domain identity" in the IE "START list";
 - 3> transmit a CELL UPDATE CONFIRM message on the downlink DCCH or optionally on the CCCH but only if ciphering is not required; and
 - 3> optionally set the IE "RLC re-establish indicator (RB2, RB3 and RB4)" and/or the IE "RLC re-establish indicator (RB5 and upwards)" to TRUE to request a RLC re-establishment in the UE, in which case the corresponding RLC entities should also be re-established in UTRAN; or
- 1> in case the procedure was triggered by reception of a URA UPDATE:
 - 2> if SRNS relocation was performed:
 - 3> transmit a URA UPDATE CONFIRM message on the downlink DCCH.
 - 2> otherwise:
 - 3> transmit a URA UPDATE CONFIRM message on the downlink CCCH or DCCH.
 - 2> include the IE "URA identity" in the URA UPDATE CONFIRM message in a cell where multiple URA identifiers are broadcast; or
- 1> initiate an RRC connection release procedure (see subclause 8.1.4) by transmitting an RRC CONNECTION RELEASE message on the downlink CCCH. In particular UTRAN should:
 - 2> if the CELL UPDATE message was sent because of an unrecoverable error in RB2, RB3 or RB4:
 - 3> initiate an RRC connection release procedure (subclause 8.1.4) by transmitting an RRC CONNECTION RELEASE message on the downlink CCCH.

UTRAN may transmit several CELL UPDATE CONFIRM/URA UPDATE CONFIRM messages to increase the probability of proper reception of the message by the UE. In such a case, the RRC SN for these repeated messages should be the same.

8.3.1.6 Reception of the CELL UPDATE CONFIRM/URA UPDATE CONFIRM message by the UE

When the UE receives a CELL UPDATE CONFIRM/URA UPDATE CONFIRM message; and

- if the message is received on the CCCH, and IE "U-RNTI" is present and has the same value as the variable U_RNTI; or
- if the message is received on DCCH:

the UE may:

- 1> maintain a list of the set of cells to which the UE has Radio Links if the IE "Cell ID" is present.

the UE shall:

- 1> stop timer T302;

- 1> in case of a cell update procedure and the CELL UPDATE CONFIRM message:
 - 2> includes "RB information elements"; and/or
 - 2> includes "Transport channel information elements"; and/or
 - 2> includes "Physical channel information elements"; and
 - 2> if the variable ORDERED_RECONFIGURATION is set to FALSE:
 - 3> set the variable ORDERED_RECONFIGURATION to TRUE.
- 1> act upon all received information elements as specified in subclause 8.6, unless specified otherwise in the following:
 - 2> if the IE "Frequency info" is included in the message:
 - 3> if the IE "RRC State Indicator" is set to the value "CELL_FACH" or "CELL_PCH" or "URA_PCH":
 - 4> select a suitable UTRA cell according to [4] on that frequency;
 - 4> act as specified in subclause 8.3.1.12.
 - 3> if the IE "RRC State Indicator" is set to the value "CELL_DCH":
 - 4> act on the IE "Frequency info" as specified in subclause 8.6.6.1.
 - 2> use the transport channel(s) applicable for the physical channel types that is used; and
 - 2> if the IE "TFS" is neither included nor previously stored in the UE for that transport channel(s):
 - 3> use the TFS given in system information.
 - 2> if none of the TFS stored is compatible with the physical channel:
 - 3> delete the stored TFS;
 - 3> use the TFS given in system information.
 - 2> if the IE "RLC re-establish indicator (RB2, RB3 and RB4)" in the CELL UPDATE CONFIRM message is set to TRUE:
 - 3> re-establish the RLC entities for signalling radio bearer RB2, signalling radio bearer RB3 and signalling radio bearer RB4 (if established);
 - 3> if the value of the IE "Status" in the variable CIPHERING_STATUS of the CN domain stored in the variable LATEST_CONFIGURED_CN_DOMAIN is set to "Started":
 - 4> set the HFN component of the respective COUNT-C values for AM RLC entities with RB identity 2, RB identity 3 and RB identity 4 (if established) equal to the START value included in the latest transmitted CELL UPDATE message for the CN domain stored in the variable LATEST_CONFIGURED_CN_DOMAIN.
 - 2> if the IE "RLC re-establish indicator (RB5 and upwards)" in the CELL UPDATE CONFIRM message is set to TRUE:
 - 3> for radio bearers with RB identity 5 and upwards:
 - 4> re-establish the AM RLC entities;
 - 4> if the value of the IE "Status" in the variable CIPHERING_STATUS of the CN domain as indicated in the IE "CN domain identity" in the IE "RAB info" in the variable ESTABLISHED_RABS is set to "Started":
 - 5> set the HFN component of the respective COUNT-C values for AM RLC entities equal to the START value included in this CELL UPDATE message for the CN domain as indicated in the IE "CN domain identity" in the IE "RAB info" in the variable ESTABLISHED_RABS.

- 1> if the CELL UPDATE CONFIRM / URA UPDATE CONFIRM message contained the IE "Ciphering mode info" or contained the IE "Integrity protection mode info":
 - 2> set the IE "Status" in the variable SECURITY_MODIFICATION for all the CN domains in the variable SECURITY_MODIFICATION to "Affected".
- 1> enter a state according to subclause 8.6.3.3 applied on the CELL UPDATE CONFIRM / URA UPDATE CONFIRM message.

If the UE after state transition enters CELL_DCH state, it shall:

- 1> perform the physical layer synchronisation procedure A as specified in [29] (FDD only);
- 1> not prohibit periodical status transmission in RLC.

If the UE after state transition remains in CELL_FACH state, it shall

- 1> start the timer T305 using its initial value if timer T305 is not running and periodical cell update has been configured by T305 in the IE "UE Timers and constants in connected mode" set to any other value than "infinity";
 - 1> select PRACH according to subclause 8.5.17;
 - 1> select Secondary CCPCH according to subclause 8.5.19;
 - 1> not prohibit periodical status transmission in RLC;
 - 1> if the IE "UTRAN DRX cycle length coefficient" is included in the same message:
 - 2> ignore that IE and stop using DRX.

If the UE after state transition enters URA_PCH or CELL_PCH state, it shall:

- 1> prohibit periodical status transmission in RLC;
- 1> clear the variable C_RNTI;
- 1> stop using that C_RNTI just cleared from the variable C_RNTI in MAC;
- 1> start the timer T305 using its initial value if timer T305 is not running and periodical update has been configured by T305 in the IE "UE Timers and constants in connected mode" set to any other value than "infinity";
 - 1> select Secondary CCPCH according to subclause 8.5.19;
 - 1> if the IE "UTRAN DRX cycle length coefficient" is included in the same message:
 - 2> use the value in the IE "UTRAN DRX Cycle length coefficient" for calculating Paging Occasion and PICH Monitoring Occasion as specified in subclause 8.6.3.2.
 - 1> if the IE "UTRAN DRX cycle length coefficient" is not included in the same message:
 - 2> set the variable INVALID_CONFIGURATION to TRUE.

If the UE after the state transition remains in CELL_FACH state; and

- 1> the contents of the variable C_RNTI are empty:

it shall check the value of V302; and:

- 1> if V302 is equal to or smaller than N302:
 - 2> if, caused by the received CELL UPDATE CONFIRM or URA UPDATE CONFIRM message:
 - 3> the IE "Reconfiguration" in the variable CIPHERING_STATUS is set to TRUE; and/or
 - 3> the IE "Reconfiguration" in the variable INTEGRITY_PROTECTION_INFO is set to TRUE:
 - 4> abort the ongoing integrity and/or ciphering reconfiguration;

- 4> if the received CELL UPDATE CONFIRM or URA UPDATE CONFIRM message contained the IE "Ciphering mode info":
 - 5> set the IE "Reconfiguration" in the variable CIPHERING_STATUS to FALSE; and
 - 5> clear the variable RB_UPLINK_CIPHERING_ACTIVATION_TIME_INFO.
- 4> if the received CELL UPDATE CONFIRM or URA UPDATE CONFIRM message contained the IE "Integrity protection mode info":
 - 5> set the IE "Reconfiguration" in the variable INTEGRITY_PROTECTION_INFO to FALSE; and
 - 5> clear the variable INTEGRITY_PROTECTION_ACTIVATION_INFO.
- 2> in case of a URA update procedure:
 - 3> stop the URA update procedure;
 - 3> clear any entry for the URA UPDATE CONFIRM message in the table "Accepted transactions" in the variable TRANSACTIONS; and
 - 3> continue with a cell update procedure.
- 2> set the contents of the CELL UPDATE message according to subclause 8.3.1.3, except for the IE "Cell update cause" which shall be set to "cell reselection";
- 2> submit the CELL UPDATE message for transmission on the uplink CCCH;
- 2> increment counter V302;
- 2> restart timer T302 when the MAC layer indicates success or failure to transmit the message.
- 1> if V302 is greater than N302:
 - 2> clear the variable RB_UPLINK_CIPHERING_ACTIVATION_TIME_INFO;
 - 2> clear the variable INTEGRITY_PROTECTION_ACTIVATION_INFO;
 - 2> in case of a cell update procedure:
 - 3> clear the entry for the CELL UPDATE CONFIRM message in the table "Rejected transactions" in the variable TRANSACTIONS.
 - 2> in case of a URA update procedure:
 - 3> clear the entry for the URA UPDATE CONFIRM message in the table "Rejected transactions" in the variable TRANSACTIONS.
 - 2> release all its radio resources;
 - 2> indicate release (abort) of the established signalling connections (as stored in the variable ESTABLISHED_SIGNALLING_CONNECTIONS) and established radio access bearers (as stored in the variable ESTABLISHED_RABS) to upper layers;
 - 2> clear the variable ESTABLISHED_SIGNALLING_CONNECTIONS;
 - 2> clear the variable ESTABLISHED_RABS;
 - 2> enter idle mode;
 - 2> other actions the UE shall perform when entering idle mode from connected mode are specified in subclause 8.5.2;
 - 2> and the procedure ends.

If the UE after the state transition remains in CELL_FACH state; and

- a C-RNTI is stored in the variable C_RNTI;

or

- the UE after the state transition moves to another state than the CELL_FACH state:

the UE shall:

- 1> if the CELL UPDATE CONFIRM / URA UPDATE CONFIRM message contained the IE "Ciphering mode info":
 - 2> include and set the IE "Radio bearer uplink ciphering activation time info" in any response message transmitted below to the value of the variable RB_UPLINK_CIPHERING_ACTIVATION_TIME_INFO.
- 1> in case cell reselection interrupted an ongoing cell update procedure and a CELL UPDATE CONFIRM/URA UPDATE CONFIRM was received with the IE "Downlink counter synchronisation info" present and the response to which was not submitted to the lower layers due to the cell re-selection:
 - 2> include the IE "START list" in the response message transmitted according to subclause 8.3.1.7;
 - 2> if the CELL UPDATE CONFIRM/URA UPDATE CONFIRM, the response to which was not delivered to the lower layers, due to the cell re-selection, included the IE "RB with PDCP information list":
 - 3> include the IE "RB with PDCP information list" in the response message transmitted according to subclause 8.3.1.7.
- 1> in case of a cell update procedure:
 - 2> set the IE "RRC transaction identifier" in any response message transmitted below to the value of "RRC transaction identifier" in the entry for the CELL UPDATE CONFIRM message in the table "Accepted transactions" in the variable TRANSACTIONS; and
 - 2> clear that entry.
- 1> in case of a URA update procedure:
 - 2> set the IE "RRC transaction identifier" in any response message transmitted below to the value of "RRC transaction identifier" in the entry for the URA UPDATE CONFIRM message in the table "Accepted transactions" in the variable TRANSACTIONS; and
 - 2> clear that entry;
- 1> if the variable PDCP_SN_INFO is non-empty:
 - 2> include the IE "RB with PDCP information list" in any response message transmitted below and set it to the value of the variable PDCP_SN_INFO.
- 1> if the received CELL UPDATE CONFIRM or URA UPDATE CONFIRM message included the IE "Downlink counter synchronisation info":
 - 2> re-establish RB2;
 - 2> set the new uplink and downlink HFN component of the COUNT-C of RB2 to MAX(uplink HFN component of the COUNT-C of RB2, downlink HFN component of the COUNT-C of RB2);
 - 2> increment by one the downlink and uplink values of the HFN component of the COUNT-C for RB2;
 - 2> calculate the START value according to subclause 8.5.9;
 - 2> include the calculated START values for each CN domain in the IE "START list" in the IE "Uplink counter synchronisation info" in any response message transmitted below.
- 1> transmit a response message as specified in subclause 8.3.1.7;
- 1> if the IE "Integrity protection mode info" was present in the CELL UPDATE CONFIRM or URA UPDATE CONFIRM message:
 - 2> start applying the new integrity protection configuration in the uplink for signalling radio bearer RB2 from and including the transmitted response message.

- 1> if the variable ORDERED_RECONFIGURATION is set to TRUE caused by the received CELL UPDATE CONFIRM message in case of a cell update procedure:
 - 2> set the variable ORDERED_RECONFIGURATION to FALSE.
- 1> clear the variable PDCP_SN_INFO;
- 1> when the response message transmitted per subclause 8.3.1.7 to the UTRAN has been confirmed by RLC:
 - 2> if the CELL UPDATE CONFIRM / URA UPDATE CONFIRM message contained the IE "Ciphering mode info":
 - 3> resume data transmission on any suspended radio bearer and signalling radio bearer mapped on RLC-AM or RLC-UM;
 - 3> set the IE "Reconfiguration" in the variable CIPHERING_STATUS to FALSE; and
 - 3> clear the variable RB_UPLINK_CIPHERING_ACTIVATION_TIME_INFO.
 - 2> if the CELL UPDATE CONFIRM / URA UPDATE CONFIRM message contained the IE "Integrity protection mode info":
 - 3> set "Uplink RRC Message sequence number" for signalling radio bearer RB0 in the variable INTEGRITY_PROTECTION_INFO to a value such that next RRC message to be sent on uplink RB0 will use the new integrity protection configuration;
 - 3> allow the transmission of RRC messages on all signalling radio bearers with any RRC SN;
 - 3> set the IE "Reconfiguration" in the variable INTEGRITY_PROTECTION_INFO to FALSE.
 - 2> clear the variable INTEGRITY_PROTECTION_ACTIVATION_INFO.
- 1> in case of a cell update procedure:
 - 2> clear the entry for the CELL UPDATE CONFIRM message in the table "Rejected transactions" in the variable TRANSACTIONS.
- 1> in case of a URA update procedure:
 - 2> clear the entry for the URA UPDATE CONFIRM message in the table "Rejected transactions" in the variable TRANSACTIONS.
- 1> set the variable CELL_UPDATE_STARTED to FALSE;
- 1> clear the variable SECURITY_MODIFICATION.

The procedure ends.

8.3.1.7 Transmission of a response message to UTRAN

If the CELL UPDATE CONFIRM message:

- includes the IE "RB information to release list":

the UE shall:

- 1> transmit a RADIO BEARER RELEASE COMPLETE as response message using AM RLC.

If the CELL UPDATE CONFIRM message:

- does not include the IE "RB information to release list"; and
- includes the IE "RB information to reconfigure list"; or
- includes the IE "RB information to be affected list":

the UE shall:

1> transmit a RADIO BEARER RECONFIGURATION COMPLETE as response message using AM RLC.

If the CELL UPDATE CONFIRM message:

- does not include "RB information elements"; and
- includes "Transport channel information elements":

the UE shall:

1> transmit a TRANSPORT CHANNEL RECONFIGURATION COMPLETE as response message using AM RLC.

If the CELL UPDATE CONFIRM message:

- does not include "RB information elements"; and
- does not include "Transport channel information elements"; and
- includes "Physical channel information elements":

the UE shall:

1> transmit a PHYSICAL CHANNEL RECONFIGURATION COMPLETE as response message using AM RLC.

If the CELL UPDATE CONFIRM message:

- does not include "RB information elements"; and
- does not include "Transport channel information elements"; and
- does not include "Physical channel information elements"; and
- includes "CN information elements"; or
- includes the IE "Ciphering mode info"; or
- includes the IE "Integrity protection mode info"; or
- includes the IE "New C-RNTI"; or
- includes the IE "New U-RNTI":

the UE shall:

1> transmit a UTRAN MOBILITY INFORMATION CONFIRM as response message using AM RLC.

If the CELL UPDATE CONFIRM message:

- does not include "RB information elements"; and
- does not include "Transport channel information elements"; and
- does not include "Physical channel information elements"; and
- does not include "CN information elements"; and
- does not include the IE "Ciphering mode info"; and
- does not include the IE "Integrity protection mode info"; and
- does not include the IE "New C-RNTI"; and
- does not include the IE "New U-RNTI":

the UE shall:

1> transmit no response message.

If the URA UPDATE CONFIRM message:

- includes "CN information elements"; or
- includes the IE "Ciphering mode info"; or
- includes the IE "Integrity protection mode info"; or
- includes any one or both of the IEs "New C-RNTI" and "New U-RNTI":

the UE shall:

- 1> transmit a UTRAN MOBILITY INFORMATION CONFIRM as response message using AM RLC.

If the URA UPDATE CONFIRM message:

- does not include "CN information elements"; and
- does not include the IE "Ciphering mode info"; and
- does not include the IE "Integrity protection mode info"; and
- does not include the IE "New U-RNTI"; and
- does not include the IE "New C-RNTI":

the UE shall:

- 1> transmit no response message.

If the new state is CELL_DCH or CELL_FACH, the response message shall be transmitted using the new configuration after the state transition., and the UE shall:

- 1> if the IE "Downlink counter synchronisation info" was included in the received CELL UPDATE CONFIRM or URA UPDATE CONFIRM message:
 - 2> when RLC has confirmed the successful transmission of the response message:
 - 3> re-establish all AM and UM RLC entities with RB identities larger than 4 and set the first 20 bits of all the HFN component of the respective COUNT-C values to the START value included in the response message for the corresponding CN domain;
 - 3> re-establish the RLC entities with RB identities 1, 3 and 4 and set the first 20 bits of all the HFN component of the respective COUNT-C values to the START value included in the response message for the CN domain stored in the variable LATEST_CONFIGURED_CN_DOMAIN;
 - 3> set the remaining bits of the HFN component of the COUNT-C values of all UM RLC entities to zero;
 - 3> re-initialise the PDCP header compression entities of each radio bearer in the variable ESTABLISHED_RABS as specified in [36].
- 1> if the variable PDCP_SN_INFO is empty:
 - 2> if the CELL UPDATE CONFIRM or URA UPDATE CONFIRM message contained the IE "Ciphering mode info":
 - 3> when RLC has confirmed the successful transmission of the response message:
 - 4> continue with the remainder of the procedure.
 - 2> if the CELL UPDATE CONFIRM or URA UPDATE CONFIRM message did not contain the IE "Ciphering mode info":
 - 3> when RLC has been requested to transmit the response message,
 - 4> continue with the remainder of the procedure.
- 1> if the variable PDCP_SN_INFO non-empty:

- 2> when RLC has confirmed the successful transmission of the response message:
 - 3> for each radio bearer in the variable PDCP_SN_INFO:
 - 4> if the IE "RB started" in the variable ESTABLISHED_RABS is set to "started":
 - 5> configure the RLC entity for that radio bearer to "continue".
 - 3> continue with the remainder of the procedure.

If the new state is CELL_PCH or URA_PCH, the response message shall be transmitted in CELL_FACH state, and the UE shall:

- 1> when RLC has confirmed the successful transmission of the response message:
 - 2> if the IE "Downlink counter synchronisation info" was included in the received CELL UPDATE CONFIRM or URA UPDATE CONFIRM message:
 - 3> re-establish all AM and UM RLC entities with RB identities larger than 4 and set the first 20 bits of all the HFN component of the respective COUNT-C values to the START value included in the response message for the corresponding CN domain;
 - 3> re-establish the RLC entities with RB identities 1, 3 and 4 and set the first 20 bits of all the HFN component of the respective COUNT-C values to the START value included in the response message for the CN domain stored in the variable LATEST_CONFIGURED_CN_DOMAIN;
 - 3> set the remaining bits of the HFN component of the COUNT-C values of all UM RLC entities to zero;
 - 3> re-initialise the PDCP header compression entities of each radio bearer in the variable ESTABLISHED_RABS as specified in [36].
 - 2> for each radio bearer in the variable PDCP_SN_INFO:
 - 3> if the IE "RB started" in the variable ESTABLISHED_RABS is set to "started":
 - 4> configure the RLC entity for that radio bearer to "continue".
 - 2> enter the new state (CELL_PCH or URA_PCH, respectively).
- 1> continue with the remainder of the procedure.

8.3.1.7a Physical channel failure

If the received CELL UPDATE CONFIRM message would cause the UE to transit to CELL_DCH state:

- 1> if the UE failed to establish the physical channel(s) indicated in the received CELL UPDATE CONFIRM message according to the criteria defined in subclause 8.5.4 are not fulfilled; or
- 1> the received CELL UPDATE CONFIRM message does not contain dedicated physical channels:

the UE shall:

- 1> if, caused by the received CELL UPDATE CONFIRM message
 - 2> the IE "Reconfiguration" in the variable CIPHERING_STATUS is set to TRUE; and/or
 - 2> the IE "Reconfiguration" in the variable INTEGRITY_PROTECTION_INFO is set to TRUE:
 - 3> abort the ongoing integrity and/or ciphering reconfiguration;
 - 3> if the received CELL UPDATE CONFIRM message contained the IE "Ciphering mode info":
 - 4> set the IE "Reconfiguration" in the variable CIPHERING_STATUS to FALSE; and
 - 4> clear the variable RB_UPLINK_CIPHERING_ACTIVATION_TIME_INFO.
 - 3> if the received CELL UPDATE CONFIRM message contained the IE "Integrity protection mode info":

- 4> set the IE "Reconfiguration" in the variable INTEGRITY_PROTECTION_INFO to FALSE; and
 - 4> clear the variable INTEGRITY_PROTECTION_ACTIVATION_INFO.
- 1> if the variable ORDERED_RECONFIGURATION is set to TRUE caused by the received CELL UPDATE CONFIRM message:
- 2> set the variable ORDERED_RECONFIGURATION to FALSE.
- 1> if V302 is equal to or smaller than N302:
- 2> select a suitable UTRA cell according to [4];
 - 2> set the contents of the CELL UPDATE message according to subclause 8.3.1.3, except for the IE "Cell update cause" which shall be set to "Radio link failure";
 - 2> submit the CELL UPDATE message for transmission on the uplink CCCH;
 - 2> increment counter V302;
 - 2> restart timer T302 when the MAC layer indicates success or failure to transmit the message.
- 1> if V302 is greater than N302:
- 2> clear the variable RB_UPLINK_CIPHERING_ACTIVATION_TIME_INFO;
 - 2> clear the variable INTEGRITY_PROTECTION_ACTIVATION_INFO;
 - 2> in case of a cell update procedure:
 - 3> clear the entry for the CELL UPDATE CONFIRM message in the table "Rejected transactions" in the variable TRANSACTIONS.
 - 2> release all its radio resources;
 - 2> indicate release (abort) of the established signalling connections (as stored in the variable ESTABLISHED_SIGNALLING_CONNECTIONS) and established radio access bearers (as stored in the variable ESTABLISHED_RABS) to upper layers;
 - 2> clear the variable ESTABLISHED_SIGNALLING_CONNECTIONS;
 - 2> clear the variable ESTABLISHED_RABS;
 - 2> set the variable CELL_UPDATE_STARTED to FALSE;
 - 2> enter idle mode.

8.3.1.8 Unsupported configuration by the UE

If the UE does not support the configuration in the CELL UPDATE CONFIRM message and/or the variable UNSUPPORTED_CONFIGURATION is set to TRUE, the UE shall:

- 1> if V302 is equal to or smaller than N302, the UE shall:
- 2> if, caused by the received CELL UPDATE CONFIRM message
 - 3> the IE "Reconfiguration" in the variable CIPHERING_STATUS is set to TRUE; and/or
 - 3> the IE "Reconfiguration" in the variable INTEGRITY_PROTECTION_INFO is set to TRUE:
 - 4> abort the ongoing integrity and/or ciphering reconfiguration;
 - 4> if the received CELL UPDATE CONFIRM message contained the IE "Ciphering mode info":
 - 5> set the IE "Reconfiguration" in the variable CIPHERING_STATUS to FALSE; and
 - 5> clear the variable RB_UPLINK_CIPHERING_ACTIVATION_TIME_INFO.

- 4> if the received CELL UPDATE CONFIRM message contained the IE "Integrity protection mode info":
 - 5> set the IE "Reconfiguration" in the variable INTEGRITY_PROTECTION_INFO to FALSE; and
 - 5> clear the variable INTEGRITY_PROTECTION_ACTIVATION_INFO.
- 2> if the variable ORDERED_RECONFIGURATION is set to TRUE due to the received CELL UPDATE CONFIRM message in case of a cell update procedure:
 - 3> set the variable ORDERED_RECONFIGURATION to FALSE.
 - 2> set the variable FAILURE_INDICATOR to TRUE;
 - 2> set the variable FAILURE_CAUSE to "Unsupported configuration";
 - 2> set the content of the CELL UPDATE message according to subclause 8.3.1.3;
 - 2> submit the CELL UPDATE message for transmission on the uplink CCCH;
 - 2> increment counter V302;
 - 2> restart timer T302 when the MAC layer indicates success or failure to transmit the message.
- 1> if V302 is greater than N302, the UE shall:
 - 2> clear the variable RB_UPLINK_CIPHERING_ACTIVATION_TIME_INFO;
 - 2> clear the variable INTEGRITY_PROTECTION_ACTIVATION_INFO;
 - 2> clear the variable PDCP_SN_INFO;
 - 2> clear the entry for the CELL UPDATE CONFIRM message in the table "Rejected transactions" in the variable TRANSACTIONS;
 - 2> release all its radio resources;
 - 2> indicate release (abort) of the established signalling connections (as stored in the variable ESTABLISHED_SIGNALLING_CONNECTIONS) and established radio access bearers (as stored in the variable ESTABLISHED_RABS) to upper layers;
 - 2> clear the variable ESTABLISHED_SIGNALLING_CONNECTIONS;
 - 2> clear the variable ESTABLISHED_RABS;
 - 2> set the variable CELL_UPDATE_STARTED to FALSE;
 - 2> enter idle mode;
 - 2> Other actions the UE shall perform when entering idle mode from connected mode are specified in subclause 8.5.2;
 - 2> and the procedure ends.

8.3.1.9 Invalid configuration

If the variable INVALID_CONFIGURATION is set to TRUE, the UE shall:

- 1> if V302 is equal to or smaller than N302:
 - 2> if, caused by the received CELL UPDATE CONFIRM or URA UPDATE CONFIRM message
 - 3> the IE "Reconfiguration" in the variable CIPHERING_STATUS is set to TRUE; and/or
 - 3> the IE "Reconfiguration" in the variable INTEGRITY_PROTECTION_INFO is set to TRUE:
 - 4> abort the ongoing integrity and/or ciphering reconfiguration;

- 4> if the received CELL UPDATE CONFIRM or URA UPDATE CONFIRM message contained the IE "Ciphering mode info":
 - 5> set the IE "Reconfiguration" in the variable CIPHERING_STATUS to FALSE; and
 - 5> clear the variable RB_UPLINK_CIPHERING_ACTIVATION_TIME_INFO.
- 4> if the received CELL UPDATE CONFIRM or URA UPDATE CONFIRM message contained the IE "Integrity protection mode info":
 - 5> set the IE "Reconfiguration" in the variable INTEGRITY_PROTECTION_INFO to FALSE; and
 - 5> clear the variable INTEGRITY_PROTECTION_ACTIVATION_INFO.
- 2> if the variable ORDERED_RECONFIGURATION is set to TRUE caused by the received CELL UPDATE CONFIRM message in case of a cell update procedure:
 - 3> set the variable ORDERED_RECONFIGURATION to FALSE.
- 2> in case of a cell update procedure:
 - 3> set the variable FAILURE_INDICATOR to TRUE;
 - 3> set the variable FAILURE_CAUSE to "Invalid configuration";
 - 3> set the contents of the CELL UPDATE message according to subclause 8.3.1.3;
 - 3> submit the CELL UPDATE message for transmission on the uplink CCCH.
- 2> in case of a URA update procedure:
 - 3> set the contents of the URA UPDATE message according to subclause 8.3.1.3;
 - 3> submit the URA UPDATE message for transmission on the uplink CCCH.
- 2> increment counter V302;
- 2> restart timer T302 when the MAC layer indicates success or failure to transmit the message.
- 1> if V302 is greater than N302:
 - 2> clear the variable RB_UPLINK_CIPHERING_ACTIVATION_TIME_INFO;
 - 2> clear the variable INTEGRITY_PROTECTION_ACTIVATION_INFO;
 - 2> clear the variable PDCP_SN_INFO;
 - 2> clear the entry for the CELL UPDATE CONFIRM message in the table "Rejected transactions" in the variable TRANSACTIONS;
 - 2> release all its radio resources;
 - 2> indicate release (abort) of the established signalling connections (as stored in the variable ESTABLISHED_SIGNALLING_CONNECTIONS) and established radio access bearers (as stored in the variable ESTABLISHED_RABS) to upper layers;
 - 2> clear the variable ESTABLISHED_SIGNALLING_CONNECTIONS;
 - 2> clear the variable ESTABLISHED_RABS;
 - 2> set the variable CELL_UPDATE_STARTED to FALSE;
 - 2> enter idle mode;
 - 2> Other actions the UE shall perform when entering idle mode from connected mode are specified in subclause 8.5.2;
 - 2> the procedure ends.

8.3.1.9a Incompatible simultaneous reconfiguration

In case of a cell update procedure and if the received CELL UPDATE CONFIRM message

- includes "RB information elements"; and/or
- includes "Transport channel information elements"; and/or
- includes "Physical channel information elements"; and
- the variable ORDERED_RECONFIGURATION is set to TRUE because of an ongoing Reconfiguration procedure;

or

If the variable INCOMPATIBLE_SECURITY_RECONFIGURATION is set to TRUE due to the received CELL UPDATE CONFIRM or URA UPDATE CONFIRM message:

the UE shall:

1> if V302 is equal to or smaller than N302:

2> if, caused by the received CELL UPDATE CONFIRM or URA UPDATE CONFIRM message

3> the IE "Reconfiguration" in the variable CIPHERING_STATUS is set to TRUE; and/or

3> the IE "Reconfiguration" in the variable INTEGRITY_PROTECTION_INFO is set to TRUE:

4> abort the ongoing integrity and/or ciphering reconfiguration;

4> if the received CELL UPDATE CONFIRM or URA UPDATE CONFIRM message contained the IE "Ciphering mode info":

5> set the IE "Reconfiguration" in the variable CIPHERING_STATUS to FALSE; and

5> clear the variable RB_UPLINK_CIPHERING_ACTIVATION_TIME_INFO.

4> if the received CELL UPDATE CONFIRM or URA UPDATE CONFIRM message contained the IE "Integrity protection mode info":

5> set the IE "Reconfiguration" in the variable INTEGRITY_PROTECTION_INFO to FALSE; and

5> clear the variable INTEGRITY_PROTECTION_ACTIVATION_INFO.

2> if the variable ORDERED_RECONFIGURATION is set to TRUE due to the received CELL UPDATE CONFIRM message in case of a cell update procedure:

3> set the variable ORDERED_RECONFIGURATION to FALSE.

2> set the variable FAILURE_INDICATOR to TRUE;

2> set the variable FAILURE_CAUSE to "Incompatible simultaneous reconfiguration";

2> set the content of the CELL UPDATE message according to subclause 8.3.1.3;

2> submit the CELL UPDATE message for transmission on the uplink CCCH;

2> increment counter V302;

2> restart timer T302 when the MAC layer indicates success or failure to transmit the message.

1> if V302 is greater than N302:

2> clear the variable RB_UPLINK_CIPHERING_ACTIVATION_TIME_INFO;

2> clear the variable INTEGRITY_PROTECTION_ACTIVATION_INFO;

2> clear the variable PDCP_SN_INFO;

- 2> set the variable INCOMPATIBLE_SECURITY_RECONFIGURATION to FALSE;
- 2> clear the entry for the CELL UPDATE CONFIRM message in the table "Rejected transactions" in the variable TRANSACTIONS;
- 2> release all its radio resources;
- 2> indicate release (abort) of the established signalling connections (as stored in the variable ESTABLISHED_SIGNALLING_CONNECTIONS) and established radio access bearers (as stored in the variable ESTABLISHED_RABS) to upper layers;
- 2> clear the variable ESTABLISHED_SIGNALLING_CONNECTIONS;
- 2> clear the variable ESTABLISHED_RABS;
- 2> set the variable CELL_UPDATE_STARTED to FALSE;
- 2> enter idle mode;
- 2> Other actions the UE shall perform when entering idle mode from connected mode are specified in subclause 8.5.2;
- 2> the procedure ends.

8.3.1.9b Security reconfiguration during Cell update procedure

If:

- the variable CELL_UPDATE_STARTED is set to TRUE; and
- the UE receives a SECURITY MODE COMMAND message:

the UE shall

- 1> ignore the received SECURITY MODE COMMAND and continue with any ongoing processes and procedures as if the SECURITY MODE COMMAND message has not been received.

8.3.1.10 Confirmation error of URA ID list

If the URA UPDATE CONFIRM message causes a confirmation error of URA identity list as specified in subclause 8.6.2.1 the UE shall:

- 1> check the value of V302; and
- 1> if V302 is smaller or equal than N302:
 - 2> if, caused by the received URA UPDATE CONFIRM message
 - 3> the IE "Reconfiguration" in the variable CIPHERING_STATUS is set to TRUE; and/or
 - 3> the IE "Reconfiguration" in the variable INTEGRITY_PROTECTION_INFO is set to TRUE:
 - 4> abort the ongoing integrity and/or ciphering reconfiguration;
 - 4> if the received URA UPDATE CONFIRM message contained the IE "Ciphering mode info":
 - 5> set the IE "Reconfiguration" in the variable CIPHERING_STATUS to FALSE; and
 - 5> clear the variable RB_UPLINK_CIPHERING_ACTIVATION_TIME_INFO.
 - 4> if the received URA UPDATE CONFIRM message contained the IE "Integrity protection mode info"
 - 5> set the IE "Reconfiguration" in the variable INTEGRITY_PROTECTION_INFO to FALSE; and
 - 5> clear the variable INTEGRITY_PROTECTION_ACTIVATION_INFO.
 - 2> set the IEs in the URA UPDATE message according to subclause 8.3.1.3;

- 2> submit the URA UPDATE message for transmission on the uplink CCCH;
 - 2> increment counter V302;
 - 2> restart timer T302 when the MAC layer indicates success or failure to transmit the message.
- 1> if V302 is greater than N302:
- 2> release all its radio resources;
 - 2> clear the variable RB_UPLINK_CIPHERING_ACTIVATION_TIME_INFO;
 - 2> clear the variable INTEGRITY_PROTECTION_ACTIVATION_INFO;
 - 2> clear the variable PDCP_SN_INFO;
 - 2> indicate release (abort) of the established signalling connections (as stored in the variable ESTABLISHED_SIGNALLING_CONNECTIONS) and established radio access bearers (as stored in the variable ESTABLISHED_RABS) to upper layers;
 - 2> clear the variable ESTABLISHED_SIGNALLING_CONNECTIONS;
 - 2> clear the variable ESTABLISHED_RABS;
 - 2> set the variable CELL_UPDATE_STARTED to FALSE;
 - 2> enter idle mode;
 - 2> perform the actions specified in subclause 8.5.2 when entering idle mode from connected mode;
 - 2> the procedure ends.

8.3.1.11 Invalid CELL UPDATE CONFIRM/URA UPDATE CONFIRM message

If the UE receives an CELL UPDATE CONFIRM/URA UPDATE CONFIRM message, which contains a protocol error causing the variable `PROTOCOL_ERROR_REJECT` to be set to TRUE according to clause 9, the UE shall perform procedure specific error handling as follows:

- 1> If V302 is equal to or smaller than N302, the UE shall:
- 2> set the variable `PROTOCOL_ERROR_INDICATOR` to TRUE;
 - 2> in case of a cell update procedure:
 - 3> set the contents of the CELL UPDATE message according to subclause 8.3.1.3;
 - 3> submit the CELL UPDATE message for transmission on the uplink CCCH.
 - 2> in case of a URA update procedure:
 - 3> set the contents of the URA UPDATE message according to subclause 8.3.1.3;
 - 3> submit the URA UPDATE message for transmission on the uplink CCCH.
 - 2> increment counter V302;
 - 2> restart timer T302 when the MAC layer indicates success or failure to transmit the message.
- 1> if V302 is greater than N302, the UE shall:
- 2> clear the variable `RB_UPLINK_CIPHERING_ACTIVATION_TIME_INFO`;
 - 2> in case of a cell update procedure:
 - 3> clear the entry for the CELL UPDATE CONFIRM message in the table "Rejected transactions" in the variable `TRANSACTIONS`.
 - 2> in case of a URA update procedure:

- 3> clear the entry for the URA UPDATE CONFIRM message in the table "Rejected transactions" in the variable TRANSACTIONS.
- 2> indicate release (abort) of the established signalling connections (as stored in the variable ESTABLISHED_SIGNALLING_CONNECTIONS) and established radio access bearers (as stored in the variable ESTABLISHED_RABS) to upper layers;
- 2> clear the variable ESTABLISHED_SIGNALLING_CONNECTIONS;
- 2> clear the variable ESTABLISHED_RABS;
- 2> set the variable CELL_UPDATE_STARTED to FALSE;
- 2> release all its radio resources;
- 2> enter idle mode;
- 2> Other actions the UE shall perform when entering idle mode from connected mode are specified in subclause 8.5.2;
- 2> the procedure ends.

8.3.1.12 T302 expiry or cell reselection

If any or several of the following conditions are true:

- expiry of timer T302;
- reselection to another UTRA cell (including the previously serving cell) before completion of the cell update or URA update procedure;

the UE shall:

- 1> stop T302 if it is running;
- 1> if the UE was in CELL_DCH state prior to the initiation of the procedure; and
 - 2> if timers T314 and T315 have elapsed while T302 was running:
 - 3> enter idle mode.
 - 3> indicate release (abort) of the established signalling connections (as stored in the variable ESTABLISHED_SIGNALLING_CONNECTIONS) and established radio access bearers (as stored in the variable ESTABLISHED_RABS) to upper layers. Other actions the UE shall perform when entering idle mode from connected mode are specified in subclause 8.5.2.
 - 3> and the procedure ends.
 - 2> if timer T314 has elapsed while T302 was running and,
 - 3> if "T314 expired" in the variable RB_TIMER_INDICATOR is set to FALSE and
 - 3> if T315 is still running:
 - 4> release locally all radio bearers which are associated with any radio access bearers for which in the variable ESTABLISHED_RABS the value of the IE "Re-establishment timer" is set to "useT314";
 - 4> indicate release of those radio access bearers to upper layers;
 - 4> delete all information about those radio access bearers from the variable ESTABLISHED_RABS;
 - 4> set "T314 expired" in the variable RB_TIMER_INDICATOR to TRUE.
 - 2> if timer T315 has elapsed while T302 was running and,
 - 3> if "T315 expired" in the variable RB_TIMER_INDICATOR is set to FALSE and,

- 3> if T314 is still running:
 - 4> release locally all radio bearers which are associated with any radio access bearers for which in the variable ESTABLISHED_RABS the value of the IE "Re-establishment timer" is set to "useT315";
 - 4> indicate release of those radio access bearers to upper layers;
 - 4> delete all information about those radio access bearers from the variable ESTABLISHED_RABS;
 - 4> set "T315 expired" in the variable RB_TIMER_INDICATOR to TRUE.
- 1> check whether it is still in "in service area" (see subclause 8.5.5.2);
- 1> if the variable ORDERED_RECONFIGURATION is set to TRUE caused by the received CELL UPDATE CONFIRM message in case of a cell update procedure:
 - 2> set the variable ORDERED_RECONFIGURATION to FALSE.
- 1> in case of a cell update procedure:
 - 2> clear any entry for the CELL UPDATE CONFIRM message in the table "Accepted transactions" in the variable TRANSACTIONS.
- 1> in case of a URA update procedure:
 - 2> clear any entry for the URA UPDATE CONFIRM message in the table "Accepted transactions" in the variable TRANSACTIONS.

If the UE detects "in service area" if it has not entered idle mode, and:

- 1> if V302 is equal to or smaller than N302, the UE shall:
 - 2> if the UE performed cell re-selection:
 - 3> delete its C-RNTI.
 - 2> in case of a cell update procedure:
 - 3> set the contents of the CELL UPDATE message according to subclauses 8.3.1.3 and 8.5.10;
 - 3> if a CELL UPDATE CONFIRM message was received and caused the IE "Reconfiguration" in the variable CIPHERING_STATUS to be set to TRUE and/or the IE "Reconfiguration" in the variable INTEGRITY_PROTECTION_INFO to be set to TRUE:
 - 4> if the IE "Downlink counter synchronisation info" was included in the received CELL UPDATE CONFIRM message:
 - 5> apply the new security (integrity protection) configuration received in the CELL UPDATE CONFIRM on the CELL UPDATE message.
 - 3> submit the CELL UPDATE message for transmission on the uplink CCCH.
 - 2> in case of a URA update procedure:
 - 3> set the contents of the URA UPDATE message according to subclauses 8.3.1.3 and 8.5.10;
 - 3> if a URA UPDATE CONFIRM message was received and caused the IE "Reconfiguration" in the variable CIPHERING_STATUS to be set to TRUE and/or the IE "Reconfiguration" in the variable INTEGRITY_PROTECTION_INFO is set to TRUE:
 - 4> if the IE "Downlink counter synchronisation info" was included in the received URA UPDATE CONFIRM message:
 - 5> apply the new security (integrity protection) configuration received in the URA UPDATE CONFIRM on the URA UPDATE message.
 - 3> submit the URA UPDATE message for transmission on the uplink CCCH.

- 2> increment counter V302;
- 2> restart timer T302 when the MAC layer indicates success or failure to transmit the message.
- 1> if V302 is greater than N302, the UE shall:
 - 2> clear the variable RB_UPLINK_CIPHERING_ACTIVATION_TIME_INFO;
 - 2> clear the variable INTEGRITY_PROTECTION_ACTIVATION_INFO;
 - 2> clear the variable PDCP_SN_INFO;
 - 2> in case of a cell update procedure:
 - 3> clear the entry for the CELL_UPDATE_CONFIRM message in the table "Rejected transactions" in the variable TRANSACTIONS.
 - 2> in case of a URA update procedure:
 - 3> clear the entry for the URA_UPDATE_CONFIRM message in the table "Rejected transactions" in the variable TRANSACTIONS.
 - 2> release all its radio resources;
 - 2> indicate release (abort) of the established signalling connections (as stored in the variable ESTABLISHED_SIGNALLING_CONNECTIONS) and established radio access bearers (as stored in the variable ESTABLISHED_RABS) to upper layers;
 - 2> clear the variable ESTABLISHED_SIGNALLING_CONNECTIONS;
 - 2> clear the variable ESTABLISHED_RABS;
 - 2> set the variable CELL_UPDATE_STARTED to FALSE;
 - 2> enter idle mode;
 - 2> other actions the UE shall perform when entering idle mode from connected mode are specified in subclause 8.5.2;
 - 2> and the procedure ends.

If the UE does not detect "in service area", it shall:

- 1> continue searching for "in service area".

8.3.1.13 T314 expiry

Upon expiry of timer T314 the UE shall:

- 1> if timer T302 is running:
 - 2> continue awaiting response message from UTRAN.
- 1> if timer T302 is not running and timer T315 is running:
 - 2> set IE "T314 expired" in variable RB_TIMER_INDICATOR to TRUE;
 - 2> release locally all radio bearers which are associated with any radio access bearers for which in the variable ESTABLISHED_RABS the value of the IE "Re-establishment timer" is set to "useT314";
 - 2> indicate release of those radio access bearers to upper layers;
 - 2> delete all information about those radio access bearers from the variable ESTABLISHED_RABS.
- 1> if timers T302 and T315 are not running:
 - 2> clear the variable RB_UPLINK_CIPHERING_ACTIVATION_TIME_INFO;

- 2> clear the variable INTEGRITY_PROTECTION_ACTIVATION_INFO;
- 2> clear the variable PDCP_SN_INFO;
- 2> clear the entry for the CELL UPDATE CONFIRM message in the table "Rejected transactions" in the variable TRANSACTIONS;
- 2> release all its radio resources;
- 2> indicate release (abort) of the established signalling connections (as stored in the variable ESTABLISHED_SIGNALLING_CONNECTIONS) and established radio access bearers (as stored in the variable ESTABLISHED_RABS) to upper layers;
- 2> clear the variable ESTABLISHED_SIGNALLING_CONNECTIONS;
- 2> clear the variable ESTABLISHED_RABS;
- 2> set the variable CELL_UPDATE_STARTED to FALSE;
- 2> enter idle mode;
- 2> other actions the UE shall perform when entering idle mode from connected mode are specified in subclause 8.5.2;
- 2> and the procedure ends.

8.3.1.14 T315 expiry

Upon expiry of timer T315 the UE shall:

- 1> if timer T302 is running:
 - 2> continue awaiting response message from UTRAN.
- 1> if timer T302 is not running and timer T314 is running:
 - 2> set IE "T315 expired" in variable RB_TIMER_INDICATOR to TRUE;
 - 2> release locally all radio bearers which are associated with any radio access bearers for which in the variable ESTABLISHED_RABS the value of the IE "Re-establishment timer" is set to "use T315";
 - 2> indicate release of those radio access bearers to upper layers;
 - 2> delete all information about those radio access bearers from the variable ESTABLISHED_RABS.
- 1> if timers T302 and T314 are not running:
 - 2> clear the variable RB_UPLINK_CIPHERING_ACTIVATION_TIME_INFO;
 - 2> clear the variable INTEGRITY_PROTECTION_ACTIVATION_INFO;
 - 2> clear the variable PDCP_SN_INFO;
 - 2> clear the entry for the CELL UPDATE CONFIRM message in the table "Rejected transactions" in the variable TRANSACTIONS;
 - 2> release all its radio resources;
 - 2> indicate release (abort) of the established signalling connections (as stored in the variable ESTABLISHED_SIGNALLING_CONNECTIONS) and established radio access bearers (as stored in the variable ESTABLISHED_RABS) to upper layers;
 - 2> clear the variable ESTABLISHED_SIGNALLING_CONNECTIONS;
 - 2> clear the variable ESTABLISHED_RABS;
 - 2> set the variable CELL_UPDATE_STARTED to FALSE;

2> enter idle mode;

2> other actions the UE shall perform when entering idle mode from connected mode are specified in subclause 8.5.2;

2> and the procedure ends.

8.3.1.15 Reception of the UTRAN MOBILITY INFORMATION CONFIRM message by the UTRAN

See subclause 8.3.3.4.

8.3.2 URA update

See subclause 8.3.1.

8.3.3 UTRAN mobility information

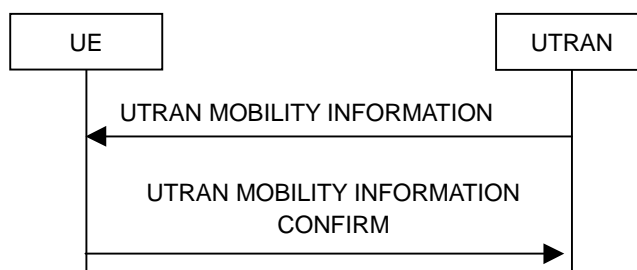

Figure 8.3.3-1: UTRAN mobility information procedure, normal flow

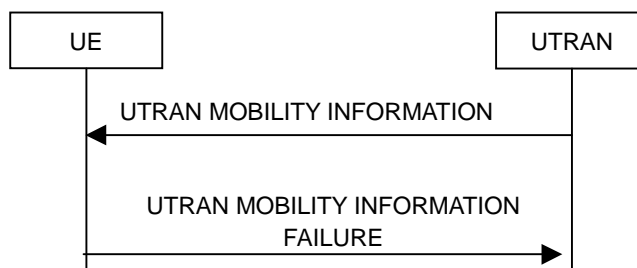

Figure 8.3.3-2: UTRAN mobility information procedure, failure case

8.3.3.1 General

The purpose of this procedure is to allocate any one or a combination of the following to a UE in connected mode:

- a new C-RNTI;
- a new U-RNTI;
- other mobility related information.

8.3.3.2 Initiation

To initiate the procedure UTRAN transmits a UTRAN MOBILITY INFORMATION message to the UE on the downlink DCCH using AM or UM RLC. In case of SRNS relocation, the message is sent using UM RLC only.

8.3.3.3 Reception of UTRAN MOBILITY INFORMATION message by the UE

When the UE receives a UTRAN MOBILITY INFORMATION message, it shall:

1> act on received information elements as specified in subclause 8.6;

1> if the IE "UE Timers and constants in connected mode" is present:

2> store the values of the IE "UE Timers and constants in connected mode" in the variable TIMERS_AND_CONSTANTS, replacing any previously stored value for each timer and constant; and

2> for each updated timer value:

3> start using the new value next time the timer is started;

NOTE: If a new value of timer T305 is included in the IE "UE Timers and constants in connected mode", and the old value of timer T305 is "infinity", the UE will not use the new value of the timer T305 until the next cell reselection.

2> for each updated constant value:

3> start using the new value directly;

1> if the IE "CN domain specific DRX cycle length coefficient" is present:

2> store the value of the IE "CN domain specific DRX cycle length coefficient" for that CN domain, replacing any previously stored value; and

2> use the value to determine the connected mode paging occasions according to [4].

1> set the IE "RRC transaction identifier" in the UTRAN MOBILITY INFORMATION CONFIRM message to the value of "RRC transaction identifier" in the entry for the UTRAN MOBILITY INFORMATION message in the table "Accepted transactions" in the variable TRANSACTIONS; and

1> clear that entry;

1> if the UTRAN MOBILITY INFORMATION message contained the IE "Ciphering mode info" or contained the IE "Integrity protection mode info":

2> set the IE "Status" in the variable SECURITY_MODIFICATION for all the CN domains in the variable SECURITY_MODIFICATION to "Affected";

1> if the UTRAN MOBILITY INFORMATION message contained the IE "Ciphering mode info":

2> include and set the IE "Radio bearer uplink ciphering activation time info" to the value of the variable RB_UPLINK_CIPHERING_ACTIVATION_TIME_INFO.

1> if the variable PDCP_SN_INFO is non-empty:

2> include the IE "RB with PDCP information list" in the UTRAN MOBILITY INFORMATION CONFIRM message and set it to the value of the variable PDCP_SN_INFO.

1> if the received UTRAN MOBILITY INFORMATION message included the IE "Downlink counter synchronisation info":

2> re-establish RB2;

2> set the new uplink and downlink HFN component of COUNT-C of RB2 to MAX(uplink HFN component of COUNT-C of RB2, downlink HFN component of COUNT-C of RB2);

2> increment by one the downlink and uplink values of the HFN component of COUNT-C for RB2;

2> calculate the START value according to subclause 8.5.9;

2> include the calculated START values for each CN domain in the IE "START list" in the IE "Uplink counter synchronisation info" in the UTRAN MOBILITY INFORMATION CONFIRM message.

1> transmit a UTRAN MOBILITY INFORMATION CONFIRM message on the uplink DCCH using AM RLC;

1> if the IE "Integrity protection mode info" was present in the UTRAN MOBILITY INFORMATION message:

- 2> start applying the new integrity protection configuration in the uplink for signalling radio bearer RB2 from and including the transmitted UTRAN MOBILITY INFORMATION CONFIRM message.
- 1> if the IE "Downlink counter synchronisation info" was included in the received UTRAN MOBILITY INFORMATION message:
 - 2> when RLC has confirmed the successful transmission of the response message:
 - 3> re-establish all AM and UM RLC entities with RB identities larger than 4 and set the first 20 bits of all the HFN component of the respective COUNT-C values to the START value included in the response message for the corresponding CN domain;
 - 3> re-establish the RLC entities with RB identities 1, 3 and 4 and set the first 20 bits of all the HFN component of the respective COUNT-C values to the START value included in the response message for the CN domain stored in the variable LATEST_CONFIGURED_CN_DOMAIN;
 - 3> set the remaining bits of the HFN component of the COUNT-C values of all UM RLC entities to zero;
 - 3> re-initialise the PDCP header compression entities of each radio bearer in the variable ESTABLISHED_RABS as specified in [36].
 - 1> if the variable PDCP_SN_INFO is empty; and
 - 2> if the UTRAN MOBILITY INFORMATION message contained the IE "Ciphering mode info":
 - 3> when RLC has confirmed the successful transmission of the UTRAN MOBILITY INFORMATION CONFIRM message, perform the actions below.
 - 2> if the UTRAN MOBILITY INFORMATION message did not contain the IE "Ciphering mode info":
 - 3> when RLC has been requested to transmit the UTRAN MOBILITY INFORMATION CONFIRM message, perform the actions below.
 - 1> if the variable PDCP_SN_INFO is non-empty:
 - 2> when RLC has confirmed the successful transmission of the UTRAN MOBILITY INFORMATION CONFIRM message:
 - 3> for each radio bearer in the variable PDCP_SN_INFO:
 - 4> if the IE "RB started" in the variable ESTABLISHED_RABS is set to "started":
 - 5> configure the RLC entity for that radio bearer to "continue".
 - 3> clear the variable PDCP_SN_INFO.
 - 1> if the UTRAN MOBILITY INFORMATION message contained the IE "Ciphering mode info":
 - 2> resume data transmission on any suspended radio bearer and signalling radio bearer mapped on RLC-AM or RLC-UM;
 - 2> set the IE "Reconfiguration" in the variable CIPHERING_STATUS to FALSE; and
 - 2> clear the variable RB_UPLINK_CIPHERING_ACTIVATION_TIME_INFO.
 - 1> if the UTRAN MOBILITY INFORMATION message contained the IE "Integrity protection mode info":
 - 2> allow the transmission of RRC messages on all signalling radio bearers with any RRC SN;
 - 2> set the IE "Reconfiguration" in the variable INTEGRITY_PROTECTION_INFO to FALSE; and
 - 2> clear the variable INTEGRITY_PROTECTION_ACTIVATION_INFO.
 - 1> clear the variable SECURITY_MODIFICATION.

The procedure ends.

8.3.3.4 Reception of an UTRAN MOBILITY INFORMATION CONFIRM message by the UTRAN

When the network receives UTRAN MOBILITY INFORMATION CONFIRM message, UTRAN may delete any old U-RNTI. The procedure ends.

8.3.3.5 Cell re-selection

If the UE performs cell re-selection, the UE shall:

- 1> initiate a cell update procedure according to subclause 8.3.1;
- 1> if the UTRAN MOBILITY INFORMATION message contains the IE "New C-RNTI"; and
- 1> if the UE has not yet submitted the UTRAN MOBILITY INFORMATION CONFIRM message to lower layers for transmission; and
- 1> if the IE "Downlink counter synchronisation info" was not included in the received UTRAN MOBILITY INFORMATION message:
 - 2> transmit a UTRAN MOBILITY INFORMATION FAILURE message on the uplink DCCH using AM RLC;
 - 2> set the IE "RRC transaction identifier" in the UTRAN MOBILITY INFORMATION FAILURE message to the value of "RRC transaction identifier" in the entry for the UTRAN MOBILITY INFORMATION message in the table "Accepted transactions" in the variable TRANSACTIONS; and
 - 2> clear that entry.
 - 2> set the IE "failure cause" to the cause value "cell update occurred";
 - 2> when the UTRAN MOBILITY INFORMATION FAILURE message has been submitted to lower layers for transmission:
 - 3> continue with any ongoing processes and procedures as if the invalid UTRAN MOBILITY INFORMATION message has not been received and the procedure ends.
- 1> otherwise:
 - 2> if a UTRAN MOBILITY INFORMATION message was received and caused the IE "Reconfiguration" in the variable CIPHERING_STATUS to be set to TRUE and/or the IE "Reconfiguration" in the variable INTEGRITY_PROTECTION_INFO to be set to TRUE; and
 - 2> if the IE "Downlink counter synchronisation info" was included in the received UTRAN MOBILITY INFORMATION message:
 - 3> apply the new security (integrity protection) configuration received in the UTRAN MOBILITY INFORMATION message on the CELL UPDATE message to be transmitted.
 - 2> continue the procedure normally.

8.3.3.5a Incompatible simultaneous security reconfiguration

If the variable INCOMPATIBLE_SECURITY_RECONFIGURATION becomes set to TRUE of the received UTRAN MOBILITY INFORMATION message, the UE shall:

- 1> transmit a UTRAN MOBILITY INFORMATION FAILURE message on the uplink DCCH using AM RLC;
- 1> set the IE "RRC transaction identifier" in the UTRAN MOBILITY INFORMATION FAILURE message to the value of "RRC transaction identifier" in the entry for the UTRAN MOBILITY INFORMATION message in the table "Accepted transactions" in the variable TRANSACTIONS; and
- 1> clear that entry;
- 1> set the IE "failure cause" to the cause value "incompatible simultaneous reconfiguration";

- 1> when the UTRAN MOBILITY INFORMATION FAILURE message has been delivered to lower layers for transmission:
- 2> set the variable INCOMPATIBLE_SECURITY_RECONFIGURATION to FALSE;
- 2> continue with any ongoing processes and procedures as if the UTRAN MOBILITY INFORMATION message has not been received;
- 2> and the procedure ends.

8.3.3.6 Invalid UTRAN MOBILITY INFORMATION message

If the UTRAN MOBILITY INFORMATION message contains a protocol error causing the variable PROTOCOL_ERROR_REJECT to be set to TRUE according to clause 9, the UE shall perform procedure specific error handling as follows. The UE shall:

- 1> transmit a UTRAN MOBILITY INFORMATION FAILURE message on the uplink DCCH using AM RLC;
- 1> set the IE "RRC transaction identifier" in the UTRAN MOBILITY INFORMATION FAILURE message to the value of "RRC transaction identifier" in the entry for the UTRAN MOBILITY INFORMATION message in the table "Rejected transactions" in the variable TRANSACTIONS, and;
- 1> clear that entry.
- 1> set the IE "failure cause" to the cause value "protocol error";
- 1> include the IE "Protocol error information" with contents set to the value of the variable PROTOCOL_ERROR_INFORMATION;
- 1> when the UTRAN MOBILITY INFORMATION FAILURE message has been submitted to lower layers for transmission:
 - 2> continue with any ongoing processes and procedures as if the invalid UTRAN MOBILITY INFORMATION message has not been received;
 - 2> and the procedure ends.

8.3.4 Active set update

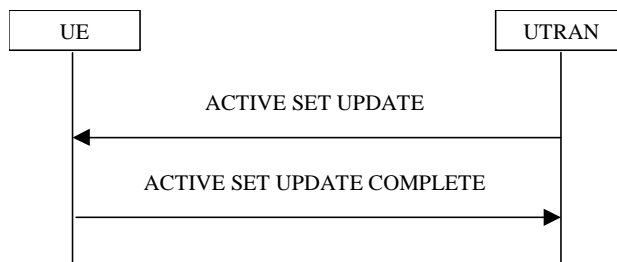

Figure 8.3.4-1: Active Set Update procedure, successful case

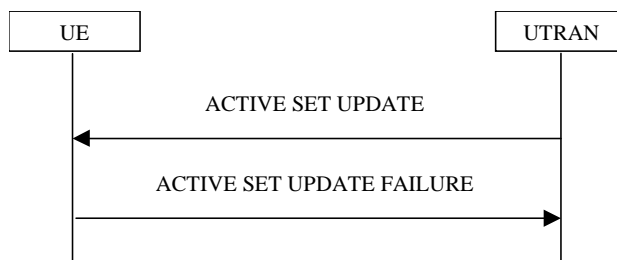

Figure 8.3.4-2: Active Set Update procedure, failure case

8.3.4.1 General

The purpose of the active set update procedure is to update the active set of the connection between the UE and UTRAN. This procedure shall be used in CELL_DCH state. The UE should keep on using the old RLs while configuring the new RLs. Also the UE should keep the transmitter turned on during the procedure. This procedure is only used in FDD mode.

8.3.4.2 Initiation

The procedure is initiated when UTRAN orders a UE in CELL_DCH state, to make the following modifications of the active set of the connection:

- a) Radio link addition;
- b) Radio link removal;
- c) Combined radio link addition and removal.

In case a) and c), UTRAN should:

- 1> prepare new additional radio link(s) in the UTRAN prior to the command to the UE.

In all cases, UTRAN should:

- 1> send an ACTIVE SET UPDATE message on downlink DCCH using AM or UM RLC;
- 1> create active sets that contain at least one common radio link across a DPCH frame boundary as the result of one or multiple (parallel) active set update procedures.

UTRAN should include the following information:

- 1> IE "Radio Link Addition Information": Downlink DPCH information and other optional parameters relevant for the radio links to be added along with the IE "Primary CPICH info" used for the reference ID to indicate which radio link to add. This IE is needed in cases a) and c) listed above;
- 1> IE "Radio Link Removal Information": IE "Primary CPICH info" used for the reference ID to indicate which radio link to remove. This IE is needed in cases b) and c) listed above.

8.3.4.3 Reception of an ACTIVE SET UPDATE message by the UE

Upon reception of an ACTIVE SET UPDATE message the UE shall act upon all received information elements as specified in 8.6, unless specified otherwise in the following.

The UE may:

- 1> maintain a list of the set of cells to which the UE has Radio Links if the IE "Cell ID" is present.

The UE shall:

- 1> first add the RLs indicated in the IE "Radio Link Addition Information";
- 1> remove the RLs indicated in the IE "Radio Link Removal Information". If the UE active set is full or becomes full, an RL, which is included in the IE "Radio Link Removal Information" for removal, shall be removed before adding RL, which is included in the IE "Radio Link Addition Information" for addition;
- 1> perform the physical layer synchronisation procedure B as specified in [29];
- 1> if the IE "TFCI combining indicator" associated with a radio link to be added is set to TRUE:
 - 2> if a DSCH transport channel is assigned and there is a 'hard' split in the TFCI field:
 - 3> configure Layer 1 to soft-combine TFCI (field 2) of this new link with those links already in the TFCI (field 2) combining set.

- 1> set the IE "RRC transaction identifier" in the ACTIVE SET UPDATE COMPLETE message to the value of "RRC transaction identifier" in the entry for the ACTIVE SET UPDATE message in the table "Accepted transactions" in the variable TRANSACTIONS; and
- 1> clear that entry;
- 1> transmit an ACTIVE SET UPDATE COMPLETE message on the uplink DCCH using AM RLC without waiting for the completion of the Physical Layer synchronisation B, as specified in [29];
- 1> the procedure ends on the UE side.

8.3.4.4 Unsupported configuration in the UE

If UTRAN instructs the UE to use a configuration that it does not support, the UE shall:

- 1> keep the active set as it was before the ACTIVE SET UPDATE message was received;
- 1> transmit an ACTIVE SET UPDATE FAILURE message on the DCCH using AM RLC;
- 1> set the IE "RRC transaction identifier" in the ACTIVE SET UPDATE FAILURE message to the value of "RRC transaction identifier" in the entry for the ACTIVE SET UPDATE message in the table "Accepted transactions" in the variable TRANSACTIONS; and
- 1> clear that entry;
- 1> set the IE "failure cause" to "configuration unsupported";
- 1> when the ACTIVE SET UPDATE FAILURE message has been submitted to lower layers for transmission:
 - 2> the procedure ends on the UE side.

8.3.4.5 Invalid configuration

If any of the following conditions are valid:

- a radio link indicated by the IE "Downlink DPCH info for each RL" in the IE "Radio link addition information" has a different spreading factor than the spreading factor for the radio links in the active set that will be established at the time indicated by the IE "Activation time"; and/or
- a radio link in the IE "Radio link addition information" is also present in the IE "Radio Link Removal Information"; and/or
- the IE "Radio Link Removal Information" contains all the radio links which are part of or will be part of the active set at the time indicated by the IE "Activation time"; and/or
- the IE "TX Diversity Mode" is not set to "none" and it indicates a diversity mode that is different from the one currently used in all or part of the active set; and/or
- a radio link indicated by the IE "Radio Link Removal Information" does not exist in the active set; and/or
- after the removal of all radio links indicated by the IE "Radio Link Removal Information" and the addition of all radio links indicated by the IE "Radio Link Addition Information" the active set would contain more than the maximum allowed number of radio links; and/or
- the variable INVALID_CONFIGURATION is set to TRUE:

the UE shall:

- 1> keep the active set as it was before the ACTIVE SET UPDATE message was received;
- 1> transmit an ACTIVE SET UPDATE FAILURE message on the DCCH using AM RLC;
- 1> set the IE "RRC transaction identifier" in the ACTIVE SET UPDATE FAILURE message to the value of "RRC transaction identifier" in the entry for the ACTIVE SET UPDATE message in the table "Accepted transactions" in the variable TRANSACTIONS; and

- 1> clear that entry;
- 1> set the IE "failure cause" to "Invalid configuration";
- 1> When the ACTIVE SET UPDATE FAILURE message has been submitted to lower layers for transmission:
 - 2> the procedure ends on the UE side.

If the following condition is valid:

- the active set update procedure results in active sets that do not contain at least one common radio link before and after a DPCH frame boundary:

the UE behaviour is not specified.

8.3.4.5a Void

8.3.4.5b Incompatible simultaneous reconfiguration

If the variable ORDERED_RECONFIGURATION is set to TRUE, the UE may:

- 1> if the activation time for the procedure that has set variable ORDERED_RECONFIGURATION and the activation time for the Active Set Update procedure are within a time window of 5 frames:
 - 2> transmit an ACTIVE SET UPDATE FAILURE message on the uplink DCCH using AM RLC;
 - 2> set the IE "RRC transaction identifier" in the ACTIVE SET UPDATE FAILURE message to the value of "RRC transaction identifier" in the entry for the ACTIVE SET UPDATE message in the table "Accepted transactions" in the variable TRANSACTIONS; and
 - 2> clear that entry;
 - 2> set the IE "failure cause" to the cause value "incompatible simultaneous reconfiguration";
 - 2> when the ACTIVE SET UPDATE FAILURE message has been delivered to lower layers for transmission:
 - 3> continue with any ongoing processes and procedures as if the ACTIVE SET UPDATE message has not been received.
 - 3> and the procedure ends.

8.3.4.6 Reception of the ACTIVE SET UPDATE COMPLETE message by the UTRAN

When the UTRAN has received the ACTIVE SET UPDATE COMPLETE message,

- 1> the UTRAN may remove radio link(s) that are indicated to remove to the UE in case b) and c); and
- 1> the procedure ends on the UTRAN side.

8.3.4.7 Reception of the ACTIVE SET UPDATE FAILURE message by the UTRAN

When the UTRAN has received the ACTIVE SET UPDATE FAILURE message, the UTRAN may delete radio links that were included in the IE "Radio Link Addition Information" for addition. The procedure ends on the UTRAN side.

8.3.4.8 Invalid ACTIVE SET UPDATE message

If the ACTIVE SET UPDATE message contains a protocol error causing the variable PROTOCOL_ERROR_REJECT to be set to TRUE according to clause 9, the UE shall perform procedure specific error handling as follows. The UE shall:

- 1> transmit a ACTIVE SET UPDATE FAILURE message on the uplink DCCH using AM RLC;

- 1> set the IE "RRC transaction identifier" in the ACTIVE SET UPDATE FAILURE message to the value of "RRC transaction identifier" in the entry for the ACTIVE SET UPDATE message in the table "Rejected transactions" in the variable TRANSACTIONS; and
- 1> clear that entry;
- 1> set the IE "failure cause" to the cause value "protocol error";
- 1> include the IE "Protocol error information" with contents set to the value of the variable PROTOCOL_ERROR_INFORMATION;
- 1> when the ACTIVE SET UPDATE FAILURE message has been delivered to lower layers for transmission:
 - 2> continue with any ongoing processes and procedures as if the invalid ACTIVE SET UPDATE message has not been received;
 - 2> and the procedure ends.

8.3.4.9 Reception of an ACTIVE SET UPDATE message in wrong state

If the UE is in another state than CELL_DCH state upon reception of the ACTIVE SET UPDATE message, the UE shall perform procedure specific error handling as follows. The UE shall:

- 1> transmit a ACTIVE SET UPDATE FAILURE message on the uplink DCCH using AM RLC;
- 1> set the IE "RRC transaction identifier" in the ACTIVE SET UPDATE FAILURE message to the value of "RRC transaction identifier" in the entry for the ACTIVE SET UPDATE message in the table "Accepted transactions" in the variable TRANSACTIONS; and
- 1> clear that entry;
- 1> set the IE "failure cause" to the cause value "protocol error";
- 1> include the IE "Protocol error information" with the IE "Protocol error cause" set to "Message not compatible with receiver state";
- 1> when the ACTIVE SET UPDATE FAILURE message has been delivered to lower layers for transmission:
 - 2> continue with any ongoing processes and procedures as if the ACTIVE SET UPDATE message has not been received;
 - 2> and the procedure ends.

8.3.5 Hard handover

When performing hard handover with change of frequency, the UE shall:

- 1> stop all intra-frequency and inter-frequency measurements on the cells listed in the variable CELL_INFO_LIST. Each stopped measurement is restarted when a MEASUREMENT CONTROL message is received with the corresponding measurement identity.

8.3.5.1 Timing re-initialised hard handover

8.3.5.1.1 General

The purpose of the timing re-initialised hard handover procedure is to remove all the RL(s) in the active set and establish new RL(s) along with a change in the UL transmission timing and the CFN in the UE according to the SFN of the target cell.(see subclause 8.5.15).

This procedure is initiated when UTRAN does not know the target SFN timing before hard handover.

8.3.5.1.2 Initiation

Timing re-initialised hard handover initiated by the UTRAN is normally performed by using the procedure "Physical channel reconfiguration" (subclause 8.2.6), but may also be performed by using either one of the following procedures:

- "radio bearer establishment" (subclause 8.2.1);
- "Radio bearer reconfiguration" (subclause 8.2.2);
- "Radio bearer release" (subclause 8.2.3); or
- "Transport channel reconfiguration" (subclause 8.2.4).

If IE "Timing indication" has the value "initialise", UE shall:

- 1> execute the Timing Re-initialised hard handover procedure by following the procedure indicated in the subclause relevant to the procedure chosen by the UTRAN.

In this case of a timing re-initialised hard handover, UTRAN should include the IE "Default DPCH Offset Value" and:

1> in FDD mode:

- 2> set "Default DPCH Offset Value" and "DPCH frame offset" respecting the following relation

$$(\text{Default DPCH Offset Value}) \bmod 38400 = \text{DPCH frame offset}_j$$

- 3> where j indicates the first radio link listed in the message and the IE values used are the Actual Values of the IEs as defined in clause 11.

If the IE "Default DPCH Offset Value" is included, the UE shall:

1> in FDD mode:

- 2> if the above relation between "Default DPCH Offset Value" and "DPCH frame offset" is not respected:

- 3> set the variable INVALID_CONFIGURATION to true.

If the IE "Default DPCH Offset Value" is not included, the UE shall:

- 1> set the variable INVALID_CONFIGURATION to true.

8.3.5.2 Timing-maintained hard handover

8.3.5.2.1 General

The purpose of the Timing-maintained hard handover procedure is to remove all the RL(s) in the active set and establish new RL(s) while maintaining the UL transmission timing and the CFN in the UE.

This procedure can be initiated only if UTRAN knows the target SFN timing before hard handover. The target SFN timing can be known by UTRAN in the following 2 cases:

- UE reads SFN when measuring "Cell synchronisation information" and sends it to the UTRAN in MEASUREMENT REPORT message.
- UTRAN internally knows the time difference between the cells.

8.3.5.2.2 Initiation

Timing-maintained hard handover initiated by the network is normally performed by using the procedure "Physical channel reconfiguration" (subclause 8.2.6), but may also be performed by using either one of the following procedures:

- "radio bearer establishment" (subclause 8.2.1);
- "Radio bearer reconfiguration" (subclause 8.2.2);
- "Radio bearer release" (subclause 8.2.3); or

- "Transport channel reconfiguration" (subclause 8.2.4).

If IE "Timing indication" has the value "maintain", UE shall initiate the Timing-maintained hard handover procedure by following the procedure indicated in the subclause relevant to the procedure chosen by the UTRAN. In this case UTRAN should not include the IE "Default DPCH Offset Value".

If the IE "Default DPCH Offset Value" is included, the UE shall:

- 1> ignore the IE "Default DPCH Offset Value".

8.3.6 Inter-RAT handover to UTRAN

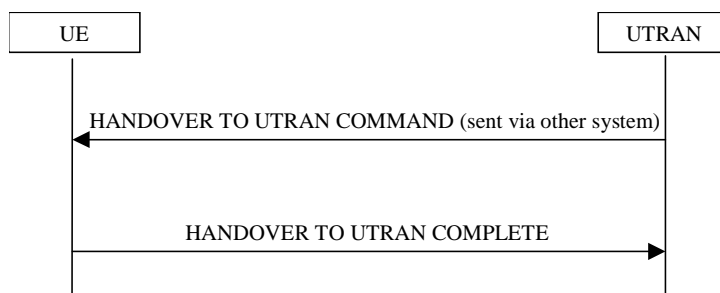

Figure 8.3.6-1: Inter-RAT handover to UTRAN, successful case

8.3.6.1 General

The purpose of the inter-RAT handover procedure is to, under the control of the network, transfer a connection between the UE and another radio access technology (e.g. GSM) to UTRAN.

8.3.6.2 Initiation

The procedure is initiated when a radio access technology other than UTRAN, e.g. GSM, using radio access technology-specific procedures, orders the UE to make a handover to UTRAN.

A HANDOVER TO UTRAN COMMAND message is sent to the UE via the radio access technology from which inter-RAT handover is performed.

In case UTRAN decides to use a predefined or default radio configuration that is stored in the UE, it should include the following information in the HANDOVER TO UTRAN COMMAND message.

- the IE "New U-RNTI" to be assigned;
- the IE "Predefined configuration identity", to indicate which pre-defined configuration of RB, transport channel and physical channel parameters shall be used; or
- the IE "Default configuration mode" and IE "Default configuration identity", to indicate which default configuration of RB, transport channel and physical channel parameters shall be used;
- PhyCH information elements.

NOTE 1: When using a predefined or default configuration during handover to UTRAN, UTRAN can only assign values of IEs "New U-RNTI" and "scrambling code" that are within the special subranges defined exclusively for this procedure. UTRAN may re-assign other values after completion of the handover procedure.

NOTE 2: When using a predefined or default configuration during handover to UTRAN, fewer IEs are signalled; when using this signalling option some parameters e.g. concerning compressed mode, DSCH, SSdT can not be configured. In this case, the corresponding functionality can not be activated immediately.

In case UTRAN does not use a predefined radio configuration that is stored in the UE, it should include the following information in the HANDOVER TO UTRAN COMMAND message.

- the IE "New U-RNTI" to be assigned;
- the complete set of RB, TrCH and PhyCH information elements to be used.

8.3.6.3 Reception of HANDOVER TO UTRAN COMMAND message by the UE

The UE shall be able to receive a HANDOVER TO UTRAN COMMAND message and perform an inter-RAT handover, even if no prior UE measurements have been performed on the target UTRAN cell and/or frequency.

The UE shall act upon all received information elements as specified in subclause 8.6, unless specified otherwise in the following.

The UE may:

- 1> maintain a list of the set of cells to which the UE has Radio Links if the IE "Cell ID" is present.

The UE shall:

- 1> store a U-RNTI value (32 bits), which is derived by the IEs "SRNC identity" (12 bits) and "S-RNTI 2" (10 bits) included in IE "U-RNTI-short". In order to produce a full size U-RNTI value, a full size "S-RNTI" (20 bits) shall be derived by padding the IE "S-RNTI 2" with 10 zero bits in the most significant positions; and
- 1> initialise the variable ESTABLISHED_SIGNALLING_CONNECTIONS with the signalling connections that remains after the handover according to the specifications of the source RAT;
- 1> initialise the variable UE_CAPABILITIES_TRANSFERRED with the UE capabilities that have been transferred to the network up to the point prior to the handover, if any;
- 1> initialise the variable TIMERS_AND_CONSTANTS to the default values and start to use those timer and constants values;
- 1> if IE "Specification mode" is set to "Preconfiguration" and IE "Preconfiguration mode" is set to "Predefined configuration":
 - 2> initiate the radio bearer and transport channel configuration in accordance with the predefined parameters identified by the IE "Predefined configuration identity";
 - 2> initiate the physical channels in accordance with the predefined parameters identified by the IE "Predefined radio configuration identity" and the received physical channel information elements;
 - 2> store information about the established radio access bearers and radio bearers according to the IE "Predefined configuration identity"; and
 - 2> set the IE "RAB Info Post" in the variable ESTABLISHED_RABS and the IE "Re-establishment timer" in the IE "RAB Info" in the variable ESTABLISHED_RABS to "useT314".
- 1> if IE "Specification mode" is set to "Preconfiguration" and IE "Preconfiguration mode" is set to "Default configuration":
 - 2> initiate the radio bearer and transport channel configuration in accordance with the default parameters identified by the IE "Default configuration mode" and IE "Default configuration identity";
 - 2> initiate the physical channels in accordance with the default parameters identified by the IE "Default configuration mode" and IE "Default configuration identity" and the received physical channel information elements;

NOTE: IE "Default configuration mode" specifies whether the FDD or TDD version of the default configuration shall be used.

- 2> set the IE "RAB Info Post" in the variable ESTABLISHED_RABS and the IE "Re-establishment timer" in the IE "RAB Info" in the variable ESTABLISHED_RABS to "useT314".
- 1> if IE "Specification mode" is set to "Preconfiguration":

2> use the following values for parameters that are neither signalled within the HANOVER TO UTRAN COMMAND message nor included within pre-defined or default configuration:

3> 0 dB for the power offset $P_{\text{Pilot-DPDCH}}$ bearer in FDD;

3> calculate the Default DPCH Offset Value using the following formula:

3> in FDD:

$$\text{Default DPCH Offset Value} = (\text{SRNTI} \cdot 2 \bmod 600) * 512$$

3> in TDD:

$$\text{Default DPCH Offset Value} = (\text{SRNTI} \cdot 2 \bmod 7)$$

3> handle the above Default DPCH Offset Value as if an IE with that value was included in the message, as specified in subclause 8.6.6.21.

1> if IE "Specification mode" is set to "Complete specification":

2> initiate the radio bearer, transport channel and physical channel configuration in accordance with the received radio bearer, transport channel and physical channel information elements.

1> perform an open loop estimation to determine the UL transmission power according to subclause 8.5.3;

1> set the IE "START" for each CN domain, in the IE "START list" in the HANOVER TO UTRAN COMPLETE message equal to the START value for each CN domain stored in the USIM if the USIM is present, or as stored in the UE for each CN domain if the SIM is present;

1> if ciphering has been activated and ongoing in the radio access technology from which inter- RAT handover is performed:

2> for the CN domain included in the IE "CN domain identity" which is included in the IE "RAB info" of the IE "RAB information to setup", or the CS domain when these IEs are not present:

3> set the variable LATEST_CONFIGURED_CN_DOMAIN to the value indicated in the IE "CN domain identity", or to the CS domain when this IE is not present;

3> set the 20 MSB of the HFN component of the COUNT-C variable for all radio bearers using RLC-TM and all signalling radio bearers to the "START" value included in the IE "UE security information" in the variable "INTER_RAT_HANOVER_INFO_TRANSFERRED";

3> set the remaining LSBs of the HFN component of COUNT-C for all radio bearers using RLC-TM and all signalling radio bearers to zero;

3> not increment the HFN component of COUNT-C for radio bearers using RLC-TM, i.e. keep the HFN value fixed without incrementing every CFN cycle;

3> set the CFN component of the COUNT-C variable to the value of the CFN as calculated in subclause 8.5.15;

3> set the IE "Status" in the variable CIPHERING_STATUS to "Started";

3> apply the algorithm according to IE "Ciphering Algorithm" and apply ciphering immediately upon reception of the HANOVER TO UTRAN COMMAND.

1> if ciphering has not been activated and ongoing in the radio access technology from which inter-RAT handover is performed:

2> for the CN domain included in the IE "CN domain identity" which is included in the IE "RAB info" of the IE "RAB information to setup", or the CS domain when these IEs are not present:

3> set the IE "Status" in the variable CIPHERING_STATUS to "Not Started".

If the UE succeeds in establishing the connection to UTRAN, it shall:

- 1> if the IE "Status" in the variable CIPHERING_STATUS of a CN domain is set to "Started" and transparent mode radio bearers have been established by this procedure for that CN domain:
 - 2> include the IE "COUNT-C activation time" in the response message and specify a CFN value for this IE other than the default, "Now", that is a multiple of 8 frames ($CFN \bmod 8 = 0$) and lies at least 200 frames ahead of the CFN in which the response message is first transmitted;
 - 2> at the CFN value as indicated in the response message in the IE "COUNT-C activation time" for radio bearers using RLC-TM:
 - 3> set the 20 MSB of the HFN component of the COUNT-C variable common for all transparent mode radio bearers of this CN domain to the START value as indicated in the IE "START list" of the response message for the relevant CN domain; and
 - 3> set the remaining LSBs of the HFN component of COUNT-C to zero;
 - 3> increment the HFN component of the COUNT-C variable by one even if the "COUNT-C activation time" is equal to zero;
 - 3> set the CFN component of the COUNT-C to the value of the IE "COUNT-C activation time" of the response message. The HFN component and the CFN component completely initialise the COUNT-C variable;
 - 3> step the COUNT-C variable, as normal, at each CFN value. The HFN component is no longer fixed in value but incremented at each CFN cycle.
- 1> if the IE "Status" in the variable CIPHERING_STATUS of a CN domain is set to "Not Started" and transparent mode radio bearers have been established by this procedure for that CN domain:
 - 2> initialise the 20 MSB of the HFN component of COUNT-C common for all transparent mode radio bearers of this CN domain with the START value as indicated in the IE "START list" of the response message for the relevant CN domain;
 - 2> set the remaining LSBs of the HFN component of COUNT-C to zero;
 - 2> do not increment the COUNT-C value common for all transparent mode radio bearers for this CN domain.
- 1> transmit a HANOVER TO UTRAN COMPLETE message on the uplink DCCH, using, if ciphering has been started, the new ciphering configuration;
- 1> when the HANOVER TO UTRAN COMPLETE message has been submitted to lower layers for transmission:
 - 2> enter UTRA RRC connected mode in state CELL_DCH;
 - 2> initialise variables upon entering UTRA RRC connected mode as specified in subclause 13.4;
 - 2> update the variable UE_CAPABILITY_TRANSFERRED with the UE capabilities stored in the variable INTER_RAT_HANOVER_INFO_TRANSFERRED;
 - 2> for all radio bearers using RLC-AM or RLC-UM:
 - 3> set the 20 MSB of the HFN component of the uplink and downlink COUNT-C variable to the START value indicated in the IE "START list" of the response message for the relevant CN domain; and
 - 3> set the remaining LSBs of the HFN component of COUNT-C to zero;
 - 3> increment the HFN component of the COUNT-C variable by one;
 - 3> start incrementing the COUNT-C values.
- 1> and the procedure ends.

8.3.6.4 Invalid Handover to UTRAN command message

If the UE receives a HANOVER TO UTRAN COMMAND message, which contains a protocol error causing the variable `PROTOCOL_ERROR_REJECT` to be set to `TRUE` according to clause 9, the UE shall perform procedure specific error handling according to the source radio access technology. The UE shall:

- 1> if allowed by the source RAT:
 - 2> transmit an RRC FAILURE INFO message to the source radio access technology; and
 - 2> include the IE "Protocol error information" with contents set to the value of the variable `PROTOCOL_ERROR_INFORMATION`;
- 1> Other details may be provided in the specifications related to the source radio access technology.

NOTE: The other RAT may include the above diagnostics information in a subsequent handover request towards the same RNC.

8.3.6.4a Unsupported configuration in HANOVER TO UTRAN COMMAND message

If the UE does not support the configuration included in the HANOVER TO UTRAN COMMAND message, e.g., the message includes a pre-defined configuration that the UE has not stored, the UE shall:

- 1> continue the connection using the other radio access technology; and
- 1> indicate the failure to the other radio access technology.

8.3.6.5 UE fails to perform handover

If the UE does not succeed in establishing the connection to UTRAN, it shall:

- 1> terminate the procedure including release of the associated resources;
- 1> resume the connection used before the handover; and
- 1> indicate the failure to the other radio access technology.

Upon receiving an indication about the failure from the other radio access technology, UTRAN should release the associated resources and the context information concerning this UE.

8.3.6.6 Reception of message HANOVER TO UTRAN COMPLETE by the UTRAN

Upon receiving a HANOVER TO UTRAN COMPLETE message, UTRAN should consider the inter-RAT handover procedure as having been completed successfully and indicate this to the Core Network.

8.3.7 Inter-RAT handover from UTRAN

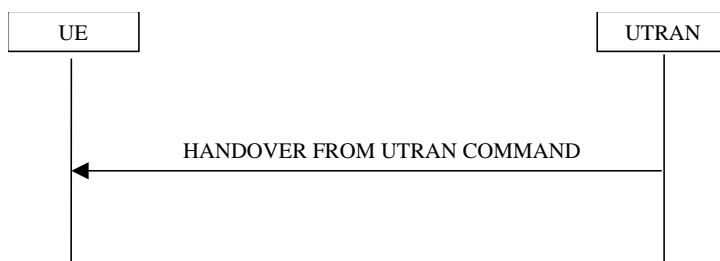

Figure 8.3.7-1: Inter-RAT handover from UTRAN, successful case

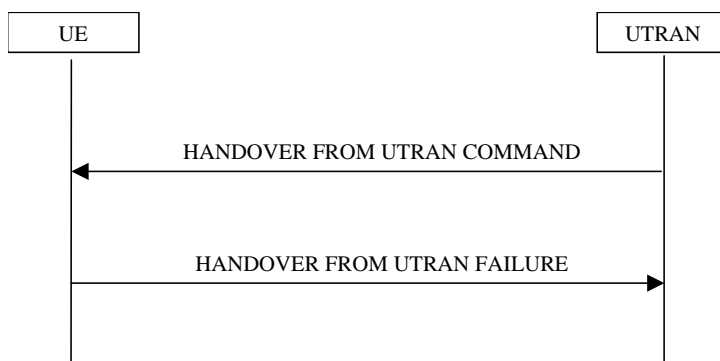

Figure 8.3.7-2: Inter-RAT handover from UTRAN, failure case

8.3.7.1 General

The purpose of the inter-RAT handover procedure is to, under the control of the network, transfer a connection between the UE and UTRAN to another radio access technology (e.g. GSM). This procedure may be used in CELL_DCH state. This procedure may be used when no RABs are established or when the established RABs are only in the CS domain or when the established RABs are in both CS and PS domains.

8.3.7.2 Initiation

The procedure is initiated when UTRAN orders a UE in CELL_DCH state, to make a handover to a radio access technology other than UTRAN, e.g. GSM.

To initiate the procedure, UTRAN sends a HANDOVER FROM UTRAN COMMAND message.

8.3.7.3 Reception of a HANDOVER FROM UTRAN COMMAND message by the UE

The UE shall be able to receive a HANDOVER FROM UTRAN COMMAND message and perform an inter-RAT handover, even if no prior UE measurements have been performed on the target cell.

The UE shall:

- 1> establish the connection to the target radio access technology, by using the contents of the IE "Inter-RAT message". This IE contains a message specified in another standard, as indicated by the IE "System type", and carries information about the candidate/ target cell identifier(s) and radio parameters relevant for the target radio access technology. The correspondence between the value of the IE "System type", the standard to apply and the message contained within IE "Inter RAT message" is shown in the following:

Value of the IE "System type"	Standard to apply	Inter RAT Message
GSM	GSM TS 04.18, version 8.5.0 or later	HANDOVER COMMAND
cdma2000	TIA/EIA/IS-2000 or later, TIA/EIA/IS-833 or later, TIA/EIQ/IS-834 or later	

- 1> if the IE "System type" has the value "GSM":

- 2> if the IE "Frequency band" has the value "GSM /DCS 1800 band used":
 - 3> set the BAND_INDICATOR [45] to "ARFCN indicates 1800 band".
- 2> if the IE "Frequency band" has the value " GSM /PCS 1900 band used":
 - 3> set the BAND_INDICATOR [45] to "ARFCN indicates 1900 band".

- 1> apply the "Inter RAT Message" according to the "standard to apply" in the table above.

- 1> if the IE "RAB information List" is included in the HANDOVER FROM UTRAN COMMAND message:

2> if the IE "RAB information List" includes one IE "RAB Info" with the IE "CN domain Identity" set to "CS domain":

3> connect upper layer entities corresponding to the indicated CS domain RAB to the radio resources indicated in the inter-RAT message.

NOTE: In this version of the specification the maximum number of CS domain RABs which may be included in the IE "RAB information List" is limited to 1.

NOTE: Requirements concerning the establishment of the radio connection towards the other radio access technology and the signalling procedure are outside the scope of this specification.

8.3.7.4 Successful completion of the inter-RAT handover

Upon successfully completing the handover, UTRAN should:

1> release the radio connection; and

1> remove all context information for the concerned UE.

Upon successfully completing the handover, the UE shall:

1> if there are any NAS messages with the IE "CN domain identity" set to "CS domain" for which the successful delivery of the INITIAL DIRECT TRANSFER message or UPLINK DIRECT TRANSFER message on signalling radio bearer RB3 or signalling radio bearer RB4 that have not yet been confirmed by RLC:

2> retransmit those NAS messages to the network on the newly established radio connection to the target radio access technology.

1> clear or set variables upon leaving UTRA RRC connected mode as specified in subclause 13.4.

NOTE: The release of the UMTS radio resources is initiated from the target RAT.

8.3.7.5 UE fails to complete requested handover

If the UE does not succeed in establishing the connection to the target radio access technology, it shall:

1> revert back to the UTRA configuration;

1> establish the UTRA physical channel(s) used at the time for reception of HANDOVER FROM UTRAN COMMAND;

1> if the UE does not succeed to establish the UTRA physical channel(s):

2> perform a cell update procedure according to subclause 8.3.1 with cause "Radio link failure";

2> when the cell update procedure has completed successfully:

3> proceed as below.

1> transmit the HANDOVER FROM UTRAN FAILURE message setting the information elements as specified below:

2> include the IE "RRC transaction identifier"; and

2> set it to the value of "RRC transaction identifier" in the entry for the HANDOVER FROM UTRAN COMMAND message in the table "Accepted transactions" in the variable TRANSACTIONS; and

2> clear that entry;

2> set the IE "Inter-RAT handover failure" to "physical channel failure".

1> When the HANDOVER FROM UTRAN FAILURE message has been submitted to lower layer for transmission:

2> the procedure ends.

8.3.7.6 Invalid HANDOVER FROM UTRAN COMMAND message

If the IE "Inter-RAT message" received within the HANDOVER FROM UTRAN COMMAND message does not include a valid inter RAT handover message in accordance with the protocol specifications for the target RAT, the UE shall perform procedure specific error handling as follows. The UE shall:

- 1> set the IE "failure cause" to the cause value "Inter-RAT protocol error";
- 1> include the IE "Inter-RAT message" in accordance with the specifications applicable to the other RAT;
- 1> transmit a HANDOVER FROM UTRAN FAILURE message on the uplink DCCH using AM RLC;
- 1> when the transmission of the HANDOVER FROM UTRAN FAILURE message has been confirmed by RLC:
 - 2> continue with any ongoing processes and procedures as if the invalid HANDOVER FROM UTRAN COMMAND message has not been received;
 - 2> and the procedure ends.

If the HANDOVER FROM UTRAN COMMAND message contains a protocol error causing the variable `PROTOCOL_ERROR_REJECT` to be set to TRUE according to clause 9, the UE shall perform procedure specific error handling as follows. The UE shall:

- 1> set the IE "RRC transaction identifier" in the HANDOVER FROM UTRAN FAILURE message to the value of "RRC transaction identifier" in the entry for the HANDOVER FROM UTRAN COMMAND message in the table "Rejected transactions" in the variable `TRANSACTIONS`; and
- 1> clear that entry;
- 1> set the IE "failure cause" to the cause value "protocol error";
- 1> include the IE "Protocol error information" with contents set to the value of the variable `PROTOCOL_ERROR_INFORMATION`;
- 1> transmit a HANDOVER FROM UTRAN FAILURE message on the uplink DCCH using AM RLC;
- 1> when the HANDOVER FROM UTRAN FAILURE message has been submitted to lower layers for transmission:
 - 2> continue with any ongoing processes and procedures as if the invalid HANDOVER FROM UTRAN COMMAND message has not been received;
 - 2> and the procedure ends.

8.3.7.7 Reception of an HANDOVER FROM UTRAN FAILURE message by UTRAN

Upon receiving an HANDOVER FROM UTRAN FAILURE message, UTRAN may initiate the release the resources in the target radio access technology.

8.3.7.8 Unsupported configuration in HANDOVER FROM UTRAN COMMAND message

If:

- the UTRAN instructs the UE to perform a non-supported handover scenario; or
- the UTRAN instructs the UE to use a non-supported configuration; or
- the IE "RAB information List" is included in the HANDOVER FROM UTRAN COMMAND message and this IE does not include any IE "RAB Info" with the IE "CN domain Identity" set to "CS domain":

the UE shall:

- 1> transmit a HANDOVER FROM UTRAN FAILURE message, setting the information elements as specified below:

- 2> include the IE "RRC transaction identifier"; and
- 2> set it to the value of "RRC transaction identifier" in the entry for the HANOVER FROM UTRAN COMMAND message in the table "Accepted transactions" in the variable TRANSACTIONS; and
- 2> clear that entry;
- 2> set the IE "Inter-RAT handover failure" to "configuration unacceptable";
- 2> when the HANOVER FROM UTRAN FAILURE message has been submitted to lower layers for transmission:
 - 3> resume normal operation as if the invalid HANOVER FROM UTRAN COMMAND message has not been received;
 - 3> and the procedure ends.

8.3.7.8a Reception of HANOVER FROM UTRAN COMMAND message by UE in CELL_FACH

If the UE receives HANOVER FROM UTRAN COMMAND while in CELL_FACH, the UE shall:

- 1> transmit a HANOVER FROM UTRAN FAILURE message, setting the information elements as specified below:
 - 2> include the IE "RRC transaction identifier"; and
 - 2> set it to the value of "RRC transaction identifier" in the entry for the HANOVER FROM UTRAN COMMAND message in the table "Accepted transactions" in the variable TRANSACTIONS; and
 - 2> clear that entry;
 - 2> set the IE "Inter-RAT handover failure" to "protocol error", include IE "Protocol error information"; and
 - 2> set the value of IE "Protocol error cause" to "Message not compatible with receiver state";
 - 2> when the HANOVER FROM UTRAN FAILURE message has been submitted to lower layers for transmission:
 - 3> resume normal operation as if the invalid HANOVER FROM UTRAN COMMAND message has not been received;
 - 3> and the procedure ends.

8.3.8 Inter-RAT cell reselection to UTRAN

8.3.8.1 General

The purpose of the inter-RAT cell reselection procedure to UTRAN is to transfer, under the control of the UE and to some extent the source radio access technology, a connection between the UE and another radio access technology (e.g. GSM/GPRS, but not UTRAN) to UTRAN.

8.3.8.2 Initiation

When the UE makes an inter-RAT cell reselection to UTRAN according to the criteria specified in [4], it shall initiate this procedure. The inter-RAT cell reselection made by the UE may use system information broadcast from the source radio access technology or UE dedicated information.

If the NAS procedures associated with inter-system change specified in [5] require the establishment of an RRC connection, the UE shall:

- 1> set the variable ESTABLISHMENT_CAUSE to "Inter-RAT cell reselection";

NOTE: This value of ESTABLISHMENT_CAUSE has priority over the cause requested by upper layers.

- 1> initiate an RRC connection establishment procedure as specified in subclause 8.1.3;
- 1> after initiating an RRC connection establishment:
 - 2> release all resources specific to the other radio access technology.

If the NAS procedures associated with inter-system change specified in [5] do not require the establishment of an RRC connection, the UE shall:

- 1> enter idle mode in the target cell without accessing the cell; and
- 1> release all resources specific to the other radio access technology.

8.3.8.3 UE fails to complete an inter-RAT cell reselection

If the inter-RAT cell reselection fails before the UE has initiated the RRC connection establishment the UE may return back to the other radio access technology.

If the RRC connection establishment fails, the UE shall enter idle mode.

8.3.9 Inter-RAT cell reselection from UTRAN

8.3.9.1 General

The purpose of the inter-RAT cell reselection procedure from UTRAN is to transfer, under the control of the UE and to some extent the UTRAN, a connection between the UE and UTRAN to another radio access technology (e.g. GSM/GPRS).

8.3.9.2 Initiation

This procedure is applicable in states CELL_FACH, CELL_PCH or URA_PCH.

When the UE based on received system information makes a cell reselection to a radio access technology other than UTRAN, e.g. GSM/GPRS, according to the criteria specified in [4], the UE shall:

- 1> If the NAS procedures associated with inter-system change specified in [5] require the establishment of a connection:
 - 2> initiate the establishment of a connection to the target radio access technology according to its specifications.

8.3.9.3 Successful cell reselection

When the UE has succeeded in reselecting a cell in the target radio access technology, the UE shall:

- 1> release all UTRAN specific resources.

UTRAN should:

- 1> release all UE dedicated resources upon indication that the UE has completed a connection establishment to the other radio access technology.

8.3.9.4 UE fails to complete an inter-RAT cell reselection

If the inter-RAT cell reselection fails, the UE shall:

- 1> resume the connection to UTRAN using the resources used before initiating the inter-RAT cell reselection procedure.

8.3.10 Inter-RAT cell change order to UTRAN

8.3.10.1 General

The purpose of the inter-RAT cell change order to UTRAN procedure is to transfer, under the control of the source radio access technology, a connection between the UE and another radio access technology (e.g. GSM/GPRS) to UTRAN.

8.3.10.2 Initiation

The procedure is initiated when a radio access technology other than UTRAN, e.g. GSM/GPRS, using procedures specific for that RAT, orders the UE to change to a UTRAN cell.

NOTE: Within the message used to order the UE to change to a UTRAN cell, the source RAT should specify the identity of the target UTRAN cell as specified in the specifications for that RAT.

The UE shall:

1> set the variable ESTABLISHMENT_CAUSE to "Inter-RAT cell change order";

NOTE: This value of ESTABLISHMENT_CAUSE has priority over the cause requested by upper layers.

1> initiate an RRC connection establishment procedure as specified in subclause 8.1.3.

8.3.10.3 UE fails to complete an inter-RAT cell change order

If the inter-RAT cell reselection fails the UE shall return to the other radio access technology and proceed as specified in the appropriate specifications for that RAT.

NOTE 3: The cell change was network ordered. Therefore, failure to change to the target cell should not cause the UE to move to UE- controlled cell selection.

8.3.11 Inter-RAT cell change order from UTRAN

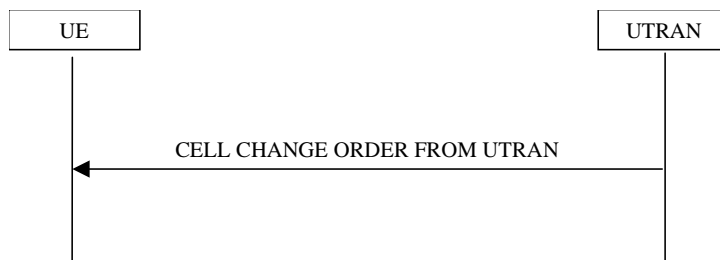

Figure 8.3.11-1: Inter-RAT cell change order from UTRAN

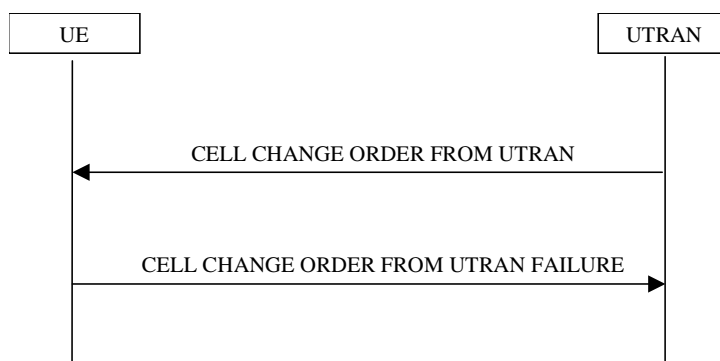

Figure 8.3.11-2: Inter-RAT cell change order from UTRAN, failure case

8.3.11.1 General

The purpose of the inter-RAT cell change order procedure is to transfer, under the control of the network, a connection between the UE and UTRAN to another radio access technology (e.g. GSM). This procedure may be used in CELL_DCH and CELL_FACH state. This procedure may be used when no RABs are established or when the established RABs are only from PS domain. This procedure may not be used when there is no PS signalling connection.

8.3.11.2 Initiation

The procedure is initiated when UTRAN orders a UE in CELL_DCH or CELL_FACH state, to make a cell change to a radio access technology other than UTRAN, e.g. GSM.

To initiate the procedure, UTRAN sends a CELL CHANGE ORDER FROM UTRAN message.

8.3.11.3 Reception of an CELL CHANGE ORDER FROM UTRAN message by the UE

The UE shall be able to receive a CELL CHANGE ORDER FROM UTRAN message and perform a cell change order to another RAT, even if no prior UE measurements have been performed on the target cell.

If the variable ESTABLISHED_SIGNALLING_CONNECTIONS does not include the CN domain identity "PS domain", or if the variable ESTABLISHED_SIGNALLING_CONNECTIONS includes the CN domain identity "CS domain":

- 1> the UE shall act as if the message was never received.

The UE shall:

- 1> start timer T309; and
- 1> establish the connection to the other radio access technology, as specified within IE "Target cell description". This IE specifies the target cell identity, in accordance with the specifications for that other RAT. In case the target cell is a GSM/ GPRS cell, IE "Target cell description" may also include IE "NC mode", which specifies the cell selection mode to be applied in the target cell; and
- 1> if IE "NC mode" is not included in the CELL CHANGE ORDER FROM UTRAN:
 - 2> retrieve it from the target cell as specified in [43];
 - 2> act upon IE "NC mode" as specified in [43].
- 1> if the IE "RAB Information List" is included in the CELL CHANGE ORDER FROM UTRAN message:
 - 2> ignore the contents of the IE "RAB Information List".

NOTE: Requirements concerning the establishment of the radio connection towards the other radio access technology and the signalling procedure are outside the scope of this specification. In case of GSM/GPRS proceed according to the procedure Network control cell reselection procedure as specified in [44].

8.3.11.4 Successful completion of the cell change order

The UE regards the procedure as completed when it has received a successful response from the target RAT, e.g. in case of GSM when it received the response to a (PACKET) CHANNEL REQUEST in the new cell.

Upon successful completion of the cell change order, the UE shall:

- 1> stop timer T309;
- 1> clear or set variables upon leaving UTRA RRC connected mode as specified in subclause 13.4.

Upon indication of the UE having successfully completed the cell change order, UTRAN should:

- 1> release the radio connection; and
- 1> remove all context information for the concerned UE.

NOTE: The release of the UMTS radio resources is initiated from another RAT.

8.3.11.5 Expiry of timer T309 or UE fails to complete requested cell change order

If:

- timer T309 expires prior to the successful establishment of a connection to the target RAT; or
- if the establishment of the connection to the other RAT failed due to other reasons e.g. (random) access failure, rejection due to lack of resources:

the UE shall:

- 1> if it received the CELL CHANGE ORDER FROM UTRAN message in state CELL_DCH:
 - 2> revert back to the UTRA configuration;
 - 2> establish the UTRA physical channel(s) used at the time for reception of CELL CHANGE ORDER FROM UTRAN;
 - 2> if the UE does not succeed in establishing the UTRA physical channel(s):
 - 3> perform a cell update procedure according to subclause 8.3.1 with cause "Radio link failure";
 - 3> when the cell update procedure has completed successfully:
 - 4> proceed as below.
 - 2> transmit the CELL CHANGE ORDER FROM UTRAN FAILURE message setting the information elements as specified below:
 - 3> include the IE "RRC transaction identifier"; and
 - 3> set it to the value of "RRC transaction identifier" in the entry for the received message in the table "Accepted transactions" in the variable TRANSACTIONS; and
 - 3> clear that entry;
 - 3> set the IE "Inter-RAT change failure" to "physical channel failure".
 - 2> When the CELL CHANGE ORDER FROM UTRAN FAILURE message has been submitted to lower layer for transmission, the procedure ends.
- 1> if the UE receives the CELL CHANGE ORDER FROM UTRAN message in CELL_FACH state:
 - 2> revert to the cell it was camped on at the reception of the CELL CHANGE ORDER FROM UTRAN message;
 - 2> if the UE is unable to return to this cell:
 - 3> select a suitable UTRA cell according to [4];
 - 3> initiate the cell update procedure according to subclause 8.3.1 using the cause "cell re-selection";
 - 3> when the cell update procedure completed successfully:
 - 4> proceed as below.
 - 2> transmit the CELL CHANGE ORDER FROM UTRAN FAILURE message setting the information elements as specified below:
 - 3> include the IE "RRC transaction identifier"; and
 - 3> set it to the value of "RRC transaction identifier" in the entry for the CELL CHANGE ORDER FROM UTRAN message in the table "Accepted transactions" in the variable TRANSACTIONS; and
 - 3> clear that entry;

- 3> set the IE "Inter-RAT change failure" to "physical channel failure".
- 2> When the CELL CHANGE ORDER FROM UTRAN FAILURE message has been submitted to lower layer for transmission:
 - 3> the procedure ends.

8.3.11.6 Unsupported configuration in CELL CHANGE ORDER FROM UTRAN message

If the UTRAN instructs the UE to perform a non-supported cell change order scenario or to use a non-supported configuration, the UE shall:

- 1> transmit a CELL CHANGE ORDER FROM UTRAN FAILURE message, setting the information elements as specified below:
 - 2> include the IE "RRC transaction identifier"; and
 - 2> set it to the value of "RRC transaction identifier" in the entry for the received message in the table "Accepted transactions" in the variable TRANSACTIONS; and
 - 2> clear that entry;
 - 2> set the IE "Inter-RAT change failure" to "configuration unacceptable";
 - 2> when the CELL CHANGE ORDER FROM UTRAN FAILURE message has been submitted to lower layers for transmission:
 - 3> resume normal operation as if the CELL CHANGE ORDER FROM UTRAN message has not been received;
 - 3> and the procedure ends.

8.3.11.7 Invalid CELL CHANGE ORDER FROM UTRAN message

If the CELL CHANGE ORDER FROM UTRAN message contains a protocol error causing the variable `PROTOCOL_ERROR_REJECT` to be set to TRUE according to clause 9, the UE shall perform procedure specific error handling as follows. The UE shall:

- 1> set the IE "RRC transaction identifier" in the CELL CHANGE ORDER FROM UTRAN FAILURE message to the value of "RRC transaction identifier" in the entry for the CELL CHANGE ORDER FROM UTRAN message in the table "Rejected transactions" in the variable TRANSACTIONS; and
- 1> clear that entry;
- 1> set the IE "Inter-RAT change failure" to the cause value "protocol error";
- 1> include the IE "Protocol error information" with contents set to the value of the variable `PROTOCOL_ERROR_INFORMATION`;
- 1> transmit a CELL CHANGE ORDER FROM UTRAN FAILURE message on the uplink DCCH using AM RLC;
- 1> when the CELL CHANGE ORDER FROM UTRAN FAILURE message has been submitted to lower layers for transmission:
 - 2> resume normal operation as if the invalid CELL CHANGE ORDER FROM UTRAN message has not been received;
 - 2> and the procedure ends.

8.4 Measurement procedures

8.4.0 Measurement related definitions

UTRAN may control a measurement in the UE either by broadcast of SYSTEM INFORMATION and/or by transmitting a MEASUREMENT CONTROL message.

The following information is used to control the UE measurements and the measurement results reporting:

1. **Measurement identity:** A reference number that should be used by the UTRAN when setting up, modifying or releasing the measurement and by the UE in the measurement report.
2. **Measurement command:** One out of three different measurement commands.
 - Setup: Setup a new measurement.
 - Modify: Modify a previously defined measurement, e.g. to change the reporting criteria.
 - Release: Stop a measurement and clear all information in the UE that are related to that measurement.
3. **Measurement type:** One of the types listed below describing what the UE shall measure.

Presence or absence of the following control information depends on the measurement type

4. **Measurement objects:** The objects on which the UE shall measure measurement quantities, and corresponding object information.
5. **Measurement quantity:** The quantity the UE shall measure on the measurement object. This also includes the filtering of the measurements.
6. **Reporting quantities:** The quantities the UE shall include in the report in addition to the quantities that are mandatory to report for the specific event.
7. **Measurement reporting criteria:** The triggering of the measurement report, e.g. periodical or event-triggered reporting.
8. **Measurement Validity:** Defines in which UE states the measurement is valid.
9. **Measurement reporting mode:** This specifies whether the UE shall transmit the measurement report using AM or UM RLC.
10. **Additional measurement identities:** A list of references to other measurements. When this measurement triggers a measurement report, the UE shall also include the reporting quantities for the measurements referenced by the additional measurement identities.

All these measurement parameters depend on the measurement type and are described in more detail in clause 14.

The different types of measurements are:

- **Intra-frequency measurements:** measurements on downlink physical channels at the same frequency as the active set. A measurement object corresponds to one cell. Detailed description is found in subclause 14.1.
- **Inter-frequency measurements:** measurements on downlink physical channels at frequencies that differ from the frequency of the active set and on downlink physical channels in the active set. A measurement object corresponds to one cell. Detailed description is found in subclause 14.2.
- **Inter-RAT measurements:** measurements on downlink physical channels belonging to another radio access technology than UTRAN, e.g. GSM. A measurement object corresponds to one cell. Detailed description is found in subclause 14.3.
- **Traffic volume measurements:** measurements on uplink traffic volume. A measurement object corresponds to one cell. Detailed description is found in subclause 14.4.

- **Quality measurements:** Measurements of downlink quality parameters, e.g. downlink transport block error rate. A measurement object corresponds to one transport channel in case of BLER. A measurement object corresponds to one timeslot in case of SIR (TDD only). Detailed description is found in subclause 14.5.
- **UE-internal measurements:** Measurements of UE transmission power and UE received signal level. Detailed description is found in subclause 14.6.
- **UE positioning measurements:** Measurements of UE position. Detailed description is found in subclause 14.7.

The UE shall support a number of measurements running in parallel as specified in [19] and [20]. The UE shall also support that each measurement is controlled and reported independently of every other measurement.

Cells that the UE is monitoring are grouped in the UE into three mutually exclusive categories:

1. Cells, which belong to the **active set**. User information is sent from all these cells. In FDD, the cells in the active set are involved in soft handover. In TDD the active set always comprises one cell only. The UE shall only consider active set cells included in the variable CELL_INFO_LIST for measurement; i.e. active set cells not included in the CELL_INFO_LIST shall not be considered in any event evaluation and measurement reporting.
2. Cells, which are not included in the active set, but are included in the CELL_INFO_LIST belong to the **monitored set**.
3. Cells detected by the UE, which are neither in the CELL_INFO_LIST nor in the active set belong to the **detected set**. Reporting of measurements of the detected set is only applicable to intra-frequency measurements made by UEs in CELL_DCH state.

If the IE "Cells for measurement" has been included in a MEASUREMENT CONTROL message, only monitored set cells explicitly indicated for a given intra-frequency (resp. inter-frequency, interRAT) measurement by the IE "Cells for measurement" shall be considered for measurement. If the IE "Cells for measurement" has not been included in a MEASUREMENT CONTROL message, all of the intra-frequency (resp. inter-frequency, inter RAT) cells stored in the variable CELL_INFO_LIST shall be considered for measurement. The IE "Cells for measurement" is not applicable to active set cells or virtual active set cells e.g. when the triggering condition refers to active set cells, the UE shall consider all active set cells in the CELL_INFO_LIST for measurement irrespective if these cells are explicitly indicated by the IE "Cells for measurement".

8.4.1 Measurement control



Figure 8.4.1-1: Measurement Control, normal case

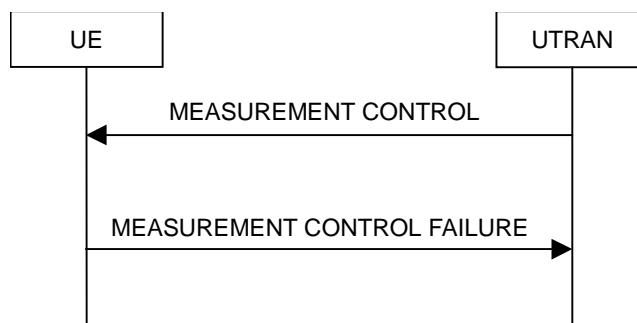

Figure 8.4.1-2: Measurement Control, failure case

8.4.1.1 General

The purpose of the measurement control procedure is to setup, modify or release a measurement in the UE.

8.4.1.2 Initiation

The UTRAN may request a measurement by the UE to be setup, modified or released with a MEASUREMENT CONTROL message, which is transmitted on the downlink DCCH using AM RLC.

The UTRAN should take the UE capabilities into account when a measurement is requested from the UE.

When a new measurement is created, UTRAN should set the IE "Measurement identity" to a value, which is not used for other measurements. UTRAN may use several "Measurement identity" for the same "Measurement type". In case of setting several "Measurement identity" within a same "Measurement type", the measurement object or the list of measurement objects can be set differently for each measurement with different "Measurement identity".

When a current measurement is modified or released, UTRAN should set the IE "Measurement identity" to the value, which is used for the measurement being modified or released. In case of modifying IEs within a "Measurement identity", it is not needed for UTRAN to indicate the IEs other than modified IEs, and the UE continues to use the current values of the IEs that are not modified. UTRAN should not use "modify" to change the type of measurement stored in the variable MEASUREMENT_IDENTITY for a given measurement identity.

8.4.1.3 Reception of MEASUREMENT CONTROL by the UE

Upon reception of a MEASUREMENT CONTROL message the UE shall perform actions specified in subclause 8.6 unless otherwise specified below.

The UE shall:

- 1> read the IE "Measurement command";
- 1> if the IE "Measurement command" has the value "setup":
 - 2> store this measurement in the variable MEASUREMENT_IDENTITY according to the IE "measurement identity", first releasing any previously stored measurement with that identity if that exists;
 - 2> if the measurement type is quality, UE internal, intra-frequency, inter-frequency or inter-RAT:
 - 3> if the UE is in CELL_FACH state:
 - 4> the UE behaviour is not specified.
 - 2> for measurement types "inter-RAT measurement" or "inter-frequency measurement" that require measurements on a frequency other than the actually used frequency:
 - 3> if, according to its measurement capabilities, the UE requires compressed mode to perform that measurement type and after reception of this message a compressed mode pattern sequence with an appropriate measurement purpose is active according to the IE "Current TGPS Status Flag" in UE variable TGPS_IDENTITY; or
 - 3> if, according to its measurement capabilities, the UE does not require compressed mode to perform the measurements on at least one supported band of that measurement type:
 - 4> if the measurement is valid in the current RRC state of the UE:
 - 5> begin measurements according to the stored control information for this measurement identity.

NOTE: The UE is not required to perform measurements on cells for which it needs compressed mode but a suitable compressed mode pattern is not activated.

- 2> for measurement type "inter-frequency measurement" that requires measurements only on the same frequency as the actually used frequency:
 - 3> if the measurement is valid in the current RRC state of the UE:

- 4> begin measurements according to the stored control information for this measurement identity.
- 2> for measurement type "UE positioning measurement":
 - 3> if the UE is in CELL_FACH state:
 - 4> if IE "Positioning Method" is set to "OTDOA":
 - 5> if IE "Method Type" is set to "UE assisted":
 - 6> if IE "UE positioning OTDOA assistance data for UE assisted" is not included:
 - 7> if System Information Block type 15.4 is broadcast:
 - 8> read System Information Block type 15.4.
 - 7> act as specified in subclause 8.6.7.19.2.
 - 5> if IE "Method Type" is set to "UE based":
 - 6> if IE "UE positioning OTDOA assistance data for UE based" is not included:
 - 7> if System Information Block type 15.5 is broadcast:
 - 8> read System Information Block type 15.5.
 - 7> act as specified in subclause 8.6.7.19.2a.
- 2> for any other measurement type:
 - 3> if the measurement is valid in the current RRC state of the UE:
 - 4> begin measurements according to the stored control information for this measurement identity.
- 1> if the IE "Measurement command" has the value "modify":
 - 2> for all IEs present in the MEASUREMENT CONTROL message:
 - 3> if a measurement was stored in the variable MEASUREMENT_IDENTITY associated to the identity by the IE "measurement identity":
 - 4> if the measurement type is quality, UE internal, intra-frequency, inter-frequency or inter-RAT:
 - 5> if the UE is in CELL_FACH state:
 - 6> the UE behaviour is not specified.
 - 4> if measurement type is set to "intra-frequency measurement", for any of the optional IEs "Intra-frequency measurement objects list", "Intra-frequency measurement quantity", "Intra-frequency reporting quantity", "Measurement Validity", "report criteria" and "parameters required for each event" (given "report criteria" is set to "intra-frequency measurement reporting criteria") that are present in the MEASUREMENT CONTROL message:
 - 4> if measurement type is set to "inter-frequency measurement", for any of the optional IEs "Inter-frequency measurement quantity", "Inter-frequency reporting quantity", "Measurement Validity", "Inter-frequency set update" and "parameters required for each event" (given "report criteria" is set to either "inter-frequency measurement reporting criteria" or "intra-frequency measurement reporting criteria") that are present in the MEASUREMENT CONTROL message:
 - 4> if measurement type is set to "inter-RAT measurement", for any of the optional IEs "Inter-RAT measurement objects list", "Inter-RAT measurement quantity", "Inter-RAT reporting quantity" and "parameters required for each event" (given "report criteria" is set to "inter-RAT measurement reporting criteria") that are present in the MEASUREMENT CONTROL message:
 - 4> if measurement type is set to "UE positioning measurement" and the IE "UE positioning OTDOA assistance data" is present, for any of the optional IEs "UE positioning OTDOA neighbour cell info for UE-assisted", "UE positioning OTDOA reference cell info for UE-assisted", "UE positioning

- OTDOA reference cell info for UE-based", "UE positioning OTDOA neighbour cell info for UE-based" and "UE positioning" that are present in the MEASUREMENT CONTROL message:
- 4> if measurement type is set to "UE positioning measurement" and the IE "UE positioning GPS assistance data" is present, for any of the optional IEs "UE positioning GPS reference time", "UE positioning GPS reference UE position", "UE positioning GPS DGPS corrections", "UE positioning GPS navigation model", "UE positioning GPS ionospheric model", "UE positioning GPS UTC model", "UE positioning GPS almanac", "UE positioning GPS acquisition assistance", "UE positioning GPS real-time integrity" that are present in the MEASUREMENT CONTROL message:
 - 4> if measurement type is set to "traffic volume measurement", for any of the optional IEs "Traffic volume measurement Object", "Traffic volume measurement quantity", "Traffic volume reporting quantity", "Measurement Validity" and "parameters required for each event" (given "report criteria" is set to "traffic volume measurement reporting criteria") that are present in the MEASUREMENT CONTROL message:
 - 4> if measurement type is set to "quality measurement", for any of the optional IE "Quality reporting quantity" that is present in the MEASUREMENT CONTROL message:
 - 4> if measurement type is set to "UE internal measurement", for any of the optional IEs "UE internal measurement quantity", "UE internal reporting quantity" and "parameters required for each event" (given "report criteria" is set to "UE internal measurement reporting criteria") that are present in the MEASUREMENT CONTROL message:
 - 5> replace the corresponding information (the IEs listed above and all their children) stored in variable MEASUREMENT_IDENTITY associated to the identity indicated by the IE "measurement identity" with the one received in the MEASUREMENT CONTROL message;
 - 5> leave all other stored information elements unchanged in the variable MEASUREMENT_IDENTITY.
- 3> otherwise:
- 4> set the variable CONFIGURATION_INCOMPLETE to TRUE.
- 2> if measurement type is set to "inter-frequency measurement":
- 3> if "report criteria" is set to "intra-frequency report criteria" and "reporting criteria" in "inter-frequency measurement quantity" is set to "intra-frequency reporting criteria":
 - 4> leave the currently stored "inter-frequency report criteria" within "report criteria" and "inter-frequency reporting criteria" within "inter-frequency measurement quantity" unchanged, and continue to act on the information stored in these variables, and also store the newly received "intra-frequency report criteria" and intra-frequency reporting criteria.
 - 3> otherwise:
 - 4> clear the variables associated with the CHOICE "report criteria" and store the received "report criteria" choice;
 - 4> if the IE "inter-frequency measurement quantity" is present:
 - 5> clear the variables associated with the choice "reporting criteria" in "inter-frequency measurement quantity" and store the received "reporting criteria" choice.
- 2> for measurement types "inter-frequency measurement" that require measurements on a frequency other than the actually used frequency, or that require measurements on another RAT:
- 3> if, according to its measurement capabilities, the UE requires compressed mode to perform that measurement type and after reception of this message a compressed mode pattern sequence with an appropriate measurement purpose is active according to the IE "Current TGPS Status Flag" in UE variable TGPS_IDENTITY; or
 - 3> if, according to its measurement capabilities, the UE does not require compressed mode, on at least one supported band of that measurement type, to perform the measurements:

- 4> resume the measurements according to the new stored measurement control information.
 - 2> for measurement type "inter-frequency measurement" that requires measurements only on the same frequency as the actually used frequency:
 - 3> if the measurement is valid in the current RRC state of the UE:
 - 4> resume measurements according to the new stored control information for this measurement identity.
 - 2> for any other measurement type:
 - 3> resume the measurements according to the new stored measurement control information.
 - 1> if the IE "measurement command" has the value "release":
 - 2> terminate the measurement associated with the identity given in the IE "measurement identity";
 - 2> clear all stored measurement control information related associated to this measurement identity in variable MEASUREMENT_IDENTITY.
 - 1> if the IE "DPCH Compressed Mode Status Info" is present:
 - 2> if, as the result of this message, UE will have more than one transmission gap pattern sequence with the same measurement purpose active (according to IE "TGMP" in variable TGPS_IDENTITY):
 - 3> set the variable CONFIGURATION_INCOMPLETE to TRUE.
 - 2> if there is any pending "TGPS reconfiguration CFN" or any pending "TGCFN":
 - 3> the UE behaviour is unspecified;
 - 2> if pattern sequence corresponding to IE "TGPSI" is already active (according to "Current TGPS Status Flag") in the variable TGPS_IDENTITY):
 - 3> if the "TGPS Status Flag" in this message is set to "deactivate" for the corresponding pattern sequence:
 - 4> deactivate this pattern sequence at the beginning of the frame indicated by IE "TGPS reconfiguration CFN" received in the message;
 - 4> set the "Current TGPS Status Flag" for this pattern sequence in the variable TGPS_IDENTITY to "inactive".
 - 3> if the "TGPS Status Flag" in this message is set to "activate" for the corresponding pattern sequence:
 - 4> deactivate this pattern sequence at the beginning of the frame indicated by IE "TGPS reconfiguration CFN" received in the message.
- NOTE: The temporary deactivation of pattern sequences for which the status flag is set to "activate" can be used by the network to align the timing of already active patterns with newly activated patterns.
- 2> after the time indicated by IE "TGPS reconfiguration CFN" has elapsed:
 - 3> activate the pattern sequence corresponding to each IE "TGPSI" for which the "TGPS status flag" in this message is set to "activate" at the time indicated by IE "TGCFN"; and
 - 3> set the corresponding "Current TGPS status flag" for this pattern sequence in the variable TGPS_IDENTITY to "active"; and
 - 3> begin the inter-frequency and/or inter-RAT measurements corresponding to the pattern sequence measurement purpose of each activated pattern sequence;
 - 3> if the values of IE "TGPS reconfiguration CFN" and IE "TGCFN" are equal:
 - 4> start the concerned pattern sequence immediately at that CFN.
 - 2> not alter pattern sequences stored in variable TGPS_IDENTITY, if the pattern sequence is not identified in IE "TGPSI" in the received message.

- 1> if the UE in CELL_FACH state receives a MEASUREMENT CONTROL message, which indicates the same measurement identity as that stored in the variable MEASUREMENT_IDENTITY:
 - 2> update the stored information with the traffic volume measurement control information in variable MEASUREMENT_IDENTITY; and
 - 2> refrain from updating the traffic volume measurement control information associated with this measurement identity in the variable MEASUREMENT_IDENTITY with the information received in System Information Block type 12 (or System Information Block type 11, according to subclause 8.1.1.6.11) until this measurement is explicitly released with another MEASUREMENT CONTROL message.
- 1> if the IE "Read SFN indicator" included in the IE "Cell info" of an inter-frequency cell is set to TRUE and the variable UE_CAPABILITY_TRANSFERRED has the DL "Measurement capability" for "FDD measurements" set to TRUE (the UE requires DL compressed mode in order to perform measurements on FDD):
 - 2> set the variable CONFIGURATION_INCOMPLETE to TRUE.
- 1> clear the entry for the MEASUREMENT CONTROL message in the table "Accepted transactions" in the variable TRANSACTIONS.

The UE may:

- 1> if the IE "Measurement command" has the value "setup":
 - 2> for measurement type "UE positioning measurement":
 - 3> if the UE is CELL_FACH state:
 - 4> if IE "Positioning Method" is set to "GPS":
 - 5> if IE "UE positioning GPS assistance data" is not included and variable UE_POSITIONING_GPS_DATA is empty:
 - 6> if System Information Block types 15, 15.1, 15.2 and 15.3 are broadcast:
 - 7> read System Information Block types 15, 15.1, 15.2 and 15.3.
 - 6> act as specified in subclause 8.6.7.19.3.
- 1> and the procedure ends.

8.4.1.4 Unsupported measurement in the UE

If UTRAN instructs the UE to perform a measurement that is not supported by the UE, the UE shall:

- 1> retain the measurement configuration that was valid before the MEASUREMENT CONTROL message was received;
- 1> set the IE "RRC transaction identifier" in the MEASUREMENT CONTROL FAILURE message to the value of "RRC transaction identifier" in the entry for the MEASUREMENT CONTROL message in the table "Accepted transactions" in the variable TRANSACTIONS; and
- 1> clear that entry.
- 1> set the cause value in IE "failure cause" to "unsupported measurement";
- 1> submit the MEASUREMENT CONTROL FAILURE message to lower layers for transmission on the DCCH using AM RLC;
- 1> continue with any ongoing processes and procedures as if the invalid MEASUREMENT CONTROL message has not been received;
- 1> and the procedure ends.

8.4.1.4a Configuration Incomplete

If the variable CONFIGURATION_INCOMPLETE is set to TRUE, the UE shall:

- 1> retain the measurement configuration that was valid before the MEASUREMENT CONTROL message was received;
- 1> set the IE "RRC transaction identifier" in the MEASUREMENT CONTROL FAILURE message to the value of "RRC transaction identifier" in the entry for the MEASUREMENT CONTROL message in the table "Accepted transactions" in the variable TRANSACTIONS and clear that entry;
- 1> clear the variable CONFIGURATION_INCOMPLETE;
- 1> set the cause value in IE "failure cause" to "Configuration incomplete";
- 1> submit the MEASUREMENT CONTROL FAILURE message to lower layers for transmission on the DCCH using AM RLC;
- 1> continue with any ongoing processes and procedures as if the invalid MEASUREMENT CONTROL message has not been received;
- 1> and the procedure ends.

8.4.1.5 Invalid MEASUREMENT CONTROL message

If the MEASUREMENT CONTROL message contains a protocol error causing the variable PROTOCOL_ERROR_REJECT to be set to TRUE according to clause 9, the UE shall perform procedure specific error handling as follows. The UE shall:

- 1> set the IE "RRC transaction identifier" in the MEASUREMENT CONTROL FAILURE message to the value of "RRC transaction identifier" in the entry for the MEASUREMENT CONTROL message in the table "Rejected transactions" in the variable TRANSACTIONS; and
- 1> clear that entry.
- 1> set the IE "failure cause" to the cause value "protocol error";
- 1> include the IE "Protocol error information" with contents set to the value of the variable PROTOCOL_ERROR_INFORMATION;
- 1> submit the MEASUREMENT CONTROL FAILURE message to lower layers for transmission on the DCCH using AM RLC;
- 1> continue with any ongoing processes and procedures as if the invalid MEASUREMENT CONTROL message has not been received;
- 1> and the procedure ends.

8.4.1.6 Measurements after transition from CELL_DCH to CELL_FACH/CELL_PCH/URA_PCH state

The UE shall apply the following rules for different measurement types after transiting from CELL_DCH to CELL_FACH/CELL_PCH/URA_PCH state:

8.4.1.6.1 Intra-frequency measurement

Upon transition from CELL_DCH to CELL_FACH/CELL_PCH/URA_PCH state, the UE shall:

- 1> stop intra-frequency type measurement reporting;
- 1> if the transition is due to a reconfiguration message which included the IE "Primary CPICH info" (for FDD) or "Primary CCPCH info" (for TDD), and the UE selects a cell other than that indicated by this IE on the current frequency (in case the IE "Frequency info" is not received) or other than that indicated by this IE on the frequency indicated by the IE "Frequency info" (when the IE "Frequency info" is included); or

- 1> if the transition is due to a reconfiguration message which does not include the IE "Primary CPICH info" (for FDD) or "Primary CCPCH info" (for TDD); or
- 1> if the transition is not due to a reconfiguration message:
 - 2> delete the measurements of type intra-frequency associated with the variable MEASUREMENT_IDENTITY.
- 1> begin monitoring cells listed in the IE "intra-frequency cell info list" received in System Information Block type 12 (or System Information Block type 11, according to subclause 8.1.1.6.11).

8.4.1.6.2 Inter-frequency measurement

Upon transition from CELL_DCH to CELL_FACH/ CELL_PCH/URA_PCH state, the UE shall:

- 1> stop the inter-frequency type measurement reporting assigned in a MEASUREMENT CONTROL message;
- 1> if the transition is due to a reconfiguration message which included the IE "Primary CPICH info" (for FDD) or "Primary CCPCH info" (for TDD), and the UE selects a cell other than that indicated by this IE on the current frequency (in case the IE "Frequency info" is not received) or other than that indicated by this IE on the frequency indicated by the IE "Frequency info" (when the IE "Frequency info" is included); or
- 1> if the transition is due to a reconfiguration message which does not include the IE "Primary CPICH info" (for FDD) or "Primary CCPCH info" (for TDD); or
- 1> if the transition is not due to a reconfiguration message:
 - 2> delete the measurements of type inter-frequency associated with the variable MEASUREMENT_IDENTITY and delete the corresponding compressed mode pattern.
- 1> for remaining compressed mode patterns, set the IE "TGPS Status Flag" to "deactivate" and the IE "Current TGPS Status Flag" to "inactive" in the variable TGPS_IDENTITY.
- 1> begin monitoring cells listed in the IE "inter-frequency cell info list" received in System Information Block type 12 (or System Information Block type 11, according to subclause 8.1.1.6.11);
- 1> in CELL_FACH state:
 - 2> perform measurements on other frequencies according to the IE "FACH measurement occasion info".

8.4.1.6.3 Inter-RAT measurement

Upon transition from CELL_DCH to CELL_FACH/CELL_PCH/URA_PCH state, the UE shall:

- 1> stop the inter-RAT type measurement reporting assigned in a MEASUREMENT CONTROL message;
- 1> delete the measurements of type inter-RAT associated with the variable MEASUREMENT_IDENTITY and delete the corresponding compressed mode pattern;
- 1> begin monitoring cells listed in the IE "inter-RAT cell info list" received in System Information Block type 12 (or System Information Block type 11, according to subclause 8.1.1.6.11);
- 1> in CELL_FACH state:
 - 2> perform measurements on other systems according to the IE "FACH measurement occasion info".

8.4.1.6.4 Quality measurement

Upon transition from CELL_DCH to CELL_FACH/CELL_PCH/URA_PCH state, the UE shall:

- 1> stop quality type measurement reporting;
- 1> delete all measurement control information of measurement type "quality" stored in the variable MEASUREMENT_IDENTITY.

8.4.1.6.5 UE internal measurement

Upon transition from CELL_DCH to CELL_FACH/CELL_PCH/URA_PCH state, the UE shall:

- 1> stop UE internal measurement type measurement reporting;
- 1> delete all measurement control information of measurement type "UE internal" stored in the variable MEASUREMENT_IDENTITY.

8.4.1.6.6 Traffic volume measurement

Upon transition from CELL_DCH to CELL_FACH or CELL_PCH or URA_PCH state, the UE shall:

- 1> retrieve each set of measurement control information of measurement type "traffic volume" stored in the variable MEASUREMENT_IDENTITY; and
 - 2> if the optional IE "measurement validity" for this measurement has not been included:
 - 3> delete the measurement associated with the variable MEASUREMENT_IDENTITY.
 - 2> if the IE "measurement validity" for the measurement has been included, and the IE "UE state" has been assigned to value "CELL_DCH":
 - 3> stop measurement reporting;
 - 3> store the measurement associated with the variable MEASUREMENT_IDENTITY to be used after the next transition to CELL_DCH state.
 - 2> if the IE "measurement validity" for the measurement has been included, and the IE "UE state" has been assigned to value "all states":
 - 3> continue measurement reporting.
 - 2> if the IE "measurement validity" has been included and the IE "UE state" has been assigned to value "all states except CELL_DCH":
 - 3> resume this measurement and associated reporting.
- 1> if no traffic volume type measurement has been assigned to the UE with a MEASUREMENT CONTROL message that is valid in CELL_FACH or CELL_PCH or URA_PCH states (stored in the variable MEASUREMENT_IDENTITY), which has the same identity as the one indicated in the IE "Traffic volume measurement system information":
 - 2> store the measurement control information from the IE "Traffic volume measurement system information" received in System Information Block type 12 (or System Information Block type 11, according to subclause 8.1.1.6.11) in the variable MEASUREMENT_IDENTITY;
 - 2> begin traffic volume measurement reporting according to the assigned information.

8.4.1.6.7 UE positioning measurement

Upon transition from CELL_DCH to CELL_PCH or URA_PCH, the UE shall:

- 1> if the UE does not support UP measurement validity in CELL_PCH and URA_PCH states as indicated in the IE "UE positioning capability" included in the IE "UE Radio Access Capability":
 - 2> stop UE positioning measurement reporting.

Upon transition from CELL_DCH to CELL_FACH, or upon transition from CELL_DCH to CELL_PCH or URA_PCH and if the UE supports UP measurement validity in CELL_PCH and URA_PCH states as indicated in the IE "UE positioning capability" included in the IE "UE Radio Access Capability", the UE shall:

- 1> retrieve each set of measurement control information of measurement type "UE positioning" stored in the variable MEASUREMENT_IDENTITY; and
 - 2> if the optional IE "measurement validity" for this measurement has not been included:

- 3> delete the measurement associated with the variable MEASUREMENT_IDENTITY.
- 2> if the IE "measurement validity" for the measurement has been included, and the IE "UE state" has been assigned to value "CELL_DCH":
 - 3> stop measurement reporting;
 - 3> store the measurement associated with the variable MEASUREMENT_IDENTITY to be used after the next transition to CELL_DCH state.
- 2> if the IE "measurement validity" for the measurement has been included, and the IE "UE state" has been assigned to value "all states":
 - 3> upon transition from CELL_DCH to CELL_PCH or URA_PCH:
 - 4> if the choice in the IE "Reporting Criteria" included the IE "UE Positioning" stored in the variable MEASUREMENT_IDENTITY is set to "UE positioning reporting criteria" and the value of the IE "Measurement interval" included in this IE is less than 64 seconds:
 - 5> consider the value of the IE "Measurement interval " as being 64 seconds;
 - 4> if the choice in the IE "Reporting Criteria" included the IE "UE Positioning" stored in the variable MEASUREMENT_IDENTITY is set to "Periodical Reporting Criteria" and the value of the IE "Reporting interval" included in this IE is less than 64 seconds:
 - 5> consider the value of the IE "Reporting Interval" as being 64 seconds
 - 3> continue measurement reporting according to its UE positioning measurement reporting capability..
- 2> if the IE "measurement validity" has been included and the IE "UE state" has been assigned to value "all states except CELL_DCH":
 - 3> upon transition from CELL_DCH to CELL_PCH or URA_PCH:
 - 4> if the choice in the IE "Reporting Criteria" included the IE "UE Positioning" stored in the variable MEASUREMENT_IDENTITY is set to "UE positioning reporting criteria" and the value of the IE "Measurement interval " included in this IE is less than 64 seconds:
 - 5> consider the value of the IE "Measurement interval " as being 64 seconds.
 - 4> if the choice in the IE "Reporting Criteria" included the IE "UE Positioning" stored in the variable MEASUREMENT_IDENTITY is set to "Periodical Reporting Criteria" and the value of the IE "Reporting interval" included in this IE is less than 64 seconds:
 - 5> consider the value of the IE "Reporting Interval" as being 64 seconds.
 - 3> resume this measurement and associated reporting according to its UE Positioning measurement reporting capability.
- 1> if the transition is due to a reconfiguration message which included the IE "Primary CPICH info" (for FDD) or "Primary CCPCH info" (for TDD), and the UE selects a cell other than that indicated by this IE; or
- 1> if the transition is due to a reconfiguration message which does not include the IE "Primary CPICH info" (for FDD) or "Primary CCPCH info" (for TDD); or
- 1> if the transition is not due to a reconfiguration message:
 - 2> delete the assistance data included in the variable UE_POSITIONING_OTDOA_DATA_UE_BASED, UE_POSITIONING_OTDOA_DATA_UE_ASSISTED and UE_POSITIONING_GPS_DATA.
- 1> if the IE "Positioning Methods" stored in the variable MEASUREMENT_IDENTITY is set to "OTDOA" or "OTDOA or GPS":
 - 2> if the IE "Method type" stored in the variable MEASUREMENT_IDENTITY is set to "UE-based" or "UE assisted preferred but UE-based allowed" or "UE-based preferred but UE-assisted allowed":

- 3> begin monitoring assistance data received in System Information Block type 15.4 and System Information Block type 15.5 according to subclause 8.1.1.6.15.
- 2> if the IE "Method type" stored in the variable MEASUREMENT_IDENTITY is set to "UE-assisted":
 - 3> begin monitoring assistance data received in System Information Block type 15.4 according to subclause 8.1.1.6.15.
- 1> if the UE is in CELL_FACH state:
 - 2> if the IE "UE positioning OTDOA neighbour cell list for UE assisted" stored in the variable UE_POSITIONING_OTDOA_DATA_UE_ASSISTED or UE_POSITIONING_OTDOA_DATA_UE_BASED contains neighbour cells on other frequencies than the current frequency:
 - 3> perform measurements on other frequencies according to the IE "FACH measurement occasion info".

The UE may:

- 1> if the IE "Positioning Methods" stored in the variable MEASUREMENT_IDENTITY is set to "GPS" or "OTDOA or GPS":
 - 2> begin monitoring assistance data received in System Information Block type 15 and/or System Information Block type 15.1 and/or System Information Block type 15.2 and/or System Information Block type 15.3 according to subclause 8.1.1.6.15.

8.4.1.6a Actions in CELL_FACH/CELL_PCH/URA/PCH state upon cell re-selection

Upon cell reselection while in CELL_FACH/CELL_PCH/URA/PCH state and the cell reselection has occurred after the measurement control information was stored, the UE shall:

- 1> delete all measurements of type intra-frequency, inter-frequency, and inter-RAT associated with the variable MEASUREMENT_IDENTITY;
- 1> delete all compressed mode patterns associated with inter-frequency and inter-RAT measurements;
- 1> delete the traffic volume measurements that have not been set up or modified through a MEASUREMENT CONTROL message.

8.4.1.7 Measurements after transition from CELL_FACH to CELL_DCH state

The UE shall apply the following rules for different measurement types after transiting from CELL_FACH to CELL_DCH state:

8.4.1.7.1 Intra-frequency measurement

Upon transition from CELL_FACH to CELL_DCH state:

- 1> if intra-frequency measurements applicable to CELL_DCH state are stored in the variable MEASUREMENT_IDENTITY:
 - 2> if the cell in which the UE transited from CELL_FACH state is included in the active set for the CELL_DCH state, the UE shall:
 - 3> resume the measurement reporting.
 - 2> otherwise, the UE shall:
 - 3> not resume the measurement reporting. The measurement shall be restarted when a MEASUREMENT CONTROL message is received with the corresponding measurement identity.

8.4.1.7.2 Inter-frequency measurement

Upon transition from CELL_FACH to CELL_DCH state:

- 1> if inter-frequency measurements applicable to CELL_DCH state are stored in the variable MEASUREMENT_IDENTITY:
 - 2> if the cell in which the UE transited from CELL_FACH state is included in the active set for the CELL_DCH state, the UE shall:
 - 3> resume the measurement reporting.
 - 2> otherwise, the UE shall:
 - 3> not resume the measurement reporting. The measurement shall be restarted when a MEASUREMENT CONTROL message is received with the corresponding measurement identity.

8.4.1.7.3 Inter-RAT measurement

Upon transition from CELL_FACH to CELL_DCH state, the UE shall:

- 1> stop monitoring the list of cells assigned in the IE "inter-RAT cell info list" in System Information Block type 12 (or System Information Block type 11, according to subclause 8.1.1.6.11).

8.4.1.7.4 Traffic volume measurement

Upon transition from CELL_FACH to CELL_DCH state, the UE shall:

- 1> retrieve each set of measurement control information of measurement type "traffic volume" stored in the variable MEASUREMENT_IDENTITY;
 - 2> if the optional IE "measurement validity" for this measurement has not been included:
 - 3> delete the measurement associated with the variable MEASUREMENT_IDENTITY.
 - 2> if the IE "measurement validity" for the measurement has been included, and the IE "UE state" has been assigned to value "all states except CELL_DCH":
 - 3> stop measurement reporting; and
 - 3> save the measurement associated with the variable MEASUREMENT_IDENTITY to be used after the next transition to CELL_FACH/CELL_PCH/URA_PCH state.
 - 2> if the IE "measurement validity" for the measurement has been included, and the IE "UE state" has been assigned to value "all states":
 - 3> continue measurement reporting.
 - 2> if the IE "measurement validity" has been included and the IE "UE state" has been assigned to value "CELL_DCH":
 - 3> resume this measurement and associated reporting.
- 1> if no traffic volume type measurement has been assigned to the UE with a MEASUREMENT CONTROL message that is valid in CELL_DCH and has the same identity as the one indicated in the IE "Traffic volume measurement system information":
 - 2> store the measurement control information from the IE "Traffic volume measurement system information" received in System Information Block type 12 (or System Information Block type 11, according to subclause 8.1.1.6.11) in the variable MEASUREMENT_IDENTITY;
 - 2> begin traffic volume measurement reporting according to the assigned information.

8.4.1.7.5 UE positioning measurement

Upon transition from CELL_FACH to CELL_DCH state, the UE shall:

- 1> retrieve each set of measurement control information of measurement type "UE positioning" stored in the variable MEASUREMENT_IDENTITY; and

- 2> if the optional IE "Measurement validity" for this measurement has not been included:
 - 3> delete the measurement associated with the variable MEASUREMENT_IDENTITY.
- 2> if the IE "measurement validity" for the measurement has been included, and the IE "UE state" has been assigned to value "all states except CELL_DCH":
 - 3> stop measurement reporting; and
 - 3> save the measurement associated with the variable MEASUREMENT_IDENTITY to be used after the next transition to CELL_FACH/CELL_PCH/URA_PCH state.
- 2> if the IE "measurement validity" for the measurement has been included, and the IE "UE state" has been assigned to value "all states":
 - 3> continue measurement reporting.
- 2> if the IE "measurement validity" has been included and the IE "UE state" has been assigned to value "CELL_DCH":
 - 3> resume this measurement and associated reporting.
- 1> stop monitoring assistance data received in System Information Block type 15 or System Information Block type 15.1 or System Information Block type 15.2 or System Information Block type 15.3 or System Information Block type 15.4 or System Information Block 15.5.

8.4.1.8 Measurements after transition from idle mode to CELL_DCH state

The UE shall obey the following rules for different measurement types after transiting from idle mode to CELL_DCH state:

8.4.1.8.1 Intra-frequency measurement

Upon transition from idle mode to CELL_DCH state:

- 1> if intra-frequency measurements applicable to CELL_DCH state are stored in the variable MEASUREMENT_IDENTITY:
 - 2> if the cell in which the UE transited from idle mode is included in the active set for the CELL_DCH state, the UE shall:
 - 3> begin measurement reporting.
 - 2> otherwise, the UE shall:
 - 3> not begin the measurement reporting. The measurement shall be restarted when a MEASUREMENT CONTROL message is received with the corresponding measurement identity.

8.4.1.8.2 Inter-frequency measurement

Upon transition from idle mode to CELL_DCH state, the UE shall:

- 1> stop monitoring the list of cells assigned in the IE "inter-frequency cell info list" in System Information Block type 12 (or System Information Block type 11, according to subclause 8.1.1.6.11).

8.4.1.8.3 Inter-RAT measurement

Upon transition from idle mode to CELL_DCH state, the UE shall:

- 1> stop monitoring the list of cells assigned in the IE "inter-RAT cell info list" in System Information Block type 12 (or System Information Block type 11, according to subclause 8.1.1.6.11).

8.4.1.8.4 Traffic volume measurement

Upon transition from idle mode to CELL_DCH state, the UE shall:

- 1> begin a traffic volume type measurement, assigned in System Information Block type 11 (or System Information Block type 12, according to subclause 8.1.1.6.11).

8.4.1.8.5 UE positioning measurement

Upon transition from idle mode to CELL_DCH state, the UE shall:

- 1> stop monitoring assistance data received in System Information Block type 15 or System Information Block type 15.1 or System Information Block type 15.2 or System Information Block type 15.3 or System Information Block type 15.4 or System Information Block type 15.5.

8.4.1.9 Measurements after transition from idle mode to CELL_FACH state

The UE shall obey the follow rules for different measurement types after transiting from idle mode to CELL_FACH state:

8.4.1.9.1 Intra-frequency measurement

Upon transition from idle mode to CELL_FACH state, the UE shall:

- 1> begin or continue monitoring cells listed in the IE "intra-frequency cell info list" received in System Information Block type 12 (or System Information Block type 11, according to subclause 8.1.1.6.11).

8.4.1.9.2 Inter-frequency measurement

Upon transition from idle mode to CELL_FACH state, the UE shall:

- 1> begin or continue monitoring cells listed in the IE "inter-frequency cell info list" received in System Information Block type 12 (or System Information Block type 11, according to subclause 8.1.1.6.11);
- 1> perform measurements on other frequencies according to the IE "FACH measurement occasion info".

8.4.1.9.3 Inter-RAT measurement

Upon transition from idle mode to CELL_FACH state, the UE shall:

- 1> begin or continue monitoring cells listed in the IE "inter-RAT cell info list" received in System Information Block type 12 (or System Information Block type 11, according to subclause 8.1.1.6.11);
- 1> perform measurements on other systems according to the IE "FACH measurement occasion info".

8.4.1.9.4 Traffic volume measurement

Upon transition from idle mode to CELL_FACH state, the UE shall:

- 1> store the measurement control information from the IE "Traffic volume measurement system information" received in System Information Block type 12 (or System Information Block type 11, according to subclause 8.1.1.6.11) in the variable MEASUREMENT_IDENTITY;
- 1> begin traffic volume measurement reporting according to the assigned information.

8.4.1.9.5 UE positioning measurement

Upon transition from idle mode to CELL_FACH state, the UE may:

- 1> begin or continue monitoring assistance data received in System Information Block type 15 or System Information Block type 15.1 or System Information Block type 15.2 or System Information Block type 15.3 or System Information Block type 15.4 or System Information Block type 15.5 according to subclause 8.1.1.6.15;

- 1> if the IE "UE positioning OTDOA neighbour cell list for UE assisted" stored in the variable UE_POSITIONING_OTDOA_DATA_UE_ASSISTED; or
- 1> if the IE "UE positioning OTDOA neighbour cell list for UE based" stored in the variable UE_POSITIONING_OTDOA_DATA_UE_BASED contains neighbour cells on other frequencies than the current frequency:
 - 2> perform measurements on other frequencies according to the IE "FACH measurement occasion info".

8.4.1.9a Measurements after transition from connected mode to idle mode

Upon transition from connected mode to idle mode the UE shall:

- 1> stop measurement reporting for all measurements stored in the variable MEASUREMENT_IDENTITY;
- 1> clear the variable MEASUREMENT_IDENTITY;
- 1> apply the following rules for different measurement types.

8.4.1.9a.1 Intra-frequency measurement

Upon transition from connected mode to idle mode, the UE shall:

- 1> stop monitoring intra-frequency cells listed in the IE "intra-frequency cell info list" received in System Information Block type 12 (if System Information Block type 12 is transmitted in the cell, according to subclause 8.1.1.6.11);
- 1> begin monitoring intra-frequency cells listed in the IE "intra-frequency cell info list" received in System Information Block type 11.

8.4.1.9a.2 Inter-frequency measurement

Upon transition from connected mode to idle mode, the UE shall:

- 1> stop monitoring inter-frequency cells listed in the IE "inter-frequency cell info list" received in System Information Block type 12 (if System Information Block type 12 is transmitted in the cell, according to subclause 8.1.1.6.11);
- 1> begin monitoring inter-frequency cells listed in the IE "inter-frequency cell info list" received in System Information Block type 11.

8.4.1.9a.3 Inter-RAT measurement

Upon transition from connected mode to idle mode, the UE shall:

- 1> stop monitoring inter-RAT cells listed in the IE "inter-RAT cell info list" received in System Information Block type 12 (if System Information Block type 12 is transmitted in the cell, according to 8.1.1.6.11);
- 1> begin monitoring inter-RAT cells listed in the IE "inter-RAT cell info list" received in System Information Block type 11.

8.4.1.9a.4 UE positioning measurement

Upon transition from connected mode to idle mode, the UE may:

- 1> begin or continue monitoring assistance data received in System Information Block type 15 or System Information Block type 15.1 or System Information Block type 15.2 or System Information Block type 15.3 or System Information Block type 15.4 or System Information Block type 15.5.

8.4.1.10 Changes in measurement objects

8.4.1.10.1 Traffic volume measurement

When performing traffic volume event evaluation or reporting related to a certain transport channel, the UE shall consider all RBs which are mapped to the concerning transport channel e.g. if an additional RB is established on a transport channel used for event triggering or reporting, the new RB shall be taken into account.

NOTE: In this subclause, an "existing" uplink transport channel refers to a configured uplink transport channel applicable in the current RRC state.

The UE shall:

- 1> if the IE "Traffic volume measurement object" is included for this measurement:
 - 2> while a transport channel that is referenced in the IE "Traffic volume measurement object" does not exist:
 - 3> not perform any reporting related to this transport channel.
- 1> else:
 - 2> report on all existing uplink transport channels; e.g. if an additional transport channel is established while the measurement is ongoing, this new transport channel shall be taken into account in the traffic volume measurement reporting.

For every traffic volume event, the UE shall:

- 1> if the IE "Uplink transport channel type" is not included in the IE "Traffic volume measurement reporting criteria", or the "Uplink transport channel type" has the value "DCH" or "USCH" and the IE "UL transport channel id" is not included in the IE "Traffic volume measurement reporting criteria":
 - 2> if the IE "Traffic volume measurement object" is not included:
 - 3> take all existing UL transport channels into account for event triggering; e.g. if an additional transport channel is established while the measurement is ongoing, this new transport channel shall be taken into account in the traffic volume event triggering.
 - 2> else:
 - 3> while a transport channel that is referenced in the IE "Traffic Volume Measurement object" does not exist:
 - 4> not take this transport channel identity into account in the traffic volume measurement triggering.
- 1> else:
 - 2> while a transport channel that is referenced in the IE "Traffic Volume Measurement Reporting Criteria" does not exist:
 - 3> not take this transport channel identity into account in the traffic volume event triggering.

8.4.1.10.2 Quality measurement

While a transport channel that is explicitly referenced with a transport channel identity in the IE "Quality Reporting Quantity" does not exist, the UE shall:

- 1> not perform any reporting related to this transport channel identity.

If the IE "Quality Reporting Quantity" does not contain any explicit transport channel identities, the UE shall:

- 1> report the quality of all existing downlink dedicated transport channels;
- 1> if an additional transport channel is established while the measurement is ongoing:
 - 2> take into account this new transport channel in the quality measurement reporting.

While a transport channel that is explicitly referenced with a transport channel id in the IE "Quality Measurement Reporting Criteria" does not exist, the UE shall:

- 1> not take this transport channel identity into account in the quality measurement event triggering.

8.4.1.10.3 Intra-frequency, Inter-frequency and Inter-RAT measurements

For measurements which include the IE "Cells for measurement" the UE shall:

- 1> while an IE "Intra-frequency cell id" or IE "Inter-frequency cell id" or IE "Inter-RAT cell id" in the IE "Cells for measurement" points to a position in the variable CELL_INFO_LIST which is marked as "vacant":
- 2> not take this position into account for event triggering and reporting.

8.4.2 Measurement report



Figure 8.4.2-1: Measurement report, normal case

8.4.2.1 General

The purpose of the measurement reporting procedure is to transfer measurement results from the UE to UTRAN.

8.4.2.2 Initiation

In CELL_DCH state, the UE shall:

- 1> transmit a MEASUREMENT REPORT message on the uplink DCCH when the reporting criteria stored in variable MEASUREMENT_IDENTITY are met for any ongoing measurements that are being performed in the UE.

In CELL_FACH state, the UE shall:

- 1> transmit a MEASUREMENT REPORT message on the uplink DCCH when the reporting criteria stored in variable MEASUREMENT_IDENTITY are met for any ongoing traffic volume measurement or UE positioning measurement that is being performed in the UE;
- 1> include a measurement report in the IE "Measured results on RACH", as specified in the IE "Intra-frequency reporting quantity for RACH reporting" and the IE "Maximum number of reported cells on RACH" in System Information Block type 12 (or "System Information Block Type 11" if "System Information Block Type 12" is not being broadcast);
- 1> include in the IE "Measured results on RACH" all requested reporting quantities for cells for which measurements are reported.

In TDD, if the Radio Bearer associated with the MEASUREMENT_IDENTITY fulfilling the reporting criteria for an ongoing traffic volume measurement is mapped on transport channel of type USCH, the UE shall:

- 1> initiate the "PUSCH CAPACITY REQUEST" procedure instead of transmitting a MEASUREMENT REPORT (TDD Only).

In CELL_PCH or URA_PCH state, the UE shall:

- 1> first perform the cell update procedure according to subclause 8.3.1, using the cause "uplink data transmission", in order to transit to CELL_FACH state; and then

- 1> transmit a MEASUREMENT REPORT message on the uplink DCCH when the reporting criteria stored in variable MEASUREMENT_IDENTITY are fulfilled for any ongoing traffic volume measurement or UE positioning measurement which is being performed in the UE.

The reporting criteria are fulfilled if either:

- a periodic MEASUREMENT REPORT message shall be sent according to the IE "Periodical Reporting Criteria"; or
- an event in stored IE "Measurement reporting criteria" was triggered. Events and triggering of reports for different measurement types are described in detail in clause 14.

For the measurement, which triggered the MEASUREMENT REPORT message, the UE shall:

- 1> set the IE "measurement identity" to the measurement identity, which is associated with that measurement in variable MEASUREMENT_IDENTITY;
- 1> set the IE "measured results" to include measurements according to the IE "reporting quantity" of that measurement stored in variable MEASUREMENT_IDENTITY; and
 - 2> if all the reporting quantities are set to "false":
 - 3> not set the IE "measured results".
- 1> set the IE "Measured results" in the IE "Additional measured results" according to the IE "reporting quantity" for all measurements associated with the measurement identities included in the "Additional measurements list" stored in variable MEASUREMENT_IDENTITY of the measurement that triggered the measurement report; and
 - 2> if more than one additional measured results are to be included:
 - 3> include only the available additional measured results, and sort them in ascending order according to their IE "measurement identity" in the MEASUREMENT REPORT message.
- 1> if the MEASUREMENT REPORT message was triggered by an event (i.e. not a periodical report):
 - 2> set the IE "Event results" according to the event that triggered the report.
- 1> if the observed time difference for one or more GSM cells is included in the MEASUREMENT REPORT message:
 - 2> set the IE "GSM OTD reference cell" to the primary CPICH info of the active set cell that was used as reference for the measurement.

The UE shall:

- 1> transmit the MEASUREMENT REPORT message on the uplink DCCH using either AM or UM RLC according to the stored IE "measurement reporting mode" associated with the measurement identity that triggered the report.

When the MEASUREMENT REPORT message has been submitted to lower layers for transmission:

- 1> the procedure ends.

8.4.3 Assistance Data Delivery

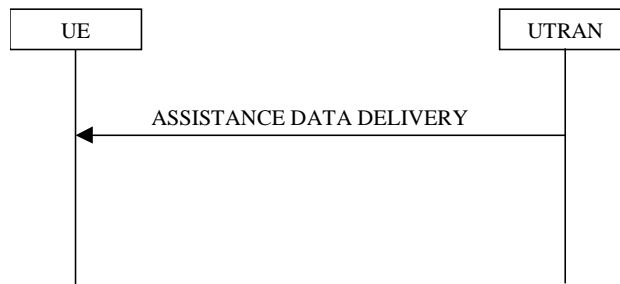

Figure 8.4.3-1 Assistance Data Delivery

8.4.3.1 General

The purpose of the assistance data delivery procedure is to transfer UE positioning related assistance data from the UTRAN to the UE.

8.4.3.2 Initiation

When requested by the Core Network, the UTRAN may deliver UE positioning related assistance data with a ASSISTANCE DATA DELIVERY message, which is transmitted on the downlink DCCH using AM RLC

8.4.3.3 Reception of ASSISTANCE DATA DELIVERY message by the UE

Upon reception of a ASSISTANCE DATA DELIVERY message the UE shall:

- 1> if IE "UE positioning OTDOA assistance data for UE-based" is included:
 - 2> act as specified in subclause 8.6.7.19.2a.
- 1> if IE "UE positioning GPS assistance data" is included:
 - 2> act as specified in subclause 8.6.7.19.3.

8.4.3.4 Invalid ASSISTANCE DATA DELIVERY message

If the UE receives a ASSISTANCE DATA DELIVERY message, which contains a protocol error causing the variable `PROTOCOL_ERROR_REJECT` to be set to `TRUE` according to clause 9, the UE shall perform procedure specific error handling as follows. The UE shall:

- 1> transmit an RRC STATUS message on the uplink DCCH using AM RLC;
- 1> include the IE "Identification of received message"; and
- 1> set the IE "Received message type" to ASSISTANCE DATA DELIVERY; and
- 1> set the IE "RRC transaction identifier" to the value of "RRC transaction identifier" in the entry for the ASSISTANCE DATA DELIVERY message in the table "Rejected transactions" in the variable TRANSACTIONS; and
- 1> clear that entry;
- 1> include the IE "Protocol error information" with contents set to the value of the variable `PROTOCOL_ERROR_INFORMATION`.
- 1> when the RRC STATUS message has been submitted to lower layers for transmission:
 - 2> continue with any ongoing processes and procedures as if the invalid ASSISTANCE DATA DELIVERY message has not been received.

8.5 General procedures

8.5.1 Selection of initial UE identity

The purpose of the IE "Initial UE identity" is to provide a unique UE identification at the establishment of an RRC connection. The type of identity shall be selected by the UE according to the following.

Upper layers shall set the variable `SELECTED_PLMN`. If the variable `SELECTED_PLMN` in the UE indicates "GSM-MAP", the UE shall choose "UE id type" in the IE "Initial UE identity" with the following priority:

1. TMSI (GSM-MAP): The TMSI (GSM-MAP) shall be chosen if available. The IE "LAI" in the IE "Initial UE identity" shall also be present when TMSI (GSM-MAP) is used, for making it unique.
2. P-TMSI (GSM-MAP): The P-TMSI (GSM-MAP) shall be chosen if available and no TMSI (GSM-MAP) is available. The IE "RAI" in the IE "Initial UE identity" shall in this case also be present when P-TMSI (GSM-MAP) is used, for making it unique.
3. IMSI (GSM-MAP): The IMSI (GSM-MAP) shall be chosen if available and no TMSI (GSM-MAP) or P-TMSI is available.
4. IMEI: The IMEI shall be chosen when none of the above three conditions are fulfilled.

When being used, the IEs "TMSI (GSM-MAP)", "P-TMSI (GSM-MAP)", "IMSI (GSM-MAP)", "LAI" and "RAI" shall be set equal to the values of the corresponding identities stored in the USIM or SIM.

If the variable `SELECTED_PLMN` in the UE indicates "ANSI-41", the UE shall choose "UE id type" in the IE "Initial UE identity" according to the procedure specified in the 3GPP2 document "3GPP2 C.P0004-A".

8.5.2 Actions when entering idle mode from connected mode

When entering idle mode from connected mode, the UE shall:

- 1> clear or set variables upon leaving UTRA RRC connected mode as specified in subclause 13.4;
- 1> attempt to select a suitable cell to camp on.

When leaving connected mode according to [4], the UE shall:

- 1> perform cell selection.

While camping on a cell, the UE shall:

- 1> acquire system information according to the system information procedure in subclause 8.1;
- 1> perform measurements according to the measurement control procedure specified in subclause 8.4; and
- 1> if the UE is registered:
 - 2> be prepared to receive paging messages according to the paging procedure in subclause 8.2.

If IE "PLMN identity" within variable `SELECTED_PLMN` has the value "GSM-MAP", the UE shall:

- 1> delete any NAS system information received in connected mode;
- 1> acquire the NAS system information in system information block type 1; and
- 1> proceed according to subclause 8.6.1.2.

When entering idle mode, the UE shall:

- 1> if the USIM is present, for each CN domain:
 - 2> if a new security key set was received for this CN domain but was not used either for integrity protection or ciphering during this RRC connection:

- 3> set the START value for this domain to zero; and
- 3> store this START value for this domain in the USIM.
- 2> else:
 - 3> if the current "START" value, according to subclause 8.5.9 for a CN domain, is greater than or equal to the value "THRESHOLD" of the variable START_THRESHOLD:
 - 4> delete the ciphering and integrity keys that are stored in the USIM for that CN domain;
 - 4> inform the deletion of these keys to upper layers.
 - 3> else:
 - 4> store the current "START" value for this CN domain on the USIM.
- 1> else:
 - 2> if the SIM is present, for each CN domain:
 - 3> if a new security key set was received for this CN domain but was not used either for integrity protection or ciphering during this RRC connection:
 - 4> set the START value for this domain to zero; and
 - 4> store this START value for this domain in the UE
 - 3> else:
 - 4> if the current "START" value, according to subclause 8.5.9 for this CN domain, is greater than or equal to the value "THRESHOLD" of the variable START_THRESHOLD:
 - 5> delete the Kc key for this CN domain;
 - 4> delete the ciphering and integrity keys that are stored in the UE for that CN domain.
 - 5> set the "START" values for this CN domain to zero and store it the UE;
 - 5> inform the deletion of the key to upper layers.
 - 4> else:
 - 5> store the current "START" value for this CN domain in the UE.

8.5.3 Open loop power control upon establishment of DPCCH

This procedure is used in FDD mode only.

When establishing the first DPCCH the UE shall start the UL inner loop power control at a power level according to:

$$1> \text{DPCCH_Initial_power} = \text{DPCCH_Power_offset} - \text{CPICH_RSCP}$$

Where

DPCCH_Power_offset shall have the value of IE "DPCCH Power offset" in IE "Uplink DPCH power control info"

The value for the CPICH_RSCP shall be measured by the UE.

8.5.4 Physical channel establishment criteria

When a physical dedicated channel establishment is initiated by the UE, the UE shall start a timer T312 and wait for layer 1 to indicate N312 "in sync" indications. On receiving N312 "in sync" indications, the physical channel is considered established and the timer T312 is stopped and reset.

If the timer T312 expires before the physical channel is established, the UE shall consider this as a "physical channel failure".

NOTE: The criteria defined in this subclause only apply in case the UE performs synchronisation procedure A (FDD only).

8.5.5 Actions in "out of service area" and "in service area"

This subclause specifies the general actions the UE shall perform when it detects "out of service" or "in service" area. The specific UE behaviour when it detects "out of service" or "in service area" and periodical update has been configured by T305 in the IE "UE Timers and constants in connected mode" set to any other value than "infinity" is specified in subclause 8.3.1.

8.5.5.1 Detection of "out of service" area

The UE shall detect "out of service" area as defined in [19].

8.5.5.1.1 Actions following detection of "out of service" area in URA_PCH or CELL_PCH state

If the UE detects the "out of service area" and the UE is in URA_PCH or CELL_PCH state it shall perform the following actions:

- 1> start timer T316;
- 1> perform processes described in subclause 7.2.2.

8.5.5.1.2 Actions following detection of "out of service" area in CELL_FACH state

If the UE detects the "out of service area" and the UE is in CELL_FACH state it shall perform the following actions. The UE shall:

- 1> start timer T317 if not already running;
- 1> perform processes described in subclause 7.2.2.

8.5.5.2 Detection of "in service" area

When a suitable cell is found based on the description in [4], the UE considers it as having detected "in service area".

8.5.5.2.1 Actions following Re-entry into "in service area" in URA_PCH or CELL_PCH state

If the UE re-enters "in service area" before T316 expiry the UE shall perform the following actions. The UE shall:

- 1> stop T316;
- 1> if T307 is active:
 - 2> stop T307.
- 1> perform processes described in subclause 7.2.2.

8.5.5.2.2 Actions following re-entry into "in service area" in CELL_FACH state

If the UE detects "in service area" before T317 expiry the UE shall perform the following actions. If no cell update procedure or URA update procedure is ongoing, the UE shall:

- 1> stop T317;
- 1> if T307 is active:

2> stop T307.

1> initiate the cell update procedure using as cause "Re-entering service area" as specified in subclause 8.3.1;

1> perform processes described in subclause 7.2.2.

If a cell update procedure or URA update procedure is ongoing, the UE shall:

1> stop T317;

1> perform the actions as specified in 8.3.1.

8.5.5.3 T316 expiry

On T316 expiry the UE shall perform the following actions. The UE shall:

1> if "out of service area" is detected:

2> start timer T317;

2> move to CELL_FACH state;

2> perform processes described in subclause 7.2.2.

1> if "in service area" is detected:

2> initiate the cell update procedure using as cause "Re-entering service area" as specified in subclause 8.3.1;

2> perform processes described in subclause 7.2.2.

8.5.5.4 T317 expiry

When the T317 expires, the UE shall:

1> move to idle mode;

1> release all dedicated resources;

1> indicate release (abort) of the established signalling connections (as stored in the variable ESTABLISHED_SIGNALLING_CONNECTIONS) and established radio access bearers (as stored in the variable ESTABLISHED_RABS) to upper layers;

1> clear the variable ESTABLISHED_SIGNALLING_CONNECTIONS;

1> clear the variable ESTABLISHED_RABS;

1> perform actions specified in subclause 8.5.2 when entering idle mode from connected mode.

8.5.6 Radio link failure criteria and actions upon radio link failure

In CELL_DCH State, after receiving N313 consecutive "out of sync" indications from layer 1 for the established DPCH physical channel in FDD, and the DPCH associated with mapped DCCHs in TDD, the UE shall:

1> start timer T313;

1> upon receiving N315 successive "in sync" indications from layer 1 and upon change of UE state:

2> stop and reset timer T313.

1> if T313 expires:

2> consider it as a "Radio link failure".

Periods in time where neither "in sync" nor "out of sync" is reported by layer 1 do not affect the evaluation of the number of consecutive (resp. successive) "in sync" or "out of sync" indications.

When a radio link failure occurs, the UE shall:

- 1> clear the dedicated physical channel configuration;
- 1> perform actions as specified for the ongoing procedure;
- 1> if no procedure is ongoing or no actions are specified for the ongoing procedure:
 - 2> perform a cell update procedure according to subclause 8.3.1 using the cause "radio link failure".

8.5.7 Open loop power control

For FDD and prior to PRACH or PCPCH transmission the UE shall:

- 1> read the IEs "Primary CPICH Tx power" and "Constant value" in System Information Block type 6 (or System Information Block type 5, if system information block type 6 is not being broadcast) and the IE "UL interference" in System Information Block type 7;
- 1> measure the value for the CPICH_RSCP;
- 1> calculate the power for the first preamble as:

$$\text{Preamble_Initial_Power} = \text{Primary CPICH TX power} - \text{CPICH_RSCP} + \text{UL interference} + \text{Constant Value}$$

Where,

- Primary CPICH TX power shall have the value of IE "Primary CPICH Tx power",
- UL interference shall have the value of IE "UL interference"; and
- Constant Value shall have the value of IE "Constant value".

- 1> as long as the physical layer is configured for PRACH or PCPCH transmission:
 - 2> continuously recalculate the Preamble_Initial_Power when any of the broadcast parameters used in the above formula changes; and
 - 2> resubmit to the physical layer the new calculated Preamble_Initial_Power.

For 3.84 Mcps TDD the UE shall:

- 1> if in the IE "Uplink DPCH Power Control info" the "CHOICE UL OL PC info" has the value "Broadcast UL OL PC info":
 - 3> acquire Reference Power, Constant Values from System Information Block type 6 (or System Information Block type 5, according to subclause 8.1.1.6.5), and I_{BTS} for all active UL timeslots from System Information Block type 14 on the BCH.
- 1> otherwise:
 - 2> acquire Reference Power, Constant Values and I_{BTS} for all active UL timeslots from the IE "Uplink DPCH Power Control info".
- 1> for PUSCH and PRACH power control:
 - 2> acquire Reference Power, Constant Values and I_{BTS} for all active UL timeslots from System Information Block type 6 (or System Information Block type 5, according to subclause 8.1.1.6.5) and System Information Block type 14 on the BCH.

calculate the UL transmit power according to the following formula for the PRACH continuously while the physical channel is active:

$$P_{\text{PRACH}} = L_{\text{PCCPCH}} + I_{\text{BTS}} + \text{PRACH Constant value},$$

- 2> 3dB shall be added to RACH Constant Value in the above equation for the case where RACH Spreading Factor = 8.

1> calculate the UL transmit power according to the following formula for the DPCH continuously while the physical channel is active:

$$P_{DPCH} = \alpha L_{PCCPCH} + (1-\alpha)L_0 + I_{BTS} + SIR_{TARGET} + DPCH \text{ Constant value}$$

1> calculate the UL transmit power according to the following formula for the PUSCH continuously while the physical channel is active:

$$P_{PUSCH} = \alpha L_{PCCPCH} + (1-\alpha)L_0 + I_{BTS} + SIR_{TARGET} + PUSCH \text{ Constant value}$$

Where, for all the above equations for TDD the following apply:

- P_{PRACH} , P_{DPCH} , & P_{PUSCH} : Transmitter power level in dBm;
- Pathloss values:
 - L_{PCCPCH} : Measurement representing path loss in dB based on beacon channels (the reference transmit power is signalled as the value of the IE "Primary CCPCH Tx Power" on BCH in System Information Block type 6 (or System Information Block type 5, according to subclause 8.1.1.6.5), or individually signalled in the IE "Uplink DPCH Power Control info").
 - L_0 : Long term average of path loss in dB;
 - If the midamble is used in the evaluation of L_{PCCPCH} and L_0 , and the Tx diversity scheme used for the P-CCPCH involves the transmission of different midambles from the diversity antennas, the received power of the different midambles from the different antennas shall be combined prior to evaluation of the variables.
- I_{BTS} : Interference signal power level at cell's receiver in dBm. I_{BTS} shall have the value of the IE "UL Timeslot Interference" (IE "UL Timeslot Interference" is broadcast on BCH in System Information Block type 14 or individually signalled to each UE in the IE "Uplink DPCH Power Control info" for each active uplink timeslot).
- α : α is a weighting parameter, which represents the quality of path loss measurements. α may be a function of the time delay between the uplink time slot and the most recent down link PCCPCH time slot. α is calculated at the UE. α shall be smaller or equal to the value of the IE "Alpha". If the IE "Alpha" is not explicitly signalled to the UE α shall be set to 1. If UE is capable of estimating its position by using the OTDOA IPDL method, the UE shall use the IPDL- α parameter.
- SIR_{TARGET} : Target SNR in dB. This value is individually signalled to UEs in IE "UL target SIR" in IE "Uplink DPCH Power Control Info" or in IE "PUSCH Power Control Info" respectively.
- PRACH Constant value: PRACH Constant value shall have the value of the IE "PRACH Constant value".
- DPCH Constant value: DPCH Constant value shall have the value of the IE "DPCH Constant value".
- PUSCH Constant value: PUSCH Constant value shall have the value of the IE "PUSCH Constant value".
- Values received by dedicated signalling shall take precedence over broadcast values.
- If IPDLs are applied, the UE may increase UL Tx power by the value given in the IE "Max power increase". This power increase is only allowed in the slots between an idle slot and the next beacon slot.

For 1.28 Mcps TDD the UE shall:

1> calculate the UL transmit power according to the following formula for each UpPCH code transmission:

$$P_{UpPCH} = L_{PCCPCH} + PRX_{UpPCHdes} + (i-1) * Pwr_{ramp}$$

NOTE: When i equals 1, the initial signature power "Signature_Initial_Power" defined in [33] corresponds to P_{UpPCH} with i set to 1.

1> calculate the UL transmit power according to the following formula for each PRACH transmission:

$$P_{PRACH} = L_{PCCPCH} + PRX_{PRACHdes} + (i_{UpPCH}-1) * Pwr_{ramp}$$

1> calculate the initial UL transmit power according to the following formula for the PUSCH. Once the UE receives TPC bits relating to the PUSCH then it transitions to closed loop power control. If successive PUSCH resource allocations are contiguous then no return is made to open loop power control at the beginning of the succeeding resource allocation.

$$P_{\text{USCH}} = \text{PRX}_{\text{PUSCHdes}} + L_{\text{PCCPCH}}$$

1> calculate the initial UL transmit power according to the following formula for the DPCH. Once the UE receives TPC bits relating to the uplink DPCH then it transitions to closed loop power control.

$$P_{\text{DPCH}} = \text{PRX}_{\text{DPCHdes}} + L_{\text{PCCPCH}}$$

Where:

- P_{UpPCH} , P_{PRACH} , P_{DPCH} , & P_{USCH} : Transmitter power level in dBm.
- L_{PCCPCH} : Measurement representing path loss in dB (reference transmit power "Primary CCPCH Tx Power" is broadcast on BCH in System Information Block type 5 and System Information Block type 6, or individually signalled to each UE in the IE "Uplink DPCH Power Control info").
- i is the number of transmission attempts on UpPCH, $i=1 \dots M_{\text{max}}$.
- i_{UpPCH} is the final value of i .
- $\text{PRX}_{\text{PRACHdes}}$: Desired PRACH RX power at the cell's receiver in dBm signalled to the UE by the network in the FPACH response to the UE's successful SYNC_UL transmission.
- $\text{PRX}_{\text{UpPCHdes}}$: Desired UpPCH RX power at the cell's receiver in dBm. The value is broadcast in "PRX_{UpPCHdes}" in IE "SYNC_UL info" on BCH and shall be read on System Information Block type 5 and System Information Block type 6. It can also be signalled directly to the UE in a protocol message triggering a hard handover.
- $\text{PRX}_{\text{PUSCHdes}}$: Desired PUSCH RX power at the cell's receiver in dBm signalled to the UE in IE "PUSCH Power Control Info".
- $\text{PRX}_{\text{DPCHdes}}$: Desired DPCH RX power at the cell's receiver in dBm signalled to the UE in IE "Uplink DPCH Power Control Info".
- P_{wramp} : The UE shall increase its transmission power by the value of the IE "Power Ramp step" by every UpPCH transmission.

8.5.8 Maintenance of Hyper Frame Numbers

The MSBs of both the ciphering sequence numbers (COUNT-C) and integrity sequence numbers (COUNT-I), for the ciphering and integrity protection algorithms, respectively [40], are called the Hyper Frame Numbers (HFN).

For integrity protection, the UE shall:

- 1> maintain COUNT-I as specified in subclause 8.5.10.

The following hyper frame numbers types are defined:

MAC-d HFN:
24 MSB of COUNT-C for data sent over RLC TM

RLC UM HFN:
25 MSB of COUNT-C for data sent over RLC UM

RLC AM HFN:
20 MSB of COUNT-C for data sent over RLC AM

RRC HFN:
28 MSB of COUNT-I

For non-transparent mode RLC signalling radio bearers and radio bearers, the UE shall:

- 1> maintain one uplink and one downlink COUNT-C per signalling radio bearer and per radio bearer and one uplink and one downlink COUNT-I per signalling radio bearer;
- 1> increment the RLC UM HFN and RLC AM HFN in uplink and downlink by one each time the RLC sequence number wraps around in uplink and downlink respectively;
- 1> if the activation time for a new ciphering configuration set by an RRC procedure is equal to zero:
 - 2> apply the configured RLC UM HFN or RLC AM HFN at this activation time, i.e. the configured HFN is not incremented.

NOTE: On the receiver side it may happen that the RLC PDU with sequence number equal to the activation time is lost and the first received PDU after the activation time implies a wrap around of the sequence number compared to the activation time. In this case the configured HFN is incremented by one. This action is taken only when the activation time is set to a RLC PDU sequence number value other than zero.

For all transparent mode RLC signalling radio bearers and radio bearers of each CN domain, the UE shall:

- 1> maintain one COUNT-C, common for all signalling radio bearers and radio bearers in uplink and downlink;
- 1> increment the MAC-d HFN by one each time the CFN wraps around;
- 1> if the activation time for a new ciphering configuration set by an RRC procedure is equal to zero:
 - 2> apply the configured MAC-d HFN at this activation time, i.e. the configured HFN is not incremented.
- 1> maintain one uplink and one downlink COUNT-I per signalling radio bearer.

NOTE: In this release of the specification there is only an uplink transparent mode COUNT-I, which is used for signalling radio bearer RB0.

COUNT-C and COUNT-I are defined in [40], with the following supplement for COUNT-C: for transparent mode RLC radio bearers with a transmission time interval of x radio frames ($x = 2, 4, 8$), the MAC PDU is carried by L1 in x consecutive radio frames due to radio frame segmentation. In this case, the CFN of the first radio frame in the TTI shall be used as the CFN component of COUNT-C for ciphering of all data in the TTI [15].

8.5.9 START value calculation

In connected mode, the START value for CN domain 'X' is calculated as

Let $START_X$ = the START value for CN domain 'X' prior to the calculation below:

$START_X' = MSB_{20} (MAX \{ COUNT-C, COUNT-I \mid \text{radio bearers and signalling radio bearers using the most recently configured } CK_X \text{ and } IK_X \}) + 2$.

- if $START_X' =$ the maximum value = 1048575 then $START_X = START_X'$;
- if the current $START_X < START_X'$ then $START_X = START_X'$, otherwise $START_X$ is unchanged.

NOTE: Here, "most recently configured" means that if there is more than one key in use for a CN domain, due to non-expiry of the ciphering and/or integrity protection activation time for any signalling radio bearers and/or radio bearers, do not include the COUNT-I/COUNT-C for these signalling radio bearers and/or radio bearers in the calculation of the $START_X'$.

COUNT-C corresponding to non-ciphered radio bearers (i.e. RBs with ciphering status set to "not started") shall not be included in the calculation of the $START_X'$. If a radio bearer is released and the radio bearer was ciphered, the values of the COUNT-C at the time the radio bearer is released shall be taken into account in the calculation of the $START_X'$.

8.5.10 Integrity protection

If the "Status" in the variable INTEGRITY_PROTECTION_INFO has the value "Started" then the UE shall:

- 1> perform integrity protection (and integrity checking) on all RRC messages, with the following exceptions:
HANDOVER TO UTRAN COMPLETE

PAGING TYPE 1
PUSCH CAPACITY REQUEST
PHYSICAL SHARED CHANNEL ALLOCATION
RRC CONNECTION REQUEST
RRC CONNECTION SETUP
RRC CONNECTION SETUP COMPLETE
RRC CONNECTION REJECT
RRC CONNECTION RELEASE (CCCH only)
SYSTEM INFORMATION
SYSTEM INFORMATION CHANGE INDICATION
TRANSPORT FORMAT COMBINATION CONTROL (TM DCCH only)

If the "Status" in the variable INTEGRITY_PROTECTION_INFO has the value "Not started" then integrity protection (and integrity checking) shall not be performed on any RRC message.

For each signalling radio bearer, the UE shall use two RRC hyper frame numbers:

- "Uplink RRC HFN";
- "Downlink RRC HFN".

and two message sequence numbers:

- "Uplink RRC Message sequence number";
- "Downlink RRC Message sequence number".

The above information is stored in the variable INTEGRITY_PROTECTION_INFO per signalling radio bearer (RB0-RB4).

Upon the first activation of integrity protection for an RRC connection, UE and UTRAN initialise the "Uplink RRC Message sequence number" and "Downlink RRC Message sequence number" for all signalling radio bearers as specified in subclauses 8.6.3.5 and 8.5.10.1.

The RRC message sequence number (RRC SN) is incremented for every integrity protected RRC message.

If the IE "Integrity Protection Mode Info" is present in a received message, the UE shall:

- 1> perform the actions in subclause 8.6.3.5 before proceeding with the integrity check of the received message.

8.5.10.1 Integrity protection in downlink

If the UE receives an RRC message on signalling radio bearer with RB identity n, the "Status" in the variable INTEGRITY_PROTECTION_INFO has the value "Started" and the IE 'Integrity check info' is present the UE shall:

- 1> check the value of the IE "RRC message sequence number" included in the IE "Integrity check info";
- 2> if the "Downlink RRC Message sequence number" is not present in the variable INTEGRITY_PROTECTION_INFO:
 - 3> initialise the "Downlink RRC Message sequence number" for signalling radio bearer RBn in the variable INTEGRITY_PROTECTION_INFO with the value of the IE "RRC message sequence number" included in the IE "Integrity check info" of the received message.
- 2> if the "Downlink RRC Message sequence number" is present in the variable INTEGRITY_PROTECTION_INFO:

- 3> if the RRC message sequence number is lower than the "Downlink RRC Message sequence number" for signalling radio bearer RBn in the variable INTEGRITY_PROTECTION_INFO:
 - 4> increment "Downlink RRC HFN" for signalling radio bearer RBn in the variable INTEGRITY_PROTECTION_INFO with one.

NOTE: The actions above imply that also for the case the "Downlink RRC HFN" is re-initialised by a security mode control procedure, this "Downlink RRC HFN" value is incremented by one before it is applied for the integrity protection of any received message if the conditions above are fulfilled.

- 3> if the RRC message sequence number is equal to the "Downlink RRC Message sequence number" for signalling radio bearer RBn in the variable INTEGRITY_PROTECTION_INFO:
 - 4> discard the message.
- 1> calculate an expected message authentication code in accordance with subclause 8.5.10.3;
- 1> compare the expected message authentication code with the value of the received IE "message authentication code" contained in the IE "Integrity check info";
 - 2> if the expected message authentication code and the received message authentication code are the same, the integrity check is successful:
 - 3> update the "Downlink RRC Message sequence number" for signalling radio bearer RBn in the variable INTEGRITY_PROTECTION_INFO with the value of the IE "RRC message sequence number" included in the IE "Integrity check info" of the received RRC message.
 - 2> if the calculated expected message authentication code and the received message authentication code differ:
 - 3> act as if the message was not received.

If the UE receives an RRC message on signalling radio bearer with identity n, the "Status" in the variable INTEGRITY_PROTECTION_INFO has the value "Started" and the IE 'Integrity check info' is not present the UE shall:

- 1> discard the message.

UTRAN may transmit several copies of the same message in the downlink to increase the probability of proper reception of the message by the UE. In such a case, the RRC SN for these repeated messages should be the same.

8.5.10.2 Integrity protection in uplink

Prior to sending an RRC message using the signalling radio bearer with radio bearer identity n, and the "Status" in the variable INTEGRITY_PROTECTION_INFO has the value "Started" the UE shall:

- 1> increment "Uplink RRC Message sequence number" for signalling radio bearer RBn in the variable INTEGRITY_PROTECTION_INFO with 1, even if the message is a retransmission of a previously transmitted message.
- 1> if the "Uplink RRC Message sequence number" for signalling radio bearer RBn in the variable INTEGRITY_PROTECTION_INFO equals zero:
 - 2> increment "Uplink RRC HFN" for signalling radio bearer RBn in the variable INTEGRITY_PROTECTION_INFO by one.

NOTE 1: The actions above imply that also for the case the "Uplink RRC HFN" is re-initialised by a security mode control procedure, this "Uplink RRC HFN" is incremented before it is applied in the integrity protection of any transmitted message if the conditions above are fulfilled.

NOTE 2: For SRB0, this is also valid in case the Message Sequence Number has been increased by N302 + 1 resulting in a wrap around. Then the uplink RRC HFN is incremented by 1.

- 1> calculate the message authentication code in accordance with subclause 8.5.10.3;
- 1> replace the "Message authentication code" in the IE "Integrity check info" in the message with the calculated message authentication code;

- 1> replace the "RRC Message sequence number" in the IE "Integrity check info" in the message with contents set to the new value of the "Uplink RRC Message sequence number" for signalling radio bearer RBn in the variable INTEGRITY_PROTECTION_INFO.

In the response message for the procedure ordering the security reconfiguration, the UE indicates the activation time, for each signalling radio bearer. When the new integrity configuration is to be applied in uplink, UTRAN should start to apply the new integrity protection configuration according to the activation time for each signalling radio bearer (except for the signalling radio bearer which is used to send the message that is reconfiguring the security configuration where the new configuration is to be applied starting from and including reception of the response message).

8.5.10.3 Calculation of message authentication code

The UE shall calculate the message authentication code in accordance with [40]. The input parameter MESSAGE [40] for the integrity algorithm shall be constructed by:

- 1> setting the "Message authentication code" in the IE "Integrity check info" in the message to the value of the IE "RB identity" for the signalling radio bearer;
- 1> setting the "RRC Message sequence number" in the IE "Integrity check info" in the message to zero;
- 1> encoding the message;
- 1> appending RRC padding (if any) as a bit string to the encoded bit string as the least significant bits.

For usage on an RRC message transmitted or received on the radio bearer with identity n, the UE shall:

- 1> construct the input parameter COUNT-I [40] by appending the following IEs from the IE "Signalling radio bearer specific integrity protection information" for radio bearer n in the variable INTEGRITY_PROTECTION_INFO:
 - 2> for uplink:
 - 3> "Uplink RRC HFN", as the MSB, and "Uplink RRC Message sequence number", as LSB.
 - 2> for downlink:
 - 3> "Downlink RRC HFN", as the MSB, and the IE "RRC message sequence number" included in the IE "Integrity check info", as LSB.

8.5.11 FACH measurement occasion calculation

When in CELL_FACH state and when the variable C_RNTI is non-empty the UE in FDD mode shall perform measurements as specified in subclauses 8.4.1.6 and 8.4.1.8 during the frame(s) with the SFN value fulfilling the following equation:

$$\text{SFN div } N = \text{C_RNTI mod } M_REP + n * M_REP$$

where

- N is the TTI (in number of 10ms frames) of the FACH having the largest TTI on the SCCPCH monitored by UE
- C_RNTI is the C-RNTI value of the UE stored in the variable C_RNTI
- M_REP is the Measurement Occasion cycle length. According to the equation above, a FACH Measurement Occasion of N frames will be repeated every $N * M_REP$ frame, and $M_REP = 2^k$.

where,

- k is the FACH Measurement occasion cycle length coefficient.
The value of the FACH Measurement occasion cycle length coefficient is read in system information in "System Information Block type 11" or "System Information Block type 12" in the IE "FACH measurement occasion info".
- n = 0,1,2... as long as SFN is below its maximum value

The UE is allowed to measure on other occasions in case the UE moves "out of service" area or in case it can simultaneously perform the ordered measurements.

A UE in TDD mode shall use the frame(s) with the SFN value fulfilling the above equation for neighbour cells measurements.

8.5.12 Establishment of Access Service Classes

The PRACH resources (i.e. access slots and preamble signatures for FDD), timeslot (with specific frame allocation and channelisation code for 3.84 Mcps TDD and SYNC_UL codes (with specific frame allocation) for 1.28 Mcps TDD) may be divided between different Access Service Classes in order to provide different priorities of RACH usage. It is possible for more than one ASC or for all ASCs to be assigned to the same access slot/signature space in FDD or frame allocation/channelisation codes in 3.84 Mcps TDD or frame allocation/SYNC_UL codes in 1.28 Mcps TDD.

Access Service Classes shall be numbered in the range $0 \leq i \leq \text{NumASC} \leq 7$ (i.e. the maximum number of ASCs is 8). An ASC is defined by an identifier, i , that defines a certain partition of the PRACH resources (SYNC_UL resources in 1.28 Mcps TDD) and an associated persistence value P_i . A set of ASC parameters consists of "NumASC+1" such parameters (i, P_i), $i = 0, \dots, \text{NumASC}$.

PRACH partitions shall be established using the information element "PRACH partitioning". The persistence values P_i to be associated with each ASC shall be derived from the dynamic persistence level $N = 1, \dots, 8$ which is broadcast in SIB 7, and the persistence scaling factors s_i , broadcast in System Information Block Type 5 and possibly also in System Information Block Type 6, as follows:

$$P(N) = 2^{-(N-1)}$$

ASC # i	0	1	2	3	4	5	6	7
P_i	1	$P(N)$	$s_2 P(N)$	$s_3 P(N)$	$s_4 P(N)$	$s_5 P(N)$	$s_6 P(N)$	$s_7 P(N)$

Scaling factors s_i are provided optionally for $i = 2, \dots, \text{NumASC}$, where NumASC+1 is the number of ASCs as defined by PRACH partitioning. If no scaling factors are broadcast, default value 1 shall be used if NumASC ≥ 2 .

If $k \geq 1$ scaling factors are broadcast and NumASC $\geq k+2$ then the last scaling factor s_{k+1} shall be used as default for the ASCs where $i > k+1$.

The set of ASC parameters is provided to MAC with the CMAC-Config-REQ primitive (see [15]), the PRACH partitioning is provided to PHY using the CPHY-RL-Setup-REQ primitive (see [34]).

The ASC enumeration shall be such that it corresponds to the order of priority (ASC 0 = highest priority, ASC 7 = lowest priority). ASC 0 shall be used in case of Emergency Call or for reasons with equivalent priority.

ASCs are numbered according to the order in which the IEs "ASC Setting" appear in the IE "PRACH partitioning", where the first IE "ASC Setting" describes ASC 0, the second IE "ASC Setting" describes ASC 1, etc.

At radio bearer setup/reconfiguration each involved logical channel is assigned a MAC Logical channel Priority (MLP) in the range 1, ..., 8. When the MAC sublayer is configured for RACH transmission in the UE, these MLP levels shall be employed for ASC selection on MAC.

8.5.13 Mapping of Access Classes to Access Service Classes

Access Classes shall only be applied at initial access, i.e. when sending an RRC CONNECTION REQUEST message. A mapping between Access Class (AC) and Access Service Class (ASC) shall be indicated by the information element "AC-to-ASC mapping" in System Information Block type 5. The correspondence between AC and ASC shall be indicated as follows.

AC	0 - 9	10	11	12	13	14	15
ASC	1 st IE	2 nd IE	3 rd IE	4 th IE	5 th IE	6 th IE	7 th IE

In the table, "nth IE" designates an ASC number i in the range 0 - 7 to AC. If the ASC indicated by the "nth IE" is undefined, the UE behaviour is unspecified.

For the random access, the parameters implied by the respective ASC shall be employed. In case the UE is member of several ACs it shall select the ASC for the highest AC number. In connected mode, AC shall not be applied.

8.5.14 PLMN Type Selection

The UE shall perform PLMN selection and reselection as stated in [4] and store the identifier of the chosen PLMN in the variable `SELECTED_PLMN` as follows. The UE shall:

- 1> if a GSM-MAP type of PLMN is selected:
 - 2> set the "PLMN Type" in the variable `SELECTED_PLMN` to "GSM-MAP";
 - 2> and store the PLMN identity of that PLMN.
- 1> if an ANSI-41 type of PLMN is selected:
 - 2> set the "PLMN Type" in the variable `SELECTED_PLMN` to "ANSI-41";
 - 2> and store the System identification (SID) of that PLMN.

8.5.14a Neighbour cells list narrowing for cell reselection

A UE having performed the PLMN identification of the neighbour cells as specified in 8.1.1.6.18 shall narrow the cell list to be used for cell reselection ([4]) to those cells that do satisfy one of the following criteria:

- 1> the PLMN identity of the neighbour cell is the identity of the selected PLMN;
- 1> the PLMN identity of the neighbour cell is indicated by higher layers to be equivalent to the identity of the selected PLMN.

8.5.15 CFN calculation

The DOFF used in the formulas in this clause concerns the value of IE "Default DPCH Offset Value" received in the message that instructs the UE to enter `CELL_DCH` state or to perform timing re-initialised hard handover.

8.5.15.1 Initialisation for `CELL_DCH` state after state transition

When the UE receives any of the messages causing the UE to perform a state transition to `CELL_DCH`, the UE shall set the CFN in relation to the SFN of the first radio link listed in the IE "Downlink information per radio link list" included in that message according to the following formula:

- for FDD:

$$\text{CFN} = (\text{SFN} - (\text{DOFF} \text{ div } 38400)) \text{ mod } 256$$

where the formula gives the CFN of the downlink DPCH frame which starts at the same time as or which starts during the PCCPCH frame with the given SFN.

- for TDD:

$$\text{CFN} = (\text{SFN} - \text{DOFF}) \text{ mod } 256.$$

8.5.15.2 Initialisation in `CELL_DCH` state at hard handover

When the UE is in `CELL_DCH` state and receives any of the messages causing the UE to perform a hard handover, the UE shall check the IE "Timing indication" in that message and:

- 1> if IE "Timing indication" has the value "initialise" (i.e. timing re-initialised hard handover):
 - 2> read SFN on target cell identified by the first radio link listed in the IE "Downlink information per radio link list" included in that message;
 - 2> set the CFN according to the following formula:

3> for FDD:

$$CFN = (SFN - (DOFF \text{ div } 38400)) \text{ mod } 256$$

where the formula gives the CFN of the downlink DPCH frame which starts at the same time as or which starts during the PCCPCH frame with the given SFN.

3> for TDD:

$$CFN = (SFN - DOFF) \text{ mod } 256.$$

1> if IE "Timing indication" has the value "maintain" (i.e. timing-maintained hard handover), the UE shall keep CFN with no change due to the hard handover, and only increase CFN (mod 256) by 1 every frame.

8.5.15.3 Initialisation for CELL_FACH

When the UE performs cell selection, re-selection or changes to CELL_FACH state the UE shall set CFN for all common or shared channels according to:

$$CFN = SFN \text{ mod } 256$$

where the formula gives the CFN of the downlink common or shared channel frame which starts at the same time as or which starts during the PCCPCH frame with the given SFN.

After the initialisation, the CFN in the UE is increased (mod 256) by 1 every frame.

8.5.15.4 Initialisation after intersystem handover to UTRAN

Upon inter RAT handover to UTRAN the UE shall, regardless of the value received within IE "Timing indication" (if received):

1> read SFN on target cell and set the CFN according to the following formula:

2> for FDD:

$$CFN = (SFN - (DOFF \text{ div } 38400)) \text{ mod } 256$$

where the formula gives the CFN of the downlink DPCH frame which starts at the same time as or which starts during the PCCPCH frame with the given SFN.

2> for TDD:

$$CFN = (SFN - DOFF) \text{ mod } 256.$$

8.5.16 Configuration of CTCH occasions

The CTCH, carrying CBS data is mapped onto only one S-CCPCH. If more than one CTCH is defined, the first CTCH that is configured in the list of S-CCPCHs is the one that is used for CBS data.

The CTCH occasions are identified by the first radio frame of the TTI that can contain CTCH data. The CTCH occasions are fixed on the system frame number cycle 0 .. 4095 (i.e. no modulo calculation) and thus repeated cyclically.

The CTCH occasions are determined by a set of parameters.

M_{TTI} : number of radio frames within the TTI of the FACH used for CTCH

N: period of CTCH allocation on S-CCPCH, integer number of radio frames,
 $M_{TTI} \leq N \leq \text{MaxSFN} - K$, where N is a multiple of M_{TTI} (see [27] and [31]).

MaxSFN: maximum system frame number = 4095 (see [10]).

K: CBS frame offset, integer number of radio frames $0 \leq K \leq N-1$ where K is a multiple of M_{TTI} .

The CTCH occasions are calculated as follows:

$$SFN = (K + m N), m = 0, 1, \dots, M, \text{ with } M \text{ chosen that } K + MN \leq \text{MaxSFN}.$$

The parameters N and K are broadcast as system information.

8.5.17 PRACH selection

For this version of the specification, when a UE selects a cell, the uplink frequency to be used for the initial PRACH transmission shall have a default duplex frequency spacing offset from the downlink frequency that the cell was selected on. The default duplex frequency separation to be used by the UE is specified in [35] (for FDD only).

NOTE: The PRACH selection scheme assumes that all PRACHs configured in System Information Block type 5 and System Information Block type 6 support all (implicitly or explicitly) configurable RLC sizes of the cell, i.e. at least the transport formats corresponding to a single transport block of each applicable RLC size of the cell must be defined for each PRACH.

The UE shall select a "PRACH system information" according to the following rule. The UE shall:

- 1> select a "PRACH system information" from the ones indicated in the IE "PRACH system information list" in System Information Block type 5 (applicable in Idle Mode and Connected Mode) or System Information Block type 6 (applicable in Connected Mode only), as follows:
 - 2> if in connected mode and System Information Block type 6 is defined and includes PRACH info:
 - 3> compile a list of candidate PRACHs that consists of the PRACH system information listed in SIB 6, in the order of appearance as in SIB 6.
 - 2> otherwise:
 - 3> compile a list of candidate PRACHs that consists of the PRACH system information listed in SIB 5, in the order of appearance as in SIB 5.
 - 2> in FDD:
 - 3> perform RACH TTI selection as specified in subclause 8.5.18.1.
 - 2> in 1.28 Mcps TDD:
 - 3> perform RACH TTI selection according to subclause 8.5.18.2.
 - 2> remove from the list of candidate PRACHs those PRACHs that have a TTI length different from the selected value;
 - 2> select a PRACH randomly from the list of candidate PRACHs as follows:

$$\text{"Index of selected PRACH"} = \text{floor}(\text{rand} * K)$$

where K is equal to the number of candidate PRACH system informations, "rand" is a random number uniformly distributed in the $0 \leq \text{rand} < 1$ and "floor" refers to rounding down to nearest integer. The candidate PRACH system informations shall be indexed from 0 to K-1. The random number generator is left to implementation. The scheme shall be implemented such that one of the available PRACH system informations is randomly selected with uniform probability. At start-up of the random number generator in the UE the seed shall be dependent on the IMSI of the UE or time, thereby avoiding that all UEs select the same RACH;

- 2> use the TFCS of the selected PRACH when performing TFC selection (see [15]);
- 2> reselect the PRACH system information when a new cell is selected. RACH reselection may also be performed after each transmission of a Transport Block Set on RACH.
- 1> for emergency call, the UE is allowed to select any of the available PRACH system informations.

After selecting a PRACH system information, the RRC in the UE shall configure the MAC and the physical layer for the RACH access according to the parameters included in the selected "PRACH system information" IE.

8.5.18 Selection of RACH TTI

8.5.18.1 FDD

In FDD mode, a RACH may employ either 10 or 20 ms TTI. The supported TTI is indicated as a semi-static parameter of the RACH Transport Format in system information. The UE shall select an appropriate TTI length from the RACHs included in the list of candidate PRACH(s) according to the following rule.

The UE shall:

- 1> only RACHs with one particular TTI length are included in the list of candidate PRACH(s):
 - 2> select this TTI length and proceed as specified in subclause 8.5.17.
- 1> if both PRACHs with 10ms and 20ms TTI lengths are included in the list of candidate PRACH(s):
 - 2> perform TTI selection as follows:
 - 3> when the UE calculates the initial preamble transmit power ("Preamble_Initial_Power") as specified in subclause 8.5.7:
 - 4> select a TF to be employed for calculation of a transmit power margin as follows:
 - 5> from the TFs supported by all candidate PRACHs keep those which correspond to a single transport block of all configured RLC sizes (i.e., in idle mode, the RLC size applicable for RB0, in connected mode, the RLC sizes configured with explicit "RB mapping info"). If more than a single TF remain applicable, the UE may select any of these. Preferably the UE should select the TF which is intended to be used at the next transmission or, if such information is not available, the TF corresponding to the largest configured RLC size.

- 4> calculate a transmit power margin,

$$\text{Margin} = \{ \min(\text{Maximum allowed UL tx power, P_MAX}) - \max(\text{Preamble_Initial_Power, Preamble_Initial_Power} + \Delta P_{p-m} + 10 \cdot \log_{10}(1 + (\beta_d / \beta_c)^2)) \}$$

where "Maximum allowed UL tx power" is the maximum allowed uplink transmit power indicated in system information (in dBm), and P_MAX is the maximum RF output power of the UE (dBm). The margin shall be calculated for the gain factors β_d and β_c of the TF selected in the step above, using 10ms TTI length.

NOTE: the expression $\text{Preamble_Initial_Power} + \Delta P_{p-m} + 10 \cdot \log_{10}(1 + (\beta_d / \beta_c)^2)$ represents the total RACH message power if the message would be sent after the initial preamble.

- 3> if the resulting "Margin" value is less than 6 dB:
 - 4> select RACH with 20 ms TTI, and proceed as specified in subclause 8.5.17.
- 3> otherwise, if the last L1 message transmission on PRACH failed (see [15]):
 - 4> the UE may select RACH with 20ms TTI length and proceed as specified in subclause 8.5.17.
- 3> otherwise:
 - 4> select RACH with 10ms TTI length and proceed as specified in subclause 8.5.17.

8.5.18.2 1.28 Mcps TDD

In 1.28 Mcps TDD, a RACH may be assigned a 5, 10 or 20 ms TTI. If, in one cell, more than one RACH is defined a UE shall select the RACH that is to be used for each transmission according to the following rule:

- 1> if only RACHs with one particular TTI length are assigned a transport format that is suitable for the transmission of the transport block set:
 - 2> select this RACH's TTI length.

- 1> if more than one RACHs are assigned a transport format that is suitable for the transmission of the transport block set:
- 2> select the longest of the TTI lengths of these RACHs.

8.5.19 Secondary CCPCH selection

In UTRAN Connected mode, the UE shall select the Secondary CCPCH according to the following rules:

- 1> in Cell_DCH state:
 - 2> select Secondary CCPCH according to subclause 8.6.6.4.
- 1> in Cell_FACH state:
 - 2> if System Information Block type 6 is defined and includes one or more SCCPCH that carry a FACH, compile a list of candidate SCCPCH that consists of these SCCPCH, in the order of appearance in System Information Block type 6.

NOTE 1: An SCCPCH carries a FACH if the size of the "FACH/PCH information" list within the IE "Secondary CCPCH system information" exceeds 1 or if the size of this list equals 1 while IE "Secondary CCPCH system information" does not contain an IE "PICH info".

- 2> otherwise:
 - 3> compile a list of candidate SCCPCH that consists of the SCCPCH(s) included in System Information Block type 5 that carry a FACH, in the order of appearance in System Information Block type 5.
 - 2> select an SCCPCH from the list of candidate SCCPCHs based on U-RNTI as follows:

$$\text{"Index of selected SCCPCH"} = \text{U-RNTI mod K,}$$

where K is equal to the number of candidate SCCPCHs.

- 1> in Cell_PCH and URA_PCH states:
 - 2> if System Information Block type 6 is defined and includes one or more SCCPCH that carry a PCH, compile a list of candidate SCCPCH that consists of these SCCPCH, in the order of appearance in System Information Block type 6

NOTE 2: An SCCPCH carries a PCH if the IE "Secondary CCPCH system information" contains IE "PICH info"

- 2> otherwise compile a list of candidate SCCPCH that consists of the SCCPCH(s) included in System Information Block type 5 that that carry a PCH , in the order of appearance in System Information Block type 5
- 2> select an SCCPCH from the list of candidate SCCPCHs based on U-RNTI as follows:

$$\text{"Index of selected SCCPCH"} = \text{U-RNTI mod K,}$$

where K is equal to the number of candidate SCCPCHs.

The UE shall set the CFN in relation to the SFN of the current cell according to subclause 8.5.15.

The UE shall support reception of all transport formats on all FACHs multiplexed on the selected S-CCPCH.

8.5.20 Unsupported configuration

The UE should set the variable UNSUPPORTED_CONFIGURATION to TRUE if the received message is not according to the UE capabilities.

8.5.21 Actions related to Radio Bearer mapping

When the UE receives the IE "RB mapping info" and/or the IE "Transport format set", when the UE performs a cell reselection or a state transition, or when the UE releases a RB, the UE shall for each of the configured Radio Bearers:

- 1> upon moving to CELL_FACH after detecting a radio link failure (see subclause 8.5.6) and upon subsequent cell reselections until the first successfully completed cell update procedure, perform the actions defined in the remainder of this subclause only for signalling radio bearers;
- 1> configure the MAC with the appropriate transport format set (with computed transport block sizes) for the transport channel used by that RB;
- 1> determine the sets of RLC sizes that apply to the logical channels used by that RB, based on the IEs "RLC size list" and/or the IEs "Logical Channel List" included in the applicable "Transport format set" (either the ones received in the same message or the ones stored if none were received);
- 1> in case the selected multiplexing option is a multiplexing option on RACH:
 - 2> ignore the RLC size indexes that do not correspond to any RLC size within the Transport Format Set stored for RACH.
 - 2> if there is no remaining RLC size index corresponding to an RLC size within the Transport Format Set stored for RACH:
 - 3> set the variable INVALID_CONFIGURATION to TRUE.
- 1> if RACH is the transport channel to be used on the uplink, if that RB has a multiplexing option on RACH and if it is using AM:
 - 2> apply the largest size amongst the ones derived according to the previous bullet for the RLC size (or RLC sizes in case the RB is realised using two logical channels) for the corresponding RLC entity.

NOTE: The IE "RB mapping info" is only included in the IE "Predefined RB configurations" in system information when used for Inter-RAT handover to UTRAN and there is no AM RLC size change involved in this case.

- 1> if that RB is using AM and the RLC size applicable to the logical channel transporting data PDUs is different from the one derived from the previously stored configuration:
 - 2> re-establish the corresponding RLC entity;
 - 2> configure the corresponding RLC entity with the new RLC size;
 - 2> for each AM RLC radio bearer in the CN domain as indicated in the IE "CN domain identity" in the IE "RAB info" in the variable ESTABLISHED_RABS whose RLC size is changed; and
 - 2> for each AM RLC signalling radio bearer in the CN domain as indicated in the IE "CN domain identity" in the variable LATEST_CONFIGURED_CN_DOMAIN whose RLC size is changed:
 - 3> if the IE "Status" in the variable CIPHERING_STATUS of this CN domain is set to "Started":
 - 4> if the information causing the RLC re-establishment was included in system information:
 - 5> set the HFN values for the corresponding RLC entity equal to the value of the IE "START" for this CN domain that will be included in the CELL UPDATE message following cell reselection.

NOTE: Since the UE cannot predict the START value at the time of the next CELL UPDATE transmission in the future, UTRAN should desist from changing the RLC size for a signalling radio bearer within a cell. Other than this case the change in RLC size for a signalling radio bearer is known to the UE when reading system information following cell reselection.

- 4> if the RLC re-establishment is caused by a CELL UPDATE CONFIRM:
 - 5> set the HFN values for the corresponding RLC entity equal to the value of the IE "START" included in the latest transmitted CELL UPDATE message for this CN domain.
- 4> if the RLC re-establishment is caused by a reconfiguration message:
 - 5> set the HFN values for the corresponding RLC entity equal to the value of the IE "START" that will be included in the reconfiguration complete message for this CN domain.

- 1> if that RB is using UM:

- 2> indicate the largest applicable RLC size to the corresponding RLC entity.
- 1> configure MAC multiplexing according to the selected multiplexing option (MAC multiplexing shall only be configured for a logical channel if the transport channel it is mapped on according to the selected multiplexing option is the same as the transport channel another logical channel is mapped on according to the multiplexing option selected for it);
- 1> configure the MAC with the logical channel priorities according to selected multiplexing option;
- 1> configure the MAC with the set of applicable RLC Sizes for each of the logical channels used for that RB;
- 1> if there is no multiplexing option applicable for the transport channels to be used:
 - 2> set the variable INVALID_CONFIGURATION to TRUE.
- 1> if there is more than one multiplexing option applicable for the transport channels to be used:
 - 2> set the variable INVALID_CONFIGURATION to TRUE.

If upon cell re-selection or upon moving to CELL_FACH after detecting a radio link failure the UE sets variable INVALID_CONFIGURATION to TRUE as a result of the actions defined in this subclause, the UE should:

- 1> move to idle mode;
- 1> release (locally) the established signalling connections (as stored in the variable ESTABLISHED_SIGNALLING_CONNECTIONS) and the established radio access bearers (as stored in the variable ESTABLISHED_RABS) and indicate this to upper layers;
- 1> perform other actions when entering idle mode from connected mode as specified in subclause 8.5.2.

8.5.22 Actions when entering another RAT from connected mode

When entering another RAT from connected mode (due to Inter-RAT handover from UTRAN, Inter-RAT cell change order from UTRAN or Inter-RAT cell reselection from UTRAN), after successful completion of the procedure causing the transition to the other RAT, the UE shall:

- 1> if the USIM is present, for each CN domain:
 - 2> if a new security key set was received for this CN domain but was not used either for integrity protection or ciphering during this RRC connection:
 - 3> set the START value for this domain to zero and;
 - 3> store this START value for this domain in the USIM;
 - 2> else:
 - 3> store the current START value for every CN domain in the USIM [50].
- 1> if the SIM is present, for each CN domain:
 - 2> if a new security key was received for this CN domain but was not used either for integrity protection or ciphering during this RRC connection:
 - 3> set the START value for this domain to zero and;
 - 3> store this START value for this domain in the USIM.
 - 2> else:
 - 3> store the current START value for this CN domain in the UE.

8.6 Generic actions on receipt and absence of an information element

8.6.1 CN information elements

8.6.1.1 Void

8.6.1.2 CN information info

If the IE "CN information info" is present in a message, the UE shall:

- 1> if present, forward the content of the IE "PLMN identity" to upper layers;
- 1> if present, forward the content of the IE "CN common GSM-MAP NAS system information" to upper layers;
- 1> if the IE "CN domain related information" is present:
 - 2> forward each occurrence of the IE "CN domain specific GSM-MAP NAS system info" together with the IE "CN domain identity" to upper layers.
 - 2> if an IE "CN domain specific GSM-MAP NAS system info" is not present for a particular CN domain:
 - 3> indicate to upper layers that no CN system information is available for that CN domain.

8.6.1.3 Signalling connection release indication

If the IE "Signalling Connection release indication" is present in a message, the UE shall:

- 1> if all radio access bearers for the CN domain identified with the value of the IE "Signalling Connection release indication" would have been released in the variable ESTABLISHED_RABS after processing of the received message:
 - 2> indicate release of the signalling connection identified with the value of the IE "Signalling Connection release indication" to the upper layers;
 - 2> remove the signalling connection identified with the value of the IE "Signalling Connection release indication" from the variable ESTABLISHED_SIGNALLING_CONNECTIONS.
- 1> if radio access bearers for the CN domain identified with the value of the IE "Signalling Connection release indication" would remain in the variable ESTABLISHED_RABS after processing of the received message:
 - 2> set the variable INVALID_CONFIGURATION to TRUE.

8.6.2 UTRAN mobility information elements

8.6.2.1 URA identity

The UE shall:

- 1> if the IE "URA identity" is included in a received message:
 - 2> if the IE "RRC State Indicator" is included and set to "URA_PCH":
 - 3> store this URA identity in the variable URA_IDENTITY;
 - 3> after sending a possible message to UTRAN and entering URA_PCH state as specified elsewhere, read system information block type 2 in the selected cell;

- 3> if the stored URA identity in the variable URA_IDENTITY is not included in the list of URA identities in System Information Block type 2 in the selected cell, the list of URA identities in system information block type 2 is empty or if the system information block type 2 can not be found, a confirmation error of URA identity list has occurred:
 - 4> if no URA update procedure is ongoing:
 - 5> initiate a URA update procedure after entering URA_PCH state; see subclause 8.3.1.2.
 - 4> if a URA update procedure is ongoing:
 - 5> take actions as specified in subclause 8.3.1.10.
- 1> if the IE "URA identity" is not included in a received message:
 - 2> if the IE "RRC State Indicator" is included and set to " URA_PCH":
 - 3> after sending a possible message to UTRAN and entering URA_PCH state as specified elsewhere, read System Information Block type 2 in the selected cell;
 - 3> if System Information Block type 2 in the selected cell contains a single URA identity:
 - 4> store this URA identity in the variable URA_IDENTITY.
 - 3> if System Information Block type 2 of the selected cell contains more than one URA identity, the list of URA identities in system information block type 2 is empty or if the system information block type 2 can not be found, a confirmation error of URA identity list has occurred:
 - 4> if no URA update procedure is ongoing:
 - 5> initiate a URA update procedure after entering URA_PCH state, see subclause 8.3.1.2.
 - 4> if a URA update procedure is ongoing:
 - 5> take actions as specified in subclause 8.3.1.10.

8.6.2.2 Mapping info

If the IE "Mapping info" is received, the UE shall in this version of the specification:

- 1> ignore the contents of this IE.

8.6.3 UE information elements

8.6.3.1 Activation time

If the UE receives a message in which presence is needed for the IE "Activation time", and the value is other than the default value "Now", the UE shall:

- 1> if the frame boundary immediately before the frame with the CFN (Connection Frame Number) value indicated by the IE "Activation Time" is at the TTI boundary common to all the transport channels that are multiplexed onto the same CCTrCh including any transport channel which is added, reconfigured or has been removed:
 - 2> select that frame boundary as the activation time T.
- 1> else:
 - 2> select the next TTI boundary, which is common to all the transport channels that are multiplexed onto the same CCTrCh including any transport channel which is added, reconfigured or has been removed, after the frame with the CFN (Connection Frame Number) value indicated by the IE "Activation Time", as the activation time T.
- 1> at the activation time T:
 - 2> for a physical channel reconfiguration caused by the received message:

- 3> release the physical channel configuration, which was present before T;
- 3> initiate the establishment of the physical channel configuration as specified for the physical channel information elements in the received message as specified elsewhere.
- 2> for actions, other than a physical channel reconfiguration, caused by the received message:
 - 3> perform the actions for the information elements in the received message as specified elsewhere.

If the UE receives a message in which presence is needed for the IE "Activation time", and the value is the default value "Now", the UE shall:

- 1> choose an activation time T as soon as possible after the reception of the message, respecting the performance requirements in subclause 13.5;
- 1> at the activation time T:
 - 2> perform the actions for the information elements in the received message as specified elsewhere.

NOTE: In FDD, if the UE was in idle mode or CELL_FACH state upon reception of the message, regardless of the state the UE enters after reception of the message, and the value of the IE "Activation time" in the received message is different from "Now", the UE behaviour is unspecified. In TDD, if the UE was in idle mode or CELL_FACH state upon reception of the message, the value of the IE "Activation time" in the received message is relative to the CFN associated with the cell from which the message was received.

8.6.3.1a CN domain specific DRX cycle length coefficient

The UE updates CN domain specific DRX cycle length coefficient as specified in [4]. The UE shall use it to calculate the CN domain specific DRX cycle length, according to the following:

- 1> set k to the value of the IE "CN domain specific DRX cycle length coefficient".
- 1> store the result of $\text{MAX}(2^k, \text{PBP})$, where PBP is the Paging Block Periodicity, as the CN domain specific DRX cycle length for the CN domain indicated by the IE "CN domain identity". For FDD PBP=1.

The UE shall determine its idle mode paging occasions and PICH monitoring occasions for that CN domain, according to [4], based on the stored CN domain specific DRX cycle length, when using DRX in idle mode.

8.6.3.2 UTRAN DRX Cycle length coefficient

If the IE "UTRAN DRX cycle length coefficient" is present, the UE shall use it to calculate the UTRAN DRX cycle length, according to the following:

- 1> set k to the value of the IE "UTRAN DRX cycle length coefficient";
- 1> store the result of $\text{MAX}(2^k \cdot \text{PBP})$, where PBP is the Paging Block Periodicity, as the DRX cycle length.

The UE shall determine its connected mode paging occasions and PICH monitoring occasions in the same way as for idle mode, according to [4].

The DRX cycle length to use in connected mode is defined in [4].

8.6.3.3 Generic state transition rules depending on received information elements

The IE "RRC State Indicator" indicates the state the UE shall enter. The UE shall enter the state indicated by the IE "RRC State Indicator" even if the received message includes other IEs relevant only for states other than indicated by the IE "RRC State Indicator". E.g. if the RRC state indicator is set to CELL_FACH while other IEs provide information about a configuration including dedicated channels, the UE shall enter CELL_FACH state. If however the UE has no information about the configuration corresponding to the state indicated by the IE "RRC State Indicator", it shall consider the requested configuration as invalid.

The UE shall, if the IE "RRC State Indicator" in the received message has the value:

1> "CELL_FACH":

2> enter CELL_FACH state as dictated by the procedure governing the message received.

1> "CELL_DCH":

2> if neither DPCH is assigned in the message nor is the UE in CELL_DCH:

3> set the variable INVALID_CONFIGURATION to TRUE.

2> else:

3> enter CELL_DCH state as dictated by the procedure governing the message received.

1> "CELL_PCH":

2> if the received message is RRC CONNECTION SETUP and IE "RRC State Indicator" is set to CELL_PCH:

3> set the variable INVALID_CONFIGURATION to TRUE.

2> else:

3> enter CELL_PCH state as dictated by the procedure governing the message received.

1> "URA_PCH":

2> if the received message is RRC CONNECTION SETUP and IE "RRC State Indicator" is set to URA_PCH:

3> set the variable INVALID_CONFIGURATION to TRUE.

2> else:

3> enter URA_PCH state as dictated by the procedure governing the message received.

8.6.3.4 Cipherng mode info

The IE "Cipherng mode info" defines the new cipherng configuration. At any given time, the UE needs to store at most two different cipherng configurations (keyset and algorithm) per CN domain at any given time in total for all radio bearers and three configurations in total for all signalling radio bearers.

If the IE "Cipherng mode info" is present and if the IE "Reconfiguration" in the variable CIPHERING_STATUS is set to TRUE, the UE shall:

1> ignore this second attempt to change the cipherng configuration; and

1> set the variable INCOMPATIBLE_SECURITY_RECONFIGURATION to TRUE.

If the IE "Cipherng mode info" is present and if the IE "Reconfiguration" in the variable CIPHERING_STATUS is set to FALSE, the UE shall:

1> if none of the IE "Status" in the variable CIPHERING STATUS has the value "Started", and this IE "Cipherng mode info" was included in a message that is not the message SECURITY MODE COMMAND; or

1> if the IE "Cipherng Mode Info" was received in the message SECURITY MODE COMMAND and there does not exist exactly one cipherng activation time in the IE "Radio bearer downlink cipherng activation time info" for each established RLC-AM and RLC-UM radio bearers included in the IE "RB information" in the IE "ESTABLISHED_RABS" for the CN domain as indicated in the variable LATEST_CONFIGURED_CN_DOMAIN; or

1> if the IE "Cipherng Mode Info" was received in the message SECURITY MODE COMMAND and the IE "Cipherng activation time for DPCH" is not included in the message, and there exist radio bearers using RLC-TM according to the IE "RB information" in the IE "ESTABLISHED_RABS" for the CN domain as indicated in the variable LATEST_CONFIGURED_CN_DOMAIN; or

1> if the IE "Cipherng Mode Info" was received in the message SECURITY MODE COMMAND and there does not exist exactly one cipherng activation time in the IE "Radio bearer downlink cipherng activation time info"

for each established signalling radio bearer included in the IE "Signalling radio bearer information" in the IE "ESTABLISHED_RABS":

- 2> ignore this attempt to change the ciphering configuration;
 - 2> set the variable INVALID_CONFIGURATION to TRUE;
 - 2> perform the actions as specified in subclause 8.1.12.4c.
- 1> set the IE "Reconfiguration" in the variable CIPHERING_STATUS to TRUE;
- 1> set the IE "Status" in the variable CIPHERING_STATUS of the CN domains for which the IE "Status" of the variable SECURITY_MODIFICATION is set to "Affected" to "Started";
- 1> apply the new ciphering configuration in the lower layers for all RBs that belong to a CN domain for which the IE "Status" of the variable SECURITY_MODIFICATION is set to "Affected" and all signalling radio bearers:
- 2> using the ciphering algorithm (UEA [40]) indicated by the IE "Ciphering algorithm" as part of the new ciphering configuration;
 - 2> for each radio bearer that belongs to a CN domain for which the IE "Status" of the variable SECURITY_MODIFICATION is set to "Affected" and all signalling radio bearers:
 - 3> using the value of the IE "RB identity" in the variable ESTABLISHED_RABS minus one as the value of BEARER [40] in the ciphering algorithm.
- 1> apply the new ciphering configuration as follows:
- 2> if the ciphering configuration for a AM or UM radio bearer or signalling radio bearer from a previously received SECURITY MODE COMMAND has not yet been applied because of the corresponding activation times not having elapsed and the current received message includes the IE "DL Counter Synch Info" or the current received message is a RADIO BEARER RECONFIGURATION message and includes the IE "New U-RNTI":
 - 3> if the previous SECURITY MODE COMMAND was received due to new keys being received:
 - 4> consider the new ciphering configuration to include the received new keys; and
 - 4> initialise the HFN values of the COUNT-C for the corresponding radio bearers or signalling radio bearers according to subclause 8.1.12.
 - 3> else:
 - 4> consider the new ciphering configuration to include the keys associated with the LATEST_CONFIGURED_CN_DOMAIN; and
 - 4> initialise the HFN values of the COUNT-C for the corresponding radio bearers or signalling radio bearers according to subclause 8.1.12 using the START value associated with the LATEST_CONFIGURED_CN_DOMAIN to be transmitted in the response to the current message (and not the START value in the most recently transmitted IE "START list" or IE "START" at the reception of the SECURITY MODE COMMAND).
 - 3> apply the new ciphering configuration in uplink and downlink immediately following RLC re-establishment.
 - 2> if the IE "Ciphering activation time for DPCH" is present in the IE "Ciphering mode info" and the UE was in CELL_DCH state prior to this procedure:
 - 3> for radio bearers using RLC-TM:
 - 4> apply the old ciphering configuration for CFN less than the number indicated in the IE "Ciphering activation time for DPCH";
 - 4> apply the new ciphering configuration for CFN greater than or equal to the number indicated in IE "Ciphering activation time for DPCH".
 - 2> if the IE "Radio bearer downlink ciphering activation time info" is present:

- 3> apply the following procedure for each radio bearer and signalling radio bearers using RLC-AM or RLC-UM indicated by the IE "RB identity":
 - 4> suspend uplink transmission on the radio bearer or the signalling radio bearer (except for the SRB where the response message is transmitted) according to the following:
 - 5> do not transmit RLC PDUs with sequence number greater than or equal to the uplink activation time, where the uplink activation time is selected according to the rules below.
 - 4> select an "RLC sequence number" at which (activation) time the new ciphering configuration shall be applied in uplink for that radio bearer according to the following:
 - 5> consider a ciphering activation time in uplink to be pending until the RLC sequence number of the next RLC PDU to be transmitted for the first time is equal to or larger than the selected activation time;
 - 5> for each radio bearer and signalling radio bearer that has no pending ciphering activation time in uplink as set by a previous procedure changing the security configuration:
 - 6> set a suitable value that would ensure a minimised delay in the change to the latest ciphering configuration.
 - 5> for each radio bearer and signalling radio bearer that has a pending ciphering activation time in uplink as set by a previous procedure changing the security configuration:
 - 6> for radio bearers and signalling radio bearers except SRB2:
 - 7> set the same value as the pending ciphering activation time.
 - 6> for signalling radio bearer SRB2:
 - 7> set a suitable value that would ensure a minimised delay in the change to the latest ciphering configuration.
 - 4> store the selected "RLC sequence number" for that radio bearer in the entry for the radio bearer in the variable RB_UPLINK_CIPHERING_ACTIVATION_TIME_INFO;
 - 4> switch to the new ciphering configuration according to the following:
 - 5> use the old ciphering configuration for the transmitted and received RLC PDUs with RLC sequence numbers smaller than the corresponding RLC sequence numbers indicated in the IE "Radio bearer uplink ciphering activation time info" sent to UTRAN and in the received IE "Radio bearer downlink ciphering activation time info" received from UTRAN, respectively;
 - 5> use the new ciphering configuration for the transmitted and received RLC PDUs with RLC sequence numbers greater than or equal to the corresponding RLC sequence numbers indicated in the IE "Radio bearer uplink ciphering activation time info" sent to UTRAN and in the received IE "Radio bearer downlink ciphering activation time info" received from UTRAN, respectively;
 - 5> for a radio bearer using RLC-AM, when the RLC sequence number indicated in the IE "Radio bearer downlink ciphering activation time info" falls below the RLC receiving window and the RLC sequence number indicated in the IE "Radio bearer uplink ciphering activation time info" falls below the RLC transmission window, the UE may release the old ciphering configuration for that radio bearer;
 - 5> if an RLC reset or re-establishment occurs before the activation time for the new ciphering configuration has been reached, ignore the activation time and apply the new ciphering configuration both in uplink and downlink immediately after the RLC reset or RLC re-establishment.

If the IE "Ciphering mode info" is not present, the UE shall:

- 1> not change the ciphering configuration.

8.6.3.5 Integrity protection mode info

The IE "Integrity protection mode info" defines the new integrity protection configuration. At any given time, the UE needs to store at most three different integrity protection configurations (keysets) in total for all signalling radio bearers for all CN domains.

If the IE "Integrity protection mode info" is present and if the IE "Reconfiguration" in the variable INTEGRITY_PROTECTION_INFO is set to TRUE, the UE shall:

- 1> ignore this second attempt to change the integrity protection configuration; and
- 1> set the variable INCOMPATIBLE_SECURITY_RECONFIGURATION to TRUE.

If the IE "Integrity protection mode command" has the value "Start", the IE "Status" in the variable INTEGRITY_PROTECTION_INFO has the value "Not started" and the IE "Integrity protection mode info" was not included in the message SECURITY MODE COMMAND; or

If the IE "Integrity protection mode command" has the value "Start", the IE "Status" in the variable INTEGRITY_PROTECTION_INFO has the value "Not started", the IE "Integrity protection mode info" was included in the message SECURITY MODE COMMAND and the IE "Integrity protection algorithm" is not included; or

If the IE "Integrity protection mode command" has the value "Modify" and the IE "Status" in the variable INTEGRITY_PROTECTION_INFO has the value "Not Started"; or

If the IE "Integrity protection mode command" has the value "Start", the IE "Status" in the variable INTEGRITY_PROTECTION_INFO has the value "Started" and the IE "Integrity protection mode command info" was included in the message SECURITY MODE COMMAND; or

If the IE "Integrity protection mode command" has the value "Modify" and there does not exist exactly one integrity protection activation time in the IE "Downlink integrity protection activation info" for each established signalling radio bearer included in the IE "Signalling radio bearer information" in the IE "ESTABLISHED_RABS"; or

If the IE "Integrity protection mode command" has the value "Modify", the IE "Status" in the variable INTEGRITY_PROTECTION_INFO has the value "Started" and the IE "Integrity protection mode info" was not included in the message SECURITY MODE COMMAND:

the UE shall:

- 1> ignore this attempt to change the integrity protection configuration; and
- 1> set the variable INVALID_CONFIGURATION to TRUE.

If the IE "Integrity protection mode info" is not present, the UE shall:

- 1> not change the integrity protection configuration.

If the IE "Integrity protection mode info" is present and if the IE "Reconfiguration" in the variable INTEGRITY_PROTECTION_INFO is set to FALSE, the UE shall:

- 1> set the IE "Reconfiguration" in the variable INTEGRITY_PROTECTION_INFO to TRUE;
- 1> perform the actions in accordance with subclauses 8.6.3.5.1, 8.6.3.5.2 and 8.6.3.5.3.

8.6.3.5.1 Initialisation of Integrity Protection

The UE shall:

- 1> if the IE "Integrity protection mode command" has the value "start" and the IE "Status" in the variable INTEGRITY_PROTECTION_INFO has the value "Not started", and this IE was included in the message SECURITY MODE COMMAND:
- 2> initialise the information for all signalling radio bearers in the variable INTEGRITY_PROTECTION_INFO according to the following:
 - 3> set the IE "Uplink RRC Message sequence number" in the variable INTEGRITY_PROTECTION_INFO to zero;

3> do not set the IE "Downlink RRC Message sequence number" in the variable INTEGRITY_PROTECTION_INFO;

3> set the variable INTEGRITY_PROTECTION_ACTIVATION_INFO to zero for each signalling radio bearer in the IE "ESTABLISHED_RABS".

NOTE: The IEs "Integrity protection activation info" and "RRC Message sequence number" included in the IE "Integrity Check Info" in the transmitted message do not have identical values, but integrity protection is applied from the first transmitted message.

- 2> set the IE "Status" in the variable INTEGRITY_PROTECTION_INFO to the value "Started";
- 2> perform integrity protection on the received message, applying the new integrity protection configuration, as described in subclause 8.5.10.1 by:
 - 3> using the algorithm (UIA [40]) indicated by the IE "Integrity protection algorithm" contained in the IE "Integrity protection mode info";
 - 3> using the IE "Integrity protection initialisation number", contained in the IE "Integrity protection mode info" as the value of FRESH [40].
- 2> start applying the new integrity protection configuration in the downlink for each signalling radio bearer in the IE "ESTABLISHED_RABS" except RB2 at the next received RRC message;
- 2> start applying the new integrity protection configuration in the downlink for signalling radio bearer RB2 from and including the received SECURITY MODE COMMAND message;
- 2> start applying the new integrity protection configuration in the uplink for signalling radio bearer RB2 from and including the transmitted SECURITY MODE COMPLETE message;
- 2> start applying the new integrity protection configuration in the uplink for signalling radio bearers other than RB2 at the uplink activation time included in the IE "Uplink integrity protection activation info".

8.6.3.5.2 Integrity Protection Re-configuration for SRNS Relocation

The UE shall:

- 1> if IE "Integrity protection mode command" has the value "start" and the IE "Status" in the variable INTEGRITY_PROTECTION_INFO has the value "Started" and this IE was not included SECURITY MODE COMMAND:

NOTE: This case is used in SRNS relocation

- 2> perform integrity protection on the received message, applying the new integrity protection configuration, as described in subclause 8.5.10.1 by:
 - 3> using the algorithm (UIA [40]) indicated by the IE "Integrity protection algorithm" contained in the IE "Integrity protection mode info";
 - 3> using the IE "Integrity protection initialisation number", contained in the IE "Integrity protection mode info" as the value of FRESH [40].
- 2> let RB_m be the signalling radio bearer where the reconfiguration message was received and let RB_n be the signalling radio bearer where the response message is transmitted;
- 2> prohibit transmission of RRC messages on all signalling radio bearers in the IE "ESTABLISHED_RABS" except on RB₀ and the radio bearer where the response message is transmitted;
- 2> if for a signalling radio bearer, a security configuration triggered by a previous SECURITY MODE COMMAND has not yet been applied, due to the activation time for the signalling radio bearer not having elapsed:
 - 3> if the previous SECURITY MODE COMMAND was received due to new keys being received:
 - 4> consider the new integrity protection configuration to include the received new keys; and

- 4> initialise the HFN of the COUNT-I values of the corresponding signalling radio bearers according to subclause 8.1.12.
- 3> else:
 - 4> consider the new Integrity Protection configuration to include the keys associated with the LATEST_CONFIGURED_CN_DOMAIN associated with the previously received SECURITY MODE COMMAND; and
 - 4> initialise the HFN of the COUNT-I values of the corresponding signalling radio bearers according to subclause 8.1.12 using the START value associated with the LATEST_CONFIGURED_CN_DOMAIN to be transmitted in the response to the current message (and not the START value in the most recently transmitted IE "START list" or IE "START" at the reception of the SECURITY MODE COMMAND).
- 2> start applying the new integrity protection configuration in the downlink for each signalling radio bearer in the IE "ESTABLISHED_RABS" except RBm at the next received RRC message for the corresponding signalling radio bearer;
- 2> start applying the new integrity protection configuration in the downlink for signalling radio bearer RBm from and including the received configuration message;
- 2> start applying the new integrity protection configuration in the uplink for signalling radio bearer RBn from and including the transmitted response message;
- 2> start applying the new integrity protection configuration in the uplink for signalling radio bearers other than RBn from the first message onwards.

8.6.3.5.3 Integrity Protection modification in case of new keys or initialisation of signalling connection

The UE shall:

- 1> if the IE "Integrity protection mode command" has the value "modify" and the IE "Status" in the variable INTEGRITY_PROTECTION_INFO has the value "Started" and this IE was included in SECURITY MODE COMMAND:
 - 2> store the (oldest currently used) integrity protection configuration until activation times have elapsed for the new integrity protection configuration to be applied on all signalling radio bearers;
 - 2> start applying the new integrity protection configuration in the downlink for each signalling radio bearer n, at the first received message with RRC Sequence number greater than or equal to the RRC sequence number indicated by the entry for signalling radio bearer n in the "RRC message sequence number list" in the IE "Downlink integrity protection activation info", included in the IE "Integrity protection mode info";
 - 2> perform integrity protection on the received message, applying the new integrity protection configuration, as described in subclause 8.5.10.1;
 - 3> if present, use the algorithm indicated by the IE "Integrity protection algorithm" (UIA [40]);
 - 2> set the content of the variable INTEGRITY_PROTECTION_ACTIVATION_INFO according to the following:
 - 3> for each established signalling radio bearer, stored in the variable ESTABLISHED_RABS:
 - 4> select a value of the RRC sequence number at which (activation) time the new integrity protection configuration shall be applied in uplink for that signalling radio bearer according to the following:
 - 5> for each signalling radio bearer that has no pending activation time as set for integrity protection by a previous procedure changing the integrity protection configuration:
 - 6> set a suitable value that would ensure a minimised delay in the change to the latest integrity protection configuration.

- 5> for signalling radio bearer that has a pending activation time as set for integrity protection by a previous procedure changing the integrity protection configuration:
 - 6> set the same value as the pending activation time for integrity protection;
 - 5> consider an integrity protection activation time in uplink to be pending until the selected activation time (as above) is equal to the next RRC sequence number to be used, which means that the last RRC message using the old integrity protection configuration has been submitted to lower layers.
 - 4> for signalling radio bearer RB0:
 - 5> set the value of the included RRC sequence number to greater than or equal to the current value of the RRC sequence number for signalling radio bearer RB0 in the variable INTEGRITY_PROTECTION_INFO, plus the value of the constant N302 plus one.
 - 4> prohibit the transmission of RRC messages on all signalling radio bearers, except for RB2, with RRC SN greater than or equal to the value in the "RRC message sequence number list" for the signalling radio bearer in the IE "Uplink integrity protection activation info" of the variable INTEGRITY_PROTECTION_ACTIVATION_INFO.
 - 2> start applying the new integrity protection configuration in the uplink at the RRC sequence number, for each RBn, except for signalling radio bearer RB2, indicated by the entry for signalling radio bearer n in the "RRC message sequence number list" in the IE "Uplink integrity protection activation info", included in the variable INTEGRITY_PROTECTION_ACTIVATION_INFO;
 - 2> start applying the new integrity protection configuration in the uplink at the RRC sequence number for signalling radio bearer RB2, as specified for the procedure initiating the integrity protection reconfiguration;
 - 2> start applying the new integrity protection configuration in the downlink at the RRC sequence number, for each RBn, except for signalling radio bearer RB2, indicated by the entry for signalling radio bearer n in the "RRC message sequence number list" in the IE "Downlink integrity protection activation info";
- NOTE: For signalling radio bearers that have a pending activation time as set for integrity protection by a previous procedure changing the integrity protection configuration, UTRAN should set this value in IE "Downlink integrity protection activation info".
- 2> start applying the new integrity protection configuration in the downlink at the RRC sequence number for signalling radio bearer RB2, as specified for the procedure initiating the integrity protection reconfiguration.

8.6.3.6 Void

8.6.3.7 Void

8.6.3.8 Integrity check info

If the IE "Integrity check info" is present the UE shall:

- 1> act as described in subclause 8.5.10.1.

8.6.3.9 New C-RNTI

If the IE "New C-RNTI" is included, the UE shall:

- 1> store the value in the variable C_RNTI, replacing any old stored value;
- 1> use that C-RNTI when using common transport channels of type RACH, FACH and CPCH in the current cell.

8.6.3.9a New DSCH-RNTI

If the IE "New DSCH-RNTI" is included, the UE shall:

1> in FDD:

- 2> if the UE will be in CELL_DCH at the end of the procedure where the received message included this IE:
- 3> if the UE supports DSCH as indicated in the IE "Physical Channel Capability" included in the IE "UE Radio Access Capability":
 - 4> store the value in the variable DSCH_RNTI, replacing any old stored value;
 - 4> use that DSCH-RNTI when using common transport channels of type DSCH in the current cell.

1> in TDD:

- 2> if the UE will be in CELL_DCH or CELL_FACH at the end of the procedure where the received message included this IE:
- 3> if the UE supports DSCH or USCH as indicated in the IE "Physical Channel Capability" included in the IE "UE Radio Access Capability":
 - 4> store the value in the variable DSCH_RNTI, replacing any old stored value;
 - 4> use that DSCH-RNTI when using SHCCH signalling in the current cell.

8.6.3.10 New U-RNTI

If the IE "New U-RNTI" is included in a received message, the UE shall:

- 1> store the value in the variable U_RNTI, replacing any old stored value.

8.6.3.11 RRC transaction identifier

The IE "RRC transaction identifier" may be used, together with the message type, for identification of an invocation of a downlink procedure (transaction). The UE behaviour for accepting or rejecting transactions based on the message type and the IE "RRC transaction identifier" is specified below.

If the IE "RRC transaction identifier" is included in a received message, the UE shall perform the actions below. The UE shall:

If the received message is any of the messages:

- RADIO BEARER SETUP; or
- RADIO BEARER RECONFIGURATION; or
- RADIO BEARER RELEASE; or
- TRANSPORT CHANNEL RECONFIGURATION; or
- PHYSICAL CHANNEL RECONFIGURATION:

the UE shall:

- 1> if the variable ORDERED_RECONFIGURATION is set to FALSE; and
- 1> if the variable CELL_UPDATE_STARTED is set to FALSE; and
- 1> if the received message does not contain a protocol error according to clause 9 and the variable PROTOCOL_ERROR_REJECT is set to FALSE; and
- 1> if the table "Accepted transactions" in the variable TRANSACTIONS does not contain an entry with an IE "Message Type" set to ACTIVE SET UPDATE:

- 2> accept the transaction; and
- 2> store the IE "Message type" and the IE "RRC transaction identifier" of the received message in the table "Accepted transactions" in the variable TRANSACTIONS.

1> else:

- 2> if the variable ORDERED_RECONFIGURATION is set to TRUE; or
- 2> if the variable CELL_UPDATE_STARTED is set to TRUE; or
- 2> if the table "Accepted transactions" in the variable TRANSACTIONS contains an entry with an IE "Message Type" set to ACTIVE SET UPDATE; or
- 2> if the received message contains a protocol error according to clause 9 causing the variable PROTOCOL_ERROR_REJECT to be set to TRUE:
 - 3> if the IE "RRC transaction identifier" of the received message is identical to the "RRC transaction identifier" stored for the same "Message Type" as the received message in the table "Accepted transactions" in the variable TRANSACTIONS:
 - 4> ignore the transaction; and
 - 4> continue with any ongoing processes and procedures as the message was not received;
 - 4> and end the procedure.
 - 3> else:
 - 4> reject the transaction; and
 - 4> if the IE "Message Type" of the received message is not present in the table "Rejected transactions" in the variable TRANSACTIONS:
 - 5> store the IE "Message type" and the IE "RRC transaction identifier" of the received message in the table "Rejected transactions" in the variable TRANSACTIONS.

Else:

If the received message is any of the messages:

- RRC CONNECTION SETUP; or
- CELL UPDATE CONFIRM; or
- URA UPDATE CONFIRM; or
- UE CAPABILITY ENQUIRY:

the UE shall:

- 1> if the IE "Message Type" of the received message is not present in the table "Accepted transactions" in the variable TRANSACTIONS:
 - 2> if the received message does not contain a protocol error according to clause 9 and the variable PROTOCOL_ERROR_REJECT is set to FALSE:
 - 3> accept the transaction; and
 - 3> store the IE "Message type" and the IE "RRC transaction identifier" of the received message in the table "Accepted transactions" in the variable TRANSACTIONS.
 - 2> else:
 - 2> if the received message contains a protocol error according to clause 9 causing the variable PROTOCOL_ERROR_REJECT to be set to TRUE:
 - 3> reject the transaction; and

3> if the IE "Message Type" of the received message is not present in the table "Rejected transactions" in the variable TRANSACTIONS:

4> store the IE "Message type" and the IE "RRC transaction identifier" of the received message in the table "Rejected transactions" in the variable TRANSACTIONS.

1> else:

1> if the IE "Message Type" of the received message is present in the table "Accepted transactions" in the variable TRANSACTIONS:

2> if the IE "RRC transaction identifier" of the received message is identical to the "RRC transaction identifier" stored for the "Message Type" in the table "Accepted transactions" in the variable TRANSACTIONS:

3> ignore the transaction; and

3> continue with any ongoing processes and procedures as the message was not received; and

3> end the procedure.

2> else:

2> if the IE "RRC transaction identifier" of the received message is different from the "RRC transaction identifier" stored for the "Message Type" in the table "Accepted transactions" in the variable TRANSACTIONS:

3> if the received message does not contain a protocol error according to clause 9 and the variable `PROTOCOL_ERROR_REJECT` is set to FALSE:

4> ignore the once accepted transaction and instead accept the new transaction; and

4> store the IE "Message type" and the IE "RRC transaction identifier" of the received message in the table "Accepted transactions" in the variable TRANSACTIONS, replacing the previous entry.

NOTE 1: The UE is expected to process the first RRC CONNECTION SETUP/CELL UPDATE CONFIRM/URA UPDATE CONFIRM message that it receives after transmitting an RRC CONNECTION REQUEST/CELL_UPDATE/URA_UPDATE message. If the UE receives further RRC CONNECTION SETUP/CELL UPDATE CONFIRM/URA UPDATE CONFIRM messages without having transmitted another RRC CONNECTION REQUEST/CELL_UPDATE/URA_UPDATE message, the UE is not required to process these messages.

NOTE 2: If the previously accepted transaction was a CELL UPDATE CONFIRM/URA UPDATE CONFIRM that included the IE "Dowlink counter synchronisation info", rather than ignore the first accepted transaction the UE may continue with the first transaction in the case where a cell re-selection interrupted the ongoing procedure causing a cell update procedure to be triggered. In this case the response message acts as an explicit acknowledgement of both the CELL UPDATE CONFIRM/URA UPDATE CONFIRM message signalling an SRNS relocation and the subsequent CELL UPDATE CONFIRM/URA UPDATE CONFIRM.

3> else:

3> if the received message contains a protocol error according to clause 9 causing the variable `PROTOCOL_ERROR_REJECT` to be set to TRUE:

4> reject the transaction; and

4> if the IE "Message Type" of the received message is not present in the table "Rejected transactions" in the variable TRANSACTIONS:

5> store the IE "Message type" and the IE "RRC transaction identifier" of the received message in the table "Rejected transactions" in the variable TRANSACTIONS.

Else:

If the received message is any other message, the UE shall:

- 1> if the IE "Message Type" of the received message is not present in the table "Accepted transactions" in the variable TRANSACTIONS:
 - 2> if the received message does not contain a protocol error according to clause 9 and the variable PROTOCOL_ERROR_REJECT is set to FALSE:
 - 3> accept the transaction; and
 - 3> store the IE "Message type" and the IE "RRC transaction identifier" of the received message in the table "Accepted transactions" in the variable TRANSACTIONS.
 - 2> else:
 - 2> if the received message contains a protocol error according to clause 9 causing the variable PROTOCOL_ERROR_REJECT to be set to TRUE:
 - 3> reject the transaction; and
 - 3> store the IE "Message type" and the IE "RRC transaction identifier" of the received message in the table "Rejected transactions" in the variable TRANSACTIONS.
- 1> else:
 - 1> if the IE "Message Type" of the received message is present in the table "Accepted transactions" in the variable TRANSACTIONS:
 - 2> if the IE "RRC transaction identifier" of the received message is identical to the "RRC transaction identifier" stored in any entry for the "Message Type" in the table "Accepted transactions" in the variable TRANSACTIONS:
 - 3> ignore the transaction; and
 - 3> continue with any ongoing processes and procedures as the message was not received; and
 - 3> end the procedure.
 - 2> else:
 - 2> if the IE "RRC transaction identifier" of the received message is different from the "RRC transaction identifier" stored in all entries for the "Message Type" in the table "Accepted transactions" in the variable TRANSACTIONS:
 - 3> if the received message does not contain a protocol error according to clause 9 and the variable PROTOCOL_ERROR_REJECT is set to FALSE:
 - 4> accept the additional transaction; and
 - 4> store the IE "Message type" and the IE "RRC transaction identifier" of the received message in the table "Accepted transactions" in the variable TRANSACTIONS, in addition to the already existing entries.
 - 3> else:
 - 3> if the received message contains a protocol error according to clause 9 causing the variable PROTOCOL_ERROR_REJECT to be set to TRUE:
 - 4> reject the transaction; and
 - 4> store the IE "Message type" and the IE "RRC transaction identifier" of the received message in the table "Rejected transactions" in the variable TRANSACTIONS.

8.6.3.12 Capability Update Requirement

If the IE "Capability Update Requirement" is included the UE shall:

- 1> if the IE "UE radio access FDD capability update requirement" has the value TRUE:

- 2> if the UE supports FDD mode:
 - 3> store its UTRA FDD capabilities and its UTRA capabilities common to FDD and TDD in the IE "UE radio access capability" and the IE "UE radio access capability extension" in variable UE_CAPABILITY_REQUESTED as specified below:
 - 4> if the UE supports multiple UTRA FDD Frequency Bands; or
 - 4> if the UE supports a single UTRA FDD Frequency Band different from 2100 MHz:
 - 5> store the IE "UE radio access capability", excluding IEs "RF capability FDD" and "Measurement capability";
 - 5> store the IE "UE radio access capability extension", including the IEs "RF capability FDD extension" and the "Measurement capability extension" associated with each supported UTRA FDD frequency band indicated in the IE "Frequency band".
 - 4> else:
 - 5> store the IE "UE radio access capability", including the IEs "RF capability FDD" and "Measurement capability" associated with the 2100 MHz UTRA FDD frequency band.
- 1> if the IE "UE radio access 3.84 Mcps TDD capability update requirement" has the value TRUE:
 - 2> if the UE supports 3.84 Mcps TDD mode:
 - 3> store its UTRAN-specific 3.84 Mcps TDD capabilities and its UTRAN-specific capabilities common to FDD and TDD in the variable UE_CAPABILITY_REQUESTED.
- 1> if the IE "UE radio access 1.28 Mcps TDD capability update requirement" has the value TRUE:
 - 2> if the UE supports 1.28 Mcps TDD mode:
 - 3> store its UTRAN-specific 1.28 Mcps TDD capabilities and its UTRAN-specific capabilities common to FDD and TDD in the variable UE_CAPABILITY_REQUESTED.
- 1> if the IE "System specific capability update requirement list" is present:
 - 2> for each of the RAT requested in the IE "UE system specific capability"
 - 3> if the UE supports the listed RAT:
 - 4> include its inter-RAT radio access capabilities for the listed RAT in the IE "UE system specific capability" from the variable UE_CAPABILITY_REQUESTED.

If the IE " Capability update requirement " is not present, the UE shall:

- 1> assume the default values as specified in subclause 10.3.3.2 and act in accordance with the above.

8.6.4 Radio bearer information elements

8.6.4.1 Signalling RB information to setup list

If the IE "Signalling RB information to setup list" is included the UE shall:

- 1> use the same START value to initialise the COUNT-C and COUNT-I variables for all the signalling radio bearers in the list;
- 1> if the IE "Signalling RB information to setup list" was included in the RADIO BEARER SETUP message:
 - 2> if the variable LATEST_CONFIGURED_CN_DOMAIN has been initialised:
 - 3> calculate the START value only once during this procedure according to subclause 8.5.9 for the CN domain indicated in the variable LATEST_CONFIGURED_CN_DOMAIN;
 - 3> store the calculated START value in the variable START_VALUE_TO_TRANSMIT.

- 1> for each occurrence of the IE "Signalling RB information to setup":
 - 2> use the value of the IE "RB identity" as the identity of the signalling radio bearer to setup;
 - 2> if the signalling radio bearer identified with the IE "RB identity" does not exist in the variable ESTABLISHED_RABS:
 - 3> create a new entry for the signalling radio bearer in the variable ESTABLISHED_RABS.
 - 2> if the IE "Signalling RB information to setup list" was received in a message other than HANDOVER TO UTRAN COMMAND; and
 - 2> if the variable LATEST_CONFIGURED_CN_DOMAIN has been initialised and the value "STATUS" of the variable CIPHERING_STATUS of the CN domain stored in this variable is "Started":
 - 3> if the IE "Uplink RLC mode" or the IE "Downlink RLC mode" either in the IE "RLC info" or referenced by the RB identity in the IE "Same as RB" is set to "AM RLC" or "UM RLC":
 - 4> initialise the 20 MSB of the hyper frame number component of COUNT-C for this signalling radio bearer with the START value in the variable START_VALUE_TO_TRANSMIT;
 - 4> set the remaining LSB of the hyper frame number component of COUNT-C for this signalling radio bearer to zero;
 - 4> start to perform ciphering on this signalling radio bearer, using the value of the IE "RB identity" minus one as the value of BEARER in the ciphering algorithm.
 - 2> if the IE "Signalling RB information to setup list" was received in a message other than HANDOVER TO UTRAN COMMAND; and
 - 2> if the variable LATEST_CONFIGURED_CN_DOMAIN has been initialised and the value "Status" of the variable "INTEGRITY_PROTECTION_INFO" of the CN domain stored in this variable is "Started":
 - 3> initialise the 20 MSB of the hyper frame number component of COUNT-I for this signalling radio bearer with the START value in the variable START_VALUE_TO_TRANSMIT;
 - 3> set the remaining LSB of the hyper frame number component of COUNT-I for this signalling radio bearer to zero;
 - 3> for this signalling radio bearer, set the IE "Uplink RRC Message sequence number" in the variable INTEGRITY_PROTECTION_INFO to zero;
 - 3> start performing integrity protection according to subclauses 8.5.10.1 and 8.5.10.2.
 - 2> perform the actions for the IE "RLC info" as specified in subclause 8.6.4.9, applied for that signalling radio bearer;
 - 2> perform the actions for the IE "RB mapping info" as specified in subclause 8.6.4.8, applied for that signalling radio bearer.
- 1> apply a default value of the IE "RB identity" equal to 1 for the first IE "Signalling RB information to setup"; and
- 1> increase the default value by 1 for each occurrence.

8.6.4.2 RAB information for setup

If the IE "RAB information for setup" is included, the procedure is used to establish radio bearers belonging to a radio access bearer, and the UE shall:

- 1> if several IEs "RAB information for setup" are included and the included IEs "CN domain identity" in the IE "RAB info" does not all have the same value:
 - 2> set the variable INVALID_CONFIGURATION to TRUE.

- 1> if the radio access bearer identified with the IE "RAB info" does not exist in the variable ESTABLISHED_RABS:
 - 2> create a new entry for the radio access bearer in the variable ESTABLISHED_RABS;
 - 2> store the content of the IE "RAB info" in the entry for the radio access bearer in the variable ESTABLISHED_RABS;
 - 2> indicate the establishment of the radio access bearer to the upper layer entity using the IE "CN domain identity", forwarding the content of the IE "RAB identity";
 - 2> if prior to this procedure there exists no transparent mode radio bearer for the CN domain included in the IE "CN domain identity" and at least one transparent mode radio bearer is included in the IE "RB information to setup"; or
 - 2> if at least one RLC-AM or RLC-UM radio bearer is included in the IE "RB information to setup":
 - 3> calculate the START value only once during this procedure (the same START value shall be used on all new radio bearers created for this radio access bearer) according to subclause 8.5.9 for the CN domain as indicated in the IE "CN domain identity" in the IE "RAB info" part of the IE "RAB information to setup";
 - 3> store the calculated START value in the variable START_VALUE_TO_TRANSMIT.
- 1> for each radio bearer in the IE "RB information to setup":
 - 2> if the radio bearer identified with the IE "RB identity" does not exist in the variable ESTABLISHED_RABS:
 - 3> perform the actions specified in subclause 8.6.4.3;
 - 3> store information about the new radio bearer in the entry for the radio access bearer identified by "RAB info" in the variable ESTABLISHED_RABS;
 - 3> create a new RAB subflow for the radio access bearer;
 - 3> number the RAB subflow in ascending order, assigning the smallest number to the RAB subflow corresponding to the first radio bearer in the list;
 - 3> if the IE "CN domain identity" in the IE "RAB info" is set to "PS domain" and the number of RAB subflows for the radio access bearer is greater than 1:
 - 4> set the variable INVALID_CONFIGURATION to TRUE.
 - 2> if the radio bearer identified with the IE "RB identity" already exists in the variable ESTABLISHED_RABS:
 - 3> set the variable INVALID_CONFIGURATION to TRUE.

8.6.4.2a RAB information to reconfigure

If the IE "RAB information to reconfigure" is included then the UE shall:

- 1> if the entry for the radio access bearer identified by the IE "CN domain identity" together with the IE "RAB Identity" in the variable ESTABLISHED_RABS already exists:
 - 2> perform the action for the IE "NAS Synchronization Indicator", according to subclause 8.6.4.12.
- 1> else:
 - 2> set the variable INVALID_CONFIGURATION to TRUE.

8.6.4.3 RB information to setup

If the IE "RB information to setup" is included, the UE shall apply the following actions on the radio bearer identified with the value of the IE "RB identity". The UE shall:

- 1> use the same START value to initialise the hyper frame number components of COUNT-C variables for all the new radio bearers to setup;

- 1> perform the actions for the IE "PDCP info", if present, according to subclause 8.6.4.10, applied for the radio bearer;
- 1> perform the actions for the IE "RLC info", according to subclause 8.6.4.9, applied for the radio bearer;
- 1> perform the actions for the IE "RB mapping info", according to subclause 8.6.4.8, applied for the radio bearer;
- 1> if the IE "Downlink RLC mode" either in the IE "RLC info" or referenced by the RB identity in the IE "Same as RB" is set to "TM RLC":
 - 2> configure delivery of erroneous SDUs in lower layers according to indication from upper layer [5].
- 1> if the IE "RB information to setup" was received in a message other than HANDOVER TO UTRAN COMMAND; and
- 1> if the IE "Uplink RLC mode" or the IE "Downlink RLC mode" either in the IE "RLC info" or referenced by the RB identity in the IE "Same as RB" is set to "AM RLC" or "UM RLC":
 - 2> initialise the 20 MSB of the hyper frame number component of COUNT-C for this radio bearer with the START value in the variable START_VALUE_TO_TRANSMIT;
 - 2> set the remaining LSB of the hyper frame number component of COUNT-C for this radio bearer to zero;
 - 2> start incrementing the COUNT-C values.
- 1> if the IE "RB information to setup" was received in a message other than HANDOVER TO UTRAN COMMAND; and
- 1> if the IE "Uplink RLC mode" and the IE "Downlink RLC mode" either in the IE "RLC info" or referenced by the RB identity in the IE "Same as RB" is set to "TM RLC":
 - 2> if prior to this procedure there exists no transparent mode radio bearer for the CN domain included in the IE "CN domain identity" in the IE "RAB info" in the variable ESTABLISHED_RABS and at least one transparent mode radio bearer is included in the IE "RB information to setup":
 - 3> if the IE "Status" in the variable CIPHERING_STATUS of the CN domain as indicated in the IE "CN domain identity" in the IE "RAB info" in the variable ESTABLISHED_RABS is set to "Not Started":
 - 4> at the activation time as specified in the IE "Ciphering activation time for DPCH" if included in the IE "Ciphering mode info" in the command message or, if this IE is not included, as specified in the IE "COUNT-C activation time" included in the response message:
 - 5> initialise the 20 most significant bits of the hyper frame number component of COUNT-C common for all transparent mode radio bearers of this CN domain with the START value in the variable START_VALUE_TO_TRANSMIT;
 - 5> set the remaining LSB of the hyper frame number component of COUNT-C to zero;
 - 5> do not increment the COUNT-C value common for all transparent mode radio bearers for this CN domain.
 - 3> if the IE "Status" in the variable CIPHERING_STATUS of the CN domain as indicated in the IE "CN domain identity" in the IE "RAB info" in the variable ESTABLISHED_RABS is set to "Started":
 - 4> at the activation time as specified in the IE "Activation Time" in the RADIO BEARER SETUP message:
 - 5> initialise the 20 most significant bits of the HFN component of COUNT-C common for all transparent mode RLC radio bearer to the value of the latest transmitted START for this CN domain, while not incrementing the value of the HFN component of COUNT-C at each CFN cycle; and
 - 5> set the remaining LSB of the HFN component of COUNT-C to zero;
 - 5> start to perform ciphering on the radio bearer in lower layers while not incrementing the HFN.

- 4> at the activation time as specified in the IE "Ciphering activation time for DPCH" if included in the IE "Ciphering mode info" in the command message or, if this IE is not included, as specified in the IE "COUNT-C activation time" included in the response message:
 - 5> initialise the 20 most significant bits of the HFN component of COUNT-C common for all transparent mode radio bearers of this CN domain with the START value in the variable START_VALUE_TO_TRANSMIT;
 - 5> set the remaining LSB of the HFN component of COUNT-C to zero;
 - 5> start incrementing the COUNT-C value common for all transparent mode radio bearers of this CN domain as normal, at each CFN value, i.e. the HFN component is no longer fixed in value but incremented at each CFN cycle.
 - 2> if prior to this procedure there exists at least one transparent mode radio bearer for the CN domain included in the IE "CN domain identity" in the IE "RAB info" in the variable ESTABLISHED_RABS:
 - 3> if the IE "Status" in the variable CIPHERING_STATUS of the CN domain as indicated in the IE "CN domain identity" in the IE "RAB info" in the variable ESTABLISHED_RABS is set to "Not Started":
 - 4> do not increment the COUNT-C value common for all transparent mode radio bearers for this CN domain.
 - 3> if the IE "Status" in the variable CIPHERING_STATUS of the CN domain as indicated in the IE "CN domain identity" in the IE "RAB info" in the variable ESTABLISHED_RABS is set to "Started":
 - 4> continue incrementing the COUNT-C value common for all transparent mode radio bearers of this CN domain.
 - 1> if the IE "Status" in the variable CIPHERING_STATUS of the CN domain as indicated in the IE "CN domain identity" in the IE "RAB info" in the variable ESTABLISHED_RABS is set to "Started":
 - 2> start to perform ciphering on the radio bearer in lower layers, using the value of the IE "RB identity" minus one as the value of BEARER in the ciphering algorithm.
- NOTE: UTRAN should not use the IE "RB information to setup" to setup radio bearers with RB identity in the range 1-4.

8.6.4.4 RB information to be affected

If the IE "RB information to be affected" is included, the UE shall apply the following actions on the radio bearer identified with the value of the IE "RB identity". The UE shall:

- 1> perform the actions for the IE "RB mapping info", according to subclause 8.6.4.8, applied for the radio bearer.

8.6.4.5 RB information to reconfigure

If the IE "RB information to reconfigure" is included, the UE shall apply the following actions on the radio bearer identified with the value of the IE "RB identity". The UE shall:

- 1> perform the actions for the IE "PDCP info", if present, according to subclause 8.6.4.10, applied for the radio bearer;
- 1> if the IE "RLC info" is present:
 - 2> perform the actions for the IE "RLC info", according to subclause 8.6.4.9, applied for the radio bearer.
- 1> else:
 - 2> continue using the current RLC configuration for the radio bearer.
- 1> perform the actions for the IE "RB mapping info", according to subclause 8.6.4.8, applied for the radio bearer;

- 1> if the IE "Downlink RLC mode" in the IE "RLC info" is set to "TM RLC":
 - 2> configure delivery of erroneous SDUs in lower layers according to indication from upper layer [5].
- 1> if the IE "PDCP SN info" is included:
 - 2> perform the actions as specified in subclause 8.6.4.11 applied for the radio bearer.
- 1> if the IE "RB stop/continue" is included; and
 - 2> if the "RB identity" has a value greater than 2; and
 - 3> if the value of the IE "RB stop/continue" is "stop":
 - 4> configure the RLC entity for the radio bearer to stop;
 - 4> set the IE "RB started" in the variable ESTABLISHED_RABS to "stopped" for that radio bearer.
 - 3> if the value of the IE "RB stop/continue" is "continue":
 - 4> configure the RLC entity for the radio bearer to continue;
 - 4> set the IE "RB started" in the variable ESTABLISHED_RABS to "started" for that radio bearer.
 - 2> if the IE "RB identity" is set to a value less than or equal to 2:
 - 3> set the variable INVALID_CONFIGURATION to TRUE.

8.6.4.6 RB information to release

If the IE "RB information to release" is included, the UE shall apply the following actions on the radio bearer identified with the value of the IE "RB identity". The UE shall:

- 1> if the IE "RB identity" is set to a value less than 4:
 - 2> set the variable INVALID_CONFIGURATION to TRUE.
- 1> if the IE "RB identity" refers to a signalling radio bearer:
 - 2> release the RLC entity for the signalling radio bearer;
 - 2> delete the information about the signalling radio bearer from the variable ESTABLISHED_RABS.
- 1> if the IE "RB identity" refers to a radio bearer:
 - 2> release the PDCP and RLC entities for that radio bearer;
 - 2> indicate release of the RAB subflow associated with the radio bearer to upper layers;
 - 2> delete the information about the radio bearer from the variable ESTABLISHED_RABS;
 - 2> when all radio bearers belonging to the same radio access bearer have been released:
 - 3> indicate release of the radio access bearer to upper layers providing the "CN domain identity" together with the "RAB identity" stored in the variable ESTABLISHED_RABS;
 - 3> delete all information about the radio access bearer from the variable ESTABLISHED_RABS.

8.6.4.7 RB with PDCP information

If the IE "RB with PDCP information" is included, the UE shall apply the following actions on the radio bearer identified with the value of the IE "RB identity". The UE shall:

- 1> for the IE "PDCP SN info":
 - 2> perform the actions as specified in subclause 8.6.4.11.

8.6.4.8 RB mapping info

If the IE "RB mapping info" is included, the UE shall:

- 1> for each multiplexing option of the RB:
 - 2> if a transport channel that would not exist as a result of the message (i.e. removed in the same message in IE "Deleted DL TrCH information" and IE "Deleted UL TrCH information") is referred to:
 - 3> set the variable INVALID_CONFIGURATION to TRUE.
 - 2> if a multiplexing option that maps a logical channel corresponding to a TM-RLC entity onto RACH, CPCH, FACH or DSCH is included:
 - 3> set the variable INVALID_CONFIGURATION to TRUE.
 - 2> if the multiplexing option realises the radio bearer on the uplink (resp. on the downlink) using two logical channels with different values of the IE "Uplink transport channel type" (resp. of the IE "Downlink transport channel type"):
 - 3> set the variable INVALID_CONFIGURATION to TRUE.
 - 2> if that RB is using TM and the IE "Segmentation indication" is set to TRUE and, based on the multiplexing configuration resulting from this message, the logical channel corresponding to it is mapped onto the same transport channel as another logical channel:
 - 3> set the variable INVALID_CONFIGURATION to TRUE.
 - 2> if the transport channel considered in that multiplexing option is different from RACH and if that RB is using AM and the set of RLC sizes applicable to the logical channel transferring data PDUs has more than one element not equal to zero:
 - 3> set the variable INVALID_CONFIGURATION to TRUE.
 - 2> if that RB is using UM or TM and the multiplexing option realises it using two logical channels:
 - 3> set the variable INVALID_CONFIGURATION to TRUE.
- 2> for each logical channel in that multiplexing option:
 - 3> if the value of the IE "RLC size list" is set to "Explicit list":
 - 4> if a "Transport format set" for the transport channel this logical channel is mapped on in this multiplexing option is included in the same message, and the value (index) of any IE "RLC size index" in the IE "Explicit list" does not correspond to an "RLC size" in the IE transport format set of that transport channel given in the message; or
 - 4> if the transport channel this logical channel is mapped on in this multiplexing option is different from RACH, and if a "Transport format set" for that transport channel is not included in the same message, and the value (index) of any IE "RLC size index" in the IE "Explicit list" does not correspond to an "RLC size" in the stored transport format set of that transport channel; or
 - 4> if a "Transport format set" for the transport channel this logical channel is mapped on in this multiplexing option is included in the same message, and the value of any IE "Logical channel list" in the transport format set is not set to "Configured"; or
 - 4> if a "Transport format set" for the transport channel this logical channel is mapped on in this multiplexing option is not included in the same message, and the value of any IE "Logical channel list" in the stored transport format set of that transport channel is not set to "Configured":
 - 5> set the variable INVALID_CONFIGURATION to TRUE.
 - 3> if the value of the IE "RLC size list" is set to "All":
 - 4> if the transport channel this logical channel is mapped on is RACH; or

- 4> if a "Transport format set" for the transport channel this logical channel is mapped on in this multiplexing option is included in the same message, and the value of any IE "Logical channel list" in the transport format set is not set to "Configured"; or
- 4> if a "Transport format set" for the transport channel this logical channel is mapped on in this multiplexing option is not included in the same message, and the value of any IE "Logical channel list" in the stored transport format set of that transport channel is not set to "Configured":
 - 5> set the variable INVALID_CONFIGURATION to TRUE.
- 3> if the value of the IE "RLC size list" is set to "Configured":
 - 4> if the transport channel this logical channel is mapped on is RACH; or
 - 4> if a "Transport format set" for the transport channel this logical channel is mapped on in this multiplexing option is included in the same message, and for none of the RLC sizes defined for that transport channel in the "Transport format set", the "Logical Channel List" is set to "All" or given as an "Explicit List" which contains this logical channel; or
 - 4> if a "Transport format set" for the transport channel this logical channel is mapped on in this multiplexing option is not included in the same message, and for none of the RLC sizes defined in the transport format set stored for that transport channel, the "Logical Channel List" is set to "All" or given as an "Explicit List" which contains this logical channel:
 - 5> set the variable INVALID_CONFIGURATION to TRUE.
- 1> if, as a result of the message this IE is included in, several radio bearers can be mapped onto the same transport channel, and the IE "Logical Channel Identity" was not included in the RB mapping info of any of those radio bearers for a multiplexing option on that transport channel or the same "Logical Channel Identity" was used more than once in the RB mapping info of those radio bearers for the multiplexing options on that transport channel:
 - 2> set the variable INVALID_CONFIGURATION to TRUE.
- 1> if the "RB mapping info" is considered as valid according to the rules above:
 - 2> delete all previously stored multiplexing options for that radio bearer;
 - 2> store each new multiplexing option for that radio bearer;
 - 2> perform the actions as specified in subclause 8.5.21.
- 1> if the IE "Uplink transport channel type" is set to the value "RACH":
 - 2> in FDD:
 - 3> refer the IE "RLC size index" to the RACH Transport Format Set of the first PRACH received in the IE "PRACH system information list" received in SIB5 or SIB6.
 - 2> in TDD:
 - 3> use the first Transport Format of the PRACH of the IE "PRACH system information list" at the position equal to the value in the IE "RLC size index".

In case IE "RLC info" includes IE "Downlink RLC mode" ("DL RLC logical channel info" is mandatory present) but IE "Number of downlink RLC logical channels" is absent in the corresponding IE "RB mapping info", the parameter values are exactly the same as for the corresponding UL logical channels. In case two multiplexing options are specified for the UL, the first options shall be used as default for the DL. As regards the IE "Channel type", the following rule should be applied to derive the DL channel type from the UL channel included in the IE:

Channel used in UL	DL channel type implied by "same as"
DCH	DCH
RACH	FACH
CPCH	FACH
USCH	DSCH

If ciphering is applied, UTRAN should not map Transparent Mode RBs of different CN domains on the same transport channel and it should not map transparent mode SRBs and RBs onto the same transport channel. In such cases the UE behaviour is not specified.

8.6.4.9 RLC Info

Upon reception of the IE "RLC Info", the UE shall:

- 1> configure the transmitting and receiving RLC entities in the UE for that radio bearer accordingly;
- 1> if the IE "Polling info" is present in the IE "RLC info":
 - 2> for each present IE in the IE "Polling info":
 - 3> configure RLC to use the corresponding function according to the value of the IE.
 - 2> for each absent IE in the IE "Polling info":
 - 3> configure RLC to not use the corresponding function.
- 1> if the IE "Polling info" is absent:
 - 2> configure RLC to not use the polling functionality.
- 1> if the IE "Downlink RLC STATUS info" is present in the IE "RLC info" (this IE is present for AM RLC):
 - 2> for each present IE in the IE "Downlink RLC STATUS info":
 - 3> configure RLC to use the corresponding function according to value of the IE.
 - 2> for each absent IE in the IE "Downlink RLC STATUS info":
 - 3> configure RLC to not use the corresponding function.
- 1> if the IE "Transmission RLC discard" is present:
 - 2> configure the discard procedure in RLC according to the IE "Transmission RLC discard"
- 1> if the IE "Transmission RLC discard" is absent (only possible for TM RLC and UM RLC):
 - 2> do not configure SDU discard in RLC.

8.6.4.10 PDCP Info

For RFC 3095:

- 1> the chosen MAX_CID shall not be greater than the value "Maximum number of ROHC context sessions" as indicated in the IE "PDCP Capability";
- 1> the configuration for the PACKET_SIZES_ALLOWED is FFS.

If IE "PDCP info" is included, the UE shall:

- 1> if the radio bearer is connected to a CS domain radio access bearer:
 - 2> set the variable INVALID_CONFIGURATION to TRUE.
- 1> if the IE "PDCP PDU header" is set to the value "absent":
 - 2> if the IE "Support for lossless SRNS relocation" is true:
 - 3> set the variable INVALID_CONFIGURATION to TRUE.
- 1> if the IE "PDCP PDU header" is set to the value "present":
 - 2> if the IE "Support for lossless SRNS relocation" is false:

- 3> if the IE "Header compression information" is absent:
 - 4> set the variable INVALID_CONFIGURATION to TRUE.
- 1> if the IE "Header compression information" is absent:
 - 2> not use Header compression after the successful completion of this procedure;
 - 2> remove any stored configuration for the IE "Header compression information".
- 1> configure the PDCP entity for that radio bearer accordingly;
- 1> configure the RLC entity for that radio bearer according to the value of the IE "Support for lossless SRNS relocation".

8.6.4.11 PDCP SN Info

If the IE "PDCP SN Info" is included, the UE shall:

- 1> transfer the sequence number to the PDCP entity for the radio bearer;
- 1> configure the RLC entity for the radio bearer to stop;
- 1> include the current PDCP receive sequence number and the radio bearer identity for the radio bearer in the variable PDCP_SN_INFO.

8.6.4.12 NAS Synchronisation Indicator

If the IE "NAS Synchronisation Indicator" is present in a message, the UE shall:

- 1> forward the content to upper layers along with the IE "CN domain identity" of the associated RAB stored in the variable ESTABLISHED_RABS at the CFN indicated in the IE "Activation time" in order to synchronise actions in NAS and AS.

8.6.5 Transport channel information elements

8.6.5.1 Transport Format Set

If the IE "Transport format set" is included, the UE shall:

- 1> if the transport format set is a RACH TFS received in System Information Block type 5 or 6, and CHOICE "Logical Channel List" has a value different from "Configured":
 - 2> ignore that System Information Block.
- 1> if the transport format set for a downlink transport channel is received in a System Information Block, and CHOICE "Logical Channel List" has a value different from 'ALL':
 - 2> ignore that System Information Block.
- 1> if the transport format set for a downlink transport channel is received in a message on a DCCH, and CHOICE "Logical Channel List" has a value different from 'ALL':
 - 2> keep the transport format set if this exists for that transport channel;
 - 2> set the variable INVALID_CONFIGURATION to TRUE.
- 1> if the value of any IE "RB identity" (and "Logical Channel" for RBs using two UL logical channels) in the IE "Logical channel list" does not correspond to a logical channel indicated to be mapped onto this transport channel in any RB multiplexing option (either included in the same message or previously stored and not changed by this message); or
- 1> if the "Logical Channel List" for any of the RLC sizes defined for that transport channel is set to "Configured" while it is set to "All" or given as an "Explicit List" for any other RLC size; or

- 1> if the "Logical Channel List" for any of the RLC sizes defined for that transport channel is set to "All" and for any logical channel mapped to this transport channel, the value of the "RLC size list" (either provided in the IE "RB mapping info" if included in the same message, or stored) is not set to "Configured"; or
- 1> if the "Logical Channel List" for any of the RLC sizes defined for that transport channel is given as an "Explicit List" that contains a logical channel for which the value of the "RLC size list" (either provided in the IE "RB mapping info" if included in the same message, or stored) is not set to "Configured"; or
- 1> if the "Logical Channel List" for all the RLC sizes defined for that transport channel are given as "Explicit List" and if one of the logical channels mapped onto this transport channel is not included in any of those lists; or
- 1> if the "Logical Channel List" for the RLC sizes defined for that transport channel is set to "Configured" and for any logical channel mapped onto that transport channel, the value of the "RLC size list" (either provided in the IE "RB mapping info" if included in the same message, or stored) is also set to "Configured"; or
- 1> if the IE "Transport Format Set" was not received within the IE "PRACH system information list" and if the "Logical Channel List" for the RLC sizes defined for that transport channel is set to "Configured" and for any logical channel mapped onto that transport channel, the "RLC size list" (either provided in the IE "RB mapping info" if included in the same message, or stored) is given as an "Explicit List" that includes an "RLC size index" that does not correspond to any RLC size in this "Transport Format Set"; or
- 1> if the IE "Transport Format Set" was not received within the IE "PRACH system information list", and if that RB is using AM and the set of RLC sizes applicable to the logical channel transferring data PDUs has more than one element not equal to zero:
 - 2> keep the transport format set if this exists for that transport channel;
 - 2> set the variable INVALID_CONFIGURATION to TRUE.
- 1> if the total number of configured transport formats for the transport channel exceeds maxTF:
 - 2> keep the transport format set if this exists for that transport channel;
 - 2> set the variable INVALID_CONFIGURATION to TRUE.
- 1> if the IE "Transport format set" is considered as valid according to the rules above:
 - 2> remove a previously stored transport format set if this exists for that transport channel;
 - 2> store the transport format set for that transport channel;
 - 2> consider the first instance of the parameter *Number of TBs and TTI List* within the *Dynamic transport format information* to correspond to transport format 0 for this transport channel, the second to transport format 1 and so on;
 - 2> if the IE "Transport format Set" has the choice "Transport channel type" set to "Dedicated transport channel":
 - 3> calculate the transport block size for all transport formats in the TFS using the following

TB size = RLC size + MAC header size	if "RLC size" <> 0,
TB size = 0	if "RLC size" = 0,
- where:
 - MAC header size is calculated according to [15] if MAC multiplexing is used. Otherwise it is 0 bits;
 - 'RLC size' reflects the RLC PDU size.
- 2> if the IE "Transport format Set" has the choice "Transport channel type" set to "Common transport channel":
 - 3> in FDD:
 - 4> for transport channels other than DSCH calculate the transport block size for all transport formats in the TFS using the following:

TB size = RLC size.

- 4> for DSCH transport channels calculate the transport block size for all transport formats in the TFS using the following:

$$\begin{array}{ll} \text{TB size} = \text{RLC size} + \text{MAC header size} & \text{if "RLC size"} \neq 0, \\ \text{TB size} = 0 & \text{if "RLC size"} = 0, \end{array}$$

where:

- MAC header size is calculated according to [15];
- 'RLC size' reflects the RLC PDU size.

- 3> for TDD calculate the transport block size for all transport formats in the TFS using the following:

$$\text{TB size} = \text{RLC size}.$$

- 2> if the IE "Number of Transport blocks" $\neq 0$ and IE "RLC size" = 0, no RLC PDU data exists but only parity bits exist for that transport format;
- 2> if the IE "Number of Transport blocks" = 0, neither RLC PDU neither data nor parity bits exist for that transport format;
- 2> perform the actions as specified in subclause 8.5.21.

For configuration restrictions on Blind Transport Format Detection, see [27].

8.6.5.2 Transport format combination set

If the IE "Transport format combination set" is included, the UE shall for that direction (uplink or downlink):

- 1> store the new transport format combination set, or (if this exists) modify a previously stored transport format combination set according to IEs included in IE "Transport format combination set";
- 1> start to respect those transport format combinations;
- 1> if IE "Transport format combination subset" is received in this message:
 - 2> perform the actions as specified in subclause 8.6.5.3.
- 1> if IE "Transport format combination subset" is not received in this message:
 - 2> clear the IE "Duration" in the variable TFC_SUBSET;
 - 2> set both the IE "Current TFC subset" and the IE "Default TFC subset" in the variable TFC_SUBSET to the value indicating "full transport format combination set".

If the IE "Transport format combination set" is not included and if there is no addition, removal or reconfiguration of transport channels, the UE shall for that direction (uplink or downlink):

- 1> use a previously stored transport format combination set if this exists.

If the IE "Transport format combination set" is not included; and

- 1> if no transport format combination set is stored in the UE; or
- 1> if transport channels are added or removed in the message; or
- 1> if any transport channel is reconfigured in the message such that the size of the transport format set is changed:

the UE shall:

- 1> set the variable INVALID_CONFIGURATION to TRUE.

In the uplink TFCS the minimum set of TFCs is the set of TFCs that is needed for the TFC selection algorithm defined in [15] to give a predictable result. The minimum set of TFCs consists of the following:

- 1> for each UM logical channel for which traffic is generated:

- 2> a TFC with one transport block for this transport channel and empty TFs (see [34]) for all the others. If more than one TFC fulfils this criteria, only the TFC with the lowest number of bits should be included in the minimum set of TFCs.
- 1> for each AM logical channel for which traffic is generated:
 - 2> a TFC with a non-empty TF for the corresponding transport channel and empty TFs for all other transport channels, where the non-empty TF includes one transport block with "Configured RLC Size" equal to the RLC PDU size.
- 1> for each set of "synchronous" TM logical channels (see the definition below) for which traffic is generated and for each set of SDU sizes associated with it:
 - 2> a TFC with TFs corresponding to any combination of SDU sizes that can be received in a TTI from higher layers on the corresponding transport channels and empty TFs for all other transport channels.
- 1> for each TM logical channel that is not part of a set of "synchronous" TM logical channels (see the definition below) for which traffic is generated:
 - 2> a TFC with non-empty TFs for the corresponding transport channel, and empty TFs for all other transport channels, where
 - 3> for non-segmented mode TM-RLC logical channels the non-empty TFs include, for the smallest SDU size that can be received in a single TTI from higher layer:
 - 4> a TF with non-zero number of transport blocks with "Configured RLC Size" equal to the corresponding SDU size. If more than one TFC fulfils this criteria, only the TFC with the lowest number of bits in the TFC is included in the minimum set of TFCs.
 - 3> for segmented mode TM-RLC, the non-empty TFs include any TF such that the number of transport blocks multiplied by the "Configured RLC Size" is equal to the smallest SDU size that can be received in a single TTI from higher layer.
 - 1> an "empty" TFC (see [34]).

Furthermore, the UTRAN should ensure that the uplink TFCS satisfies the following rules:

- 1> for each TTI length with which at least one transport channel is configured:
 - 2> for each combination of TFs for the transport channels configured with this TTI length included in the TFCS:
 - 3> a TFC with these TFs for the transport channels configured with this TTI length and empty TFs on all transport channels configured with shorter TTI lengths is also included in the TFCS.

For TDD, the TFCS of a CCTrCH should include those of the above combinations, which include a TF with one transport block for a transport channel used in that CCTrCH, and the "empty" TFC should be included in the TFCS of every CCTrCH.

Synchronous TM logical channels are logical channels on which higher layer traffic is generated in a perfectly correlated fashion (e.g. AMR RAB).

NOTE: The "Configured RLC Size" is defined as the transport block size minus the MAC header size.

8.6.5.3 Transport format combination subset

If the IE "Transport format combination subset" ("TFC subset") is included, the UE shall:

- 1> if the IE "Minimum allowed Transport format combination index" is included; and
 - 2> if the value of the IE "Minimum allowed Transport format combination index" is greater than the highest TFCI value in the current transport format combination set:
 - 3> consider the TFC subset to be incompatible with the current transport format combination set.
- 1> if the IE "Allowed transport format combination list" is included; and

- 2> if the value of any of the IEs "Allowed transport format combination" included in the IE "Allowed transport format combination list" does not match a TFCI value in the current transport format combination set:
 - 3> consider the TFC subset to be incompatible with the current transport format combination set.
- 1> if the IE "Non-allowed transport format combination list" is included; and
 - 2> if the value of any of the IEs "Non-allowed transport format combination" included in the IE "Non-allowed transport format combination list" does not match a TFCI value in the current transport format combination set:
 - 3> consider the TFC subset to be incompatible with the current transport format combination set.
- 1> if the IE "Restricted TrCH information" is included:
 - 2> if the value of any of the IEs "Uplink transport channel type" and "Restricted UL TrCH identity" included in the IE "Restricted TrCH information" do not correspond to any of the transport channels for which the current transport format combination set is valid:
 - 3> consider the TFC subset to be incompatible with the current transport format combination set.
 - 2> if the IE "Allowed TFIs" is included; and
 - 3> if the value of each of the IEs "Allowed TFI" included in the IE "Allowed TFIs" corresponds to a transport format for that transport channel within the current transport format combination set:
 - 4> allow all transport format combinations that include these transport formats for the transport channel;
 - 4> restrict all other transport format combinations.
 - 3> else:
 - 4> consider the TFC subset to be incompatible with the current transport format combination set.
 - 2> if the IE "Allowed TFIs" is not included:
 - 3> restrict all transport format combinations where the transport channel has a transport format of non-zero rate.
- 1> if the UE considers the TFC subset to be incompatible with the current Transport format combination set according to the above:
 - 2> keep any previous restriction of the transport format combination set;
 - 2> set the variable INVALID_CONFIGURATION to TRUE.
- 1> if the UE does not consider the TFC subset to be incompatible with the current Transport format combination set according to the above:
 - 2> restrict the transport format combination set in the uplink to the value of the IE "Transport format combination subset" (in case of TDD for the uplink CCTrCH specified by the IE "TFCS Id");
 - 2> clear the IE "Duration" in the variable TFC_SUBSET.
- 1> if the transport format combination subset indicates the "full transport format combination set":
 - 2> any restriction on transport format combination set is released and the UE may use the full transport format combination set.

8.6.5.4 DCH quality target

If the IE "DCH quality target" is included, the UE shall:

- 1> set, at physical channel establishment, an initial downlink target SIR value based on the received IE "DCH quality target";

- 1> adjust the target SIR for the downlink power control to meet the quality target received in the IE "DCH quality target".

NOTE 1: Adjusting the target SIR is possible to do continuously by the UE if a CRC exists in all transport formats in the downlink TFS for a DCH. If a CRC does not exist in all transport formats, the UE can only adjust the target SIR when receiving transport formats containing a CRC and the UE has knowledge about the transport format according to [27].

NOTE 2: If the UTRAN configures a UE to use blind transport format detection and configures a transport channel such that single transport format detection [27] must be used to detect the TF, then it is not possible for the UE to maintain a quality target for that transport channel.

8.6.5.5 Added or Reconfigured UL TrCH information

If the IE "Added or Reconfigured UL TrCH information" is included then the UE shall:

- 1> for the transport channel identified by the IE "UL Transport Channel Identity" and IE "Uplink transport channel type":
 - 2> perform the actions for the IE "Transport Format Set" as specified in subclause 8.6.5.1.

8.6.5.6 Added or Reconfigured DL TrCH information

If the IE "Added or Reconfigured DL TrCH information" is included then for the transport channel identified by the IE "DL Transport Channel Identity" the UE shall:

- 1> if the choice "DL parameters" is set to 'explicit':
 - 2> perform the actions for the IE "Transport Format Set" as specified in subclause 8.6.5.1.
- 1> if the choice "DL parameters" is set to 'same as uplink':
 - 2> if the IE "UL Transport Channel Identity" indicates an existing or a new UL Transport Channel:
 - 3> store as transport format for this transport channel the transport format associated with the transport channel identified by the IE "UL Transport Channel Identity".
 - 2> else:
 - 3> set the variable INVALID_CONFIGURATION to TRUE.
- 1> if the IE "DCH quality target" is included:
 - 2> perform the actions specified in subclause 8.6.5.4.

8.6.5.7 Deleted UL TrCH information

If the IE "Deleted UL TrCH information" is included the UE shall:

- 1> delete any information about the transport channel identified by the IE "UL TrCH identity" and IE "Uplink transport channel type".

8.6.5.8 Deleted DL TrCH information

If the IE "Deleted DL TrCH information" is included the UE shall:

- 1> delete any information about the transport channel identified by the IE "DL TrCH identity".

8.6.5.9 UL Transport channel information common for all transport channels

If the IE "UL Transport channel information common for all transport channels" is included the UE shall:

- 1> perform actions for the IE "TFC subset" as specified in subclause 8.6.5.3;

- 1> if the IE "PRACH TFCS" is included:
 - 2> set the variable INVALID_CONFIGURATION to TRUE.
- 1> if the IE has the choice "mode" set to FDD:
 - 2> perform actions for the IE "UL DCH TFCS" as specified in subclause 8.6.5.2.
- 1> if the IE has the choice "mode" set to TDD:
 - 2> if the IE "Individual UL CCTrCH information" is included:
 - 3> for each TFCS identified by IE "UL TFCS id":
 - 4> perform actions for the IE "UL TFCS" as specified in subclause 8.6.5.2.
- 1> if the IE "TFC subset list" is included:
 - 2> remove a previously stored TFC subset list if this exists in the variable TFC_SUBSET;
 - 2> store the IE "TFC subset list" in the IE "TFC subset list" in the variable TFC_SUBSET;
 - 2> consider the first instance of the IE "TFC subset" in the IE "TFC subset list" as Transport Format Combination Subset 0 (TFC subset identity = 0), the second instance as Transport Format Combination Subset 1 (TFC subset identity = 1) and so on.

8.6.5.10 DL Transport channel information common for all transport channels

If the IE "DL Transport channel information common for all transport channels" is included the UE shall:

- 1> if the IE "SCCPCH TFCS" is included:
 - 2> set the variable INVALID_CONFIGURATION to TRUE.
- 1> if the IE choice "mode" is set to FDD:
 - 2> if the choice "DL parameters" is set to 'explicit':
 - 3> if the IE "DL DCH TFCS" is included:
 - 4> if the IE "SCCPCH TFCS" is included and the state the UE enters after handling the received information is other than CELL_DCH:
 - 5> ignore the received IE "DL DCH TFCS".

NOTE: the IE "DL Transport channel information common for all transport channels" always includes a DL DCH TFCS configuration, either by including the IE "DL DCH TFCS" or by specifying that the TFCS is the same as in UL. If UTRAN does not require the reconfiguration of the concerned parameters, UTRAN may replace one TFC with the value that is already assigned for this IE.

- 4> else:
 - 5> perform actions as specified in subclause 8.6.5.2.
- 1> if the IE choice "mode" is set to TDD:
 - 2> if the IE "Individual DL CCTrCH information" is included:
 - 3> for each DL TFCS identified by the IE "DL TFCS identity":
 - 4> if the IE choice "DL parameters" is set to 'independent':
 - 5> perform actions for the IE "DL TFCS" as specified in subclause 8.6.5.2.
 - 4> if the IE choice "DL parameters" is set to 'same as UL':
 - 5> if the IE "UL DCH TFCS identity" indicates an existing or a new UL TFCS:

6> store for that DL TFCS the TFCS identified by the IE "UL DCH TFCS identity".

5> else:

6> set the variable INVALID_CONFIGURATION to TRUE.

8.6.5.11 DRAC static information

If the IE "DRAC static information" is included the UE shall:

- 1> store the content of the IE "Transmission Time Validity";
- 1> store the content of the IE "Time duration before retry";
- 1> store the content of the IE "DRAC Class identity".

8.6.5.12 TFCS Reconfiguration/Addition Information

If the IE "TFCS Reconfiguration/Addition Information" is included the UE shall:

- 1> store the TFCs to be reconfigured/added indicated in the IE "CTFC information" as specified below;
- 1> if the IE "Power offset information" is included:
 - 2> perform actions as specified in [29].

In order to identify the TFCs included in this IE the UE shall calculate the CTFC as specified in subclause 14.10 and

- 1> if the IE "TFCS Reconfiguration/Addition Information" was included in the IE "TFCI Field 1 Information":
 - 2> ignore for the CTFC calculation any DSCH transport channel that may be assigned.
- 1> if the IE "TFCS Reconfiguration/Addition Information" was included in the IE "TFCI Field 2 Information":
 - 2> ignore for the CTFC calculation any DCH transport channel that may be assigned.

If the IE "TFCS Reconfiguration/Addition Information" is used in case of TFCS "Complete reconfiguration" the UE shall:

- 1> remove a previously stored transport format combination set if this exists;
- 1> consider the first instance of the IE "CTFC information" as Transport Format Combination 0 in FDD (TFCI=0) and 1 in TDD (TFCI=1), the second instance as Transport Format Combination 1 in FDD (TFCI=1) and 2 in TDD (TFCI=2) and so on. In TDD the TFCI value = 0 is reserved for physical layer use.

If the IE "TFCS Reconfiguration/Addition Information" is used in case of TFCS "Addition" the UE shall insert the new additional(s) TFC into the first available position(s) in ascending TFCI order in the TFCS.

8.6.5.13 TFCS Removal Information

If the IE "TFCS Removal Information" is included the UE shall:

- 1> remove the TFC indicated by the IE "TFCI" from the current TFCS, and regard this position (TFCI) in the TFCS as vacant.

8.6.5.14 TFCI Field 2 Information

If the IE "TFCI Field 2 Information" is included the UE shall:

- 1> if the IE choice "Signalling method" is set to "TFCI range":
 - 2> for the first group in the IE "TFCI(field 2) range":

- 3> apply the Transport Format Combination indicated by the value of the IE "TFCS Information for DSCH (TFCI range method)" to the group of values of TFCI(field 2) between 0 and the IE "Max TFCI(field2) value".
- 2> for the following groups in the IE "TFCI(field 2) range":
 - 3> apply the Transport Format Combination indicated by the value of the IE "TFCS Information for DSCH (TFCI range method)" to the group of values of TFCI(field 2) between the largest value reached in the previous group plus one and the IE "Max TFCI(field2) value".
- 1> if the IE choice "Signalling method" is set to 'Explicit':
 - 2> perform actions for the IE "TFCS explicit configuration" as specified in subclause 8.6.5.15.

8.6.5.15 TFCS Explicit Configuration

If the IE "TFCS Explicit Configuration" is included the UE shall:

- 1> if the IE choice "TFCS representation" is set to 'complete reconfiguration':
 - 2> perform the actions for the IE "TFCS Reconfiguration/Addition Information" as specified in subclause 8.6.5.12.
- 1> if the IE choice "TFCS representation" is set to 'addition':
 - 2> perform the actions for the IE "TFCS Reconfiguration/Addition Information" as specified in subclause 8.6.5.12.
- 1> if the IE choice "TFCS representation" is set to 'removal':
 - 2> perform the actions for the IE "TFCS Removal Information" as specified in subclause 8.6.5.13.
- 1> if the IE choice "TFCS representation" is set to 'replace':
 - 2> perform first the actions for the IE "TFCS Removal Information" as specified in subclause 8.6.5.13; and then
 - 2> perform the actions for the IE "TFCS Reconfiguration/Addition Information" as specified in subclause 8.6.5.12.

8.6.6 Physical channel information elements

This subclause specifies the actions upon reception and/or non-reception of the physical channel information elements. The combination of the values of those information elements included in a given message shall follow the compatibility rules that are specified in the physical layer specifications. In case those rules are not followed, the UE shall set the variable INVALID_CONFIGURATION to TRUE.

8.6.6.1 Frequency info

If, after completion of the procedure, the UE will be in CELL_DCH state, the UE shall:

- 1> if the IE "Frequency info" is included:
 - 2> if the frequency is different from the currently used frequency:
 - 3> store and use the frequency indicated by the IE "Frequency Info"; and
 - 3> perform the physical layer synchronisation procedure A as specified in [29] (FDD only).
 - 2> if the frequency is the same as the currently used frequency:
 - 3> continue to use the stored active currently used frequency;
 - 3> perform the physical layer synchronisation procedure A as specified in [29] (FDD only).
- 1> if the IE "Frequency info" is not included and the UE has a currently used frequency:

2> continue to use the currently used frequency.

8.6.6.2 Void

8.6.6.2a PNBSCH allocation

The UE shall consider the frame numbers fulfilling the following equation as "PRACH blocked frames" as specified in [33].

$$\text{SFN} = \lfloor k * \text{Repetition period} \rfloor$$

for an integer k with k {0, 1, 2, 3, 4, ... , value of IE "Number of repetitions per SFN period" - 1}, where:

Repetition period is: 4096 / value of IE "Number of repetitions per SFN period".

The UE shall configure the physical layer for the physical random access procedure accordingly.

8.6.6.3 Void

8.6.6.3a Downlink information per radio link list

If the IE "Downlink information per radio link list" is included in a received message, the UE shall:

- 1> if the message was received in CELL_DCH state and the UE remains in CELL_DCH state according to subclause 8.6.3.3 applied on the received message:
 - 2> if all radio links included in the IE "Downlink information per radio link list" are part of the current active set:
 - 3> for radio links part of the current active set, and present in the IE "Downlink information per radio link list":
 - 4> update the downlink physical channel configuration according to the IE "Downlink information for each radio link" as specified in subclause 8.6.6.4.
 - 3> for radio links part of the current active set, and absent in the IE "Downlink information per radio link list":
 - 4> not change its current downlink physical channel configuration.
 - 2> if all radio links included in the IE "Downlink information per radio link list" are not part of the current active set:
 - 3> replace all the radio links in the current active set with the radio links in the IE "Downlink information per radio link list", each with a downlink physical channel configuration according to the IE "Downlink information for each radio link" as specified in subclause 8.6.6.4.

NOTE: UTRAN should not mix radio links which are part of the current active set and radio links which are not part of the current active set in the same IE "Downlink information per radio link list". In such cases the UE behaviour is unspecified.

1> otherwise:

- 2> if the message was received in CELL_FACH state and the UE would transit to CELL_DCH state according to subclause 8.6.3.3 applied on the received message:
 - 3> establish a downlink physical channel configuration for each of the included radio links according to the IE "Downlink information for each radio link" as specified in subclause 8.6.6.4.

8.6.6.4 Downlink information for each radio link

If the IE "Downlink information for each radio link" is included in a received message, the UE shall:

- 1> if the UE would enter CELL_DCH state according to subclause 8.6.3.3 applied on the received message:
 - 2> if the IE "SCCPCH Information for FACH" is included; and
 - 2> if the UE is in FDD mode and is not capable of simultaneous reception of DPCH and Secondary CCPCH:
 - 3> set the variable UNSUPPORTED_CONFIGURATION to TRUE;
 - 2> if the UE is in FDD mode and is capable of simultaneous reception of DPCH and SCCPCH:
 - 3> start to receive the indicated Secondary CCPCH.
 - 2> if the UE is in TDD mode and shared transport channels are assigned to the UE:
 - 3> start to receive the indicated Secondary CCPCH.
 - 2> if the UE is in TDD mode and no shared transport channels are assigned to the UE:
 - 3> set the variable UNSUPPORTED_CONFIGURATION to TRUE.
 - 2> act on the other IEs contained in the IE "Downlink information for each radio link" as specified in subclause 8.6 applied on this radio link.
- 1> in addition, if the message was received in CELL_DCH state and the UE remains in CELL_DCH state according to subclause 8.6.3.3 applied on the received message:
 - 2> for each optional IE part of the IE "Downlink information for each radio link" that is not present:
 - 3> do not change its current downlink physical channel configuration corresponding to the IE, which is absent, if not stated otherwise elsewhere.

NOTE: The Release '99 RADIO BEARER RECONFIGURATION message always includes at least one IE "Downlink information for each radio link" containing the mandatory IEs, even if UTRAN does not require the reconfiguration of any radio link.

- 1> if the UE would enter either the CELL_FACH, CELL_PCH or URA_PCH state according to subclause 8.6.3.3 applied on the received message:
 - 2> if the received message is CELL UPDATE CONFIRM:
 - 3> ignore the IE "Downlink information for each radio link".
 - 2> if the received message is any other message than CELL UPDATE CONFIRM; and
 - 2> if IEs other than the IE "Primary CPICH info" (for FDD) or the IE "Primary CCPCH info" (for TDD) are included in the IE "Downlink information for each radio link":
 - 3> ignore these IEs.
 - 2> act on the other IEs contained in the IE "Downlink information for each radio link" as specified in subclause 8.6 applied on this radio link.

8.6.6.5 Void

8.6.6.6 Uplink DPCH info

If the IE "Uplink DPCH info" is included, the UE shall:

- 1> release any active uplink physical channels and activate the given physical channels;

1> if the IE "Number of FBI bits" is not included:

2> use 0 FBI bits in the Uplink DPCH.

1> use an SF equal to or greater than the minimum SF indicated in the IE "Spreading Factor" during uncompressed frames or compressed frames by HL scheduling;

1> use an SF equal to or greater than the minimum SF divided by 2 during compressed frames by SF reduction.

8.6.6.7 Void

8.6.6.8 Maximum allowed UL TX power

If the IE "Maximum allowed UL TX power" is included in the Handover to UTRAN Command, in any other dedicated message or in System Information Block type 3 or in System Information Block 4, the UE shall:

1> store and use the value until it is updated.

If the IE "Maximum allowed UL TX power" was not included in any dedicated message, the UE shall:

1> use the value previously stored, when received in an earlier dedicated message, Handover to UTRAN Command message or received in System Information Block type 3 or in System Information Block 4.

For all cases, the UE shall:

1> keep the UE uplink transmit power at or below the indicated power value;

1> if the current UE uplink transmit power is above the indicated power value:

2> decrease the power to a level at or below the power value.

The maximum UE transmitter power is defined as the lower of the maximum output power of the UE power class and the maximum allowed UL TX power indicated in this IE. The maximum UE transmitter power shall not be exceeded.

8.6.6.9 PDSCH with SHO DCH Info (FDD only)

If the IE "PDSCH with SHO DCH Info" is included, the UE shall:

1> if the variable DSCH_RNTI is empty:

2> set the variable INVALID_CONFIGURATION to TRUE.

1> configure itself to receive the PDSCH from the specified radio link within the active set identified by the IE "DSCH radio link identifier";

1> if the TFCI has a 'hard' split:

2> if the IE "TFCI(field2) combining set" is included:

3> configure the Layer 1 to combine soft only the DPCH TFCI(field 2) of the radio links within the active set which are identified by the IE "Radio link identifier" in the IE "TFCI(field2) Combining set".

2> if the IE "TFCI(field2) combining set" is not included:

3> configure the L1 to combine soft the DPCH TFCI(field 2) of all radio links within the active set.

8.6.6.10 PDSCH code mapping (FDD only)

If the IE "PDSCH code mapping" is included, the UE shall:

1> if the variable DSCH_RNTI is empty:

2> set the variable INVALID_CONFIGURATION to TRUE.

- 1> use the scrambling code defined by the IE "DL Scrambling Code" to receive the PDSCH;
- 1> if the IE choice "signalling method" is set to 'code range':
 - 2> map the TFCI(field2) values to PDSCH codes in the following way:
 - 2> for the first group of the IE "PDSCH code mapping":
 - 3> if the value of the IE "multi-code info" equals 1:
 - 4> map the TFCI(field 2) = 0 to the PDSCH code specified by the IE "Spreading factor" and the code number given by the IE "Code number (for PDSCH code) start";
 - 4> map TFCI(field 2) = 1 to the PDSCH code specified by the IE "Spreading factor" and the code number given by the IE "Code number (for PDSCH code) start"+1;
 - 4> continue this process with unit increments in the value of TFCI(field 2) mapped to unit increments in code number until the code number equals the value of the IE "Code number (for PDSCH code) stop".
 - 3> if the value of the IE "multi-code info" is greater than 1:
 - 4> if the value of the difference between the IE "Code number (for PDSCH code) start" and the IE "Code number (for PDSCH code) stop" + 1 is not a multiple of the value of the IE "multi-code info":
 - 5> set the variable INVALID_CONFIGURATION to TRUE.
 - 4> map TFCI (field 2)=0 to a set of PDSCH contiguous codes. This code set is specified by the IE "Spreading factor" and code numbers between 'code number start' denoted by the IE "Code number (for PDSCH code) start" and 'code number stop' given by IE "Code number (for PDSCH code) start" - 1 + the value of the IE "multi-code info";
 - 4> continue this process with unit increments in the value of TFCI(field 2) mapped to a set of contiguous codes. This code set is specified by the IE "Spreading factor" and code numbers between 'code number start' = 'code number stop' + 1 of the previous TFCI(field2) and 'code number stop'='code number start' - 1 + the value of the IE "multi-code info";
 - 4> stop this process when the 'code number stop' associated to the last TFCI(field2) equals the value of the IE "Code number (for PDSCH code) stop".
 - 2> for each of the next groups included in the IE "PDSCH code mapping":
 - 3> continue the process in the same way as for the first group with the TFCI(field 2) value used by the UE to construct its mapping table starting at the largest TFCI(field 2) value reached in the previous group plus one.
 - 2> if the value of the IE "Code number (for PDSCH code) start" equals the value of the IE "Code number (for PDSCH code) stop" (as may occur when mapping the PDSCH root code to a TFCI (field 2) value):
 - 3> consider this as defining the mapping between the channelisation code and a single TFCI (i.e., TFCI(field 2) shall not be incremented twice).
 - 1> if the IE choice "signalling method" is set to "TFCI range":
 - 2> map the TFCI(field2) values to PDSCH codes in the following way:
 - 2> for the first group of the IE "DSCH mapping":
 - 3> map each of the TFCI(field 2) between 0 and the value of the IE "Max TFCI(field2)" to the PDSCH code specified by the IE "Spreading factor (for PDSCH code)" and the code number given by the IE "Code number (for PDSCH code)".
 - 2> for each of the next groups included in the IE "DSCH mapping":
 - 3> map each of the TFCI(field 2) between the IE "Max TFCI(field2) value" specified in the last group plus one and the specified IE "Max TFCI(field2)" in the current group to the PDSCH code specified by the IE "Spreading factor (for PDSCH code)" and the code number given by the IE "Code number (for PDSCH code)".

- 2> if the value of the IE "multi-code info" is greater than 1:
 - 3> map each value of TFCI (field 2) to a set of PDSCH contiguous codes starting at the channelisation code denoted by the 'code number' parameter and including all codes with code numbers up to and including 'code number' - 1 + the value of the IE "multi-code info".
- 1> if the IE choice "signalling method" is set to 'Explicit'
 - 2> map the TFCI(field2) values to PDSCH codes in the following way:
 - 2> for the first instance on the IE "PDSCH code info":
 - 3> apply the PDSCH code specified by the IE "Spreading factor (for PDSCH code)" and the code number given by the IE "Code number (for PDSCH code)" for TFCI(field2)=0.
 - 2> for the second instance of the IE "PDSCH code info":
 - 3> apply the PDSCH code specified by the IE "Spreading factor (for PDSCH code)" and the code number given by the IE "Code number (for PDSCH code)" for TFCI(field2)=1.
 - 2> continue in a similar way for each next instance of the IE "PDSCH code info";
 - 2> if the value of the IE "multi-code info" is greater than 1, then
 - 3> map each value of TFCI (field 2) to a set of PDSCH contiguous codes starting at the channelisation code denoted by the 'code number' parameter and including all codes with code numbers up to and including 'code number' - 1 + the value of the IE "multi-code info".
- 1> if the IE choice "signalling method" is set to 'Replace':
 - 2> map the TFCI(field2) values to PDSCH codes in the following way:
 - 2> for each instance of the IE "Replaced PDSCH code":
 - 3> replace the corresponding PDSCH code for the TFCI(field2) identified by the IE "TFCI(field2)" with the new code specified by the IE "Spreading factor (for PDSCH code)" and the code number given by the IE "Code number (for PDSCH code)".
 - 2> if the value of the IE "multi-code info" is greater than 1:
 - 3> map each value of TFCI (field 2) to a set of PDSCH contiguous codes starting at the channelisation code denoted by the 'code number' parameter and including all codes with code numbers up to and including 'code number' - 1 + the value of the IE "multi-code info".

8.6.6.11 Uplink DPCH power control info

The UE shall:

- 1> in FDD:
 - 2> if the IE "Uplink DPCH power control info" is included:
 - 3> if a synchronisation procedure A is performed according to [29]:
 - 4> calculate and set an initial uplink transmission power;
 - 4> start inner loop power control as specified in subclause 8.5.3;
 - 4> for the UL inner loop power control:
 - 5> use the parameters specified in the IE.
 - 3> else:
 - 4> act on the IE "Power control algorithm" and the IE "TPC step size" if included and ignore any other IEs that are included.

1> in 3.84 Mcps TDD:

2> if the IE "Uplink DPCH power control info" is included:

3> use the parameters specified in the IE for open loop power control as defined in subclause 8.5.7.

2> else:

3> use the current uplink transmission power.

1> in 1.28 Mcps TDD:

2> if the IE "Uplink DPCH power control info" is included:

3> if the IE "PRX_{DPCHdes}" is included:

4> calculate and set an initial uplink transmission power.

4> if the IE "TPC step size" is included:

5> use this IE upon reception of TPC commands for closed loop power control.

4> else:

5> use the current value of this IE upon reception of TPC commands for closed loop power control.

3> else:

4> if the IE "TPC step size" is included:

5> use this IE for closed loop power control;

4> else:

5> ignore the IE "Uplink DPCH power control info".

1> both in FDD and TDD;

2> if the IE "Uplink DPCH power control info" is not included in a message used to enter CELL_DCH:

3> set the variable INVALID_CONFIGURATION to true.

8.6.6.12 Secondary CPICH info

If the IE Secondary CPICH info is included, the UE may:

1> use the channelisation code according to IE "channelisation code", with scrambling code according to IE "DL scrambling code" in the IE "Secondary CPICH info", for channel estimation of that radio link;

1> use the pilot bits on DPCCH for channel estimation.

If the IE Secondary CPICH info is not included, the UE shall:

1> not use any previously stored configuration corresponding to the usage of the Secondary CPICH info.

8.6.6.13 Primary CPICH usage for channel estimation

If the IE "Primary CPICH usage for channel estimation" is included and has the value "Primary CPICH may be used" the UE:

1> may use the Primary CPICH for channel estimation;

1> may use the pilot bits on DPCCH for channel estimation.

If the IE "Primary CPICH usage for channel estimation" is included and has the value "Primary CPICH shall not be used" the UE:

- 1> shall not use the Primary CPICH for channel estimation;
- 1> may use the Secondary CPICH for channel estimation;
- 1> may use the pilot bits on DPCCH for channel estimation.

8.6.6.14 DPCH frame offset

If "DPCH frame offset" is included in a message that instructs the UE to enter CELL_DCH state:

1> UTRAN should:

2> if only one Radio Link is included in the message:

3> set "Default DPCH Offset Value" and "DPCH frame offset" respecting the following relation:

$$(\text{Default DPCH Offset Value}) \bmod 38400 = \text{DPCH frame offset}$$

- where the IE values used are the Actual Values of the IEs as defined in clause 11.

2> if more than one Radio Link are included in the message:

3> set "Default DPCH Offset Value" and "DPCH frame offset" respecting the following relation:

$$(\text{Default DPCH Offset Value}) \bmod 38400 = \text{DPCH frame offset}_j$$

- where j indicates the first radio link listed in the message and the IE values used are the Actual Values of the IEs as defined in clause 11.

1> The UE shall:

2> on reception of a message where the above relation between "Default DPCH Offset Value" and "DPCH frame offset" is not respected:

3> set the variable INVALID_CONFIGURATION to true.

If the IE "DPCH frame offset" is included the UE shall:

1> use its value to determine the beginning of the DPCH frame.

8.6.6.15 DPCH Compressed mode info

If the IE "DPCH compressed mode info" is included, and if the IE group "transmission gap pattern sequence configuration parameters" is included, the UE shall for each transmission gap pattern sequence perform the following consistency checks:

1> if the UE, according to its measurement capabilities, and for all supported bands of the UTRA mode or RAT associated with the measurement purpose indicated by IE "TGMP", requires UL compressed mode, and CHOICE 'UL/DL mode' indicates 'DL only':

2> set the variable INVALID_CONFIGURATION to TRUE.

1> if the UE, according to its measurement capabilities, and for all supported bands of the UTRA mode or RAT associated with the measurement purpose indicated by IE "TGMP", requires DL compressed mode, and CHOICE 'UL/DL mode' indicates 'UL only':

2> set the variable INVALID_CONFIGURATION to TRUE.

1> if the UE, according to its measurement capabilities, does not require UL compressed mode for any of supported band of the UTRA mode or RAT associated with the measurement purpose indicated by the IE "TGMP", and CHOICE 'UL/DL mode' indicates 'UL only' or 'UL and DL':

2> set the variable INVALID_CONFIGURATION to TRUE.

- 1> if the UE, according to its measurement capabilities, does not require DL compressed mode for any supported band of the UTRA mode or RAT associated with the measurement purpose indicated by the IE "TGMP", and CHOICE 'UL/DL mode' indicates 'DL only' or 'UL and DL':
 - 2> set the variable INVALID_CONFIGURATION to TRUE.
- 1> if UE already has an active transmission gap pattern sequence that, according to IE "TGMP", has the same measurement purpose, and both patterns will be active after the new configuration has been taken into use:
 - 2> set the variable INVALID_CONFIGURATION to TRUE.
- 1> if there is any pending "TGPS reconfiguration CFN" or any pending "TGCFN":
 - 2> the UE behaviour is unspecified.

If variable INVALID_CONFIGURATION has value FALSE after UE has performed the checks above, the UE shall:

- 1> if pattern sequence corresponding to IE "TGPSI" is already active (according to "Current TGPS Status Flag") in the variable TGPS_IDENTITY):
 - 2> if the "TGPS Status Flag" in this message is set to "deactivate" for the corresponding pattern sequence:
 - 3> deactivate this pattern sequence at the beginning of the frame, indicated by IE "Activation time"(see subclause 8.6.3.1) received in this message, when the new configuration received in this message is taken into use.
 - 3> set the "Current TGPS Status Flag" for this pattern sequence in the variable TGPS_IDENTITY to "inactive".
 - 2> if the "TGPS Status Flag" in this message is set to "activate" for the corresponding pattern sequence:
 - 3> deactivate this pattern sequence at the beginning of the frame, indicated by IE "Activation time"(see subclause 8.6.3.1) received in this message, when the new configuration received in this message is taken into use.

NOTE: The temporary deactivation of pattern sequences for which the status flag is set to "activate" can be used by the network to align the timing of already active patterns with newly activated patterns.

- 1> update each pattern sequence to the variable TGPS_IDENTITY according to the IE "TGPSI";
- 1> update into the variable TGPS_IDENTITY the configuration information defined by IE group "transmission gap pattern sequence configuration parameters";
- 1> after the new configuration has been taken into use:
 - 2> activate the stored pattern sequence corresponding to each IE "TGPSI" for which the "TGPS status flag" in the variable TGPS_IDENTITY is set to "activate" at the time indicated by IE "TGCFN"; and
 - 2> begin the inter-frequency and/or inter-RAT measurements corresponding to the pattern sequence measurement purpose of each activated pattern sequence;
 - 2> if the new configuration is taken into use at the same CFN as indicated by IE "TGCFN":
 - 3> start the concerned pattern sequence immediately at that CFN.
- 1> monitor if the parallel transmission gap pattern sequences create an illegal overlap, and in case of overlap, take actions as specified in subclause 8.2.11.2.

If the IE "DPCH compressed mode info" is included, and if the IE group "transmission gap pattern sequence configuration parameters" is not included, the UE shall:

- 1> if pattern sequence corresponding to IE "TGPSI" is already active (according to "Current TGPS Status Flag" in the variable TGPS_IDENTITY):
 - 2> if the "TGPS Status Flag" in this message is set to "deactivate" for the corresponding pattern sequence:

- 3> deactivate this pattern sequence at the beginning of the frame, indicated by IE "Activation time"(see subclause 8.6.3.1) received in this message, when the new configuration received in this message is taken into use;
- 3> set the "Current TGPS Status Flag" for this pattern sequence in the variable TGPS_IDENTITY to "inactive".

2> if the "TGPS Status Flag" in this message is set to "activate" for the corresponding pattern sequence:

- 3> deactivate this pattern sequence at the beginning of the frame, indicated by IE "Activation time"(see subclause 8.6.3.1) received in this message, when the new configuration received in this message is taken into use.

NOTE: The temporary deactivation of pattern sequences for which the status flag is set to "activate" can be used by the network to align the timing of already active patterns with newly activated patterns.

1> after the new configuration has been taken into use:

2> at the time indicated by IE "TGCFN":

- 3> activate the stored pattern sequence corresponding to each IE "TGPSI" for which the "TGPS status flag" is set to "activate"; and

- 3> set the "Current TGPS Status Flag" for this pattern sequence in the variable TGPS_IDENTITY to "active".

2> begin the inter-frequency and/or inter-RAT measurements corresponding to the pattern sequence measurement purpose of each activated pattern sequence;

2> if the new configuration is taken into use at the same CFN as indicated by IE "TGCFN":

- 3> start the concerned pattern sequence immediately at that CFN.

For transmission gap pattern sequences stored in variable TGPS_IDENTITY, but not identified in IE "TGPSI" (either due to the absence of the IE "DPCH compressed mode info" in the received message or due to not receiving the corresponding TGPSI value in the IE "DPCH compressed mode info"), the UE shall:

1> if the received message implies a timing re-initialised hard handover (see subclause 8.3.5.1):

- 2> deactivate such transmission gap pattern sequences at the beginning of the frame, indicated by IE "Activation time" (see subclause 8.6.3.1) received in this message; and

2> set IE "Current TGPS Status Flag" in corresponding UE variable TGPS_IDENTITY to 'inactive'.

1> if the received message not implies a timing re-initialised hard handover (see subclause 8.3.5.1):

- 2> continue such transmission gap pattern sequence according to IE "Current TGPS Status Flag" in the corresponding UE variable TGPS_IDENTITY.

Uplink and downlink compressed mode methods are described in [27]. For UL "higher layer scheduling" compressed mode method and transport format combination selection, see [15].

8.6.6.16 Repetition period, Repetition length, Offset (TDD only)

In case the physical allocations of different channels overlap the following priority rules shall apply for common channels and shall be taken into account by the UE:

1> PICH takes precedence over Primary CCPCH;

1> PICH takes precedence over Secondary CCPCH;

1> Secondary CCPCH takes precedence over Primary CCPCH.

The frame allocation can be derived by following rules:

If no IE "Offset" is explicitly given, the parameter "Offset" to be used is calculated by the following equation:

Activation time mod Repetition period = Offset.

Frames from CFN CFN_{off} to $CFN_{off} + \text{Repetition length} - 1$ belong to the allocation with CFN_{off} fulfilling the following equation:

$$CFN_{off} \bmod \text{Repetition period} = \text{Offset.}$$

Repetition length is always a multiple of the largest TTI within the CCTrCH fulfilling the following equation:

$$(\text{largest TTI within CCTrCH}) * X = \text{Repetition Length}$$

Example of usage:

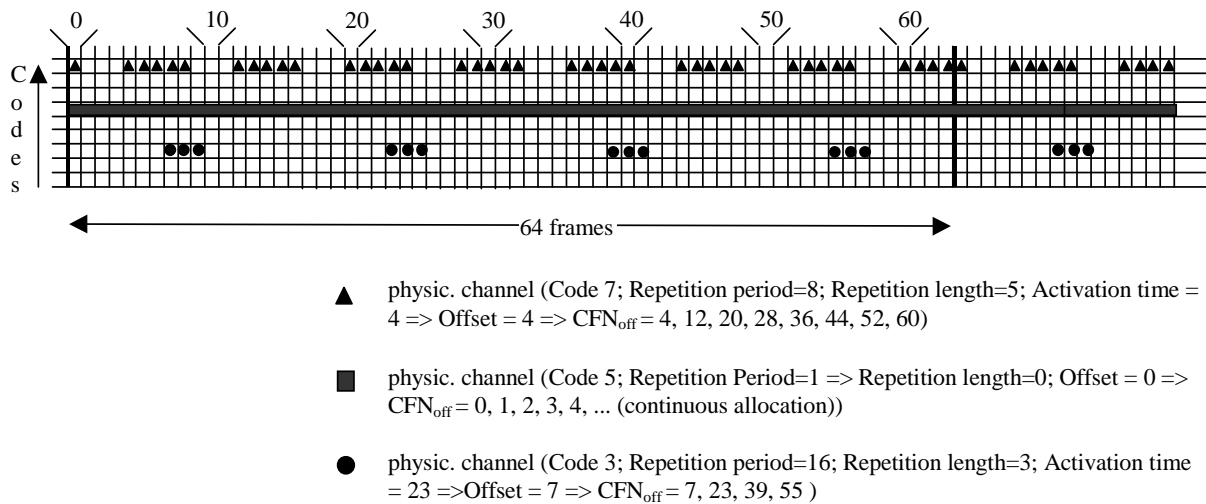

Figure 8.6.6.16-1: Examples for frame allocations in TDD

8.6.6.17 Primary CCPCH info

If the IE "Primary CCPCH info" is included, the UE shall:

- 1> use the information elements in this IE.

8.6.6.18 Primary CPICH info

If the IE "Primary CPICH info" in FDD is included, the UE shall:

- 1> use the value of this IE as the primary scrambling code for the downlink radio link.

8.6.6.19 CPCH SET Info (FDD only)

If the UE has the capability to use CPCH, the UE shall use the following general procedures:

- 1> if an IE "CPCH SET Info" is included in a dedicated message:
 - 2> read the "CPCH set ID" included in the IE;
 - 2> store the IE using the "CPCH set ID" as an address tag;
 - 2> release any active dedicated physical channels in the uplink;
 - 2> let the PCPCHs listed in the CPCH set be the default in the uplink for CPCH.

- 1> if an IE "CPCH SET Info" is included in a System Information message:
 - 2> read the "CPCH set ID" included in the IE;
 - 2> store the IE using the "CPCH set ID" as an address tag.

8.6.6.20 CPCH set ID (FDD only)

If the UE has the capability to use CPCH, the UE shall use the following general procedures. The UE shall:

- 1> if an IE "CPCH set ID" is included in a dedicated message and not as part of IE "CPCH SET Info":
 - 2> use the IE as an address tag to retrieve the corresponding stored "CPCH SET Info";
 - 2> release any active dedicated physical channels in the uplink;
 - 2> let the PCPCHs listed in the CPCH set be the default in the uplink for CPCH.
- 1> if an IE "CPCH set ID" is included in a dedicated message and not as part of IE "CPCH SET Info", and if there is no corresponding stored "CPCH SET Info":
 - 2> release any active dedicated physical channels in the uplink;
 - 2> let the last assigned PRACH be the default in the uplink for RACH;
 - 2> obtain current System Information on SCCPCH to obtain and store the "CPCH SET info" IE(s);
 - 2> upon receipt of a "CPCH SET Info" which corresponds to the "CPCH set ID" IE:
 - 3> let the PCPCHs listed in that CPCH set be the default in the uplink for CPCH.
- 1> if an IE "CPCH set ID" is not included in a dedicated message and the UE prior to the receipt of this message had configured the PCPCH as the default in the uplink:
 - 2> stop using the PCPCH;
 - 2> let the last assigned PRACH be the default in the uplink for RACH.

8.6.6.21 Default DPCH Offset Value

The UE shall:

- 1> if the IE "Default DPCH Offset Value" is included:
 - 2> use its value to determine Frame Offset and Chip Offset from the SFN timing in a cell.

8.6.6.22 Secondary Scrambling Code, Code Number

The following description applies to FDD.

Code Number can be assigned by following rules:

- 1> When more than one DL DPDCH is assigned per RL, the segmented physical channel shall be mapped on to DL DPDCHs according to [27]. When p number of DL DPDCHs are assigned to each RL, the first pair of Secondary Scrambling Code and Code Number corresponds to "*PhCH number 1*", the second to "*PhCH number 2*", and so on until the p th to "*PhCH number p*".

8.6.6.23 PDSCH Power Control info

The UE shall:

- 1> if the IE "PDSCH Power Control info" is included:
 - 2> configure PDSCH power control with the received values.
- 1> if the IE "PDSCH Power Control info" is not included:
 - 2> continue to use the stored values.

8.6.6.24 Tx Diversity Mode

If the IE "Tx Diversity Mode" is included the UE shall:

- 1> if the value of the IE "Tx Diversity Mode" is STTD:
 - 2> configure the Layer 1 to use the Tx diversity mode indicated in the IE "Tx Diversity Mode" for the radio links for which the IE "Closed loop timing adjustment mode" is included, ignoring the actual value of IE "Closed loop timing adjustment mode". The UE may apply the Tx diversity mode indicated in IE "Tx Diversity Mode" not only to the radio links for which the IE "Closed loop timing adjustment mode" is included, but also to the remaining radio links in the active set, as specified in [26].
- 1> if the value of the IE "Tx Diversity Mode" is closed loop mode1 or closed loop mode 2:
 - 2> configure the Layer 1 to use the Tx diversity mode indicated in the IE "Tx Diversity Mode" for the radio links for which the IE "Closed loop timing adjustment mode" is included, using the actual value of IE "Closed loop timing adjustment mode". The UE may apply the Tx diversity mode indicated in the IE "Tx Diversity Mode" not only to the radio links for which the IE "Closed loop timing adjustment mode" is included, but also to the remaining radio links in the active set, as specified in [26]. The UE behaviour is unspecified if different values of the IE "Closed loop timing adjustment mode" are indicated for different radio links of the active set.
- 1> if the value of the IE "Tx Diversity Mode" is "none":
 - 2> configure the Layer 1 not to use Tx diversity.

If the IE "Tx Diversity Mode" is not included, the UE shall:

- 1> continue to use the already configured Tx diversity mode;
- 1> in case no Tx diversity mode has been configured:
 - 2> not apply Tx diversity.

8.6.6.25 SSDT Information

If the IE "SSDT Information" is included the UE shall:

- 1> configure the size of the S-field in the FBI field on the uplink DPCCCH to the value indicated in the IE "S-field";
- 1> if the IE "Code Word Set" has the value "long", "medium" or "short":
 - 2> use the length of the temporary cell ID code for SSDT indicated in the IE "Code Word Set".
- 1> if the IE "Code Word Set" has the value "SSDT off":
 - 2> terminate SSDT.

8.6.6.26 UL Timing Advance Control (TDD only)

If the IE "UL Timing Advance Control" is present, the UE shall:

- 1> if the IE "Uplink Timing Advance Control" has the value "disabled":
 - 2> reset timing advance to 0;
 - 2> disable calculated timing advance following handover;
 - 2> in case of handover:
 - 3> start uplink transmissions in the target cell without applying timing advance.
- 1> if the IE "Uplink Timing Advance Control" has the value "enabled":
 - 2> in 3.84 Mcps TDD:

- 3> in case of no cell change:
 - 4> evaluate and apply the timing advance value for uplink transmission as indicated in the IE "Uplink Timing Advance" at the CFN indicated in the IE "Activation Time".
- 3> in case of cell change:
 - 4> use the IE "Uplink Timing Advance" as TA_{old} and apply TA_{new} for uplink transmission in the target cell at the CFN indicated in the IE "Activation Time" as specified in [33];
 - 4> include the value of the applied timing advance in the IE "Timing Advance" in the COMPLETE message.
- 2> in 1.28 Mcps TDD:
 - 3> if the IE "Synchronisation parameters" is included:
 - 4> initiate a sequence of UpPCH SYNC_UL code transmissions using a code selected from the set specified and continue until a timing correction is received in the specified FPACH (received for WT sub-frames following the sub-frame in which the transmission was made) or until Max SYNC_UL transmissions have been completed. The power used for each SYNC_UL transmission is as specified in subclause 8.5.7. Each transmission is made in the first sub-frame possible following the end of each FPACH reception interval using the timing specified in [33]. A new code is selected for each transmission. The detection that the FPACH relates to the transmitted SYNC_UL code is described in [33];
 - 4> if a timing correction is received within Max SYNC_UL transmissions the procedure is completed. The assigned uplink resources may then be used, commencing at the first possible TTI boundary or the SFN in which the assignment commences, whichever is the later. The timing of the uplink transmission is described in [33];
 - 4> if no timing correction has been received within Max SYNC_UL transmissions, the synchronisation procedure has failed. If the assigned resources are DCH, the UE should not transmit using these resources and should respond as if a physical channel failure has occurred as specified in subclauses 8.1.3.7 or 8.2.2.7 or 8.3.1.7, or 8.3.6.5. If the assigned resources are USCH then the UE should ignore the USCH allocation.
 - 3> if the IE "Synchronisation parameters" is not included:
 - 4> in case of no cell change:
 - 5> continue to use the current uplink timing.
 - 4> in case of cell change:
 - 5> evaluate and apply the timing correction TA_{new} for uplink transmissions using the procedure as specified in [33].

8.6.6.26a Uplink synchronisation parameters

The UE shall apply uplink synchronisation using the values of the IEs "Uplink synchronisation step size" and "Uplink synchronisation frequency" as specified in [33].

8.6.6.27 Downlink information common for all radio links

If the IE "Downlink information common for all radio links" is included the UE shall:

- 1> if the IE "Downlink DPCH info common for all RL" is included:
 - 2> perform actions as specified in subclause 8.6.6.28.
- 1> if the IE choice "mode" is set to 'FDD':
 - 2> perform actions for the IE "DPCH compressed mode info" as specified in subclause 8.6.6.15;

- 2> perform actions for the IE "Tx Diversity mode" as specified in subclause 8.6.6.24;
- 2> if the IE "SSDT information" is included:
 - 3> perform actions as specified in subclause 8.6.6.25.
- 1> if the IE "Default DPCH Offset value" is included:
 - 2> perform actions as specified in the subclause 8.6.6.21.

8.6.6.28 Downlink DPCH info common for all radio links

If the IE "Downlink DPCH info common for all RL" is included the UE shall:

- 1> if the IE "Downlink DPCH info common for all RL" is included in a message used to perform a hard handover:
 - 2> perform actions for the IE "Timing indication" as specified in subclause 8.5.15.2, and subclause 8.3.5.1 or 8.3.5.2.
- 1> ignore the value received in IE "CFN-targetSFN frame offset";
- 1> if the IE "Downlink DPCH power control information" is included:
 - 2> perform actions for the IE "DPC Mode" according to [29].
- 1> if the IE choice "mode" is set to 'FDD':
 - 2> if the IE "Downlink rate matching restriction information" is included:
 - 3> set the variable INVALID_CONFIGURATION to TRUE.
 - 2> perform actions for the IE "spreading factor";
 - 2> perform actions for the IE "Fixed or Flexible position";
 - 2> perform actions for the IE "TFCI existence";
 - 2> if the IE choice "SF" is set to 256:
 - 3> store the value of the IE "Number of bits for pilot bits".
 - 2> if the IE choice "SF" set to 128:
 - 3> store the value of the IE "Number of bits for pilot bits".
- 1> if the IE choice "mode" is set to 'TDD':
 - 2> perform actions for the IE "Common timeslot info".

If the IE "Downlink DPCH info common for all RL" is included in a message used to perform a Timing re-initialised hard handover or the IE "Downlink DPCH info common for all RL" is included in a message other than RB SETUP used to transfer the UE from a state different from Cell_DCH to Cell_DCH, and ciphering is active for any radio bearer using RLC-TM, the UE shall, after having activated the dedicated physical channels indicated by that IE:

- 1> if any ciphering configuration for a radio bearer using RLC-TM has not been applied, due to that the activation time from a previous procedure has not elapsed:
 - 2> apply the ciphering configuration immediately and consider the activation time from the previous procedure to be elapsed;
- 1> if the IE "MAC-d HFN initial value" is included in the IE "Downlink DPCH info common for all RL":
 - 2> set the HFN component of COUNT-C for TM-RLC to the value of the IE "MAC-d HFN initial value", while not incrementing the value of the HFN component of COUNT-C at each CFN cycle.

NOTE: The UTRAN should choose a value for the IE "MAC-d HFN initial value" using the COUNT-C value of the RBs using RLC-TM indicated by the Source RNC to the Target RNC in the IE "SRNS Relocation Info" and include some margin in such a way that no values of COUNT-C are repeated after the handover.

1> else:

2> set the 20 MSB of the HFN component of COUNT-C for TM-RLC to the value of the latest transmitted IE "START" or "START List" for this CN domain, while not incrementing the value of the HFN component of COUNT-C at each CFN cycle; and

2> set the remaining LSBs of the HFN component of COUNT-C to zero.

1> start to perform ciphering on the radio bearer in lower layers while not incrementing the HFN;

1> include the IE "COUNT-C activation time" in the response message and specify a CFN value for this IE other than the default, "Now", that is a multiple of 8 frames ($CFN \bmod 8 = 0$) and lies at least 200 frames ahead off the CFN in which the response message is first transmitted;

1> calculate the START value according to subclause 8.5.9;

1> include the calculated START values for each CN domain in the IE "START list" in the IE "Uplink counter synchronisation info" in the response message;

1> at the CFN value as indicated in the response message in the IE "COUNT-C activation time":

2> set the 20 MSB of the HFN component of the COUNT-C variable common for all transparent mode radio bearers of this CN domain to the START value as indicated in the IE "START list" of the response message for the relevant CN domain; and

2> set the remaining LSBs of the HFN component of COUNT-C to zero;

2> increment the HFN component of the COUNT-C variable by one even if the "COUNT-C activation time" is equal to zero;

2> set the CFN component of the COUNT-C to the value of the IE "COUNT-C activation time" of the response message. The HFN component and the CFN component completely initialise the COUNT-C variable;

2> step the COUNT-C variable, as normal, at each CFN value, i.e. the HFN component is no longer fixed in value but incremented at each CFN cycle.

8.6.6.29 ASC setting

If the IE "ASC setting" is included, the UE shall:

1> establish the available signatures for this ASC as specified in the following:

2> renumber the list of available signatures specified in the IE "Available signature" included in the IE "PRACH info" from signature index 0 to signature index N-1, where N is the number of available signatures, starting with the lowest available signature number and continuing in sequence, in the order of increasing signature numbers;

2> consider as available signatures for this ASC the signatures included in this renumbered list from the index specified by the IE "Available signature Start Index" to the index specified by the IE "Available signature End Index".

1> establish the available access slot sub-channels for this ASC as specified in the following:

2> if the IE "AICH transmission timing" included in the IE "AICH Info" is set to '0';

3> ignore the leftmost (most significant) bit (bit b3) of the bit string specified by the IE "Assigned Sub-Channel Number";

3> repeat 4 times the 3 rightmost (least significant) bits (bits b2-b0) of the bit string specified by the IE "Assigned Sub-Channel Number" to form a resulting bit string 'b2 b1 b0 b2 b1 b0 b2 b1 b0 b2 b1 b0' of length 12 bits, where the leftmost bit is the most significant.

- 2> if the IE "AICH transmission timing" included in the IE "AICH Info" is set to '1':
 - 3> repeat 3 times the bit string (bits b3-b0) specified by the IE "Assigned Sub-Channel Number" to form a bit string 'b3 b2 b1 b0 b3 b2 b1 b0 b3 b2 b1 b0' of length 12 bits, where the leftmost bit is the most significant.
- 2> perform in both cases, for the resulting bit string (that includes the repetitions) bit-wise logical AND operation with the IE "Available Sub Channel number" included in IE "PRACH info (for RACH)";
- 2> consider as available sub-channels for this ASC the available sub-channels indicated in the resulting bit string, after logical AND operation i.e. each bit set to 1 or 0 indicates availability or non-availability, respectively, of sub-channel number x , with x from 0 to 11, for the respective ASC.

NOTE 1: In FDD, the list of available signatures is renumbered from signature index 0 to signature index $N-1$, where N is the number of available signatures, starting with the lowest available signature number and continuing in sequence, in the order of increasing signature numbers.

- List of available signatures: 16 or fewer signatures are available.
- Example: only signatures 0, 5, 10 and 15 are available, then :
- Signature 0 is: available signature index 0
- Signature 5 is: available signature index 1
- Signature 10 is: available signature index 2
- Signature 15 is: available signature index 3

NOTE 2: In 3.84 Mcps TDD, the list of available channelisation codes (defined in PRACH info) is renumbered from channelisation code index 0 to channelisation code index $N-1$, where N is the number of available channelisation codes, starting with the lowest available channelisation code number and continuing in sequence, in the order of increasing channelisation code numbers

List of available channelisation codes : 8 or less channelisation codes are available.

The i -th bit of the bitmap defined in the IE "Available Channelisation Code indices" defines whether the channelisation code with the available channelisation code index i is to be used for this ASC (bit set means used, bit unset means not used). Only the low N bits shall be used in the bitmap, where N is the number of available channelisation codes defined in PRACH info.

Ex : spreading factor 16, channelisation codes 16/1, 16/2, 16/5, 16/10 are available :

- Channelisation code 16/1 is: available channelisation code index 0
- Channelisation code 16/2 is: available channelisation code index 1
- Channelisation code 16/5 is: available channelisation code index 2
- Channelisation code 16/10 is: available channelisation code index 3

Available Channelisation Code indices has the value '00001100' means: Channelisation Codes 16/5 and 16/10 are available for this ASC.

NOTE 3: In TDD, the subchannel description is found in [33].

NOTE 4: In 1.28 Mcps TDD, the list of available SYNC_UL codes (defined in PRACH info) is numbered from SYNC_UL code index 0 to SYNC_UL code index N-1, where N is the number of available SYNC_UL codes, starting with the lowest available SYNC_UL code number and continuing in sequence, in the order of increasing SYNC_UL code numbers

The i-th bit of the bitmap defined in the IE "Available SYNC_UL codes indices" defines whether the SYNC_UL code with the available SYNC_UL code index i is to be used for this ASC (bit set means used, bit unset means not used). Only the low N bits shall be used in the bitmap, where N is the number of available SYNC_UL codes defined in PRACH info.

- List of available SYNC_UL codes: 8 or fewer SYNC_UL codes are available.

Example: only signatures 0, 5, 6 and 7 are available, then:

- SYNC_UL codes 0 is: available SYNC_UL codes index 0
- SYNC_UL codes 5 is: available SYNC_UL codes index 1
- SYNC_UL codes 6 is: available SYNC_UL codes index 2
- SYNC_UL codes 7 is: available SYNC_UL codes index 3

Available SYNC_UL codes indices has the value '00001100' means: SYNC_UL codes 6 and 7 are available for this ASC.

8.6.6.30 SRB delay, PC preamble (FDD only)

When the IE "SRB delay" and IE "PC preamble" is received in a message that results in a configuration of uplink DPCH, the UE shall:

- 1> after the establishment of the uplink physical channel, send DPCCCH and no DPDCH according to [26] during the number of frames indicated in the IE "PC preamble"; and
- 1> then not send any data on signalling radio bearers RB0 to RB4 during the number of frames indicated in the IE "SRB delay".

8.6.6.31 FPACH/PRACH Selection (1.28 Mcps TDD only)

Where more than one FPACH is defined, the FPACH that a UE should receive following a UpPCH transmission is defined by the UpPCH signature (SYNC_UL) code that the UE used. The FPACH/PRACH number = $N \bmod M$ where N denotes the signature number (0..7) and M denotes the number of FPACH/PRACH combinations that have been defined. The FPACH/PRACH number indicates the position of the FPACH/PRACH description in the IE "PRACH info".

The PRACH that should be used is selected out of the ones associated with the FPACH in the IE "PRACH info" according to [33].

8.6.7 Measurement information elements

On reception of measurement information elements the UE shall:

- 1> store the received information in the variable MEASUREMENT_IDENTITY and CELL_INFO_LIST as specified;
- 1> perform further actions as specified in subclause 8.6.7 and subclause 8.4, based on the content of the variable MEASUREMENT_IDENTITY.

If a configuration is considered to be invalid the UE may:

- 1> set the variable CONFIGURATION_INCOMPLETE to TRUE.

8.6.7.1 Measurement validity

If the IE "measurement validity" for a given measurement has not been included in measurement control information, the UE shall delete the measurement associated with the variable MEASUREMENT_IDENTITY after the UE makes a transition to a new state.

If the IE "measurement validity" for this measurement has been included in measurement control information, the UE shall save the measurement associated with the variable MEASUREMENT_IDENTITY. The IE "UE state" defines the scope of resuming the measurement.

If the "UE state" is defined as "all states", the UE shall continue the measurement after making a transition to a new state. This scope is assigned for traffic volume measurement type and UE positioning measurement type. For traffic volume measurement type this scope can only be applied by the UE if the IE "traffic volume measurement object" has been included in measurement control information. If the IE "traffic volume measurement object" has not been included in measurement control information, the UE shall not save the measurement control information in variable MEASUREMENT_IDENTITY, but shall send a MEASUREMENT CONTROL FAILURE message to the UTRAN with failure cause "Configuration incomplete".

If the "UE state" is defined as "all states except CELL_DCH", the UE shall store the measurement to be resumed after a subsequent transition from CELL_DCH state to any of the other states in connected mode. This scope is assigned for traffic volume measurement type or UE positioning measurement type.

If the "UE state" is defined as "CELL_DCH", the UE shall store the measurement to be resumed after a subsequent transition to CELL_DCH state.

If the "measurement type" received in a MEASUREMENT CONTROL message is set to "inter-frequency measurement" or "intra-frequency measurement" and the IE "measurement validity" is present and is set to a value other than "CELL_DCH", the UE behaviour is unspecified.

8.6.7.2 Filter coefficient

If the IE "Filter coefficient" is received the UE shall, depending on the measurement quantity (see Table 8.6.7.2), apply filtering of the measurements for that measurement quantity according to the formula below. This filtering shall be performed by the UE before UE event evaluation. The UE shall depending on the reporting quantity (see Table 8.6.7.2), also filter the measurements reported in the IE "Measured results". The filtering shall not be performed for the measurements reported in the IE "Measured results on RACH" and for cell-reselection in connected or idle mode.

The filtering shall be performed according to the following formula.

$$F_n = (1 - a) \cdot F_{n-1} + a \cdot M_n$$

The variables in the formula are defined as follows:

F_n is the updated filtered measurement result

F_{n-1} is the old filtered measurement result

M_n is the latest received measurement result from physical layer measurements, the unit used for M_n is the same unit as the reported unit in the MEASUREMENT REPORT message or the unit used in the event evaluation.

$a = 1/2^{(k/2)}$, where k is the parameter received in the IE "Filter coefficient".

NOTE: if k is set to 0 that will mean no layer 3 filtering.

In order to initialise the averaging filter, F_0 is set to M_1 when the first measurement result from the physical layer measurement is received.

The physical layer measurement results are sampled once every measurement period. The measurement period and the accuracy for a certain measurement is defined in [19] and [20].

Table 8.6.7.2 lists for all measurement quantities and reporting quantities if L3-filtering is applicable or not. If L3-filtering is applicable for a certain measurement quantity or reporting quantity, the table specifies if the UE shall apply the filtering on linear values ("Lin"), logarithmic values ("Log") or either linear or logarithmic values ("Lin or Log"). In the last case, the choice between filtering on linear or logarithmic values is based on UE selection.

Table 8.6.7.2: L3 filtering applicable for each measurement quantity and reporting quantity

Measurement- / Reporting quantity	L3-filtering applicable	Linear or logarithmic filtering	Comment
Pathloss	Yes	Lin or Log	
Cell synchronisation information	No	-	
Cell Identity	No	-	
Frequency quality estimate	No	-	Although the frequency quality estimate itself is not filtered, the inputs to the frequency quality estimate calculation (CPICH Ec/N0 or CPICH RSCP or P-CCPCH RSCP) are filtered
UTRA carrier RSSI	Yes	[Log]	
GSM carrier RSSI	Yes	Log	
Observed time difference to GSM cell	No	-	
UE transmitted power	Yes	[Log]	
FDD			
> UE Rx-Tx time difference	No	-	
> CPICH Ec/N0	Yes	Lin or Log	
> CPICH RSCP	Yes	Lin or Log	
TDD			
> Primary CCPCH RSCP	Yes	Lin or Log	
> Proposed TGSN	No	-	
> Timeslot ISCP	Yes	Lin or Log	
> TADV (1.28 Mcps TDD)	No	-	
> Applied TA (3.84 Mcps TDD)	No	-	

The UE shall support 2 different layer 3 filters per measurement type defined in subclause 8.4.0 (i.e. the UE shall be capable to apply at least 2 different L3 filters to intra-frequency measurement results, at least 2 different L3 filters to inter-frequency measurement results, etc.). If a MEASUREMENT CONTROL message is received that would require the UE to configure more than 2 different layer 3 filters, the UE may:

- 1> set the variable CONFIGURATION_INCOMPLETE to TRUE.

8.6.7.3 Intra-frequency/Inter-frequency/Inter-RAT cell info list

If the IE "Intra-frequency cell info list" is received in System Information Block Type 11, the UE shall update the variable CELL_INFO_LIST accordingly and in the following order. The UE shall:

- 1> if the IE "Intra-frequency cell removal" is received:
 - 2> ignore the IE.
- 1> if the IE "New Intra-frequency cells" is received, for each cell, and in the same order as the cells appear in the IE:
 - 2> update the variable CELL_INFO_LIST as follows:
 - 3> if the IE "Intra-frequency cell id" is received:
 - 4> store received cell information at this position in the Intra-frequency cell info list in the variable CELL_INFO_LIST, possibly overwriting any existing information in this position; and
 - 4> mark the position "occupied".
 - 3> if the IE "Intra-frequency cell id" is not received:
 - 4> store the received cell information at the first vacant position in ascending order in the Intra-frequency cell info list in the variable CELL_INFO_LIST; and

4> mark the position as "occupied".

If the IE "Intra-frequency cell info list" is received in System Information Block Type 12, the UE shall update the variable CELL_INFO_LIST accordingly and in the following order. The UE shall:

- 1> if the IE "Intra-frequency cell removal" is received:
 - 2> if it has the value "Remove some intra-frequency cells", at the position indicated by the IE "Intra-frequency cell id":
 - 3> clear the cell information stored in the variable CELL_INFO_LIST; and
 - 3> mark the position "vacant".
 - 2> if it has the value "Remove all intra-frequency cells":
 - 3> for each position referring to an intra-frequency cell in the variable CELL_INFO_LIST:
 - 4> clear the cell information stored in the variable CELL_INFO_LIST; and
 - 4> mark the position "vacant".
 - 2> if it has the value "Remove no intra-frequency cells":
 - 3> leave the variable CELL_INFO_LIST unchanged.
- 1> if the IE "New Intra-frequency cells" is received, for each cell, and in the same order as the cells appear in the IE:
 - 2> update the variable CELL_INFO_LIST as follows:
 - 3> if the IE "Intra-frequency cell id" is received:
 - 4> store received cell information at this position in the Intra-frequency cell info list in the variable CELL_INFO_LIST, possibly overwriting any existing information in this position; and
 - 4> mark the position "occupied".
 - 3> if the IE "Intra-frequency cell id" is not received:
 - 4> store the received cell information at the first vacant position in ascending order in the Intra-frequency cell info list in the variable CELL_INFO_LIST; and
 - 4> mark the position as "occupied".

If the IE "Intra-frequency cell info list" is received in a MEASUREMENT CONTROL message, the UE shall update the variable CELL_INFO_LIST accordingly and in the following order. The UE shall:

- 1> if the CHOICE "Intra-frequency cell removal" is received:
 - 2> if it has the value "Remove some intra-frequency cells", at the position indicated by the IE "Intra-frequency cell id":
 - 3> clear the cell information stored in the variable CELL_INFO_LIST; and
 - 3> mark the position "vacant".
 - 2> if it has the value "Remove all intra-frequency cells":
 - 3> for each position referring to an intra-frequency cell in the variable CELL_INFO_LIST:
 - 4> clear the cell information stored in the variable CELL_INFO_LIST; and
 - 4> mark the position "vacant".
 - 2> if it has the value "Remove no intra-frequency cells":
 - 3> leave the variable CELL_INFO_LIST unchanged.

- 1> if the IE "New Intra-frequency cells" is received, for each cell, and in the same order as the cells appear in the IE:
 - 2> update the variable CELL_INFO_LIST as follows:
 - 3> if the IE "Intra-frequency cell id" is received:
 - 4> store received cell information at this position in the Intra-frequency cell info list in the variable CELL_INFO_LIST, possibly overwriting any existing information in this position; and
 - 4> mark the position "occupied".
 - 3> if the IE "Intra-frequency cell id" is not received:
 - 4> store the received cell information at the first vacant position in ascending order in the Intra-frequency cell info list in the variable CELL_INFO_LIST; and
 - 4> mark the position as "occupied".
- 1> if the IE "Cells for measurement" is received, in the measurement configured by this message only:
 - 2> consider Intra-frequency cells whose cell information is stored at the position indicated by the IE "Intra-frequency cell id" in the variable CELL_INFO_LIST.
- 1> if the IE "Cells for measurement" is not received, in the measurement configured by this message:
 - 2> consider all Intra-frequency cells whose cell information is stored in CELL_INFO_LIST.

If the IE "Inter-frequency cell info list" is received in System Information Block Type 11 update the variable CELL_INFO_LIST accordingly and in the following order. The UE shall:

- 1> if the IE "Inter-frequency cell removal" is received:
 - 2> ignore the IE.
- 1> if the IE "New Inter-frequency cells" is received, for each cell, and in the same order as the cells appear in the IE:
 - 2> update the variable CELL_INFO_LIST as follows:
 - 3> if the IE "Inter-frequency cell id" is received:
 - 4> store received cell information at this position in the Inter-frequency cell info list in the variable CELL_INFO_LIST, possibly overwriting any existing information in this position; and
 - 4> mark the position "occupied".
 - 3> if the IE "Inter-frequency cell id" is not received:
 - 4> store the received cell information at the first vacant position in ascending order in the Inter-frequency cell info list in the variable CELL_INFO_LIST; and
 - 4> mark the position as "occupied".

If the IE "Inter-frequency cell info list" is received in System Information Block Type 12, the UE shall update the variable CELL_INFO_LIST accordingly and in the following order. The UE shall:

- 1> if the CHOICE "Inter-frequency cell removal" is received:
 - 2> if it has the value "Remove some inter-frequency cells", at the position indicated by the IE "Inter-frequency cell id":
 - 3> clear the cell information stored in the variable CELL_INFO_LIST; and
 - 3> mark the position "vacant".
 - 2> if it has the value "Remove all inter-frequency cells":

- 3> for each position referring to an inter-frequency cell in the variable CELL_INFO_LIST:
 - 4> clear the cell information stored in the variable CELL_INFO_LIST; and
 - 4> mark the position "vacant".
- 2> if it has the value "Remove no inter-frequency cells":
 - 3> leave the variable CELL_INFO_LIST unchanged.
- 1> if the IE "New Inter-frequency cells" is received, for each cell, and in the same order as the cells appear in the IE:
 - 2> update the variable CELL_INFO_LIST as follows:
 - 3> if the IE "Inter-frequency cell id" is received:
 - 4> store received cell information at this position in the Inter-frequency cell info list in the variable CELL_INFO_LIST, possibly overwriting any existing information in this position; and
 - 4> mark the position "occupied".
 - 3> if the IE "Inter-frequency cell id" is not received:
 - 4> store the received cell information at the first vacant position in ascending order in the Inter-frequency cell info list in the variable CELL_INFO_LIST; and
 - 4> mark the position as "occupied".

If the IE "Inter-frequency cell info list" is received in a MEASUREMENT CONTROL message, the UE shall update the variable CELL_INFO_LIST accordingly and in the following order:

- 1> if the CHOICE "Inter-frequency cell removal" is received:
 - 2> if it has the value "Remove some inter-frequency cells", at the position indicated by the IE "Inter-frequency cell id":
 - 3> clear the cell information stored in the variable CELL_INFO_LIST; and
 - 3> mark the position "vacant".
 - 2> if it has the value "Remove all inter-frequency cells":
 - 3> for each position referring to an inter-frequency cell in the variable CELL_INFO_LIST:
 - 4> clear the cell information stored in the variable CELL_INFO_LIST; and
 - 4> mark the position "vacant".
 - 2> if it has the value "Remove no inter-frequency cells":
 - 3> leave the variable CELL_INFO_LIST unchanged.
- 1> if the IE "New Inter-frequency cells" is received, for each cell, and in the same order as the cells appear in the IE:
 - 2> update the variable CELL_INFO_LIST as follows:
 - 3> if the IE "Inter-frequency cell id" is received:
 - 4> store received cell information at this position in the Inter-frequency cell info list in the variable CELL_INFO_LIST, possibly overwriting any existing information in this position; and
 - 4> mark the position "occupied".
 - 3> if the IE "Inter-frequency cell id" is not received:

- 4> store the received cell information at the first vacant position in ascending order in the Inter-frequency cell info list in the variable CELL_INFO_LIST; and
- 4> mark the position as "occupied".

1> if the IE "Cells for measurement" is received, in the measurement configured by this message only:

- 2> consider Inter-frequency cells whose cell information is stored at the position indicated by the IE "Inter-frequency cell id" in the variable CELL_INFO_LIST.

1> if the IE "Cells for measurement" is not received, in the measurement configured by this message:

- 2> consider all Inter-frequency cells whose cell information is stored in CELL_INFO_LIST.

If the IE "Inter-RAT cell info list" is received in System Information Block Type 11, the UE shall update the variable CELL_INFO_LIST accordingly and in the following order. The UE shall:

1> ignore the IE "Inter-RAT cell removal".

1> if the IE "New Inter-RAT cells" is received, for each cell, and in the same order as the cells appear in the IE:

- 2> if the IE "Radio Access Technology" is set to "None":

- 3> ignore the cell.

- 2> otherwise:

- 3> update the variable CELL_INFO_LIST as follows:

- 4> if the IE "Inter-RAT cell id" is received:

- 5> store received cell information at this position in the Inter-RAT cell info list in the variable CELL_INFO_LIST, possibly overwriting any existing information in this position; and

- 5> mark the position "occupied".

- 4> if the IE "Inter-RAT cell id" is not received:

- 5> store the received cell information at the first vacant position in ascending order in the Inter-RAT cell info list in the variable CELL_INFO_LIST; and

- 5> mark the position as "occupied".

1> if the IE "Cells for measurement" is received:

- 2> ignore the IE.

If the IE "Inter-RAT cell info list" is received in System Information Block Type 12, the UE shall update the variable CELL_INFO_LIST accordingly and in the following order. The UE shall:

1> if the IE "Inter-RAT cell removal" is received:

- 2> if it has the value "Remove some inter-RAT cells", at the position indicated by the IE "Inter-RAT cell id":

- 3> clear the cell information stored in the variable CELL_INFO_LIST; and

- 3> mark the position "vacant".

- 2> if it has the value "Remove all inter-RAT cells":

- 3> for each position referring to an inter-RAT cell in the variable CELL_INFO_LIST:

- 4> clear the cell information stored in the variable CELL_INFO_LIST; and

- 4> mark the position "vacant".

- 2> if it has the value "Remove no inter-RAT cells":

- 3> leave the variable CELL_INFO_LIST unchanged.
- 1> if the IE "New Inter-RAT cells" is received, for each cell, and in the same order as the cells appear in the IE:
 - 2> if the IE "Radio Access Technology" is set to "None":
 - 3> ignore the cell.
 - 2> otherwise:
 - 3> update the variable CELL_INFO_LIST as follows:
 - 4> if the IE "Inter-RAT cell id" is received:
 - 5> store received cell information at this position in the Inter-RAT cell info list in the variable CELL_INFO_LIST, possibly overwriting any existing information in this position; and
 - 5> mark the position "occupied".
 - 4> if the IE "Inter-RAT cell id" is not received:
 - 5> store the received cell information at the first vacant position in ascending order in the Inter-RAT cell info list in the variable CELL_INFO_LIST; and
 - 5> mark the position as "occupied".
- 1> if the IE "Cells for measurement" is received:
 - 2> ignore the IE.

If the IE "Inter-RAT cell info list" is received in a MEASUREMENT CONTROL message, the UE shall update the variable CELL_INFO_LIST accordingly and in the following order. The UE shall:

- 1> if the IE "Inter-RAT cell removal" is received:
 - 2> if it has the value "Remove some inter-RAT cells", at the position indicated by the IE "Inter-RAT cell id":
 - 3> clear the cell information stored in the variable CELL_INFO_LIST; and
 - 3> mark the position "vacant".
 - 2> if it has the value "Remove all inter-RAT cells":
 - 3> for each position referring to an inter RAT cell in the variable CELL_INFO_LIST:
 - 4> clear the cell information stored in the variable CELL_INFO_LIST; and
 - 4> mark the position "vacant".
 - 2> if it has the value "Remove no inter-RAT cells":
 - 3> leave the variable CELL_INFO_LIST unchanged.
- 1> if the IE "New Inter-RAT cells" is received, for each cell, and in the same order as the cells appear in the IE:
 - 2> if the IE "Radio Access Technology" is set to "None":
 - 3> ignore the cell.
 - 2> otherwise:
 - 3> update the variable CELL_INFO_LIST as follows:
 - 4> if the IE "Inter-RAT cell id" is received:
 - 5> store received cell information at this position in the Inter-RAT cell info list in the variable CELL_INFO_LIST, possibly overwriting any existing information in this position; and
 - 5> mark the position "occupied".

- 4> if the IE "Inter-RAT cell id" is not received:
 - 5> store the received cell information at the first vacant position in ascending order in the Inter-RAT cell info list in the variable CELL_INFO_LIST; and
 - 5> mark the position as "occupied".
- 1> if the IE "Cells for measurement" is received, in the measurement configured by this message only:
 - 2> consider Inter-RAT cells whose cell information is stored at the position indicated by the IE "Inter-RAT cell id" in the variable CELL_INFO_LIST.
- 1> if the IE "Cells for measurement" is not received, in the measurement configured by this message:
 - 2> consider all Inter-RAT cells whose cell information is stored in CELL_INFO_LIST.
- 1> if the IE "Cell selection and re-selection info for SIB11/12" is present:
 - 2> ignore the IE.

8.6.7.4 Intra-frequency measurement quantity

If the IE "Intra-frequency measurement quantity" is received in a MEASUREMENT CONTROL message, the UE shall:

- 1> if the IE "Measurement quantity" is set to "pathloss"; and
- 1> for any intra-frequency cell indicated by the IE "Cells for measurement", the IE "Primary CPICH Tx power" in FDD or the IE "Primary CCPCH TX Power" in TDD in the intra frequency cell info list in the variable CELL_INFO_LIST is not present:
 - 2> set the variable CONFIGURATION_INCOMPLETE to TRUE.
- 1> else:
 - 2> configure the measurement quantity accordingly.

8.6.7.5 Inter-RAT measurement quantity

If the IE "Inter-RAT measurement quantity" is received in a MEASUREMENT CONTROL message and CHOICE system is GSM, the UE shall:

- 1> if IE "BSIC verification required" is set to "required", for cells that match any of the BCCH ARFCN and BSIC combinations in the list of inter-RAT cells that the UE has received in IE "Inter-RAT cell info list", and that has a "verified" BSIC:
 - 2> report measurement quantities according to IE "inter-RAT reporting quantity" taking into account the restrictions defined in subclause 8.6.7.6;
 - 2> trigger inter-RAT events according to IE "inter-RAT measurement reporting criteria"; and
 - 2> perform event evaluation for event-triggered reporting after BSIC has been verified for a GSM cell as defined in [19]; and
 - 2> trigger periodical reports according to the given "Reporting interval"; and
 - 2> when a periodical measurement report is triggered, include only BSIC verified GSM cells in the IE "Inter-RAT measured results list"; and
 - 3> indicate verified BSIC for a GSM cell in the IE "Inter-RAT measured results list" as defined in subclause 8.6.7.6.
 - 2> when an event triggered measurement report is triggered, include only BSIC verified GSM cells in the IE "Inter-RAT measured results list"; and
 - 3> indicate verified BSIC for a GSM cell in the IE "Inter-RAT measured results list" as defined in subclause 8.6.7.6.

- 1> if IE "BSIC verification required" is set to "not required", for cells that match any of the BCCH ARFCN in the list of inter-RAT cells that the UE has received in IE "Inter-RAT cell info list", regardless if the BSIC is "verified" or "non-verified":
 - 2> report measurement quantities according to IE "inter-RAT reporting quantity";
 - 2> trigger inter-RAT events according to IE "inter-RAT measurement reporting criteria";
 - 2> when an event triggered or periodical measurement report is triggered, include GSM cells in the IE "Inter-RAT measured results list" regardless of whether the BSIC of the GSM cell has been verified or not; and
 - 3> for any GSM cell that has not been verified, indicate non-verified BSIC for a GSM cell in the "Inter-RAT measured results list" IE as defined in subclause 8.6.7.6.
 - 3> for any GSM cell that has been verified, indicate verified BSIC for a GSM cell in the "Inter-RAT measured results list" IE as defined in subclause 8.6.7.6.
- 1> if the IE "Measurement quantity" is set to "pathloss":
 - 2> set the variable CONFIGURATION_INCOMPLETE to TRUE.

NOTE: The requirements for a cell to be considered "verified" or "non-verified" can be found in [19].

8.6.7.6 Inter-RAT reporting quantity

If the IE "Inter-RAT reporting quantity" is received by the UE, the UE shall:

- 1> store the content of the IE to the variable MEASUREMENT_IDENTITY.

If the IE "Inter-RAT measurement quantity" is received and CHOICE system is GSM, the UE shall check each quantity in the GSM choice. The UE shall include measured results in MEASUREMENT REPORT as specified in the IE "Inter-RAT reporting quantity" with the following restrictions:

- 1> if the UE has not confirmed the BSIC of the measured cell:
 - 2> if no compressed mode pattern sequence specified with measurement purpose "Initial BSIC identification" is active and according to its capabilities the UE requires compressed mode to measure this, the UE is not required to include the "inter-RAT cell id" nor "Observed time difference to GSM cell" in the IE "Inter-RAT measured results list", when a MEASUREMENT REPORT is triggered.
- 1> if the UE has confirmed the BSIC of the measured cell, then:
 - 2> if no compressed mode pattern sequence specified with measurement purpose "Initial BSIC identification" nor "BSIC re-confirmation" is active and according to its capabilities the UE requires compressed mode to measure this, the UE is not required to include the "inter-RAT cell id" nor "Observed time difference to GSM cell" in the IE "Inter-RAT measured results", when a MEASUREMENT REPORT is triggered. If no compressed mode pattern sequence with measurement purpose "GSM carrier RSSI measurements" is active and according to its capabilities the UE requires compressed mode to measure this, the UE may include "inter-RAT cell id" or "Observed time difference to GSM cell" in MEASUREMENT REPORT without "GSM carrier RSSI" even if it is defined in the IE "Inter-RAT reporting quantity".
- 1> if the IE "UTRAN estimated quality" is set to "TRUE":
 - 2> ignore that IE.
- 1> if IE "Observed time difference to GSM cell Reporting indicator" is set to "TRUE":
 - 2> include optional IE "Observed time difference to GSM cell" with the value set to the time difference to that GSM cell for the GSM cells that have a BSIC that is "verified", and that match any of the BCCH ARFCN and BSIC combinations in the list of inter-RAT cells that the UE has received in IE "Inter-RAT cell info list". Observed time difference to GSM cells with "non-verified" BSIC shall not be included.
- 1> if IE "GSM Carrier RSSI" is set to "TRUE":
 - 2> include optional IE "GSM Carrier RSSI" with a value set to the measured RXLEV to that GSM cell in IE "Inter-RAT measured results list". If no compressed mode pattern sequence specified with measurement

purpose "GSM carrier RSSI measurements" is active and according to its capabilities the UE requires compressed mode to measure this, the UE is not required to include the "GSM carrier RSSI" in the IE "Inter-RAT measured results list", when a MEASUREMENT REPORT is triggered.

1> if the BSIC of reported GSM cell is "verified":

2> set the CHOICE BSIC to "Verified BSIC" and IE "inter-RAT cell id" to the value that GSM cell had in the IE "Inter-RAT cell info list".

1> if the BSIC of reported GSM cell is "non-verified":

2> set the CHOICE BSIC to "Non verified BSIC" and the IE "BCCH ARFCN" to the value of that GSM cells ARFCN.

The requirements for a cell to be considered "verified" or "non-verified" can be found in [19].

8.6.7.7 Cell Reporting Quantities

If the IE "Cell Reporting Quantities" is received by the UE, the UE shall store the content of the IE "Cell Reporting Quantities" to the variable MEASUREMENT_IDENTITY.

The UE shall include measured results in MEASUREMENT REPORT as specified in the IE "Cell Reporting Quantities", except for the following cases:

If the IE "Cell Identity" is set to TRUE, the UE shall in this version of the specification:

1> treat the IE as if the IE "Cell Identity" is set to FALSE.

If the IE "Cell synchronisation information reporting indicator" is set to TRUE, the UE shall:

1> include the IE "Cell synchronisation information" in MEASUREMENT REPORT as specified in the IE "Cell Reporting Quantities":

2> if the measurement is performed on another frequency; or

2> if the IE "Read SFN indicator" included in the IE "Cell info" of the measured cell is set to FALSE:

3> the UE may omit the information group "COUNT-C-SFN frame difference" in the IE "Cell synchronisation information".

2> if the measurement is performed on the same frequency and no RLC Transparent Mode COUNT-C exists in the UE:

3> set the IE "COUNT-C-SFN high" to 0.

2> otherwise:

3> include the information group "COUNT-C-SFN frame difference" with IE "COUNT-C-SFN high" set to:

COUNT-C-SFN high = (((SFN - (COUNT-C mod 4096)) mod 4096) div 256) * 256;

3> if RLC Transparent Mode COUNT-Cs exist in both CN domains:

4> use the COUNT-C of CS domain in this measurement.

If the IE "Proposed TGSN Reporting required" is set to TRUE, the UE shall:

1> if compressed mode was used to monitor a TDD cell and the variable TGSN_REPORTED is set to FALSE:

2> report the IE "Proposed TGSN" indicating the TGSN that suits best to the measured cell;

2> set the variable TGSN_REPORTED to TRUE.

1> otherwise

2> omit the IE "Proposed TGSN".

8.6.7.8 Periodical Reporting Criteria

If the IE "Periodical Reporting Criteria" is received by the UE, the UE shall:

- 1> store the contents of the IE "Amount of Reporting" and IE "Reporting interval" in the variable MEASUREMENT_IDENTITY.

For the first MEASUREMENT REPORT message, the UE shall:

- 1> send the MEASUREMENT REPORT as soon as all requested reporting quantities are available according to the requirements and the measurement capabilities set in [19] and [20] for at least one measurement object stored in the variable MEASUREMENT_IDENTITY, but never later than one reporting interval after measurement initiation.

Following the first MEASUREMENT REPORT message, the UE shall:

- 1> send a MEASUREMENT REPORT message one reporting interval after the previous MEASUREMENT REPORT message;

The first and subsequent periodic MEASUREMENT REPORT messages shall only include measured results for reporting quantities that are available according to the requirements and the measurement capabilities set in [19] and [20] i.e. if no measured results are available, the IE "Measured Results" shall not be included in the MEASUREMENT REPORT message.

After the UE has sent a total number of MEASUREMENT REPORT messages, which equal the value indicated in the IE "Amount of reporting", the UE shall:

- 1> terminate measurement reporting; and
- 1> delete all measurement information linked with the "Measurement identity" of the ongoing measurement from the variable MEASUREMENT_IDENTITY.

8.6.7.9 Reporting Cell Status

If the IE "Reporting Cell Status" is received, the UE shall set the IE "Measured Results" in MEASUREMENT REPORT as follows. The UE shall:

- 1> for intra-frequency measurement and inter-frequency measurement:
 - 2> include the IE "Cell Measured Results" for cells (excluding cells of another RAT) that satisfy the condition (such as "Report cells within active set") specified in the IE "Reporting Cell Status", in descending order by the measurement quantity.
 - 2> the maximum number of the IE "Cell Measured Results" to be included in the IE "Measured Results" per reported frequency is the number specified in the IE "Reporting Cell Status".
- 1> for periodic inter-frequency measurement:
 - 2> include in the IE "Inter-frequency measured results list" the measured results for all non-used frequencies.
- 1> for inter-RAT measurement:
 - 2> include the measurement results for cells of other RAT (e.g., GSM) that satisfy the condition specified in the IE "Reporting Cell Status", in descending order by the measurement quantity.
 - 2> the maximum number of the IE "Measured GSM Cells" to be included in the IE "Measured Results" is the number specified in the IE "Reporting Cell Status".

If the IE "Reporting Cell Status" is not received for intra-frequency, inter-frequency measurement, or inter-RAT measurement, the UE shall:

- 1> for intra-frequency measurement, inter-frequency measurement and inter-RAT measurement:
 - 2> exclude the IE "Measured Results" in MEASUREMENT REPORT.

NOTE: The IE "Reporting Cell Status" within "Event Criteria List" defines whether "Cell Measured Results" is present for event-based reporting.

The IE "Reporting Cell Status" is not included in SIB 11/12 for periodic intra-frequency measurements. In this case the UE shall assume the default values "Report cells within active set and/or monitored set on used frequency " and "6".

8.6.7.10 Traffic Volume Measurement

If the IE "Traffic Volume Measurement" is received by the UE, the UE shall:

- 1> store the content of the IE to the variable MEASUREMENT_IDENTITY.

If IE "Traffic volume measurement" is received by the UE in a MEASUREMENT CONTROL message, where IE "measurement command" has the value "setup", and if the IE "traffic volume reporting quantity" is included, the UE shall:

- 1> if the parameter "Average of RLC Buffer Payload for each RB" or the parameter "Variance of RLC Buffer payload for each RB" is set to "TRUE":
 - 2> if the IE "Traffic volume measurement quantity" is not included:
 - 3> set the variable CONFIGURATION_INCOMPLETE to TRUE.
 - 2> if the IE "Traffic volume measurement quantity" is included:
 - 3> if the parameter "time interval to take an average or a variance" is not included:
 - 4> set the variable CONFIGURATION_INCOMPLETE to TRUE.

If IE "Traffic volume measurement" is received by the UE in a MEASUREMENT CONTROL message, where IE "measurement command" has the value "setup", but IE "Traffic volume reporting quantity" or is not received, the UE shall:

- 1> set the variable CONFIGURATION_INCOMPLETE to TRUE.

8.6.7.11 Traffic Volume Measurement Reporting Criteria

If the IE "Traffic Volume Measurement Reporting Criteria" is received by the UE, the UE shall:

- 1> if the IE "Parameters sent for each transport channel" is absent:
 - 2> set the variable PROTOCOL_ERROR_REJECT to TRUE;
 - 2> set the IE "Protocol error cause" in the variable PROTOCOL_ERROR_INFORMATION to "Information element missing".
- 1> for each IE "Parameters sent for each transport channel":
 - 2> if the IE "Parameters required for each Event" is absent:
 - 3> set the variable CONFIGURATION_INCOMPLETE to TRUE.

8.6.7.12 FACH measurement occasion info

IE "FACH measurement occasion info" is used to control UE measurement activities in inter-frequency and inter-RAT cells in CELL_FACH state.

If IE "FACH measurement occasion info" is received, UE shall, when in CELL_FACH state:

- 1> if IE "FACH Measurement occasion cycle length coefficient" is included:
 - 2> if, according to its measurement capabilities, UE is not able to perform some of the indicated measurements in this IE simultaneously as receiving the SCCPCH of serving cell:
 - 3> perform those measurements during FACH measurement occasions, see subclause 8.5.11.

- 2> if, according to its measurement capabilities, UE is able to perform some of the indicated measurements in this IE simultaneously as receiving the SCCPCH of serving cell:
 - 3> UE may perform measurements also on other occasions.
- 2> if, according to its measurement capabilities, UE is able to perform the measurements and indicated in this IE simultaneously as receiving the SCCPCH of serving cell:
 - 3> perform the measurements simultaneously as receiving the SCCPCH of serving cell.
- 1> if IE "FACH Measurement occasion cycle length coefficient" is not included:
 - 2> perform those indicated measurements indicated in this IE that UE, according to its measurement capabilities, is able to perform simultaneously as receiving the SCCPCH of serving cell.
- 1> if IE "Inter-frequency FDD measurement indicator" is set to TRUE:
 - 2> perform measurements and evaluate cell re-selection criteria according to [4] on inter-frequency FDD cells listed in IE "Measurement control system information" in "System Information Block type 11" or "System Information Block type 12".
- 1> if IE "Inter-frequency FDD measurement indicator" is set to FALSE:
 - 2> neither perform measurements nor evaluate cell re-selection criteria on inter-frequency FDD cells.
- 1> if IE "Inter-frequency TDD measurement indicator" is set to TRUE:
 - 2> perform measurements and evaluate cell re-selection criteria according to [4] on inter-frequency TDD cells listed in IE "Measurement control system information" in "System Information Block type 11" or "System Information Block type 12".
- 1> if IE "Inter-frequency TDD measurement indicator" is set to FALSE:
 - 2> neither perform measurements nor evaluate cell re-selection criteria on inter-frequency TDD cells.
- 1> if IE "Inter-RAT measurement indicators" is included:
 - 2> perform measurements and evaluate cell re-selection criteria according to [4] on those cells of listed Inter-RAT types that are present in IE "Measurement control system information" in "System Information Block type 11" or "System Information Block type 12".

8.6.7.13 Measurement Reporting Mode

If IE "Measurement Reporting Mode" is received by the UE, the UE shall:

- 1> store the contents of the IE "Measurement Report Transfer Mode" in the variable MEASUREMENT_IDENTITY;
- 1> use the indicated RLC mode when sending MEASUREMENT REPORT message(s) related to this measurement;
- 1> ignore IE "Periodical Reporting / Event Trigger Reporting Mode".

If IE "Measurement Reporting Mode" is not received by the UE in MEASUREMENT CONTROL message, where IE "measurement command" has the value "setup", the UE shall:

- 1> clear all stored measurement control information related associated to this measurement identity in variable MEASUREMENT_IDENTITY;
- 1> set the variable CONFIGURATION_INCOMPLETE to TRUE.

8.6.7.14 Inter-frequency measurement

If the Inter-frequency cell info list, included in the variable CELL_INFO_LIST, includes a number (M) of frequencies that is larger than the number (N) considered in a UE performance requirement defined in [19] and [20]:

- 1> the UE shall:

2> meet this performance requirement on the first relevant (N) frequencies, according to the order defined by the position of the frequencies in the Inter-frequency cell info list, included in the variable CELL_INFO_LIST.

1> the UE may:

2> ignore the remaining (M-N) frequencies.

If IE "Inter-frequency measurement" is received by the UE in a MEASUREMENT CONTROL message, where IE "measurement command" has the value "setup", but IE "Inter-frequency measurement quantity", IE "Inter-frequency reporting quantity" or IE "parameters required for each event" (given "CHOICE Report criteria" is set to "inter-frequency measurement reporting criteria" or "intra-frequency measurement reporting criteria") is not received, the UE shall:

1> clear all stored measurement control information related associated to this measurement identity in variable MEASUREMENT_IDENTITY;

1> set the variable CONFIGURATION_INCOMPLETE to TRUE.;

In the case of an inter-frequency measurement for FDD, the UE shall:

1> if IE "Inter-frequency measurement" is received by the UE in a MEASUREMENT CONTROL message, where IE "measurement command" has the value "setup", if an inter-frequency event is configured that is different from event 2d or 2f, and if the IE "Inter-frequency SET UPDATE" is not received in that same message:

2> set the variable CONFIGURATION_INCOMPLETE to TRUE.

1> if the IE "Inter-frequency SET UPDATE" is received:

2> if the value of the IE "UE autonomous update mode" set to "Off" or "On":

3> if more than one frequency is included in the list of cells pointed at in the IE "cells for measurement" if also included in the same IE "Inter-frequency measurement", or otherwise included in the "Inter-frequency cell info" part of the variable CELL_INFO_LIST:

4> set the variable CONFIGURATION_INCOMPLETE to TRUE.

If IE "Inter-frequency measurement" is received by the UE in a MEASUREMENT CONTROL message:

1> if "CHOICE Report criteria" is set to "inter-frequency reporting criteria" and "inter-frequency measurement quantity" is not set to "inter-frequency reporting criteria"; or

1> if "CHOICE Report criteria" is set to "intra-frequency reporting criteria" and "inter-frequency measurement quantity" is not set to "intra-frequency reporting criteria":

2> the UE behaviour is not specified.

If the variable CONFIGURATION_INCOMPLETE is set to TRUE, the UE shall:

1> act as described in subclause 8.4.1.4a.

8.6.7.15 Inter-RAT measurement

If the Inter-RAT cell info list, included in the variable CELL_INFO_LIST, includes a number (M) of frequencies that is larger than the number (N) considered in a UE performance requirement defined in [19] and [20]:

1> the UE shall:

2> meet this performance requirement on the first relevant (N) frequencies, according to the order defined by the position of the frequencies in the Inter-RAT cell info list, included in the variable CELL_INFO_LIST.

1> the UE may:

2> ignore the remaining (M-N) frequencies.

If IE "Inter-RAT measurement" is received by the UE in a MEASUREMENT CONTROL message, where IE "measurement command" has the value "setup", but IE "Inter-RAT measurement quantity", IE "Inter-RAT reporting

quantity" or "parameters required for each event" (given "CHOICE Report criteria" is set to "inter-RAT measurement reporting criteria") is not received, the UE shall:

- 1> clear all stored measurement control information related associated to this measurement identity in variable MEASUREMENT_IDENTITY;
- 1> set the variable CONFIGURATION_INCOMPLETE to TRUE.

8.6.7.16 Intra-frequency measurement

If IE "Intra-frequency measurement" is received by the UE in a MEASUREMENT CONTROL message, where IE "measurement command" has the value "setup", but IE "Intra-frequency measurement quantity", IE "Intra-frequency reporting quantity", "CHOICE Report criteria" or "parameters required for each event" (given "CHOICE report criteria" is set to "intra-frequency measurement reporting criteria") is not received, the UE shall:

- 1> clear all stored measurement control information related associated to this measurement identity in variable MEASUREMENT_IDENTITY;
- 1> set the variable CONFIGURATION_INCOMPLETE to TRUE.

In case of 1a or 1e event-triggered reporting:

- 1> if the IE "Intra-frequency measurement quantity" is set to "pathloss", the UE shall:
 - 2> if detected set cells are indicated as possibly triggering the event within the IEs "Triggering condition 2" :
 - 3> set the variable CONFIGURATION_INCOMPLETE to TRUE.

8.6.7.17 Quality measurement

If IE "Quality measurement" is received by the UE in a MEASUREMENT CONTROL message, where IE "measurement command" has the value "setup", but IE "Quality reporting quantity" is not received, the UE shall:

- 1> clear all stored measurement control information related associated to this measurement identity in variable MEASUREMENT_IDENTITY;
- 1> set the variable CONFIGURATION_INCOMPLETE to TRUE.

8.6.7.18 UE internal measurement

If IE "UE internal measurement" is received by the UE in a MEASUREMENT CONTROL message, where IE "measurement command" has the value "setup", but IE "UE internal measurement quantity", IE "UE internal reporting quantity" or "parameters sent for each UE internal measurement event" (given "CHOICE report criteria" is set to "UE internal measurement reporting criteria") is not received, the UE shall:

- 1> clear all stored measurement control information related associated to this measurement identity in variable MEASUREMENT_IDENTITY;
- 1> set the variable CONFIGURATION_INCOMPLETE to TRUE.

8.6.7.18a UE positioning measurement

If IE "UE positioning measurement" is received by the UE in a MEASUREMENT CONTROL message, where IE "measurement command" has the value "setup", but IE "UE positioning reporting quantity" or "CHOICE report criteria" is not received, the UE shall:

- 1> clear all stored measurement control information related associated to this measurement identity in variable MEASUREMENT_IDENTITY;
- 1> set the variable CONFIGURATION_INCOMPLETE to TRUE.

8.6.7.19 UE positioning

8.6.7.19.0 UE positioning reporting criteria

If IE "UE positioning reporting criteria" is included, the UE shall:

- 1> perform the necessary measurements and evaluate the event in the interval indicated in IE "Measurement Interval";
- 1> if IE "Event ID" is set to "7a" and if IE "Report first fix" is set to TRUE:
 - 2> if the IE "Method Type" included in the variable MEASUREMENT_IDENTITY is set to "UE based":
 - 3> act as specified in subclause 8.6.7.19.1b.

8.6.7.19.1 UE positioning reporting quantity

The UE shall:

- 1> ignore IE "Multiple Sets";
- 1> ignore IE "Response Time";
- 1> if IE "Horizontal Accuracy" and/or IE "Vertical Accuracy" is included:
 - 2> should try to achieve the requested level(s) of positioning accuracy with 67% confidence.
- 1> if IE "Positioning Methods" is set to "Cell ID":
 - 2> act as specified in subclause 8.6.7.19.1a.
- 1> if the IE "Method Type" is set to "UE based":
 - 2> act as specified in subclause 8.6.7.19.1b.
- 1> if the IE "Method Type" is set to "UE assisted":
 - 2> act as specified in subclause 8.6.7.19.1a.
- 1> if the IE "Method Type" is set to "UE-assisted preferred but UE-based allowed" or "UE-based preferred but UE-assisted allowed":
 - 2> act either according to subclause 8.6.7.19.1a or 8.6.7.19.1b depending on the method type chosen by the UE.

If UE according to its capabilities supports Rx-Tx time difference type 2 measurement and if IE "Positioning Methods" is set to "Cell ID" and the IE "Measurement validity" stored in the variable MEASUREMENT_IDENTITY is other than "CELL_DCH", the UE shall:

- 1> set the variable CONFIGURATION_INCOMPLETE to TRUE, and
- 1> act as specified in subclause 8.4.1.4b.

The UE shall perform the following consistency check:

- 1> if UE, according to its capabilities, does not support UE-based OTDOA and if IE "Positioning Methods" is set to "OTDOA" and if IE "Method Type" is set to "UE-based":
 - 2> set the variable CONFIGURATION_INCOMPLETE to TRUE.
- 1> if UE, according to its capabilities, does not support UE-based GPS and if IE "Positioning Methods" is set to "GPS" and if IE "Method Type" is set to "UE-based":
 - 2> set the variable CONFIGURATION_INCOMPLETE to TRUE.
- 1> if UE, according to its capabilities, does not support UE-assisted GPS and if IE "Positioning Methods" is set to "GPS" and if IE "Method Type" is set to "UE-assisted":

- 2> set the variable CONFIGURATION_INCOMPLETE to TRUE.
- 1> if UE, according to its capabilities, does not support UE-based positioning and if IE "Positioning Methods" is set to "OTDOAorGPS" and if IE "Method Type" is set to "UE-based":
 - 2> set the variable CONFIGURATION_INCOMPLETE to TRUE.
- 1> if UE, according to its capabilities, does not support Rx-Tx time difference type 2 measurement and if IE "Positioning Methods" is set to "Cell ID":
 - 2> set the variable CONFIGURATION_INCOMPLETE to TRUE.
- 1> if UE, according to its capabilities, does not support UE GPS timing of cell frames measurement and if IE "GPS timing of Cell wanted" is set to TRUE:
 - 2> set the variable CONFIGURATION_INCOMPLETE to TRUE.

8.6.7.19.1a UE positioning reporting for UE assisted methods

The UE shall:

- 1> when a measurement report is triggered; and
- 1> if higher layers indicated that the positioning request is permitted:
 - 2> if the UE was able to perform measurements on at least one neighbour cell in case of OTDOA or one satellite in case of GPS positioning:
 - 3> if the IE "Vertical Accuracy" is included:
 - 4> interpret the presence of this IE to indicate that the UTRAN desires to compute a 3-dimensional position estimate.
 - 3> if the IE "Positioning Methods" is set to "GPS":
 - 4> include the IE "UE positioning GPS measured results" in the measurement report and set the contents of the IE as follows:
 - 5> if the UE supports the capability to provide the GPS timing of the cell frames measurement:
 - 6> if the IE "GPS timing of Cell wanted" is set to TRUE:
 - 7> perform the UE GPS timing of cell frames measurement on the serving cell or on one cell of the active set.
 - 7> include the IE "Primary CPICH Info" for FDD or the IE "cell parameters id" for TDD; and
 - 7> include the IE "Reference SFN" and the IE "UE GPS timing of cell frames".
 - 6> if the UE does not support the capability to provide the GPS timing of the cell; or
 - 6> if the IE "GPS timing of Cell wanted" is set to FALSE:
 - 7> include the IE "GPS TOW msec".
 - 3> if the IE "Positioning Methods" is set to "OTDOA":
 - 4> include the IE "UE positioning OTDOA measured results" in the measurement report and set the contents of the IE as follows:
 - 5> set IE "SFN" to the SFN when the last measurement was performed;
 - 5> if the UE supports the capability to perform the Rx-Tx time difference type 2 measurement:
 - 6> if the UE is in CELL_DCH state:
 - 7> if the measured value is equal to "1279.9375":

- 8> set the IE "Rx-Tx time difference type 2" in IE "UE positioning OTDOA measured results" for the reference cell to "1279.8750".
- 7> otherwise:
 - 8> set the IE "Rx-Tx time difference type 2" in IE "UE positioning OTDOA measured results" for the reference cell to the measured value.
 - 7> include the IE group "Rx-Tx time difference type 2 info" for the reference cell and for each neighbour cell listed in variable UE_POSITIONING_OTDOA_DATA_UE_ASSISTED that belongs to the active set.
- 5> if the UE does not support the capability to perform the Rx-Tx time difference type 2 measurement:
 - 6> set the IE "Rx-Tx time difference type 2" in IE "UE positioning OTDOA measured results" for the reference cell to value "1279.9375" to indicate that the measurement is not supported.
- 4> include IE group "Neighbour" for all neighbour cells listed in variable UE_POSITIONING_OTDOA_DATA_UE_ASSISTED on which the SFN-SFN observed time difference type 2 measurement could be performed.
- 3> if IE "Positioning Methods" in the MEASUREMENT CONTROL message has been assigned to value "OTDOA or GPS":
 - 4> the UE may choose to either act as if IE "Positioning Methods" is set to "GPS" or "OTDOA" depending on the method chosen by the UE.
- 3> if the IE "Positioning Methods" is set to "CELL ID":
 - 4> if the UE supports the capability to perform the Rx-Tx time difference type 2 measurement; and
 - 4> if the UE is in CELL_DCH state:
 - 5> perform the Rx-Tx time difference type 2 measurement on the cells in the active set; and
 - 5> report the measurement results back to the network in the MEASUREMENT REPORT by using IE "UE positioning OTDOA measured results" including measurements on the cells in the active set; and
 - 5> in case the reference cell (indicated in the IE "UE positioning OTDOA assistance data") belongs to the active set of the UE:
 - 6> report Rx-Tx time difference type 2 of the reference cell also.
 - 5> in case the reference cell (indicated in the IE "UE positioning OTDOA assistance data") does not belong to the active set of the UE:
 - 6> set the IE "Rx-Tx time difference type 2" in IE "UE positioning OTDOA measured results" for the reference cell to value "1279.9375".
 - 5> for all reported cells:
 - 6> set the IE "SFN-SFN observed time difference type 2" in IE "UE positioning OTDOA measured results" to value "0".
- 1> if the UE is not able to report the requested measurement results; or
- 1> if higher layers have indicated that the positioning request is not permitted; or
- 1> if the positioning request was not processed by higher layers and timed out:
 - 2> include IE "UE positioning error" in the MEASUREMENT REPORT and set the contents of this IE as specified in subclause 8.6.7.19.5.

8.6.7.19.1b UE positioning reporting for UE based methods

The UE shall:

- 1> when a measurement report is triggered; and
- 1> if higher layers indicated that the positioning request is permitted:
 - 2> if the UE has been able to calculate a position:
 - 3> include IE "UE positioning Position Estimate Info" in the MEASUREMENT REPORT and set the contents of the IE as follows:
 - 4> if the UE supports the capability to perform the UE GPS timing of cell frames measurement and UTRAN has requested to report the GPS timing of cell frames:
 - 5> perform the UE GPS timing of cell frames measurement on the serving cell or on one cell of the active set.
 - 5> include the IE "Primary CPICH Info" for FDD or the IE "cell parameters id" for TDD;
 - 5> include the SFN when the position was determined;
 - 5> include the IE "UE GPS timing of cell frames".
 - 4> if the UE does not support the capability to perform the UE GPS timing of cell frames measurement;
or
 - 4> if the IE "GPS timing of Cell wanted" is set to FALSE:
 - 5> include the IE "GPS TOW msec".
 - 4> if IE "Vertical Accuracy" has been included in IE "UE positioning reporting quantity":
 - 5> if the IE "Vertical Accuracy" has been assigned to value "0":
 - 6> if the IE "Horizontal Accuracy" has been assigned a value "0":
 - 7> may include IE "Ellipsoid point with altitude".
 - 6> if the IE "Horizontal Accuracy" has been assigned a value unequal to "0"; and
 - 6> if the UE has been able to calculate a 3-dimensional position
 - 7> include IE "Ellipsoid point with altitude" or IE "Ellipsoid point with altitude and uncertainty ellipsoid" as the position estimate.
 - 6> if the UE has not been able to calculate a 3-dimensional position:
 - 7> may act as if IE "Vertical Accuracy" was not included in IE "UE positioning reporting quantity".
 - 5> if the IE "Vertical Accuracy" has been assigned to a value unequal to "0":
 - 6> if the UE has been able to calculate a 3-dimensional position:
 - 7> include IE "Ellipsoid point with altitude and uncertainty ellipsoid" as the position estimate.
 - 6> if the UE has not been able to calculate a 3-dimensional position:
 - 7> act as if IE "Vertical Accuracy" has not been included in IE "UE positioning reporting quantity".
 - 4> if IE "Vertical Accuracy" has not been included in IE "UE positioning reporting quantity":
 - 5> if IE "Horizontal Accuracy" in IE "UE positioning reporting quantity" has been assigned to value "0":

6> may include IE "Ellipsoid point".

5> if IE "Horizontal Accuracy" in IE "UE positioning reporting quantity" has been assigned to a value unequal to 0:

6> include either IE "Ellipsoid point with uncertainty circle" or IE "Ellipsoid point with uncertainty ellipse" or IE "Ellipsoid point with altitude and uncertainty ellipsoid" as the position estimate.

1> if the UE was not able to calculate a position; or

1> if higher layers have indicated that the positioning request is not permitted; or

2> if the positioning request was not processed by higher layers and timed out:

3> include IE "UE positioning error" in the MEASUREMENT REPORT and set the contents of this IE as specified in subclause 8.6.7.19.5.

8.6.7.19.2 UE positioning OTDOA assistance data for UE-assisted

If IE "UE positioning OTDOA reference cell info for UE-assisted" is received in System Information Block type 15.4 or in the MEASUREMENT CONTROL message, the UE shall update the variable UE_POSITIONING_OTDOA_DATA_UE_ASSISTED accordingly. The UE shall:

1> store received cell information in the UE positioning reference cell info in the variable UE_POSITIONING_OTDOA_DATA_UE_ASSISTED, overwriting any existing information.

If IE "UE positioning OTDOA neighbour cell list for UE-assisted" is received in System Information Block type 15.4 or in the MEASUREMENT CONTROL message, the UE shall update the variable UE_POSITIONING_OTDOA_DATA_UE_ASSISTED accordingly. The UE shall:

1> store received cell information in the neighbour cell info list in the variable UE_POSITIONING_OTDOA_DATA_UE_ASSISTED, overwriting any existing information.

If, according to its capabilities, UE does not support IPDLs and if IE "IPDL parameters" is received for the reference or any of the neighbour cells, the UE shall:

1> ignore this IE.

If IE "SFN offset validity" is set to FALSE, the UE shall:

1> ignore the IE "SFN offset".

If IE "UE positioning measurement" is received in the MEASUREMENT CONTROL message, the UE shall also perform the following consistency checks:

1> if IE "Positioning Methods" is set to "OTDOA" or "Cell ID":

2> if IE "UE positioning OTDOA reference cell info for UE-assisted" is not included and if UE positioning OTDOA reference cell info for UE-assisted in variable UE_POSITIONING_OTDOA_DATA_UE_ASSISTED is empty:

3> set the variable CONFIGURATION_INCOMPLETE to TRUE.

1> if IE "Positioning Methods" is set to "OTDOA":

2> if IE "UE positioning OTDOA neighbour cell list for UE-assisted" is not included and if less than two neighbour cells are stored in UE positioning OTDOA neighbour cell info list for UE-assisted in variable UE_POSITIONING_OTDOA_DATA_UE_ASSISTED:

3> set the variable CONFIGURATION_INCOMPLETE to TRUE.

8.6.7.19.2a UE positioning OTDOA assistance data for UE-based

The UE shall:

- 1> if IE "UE positioning OTDOA reference cell info for UE-based" is received in System Information Block type 15.5 or in the MEASUREMENT CONTROL message or in the ASSISTANCE DATA DELIVERY:
 - 2> update the variable UE_POSITIONING_OTDOA_DATA_UE_BASED accordingly;
 - 2> store received cell information in the UE positioning reference cell info for UE-based in the variable UE_POSITIONING_OTDOA_DATA_UE_BASED, overwriting any existing information.
- 1> if IE "UE positioning OTDOA neighbour cell list for UE-based" is received in System Information Block type 15.5 or in the MEASUREMENT CONTROL message or in the ASSISTANCE DATA DELIVERY:
 - 2> update the variable UE_POSITIONING_OTDOA_DATA_UE_BASED accordingly;
 - 2> store received cell information in the neighbour cell info list for UE-based in the variable UE_POSITIONING_OTDOA_DATA_UE_BASED, overwriting any existing information.
- 1> if, according to its capabilities, UE does not support IPDLs and if IE "IPDL parameters" is received for the reference or any of the neighbour cells:
 - 2> ignore this IE.
- 1> if IE "SFN offset validity" is set to FALSE:
 - 2> ignore the IE "SFN offset".
- 1> if IE "UE positioning measurement" is received in the MEASUREMENT CONTROL message:
 - 2> also perform the following consistency checks:
 - 3> if IE "Positioning Methods" is set to "OTDOA":
 - 4> if IE "UE positioning OTDOA reference cell info for UE-based" is not included and if UE positioning OTDOA reference cell info for UE-based in variable UE_POSITIONING_OTDOA_DATA_UE_BASED is empty:
 - 5> set the variable CONFIGURATION_INCOMPLETE to TRUE.
 - 3> if IE "Positioning Methods" is set to "OTDOA":
 - 4> if IE "UE positioning OTDOA neighbour cell list for UE-based" is not included and if less than two neighbour cells are stored in UE positioning OTDOA neighbour cell info list for UE-based in variable UE_POSITIONING_OTDOA_DATA_UE_BASED:
 - 5> set the variable CONFIGURATION_INCOMPLETE to TRUE.
 - 4> if IE "Method Type" is set to "UE based":
 - 5> if IE "UE positioning OTDOA reference cell info for UE-based" is included and if IE "Cell Position" for the reference cell is not included:
 - 6> set the variable CONFIGURATION_INCOMPLETE to TRUE.
 - 5> if the IE "UE positioning OTDOA neighbour cell list for UE-based" is included and if cell position of less than two neighbour cells of the cells included in this IE and stored in variable UE_POSITIONING_OTDOA_DATA_UE_BASED are different and if those cell positions are not different to the one of the reference cell stored in variable UE_POSITIONING_OTDOA_DATA_UE_BASED:
 - 6> set the variable CONFIGURATION_INCOMPLETE to TRUE.
 - 5> if the IE "UE positioning OTDOA neighbouring cell list for UE-based" is included and only two neighbour cells are included or stored in variable UE_POSITIONING_OTDOA_DATA_UE_BASED and if the IE "Round Trip Time" is neither included for the neighbour cells nor for the reference cell info:
 - 6> set the variable CONFIGURATION_INCOMPLETE to TRUE.

8.6.7.19.3 UE positioning GPS assistance data

The UE may receive GPS assistance data in System Information Block types 15, 15.1, 15.2, or 15.3, or in the ASSISTANCE DATA DELIVERY message, or in the MEASUREMENT CONTROL message.

8.6.7.19.3.1 UE positioning GPS acquisition assistance

If the IE "UE positioning GPS acquisition assistance" is included, the UE shall:

- 1> update the variable UE_POSITIONING_GPS_DATA as follows:
 - 2> delete all information currently stored in the IE "UE positioning GPS acquisition assistance" in the variable UE_POSITIONING_GPS_DATA;
 - 2> store the received acquisition assistance information in the IE "UE positioning GPS acquisition assistance" in the variable UE_POSITIONING_GPS_DATA;
 - 2> store the IE "GPS TOW msec" in the IE "UE positioning GPS acquisition assistance" in variable UE_POSITIONING_GPS_DATA and use it as an estimate of the current GPS Time-of-Week;
- 1> if the IEs "SFN" and "UTRAN GPS timing of cell frames" are included:
 - 2> if the UE is able to utilise these IEs:
 - 3> store these IEs in the IE "UE positioning GPS acquisition assistance" in variable UE_POSITIONING_GPS_DATA;
 - 3> if the IE "Primary CPICH Info" for FDD or IE "cell parameters id" for TDD is not included:
 - 4> if the UE is not in CELL_DCH state:
 - 5> use IEs "SFN" and "UTRAN GPS timing of cell frames" to estimate the relationship between GPS time and radio interface timing of the NODE B transmission in the serving cell.
 - 4> if the UE is in CELL_DCH state:
 - 5> ignore IEs "SFN" and "UTRAN GPS timing of cell frames".
 - 3> if the IE "Primary CPICH Info" for FDD or IE "cell parameters id" for TDD is also included:
 - 4> store this IE in the IE "UE positioning acquisition assistance" in variable UE_POSITIONING_GPS_DATA;
 - 4> use IEs "SFN" and "UTRAN GPS timing of cell frames" to estimate the relationship between GPS time and air-interface timing of the NODE B transmission in the cell indicated by "Primary CPICH info" or "cell parameters id".

8.6.7.19.3.2 UE positioning GPS Almanac

If the IE "UE positioning GPS Almanac" is included, the UE shall:

- 1> if the IE "SV Global Health" is included:
 - 1> store this IE in the IE in the IE "SV Global Health" in the IE "UE positioning GPS Almanac" in variable UE_POSITIONING_GPS_DATA.
- 1> for each satellite:
 - 2> store received GPS almanac information at the position indicated by the IE "Sat ID" in the IE "UE positioning GPS Almanac" in the variable UE_POSITIONING_GPS_DATA, possibly overwriting any existing information in this position.
 - 2> interpret IE "Data ID" as the Data ID field contained in the indicated subframe, word 3, most significant 2 bits, as defined by [12];
 - 2> act on the rest of the IEs in a similar manner as specified in [12].

8.6.7.19.3.3 UE positioning D-GPS Corrections

If the IE "UE positioning GPS DGPS corrections" is included, the UE shall:

- 1> update the variable UE_POSITIONING_GPS_DATA as follows:
 - 2> delete all information currently stored in the IE "UE positioning GPS DGPS corrections" in the variable UE_POSITIONING_GPS_DATA;
 - 2> store the received DGPS corrections in the IE "UE positioning GPS DGPS corrections" in the variable UE_POSITIONING_GPS_DATA.
- 1> use IE "GPS TOW sec" to determine when the differential corrections were calculated;
- 1> use IE "Status/Health" to determine the status of the differential corrections.

8.6.7.19.3.3a UE positioning GPS Navigation Model

If the IE "UE positioning GPS Navigation Model" is included, for each satellite, the UE shall:

- 1> use IE "Satellite Status" to determine if an update of IE "UE positioning GPS Ephemeris and Clock Correction parameters" has been provided for the satellite indicated by the IE "SatID";
- 1> if an update has been provided for this satellite:
 - 2> act as specified in subclause 8.6.7.19.3.4.

8.6.7.19.3.4 UE positioning GPS Ephemeris and Clock Correction Parameters

If the IE "UE positioning GPS Ephemeris and Clock Correction parameters" is included, for each satellite, the UE shall:

- 1> update the variable UE_POSITIONING_GPS_DATA as follows:
 - 2> store this IE at the position indicated by the IE "Sat ID" in the IE "UE positioning GPS Navigation Model" in the variable UE_POSITIONING_GPS_DATA, possibly overwriting any existing information in this position.
- 1> act on these GPS ephemeris and clock correction parameters in a manner similar to that specified in [12].

8.6.7.19.3.5 UE positioning GPS ionospheric model

If IE "UE positioning GPS ionospheric model" is included, the UE shall:

- 1> store this IE in the IE "UE positioning GPS ionospheric model" in variable UE_POSITIONING_GPS_DATA;
- 1> act on these GPS ionospheric model parameters in a manner similar to that specified in [12].

8.6.7.19.3.6 UE positioning GPS real-time integrity

If this list of bad satellites is included, the UE shall:

- 1> update the variable UE_POSITIONING_GPS_DATA as follows:
 - 2> add the Sat IDs that are not yet included in the list of satellites in the IE "UE positioning GPS real time integrity" in the variable UE_POSITIONING_GPS_DATA;
 - 2> remove all Sat IDs in the list of satellites in the IE "UE positioning GPS real time integrity" in the variable UE_POSITIONING_GPS_DATA that are not included in IE UE positioning GPS real time integrity.
- 1> consider the data associated with the satellites identified in the variable UE_POSITIONING_GPS_DATA as invalid.

8.6.7.19.3.7 UE positioning GPS reference time

If the IE "UE positioning GPS reference time" is included, the UE shall:

- 1> store the IE "GPS Week" in "UE positioning GPS reference time" in variable UE_POSITIONING_GPS_DATA and use it as the current GPS week;
- 1> store the IE "GPS TOW msec" in the IE "UE positioning GPS reference time" in variable UE_POSITIONING_GPS_DATA and use it as an estimate of the current GPS Time-of-Week;
- 1> if the IE "SFN" and IE "UTRAN GPS timing of cell frames" are included:
 - 2> if the UE is able to utilise the IEs:
 - 3> store these IEs in the IE "UE positioning GPS reference time" in variable UE_POSITIONING_GPS_DATA;
 - 3> if the IE "Primary CPICH Info" for FDD or IE "cell parameters id" for TDD is not included:
 - 4> if the UE is not in CELL_DCH state:
 - 5> use IEs "SFN" and "UTRAN GPS timing of cell frames" to estimate the relationship between GPS time and air-interface timing of the NODE B transmission in the serving cell.
 - 4> if the UE is in CELL_DCH state:
 - 5> ignore IEs "SFN" and "UTRAN GPS timing of cell frames".
 - 3> if the IE "Primary CPICH Info" for FDD or IE "cell parameters id" for TDD is also included:
 - 4> store this IE in the IE "UE positioning GPS reference time" in variable UE_POSITIONING_GPS_DATA;
 - 4> use IEs "SFN" and "UTRAN GPS timing of cell frames" to estimate the relationship between GPS time and air-interface timing of the NODE B transmission in the cell indicated by "Primary CPICH info" or "cell parameters id".
 - 1> if the IE "SFN-TOW Uncertainty" is included:
 - 2> store this IE in the IE "UE positioning GPS reference time" in variable UE_POSITIONING_GPS_DATA and use it to determine if the relationship between GPS time and air-interface timing of the NODE B transmission is known to within at least 10ms.
 - 1> if the IE "T_{UTRAN-GPS} drift rate" is included:
 - 2> store this IE in the IE "UE positioning GPS reference time" in variable UE_POSITIONING_GPS_DATA; and
 - 2> may use it as an estimate of the drift rate of the NODE B clock relative to GPS time.
 - 1> if the IE "GPS TOW Assist" is included:
 - 2> for each satellite:
 - 3> delete all information currently stored in the IE "GPS TOW Assist" in the IE "UE positioning GPS reference time" in the variable UE_POSITIONING_GPS_DATA;
 - 3> store the received GPS TOW Assist information in the IE "UE positioning GPS reference time" in the variable UE_POSITIONING_GPS_DATA.

8.6.7.19.3.8 UE positioning GPS reference UE position

If the IE "UE positioning GPS reference UE position" is included, the UE shall:

- 1> store this IE in the IE "UE positioning GPS reference UE position" in variable UE_POSITIONING_GPS_DATA; and
- 1> use it as a priori knowledge of the approximate location of the UE.

8.6.7.19.3.9 UE positioning UTC model

If the IE "UE positioning GPS UTC model" is included, the UE shall:

- 1> store this IE in the IE "UE positioning GPS UTC model" in variable UE_POSITIONING_GPS_DATA.

8.6.7.19.4 UE positioning Cipherring info

The UE shall:

- 1> if deciphering information is received from higher layers for deciphering of GPS assistance data broadcast on system information:

- 2> store the current key in IE "Current deciphering key" in variable UE_POSITIONING_GPS_DATA;
- 2> store the next key in IE "Next deciphering key" in variable UE_POSITIONING_GPS_DATA;
- 2> store the cipherring key flag in UE_POSITIONING_GPS_DATA.

- 1> if deciphering information is received from higher layers for deciphering of OTDOA assistance data broadcast on system information:

- 2> store the current key in IE "Current deciphering key" in variable UE_POSITIONING_OTDOA_DATA_UE_BASED;
- 2> store the next key in IE "Next deciphering key" in variable UE_POSITIONING_OTDOA_DATA_UE_BASED;
- 2> store the cipherring key flag in UE_POSITIONING_OTDOA_DATA_UE_BASED.

- 1> if the IE "GPS Data cipherring info" is included in System Information Block type 15:

- 2> select one of the two deciphering keys received and stored it in UE_POSITIONING_GPS_DATA according to the following:
 - 3> if the value of the received IE "Cipherring Key Flag" is the same as the value of the IE "Cipherring Key Flag" stored in the variable UE_POSITIONING_GPS_DATA:
 - 4> select the current deciphering key.
 - 3> if the value of the received IE "Cipherring Key Flag" is different from the value of the IE "Cipherring Key Flag" stored in the variable UE_POSITIONING_GPS_DATA:
 - 4> select the next deciphering key.
- 2> store the received IE in the variable UE_POSITIONING_GPS_DATA;
- 2> use the selected deciphering key to decipher the broadcast UE positioning GPS information contained within the System Information Block types 15.1, 15.2 and 15.3.

- 1> if the IE "OTDOA positioning cipherring info" is included in System Information Block type 15.4:

- 2> select one of the two deciphering keys and stored it in UE_POSITIONING_OTDOA_DATA_UE_BASED according to the following:
 - 3> if the value of the received IE "Cipherring Key Flag" is the same as the value of the IE "Cipherring Key Flag" stored in the variable UE_POSITIONING_OTDOA_DATA_UE_BASED:
 - 4> select the current deciphering key.
 - 3> if the value of the received IE "Cipherring Key Flag" is different from the value of the IE "Cipherring Key Flag" stored in the variable UE_POSITIONING_OTDOA_DATA_UE_BASED:
 - 4> select the next deciphering key.
- 2> store the received IE in the variable UE_POSITIONING_OTDOA_DATA_UE_BASED;

- 2> use the selected deciphering key to decipher the IE "OTDOA assistance data" included in the System Information Block types 15.4.

8.6.7.19.5 UE positioning Error

The UE shall set the contents of the IE "UE positioning Error" as follows:

- 1> if the IE "Positioning Methods" in IE "UE positioning reporting quantity" has been assigned to value "OTDOA" and no neighbour cells could be received,
 - 2> set IE "Error reason" to "ER1";
- 1> if the IE "Positioning Methods" in IE "UE positioning reporting quantity" has been assigned to value "GPS":
 - 2> if there were not enough GPS satellites to be received:
 - 3> set IE "Error reason" to "ER2".
 - 2> if some GPS assistance data was missing:
 - 3> set IE "Error reason" to "ER3"; and
 - 3> if the IE "Additional Assistance Data Request" included in the IE "UE positioning reporting quantity" stored in the variable MEASUREMENT_IDENTITY is set to TRUE:
 - 4> include the IE GPS Additional Assistance Data Request".
 - 2> if the UE was not able to read the SFN of the reference cell included in the IE "UE positioning GPS reference time" or in the IE "UE positioning acquisition assistance":
 - 3> set IE "Error reason" to "ER7".
 - 2> if the UE was not able to measure the requested GPS timing of cell frames measurement:
 - 3> set IE "Error reason" to "ER8".
 - 1> if higher layers have indicated that the positioning request is not permitted:
 - 2> set IE "Error reason" to "ER5".
 - 1> if the positioning request was not processed by higher layers and timed out:
 - 2> set IE "Error reason" to "ER6".
 - 1> if none of the conditions above are fulfilled:
 - 2> set IE "Error reason" to "ER4".

8.6.7.19.6 Void

8.6.7.20 Void

8.6.7.21 Intra-frequency reporting quantity for RACH reporting

If the IE "Intra-frequency reporting quantity for RACH reporting" is included, the UE shall:

- 1> if the IE "SFN-SFN observed time difference reporting indicator" has the value "type 2":
 - 2> act as if the value of the IE "SFN-SFN observed time difference reporting indicator" is "no reporting".

8.6.7.22 Additional Measurement List

If the IE "Additional Measurement List" is received in a MEASUREMENT CONTROL message, the UE shall:

1> if the received measurement configuration in this MEASUREMENT CONTROL message, or any measurement referenced in the "Additional Measurement List" do not all have the same validity:

2> set the variable CONFIGURATION_INCOMPLETE to TRUE.

1> if any of the measurements referenced in the "Additional Measurement List" is an intra-frequency, inter-frequency or inter-RAT measurement, and this measurement is configured with event based reporting:

2> the UE behaviour is not specified.

1> if the result of this MEASUREMENT CONTROL message is such that more than one additional measurement of the same type will be referenced in the IE "Additional Measurement List" in the MEASUREMENT_IDENTITY variable:

2> the UE behaviour is not specified.

If, at any time during the life-time of a measurement, any measurement referenced in the Additional Measurement List does not exist, the UE shall remove this measurement identity from the Additional Measurement List.

NOTE: A measurement referenced in the Additional Measurement List which is updated with a measurement command set to "modify", or replaced with a measurement command set to "setup", continues to exist.

If the measurement configured with the MEASUREMENT CONTROL message triggers a measurement report, the UE shall also include the reporting quantities for the measurements referenced by the additional measurement identities. The contents of the IE "Additional Measured results" is completely determined by the measurement configuration of the referenced additional measurement.

8.6.8 Void

9 Handling of unknown, unforeseen and erroneous protocol data

9.1 General

This subclause specifies procedures for the handling of unknown, unforeseen, and erroneous protocol data by the receiving entity. These procedures are called "error handling procedures", but in addition to provide recovery mechanisms for error situations they define a compatibility mechanism for future extensions of the protocol.

The error handling procedures specified in this subclause shall apply to all RRC messages. When there is a specific handling for messages received on different logical channels this is specified.

For system information received on the BCCH, the error handling procedures are applied on the BCCH message SYSTEM INFORMATION, the re-assembled system information segments as well as the system information blocks (including the master information block and the scheduling blocks), with specific error handling as specified below.

When the UE receives an RRC message, it shall set the variable PROTOCOL_ERROR_REJECT to FALSE and then perform the checks in the order as defined below.

The error cases specified in the following include the handling upon reception of spare values. This behaviour also applies in case the actual value of the IE results from mapping the originally sent IE value. Moreover, in certain error cases, as specified in the following, default values apply. In this case, the default values specified within the ASN.1, the tabular and the procedure specifications apply.

9.2 ASN.1 violation or encoding error

If the UE receives an RRC message on the DCCH for which the encoded message does not result in any valid abstract syntax value [49] (or "encoding error"), it shall perform the following. The UE shall:

- 1> set the variable `PROTOCOL_ERROR_REJECT` to `TRUE`;
- 1> transmit an RRC STATUS message on the uplink DCCH. The IE "Protocol error information" shall contain an IE "Protocol error cause" set to "ASN.1 violation or encoding error";
- 1> when RRC STATUS message has been submitted to lower layers for transmission:
 - 2> continue with any ongoing processes and procedures as if the invalid message had not been received.

If the UE receives an RRC message sent via a radio access technology other than UTRAN, for which the encoded message does not result in any valid abstract syntax, the UE shall:

- 1> set the variable `PROTOCOL_ERROR_REJECT` to `TRUE`;
- 1> set the IE "Protocol error cause" in the variable `PROTOCOL_ERROR_INFORMATION` to "ASN.1 violation or encoding error";
- 1> perform procedure specific error handling according to clause 8.

If a reassembled set of system information segments received in messages on the BCCH does not result in any valid abstract syntax value, the UE shall:

- 1> ignore the reassembled set of system information segments;
- 1> treat the rest of each message containing the ignored system information segments as if those segments were not present.

If the UE receives an RRC message on the BCCH, PCCH, CCCH or SHCCH for which the encoded message does not result in any valid abstract syntax value, it shall ignore the message.

9.3 Unknown or unforeseen message type

If a UE receives an RRC message on the DCCH with a message type not defined for the DCCH it shall:

- 1> set the variable `PROTOCOL_ERROR_REJECT` to `TRUE`;
- 1> transmit an RRC STATUS message on the uplink DCCH. The IE "Protocol error information" shall contain an IE "Protocol error cause" set to "Message type non-existent or not implemented";
- 1> when the RRC STATUS message has been submitted to lower layers for transmission:
 - 2> continue with any ongoing processes and procedures as if the invalid message had not been received.

If the UE receives an RRC message on the BCCH, PCCH, CCCH or SHCCH with a message type not defined for the logical channel type the message was received on, it shall ignore the message.

9.3a Unsolicited received message

If the UE receives any of the following messages:

- an RRC CONNECTION SETUP message addressed to the UE on the CCCH; or
- an RRC CONNECTION REJECT message addressed to the UE on the CCCH; or
- a UE CAPABILITY INFORMATION CONFIRM message on the DCCH; or
- a CELL UPDATE CONFIRM message addressed to the UE on the CCCH or on the DCCH; or
- a URA UPDATE CONFIRM message addressed to the UE on the CCCH or on the DCCH

and no procedure is ongoing according to clause 8 which expects the message to be received:

the UE shall:

- 1> ignore the received message.

9.3b Unexpected critical message extension

If the UE receives an RRC message on the DCCH, or addressed to the UE on the CCCH or on the SHCCH, or sent via a radio access technology other than UTRAN, containing an undefined critical message extension, the UE shall:

- 1> set the variable `PROTOCOL_ERROR_REJECT` to `TRUE`;
- 1> set the IE "Protocol error cause" in the variable `PROTOCOL_ERROR_INFORMATION` to "Message extension not comprehended";
- 1> if the IE "Message Type" of the received message is not present in the table "Rejected transactions" in the variable `TRANSACTIONS`:
 - 2> store the IE "Message type" of the received message in the table "Rejected transactions" in the variable `TRANSACTIONS`; and
 - 2> set the IE "RRC transaction identifier" to zero in that table entry.
- 1> perform procedure specific error handling according to clause 8.

If the UE receives an RRC message on the BCCH or PCCH, containing an undefined critical message extension, the UE shall:

- 1> ignore the message.

9.4 Unknown or unforeseen information element value, mandatory information element

If the UE receives an RRC message on the DCCH, or addressed to the UE on the CCCH or on the SHCCH, or sent via a radio access technology other than UTRAN, with a mandatory IE having a value, including choice, reserved for future extension (spare) or a value not used in this version of the specification (e.g. a dummy value), the UE shall:

- 1> if a default value of the IE is defined:
 - 2> treat the rest of the message using the default value of the IE.
- 1> if no default value of the IE is defined:
 - 2> set the variable `PROTOCOL_ERROR_REJECT` to `TRUE`;
 - 2> set the IE "Protocol error cause" in the variable `PROTOCOL_ERROR_INFORMATION` to "Information element value not comprehended";
 - 2> perform procedure specific error handling according to clause 8.

If the UE receives a system information block on the BCCH with a mandatory IE having a value reserved for future extension (spare) or a value not used in this version of the specification (e.g. a dummy value), the UE shall:

- 1> if a default value of the IE is defined:
 - 2> treat the rest of the system information block using the default value of the IE.
- 1> if no default value of the IE is defined:
 - 2> ignore the system information block.

If the UE receives an RRC message on the BCCH or PCCH with a mandatory IE having a value reserved for future extension (spare) or a value not used in this version of the specification (e.g. a dummy value), the UE shall:

- 1> if a default value of the IE is defined:
 - 2> treat the rest of the message using the default value of the IE.
- 1> if no default value of the IE is defined:

2> ignore the message.

9.5 Conditional information element error

If the UE receives an RRC message on the DCCH, BCCH, PCCH, or addressed to the UE on the CCCH or on the SHCCH, or sent via a radio access technology other than UTRAN, for which the specified conditions for absence of a conditional IE are met and that IE is present, the UE shall:

- 1> ignore the IE;
- 1> treat the rest of the message as if the IE was not present.

If the UE receives an RRC message on the DCCH, or addressed to the UE on the CCCH or on the SHCCH, or sent via a radio access technology other than UTRAN, for which the specified conditions for presence of a conditional IE are met and that IE is absent, the UE shall:

- 1> set the variable `PROTOCOL_ERROR_REJECT` to `TRUE`;
- 1> set the IE "Protocol error cause" in the variable `PROTOCOL_ERROR_INFORMATION` to "Information element missing";
- 1> perform procedure specific error handling according to clause 8.

If the UE receives a system information block on the BCCH for which the specified conditions for presence of a conditional IE are met and that IE is absent, the UE shall:

- 1> ignore the system information block.

If the UE receives an RRC message on the BCCH or PCCH for which the specified conditions for presence of a conditional IE are met and that IE is absent, the UE shall:

- 1> ignore the message.

9.6 Unknown or unforeseen information element value, conditional information element

If the UE receives an RRC message on the DCCH, or addressed to the UE on the CCCH or on the SHCCH, or sent via a radio access technology other than UTRAN, for which the specified conditions for presence of a conditional IE are met, that IE is present, and that IE has a value, including choice, reserved for future extension (spare) or a value not used in this version of the specification (e.g. a dummy value), the UE shall:

- 1> if a default value of the IE is defined:
 - 2> treat the rest of the message using the default value of the IE.
- 1> if no default value of the IE is defined:
 - 2> set the variable `PROTOCOL_ERROR_REJECT` to `TRUE`;
 - 2> set the IE "Protocol error cause" in the variable `PROTOCOL_ERROR_INFORMATION` to "Information element value not comprehended";
 - 2> perform procedure specific error handling according to clause 8.

If the UE receives a system information block on the BCCH for which the specified conditions for presence of a conditional IE are met, that IE is present, and that IE has a value, including choice, reserved for future extension (spare) or a value not used in this version of the specification (e.g. a dummy value), the UE shall:

- 1> if a default value of the IE is defined:
 - 2> treat the rest of the system information block using the default value of the IE.
- 1> if no default value of the IE is defined:

- 2> ignore the system information block.

If the UE receives an RRC message on the BCCH or PCCH for which the specified conditions for presence of a conditional IE are met, that IE is present, and that IE has a value, including choice, reserved for future extension (spare) or a value not used in this version of the specification (e.g. a dummy value), the UE shall:

- 1> if a default value of the IE is defined:
 - 2> treat the rest of the message using the default value of the IE.
- 1> if no default value of the IE is defined:
 - 2> ignore the message.

9.7 Unknown or unforeseen information element value, optional information element

If the UE receives an RRC message on the DCCH, or addressed to the UE on the CCCH or on the SHCCH, or sent via a radio access technology other than UTRAN, with an optional IE having a value, including choice, reserved for future extension (spare) or a value not used in this version of the specification (e.g. a dummy value), it shall:

- 1> ignore the value of the IE;
- 1> treat the rest of the message as if the IE was not present.

If the UE receives a system information block on the BCCH with an optional IE having a value, including choice, reserved for future extension (spare) or a value not used in this version of the specification (e.g. a dummy value), it shall:

- 1> ignore the value of the IE;
- 1> treat the rest of the system information block as if the IE was not present.

If the UE receives an RRC message on the BCCH or PCCH with an optional IE having a value, including choice, reserved for future extension (spare) or a value not used in this version of the specification (e.g. a dummy value), it shall:

- 1> ignore the value of the IE;
- 1> treat the rest of the message as if the IE was not present.

9.8 Unexpected non-critical message extension

If the UE receives an RRC message on the DCCH, or addressed to the UE on the CCCH or on the SHCCH, or sent via a radio access technology other than UTRAN, containing an undefined non-critical message extension, the UE shall:

- 1> if the non critical extension is included in the "Variable Length Extension Container":
 - 2> ignore the content of the extension and the contents of this container after the not comprehended extension, and continue decoding the rest of the message.
- 1> otherwise:
 - 2> ignore the content of the extension and the message contents after the extension, but treat the parts of the message up to the extension normally.

If the UE receives a system information block on the BCCH containing an undefined non-critical message extension, the UE shall:

- 1> ignore the content of the extension and the system information block contents after the extension, but treat the parts of the system information block up to the extension normally.

If the UE receives an RRC message on the BCCH or PCCH, containing an undefined non-critical message extension, the UE shall:

- 1> ignore the content of the extension and the message contents after the extension, but treat the parts of the message up to the extension normally.

9.9 Handling of errors in nested information elements

An erroneous IE may be included in another IE, which may be included in another IE and so on. This subclause specifies the handling of errors in mandatory IEs as well as for conditional IEs for which the specified conditions for presence are met, that are nested in another IE.

In case the UE receives an IE (IE1) that includes a mandatory IE (IE1-1) having a value, including choice, reserved for future extension (spare) or a value not used in this version of the specification (e.g. a dummy value), the UE shall:

- 1> consider IE1 to have an undefined value; and
- 1> apply the corresponding generic error handling to IE1.

In case there are many IE nesting levels, in all of which the IE is mandatory while no default value is defined, this treatment may need to be repeated several times. The following example illustrates the general principle.

ExampleMessage ::=	SEQUENCE {	
ie1	IE1	OPTIONAL,
ie2	IE2	
}		
IE1 ::=	SEQUENCE {	
ie1-1	INTEGER (1..16),	
-- ie1-1 values 13..16 are spare and should not be used in this version of the protocol		
ie1-2	IE1-2	OPTIONAL,
ie1-3	IE1-3	
}		

If in the above example, UTRAN would include ie1 and set ie1-1 to value 13, the UE experiences an error in a mandatory IE. The guideline outlined in the previous then means that the UE shall not discard the entire message but instead consider "ie1" to have an unknown value. Since IE1 is optional, the generic error handling would be to ignore "ie1".

In case the UE receives an IE (IE1) that includes a list of another IE (IE1-1) for which one or more entries in the list have a value, including choice, reserved for future extension (spare) or a value not used in this version of the specification (e.g. a dummy value), the UE shall:

- 1> consider the list as if these entries were not included.

NOTE: In case the above generic error handling procedures do not result in the desired behaviour, the introduction of spares may need to be reconsidered.

10 Message and information element functional definition and content

10.1 General

The function of each Radio Resource Control message together with message contents in the form of a list of information elements is defined in subclause 10.2.

Functional definitions of the information elements are then described in subclause 10.3.

Information elements are marked as either MP - Mandatory present, MD - Mandatory with default value, OP - Optional, CV - Conditional on value or CH - Conditional on history (see Table 10.1 with information extracted from [14]).

Table 10.1: Meaning of abbreviations used in RRC messages and information elements

Abbreviation	Meaning
MP	<p>Mandatory present</p> <p>A value for that information is always needed, and no information is provided about a particular default value. If ever the transfer syntax allows absence (e.g., due to extension), then absence leads to an error diagnosis.</p>
MD	<p>Mandatory with default value</p> <p>A value for that information is always needed, and a particular default value is mentioned (in the 'Semantical information' column). This opens the possibility for the transfer syntax to use absence or a special pattern to encode the default value.</p>
CV	<p>Conditional on value</p> <p>The need for a value for that information depends on the value of some other IE or IEs, and/or on the message flow (e.g., channel, SAP). The need is specified by means of a condition, the result of which may be that the information is mandatory present, mandatory with default value, not needed or optional.</p> <p>If one of the results of the condition is that the information is mandatory present, the transfer syntax must allow for the presence of the information. If in this case the information is absent an error is diagnosed.</p> <p>If one of the results of the condition is that the information is mandatory with default value, and a particular default value is mentioned (in the 'Semantical information' column), the transfer syntax may use absence or a special pattern to encode the default value.</p> <p>If one of the results of the condition is that the information is not needed, the transfer syntax must allow encoding the absence. If in this case the information is present, it will be ignored. In specific cases however, an error may be diagnosed instead.</p> <p>If one of the results of the condition is that the information is optional, the transfer syntax must allow for the presence of the information. In this case, neither absence nor presence of the information leads to an error diagnosis.</p>
CH	<p>Conditional on history</p> <p>The need for a value for that information depends on information obtained in the past (e.g., from messages received in the past from the peer). The need is specified by means of a condition, the result of which may be that the information is mandatory present, mandatory with default value, not needed or optional.</p> <p>The handling of the conditions is the same as described for CV.</p>
OP	<p>Optional</p> <p>The presence or absence is significant and modifies the behaviour of the receiver. However whether the information is present or not does not lead to an error diagnosis.</p>

10.1.1 Protocol extensions

RRC messages may be extended in future versions of this protocol, either by adding values for choices, enumerated and size constrained types or by adding information elements. An important aspect concerns the behaviour of a UE, conforming to this revision of the standard, upon receiving a not comprehended future extension. The details of this error handling behaviour are provided in clause 9.

NOTE 1: By avoiding the need for partial decoding (skipping uncomprehended IEs to continue decoding the remainder of the message), the RRC protocol extension mechanism also avoids the overhead of length determinants for extensions. "Variable length extension containers" (i.e. non critical extension containers that have their abstract syntax defined using the ASN.1 type "BIT STRING") have been defined to support the introduction of extensions to a release after the subsequent release is frozen (and UEs based on that subsequent release may appear). For this container a length determinant is used, which facilitates partial decoding of the container as well as the decoding of the extensions included after the container.

Two kinds of protocol extensions are distinguished: non-critical and critical extensions. In general, a receiver shall process a message including not comprehended non-critical extensions as if the extensions were absent. However, a receiver shall entirely reject a message including not comprehended critical extensions (there is no partial rejection) and notify the sender, as specified in clause 9.

The general mechanism for adding critical extensions is by defining a new version of the message, which is indicated at the beginning of the message.

The UE shall always comprehend the complete transfer syntax specified for the protocol version it supports; if the UE comprehends the transfer syntax defined within protocol version A for message 1, it shall also comprehend the transfer syntax defined within protocol version A for message 2.

The following table shows for which messages only non-critical extensions may be added while for others both critical and non-critical extensions may be added.

NOTE 2: Critical extensions can only be added to certain downlink messages.

Extensions	Message
Critical and non-critical extensions	ACTIVE SET UPDATE 10.2.1 ASSISTANCE DATA DELIVERY 10.2.4 CELL CHANGE ORDER FROM UTRAN 10.2.5 CELL UPDATE CONFIRM 10.2.8 COUNTER CHECK 10.2.9 DOWNLINK DIRECT TRANSFER 10.2.11 HANDOVER TO UTRAN COMMAND 10.2.16a HANDOVER FROM UTRAN COMMAND 10.2.15 MEASUREMENT CONTROL 10.2.17 PHYSICAL CHANNEL RECONFIGURATION 10.2.22 PHYSICAL SHARED CHANNEL ALLOCATION 10.2.25 RADIO BEARER RECONFIGURATION 10.2.27 RADIO BEARER RELEASE 10.2.30 RADIO BEARER SETUP 10.2.33 RRC CONNECTION REJECT 10.2.36 RRC CONNECTION RELEASE 10.2.37 RRC CONNECTION SETUP 10.2.40 SECURITY MODE COMMAND 10.2.43 SIGNALLING CONNECTION RELEASE 10.2.46 TRANSPORT CHANNEL RECONFIGURATION 10.2.50 UE CAPABILITY ENQUIRY 10.2.55 UE CAPABILITY INFORMATION CONFIRM 10.2.57 UPLINK PHYSICAL CHANNEL CONTROL 10.2.59 URA UPDATE CONFIRM 10.2.61 UTRAN MOBILITY INFORMATION 10.2.62
Non-critical extensions only	ACTIVE SET UPDATE COMPLETE 10.2.2 ACTIVE SET UPDATE FAILURE 10.2.3 CELL CHANGE ORDER FROM UTRAN FAILURE 10.2.6 CELL UPDATE 10.2.7 COUNTER CHECK RESPONSE 10.2.10 HANDOVER TO UTRAN COMPLETE 10.2.16b INITIAL DIRECT TRANSFER 10.2.16c HANDOVER FROM UTRAN FAILURE 10.2.16 MEASUREMENT CONTROL FAILURE 10.2.18 MEASUREMENT REPORT 10.2.19 PAGING TYPE 1 10.2.20 PAGING TYPE 2 10.2.21 PHYSICAL CHANNEL RECONFIGURATION COMPLETE 10.2.23 PHYSICAL CHANNEL RECONFIGURATION FAILURE 10.2.24 PUSCH CAPACITY REQUEST 10.2.26 RADIO BEARER RECONFIGURATION COMPLETE 10.2.28

Extensions	Message
	RADIO BEARER RECONFIGURATION FAILURE 10.2.29 RADIO BEARER RELEASE COMPLETE 10.2.31 RADIO BEARER RELEASE FAILURE 10.2.32 RADIO BEARER SETUP COMPLETE 10.2.34 RADIO BEARER SETUP FAILURE 10.2.35 RRC CONNECTION RELEASE COMPLETE 10.2.38 RRC CONNECTION REQUEST 10.2.39 RRC CONNECTION SETUP COMPLETE 10.2.41 RRC STATUS 10.2.42 SECURITY MODE COMPLETE 10.2.44 SECURITY MODE FAILURE 10.2.45 SIGNALLING CONNECTION RELEASE INDICATION 10.2.47 Master Information Block 10.2.48.8.1 System Information Block type 1 to System Information Block type 17 10.2.48.8.2 to 10.2.48.8.19 SYSTEM INFORMATION CHANGE INDICATION 10.2.49 TRANSPORT CHANNEL RECONFIGURATION COMPLETE 10.2.51 TRANSPORT CHANNEL RECONFIGURATION FAILURE 10.2.52 TRANSPORT FORMAT COMBINATION CONTROL 10.2.53 TRANSPORT FORMAT COMBINATION CONTROL FAILURE 10.2.54 UE CAPABILITY INFORMATION 10.2.56 UPLINK DIRECT TRANSFER 10.2.58 URA UPDATE 10.2.60 UTRAN MOBILITY INFORMATION CONFIRM 10.2.63 UTRAN MOBILITY INFORMATION FAILURE 10.2.64
No extensions	SYSTEM INFORMATION 10.2.48 First Segment 10.2.48.1 Subsequent or last Segment 10.2.48.3 Complete SIB 10.2.48.5 SIB content 10.2.48.8.1

NOTE 3: For the SYSTEM INFORMATION message protocol extensions are only possible at the level of system information blocks.

10.1.1.1 Non-critical extensions

10.1.1.1.1 Extension of an information element with additional values or choices

In future versions of this protocol, non-critical values may be added to choices, enumerated and size constrained types.

For choices, enumerated and size constrained types it is possible to indicate how many non-critical spare values need to be reserved for future extension. In this case, the tabular format should indicate the number of spare values that are needed. The value range defined in ASN.1 for the extensible IE should include the number of spares that are needed, since a value outside the range defined for this IE will result in a general ASN.1 violation error.

For downlink messages, spare values may be defined for non-critical information elements for which the need is specified to be MD or OP (or CV case leading to MD or OP). In this case, a receiver not comprehending the received spare value shall consider the information element to have the default value or consider it to be absent respectively.

For uplink messages spare values may be defined for all information elements, including those for which the need is specified to be MP (or CV case leading to MP).

In all cases at most one spare should be defined for choices. In this case, information elements applicable to the spare choices shall be added to the end of the message.

10.1.1.1.2 Extension of a message with additional information elements

In future versions of this protocol, non-critical information elements may be added to RRC messages. These additional information elements shall be normally appended at the end of the message; the transfer syntax specified in this revision of the standard facilitates this. A receiver conformant to this revision of the standard shall accept such extension, and proceed as if it was not included. Extensions to a release that are introduced after the subsequent release is frozen may however be inserted prior to the end of the message. To facilitate this, "variable length extension containers" have been introduced in most messages.

10.1.1.2 Critical extensions

10.1.1.2.1 Extension of an information element with additional values or choices

In versions of this protocol, choices, enumerated and size constrained types may be extended with critical values. For extension with critical values the general critical extension mechanism is used, i.e. for this no spare values are reserved since backward compatibility is not required.

10.1.1.2.2 Extension of a message with additional information elements

In future versions of this protocol, RRC messages may be extended with new information elements. Since messages including critical extensions are rejected by receivers not comprehending them, these messages may be modified completely, e.g. IEs may be inserted at any place and IEs may be removed or redefined.

10.2 Radio Resource Control messages

10.2.1 ACTIVE SET UPDATE

NOTE: Only for FDD.

This message is used by UTRAN to add, replace or delete radio links in the active set of the UE.

RLC-SAP: AM or UM

Logical channel: DCCH

Direction: UTRAN → UE

Information Element/Group name	Need	Multi	Type and reference	Semantics description
Message Type	MP		Message Type	
UE information elements				
RRC transaction identifier	MP		RRC transaction identifier 10.3.3.36	
Integrity check info	CH		Integrity check info 10.3.3.16	
Activation time	MD		Activation time 10.3.3.1	Default value is "now".
New U-RNTI	OP		U-RNTI 10.3.3.47	
CN information elements				
CN Information info	OP		CN Information info 10.3.1.3	
Phy CH information elements				
Uplink radio resources				
Maximum allowed UL TX power	MD		Maximum allowed UL TX power 10.3.6.39	Default value is the existing "maximum UL TX power".
Downlink radio resources				
Radio link addition information	OP	1 to <maxRL-1>		Radio link addition information required for each RL to add
>Radio link addition information	MP		Radio link addition information 10.3.6.68	

Information Element/Group name	Need	Multi	Type and reference	Semantics description
Radio link removal information	OP	1 to <maxRL>		Radio link removal information required for each RL to remove
>Radio link removal information	MP		Radio link removal information 10.3.6.69	
TX Diversity Mode	MD		TX Diversity Mode 10.3.6.86	Default value is the existing TX diversity mode.
SSDT information	OP		SSDT information 10.3.6.77	

10.2.2 ACTIVE SET UPDATE COMPLETE

NOTE: For FDD only.

This message is sent by UE when active set update has been completed.

RLC-SAP: AM

Logical channel: DCCH

Direction: UE→UTRAN

Information Element/Group name	Need	Multi	Type and reference	Semantics description
Message Type	MP		Message Type	
UE information elements				
RRC transaction identifier	MP		RRC transaction identifier 10.3.3.36	
Integrity check info	CH		Integrity check info 10.3.3.16	

10.2.3 ACTIVE SET UPDATE FAILURE

NOTE: Only for FDD.

This message is sent by UE if the update of the active set has failed, e.g. because the radio link is not a part of the active set.

RLC-SAP: AM

Logical channel: DCCH

Direction: UE→UTRAN

Information Element/Group name	Need	Multi	Type and reference	Semantics description
Message Type	MP		Message Type	
UE information elements				
RRC transaction identifier	MP		RRC transaction identifier 10.3.3.36	
Integrity check info	CH		Integrity check info 10.3.3.16	
Failure cause	MP		Failure cause and error information 10.3.3.14	

10.2.4 ASSISTANCE DATA DELIVERY

This message is sent by UTRAN to convey UE positioning assistance data to the UE.

RLC-SAP: AM

Logical channel: DCCH

Direction: UTRAN→UE

Information Element/Group name	Need	Multi	Type and reference	Semantics description
Message Type	MP		Message Type	
UE information elements				
RRC transaction identifier	MP		RRC transaction identifier 10.3.3.36	
Integrity check info	CH		Integrity check info 10.3.3.16	
Measurement Information elements				
UE positioning OTDOA assistance data for UE-based	OP		UE positioning OTDOA assistance data for UE-based 10.3.7.103a	
UE positioning GPS assistance data	OP		UE positioning GPS assistance data 10.3.7.90	

10.2.5 CELL CHANGE ORDER FROM UTRAN

This message is used to order a cell change from UTRA to another radio access technology, e.g., GSM.

RLC-SAP: AM

Logical channel: DCCH

Direction: UTRAN→UE

Information Element/Group name	Need	Multi	Type and reference	Semantics description
Message Type	MP		Message Type	
UE information elements				
RRC transaction identifier	MP		RRC transaction identifier 10.3.3.36	
Integrity check info	CH		Integrity check info 10.3.3.16	
Activation time	MD		Activation time 10.3.3.1	Default value is "now"
RB Information elements				
RAB information list	OP	1 to <maxRABs etup>		This IE should not be included in this version of the protocol.
>RAB info	MP		RAB info 10.3.4.8	
Other information elements				
Target cell description	MP			
>CHOICE <i>Radio Access Technology</i>	MP			Two spare values are needed.
>>GSM				
>>>BSIC	MP		BSIC 10.3.8.2	
>>>Band Indicator	MP		Enumerated (DCS 1800 band used, PCS 1900 band used)	Indicates how to interpret the BCCH ARFCN
>>>BCCH ARFCN	MP		Integer (0..1023)	[45]
>>>NC mode	OP		Bit string(3)	Includes bits b1-b3 of the NC mode IE specified in [43]. The first/leftmost/most significant bit of the bit string contains the most significant bit (b3) of NC mode. NOTE: The Bit string should be extended to 4 bits in a later version of the message.
>>IS-2000				

10.2.6 CELL CHANGE ORDER FROM UTRAN FAILURE

This message is sent on the RRC connection used before the Cell change order from UTRAN was executed. The message indicates that the UE has failed to seize the new channel in the other radio access technology.

RLC-SAP: AM

Logical channel: DCCH

Direction: UE→UTRAN

Information Element/Group name	Need	Multi	Type and reference	Semantics description
Message Type	MP		Message Type	
UE information elements				
RRC transaction identifier	MP		RRC transaction identifier 10.3.3.36	
Integrity check info	CH		Integrity check info 10.3.3.16	
Other information elements				
Inter-RAT change failure	MP		Inter-RAT change failure 10.3.8.5	

10.2.7 CELL UPDATE

This message is used by the UE to initiate a cell update procedure.

RLC-SAP: TM

Logical channel: CCCH

Direction: UE→UTRAN

Information Element/Group name	Need	Multi	Type and reference	Semantics description
Message Type	MP		Message Type	
UE information elements				
U-RNTI	MP		U-RNTI 10.3.3.47	
RRC transaction identifier	<i>CV-Failure</i>		RRC transaction identifier 10.3.3.36	
Integrity check info	CH		Integrity check info 10.3.3.16	
START list	MP	1 to <maxCNdo mains>		START [40] values for all CN domains.
>CN domain identity	MP		CN domain identity 10.3.1.1	
>START	MP		START 10.3.3.38	START value to be used in this CN domain.
AM_RLC error indication(RB2, RB3 or RB4)	MP		Boolean	TRUE indicates AM_RLC unrecoverable error [16] occurred on RB2, RB3 or RB4 in the UE
AM_RLC error indication(RB>4)	MP		Boolean	TRUE indicates AM_RLC unrecoverable error [16] occurred on RB>4 in the UE
Cell update cause	MP		Cell update cause 10.3.3.3	
Failure cause	OP		Failure cause and error	

Information Element/Group name	Need	Multi	Type and reference	Semantics description
			information 10.3.3.14	
RB timer indicator	MP		RB timer indicator 10.3.3.28	
Measurement information elements				
Measured results on RACH	OP		Measured results on RACH 10.3.7.45	

Condition	Explanation
<i>Failure</i>	This IE is mandatory present if the IE "Failure cause" is present and not needed otherwise.

10.2.8 CELL UPDATE CONFIRM

This message confirms the cell update procedure and can be used to reallocate new RNTI information for the UE valid in the new cell.

RLC-SAP: UM

Logical channel: CCCH or DCCH

Direction: UTRAN→UE

Information Element/Group name	Need	Multi	Type and reference	Semantics description
Message Type	MP		Message Type	
UE Information Elements				
U-RNTI	<i>CV-CCCH</i>		U-RNTI 10.3.3.47	
RRC transaction identifier	MP		RRC transaction identifier 10.3.3.36	
Integrity check info	CH		Integrity check info 10.3.3.16	
Integrity protection mode info	OP		Integrity protection mode info 10.3.3.19	The UTRAN should not include this IE unless it is performing an SRNS relocation.
Ciphering mode info	OP		Ciphering mode info 10.3.3.5	The UTRAN should not include this IE unless it is performing an SRNS relocation and a change in ciphering algorithm.
Activation time	MD		Activation time 10.3.3.1	Default value is "now"
New U-RNTI	OP		U-RNTI 10.3.3.47	
New C-RNTI	OP		C-RNTI 10.3.3.8	
New DSCH-RNTI	OP		DSCH-RNTI 10.3.3.9a	
RRC State Indicator	MP		RRC State Indicator 10.3.3.35a	
UTRAN DRX cycle length	OP		UTRAN DRX	

Information Element/Group name	Need	Multi	Type and reference	Semantics description
coefficient			cycle length coefficient 10.3.3.49	
RLC re-establish indicator (RB2, RB3 and RB4)	MP		RLC re-establish indicator 10.3.3.35	
RLC re-establish indicator (RB5 and upwards)	MP		RLC re-establish indicator 10.3.3.35	
CN Information Elements				
CN Information info	OP		CN Information info 10.3.1.3	
UTRAN Information Elements				
URA identity	OP		URA identity 10.3.2.6	
RB information elements				
RB information to release list	OP	1 to <maxRB>		
>RB information to release	MP		RB information to release 10.3.4.19	
RB information to reconfigure list	OP	1 to <maxRB>		
>RB information to reconfigure	MP		RB information to reconfigure 10.3.4.18	
RB information to be affected list	OP	1 to <maxRB>		
>RB information to be affected	MP		RB information to be affected 10.3.4.17	
Downlink counter synchronisation info	OP			
>RB with PDCP information list	OP	1 to <maxRBall RABs>		This IE is needed for each RB having PDCP in the case of lossless SRNS relocation
>>RB with PDCP information	MP		RB with PDCP information 10.3.4.22	
TrCH Information Elements				
Uplink transport channels				
UL Transport channel information common for all transport channels	OP		UL Transport channel information common for all transport channels 10.3.5.24	
Deleted TrCH information list	OP	1 to <maxTrCH>		
>Deleted UL TrCH information	MP		Deleted UL TrCH information 10.3.5.5	
Added or Reconfigured TrCH	OP	1 to		

Information Element/Group name	Need	Multi	Type and reference	Semantics description
information list		<maxTrCH >		
>Added or Reconfigured UL TrCH information	MP		Added or Reconfigured UL TrCH information 10.3.5.2	
CHOICE <i>mode</i>	MP			
>FDD				
>>CPCH set ID	OP		CPCH set ID 10.3.5.3	
>>>Added or Reconfigured TrCH information for DRAC list	OP	1 to <maxTrCH >		
>>>>DRAC static information	MP		DRAC static information 10.3.5.7	
>TDD				(no data)
Downlink transport channels				
DL Transport channel information common for all transport channels	OP		DL Transport channel information common for all transport channels 10.3.5.6	
Deleted TrCH information list	OP	1 to <maxTrCH >		
>Deleted DL TrCH information	MP		Deleted DL TrCH information 10.3.5.4	
Added or Reconfigured TrCH information list	OP	1 to <maxTrCH >		
>Added or Reconfigured DL TrCH information	MP		Added or Reconfigured DL TrCH information 10.3.5.1	
PhyCH information elements				
Frequency info	OP		Frequency info 10.3.6.36	
Uplink radio resources				
Maximum allowed UL TX power	MD		Maximum allowed UL TX power 10.3.6.39	Default value is the existing maximum UL TX power
CHOICE <i>channel requirement</i>	OP			
>Uplink DPCH info			Uplink DPCH info 10.3.6.88.	
>CPCH SET Info			CPCH SET Info 10.3.6.13	
Downlink radio resources				
CHOICE <i>mode</i>	MP			
>FDD				
>>>Downlink PDSCH information	OP		Downlink PDSCH information 10.3.6.30	
>TDD				(no data)

Information Element/Group name	Need	Multi	Type and reference	Semantics description
Downlink information common for all radio links	OP		Downlink information common for all radio links 10.3.6.24	
Downlink information per radio link list	OP	1 to <maxRL>		Send downlink information for each radio link to be set-up
>Downlink information for each radio link	MP		Downlink information for each radio link 10.3.6.27	

Condition	Explanation
CCCH	This IE is mandatory present when CCCH is used and ciphering is not required and not needed otherwise.

10.2.9 COUNTER CHECK

This message is used by the UTRAN to indicate the current COUNT-C MSB values associated to each radio bearer utilising UM or AM RLC mode and to request the UE to compare these to its COUNT-C MSB values and to report the comparison results to UTRAN.

RLC-SAP: AM

Logical channel: DCCH

Direction: UTRAN→UE

Information Element/Group name	Presence	Multi	IE type and reference	Semantics description
Message Type	MP			
UE information elements				
RRC transaction identifier	MP		RRC transaction identifier 10.3.3.36	
Integrity check info	CH		Integrity check info 10.3.3.16	
RB information elements				
RB COUNT-C MSB information	MP	1 to <maxRBallRABs >		For each RB (excluding signalling radio bearers) using UM or AM RLC.
>RB COUNT-C MSB information	MP		RB COUNT-C MSB information 10.3.4.14	

10.2.10 COUNTER CHECK RESPONSE

This message is used by the UE to respond to a COUNTER CHECK message.

RLC-SAP: AM

Logical channel: DCCH

Direction: UE→UTRAN

Information Element/Group name	Presence	Multi	IE type and reference	Semantics description
Message Type	MP			
UE information elements				
RRC transaction identifier	MP		RRC transaction identifier 10.3.3.36	
Integrity check info	CH		Integrity check info 10.3.3.16	
RB information elements				
RB COUNT-C information	OP	1 to < maxRBAllRABs >		
>RB COUNT-C information	MP		RB COUNT-C information 10.3.4.15	

10.2.11 DOWNLINK DIRECT TRANSFER

This message is sent by UTRAN to transfer higher layer messages.

RLC-SAP: AM

Logical channel: DCCH

Direction: UTRAN -> UE

Information Element/Group name	Need	Multi	Type and reference	Semantics description
Message Type	MP		Message Type	
UE information elements				
RRC transaction identifier	MP		RRC transaction identifier 10.3.3.36	
Integrity check info	CH		Integrity check info 10.3.3.16	
CN information elements				
CN Domain Identity	MP		Core Network Domain Identity 10.3.1.1	
NAS message	MP		NAS message 10.3.1.8	

10.2.12 Void

10.2.13 Void

10.2.14 Void

10.2.15 HANDOVER FROM UTRAN COMMAND

This message is used for handover from UMTS to another system e.g. GSM. One or several messages from the other system can be included in the Inter-RAT message information element in this message. These messages are structured and coded according to that systems specification.

RLC-SAP: AM

Logical channel: DCCH

Direction: UTRAN→UE

Information Element/Group name	Need	Multi	Type and reference	Semantics description
Message Type	MP		Message Type	
UE information elements				
RRC transaction identifier	MP		RRC transaction identifier 10.3.3.36	
Integrity check info	CH		Integrity check info 10.3.3.16	
Activation time	MD		Activation time 10.3.3.1	Default value is "now"
RB information elements				
RAB information list	OP	1 to <maxRABs etup>		For each RAB to be handed over. In this version, the maximum size of the list of 1 shall be applied for all system types.
>RAB info	MP		RAB info 10.3.4.8	
Other information elements				
CHOICE <i>System type</i>	MP			This IE indicates which specification to apply, to decode the transported messages
>GSM				
>>Frequency band	MP		Enumerated (GSM/DCS 1800 band used), GSM/PCS 1900 band used)	
>>GSM message				
>>>Single GSM message	MP		Bit string (no explicit size constraint)	Formatted and coded according to GSM specifications The first/leftmost/most significant bit of the bit string contains bit 8 of the first octet of the GSM message.
>>>GSM message List	MP	1.to.<maxInterSysMessages>	Bit string (1..512)	Formatted and coded according to GSM specifications. The first/leftmost/most significant bit of the bit string contains bit 8 of the first octet of the GSM message.

Information Element/Group name	Need	Multi	Type and reference	Semantics description
>cdma2000				
>>cdma2000MessageList	MP	1.to.<maxl nterSysMe ssages>		
>>>MSG_TYPE(s)	MP		Bit string (8)	Formatted and coded according to cdma2000 specifications. The MSG_TYPE bits are numbered b0 to b7. The first/leftmost/most significant bit of the bit string contains bit 7 of the MSG_TYPE.
>>>cdma2000Messagepayload(s)	MP		Bit string (1..512)	Formatted and coded according to cdma2000 specifications. The first/leftmost/most significant bit of the bit string contains the bit 7 of the first octet of the cdma2000 message.

10.2.16 HANDOVER FROM UTRAN FAILURE

This message is sent on the RRC connection used before the Inter-RAT Handover was executed. The message indicates that the UE has failed to seize the new channel in the other system.

RLC-SAP: AM

Logical channel: DCCH

Direction: UE→UTRAN

Information Element/Group name	Need	Multi	Type and reference	Semantics description
Message Type	MP		Message Type	
UE information elements				
RRC transaction identifier	MP		RRC transaction identifier 10.3.3.36	
Integrity check info	CH		Integrity check info 10.3.3.16	
Other information elements				
Inter-RAT handover failure	OP		Inter-RAT handover failure 10.3.8.6	
CHOICE <i>System type</i>	OP			This IE indicates which specification to apply to decode the transported messages
>GSM				
>GSM message List	MP	1.to.<maxl nterSysMe ssages>	Bit string (1..512)	Formatted and coded according to GSM specifications. The first/leftmost/most significant bit of the bit string contains bit 8 of the first octet of the GSM message.
>cdma2000				
>>cdma2000MessageList	MP	1.to.<maxl nterSysMe ssages>		

Information Element/Group name	Need	Multi	Type and reference	Semantics description
>>>MSG_TYPE(s)	MP		Bit string (8)	Formatted and coded according to cdma2000 specifications. The MSG_TYPE bits are numbered b0 to b7. The first/leftmost/most significant bit of the bit string contains bit 7 of the MSG_TYPE.
>>>cdma2000Messagepayload(s)	MP		Bit string (1..512)	Formatted and coded according to cdma2000 specifications. The first/leftmost/most significant bit of the bit string contains bit 7 of the first octet of the cdma2000 message.

10.2.16a HANDOVER TO UTRAN COMMAND

This message is sent to the UE via other system to make a handover to UTRAN.

RLC-SAP: N/A (Sent through a different RAT)

Logical channel: N/A (Sent through a different RAT)

Direction: UTRAN → UE

Information Element/Group name	Need	Multi	Type and reference	Semantics description
New U-RNTI	MP		U-RNTI Short 10.3.3.48	
Ciphering algorithm	OP		Ciphering algorithm 10.3.3.4	
<i>CHOICE specification mode</i>	MP			
>Complete specification				
RB information elements				
>>Signalling RB information to setup list	MP	1 to <maxSRBs etup>		For each signalling radio bearer established
>>>Signalling RB information to setup	MP		Signalling RB information to setup 10.3.4.24	
>>RAB information to setup list	OP	1 to <maxRABs etup>		For each RAB established
>>>RAB information for setup	MP		RAB information for setup 10.3.4.10	
Uplink transport channels				
>>UL Transport channel information common for all transport channels	MP		UL Transport channel information common for all transport channels 10.3.5.24	
>>Added or Reconfigured TrCH information	MP	1 to <maxTrCH >		
>>>Added or Reconfigured UL	MP		Added or	

Information Element/Group name	Need	Multi	Type and reference	Semantics description
TrCH information			Reconfigured UL TrCH information 10.3.5.2	
Downlink transport channels				
>>DL Transport channel information common for all transport channels	MP		DL Transport channel information common for all transport channels 10.3.5.6	
>>Added or Reconfigured TrCH information	MP	1 to <maxTrCH>		
>>>Added or Reconfigured DL TrCH information	MP		Added or Reconfigured DL TrCH information 10.3.5.1	
Uplink radio resources				
>>Uplink DPCH info	MP		Uplink DPCH info 10.3.6.88	
>>CHOICE <i>mode</i>	MP			
>>>FDD				
>>>>CPCH SET Info	OP		CPCH SET Info 10.3.6.13	
Downlink radio resources				
>>>>Downlink PDSCH information	OP		Downlink PDSCH information 10.3.6.30	
>>>TDD				(no data)
>>Downlink information common for all radio links	MP		Downlink information common for all radio links 10.3.6.24	
>>Downlink information per radio link	MP	1 to <maxRL>		
>>>Downlink information for each radio link	MP		Downlink information for each radio link 10.3.6.27	
>Preconfiguration				
>>CHOICE <i>Preconfiguration mode</i>	MP			
>>>Predefined configuration	MP		Predefined configuration identity 10.3.4.5	
>>>Default configuration				
>>>>Default configuration mode	MP		Enumerated (FDD, TDD)	Indicates whether the FDD or TDD version of the default configuration shall be used
>>>>Default configuration identity	MP		Default configuration identity 10.3.4.0	
>>RAB info	OP		RAB info Post 10.3.4.9	One RAB is established

Information Element/Group name	Need	Multi	Type and reference	Semantics description
>>Uplink DPCH info	MP		Uplink DPCH info Post 10.3.6.89	
Downlink radio resources				
>>Downlink information common for all radio links	MP		Downlink information common for all radio links Post 10.3.6.25	
>>Downlink information per radio link	MP	1 to <maxRL>		Send downlink information for each radio link to be set-up. In TDD MaxRL is 1.
>>>Downlink information for each radio link	MP		Downlink information for each radio link Post 10.3.6.28	
>>CHOICE <i>mode</i>	MP			
>>>FDD				(no data)
>>>TDD				
>>>>Primary CCPCH Tx Power	MP		Primary CCPCH Tx Power 10.3.6.59	
Frequency info	MP		Frequency info 10.3.6.36	
Maximum allowed UL TX power	MP		Maximum allowed UL TX power 10.3.6.39	

10.2.16b HANDOVER TO UTRAN COMPLETE

This message is sent by the UE when a handover to UTRAN has been completed.

RLC-SAP: AM

Logical channel: DCCH

Direction: UE → UTRAN

Information Element/Group name	Need	Multi	Type and reference	Semantics description
Message Type	MP		Message Type	
UE Information elements				
START list	CH	1 to <maxCNdo mains>		START [40] values for all CN domains.
>CN domain identity	MP		CN domain identity 10.3.1.1	
>START	MP		START 10.3.3.38	
RB Information elements				
COUNT-C activation time	OP		Activation time 10.3.3.1	Used for radio bearers mapped on RLC-TM.

10.2.16c INITIAL DIRECT TRANSFER

This message is used to initiate a signalling connection based on indication from the upper layers, and to transfer a NAS message.

RLC-SAP: AM

Logical channel: DCCH

Direction: UE -> UTRAN

Information Element/Group name	Need	Multi	Type and reference	Semantics description
Message Type	MP		Message Type	
UE information elements				
Integrity check info	CH		Integrity check info 10.3.3.16	
CN information elements				
CN domain identity	MP		CN domain identity 10.3.1.1	
Intra Domain NAS Node Selector	MP		Intra Domain NAS Node Selector 10.3.1.6	
NAS message	MP		NAS message 10.3.1.8	
START	OP		START 10.3.3.38	START value to be used in the CN domain as indicated in the IE "CN domain identity". This IE shall always be present in this version of the protocol.
Measurement information elements				
Measured results on RACH	OP		Measured results on RACH 10.3.7.45	

10.2.16d INTER RAT HANDOVER INFO

This message is sent by the UE via another radio access technology to provide information to the target RNC when preparing for a handover to UTRAN.

RLC-SAP: N/A (Sent through a different RAT)

Logical channel: N/A (Sent through a different RAT)

Direction: UE → UTRAN

Information Element/Group Name	Need	Multi	Type and reference	Semantics description
Radio Bearer IEs				
Predefined configuration status information	OP		Predefined configuration status information 10.3.4.5a	
UE Information elements				
UE security information	OP		UE security information 10.3.3.42b	

Information Element/Group Name	Need	Multi	Type and reference	Semantics description
>UE Specific Behaviour Information 1 interRAT	OP		UE Specific Behaviour Information 1 interRAT 10.3.3.52	This IE shall not be included in this version of the protocol
UE capability container	OP			
>UE radio access capability	MP		UE radio access capability 10.3.3.42	
>UE radio access capability extension	MP		UE radio access capability extension 10.3.3.42a	Although this IE is not always required, the need has been set to MP to align with the ASN.1

10.2.17 MEASUREMENT CONTROL

This message is sent by UTRAN to setup, modify or release a measurement in the UE.

RLC-SAP: AM

Logical channel: DCCH

Direction: UTRAN→UE

Information Element/Group name	Need	Multi	Type and reference	Semantics description
Message Type	MP		Message Type	
UE information elements				
RRC transaction identifier	MP		RRC transaction identifier 10.3.3.36	
Integrity check info	CH		Integrity check info 10.3.3.16	
Measurement Information elements				
Measurement Identity	MP		Measurement Identity 10.3.7.48	
Measurement Command	MP		Measurement Command 10.3.7.46	
Measurement Reporting Mode	OP		Measurement Reporting Mode 10.3.7.49	
Additional measurements list	OP		Additional measurements list 10.3.7.1	
CHOICE <i>Measurement type</i>	CV- <i>command</i>			
>Intra-frequency measurement			Intra-frequency measurement 10.3.7.36	
>Inter-frequency measurement			Inter-frequency measurement 10.3.7.16	

Information Element/Group name	Need	Multi	Type and reference	Semantics description
>Inter-RAT measurement			Inter-RAT measurement 10.3.7.27	
>UE positioning measurement			UE positioning measurement 10.3.7.100	
>Traffic Volume measurement			Traffic Volume measurement 10.3.7.68	
>Quality measurement			Quality measurement 10.3.7.56	
>UE internal measurement			UE internal measurement 10.3.7.77	
Physical channel information elements				
DPCH compressed mode status info	OP		DPCH compressed mode status info 10.3.6.34	

Condition	Explanation
<i>Command</i>	The IE is mandatory present if the IE "Measurement command" is set to "Setup", optional if the IE "Measurement command" is set to "modify", otherwise the IE is not needed.

10.2.18 MEASUREMENT CONTROL FAILURE

This message is sent by UE, if it cannot initiate a measurement as instructed by UTRAN.

RLC-SAP: AM

Logical channel: DCCH

Direction: UE→UTRAN

Information Element/Group name	Need	Multi	Type and reference	Semantics description
Message Type	MP		Message Type	
UE information elements				
RRC transaction identifier	MP		RRC transaction identifier 10.3.3.36	
Integrity check info	CH		Integrity check info 10.3.3.16	
Failure cause	MP		Failure cause and error information 10.3.3.14	

10.2.19 MEASUREMENT REPORT

This message is used by UE to transfer measurement results to the UTRAN.

RLC-SAP: AM or UM

Logical channel: DCCH

Direction: UE→UTRAN

Information Element/Group name	Need	Multi	Type and reference	Semantics description	Version
Message Type	MP		Message Type		
UE information elements					
Integrity check info	CH		Integrity check info 10.3.3.16		
Measurement Information Elements					
Measurement identity	MP		Measurement identity 10.3.7.48		
Measured Results	OP		Measured Results 10.3.7.44		
Measured Results on RACH	OP		Measured Results on RACH 10.3.7.45		
Additional Measured results	OP	1 to <maxAdditional Meas>			
>Measured Results	MP		Measured Results 10.3.7.44		
Event results	OP		Event results 10.3.7.7		
GSM OTD reference cell	OP		Primary CPICH info 10.3.6.60		REL-4

10.2.20 PAGING TYPE 1

This message is used to send information on the paging channel. One or several UEs, in idle or connected mode, can be paged in one message, which also can contain other information.

RLC-SAP: TM

Logical channel: PCCH

Direction: UTRAN → UE

Information Element/Group name	Need	Multi	Type and reference	Semantics description
Message Type	MP		Message Type	
UE Information elements				
Paging record list	OP	1 to <maxPage		

		1>		
>Paging record	MP		Paging record 10.3.3.23	
Other information elements				
BCCH modification info	OP		BCCH modification info 10.3.8.1	

If the encoded message does not fill a transport block, the RRC layer shall add padding according to subclause 12.1.

10.2.21 PAGING TYPE 2

This message is used to page a UE in connected mode, when using the DCCH for CN originated paging.

RLC-SAP: AM

Logical channel: DCCH

Direction: UTRAN → UE

Information Element/Group name	Need	Multi	Type and reference	Semantics description
Message Type	MP		Message Type	
UE information elements				
RRC transaction identifier	MP		RRC transaction identifier 10.3.3.36	
Integrity check info	CH		Integrity check info 10.3.3.16	
Paging cause	MP		Paging cause 10.3.3.22	
CN Information elements				
CN domain identity	MP		CN domain identity 10.3.1.1	
Paging Record Type Identifier	MP		Paging Record Type Identifier 10.3.1.10	

10.2.22 PHYSICAL CHANNEL RECONFIGURATION

This message is used by UTRAN to assign, replace or release a set of physical channels used by a UE.

RLC-SAP: AM or UM

Logical channel: DCCH

Direction: UTRAN → UE

Information Element/Group name	Need	Multi	Type and reference	Semantics description
Message Type	MP		Message Type	
UE Information Elements				
RRC transaction identifier	MP		RRC transaction identifier 10.3.3.36	

Information Element/Group name	Need	Multi	Type and reference	Semantics description
Integrity check info	CH		Integrity check info 10.3.3.16	
Integrity protection mode info	OP		Integrity protection mode info 10.3.3.19	The UTRAN should not include this IE unless it is performing an SRNS relocation.
Ciphering mode info	OP		Ciphering mode info 10.3.3.5	The UTRAN should not include this IE unless it is performing an SRNS relocation and a change in ciphering algorithm.
Activation time	MD		Activation time 10.3.3.1	Default value is "now"
New U-RNTI	OP		U-RNTI 10.3.3.47	
New C-RNTI	OP		C-RNTI 10.3.3.8	
New DSCH-RNTI	OP		DSCH-RNTI 10.3.3.9a	
RRC State Indicator	MP		RRC State Indicator 10.3.3.35a	
UTRAN DRX cycle length coefficient	OP		UTRAN DRX cycle length coefficient 10.3.3.49	
CN Information Elements				
CN Information info	OP		CN Information info 10.3.1.3	
UTRAN mobility information elements				
URA identity	OP		URA identity 10.3.2.6	
RB information elements				
Downlink counter synchronisation info	OP			
>RB with PDCP information list	OP	1 to <maxRBall RABs>		This IE is needed for each RB having PDCP in the case of lossless SRNS relocation
>>RB with PDCP information	MP		RB with PDCP information 10.3.4.22	
PhyCH information elements				
Frequency info	OP		Frequency info 10.3.6.36	
Uplink radio resources				
Maximum allowed UL TX power	MD		Maximum allowed UL TX power 10.3.6.39	Default value is the existing value of the maximum allowed UL TX power
<i>CHOICE channel requirement</i>				
>Uplink DPCH info			Uplink DPCH info 10.3.6.88	
>CPCH SET Info			CPCH SET Info 10.3.6.13	
>CPCH set ID			CPCH set ID 10.3.5.3	
Downlink radio resources				
<i>CHOICE mode</i>	MP			

Information Element/Group name	Need	Multi	Type and reference	Semantics description
>FDD				
>>Downlink PDSCH information	OP		Downlink PDSCH information 10.3.6.30	
>TDD				(no data)
Downlink information common for all radio links	OP		Downlink information common for all radio links 10.3.6.24	
Downlink information per radio link list	OP	1 to <maxRL>		Send downlink information for each radio link
>Downlink information for each radio link	MP		Downlink information for each radio link 10.3.6.27	

10.2.23 PHYSICAL CHANNEL RECONFIGURATION COMPLETE

This message is sent from the UE when a physical channel reconfiguration has been done.

RLC-SAP: AM

Logical channel: DCCH

Direction: UE → UTRAN

Information Element/Group name	Need	Multi	Type and reference	Semantics description	Version
Message Type	MP		Message Type		
UE information elements					
RRC transaction identifier	MP		RRC transaction identifier 10.3.3.36		
Integrity check info	CH		Integrity check info 10.3.3.16		
Uplink integrity protection activation info	OP		Integrity protection activation info 10.3.3.17		
CHOICE <i>mode</i>	MP				
>FDD				(no data)	
>TDD					
>>CHOICE <i>TDD option</i>	MP				REL-4
>>>3.84 Mcps TDD	MP				REL-4
>>>>Uplink Timing Advance	OP		Uplink Timing Advance 10.3.6.95		
>>>1.28 Mcps TDD				(no data)	REL-4
RB Information elements					
COUNT-C activation time	OP		Activation time 10.3.3.1	Used for radio bearers mapped on RLC-TM.	
Radio bearer uplink ciphering activation time info	OP		RB activation time info		

Information Element/Group name	Need	Multi	Type and reference	Semantics description	Version
			10.3.4.13		
Uplink counter synchronisation info	OP				
>RB with PDCP information list	OP	1 to <maxRBall RABs>			
>>RB with PDCP information	MP		RB with PDCP information 10.3.4.22		
>START list	MP	1 to <maxCNdo mains>		START [40] values for all CN domains.	
>>CN domain identity	MP		CN domain identity 10.3.1.1		
>>START	MP		START 10.3.3.38	START value to be used in this CN domain.	

10.2.24 PHYSICAL CHANNEL RECONFIGURATION FAILURE

This message is sent by UE if the configuration given by UTRAN is unacceptable or if the UE failed to assign, replace or release a set of physical channel(s).

RLC-SAP: AM

Logical channel: DCCH

Direction: UE→UTRAN

Information Element/Group name	Need	Multi	Type and reference	Semantics description
Message type	MP		Message type	
UE information elements				
RRC transaction identifier	OP		RRC transaction identifier 10.3.3.36	
Integrity check info	CH		Integrity check info 10.3.3.16	
Failure cause	MP		Failure cause and error information 10.3.3.14	

10.2.25 PHYSICAL SHARED CHANNEL ALLOCATION

NOTE: Only for TDD.

This message is used by UTRAN to assign physical resources to USCH/DSCH transport channels in TDD, for temporary usage by the UE.

RLC-SAP: UM on SHCCH, UM on DCCH

Logical channel: SHCCH or DCCH

Direction: UTRAN → UE

Information Element/Group name	Need	Multi	Type and reference	Semantics description
Message Type	MP		Message type	
DSCH-RNTI	OP		DSCH-RNTI 10.3.3.9a	
RRC transaction identifier	MP		RRC transaction identifier 10.3.3.36	
Uplink timing advance Control	MD		Uplink Timing Advance Control 10.3.6.96	Default value is the existing value for uplink timing advance
PUSCH capacity allocation info	OP		PUSCH Capacity Allocation info 10.3.6.64	
PDSCH capacity allocation info	OP		PDSCH Capacity Allocation info 10.3.6.42	
Confirm request	MD		Enumerated(No Confirm, Confirm PDSCH, Confirm PUSCH)	Default value is No Confirm
Traffic volume report request	OP		Integer (0 .. 255)	Indicates the number of frames between start of the allocation period and sending measurement report. The value should be less than the value for Allocation Duration.
ISCP Timeslot list	OP	1 to maxTS		
>Timeslot number	MP		Timeslot number 10.3.6.84	Timeslot numbers, for which the UE shall report the timeslot ISCP in PUSCH CAPACITY REQUEST message.
Request P-CCPCH RSCP	MP		Boolean	TRUE indicates that a Primary CCPCH RSCP measurement shall be reported by the UE in PUSCH CAPACITY REQUEST message.

10.2.26 PUSCH CAPACITY REQUEST

NOTE: Only for TDD.

This message is used by the UE for request of PUSCH resources to the UTRAN.

RLC-SAP: TM

Logical channel: SHCCH

Direction: UE → UTRAN

Information Element/Group name	Need	Multi	Type and reference	Semantics description
Message Type	MP		Message Type	
DSCH-RNTI	OP		DSCH-RNTI	

Information Element/Group name	Need	Multi	Type and reference	Semantics description
			10.3.3.9a	
RRC transaction identifier	CV-ProtErr		RRC transaction identifier 10.3.3.36	
Traffic Volume	OP		Traffic Volume, measured results list 10.3.7.67	
Timeslot list	OP	1 to maxTS		
>Timeslot number	MP		Timeslot number 10.3.6.84	
>Timeslot ISCP	MP		Timeslot ISCP info 10.3.7.65	
Primary CCPCH RSCP	OP		Primary CCPCH RSCP info 10.3.7.54	
CHOICE Allocation confirmation	OP			
>PDSCH Confirmation			Integer(1..hi PDSCHidentities)	
>PUSCH Confirmation			Integer(1..hi PUSCHidentities)	
Protocol error indicator	MD		Protocol error indicator 10.3.3.27	Default value is FALSE
Protocol error information	CV-ProtErr		Protocol error information 10.3.8.12	

Condition	Explanation
<i>ProtErr</i>	This IE is mandatory present if the IE "Protocol error indicator" has the value "TRUE". Otherwise it is not needed.

10.2.27 RADIO BEARER RECONFIGURATION

This message is sent from UTRAN to reconfigure parameters related to a change of QoS. This procedure can also change the multiplexing of MAC, reconfigure transport channels and physical channels.

RLC-SAP: AM or UM

Logical channel: DCCH

Direction: UTRAN → UE

Information Element/Group name	Need	Multi	Type and reference	Semantics description	Version
Message Type	MP		Message Type		
UE Information elements					
RRC transaction identifier	MP		RRC transaction identifier		

Information Element/Group name	Need	Multi	Type and reference	Semantics description	Version
			10.3.3.36		
Integrity check info	CH		Integrity check info 10.3.3.16		
Integrity protection mode info	OP		Integrity protection mode info 10.3.3.19	The UTRAN should not include this IE unless it is performing an SRNS relocation	
Ciphering mode info	OP		Ciphering mode info 10.3.3.5	The UTRAN should not include this IE unless it is performing an SRNS relocation and a change in ciphering algorithm	
Activation time	MD		Activation time 10.3.3.1	Default value is "now"	
New U-RNTI	OP		U-RNTI 10.3.3.47		
New C-RNTI	OP		C-RNTI 10.3.3.8		
New DSCH-RNTI	OP		DSCH-RNTI 10.3.3.9a		
RRC State Indicator	MP		RRC State Indicator 10.3.3.35a		
UTRAN DRX cycle length coefficient	OP		UTRAN DRX cycle length coefficient 10.3.3.49		
CN information elements					
CN Information info	OP		CN Information info 10.3.1.3		
UTRAN mobility information elements					
URA identity	OP		URA identity 10.3.2.6		
RB information elements					
RAB information to reconfigure list	OP	1 to <maxRABse tup >			
>RAB information to reconfigure	MP		RAB information to reconfigure 10.3.4.11		
RB information to reconfigure list	MP	1to <maxRB>		Although this IE is not always required, need is MP to align with ASN.1	
	OP				REL-4
>RB information to reconfigure	MP		RB information to reconfigure 10.3.4.18		
RB information to be affected list	OP	1 to <maxRB>			
>RB information to be affected	MP		RB information to be		

Information Element/Group name	Need	Multi	Type and reference	Semantics description	Version
			affected 10.3.4.17		
TrCH Information Elements					
Uplink transport channels					
UL Transport channel information common for all transport channels	OP		UL Transport channel information common for all transport channels 10.3.5.24		
Deleted TrCH information list	OP	1 to <maxTrCH >			
>Deleted UL TrCH information	MP		Deleted UL TrCH information 10.3.5.5		
Added or Reconfigured TrCH information list	OP	1 to <maxTrCH >			
>Added or Reconfigured UL TrCH information	MP		Added or Reconfigured UL TrCH information 10.3.5.2		
CHOICE mode	OP				
>FDD					
>>CPCH set ID	OP		CPCH set ID 10.3.5.3		
>>>Added or Reconfigured TrCH information for DRAC list	OP	1 to <maxTrCH >			
>>>>DRAC static information	MP		DRAC static information 10.3.5.7		
>TDD				(no data)	
Downlink transport channels					
DL Transport channel information common for all transport channels	OP		DL Transport channel information common for all transport channels 10.3.5.6		
Deleted TrCH information list	OP	1 to <maxTrCH >			
>Deleted DL TrCH information	MP		Deleted DL TrCH information 10.3.5.4		
Added or Reconfigured TrCH information list	OP	1 to <maxTrCH >			
>Added or Reconfigured DL TrCH information	MP		Added or Reconfigured DL TrCH information 10.3.5.1		
PhyCH information elements					
Frequency info	OP		Frequency info 10.3.6.36		
Uplink radio resources					

Information Element/Group name	Need	Multi	Type and reference	Semantics description	Version
Maximum allowed UL TX power	MD		Maximum allowed UL TX power 10.3.6.39	Default value is the existing maximum UL TX power	
<i>CHOICE channel requirement</i>	OP				
>Uplink DPCH info			Uplink DPCH info 10.3.6.88		
>CPCH SET Info			CPCH SET Info 10.3.6.13		
Downlink radio resources					
<i>CHOICE mode</i>	MP				
>FDD					
>>Downlink PDSCH information	OP		Downlink PDSCH information 10.3.6.30		
>TDD				(no data)	
Downlink information common for all radio links	OP		Downlink information common for all radio links 10.3.6.24		
Downlink information per radio link list	MP	1 to <maxRL>		Although this IE is not always required, need is MP to align with ASN.1	
	OP				REL-4
>Downlink information for each radio link	MP		Downlink information for each radio link 10.3.6.27		

10.2.28 RADIO BEARER RECONFIGURATION COMPLETE

This message is sent from the UE when a RB and signalling link reconfiguration has been done.

RLC-SAP: AM

Logical channel: DCCH

Direction: UE → UTRAN

Information Element/Group name	Need	Multi	Type and reference	Semantics description	Version
Message Type	MP		Message Type		
UE information elements					
RRC transaction identifier	MP		RRC transaction identifier 10.3.3.36		
Integrity check info	CH		Integrity check info 10.3.3.16		
Uplink integrity protection activation info	OP		Integrity protection activation info 10.3.3.17		

Information Element/Group name	Need	Multi	Type and reference	Semantics description	Version
CHOICE <i>mode</i>	MP				
>FDD				(no data)	
>TDD					
>>CHOICE <i>TDD option</i>	MP				REL-4
>>>3.84 Mcps TDD					REL-4
>>>>Uplink Timing Advance	OP		Uplink Timing Advance 10.3.6.95		
>>>1.28 Mcps TDD				(no data)	REL-4
RB Information elements					
COUNT-C activation time	OP		Activation time 10.3.3.1	Used for radio bearers mapped on RLC-TM.	
Radio bearer uplink ciphering activation time info	OP		RB activation time info 10.3.4.13		
Uplink counter synchronisation info	OP				
>RB with PDCP information list	OP	1 to <maxRBall RABs>			
>>RB with PDCP information	MP		RB with PDCP information 10.3.4.22		
>START list	MP	1 to <maxCNdo mains>		START [40] values for all CN domains.	
>>CN domain identity	MP		CN domain identity 10.3.1.1		
>>START	MP		START 10.3.3.38	START value to be used in this CN domain.	

10.2.29 RADIO BEARER RECONFIGURATION FAILURE

This message is sent by UE if the configuration given by UTRAN is unacceptable or if the UE failed to establish the physical channel(s).

RLC-SAP: AM

Logical channel: DCCH

Direction: UE→UTRAN

Information Element/Group name	Need	Multi	Type and reference	Semantics description
Message Type	MP		Message Type	
UE information elements				
RRC transaction identifier	MP		RRC transaction identifier 10.3.3.36	
Integrity check info	CH		Integrity check info 10.3.3.16	
Failure cause	MP		Failure cause and error information 10.3.3.14	
RB information elements				
Radio bearers for which reconfiguration would have succeeded List	OP	1 to <maxRB>		
>Radio bearer for which reconfiguration would have succeeded	MP		RB identity, 10.3.4.16	

10.2.30 RADIO BEARER RELEASE

This message is used by UTRAN to release a radio bearer. It can also include modifications to the configurations of transport channels and/or physical channels. It can simultaneously indicate release of a signalling connection when UE is connected to more than one CN domain.

RLC-SAP: AM or UM

Logical channel: DCCH

Direction: UTRAN → UE

Information Element/Group name	Need	Multi	Type and reference	Semantics description
Message Type	MP		Message Type	
UE Information Elements				
RRC transaction identifier	MP		RRC transaction identifier 10.3.3.36	
Integrity check info	CH		Integrity check info 10.3.3.16	
Integrity protection mode info	OP		Integrity protection mode info 10.3.3.19	The UTRAN should not include this IE unless it is performing an SRNS relocation.
Ciphering mode info	OP		Ciphering mode info 10.3.3.5	The UTRAN should not include this IE unless it is performing an SRNS relocation and a change in ciphering algorithm.
Activation time	MD		Activation time 10.3.3.1	Default value is "now"
New U-RNTI	OP		U-RNTI 10.3.3.47	
New C-RNTI	OP		C-RNTI 10.3.3.8	
New DSCH-RNTI	OP		DSCH-RNTI	

Information Element/Group name	Need	Multi	Type and reference	Semantics description
			10.3.3.9a	
RRC State Indicator	MP		RRC State Indicator 10.3.3.35a	
UTRAN DRX cycle length coefficient	OP		UTRAN DRX cycle length coefficient 10.3.3.49	
CN Information Elements				
CN Information info	OP		CN Information info 10.3.1.3	
Signalling Connection release indication	OP		CN domain identity 10.3.1.1	
UTRAN mobility information elements				
URA identity	OP		URA identity 10.3.2.6	
RB Information Elements				
RAB information to reconfigure list	OP	1 to <maxRABsetup >		
>RAB information to reconfigure	MP		RAB information to reconfigure 10.3.4.11	
RB information to release list	MP	1 to <maxRB>		
>RB information to release	MP		RB information to release 10.3.4.19	
RB information to be affected list	OP	1 to <maxRB>		
>RB information to be affected	MP		RB information to be affected 10.3.4.17	
Downlink counter synchronisation info	OP			
>RB with PDCP information list	OP	1 to <maxRBallRABs>		This IE is needed for each RB having PDCP in the case of lossless SRNS relocation
>>RB with PDCP information	MP		RB with PDCP information 10.3.4.22	
TrCH Information Elements				
Uplink transport channels				
UL Transport channel information common for all transport channels	OP		UL Transport channel information common for all transport channels 10.3.5.24	
Deleted TrCH information list	OP	1 to <maxTrCH >		
>Deleted UL TrCH information	MP		Deleted UL TrCH information	

Information Element/Group name	Need	Multi	Type and reference	Semantics description
			10.3.5.5	
Added or Reconfigured TrCH information list	OP	1 to <maxTrCH >		
>Added or Reconfigured UL TrCH information	MP		Added or Reconfigured UL TrCH information 10.3.5.2	
CHOICE <i>mode</i>	OP			
>FDD				
>>CPCH set ID	OP		CPCH set ID 10.3.5.3	
>>>Added or Reconfigured TrCH information for DRAC list	OP	1 to <maxTrCH >		
>>>DRAC static information	MP		DRAC static information 10.3.5.7	
>TDD				(no data)
Downlink transport channels				
DL Transport channel information common for all transport channels	OP		DL Transport channel information common for all transport channels 10.3.5.6	
Deleted TrCH information list	OP	1 to <maxTrCH >		
>Deleted DL TrCH information	MP		Deleted DL TrCH information 10.3.5.4	
Added or Reconfigured TrCH information list	OP	1 to <maxTrCH >		
>Added or Reconfigured DL TrCH information	MP		Added or Reconfigured DL TrCH information 10.3.5.1	
PhyCH information elements				
Frequency info	OP		Frequency info 10.3.6.36	
Uplink radio resources				
Maximum allowed UL TX power	MD		Maximum allowed UL TX power 10.3.6.39	Default value is the existing maximum UL TX power
CHOICE <i>channel requirement</i>	OP			
>Uplink DPCH info			Uplink DPCH info 10.3.6.88	
>CPCH SET Info			CPCH SET Info 10.3.6.13	
Downlink radio resources				
CHOICE <i>mode</i>	MP			
>FDD				
>>>Downlink PDSCH information	OP		Downlink PDSCH information	

Information Element/Group name	Need	Multi	Type and reference	Semantics description
			10.3.6.30	
>TDD				(no data)
Downlink information common for all radio links	OP		Downlink information common for all radio links 10.3.6.24	
Downlink information per radio link list	OP	1 to <maxRL>		Send downlink information for each radio link to be set-up
>Downlink information for each radio link	MP		Downlink information for each radio link 10.3.6.27	

10.2.31 RADIO BEARER RELEASE COMPLETE

This message is sent from the UE when radio bearer release has been completed.

RLC-SAP: AM

Logical channel: DCCH

Direction: UE → UTRAN

Information Element/Group name	Need	Multi	Type and reference	Semantics description	Version
Message Type	MP		Message Type		
UE information elements					
RRC transaction identifier	MP		RRC transaction identifier 10.3.3.36		
Integrity check info	CH		Integrity check info 10.3.3.16	Integrity check info is included if integrity protection is applied	
Uplink integrity protection activation info	OP		Integrity protection activation info 10.3.3.17		
CHOICE <i>mode</i>	MP				
>FDD				(no data)	
>TDD					
>>CHOICE <i>TDD option</i>	MP				REL-4
>>>3.84 Mcps TDD					REL-4
>>>>Uplink Timing Advance	OP		Uplink Timing Advance 10.3.6.95	This information element shall be present in case of handover procedure if timing advance is enabled. Calculated timing advance value for the new cell after handover in a synchronous TDD network	
>>>1.28 Mcps TDD				(no data)	REL-4
RB Information elements					

Information Element/Group name	Need	Multi	Type and reference	Semantics description	Version
COUNT-C activation time	OP		Activation time 10.3.3.1	Used for radio bearers mapped on RLC-TM.	
Radio bearer uplink ciphering activation time info	OP		RB activation time info 10.3.4.13		
Uplink counter synchronisation info	OP				
>RB with PDCP information list	OP	1 to <maxRBall RABs>		This IE is needed for each RB having PDCP in the case of lossless SRNS relocation	
>>RB with PDCP information	MP		RB with PDCP information 10.3.4.22		
>START list	MP	1 to <maxCNdo mains>		START [40] values for all CN domains.	
>>CN domain identity	MP		CN domain identity 10.3.1.1		
>>>START	MP		START 10.3.3.38	START value to be used in this CN domain.	

10.2.32 RADIO BEARER RELEASE FAILURE

This message is sent by UE if the configuration given by UTRAN is unacceptable or if radio bearer cannot be released.

RLC-SAP: AM

Logical channel: DCCH

Direction: UE→UTRAN

Information Element/Group name	Need	Multi	Type and reference	Semantics description
Message Type	MP		Message Type	
UE information elements				
RRC transaction identifier	MP		RRC transaction identifier 10.3.3.36	
Integrity check info	CH		Integrity check info 10.3.3.16	
Failure cause	MP		Failure cause and error information 10.3.3.14	
RB information elements				
Radio bearers for which reconfiguration would have succeeded	OP	1 to <maxRB>		
>Radio bearer for which reconfiguration would have been succeeded	MP		RB identity, 10.3.4.16	

10.2.33 RADIO BEARER SETUP

This message is sent by UTRAN to the UE to establish new radio bearer(s). It can also include modifications to the configurations of transport channels and/or physical channels.

RLC-SAP: AM or UM

Logical channel: DCCH

Direction: UTRAN → UE

Information Element/Group name	Need	Multi	Type and reference	Semantics description
Message Type	MP		Message Type	
UE Information Elements				
RRC transaction identifier	MP		RRC transaction identifier 10.3.3.36	
Integrity check info	CH		Integrity check info 10.3.3.16	
Integrity protection mode info	OP		Integrity protection mode info 10.3.3.19	The UTRAN should not include this IE unless it is performing an SRNS relocation
Ciphering mode info	OP		Ciphering mode info 10.3.3.5	The UTRAN should not include this IE unless it is performing an SRNS relocation and a change in ciphering algorithm.
Activation time	MD		Activation time 10.3.3.1	Default value is "now"
New U-RNTI	OP		U-RNTI 10.3.3.47	
New C-RNTI	OP		C-RNTI 10.3.3.8	
New DSCH-RNTI	OP		DSCH-RNTI 10.3.3.9a	

Information Element/Group name	Need	Multi	Type and reference	Semantics description
RRC State Indicator	MP		RRC State Indicator 10.3.3.35a	
UTRAN DRX cycle length coefficient	OP		UTRAN DRX cycle length coefficient 10.3.3.49	
CN Information Elements				
CN Information info	OP		CN Information info 10.3.1.3	
UTRAN mobility information elements				
URA identity	OP		URA identity 10.3.2.6	
RB Information Elements				
Signalling RB information to setup list	OP	1 to <maxSRBs etup>		For each signalling radio bearer established
>Signalling RB information to setup	MP		Signalling RB information to setup 10.3.4.24	
RAB information to setup list	OP	1 to <maxRABs etup>		For each RAB established
>RAB information for setup	MP		RAB information for setup 10.3.4.10	
RB information to be affected list	OP	1 to <maxRB>		
>RB information to be affected	MP		RB information to be affected 10.3.4.17	
Downlink counter synchronisation info	OP			
>RB with PDCP information list	OP	1 to <maxRBall RABs>		This IE is needed for each RB having PDCP in the case of lossless SRNS relocation
>>RB with PDCP information	MP		RB with PDCP information 10.3.4.22	
TrCH Information Elements				
Uplink transport channels				
UL Transport channel information common for all transport channels	OP		UL Transport channel information common for all transport channels 10.3.5.24	
Deleted TrCH information list	OP	1 to <maxTrCH >		
>Deleted UL TrCH information	MP		Deleted UL TrCH information 10.3.5.5	
Added or Reconfigured TrCH information list	OP	1 to <maxTrCH		

Information Element/Group name	Need	Multi	Type and reference	Semantics description
		>		
>Added or Reconfigured UL TrCH information	MP		Added or Reconfigured UL TrCH information 10.3.5.2	
CHOICE <i>mode</i>	OP			
>FDD				
>>CPCH set ID	OP		CPCH set ID 10.3.5.3	
>>>Added or Reconfigured TrCH information for DRAC list	OP	1 to <maxTrCH >		
>>>DRAC static information	MP		DRAC static information 10.3.5.7	
>TDD				(no data)
Downlink transport channels				
DL Transport channel information common for all transport channels	OP		DL Transport channel information common for all transport channels 10.3.5.6	
Deleted TrCH information list	OP	1 to <maxTrCH >		
>Deleted DL TrCH information	MP		Deleted DL TrCH information 10.3.5.4	
Added or Reconfigured TrCH information list	OP	1 to <maxTrCH >		
>Added or Reconfigured DL TrCH information	MP		Added or Reconfigured DL TrCH information 10.3.5.1	
PhyCH information elements				
Frequency info	OP		Frequency info 10.3.6.36	
Uplink radio resources				
Maximum allowed UL TX power	MD		Maximum allowed UL TX power 10.3.6.39	Default value is the existing maximum UL TX power
CHOICE <i>channel requirement</i>	OP			
>Uplink DPCH info			Uplink DPCH info 10.3.6.88	
>CPCH SET Info			CPCH SET Info 10.3.6.13	
Downlink radio resources				
CHOICE <i>mode</i>	MP			
>FDD				
>>Downlink PDSCH information	OP		Downlink PDSCH information 10.3.6.30	
>TDD				(no data)
Downlink information common	OP		Downlink	

Information Element/Group name	Need	Multi	Type and reference	Semantics description
for all radio links			information common for all radio links 10.3.6.24	
Downlink information per radio link list	OP	1 to <maxRL>		Send downlink information for each radio link
>Downlink information for each radio link	MP		Downlink information for each radio link 10.3.6.27	

10.2.34 RADIO BEARER SETUP COMPLETE

This message is sent by the UE to confirm the establishment of the radio bearer.

RLC-SAP: AM

Logical channel: DCCH

Direction: UE → UTRAN

Information Element/Group name	Need	Multi	Type and reference	Semantics description	Version
Message Type	MP		Message Type		
UE information elements					
RRC transaction identifier	MP		RRC transaction identifier 10.3.3.36		
Integrity check info	CH		Integrity check info 10.3.3.16		
Uplink integrity protection activation info	OP		Integrity protection activation info 10.3.3.17		
CHOICE <i>mode</i>	OP				
>FDD				(no data)	
>TDD					
>>CHOICE <i>TDD option</i>	MP				REL-4
>>>3.84 Mcps TDD					REL-4
>>>>Uplink Timing Advance	OP		Uplink Timing Advance 10.3.6.95	This information element shall be present in case of handover procedure if timing advance is enabled. Calculated timing advance value for the new cell after handover in a synchronous TDD network	
>>>1.28 Mcps TDD				(No data)	REL-4
START	OP		START 10.3.3.38	This information element is not needed for transparent mode RBs if prior to this procedure there	

Information Element/Group name	Need	Multi	Type and reference	Semantics description	Version
				exists one RB using RLC-TM.	
RB Information elements					
COUNT-C activation time	OP		Activation time 10.3.3.1	Used for radio bearers mapped on RLC-TM.	
Radio bearer uplink ciphering activation time info	OP		RB activation time info 10.3.4.13		
Uplink counter synchronisation info	OP				
>RB with PDCP information list	OP	1 to <maxRBall RABs>		This IE is needed for each RB having PDCP in the case of lossless SRNS relocation	
>>RB with PDCP information	MP		RB with PDCP information 10.3.4.22		
>START list	MP	1 to <maxCNdo mains>		START [40] values for all CN domains.	
>>CN domain identity	MP		CN domain identity 10.3.1.1		
>>START	MP		START 10.3.3.38	START value to be used in this CN domain.	

10.2.35 RADIO BEARER SETUP FAILURE

This message is sent by UE, if it does not support the configuration given by UTRAN.

RLC-SAP: AM

Logical channel: DCCH

Direction: UE→UTRAN

Information Element/Group name	Need	Multi	Type and reference	Semantics description
Message Type	MP		Message Type	
UE information elements				
RRC transaction identifier	MP		RRC transaction identifier 10.3.3.36	
Integrity check info	CH		Integrity check info 10.3.3.16	
Failure cause	MP		Failure cause and error information 10.3.3.14	
RB information elements				
Radio bearers for which reconfiguration would have succeeded	OP	1 to <maxRB>		
>Radio bearer for which reconfiguration would have succeeded	MP		RB identity, 10.3.4.16	

10.2.36 RRC CONNECTION REJECT

The network transmits this message when the requested RRC connection cannot be accepted.

RLC-SAP: UM

Logical channel: CCCH

Direction: UTRAN → UE

Information Element/Group name	Need	Multi	Type and reference	Semantics description
Message Type	MP		Message Type	
UE information elements				
RRC transaction identifier	MP		RRC transaction identifier 10.3.3.36	
Initial UE identity	MP		Initial UE identity 10.3.3.15	
Rejection cause	MP		Rejection cause 10.3.3.31	
Wait time	MP		Wait time 10.3.3.50	
Redirection info	OP		Redirection info 10.3.3.29	

10.2.37 RRC CONNECTION RELEASE

This message is sent by UTRAN to release the RRC connection. The message also releases the signalling connection and all radio bearers between the UE and UTRAN.

RLC-SAP: UM

Logical channel: CCCH or DCCH

Direction: UTRAN→UE

Information Element/Group name	Need	Multi	Type and reference	Semantics description
Message Type	MP		Message Type	
UE information elements				
U-RNTI	CV- <i>CCCH</i>		U-RNTI 10.3.3.47	
RRC transaction identifier	MP		RRC transaction identifier 10.3.3.36	
Integrity check info	CV- <i>DCCH</i>		Integrity check info 10.3.3.16	Integrity check info is included if integrity protection is applied
N308	CH- <i>Cell_DCH</i>		Integer(1..8)	
Release cause	MP		Release cause 10.3.3.32	
Other information elements				
Rplmn information	OP		Rplmn information 10.3.8.15	

Condition	Explanation
<i>CCCH</i>	This IE is mandatory present when <i>CCCH</i> is used and not needed otherwise.
<i>DCCH</i>	This IE is mandatory present when <i>DCCH</i> is used and not needed otherwise.
<i>Cell_DCH</i>	This IE is mandatory present when UE is in <i>CELL_DCH</i> state and not needed otherwise.

10.2.38 RRC CONNECTION RELEASE COMPLETE

This message is sent by UE to confirm that the RRC connection has been released.

RLC-SAP: AM or UM

Logical channel: DCCH

Direction: UE → UTRAN

Information Element/Group name	Need	Multi	Type and reference	Semantics description
Message Type	MP		Message Type	
UE information elements				
RRC transaction identifier	MP		RRC transaction identifier 10.3.3.36	
Integrity check info	CH		Integrity check info 10.3.3.16	
Error indication	OP		Failure cause and error information 10.3.3.14	

10.2.39 RRC CONNECTION REQUEST

RRC Connection Request is the first message transmitted by the UE when setting up an RRC Connection to the network.

RLC-SAP: TM

Logical channel: CCCH

Direction: UE → UTRAN

Information Element/Group name	Need	Multi	Type and reference	Semantics description	Version
Message Type	MP		Message Type		
UE information elements					
Initial UE identity	MP		Initial UE identity 10.3.3.15		
Establishment cause	MP		Establishment cause 10.3.3.11		
Protocol error indicator	MD		Protocol error indicator 10.3.3.27	Default value is FALSE	
>UE Specific Behaviour Information 1 idle	OP		UE Specific Behaviour Information 1 idle 10.3.3.51	This IE shall not be included in this version of the protocol	
Measurement information elements					
Measured results on RACH	OP		Measured results on RACH 10.3.7.45		
Access stratum release indicator	MP		Enumerated(REL-4)	Absence of the IE implies R99. The IE also indicates the release of the RRC transfer syntax supported by the UE 15 spare values are needed	REL-4

If the encoded message does not fill a transport block, the RRC layer shall insert padding according to subclause 12.1.

10.2.40 RRC CONNECTION SETUP

This message is used by the network to accept the establishment of an RRC connection for a UE, including assignment of signalling link information, transport channel information and optionally physical channel information.

RLC-SAP: UM

Logical channel: CCCH

Direction: UTRAN → UE

Information Element/Group name	Need	Multi	Type and reference	Semantics description	Version
Message Type	MP		Message Type		
UE Information Elements					
Initial UE identity	MP		Initial UE identity 10.3.3.15		
RRC transaction identifier	MP		RRC transaction identifier 10.3.3.36		
Activation time	MD		Activation time 10.3.3.1	Default value is "now"	
New U-RNTI	MP		U-RNTI 10.3.3.47		

Information Element/Group name	Need	Multi	Type and reference	Semantics description	Version
New C-RNTI	OP		C-RNTI 10.3.3.8		
RRC State Indicator	MP		RRC State Indicator 10.3.3.35a		
UTRAN DRX cycle length coefficient	MP		UTRAN DRX cycle length coefficient 10.3.3.49		
Capability update requirement	MD		Capability update requirement 10.3.3.2	Default value is defined in subclause 10.3.3.2	
RB Information Elements					
Signalling RB information to setup list	MP	3 to 4			
>Signalling RB information to setup	MP		Signalling RB information to setup 10.3.4.24		
TrCH Information Elements					
Uplink transport channels					
UL Transport channel information common for all transport channels	OP		UL Transport channel information common for all transport channels 10.3.5.24		
Added or Reconfigured TrCH information list	MP	1 to <maxTrCH >		Although this IE is not required when the IE "RRC state indicator" is set to "CELL_FACH", need is MP to align with ASN.1	
	OP				REL-4
>Added or Reconfigured UL TrCH information	MP		Added or Reconfigured UL TrCH information 10.3.5.2		
Downlink transport channels					
DL Transport channel information common for all transport channels	OP		DL Transport channel information common for all transport channels 10.3.5.6		
Added or Reconfigured TrCH information list	MP	1 to <maxTrCH >		Although this IE is not required when the IE "RRC state indicator" is set to "CELL_FACH", need is MP to align with ASN.1	
	OP				REL-4
>Added or Reconfigured DL TrCH information	MP		Added or Reconfigured DL TrCH information 10.3.5.1		
PhyCH information elements					

Information Element/Group name	Need	Multi	Type and reference	Semantics description	Version
Frequency info	OP		Frequency info 10.3.6.36		
Uplink radio resources					
Maximum allowed UL TX power	MD		Maximum allowed UL TX power 10.3.6.39	Default value is the existing maximum UL TX power	
<i>CHOICE channel requirement</i>					
>Uplink DPCH info			Uplink DPCH info 10.3.6.88		
>CPCH SET Info			CPCH SET Info 10.3.6.13		
Downlink radio resources					
Downlink information common for all radio links	OP		Downlink information common for all radio links 10.3.6.24		
Downlink information per radio link list	OP	1 to <MaxRL>		Send downlink information for each radio link to be set-up	
>Downlink information for each radio link	MP		Downlink information for each radio link 10.3.6.27		

10.2.41 RRC CONNECTION SETUP COMPLETE

This message confirms the establishment of the RRC Connection by the UE.

RLC-SAP: AM

Logical channel: DCCH

Direction: UE → UTRAN

Information Element/Group name	Need	Multi	Type and reference	Semantics description
Message Type	MP		Message Type	
UE Information Elements				
RRC transaction identifier	MP		RRC transaction identifier 10.3.3.36	
START list	MP	1 to <maxCNdo mains>		START [40] values for all CN domains.
>CN domain identity	MP		CN domain identity 10.3.1.1	
>START	MP		START 10.3.3.38	START value to be used in this CN domain.
UE radio access capability	OP		UE radio access capability 10.3.3.42	

Information Element/Group name	Need	Multi	Type and reference	Semantics description
UE radio access capability extension	OP		UE radio access capability extension 10.3.3.42a	
Other information elements				
UE system specific capability	OP	1 to <maxInter SysMessages>		
>Inter-RAT UE radio access capability	MP		Inter-RAT UE radio access capability 10.3.8.7	

10.2.41a RRC FAILURE INFO

This message is sent by the UE via another radio access technology to provide information about the cause for failure to perform the requested operation.

RLC-SAP: N/A (Sent through a different RAT)

Logical channel: N/A (Sent through a different RAT)

Direction: UE → UTRAN

Information Element/Group Name	Need	Multi	Type and reference	Semantics description
Other Information elements				
Failure cause	MP		Failure cause 10.3.3.13	
Protocol error information	CV-ProtErr		Protocol error information 10.3.8.12	

Condition	Explanation
<i>ProtErr</i>	Presence is mandatory if the IE "Failure cause" has the value "Protocol error"; otherwise the element is not needed in the message.

10.2.42 RRC STATUS

This message is sent to indicate a protocol error.

RLC-SAP: AM

Logical channel: DCCH

Direction: UE→UTRAN

Information Element/Group name	Need	Multi	Type and reference	Semantics description
Message Type	MP		Message Type	
UE information elements				
Integrity check info	CH		Integrity check info 10.3.3.16	Integrity check info is included if integrity protection is applied

Information Element/Group name	Need	Multi	Type and reference	Semantics description
Identification of received message	CV- <i>Message identified</i>			
>Received message type	MP		Message Type	
>RRC transaction identifier	MP		RRC transaction identifier 10.3.3.36	
Other information elements				
Protocol error information	MP		Protocol error information 10.3.8.12	

Condition	Explanation
<i>Message identified</i>	This IE is mandatory present if the IE "Protocol error cause" in the IE "Protocol error information" has any other value than "ASN.1 violation or encoding error" or "Message type non-existent or not implemented" and not needed otherwise.

10.2.43 SECURITY MODE COMMAND

This message is sent by UTRAN to start or reconfigure ciphering and/or integrity protection parameters.

RLC-SAP: AM

Logical channel: DCCCH

Direction: UTRAN to UE

Information Element/Group name	Need	Multi	Type and reference	Semantics description
Message Type	MP		Message Type	
UE information elements				
RRC transaction identifier	MP		RRC transaction identifier 10.3.3.36	
Integrity check info	MP		Integrity check info 10.3.3.16	
Security capability	MP		Security capability 10.3.3.37	
Ciphering mode info	OP		Ciphering mode info 10.3.3.5	Only present if ciphering shall be controlled
Integrity protection mode info	OP		Integrity protection mode info 10.3.3.19	Only present if integrity protection shall be controlled
CN Information elements				
CN domain identity	MP		CN domain identity 10.3.1.1	Indicates which cipher and integrity protection keys are applicable

Information Element/Group name	Need	Multi	Type and reference	Semantics description
Other information elements				
UE system specific security capability	CH	1 to <maxInter SysMessages>		This IE is included if the IE "Inter-RAT UE radio access capability" was included in RRC CONNECTION SETUP COMPLETE message
>Inter-RAT UE security capability	MP		Inter-RAT UE security capability 10.3.8.8a	

10.2.44 SECURITY MODE COMPLETE

This message is sent by UE to confirm the reconfiguration of ciphering and/or integrity protection.

RLC-SAP: AM

Logical channel: DCCH

Direction: UE to UTRAN

Information Element/Group name	Need	Multi	Type and reference	Semantics description
Message Type	MP		Message Type	
UE information elements				
RRC transaction identifier	MP		RRC transaction identifier 10.3.3.36	
Integrity check info	MP		Integrity check info 10.3.3.16	
Uplink integrity protection activation info	OP		Integrity protection activation info 10.3.3.17	
RB Information elements				
Radio bearer uplink ciphering activation time info	OP		RB activation time info 10.3.4.13	

10.2.45 SECURITY MODE FAILURE

This message is sent to indicate a failure to act on a received SECURITY MODE COMMAND message.

RLC-SAP: AM

Logical channel: DCCH

Direction: UE→UTRAN

Information Element/Group name	Need	Multi	Type and reference	Semantics description
Message Type	MP		Message Type	
UE information elements				
RRC transaction identifier	MP		RRC transaction identifier 10.3.3.36	
Integrity check info	CH		Integrity check info 10.3.3.16	
Failure cause	MP		Failure cause and error information 10.3.3.14	

10.2.46 SIGNALLING CONNECTION RELEASE

This message is used to notify the UE that its ongoing signalling connection to a CN domain has been released.

RLC-SAP: AM

Logical channel: DCCH

Direction: UTRAN→UE

Information Element/Group name	Need	Multi	Type and reference	Semantics description
Message Type	MP		Message Type	
UE information elements				
RRC transaction identifier	MP		RRC transaction identifier 10.3.3.36	
Integrity check info	CH		Integrity check info 10.3.3.16	Integrity check info is included if integrity protection is applied
CN information elements				
CN domain identity	MP		CN domain identity 10.3.1.1	

10.2.47 SIGNALLING CONNECTION RELEASE INDICATION

This message is used by the UE to indicate to UTRAN the release of an existing signalling connection.

RLC-SAP: AM

Logical channel: DCCH

Direction: UE→UTRAN

Information Element/Group name	Need	Multi	IE type and reference	Semantics description
Message Type	MP		Message type	
UE Information Elements				
Integrity check info	CH		Integrity check info 10.3.3.16	
CN information elements				
CN domain identity	MP		CN domain identity 10.3.1.1	

10.2.48 SYSTEM INFORMATION

Information Element/Group name	Need	Multi	Type and reference	Semantics description
Message type	CV- <i>channel1</i>		Message type	
SFNprime	CV- <i>channel2</i>		Integer(0..40 94 by step of 2)	SFN=SFNprime (for first 10ms frame of 20ms TTI), SFN=SFNprime+1 (for last 10ms frame of 20ms TTI)
CHOICE <i>Segment combination</i>	MP			Five spares are needed
>Combination 1				(no data)
>Combination 2				
>>First Segment	MP		First Segment, 10.2.48.1	
>Combination 3				
>>Subsequent Segment	MP		Subsequent Segment, 10.2.48.3	
>Combination 4				
>>Last segment	MP		Last segment (short),10.2. 48.5	
>Combination 5				
>>Last segment	MP		Last Segment (short)10.2.4 8.5	
>>First Segment	MP		First Segment (short), 10.2.48.2	
>Combination 6				
>>Last Segment	MP		Last Segment (short), 10.2.48.5	
>>Complete list	MP	1 to maxSIBper Msg		Note 1

Information Element/Group name	Need	Multi	Type and reference	Semantics description
>>>Complete	MP		Complete SIB (short),10.2.48.7	
>Combination 7				
>>Last Segment	MP		Last Segment (short), 10.2.48.5	
>>Complete list	MP	1..<maxSIBperMsg>		Note 1
>>>Complete	MP		Complete SIB (short),10.2.48.7	
>>First Segment	MP		First Segment (short), 10.2.48.2	
>Combination 8				
>>Complete list	MP	1 to maxSIBperMsg		Note 1
>>>Complete	MP		Complete SIB (short),10.2.48.7	
>Combination 9				
>>Complete list	MP	1..MaxSIBperMsg		Note 1
>>>Complete	MP		Complete SIB (short),10.2.48.7	
>>First Segment	MP		First Segment (short), 10.2.48.2	
>Combination 10				
>>>Complete SIB of size 215 to 226	MP		Complete SIB,10.2.48.6	
>Combination 11				
>>Last segment of size 215 to 222	MP		Last segment,10.2.48.4	

Condition	Explanation
<i>channel1</i>	The IE is mandatory present if the message is sent on the FACH and not needed otherwise.
<i>channel2</i>	This IE is mandatory present if the channel is BCH, otherwise it is not needed.

If the encoded message does not fill a transport block, the RRC layer shall insert padding according to subclause 12.1. Padding is needed e.g. if the remaining space is insufficient to start a new First Segment (which requires several bits for SIB type, SEG_COUNT and SIB data).

NOTE 1: If Combination 6 - 9 contains a Master information block Master information shall be located as the first IE in the list.

10.2.48.1 First Segment

This segment type is used to transfer the first segment of a segmented system information block. The IE is used when the first segment fills the entire transport block (Combination 2).

Information Element/Group name	Need	Multi	Type and reference	Semantics description
Other information elements				
SIB type	MP		SIB Type, 10.3.8.21	
SEG_COUNT	MP		SEG COUNT, 10.3.8.17	
SIB data fixed	MP		SIB data fixed, 10.3.8.19	

10.2.48.2 First Segment (short)

This segment type is used to transfer the first segment of a segmented system information block. The IE is used when the first segment is concatenated after other segments in a transport block (Combination 5, 7 and 9).

Information Element/Group name	Need	Multi	Type and reference	Semantics description
Other information elements				
SIB type	MP		SIB Type, 10.3.8.21	
SEG_COUNT	MP		SEG COUNT, 10.3.8.17	
SIB data variable	MP		SIB data variable, 10.3.8.20	

10.2.48.3 Subsequent Segment

This segment type is used to transfer a subsequent segment of a segmented system information block.

Information Element/Group name	Need	Multi	Type and reference	Semantics description
Other information elements				
SIB type	MP		SIB Type, 10.3.8.21	
Segment index	MP		Segment Index, 10.3.8.18	
SIB data fixed	MP		SIB data fixed, 10.3.8.19	

10.2.48.4 Last Segment

This segment type is used to transfer the last segment of a segmented system information block. The IE is used when the last segment has a length, excluding length denominator, from 215 through 222 (Combination 11).

Information Element/Group name	Need	Multi	Type and reference	Semantics description
Other information elements				
SIB type	MP		SIB Type, 10.3.8.21	
Segment index	MP		Segment Index, 10.3.8.18	
SIB data fixed	MP		SIB data fixed, 10.3.8.19	In case the SIB data is less than 222 bits, padding shall be used. The same padding bits shall be used as defined in clause 12.1

10.2.48.5 Last Segment (short)

This segment type is used to transfer the last segment of a segmented system information block. The IE is used when the last segment has a length, excluding length denominator, of upto 214 bits (Combination 4, 5, 6 and 7).

Information Element/Group name	Need	Multi	Type and reference	Semantics description
Other information elements				
SIB type	MP		SIB Type, 10.3.8.21	
Segment index	MP		Segment Index, 10.3.8.18	
SIB data variable	MP		SIB data variable, 10.3.8.20	

10.2.48.6 Complete SIB

This segment type is used to transfer a non-segmented system information block. The IE is used when the complete SIB has a length, excluding length denominator, from 215 through 226 (Combination 10).

Information Element/Group name	Need	Multi	Type and reference	Semantics description
Other information elements				
SIB type	MP		SIB Type, 10.3.8.21	
SIB data fixed	MP		Bit string (226)	The first/leftmost/most significant bit of the bit string contains the first bit of the segment. In case the SIB data is less than 226 bits, padding shall be used. The same padding bits shall be used as defined in clause 12.1

10.2.48.7 Complete SIB (short)

This segment type is used to transfer a non-segmented system information block. The IE is used when the complete SIB has a length, excluding length denominator, of upto 214 bits (Combination 6, 7, 8 and 9).

Information Element/Group name	Need	Multi	Type and reference	Semantics description
Other information elements				
SIB type	MP		SIB Type, 10.3.8.21	
SIB data variable	MP		SIB data variable, 10.3.8.20	

10.2.48.8 System Information Blocks

The IE "SIB data" within the IEs, "First Segment", "Subsequent or last Segment" and "Complete SIB" contains either complete system information block or a segment of a system information block. The actual system information blocks are defined in the following clauses.

10.2.48.8.1 Master Information Block

Information Element/Group name	Need	Multi	Type and reference	Semantics description
Other information elements				
MIB Value tag	MP		MIB Value tag 10.3.8.9	
CN information elements				
Supported PLMN types	MP		PLMN Type 10.3.1.12	
PLMN Identity	CV-GSM		PLMN Identity 10.3.1.11	
ANSI-41 information elements				
ANSI-41 Core Network Information	CV-ANSI-41		ANSI-41 Core Network Information 10.3.9.1	
References to other system information blocks and scheduling blocks	MP		References to other system information blocks and scheduling blocks 10.3.8.14	

Condition	Explanation
GSM	The IE is mandatory present if the IE "Supported PLMN Types" is set to 'GSM-MAP' or 'GSM-MAP AND ANSI-41', and not needed otherwise
ANSI-41	The IE is mandatory present if the IE "Supported PLMN Types" is set to 'ANSI-41' or 'GSM-MAP AND ANSI-41', and not needed otherwise

10.2.48.8.2 Scheduling Block 1

Information Element/Group name	Need	Multi	Type and reference	Semantics description
References to other system information blocks	MP		References to other system information blocks 10.3.8.13	

10.2.48.8.3 Scheduling Block 2

Information Element/Group name	Need	Multi	Type and reference	Semantics description
References to other system information blocks	MP		References to other system information blocks 10.3.8.13	

10.2.48.8.4 System Information Block type 1

The system information block type 1 contains NAS system information as well as UE timers and counters to be used in idle mode and in connected mode.

Information Element/Group name	Need	Multi	Type and reference	Semantics description
CN information elements				
CN common GSM-MAP NAS system information	MP		NAS system information (GSM-MAP) 10.3.1.9	
CN domain system information list	MP	1 to <maxCNdo mains>		Send CN information for each CN domain.
>CN domain system information	MP		CN domain system information 10.3.1.2	
UE information				
UE Timers and constants in idle mode	MD		UE Timers and constants in idle mode 10.3.3.44	Default value means that for all timers and constants - For parameters with need MD, the defaults specified in 10.3.3.44 apply and - For parameters with need OP, the parameters are absent
UE Timers and constants in connected mode	MD		UE Timers and constants in connected mode 10.3.3.43	Default value means that for all timers and constants - For parameters with need MD, the defaults specified in 10.3.3.43 apply and - For parameters with need OP, the parameters are absent

10.2.48.8.5 System Information Block type 2

The system information block type 2 contains the URA identity.

Information Element/Group name	Need	Multi	Type and reference	Semantics description
UTRAN mobility information elements				
URA identity list	MP	1 ..<maxURA>		
>URA identity	MP		URA identity 10.3.2.6	

10.2.48.8.6 System Information Block type 3

The system information block type 3 contains parameters for cell selection and re-selection.

Information Element/Group name	Need	Multi	Type and reference	Semantics description
SIB4 Indicator	MP		Boolean	TRUE indicates that SIB4 is broadcast in the cell.
UTRAN mobility information elements				
Cell identity	MP		Cell identity 10.3.2.2	
Cell selection and re-selection info	MP		Cell selection and re-selection info for SIB3/4 10.3.2.3	
Cell Access Restriction	MP		Cell Access Restriction 10.3.2.1	

10.2.48.8.7 System Information Block type 4

The system information block type 4 contains parameters for cell selection and re-selection to be used in connected mode.

Information Element/Group name	Need	Multi	Type and reference	Semantics description
UTRAN mobility information elements				
Cell identity	MP		Cell identity 10.3.2.2	
Cell selection and re-selection info	MP		Cell selection and re-selection info for SIB3/4 10.3.2.3	
Cell Access Restriction	MP		Cell Access Restriction 10.3.2.1	

10.2.48.8.8 System Information Block type 5

The system information block type 5 contains parameters for the configuration of the common physical channels in the cell.

Information Element/Group name	Need	Multi	Type and reference	Semantics description
SIB6 Indicator	MP		Boolean	TRUE indicates that SIB6 is broadcast in the cell.
PhyCH information elements				
PICH Power offset	MP		PICH Power offset 10.3.6.50	
CHOICE <i>mode</i>	MP			
>FDD				
>>AICH Power offset	MP		AICH Power offset 10.3.6.3	This AICH Power offset also indicates the power offset for AP-AICH and for CD/CA-ICH.
>TDD				
>>PUSCH system information	OP		PUSCH system information 10.3.6.66	
>>PDSCH system information	OP		PDSCH system information 10.3.6.46	
>>TDD open loop power control	MP		TDD open loop power control 10.3.6.79	
Primary CCPCH info	OP		Primary CCPCH info 10.3.6.57	Note 1
PRACH system information list	MP		PRACH system information list 10.3.6.55	
Secondary CCPCH system information	MP		Secondary CCPCH system information 10.3.6.72	
CBS DRX Level 1 information	CV-CTCH		CBS DRX Level 1 information 10.3.8.3	

NOTE 1: DL scrambling code of the Primary CCPCH is the same as the one for Primary CPICH (FDD only).

Condition	Explanation
CTCH	The IE is mandatory present if the IE "CTCH indicator" is equal to TRUE for at least one FACH, otherwise the IE is not needed in the message

10.2.48.8.9 System Information Block type 6

The system information block type 6 contains parameters for the configuration of the common and shared physical channels to be used in connected mode.

Information Element/Group name	Need	Multi	Type and reference	Semantics description
PhyCH information elements				
PICH Power offset	MP		PICH Power offset	

Information Element/Group name	Need	Multi	Type and reference	Semantics description
CHOICE <i>mode</i>	MP		10.3.6.50	
>FDD				
>>AICH Power offset	MP		AICH Power offset 10.3.6.3	This AICH Power offset also indicates the power offset for AP-AICH and for CD/CA-ICH.
>TDD				
>>PUSCH system information	OP		PUSCH system information 10.3.6.66	
>>PDSCH system information	OP		PDSCH system information 10.3.6.46	
>>TDD open loop power control	MP		TDD open loop power control 10.3.6.79	
Primary CCPCH info	OP		Primary CCPCH info 10.3.6.57	Note 1
PRACH system information list	OP		PRACH system information list 10.3.6.55	
Secondary CCPCH system information	OP		Secondary CCPCH system information 10.3.6.72	
CBS DRX Level 1 information	CV-CTCH		CBS DRX Level 1 information 10.3.8.3	

NOTE 1: DL scrambling code of the Primary CCPCH is the same as the one for Primary CPICH (FDD only).

Condition	Explanation
CTCH	The IE is mandatory present if the IE "CTCH indicator" is equal to TRUE for at least one FACH, otherwise the IE is not needed

10.2.48.8.10 System Information Block type 7

The system information block type 7 contains the fast changing parameters UL interference and Dynamic persistence level.

Information Element/Group name	Need	Multi	Type and reference	Semantics description
CHOICE <i>mode</i>	MP			
>FDD				
>>UL interference	MP		UL interference 10.3.6.87	
>TDD				(no data)
PhyCH information elements				
PRACHs listed in system information block type 5	MP	1 to <maxPRACH>		The order of the PRACHs is the same as in system information block type 5.
>Dynamic persistence level	MP		Dynamic persistence level 10.3.6.35	
PRACHs listed in system information block type 6	OP	1 to <maxPRACH>		The order of the PRACHs is the same as in system information block type 6.
>Dynamic persistence level	MP		Dynamic persistence level 10.3.6.35	
Expiration Time Factor	MD		Expiration Time Factor 10.3.3.12	Default is 1.

10.2.48.8.11 System Information Block type 8

NOTE: Only for FDD.

The system information block type 8 contains static CPCH information to be used in the cell.

Information Element/Group name	Need	Multi	Type and reference	Semantics description
UE information				
CPCH parameters	MP		CPCH parameters 10.3.3.7	
PhyCH information elements				
CPCH set info list	MP	1 to <maxCPC Hsets>		
>CPCH set info	MP		CPCH set info 10.3.6.13	
CSICH Power offset	MP		CSICH Power offset 10.3.6.15	

10.2.48.8.12 System Information Block type 9

NOTE: Only for FDD.

The system information block type 9 contains CPCH information to be used in the cell.

Information Element/Group name	Need	Multi	Type and reference	Semantics description
PhyCH information elements				
CPCH set persistence levels list	MP	1 to <maxCPC Hsets>		
>CPCH set persistence levels	MP		CPCH persistence levels 10.3.6.12	

10.2.48.8.13 System Information Block type 10

NOTE: Only for FDD.

The system information block type 10 contains information to be used by UEs having their DCH controlled by a DRAC procedure.

Information Element/Group name	Need	Multi	Type and reference	Semantics description
UE information				
DRAC system information	MP		DRAC system information 10.3.3.9	DRAC information is sent for each class of terminal

10.2.48.8.14 System Information Block type 11

The system information block type 11 contains measurement control information to be used in the cell.

Information Element/Group name	Need	Multi	Type and reference	Semantics description
SIB12 Indicator	MP		Boolean	TRUE indicates that SIB12 is broadcast in the cell.
Measurement information elements				
FACH measurement occasion info	OP		FACH measurement occasion info 10.3.7.8	
Measurement control system information	MP		Measurement control system information 10.3.7.47	

10.2.48.8.15 System Information Block type 12

The system information block type 12 contains measurement control information to be used in connected mode.

Information Element/Group name	Need	Multi	Type and reference	Semantics description
Measurement information elements				
FACH measurement occasion info	OP		FACH measurement occasion info 10.3.7.8	
Measurement control system information	MP		Measurement control system information 10.3.7.47	

10.2.48.8.16 System Information Block type 13

The system information block type 13 contains ANSI-41 system information.

Information Element/Group name	Need	Multi	Type and reference	Semantics description
Other information elements				
CN Information Elements				
CN Domain system information list	MP	1 to <maxCNdo mains>		Send CN information for each CN domain.
>CN Domain system information	MP		CN Domain system information 10.3.1.2	
UE Information				
UE timers and constants in idle mode	MD		UE timers and constants in idle mode 10.3.3.44	Default value means that for all timers and constants <ul style="list-style-type: none"> - for parameters with need MD, the defaults specified in 10.3.3.44 apply; and - for parameters with need OP, the parameters are absent.
Capability update requirement	MD		Capability update requirement 10.3.3.2	Default value is defined in subclause 10.3.3.2

10.2.48.8.16.1 System Information Block type 13.1

The system information block type 13.1 contains the ANSI-41 RAND information.

Information Element/Group name	Need	Multi	Type and reference	Semantics description
ANSI-41 information elements				
ANSI-41 RAND information	MP		ANSI-41 RAND information 10.3.9.6	

10.2.48.8.16.2 System Information Block type 13.2

The system information block type 13.2 contains the ANSI-41 User Zone Identification information.

Information Element/Group name	Need	Multi	Type and reference	Semantics description
ANSI-41 information elements				
ANSI-41 User Zone Identification information	MP		ANSI-41 User Zone Identification information 10.3.9.7	

10.2.48.8.16.3 System Information Block type 13.3

The system information block type 13.3 contains the ANSI-41 Private Neighbour List information.

Information Element/Group name	Need	Multi	Type and reference	Semantics description
ANSI-41 information elements				
ANSI-41 Private Neighbour List information	MP		ANSI-41 Private Neighbour List information 10.3.9.5	

10.2.48.8.16.4 System Information Block type 13.4

The system information block type 13.4 contains the ANSI-41 Global Service Redirection information.

Information Element/Group name	Need	Multi	Type and reference	Semantics description
ANSI-41 information elements				
ANSI-41 Global Service Redirection information	MP		ANSI-41 Global Service Redirection information 10.3.9.2	

10.2.48.8.17 System Information Block type 14

NOTE: Only for 3.84 Mcps TDD.

The system information block type 14 contains parameters for common and dedicated physical channel uplink outer loop power control information to be used in both idle and connected mode.

Information Element/Group name	Need	Multi	Type and reference	Semantics description
PhyCH information elements				
Individual Timeslot interference list	MP	1 to <maxTS>		
>Individual Timeslot interference	MP		Individual Timeslot interference 10.3.6.38	
Expiration Time Factor	MD		Expiration Time Factor 10.3.3.12	Default is 1.

10.2.48.8.18 System Information Block type 15

The system information block type 15 contains information useful for UE-based or UE-assisted positioning methods.

Information Element/Group name	Need	Multi	Type and Reference	Semantics description
GPS Data ciphering info	OP		UE positioning Cipher info 10.3.7.86	If this IE is present then the SIB types 15.1, 15.2 & 15.3 are ciphered in accordance with the Data Assistance Ciphering Algorithm specified in [18]
Reference position	MP		Ellipsoid point with altitude and uncertainty ellipsoid 10.3.8.4c	approximate position where the UE is located
GPS reference time	MP		UE positioning GPS reference time 10.3.7.96	
Satellite information	OP	1 to <maxSat>		This IE is present whenever bad (failed/failing) satellites are detected by UTRAN [18].
>BadSatID	MP		Enumerated(0..63)	

10.2.48.8.18.1 System Information Block type 15.1

The system information block type 15.1 contains information useful for UE positioning DGPS Corrections. The DGPS Corrections message contents are based on a Type-1 message of DGPS specified in [13].

Information Element/Group name	Need	Multi	Type and Reference	Semantics description
DGPS corrections	MP		UE positioning GPS DGPS corrections 10.3.7.91	

10.2.48.8.18.2 System Information Block type 15.2

The system information block type 15.2 contains information useful for GPS Navigation Model. These IE fields are based on information extracted from the subframes 1 to 3 of the GPS navigation message [12].

Information Element/Group name	Need	Multi	Type and Reference	Semantics description
Transmission TOW	MP		Integer (0..604799)	The approximate GPS time-of-week when the message is broadcast. in seconds
SatID	MP		Enumerated(0..63)	Satellite ID
GPS Ephemeris and Clock Correction Parameters	MP		UE positioning GPS Ephemeris and Clock Correction parameters 10.3.7.91a	

10.2.48.8.18.3 System Information Block type 15.3

The system information block type 15.3 contains information useful for ionospheric delay, UTC offset, and Almanac. These IEs contain information extracted from the subframes 4 and 5 of the GPS navigation message, [12].

Information Element/Group name	Need	Multi	Type and Reference	Semantics description
Transmission TOW	MP		Integer (0..604799)	The approximate GPS time-of-week when the message is broadcast. in seconds
GPS Almanac and Satellite Health	OP		UE positioning GPS almanac 10.3.7.89	
GPS ionospheric model	OP		UE positioning GPS ionospheric model 10.3.7.92	
GPS UTC model	OP		UE positioning GPS UTC model 10.3.7.97	
SatMask	CV- <i>Almanac</i>		Bit string(1..32)	indicates the satellites that contain the pages being broadcast in this data set
LSB TOW	CV- <i>Almanac</i>		Bit string(8)	

Condition	Explanation
<i>Almanac</i>	This IE is mandatory present if the IE "GPS Almanac and Satellite Health" is present

10.2.48.8.18.4 System Information Block type 15.4

The system information block type 15.4 contains ciphering information for System Information Block type 15.5 and information useful for OTDOA UE-assisted Positioning method.

Information Element/Group name	Need	Multi	Type and Reference	Semantics description
OTDOA Data ciphering info	OP		UE positioning Ciphering info 10.3.7.86	If this IE is present then the for UE-based the System Information Block type 15.5 is ciphered in accordance with the Data Assistance Ciphering Algorithm specified in [18]
OTDOA assistance data for UE-assisted	MP		UE positioning OTDOA assistance data for UE-assisted 10.3.7.103	

10.2.48.8.18.4a System Information Block type 15.5

The system information block type 15.5 contains information useful for OTDOA UE-based Positioning method.

Information Element/Group name	Need	Multi	Type and Reference	Semantics description
OTDOA assistance data for UE-based	MP		UE positioning OTDOA assistance data for UE-based 10.3.7.103a	

10.2.48.8.19 System Information Block type 16

The system information block type 16 contains radio bearer, transport channel and physical channel parameters to be stored by UE in idle and connected mode for use during handover to UTRAN.

Information Element/Group name	Need	Multi	Type and Reference	Semantics description
RB information elements				
Predefined RB configuration	MP		Predefined RB configuration 10.3.4.7	
TrCH Information Elements				
Predefined TrCH configuration	MP		Predefined TrCH configuration 10.3.5.9	
PhyCH Information Elements				
Predefined PhyCH configuration	MP		Predefined PhyCH configuration 10.3.6.56	

10.2.48.8.20 System Information Block type 17

NOTE: Only for TDD.

The system information block type 17 contains fast changing parameters for the configuration of the shared physical channels to be used in connected mode.

Information Element/Group name	Need	Multi	Type and reference	Semantics description
PhyCH information elements				
PUSCH system information	OP		PUSCH system information 10.3.6.66	
PDSCH system information	OP		PDSCH system information 10.3.6.46	

10.2.48.8.21 System Information Block type 18

The System Information Block type 18 contains PLMN identities of neighbouring cells to be considered in idle mode as well as in connected mode.

Information Element/Group name	Need	Multi	Type and reference	Semantics description
Idle mode PLMN identities	OP		PLMN identities of neighbour cells 10.3.7.53a	
Connected mode PLMN identities	OP		PLMN identities of neighbour cells 10.3.7.53a	

10.2.49 SYSTEM INFORMATION CHANGE INDICATION

This message is used to send information on FACH to the UEs in state CELL_FACH about coming modification of the system information.

RLC-SAP: TM

Logical channel: BCCH

Direction: UTRAN → UE

Information Element/Group name	Need	Multi	Type and reference	Semantics description
Message Type	MP		Message Type	
Other information elements				
BCCH modification info	MP		BCCH modification info 10.3.8.1	

If the encoded message does not fill a transport block, the RRC layer shall insert padding according to subclause 12.1.

10.2.50 TRANSPORT CHANNEL RECONFIGURATION

This message is used by UTRAN to configure the transport channel of a UE. This also includes a possible reconfiguration of physical channels. The message can also be used to assign a TFC subset and reconfigure physical channel.

RLC-SAP: AM or UM

Logical channel: DCCH

Direction: UTRAN → UE

Information Element/Group name	Need	Multi	Type and reference	Semantics description
Message Type	MP		Message Type	
UE Information Elements				
RRC transaction identifier	MP		RRC transaction identifier 10.3.3.36	
Integrity check info	CH		Integrity check info	

Information Element/Group name	Need	Multi	Type and reference	Semantics description
			10.3.3.16	
Integrity protection mode info	OP		Integrity protection mode info 10.3.3.19	The UTRAN should not include this IE unless it is performing an SRNS relocation.
Ciphering mode info	OP		Ciphering mode info 10.3.3.5	The UTRAN should not include this IE unless it is performing an SRNS relocation and a change in ciphering algorithm.
Activation time	MD		Activation time 10.3.3.1	Default value is "now"
New U-RNTI	OP		U-RNTI 10.3.3.47	
New C-RNTI	OP		C-RNTI 10.3.3.8	
New DSCH-RNTI	OP		DSCH-RNTI 10.3.3.9a	
RRC State Indicator	MP		RRC State Indicator 10.3.3.35a	
UTRAN DRX cycle length coefficient	OP		UTRAN DRX cycle length coefficient 10.3.3.49	
CN Information Elements				
CN Information info	OP		CN Information info 10.3.1.3	
UTRAN mobility information elements				
URA identity	OP		URA identity 10.3.2.6	
RB information elements				
Downlink counter synchronisation info	OP			
>RB with PDCP information list	OP	1 to <maxRBall RABs>		This IE is needed for each RB having PDCP in the case of lossless SRNS relocation
>>RB with PDCP information	MP		RB with PDCP information 10.3.4.22	
TrCH Information Elements				
Uplink transport channels				
UL Transport channel information common for all transport channels	OP		UL Transport channel information common for all transport channels 10.3.5.24	
Added or Reconfigured TrCH information list	OP	1 to <maxTrCH >		
>Added or Reconfigured UL TrCH information	MP		Added or Reconfigured UL TrCH information 10.3.5.2	
CHOICE <i>mode</i>	OP			
>FDD				
>>CPCH set ID	OP		CPCH set ID 10.3.5.3	
>>Added or Reconfigured TrCH	OP	1 to		

Information Element/Group name	Need	Multi	Type and reference	Semantics description
information for DRAC list		<maxTrCH >		
>>>DRAC static information	MP		DRAC static information 10.3.5.7	
>TDD				(no data)
Downlink transport channels				
DL Transport channel information common for all transport channels	OP		DL Transport channel information common for all transport channels 10.3.5.6	
Added or Reconfigured TrCH information list	OP	1 to <maxTrCH >		
>Added or Reconfigured DL TrCH information	MP		Added or Reconfigured DL TrCH information 10.3.5.1	
PhyCH information elements				
Frequency info	OP		Frequency info 10.3.6.36	
Uplink radio resources				
Maximum allowed UL TX power	MD		Maximum allowed UL TX power 10.3.6.39	Default value is the existing maximum UL TX power
CHOICE <i>channel requirement</i>	OP			
>Uplink DPCH info			Uplink DPCH info 10.3.6.88	
>CPCH SET Info			CPCH SET Info 10.3.6.13	
Downlink radio resources				
CHOICE <i>mode</i>	MP			
>FDD				
>>>Downlink PDSCH information	OP		Downlink PDSCH information 10.3.6.30	
>TDD				(no data)
Downlink information common for all radio links	OP		Downlink information common for all radio links 10.3.6.24	
Downlink information per radio link list	OP	1 to <maxRL>		Send downlink information for each radio link
>Downlink information for each radio link	MP		Downlink information for each radio link 10.3.6.27	

10.2.51 TRANSPORT CHANNEL RECONFIGURATION COMPLETE

This message is sent from the UE when a transport channel reconfiguration has been done.

RLC-SAP: AM

Logical channel: DCCH

Direction: UE → UTRAN

Information Element/Group name	Need	Multi	Type and reference	Semantics description	Version
Message Type	MP		Message Type		
UE information elements					
RRC transaction identifier	MP		RRC transaction identifier 10.3.3.36		
Integrity check info	CH		Integrity check info 10.3.3.16		
Uplink integrity protection activation info	OP		Integrity protection activation info 10.3.3.17		
CHOICE <i>mode</i>	OP				
>FDD				(no data)	
>TDD					
>>CHOICE <i>TDD option</i>	MP				REL-4
>>>3.84 Mcps TDD					REL-4
>>>>Uplink Timing Advance	OP		Uplink Timing Advance 10.3.6.95		
>>>1.28 Mcps TDD				(no data)	REL-4
RB Information elements					
COUNT-C activation time	OP		Activation time 10.3.3.1	Used for radio bearers mapped on RLC-TM. Only applicable if the UE is moving to CELL_DCH state due to this procedure	
Radio bearer uplink ciphering activation time info	OP		RB activation time info 10.3.4.13		
Uplink counter synchronisation info	OP				
>RB with PDCP information list	OP	1 to <maxRBall RABs>			
>>RB with PDCP information	MP		RB with PDCP information 10.3.4.22		
>START list	MP	1 to <maxCNdo mains>		START [40] values for all CN domains.	
>>CN domain identity	MP		CN domain identity 10.3.1.1		
>>>START	MP		START 10.3.3.38	START value to be used in this CN domain.	

10.2.52 TRANSPORT CHANNEL RECONFIGURATION FAILURE

This message is sent by UE if the configuration given by UTRAN is unacceptable or if the UE failed to establish the physical channel(s).

RLC-SAP: AM

Logical channel: DCCH

Direction: UE→UTRAN

Information Element/Group name	Need	Multi	Type and reference	Semantics description
Message Type	MP		Message Type	
UE information elements				
RRC transaction identifier	MP		RRC transaction identifier 10.3.3.36	
Integrity check info	CH		Integrity check info 10.3.3.16	
Failure cause	MP		Failure cause and error information 10.3.3.14	

10.2.53 TRANSPORT FORMAT COMBINATION CONTROL

This message is sent by UTRAN to control the uplink transport format combination within the allowed transport format combination set. This message has different structures depending if the message is sent on transparent (TM) or non-transparent mode (AM or UM).

RLC-SAP: AM or UM

Logical channel: DCCH

Direction: UTRAN→UE

Information Element/Group name	Need	Multi	Type and reference	Semantics description
Message Type	MP		Message Type	
UE information elements				
RRC transaction identifier	MP		RRC transaction identifier 10.3.3.36	
Integrity check info	CH		Integrity check info 10.3.3.16	
TrCH information elements				
CHOICE <i>mode</i>	MP			
>FDD				(no data)
>TDD				
>>TFCS Id	OP		Transport Format Combination Set Identity 10.3.5.21	
DPCH/PUSCH TFCS in uplink	MP		Transport Format Combination	

Information Element/Group name	Need	Multi	Type and reference	Semantics description
			subset 10.3.5.22	
Activation time for TFC subset	MD		Activation time 10.3.3.1	Default value is "now"
TFC Control duration	OP		TFC Control duration 10.3.6.80	

In case of transparent mode signalling the following message structure shall be used:

RLC-SAP: TM

Logical channel: DCCH

Direction: UTRAN→UE

Information Element/Group name	Need	Multi	Type and reference	Semantics description
CHOICE <i>TFCsubsetListSize</i>	MP			
>Three bits list size				
>>TFC subset identity	MP		INTEGER (0..7)	
>Five bits list size				
>>TFC subset identity	MP		INTEGER (0..31)	
>Ten bits list size				
>>TFC subset identity	MP		INTEGER (0..1023)	

The encoding of this message is specified in subclause 12.4.1.1.

10.2.54 TRANSPORT FORMAT COMBINATION CONTROL FAILURE

This message is sent to indicate that a received TRANSPORT FORMAT COMBINATION CONTROL message could not be handled by the UE.

RLC-SAP: AM

Logical channel: DCCH

Direction: UE→UTRAN

Information Element/Group name	Need	Multi	Type and reference	Semantics description
Message Type	MP		Message Type	
UE information elements				
RRC transaction identifier	MP		RRC transaction identifier 10.3.3.36	
Integrity check info	CH		Integrity check info 10.3.3.16	
Failure cause	MP		Failure cause and error information 10.3.3.14	

10.2.55 UE CAPABILITY ENQUIRY

The UE CAPABILITY ENQUIRY is used by the UTRAN to enquire inter-RAT classmarks from the UE.

RLC-SAP: AM or UM

Logical channel: DCCH

Direction: UTRAN → UE

Information Element/Group name	Need	Multi	Type and reference	Semantics description
Message Type	MP		Message Type	
UE information elements				
RRC transaction identifier	MP		RRC transaction identifier 10.3.3.36	
Integrity check info	CH		Integrity check info 10.3.3.16	Integrity check info is included if integrity protection is applied
Capability update requirement	MP		Capability update requirement 10.3.3.2	

10.2.56 UE CAPABILITY INFORMATION

This message is sent by UE to convey UE specific capability information to the UTRAN.

RLC-SAP: AM

Logical channel: DCCH

Direction: UE → UTRAN

Information Element/Group name	Need	Multi	Type and reference	Semantics description
Message Type	MP		Message Type	
UE information elements				
RRC transaction identifier	OP		RRC transaction identifier 10.3.3.36	
Integrity check info	CH		Integrity check info 10.3.3.16	Integrity check info is included if integrity protection is applied
UE radio access capability	OP		UE radio access capability 10.3.3.42	
UE radio access capability extension	OP		UE radio access capability extension 10.3.3.42a	
Other information elements				
UE system specific capability	OP	1 to <maxInter SysMessages>		
>Inter-RAT UE radio access capability	MP		Inter-RAT UE radio access capability 10.3.8.7	

10.2.57 UE CAPABILITY INFORMATION CONFIRM

This message is sent by UTRAN to confirm that UE capability information has been received.

RLC-SAP: AM or UM

Logical channel: DCCH

Direction: UTRAN → UE

Information Element/Group name	Need	Multi	Type and reference	Semantics description
Message Type	MP		Message Type	
UE information elements				
RRC transaction identifier	MP		RRC transaction identifier 10.3.3.36	
Integrity check info	CH		Integrity check info 10.3.3.16	Integrity check info is included if integrity protection is applied

10.2.58 UPLINK DIRECT TRANSFER

This message is used to transfer NAS messages for an existing signalling connection.

RLC-SAP: AM

Logical channel: DCCH

Direction: UE → UTRAN

Information Element/Group name	Need	Multi	Type and reference	Semantics description
Message Type	MP		Message Type	
UE information elements				
Integrity check info	CH		Integrity check info 10.3.3.16	Integrity check info is included if integrity protection is applied
CN information elements				
CN domain identity	MP		CN domain identity 10.3.1.1	
NAS message	MP		NAS message 10.3.1.8	
Measurement information elements				
Measured results on RACH	OP		Measured results on RACH 10.3.7.45	

10.2.59 UPLINK PHYSICAL CHANNEL CONTROL

NOTE: Only for TDD.

This message is used to transfer uplink physical channel parameters to the UE.

RLC-SAP: AM or UM

Logical channel: DCCH

Direction: UTRAN→UE

Information Element/Group name	Need	Multi	Type and Reference	Semantics description	Version
Message Type	MP		Message Type		
UE information elements					
RRC transaction identifier	MP		RRC transaction identifier 10.3.3.36		
Integrity check info	OP		Integrity check info 10.3.3.16		
PhyCH information elements					
CCTrCH power control info	OP		CCTrCH power control info 10.3.6.8	Power control information for one CCTrCH	
Special Burst Scheduling	OP		Special Burst Scheduling 10.3.6.75a	UL Special Burst generation period in radio frames	
CHOICE <i>TDD option</i>	MP				REL-4
>3.84 Mcps TDD					REL-4
>>Alpha	OP		Alpha 10.3.6.5		
>>Timing Advance Control	OP		UL Timing Advance Control 10.3.6.96		
>>PRACH Constant Value	OP		Constant value TDD	Operator controlled PRACH	

Information Element/Group name	Need	Multi	Type and Reference	Semantics description	Version
>>PUSCH Constant Value	OP		10.3.6.11a Constant value TDD 10.3.6.11a	Margin Operator controlled PUSCH Margin	
>>UE positioning related parameters	CV- <i>IPDLs</i>				REL-4
>>>IPDL-Alpha	MP		Alpha 10.3.6.5		REL-4
>>>Max power increase	MP		Integer (0..3)	In dB	REL-4
>1.28 Mcps TDD					REL-4
>>Uplink synchronisation parameters	MD			Default: Uplink synchronisation step size 1. Uplink synchronisation frequency 1.	REL-4
>>>Uplink synchronisation step size	MP		Integer(1..8)	This parameter specifies the step size to be used for the adjustment of the uplink transmission timing	REL-4
>>>Uplink synchronisation frequency	MP		Integer(1..8)	This parameter specifies the frequency of the adjustment of the uplink transmission timing	REL-4

Condition	Explanation
<i>IPDLs</i>	This IE is present only if idle periods are applied

10.2.60 URA UPDATE

This message is used by the UE to initiate a URA update procedure.

RLC-SAP: TM

Logical channel: CCCH

Direction: UE→UTRAN

Information Element/Group name	Need	Multi	Type and reference	Semantics description
Message Type	MP		Message Type	
UE information elements				
U-RNTI	MP		U-RNTI 10.3.3.47	
RRC transaction identifier	CV- <i>ProtErr</i>		RRC transaction identifier 10.3.3.36	
Integrity check info	CH		Integrity check info 10.3.3.16	
URA update cause	MP		URA update cause 10.3.3.46	
Protocol error indicator	MD		Protocol	Default value is FALSE

Information Element/Group name	Need	Multi	Type and reference	Semantics description
			error indicator 10.3.3.27	
Other information elements				
Protocol error information	CV-ProtErr		Protocol error information 10.3.8.12	

Condition	Explanation
<i>ProtErr</i>	The IE is mandatory present if the IE "Protocol error indicator" has the value "TRUE" and not needed otherwise.

10.2.61 URA UPDATE CONFIRM

This message confirms the URA update procedure and can be used to reallocate new RNTI information for the UE valid after the URA update.

RLC-SAP: UM

Logical channel: CCCH or DCCH

Direction: UTRAN→UE

Information Element/Group name	Need	Multi	Type and reference	Semantics description
Message Type	MP		Message Type	
UE information elements				
U-RNTI	CV-CCCH		U-RNTI 10.3.3.47	
RRC transaction identifier	MP		RRC transaction identifier 10.3.3.36	
Integrity check info	CH		Integrity check info 10.3.3.16	Integrity check info is included if integrity protection is applied
Integrity protection mode info	OP		Integrity protection mode info 10.3.3.19	The UTRAN should not include this IE unless it is performing an SRNS relocation.
Ciphering mode info	OP		Ciphering mode info 10.3.3.5	The UTRAN should not include this IE unless it is performing an SRNS relocation and a change in ciphering algorithm.
New U-RNTI	OP		U-RNTI 10.3.3.47	
New C-RNTI	OP		C-RNTI 10.3.3.8	
RRC State Indicator	MP		RRC State Indicator 10.3.3.35a	
UTRAN DRX cycle length coefficient	OP		UTRAN DRX cycle length coefficient 10.3.3.49	
CN Information Elements				
CN Information info	OP		CN Information	

Information Element/Group name	Need	Multi	Type and reference	Semantics description
			info 10.3.1.3	
UTRAN mobility information elements				
URA identity	OP		URA identity 10.3.2.6	
RB information elements				
Downlink counter synchronisation info	OP			
>RB with PDCP information list	OP	1 to <maxRBall RABs>		This IE is needed for each RB having PDCP in the case of lossless SRNS relocation
>>RB with PDCP information	MP		RB with PDCP information 10.3.4.22	

Condition	Explanation
<i>CCCH</i>	This IE is mandatory present when CCCH is used and not needed otherwise.

10.2.62 UTRAN MOBILITY INFORMATION

This message is used by UTRAN to allocate a new RNTI and to convey other UTRAN mobility related information to a UE.

RLC-SAP: AM or UM

Logical channel: DCCH

Direction: UTRAN→UE

Information Element/Group name	Need	Multi	Type and reference	Semantics description
Message Type	MP		Message Type	
UE Information Elements				
Integrity check info	CH		Integrity check info 10.3.3.16	
RRC transaction identifier	MP		RRC transaction identifier 10.3.3.36	
Integrity protection mode info	OP		Integrity protection mode info 10.3.3.19	The UTRAN should not include this IE unless it is performing an SRNS relocation.
Ciphering mode info	OP		Ciphering mode info 10.3.3.5	The UTRAN should not include this IE unless it is performing an SRNS relocation and a change in ciphering algorithm.
New U-RNTI	OP		U-RNTI 10.3.3.47	
New C-RNTI	OP		C-RNTI 10.3.3.8	
UE Timers and constants in connected mode	OP		UE Timers and constants in connected mode 10.3.3.43	

Information Element/Group name	Need	Multi	Type and reference	Semantics description
CN Information Elements				
CN Information info	OP		CN Information info full 10.3.1.3a	
UTRAN Information Elements				
URA identity	OP		URA identity 10.3.2.6	
RB Information elements				
Downlink counter synchronisation info	OP			
>RB with PDCP information list	OP	1 to <maxRBall RABs>		This IE is needed for each RB having PDCP in the case of lossless SRNS relocation
>>RB with PDCP information	MP		RB with PDCP information 10.3.4.22	

10.2.63 UTRAN MOBILITY INFORMATION CONFIRM

This message is used to confirm the new UTRAN mobility information for the UE.

RLC-SAP: AM

Logical channel: DCCH

Direction: UE→UTRAN

Information Element/Group name	Need	Multi	Type and reference	Semantics description
Message Type	MP		Message Type	
UE information elements				
RRC transaction identifier	MP		RRC transaction identifier 10.3.3.36	
Integrity check info	CH		Integrity check info 10.3.3.16	
Uplink integrity protection activation info	OP		Integrity protection activation info 10.3.3.17	
RB Information elements				
COUNT-C activation time	OP		Activation time 10.3.3.1	Used for radio bearers mapped on RLC-TM. Only applicable if the UE is moving to CELL_DCH state due to this procedure
Radio bearer uplink ciphering activation time info	OP		RB activation time info 10.3.4.13	
Uplink counter synchronisation info	OP			
>RB with PDCP information list	OP	1 to <maxRBall RABs>		This IE is needed for each RB having PDCP in the case of lossless SRNS relocation
>>RB with PDCP information	MP		RB with PDCP	

Information Element/Group name	Need	Multi	Type and reference	Semantics description
			information 10.3.4.22	
>START list	MP	1 to <maxCNdo mains>		START [40] values for all CN domains.
>>CN domain identity	MP		CN domain identity 10.3.1.1	
>>START	MP		START 10.3.3.38	START value to be used in this CN domain.

10.2.64 UTRAN MOBILITY INFORMATION FAILURE

This message is sent to indicate a failure to act on a received UTRAN MOBILITY INFORMATION message.

RLC-SAP: AM

Logical channel: DCCH

Direction: UE→UTRAN

Information Element/Group name	Need	Multi	Type and reference	Semantics description
Message Type	MP		Message Type	
UE information elements				
RRC transaction identifier	MP		RRC transaction identifier 10.3.3.36	
Integrity check info	CH		Integrity check info 10.3.3.16	
Failure cause	MP		Failure cause and error information 10.3.3.14	

10.3 Information element functional definitions

10.3.1 CN Information elements

10.3.1.1 CN domain identity

Identifies the type of core network domain.

Information Element/Group name	Need	Multi	Type and reference	Semantics description
CN domain identity	MP		Enumerated (CS domain, PS domain)	

10.3.1.2 CN Domain System Information

Information Element/Group name	Need	Multi	Type and reference	Semantics description
CN domain identity	MP		CN domain	

Information Element/Group name	Need	Multi	Type and reference	Semantics description
			identity 10.3.1.1	
CHOICE <i>CN Type</i>	MP			
>GSM-MAP				
>>CN domain specific NAS system information	MP		NAS system information (GSM-MAP) 10.3.1.9	
>ANSI-41				
>>CN domain specific NAS system information	MP		ANSI-41 NAS system information, 10.3.9.4	
CN domain specific DRX cycle length coefficient	MP		CN domain specific DRX cycle length coefficient, 10.3.3.6	

10.3.1.3 CN Information info

Information Element/Group name	Need	Multi	Type and reference	Semantics description
PLMN identity	OP		PLMN identity 10.3.1.11	
CN common GSM-MAP NAS system information	OP		NAS system information (GSM-MAP) 10.3.1.9	
CN domain related information	OP	1 to <maxCNdomains>		
>CN domain identity	MP		CN domain identity 10.3.1.1	
>CN domain specific GSM-MAP NAS system info	MP		NAS system information (GSM-MAP) 10.3.1.9	

NOTE: Necessity of PLMN is FFS and for CN domain identity and NAS system information, the confirmation in SA WG2 is needed.

10.3.1.3a CN Information info full

Information Element/Group name	Need	Multi	Type and reference	Semantics description
PLMN identity	OP		PLMN identity 10.3.1.11	
CN common GSM-MAP NAS system information	OP		NAS system information (GSM-MAP) 10.3.1.9	
CN domain related information	OP	1 to <maxCNdomains>		
>CN domain identity	MP		CN domain identity 10.3.1.1	
>CN domain specific GSM-MAP NAS system info	MP		NAS system information (GSM-MAP) 10.3.1.9	
>CN domain specific DRX cycle length coefficient	MP		CN domain specific DRX cycle length coefficient, 10.3.3.6	

10.3.1.4 IMEI

This IE contains an International Mobile Equipment Identity. Setting specified in [11].

Information Element/Group name	Need	Multi	Type and reference	Semantics description
IMEI	MP	15		The first element contains the first IMEI digit, the second element the second IMEI digit and so on.
>IMEI digit	MP		INTEGER(0..15)	

10.3.1.5 IMSI (GSM-MAP)

This IE contains an International Mobile Subscriber Identity, used towards a GSM-MAP type of PLMN. Setting specified in [11].

Information Element/Group name	Need	Multi	Type and reference	Semantics description
IMSI	MP	6 to 21		The first element contains the first IMSI digit, the second element the second IMSI digit and so on. Although normally upto 15 digits are used for this IE, a bigger length is used to support future extension.
>IMSI digit	MP		INTEGER(0..9)	

10.3.1.6 Intra Domain NAS Node Selector

This IE carries information to be used to route the establishment of a signalling connection to a CN node within a CN domain.

Information Element/Group name	Need	Multi	Type and reference	Semantics description
CHOICE <i>version</i>	MP			
>R99				This choice shall also be used by mobiles that are compliant to this version of the protocol
>>CHOICE <i>CN type</i>	MP			
>>>GSM-MAP				
>>>>CHOICE <i>Routing basis</i>	MP			
>>>>>local (P)TMSI				TMSI allocated in the current LA or PTMSI allocated in the current RA
>>>>>>Routing parameter	MP		Bit string (10)	The TMSI/ PTMSI consists of 4 octets (32bits). This can be represented by a string of bits numbered from b0 to b31, with bit b0 being the least significant The "Routing parameter" bit string consists of bits b14 through b23 of the TMSI/ PTMSI. The first/leftmost/most significant bit of the bit string contains bit b23 of the TMSI/PTMSI.
>>>>>>(P)TMSI of same PLMN, different (RA)LA				TMSI allocated in another LA of this PLMN or PTMSI allocated in another RA this PLMN
>>>>>>>Routing parameter	MP		Bit string (10)	The TMSI/ PTMSI consists of 4 octets (32bits). This can be represented by a string of bits numbered from b0 to b31, with bit b0 being the least significant The "Routing parameter" bit string consists of bits b14 through b23 of the TMSI/ PTMSI. The first/leftmost/most significant bit of the bit string contains bit b23 of the TMSI/ PTMSI.
>>>>>>>(P)TMSI of different PLMN				TMSI or a PTMSI allocated in another PLMN
>>>>>>>>>Routing parameter	MP		Bit string (10)	The TMSI/ PTMSI consists of 4 octets (32bits). This can be represented by a string of bits numbered from b0 to b31, with bit b0 being the least significant. The "Routing parameter" bit string consists of bits b14 through b23 of the TMSI/ PTMSI. The first/leftmost/most significant bit of the bit string contains bit b23 of the TMSI/ PTMSI.
>>>>>>>>>>IMSI(response to IMSI paging)				NAS identity is IMSI

Information Element/Group name	Need	Multi	Type and reference	Semantics description
>>>>>Routing parameter	MP		Bit string (10)	The "Routing parameter" bit string consists of DecimalToBinary [(IMSI div 10) mod 1000]. The first/leftmost bit of the bit string contains the most significant bit of the result.
>>>>>IMSI(cause UE initiated event)				NAS identity is IMSI
>>>>>Routing parameter	MP		Bit string (10)	The "Routing parameter" bit string consists of DecimalToBinary [(IMSI div 10) mod 1000]. The first/leftmost bit of the bit string contains the most significant bit of the result.
>>>>>IMEI				NAS parameter is IMEI
>>>>>Routing parameter	MP		Bit string (10)	The "Routing parameter" bit string consists of DecimalToBinary [(IMEI div 10) mod 1000]. The first/leftmost bit of the bit string contains the most significant bit of the result.
>>>>>Spare 1			Bit string (10)	This choice shall not be used in this version
>>>>>Spare 2			Bit string (10)	This choice shall not be used in this version
>>>>Entered parameter	MP		Boolean	Entered parameter shall be set to TRUE if the most significant byte of the current LAI/RAI is different compared to the most significant byte of the LAI/RAI stored on the SIM; Entered parameter shall be set to FALSE otherwise
>>>ANSI-41			Bit string (14)	All bits shall be set to 0
>Later			Bit string(15)	This bit string shall not be sent by mobiles that are compliant to this version of the protocol.

10.3.1.7 Location Area Identification

Identifies uniquely a location area for a GSM-MAP type of PLMN. Setting specified in [5].

Information Element/Group name	Need	Multi	Type and reference	Semantics description
PLMN identity	MP		PLMN identity 10.3.1.11	
LAC	MP		Bit string(16)	The first/leftmost bit of the bit string contains the most significant bit of the LAC..

10.3.1.8 NAS message

A non-access stratum message to be transferred transparently through UTRAN.

Information Element/Group name	Need	Multi	Type and reference	Semantics description
--------------------------------	------	-------	--------------------	-----------------------

NAS message	MP		Octet string (1..4095)	The first octet contains octet 1 [17] of the NAS message, the second octet contains octet 2 of the NAS message and so on.
-------------	----	--	------------------------	---

10.3.1.9 NAS system information (GSM-MAP)

This information element contains system information that belongs to the non-access stratum for a GSM-MAP type of PLMN. This information is transparent to RRC. It may contain either information specific to one CN domain (CS or PS) or information common for both CN domains.

Information Element/Group name	Need	Multi	Type and reference	Semantics description
GSM-MAP NAS system information	MP		Octet string(1..8)	The first octet contains octet 1 [17] of the NAS system information element, the second octet contains octet 2 of the NAS system information element and so on.

10.3.1.10 Paging record type identifier

Information Element/Group name	Need	Multi	Type and reference	Semantics description
Paging record type identifier	MP		Enumerated (IMSI (GSM-MAP), TMSI (GSM-MAP)/ P-TMSI, IMSI (DS-41), TMSI (DS-41))	

10.3.1.11 PLMN identity

This information element identifies a Public Land Mobile Network for a GSM-MAP type of PLMN. Setting of digits is defined in [11].

Information Element/Group name	Need	Multi	Type and reference	Semantics description
MCC	MP	3		The first element contains the first MCC digit, the second element the second MCC digit and so on.
>MCC digit	MP		INTEGER(0..9)	
MNC	MP	2 to 3		The first element contains the first MNC digit, the second element the second MNC digit and so on.
>MNC digit	MP		INTEGER(0..9)	

10.3.1.12 PLMN Type

Identifies the type of Public Land Mobile Network (PLMN). This IE shall be used to control the interpretation of network dependent messages and information elements in the RRC protocol.

Information Element/Group name	Need	Multi	Type and reference	Semantics description
PLMN Type	MP		Enumerated (GSM-MAP, ANSI-41, GSM-MAP and ANSI-41)	One spare value is needed.

10.3.1.13 P-TMSI (GSM-MAP)

This IE contains a Packet Temporary Mobile Subscriber Identity, used towards a GSM-MAP type of PLMN.

Information Element/Group name	Need	Multi	Type and reference	Semantics description
P-TMSI	MP		Bit string (32)	Setting specified in [11]. The first/leftmost bit of the bit string contains the most significant bit of the P-TMSI.

10.3.1.14 RAB identity

This information element uniquely identifies a radio access bearer within a CN domain.

Information Element/Group name	Need	Multi	Type and reference	Semantics description
<i>CHOICE RAB identity type</i>	MP			
>RAB identity (GSM-MAP)			Bit string (8)	Formatted according to [5]. The first/leftmost bit of the bit string contains the most significant bit of the RAB identity.
>RAB identity (ANSI-41)			Bit string (8)	The first/leftmost bit of the bit string contains the most significant bit of the RAB identity.

<i>CHOICE NAS binding info type</i>	Condition under which the given <i>RAB identity type</i> is chosen
RAB identity (GSM-MAP)	PLMN is of type GSM-MAP
RAB identity (ANSI-41)	PLMN is of type ANSI-41

10.3.1.15 Routing Area Code

Identifies a routing area within a location area for a GSM-MAP type of PLMN.

Information Element/Group name	Need	Multi	Type and reference	Semantics description
Routing Area Code	MP		Bit string(8)	Setting specified in [11]. The first/leftmost bit of the bit string contains the most significant bit of the Routing Area Code.

10.3.1.16 Routing Area Identification

Identifies uniquely a routing area for a GSM-MAP type of PLMN. Setting specified in [11].

Information Element/Group name	Need	Multi	Type and reference	Semantics description
LAI	MP		Location area identification 10.3.1.7	
RAC	MP		Routing area code 10.3.1.15	

10.3.1.17 TMSI (GSM-MAP)

This IE contains a Temporary Mobile Subscriber Identity, used towards a GSM-MAP type of PLMN.

Information Element/Group name	Need	Multi	Type and reference	Semantics description
TMSI (GSM-MAP)	MP		Bit string (32)	Setting specified in [11]. The first/leftmost bit of the bit string contains the most significant bit of the TMSI.

10.3.2 UTRAN mobility Information elements

10.3.2.1 Cell Access Restriction

Indicates the restrictions to cell access.

Information Element/Group name	Need	Multi	Type and reference	Semantics description
Cell Barred	MP		Enumerated(not barred, barred)	
Intra-frequency cell re-selection indicator	<i>CV-Barred</i>		Enumerated(not allowed, allowed)	
T_{barred}	<i>CV-Barred</i>		Integer (10,20,40,80, 160,320,640, 1280)	[4] [s]
Cell Reserved for operator use	MP		Enumerated(reserved, not reserved)	
Cell Reservation Extension	MP		Enumerated(reserved, not reserved)	
Access Class Barred list	<i>CV-SIB3-MD</i>	maxAC		Default is no access class barred is applied. The first instance of the parameter corresponds to Access Class 0, the second to Access Class 1 and so on up to Access Class 15. UE reads this IE of its access class stored in SIM.
>Access Class Barred	MP		Enumerated(not barred, barred)	

Condition	Explanation
<i>Barred</i>	The IE is mandatory present if the IE "Cell Barred" has the value "Barred"; otherwise the element is not needed in the message.
<i>SIB3-MD</i>	The IE is mandatory and has a default value if the IE "Cell Access Restriction" is included in SIB 3. Otherwise the IE is not needed.

10.3.2.2 Cell identity

This information element identifies a cell unambiguously within a PLMN.

NOTE: This information element may carry any implementation dependent identity that unambiguously identifies a cell within a PLMN.

Information Element/Group name	Need	Multi	Type and reference	Semantics description
Cell identity	MP		bit string(28)	

10.3.2.3 Cell selection and re-selection info for SIB3/4

Information Element/Group name	Need	Multi	Type and reference	Semantics description
Mapping Info	OP		Mapping info 10.3.2.5	This IE should not be sent.
Cell selection and reselection quality measure	MP		Enumerated (CPICH Ec/N0, CPICH RSCP)	Choice of measurement (CPICH Ec/N0 or CPICH RSCP) to use as quality measure Q for FDD cells. This IE is also sent to the UE in SIB11/12. Both occurrences of the IE should be set to the same value.
CHOICE <i>mode</i>	MP			
>FDD				
>>S _{intrasearch}	OP		Integer (-32..20 by step of 2)	If a negative value is received the UE shall consider the value to be 0. [4] [dB]
>>S _{intersearch}	OP		Integer (-32..20 by step of 2)	If a negative value is received the UE shall consider the value to be 0. [4] [dB]
>>S _{searchHCS}	OP		Integer (-105..91 by step of 2)	If a negative value is received the UE shall consider the value to be 0. [4] [dB]
>>RAT List	OP	1 to <maxOther RAT>		
>>>RAT identifier	MP		Enumerated (GSM, cdma2000)	
>>>S _{search,RAT}	MP		Integer (-32..20 by step of 2)	In case the value 20 is received the UE shall consider this IE as if it was absent according to [4] If a negative value is received the UE shall consider the value to be 0. [dB]

Information Element/Group name	Need	Multi	Type and reference	Semantics description
>>>S _{HCS,RAT}	OP		Integer (-105..91 by step of 2)	If a negative value is received the UE shall consider the value to be 0. [4] [dB]
>>>S _{limit,SearchRAT}	MP		Integer (-32..20 by step of 2)	If a negative value is received the UE shall consider the value to be 0. [4] [dB]
>>Q _{qualmin}	MP		Integer (-24..0)	Ec/N0, [dB]
>>Q _{rxlevmin}	MP		Integer (-115..-25 by step of 2)	RSCP, [dBm]
>TDD				
>>S _{intrasearch}	OP		Integer (-105..91 by step of 2)	If a negative value is received the UE shall consider the value to be 0. [4] [dB]
>>S _{intersearch}	OP		Integer (-105..91 by step of 2)	If a negative value is received the UE shall consider the value to be 0. [4] [dB]
>>S _{searchHCS}	OP		Integer (-105..91 by step of 2)	If a negative value is received the UE shall consider the value to be 0. [4] [dB]
>>RAT List	OP	1 to <maxOther RAT>		
>>>RAT identifier	MP		Enumerated (GSM, cdma2000)	
>>>S _{search,RAT}	MP		Integer (-105..91 by step of 2)	In case the value 91 is received the UE shall consider this IE as if it was absent according to [4] If a negative value is received the UE shall consider the value to be 0. [dB]
>>>S _{HCS,RAT}	OP		Integer (-105..91 by step of 2)	If a negative value is received the UE shall consider the value to be 0. [4] [dB]
>>>S _{limit,SearchRAT}	MP		Integer (-105..91 by step of 2)	If a negative value is received the UE shall consider the value to be 0. [4] [dB]
>>Q _{rxlevmin}	MP		Integer (-115..-25 by step of 2)	RSCP, [dBm]
Q _{hyst1s}	MP		Integer (0..40 by step of 2)	[4] [dB]
Q _{hyst2s}	CV-FDD-Quality-Measure		Integer (0..40 by step of 2)	Default value is Q _{hyst1s} [4] [dB]
T _{reselections}	MP		Integer (0..31)	[s]

Information Element/Group name	Need	Multi	Type and reference	Semantics description
HCS Serving cell Information	OP		HCS Serving cell information 10.3.7.12	
Maximum allowed UL TX power	MP		Maximum allowed UL TX power 10.3.6.39	[dBm] UE_TXPWR_MAX_RACH in [4].

Condition	Explanation
<i>FDD-Quality-Measure</i>	The IE is not needed if the IE "Cell selection and reselection quality measure" has the value CPICH RSCP, otherwise the IE is mandatory and has a default value.

10.3.2.4 Cell selection and re-selection info for SIB11/12

Information Element/Group name	Need	Multi	Type and reference	Semantics description
Qoffset1 _{s,n}	MD		Integer(-50..50)	Default value is 0. [dB]
Qoffset2 _{s,n}	<i>CV-FDD-Quality-Measure</i>		Integer(-50..50)	Default value is 0. [dB]
Maximum allowed UL TX power	MD		Maximum allowed UL TX power 10.3.6.39	According to UE_TXPWR_MAX_RACH in [4], [dBm]. If applied to FDD or TDD cells, the default is the Maximum allowed UL TX power for the serving cell. If applied to a GSM cell, the default is the UE maximum output power applicable for this GSM cell, according to the UE's radio access capability.
HCS neighbouring cell information	OP		HCS Neighbouring cell information 10.3.7.11	
CHOICE <i>mode</i>	MP			
>FDD				
>>Qqualmin	<i>CV-FDD-Serving-Cell</i>		Integer (-24..0)	Ec/N0, [dB] Default value is Qqualmin for the serving cell
>>Qrxlevmin	MD		Integer (-115..-25 by step of 2)	RSCP, [dBm] Default value is Qrxlevmin for the serving cell
>TDD				
>>Qrxlevmin	MD		Integer (-115..-25 by step of 2)	RSCP, [dBm] Default value is Qrxlevmin for the serving cell
>GSM				
>>Qrxlevmin	MD		Integer (-115..-25 by step of 2)	GSM RSSI, [dBm] Default value is Qrxlevmin for the serving cell

Condition	Explanation
<i>FDD-Quality-Measure</i>	This IE is mandatory and has a default value for Intra/Inter Frequency Cells if the IE "Cell selection and reselection quality measure" has the value CPICH Ec/No. Otherwise the IE is absent.
<i>FDD-Serving-Cell</i>	This IE is mandatory and has a default value if the serving cell is an FDD cell. Otherwise the IE is mandatory present.

10.3.2.5 Mapping Info

Information Element/Group name	Need	Multi	Type and Reference	Semantics description	Version
Mapping List	MP	1 to <MaxRAT>			
>RAT	MP		Enumerated (UTRA FDD, UTRA TDD 3.84 Mcps, UTRA TDD 1.28 Mcps, GSM, cdma2000)		UTRA TDD 1.28 Mcps is included for REL-4.
>Mapping Function Parameter List	MP	1 to <maxMeas Intervals>			
>>Function type	MP		Enumerated (linear, function type 2, function type 3, function type 4)	Type of the function within the interval.	
>>Map_parameter_1	MD		Integer (0..99)	Parameter describing the mapping function between the quality measurement and the representing quality value, see [4]. Default value is zero for the first interval or otherwise the value of Map_parameter_2 of the interval before.	
>>Map_parameter_2	MP		Integer (0..99)	Parameter describing the mapping function between the quality measurement and the representing quality value, see [4].	
>>Upper_limit	CV- <i>MaxInt</i>		Integer (1..MaxMeas)	Upper limit of interval for which the Map_parameter_1 and	UTRA TDD 1.28 Mcps is included for REL-

Information Element/Group name	Need	Multi	Type and Reference	Semantics description	Version
				Map_parameter_2 are valid. MaxMeas = 25 if RAT = UTRA FDD / CPICH Ec/N0, MaxMeas = 91 if RAT = UTRA TDD 3.84 Mcps or if RAT = UTRA TDD 1.28 Mcps or if RAT = UTRA FDD/ CPICH RSCP, MaxMeas = 63 if RAT = GSM.	4.

Condition	Explanation
<i>MaxInt</i>	This IE is mandatory present if Mapping Function Parameter List has not reached maxMeasIntervals and is not needed otherwise.

10.3.2.6 URA identity

Gives the identity of the UTRAN Registration Area. It can be used to indicate to the UE which URA it shall use in case of overlapping URAs.

Information Element/Group name	Need	Multi	Type and reference	Semantics description
URA identity	MP		bit string(16)	

10.3.3 UE Information elements

10.3.3.1 Activation time

Activation Time defines the frame number/time at which the operation/changes caused by the related message shall take effect. Values between 0 and 255 indicate the absolute value of CFN (Connection Frame Number) of that frame number/time.

Information Element/Group name	Need	Multi	Type and reference	Semantics description
Activation time	MP		Integer(0..255)	CFN [10]

10.3.3.2 Capability Update Requirement

This IE indicates to the UE which specific capabilities to transfer to the network.

Information Element/Group name	Need	Multi	Type and reference	Semantics description	Version
UE radio access FDD capability update requirement	MP		Boolean	TRUE indicates update required	
UE radio access 3.84 Mcps TDD capability update requirement	MP		Boolean	TRUE indicates update required	Name changed in REL-4
UE radio access 1.28 Mcps TDD capability update requirement	MP		Boolean	TRUE indicates update required	REL-4
System specific capability	OP	1 to		In this version, a	

Information Element/Group name	Need	Multi	Type and reference	Semantics description	Version
update requirement list		<maxSystemCapability>		maximum size of 4 of the list shall be applied and any items after the 4 th item in the list shall be ignored.	
>System specific capability update requirement	MP		Enumerated (GSM)		

Default value is:

"UE radio capability FDD update requirement" = false

"UE radio capability 3.84 Mcps TDD update requirement" = false

"UE radio capability 1.28 Mcps TDD update requirement" = false

"System specific capability update requirement" not present.

10.3.3.3 Cell update cause

Indicates the cause for cell update.

Information Element/Group name	Need	Multi	Type and reference	Semantics description
Cell update cause	MP		Enumerated (cell reselection, periodical cell update, uplink data transmission, paging response, re-entered service area, radio link failure, RLC unrecoverable error)	One spare value is needed.

10.3.3.4 Ciphering Algorithm

Information Element/Group name	Need	Multi	Type and reference	Semantics description
Ciphering algorithm	MP		Enumerated (UEA0, UEA1)	

10.3.3.5 Ciphering mode info

This information element contains the ciphering specific security mode control information.

Information Element/Group name	Need	Multi	Type and reference	Semantics description
Ciphering mode command	MP		Enumerated (start/restart)	
Ciphering algorithm	MP		Ciphering algorithm 10.3.3.4	
Ciphering activation time for DPCH	OP		Activation time 10.3.3.1	Used for radio bearers mapped on RLC-TM. Only applicable if the UE is already in CELL_DCH state
Radio bearer downlink ciphering activation time info	OP		RB activation time info, 10.3.4.13	Used for radio bearers mapped on RLC-AM or RLC-UM

10.3.3.6 CN domain specific DRX cycle length coefficient

A coefficient in the formula to count the paging occasions to be used by a specific UE (specified in [4]) .

Information Element/Group name	Need	Multi	Type and reference	Semantics description
CN domain specific DRX cycle length coefficient	MP		Integer(6..9)	Refers to 'k' in the formula as specified in [4], Discontinuous reception

10.3.3.7 CPCH Parameters

NOTE: Only for FDD.

These parameters are used by any UE using any CPCH set allocated to the cell that is broadcasting this system information.

Information Element/Group name	Need	Multi	Type and reference	Semantics description
Initial Priority Delay	OP	1 to maxASC		Initial delays for ASC priority.
>NS_IP	MP		Integer (0..28)	Number of slots for initial fixed delay for each ASC priority level
Backoff control parameters	MP			
>N_ap_retrans_max	MP		Integer (1..64)	Max number of AP transmissions without AP-AICH response, a PHY parameter.
>N_access_fails	MP		Integer (1..64)	Max number of preamble ramping cycles when NAK response received, a MAC parameter.
>NF_bo_no_aich	MP		Integer (0..31)	Number of frames for UE backoff after N _{ap_retrans_max} unsuccessful AP access attempts, a MAC parameter.
>NS_bo_busy	MP		Integer (0..63)	Number of slots for UE fixed backoff after access attempt to busy CPCH, a MAC parameter.
>NF_bo_all_busy	MP		Integer (0..31)	Max number of frames for UE backoff after access attempt to last busy CPCH, a MAC parameter. UE randomly selects backoff value from range (0..NF_bo_all_busy)
>NF_bo_mismatch	MP		Integer	Max number of frames for the

Information Element/Group name	Need	Multi	Type and reference	Semantics description
			(0...127)	UE backoff after received mismatch on CD/CA-ICH, a MAC parameter. UE randomly selects backoff value from range (0..NF_bo_mismatch)
>T_CPCH	MP		Enumerated (0, 1)	CPCH channel timing used to determine Tau, a PHY parameter
Power Control Algorithm	MP		Enumerated (algorithm 1, algorithm 2)	Specifies algorithm to be used by UE to interpret TPC commands
TPC step size	<i>CV-algo</i>		Integer (1, 2)	In dB
DL DPCCH BER	MP		Integer (0..63)	The BER quality value shall be set in the range $0 \leq \text{DPCCH BER} \leq 1$ in the unit BER_dB where: BER_dB_0: DPCCH BER = 0 BER_dB_1: $-\infty < \text{Log}_{10}(\text{DPCCH BER}) < -4.03$ BER_dB_2: $-4.03 \leq \text{Log}_{10}(\text{DPCCH BER}) < -3.965$ BER_dB_3: $-3.965 \leq \text{Log}_{10}(\text{DPCCH BER}) < -3.9$... BER_dB_61: $-0.195 \leq \text{Log}_{10}(\text{DPCCH BER}) < -0.13$ BER_dB_62: $-0.13 \leq \text{Log}_{10}(\text{DPCCH BER}) < -0.065$ BER_dB_63: $-0.065 \leq \text{Log}_{10}(\text{DPCCH BER}) \leq 0$

Condition	Explanation
<i>algo</i>	The IE is mandatory present if "Power Control Algorithm" is set to "algorithm 1", otherwise the IE is not needed

10.3.3.8 C-RNTI

The cell RNTI (C-RNTI) identifies a UE having a RRC connection within a cell.

Information Element/Group name	Need	Multi	Type and reference	Semantics description
C-RNTI	MP		bit string(16)	

10.3.3.9 DRAC system information

Information element	Need	Multi	Type and reference	Semantics description
DRAC system information	MP	1 to <maxDRA Cclasses>		DRAC information is sent for each class of terminal
>Transmission probability	MP		Transmission probability 10.3.3.39	
>Maximum bit rate	MP		Maximum bit rate 10.3.3.20	

10.3.3.9a DSCH-RNTI

In FDD, the DSCH-RNTI identifies a UE in CELL_DCH using a DSCH within a cell. In TDD, the DSCH-RNTI identifies a UE in CELL_DCH or CELL_FACH using a DSCH or USCH within the cell.

Information Element/Group name	Need	Multi	Type and reference	Semantics description
DSCH-RNTI	MP		bit string(16)	

10.3.3.10 Void

10.3.3.11 Establishment cause

Cause for an RRC connection establishment request.

Information Element/Group name	Need	Multi	Type and reference	Semantics description
Establishment cause	MP		Enumerated(Originating Conversational Call, Originating Streaming Call, Originating Interactive Call, Originating Background Call, Originating Subscribed traffic Call, Terminating Conversational Call, Terminating Streaming Call, Terminating Interactive Call, Terminating Background Call, Emergency Call, Inter-RAT cell re-selection, Inter-RAT cell change order, Registration, Detach, Originating High Priority Signalling, Originating Low Priority Signalling, Call re-establishment, Terminating High Priority Signalling, Terminating Low Priority Signalling, Terminating – cause unknown)	Twelve spare values are needed.

10.3.3.12 Expiration Time Factor

Information Element/Group name	Need	Multi	Type and reference	Semantics description
Expiration Time Factor	MP		Enumerated(2times, 4times, 8times, 16times, 32times, 64times, 128times, 256times)	

10.3.3.13 Failure cause

Cause for failure to perform the requested procedure.

Information Element/Group name	Need	Multi	Type and reference	Semantics description
Failure cause	MP		Enumerated (configuration unsupported, physical channel failure, incompatible simultaneous reconfiguration, protocol error, compressed mode runtime error, cell update occurred, invalid configuration, configuration incomplete, unsupported measurement)	Seven spare values are needed.

10.3.3.14 Failure cause and error information

Cause for failure to perform the requested procedure.

Information Element/Group name	Need	Multi	Type and reference	Semantics description
Failure cause	MP		Failure cause 10.3.3.13	
Protocol error information	CV-ProtErr		Protocol error information 10.3.8.12	
Deleted TGPSI	CV-CompModeErr		TGPSI 10.3.6.82	

Condition	Explanation
<i>ProtErr</i>	The IE is mandatory present if the IE "Failure cause" has the value "Protocol error"; otherwise it is not needed in the message.
<i>CompModeErr</i>	The IE is mandatory present if the IE "Failure cause" has the value "Compressed mode runtime error"; otherwise it is not needed in the message.

10.3.3.15 Initial UE identity

This information element identifies the UE at a request of an RRC connection.

Information Element/Group name	Need	Multi	Type and reference	Semantics description
CHOICE <i>UE id type</i>	MP			
>IMSI (GSM-MAP)			IMSI (GSM-MAP) 10.3.1.5	
>TMSI and LAI (GSM-MAP)				
>>TMSI (GSM-MAP)	MP		TMSI (GSM-MAP) 10.3.1.17	
>>LAI (GSM-MAP)	MP		Location Area Identification 10.3.1.7	
>P-TMSI and RAI (GSM-MAP)				
>>P-TMSI (GSM-MAP)	MP		P-TMSI (GSM-MAP) 10.3.1.13	
>>RAI (GSM-MAP)	MP		Routing Area Identification 10.3.1.16	
>IMEI			IMEI 10.3.1.4	
>ESN (DS-41)			Bit string (SIZE (32))	TIA/EIA/IS-2000-4
>IMSI (DS-41)			Octet string (SIZE (5..7))	TIA/EIA/IS-2000-4
>IMSI and ESN (DS-41)				TIA/EIA/IS-2000-4
>>IMSI (DS-41)	MP		Octet string (SIZE (5..7))	TIA/EIA/IS-2000-4
>>ESN (DS-41)	MP		Bit string (SIZE (32))	TIA/EIA/IS-2000-4
>TMSI (DS-41)			Octet string (SIZE (2..17))	TIA/EIA/IS-2000-4 Although normally upto 12 digits are used for this IE, a bigger length is used to support future extension.

10.3.3.16 Integrity check info

The Integrity check info contains the RRC message sequence number needed in the calculation of XMAC-I [40] and the calculated MAC-I.

Information Element/Group name	Need	Multi	Type and reference	Semantics description
Message authentication code	MP		bit string(32)	MAC-I [40]. The first/leftmost bit of the bit string contains the most significant bit of the MAC-I. The 27 MSB of the IE shall be set to zero and the 5 LSB of the IE shall be set to the value of the IE "RB identity" for the used signalling radio bearer when the encoded RRC message is used as the MESSAGE parameter in the integrity protection algorithm.
RRC Message sequence number	MP		Integer (0..15)	The local RRC hyper frame number (RRC HFN) is concatenated with the RRC message sequence number to form the input parameter COUNT-I for the integrity protection algorithm. The IE value shall be set to zero when the encoded RRC message is used as the MESSAGE parameter in the integrity protection algorithm.

10.3.3.17 Integrity protection activation info

This IE contains the time, in terms of RRC sequence numbers, when a new integrity protection configuration shall be activated for the signalling radio bearers.

Information Element/Group name	Need	Multi	Type and reference	Semantics description
RRC message sequence number list	MP	4 to 5		The RRC sequence number when a new integrity protection configuration shall be applied, for signalling radio bearers in the order RB0, RB1, RB2, RB3, RB4. The value for RB1 shall be ignored if this IE was included in a RRC message sent on RB1. The value for RB2 shall be ignored if this IE was included in a RRC message sent on RB2.
>RRC message sequence number	MP		Integer (0..15)	

10.3.3.18 Integrity protection Algorithm

Information Element/Group name	Need	Multi	Type and reference	Semantics description
Integrity protection algorithm	MP		Enumerated (UIA1)	

10.3.3.19 Integrity protection mode info

Information Element/Group name	Need	Multi	Type and reference	Semantics description
Integrity protection mode command	MP		Enumerated(start, modify)	
Downlink integrity protection activation info	CV-modify		Integrity protection activation info 10.3.3.17	
Integrity protection algorithm	OP		Integrity protection algorithm 10.3.3.18	
Integrity protection initialisation number	CV-start		Bit string(32)	FRESH [40]. The first/leftmost bit of the bit string contains the most significant bit of the FRESH.

Condition	Explanation
Start	The IE is mandatory present if the IE "Integrity protection mode command" has the value "start ", otherwise it is not needed in the message.
Modify	The IE is mandatory present if the IE "Integrity protection mode command" has the value "modify" and not needed otherwise.

10.3.3.20 Maximum bit rate

NOTE: Only for FDD.

Indicates the maximum user bit rate allowed on a DCH controlled by DRAC procedure for the transmission period (Transmission time validity).

Information Element/Group name	Need	Multi	Type and reference	Semantics description
Maximum bit rate	MP		integer(0..512 by step of 16)	=kbit/s

10.3.3.21 Measurement capability

Information Element/Group name	Need	Multi	Type and reference	Semantics description	Version
Need for downlink compressed mode					
FDD measurements	MP		Boolean	TRUE means that the UE requires DL compressed mode in order to perform measurements on FDD	
3.84 Mcps TDD measurements	CV-3.84_Mcps_tdd_sup		Boolean	TRUE means that the UE requires DL compressed mode in order to perform measurements on 3.84 Mcps TDD	Name changed in REL-4
1.28 Mcps TDD measurements	CV-1.28_Mcps		Boolean	TRUE means that the UE requires	REL-4

Information Element/Group name	Need	Multi	Type and reference	Semantics description	Version
	<i>_tdd_sup</i>			DL compressed mode in order to perform measurements on 1.28 Mcps TDD	
GSM measurements	<i>CV-gsm_sup</i>				
>GSM 900	MP		Boolean	TRUE means that the UE requires DL compressed mode in order to perform measurements on GSM 900	
>DCS 1800	MP		Boolean	TRUE means that the UE requires DL compressed mode in order to perform measurements on DCS 1800	
>GSM 1900	MP		Boolean	TRUE means that the UE requires DL compressed mode in order to perform measurements on GSM 1900	
Multi-carrier measurement	<i>CV-mc_sup</i>		Boolean	TRUE means that the UE requires DL compressed mode in order to perform measurements on multi-carrier	
Need for uplink compressed mode					
FDD measurements	MP		Boolean	TRUE means that the UE requires UL compressed mode in order to perform measurements on FDD	
3.84 Mcps TDD measurements	<i>CV-3.84_Mcps_tdd_sup</i>		Boolean	TRUE means that the UE requires UL compressed mode in order to perform measurements on 3.84 Mcps TDD	Name changed in REL-4
1.28 Mcps TDD measurements	<i>CV-1.28_Mcps_tdd_sup</i>		Boolean	TRUE means that the UE requires DL compressed mode in order to perform measurements on 1.28 Mcps TDD	REL-4
GSM measurements	<i>CV-gsm_sup</i>				
>GSM 900	MP		Boolean	TRUE means that the UE requires UL compressed mode in order to perform measurements on	

Information Element/Group name	Need	Multi	Type and reference	Semantics description	Version
>DCS 1800	MP		Boolean	GSM 900 TRUE means that the UE requires UL compressed mode in order to perform measurements on DCS 1800	
>GSM 1900	MP		Boolean	TRUE means that the UE requires UL compressed mode in order to perform measurements on GSM 1900	
Multi-carrier measurement	CV- <i>mc_sup</i>		Boolean	TRUE means that the UE requires UL compressed mode in order to perform measurements on multi-carrier	

Condition	Explanation
<i>3.84_Mcps_tdd_sup</i>	The IE is mandatory present if an IE "TDD RF capability" is present with the IE "Chip rate capability" set to "3.84 Mcps". Otherwise this field is not needed in the message.
<i>1.28_Mcps_tdd_sup</i>	The IE is mandatory present if an IE "TDD RF capability" is present with the IE "Chip rate capability" set to "1.28 Mcps". Otherwise this field is not needed in the message.
<i>gsm_sup</i>	The IE is mandatory present if the IE "Inter-RAT UE radio access capability" indicates support for GSM900, GSM1800 and/or GSM1900. Otherwise this field is not needed in the message.
<i>mc_sup</i>	The IE is mandatory present if the IE "Support of multi-carrier" has the value TRUE. Otherwise this field is not needed in the message.

10.3.3.21a Measurement capability extension

This IE may be used to replace the measurement capability information provided within IE "Measurement capability".

Information Element/Group name	Need	Multi	Type and reference	Semantics description
FDD measurements	MP	1 to <maxFreq BandsFDD >		
>FDD Frequency band	MD		Enumerated(FDD2100, FDD1900)	The default value is the same as indicated in the IE "Frequency band" included in the IE " UE radio access capability extension". Six spare values are needed
>Need for DL compressed mode	MP		Boolean	TRUE means that the UE requires DL compressed mode in order to perform measurements on the FDD frequency band indicated by the IE "FDD Frequency band"

Information Element/Group name	Need	Multi	Type and reference	Semantics description
>Need for UL compressed mode	MP		Boolean	TRUE means that the UE requires UL compressed mode in order to perform measurements on the FDD frequency band indicated by the IE "FDD Frequency band"
TDD measurements	CV- <i>tdd_sup</i>	1 to <maxFreq BandsTDD >		
>TDD Frequency band	MP		Enumerated(a, b, c)	
>Need for DL compressed mode	MP		Boolean	TRUE means that the UE requires DL compressed mode in order to perform measurements on TDD frequency band indicated by the IE "TDD Frequency band"
>Need for UL compressed mode	MP		Boolean	TRUE means that the UE requires UL compressed mode in order to perform measurements on TDD frequency band indicated by the IE "TDD Frequency band"
GSM measurements	CV- <i>gsm_sup</i>	1 to <maxFreq BandsGS M>		
>GSM Frequency band	MP		Enumerated(GSM450, GSM480, GSM850, GSM900P, GSM900E, GSM1800, GSM1900)	as defined in [45]. Nine spare values are needed.
>Need for DL compressed mode	MP		Boolean	TRUE means that the UE requires DL compressed mode in order to perform measurements on GSM frequency band indicated by the IE "GSM Frequency band"
>Need for UL compressed mode	MP		Boolean	TRUE means that the UE requires UL compressed mode in order to perform measurements on GSM frequency band indicated by the IE "GSM Frequency band"
Multi-carrier measurement	CV- <i>mc_sup</i>			
>Need for DL compressed mode	MP		Boolean	TRUE means that the UE requires DL compressed mode in order to perform measurements on multi-carrier
>Need for UL compressed mode	MP		Boolean	TRUE means that the UE requires UL compressed mode in order to perform measurements on multi-carrier

Condition	Explanation
<i>tdd_sup</i>	The IE is mandatory present if the IE "Multi-mode capability" has the value "TDD" or "FDD/TDD". Otherwise this field is not needed in the message.
<i>gsm_sup</i>	The IE is mandatory present if the IE "Support of GSM" has the value TRUE. Otherwise this field is not needed in the message.
<i>mc_sup</i>	The IE is mandatory present if the IE "Support of multi-carrier" has the value TRUE. Otherwise this field is not needed in the message.

10.3.3.22 Paging cause

Cause for a CN originated page.

Information Element/Group name	Need	Multi	Type and reference	Semantics description
Paging cause	MP		Enumerated(Terminating Conversational Call, Terminating Streaming Call, Terminating Interactive Call, Terminating Background Call, Terminating High Priority Signalling, Terminating Low Priority Signalling, Terminating – cause unknown)	One spare value is needed.

10.3.3.23 Paging record

Information Element/Group name	Need	Multi	Type and reference	Semantics description
CHOICE <i>Used paging identity</i>	MP			
>CN identity				
>>Paging cause	MP		Paging cause 10.3.3.22	
>>>CN domain identity	MP		CN domain identity 10.3.1.1	
>>>CHOICE <i>UE Identity</i>	MP			Three spare values are needed.
>>>>IMSI (GSM-MAP)			IMSI (GSM-MAP) 10.3.1.5	
>>>>TMSI (GSM-MAP)			TMSI (GSM-MAP) 10.3.1.17	
>>>>P-TMSI (GSM-MAP)			P-TMSI (GSM-MAP) 10.3.1.13	

Information Element/Group name	Need	Multi	Type and reference	Semantics description
>>>IMSI (DS-41)			TIA/EIA/IS-2000-4	
>>>TMSI (DS-41)			TIA/EIA/IS-2000-4	
>UTRAN identity				
>>U-RNTI	MP		U-RNTI 10.3.3.47	
>>CN originated page to connected mode UE	OP			
>>>Paging cause	MP		Paging cause 10.3.3.22	
>>>CN domain identity	MP		CN domain identity 10.3.1.1	
>>>Paging record type identifier	MP		Paging record type identifier 10.3.1.10	

Condition	Explanation
CHOICE <i>Used paging identity</i>	Condition under which the given <i>used paging identity</i> is chosen
CN identity	For CN originating pages (for idle mode UEs)
UTRAN identity	For UTRAN originating pages (for connected mode UEs)

10.3.3.24 PDCP capability

Indicates which algorithms and which value range of their parameters are supported by the UE.

Information Element/Group name	Need	Multi	Type and reference	Semantics description	Version
Support for lossless SRNS relocation	MP		Boolean	TRUE means supported	
Support for RFC2507	MP		Boolean	TRUE means supported	
>Max HC context space			Integer(512, 1024, 2048, 4096, 8192)		
Support for RFC 3095	MP		Boolean	TRUE means supported	REL-4
>Maximum number of ROHC context sessions	MD		Integer(2, 4, 8, 12, 16, 24, 32, 48, 64, 128, 256, 512, 1024, 16384)	Default value is 16.	REL-4
>Reverse decompression depth	MD		Integer (0..65535)	Default value is 0 (reverse decompression is not supported).	REL-4

10.3.3.25 Physical channel capability

Information Element/Group name	Need	Multi	Type and Reference	Semantics description	Version
Downlink physical channel capability information elements					
FDD downlink physical channel capability	CH- <i>fdd_req_su</i>				

Information Element/Group name	Need	Multi	Type and Reference	Semantics description	Version
	<i>p</i>				
>Max no DPCH/PDSCH codes	MP		Integer (1..8)	Maximum number of DPCH/PDSCH codes to be simultaneously received	
>Max no physical channel bits received	MP		Integer (600, 1200, 2400, 3600, 4800, 7200, 9600, 14400, 19200, 28800, 38400, 48000, 57600, 67200, 76800)	Maximum number of physical channel bits received in any 10 ms interval (DPCH, PDSCH, S-CCPCH)	
>Support for SF 512	MP		Boolean	TRUE means supported	
>Support of PDSCH	MP		Boolean	TRUE means supported	
>Simultaneous reception of SCCPCH and DPCH	MP		Boolean	TRUE means supported	
>Simultaneous reception of SCCPCH, DPCH and PDSCH	CV- <i>if_sim_rec_pdsch_sup</i>		Boolean	TRUE means supported	
>Max no of S-CCPCH RL	CV- <i>if_sim_rec</i>		Integer(1)	Maximum number of simultaneous S-CCPCH radio links	
>Support of dedicated pilots for channel estimation	MD		Enumerated (true)	Presence of this element means supported and absence not supported. If the UE notifies support of this functionality, it should comply with the corresponding performance requirements. Note 1.	
3.84 Mcps TDD downlink physical channel capability	CH- <i>3.84_Mcps_tdd_req_sup</i>				Name changed in REL-4
>Maximum number of timeslots per frame	MP		Integer (1..14)		
>Maximum number of physical channels per frame	MP		Integer (1..224)		
>Minimum SF	MP		Integer (1, 16)		
>Support of PDSCH	MP		Boolean	TRUE means supported	
>Maximum number of physical channels per timeslot	MP		Integer (1..16)		
1.28 Mcps TDD downlink physical channel capability	CH- <i>1.28_Mcps_tdd_req_sup</i>				REL-4
>Maximum number of timeslots per subframe	MP		Integer (1..6)		REL-4

Information Element/Group name	Need	Multi	Type and Reference	Semantics description	Version
>Maximum number of physical channels per subframe	MP		Integer (1..96)		REL-4
>Minimum SF	MP		Integer (1, 16)		REL-4
>Support of PDSCH	MP		Boolean	TRUE means supported	REL-4
>Maximum number of physical channels per timeslot	MP		Integer (1..16)		REL-4
>Support of 8PSK	MP		Boolean	TRUE means supported	REL-4
Uplink physical channel capability information elements					
FDD uplink physical channel capability	CH- <i>fdd_req_su</i> <i>p</i>				
>Maximum number of DPDCH bits transmitted per 10 ms	MP		Integer (600, 1200, 2400, 4800, 9600, 19200, 28800, 38400, 48000, 57600)		
>Support of PCPCH	MP		Boolean	TRUE means supported	
3.84 Mcps TDD uplink physical channel capability	CH- <i>3.84_Mcps</i> <i>_tdd_req_s</i> <i>up</i>				Name changed in REL-4
>Maximum Number of timeslots per frame	MP		Integer (1..14)		
>Maximum number of physical channels per timeslot	MP		Integer (1, 2)		
>Minimum SF	MP		Integer (1, 2, 4, 8, 16)		
>Support of PUSCH	MP		Boolean	TRUE means supported	
1.28 Mcps TDD uplink physical channel capability	CH- <i>1.28_Mcps</i> <i>_tdd_req_s</i> <i>up</i>				REL-4
>Maximum Number of timeslots per subframe	MP		Integer (1..6)		REL-4
>Maximum number of physical channels per timeslot	MP		Integer (1, 2)		REL-4
>Minimum SF	MP		Integer (1, 2, 4, 8, 16)		REL-4
>Support of PUSCH	MP		Boolean	TRUE means supported	REL-4
>Support of 8PSK	MP		Boolean	TRUE means supported	REL-4

Condition	Explanation
<i>if_sim_rec_pdsch_sup</i>	The IE is mandatory present if the IE "Simultaneous reception of SCCPCH and DPCH" = True and IE Support of PDSCH = True. Otherwise this field is not needed in the message.
<i>if_sim_rec</i>	The IE is mandatory present if the IE "capability Simultaneous reception of SCCPCH and DPCH" = True. Otherwise this field is not needed in the message.
<i>3.84_Mcps_tdd_req_sup</i>	The IE is mandatory present if the IE "TDD RF capability" is present with the IE "Chip rate capability" set to "3.84 Mcps" and a 3.84 Mcps TDD capability update has been requested in a previous message. Otherwise this field is not needed in the message.
<i>1.28_Mcps_tdd_req_sup</i>	The IE is mandatory present if the IE "TDD RF capability" is present with the IE "Chip rate capability" set to "1.28 Mcps" and a 1.28 Mcps TDD capability update has been requested in a previous message. Otherwise this field is not needed in the message.
<i>fdd_req_sup</i>	The IE is mandatory present if the IE "Multi-mode capability" has the value "FDD" or "FDD/TDD" and a FDD capability update has been requested in a previous message. Otherwise this field is not needed in the message.

NOTE 1: These performance requirements are defined in Release 5.

10.3.3.26 Protocol error cause

This IE indicates the cause for a message or information that was not comprehended.

Information Element/Group name	Need	Multi	Type and reference	Semantics description
Protocol error cause	MP		Enumerated (ASN.1 violation or encoding error, Message type non-existent or not implemented, Message not compatible with receiver state, Information element value not comprehended, Information element missing, Message extension not comprehended)	Two spare values are needed.

10.3.3.27 Protocol error indicator

This IE indicates whether a message was transmitted due to a protocol error or not.

Information Element/Group name	Need	Multi	Type and Reference	Semantics description
Protocol error indicator	MP		Boolean	TRUE means a protocol error occurred. FALSE means a protocol error did not occur.

10.3.3.28 RB timer indicator

This IE is used to indicate to UTRAN if the timers T314 or T315 has expired in the UE.

Information Element/Group name	Need	Multi	Type and reference	Semantics description
T314 expired	MP		Boolean	TRUE means that the timer has expired or the stored value is zero. FALSE means that the timer has not expired.
T315 expired	MP		Boolean	TRUE means that the timer has expired or the stored value is zero. FALSE means that the timer has not expired.

10.3.3.29 Redirection info

This IE is used to redirect the UE to another frequency or other system.

Information Element/Group name	Need	Multi	Type and reference	Semantics description
CHOICE <i>Redirection Information</i>	MP			
>Frequency info			Frequency info 10.3.6.36	
>Inter-RAT info			Inter-RAT info 10.3.7.25	

10.3.3.30 Re-establishment timer

This information element indicates which timer to associate with RAB.

Information Element/Group name	Need	Multi	Type and reference	Semantics description
Re-establishment timer	MP		Enumerated(useT314, useT315)	

10.3.3.31 Rejection cause

Cause for rejection of RRC connection establishment request.

Information Element/Group name	Need	Multi	Type and reference	Semantics description
Rejection cause	MP		Enumerated(congestion, unspecified)	

10.3.3.32 Release cause

Cause for release of RRC connection.

Information Element/Group name	Need	Multi	Type and reference	Semantics description
Release cause	MP		Enumerated (normal event, unspecified, pre-emptive release, congestion, re-establishment reject, user inactivity), directed signalling connection re-establishment)	One spare value is needed.

10.3.3.33 RF capability FDD

Information Element/Group name	Need	Multi	Type and Reference	Semantics description	Version
UE power class	MP		Enumerated(1..4)	as defined in [21]	
Tx/Rx frequency separation	MP		Enumerated(190, 174.8-205.2, 134.8-245.2)	In MHz as defined in [21]. NOTE: Not applicable if UE is not operating in frequency band a (as defined in [21]).	

10.3.3.33a RF capability FDD extension

Information Element/Group name	Need	Multi	Type and Reference	Semantics description
UE power class extension	MP		Enumerated(1..4)	as defined in [21]. Four spare values are needed
Tx/Rx frequency separation	MP		Enumerated(190, 174.8-205.2, 134.8-245.2)	In MHz as defined in [21]. NOTE: Not applicable if UE is not operating in frequency band a (as defined in [21]).

10.3.3.33b RF capability TDD

Information Element/Group name	Need	Multi	Type and Reference	Semantics description
UE power class	MP		Enumerated(1..4)	as defined in [22]
Radio frequency bands	MP		Enumerated(a, b, c, a+b, a+c, b+c, a+b+c)	as defined in [22]. One spare value needed.
Chip rate capability	MP		Enumerated(3.84Mcps, 1.28Mcps)	as defined in [22]

10.3.3.34 RLC capability

Information Element/Group name	Need	Multi	Type and Reference	Semantics description
Total RLC AM buffer size	MP		Integer(2,10,50,100,150,500,1000)	Total receiving and transmitting RLC AM buffer capability in kBytes. One spare value is needed.
Maximum RLC AM Window Size	MP		Integer(2047,4095)	Maximum supported RLC TX and RX window in UE
Maximum number of AM entities	MP		Integer(3,4,5,6,8,16,30)	

10.3.3.35 RLC re-establish indicator

This IE is used to re-configure AM RLC on c-plane and u-plane.

Information Element/Group name	Need	Multi	Type and reference	Semantics description
RLC re-establish indicator	MP		Boolean	TRUE means re-establish required FALSE means re-establish not required

10.3.3.35a RRC State Indicator

Indicates to a UE the RRC state to be entered.

Information Element/Group name	Need	Multi	Type and reference	Semantics description
RRC State indicator	MP		Enumerated(CELL_DCH, CELL_FACH, CELL_PCH, URA_PCH)	

10.3.3.36 RRC transaction identifier

This IE contains an identification of the RRC procedure transaction local for the type of the message this IE was included within.

Information Element/Group name	Need	Multi	Type and reference	Semantics description
RRC transaction identifier	MP		Integer (0..3)	

10.3.3.37 Security capability

Information Element/Group name	Need	Multi	Type and reference	Semantics description
Ciphering algorithm capability	MP			
>UEA0	MP		Boolean	
>UEA1	MP		Boolean	
>Spare	MP	14	Boolean	Shall be set to FALSE by UEs complying with this version of the protocol.
Integrity protection algorithm capability	MP			
>UIA1	MP		Boolean	The value TRUE means that UIA1, Kasumi, is supported
>Spare	MP	15	Boolean	Shall be set to FALSE by UEs complying with this version of the protocol.

10.3.3.38 START

There is a START value per CN domain. The START is used to initialise the 20 MSBs of all hyper frame numbers (MAC-d HFN, RLC UM HFN, RLC AM HFN, RRC HFN) for a CN domain.

Information Element/Group name	Need	Multi	Type and Reference	Semantics description
START	MP		Bit string (20)	START [40]. The first/leftmost bit of the bit string contains the most significant bit of the START.

10.3.3.39 Transmission probability

NOTE: Only for FDD.

Indicates the probability for a mobile to be allowed to transmit on a DCH controlled by DRAC procedure.

Information Element/Group name	Need	Multi	Type and reference	Semantics description
Transmission probability	MP		Real(0.125..1.0 by step of 0.125)	probability

10.3.3.40 Transport channel capability

Information Element/Group name	Need	Multi	Type and Reference	Semantics description
Downlink transport channel capability information elements				
Max no of bits received	MP		Integer(640, 1280, 2560, 3840, 5120, 6400, 7680, 8960, 10240, 20480, 40960, 81920, 163840)	Maximum sum of number of bits of all transport blocks received at an arbitrary time instant
Max convolutionally coded bits received	MP		Integer(640, 1280, 2560, 3840, 5120, 6400, 7680, 8960, 10240, 20480, 40960, 81920, 163840)	Maximum sum of number of bits of all convolutionally coded transport blocks received at an arbitrary time instant
Max turbo coded bits received	CV-turbo_dec_sup		Integer(640, 1280, 2560, 3840, 5120, 6400, 7680, 8960, 10240, 20480, 40960, 81920, 163840)	Maximum sum of number of bits of all turbo coded transport blocks received at an arbitrary time instant
Maximum number of simultaneous transport channels	MP		Integer(4, 8, 16, 32)	
Maximum number of simultaneous CCTrCH	MP		Integer (1..8)	
Max no of received transport blocks	MP		Integer(4, 8, 16, 32, 48, 64, 96, 128, 256, 512)	Maximum total number of transport blocks received within TTIs that end at within the same 10ms interval
Maximum number of TFC	MP		Integer(16, 32, 48, 64, 96, 128, 256, 512, 1024)	
Maximum number of TF	MP		Integer(32, 64, 128, 256, 512, 1024)	
Support for turbo decoding	MP		Boolean	TRUE means supported
Uplink transport channel capability information elements				
Max no of bits transmitted	MP		Integer(640, 1280, 2560, 3840, 5120, 6400, 7680, 8960, 10240, 20480, 40960, 81920, 163840)	Maximum sum of number of bits of all transport blocks transmitted at an arbitrary time instant

Information Element/Group name	Need	Multi	Type and Reference	Semantics description
Max convolutionally coded bits transmitted	MP		Integer(640, 1280, 2560, 3840, 5120, 6400, 7680, 8960, 10240, 20480, 40960, 81920, 163840)	Maximum sum of number of bits of all convolutionally coded transport blocks transmitted at an arbitrary time instant
Max turbo coded bits transmitted	CV- <i>turbo_enc_sup</i>		Integer(640, 1280, 2560, 3840, 5120, 6400, 7680, 8960, 10240, 20480, 40960, 81920, 163840)	Maximum sum of number of bits of all turbo coded transport blocks transmitted at an arbitrary time instant
Maximum number of simultaneous transport channels	MP		Integer(2, 4, 8, 16, 32)	
Maximum number of simultaneous CCTrCH of DCH type	CH- <i>tdd_req_sup</i>		Integer (1..8)	
Max no of transmitted transport blocks	MP		Integer(2, 4, 8, 16, 32, 48, 64, 96, 128, 256, 512)	Maximum total number of transport blocks transmitted within TTIs that start at the same time
Maximum number of TFC	MP		Integer(4, 8, 16, 32, 48, 64, 96, 128, 256, 512, 1024)	
Maximum number of TF	MP		Integer(32, 64, 128, 256, 512, 1024)	
Support for turbo encoding	MP		Boolean	TRUE means supported

Condition	Explanation
<i>turbo_dec_sup</i>	The IE is mandatory present if the IE "Support of turbo decoding" = True. Otherwise this field is not needed in the message.
<i>turbo_enc_sup</i>	The IE is mandatory present if the IE "Support of turbo encoding" = True. Otherwise this field is not needed in the message.
<i>tdd_req_sup</i>	The IE is mandatory present if the IE "Multi-mode capability" has the value "TDD" or "FDD/TDD" and a TDD capability update has been requested in a previous message. Otherwise this field is not needed in the message.

10.3.3.41 UE multi-mode/multi-RAT capability

Information Element/Group name	Need	Multi	Type and Reference	Semantics description
Multi-RAT capability				
Support of GSM	MP		Boolean	
Support of multi-carrier	MP		Boolean	
Multi-mode capability	MP		Enumerated (TDD, FDD, FDD/TDD)	

10.3.3.42 UE radio access capability

Information Element/Group name	Need	Multi	Type and reference	Semantics description	Version
Access stratum release indicator	MP		Enumerated(R99)	Indicates the release of the UE according to [35]. The IE also indicates the release of the RRC transfer syntax supported by the UE..	
	CV-not_rrc_connectionSetupComplete		Enumerated(REL-4)	15 spare values are needed.	REL-4
PDCP capability	MP		PDCP capability 10.3.3.24		
RLC capability	MP		RLC capability 10.3.3.34		
Transport channel capability	MP		Transport channel capability 10.3.3.40		
RF capability FDD	OP		RF capability FDD 10.3.3.33		
RF capability TDD	OP		RF capability TDD 10.3.3.33b	One "TDD RF capability" entity shall be included for every Chip rate capability supported.	
		1 to 2			REL-4
Physical channel capability	MP		Physical channel capability 10.3.3.25		
UE multi-mode/multi-RAT capability	MP		UE multi-mode/multi-RAT capability 10.3.3.41		
Security capability	MP		Security capability 10.3.3.37		
UE positioning capability	MP		UE positioning capability 10.3.3.45		
Measurement capability	CH-fdd_req_susp		Measurement capability 10.3.3.21		

Condition	Explanation
<i>fd_d_req_sup</i>	The IE is mandatory present if the IE "Multi-mode capability" has the value "FDD" or "FDD/TDD" and a FDD capability update has been requested in a previous message. Otherwise this field is not needed in the message.
<i>not_rrc_connectionSetupComplete</i>	The IE is not needed in the RRC CONNECTION SETUP COMPLETE message. Otherwise the IE is mandatory present.

10.3.3.42a UE radio access capability extension

Information Element/Group name	Need	Multi	Type and reference	Semantics description
Frequency band specific capability list	MP	1 to <maxFreqbandsFDD>		
>Frequency band	MP		Enumerated(FDD2100, FDD1900)	Six spare values are needed
>RF capability FDD extension	MD		RF capability FDD extension 10.3.3.33a	the default values are the same values as in the immediately preceding IE "RF capability FDD extension"; the first occurrence is MP
>Measurement capability extension	MP		Measurement capability extension 10.3.3.21a	

10.3.3.42b UE security information

Upon receiving a UE information request from another system, the UE shall indicate the requested security information. The UE security information includes the following RRC information.

Information Element/Group name	Need	Multi	Type and reference	Semantics description
UE information elements				
START-CS	MP		START 10.3.3.38	START values to be used in this CN domain.

10.3.3.43 UE Timers and Constants in connected mode

This information element specifies timer- and constants values used by the UE in connected mode.

Information Element/Group name	Need	Multi	Type and reference	Semantics description
T301	MD		Integer(100, 200 .. 2000 by step of 200, 3000, 4000, 6000, 8000)	Value in milliseconds. Default value is 2000. This IE should not be used by the UE in this release of the protocol. One spare value is needed.
N301	MD		Integer(0..7)	Default value is 2. This IE should not be used by the UE in this release of the protocol.
T302	MD		Integer(100, 200... 2000 by step of 200, 3000, 4000, 6000, 8000)	Value in milliseconds. Default value is 4000. One spare value is needed.

Information Element/Group name	Need	Multi	Type and reference	Semantics description
N302	MD		Integer(0..7)	Default value is 3.
T304	MD		Integer(100, 200, 400, 1000, 2000)	Value in milliseconds. Default value is 2000. Three spare values are needed.
N304	MD		Integer(0..7)	Default value is 2..
T305	MD		Integer(5, 10, 30, 60, 120, 360, 720, infinity)	Value in minutes. Default value is 30. Infinity means no update
T307	MD		Integer(5, 10, 15, 20, 30, 40, 50)	Value in seconds. Default value is 30. One spare value is needed.
T308	MD		Integer(40, 80, 160, 320)	Value in milliseconds. Default value is 160.
T309	MD		Integer(1..8)	Value in seconds. Default value is 5.
T310	MD		Integer(40 .. 320 by step of 40)	Value in milliseconds. Default value is 160.
N310	MD		Integer(0 .. 7)	Default value is 4.
T311	MD		Integer(250 .. 2000 by step of 250)	Value in milliseconds. Default value is 2000.
T312	MD		Integer (0..15)	Value in seconds. Default value is 1. The value 0 is not used in this version of the specification.
N312	MD		Integer (1, 2, 4, 10, 20, 50, 100, 200, 400, 600, 800, 1000)	Default value is 1.
T313	MD		Integer (0..15)	Value in seconds. Default value is 3.
N313	MD		Integer (1, 2, 4, 10, 20, 50, 100, 200)	Default value is 20.
T314	MD		Integer(0, 2, 4, 6, 8, 12, 16, 20)	Value in seconds. Default value is 12.
T315	MD		Integer (0,10, 30, 60, 180, 600, 1200, 1800)	Value in seconds. Default value is 180.
N315	MD		Integer (1, 2, 4, 10, 20, 50, 100, 200, 400, 600, 800, 1000)	Default value is 1.
T316	MD		Integer(0, 10, 20, 30, 40, 50, infinity)	Value in seconds. Default value is 30. One spare value is needed.
T317	MD		Integer (0,10, 30, 60, 180, 600, 1200, 1800)	Value in seconds. Default value is 180.

10.3.3.44 UE Timers and Constants in idle mode

This information element specifies timer- and constant values used by the UE in idle mode.

Information Element/Group name	Need	Multi	Type and reference	Semantics description
T300	MP		Integer(100, 200... 2000 by step of 200, 3000, 4000, 6000, 8000)	Value in milliseconds. Default value is 1000. Use of Default is described in 10.2.48.8.4 and in 10.2.48.8.16.
N300	MP		Integer(0..7)	Default value is 3. Use of Default is described in 10.2.48.8.4 and in 10.2.48.8.16.
T312	MP		Integer(0 .. 15)	Value in seconds. Default value is 1. Use of Default is described in 10.2.48.8.4 and in 10.2.48.8.16. The value 0 is not used in this version of the specification.
N312	MP		Integer (1, 2, 4, 10, 20, 50, 100, 200, 400, 600, 800, 1000)	Default value is 1. Use of Default is described in 10.2.48.8.4 and in 10.2.48.8.16.

10.3.3.45 UE positioning capability

Information Element/Group name	Need	Multi	Type and reference	Semantics description
Standalone location method(s) supported	MP		Boolean	Defines if a UE can measure its location by some means unrelated to UTRAN TRUE means supported
UE based OTDOA supported	MP		Boolean	TRUE means supported
Network Assisted GPS support	MP		Enumerated ('Network based', 'UE based', 'Both', 'None')	Defines if the UE supports network based or UE based GPS methods.
Support for GPS timing of cell frames measurement	MP		Boolean	Defines if a UE has the capability to perform the UE GPS timing of cell frames measurement [7]. TRUE means capable
Support for IPDL	MP		Boolean	Defines if a UE has the capability to use IPDL to enhance its 'SFN-SFN observed time difference –type 2' measurement. TRUE means supported
Support for Rx-Tx time difference type2 measurement	MP		Boolean	TRUE means supported
Support for UP measurement validity in CELL_PCH and URA_PCH states	MD		Enumerated (true)	Absence of this element means not supported and presence means supported. NOTE 1.

NOTE 1: The performance requirements for this capability are defined in Release 5.

10.3.3.46 URA update cause

Indicates the cause for s URA update.

Information Element/Group name	Need	Multi	Type and reference	Semantics description
URA update cause	MP		Enumerated(change of URA, periodic URA update)	One spare value is needed.

10.3.3.47 U-RNTI

The U-RNTI (UTRAN Radio Network Temporary Identity) is allocated to a UE having a RRC connection and identifies the UE within UTRAN.

Information Element/Group name	Need	Multi	Type and reference	Semantics description
SRNC identity	MP		bit string(12)	
S-RNTI	MP		bit string(20)	

10.3.3.48 U-RNTI Short

The U-RNTI (UTRAN Radio Network Temporary Identity) is allocated to a UE having a RRC connection and identifies the UE within UTRAN.

Information Element/Group name	Need	Multi	Type and reference	Semantics description
SRNC identity	MP		bit string(12)	
S-RNTI 2	MP		bit string(10)	

10.3.3.49 UTRAN DRX cycle length coefficient

A coefficient in the formula to count the paging occasions to be used by a specific UE (specified in [4]).

Information Element/Group name	Need	Multi	Type and reference	Semantics description
DRX cycle length coefficient	MP		Integer(3..9)	Refers to 'k' in the formula as specified in [4], Discontinuous reception

10.3.3.50 Wait time

Wait time defines the time period the UE has to wait before repeating the rejected procedure.

Information Element/Group name	Need	Multi	Type and reference	Semantics description
Wait time	MP		Integer(0..15)	Wait time in seconds The value 0 indicates that repetition is not allowed.

10.3.3.51 UE Specific Behaviour Information 1 idle

This IE indicates the UE conformance typically for RRC connection establishment from idle mode.

Information Element/Group name	Need	Multi	Type and Reference	Semantics description
UE Specific Behaviour Information 1 idle	MP		bit string(4)	

10.3.3.52 UE Specific Behaviour Information 1 interRAT

This IE indicates the UE conformance typically for RRC connection establishment from another RAT.

Information Element/Group name	Need	Multi	Type and Reference	Semantics description
UE Specific Behaviour Information 1 interRAT	MP		bit string(8)	

10.3.4 Radio Bearer Information elements

10.3.4.0 Default configuration identity

This information element identifies a default radio parameter configuration.

Information Element/Group name	Need	Multi	Type and reference	Semantics description	Version
Default configuration identity	MP		Integer (0..10	The corresponding default configurations are specified in 13.7	
			11, 12)		

10.3.4.1 Downlink RLC STATUS info

Information Element/Group name	Need	Multi	Type and reference	Semantics description
Timer_Status_Prohibit	OP		Integer(10..50 by step of 10, 550..1000 by step of 50)	Minimum time in ms between STATUS reports
Timer_EPC	OP		Integer(50, 60, 70, 80, 90, 100, 120, 140, 160, 180, 200, 300, 400, 500, 700, 900)	Time in ms
Missing PDU Indicator	MP		Boolean	Value true indicates that UE should send a STATUS report for each missing PDU that is detected
Timer_STATUS_periodic	OP		Integer(100, 200, 300, 400, 500, 750, 1000, 2000)	Time in milliseconds

10.3.4.2 PDCP info

The purpose of the PDCP info IE is to indicate which algorithms shall be established and to configure the parameters of each of the algorithms.

Information Element/Group name	Need	Multi	Type and reference	Semantics description	Version
Support for lossless SRNS	CV-		Boolean	TRUE means	

Information Element/Group name	Need	Multi	Type and reference	Semantics description	Version
relocation	<i>LosslessCriteria</i>			support	
Max PDCP SN window size	CV- <i>Lossless</i>		Enumerated(sn255, sn65535)	Maximum PDCP sequence number window size. The handling of sequence number when the Max PDCP SN window size is 255 is specified in [23].	
PDCP PDU header	MD		Enumerated (present, absent)	Whether a PDCP PDU header is existent or not. Default value is "present"	
Header compression information	OP	1 to <maxPDCPAlgoType >			
>CHOICE <i>algorithm type</i> >>RFC 2507	MP			Header compression according to IETF standard RFC 2507	
>>>F_MAX_PERIOD	MD		Integer (1..65535)	Largest number of compressed non-TCP headers that may be sent without sending a full header. Default value is 256.	
>>>F_MAX_TIME	MD		Integer (1..255)	Compressed headers may not be sent more than F_MAX_TIME seconds after sending last full header. Default value is 5.	
>>>MAX_HEADER	MD		Integer (60..65535)	The largest header size in octets that may be compressed. Default value is 168.	
>>>TCP_SPACE	MD		Integer (3..255)	Maximum CID value for TCP connections. Default value is 15.	
>>>NON_TCP_SPACE	MD		Integer (3..65535)	Maximum CID value for non-TCP connections. Default value is 15.	
>>>EXPECT_REORDERING	MD		Enumerated (reordering not expected, reordering expected)	Whether the algorithm shall reorder PDCP SDUs or not. Default value is "reordering not expected".	
>>RFC 3095				Header	REL-4

Information Element/Group name	Need	Multi	Type and reference	Semantics description	Version
				compression according to IETF standard RFC 3095	
>>>Uplink	OP			Indicates the necessary information elements for Uplink.	REL-4
>>>>CID inclusion info	MP		Enumerated (PDCP header, RFC3095 packet format)	Configures which method shall be used to carry RFC3095 CID values.	REL-4
>>>>Max_CID	MD		Integer (1..16383)	Highest context ID number to be used by the UE compressor. Default value is 15.	REL-4
>>>>Profiles	MP	1 to <maxROHC-Profiles>		Profiles supported by the UTRAN decompressor.	REL-4
>>>>>Profile instance	MP		Integer(1 .. 3)	Supported profile types. At least four spare values.	REL-4
>>>>>Packet_Sizes_Allowed	OP	1 to <maxROHC-PacketSizes>		List of packet sizes that are allowed to be produced by the UE compressor.	REL-4
>>>>>>Packet size	MP		Integer (2 .. 1500)	Packet size as defined in RFC 3095.	REL-4
>>>>Downlink	OP			Indicates the necessary information elements for Downlink.	REL-4
>>>>>CID inclusion info	MP		Enumerated (PDCP header, RFC3095 packet format)	Configures which method shall be used to carry RFC3095 CID values.	REL-4
>>>>>>Max_CID	MD		Integer (1..16383)	Highest context ID number to be used by the UE decompressor. Default value is 15.	REL-4
>>>>>>>Reverse-Decompression_Depth	MD		Integer (0..65535)	Determines whether reverse decompression should be used or not and the maximum number of packets that can be reverse decompressed by the UE decompressor. Default value is 0 (reverse	REL-4

Information Element/Group name	Need	Multi	Type and reference	Semantics description	Version
				decompression shall not be used).	

Condition	Explanation
<i>LosslessCriteria</i>	This IE is mandatory present if the IE "RLC mode" is "Acknowledged", the IE "In-sequence delivery" is "True" and the IE "SDU Discard Mode" is "No discard" and not needed otherwise.
<i>Lossless</i>	This IE is mandatory present if the IE "Support for lossless SRNS relocation" Is TRUE, otherwise it is not needed.

10.3.4.3 PDCP SN info

Information Element/Group name	Need	Multi	Type and Reference	Semantics description
Receive PDCP sequence number	MP		Integer(0..65535)	The PDCP sequence number, which the sender of the message is expecting next to be received.

10.3.4.4 Polling info

Information Element/Group name	Need	Multi	Type and reference	Semantics description
Timer_poll_prohibit	OP		Integer(10..550 by step of 10, 600..1000 by step of 50)	Minimum time between polls in ms
Timer_poll	OP		Integer(10..550 by step of 10, 600..1000 by step of 50)	Time in ms.
Poll_PDU	OP		Integer(1,2,4,8,16,32,64,128)	Number of PDUs, interval between pollings
Poll_SDU	OP		Integer(1,4,16,64)	Number of SDUs, interval between pollings
Last transmission PDU poll	MP		Boolean	TRUE indicates that poll is made at last PDU in transmission buffer
Last retransmission PDU poll	MP		Boolean	TRUE indicates that poll is made at last PDU in retransmission buffer
Poll_Window	OP		Integer(50,60,70,80,85,90,95,99)	Percentage of transmission window, threshold for polling
Timer_poll_periodic	OP		Integer(100, 200, 300, 400, 500, 750, 1000, 2000)	Time in milliseconds Timer for periodic polling.

10.3.4.5 Predefined configuration identity

This information element identifies a pre- defined radio parameter configuration.

Information Element/Group name	Need	Multi	Type and reference	Semantics description
Predefined radio configuration identity	MP		Integer (0..15)	

10.3.4.5a Predefined configuration status information

Another system may provide the UE with one or more predefined UTRAN configurations, comprising of radio bearer, transport channel and physical channel parameters. If requested, the UE shall indicate the configurations it has stored. The predefined configuration status information should include the following RRC information.

Information Element/Group name	Need	Multi	Type and reference	Semantics description
RB information elements				
Predefined configurations		maxPredef ConfigCount		The list is in order of preconfiguration identity
>Predefined configuration value tag	OP		Predefined configuration value tag 10.3.4.6	The UE shall include the value tag if it has stored the concerned configuration

Multi Bound	Explanation
MaxPredefConfigCount	Maximum number of predefined configurations

10.3.4.6 Predefined configuration value tag

This information element is used to identify different versions of a radio bearer configuration as may be used within one PLMN e.g. to support different UTRAN implementations.

Information Element/Group name	Need	Multi	Type and Reference	Semantics description
Predefined configuration value tag	MP		Integer(0..15)	

10.3.4.7 Predefined RB configuration

This information element concerns a pre- defined configuration of radio bearer parameters

Information Element/Group name	Need	Multi	Type and Reference	Semantics description
UE information elements				
Re-establishment timer	MP		Re-establishment timer 10.3.3.30	Only one RAB supported
Signalling radio bearer information				
Signalling RB information to setup List	MP	1 to <maxSRBsetup>		For each signalling radio bearer
>Signalling RB information to setup	MP		Signalling RB information to setup 10.3.4.24	
RB information				
RB information to setup list	MP	1 to <maxRBperRAB>		Only one RAB supported
>RB information to setup	MP		RB information to setup 10.3.4.20	

10.3.4.8 RAB info

This IE contains information used to uniquely identify a radio access bearer.

Information Element/Group name	Need	Multi	Type and reference	Semantics description
RAB identity	MP		RAB identity 10.3.1.14	
CN domain identity	MP		CN domain identity 10.3.1.1	
NAS Synchronization Indicator	OP		NAS Synchronization indicator 10.3.4.12	
Re-establishment timer	MP		Re-establishment timer 10.3.3.30	

10.3.4.9 RAB info Post

This IE contains information used to uniquely identify a radio access bearer.

Information Element/Group name	Need	Multi	Type and reference	Semantics description
RAB identity	MP		RAB identity 10.3.1.14	
CN domain identity	MP		CN domain identity 10.3.1.1	
NAS Synchronization Indicator	OP		NAS Synchronization indicator 10.3.4.12	

10.3.4.10 RAB information for setup

Information Element/Group name	Need	Multi	Type and reference	Semantics description
RAB info	MP		RAB info 10.3.4.8	
RB information to setup list	MP	1 to <maxRBperRAB>		
>RB information to setup	MP		RB information to setup 10.3.4.20	

10.3.4.11 RAB information to reconfigure

Information Element/Group name	Need	Multi	Type and reference	Semantics description
RAB identity	MP		RAB Identity 10.3.1.14	
CN domain identity	MP		CN domain identity 10.3.1.1	
NAS synchronization indicator	MP		NAS Synchronization info 10.3.4.12	

10.3.4.12 NAS Synchronization indicator

A container for non-access stratum information to be transferred transparently through UTRAN.

Information Element/Group name	Need	Multi	Type and reference	Semantics description
NAS Synchronization indicator	MP		Bit string(4)	The first/leftmost bit of the bit string contains the most significant bit of the NAS Synchronization indicator.

10.3.4.13 RB activation time info

This IE contains the time, in terms of RLC sequence numbers, when a certain configuration shall be activated, for a number of radio bearers.

Information Element/Group name	Need	Multi	Type and reference	Semantics description
Radio bearer activation time	MP	1 to <maxRB>		
>RB identity	MP		RB identity 10.3.4.16	
>RLC sequence number	MP		Integer (0..4095)	RLC SN [16] . Used for radio bearers mapped on RLC AM and UM

10.3.4.14 RB COUNT-C MSB information

The MSB of the COUNT-C values of the radio bearer.

Information Element/Group name	Needed	Multi	Type and reference	Semantics description
RB identity	MP		RB identity 10.3.4.16	
COUNT-C-MSB-uplink	MP		Integer (0.. $2^{25}-1$)	25 MSBs from COUNT-C associated to this RB
COUNT-C-MSB-downlink	MP		Integer (0.. $2^{25}-1$)	25 MSBs from COUNT-C associated to this RB

10.3.4.15 RB COUNT-C information

The COUNT-C values of the radio bearer.

Information Element/Group name	Needed	Multi	Type and reference	Semantics description
RB identity	MP		RB identity 10.3.4.16	
COUNT-C-uplink	MP		Integer (0.. $2^{32}-1$)	
COUNT-C-downlink	MP		Integer (0.. $2^{32}-1$)	

10.3.4.16 RB identity

An identification number for the radio bearer affected by a certain message.

Information Element/Group name	Need	Multi	Type and reference	Semantics description
RB identity	MP		Integer(1..32)	Values 1-4 shall only be used for signalling radio bearers. The IE value minus one shall be used as BEARER in the ciphering algorithm.

10.3.4.17 RB information to be affected

Information Element/Group name	Need	Multi	Type and reference	Semantics description
RB identity	MP		RB identity 10.3.4.16	
RB mapping info	MP		RB mapping info 10.3.4.21	

10.3.4.18 RB information to reconfigure

Information Element/Group name	Need	Multi	Type and reference	Semantics description
RB identity	MP		RB identity 10.3.4.16	
PDCP info	OP		PDCP info 10.3.4.2	
PDCP SN info	OP		PDCP SN info 10.3.4.3	PDCP sequence number info from the network. Present only in case of lossless SRNS relocation.
RLC info	OP		RLC info 10.3.4.23	
RB mapping info	OP		RB mapping info 10.3.4.21	
RB stop/continue	OP		Enumerated(stop, continue)	

10.3.4.19 RB information to release

Information Element/Group name	Need	Multi	Type and reference	Semantics description
RB identity	MP		RB identity 10.3.4.16	

10.3.4.20 RB information to setup

Information Element/Group name	Need	Multi	Type and reference	Semantics description
RB identity	MP		RB identity 10.3.4.16	
PDCP info	OP		PDCP info 10.3.4.2	
CHOICE <i>RLC info type</i>	MP			
>RLC info			RLC info 10.3.4.23	
>Same as RB			RB identity 10.3.4.16	Identity of RB with exactly the same RLC info IE values
RB mapping info	MP		RB mapping info 10.3.4.21	

NOTE: This information element is included within IE "Predefined RB configuration".

10.3.4.21 RB mapping info

A multiplexing option for each possible transport channel this RB can be multiplexed on.

Information Element/Group name	Need	Multi	Type and reference	Semantics description
Information for each multiplexing option	MP	1 to <maxRBmuxOptions>		
>RLC logical channel mapping indicator	<i>CV-UL-RLCLogicalChannels</i>		Boolean	TRUE indicates that the first logical channel shall be used for data PDUs and the second logical channel shall be used for control PDUs. FALSE indicates that control and data PDUs can be sent on either of the two logical channels. This parameter is not used in this release and shall be set to TRUE.
>Number of uplink RLC logical channels	<i>CV-UL-RLC info</i>	1 to MaxLoCHperRLC		1 or 2 logical channels per RLC entity or radio bearer RLC [16]
>>Uplink transport channel type	MP		Enumerated(DCH,RACH, CPCH,USCH)	CPCH is FDD only USCH is TDD only
>>>ULTransport channel identity	<i>CV-UL-DCH/USCH</i>		Transport channel identity 10.3.5.18	This is the ID of a DCH or USCH (TDD only) that this RB could be mapped onto.
>>>Logical channel identity	OP		Integer(1..15)	This parameter is used to distinguish logical channels multiplexed by MAC on a transport channel.
>>>>CHOICE RLC size list	MP			The RLC sizes that are allowed for this logical channel.
>>>>>All			Null	All RLC sizes listed in the <i>Transport Format Set</i> 10.3.5.23
>>>>>Configured			Null	The RLC sizes configured for this logical channel in the <i>Transport Format Set</i> 10.3.5.23 if present in this message or in the previously stored configuration otherwise
>>>>>Explicit List		1 to <maxTF>		Lists the RLC sizes that are valid for the logical channel.
>>>>>>RLC size index	MP		Integer(1..maxTF)	The integer number is a reference to the <i>RLC size</i> which arrived at that position in the <i>Transport Format Set</i> 10.3.5.23
>>>>>>MAC logical channel priority	MP		Integer(1..8)	This is priority between a user's different RBs (or logical channels). [15]
>Downlink RLC logical channel info	<i>CV-DL-RLC info</i>			
>>>>>>Number of downlink RLC logical channels	<i>MD</i>	1 to MaxLoCHperRLC		1 or 2 logical channels per RLC entity or radio bearer RLC [16] Default value is that parameter values for DL are exactly the same as for corresponding UL logical channel. In case two

Information Element/Group name	Need	Multi	Type and reference	Semantics description
				multiplexing options are specified for the UL, the first options shall be used as default for the DL. As regards to the IE "Channel type", rule is specified in 8.6.4.8.
>>>Downlink transport channel type	MP		Enumerated(DCH,FACH, DSCH,DCH+DSCH)	
>>>DL DCH Transport channel identity	CV-DL-DCH		Transport channel identity 10.3.5.18	
>>>DL DSCH Transport channel identity	CV-DL-DSCH		Transport channel identity 10.3.5.18	
>>>Logical channel identity	OP		Integer(1..15)	16 is reserved

Condition	Explanation
<i>UL-RLC info</i>	If "CHOICE <i>Uplink RLC mode</i> " in the IE "RLC info" that applies for that RB (i.e. either the one stored or received in the same message for the RB for which the "RB mapping info" was received, or the one stored or received in the same message for the RB pointed at in the IE "Same as RB" in the IE "RB information to setup" stored or received in the same message) is present this IE is mandatory present. Otherwise the IE is not needed.
<i>DL-RLC info</i>	If "CHOICE <i>Downlink RLC mode</i> " in the IE "RLC info" that applies for that RB (i.e. either the one stored or received in the same message for the RB for which the "RB mapping info" was received, or the one stored or received in the same message for the RB pointed at in the IE "Same as RB" in the IE "RB information to setup" stored or received in the same message) is present this IE is mandatory present. Otherwise the IE is not needed.
<i>UL-RLCLogicalChannels</i>	If "Number of uplink RLC logical channels" in IE "RB mapping info" is 2, then this IE is mandatory present. Otherwise this IE is not needed.
<i>UL-DCH/USCH</i>	If IE "Uplink transport channel type" is equal to "DCH" or "USCH" (TDD only) this IE is mandatory present. Otherwise the IE is not needed.
<i>DL-DCH</i>	If IE "Downlink transport channel type" is equal to "DCH" or "DCH+DSCH" this IE is mandatory present. Otherwise the IE is not needed.
<i>DL-DSCH</i>	If IE "Downlink transport channel type" is equal to "DSCH" or "DCH+DSCH" this IE is mandatory present. Otherwise the IE is not needed.

10.3.4.22 RB with PDCP information

Information Element/Group name	Need	Multi	Type and reference	Semantics description
RB identity	MP		RB identity 10.3.4.16	
PDCP SN info	MP		PDCP SN info 10.3.4.3	PDCP sequence number info from the sender of the message for lossless SRNS relocation.

10.3.4.23 RLC info

Information Element/Group name	Need	Multi	Type and reference	Semantics description
CHOICE <i>Uplink RLC mode</i>	OP			Indicates if Acknowledged, Unacknowledged or Transparent mode RLC shall be used.
>AM RLC				
>>Transmission RLC discard	MP		Transmission RLC discard 10.3.4.25	
>>Transmission window size	MP		Integer(1,8,16,32,64,128,256,512,768,1024,1536,2047,2560,3072,3584,4095)	Maximum number of RLC PUs sent without getting them acknowledged. This parameter is needed if acknowledged mode is used. UE shall also assume that the UTRAN receiver window is equal to this value.
>>Timer_RST	MP		Integer(50, 100, 150, 200, 250, 300, 350, 400, 450, 500, 550, 600, 700, 800, 900, 1000)	Elapsed time in milliseconds. It is used to trigger the retransmission of RESET PDU.
>>Max_RST	MP		Integer(1, 4, 6, 8, 12, 16, 24, 32)	Defined in [16]
>>Polling info	OP		Polling info 10.3.4.4	
>UM RLC				
>>Transmission RLC discard	OP		Transmission RLC discard 10.3.4.25	
>TM RLC				
>>Transmission RLC discard	OP		Transmission RLC discard 10.3.4.25	
>>Segmentation indication	MP		Boolean	TRUE indicates that segmentation is performed.
CHOICE <i>Downlink RLC mode</i>	OP			Indicates if Acknowledged, Unacknowledged or Transparent mode RLC shall be used
>AM RLC				
>>In-sequence delivery	MP		Boolean	TRUE indicates that RLC shall preserve the order of higher layer PDUs when these are delivered. FALSE indicates that receiving RLC entity could allow SDUs to be delivered to the higher layer in different order than submitted to RLC sublayer at the transmitting side.
>>Receiving window size	MP		Integer(1,8,16,32,64,128,	Maximum number of RLC PUs allowed to be received. This

Information Element/Group name	Need	Multi	Type and reference	Semantics description
			256,512,768,1024,1536,2047,2560,3072,3584,4095)	parameter is needed if acknowledged mode is used. UE shall also assume that the UTRAN transmitter window is equal to this value
>>Downlink RLC status Info	MP		Downlink RLC status info 10.3.4.1	
>UM RLC				(No data)
>TM RLC				
>>Segmentation indication	MP		Boolean	TRUE indicates that segmentation is performed.

NOTE: This information element is included within IE "Predefined RB configuration".

10.3.4.24 Signalling RB information to setup

Information Element/Group name	Need	Multi	Type and reference	Semantics description
RB identity	MD		RB identity 10.3.4.16	Default value is specified in subclause 8.6.4.1
CHOICE <i>RLC info type</i>	MP			
>RLC info			RLC info 10.3.4.23	
>Same as RB			RB identity 10.3.4.16	Identity of RB with exactly the same RLC info IE values
RB mapping info	MP		RB mapping info 10.3.4.21	

NOTE: This information element is included within IE "Predefined RB configuration".

10.3.4.25 Transmission RLC Discard

Information Element/Group name	Need	Multi	Type and reference	Semantics description
CHOICE <i>SDU Discard Mode</i>	MP			Different modes for discharge the RLC buffer on the transmitter side; "Timer based with explicit signalling", "Timer based without explicit signalling", "Discard after Max_DAT retransmissions" or "No_discard". For unacknowledged mode and transparent mode, only Timer based without explicit signalling is applicable. If "No_discard" is used, reset procedure shall be done after Max_DAT retransmissions
>Timer based explicit				
>>Timer_MRW	MP		Integer(50,60,70,80,90,100,120,140,160,180,200,300,400,500,700,900)	Elapsed time in milliseconds. It is used to trigger the retransmission of a STATUS PDU containing an MRW SUFI field

Information Element/Group name	Need	Multi	Type and reference	Semantics description
>>Timer_discard	MP		Integer(100, 250, 500, 750, 1000, 1250, 1500, 1750, 2000, 2500, 3000, 3500, 4000, 4500, 5000, 7500)	Elapsed time in milliseconds before a SDU is discarded.
>>MaxMRW	MP		Integer(1, 4, 6, 8, 12, 16, 24, 32)	Defined in [16]
>Timer based no explicit				
>>Timer_discard	MP		Integer(10,20,30,40,50,60,70,80,90,100)	Elapsed time in milliseconds before a SDU is discarded.
>Max DAT retransmissions				
>>Max_DAT	MP		Integer(1, 2, 3, 4, 5, 6, 7, 8, 9, 10, 15, 20, 25, 30, 35, 40)	Defined in [16]
>>Timer_MRW	MP		Integer(50, 60, 70, 80, 90, 100, 120, 140, 160, 180, 200, 300, 400, 500, 700, 900)	Elapsed time in milliseconds. It is used to trigger the retransmission of a STATUS PDU containing an MRW SUFI field
>>MaxMRW	MP		Integer(1, 4, 6, 8, 12, 16, 24, 32)	Defined in [16]
>No discard				
>>Max_DAT	MP		Integer(1, 2, 3, 4, 5, 6, 7, 8, 9, 10, 15, 20, 25, 30, 35, 40)	Defined in [16]

CHOICE SDU Discard Mode	Condition under which the given SDU Discard Mode is chosen
Timer based explicit	If the modes for discharge of the RLC buffer on the transmitter side is "Timer based with explicit signalling"
Timer based no explicit	If the modes for discharge of the RLC buffer on the transmitter side is "Timer based without explicit signalling" For unacknowledged mode, only Timer based without explicit signalling is applicable.
Max DAT retransmissions	If the modes for discharge of the RLC buffer on the transmitter side is "Discard after Max_DAT retransmissions"
No discard	If the modes for discharge the of RLC buffer on the transmitter side is "Reset procedure shall be done after Max_DAT retransmissions"

10.3.5 Transport CH Information elements

10.3.5.1 Added or Reconfigured DL TrCH information

Information Element/Group name	Need	Multi	Type and reference	Semantics description
Downlink transport channel type	MP		Enumerated(DCH,DSCH)	
DL Transport channel identity	MP		Transport channel identity 10.3.5.18	
CHOICE <i>DL parameters</i>				
>Explicit				
>>TFS	MP		Transport Format Set 10.3.5.23	
>SameAsUL				
>>Uplink transport channel type	MP		Enumerated(DCH,USCH)	USCH is TDD only
>>UL TrCH identity	MP		Transport channel identity 10.3.5.18	Same TFS applies as specified for indicated UL TrCH
DCH quality target	OP		Quality target 10.3.5.10	

10.3.5.2 Added or Reconfigured UL TrCH information

Information Element/Group name	Need	Multi	Type and reference	Semantics description
Uplink transport channel type	MP		Enumerated(DCH,USCH)	USCH is TDD only
UL Transport channel identity	MP		Transport channel identity 10.3.5.18	
TFS	MP		Transport Format Set 10.3.5.23	

NOTE: This information element is included within IE "Predefined RB configuration".

10.3.5.3 CPCH set ID

NOTE: Only for FDD.

This information element indicates that this transport channel may use any of the Physical CPCH channels defined in the CPCH set info, which contains the same CPCH set ID. The CPCH set ID associates the transport channel with a set of PCPCH channels defined in a CPCH set info IE and a set of CPCH persistency values. The CPCH set info IE(s) and the CPCH persistency values IE(s) each include the CPCH set ID and are part of the SYSTEM INFORMATION message.

Information Element/Group name	Need	Multi	Type and reference	Semantics description
CPCH set ID	MP		Integer(1...maxCPCHsets)	Identifier for CPCH set info and CPCH persistency value messages

10.3.5.4 Deleted DL TrCH information

Information Element/Group name	Need	Multi	Type and reference	Semantics description
Downlink transport channel type	MP		Enumerated(DCH,DSCH)	
DL Transport channel identity	MP		Transport channel identity 10.3.5.18	

10.3.5.5 Deleted UL TrCH information

Information Element/Group name	Need	Multi	Type and reference	Semantics description
Uplink transport channel type	MP		Enumerated(DCH,USCH)	USCH is TDD only
UL Transport channel identity	MP		Transport channel identity 10.3.5.18	

10.3.5.6 DL Transport channel information common for all transport channels

Information Element/Group name	Need	Multi	Type and reference	Semantics description	Version
SCCPCH TFCS	OP		Transport Format Combination Set 10.3.5.20	This IE should not be included in this version of the protocol.	
CHOICE <i>mode</i>	MP			Although this IE is not always required, need is MP to align with ASN.1	
>FDD	OP				REL-4
>>CHOICE <i>DL parameters</i>	OP				
>>>Explicit					
>>>>DL DCH TFCS	MP		Transport Format Combination Set 10.3.5.20	Although this IE is not always required, need is MP to align with ASN.1	
>>>>SameAsUL	OP			(no data)	REL-4
>TDD					
>>Individual DL CCH information	OP	1 to <maxCCH>			
>>>DL TFCS Identity	MP		Transport format combination set identity 10.3.5.21	Identifies a special CCH for shared or dedicated channels.	
>>>CHOICE <i>DL parameters</i>	MP				
>>>>Independent					
>>>>>DL TFCS	MP		Transport format combination set 10.3.5.20		
>>>>>SameAsUL					

Information Element/Group name	Need	Multi	Type and reference	Semantics description	Version
>>>>UL DCH TFCS Identity	MP		Transport format combination set identity 10.3.5.21	Same TFCS applies as specified for the indicated UL DCH TFCS identity except for information applicable for UL only	

NOTE: This information element is included within IE "Predefined TrCh configuration".

10.3.5.7 DRAC Static Information

NOTE: Only for FDD.

Contains static parameters used by the DRAC procedure. Meaning and use is described in subclause 14.8.

Information Element/Group name	Need	Multi	Type and reference	Semantics description
Transmission Time Validity	MP		Integer(1..256)	number of frames
Time duration before retry	MP		Integer(1..256)	number of frames
DRAC Class Identity	MP		Integer(1..maxDRACclasses)	Indicates the class of DRAC parameters to use in SIB10 message

10.3.5.8 Power Offset Information

Information Element/Group name	Need	Multi	Type and reference	Semantics description
CHOICE <i>Gain Factors</i>	MP			
>Signalled Gain Factors				
>>CHOICE <i>mode</i>				
>>>FDD				
>>>>Gain Factor β_c	MP		Integer (0.. 15)	For UL DPCH or control part of PRACH or PCPCH (no data)
>>>TDD				
>>>>Gain Factor β_d	MP		Integer (0..15)	For UL DPCH or data part of PRACH or PCPCH in FDD and all uplink channels in TDD
>>>Reference TFC ID	OP		Integer (0..3)	If this TFC is a reference TFC, indicates the reference ID.
>Computed Gain Factors				
>>>Reference TFC ID	MP		Integer (0.. 3)	Indicates the reference TFC Id of the TFC to be used to calculate the gain factors for this TFC. In case of using computed gain factors, at least one signalled gain factor is necessary for reference.
CHOICE <i>mode</i>	MP			
>FDD				
>>>Power offset P _{p-m}	OP		Integer(-5..10)	In dB. Power offset between the last transmitted preamble and the control part of the message (added to the preamble power to receive the power of the message control

Information Element/Group name	Need	Multi	Type and reference	Semantics description
				part) Needed only for PRACH
>TDD				(no data)

CHOICE Gain Factors	Condition under which the way to signal the Gain Factors is chosen
Signalled Gain Factors	The values for gain factors β_c (only in FDD mode) and β_d are signalled directly for a TFC.
Computed Gain Factors	The gain factors β_c (only in FDD mode) and β_d are computed for a TFC, based on the signalled settings for the associated reference TFC.

10.3.5.9 Predefined TrCH configuration

This information element concerns a pre- defined configuration of transport channel parameters.

Information Element/Group name	Need	Multi	Type and Reference	Semantics description
UL Transport channel information common for all transport channels	MP		UL Transport channel information common for all transport channels 10.3.5.24	
Added or Reconfigured TrCH information				
Added or Reconfigured UL TrCH information	MP	1 to <maxTrCH preconf>		
>Added or Reconfigured UL TrCH information	MP		Added or Reconfigured UL TrCH information 10.3.5.2	
DL Transport channel information common for all transport channels	MP		DL Transport channel information common for all transport channels 10.3.5.6	
Downlink transport channels				
Added or Reconfigured DL TrCH information	MP	1 to <maxTrCH preconf>		
>Added or Reconfigured DL TrCH information	MP		Added or Reconfigured DL TrCH information 10.3.5.1	

10.3.5.10 Quality Target

Information Element/Group name	Need	Multi	Type and reference	Semantics description
BLER Quality value	MP		Real(-6.3 ..0 by step of 0.1)	Signalled value is Log10(Transport channel BLER quality target)

10.3.5.11 Semi-static Transport Format Information

Information Element/Group name	Need	Multi	Type and reference	Semantics description	Version
Transmission time interval	MP		Integer(10, 20, 40, 80, dynamic	In ms. The value dynamic is only used in TDD mode.	REL-4
			5)	5 is only applicable for the RACH in 1.28 Mcps TDD	
Type of channel coding	MP		Enumerated(No coding, Convolutional, Turbo)	The option "No coding" is only valid for TDD.	
Coding Rate	<i>CV-Coding</i>		Enumerated(1/2, 1/3)		
Rate matching attribute	MP		Integer(1..hi RM)		
CRC size	MP		Integer(0, 8, 12, 16, 24)	in bits	

Condition	Explanation
<i>Coding</i>	This IE is mandatory present if IE "Type of channel coding" is "Convolutional" and not needed otherwise.

10.3.5.12 TFCI Field 2 Information

This IE is used for signalling the mapping between TFCI (field 2) values and the corresponding TFC.

Information Element/Group name	Need	Multi	IE type and reference	Semantics description
CHOICE <i>Signalling method</i>	MP			
>TFCI range				
>>TFCI(field 2) range	MP	1 to <maxPDSCH-TFCIgroups>		
>>>Max TFCI(field2) value	MP		Integer(1..1023)	This is the Maximum value in the range of TFCI(field2) values for which the specified CTFC(field2) applies
>>>TFCS Information for DSCH (TFCI range method)	MP		TFCS Information for DSCH (TFCI range method) 10.3.5.14	
>Explicit				
>>TFCS explicit configuration	MP		TFCS explicit configuration 10.3.5.13	

10.3.5.13 TFCS Explicit Configuration

Information Element/Group name	Need	Multi	IE type and reference	Semantics description
CHOICE <i>TFCS representation</i>	MP			
>Complete reconfiguration				
>>TFCS complete reconfiguration information	MP		TFCS Reconfiguration/Addition information 10.3.5.15	
>Addition				
>>TFCS addition information	MP		TFCS Reconfiguration/Addition information 10.3.5.15	
>Removal				
>>TFCS removal information	MP		TFCS Removal Information 10.3.5.16	
>Replace				
>>TFCS removal information	MP		TFCS Removal Information 10.3.5.16	
>>TFCS addition information	MP		TFCS Reconfiguration/Addition information 10.3.5.15	

10.3.5.14 TFCS Information for DSCH (TFCI range method)

Information Element/Group name	Need	Multi	IE type and reference	Semantics description
CHOICE <i>CTFC Size</i>	MP			
>2 bit CTFC				
>>2bit CTFC	MP		Integer(0..3)	
>4 bit CTFC				
>>4bit CTFC	MP		Integer(0..15)	
>6 bit CTFC				
>>6 bit CTFC	MP		Integer(0..63)	
>8 bit CTFC				
>>8 bit CTFC	MP		Integer(0..255)	
>12 bit CTFC				
>>12 bit CTFC	MP		Integer(0..4095)	
>16 bit CTFC				
>>16 bit CTFC	MP		Integer(0..65535)	
>24 bit CTFC				
>>24 bit CTFC	MP		Integer(0..16777215)	

10.3.5.15 TFCS Reconfiguration/Addition Information

Information Element/Group name	Need	Multi	IE type and reference	Semantics description
CHOICE CTFC Size	MP			
>2 bit CTFC				
>>CTFC information	MP	1 to <maxTFC>		
>>>2bit CTFC	MP		Integer(0..3)	
>>>Power offset Information	OP		Power Offset Information 10.3.5.8	Needed only for uplink physical channels.
>4 bit CTFC				
>>CTFC information	MP	1 to <maxTFC>		
>>>4bit CTFC	MP		Integer(0..15)	
>>>Power offset Information	OP		Power Offset Information 10.3.5.8	Needed only for uplink physical channels.
>6 bit CTFC				
>>CTFC information	MP	1 to <maxTFC>		
>>>6 bit CTFC	MP		Integer(0..63)	
>>>Power offset Information	OP		Power Offset Information 10.3.5.8	Needed only for uplink physical channels.
>8 bit CTFC				
>>CTFC information	MP	1 to <MaxTFC>		
>>>8 bit CTFC	MP		Integer(0..255)	
>>>Power offset Information	OP		Power Offset Information 10.3.5.8	Needed only for uplink physical channels.
>12 bit CTFC				
>>CTFC information	MP	1 to <maxTFC>		
>>>12 bit CTFC	MP		Integer(0..4095)	
>>>Power offset Information	OP		Power Offset Information 10.3.5.8	Needed only for uplink physical channels.
>16 bit CTFC				
>>CTFC information	MP	1 to <maxTFC>		
>>>16 bit CTFC	MP		Integer(0..65535)	
>>>Power offset Information	OP		Power Offset Information 10.3.5.8	Needed only for uplink physical channels.
>24 bit CTFC				
>>CTFC information	MP	1 to <MaxTFC>		
>>>24 bit CTFC	MP		Integer(0..16777215)	
>>>Power offset Information	OP		Power Offset Information 10.3.5.8	Needed only for uplink physical channels.

10.3.5.16 TFCS Removal Information

Information Element/Group name	Need	Multi	IE type and reference	Semantics description
Removal TFCI information	MP	1 to <maxTFC>		
>TFCI	MP		Transport Format Combination (TFC) 10.3.5.19	In TDD 0 is a reserved value

10.3.5.17 Void

10.3.5.18 Transport channel identity

This information element is used to distinguish transport channels. Transport channels of different type (RACH, CPCH, USCH, FACH/PCH, DSCH or DCH) have separate series of identities. This also holds for uplink and downlink transport channel identities (i.e. for DCH). Depending on in which context a transport channel identity n that is sent, it will have different meaning

Information Element/Group name	Need	Multi	Type and reference	Semantics description
Transport channel identity	MP		Integer(1..32)	

10.3.5.19 Transport Format Combination (TFC)

Information Element/Group name	Need	Multi	Type and reference	Semantics description
Transport format combination	MP		Integer (0..1023)	

10.3.5.20 Transport Format Combination Set

Indicates the allowed combinations of already defined Transport formats and the mapping between these allowed TFCs and the corresponding TFCI values.

For TDD, different coded composite transport channels have independent transport format combination sets and thus independent TFCI values.

For FDD, Where the UE is assigned access to one or more DSCH transport channels, a TFCI(field2) is used to signal the transport format combination for the DSCH. The following two cases exist:

- Case 1:
Using one TFCI-word on the physical layer. A logical split determines the available number of transport format combinations for DCH and DSCH.
- Case 2:
Using split TFCI on the physical layer. Two TFCI-words, each having a static length of five bits, are used.

Information Element/Group name	Need	Multi	IE type and reference	Semantics description
CHOICE <i>TFCI signalling</i>	MP			'Normal' : meaning no split in the TFCI field (either 'Logical' or 'Hard') 'Split' : meaning there is a split in the TFCI field (either 'Logical' or 'Hard'). This value is only valid for FDD downlink when using DSCH.
>Normal				
>>TFCI Field 1 Information	MP		TFCS explicit Configuration 10.3.5.13	
>Split				
>>Split type	OP		Enumerated ('Hard', 'Logical')	'Hard' : meaning that TFCI (field 1) and TFCI (field 2) are each 5 bits long and each field is block coded separately. 'Logical' : meaning that on the physical layer TFCI (field 1) and TFCI (field 2) are concatenated, field 1 taking the most significant bits and field 2 taking the least significant bits). The whole is then encoded with a single block code.
>>Length of TFCI(field2)	OP		Integer (1..10)	This IE indicates the length measured in number of bits of TFCI(field2)
>>TFCI Field 1 Information	OP		TFCS explicit Configuration 10.3.5.13	
>>TFCI Field 2 Information	OP		TFCI field 2 information 10.3.5.12	

CHOICE <i>TFCI signalling</i>	Condition under which <i>TFCI signalling type</i> is chosen
Normal	It is chosen when no split in the TFCI field.
Split	It is chosen when split in the TFCI field. This value is only valid for FDD downlink when using DSCH.

10.3.5.21 Transport Format Combination Set Identity

NOTE: Only for TDD.

Information Element/Group name	Need	Multi	Type and reference	Semantics description
TFCS ID	MD		Integer (1..8)	Indicates the identity of every TFCS within a UE. Default value is 1.
Shared Channel Indicator	MP		Boolean	TRUE indicates the use of shared channels. Default is false.

10.3.5.22 Transport Format Combination Subset

Indicates which Transport format combinations in the already defined Transport format combination set are allowed.

Information Element/Group name	Need	Multi	Type and reference	Semantics description
CHOICE <i>Subset representation</i>	MP			
>Minimum allowed Transport format combination index			Transport format combination 10.3.5.19	
>Allowed transport format combination list		1 to <maxTFC>		
>>Allowed transport format combination	MP		Transport format combination 10.3.5.19	
>Non-allowed transport format combination list		1 to <maxTFC>		
>>Non-allowed transport format combination	MP		Transport format combination 10.3.5.19	
>Restricted TrCH information		1 to <maxTrCH>		
>>Uplink transport channel type	MP		Enumerated(DCH, USCH)	USCH is TDD only
>>>Restricted UL TrCH identity	MP		Transport channel identity 10.3.5.18	
>>>Allowed TFIs	OP	1 to <maxTF>		
>>>>Allowed TFI	MP		Integer(0..31)	
>Full transport format combination set				(No data)

10.3.5.23 Transport Format Set

Information Element/Group name	Need	Multi	Type and reference	Semantics description
CHOICE <i>Transport channel type</i>	MP			
>Dedicated transport channels				The transport channel that is configured with this TFS is of type DCH
>>Dynamic Transport Format Information	MP	1 to <maxTF>		
>>>RLC Size	MP		Integer(0..4992)	Unit is bits
>>>>Number of TBs and TTI List	MP	1 to <maxTF>		Present for every valid number of TB's (and TTI) for this RLC Size.
>>>>>Transmission Time Interval	CV- <i>dynamicTTI</i>		Integer(10,20,40,80)	Unit is ms.
>>>>>Number of Transport blocks	MP		Integer(0..512)	
>>>>>CHOICE <i>Logical Channel List</i>	MP			The logical channels that are allowed to use this RLC Size
>>>>>>ALL			Null	All logical channels mapped to this transport channel.
>>>>>>>Configured			Null	The logical channels configured to use this RLC size in the <i>RB mapping info.</i> 10.3.4.21 if present in this

Information Element/Group name	Need	Multi	Type and reference	Semantics description
				message or in the previously stored configuration otherwise
>>>>Explicit List		1 to 15		Lists the logical channels that are allowed to use this RLC size.
>>>>>RB Identity	MP		RB identity 10.3.4.16	
>>>>>LogicalChannel	CH-UL- RLCLogical Channels		Integer(0..1)	Indicates the relevant UL logical channel for this RB. "0" corresponds to the first, "1" corresponds to the second UL logical channel configured for this RB in the IE "RB mapping info".
>>Semi-static Transport Format Information	MP		Semi-static Transport Format Information 10.3.5.11	
>Common transport channels				The transport channel that is configured with this TFS is of a type not equal to DCH
>>Dynamic Transport Format Information	MP	1 to <maxTF>		Note
>>>RLC Size	MP		Integer(0..49 92)	Unit is bits
>>>Number of TBs and TTI List	MP	1 to <maxTF>		Present for every valid number of TB's (and TTI) for this RLC Size.
>>>>Number of Transport blocks	MP		Integer(0..51 2)	
>>>>CHOICE <i>mode</i>	MP			
>>>>>FDD				(no data)
>>>>>TDD				
>>>>>>Transmission Time Interval	CV- dynamicTT I		Integer(10,2 0,40,80)	Unit is ms.
>>>>CHOICE <i>Logical Channel List</i>	MP			The logical channels that are allowed to use this RLC Size.
>>>>>ALL			Null	All logical channels mapped to this transport channel.
>>>>>Configured			Null	The logical channels configured to use this RLC size in the <i>RB mapping info</i> . 10.3.4.21 if present in this message or in the previously stored configuration otherwise
>>>>>Explicit List		1 to 15		Lists the logical channels that are allowed to use this RLC size.
>>>>>>RB Identity	MP		RB identity 10.3.4.16	
>>>>>>LogicalChannel	CV-UL- RLCLogical Channels		Integer(0..1)	Indicates the relevant UL logical channel for this RB. "0" corresponds to the first, "1" corresponds to the second UL logical channel configured for this RB in the IE "RB mapping info".
>>Semi-static Transport Format Information	MP		Semi-static Transport Format Information 10.3.5.11	

Condition	Explanation
<i>DynamicTTI</i>	This IE is mandatory present if dynamic TTI usage is indicated in IE Transmission Time Interval in Semi-static Transport Format Information. Otherwise it is not needed.
<i>UL-RLCLogicalChannels</i>	If "Number of uplink RLC logical channels" in IE "RB mapping info" in this message is 2 or the IE "RB mapping info" is not present in this message and 2 UL logical channels are configured for this RB, then this IE is mandatory present. Otherwise this IE is not needed.

NOTE: The parameter "rate matching attribute" is in line with the RAN WG1 specifications. However, it is not currently in line with the description in [34].

10.3.5.24 UL Transport channel information common for all transport channels

Information Element/Group name	Need	Multi	Type and reference	Semantics description	Version
PRACH TFCS	OP		Transport format combination set 10.3.5.20	This IE should not be included in this version of the protocol.	
CHOICE <i>mode</i>	OP				
>FDD					

>>TFC subset	MD		Transport Format Combination Subset 10.3.5.22	Default value is the complete existing set of transport format combinations	
>>UL DCH TFCS	MP		Transport formation combination set 10.3.5.20		
>TDD					
>>Individual UL CCTrCH information	OP	1 to <maxCCTrCH>			
>>>UL TFCS Identity	MP		Transport format combination set identity 10.3.5.21	Identifies a special CCTrCH for shared or dedicated channels.	
>>>UL TFCS	MP		Transport format combination set 10.3.5.20		
>>>TFC subset	MD		Transport Format Combination Subset 10.3.5.22	Default value is the complete existing set of transport format combinations	
TFC subset list	OP	1 to <maxTFCs ub>			REL-4
>CHOICE <i>mode</i>	MP				
>>FDD				(no data)	
>>TDD					
>>>TFCS Id	OP		Transport Format Combination Set Identity 10.3.5.21		
>TFC subset	MP		Transport Format Combination Subset 10.3.5.22		

NOTE: This information element is included within IE "Predefined TrCh configuration".

10.3.6 Physical CH Information elements

10.3.6.1 AC-to-ASC mapping

Information Element/Group name	Need	Multi	Type and reference	Semantics description
AC-to-ASC mapping table	MP	maxASCmap		
>AC-to-ASC mapping	MP		Integer(0..7)	Mapping of Access Classes to Access Service Classes (see subclause 8.5.13.)

10.3.6.2 AICH Info

NOTE: Only for FDD.

Information Element/Group name	Need	Multi	Type and reference	Semantics description
Channelisation code	MP		Integer(0..255)	SF is fixed and equal to 256
STTD indicator	MP		STTD Indicator 10.3.6.78	
AICH transmission timing	MP		Enumerated(0, 1)	See parameter AICH_Transmission_Timing in [26]

10.3.6.3 AICH Power offset

NOTE: Only for FDD.

This parameter is used to indicate the power level of AICH, AP-AICH and CD/CA-ICH channels. This is the power per transmitted Acquisition Indicator, AP Acquisition Indicator or CD/CA Indicator minus power of the Primary CPICH.

Information Element/Group name	Need	Multi	Type and reference	Semantics description
AICH Power offset	MP		Integer(-22..+5)	Offset in dB

10.3.6.4 Allocation period info

NOTE: Only for TDD.

Parameters used by UE to determine period of shared channel allocation.

Information Element/Group name	Need	Multi	Type and reference	Semantics description
Allocation Activation Time	MP		Integer(0..255)	Start the allocation period at the given CFN.
Allocation Duration	MP		Integer(1..256)	Total number of frames for the allocation period.

10.3.6.5 Alpha

Information Element/Group name	Need	Multi	Type and reference	Semantics description
Alpha Value	MP		Enumerated(0, 1/8, 2/8, 3/8, 4/8, 5/8, 6/8, 7/8, 1)	

10.3.6.6 ASC setting

Information Element/Group name	Need	Multi	Type and reference	Semantics description	Version
CHOICE <i>mode</i>	MP				
>FDD					
>>Available signature Start Index	MP		Integer(0..15)		
>>Available signature End Index	MP		Integer(0..15)		
>>Assigned Sub-Channel	MP		Bit string(4)	This IE defines	

Information Element/Group name	Need	Multi	Type and reference	Semantics description	Version
Number				the subchannel assignment as specified in 8.6.6.29. The first/leftmost bit of the bit string contains the most significant bit of the Assigned Sub-Channel Number..	
>TDD					
>>CHOICE <i>TDD option</i>	MP				REL-4
>>>3.84 Mcps TDD					REL-4
>>>>Available Channelisation codes indices	MD		Bit string(8)	Each bit indicates availability of a channelisation code index, where the channelisation code indices are numbered "channelisation code index 0" to "channelisation code index 7". The value 1 of a bit indicates that the channelisation code index is available for the ASC this IE is associated to. The value 0 of a bit indicates that the channelisation code index is not available for the ASC this IE is associated to. Default is that all channelisation codes defined in PRACH Info are available.	
>>>1.28 Mcps TDD					REL-4
>>>>Available SYNC_UL codes indices	MD		Bit string(8)	Each bit indicates availability of a SYNC_UL code index, where the SYNC_UL code indices are numbered "SYNC_UL code index 0" to "SYNC_UL code index 7". The value 1 of a bit indicates that the SYNC_UL code index is available for the ASC this IE is associated to. The value 0 of a bit indicates that the SYNC_UL code index is not available for the	REL-4

Information Element/Group name	Need	Multi	Type and reference	Semantics description	Version
				ASC this IE is associated to. Default is that all SYNC_UL codes defined in SYNC_UL Info are available.	
>>CHOICE <i>subchannel size</i>	MP				
>>>Size1					
>>>>Available Subchannels	MP		null	Indicates that all Subchannels are available	
>>>>Size2					
>>>>>Available Subchannels	MD		Bit string (2)	NOTE	
>>>>>Size4					
>>>>>>Available Subchannels	MD		Bit string (4)	NOTE	
>>>>>>Size8					
>>>>>>>Available Subchannels	MD		Bit string (8)	NOTE	

NOTE: Each bit indicates availability of a subchannel, where the subchannels are numbered subchannel 0, subchannel 1 etc. The value 1 of a bit indicates that the subchannel is available for the ASC this IE is associated with. The value 0 of a bit indicates that the subchannel is not available for the ASC this IE is associated with. Default value of the IE is that all subchannels within the size are available for the ASC this IE is associated with.

10.3.6.7 Void

10.3.6.8 CCTrCH power control info

Parameters used by UE to set the SIR target value for uplink open loop power control in TDD.

Information Element/Group name	Need	Multi	Type and Reference	Semantics description
TFCS Identity	OP		Transport Format Combination Set Identity 10.3.5.21	TFCS Identity of this CCTrCH. Default value is 1.
Uplink DPCH power control info	MP		Uplink DPCH power control info 10.3.6.91	

10.3.6.8a Cell and Channel Identity info

NOTE: Only for TDD.

Information Element/Group name	Need	Multi	Type and Reference	Semantics description
Burst type	MP		Enumerated (Type1, Type2)	Identifies the channel in combination with the Midamble shift and slot number
Midamble Shift	MP		Integer (0...15)	
Time Slot	OP		Timeslot number 10.3.6.84	This IE is present only if no IPDL scheme is configured in the reference cell. Otherwise the slot is defined by the IPDL configuration.
Cell parameters ID	MP		Cell parameters ID 10.3.6.9	Identifies the cell

10.3.6.9 Cell parameters Id

Information Element/Group name	Need	Multi	Type and Reference	Semantics description
Cell parameter Id	MP		Integer(0..127)	

10.3.6.10 Common timeslot info

Information Element/Group name	Need	Multi	Type and reference	Semantics description
2 nd interleaving mode	MD		Enumerated (Frame, Timeslot)	Frame timeslot related interleaving. Default value is "Frame"
TFCI coding	MD		Integer(4,8,16,32)	Describes the amount of bits for the TFCI bits code word as described in [31]. Defaults is no TFCI bit: In case of 8 PSK in 1.28Mcps TDD: 4 corresponds to 6 TFCI code word bits. 8 corresponds to 12 TFCI code word bits. 16 corresponds to 24 TFCI code word bits. 32 corresponds to 48 TFCI code word bits.
Puncturing limit	MP		Real(0.40..1.0 by step of 0.04)	
Repetition period	MD		Integer(1, 2,4,8,16,32,64)	Default is continuous allocation. Value 1 indicate continuous
Repetition length	MP		Integer(1..Repetition period -1)	NOTE: This is empty if repetition period is set to 1.

10.3.6.11 Constant value

NOTE: Only for FDD.

This constant value is used by the UE to calculate the initial output power on PRACH according to the Open loop power control procedure.

Information Element/Group name	Need	Multi	Type and reference	Semantics description
Constant value	MP		Integer (-35..-10)	In dB

10.3.6.11a Constant value TDD

NOTE: Only for 3.84 Mcps TDD.

3.84 Mcps TDD constant values are used for open loop power control of PRACH, USCH and UL DPCH as defined in subclause 8.5.7.

Information Element/Group name	Need	Multi	Type and reference	Semantics description
TDD Constant value	MP		Integer (-35..+10)	In dB

10.3.6.12 CPCH persistence levels

NOTE: Only for FDD.

This IE is dynamic and is used by RNC for load balancing and congestion control. This is broadcast often in the system information message.

Information Element/Group name	Need	Multi	Type and reference	Semantics description
CPCH set ID	MP		Integer (1 .. <maxCPCHs ets>)	Identifier for CPCH set info.
Dynamic persistence level	MP	1 to <maxTF-CPCH>		
>Dynamic persistence level	MP		Dynamic persistence level 10.3.6.35	Persistence level for transport format.

10.3.6.13 CPCH set info

NOTE: Only for FDD.

This IE may be broadcast in the System Information message or assigned by SRNC. It is pseudo-static in a cell.

Information Element/Group name	Need	Multi	Type and reference	Semantics description
CPCH set ID	MP		CPCH set ID 10.3.5.3	Indicates the ID number for a particular CPCH set allocated to a cell.
TFS	MP		Transport Format Set 10.3.5.23	Transport Format Set Information allocated to this CPCH set.
TFCS	MP		Transport Format Combination Set 10.3.5.20	Transport Format Set Information allocated to this CPCH set
AP preamble scrambling code	MP		Integer (0..79)	Preamble scrambling code for AP in UL
AP-AICH channelisation code	MP		Integer(0..255)	Channelisation code for AP-AICH in DL
CD preamble scrambling code	MP		Integer (0..79)	Preamble scrambling code for CD in UL

Information Element/Group name	Need	Multi	Type and reference	Semantics description
CD/CA-ICH channelisation code	MP		Integer (0..255)	Channelisation code for CD/CA-ICH in DL
Available CD access slot subchannel	CV- <i>CDSigPresent</i>	1 to <maxPCP CH-CDsubCh>		Lists the set of subchannels to be used for CD access preambles. NOTE: If not present, all subchannels are to be used without access delays.
>CD access slot subchannel	MP		Integer (0..11)	
Available CD signatures	OP	1 to <maxPCP CH-CDsig>		Signatures for CD preamble in UL. NOTE: If not present, all signatures are available for use.
>CD signatures	MP		Integer (0..15)	
DeltaPp-m	MP		Integer (-10..10)	In dB. Power offset between the transmitted CD preamble and UL DPCCH of the power control preamble or message part (added to the preamble power to calculate the power of the UL DPCCH)
UL DPCCH Slot Format	MP		Enumerated (0,1,2)	Slot format for UL DPCCH in power control preamble and in message part
N_start_message	MP		Integer (1..8)	Number of Frames for start of message indication
N_EOT	MP		Integer(0..7)	Actual number of appended EOT indicators is $T_EOT = N_TTI * \text{ceil}(N_EOT/N_TTI)$, where N_TTI is the number of frames per TTI and "ceil" refers to rounding up to nearest integer.
Channel Assignment Active	OP		Boolean	When present, indicates that Node B send a CA message and VCAM mapping rule (14.11) shall be used.
CPCH status indication mode	MP		CPCH status indication mode 10.3.6.14	
PCPCH Channel Info.	MP	1 to <maxPCP CHs>		
>UL scrambling code	MP		Integer (0..79)	For PCPCH message part
>DL channelisation code	MP		Integer (0...511)	For DL DPCCH for PCPCH message part
>DL scrambling code	MD		Secondary Scrambling Code 10.3.6.74	Default is the same scrambling code as for the primary CPICH.
>PCP length	MP		Enumerated (0, 8)	Indicates length of power control preamble, 0slots (no preamble used) or 8 slots
>UCSM Info	CV- <i>NCAA</i>			
>>Minimum Spreading Factor	MP		Integer (4,8,16,32,64,128,256)	The UE may use this PCPCH at any Spreading Factor equal to or greater than the indicated minimum Spreading Factor. The Spreading Factor for initial access is the minimum

Information Element/Group name	Need	Multi	Type and reference	Semantics description
				Spreading Factor.
>>NF_max	MP		Integer (1..64)	Maximum number of frames for PCPCH message part
>>>Channel request parameters for UCSM	MP			Required in UE channel selection mode.
>>>>Available AP signature	MP	1 to <maxPCP CH-APsig>		AP preamble signature codes for selection of this PCPCH channel.
>>>>>AP signature	MP		Integer (0..15)	
>>>>>Available AP access slot subchannel	OP	1 to <maxPCP CH-APsubCh>		Lists the set of subchannels to be used for AP access preambles in combination with the above AP signature(s). NOTE: If not present, all subchannels are to be used without access delays.
>>>>>>AP access slot subchannel	MP		Integer (0..11)	
VCAM info	CV-CAA			
>Available Minimum Spreading Factor	MP	1 to <maxPCP CH-SF>		
>>Minimum Spreading Factor	MP		Enumerated (4,8,16,32,64,128,256)	
>>NF_max	MP		Integer (1..64)	Maximum number of frames for PCPCH message part
>>>Maximum available number of PCPCH	MP		Integer (1..64)	Maximum available number of PCPCH for the indicated Spreading Factor.
>>>>Available AP signatures	MP	1 to <maxPCP CH-APsig>		Signatures for AP preamble in UL.
>>>>>AP signature			Integer (0..15)	
>>>>>>Available AP sub-channel	OP	1 to <maxPCP CH-APsubCh>		AP sub-channels for the given AP signature in UL. NOTE: If not present, all subchannels are to be used without access delays.
>>>>>>>AP sub-channel	MP		Integer (0..11)	

Condition	Explanation
<i>CDSigPresent</i>	This IE is optional if IE "Available CD signatures" is present and not needed otherwise.
<i>NCAA</i>	This IE is mandatory present if IE "Channel Assignment Active" is not present and not needed otherwise.
<i>CAA</i>	This IE is mandatory present if IE "Channel Assignment Active" is present and not needed otherwise.

10.3.6.14 CPCH Status Indication mode

NOTE: Only for FDD.

Information Element/Group name	Need	Multi	Type and reference	Semantics description
CPCH Status Indication mode	MP		Enumerated (PA mode, PAMASF mode)	Defines the status information type broadcast on the CPCH Status Indication Channel (CSICH)

CPCH Status Indication mode defines the structure of the CSICH information that is broadcast by Node B on the CSICH channel. CSICH mode can take 2 values: PCPCH Availability (PA) mode and PCPCH Availability with Minimum Available Spreading Factor (PAMASF) mode. PAMASF mode is used when Channel Assignment is active. PA mode is used when Channel Assignment is not active (UE Channel Selection is active). [26] defines the structure of the CSICH information for both CSICH modes.

10.3.6.15 CSICH Power offset

NOTE: Only for FDD.

This is the power per transmitted CSICH Indicator minus power of the Primary CPICH.

Information Element/Group name	Need	Multi	Type and reference	Semantics description
CSICH Power offset	MP		Integer(-10..+5)	Offset in dB, granularity of 1 dB

10.3.6.16 Default DPCH Offset Value

Indicates the default offset value within interleaving size at a resolution of 512chip (1/5 slot) in FDD and a resolution of one frame in TDD to offset CFN in the UE. This is used to distribute discontinuous transmission periods in time and also to distribute NodeB-RNC transmission traffics in time. Even though the CFN is offset by DOFF, the start timing of the interleaving will be the timing that "CFN mod (interleaving size)"=0 (e.g. interleaving size: 2,4,8) in both UE and SRNC.

Information Element/Group name	Need	Multi	Type and reference	Semantics description
CHOICE <i>mode</i>				
>FDD				
>>Default DPCH Offset Value (DOFF)	MP		Integer (0..306688 by step of 512)	Number of chips=. 0 to 599 time 512 chips, see [10].
>TDD				
>>Default DPCH Offset Value (DOFF)	MP		Integer(0..7)	Number of frames; See [10]

10.3.6.17 Downlink channelisation codes

NOTE: Only for TDD

Information Element/Group name	Need	Multi	Type and reference	Semantics description
CHOICE <i>codes representation</i>	MP			
>Consecutive codes				
>>First channelisation code	MP		Enumerated ((16/1)...(16/16))	If a TFCI exists in this timeslot, it is mapped to the channelisation code as defined in [30].
>>>Last channelisation code	MP		Enumerated ((16/1)...(16/16))	If this is the same as First channelisation code, only one code is used by the physical layer.
>Bitmap				
>>Channelisation codes bitmap	MP		Bit string(16)	Each bit indicates the availability of a channelisation code for SF16, where the channelisation codes are numbered as channelisation code 1 (SF16) to channelisation code 16 (SF16). (For SF 16, a 1 in the bitmap means that the corresponding code is used, a 0 means that the corresponding code is not used.) If all bits are set to zero, SF 1 shall be used.

10.3.6.18 Downlink DPCH info common for all RL

Information Element/Group name	Need	Multi	Type and reference	Semantics description	Version
Timing Indication	MP		Enumerated(Initialise, Maintain)	NOTE	
CFN-targetSFN frame offset	CV- <i>TimInd</i>		Integer(0..255)	In frame	
Downlink DPCH power control information	OP		Downlink DPCH power control information 10.3.6.23		
MAC-d HFN initial value	CV- <i>Message</i>		Bit string(24)		REL-4
CHOICE <i>mode</i>	MP				
>FDD					
>>Power offset $P_{\text{Pilot}} - P_{\text{DPDCH}}$	MP		Integer(0..24)	Power offset equals $P_{\text{Pilot}} - P_{\text{DPDCH}}$, range 0..6 dB, in steps of 0.25 dB	
>>>Downlink rate matching restriction information	OP		Downlink rate matching restriction information 10.3.6.31	If this IE is set to "absent", no Transport CH is restricted in TFI.	
>>>Spreading factor	MP		Integer(4, 8, 16, 32, 64, 128, 256, 512)		

Information Element/Group name	Need	Multi	Type and reference	Semantics description	Version
>>Fixed or Flexible Position	MP		Enumerated (Fixed, Flexible)		
>>TFCI existence	MP		Boolean	TRUE indicates that TFCI is used. When spreading factor is less than or equal to 64, FALSE indicates that TFCI is not used and therefore DTX is used in the TFCI field.	
>>CHOICE SF	MP				
>>>SF = 256					
>>>>Number of bits for Pilot bits	MP		Integer (2,4,8)	In bits	
>>>SF = 128					
>>>>Number of bits for Pilot bits	MP		Integer(4, 8)	In bits	
>>>Otherwise				(no data). In ASN.1 choice "Otherwise" is not explicitly available as all values are available, it is implied by the use of any value other than 128 or 256.	
>TDD				(no data)	

CHOICE SF	Condition under which the given SF is chosen
SF=128	"Spreading factor" is set to 128
SF=256	"Spreading factor" is set to 256
Otherwise	"Spreading factor" is set to a value distinct from 128 and 256

Condition	Explanation
<i>TimInd</i>	This IE is optional if the IE "Timing Indication" is set to "Initialise". Otherwise it is not needed.
<i>Message</i>	This IE is not needed if the IE "Downlink DPCH info common for all RL" is included in RRC CONNECTION SETUP or HANDOVER TO UTRAN COMMAND messages. Otherwise it is optional.

NOTE: Within the HANDOVER TO UTRAN COMMAND message, only value "initialise" is applicable.

10.3.6.19 Downlink DPCH info common for all RL Post

Information Element/Group name	Need	Multi	Type and reference	Semantics description
Downlink DPCH power control information	OP		Downlink DPCH power control information 10.3.6.23	

10.3.6.20 Downlink DPCH info common for all RL Pre

Information Element/Group name	Need	Multi	Type and reference	Semantics description
CHOICE mode	MP			
>FDD				
>>Spreading factor	MP		Integer(4, 8,	Defined in CHOICE SF512-

Information Element/Group name	Need	Multi	Type and reference	Semantics description
CHOICE <i>mode</i>	MP			
>FDD				
			16, 32, 64, 128, 256, 512)	Andpilot with "number of its for pilot bits" in ASN.1
>>Fixed or Flexible Position	MP		Enumerated (Fixed, Flexible)	
>>TFCI existence	MP		Boolean	TRUE indicates that TFCI is used. When spreading factor is less than or equal to 64, FALSE indicates that TFCI is not used and therefore DTX is used in the TFCI field.
>>CHOICE <i>SF</i>	MP			
>>>SF = 256				
>>>>Number of bits for Pilot bits	MP		Integer (2,4,8)	In bits
>>>SF = 128				
>>>>Number of bits for Pilot bits	MP		Integer(4,8)	In bits
>>>Otherwise				(no data)
>TDD				
>>Common timeslot info	MP		Common Timeslot Info 10.3.6.10	

CHOICE <i>SF</i>	Condition under which the given <i>SF</i> is chosen
SF=128	"Spreading factor" is set to 128
SF=256	"Spreading factor" is set to 256
Otherwise	"Spreading factor" is set to a value distinct from 128 and 256

10.3.6.21 Downlink DPCH info for each RL

Information Element/Group name	Need	Multi	Type and reference	Semantics description
CHOICE <i>mode</i>	MP			
>FDD				
>>Primary CPICH usage for channel estimation	MP		Primary CPICH usage for channel estimation 10.3.6.62	
>>DPCH frame offset	MP		Integer(0..38 144 by step of 256)	Offset (in number of chips) between the beginning of the P-CCPCH frame and the beginning of the DPCH frame This is called $\tau_{DPCH,n}$ in [26]
>>Secondary CPICH info	OP		Secondary CPICH info 10.3.6.73	
>>DL channelisation code	MP	1 to <maxDPC H-DLchan>		For the purpose of physical channel mapping [27] the DPCHs are numbered, starting from DPCH number 1, according to the order that they are contained in this IE.
>>>Secondary scrambling code	MD		Secondary scrambling code	Default is the same scrambling code as for the Primary CPICH code

Information Element/Group name	Need	Multi	Type and reference	Semantics description
			10.3.6.74	
>>>Spreading factor	MP		Integer(4, 8, 16, 32, 64, 128, 256, 512)	Defined in CHOICE SF512-AndCodenumber with "code number" in ASN.1
>>>Code number	MP		Integer(0..Spreading factor - 1)	
>>>Scrambling code change	CH-SF/2		Enumerated (code change, no code change)	Indicates whether the alternative scrambling code is used for compressed mode method 'SF/2'.
>>TPC combination index	MP		TPC combination index 10.3.6.85	
>>SSDT Cell Identity	OP		SSDT Cell Identity 10.3.6.76	
>>Closed loop timing adjustment mode	CH-TxDiversity Mode		Integer(1, 2)	It is present if Tx Diversity is used in the radio link.
>TDD				
>>DL CCTrCh List	OP	1..<maxCC TrCH>		DL physical channels to establish or reconfigure list.
>>>TFCS ID	MD		Integer(1..8)	Identity of this CCTrCh. Default value is 1
>>>Time info	MP		Time Info 10.3.6.83	
>>>Common timeslot info	MD		Common Timeslot Info 10.3.6.10	Default is the current Common timeslot info
>>>Downlink DPCH timeslots and codes	MD		Downlink Timeslots and Codes 10.3.6.32	Default is to use the old timeslots and codes.
>>>UL CCTrCH TPC List	MD	0..<maxCC TrCH>		UL CCTrCH identities for TPC commands associated with this DL CCTrCH. Default is previous list or all defined UL CCTrCHs. This list is not required for 1.28 Mcps TDD and is to be ignored by the UE.
>>>>UL TPC TFCS Identity	MP		Transport Format Combination Set Identity 10.3.5.21	
>>DL CCTrCH List to Remove	OP	1..<maxCC TrCH>		DL physical channels to remove list.
>>>TFCS ID	MP		Integer(1..8)	

Condition	Explanation
<i>SF/2</i>	The information element is mandatory present if the UE has a compressed mode pattern sequence configured in variable TGPS_IDENTITY or included in the message including IE "Downlink DPCH info for each RL", which is using compressed mode method "SF/2". Otherwise the IE is not needed.
<i>TxDiversity Mode</i>	This IE is mandatory present if any TX Diversity Mode is used on the radio link, i.e. if STTD, "closed loop mode 1" or "closed loop mode 2" is used on the radio link. Otherwise the IE is not needed.

10.3.6.22 Downlink DPCH info for each RL Post

Information Element/Group name	Need	Multi	Type and reference	Semantics description
CHOICE <i>mode</i>	MP			
>FDD				
>>Primary CPICH usage for channel estimation	MP		Primary CPICH usage for channel estimation 10.3.6.62	
>>Secondary scrambling code	MD		Secondary scrambling code 10.3.6.74	Default is the same scrambling code as for the Primary CPICH
>>CHOICE <i>Spreading factor</i>	MP		Integer(4, 8, 16, 32, 64, 128, 256, 512)	Defined in CHOICE SF512-AndCodenummer with "code number" in ASN.1
>>Code number	MP		Integer(0.. Spreading factor - 1)	
>>Scrambling code change	CH-SF/2		Enumerated (code change, no code change)	Indicates whether the alternative scrambling code is used for compressed mode method 'SF/2'.
>>>TPC combination index	MP		TPC combination index 10.3.6.85	
>TDD				
>>Downlink DPCH timeslots and codes	MP		Downlink Timeslots and Codes 10.3.6.32	

Condition	Explanation
<i>SF/2</i>	The information element is mandatory present if the UE has a compressed mode pattern sequence configured in variable TGPS_IDENTITY or included in the message including IE "Downlink DPCH info for each RL Post", which is using compressed mode method "SF/2". Otherwise the IE is not needed.

10.3.6.23 Downlink DPCH power control information

Information Element/Group name	Need	Multi	Type and reference	Semantics description
CHOICE <i>mode</i>	MP			
>FDD				
>>DPC Mode	MP		Enumerated (Single TPC, TPC triplet in soft)	"Single TPC" is DPC_Mode=0 and "TPC triplet in soft" is DPC_mode=1 in [29].
>TDD				
>>TPC Step Size	OP		Integer (1, 2, 3)	In dB

10.3.6.24 Downlink information common for all radio links

Information Element/Group name	Need	Multi	Type and reference	Semantics description	Version
Downlink DPCH info common for all RL	OP		Downlink DPCH info common for all RL 10.3.6.18		
CHOICE <i>mode</i>	MP				
>FDD					
>>DPCH compressed mode info	OP		DPCH compressed mode info 10.3.6.33		
>>TX Diversity Mode	MD		TX Diversity Mode 10.3.6.86	Default value is the existing value of TX Diversity mode	
>>SSDT information	OP		SSDT information 10.3.6.77		
>TDD				(no data)	
>>CHOICE <i>TDD option</i>	MP				REL-4
>>>3.84 Mcps TDD				(no data)	REL-4
>>>1.28 Mcps TDD					REL-4
>>>>TSTD indicator	MP		TSTD indicator 10.3.6.85a		REL-4
Default DPCH Offset Value	OP		Default DPCH Offset Value, 10.3.6.16		

10.3.6.25 Downlink information common for all radio links Post

Information Element/Group name	Need	Multi	Type and reference	Semantics description
Downlink DPCH info common for all RL	MP		Downlink DPCH info common for all RL Post 10.3.6.19	

10.3.6.26 Downlink information common for all radio links Pre

Information Element/Group name	Need	Multi	Type and reference	Semantics description
Downlink DPCH info common for all RL	MP		Downlink DPCH info common for all RL Pre 10.3.6.20	

10.3.6.27 Downlink information for each radio link

Information Element/Group name	Need	Multi	Type and reference	Semantics description	Version
Choice mode	MP				
>FDD					
>>Primary CPICH info	MP		Primary CPICH info 10.3.6.60		
>>>Cell ID	OP		Cell ID 10.3.2.2		REL-4
>>PDSCH with SHO DCH Info	OP		PDSCH with SHO DCH Info 10.3.6.47		
>>PDSCH code mapping	OP		PDSCH code mapping 10.3.6.43		
>TDD					
>>Primary CCPCH info	MP		Primary CCPCH info 10.3.6.57		
Downlink DPCH info for each RL	OP		Downlink DPCH info for each RL 10.3.6.21		
SCCPCH Information for FACH	OP		SCCPCH Information for FACH 10.3.6.70		

10.3.6.28 Downlink information for each radio link Post

Information Element/Group name	Need	Multi	Type and reference	Semantics description	Version
Choice mode	MP				
>FDD					
>>Primary CPICH info	MP		Primary CPICH info 10.3.6.60		
>>>Cell ID	OP		Cell ID 10.3.2.2		REL-4
>TDD					
>>Primary CCPCH info	MP		Primary CCPCH info post 10.3.6.58		
Downlink DPCH info for each RL	MP		Downlink DPCH info for each RL Post 10.3.6.22		

10.3.6.29 Void

10.3.6.30 Downlink PDSCH information

NOTE: Only for FDD.

Information Element/Group name	Need	Multi	Type and reference	Semantics description
PDSCH with SHO DCH Info	OP		PDSCH with SHO DCH Info 10.3.6.47	
PDSCH code mapping	OP		PDSCH code mapping 10.3.6.43	

10.3.6.31 Downlink rate matching restriction information

This IE indicates which TrCH is restricted in TFI.

Information Element/Group name	Need	Multi	Type and reference	Semantics description
Restricted TrCH information	OP	1 to <maxTrCH >		
>Downlink transport channel type	MP		Enumerated(DCH,DSCH)	
>Restricted DL TrCH identity	MP		Transport channel identity 10.3.5.18	
>Allowed TFIs	MP	1 to <maxTF>		
>>Allowed TFI	MP		Integer(0..31)	

10.3.6.32 Downlink Timeslots and Codes

NOTE: Only for TDD

Information Element/Group name	Need	Multi	Type and reference	Semantics description
First Individual timeslot info	MP		Individual timeslot info 10.3.6.37	Individual timeslot info for the first timeslot used by the physical layer.
First timeslot channelisation codes	MP		Downlink channelisation codes 10.3.6.17	These codes shall be used by the physical layer in the timeslot given in First Individual timeslot info.
CHOICE <i>more timeslots</i>	MP			
>No more timeslots				(no data)
>Consecutive timeslots				

Information Element/Group name	Need	Multi	Type and reference	Semantics description
>>Number of additional timeslots	MP		Integer(1..maxTS-1)	The timeslots used by the physical layer shall be timeslots: N mod maxTS (N+1) mod maxTS ... (N+k) mod maxTS in that order, where N is the timeslot number in the First individual timeslot info and k the Number of additional timeslots. The additional timeslots shall use the same parameters (e.g. channelisation codes, midamble shifts etc.) as the first timeslot.
>Timeslot list				
>>Additional timeslot list	MP	1 to <maxTS-1>		The first instance of this parameter corresponds to the timeslot that shall be used second by the physical layer, the second to the timeslot that shall be used third and so on.
>>>CHOICE parameters	MP			
>>>>Same as last				
>>>>>Timeslot number	MP		Timeslot Number 10.3.6.84	The physical layer shall use the same parameters (e.g. channelisation codes, midamble shifts etc.) for this timeslot as for the last one.
>>>>>New parameters				
>>>>>Individual timeslot info	MP		Individual timeslot info 10.3.6.37	
>>>>>Channelisation codes	MP		Downlink channelisation codes 10.3.6.17	

10.3.6.33 DPCH compressed mode info

NOTE: Only for FDD.

This information element indicates the parameters of the compressed mode to be used by the UE in order to perform inter-frequency and inter-RAT measurements.

Information Element/Group name	Need	Multi	Type and reference	Semantics description
Transmission gap pattern sequence	MP	1 to <maxTGPS>		
>TGPSI	MP		TGPSI 10.3.6.82	
>TGPS Status Flag	MP		Enumerated(activate, deactivate)	This flag indicates whether the Transmission Gap Pattern Sequence shall be activated or deactivated.

Information Element/Group name	Need	Multi	Type and reference	Semantics description
>TGCFN	CV-Active		Integer (0..255)	Connection Frame Number of the first frame of the first pattern within the Transmission Gap Pattern Sequence.
>Transmission gap pattern sequence configuration parameters	OP			
>>TGMP	MP		Enumerated(TDD measurement, FDD measurement, GSM carrier RSSI measurement, GSM Initial BSIC identification, GSM BSIC re-confirmation, Multi-carrier measurement)	Transmission Gap pattern sequence Measurement Purpose.
>>TGPRC	MP		Integer (1..511, Infinity)	The number of transmission gap patterns within the Transmission Gap Pattern Sequence.
>>TGSN	MP		Integer (0..14)	Transmission Gap Starting Slot Number The slot number of the first transmission gap slot within the TGCFN.
>>TGL1	MP		Integer(1..14)	The length of the first Transmission Gap within the transmission gap pattern expressed in number of slots
>>TGL2	MD		Integer (1..14)	The length of the second Transmission Gap within the transmission gap pattern. If omitted, then TGL2=TGL1. The value of TGL2 shall be ignored if TGD is set to "undefined"
>>TGD	MP		Integer(15..269, undefined)	Transmission gap distance indicates the number of slots between starting slots of two consecutive transmission gaps within a transmission gap pattern. If there is only one transmission gap in the transmission gap pattern, this parameter shall be set to undefined.
>>TGPL1	MP		Integer (1..144)	The duration of transmission gap pattern 1.
>>TGPL2	MD		Integer (1..144)	The duration of transmission gap pattern 2. If omitted, then TGPL2=TGPL1.
>>RPP	MP		Enumerated (mode 0, mode 1).	Recovery Period Power control mode during the frame after the transmission gap within the compressed frame. Indicates whether normal PC

Information Element/Group name	Need	Multi	Type and reference	Semantics description
				mode or compressed PC mode is applied
>>ITP	MP		Enumerated (mode 0, mode 1).	Initial Transmit Power is the uplink power control method to be used to compute the initial transmit power after the compressed mode gap.
>>CHOICE <i>UL/DL mode</i>	MP			
>>>DL only				Compressed mode used in DL only
>>>>Downlink compressed mode method	MP		Enumerated (puncturing, SF/2, higher layer scheduling)	Method for generating downlink compressed mode gap
>>>UL only				Compressed mode used in UL only
>>>>Uplink compressed mode method	MP		Enumerated (SF/2, higher layer scheduling)	Method for generating uplink compressed mode gap
>>>UL and DL				Compressed mode used in UL and DL
>>>>Downlink compressed mode method	MP		Enumerated (puncturing, SF/2, higher layer scheduling)	Method for generating downlink compressed mode gap
>>>>Uplink compressed mode method	MP		Enumerated (SF/2, higher layer scheduling)	Method for generating uplink compressed mode gap
>>Downlink frame type	MP		Enumerated (A, B)	
>>DeltaSIR1	MP		Real(0..3 by step of 0.1)	Delta in DL SIR target value to be set in the UE during the frame containing the start of the first transmission gap in the transmission gap pattern (without including the effect of the bit-rate increase)
>>DeltaSIRafter1	MP		Real(0..3 by step of 0.1)	Delta in DL SIR target value to be set in the UE one frame after the frame containing the start of the first transmission gap in the transmission gap pattern.
>>DeltaSIR2	OP		Real(0..3 by step of 0.1)	Delta in DL SIR target value to be set in the UE during the frame containing the start of the second transmission gap in the transmission gap pattern (without including the effect of the bit-rate increase) When omitted, DeltaSIR2 = DeltaSIR1.
>>DeltaSIRafter2	OP		Real(0..3 by step of 0.1)	Delta in DL SIR target value to be set in the UE one frame after the frame containing the start of the second transmission gap in the transmission gap pattern. When omitted, DeltaSIRafter2 = DeltaSIRafter1.

Information Element/Group name	Need	Multi	Type and reference	Semantics description
>>N Identify abort	CV-Initial BSIC		Integer(1..128)	Indicates the maximum number of repeats of patterns that the UE shall use to attempt to decode the unknown BSIC of the GSM cell in the initial BSIC identification procedure
>>T Reconfirm abort	CV-Re-confirm BSIC		Real(0.5..10.0 by step of 0.5)	Indicates the maximum time allowed for the re-confirmation of the BSIC of one GSM cell in the BSIC re-confirmation procedure. The time is given in steps of 0.5 seconds.

Condition	Explanation
Active	This IE is mandatory present when the value of the IE "TGPS Status Flag" is "Activate" and not needed otherwise.
Initial BSIC	This IE is mandatory present when the value of the IE "TGMP" is set to "GSM Initial BSIC identification" and not needed otherwise.
Re-confirm BSIC	This IE is mandatory present when the value of the IE "TGMP" is set to "GSM BSIC re-confirmation" and not needed otherwise.

10.3.6.34 DPCH Compressed Mode Status Info

This information element indicates status information of the compressed mode used by the UE in order to perform inter-frequency and inter-RAT measurements.

Information Element/Group name	Need	Multi	Type and reference	Semantics description
TGPS reconfiguration CFN	MP		Integer (0..255)	
Transmission gap pattern sequence	MP	1 to <maxTGP S>		
>TGPSI	MP		TGPSI 10.3.6.82	Transmission Gap Pattern Sequence Identifier
>TGPS Status Flag	MP		Enumerated(activate, deactivate)	This flag indicates whether the Transmission Gap Pattern Sequence it shall be activated or deactivated.
>TGCFN	CV-Active		Integer (0..255)	Connection Frame Number of the first frame of the first pattern within the Transmission Gap Pattern Sequence.

Condition	Explanation
Active	This IE is mandatory present when the value of the IE "TGPS Status Flag" is "Activate" and not needed otherwise.

10.3.6.35 Dynamic persistence level

Information Element/Group name	Need	Multi	Type and reference	Semantics description
Dynamic persistence level	MP		Integer(1..8)	Level shall be mapped to a dynamic persistence value in the range 0 .. 1. The mapping is described in subclause 8.5.12.

10.3.6.35a FPACH info

NOTE: Only for 1.28 Mcps TDD.

Information Element/Group name	Need	Multi	Type and reference	Semantics description	Version
Timeslot number	MP		Integer(0..6)		REL-4
Channelisation code	MP		Enumerated(16/1)..(16/16)		REL-4
Midamble Shift and burst type	MP		Midamble shift and burst type 10.3.6.41		REL-4
WT	MP		Integer(1..4)	The number of sub-frames, following the sub-frame in which the SYNC UL is transmitted, in which the FPACH can be transmitted.	REL-4

10.3.6.36 Frequency info

Information Element/Group name	Need	Multi	Type and reference	Semantics description
CHOICE <i>mode</i>	MP			
>FDD				
>>UARFCN uplink (Nu)	OP		Integer(0..16383)	If this IE is not present, the default duplex distance defined for the operating frequency band shall be used [21]
>>UARFCN downlink (Nd)	MP		Integer(0 .. 16383)	[21]
>TDD				
>>UARFCN (Nt)	MP		Integer(0 .. 16383)	[22]

10.3.6.37 Individual timeslot info

Information Element/Group name	Need	Multi	Type and reference	Semantics description	Version
Timeslot number	MP		Timeslot number 10.3.6.84	Timeslot within a frame	
TFCl existence	MP		Boolean	TRUE indicates that the TFCl exists. It shall be coded in the	

Information Element/Group name	Need	Multi	Type and reference	Semantics description	Version
				physical channel defined in [30] of this timeslot.	
Midamble Shift and burst type	MP		Midamble shift and burst type 10.3.6.41		
CHOICE <i>TDD option</i>	MP				REL-4
>3.84 Mcps TDD				(no data)	REL-4
>1.28 Mcps TDD					REL-4
>>Modulation	MP		Enumerated(QPSK, 8PSK)		REL-4
>>SS-TPC Symbols	MP		Enumerated(0, 1, 16/SF)	Denotes amount of SS and TPC bits send in this timeslot	REL-4
>>Additional TPC-SS Symbols	OP		Integer(1..15)	Specifies the number of additional codes in this timeslot that carry TPC and SS symbols as specified in [33]	REL-4

10.3.6.38 Individual Timeslot interference

Parameters used by the UE for uplink open loop power control in TDD.

Information element	Need	Multi	Type and reference	Semantics description
Timeslot number	MP		Timeslot number 10.3.6.84	
UL Timeslot Interference	MP		UL Interference TDD 10.3.6.87a	

10.3.6.39 Maximum allowed UL TX power

This information element indicates the maximum allowed uplink transmit power.

Information Element	Need	Multi	Type and reference	Semantics description
Maximum allowed UL TX power	MP		Integer(-50..33)	In dBm

10.3.6.40 Void

10.3.6.41 Midamble shift and burst type

NOTE: Only for TDD.

This information element indicates burst type and midamble allocation. Three different midamble allocation schemes exist:

- Default midamble: the midamble shift is selected by layer 1 depending on the associated channelisation code (DL and UL)
- Common midamble: the midamble shift is chosen by layer 1 depending on the number of channelisation codes (possible in DL only)
- UE specific midamble: a UE specific midamble is explicitly assigned (DL and UL).

Information Element/Group name	Need	Multi	Type and reference	Semantics description	Version
CHOICE <i>TDD option</i>	MP				REL-4
>3.84 Mcps TDD					REL-4
>>CHOICE <i>Burst Type</i>	MP				
>>>Type 1					
>>>>Midamble Allocation Mode	MP		Enumerated (Default midamble, Common midamble, UE specific midamble)		
>>>>Midamble configuration burst type 1 and 3	MP		Integer(4, 8, 16)	As defined in [30]	
>>>>Midamble Shift	CV-UE		Integer(0..15)		
>>>Type 2					
>>>>Midamble Allocation Mode	MP		Enumerated (Default midamble, Common midamble, UE specific midamble)		
>>>>Midamble configuration burst type 2	MP		Integer(3, 6)	As defined in [30]	
>>>>Midamble Shift	CV-UE		Integer(0..5)		
>>>Type 3					
>>>>Midamble Allocation Mode	MP		Enumerated (Default midamble, UE specific midamble)		
>>>>Midamble configuration burst type 1 and 3	MP		Integer(4, 8, 16)	As defined in [30]	
>>>>Midamble Shift	CV-UE		Integer (0..15)	NOTE: Burst Type 3 is only used in uplink.	
>1.28 Mcps TDD					REL-4
>>Midamble Allocation Mode	MP		Enumerated (Default midamble, Common midamble, UE specific midamble)		REL-4
>>Midamble configuration	MP		Integer(2, 4, 6, 8, 10, 12, 14, 16)	As defined in [30]	REL-4
>>Midamble Shift	CV-UE		Integer (0..15)		REL-4

Condition	Explanation
UE	This IE is mandatory present when the value of the IE "Midamble Allocation Mode" is "UE-specific midamble" and not needed otherwise.

10.3.6.42 PDSCH Capacity Allocation info

NOTE: Only for TDD.

Information Element/Group name	Need	Multi	Type and reference	Semantics description
PDSCH allocation period info	MP		Allocation Period Info 10.3.6.4	
CHOICE <i>Configuration</i>	MP			
>Old configuration				
>>TFCS ID	MD		Integer(1..8)	Default is 1.
>>PDSCH Identity	MP		Integer(1..hi PDSCHidentities)	
>New configuration				
>>PDSCH Info	MP		PDSCH Info 10.3.6.44	
>>PDSCH Identity	OP		Integer(1..hi PDSCHidentities)	
>>PDSCH power control info	OP		PDSCH power control info 10.3.6.45	

10.3.6.43 PDSCH code mapping

NOTE: Only for FDD.

This IE indicates the association between each possible value of TFCI(field 2) and the corresponding PDSCH channelisation code(s). The following signalling methods are specified:

- 'code range': the mapping is described in terms of a number of groups, each group associated with a given spreading factor;
- 'TFCI range': the mapping is described in terms of a number of groups, each group corresponding to a given PDSCH channelisation code;
- 'Explicit': the mapping between TFCI(field 2) value and PDSCH channelisation code is spelt out explicitly for each value of TFCI (field2);
- 'Removal': replace individual entries in the TFCI(field 2) to PDSCH code mapping table with new PDSCH code values.

Information Element/Group name	Need	Multi	Type and reference	Semantics description
DL Scrambling Code	MD		Secondary scrambling code 10.3.6.74	Scrambling code on which PDSCH is transmitted. Default is the same scrambling code as for the Primary CPICH
Choice <i>signalling method</i>	MP			
>code range				
>>PDSCH code mapping	MP	1 to < maxPDSC H-TFCIgroups >		

Information Element/Group name	Need	Multi	Type and reference	Semantics description
>>>Spreading factor	MP		Integer(4, 8, 16, 32, 64, 128, 256)	
>>>multi-code info	MP		Integer(1..16)	
>>>Code number (for PDSCH code) start	MP		Integer(0..Spreading factor-1)	
>>>Code number (for PDSCH code) stop	MP		Integer(0..Spreading factor-1)	
>TFCI range				
>>DSCH mapping	MP	1 to < maxPDSC H-TFCIgroups >		
>>>Max TFCI(field2) value	MP		Integer(1..1023)	This is the maximum value in the range of TFCI(field 2) values for which the specified PDSCH code applies
>>>Spreading factor (for PDSCH code)	MP		Integer(4, 8, 16, 32, 64, 128, 256)	
>>>Code number (for PDSCH code)	MP		Integer(0..Spreading factor-1)	
>>>multi-code info	MP		Integer(1..16)	
>Explicit				
>>PDSCH code info	MP	1 to < maxTFCI-2-Combs >		The first instance of the parameter <i>PDSCH code</i> corresponds to TFCI (field2) = 0, the second to TFCI(field 2) = 1 and so on.
>>>Spreading factor (for PDSCH code)	MP		Integer(4, 8, 16, 32, 64, 128, 256)	
>>>Code number (for PDSCH code)	MP		Integer(0..Spreading factor-1)	
>>>multi-code info	MP		Integer(1..16)	
>Replace				This choice is made if the PDSCH code(s) associated with a given value of TFCI(field 2) is to be replaced.
>>Replaced PDSCH code	MP	1 to < maxTFCI-2-Combs >		Identity of the PDSCH code(s) to be used for the specified value of TFCI(field 2). These code identity(s) replace any that had been specified before
>>>TFCI (field 2)	MP		Integer (0..1023)	Value of TFCI(field 2) for which PDSCH code mapping will be changed
>>>Spreading factor (for PDSCH code)	MP		Integer(4, 8, 16, 32, 64, 128, 256)	
>>>Code number (for PDSCH code)	MP		Integer(0..Spreading factor-1)	
>>>multi-code info	MP		Integer(1..16)	

10.3.6.44 PDSCH info

NOTE: Only for TDD.

Information Element/Group name	Need	Multi	Type and reference	Semantics description
TFCS ID	MD		Integer(1..8)	TFCS to be used. Default value is 1.
Common timeslot info	OP		Common timeslot info 10.3.6.10	
PDSCH timeslots and codes	OP		Downlink Timeslots and Codes 10.3.6.32	Default is to use the old timeslots and codes.

10.3.6.45 PDSCH Power Control info

NOTE: Only for TDD.

Information Element/Group name	Need	Multi	Type and reference	Semantics description
TPC Step Size	OP		Integer (1, 2, 3)	In dB
UL CCTrCH TPC List	OP	1..<maxCC TrCH>		UL CCTrCH identities for TPC commands associated with this DL CCTrCH. This list is not used in 1.28 Mcps TDD.
>UL TPC TFCS Identity	MP		Transport Format Combination Set Identity 10.3.5.21	

10.3.6.46 PDSCH system information

NOTE: Only for TDD.

Information Element/Group name	Need	Multi	Type and reference	Semantics description
PDSCH information	MP	1 to <maxPDSCH>		
>PDSCH Identity	MP		Integer(1..hi PDSCHidentities)	
>PDSCH info	MP		PDSCH info 10.3.6.44	
>SFN Time Info	CH-Block17		SFN Time Info 10.3.6.75	
>DSCH TFS	OP		Transport format set 10.3.5.23	
>DSCH TFCS	OP		Transport Format Combination Set 10.3.5.20	

Condition	Explanation
<i>Block17</i>	This IE is not needed in System Information Block 17. Otherwise it is optional.

10.3.6.47 PDSCH with SHO DCH Info

NOTE: Only for FDD

Information Element/Group name	Need	Multi	Type and reference	Semantics description
DSCH radio link identifier	MP		Primary CPICH info 10.3.6.60	This parameter indicates on which radio link the user will be allocated resource on the DSCH.
TFCI(field2) Combining set	OP	1 to <maxRL>		This is used to indicate which of the downlink TFCI(field 2) transmissions made on the DPCCHs within the active set should be soft combined on the physical layer. This parameter may only be sent if there is a 'hard' split of the TFCI field and in this case the sending of the parameter is optional.
>Radio link identifier	MP		Primary CPICH info 10.3.6.60	

10.3.6.48 Persistence scaling factors

This IE defines scaling factors associated with ASC 2 – ASC 7 to be applied to the dynamic persistence value.

Information Element/Group name	Need	Multi	Type and reference	Semantics description
Access Service Class	MP	1 to maxASCpersistence		multiplicity corresponds to the number of PRACH partitions minus 2
>Persistence scaling factor	MP		Real(0.9..0.2, by step of 0.1)	Scaling factors in the range 0,...,1

10.3.6.49 PICH Info

Information Element/Group name	Need	Multi	Type and reference	Semantics description	Version
CHOICE <i>mode</i>	MP				
>FDD					
>>Channelisation code	MP		Integer(0..255)	SF is fixed and equal to 256	
>>Number of PI per frame	MP		Integer (18, 36, 72, 144)		
>>STTD indicator	MP		STTD Indicator 10.3.6.78		
>TDD					
>>Timeslot number	MD		Timeslot number 10.3.6.84	Default value is the timeslot used by the SCCPCH carrying the associated PCH.	
>>Midamble shift and burst type	MP		Midamble		

			shift and burst type 10.3.6.41		
>>CHOICE <i>TDD option</i>	MP				REL-4
>>>3.84 Mcps TDD					REL-4
>>>>Channelisation code	MD		Enumerated ((16/1)...(16/1 6))	Default value is the channelisation code used by the SCCPCH carrying the associated PCH.	
>>>1.28 Mcps TDD					REL-4
>>>>Codes list	MP	1..2			REL-4
>>>>>Channelisation code	MP		Enumerated ((16/1)...(16/1 6))		REL-4
>>Repetition period/length	MD		Enumerated((4/2),(8/2), (8/4),(16/2), (16/4), (32/2),(32/4), (64/2),(64/4))	Default value is "(64/2)".	
>>Offset	MP		Integer (0...Repetition period -1)	SFN mod Repetition period = Offset.	
>>Paging indicator length	MD		Integer (4, 8, 16)	Indicates the length of one paging indicator in Bits. Default value is 4.	
>>N _{GAP}	MD		Integer(2, 4, 8)	Number of frames between the last frame carrying PICH for this Paging Occasion and the first frame carrying paging messages for this Paging Occasion. Default value is 4.	
>>N _{PCH}	MD		Integer(1 .. 8)	Number of paging groups. Default value is 2.	

10.3.6.50 PICH Power offset

This is the power transmitted on the PICH minus power of the Primary CPICH in FDD and Primary CCPCH Tx Power in TDD.

Information Element/Group name	Need	Multi	Type and reference	Semantics description
PICH Power offset	MP		Integer(-10 .. +5)	Offset in dB

10.3.6.51 PRACH Channelisation Code List

NOTE: Only for 3.84 Mcps TDD.

Information Element/Group name	Need	Multi	Type and reference	Semantics description	Version
CHOICE <i>SF</i>	MP				
>SF16					
>>Channelisation Code List	MP	1 to 8			

Information Element/Group name	Need	Multi	Type and reference	Semantics description	Version
>>>Channelisation code	MP		Enumerated ((16/1)..(16/16))	1:1 mapping between spreading code and midamble shift	
>SF8					
>>Channelisation Code List	MP	1 to 8			
>>>Channelisation Code	MP		Enumerated((8/1)..(8/8))		

10.3.6.51a PRACH Channelisation Code 1.28 Mcps TDD

NOTE: Only for 1.28 Mcps TDD.

Information Element/Group name	Need	Multi	Type and reference	Semantics description	Version
Channelisation Code List	MP	1 to 4			REL-4
>Channelisation Code	MP		Enumerated((4/1)..(4/4),(8/1)..(8/8),(16/1)..(16/16))		REL-4

10.3.6.52 PRACH info (for RACH)

Information Element/Group name	Need	Multi	Type and reference	Semantics description	Version
CHOICE <i>mode</i>	MP				
>FDD					
>>Available Signature	MP		Bit string(16)	Each bit indicates availability for a signature, where the signatures are numbered "signature 0" up to "signature 15". The value 1 of a bit indicates that the corresponding signature is available and the value 0 that it is not available.	
>>Available SF	MP		Integer (32,64,128,256)	In chips per symbol Defines the minimum allowed SF (i.e. the maximum rate)	
>>Preamble scrambling code number	MP		Integer (0 .. 15)	Identification of scrambling code see [28]	
>>Puncturing Limit	MP		Real(0.40..1.00 by step of 0.04)		
>>Available Sub Channel Number	MP		Bit string(12)	Each bit indicates availability for a subchannel, where the subchannels are numbered "subchannel 0" to "subchannel 11".	

				The value 1 of a bit indicates that the corresponding subchannel is available and the value 0 indicates that it is not available.	
>TDD					
>>CHOICE <i>TDD option</i>	MP				REL-4
>>>3.84 Mcps TDD					REL-4
>>>>Timeslot number	MP		Timeslot number 10.3.6.84		
>>>>PRACH Channelisation Code List	MP		PRACH Channelisation Code List 10.3.6.51		
>>>>PRACH Midamble	MP		Enumerated (Direct, Direct/Inverted)	Direct or direct and inverted midamble are used for PRACH	
>>>>PNBSCH allocation	OP		PNBSCH allocation 10.3.8.10a	Identifies frames used for cell synchronisation purposes	REL-4
>>>1.28 Mcps TDD					REL-4
>>>>SYNC_UL info	MP		SYNC_UL info 10.3.6.78a		REL-4
>>>>PRACH Definition	MP	1..<maxPRACH_FPA CH>			REL-4
>>>>>Timeslot number	MP		Timeslot number 10.3.6.84		REL-4
>>>>>PRACH Channelisation Code	MP		PRACH Channelisation Code 1.28 Mcps TDD 10.3.6.51a		REL-4
>>>>>Midamble Shift and burst type	MP		Midamble shift and burst type 10.3.6.41		REL-4
>>>>>FPACH info	MP		FPACH info 10.3.6.35a		REL-4

10.3.6.53 PRACH partitioning

Information Element/Group name	Need	Multi	Type and reference	Semantics description
Access Service class	MP	1 to maxASC		If only "NumASC+1" (with, NumASC+1 < maxASC) ASCs are listed, the remaining (NumASC+2 through maxASC) ASCs are unspecified.
>ASC Setting	MD		ASC setting 10.3.6.6	The default values are same as the previous ASC. If the "default" is used for the first ASC, the default values are all available signatures and "all available sub-channels" for FDD and "all available channelisation codes" and "all available subchannels" with "subchannel size=Size 1" in TDD.

10.3.6.54 PRACH power offset

NOTE: Only for FDD.

Information Element/Group name	Need	Multi	Type and reference	Semantics description
Power Ramp Step	MP		Integer (1..8)	Power step when no acquisition indicator is received in dB
Preamble Retrans Max	MP		Integer (1..64)	Maximum number of preambles in one preamble ramping cycle

10.3.6.55 PRACH system information list

Information element	Need	Multi	Type and reference	Semantics description
PRACH system information	MP	1 .. <maxPRACH>		
>PRACH info	MP		PRACH info (for RACH) 10.3.6.52	
>Transport channel identity	MP		Transport channel identity 10.3.5.18	
>RACH TFS	MD		Transport format set 10.3.5.23	Default value is the value of "RACH TFS" for the previous PRACH in the list NOTE: The first occurrence is then MP). NOTE: For TDD in this release there is a single TF within the RACH TFS.
>RACH TFCS	MD		Transport Format Combination Set 10.3.5.20	Default value is the value of "RACH TFCS" for the previous PRACH in the list. NOTE: The first occurrence is then MP).

Information element	Need	Multi	Type and reference	Semantics description
				NOTE: For TDD in this release there is no TFCS required.
>PRACH partitioning	MD		PRACH partitioning 10.3.6.53	Default value is the value of "PRACH partitioning" for the previous PRACH in the list (note : the first occurrence is then MP)
>Persistence scaling factors	OP		Persistence scaling factors 10.3.6.48	This IE shall not be present if only ASC 0 and ASC 1 are defined. If this IE is absent, value is the value of "Persistence scaling factors" for the previous PRACH in the list if value exists
>AC-to-ASC mapping	CV-SIB5-MD		AC-to-ASC mapping 10.3.6.1	Only present in SIB 5. Default value is the value of "AC-to-ASC mapping" for the previous PRACH in the list. NOTE: The first occurrence is then MP in SIB5.
>CHOICE mode	MP			
>>FDD				
>>>Primary CPICH TX power	MD		Primary CPICH TX power 10.3.6.61	Default value is the value of "Primary CPICH TX power" for the previous PRACH in the list. NOTE: The first occurrence is then MP.
>>>Constant value	MD		Constant value 10.3.6.11	Default value is the value of "Constant value" for the previous PRACH in the list. NOTE: The first occurrence is then MP.
>>>PRACH power offset	MD		PRACH power offset 10.3.6.54	Default value is the value of "PRACH power offset" for the previous PRACH in the list. NOTE: The first occurrence is then MP.
>>>RACH transmission parameters	MD		RACH transmission parameters 10.3.6.67	Default value is the value of "RACH transmission parameters" for the previous PRACH in the list. NOTE: The first occurrence is then MP.
>>>AICH info	MD		AICH info 10.3.6.2	Default value is the value of "AICH info" for the previous PRACH in the list. NOTE: The first occurrence is then MP.
>>TDD				(no data)

Condition	Explanation
SIB5-MD	The information element is present only in SIB 5 and in SIB 5 it is mandatory with default.

NOTE: If the setting of the PRACH information results in that a combination of a signature, preamble scrambling code and subchannel corresponds to a RACH with different TFS and/or TFCS, then for that combination only the TFS/TFCS of the PRACH listed first is valid, where PRACHs listed in System Information Block type 5 shall be counted first.

10.3.6.56 Predefined PhyCH configuration

This information element concerns a pre- defined configuration of physical channel parameters.

Information Element/Group name	Need	Multi	Type and Reference	Semantics description
Uplink radio resources				
Uplink DPCH info	MP		Uplink DPCH info Pre 10.3.6.90	
Downlink radio resources				
Downlink information common for all radio links	OP		Downlink information common for all radio links Pre 10.3.6.26	

10.3.6.57 Primary CCPCH info

Information Element/Group name	Need	Multi	Type and reference	Semantics description	Version
CHOICE <i>mode</i>	MP				
>FDD					
>>TX Diversity indicator	MP		Boolean	TRUE indicates that transmit diversity is used.	
>TDD					
>>CHOICE <i>TDD option</i>	MP				REL-4
>>>3.84 Mcps TDD					REL-4
>>>>CHOICE <i>SyncCase</i>	OP				
>>>>>Sync Case 1					
>>>>>>Timeslot	MP		Integer (0...14)	PCCPCH timeslot	
>>>>>>Sync Case 2					
>>>>>>>Timeslot	MP		Integer(0..6)		
>>>1.28 Mcps TDD					REL-4
>>>>TSTD indicator	MP		TSTD indicator 10.3.6.85a		REL-4
>>Cell parameters ID	OP		Cell parameters Id 10.3.6.9	The Cell parameters ID is described in [32].	
>>SCTD indicator	MP		SCTD indicator 10.3.6.70a		

10.3.6.58 Primary CCPCH info post

NOTE: Only for TDD

Information Element/Group name	Need	Multi	Type and reference	Semantics description	Version
CHOICE <i>TDD option</i>	MP				REL-4
>3.84 Mcps TDD					REL-4
>>CHOICE <i>SyncCase</i>	MP				
>>>Sync Case 1					
>>>>Timeslot	MP		Integer (0...14)	PCCPCH timeslot	
>>>>Sync Case 2					
>>>>>Timeslot	MP		Integer(0..6)		

Information Element/Group name	Need	Multi	Type and reference	Semantics description	Version
>1.28 Mcps TDD					REL-4
>>TSTD indicator	MP		TSTD indicator 10.3.6.85a		REL-4
Cell parameters ID	MP		Cell parameters Id 10.3.6.9	The Cell parameters ID is described in [32].	
SCTD indicator	MP		SCTD indicator 10.3.6.70a		

10.3.6.59 Primary CCPCH TX Power

NOTE: Only for TDD.

Information Element/group name	Need	Multi	Type and reference	Semantics description
Primary CCPCH Tx Power	MP		Integer(6..43)	In dBm

10.3.6.60 Primary CPICH info

NOTE: Only for FDD.

Information Element/Group name	Need	Multi	Type and reference	Semantics description
Primary scrambling code	MP		Integer(0..511)	

10.3.6.61 Primary CPICH Tx power

NOTE: Only for FDD.

Information Element/Group name	Need	Multi	Type and reference	Semantics description
Primary CPICH Tx Power	MP		Integer(-10..50)	Power in dBm.

10.3.6.62 Primary CPICH usage for channel estimation

NOTE: Only for FDD.

Information Element/Group name	Need	Multi	Type and Reference	Semantics description
Primary CPICH usage for channel estimation	MP		Enumerated(Primary CPICH may be used, Primary CPICH shall not be used)	

10.3.6.63 PUSCH info

NOTE: Only for TDD.

Information Element/Group name	Need	Multi	Type and reference	Semantics description
TFCS ID	MD		Integer(1..8)	Default value is 1
Common timeslot info	OP		Common timeslot info 10.3.6.10	
PUSCH timeslots and codes	OP		Uplink Timeslots and Codes 10.3.6.94	

10.3.6.64 PUSCH Capacity Allocation info

NOTE: Only for TDD.

Information Element/Group name	Need	Multi	Type and reference	Semantics description
CHOICE <i>PUSCH allocation</i>	MP			
>PUSCH allocation pending				(no data)
>PUSCH allocation assignment				
>>PUSCH allocation period info	MP		Allocation Period Info 10.3.6.4	
>>PUSCH power control info	OP		PUSCH power control info 10.3.6.65	
>>CHOICE <i>Configuration</i>	MP			
>>>Old configuration				
>>>>TFCS ID	MD		Integer(1..8)	Default is 1.
>>>>PUSCH Identity	MP		Integer(1..hi PUSCHidentities)	
>>>New configuration				
>>>>PUSCH info	MP		PUSCH info 10.3.6.63	
>>>>PUSCH Identity	OP		Integer(1..hiPUSCHidentities)	

10.3.6.65 PUSCH power control info

NOTE: Only for TDD.

Interference level measured for a frequency at the UTRAN access point used by UE to set PUSCH output power.

Information Element/Group name	Need	Multi	Type and reference	Semantics description	Version
CHOICE <i>TDD option</i>	MP				REL-4
>3.84 Mcps TDD					REL-4
>>UL target SIR	MP		Real (-11 .. 20 by step of 0.5)	in dB	
>1.28 Mcps TDD					REL-4
>>PRX _{PUSCHdes}	MP		Integer(-120...-58 by step of 1)	in dBm	REL-4
>>TPC Step Size	OP		Integer (1, 2, 3)	In dB	REL-4

10.3.6.66 PUSCH system information

NOTE: Only for TDD.

Information Element/Group name	Need	Multi	Type and reference	Semantics description
PUSCH information	MP	1 to <maxPUSCH>		
>PUSCH Identity	MP		Integer(1..hi PUSCHidentities)	
>PUSCH info	MP		PUSCH info 10.3.6.63	
>SFN Time Info	CH-Block17		SFN Time Info 10.3.6.75	
>USCH TFS	OP		Transport format set 10.3.5.23	
>USCH TFCS	OP		Transport Format Combination Set 10.3.5.20	

Condition	Explanation
Block17	This IE is not needed in System Information Block 17. Otherwise it is optional.

10.3.6.67 RACH transmission parameters

NOTE: Only for FDD.

Information Element/Group name	Need	Multi	Type and reference	Semantics description
Mmax	MP		Integer(1..32)	Maximum number of preamble cycles
NB01min	MP		Integer(0..50)	Sets lower bound for random back-off
NB01max	MP		Integer(0..50)	Sets upper bound for random back-off

10.3.6.68 Radio link addition information

Information Element/Group name	Need	Multi	Type and reference	Semantics description	Version
Primary CPICH info	MP		Primary CPICH info 10.3.6.60		
Cell ID	OP		Cell ID 10.3.2.2		REL-4
Downlink DPCH info for each RL	MP		Downlink DPCH info for each RL 10.3.6.21		
TFCl combining indicator	MP		TFCl combining indicator 10.3.6.81		
SCCPCH Information for FACH	OP		SCCPCH Information for FACH	Note 1	

Information Element/Group name	Need	Multi	Type and reference	Semantics description	Version
			10.3.6.70		

NOTE 1: These IEs are present when the UE needs to listen to system information on FACH in CELL_DCH state.

10.3.6.69 Radio link removal information

Information Element/Group name	Need	Multi	Type and reference	Semantics description
Primary CPICH info	MP		Primary CPICH info 10.3.6.60	

10.3.6.70 SCCPCH Information for FACH

Information Element/Group name	Need	Multi	Type and reference	Semantics description
Secondary CCPCH info	MP		Secondary CCPCH info 10.3.6.71	
TFCS	MP		Transport format combination set 10.3.5.20	For FACHs and PCH
FACH/PCH information	MP	1 to <maxFACH/HPCH>		
>TFS	MP		Transport format set 10.3.5.23	For each FACHs and PCH
>Transport channel identity	MP		Transport channel identity 10.3.5.18	
>CTCH indicator	MP		Boolean	The value "TRUE" indicates that a CTCH is mapped on the FACH, and "FALSE" that no CTCH is mapped.
CHOICE mode				
>FDD				
>>References to system information blocks	MP	1 to <maxSIB-FACH>		
>>>Scheduling information	MP		Scheduling information 10.3.8.16	
>>>SIB type SIBs only	MP		SIB Type SIBs only, 10.3.8.22	
>TDD				(No data)

NOTE: TFS for PCH shall be the first "FACH/PCH information" in the list if a PCH exists for the respective secondary CCPCH.

10.3.6.70a SCTD indicator

NOTE: Only for TDD

Information Element/Group name	Need	Multi	Type and reference	Semantics description
SCTD indicator	MP		Boolean	TRUE indicates that SCTD is used

10.3.6.71 Secondary CCPCH info

Information Element/Group name	Need	Multi	Type and reference	Semantics description
CHOICE <i>mode</i>	MP			
>FDD				
>>Secondary scrambling code	OP		Secondary scrambling code 10.3.6.74	May only be sent for SCCPCH channels not carrying the PCH.
>>STTD indicator	MD		STTD Indicator 10.3.6.78	Default value is "TRUE"
>>Spreading factor	MP		Integer(4, 8, 16, 32, 64, 128, 256)	
>>Code number	MP		Integer(0..Spreading factor - 1)	
>>Pilot symbol existence	MD		Boolean	TRUE means the existence. Default value is "TRUE"
>>TFCI existence	MD		Boolean	TRUE indicates that TFCI is used. When spreading factor is less than or equal to 64, FALSE indicates that TFCI is not used and therefore DTX is used in the TFCI field. Default value is "TRUE"
>>Fixed or Flexible Position	MD		Enumerated (Fixed, Flexible)	Default value is "Flexible"
>>Timing Offset	MD		Integer(0..38144 by step of 256)	Chip Delay of the Secondary CCPCH relative to the Primary CCPCH. Default value is 0.
>TDD				
>>Offset	MP		Integer (0..Repetition Period -1)	SFN modulo Repetition period = offset. Repetition period is the one indicated in the accompanying Common timeslot info IE
>>Common timeslot info	MP		Common timeslot info 10.3.6.10	
>>Individual timeslot info	MP		Individual timeslot info 10.3.6.37	
>>Code List	MP	1 to 16		
>>>Channelisation Code	MP		Enumerated((16/1)..(16/16))	

10.3.6.72 Secondary CCPCH system information

Information element	Need	Multi	Type and reference	Semantics description
Secondary CCPCH system information	MP	1 to <maxSCC PCH>		
>Secondary CCPCH info	MP		Secondary CCPCH info 10.3.6.71	Note 1
>TFCS	MD		Transport format combination set 10.3.5.20	For FACHs and PCH Default value is the value of "TFCS" for the previous SCCPCH in the list. NOTE: The first occurrence is then MP.
>FACH/PCH information	MD	1 to <maxFAC HPCH>		Default value is the value of "FACH/PCH" for the previous SCCPCH in the list. NOTE: The first occurrence is then MP.
>>TFS	MP		Transport format set 10.3.5.23	For each FACH and PCH Note 2
>>Transport channel identity	MP		Transport channel identity 10.3.5.18	
>>CTCH indicator	MP		Boolean	The value "TRUE" indicates that a CTCH is mapped on the FACH, and "FALSE" that no CTCH is mapped.
>PICH info	OP		PICH info 10.3.6.49	PICH info is present only when PCH is multiplexed on Secondary CCPCH

NOTE 1: The secondary CCPCHs carrying a PCH shall be listed first.

NOTE 2: TFS for PCH shall be the first "FACH/PCH information" in the list if a PCH exists for the respective secondary CCPCH.

10.3.6.73 Secondary CPICH info

NOTE: Only for FDD.

Information Element/Group name	Need	Multi	Type and reference	Semantics description
Secondary scrambling code	MD		Secondary scrambling code 10.3.6.74	Default is the same scrambling code as for the Primary CPICH
Channelisation code	MP		Integer(0..255)	SF=256

10.3.6.74 Secondary scrambling code

Information Element/Group name	Need	Multi	Type and reference	Semantics description
Secondary scrambling code	MP		Integer(1..15)	

10.3.6.75 SFN Time info

Information Element/Group name	Need	Multi	Type and reference	Semantics description
Activation time SFN	MP		Integer (0..4095)	System frame number start of the physical channel existence.
Duration	MP		Integer(1..4096)	Total number of frames the physical channel will exist.

10.3.6.75a Special Burst Scheduling

NOTE: Only for TDD.

Information Element/Group name	Need	Multi	Type and reference	Semantics description
Special Burst Generation Period	MP		Integer (2, 4, 8, 16, 32, 64, 128, 256)	Value in radio frames

10.3.6.76 SSdT cell identity

NOTE: Only for FDD.

This IE is used to associate a cell identity with a given radio link.

Information Element/Group name	Need	Multi	Type and reference	Semantics description
SSdT cell id	MP		Enumerated (a, b, c, d, e, f, g, h)	

10.3.6.77 SSdT information

NOTE: Only for FDD.

This information element indicates the status (e.g. initiated/terminated) of the Site Selection.

Diversity Transmit power control (SSdT). It is used to change the SSdT status. The parameter 'code word set' indicates how cell identities are coded (using many bits or few, values are long, medium, or short).

Information Element/Group name	Need	Multi	Type and reference	Semantics description	Version
S field	MP		Integer (1, 2)	In bits	
Code Word Set	MP		Enumerated (long, medium, shortSSdT off)		
SSdT UL	OP		Enumerated (UL, ULandDL)		REL-4

NOTE: These parameters shall be set optionally associated with DL DPCH info but not for each RL.

10.3.6.78 STTD indicator

NOTE: Only for FDD

Indicates whether STTD is used or not.

Information Element/Group name	Need	Multi	Type and reference	Semantics description
STTD Indicator	MP		Boolean	TRUE means that STTD is used

10.3.6.78a SYNC_UL info

NOTE: Only for 1.28 Mcps TDD.

Information Element/ Group name	Need	Multi	Type and reference	Semantics description	Version
SYNC_UL codes bitmap	MP		Bitstring(8)	Each bit indicates availability of a SYNC_UL code, where the SYNC_UL codes are numbered "code 0" to "code 7". The value 1 of a bit indicates that the corresponding SYNC_UL code can be used. The value 0 of a bit indicates that the corresponding SYNC_UL code can not be used.	REL-4
PRX _{UpPCHdes}	MP		Integer(-120...-58 by step of 1)	In dBm	REL-4
Power Ramp Step	MP		Integer(0,1,2,3)	In dB	REL-4
Max SYNC_UL Transmissions	MP		Integer(1,2,4,8)	Maximum numbers of SYNC_UL transmissions in a power ramping sequence.	REL-4
Mmax	MP		Integer(1..32)	Maximum number of synchronisation attempts.	REL-4

10.3.6.79 TDD open loop power control

This information element contains parameters for open loop power control setting for TDD.

Information Element/Group name	Need	Multi	Type and reference	Semantics description	Version
Primary CCPCH Tx Power	MP		Primary CCPCH Tx Power 10.3.6.59	For path loss calculation	
CHOICE <i>TDD option</i>	MP				REL-4
>3.84 Mcps TDD					REL-4
>>Alpha	OP		Alpha 10.3.6.5		
>>PRACH Constant Value	MP		Constant Value TDD 10.3.6.11a	Operator controlled PRACH Margin	
>>DPCH Constant Value	MP		Constant	Operator	

Information Element/Group name	Need	Multi	Type and reference	Semantics description	Version
			Value TDD 10.3.6.11a	controlled UL DPCH Margin	
>>PUSCH Constant Value	OP		Constant Value TDD 10.3.6.11a	Operator controlled PUSCH Margin	
>>UE positioning related parameters	CV-IPDLs				REL-4
>>>IPDL-Alpha	MP		Alpha 10.3.6.5		REL-4
>>>Max power increase	MP		Integer (0..3)	In db	REL-4
>1.28 Mcps TDD				(no data)	REL-4

Condition	Explanation
IPDLs	This IE is present only if idle periods are applied

10.3.6.80 TFC Control duration

Information Element/Group name	Need	Multi	Type and reference	Semantics description
TFC Control duration	MP		Integer (1, 2, 4, 8, 16, 24, 32, 48, 64, 128, 192, 256, 512)	Defines the period in multiples of 10 ms frames for which the defined TFC sub-set is to be applied.

10.3.6.81 TFCI Combining Indicator

NOTE: Only for FDD.

This IE indicates whether the TFCI (field 2), which will be transmitted on the DPCCH of a newly added radio link, should be soft-combined with the others in the TFCI (field 2) combining set. This IE is relevant only when the UE is in CELL_DCH state with a DSCH transport channel assigned and when there is a 'hard' split in the TFCI field (such that TFCI1 and TFCI2 have their own separate block coding).

Information Element/Group name	Need	Multi	Type and reference	Semantics description
TFCI combining indicator	MP		Boolean	TRUE means that TFCI is combined, FALSE means that TFCI is not combined or that this IE is not applicable to the added radio link.

10.3.6.82 TGPSI

Information Element/Group name	Need	Multi	Type and reference	Semantics description
TGPSI	MP		Integer(1..M axTGPS)	Transmission Gap Pattern Sequence Identifier Establish a reference to the compressed mode pattern sequence. Up to <MaxTGPS> simultaneous compressed mode pattern sequences can be used.

10.3.6.83 Time info

Information Element/Group name	Need	Multi	Type and reference	Semantics description
Activation time	MD		Activation time 10.3.3.1	Frame number start of the physical channel existence. Default value is "Now"
Duration	MD		Integer(1..4096, infinite)	Total number of frames the physical channel will exist. Default value is "infinite".

10.3.6.84 Timeslot number

Information Element/Group name	Need	Multi	Type and reference	Semantics description	Version
CHOICE <i>TDD option</i>	MP				REL-4
>3.84 Mcps TDD					REL-4
>>Timeslot number	MP		Integer(0..14)	Timeslot within a frame	
>1.28 Mcps TDD					REL-4
>>Timeslot number	MP		Integer(0..6)	Timeslot within a subframe	REL-4

10.3.6.85 TPC combination index

NOTE: Only for FDD.

Information Element/Group name	Need	Multi	Type and reference	Semantics description
TPC combination index	MP		Integer(0..5)	Radio links with the same index have TPC bits, which for the UE are known to be the same.

10.3.6.85a TSTD indicator

NOTE: Only for 1.28 Mcps TDD.

Information Element/Group name	Need	Multi	Type and reference	Semantics description	Version
TSTD indicator	MD		Boolean	Default value is "TRUE"	REL-4

10.3.6.86 TX Diversity Mode

NOTE: Only for FDD.

Information Element/Group name	Need	Multi	Type and reference	Semantics description
Tx diversity Mode	MP		Enumerated (none, STTD, closed loop mode1, closed loop mode2)	

10.3.6.87 UL interference

Information Element/Group name	Need	Multi	Type and reference	Semantics description
UL interference	MP		Integer (-110..-70)	In dBm

NOTE: In TDD, this IE is a timeslot specific value.

10.3.6.87a UL interference TDD

NOTE: Only for TDD.

Information Element/Group name	Need	Multi	Type and reference	Semantics description
TDD UL interference	MP		Integer (-110..-52)	In dBm

NOTE: This IE is a timeslot specific value.

10.3.6.88 Uplink DPCH info

Information Element/Group name	Need	Multi	Type and reference	Semantics description
Uplink DPCH power control info	OP		Uplink DPCH power control info 10.3.6.91	
CHOICE <i>mode</i>	MP			
>FDD				
>>Scrambling code type	MP		Enumerated(short, long)	
>>Scrambling code number	MP		Integer(0..16 777215)	
>>Number of DPDCH	MD		Integer(1..maxDPDCH)	Default value is 1. Number of DPDCH is 1 in HANDOVER TO UTRAN COMMAND
>>Spreading factor	MP		Integer(4, 8, 16, 32, 64, 128, 256)	Minimum allowed SF of the channelisation code for data part
>>TFCI existence	MD		Boolean	TRUE means existence. Default value is "TRUE"
>>Number of FBI bits	OP		Integer (1, 2)	In bits.
>>Puncturing Limit	MP		Real(0.40 ..1 by step of 0.04)	
>TDD				
>>Uplink Timing Advance Control	OP		Uplink Timing Advance Control 10.3.6.96	
>>UL CTrCH List	OP	1 to <maxCCTrCH>		UL physical channels to establish or reconfigure list.
>>>TFCS ID	MD		Integer(1..8)	Default value is 1.
>>>UL target SIR	MP		Real (-11 .. 20 by step of 0.5dB)	In dB
>>>Time info	MP		Time info 10.3.6.83	
>>>Common timeslot info	MD		Common timeslot info 10.3.6.10	Default is the current Common timeslot info
>>>Uplink DPCH timeslots and codes	MD		Uplink Timeslots and Codes 10.3.6.94	Default is to use the old timeslots and codes.
>>UL CTrCH List to Remove	OP	1..<maxCCTrCH>		UL physical channels to remove list
>>>TFCS ID	MP		Integer(1..8)	

10.3.6.89 Uplink DPCH info Post

Information Element/Group name	Need	Multi	Type and reference	Semantics description
Uplink DPCH power control info	MP		Uplink DPCH power control info Post 10.3.6.92	
CHOICE <i>mode</i>	MP			
>FDD				
>>Scrambling code type	MP		Enumerated(short, long)	
>>Reduced scrambling code number	MP		Integer(0..8191)	Sub-range of values for initial use upon handover to UTRAN.
>>Spreading factor	MP		Integer(4, 8, 16, 32, 64, 128, 256)	SF of the channelisation code for data part There is only one DPDCH for this case
>TDD				
>>Uplink Timing Advance Control	OP		Uplink Timing Advance Control 10.3.6.96	
>>Uplink DPCH timeslots and codes	MP		Uplink Timeslots and Codes 10.3.6.94	

10.3.6.90 Uplink DPCH info Pre

Information Element/Group name	Need	Multi	Type and reference	Semantics description
Uplink DPCH power control info	OP		Uplink DPCH power control info Pre 10.3.6.93	
CHOICE <i>mode</i>	MP			
>FDD				
>>TFCI existence	MP		Boolean	TRUE means existence. Default value is "TRUE"
>>Puncturing Limit	MP		Real(0.40 ..1 by step of 0.04)	
>TDD				
>>Common timeslot info	MP		Common Timeslot Info 10.3.6.10	

Condition	Explanation
<i>Single</i>	This IE is mandatory present if the IE "Number of DPDCH" is "1" and not needed otherwise.

10.3.6.91 Uplink DPCH power control info

Parameters used by UE to set DPCH initial output power and to use for closed-loop power control in FDD and 1.28 Mcps TDD and parameters for uplink open loop power control in 3.84 Mcps TDD.

Information Element/Group name	Need	Multi	Type and reference	Semantics description	Version
--------------------------------	------	-------	--------------------	-----------------------	---------

Information Element/Group name	Need	Multi	Type and reference	Semantics description	Version
CHOICE <i>mode</i>	MP				
>FDD					
>>DPCCH Power offset	MP		Integer(-164,..-6 by step of 2)	In dB	
>>PC Preamble	MP		Integer (0..7)	In number of frames	
>>SRB delay	MP		Integer(0..7)	In number of frames	
>>Power Control Algorithm	MP		Enumerated (algorithm 1, algorithm 2)	Specifies algorithm to be used by UE to interpret TPC commands	
>>TPC step size	<i>CV-algo</i>		Integer (1, 2)	In dB	
>TDD					
>>CHOICE <i>TDD option</i>					REL-4
>>>3.84 Mcps TDD					REL-4
>>>>UL target SIR	OP		Real (-11 .. 20 by step of 0.5dB)	In dB	
>>>>1.28 Mcps TDD					REL-4
>>>> PRXPDPCHdes	OP		Integer(-120...-58 by step of 1)	in dBm	REL-4
>>CHOICE <i>UL OL PC info</i>	MP				
>>>Broadcast UL OL PC info			Null	No data	
>>>Individually Signalled	OP				
>>>>CHOICE <i>TDD option</i>	MP				REL-4
>>>>>3.84 Mcps TDD					REL-4
>>>>>>Individual timeslot interference info	MP	1 to <maxTS>			
>>>>>>>Individual timeslot interference	MP		Individual timeslot interference 10.3.6.38		
>>>>>>>DPCH Constant Value	OP		Constant Value TDD 10.3.6.11a	Quality Margin	
>>>>>>>1.28 Mcps TDD					REL-4
>>>>>>>TPC step size	MP		Integer(1,2,3)		REL-4
>>>>>Primary CCPCH Tx Power	OP		Primary CCPCH Tx Power 10.3.6.59	For Pathloss Calculation	

Condition	Explanation
<i>algo</i>	The IE is mandatory present if the IE "Power Control Algorithm" is set to "algorithm 1", otherwise the IE is not needed

10.3.6.92 Uplink DPCH power control info Post

Parameters used by UE to set DPCH initial output power and to use for closed-loop power control.

Information Element/Group name	Need	Multi	Type and reference	Semantics description	Version
CHOICE <i>mode</i>	MP				
>FDD					
>>DPCCH Power offset	MP		Integer(-110..-50 by	In dB	

Information Element/Group name	Need	Multi	Type and reference	Semantics description	Version
			step of 4)		
>>PC Preamble	MP		Integer (0..7)	in number of frames	
>>SRB delay	MP		Integer (0..7)	In number of frames	
>TDD					
>>UL target SIR	MP		Real (-11 .. 20 by step of 0.5dB)	In dB	
>>CHOICE <i>TDD option</i>	MP				REL-4
>>>3.84 Mcps TDD					REL-4
>>>>UL Timeslot Interference	MP		UL Interference TDD 10.3.6.87a		
>>>1.28 Mcps TDD				(no data)	REL-4

Condition	Explanation
<i>algo</i>	The IE is mandatory present if the IE "Power Control Algorithm" is set to "algorithm 1", otherwise the IE is not needed

10.3.6.93 Uplink DPCH power control info Pre

Parameters used by UE to set DPCH initial output power and to use for closed-loop power control in FDD and parameters for uplink open loop power control in 3.84 Mcps TDD.

Information Element/Group name	Need	Multi	Type and reference	Semantics description	Version
CHOICE <i>mode</i>	MP				
>FDD					
>>Power Control Algorithm	MP		Enumerated (algorithm 1, algorithm 2)	Specifies algorithm to be used by UE to interpret TPC commands	
>>TPC step size	<i>CV-algo</i>		Integer (1, 2)	In dB	
>TDD				(No data)	
>>CHOICE <i>TDD option</i>	MP				REL-4
>>>3.84 Mcps TDD					REL-4
>>DPCH Constant Value	MP		Constant Value TDD 10.3.6.11a	Quality Margin	
>>>1.28 Mcps TDD				(no data)	REL-4

Condition	Explanation
<i>algo</i>	The IE is mandatory present if the IE "Power Control Algorithm" is set to "algorithm 1", otherwise the IE is not needed

10.3.6.94 Uplink Timeslots and Codes

NOTE: Only for TDD

Information Element/Group name	Need	Multi	Type and reference	Semantics description
Dynamic SF usage	MP		Boolean	
First Individual timeslot info	MP		Individual timeslot info	Individual timeslot info for the first timeslot used by the

Information Element/Group name	Need	Multi	Type and reference	Semantics description
			10.3.6.37	physical layer.
First timeslot Code List	MP	1..2		Code list used in the timeslot. given in First individual timeslot info.
>Channelisation Code	MP		Enumerated((1/1),(2/1),(2/2),(4/1)..(4/4),(8/1)..(8/8),(16/1)..(16/16))	
CHOICE <i>more timeslots</i>	MP			
>No more timeslots				(no data)
>Consecutive timeslots				
>>Number of additional timeslots	MP		Integer(1..maxTS-1)	The timeslots used by the physical layer shall be timeslots: N mod maxTS (N+1) mod maxTS ... (N+k) mod maxTS in that order, where N is the timeslot number in the First individual timeslot info and k the Number of additional timeslots. The additional timeslots shall use the same parameters (e.g. channelisation codes, midamble shifts etc.) as the first timeslot.
>Timeslot list				
>>Additional timeslot list	MP	1 to <maxTS-1>		The first instance of this parameter corresponds to the timeslot that shall be used second by the physical layer, the second to the timeslot that shall be used third and so on.
>>>CHOICE <i>parameters</i>	MP			
>>>>Same as last				
>>>>>Timeslot number	MP		Timeslot Number 10.3.6.84	This physical layer shall use the same parameters (e.g. channelisation codes, midamble shifts etc.) for this timeslot as for the last one.
>>>>>New parameters				
>>>>>Individual timeslot info	MP		Individual timeslot info 10.3.6.37	
>>>>>Code List	MP	1..2		
>>>>>>Channelisation Code	MP		Enumerated((1/1),(2/1),(2/2),(4/1)..(4/4),(8/1)..(8/8),(16/1)..(16/16))	

10.3.6.95 Uplink Timing Advance

NOTE: Only for 3.84 Mcps TDD.

Information Element/Group name	Need	Multi	Type and reference	Semantics description	Version
UL Timing Advance	MP		Integer (0..63)	Absolute timing advance value to be used to avoid large delay spread at the NodeB	

10.3.6.96 Uplink Timing Advance Control

NOTE: Only for TDD

Information Element/Group name	Need	Multi	Type and reference	Semantics description	Version
CHOICE <i>Timing Advance</i>	MP				
>Disabled			Null	Indicates that no timing advance is applied	
>Enabled					
>>CHOICE <i>TDD option</i>	MP				REL-4
>>>3.84 Mcps TDD					REL-4
>>>>UL Timing Advance	MD		Uplink Timing Advance 10.3.6.95	Absolute timing advance value to be used to avoid large delay spread at the NodeB. Default value is the existing value for uplink timing advance.	
>>>>Activation Time	OP		Activation Time 10.3.3.1	Frame number timing advance is to be applied. This IE is required when a new UL Timing Advance adjustment is specified and Activation Time is not otherwise specified in the RRC message.	
>>1.28 Mcps TDD				(no data)	REL-4
>>>Uplink synchronisation parameters	MD			Default: Uplink synchronisation step size is 1. Uplink synchronisation frequency is 1.	REL-4
>>>>Uplink synchronisation step size	MP		Integer(1..8)	This parameter specifies the step size to be used for the adjustment of the uplink transmission timing	REL-4
>>>>Uplink synchronisation frequency	MP		Integer(1..8)	This parameter specifies the frequency of the adjustment of the uplink transmission timing	REL-4
>>>Synchronisation parameters	OP				
>>>>SYNC_UL codes bitmap	MP		Bitstring(8)	Each bit indicates availability of a	REL-4

Information Element/Group name	Need	Multi	Type and reference	Semantics description	Version
				SYNC_UL code, where the SYNC_UL codes are numbered "code 0" to "code 7". The value 1 of a bit indicates that the corresponding SYNC_UL code can be used. The value 0 of a bit indicates that the corresponding SYNC_UL code can not be used.	
>>>>FPACH info	MP		FPACH info 10.3.6.35a		REL-4
>>>>PRX _{UpPCHdes}	MP		Integer(-120...-58 by step of 1)	In dBm	REL-4
>>>>SYNC_UL procedure	MD			Default is: Max SYNC_UL Transmission is 2. Power Ramp Step is 2.	REL-4
>>>>>Max SYNC_UL Transmissions	MP		Integer(1,2,4,8)	Maximum numbers of SYNC_UL transmissions in a power ramping sequence.	REL-4
>>>>>Power Ramp Step	MP		Integer(0,1,2,3)	In dB	REL-4

10.3.7 Measurement Information elements

10.3.7.1 Additional measurements list

Information Element/Group name	Need	Multi	Type and reference	Semantics description
Additional measurements	MP	1 to <MaxAdditionalMeas>		
>Additional measurement identity	MP		Measurement identity 10.3.7.48	

10.3.7.2 Cell info

Includes non-frequency related cell info used in the IE "inter-frequency cell info list" and "intra frequency cell info list".

Information Element/Group name	Need	Multi	Type and reference	Semantics description	Version
Cell individual offset	MD		Real(-10..10 by step of 0.5)	In dB Default value is 0 dB Used to offset measured quantity value	
Reference time difference to cell	OP		Reference	In chips.	

			time difference to cell 10.3.7.60	This IE is absent for serving cell.	
Read SFN indicator	MP		Boolean	TRUE indicates that read of SFN is requested for the target cell	
CHOICE <i>mode</i>	MP				
>FDD					
>>Primary CPICH info	OP		Primary CPICH info 10.3.6.60	This IE is absent only if measuring RSSI only (broadband measurement.)	
>>Primary CPICH Tx power	OP		Primary CPICH Tx power 10.3.6.61	Required if calculating pathloss.	
>>TX Diversity Indicator	MP		Boolean	TRUE indicates that transmit diversity is used.	
>TDD					
>>Primary CCPCH info	MP		Primary CCPCH info 10.3.6.57		
>>Primary CCPCH TX power	OP		Primary CCPCH TX power 10.3.6.59		
>>Timeslot list	OP	1 to <maxTS>		The UE shall report Timeslot ISCP values according the order of the listed Timeslot numbers	
>>>CHOICE <i>TDD option</i>	MP				REL-4
>>>>3.84 Mcps TDD					REL-4
>>>>>Timeslot number	MP		Integer (0...14)	Timeslot numbers, for which the UE shall report Timeslot ISCP	
>>>>>Burst Type	MD		Enumerated (Type1, Type2)	Use for Timeslot ISCP measurements only. Default value is "Type1"	
>>>>>1.28 Mcps TDD					REL-4
>>>>>>Timeslot number	MP		Integer (1...6)	Timeslot numbers, for which the UE shall report Timeslot ISCP	REL-4
Cell Selection and Re-selection Info	CV- <i>BCHopt</i>		Cell Selection and Re-selection for SIB11/12Info 10.3.2.4		

Condition	Explanation
<i>BCHopt</i>	This IE is Optional when sent in SYSTEM INFORMATION, Otherwise, the IE is not needed

10.3.7.3 Cell measured results

Includes non-frequency related measured results for a cell.

Information Element/Group name	Need	Multi	Type and reference	Semantics description
Cell Identity	OP		Cell Identity 10.3.2.2	
Cell synchronisation information	OP		Cell synchronisation information 10.3.7.6	
CHOICE <i>mode</i>	MP			
>FDD				
>>Primary CPICH info	MP		Primary CPICH info 10.3.6.60	
>>CPICH Ec/No	OP		Integer(0..49)	According to CPICH_Ec/No in [19] and [20]. Fourteen spare values are needed.
>>CPICH RSCP	OP		Integer(0..91)	According to CPICH_RSCP in [19] and [20]. Thirty-six spare values are needed.
>>Pathloss	OP		Integer(46..158)	In dB. Fifteen spare values are needed.
>TDD				
>>Cell parameters Id	MP		Cell parameters Id 10.3.6.9	
>>Proposed TGSN	OP		Integer (0..14)	Proposal for the next TGSN
>>Primary CCPCH RSCP	OP		Primary CCPCH RSCP info 10.3.7.54	
>>Pathloss	OP		Integer(46..158)	In dB. Fifteen spare values are needed.
>>Timeslot list	OP	1 to <maxTS>		
>>>Timeslot ISCP	MP		Timeslot ISCP Info 10.3.7.65	The UE shall report the Timeslot ISCP in the same order as indicated in the cell info

10.3.7.4 Cell measurement event results

Includes non-frequency related cell reporting quantities.

Information Element/Group name	Need	Multi	Type and reference	Semantics description
CHOICE <i>mode</i>	MP			
>FDD				
>>Primary CPICH info	MP	1 to <maxCellMeas>	Primary CPICH info 10.3.6.60	
>TDD				
>>Primary CCPCH info	MP	1 to <maxCellMeas>	Primary CCPCH info 10.3.6.57	

10.3.7.5 Cell reporting quantities

Includes non-frequency related cell reporting quantities.

For all boolean types TRUE means inclusion in the report is requested.

Information Element/Group name	Need	Multi	Type and reference	Semantics description
Cell synchronisation information reporting indicator	MP		Boolean	
Cell Identity reporting indicator	MP		Boolean	
CHOICE <i>mode</i>	MP			
>FDD				
>>CPICH Ec/N0 reporting indicator	MP		Boolean	
>>CPICH RSCP reporting indicator	MP		Boolean	
>>Pathloss reporting indicator	MP		Boolean	
>TDD				
>>Timeslot ISCP reporting indicator	MP		Boolean	
>>Proposed TGSN Reporting required	MP		Boolean	
>>Primary CCPCH RSCP reporting indicator	MP		Boolean	
>>Pathloss reporting indicator	MP		Boolean	

10.3.7.6 Cell synchronisation information

The IE "Cell synchronisation information" contains the OFF and Tm as defined in [7] and [8] and the four most significant bits of the difference between the 12 least significant bits of the RLC Transparent Mode COUNT-C in the UE and the SFN of the measured cell. It is notified to SRNC by Measurement Report message or Measurement Information Element in other RRC messages

Information Element/Group name	Need	Multi	Type and reference	Semantics description
CHOICE <i>mode</i>	MP			
>FDD				
>>COUNT-C-SFN frame difference	OP			
>>>COUNT-C-SFN high	MP		Integer(0..3840 by step of 256)	in frames
>>>OFF	MP		Integer(0..255)	in frames
>>Tm	MP		Integer(0..38399)	in chips
>TDD				
>>COUNT-C-SFN frame difference	OP			
>>>COUNT-C-SFN high	MP		Integer(0..3840 by step of 256)	in frames
>>>OFF	MP		Integer(0..255)	in frames

10.3.7.7 Event results

Information Element/Group name	Need	Multi	Type and reference	Semantics description
CHOICE <i>event result</i>	MP			One spare value is needed.
>Intra-frequency measurement event results			Intra-frequency	

Information Element/Group name	Need	Multi	Type and reference	Semantics description
			measurement event results 10.3.7.37	
>Inter-frequency measurement event results			Inter-frequency measurement event results 10.3.7.17	
>Inter-RAT measurement event results			Inter-RAT measurement event results 10.3.7.28	For IS-2000 results, include fields of the <i>Pilot Strength Measurement Message</i> from subclause 2.7.2.3.2.5 of TIA/EIA/IS-2000.5
>Traffic volume measurement event results			Traffic volume measurement event results 10.3.7.69	
>Quality measurement event results			Quality measurement event results 10.3.7.57	
>UE internal measurement event results			UE internal measurement event results 10.3.7.78	
>UE positioning measurement event results			UE positioning measurement event results 10.3.7.101	

CHOICE event result	Condition under which the given event result is chosen
Intra-frequency measurement event results	If measurement type = intra-frequency measurement
Inter-frequency measurement event results	If measurement type = inter-frequency measurement
Inter-RAT measurement event results	If measurement type = inter-RAT measurement
Traffic volume measurement event results	If measurement type = traffic volume measurement
Quality measurement event results	If measurement type = Quality measurement
UE internal measurement event results	If measurement type = UE internal measurement
UE positioning measurement event results	If measurement type = UE positioning measurement

10.3.7.8 FACH measurement occasion info

Information Element/Group name	Need	Multi	Type and reference	Semantics description	Version
FACH Measurement occasion cycle length coefficient	OP		Integer(1..12)		
Inter-frequency FDD measurement indicator	MP		Boolean	TRUE means that measurements are required	
Inter-frequency TDD 3.84 Mcps measurement indicator	MP		Boolean	TRUE means that measurements are required	REL-4
Inter-frequency TDD 1.28 Mcps measurement indicator	MP		Boolean	TRUE means that measurements	REL-4

Information Element/Group name	Need	Multi	Type and reference	Semantics description	Version
				are required	
Inter-RAT measurement indicators	OP	1 to <maxOther RAT>			
>RAT type	MP		Enumerated(GSM, IS2000)		

10.3.7.9 Filter coefficient

Information Element/Group name	Need	Multi	Type and reference	Semantics description
Filter coefficient	MD		Integer(0, 1, 2, 3, 4, 5, 6, 7, 8, 9, 11, 13, 15, 17, 19)	Default value is 0

10.3.7.10 HCS Cell re-selection information

Information Element/Group name	Need	Multi	Type and reference	Semantics description
Penalty_time	MD		Integer(0, 10, 20, 30, 40, 50, 60)	Default value is 0 which means = not used In seconds
Temporary_offsets	<i>CV-Penalty used</i>			
>Temporary_offset1	MP		Integer(3, 6, 9, 12, 15, 18, 21, inf)	[dB]
>Temporary_offset2	<i>CV-FDD-Quality-Measure</i>		Integer(2, 3, 4, 6, 8, 10, 12, inf)	[dB]

Condition	Explanation
<i>Penalty used</i>	This IE is not needed if the IE "Penalty time" equals "not used", else it is mandatory present.
<i>FDD-Quality-Measure</i>	This IE is not needed if the IE "Cell selection and reselection quality measure" has the value CPICH RSCP, otherwise the IE is mandatory present. This conditional presence is implemented in ASN.1 by the use of a specific RSCP and EcN0 variant of 10.3.7.10.

10.3.7.11 HCS neighbouring cell information

Information Element/Group name	Need	Multi	Type and reference	Semantics description
HCS_PRIO	MD		Integer (0..7)	Default value = 0
Qhcs	MD		Qhcs 10.3.7.54a	Default value = 0
HCS Cell Re-selection Information	MP		HCS Cell Re-selection Information 10.3.7.10	

10.3.7.12 HCS Serving cell information

Information Element/Group name	Need	Multi	Type and Reference	Semantics description
HCS_PRIO	MD		Integer (0..7)	Default value = 0
Qhcs	MD		Qhcs 10.3.7.54a	Default value = 0
T _{CRmax}	MD		Enumerated(not used, 30, 60, 120, 180, 240)	[s] Default value is not used
N _{CR}	CV-UE speed detector		Integer(1..16)	Default value = 8
T _{CRmaxHyst}	CV-UE speed detector		Enumerated(not used, 10, 20, 30, 40, 50, 60, 70)	[s]

Condition	Explanation
UE Speed detector	This IE is not needed if T _{CRmax} equals 'not used', else it is mandatory present.

10.3.7.13 Inter-frequency cell info list

Contains the information for the list of measurement objects for an inter-frequency measurement.

Information Element/Group name	Need	Multi	Type and reference	Semantics description
CHOICE <i>Inter-frequency cell removal</i>	OP			
>Remove all inter-frequency cells				No data
>Remove some inter-frequency cells				
>>Removed inter-frequency cells	MP	1 .. <maxCellMeas>		
>>>Inter-frequency cell id	MP		Integer(0 .. <maxCellMeas>-1)	
>No inter-frequency cells removed				No data
New inter-frequency cells	OP	1 to <maxCellMeas>		
>Inter-frequency cell id	MD		Integer(0 .. <maxCellMeas>-1)	
>Frequency info	MD		Frequency info 10.3.6.36	Default value is the value of the previous "frequency info" in the list. NOTE: The first occurrence is then MP.
>Cell info	MP		Cell info 10.3.7.2	
Cells for measurement	CV- BCHopt	1 to <maxCellMeas>		
>Inter-frequency cell id	MP		Integer(0 .. <maxCellMeas>-1)	

Condition	Explanation
<i>BCHopt</i>	This IE is not needed when sent in SYSTEM INFORMATION. Otherwise, the IE is Optional

10.3.7.14 Inter-frequency event identity

Information Element/Group name	Need	Multi	Type and reference	Semantics description
Inter-frequency event identity	MP		Enumerated(2a, 2b, 2c, 2d, 2e, 2f)	Two spare values are needed.

10.3.7.15 Inter-frequency measured results list

Information Element/Group name	Need	Multi	Type and reference	Semantics description
Inter-frequency measurement results	OP	1 to <maxFreq>		
>Frequency info	MD		Frequency info 10.3.6.36	Default value is the value of the previous "frequency info" in the list. NOTE: The first occurrence is then MP.
>UTRA carrier RSSI	OP		Integer(0..76)	According to UTRA_carrier_RSSI_LEV in [19] and [20]. Fifty-one spare values are needed.
>Inter-frequency cell measurement results	OP	1 to <maxCellMeas>		Only cells for which all reporting quantities are available should be included.
>>Cell measured results	MP		Cell measured results 10.3.7.3	

10.3.7.16 Inter-frequency measurement

Information Element/Group name	Need	Multi	Type and reference	Semantics description
Inter-frequency measurement objects list	MP		Inter-frequency cell info list 10.3.7.13	
Inter-frequency measurement quantity	OP		Inter-frequency measurement quantity 10.3.7.18	
Inter-frequency reporting quantity	OP		Inter-frequency reporting quantity 10.3.7.21	
Reporting cell status	CV-reporting		Reporting cell status 10.3.7.61	
Measurement validity	OP		Measurement validity 10.3.7.51	
Inter-frequency set update	OP		Inter-frequency	

Information Element/Group name	Need	Multi	Type and reference	Semantics description
			set update 10.3.7.22	
CHOICE <i>report criteria</i>	MP			
>Intra-frequency measurement reporting criteria			Intra-frequency measurement reporting criteria 10.3.7.39	
>Inter-frequency measurement reporting criteria			Inter-frequency measurement reporting criteria 10.3.7.19	
>Periodical reporting criteria			Periodical reporting criteria 10.3.7.53	
>No reporting				(no data) Chosen when this measurement only is used as additional measurement to another measurement

Condition	Explanation
<i>reporting</i>	This IE is optional if the CHOICE " <i>report criteria</i> " is equal to "periodical reporting criteria" or "No reporting", otherwise the IE is not needed

10.3.7.17 Inter-frequency measurement event results

This IE contains the measurement event results that are reported to UTRAN for inter-frequency measurements.

Information Element/Group name	Need	Multi	Type and reference	Semantics description
Inter-frequency event identity	MP		Inter-frequency event identity 10.3.7.14	
Inter-frequency cells	OP	1 to <maxFreq>		
>Frequency info	MP		Frequency info 10.3.6.36	
>Non frequency related measurement event results	MP		Cell measurement event results 10.3.7.4	

10.3.7.18 Inter-frequency measurement quantity

The quantity the UE shall measure in case of inter-frequency measurement. It also includes the filtering of the measurements.

Information Element/Group name	Need	Multi	Type and reference	Semantics description
CHOICE <i>reporting criteria</i>	MP			
>Intra-frequency reporting				

Information Element/Group name	Need	Multi	Type and reference	Semantics description
criteria				
>>Intra-frequency measurement quantity	MP		Intra-frequency measurement quantity 10.3.7.38	
>Inter-frequency reporting criteria				
>>Filter coefficient	MP		Filter coefficient 10.3.7.9	
>>CHOICE <i>mode</i>	MP			
>>>FDD				
>>>>Measurement quantity for frequency quality estimate	MP		Enumerated(CPICH Ec/N0, CPICH RSCP)	
>>>TDD				
>>>>Measurement quantity for frequency quality estimate	MP		Enumerated(Primary CCPCH RSCP)	

10.3.7.19 Inter-frequency measurement reporting criteria

The triggering of the event-triggered reporting for an inter-frequency measurements. All events concerning inter-frequency measurements are labelled 2x where x is a,b,c, ...

Event 2a: Change of best frequency.

Event 2b: The estimated quality of the currently used frequency is below a certain threshold **and** the estimated quality of a non-used frequency is above a certain threshold.

Event 2c: The estimated quality of a non-used frequency is above a certain threshold.

Event 2d: The estimated quality of the currently used frequency is below a certain threshold.

Event 2e: The estimated quality of a non-used frequency is below a certain threshold.

Event 2f: The estimated quality of the currently used frequency is above a certain threshold.

Information Element/Group name	Need	Multi	Type and reference	Semantics description
Parameters required for each event	OP	1 to <maxMeas Event>		
>Inter-frequency event identity	MP		Inter-frequency event identity 10.3.7.14	
>Threshold used frequency	CV-clause 0		Integer(-115..0)	Ranges used depend on measurement quantity. CPICH Ec/No -24..0dB CPICH/Primary CCPCH RSCP -115..-25dBm
>W used frequency	CV-clause 2		Real(0, 0.1..2.0 by step of 0.1)	
>Hysteresis	MP		Real(0, 0.5..14.5 by step of 0.5)	In event 2a, 2b, 2c, 2d, 2e, 2f
>Time to trigger	MP		Time to trigger 10.3.7.64	Indicates the period of time during which the event condition has to be satisfied, before sending a Measurement Report. Time in ms.
>Reporting cell status	OP		Reporting cell status 10.3.7.61	
>Parameters required for each non-used frequency	OP	1 to <maxFreq >		In this release, the first listed threshold and W parameter shall apply to all non-used frequencies.
>>Threshold non used frequency	CV-clause 1		Integer(-115..0)	Ranges used depend on measurement quantity. CPICH Ec/No -24..0dB CPICH/Primary CCPCH RSCP -115..-25dBm. This IE is not needed if the IE "Inter-frequency event identity" is set to 2a. However, it is specified to be mandatory to align with the ASN.1.
>>W non-used frequency	CV-clause 1		Real(0, 0.1..2.0 by step of 0.1)	

Condition	Explanation
Clause 0	This IE is mandatory present if the IE "Inter frequency event identity" is set to 2b, 2d, or 2f, otherwise the IE is not needed.
Clause 1	This IE is mandatory present if the IE "Inter frequency event identity" is set to 2a, 2b, 2c or 2e, otherwise the IE is not needed
Clause 2	This IE is mandatory present if the IE "Inter-frequency event identity" is set to 2a, 2b, 2d or 2f, otherwise the IE is not needed.

10.3.7.20 Inter-frequency measurement system information

Information Element/Group name	Need	Multi	Type and reference	Semantics description
Inter-frequency cell info list	OP		Inter-frequency cell info list 10.3.7.13	

10.3.7.21 Inter-frequency reporting quantity

Information Element/Group name	Need	Multi	Type and reference	Semantics description
UTRA Carrier RSSI	MP		Boolean	TRUE means report is requested.
Frequency quality estimate	MP		Boolean	TRUE means that report is requested. This parameter is not used in this release and should be set to FALSE. It shall be ignored by the UE.
Non frequency related cell reporting quantities	MP		Cell reporting quantities 10.3.7.5	

10.3.7.22 Inter-frequency SET UPDATE

NOTE 1: Only for FDD.

Contains the changes of the virtual active set associated with a non-used frequency. This information makes it possible to use events defined for Intra-frequency measurement within the same non-used frequency for Inter-frequency measurement reporting criteria. This information also controls if the UE should use autonomous updating of the virtual active set associated with a non-used frequency.

Information Element/group name	Need	Multi	Type and reference	Semantics description
UE autonomous update mode	MP		Enumerated (On, On with no reporting, Off)	
Non autonomous update mode	<i>CV-Update</i>			
>Radio link addition information	OP	1 to <maxRL>		Radio link addition information required for each RL to add
>>Primary CPICH info	MP		Primary CPICH info 10.3.6.60	NOTE 2
>Radio link removal information	OP	1 to <MaxRL>		Radio link removal information required for each RL to remove
>>Primary CPICH info	MP		Primary CPICH info 10.3.6.60	NOTE 2

Condition	Explanation
<i>Update</i>	The IE is mandatory present if the IE "UE autonomous update mode" is set to "Off", otherwise the IE is not needed.

NOTE 2: If it is assumed that CPICH downlink scrambling code is always allocated with sufficient reuse distances, CPICH downlink scrambling code will be enough for designating the different radio links.

10.3.7.23 Inter-RAT cell info list

Contains the information for the list of measurement objects for an inter-RAT measurement.

Information Element/Group name	Need	Multi	Type and reference	Semantics description	Version
CHOICE <i>Inter-RAT cell removal</i>	MP				
>Remove all inter-RAT cells				No data	
>Remove some inter-RAT cells					
>>Removed inter-RAT cells	MP	1 to <maxCellMeas>			
>>>Inter-RAT cell id	MP		Integer(0 .. <maxCellMeas> - 1)		
>Remove no inter-RAT cells					
New inter-RAT cells	MP	1 to <maxCellMeas>		Although this IE is not always required, need is MP to align with ASN.1	
	OP				REL-4
>Inter-RAT cell id	OP		Integer(0 .. <maxCellMeas> - 1)		
>CHOICE <i>Radio Access Technology</i>	MP				
>>GSM					
>>>Cell individual offset	MP		Integer (-50..50)	In dB Used to offset measured quantity value	
>>>Cell selection and re-selection info	OP		Cell selection and re-selection info for SIB11/12 10.3.2.4	See subclause 8.6.7.3	
>>>BSIC	MP		BSIC 10.3.8.2		
>>>Band indicator	MP		Enumerated (DCS 1800 band used, PCS 1900 band used)	Indicates how to interpret the BCCH ARFCN	
>>>BCCH ARFCN	MP		Integer (0..1023)	[45]	
>>IS-2000					
>>>System specific measurement info	MP		enumerated (frequency, timeslot, colour code, output power, PN offset)	For IS-2000, use fields from TIA/EIA/IS-2000.5, subclause 3.7.3.3.2.27, <i>Candidate Frequency Neighbour List Message</i>	

Information Element/Group name	Need	Multi	Type and reference	Semantics description	Version
>>None			(no data)	This value has been introduced to handle the case when IE "New inter-RAT cells" is not required	
Cell for measurement	OP	1 to <maxCellMeas>			
>Inter-RAT cell id	MP		Integer(0 .. <maxCellMeas>-1)		

10.3.7.24 Inter-RAT event identity

Information Element/Group name	Need	Multi	Type and reference	Semantics description
Inter-RAT event identity	MP		Enumerated (3a, 3b, 3c, 3d)	

10.3.7.25 Inter-RAT info

Inter-RAT info defines the target system for redirected cell selection.

Information Element/Group name	Need	Multi	Type and reference	Semantics description
Inter-RAT info	MP		Enumerated (GSM)	

10.3.7.26 Inter-RAT measured results list

Information Element/Group name	Need	Multi	Type and reference	Semantics description
Inter-RAT measurement results	OP	1 to <maxOther RAT-16>		
>CHOICE <i>system</i>	MP			One spare value is needed.
>>GSM				
>>>Measured GSM cells	MP	1 to <maxReportedGSMCells>		
>>>>GSM carrier RSSI	OP		bit string(6)	RXLEV is mapped to a value between 0 and 63, [46]. When mapping the RXLEV value to the RSSI bit string, the first/leftmost bit of the bit string contains the most significant bit.
>>>>CHOICE <i>BSIC</i>	MP			
>>>>>Verified BSIC				
>>>>>>inter-RAT cell id	MP		Integer(0..<maxCellMeasurements>-1)	
>>>>>Non verified BSIC				
>>>>>>BCCH ARFCN	MP		Integer (0..1023)	[45]
>>>>>>>Observed time difference to GSM cell	OP		Observed time difference to GSM cell 10.3.7.52	

10.3.7.27 Inter-RAT measurement

Information Element/Group name	Need	Multi	Type and reference	Semantics description
Inter-RAT measurement objects list	OP		Inter-RAT cell info list 10.3.7.23	
Inter-RAT measurement quantity	OP		Inter-RAT measurement quantity 10.3.7.29	
Inter-RAT reporting quantity	OP		Inter-RAT reporting quantity 10.3.7.32	
Reporting cell status	CV-reporting		Reporting cell status 10.3.7.61	
CHOICE <i>report criteria</i>	MP			
>Inter-RAT measurement reporting criteria			Inter-RAT measurement reporting criteria 10.3.7.30	
>Periodical reporting criteria			Periodical reporting criteria 10.3.7.53	
>No reporting				(no data) Chosen when this measurement only is used as additional measurement to another measurement

Condition	Explanation
<i>reporting</i>	This IE is optional if the CHOICE " <i>report criteria</i> " is equal to "periodical reporting criteria" or "No reporting", otherwise the IE is not needed

10.3.7.28 Inter-RAT measurement event results

This IE contains the measurement event results that are reported to UTRAN for inter-RAT measurements.

Information Element/Group name	Need	Multi	Type and reference	Semantics description
Inter-RAT event identity	MP		Inter-RAT event identity 10.3.7.24	
Cells to report	MP	1 to <maxCellMeas>		
>CHOICE <i>BSIC</i>	MP			
>>Verified <i>BSIC</i>				
>>>inter-RAT cell id	MP		Integer(0..<maxCellMeas>-1)	
>>Non verified <i>BSIC</i>				
>>>BCCH ARFCN	MP		Integer (0..1023)	[45]

10.3.7.29 Inter-RAT measurement quantity

The quantity the UE shall measure in case of inter-RAT measurement. It also includes the filtering of the measurements.

Information Element/Group name	Need	Multi	Type and reference	Semantics description
Measurement quantity for UTRAN quality estimate	OP		Intra-frequency measurement quantity 10.3.7.38	
CHOICE <i>system</i>	MP			
>GSM				
>>Measurement quantity	MP		Enumerated(GSM Carrier RSSI)	
>>Filter coefficient	MP		Filter coefficient 10.3.7.9	
>>BSIC verification required	MP		Enumerated(required, not required)	
>IS2000				
>>TADD E_c/I_0	MP		Integer(0..63)	Admission criteria for neighbours, see subclause 2.6.6.2.6 of TIA/EIA/IS-2000.5
>>TCOMP E_c/I_0	MP		Integer(0..15)	Admission criteria for neighbours, see subclause 2.6.6.2.5.2 of TIA/EIA/IS-2000.5
>>SOFT SLOPE	OP		Integer(0..63)	Admission criteria for neighbours, see subclause 2.6.6.2.3 and 2.6.6.2.5.2 of TIA/EIA/IS-2000.5
>>ADD_INTERCEPT	OP		Integer(0..63)	Admission criteria for neighbours, see subclause 2.6.6.2.5.2 of TIA/EIA/IS-2000.5

The IE "BSIC verification required" must be set to "required" if IE "Observed time difference to GSM cell Reporting indicator" in IE "Inter-RAT reporting quantity" is set to "true".

10.3.7.30 Inter-RAT measurement reporting criteria

The triggering of the event-triggered reporting for an inter-RAT measurement. All events concerning inter-RAT measurements are labelled 3x where x is a,b,c, ...

Event 3a: The estimated quality of the currently used UTRAN frequency is below a certain threshold **and** the estimated quality of the other system is above a certain threshold.

Event 3b: The estimated quality of other system is below a certain threshold.

Event 3c: The estimated quality of other system is above a certain threshold.

Event 3d: Change of best cell in other system.

Information Element/Group name	Need	Multi	Type and reference	Semantics description
Parameters required for each event	OP	1 to <maxMeas Event>		
>Inter-RAT event identity	MP		Inter-RAT event identity 10.3.7.24	
>Threshold own system	CV-clause 0		Integer (-115..0)	
>W	CV-clause 0		Real(0, 0.1..2.0 by step of 0.1)	In event 3a
>Threshold other system	CV-clause 1		Integer (-115..0)	In event 3a, 3b, 3c
>Hysteresis	MP		Real(0..7.5 by step of 0.5)	
>Time to trigger	MP		Time to trigger 10.3.7.64	Indicates the period of time during which the event condition has to be satisfied, before sending a Measurement Report.
>Reporting cell status	OP		Reporting cell status 10.3.7.61	

Condition	Explanation
Clause 0	The IE is mandatory present if the IE "Inter-RAT event identity" is set to "3a", otherwise the IE is not needed
Clause 1	The IE is mandatory present if the IE "Inter-RAT event identity" is set to 3a, 3b or 3c, otherwise the IE is not needed

10.3.7.31 Inter-RAT measurement system information

Information Element/Group name	Need	Multi	Type and reference	Semantics description
Inter-RAT cell info list	OP		Inter-RAT cell info list 10.3.7.23	

10.3.7.32 Inter-RAT reporting quantity

For all boolean types TRUE means inclusion in the report is requested.

Information Element/Group name	Need	Multi	Type and reference	Semantics description
UTRAN estimated quality	MP		Boolean	This parameter is not used in this release and should be set to FALSE.
CHOICE <i>system</i>	MP			
>GSM				
>>Observed time difference to GSM cell Reporting indicator	MP		Boolean	
>>GSM Carrier RSSI Reporting indicator	MP		Boolean	

10.3.7.33 Intra-frequency cell info list

Contains the information for the list of measurement objects for an intra-frequency measurement.

Information Element/Group name	Need	Multi	Type and reference	Semantics description
CHOICE <i>Intra-frequency cell removal</i>	OP			Absence of this IE is equivalent to choice "Remove no intra-frequency cells".
>Remove all intra-frequency cells				No data
>Remove some intra-frequency cells				
>>Removed intra-frequency cells	MP	1 to <maxCellMeas>		
>>>Intra-frequency cell id	MP		Integer(0 .. <maxCellMeas> - 1)	
>Remove no intra-frequency cells				
New intra-frequency cells	OP	1 to <maxCellMeas>		This information element must be present when "Intra-frequency cell info list" is included in the system information
>Intra-frequency cell id	OP		Integer(0 .. <maxCellMeas> - 1)	
>Cell info	MP		Cell info 10.3.7.2	This IE must be included for the serving cell when the IE "Intra frequency cell info list" is included in System Information Block type 11.
Cells for measurement	CV- <i>BCHopt</i>	1 to <maxCellMeas>		
>Intra-frequency cell id	MP		Integer(0 .. <maxCellMeas>-1)	

Condition	Explanation
<i>BCHopt</i>	This IE is not needed when sent in SYSTEM INFORMATION. Otherwise, the IE is Optional

10.3.7.34 Intra-frequency event identity

Information Element/Group name	Need	Multi	Type and reference	Semantics description
Intra-frequency event identity	MP		Enumerated (1a,1b,1c,1d,1e,1f,1g,1h,1i)	Seven spare values are needed.

10.3.7.35 Intra-frequency measured results list

Information Element/Group name	Need	Multi	Type and reference	Semantics description
Intra-frequency measurement results	OP	1 to <maxCellMeas>		
>Cell measured results	MP		Cell measured results 10.3.7.3	Only cells for which all reporting quantities are available should be included.

10.3.7.36 Intra-frequency measurement

Information Element/Group name	Need	Multi	Type and reference	Semantics description
Intra-frequency measurement objects list	OP		Intra-frequency cell info list 10.3.7.33	
Intra-frequency measurement quantity	OP		Intra-frequency measurement quantity 10.3.7.38	
Intra-frequency reporting quantity	OP		Intra-frequency reporting quantity 10.3.7.41	
Reporting cell status	CV-reporting		Reporting cell status 10.3.7.61	
Measurement validity	OP		Measurement validity 10.3.7.51	
CHOICE <i>report criteria</i>	OP			
>Intra-frequency measurement reporting criteria			Intra-frequency measurement reporting criteria 10.3.7.39	
>Periodical reporting criteria			Periodical reporting criteria 10.3.7.53	
>No reporting				(no data) Chosen when this measurement only is used as additional measurement to another measurement

Condition	Explanation
<i>reporting</i>	This IE is optional if the CHOICE " <i>report criteria</i> " is equal to "periodical reporting criteria" or "No reporting", otherwise the IE is not needed

10.3.7.37 Intra-frequency measurement event results

This IE contains the measurement event results that are reported to UTRAN for intra-frequency measurements.

Information Element/Group name	Need	Multi	Type and reference	Semantics description
Intra-frequency event identity	MP		Intra-frequency event identity 10.3.7.34	
Cell measurement event results	MP		Cell measurement event results 10.3.7.4	

10.3.7.38 Intra-frequency measurement quantity

The quantity the UE shall measure in case of intra-frequency measurement. It also includes the filtering of the measurements.

Information Element/Group name	Need	Multi	Type and reference	Semantics description
Filter coefficient	MP		Filter coefficient 10.3.7.9	
<i>CHOICE mode</i>	MP			
>FDD				
>>Measurement quantity	MP		Enumerated(CPICH Ec/N0, CPICH RSCP, Pathloss)	
>TDD				
>>Measurement quantity list	MP	1 to 4		
>>>Measurement quantity	MP		Enumerated(Primary CCPCH RSCP, Pathloss, Timeslot ISCP)	

10.3.7.39 Intra-frequency measurement reporting criteria

The triggering of the event-triggered reporting for an intra-frequency measurement. All events concerning intra-frequency measurements are labelled 1x where x is a, b, c....

Event 1a: A Primary CPICH enters the Reporting Range (FDD only).

Event 1b: A Primary CPICH leaves the Reporting Range (FDD only).

Event 1c: A Non-active Primary CPICH becomes better than an active Primary CPICH (FDD only).

Event 1d: Change of best cell (FDD only).

Event 1e: A Primary CPICH becomes better than an absolute threshold (FDD only).

Event 1f: A Primary CPICH becomes worse than an absolute threshold (FDD only).

Event 1g: Change of best cell in TDD.

Event 1h: Timeslot ISCP below a certain threshold (TDD only).

Event 1i: Timeslot ISCP above a certain threshold (TDD only).

Information Element/Group name	Need	Multi	Type and reference	Semantics description
Parameters required for each event	OP	1 to <maxMeas Event>		
>Intra-frequency event identity	MP		Intra-frequency event identity 10.3.7.34	
>Triggering condition 1	CV-clause 0		Enumerated(Active set cells, Monitored set cells, Active set cells and monitored set cells)	Indicates which cells can trigger the event
>Triggering condition 2	CV-clause 6		Enumerated(Active set cells, Monitored set cells, Active set cells and monitored set cells, Detected set cells, Detected set cells and monitored set cells)	Indicates which cells can trigger the event
>Reporting Range Constant	CV-clause 2		Real(0..14.5 by step of 0.5)	In dB. In event 1a,1b.
>Cells forbidden to affect Reporting range	CV-clause 1	1 to <maxCellMeas>		In event 1a,1b
>>CHOICE mode	MP			
>>>FDD				
>>>>Primary CPICH info	MP		Primary CPICH info 10.3.6.60	
>>>TDD				
>>>>Primary CCPCH info	MP		Primary CCPCH info 10.3.6.57	
>W	CV-clause 2		Real(0.0..2.0 by step of 0.1)	
>Hysteresis	MP		Real(0..7.5 by step of 0.5)	In dB.
>Threshold used frequency	CV-clause 3		Integer (-115..165)	Range used depend on measurement quantity. CPICH RSCP -115..-25 dBm CPICH Ec/No -24..0 dB Pathloss 30..165dB ISCP -115..-25 dBm
>Reporting deactivation threshold	CV-clause 4		Integer(0, 1, 2, 3, 4, 5, 6, 7)	In event 1a Indicates the maximum number of cells allowed in the active set in order for event 1a to occur. 0 means not applicable

Information Element/Group name	Need	Multi	Type and reference	Semantics description
>Replacement activation threshold	CV-clause 5		Integer(0, 1, 2, 3, 4, 5, 6, 7)	In event 1c Indicates the minimum number of cells allowed in the active set in order for event 1c to occur. 0 means not applicable
>Time to trigger	MP		Time to trigger 10.3.7.64	Indicates the period of time during which the event condition has to be satisfied, before sending a Measurement Report. Time in ms
>Amount of reporting	CV-clause 7		Integer(1, 2, 4, 8, 16, 32, 64, Infinity)	In case the IE "Intra-frequency reporting criteria" is included in the IE "Inter-frequency measurement", this IE is not needed.
>Reporting interval	CV-clause 7		Integer(0, 250, 500, 1000, 2000, 4000, 8000, 16000)	Indicates the interval of periodical reporting when such reporting is triggered by an event. Interval in milliseconds. 0 means no periodical reporting. In case the IE "Intra-frequency reporting criteria" is included in the IE "Inter-frequency measurement", this IE is not needed.
>Reporting cell status	OP		Reporting cell status 10.3.7.61	

Condition	Explanation
Clause 0	The IE is mandatory present if the IE "Intra-frequency event identity" is set to "1b" or "1f", otherwise the IE is not needed.
Clause 1	The IE is optional if the IE "Intra-frequency event identity" is set to "1a" or "1b", otherwise the IE is not needed.
Clause 2	The IE is mandatory present if the IE "Intra-frequency event identity" is set to "1a" or "1b", otherwise the IE is not needed.
Clause 3	The IE is mandatory present if the IE "Intra-frequency event identity" is set to , "1e", "1f", "1h" or "1i", otherwise the IE is not needed.
Clause 4	The IE is mandatory present if the IE "Intra-frequency event identity" is set to "1a", otherwise the IE is not needed.
Clause 5	The IE is mandatory present if the IE "Intra-frequency event identity" is set to "1c", otherwise the IE is not needed.
Clause 6	The IE is mandatory present if the IE "Intra-frequency event identity" is set to "1a" or "1e", otherwise the IE is not needed.
Clause 7	The IE is mandatory present if the IE "Intra-frequency event identity" is set to "1a" or "1c", otherwise the IE is not needed.

10.3.7.40 Intra-frequency measurement system information

Information Element/Group name	Need	Multi	Type and reference	Semantics description
Intra-frequency measurement identity	MD		Measurement identity	The intra-frequency measurement identity has

Information Element/Group name	Need	Multi	Type and reference	Semantics description
			10.3.7.48	default value 1.
Intra-frequency cell info list	OP		Intra-frequency cell info list 10.3.7.33	
Intra-frequency measurement quantity	OP		Intra-frequency measurement quantity 10.3.7.38	
Intra-frequency reporting quantity for RACH Reporting	OP		Intra-frequency reporting quantity for RACH Reporting 10.3.7.42	
Maximum number of reported cells on RACH	OP		Maximum number of reported cells on RACH 10.3.7.43	
Reporting information for state CELL_DCH	OP		Reporting information for state CELL_DCH 10.3.7.62	Note 1

NOTE 1: The reporting of intra-frequency measurements is activated when state CELL_DCH is entered.

10.3.7.41 Intra-frequency reporting quantity

Contains the reporting quantity information for an intra-frequency measurement.

Information Element/Group name	Need	Multi	Type and reference	Semantics description
Reporting quantities for active set cells	MP		Cell reporting quantities 10.3.7.5	
Reporting quantities for monitored set cells	MP		Cell reporting quantities 10.3.7.5	
Reporting quantities for detected set cells	OP		Cell reporting quantities 10.3.7.5	

10.3.7.42 Intra-frequency reporting quantity for RACH reporting

Contains the reporting quantity information for an intra-frequency measurement report, which is sent on the RACH.

Information Element/Group name	Need	Multi	Type and reference	Semantics description
SFN-SFN observed time difference reporting indicator	MP		Enumerated(No report, type 1, type 2)	
CHOICE <i>mode</i> >FDD	MP			

Information Element/Group name	Need	Multi	Type and reference	Semantics description
>>Reporting quantity	MP		Enumerated(CPICH Ec/NO, CPICH RSCP, Pathloss, No report)	
>TDD				
>>Reporting quantity list	MP	1 to 2		
>>>Reporting quantity	MP		Enumerated(Timeslot ISCP, Primary CCPCH RSCP, No report)	

10.3.7.43 Maximum number of reported cells on RACH

Information Element/Group name	Need	Multi	Type and reference	Semantics description
Maximum number of reported cells	MP		Enumerated (no report, current cell, current cell + best neighbour, current cell+2 best neighbours, ..., current cell+6 best neighbours)	

10.3.7.44 Measured results

Contains the measured results of the quantity indicated optionally by Reporting Quantity in Measurement Control. "Measured results" can be used for both event trigger mode and periodical reporting mode. The list should be in the order of the value of the measurement quality (the first cell should be the best cell). The "best" FDD cell has the largest value when the measurement quantity is "Ec/No" or "RSCP". On the other hand, the "best" cell has the smallest value when the measurement quantity is "Pathloss". The "best" TDD cell has the largest value when measurement quantity is "Primary CCPCH RSCP".

Information Element/Group name	Need	Multi	Type and reference	Semantics description
CHOICE <i>Measurement</i>	MP			One spare value is needed.
>Intra-frequency measured results list			Intra-frequency measured results list 10.3.7.35	
>Inter-frequency measured results list			Inter-frequency measured results list 10.3.7.15	
>Inter-RAT measured results list			Inter-RAT measured results list 10.3.7.26	
>Traffic volume measured results list			Traffic volume	

Information Element/Group name	Need	Multi	Type and reference	Semantics description
			measured results list 10.3.7.67	
>Quality measured results list			Quality measured results list 10.3.7.55	
>UE Internal measured results			UE Internal measured results 10.3.7.76	
>UE positioning measured results			UE positioning measured results 10.3.7.99	

10.3.7.45 Measured results on RACH

Contains the measured results on RACH of the quantity indicated optionally by Reporting Quantity in the system information broadcast on BCH. The list should be in the order of the value of the measurement quality (the first cell should be the best cell). The "best" FDD cell has the largest value when the measurement quantity is "Ec/No" or "RSCP". On the other hand, the "best" cell has the smallest value when the measurement quantity is "Pathloss". The "best" TDD cell has the largest value when measurement quantity is "Primary CCPCH RSCP".

Information Element/group name	Need	Multi	Type and reference	Semantics description	Version
Measurement result for current cell					
CHOICE <i>mode</i>	MP				
>FDD					
>>CHOICE <i>measurement quantity</i>	MP			One spare value is needed.	
>>>CPICH Ec/No			Integer(0..49)	In dB. According to CPICH_Ec/No in [19]. Fourteen spare values are needed.	
>>>CPICH RSCP			Integer(0..91)	In dBm. According to CPICH_RSCP_LEV in [19]. Thirty-six spare values are needed.	
>>>Pathloss			Integer(46..158)	In dB. Fifteen spare values are needed.	
>TDD					
>>CHOICE <i>TDD option</i>	MP				REL-4
>>>3.84 Mcps TDD					REL-4
>>>>Timeslot List	OP	1 to 14			
>>>>>Timeslot ISCP	MP		Timeslot ISCP info 10.3.7.65	The UE shall report the Timeslot ISCP in the same order as indicated in the cell info	
>>>1.28 Mcps TDD					REL-4
>>>>Timeslot List	OP	1 to 6			REL-4
>>>>>Timeslot ISCP	MP		Timeslot	The UE shall	REL-4

Information Element/group name	Need	Multi	Type and reference	Semantics description	Version
			ISCP info 10.3.7.65	report the Timeslot ISCP in the same order as indicated in the cell info	
>>Primary CCPCH RSCP	OP		Primary CCPCH RSCP info 10.3.7.54		
Measurement results for monitored cells	OP	1 to 8			
>SFN-SFN observed time difference	OP		SFN-SFN observed time difference 10.3.7.63	It is absent for current cell	
>CHOICE <i>mode</i>	MP				
>>FDD					
>>>Primary CPICH info	MP		Primary CPICH info 10.3.6.60		
>>>CHOICE <i>measurement quantity</i>	OP			It is absent for current cell. One spare value is needed.	
>>>>CPICH Ec/No			Integer(0..49)	In dB. According to CPICH_Ec/No in [19]. Fourteen spare values are needed.	
>>>>CPICH RSCP			Integer(0..91)	In dBm. According to CPICH_RSCP_LEV in [19]. Thirty-six spare values are needed.	
>>>>Pathloss			Integer(46..158)	In dB. Fifteen spare values are needed.	
>>TDD					
>>>Cell parameters Id	MP		Cell parameters Id 10.3.6.9		
>>>Primary CCPCH RSCP	MP		Primary CCPCH RSCP info 10.3.7.54		

NOTE: Monitored cells consist of current cell and neighbouring cells.

10.3.7.46 Measurement Command

Information Element/Group name	Need	Multi	Type and reference	Semantics description
Measurement command	MP		Enumerated(Setup, Modify, Release)	

10.3.7.47 Measurement control system information

Information element/Group name	Need	Multi	Type and reference	Semantics description
Use of HCS	MP		Enumerated (Not used, used)	Indicates if the serving cell belongs to a HCS structure
Cell selection and reselection quality measure	MP		Enumerated (CPICH Ec/N0, CPICH RSCP)	Choice of measurement (CPICH Ec/N0 or CPICH RSCP) to use as quality measure Q.
Intra-frequency measurement system information	OP		Intra-frequency measurement system information 10.3.7.40	
Inter-frequency measurement system information	OP		Inter-frequency measurement system information 10.3.7.20	
Inter-RAT measurement system information	OP		Inter-RAT measurement system information 10.3.7.31	
Traffic volume measurement system information	OP		Traffic volume measurement system information 10.3.7.73	

10.3.7.48 Measurement Identity

A reference number that is used by the UTRAN at modification and release of the measurement, and by the UE in the measurement report.

Information Element/Group name	Need	Multi	Type and reference	Semantics description
Measurement identity	MP		Integer(1..16)	

10.3.7.49 Measurement reporting mode

Contains the type of Measurement Report transfer mode and the indication of periodical/event trigger.

Information Element/Group name	Need	Multi	Type and reference	Semantics description
Measurement Report Transfer Mode	MP		enumerated (Acknowledged mode RLC, Unacknowledged mode RLC)	
Periodical Reporting / Event Trigger Reporting Mode	MP		Enumerated (Periodical reporting, Event trigger)	

10.3.7.50 Measurement Type

Information Element/Group name	Need	Multi	Type and reference	Semantics description
Measurement Type	MP		Enumerated (Intra-frequency, Inter-frequency, Inter-RAT, Traffic volume, Quality, UE internal, UE positioning)	

10.3.7.51 Measurement validity

Information Element/Group name	Need	Multi	Type and reference	Semantics description
UE state	MP		Enumerated (CELL_DCH, all states except CELL_DCH, all states)	

10.3.7.52 Observed time difference to GSM cell

Information Element/Group name	Need	Multi	Type and reference	Semantics description
Observed time difference to GSM cell	OP		Integer(0,4095)	According to GSM_TIME in [19] and [20]

10.3.7.53 Periodical reporting criteria

Contains the periodical reporting criteria information. It is necessary only in the periodical reporting mode.

Information Element/Group name	Need	Multi	Type and reference	Semantics description
Amount of reporting	MD		Integer(1, 2, 4, 8, 16, 32, 64, Infinity)	The default value is infinity.
Reporting interval	MP		Integer(250, 500, 1000, 2000, 3000, 4000, 6000, 8000, 12000, 16000, 20000, 24000, 28000, 32000, 64000)	Indicates the interval of periodical report. Interval in milliseconds

10.3.7.53a PLMN identities of neighbour cells

This IE contains the PLMN identities of neighbour cells.

Information Element/Group name	Need	Multi	Type and reference	Semantics description
PLMNs of intra-frequency cells list	OP	1 to <maxCellIM eas>		
>PLMN identity	MD		PLMN identity 10.3.1.11	Default value is the previous "PLMN identity" in the list. The default value for the first PLMN in the list is the identity of the selected PLMN if the "PLMN type" in the variable SELECTED_PLMN has the value "GSM-MAP"; otherwise, the first occurrence is MP.
PLMNs of inter-frequency cells list	OP	1 to <maxCellIM eas>		
>PLMN identity	MD		PLMN identity 10.3.1.11	Default value is the previous "PLMN identity" in the list. The default value for the first PLMN in the list is the identity of the selected PLMN if the "PLMN type" in the variable SELECTED_PLMN has the value "GSM-MAP"; otherwise, the first occurrence is MP.
PLMNs of inter-RAT cells list	OP	1 to <maxCellIM eas>		
>PLMN identity	MD		PLMN identity 10.3.1.11	Default value is the previous "PLMN identity" in the list. The default value for the first PLMN in the list is the identity of the selected PLMN if the "PLMN type" in the variable SELECTED_PLMN has the value "GSM-MAP"; otherwise, the first occurrence is MP.

10.3.7.54 Primary CCPCH RSCP info

NOTE: Only for TDD

Information Element/Group name	Need	Multi	IE type and reference	Semantics description
Primary CCPCH RSCP	MP		Integer(0..91)	According to P-CCPCH_RSCP_LEV in [19] and [20]. Thirty-six spare values are needed.

10.3.7.54a Qhcs

Information Element/Group name	Need	Multi	Type and Reference	Semantics description
Qhcs	MP		Integer(0..99)	Qhcs, mapped from CPICH Ec/No (FDD), see [4] [dB] 0: -24 1: -23.5 2: -23 3: -22.5 ... 45: -1.5 46: -1 47: -0.5 48: 0 49: (spare) ... 98: (spare) 99: (spare)
				Qhcs, mapped from CPICH RSCP (FDD), see [4] [dBm] 0: -115 1: -114 2: -113 : 88: -27 89: -26 90: -(spare) 91: -(spare) : 98: -(spare) 99: -(spare)
				Qhcs, mapped from PCCPCH RSCP (TDD), see [4] [dBm] 0: -115 1: -114 2: -113 : 88: -27 89: -26 90: -(spare) 91: -(spare) : 98: -(spare) 99: -(spare)

Information Element/Group name	Need	Multi	Type and Reference	Semantics description
				Qhcs level, mapped from Averaged received signal level RSSI (GSM), see [4] [dBm] 0: -110 1: -109 2: -108 : 61: -49 62: -48 63: -47 64: -46 65: -45 66: -44 67: -43 68: -42 69: -41 70: -40 71: -39 72: -38 73: -37 74: -(spare) : 98: -(spare) 99: -(spare)

10.3.7.55 Quality measured results list

Information Element/Group name	Need	Multi	Type and reference	Semantics description
BLER measurement results	OP	1 to <maxTrCH >		
>DL Transport channel identity	MP		Transport channel identity 10.3.5.18	transport channel type = DCH
>DL Transport Channel BLER	OP		Integer (0..63)	According to BLER_LOG in [19] and [20]
CHOICE <i>mode</i>	MP			
>FDD				No data
>TDD				
>>SIR measurement results	OP	1 to <MaxCCTrCH >		SIR measurements for DL CCTrCH
>>>TFCS ID	MP		Integer(1...8)	
>>>Timeslot list	MP	1 to <maxTS >		for all timeslot on which the CCTrCH is mapped on
>>>>SIR	MP		Integer(0..63)	According to UE_SIR in [20]

10.3.7.56 Quality measurement

Information Element/Group name	Need	Multi	Type and reference	Semantics description
Quality reporting quantity	OP		Quality reporting quantity 10.3.7.59	
<i>CHOICE report criteria</i>	MP			
>Quality measurement reporting criteria			Quality measurement reporting criteria 10.3.7.58	Note Given this choice, the IE "DL Transport Channel BLER" shall be set to "False" (see subclause 10.3.7.59)
>Periodical reporting criteria			Periodical reporting criteria 10.3.7.53	Note
>No reporting				Note (no data) Chosen when this measurement only is used as additional measurement to another measurement

NOTE: In this version of the specification, BLER as additional measurement is not supported.

10.3.7.57 Quality measurement event results

Information Element/Group name	Need	Multi	Type and reference	Semantics description
Transport channels causing the event	OP	1 to <maxTrCH >		
>DL Transport channel identity	MP		Transport channel identity 10.3.5.18	transport channel type = DCH

10.3.7.58 Quality measurement reporting criteria

Event 5a: Number of bad CRCs on a certain transport channel exceeds a threshold.

Information Element/Group name	Need	Multi	Type and reference	Semantics description
Parameters sent for each transport channel	MP	1 to <maxTrCH >		
>DL Transport channel identity	MP		Transport channel identity 10.3.5.18	transport channel type = DCH
>Total CRC	MP		Integer(1..512)	Number of CRCs
>Bad CRC	MP		Integer(1..512)	Number of CRCs
>Pending after trigger	MP		Integer(1..512)	Number of CRCs

10.3.7.59 Quality reporting quantity

Information Element/Group name	Need	Multi	Type and reference	Semantics description
DL Transport Channel BLER	MP		Boolean	TRUE means report requested
Transport channels for BLER reporting	<i>CV-BLER reporting</i>	1 to <maxTrCH >		The default, if no transport channel identities are present, is that the BLER is reported for all downlink transport channels
>DL Transport channel identity	MP		Transport channel identity 10.3.5.18	transport channel type = DCH
CHOICE <i>mode</i>	MP			
>FDD				No data
>TDD				
>>SIR measurement list	OP	1 to <maxCCTr CH>		SIR measurements shall be reported for all listed TFCS IDs
>>>TFCS ID	MP		Integer(1..8)	

Condition	Explanation
<i>BLER reporting</i>	This IE is not needed if the IE "DL Transport Channel BLER" is "False" and optional if the IE "DL Transport Channel BLER" is "True"

10.3.7.60 Reference time difference to cell

In the System Information message, the reference time difference to cell indicates the timing difference between the primary CCPCH of the current cell and the primary CCPCH of a neighbouring cell..

In the Measurement Control message, the reference time difference to cell indicates the timing difference between UE uplink transmission timing and the primary CCPCH of a neighbouring cell.

Information Element/Group name	Need	Multi	Type and reference	Semantics description
CHOICE <i>accuracy</i>	MP			
>40 chips				
>>Reference time difference	MP		Integer(0..38400 by step of 40)	In chips
>256 chips				
>>Reference time difference	MP		Integer(0..38400 by step of 256)	In chips
>2560 chips				
>>Reference time difference	MP		Integer(0..38400 by step of 2560)	In chips

10.3.7.61 Reporting Cell Status

Indicates maximum allowed number of cells to report and whether active set cells and/or virtual active set cells and/or monitored set cells on and/or detected set cells used frequency and/or monitored set cells on non used frequency should/should not be included in the IE "Measured results".

Information Element/Group name	Need	Multi	Type and reference	Semantics description
CHOICE <i>reported cell</i>	MP			
>Report cells within active set				This choice is not valid for inter-RAT measurements. For inter-frequency measurements

Information Element/Group name	Need	Multi	Type and reference	Semantics description
				it is only valid for reporting events 2D and 2F. See NOTE 1.
>>Maximum number of reported cells	MP		Integer(1..6)	
>Report cells within monitored set cells on used frequency				This choice is not valid for inter-RAT or inter-frequency measurements
>>Maximum number of reported cells	MP		Integer(1..6)	
>Report cells within active set and/or monitored set cells on used frequency				This choice is not valid for inter-RAT or inter-frequency measurements
>>Maximum number of reported cells	MP		Integer(1..6)	
>Report cells within detected set on used frequency				This choice is not valid for inter-RAT or inter-frequency measurements
>>Maximum number of reported cells	MP		Integer(1..6)	
>Report cells within monitored set and/or detected set on used frequency				This choice is not valid for inter-RAT or inter-frequency measurements
>>Maximum number of reported cells	MP		Integer(1..6)	
>Report all active set cells + cells within monitored set on used frequency				This choice is not valid for inter-RAT or inter-frequency measurements
>>Maximum number of reported cells	MP		Enumerated (virtual/active set cells+1, virtual/active set cells+2,, virtual/active set cells+6)	
>Report all active set cells + cells within detected set on used frequency				This choice is not valid for inter-RAT or inter-frequency measurements
>>Maximum number of reported cells	MP		Enumerated (virtual/active set cells+1, virtual/active set cells+2,, virtual/active set cells+6)	
>Report all active set cells + cells within monitored set and/or detected set on used frequency				This choice is not valid for inter-RAT or inter-frequency measurements
>>Maximum number of reported cells	MP		Enumerated (virtual/active set cells+1, virtual/active set cells+2,, virtual/active set cells+6)	
>Report cells within virtual active set				This choice is not valid for intra-frequency or inter-RAT measurements
>>Maximum number of reported cells per reported non-used frequency	MP		Integer(1..6)	
>Report cells within monitored set on non-used frequency				This choice is not valid for intra-frequency or inter-RAT

Information Element/Group name	Need	Multi	Type and reference	Semantics description
				measurements
>>Maximum number of reported cells per reported non-used frequency	MP		Integer(1..6)	
>Report cells within monitored and/or virtual active set on non-used frequency				This choice is not valid for intra-frequency or inter-RAT measurements
>>Maximum number of reported cells per reported non-used frequency	MP		Integer(1..6)	
>Report all virtual active set cells + cells within monitored set on non-used frequency				This choice is not valid for intra-frequency or inter-RAT measurements
>>Maximum number of reported cells per reported non-used frequency	MP		Enumerated (virtual/active set cells+1, virtual/active set cells+2,, virtual/active set cells+6)	
>Report cells within active set or within virtual active set or of the other RAT				If this choice is selected for inter-RAT measurements, the UE shall report only cells of the other RAT. If this choice is selected for intra-frequency measurements, the UE shall report cells within the active set. If this choice is selected for inter-frequency measurements, the UE shall report cells within the virtual active set.
>>Maximum number of reported cells	MP		Integer (1..12)	
>Report cells within active and/or monitored set on used frequency or within virtual active and/or monitored set on non-used frequency				This choice is not valid for inter-RAT measurements. If this choice is selected for intra-frequency measurements, the UE shall report cells within the active and/or monitored set. If this choice is selected for inter-frequency measurements, the UE shall report cells within the virtual active set and/or monitored set on non-used frequency.
>>Maximum number of reported cells	MP		Integer(1..12)	

NOTE 1: For Inter-frequency reporting events 2D and 2F, only CHOICE "Report cells within active set" is valid.

10.3.7.62 Reporting information for state CELL_DCH

Information Element/Group name	Need	Multi	Type and reference	Semantics description
Intra-frequency reporting quantity	MP		Intra-frequency reporting quantity 10.3.7.41	
Measurement Reporting Mode	MP		Measurement Reporting Mode 10.3.7.49	
CHOICE <i>report criteria</i>	MP			
>Intra-frequency measurement reporting criteria			Intra-frequency measurement reporting criteria 10.3.7.39	
>Periodical reporting criteria			Periodical reporting criteria 10.3.7.53	

10.3.7.63 SFN-SFN observed time difference

Information Element/Group name	Need	Multi	Type and reference	Semantics description	Version
CHOICE <i>type</i>	MP				
>Type 1			Integer(0..9830399)	According to T1_SFN-SFN_TIME in [19] and [20]. For FDD and 3.84 Mcps TDD: 6946816 spare values are needed.	
			Integer(0..3276799)	For 1.28 Mcps TDD: 13500416 spare values are needed.	Rel-4
>Type 2			Integer(0..40961)	According to T2_SFN-SFN_TIME in [19] and [20]. 24574 spare values are needed.	

10.3.7.64 Time to trigger

Information Element/Group name	Need	Multi	Type and reference	Semantics description
Time to trigger	MP		Integer(0, 10, 20, 40, 60, 80, 100, 120, 160, 200, 240, 320, 640, 1280, 2560, 5000)	Time in ms

10.3.7.65 Timeslot ISCP info

NOTE: Only for TDD

Information Element/Group name	Need	Multi	IE type and reference	Semantics description
Timeslot ISCP	MP		Integer (0..91)	According to UE_TS_ISCP_LEV in [20]. Thirty-six spare values are needed.

10.3.7.66 Traffic volume event identity

Information Element/Group name	Need	Multi	Type and reference	Semantics description
Traffic volume event identity	MP		Enumerated(4a, 4b)	

10.3.7.67 Traffic volume measured results list

Information Element/Group name	Need	Multi	Type and reference	Semantics description
Traffic volume measurement results	OP	1 to <maxRB>		
>RB Identity	MP		RB Identity 10.3.4.16	
>RLC Buffers Payload	OP		Enumerated(0, 4, 8, 16, 32, 64, 128, 256, 512, 1024, 2K, 4K, 8K, 16K, 32K, 64K, 128K, 256K, 512K, 1024K)	In bytes And N Kbytes = N*1024 bytes. Twelve spare values are needed.
>Average of RLC Buffer Payload	OP		Enumerated(0, 4, 8, 16, 32, 64, 128, 256, 512, 1024, 2K, 4K, 8K, 16K, 32K, 64K, 128K, 256K, 512K, 1024K)	In bytes And N Kbytes = N*1024 bytes. Twelve spare values are needed.
>Variance of RLC Buffer Payload	OP		Enumerated(0, 4, 8, 16, 32, 64, 128, 256, 512, 1024, 2K, 4K, 8K, 16K)	In bytes And N Kbytes = N*1024 bytes. Two spare values are needed.

10.3.7.68 Traffic volume measurement

Information Element/Group name	Need	Multi	Type and reference	Semantics description
Traffic volume measurement Object	OP		Traffic volume measurement Object 10.3.7.70	
Traffic volume measurement quantity	OP		Traffic volume measurement quantity 10.3.7.71	
Traffic volume reporting quantity	OP		Traffic volume reporting quantity 10.3.7.74	
Measurement validity	OP		Measurement validity 10.3.7.51	
CHOICE <i>report criteria</i>	MP			
>Traffic volume measurement reporting criteria			Traffic volume measurement reporting criteria 10.3.7.72	
>Periodical reporting criteria			Periodical reporting criteria 10.3.7.53	
>No reporting				(no data) Chosen when this measurement only is used as additional measurement to another measurement

10.3.7.69 Traffic volume measurement event results

Contains the event result for a traffic volume measurement.

Information Element/Group name	Need	Multi	Type and reference	Semantics description
Uplink transport channel type causing the event	MP		Enumerated(DCH,RACHorCPCH,USCH)	USCH is TDD only. CPCH is FDD only. RACHorCPCH is the currently configured default in the uplink.
UL Transport Channel identity	<i>CV-UL-DCH/USCH</i>		Transport channel identity 10.3.5.18	
Traffic volume event identity	MP		Traffic volume event identity 10.3.7.66	

Condition	Explanation
<i>UL-DCH/USCH</i>	If IE "Uplink transport channel type" is equal to "DCH" or "USCH" (TDD only) this IE is mandatory present. Otherwise the IE is not needed.

10.3.7.70 Traffic volume measurement object

Contains the measurement object information for a traffic volume measurement.

Information Element/Group name	Need	Multi	Type and reference	Semantics description
Traffic volume measurement objects	MP	1 to <maxTrCH >		
>Uplink transport channel type	MP		Enumerated(DCH,RACHorCPCH,USCH)	USCH is TDD only. CPCH is FDD only. RACHorCPCH is the currently configured default in the uplink.
>UL Target Transport Channel ID	CV-UL-DCH/USCH		Transport channel identity 10.3.5.18	

Condition	Explanation
UL-DCH/USCH	If IE "Uplink transport channel type" is equal to "DCH" or "USCH" (TDD only) this IE is mandatory present. Otherwise the IE is not needed.

10.3.7.71 Traffic volume measurement quantity

Contains the measurement quantity information for a traffic volume measurement.

Information Element/Group name	Need	Multi	Type and reference	Semantics description
Measurement quantity	MP		Enumerated(RLC buffer payload, Average RLC buffer payload, Variance of RLC buffer payload)	This parameter should be ignored.
Time Interval to take an average or a variance	CV-A/V		Integer(20, 40, ..260, by steps of 20)	In ms

Condition	Explanation
A/V	This IE is mandatory present when "Average RLC buffer" or "Variance of RLC buffer payload" is chosen and not needed otherwise.

10.3.7.72 Traffic volume measurement reporting criteria

Contains the measurement reporting criteria information for a traffic volume measurement.

Event 4a: Transport Channel Traffic Volume [15] exceeds an absolute threshold.

Event 4b: Transport Channel Traffic Volume [15] becomes smaller than an absolute threshold.

Information Element/Group name	Need	Multi	Type and reference	Semantics description
Parameters sent for each transport channel	OP	1 to <maxTrCH >		This IE is always required, need is OP to align with ASN.1
>Uplink transport channel type	OP		Enumerated(DCH,RACHorCPCH,USCH)	USCH is TDD only. CPCH is FDD only. RACHorCPCH is the currently configured default in the uplink.
>UL Transport Channel ID	CV-UL-DCH/USCH		Transport channel identity 10.3.5.18	
>Parameters required for each Event	OP	1 to <maxMeas parEvent>		
>>Traffic volume event identity	MP		Traffic volume event identity 10.3.7.66	
>>Reporting Threshold	MP		Enumerated(8,16,32,64,128,256,512,1024,2K,3K,4K,6K,8K,12K,16K,24K,32K,48K,64K,96K,128K,192K,256K,384K,512K,768K)	Threshold in bytes And N Kbytes = N*1024 bytes
>>Time to trigger	OP		Time to trigger 10.3.7.64	Indicates the period of time during which the event condition has to be satisfied, before sending a Measurement Report. Time in ms
>>Pending time after trigger	OP		Integer(250, 500, 1000, 2000, 4000, 8000, 16000)	Indicates the period of time during which it is forbidden to send any new measurement reports with the same Traffic volume event identity even if the triggering condition is fulfilled. Time in milliseconds
>>Tx interruption after trigger	OP		Integer (250, 500, 1000, 2000, 4000, 8000, 16000)	Time in milliseconds. Indicates how long the UE shall block DTCH transmissions on the RACH after a measurement report is triggered.

Condition	Explanation
UL-DCH/USCH	If IE "Uplink transport channel type" is equal to "DCH" or "USCH" (TDD only) this IE is optional. Otherwise the IE is not needed.

10.3.7.73 Traffic volume measurement system information

Information Element/Group name	Need	Multi	Type and reference	Semantics description
Traffic volume measurement identity	MD		Measurement identity 10.3.7.48	The traffic volume measurement identity has default value 4.
Traffic volume measurement object	OP		Traffic volume measurement object 10.3.7.70	
Traffic volume measurement quantity	OP		Traffic volume measurement quantity 10.3.7.71	
Traffic volume reporting quantity	OP		Traffic volume reporting quantity 10.3.7.74	
Measurement validity	OP		Measurement validity 10.3.7.51	
Measurement Reporting Mode	MP		Measurement Reporting Mode 10.3.7.49	
CHOICE <i>reporting criteria</i>	MP			
>Traffic volume measurement reporting criteria			Traffic volume measurement reporting criteria 10.3.7.72	
>Periodical reporting criteria			Periodical reporting criteria 10.3.7.53	

10.3.7.74 Traffic volume reporting quantity

Contains the reporting quantity information for a traffic volume measurement.

For all boolean types TRUE means inclusion in the report is requested.

Information Element/Group name	Need	Multi	Type and reference	Semantics description
RLC Buffer Payload for each RB	MP		Boolean	
Average of RLC Buffer Payload for each RB	MP		Boolean	
Variance of RLC Buffer Payload for each RB	MP		Boolean	

10.3.7.75 UE internal event identity

Information Element/Group name	Need	Multi	Type and reference	Semantics description
UE internal event identity	MP		Enumerated(6a,6b,6c,6d,6e, 6f, 6g)	

10.3.7.76 UE internal measured results

Information Element/Group name	Need	Multi	Type and reference	Semantics description	Version
CHOICE <i>mode</i>	MP				
>FDD					
>>UE Transmitted Power	OP		UE Transmitted Power info 10.3.7.85		
>>UE Rx-Tx report entries	OP	1 to <maxRL>			
>>>Primary CPICH info	MP		Primary CPICH info 10.3.6.60	Primary CPICH info for each cell included in the active set	
>>>UE Rx-Tx time difference type 1	MP		UE Rx-Tx time difference type 1 10.3.7.83	UE Rx-Tx time difference in chip for each RL included in the active set	
>TDD					
>>UE Transmitted Power list	OP	1 to <maxTS>		UE Transmitted Power for each used uplink timeslot in ascending timeslot number order	
>>>UE Transmitted Power	MP		UE Transmitted Power info 10.3.7.85		
>>CHOICE <i>TDD option</i>	MP				REL-4
>>>3.84 Mcps TDD					REL-4
>>>>Applied TA	OP		Uplink Timing Advance 10.3.6.95	Uplink timing advance applied by the UE	
>>>>1.28 Mcps TDD					REL-4
>>>>T _{ADV}	OP		T _{ADV} info 10.3.7.112		REL-4

10.3.7.77 UE internal measurement

Information Element/Group name	Need	Multi	Type and reference	Semantics description
UE internal measurement quantity	OP		UE internal measurement quantity 10.3.7.79	
UE internal reporting quantity	OP		UE internal reporting quantity 10.3.7.82	
<i>CHOICE report criteria</i>	MP			
>UE internal measurement reporting criteria			UE internal measurement reporting criteria 10.3.7.80	
>Periodical reporting criteria			Periodical reporting criteria 10.3.7.53	
>No reporting				(no data) Chosen when this measurement only is used as additional measurement to another measurement

<i>CHOICE report criteria</i>	Condition under which the given <i>report criteria</i> is chosen
UE internal measurement reporting criteria	Chosen when UE internal measurement event triggering is required
Periodical reporting criteria	Chosen when periodical reporting is required
No reporting	Chosen when this measurement only is used as additional measurement to another measurement

10.3.7.78 UE internal measurement event results

This IE contains the measurement event results that are reported to UTRAN for UE internal measurements.

Information Element/Group name	Need	Multi	Type and reference	Semantics description
UE internal event identity	MP		UE internal event identity 10.3.7.75	
<i>CHOICE mode</i>	MP			
>FDD				
>Primary CPICH info	<i>CV-clause 1</i>		Primary CPICH info 10.3.6.60	
>TDD				(no data)

Condition	Explanation
<i>Clause 1</i>	This IE is mandatory present if the IE "UE internal event identity" is set to "6f" or "6g", otherwise the IE is not needed.

10.3.7.79 UE internal measurement quantity

The quantity the UE shall measure in case of UE internal measurement.

Information Element/Group name	Need	Multi	Type and reference	Semantics description	Version
CHOICE <i>mode</i>	MP				
>FDD					
>>Measurement quantity	MP		Enumerated(UE Transmitted Power, UTRA Carrier RSSI, UE Rx-Tx time difference)		
>TDD					
>>Measurement quantity	MP		Enumerated(UE Transmitted Power, UTRA Carrier RSSI, T _{ADV})	Measurement on Timing Advance is for 1.28 Mcps TDD	REL-4
Filter coefficient	OP		Filter coefficient 10.3.7.9	If the IE "Measurement quantity" is set to "Rx-Tx time difference" and this IE is present, the UE behaviour is unspecified.	

10.3.7.80 UE internal measurement reporting criteria

The triggering of the event-triggered reporting for a UE internal measurement. All events concerning UE internal measurements are labelled 6x where x is a, b, c.... In TDD, the events 6a - 6d are measured and reported on timeslot basis.

Event 6a: The UE Transmitted Power becomes larger than an absolute threshold

Event 6b: The UE Transmitted Power becomes less than an absolute threshold

Event 6c: The UE Transmitted Power reaches its minimum value

Event 6d: The UE Transmitted Power reaches its maximum value

Event 6e: The UE RSSI reaches the UEs dynamic receiver range

Event 6f (FDD): The UE Rx-Tx time difference for a RL included in the active set becomes larger than an absolute threshold

Event 6f (1.28 Mcps TDD): The time difference indicated by T_{ADV} becomes larger than an absolute threshold

Event 6g: The UE Rx-Tx time difference for a RL included in the active set becomes less than an absolute threshold

Information Element/Group name	Need	Multi	Type and reference	Semantics description	Version
Parameters sent for each UE internal measurement event	OP	1 to <maxMeas Event>			
>UE internal event identity	MP		UE internal event identity 10.3.7.75		

Information Element/Group name	Need	Multi	Type and reference	Semantics description	Version
>Time-to-trigger	MP		Integer(0, 10, 20, 40, 60, 80, 100, 120, 160, 200, 240, 320, 640, 1280, 2560, 5000)	Time in ms. Indicates the period of time between the timing of event detection and the timing of sending Measurement Report.	
>UE Transmitted Power Tx power threshold	CV-clause 1		Integer(-50..33)	Power in dBm. In event 6a, 6b.	
>UE Rx-Tx time difference threshold	CV-clause 2		Integer(768..1280)	Time difference in chip. In event 6f, 6g.	
>T _{ADV} threshold	CV-clause 3		Real (0..63 step 0.125)	Time difference in chip. In event 6f	REL-4

Condition	Explanation
Clause 1	The IE is mandatory present if the IE "UE internal event identity" is set to "6a" or "6b", otherwise the IE is not needed.
Clause 2	In FDD, the IE is mandatory present if the IE "UE internal event identity" is set to "6f" or "6g", otherwise the IE is not needed.
Clause 3	In 1.28 Mcps TDD the IE is mandatory present if the IE "UE internal event identity" is set to "6f", otherwise the IE is not needed.

10.3.7.81 Void

10.3.7.82 UE Internal reporting quantity

For all boolean types TRUE means inclusion in the report is requested.

Information Element/Group name	Need	Multi	Type and reference	Semantics description	Version
UE Transmitted Power	MP		Boolean		
CHOICE <i>mode</i>	MP				
>FDD					
>>UE Rx-Tx time difference	MP		Boolean		
>TDD					
>>CHOICE <i>TDD option</i>					REL-4
>>>3.84 Mcps TDD				(no data)	REL-4
>>Applied TA	MP		Boolean		
>>>1.28 Mcps TDD					REL-4
>>>>T _{ADV} info	MP		Boolean		REL-4

10.3.7.83 UE Rx-Tx time difference type 1

The difference in time between the UE uplink DPCCH/DPDCH frame transmission and the first detected path (in time), of the downlink DPCH frame from the measured radio link. This measurement is for FDD only.

Information Element/Group name	Need	Multi	Type and reference	Semantics description
UE Rx-Tx time difference type 1	MP		Integer(768..1280)	In chips. 511 spare values are needed.

10.3.7.84 UE Rx-Tx time difference type 2

The difference in time between the UE uplink DPCCH/DPDCH frame transmission and the first detected path (in time), of the downlink DPCH frame from the measured radio link.

Information Element/Group name	Need	Multi	Type and reference	Semantics description
UE Rx-Tx time difference type 2	MP		Real(768.0..1279.9375 by step of 0.0625)	Resolution of 1/16 of a chip.

10.3.7.85 UE Transmitted Power info

Information Element/Group name	Need	Multi	IE type and reference	Semantics description
UE Transmitted Power	MP		Integer (0..104)	According to UE_TX_POWER in [19] and [20]

10.3.7.86 UE positioning Ciphering info

This IE contains information for the ciphering of UE positioning assistance data broadcast in System Information.

Information Element/Group name	Need	Multi	Type and Reference	Semantics description
Ciphering Key Flag	MP		Bit string(1)	
Ciphering Serial Number	MP		Integer(0..65535)	The serial number used in the DES ciphering algorithm

10.3.7.87 UE positioning Error

Information Element/Group name	Need	Multi	Type and Reference	Semantics description
Error reason	MP		Enumerated(ER1, ER2, ER3, ER4, ER5, ER6, ER7, ER8)	Note 1
GPS Additional Assistance Data Request	OP		UE positioning GPS Additional Assistance Data Request 10.3.7.88a	

NOTE 1: The following table gives the mapping of the IE "Error reason".

Value	Indication
ER1	There were not enough cells to be received.
ER2	There were not enough GPS satellites to be received.
ER3	UE positioning GPS assistance data missing.
ER4	Undefined error.
ER5	UE positioning request denied by upper layers.
ER6	UE positioning request not processed by upper layers and timeout.
ER7	UE was not able to read the SFN of the reference cell.
ER8	UE was not able to accomplish the GPS timing of cell frames measurement.

10.3.7.88 UE positioning GPS acquisition assistance

This IE contains parameters that enable fast acquisition of the GPS signals in UE-assisted GPS positioning.

Information Element/Group name	Need	Multi	Type and Reference	Semantics description
GPS TOW msec	MP		Integer(0..6.048*10 ⁸ -1)	GPS Time of Week in milliseconds rounded down to the nearest millisecond unit.
UTRAN GPS reference time	OP			
>UTRAN GPS timing of cell frames	MP		Integer(0 ... 2322431999 999)	GPS timing of cell frames in steps of 1 chip.
>CHOICE <i>mode</i>	OP			
>>FDD				
>>>Primary CPICH Info	MP		Primary CPICH Info 10.3.6.60	Identifies the reference cell for the GPS TOW-SFN relationship
>>TDD				
>>>cell parameters id	MP		Cell parameters id 10.3.6.9	Identifies the reference cell for the GPS TOW-SFN relationship
>SFN	MP		Integer(0..40 95)	The SFN which the UTRAN GPS timing of cell frames time stamps.
Satellite information	MP	1 to <maxSat>		
>SatID	MP		Integer (0..63)	
>Doppler (0 th order term)	MP		Real(-5120..5117.5 by step of 2.5)	Hz
>Extra Doppler	OP			
>>Doppler (1 st order term)	MP		Real (-0.966..0.483 by step of 0.023)	Scaling factor 1/42
>>>Doppler Uncertainty	MP		Enumerated (12,5,25,50, 100,200)	Hz. Three spare values are needed.
>Code Phase	MP		Integer(0..10 22)	Chips, specifies the centre of the search window
>Integer Code Phase	MP		Integer(0..19)	1023 chip segments
>GPS Bit number	MP		Integer(0..3)	Specifies GPS bit number (20 1023 chip segments)
>Code Phase Search Window	MP		Integer(1023 ,1,2,3,4,6,8,1 2,16,24,32,4 8,64,96,128, 192)	Specifies the width of the search window.
>Azimuth and Elevation	OP			
>>Azimuth	MP		Real(0..348. 75 by step of 11.25)	Degrees
>>>Elevation	MP		Real(0..78.7 5 by step of 11.25)	Degrees

10.3.7.88a UE positioning GPS Additional Assistance Data Request

Information Element/Group name	Need	Multi	Type and Reference	Semantics description
Almanac	MP		Boolean	TRUE means requested

Information Element/Group name	Need	Multi	Type and Reference	Semantics description
UTC Model	MP		Boolean	TRUE means requested
Ionospheric model	MP		Boolean	TRUE means requested
Navigation Model	MP		Boolean	TRUE means requested
DGPS Corrections	MP		Boolean	TRUE means requested
Reference Location	MP		Boolean	TRUE means requested
Reference Time	MP		Boolean	TRUE means requested
Acquisition Assistance	MP		Boolean	TRUE means requested
Real-Time Integrity	MP		Boolean	TRUE means requested
Navigation Model Additional data	CV- <i>Navigation Model</i>			this IE is present only if "Navigation Model" is set to TRUE otherwise it is absent
>GPS Week	MP		Integer (0..1023)	
>GPS_Toe	MP		Integer (0..167)	GPS time of ephemeris in hours of the latest ephemeris set contained by the UE. Eighty-eight spare values needed.
>T-Toe limit	MP		Integer (0..10)	ephemeris age tolerance of the UE to UTRAN in hours. Five spare values needed.
>Satellites list related data	MP	0 to <maxSat>		
>>SatID	MP		Integer (0..63)	
>>IODE	MP		Integer (0..255)	Issue of Data Ephemeris for SatID

10.3.7.89 UE positioning GPS almanac

This IE contains a reduced-precision subset of the ephemeris and clock correction parameters.

Information Element/Group name	Need	Multi	Type and Reference	Semantics description
WN _a	MP		Bit string(8)	
Satellite information	MP	1 to <maxSat>		
>DataID	MP		Integer(0..3)	See [12]
>SatID	MP		Enumerated(0..63)	Satellite ID
>e	MP		Bit string(16)	Eccentricity [12]
>t _{oa}	MP		Bit string(8)	Reference Time of Almanac [12]
>δi	MP		Bit string(16)	
>OMEGADOT	MP		Bit string(16)	Longitude of Ascending Node of Orbit Plane at Weekly Epoch (semi-circles/sec) [12]
>SV Health	MP		Bit string(8)	
>A ^{1/2}	MP		Bit string(24)	Semi-Major Axis (meters) ^{1/2} [12]
>OMEGA ₀	MP		Bit string(24)	Longitude of Ascending Node of Orbit Plane at Weekly Epoch (semi-circles) [12]
>M ₀	MP		Bit string(24)	Mean Anomaly at Reference Time (semi-circles) [12]
>ω	MP		Bit string(24)	Argument of Perigee (semi-circles) [12]
>af ₀	MP		Bit string(11)	apparent clock correction [12]
>af ₁	MP		Bit string(11)	apparent clock correction [12]
SV Global Health	OP		Bit string(364)	This enables GPS time recovery and possibly extended GPS correlation intervals. It is specified in page 25 of subframes 4 and 5 [12]

10.3.7.90 UE positioning GPS assistance data

This IE contains GPS assistance data.

Information Element/Group name	Need	Multi	Type and Reference	Semantics description
UE positioning GPS reference time	OP		UE positioning GPS reference time 10.3.7.96	
UE positioning GPS reference UE position	OP		Ellipsoid point with altitude and uncertainty ellipsoid 10.3.8.4c	A priori knowledge of UE 3-D position.
UE positioning GPS DGPS corrections	OP		UE positioning GPS DGPS corrections 10.3.7.91	

Information Element/Group name	Need	Multi	Type and Reference	Semantics description
UE positioning GPS navigation model	OP		UE positioning GPS navigation model 10.3.7.94	
UE positioning GPS ionospheric model	OP		UE positioning GPS ionospheric model 10.3.7.92	
UE positioning GPS UTC model	OP		UE positioning GPS UTC model 10.3.7.97	
UE positioning GPS almanac	OP		UE positioning GPS almanac 10.3.7.89	
UE positioning GPS acquisition assistance	OP		UE positioning GPS acquisition assistance 10.3.7.88	
UE positioning GPS real-time integrity	OP		UE positioning GPS real-time integrity 10.3.7.95	

10.3.7.90a Void

10.3.7.91 UE positioning GPS DGPS corrections

This IE contains DGPS corrections to be used by the UE.

Information Element/Group name	Need	Multi	Type and Reference	Semantics description
GPS TOW sec	MP		Integer(0..60 4799)	seconds GPS time-of-week when the DGPS corrections were calculated
Status/Health	MP		Enumerated(UDRE scale 1.0, UDRE scale 0.75, UDRE scale 0.5, UDRE scale 0.3, UDRE scale 0.2, UDRE scale 0.1, no data, invalid data)	
DGPS information	CV- Status/Health	1 to <maxSat>		If the Cipher information is included these fields are ciphered.

Information Element/Group name	Need	Multi	Type and Reference	Semantics description
>SatID	MP		Enumerated (0..63)	
>IODE	MP		Integer(0..255)	
>UDRE	MP		Enumerated(UDRE ≤ 1.0 m, 1.0m < UDRE ≤ 4.0m, 4.0m < UDRE ≤ 8.0m, 8.0m < UDRE)	The value in this field shall be multiplied by the UDRE Scale Factor in the IE Status/Health to determine the final UDRE estimate for the particular satellite.
>PRC	MP		Real(-655.04..655.04 by step of 0.32)	meters (different from [13])
>RRC	MP		Real(-4.064..4.064 by step of 0.032)	meters/sec (different from [13])
>Delta PRC2	MP		Integer(-127..127)	In this version of the protocol this IE should be set to zero and the UE shall ignore it
>Delta RRC2	MP		Real(-0.224..0.224 by step of 0.032)	In this version of the protocol this IE should be set to zero and the UE shall ignore it
>Delta PRC3	OP		Integer(-127..127)	This IE should not be included in this version of the protocol and if received the UE shall ignore it
>Delta RRC3	OP		Real(-0.224..0.224 by step of 0.032)	This IE should not be included in this version of the protocol and if received the UE shall ignore it

Condition	Explanation
<i>Status/Health</i>	This IE is mandatory present if "status" is not equal to "no data" or "invalid data", otherwise the IE is not needed.

10.3.7.91a UE positioning GPS Ephemeris and Clock Correction parameters

This IE contains information for GPS ephemeris and clock correction.

Information Element/Group name	Need	Multi	Type and Reference	Semantics description
C/A or P on L2	MP		Bit string(2)	Code(s) on L2 Channel [12]
URA Index	MP		Bit string(4)	User Range Accuracy [12]
SV Health	MP		Bit string(6)	[12]
IODC	MP		Bit string(10)	Issue of Data, Clock [12]
L2 P Data Flag	MP		Bit string(1)	[12]
SF 1 Reserved	MP		Bit string(87)	[12]
TGD	MP		Bit string(8)	Estimated group delay differential [12]
t _{oc}	MP		Bit string(16)	apparent clock correction [12]
af ₂	MP		Bit string(8)	apparent clock correction [12]
af ₁	MP		Bit string(16)	apparent clock correction [12]

Information Element/Group name	Need	Multi	Type and Reference	Semantics description
af ₀	MP		Bit string(22)	apparent clock correction [12]
C _{rs}	MP		Bit string(16)	Amplitude of the Sine Harmonic Correction Term to the Orbit Radius (meters) [12]
Δn	MP		Bit string(16)	Mean Motion Difference From Computed Value (semi-circles/sec) [12]
M ₀	MP		Bit string(32)	Mean Anomaly at Reference Time (semi-circles) [12]
C _{uc}	MP		Bit string(16)	Amplitude of the Cosine Harmonic Correction Term To The Argument Of Latitude (radians) [12]
e	MP		Bit string(32)	c
C _{us}	MP		Bit string(16)	Amplitude of the Sine Harmonic Correction Term To The Argument Of Latitude (radians) [12]
(A) ^{1/2}	MP		Bit string(32)	Semi-Major Axis (meters) ^{1/2} [12]
t _{oe}	MP		Bit string(16)	Reference Time Ephemeris [12]
Fit Interval Flag	MP		Bit string(1)	[12]
AODO	MP		Bit string(5)	Age Of Data Offset [12]
C _{ic}	MP		Bit string(16)	Amplitude of the Cosine Harmonic Correction Term To The Angle Of Inclination (radians) [12]
OMEGA ₀	MP		Bit string(32)	Longitude of Ascending Node of Orbit Plane at Weekly Epoch (semi-circles) [12]
C _{is}	MP		Bit string(16)	Amplitude of the Sine Harmonic Correction Term To The Angle Of Inclination (radians) [12]
i ₀	MP		Bit string(32)	Inclination Angle at Reference Time (semi-circles) [12]
C _{rc}	MP		Bit string(16)	Amplitude of the Cosine Harmonic Correction Term to the Orbit Radius (meters) [12]
ω	MP		Bit string(32)	Argument of Perigee (semi-circles) [12]
OMEGA _{dot}	MP		Bit string(24)	Longitude of Ascending Node of Orbit Plane at Weekly Epoch (semi-circles/sec) [12]
Idot	MP		Bit string(14)	Rate of Inclination Angle (semi-circles/sec) [12]

10.3.7.92 UE positioning GPS ionospheric model

The IE contains fields needed to model the propagation delays of the GPS signals through the ionosphere.

Information Element/Group name	Need	Multi	Type and Reference	Semantics description
α_0	MP		Bit string(8)	Note 1
α_1	MP		Bit string(8)	Note 1
α_2	MP		Bit string(8)	Note 1
α_3	MP		Bit string(8)	Note 1
β_0	MP		Bit string(8)	Note 2
β_1	MP		Bit string(8)	Note 2
β_2	MP		Bit string(8)	Note 2
β_3	MP		Bit string(8)	Note 2

NOTE 1: The parameters α_n are the coefficients of a cubic equation representing the amplitude of the vertical delay [12].

NOTE 2: The parameters β_n are the coefficients of a cubic equation representing the period of the ionospheric model [12].

10.3.7.93 UE positioning GPS measured results

Information Element/Group name	Need	Multi	Type and Reference	Semantics description
CHOICE <i>Reference Time</i>	MP			
>UTRAN reference time				
>>UE GPS timing of cell frames	MP		Integer(0..3715891199999)	GPS Time of Week in units of 1/16 th UMTS chips according to [19]. 33209832177664 spare values are needed.
>>>CHOICE <i>mode</i>	MP			
>>>>FDD				
>>>>>Primary CPICH Info	MP		Primary CPICH Info 10.3.6.60	Identifies the reference cell for the GPS TOW-SFN relationship.
>>>>TDD				
>>>>>cell parameters id	MP		Cell parameters id 10.3.6.9	Identifies the reference cell for the GPS TOW-SFN relationship.
>>>Reference SFN	MP		Integer(0..4095)	The SFN for which the location is valid. If UE GPS timing of cell frames is included this is also the SFN which is time stamped.
>GPS reference time only				
>>GPS TOW msec	MP		Integer(0..6.048*10 ⁸ -1)	GPS Time of Week in milliseconds (rounded down to the nearest millisecond unit). This time is the GPS TOW measured by the UE.
Measurement Parameters	MP	1 to <maxSat>		
>Satellite ID	MP		Enumerated(0..63)	
>C/N ₀	MP		Integer(0..63)	the estimate of the carrier-to-noise ratio of the received signal from the particular satellite used in the measurement. It is given in units of dB-Hz (typical levels will be in the range of 20 – 50

Information Element/Group name	Need	Multi	Type and Reference	Semantics description
>Doppler	MP		Integer(-32768..32768)	dB-Hz. Hz, scale factor 0.2.
>Whole GPS Chips	MP		Integer(0..1022)	Unit in GPS chips.
>Fractional GPS Chips	MP		Integer(0..(2 ¹⁰ -1))	Scale factor 2 ⁻¹⁰
>Multipath Indicator	MP		Enumerated(NM, low, medium, high)	Note 1.
>Pseudorange RMS Error	MP		Enumerated(range index 0..range index 63)	Note 2.

NOTE 1: The following table gives the mapping of the multipath indicator field.

Value	Multipath Indication
NM	Not measured
Low	MP error < 5m
Medium	5m < MP error < 43m
High	MP error > 43m

NOTE 2: The following table gives the bitmapping of the Pseudorange RMS Error field.

Range Index	Mantissa	Exponent	Floating-Point value, x_i	Pseudorange value, P
0	000	000	0.5	$P < 0.5$
1	001	000	0.5625	$0.5 \leq P < 0.5625$
l	X	Y	$0.5 * (1 + x/8) * 2^y$	$x_{i-1} \leq P < x_i$
62	110	111	112	$104 \leq P < 112$
63	111	111	--	$112 \leq P$

10.3.7.94 UE positioning GPS navigation model

This IE contain information required to manage the transfer of precise navigation data to the GPS-capable UE.

Information Element/Group name	Need	Multi	Type and Reference	Semantics description
Satellite information	MP	1 to <maxSat>		
>SatID	MP		Enumerated(0..63)	Satellite ID
>Satellite Status	MP		Enumerated(NS_NN, ES_SN, ES_NN, REVD)	NOTE
>GPS Ephemeris and Clock Correction parameters	CV- <i>Satellite status</i>		UE positioning GPS Ephemeris and Clock Correction parameters	

Information Element/Group name	Need	Multi	Type and Reference	Semantics description
			10.3.7.91a	

NOTE: The UE shall interpret enumerated symbols as follows.

Value	Indication
NS_NN	New satellite, new Navigation Model
ES_SN	Existing satellite, same Navigation Model
ES_NN	Existing satellite, new Navigation Model
REVD	Reserved

Condition	Explanation
<i>Satellite status</i>	The IE is not needed if the IE "Satellite status" is ES_SN and mandatory present otherwise.

10.3.7.95 UE positioning GPS real-time integrity

This IE contains parameters that describe the real-time status of the GPS constellation.

Information Element/Group name	Need	Multi	Type and Reference	Semantics description
Satellite information	MP	1 to <maxSat>		
>BadSatID	MP		Enumerated(0..63)	

10.3.7.95a Void

10.3.7.96 UE positioning GPS reference time

Information Element/Group name	Need	Multi	Type and Reference	Semantics description
GPS Week	MP		Integer(0..1023)	
GPS TOW msec	MP		Integer(0..6.048*10 ⁸ -1)	GPS Time of Week in milliseconds (rounded down to the nearest millisecond unit).
UTRAN GPS reference time	OP			
>UTRAN GPS timing of cell frames	MP		Integer(0..232243199999)	UTRAN GPS timing of cell frames in steps of 1 chip
>CHOICE <i>mode</i>	OP			
>>FDD				
>>>Primary CPICH Info	MP		Primary CPICH Info 10.3.6.60	Identifies the reference cell for the GPS TOW-SFN relationship
>>TDD				
>>>cell parameters id	MP		Cell parameters id 10.3.6.9	Identifies the reference cell for the GPS TOW-SFN relationship
>SFN	MP		Integer(0..4095)	The SFN which the UTRAN GPS timing of cell frames time stamps.
SFN-TOW Uncertainty	OP		Enumerated (lessThan10, moreThan10)	This field indicates the uncertainty of the relation GPS TOW/SFN. lessThan10 means the relation is accurate to at least 10 ms.

Information Element/Group name	Need	Multi	Type and Reference	Semantics description
T _{UTRAN-GPS} drift rate	OP		Integer (0, 1, 2, 5, 10, 15, 25, 50, -1, -2, -5, -10, -15, -25, -50)	in 1/256 chips per sec.
GPS TOW Assist	OP	1 to <maxSat>		
>SatID	MP		Enumerated(0..63)	
>TLM Message	MP		Bit string(14)	
>TLM Reserved	MP		Bit string(2)	
>Alert	MP		Boolean	
>Anti-Spoof	MP		Boolean	

10.3.7.97 UE positioning GPS UTC model

The UTC Model field contains a set of parameters needed to relate GPS time to Universal Time Coordinate (UTC).

Information Element/Group name	Need	Multi	Type and Reference	Semantics description
A ₁	MP		Bit string(24)	sec/sec [12]
A ₀	MP		Bit string(32)	seconds [12]
t _{ot}	MP		Bit string(8)	seconds [12]
WN _t	MP		Bit string(8)	weeks [12]
Δt _{LS}	MP		Bit string(8)	seconds [12]
WN _{LSF}	MP		Bit string(8)	weeks [12]
DN	MP		Bit string(8)	days [12]
Δt _{LSF}	MP		Bit string(8)	seconds [12]

10.3.7.98 UE positioning IPDL parameters

This IE contains parameters for the IPDL mode. The use of this parameters is described in [29].

Information Element/Group name	Need	Multi	Type and Reference	Semantics description	Version
CHOICE <i>mode</i>					REL-4
>FDD					REL-4
>>IP spacing	MP		Integer(5,7,10,15,20,30,40,50)	See [29]	
>>IP length	MP		Integer(5,10)	See [29]	
>>IP offset	MP		Integer(0..9)	See [29]	
>>Seed	MP		Integer(0..63)	See [29]	
>TDD					REL-4
>>IP spacing	MP		Integer(30,40,50,70,100)	See [33]	REL-4
>>IP_Start	MP		Integer(0..4095)	See [33]	REL-4
>>IP_Slot	MP		Integer(0..14)	See [33]	REL-4
>>IP_PCCPCH	CV-channel		Boolean	See [33]	REL-4
Burst mode parameters	OP				
>Burst Start	MP		Integer(0..15)	See [29] and [33]	
>Burst Length	MP		Integer(10..25)	See [29] and [33]	
>Burst freq	MP		Integer(1..16)	See [29] and [33]	

Condition	Explanation
<i>channel</i>	This IE is present only if the idle slot carries the PCCPCH

10.3.7.99 UE positioning measured results

Information Element/Group name	Need	Multi	Type and reference	Semantics description
UE positioning OTDOA measured results	OP		UE positioning OTDOA measured results 10.3.7.105	
UE positioning Position estimate info	OP		UE positioning Position estimate info 10.3.7.109	
UE positioning GPS measured results	OP		UE positioning GPS measured results 10.3.7.93	
UE positioning error	OP		UE positioning error 10.3.7.87	Included if UE positioning error occurred

10.3.7.100 UE positioning measurement

Information Element/Group name	Need	Multi	Type and reference	Semantics description
UE positioning reporting quantity	MP		UE positioning reporting quantity 10.3.7.111	
Measurement validity	OP		Measurement validity 10.3.7.51	
<i>CHOICE reporting criteria</i>	MP			
>UE positioning reporting criteria			UE positioning reporting criteria 10.3.7.110	
>Periodical reporting criteria			Periodical reporting criteria 10.3.7.53	
>No reporting				(no data) Chosen when this measurement only is used as additional measurement to another measurement
UE positioning OTDOA assistance data for UE-assisted	OP		UE positioning OTDOA assistance data for UE-	

Information Element/Group name	Need	Multi	Type and reference	Semantics description
			assisted 10.3.7.103	
UE positioning OTDOA assistance data for UE-based	OP		UE positioning OTDOA assistance data for UE-based 10.3.7.103a	
UE positioning GPS assistance data	OP		UE positioning GPS assistance data 10.3.7.90	

10.3.7.101 UE positioning measurement event results

This IE contains the measurement event results that are reported to UTRAN for UE positioning measurements.

Information Element/Group name	Need	Multi	Type and Reference	Semantics description
CHOICE <i>Event ID</i>	MP			One spare value is needed.
>7a				
>>UE positioning Position estimate info	MP		UE positioning Position estimate info 10.3.7.109	
>7b				
>>UE positioning OTDOA measured results	MP		UE positioning OTDOA measured results 10.3.7.105	
>7c				
>>UE positioning GPS measurement	MP		UE positioning GPS measured results 10.3.7.93	

10.3.7.102 Void

10.3.7.103 UE positioning OTDOA assistance data for UE-assisted

Information Element/Group name	Need	Multi	Type and Reference	Semantics description
UE positioning OTDOA reference cell info for UE-assisted	OP		UE positioning OTDOA reference cell info 10.3.7.108	
UE positioning OTDOA neighbour cell list for UE-assisted	OP	1 to <maxCellMEas>		

Information Element/Group name	Need	Multi	Type and Reference	Semantics description
>UE positioning OTDOA neighbour cell info for UE-assisted	MP		UE positioning OTDOA neighbour cell info 10.3.7.106	

10.3.7.103a UE positioning OTDOA assistance data for UE-based

Information Element/Group name	Need	Multi	Type and Reference	Semantics description
UE positioning OTDOA reference cell info for UE-based	OP		UE positioning OTDOA reference cell info for UE-based 10.3.7.108a	
UE positioning OTDOA neighbour cell list for UE-based	OP	1 to <maxCellMeas>		
>UE positioning OTDOA neighbour cell info for UE-based	MP		UE positioning OTDOA neighbour cell info for UE-based 10.3.7.106a	

10.3.7.104 Void

10.3.7.105 UE positioning OTDOA measured results

Information Element/Group name	Need	Multi	Type and Reference	Semantics description
SFN	MP		Integer(0..4095)	SFN during which the last measurement was performed
CHOICE <i>mode</i>				
>FDD				
>>Reference cell id	MP		Primary CPICH info 10.3.6.60	
>>UE Rx-Tx time difference type 2 info	MP			
>>>UE Rx-Tx time difference type 2	MP		UE Rx-Tx time difference type 2 10.3.7.84	
>>>UE positioning OTDOA quality	MP		UE positioning OTDOA quality 10.3.7.107	Quality of the UE Rx-Tx time difference type 2 measurement from the reference cell.
>TDD				(no data)
>>Reference cell id	MP		Cell parameters ID 10.3.6.9	

Information Element/Group name	Need	Multi	Type and Reference	Semantics description
Neighbours	MP	0 to <maxCellMeas>		
>CHOICE <i>mode</i>	MP			
>>FDD				
>>>Neighbour Identity	MD		Primary CPICH info 10.3.6.60	Default value is the same as in the first set of multiple sets.
>>>Frequency info	MD		Frequency info 10.3.6.36	Default value is the existing value of frequency information
>>>UE Rx-Tx time difference type 2 info	OP			Included for cell in the active set excluding the reference cell.
>>>>UE Rx-Tx time difference type 2	MP		UE Rx-Tx time difference type 2 10.3.7.84	
>>>>UE positioning OTDOA quality	MP		UE positioning OTDOA quality 10.3.7.107	Quality of the UE Rx-Tx time difference type 2 measurement from the neighbour cell.
>>TDD				
>>>Cell and Channel ID	MD		Cell and Channel Identity info 10.3.6.8a	Default value is the same as in the first set of multiple sets.
>UE positioning OTDOA quality	MP		UE positioning OTDOA quality 10.3.7.107	Quality of the SFN-SFN observed time difference type 2 measurement from the neighbour cell.
>SFN-SFN observed time difference type 2	MP		SFN-SFN observed time difference 10.3.7.63	Gives the timing relative to the reference cell. Only type 2 is allowed.

10.3.7.106 UE positioning OTDOA neighbour cell info

This IE gives approximate cell timing in order to decrease the search window.

Information Element/Group name	Need	Multi	Type and Reference	Semantics description
CHOICE <i>mode</i>	MP			
>FDD				
>>Primary CPICH info	MP		Primary CPICH info 10.3.6.60	
>TDD				
>>cell and channel ID	MP		Cell and Channel Identity info 10.3.6.8a	Identifies the channel to be measured on.
Frequency info	MD		Frequency info 10.3.6.36	Default value is the existing value of frequency information

Information Element/Group name	Need	Multi	Type and Reference	Semantics description
IPDL parameters	CV-IPDLs		UE positioning IPDL parameters 10.3.7.98	
SFN offset	MP		Integer (0 .. 4095)	Although this IE is not always required, need is MP to align with ASN.1. Define Tref as the time of beginning of system frame number SFNref of the reference cell. Define Tnc as the beginning of a frame from the neighbour cell occurring immediately after the time Tref. Let the corresponding system frame number be SFNnc. Then SFNnc = SFNref-SFN offset modulo 4096.
SFN offset validity	MD		Enumerated (false)	Absence of this element means SFN offset is valid. False means SFN offset is not valid.
SFN-SFN relative time difference	MP		Integer(0..38399)	Gives the relative timing compared to the reference cell. Equal to $\lfloor (T_{nc} - T_{ref}) * (3.84 * 10^6) \rfloor$ where $\lfloor \cdot \rfloor$ denotes rounding to the nearest lower integer. In chips, Tnc = the time of beginning of a system frame from the neighbour cell, Tref = the time of beginning of a system frame from the reference cell.
SFN-SFN drift	OP		Integer (0, -1, -2, -3, -4, -5, -8, -10, -15, -25, -35, -50, -65, -80, -100, 1, 2, 3, 4, 5, 8, 10, 15, 25, 35, 50, 65, 80, 100)	in 1/256 chips per second
Search Window Size	MP		Integer(20, 40, 80, 160, 320, 640, 1280, infinity)	In chips. If the value is X then the expected SFN-SFN observed time difference is in the range [RTD-X, RTD+X] where RTD is the value of the field SFN-SFN relative time difference. Infinity means that the uncertainty is larger than 1280 chips.
CHOICE <i>PositioningMode</i>	MP			
>UE based				(no data)
>UE assisted				(no data)

Condition	Explanation
IPDLs	This IE is mandatory present if IPDLs are applied and not needed otherwise.

10.3.7.106a UE positioning OTDOA neighbour cell info for UE-based

This IE gives approximate cell timing in order to decrease the search window, as well as the cell locations and fine cell timing for UE based OTDOA.

Information Element/Group name	Need	Multi	Type and Reference	Semantics description
UE positioning OTDOA neighbour cell info	MP		UE positioning OTDOA neighbour cell info 10.3.7.106	
Cell Position	MD			Default is the same as previous cell
>Relative North	OP		Integer(-20000..20000)	Seconds of angle, scale factor 0.03. Relative position compared to reference cell.
>Relative East	OP		Integer(-20000..20000)	Seconds of angle, scale factor 0.03. Relative position compared to reference cell.
>Relative Altitude	OP		Integer(-4000..4000)	Relative altitude in meters compared to ref. cell.
Fine SFN-SFN	MP		Real(0..0.9375 in steps of 0.0625)	Gives finer resolution
UE positioning Relative Time Difference Quality	MP		UE positioning OTDOA quality 10.3.7.109a	Quality of the relative time difference between neighbour and reference cell.
Round Trip Time	OP		Real(876.00 .. 2923.875) in steps of 0.0625	In chips. Included if cell is in active set.

10.3.7.107 UE positioning OTDOA quality

Information Element/Group name	Need	Multi	Type and Reference	Semantics description
Std Resolution	MP		Bit string(2)	Std Resolution field includes the resolution used in Std of OTDOA Measurements field. Encoding on two bits as follows: '00' 10 meters '01' 20 meters '10' 30 meters '11' Reserved
Number of OTDOA Measurements	MP		Bit string(3)	The 'Number of OTDOA measurements' field indicates how many OTDOA measurements have been used in the UE to determine the sample standard deviation of the measurements. Following 3 bit encoding is used: '001' 5-9 '010' 10-14 '011' 15-24 '100' 25-34 '101' 35-44 '110' 45-54 '111' 55 or more Special case:

Information Element/Group name	Need	Multi	Type and Reference	Semantics description
				'000':In this case the field 'Std of OTDOA measurements' contains the std of the reported SFN-SFN otd value = $\sqrt{E[(x-\mu)^2]}$, where x is the reported value and $\mu = E[x]$ is the expectation value (i.e. the true value) of x. This std can be used irrespective of the number of measurements and reporting of the number of measurements is not needed. Also other measurements such as Ec/No or Rx levels can be utilised in this case to evaluate the 'Std of OTDOA measurements' reported in this IE.
Std of OTDOA Measurements	MP		Bit string(5)	Std of OTDOA Measurements field includes sample standard deviation of OTDOA measurements (when number of measurements is reported in 'Number of OTDOA measurements field') or standard deviation of the reported SFN-SFN otd value = $\sqrt{E[(x-\mu)^2]}$, where x is the reported value and $\mu = E[x]$ is the expectation value (i.e. the true value) of x (when '000' is given in 'Number of OTDOA measurements' field). Following linear 5 bit encoding is used: '00000' 0 - (R*1-1) meters '00001' R*1 - (R*2-1) meters '00010' R*2 - (R*3-1) meters ... '11111' R*31 meters or more where R is the resolution defined by Std Resolution field. E.g. R=20 m corresponds to 0-19 m, 20-39 m,...,620+ m.

10.3.7.108 UE positioning OTDOA reference cell info

This IE defines the cell used for time references in all OTDOA measurements.

Information Element/Group name	Need	Multi	Type and Reference	Semantics description
SFN	OP		Integer (0..4095)	Time stamp (SFN of Reference Cell) of the SFN-SFN relative time differences and SFN-SFN drift rates. Included if any SFN-SFN drift value is included in IE UE positioning OTDOA neighbour cell info.
CHOICE mode	MP			
>FDD				
>>Primary CPICH info	MP		Primary CPICH info	

Information Element/Group name	Need	Multi	Type and Reference	Semantics description
			10.3.6.60	
>TDD				
>>cell and channel ID	MP		Cell and Channel Identity info 10.3.6.8a	Identifies the channel to be measured on.
Frequency info	MD		Frequency info 10.3.6.36	Default value is the existing value of frequency information. This IE shall always be set to default value
CHOICE <i>PositioningMode</i>	MP			
>UE based				
>UE assisted				(no data)
IPDL parameters	OP		UE positioning IPDL parameters 10.3.7.98	If this element is not included there are no idle periods present

10.3.7.108a UE positioning OTDOA reference cell info for UE-based

This IE defines the cell used for time references in all OTDOA measurements for UE-based methods.

Information Element/Group name	Need	Multi	Type and Reference	Semantics description
UE positioning OTDOA reference cell info	MP		UE positioning OTDOA reference cell info 10.3.7.108	
CHOICE <i>Cell Position</i>	OP			The position of the antenna that defines the cell. Used for the UE based method.
>Ellipsoid				
>>Ellipsoid point	MP		Ellipsoid point 10.3.8.4a	
>Ellipsoid with altitude				
>>Ellipsoid point with altitude	MP		Ellipsoid point with altitude 10.3.8.4b	
Round Trip Time	OP		Real(876.00 .. 2923.875) in steps of 0.0625	In chips.

10.3.7.109 UE positioning position estimate info

The purpose of this IE is to provide the position estimate from the UE to the network, if the UE is capable of determining its own position.

Information Element/Group name	Need	Multi	Type and Reference	Semantics description
CHOICE <i>Reference Time</i>	MP			
>UTRAN GPS reference time				
>>UE GPS timing of cell frames	MP		Integer(0.. 3715891199 9999)	GPS Time of Week in units of 1/16 th UMTS chips according to [19]. 33209832177664 spare values

Information Element/Group name	Need	Multi	Type and Reference	Semantics description
				are needed.
>>CHOICE <i>mode</i>	MP			
>>>FDD				
>>>>Primary CPICH Info	MP		Primary CPICH Info 10.3.6.60	Identifies the reference cell for the GPS TOW-SFN relationship
>>>TDD				
>>cell parameters id	MP		Cell parameters id 10.3.6.9	Identifies the reference cell for the GPS TOW-SFN relationship.
>>Reference SFN	MP		Integer(0..4095)	The SFN for which the location is valid and which the UTRAN GPS timing of cell frames time stamps.
>GPS reference time only				
>>GPS TOW msec	MP		Integer(0..6.048*10 ⁸ -1)	GPS Time of Week in milliseconds (rounded down to the nearest millisecond unit).
>Cell timing				
>>SFN	MP		Integer(0..4095)	SFN during which the position was calculated.
>>CHOICE <i>mode</i>	MP			
>>>FDD				
>>>>Primary CPICH Info	MP		Primary CPICH Info 10.3.6.60	Identifies the reference cell for SFN
>>>TDD				
>>cell parameters id	MP		Cell parameters id 10.3.6.9	Identifies reference cell for SFN
CHOICE <i>Position estimate</i>	MP			
>Ellipsoid Point			Ellipsoid Point; 10.3.8.4a	
>Ellipsoid point with uncertainty circle			Ellipsoid point with uncertainty circle 10.3.8.4d	
>Ellipsoid point with uncertainty ellipse			Ellipsoid point with uncertainty ellipse 10.3.8.4e	
>Ellipsoid point with altitude			Ellipsoid point with altitude 10.3.8.4b	
>Ellipsoid point with altitude and uncertainty ellipsoid			Ellipsoid point with altitude and uncertainty ellipsoid 10.3.8.4c	

10.3.7.109a UE positioning Relative Time Difference quality

Information Element/Group name	Need	Multi	Type and Reference	Semantics description
Relative Time Difference Std Resolution	MP		Bit string(2)	Std Resolution field includes the resolution used in Std of Relative Time Difference field. Encoding on two bits as follows: '00' 10 meters '01' 20 meters '10' 30 meters '11' Reserved
Std of Relative Time Difference	MP		Bit string(5)	Std of Relative Time difference field includes standard deviation of (SFN-SFN relative time difference + Fine SFN-SFN). Following linear 5 bit encoding is used: '00000' 0 - (R*1-1) meters '00001' R*1 - (R*2-1) meters '00010' R*2 - (R*3-1) meters ... '11111' R*31 meters or more where R is the resolution defined by Std Resolution field. E.g. R=20 m corresponds to 0-19 m, 20-39 m, ..., 620+ m.

10.3.7.110 UE positioning reporting criteria

The triggering of the event-triggered reporting for a UE positioning measurement.

Information Element/Group name	Need	Multi	Type and Reference	Semantics description
Parameters required for each event	OP	1 to <maxMeas Event>		
>Amount of reporting	MP		Integer(1, 2, 4, 8, 16, 32, 64,infinite)	
>Report first fix	MP		Boolean	If true the UE reports the position once the measurement control is received, and then each time an event is triggered.
>Measurement interval	MP		Integer(5,15, 60,300,900,1 800,3600,72 00)	Indicates how often the UE should make the measurement In seconds
>CHOICE <i>Event ID</i>	MP			
>>7a				
>>>Threshold Position Change	MP		Integer(10,2 0,30,40,50,1 00,200,300,5 00,1000,200 0,5000,1000 0,20000,500 00,100000)	Meters. Indicated how much the position should change compared to last reported position fix in order to trigger the event.
>>7b				
>>>Threshold SFN-SFN change	MP		Real(0.25,0. 5,1,2,3,4,5,1 0,20,50,100, 200,500,100 0,2000,5000)	Chips. Indicates how much the SFN-SFN measurement of ANY measured cell is allowed to change before the event is triggered.
>>7c				
>>>Threshold SFN-GPS TOW	MP		Integer(1,2,3 ,5,10,20,50,1 00)	Time in ms. When the GPS TOW and SFN timer has drifted apart more than the specified value the event is triggered.

10.3.7.111 UE positioning reporting quantity

The purpose of the element is to express the allowed/required location method(s), and to provide information desired QoS.

Information Element/Group name	Need	Multi	Type and Reference	Semantics description
Method Type	MP		Enumerated(UE assisted, UE based, UE based is preferred but UE assisted is allowed, UE assisted is preferred but UE based is allowed)	
Positioning Methods	MP		Enumerated(OTDOA, GPS, OTDOA or GPS, Cell ID)	
Response Time	MP		Integer(1,2,4	This IE shall be ignored.

Information Element/Group name	Need	Multi	Type and Reference	Semantics description
			, 8, 16, 32, 64, 128)	
Horizontal Accuracy	CV- MethodType		Bit string(7)	The uncertainty is derived from the "uncertainty code" k by $r = 10*(1.1^k-1)$ in meters.
Vertical Accuracy	CV- MethodType		Bit string(7)	The uncertainty is derived from the "uncertainty code" k by $r = 45*(1.025^k-1)$ in meters.
GPS timing of Cell wanted	MP		Boolean	If true the SRNC wants the UE to report the SFN-GPS timing of the reference cell. This is however optional in the UE.
Multiple Sets	MP		Boolean	This IE shall be ignored.
Additional Assistance Data Request	MP		Boolean	TRUE indicates that the UE is requested to send the IE "Additional assistance Data Request" when the IE "UE positioning Error" is present in the UE positioning measured results.
Environment Characterisation	OP		Enumerated(possibly heavy multipath and NLOS conditions, no or light multipath and usually LOS conditions, not defined or mixed environment)	One spare value is needed.

Condition	Explanation
<i>Method Type</i>	The IE is optional if the IE "Method Type" is "UE assisted"; otherwise it is mandatory present.

10.3.7.112 T_{ADV} info

NOTE: Only for 1.28 Mcps TDD.

T_{ADV} indicates the difference between the Rx timing and Tx timing of a UE.

Information Element/group name	Need	Multi	Type and reference	Semantics description	Version
T _{ADV}	MP		Integer (0..2047)	As defined in [20].	REL-4
SFN	MP		Integer(0..4095)	SFN during which the T _{ADV} measurement was performed.	REL-4

10.3.8 Other Information elements

10.3.8.1 BCCH modification info

Indicates modification of the System Information on BCCH.

Information Element/Group name	Need	Multi	Type and reference	Semantics description
MIB Value tag	MP		MIB Value tag 10.3.8.9	
BCCH modification time	OP		Integer (0..4088 in step of 8)	All SFN values in which MIB may be mapped are allowed.

10.3.8.2 BSIC

Information Element/Group name	Need	Multi	Type and reference	Semantics description
Base transceiver Station Identity Code (BSIC)	MP			[11]
>Network Colour Code (NCC)	MP		bit string(3)	The first/leftmost bit of the bit string contains the most significant bit of the NCC.
>Base Station Colour Code (BCC)	MP		bit string(3)	The first/leftmost bit of the bit string contains the most significant bit of the BCC.

10.3.8.3 CBS DRX Level 1 information

This information element contains the CBS discontinuous reception information to be broadcast for CBS DRX Level 1 calculations in the UE.

Information Element/Group name	Need	Multi	Type and reference	Semantics description
Period of CTCH allocation (N)	MP		Integer (1..256)	$M_{TTI} \leq N \leq 4096 - K$, N multiple of M_{TTI}
CBS frame offset (K)	MP		Integer (0..255)	$0 \leq K \leq N-1$, K multiple of M_{TTI}

10.3.8.4 Cell Value tag

Information Element/Group name	Need	Multi	Type and reference	Semantics description
Cell Value tag	MP		Integer (1..4)	

10.3.8.4a Ellipsoid point

This IE contains the description of an ellipsoid point as in [24].

Information Element/Group name	Need	Multi	Type and Reference	Semantics description
Latitude sign	MP		Enumerated (North, South)	
Degrees Of Latitude	MP		Integer (0...2 ²³ -1)	The IE value (<i>N</i>) is derived by this formula: $N \leq 2^{23} X / 90 < N+1$ <i>X</i> being the latitude in degree (0°.. 90°)
Degrees Of Longitude	MP		Integer (-2 ²³ ...2 ²³ -1)	The IE value (<i>N</i>) is derived by this formula: $N \leq 2^{24} X / 360 < N+1$ <i>X</i> being the longitude in degree (-180°..+180°)

10.3.8.4b Ellipsoid point with Altitude

This IE contains the description of an ellipsoid point with altitude as in [24].

Information Element/Group name	Need	Multi	Type and Reference	Semantics description
Latitude sign	MP		Enumerated (North, South)	
Degrees Of Latitude	MP		Integer (0...2 ²³ -1)	The IE value (<i>N</i>) is derived by this formula: $N \leq 2^{23} X / 90 < N+1$ <i>X</i> being the latitude in degree (0°.. 90°)
Degrees Of Longitude	MP		Integer (-2 ²³ ...2 ²³ -1)	The IE value (<i>N</i>) is derived by this formula: $N \leq 2^{24} X / 360 < N+1$ <i>X</i> being the longitude in degree (-180°..+180°)
Altitude Direction	MP		Enumerated (Height, Depth)	
Altitude	MP		Integer (0..2 ¹⁵ -1)	The IE value (<i>N</i>) is derived by this formula: $N \leq a < N+1$ <i>a</i> being the altitude in metres

10.3.8.4c Ellipsoid point with Altitude and uncertainty ellipsoid

This IE contains the description of an ellipsoid point with altitude and uncertainty ellipsoid as in [24].

Information Element/Group name	Need	Multi	Type and Reference	Semantics description
Latitude sign	MP		Enumerated (North, South)	
Degrees Of Latitude	MP		Integer (0...2 ²³ -1)	The IE value (<i>N</i>) is derived by this formula: $N \leq 2^{23} X / 90 < N+1$ <i>X</i> being the latitude in degree (0°.. 90°)

Information Element/Group name	Need	Multi	Type and Reference	Semantics description
Degrees Of Longitude	MP		Integer (- 2^{23} ... 2^{23} -1)	The IE value (N) is derived by this formula: $N \leq 2^{24} X / 360 < N+1$ X being the longitude in degree (-180°..+180°)
Altitude Direction	MP		Enumerated (Height, Depth)	
Altitude	MP		Integer (0.. 2^{15} -1)	The IE value (N) is derived by this formula: $N \leq a < N+1$ a being the altitude in metres
Uncertainty semi-major	MP		Integer (0...127)	The uncertainty r is derived from the "uncertainty code" k by $r = 10x(1.1^k - 1)$
Uncertainty semi-minor	MP		Integer (0...127)	The uncertainty r is derived from the "uncertainty code" k by $r = 10x(1.1^k - 1)$
Orientation of major axis	MP		Integer (0..89)	The IE value (N) is derived by this formula: $2N \leq a < 2(N+1)$ a being the orientation in degree (0°.. 179°)
Uncertainty Altitude	MP		Integer(0..127)	The uncertainty in altitude, h , expressed in metres is mapped from the IE value (K), with the following formula: $h = C \left((1 + x)^K - 1 \right)$ with $C = 45$ and $x = 0.025$.
Confidence	MP		Integer (0..100)	in percentage

10.3.8.4d Ellipsoid point with uncertainty Circle

This IE contains the description of an ellipsoid point with an uncertainty circle as in [24].

Information Element/Group name	Need	Multi	Type and Reference	Semantics description
Latitude sign	MP		Enumerated (North, South)	
Degrees Of Latitude	MP		Integer (0... 2^{23} -1)	The IE value (N) is derived by this formula: $N \leq 2^{23} X / 90 < N+1$ X being the latitude in degree (0°.. 90°)
Degrees Of Longitude	MP		Integer (- 2^{23} ... 2^{23} -1)	The IE value (N) is derived by this formula: $N \leq 2^{24} X / 360 < N+1$ X being the longitude in degree (-180°..+180°)
Uncertainty Code	MP		Integer (0...127)	The uncertainty r is derived from the "uncertainty code" k by $r = 10x(1.1^k - 1)$

10.3.8.4e Ellipsoid point with uncertainty Ellipse

This IE contains the description of an ellipsoid point with an uncertainty ellipse as in [24].

Information Element/Group name	Need	Multi	Type and Reference	Semantics description
Latitude sign	MP		Enumerated (North, South)	
Degrees Of Latitude	MP		Integer (0...2 ²³ -1)	The IE value (N) is derived by this formula: $N \leq 2^{23} X / 90 < N+1$ X being the latitude in degree (0°.. 90°)
Degrees Of Longitude	MP		Integer (-2 ²³ ...2 ²³ -1)	The IE value (N) is derived by this formula: $N \leq 2^{24} X / 360 < N+1$ X being the longitude in degree (-180°..+180°)
Uncertainty semi-major	MP		Integer (0...127)	The uncertainty <i>r</i> is derived from the "uncertainty code" <i>k</i> by $r = 10x(1.1^k - 1)$
Uncertainty semi-minor	MP		Integer (0...127)	The uncertainty <i>r</i> is derived from the "uncertainty code" <i>k</i> by $r = 10x(1.1^k - 1)$
Orientation of major axis	MP		Integer (0..89)	The IE value (N) is derived by this formula: $2N \leq a < 2(N+1)$ <i>a</i> being the orientation in degree (0°.. 179°)
Confidence	MP		Integer (0..100)	in percentage

10.3.8.5 Inter-RAT change failure

Information Element/Group name	Need	Multi	Type and reference	Semantics description
Inter-RAT change failure cause	MP		Enumerated(Configuration unacceptable, physical channel failure, protocol error, unspecified)	Four spare values are needed.
Protocol error information	CV-ProtErr		Protocol error information 10.3.8.12	

Condition	Explanation
<i>ProtErr</i>	The IE is mandatory present if the IE "Inter-RAT change failure cause" has the value "Protocol error" and not needed otherwise.

10.3.8.6 Inter-RAT handover failure

Information Element/Group name	Need	Multi	Type and reference	Semantics description
Inter-RAT handover failure cause	MD		Enumerated(Configuration unacceptable, physical channel failure, protocol error, inter-RAT protocol error, unspecified)	Default value is "unspecified". Eleven spare values are needed.
Protocol error information	CV-ProtErr		Protocol error information 10.3.8.12	

Condition	Explanation
<i>ProtErr</i>	The IE is mandatory present if the IE "Inter-RAT handover failure cause" has the value "Protocol error" and not needed otherwise.

10.3.8.7 Inter-RAT UE radio access capability

This Information Element contains the inter-RAT UE radio access capability that is structured and coded according to the specification used for the corresponding system type.

Information Element/Group name	Need	Multi	Type and reference	Semantics description
CHOICE <i>system</i>	MP			
>GSM				
>>Mobile Station Classmark 2	MP		Octet string (5)	This IE is formatted as 'TLV' and is coded in the same way as the <i>Mobile Station Classmark 2</i> information element in [5]. The first octet is the <i>Mobile station classmark 2 IEI</i> and its value shall be set to 33H. The second octet is the <i>Length of mobile station classmark 2</i> and its value shall be set to 3. The octet 3 contains the first octet of the value part of the <i>Mobile Station Classmark 2</i> information element, the octet 4 contains the second octet of the value part of the <i>Mobile Station Classmark 2</i> information element and so on. For each of these octets, the first/ leftmost/ most significant bit of the octet contains b8 of the corresponding octet of the <i>Mobile Station Classmark 2</i> . In this version of the protocol the first two octets of the <i>Mobile Station Classmark 2 IE</i> containing the <i>Mobile station classmark 2 IEI</i> and the

Information Element/Group name	Need	Multi	Type and reference	Semantics description
				<i>Length of mobile station classmark 2 contents should be ignored by the receiver.</i>
>>Mobile Station Classmark 3	MP		Octet string (1..32)	This IE is formatted as 'V' and is coded in the same way as the value part in the <i>Mobile station classmark 3</i> information element in [5]. The first octet contains octet 1 of the value part of <i>Mobile station classmark 3</i> , the second octet contains octet 2 of the value part of <i>Mobile station classmark 3</i> and so on. See NOTE 1.
>cdma2000				
>>cdma2000Message	MP	1.to.<maxl nterSysMe ssages>		
>>>MSG_TYPE(s)	MP		Bit string (8)	Formatted and coded according to cdma2000 specifications. The first/leftmost/most significant bit of the bit string contains bit 7 of the MSG_TYPE.
>>>cdma2000Messagepayload(s)	MP		Bit string (1..512)	Formatted and coded according to cdma2000 specifications. The first/leftmost/most significant bit of the bit string contains bit 7 of the first octet of the cdma2000 message.

NOTE 1: The value part is specified by means of CSN.1, which encoding results in a bit string, to which final padding may be appended upto the next octet boundary [5]. The first/ leftmost bit of the CSN.1 bit string is placed in the first/ leftmost/ most significant bit of the first octet. This continues until the last bit of the CSN.1 bit string, which is placed in the last/ rightmost/ least significant bit of the last octet.

10.3.8.8 Void

10.3.8.8a Inter-RAT UE security capability

Information Element/Group name	Need	Multi	Type and reference	Semantics description
CHOICE <i>system</i>	MP			
>GSM				
>>GSM security capability	MP			The value TRUE means that the indicated ciphering algorithm is supported.
>>>A5/7 supported	MP		Boolean	
>>>A5/6 supported	MP		Boolean	
>>>A5/5 supported	MP		Boolean	
>>>A5/4 supported	MP		Boolean	
>>>A5/3 supported	MP		Boolean	
>>>A5/2 supported	MP		Boolean	
>>>A5/1 supported	MP		Boolean	

10.3.8.9 MIB Value tag

Information Element/Group name	Need	Multi	Type and reference	Semantics description
MIB Value tag	MP		Integer (1..8)	

10.3.8.10 PLMN Value tag

Information Element/Group name	Need	Multi	Type and reference	Semantics description
PLMN Value tag	MP		Integer (1..256)	

10.3.8.10a PNBSCH allocation

UTRAN may use this IE to provide silent periods in the cell that may be used for cell synchronisation purposes.

Information Element/Group name	Need	Multi	Type and reference	Semantics description	Version
Number of repetitions per SFN period	MP		Integer(2, 3, 4, 5, 6, 7, 8, 9, 10, 12, 14, 16, 18, 20, 24, 28, 32, 36, 40, 48, 56, 64, 72, 80)		REL-4

10.3.8.11 Predefined configuration identity and value tag

Information Element/Group name	Need	Multi	Type and reference	Semantics description
Predefined configuration identity	MP		Predefined configuration identity 10.3.4.5	
Predefined configuration value tag	MP		Predefined configuration value tag 10.3.4.6	

10.3.8.12 Protocol error information

This information element contains diagnostics information returned by the receiver of a message that was not completely understood.

Information Element/Group name	Need	Multi	Type and reference	Semantics description
CHOICE <i>diagnostics type</i>	MP			One spare value is needed.
>Protocol error cause			Protocol error cause 10.3.3.26	

10.3.8.13 References to other system information blocks

Information element/Group name	Need	Multi	Type and reference	Semantics description
References to other system information blocks	MP	1 to <maxSIB>		System information blocks for which multiple occurrences are used, may appear more than once in this list
>Scheduling information	MP		Scheduling information, 10.3.8.16	
>SIB type SIBs only	MP		SIB Type SIBs only, 10.3.8.22	

10.3.8.14 References to other system information blocks and scheduling blocks

Information element/Group name	Need	Multi	Type and reference	Semantics description
References to other system information blocks	MP	1 to <maxSIB>		System information blocks for which multiple occurrences are used, may appear more than once in this list
>Scheduling information	MP		Scheduling information, 10.3.8.16	
>SIB and SB type	MP		SIB and SB Type, 10.3.8.18a	

10.3.8.15 Rplmn information

Contains information to provide faster RPLMN selection in the UE.

Information Element/Group name	Need	Multi	Type and reference	Semantics description	Version
GSM BA Range	OP	1 to maxNumGSMFreqRanges		GSM BA Range	
>GSM Lower Range (UARFCN)	MP		Integer(0..16383)	Lower bound for range of GSM BA freqs	
>GSM Upper Range (UARFCN)	MP		Integer(0..16383)	Upper bound for range of GSM BA freqs	
FDD UMTS Frequency list	OP	1 to maxNumFDDFreqs			
>UARFCN (Nlow)	MP		Integer(0..16383)	[21]	
>UARFCN (Nupper)	OP		Integer(0..16383)	[21] This IE is only needed when the FDD frequency list is specifying a range.	
3.84 Mcps TDD UMTS Frequency list	OP	1 to maxNumTDDFreqs			
>UARFCN	MP		Integer(0..16383)	[22]	
1.28 Mcps TDD UMTS Frequency list	OP	1 to maxNumTDDFreqs			REL-4

Information Element/Group name	Need	Multi	Type and reference	Semantics description	Version
		DDFreqs			
>UARFCN	MP		Integer(0..16383)	[22]	REL-4
CDMA2000 UMTS Frequency list	OP	1 to maxNumCDMA2000Freqs			
>BAND_CLASS	MP		Bit string(5 bits)	TIA/EIA/IS-2000 When mapping the BAND_CLASS to the bit string, the first/leftmost bit of the bit string contains the most significant bit..	
>CDMA_FREQ	MP		Bit string (11 bits)	TIA/EIA/IS-2000 When mapping the CDMA_FREQ to the bit string, the first/leftmost bit of the bit string contains the most significant bit..	

10.3.8.16 Scheduling information

Information Element/Group name	Need	Multi	Type and reference	Semantics description
CHOICE Value tag	OP			
>PLMN Value tag			PLMN Value tag 10.3.8.10	This IE is included if the following conditions are fulfilled: the SIB type equals system information block type 1
>Predefined configuration identity and value tag			Predefined configuration identity and value tag 10.3.8.11	This IE is included if the following conditions are fulfilled: the SIB type equals system information block type 16
>Cell Value tag			Cell Value tag 10.3.8.4	This IE is included if the following conditions are fulfilled: the area scope for the system information block is set to "cell" in table 8.1.1. a value tag is used to indicate changes in the system information block.
>SIB occurrence identity and value tag			SIB occurrence identity and value tag 10.3.8.20b	This IE is included if the following conditions are fulfilled: the SIB type equals system information block types 15.2 and 15.3
Scheduling	MP			
>SEG_COUNT	MD		SEG COUNT 10.3.8.17	Default value is 1
>SIB_REP	MP		Integer (4, 8, 16, 32, 64, 128, 256, 512, 1024, 2048, 4096)	Repetition period for the SIB in frames

Information Element/Group name	Need	Multi	Type and reference	Semantics description
>SIB_POS	MP		Integer (0 ..Rep-2 by step of 2)	Position of the first segment Rep is the value of the SIB_REP IE
>SIB_POS offset info	MD	1..15		see below for default value
>>SIB_OFF	MP		Integer(2..32 by step of 2)	Offset of subsequent segments

Field	Default value
SIB_POS offset info	The default value is that all segments are consecutive, i.e., that the SIB_OFF = 2 for all segments except when MIB segment/complete MIB is scheduled to be transmitted in between segments from same SIB. In that case, SIB_OFF=4 in between segments which are scheduled to be transmitted at SFNprime = 8 *n-2 and 8*n + 2, and SIB_OFF=2 for the rest of the segments.

10.3.8.17 SEG COUNT

Information Element/Group name	Need	Multi	Type and reference	Semantics description
SEG_COUNT	MP		Integer (1..16)	Number of segments in the system information block

10.3.8.18 Segment index

Each system information segment has an individual segment index.

Information Element/Group name	Need	Multi	Type and reference	Semantics description
Segment index	MP		Integer (1..15)	Segments of a system information block are numbered starting with 0 for the first segment and 1 for the next segment, which can be the first subsequent segment or a last segment.

10.3.8.18a SIB and SB type

The SIB type identifies a specific system information block.

Information Element/Group name	Need	Multi	Type and reference	Semantics description
SIB and SB type	MP		Enumerated, see below	

The list of values to encode is:

- System Information Type 1,
- System Information Type 2,
- System Information Type 3,
- System Information Type 4,
- System Information Type 5,

System Information Type 6,
 System Information Type 7,
 System Information Type 8,
 System Information Type 9,
 System Information Type 10,
 System Information Type 11,
 System Information Type 12,
 System Information Type 13,
 System Information Type 13.1,
 System Information Type 13.2,
 System Information Type 13.3,
 System Information Type 13.4,
 System Information Type 14,
 System Information Type 15,
 System Information Type 15.1,
 System Information Type 15.2,
 System Information Type 15.3,
 System Information Type 15.4,
 System Information Type 15.5,
 System Information Type 16,
 System Information Type 17,
 System Information Type 18,
 Scheduling Block 1,
 Scheduling Block 2.

In addition, three spare values are needed.

10.3.8.19 SIB data fixed

Contains the result of a master information block or a system information block after encoding and segmentation. The IE is used for segments with fixed length (segments filling an entire transport block).

Information Element/Group name	Need	Multi	Type and reference	Semantics description
SIB data fixed	MP		Bit string (222)	The first bit contains the first bit of the segment.

10.3.8.20 SIB data variable

Contains either a complete system information block or a segment of a system information block. Contains the result of a master information block or a system information block after encoding and segmentation. The IE is used for segments with variable length. The system information blocks are defined in clauses 10.2.48.8.1 to 10.2.48.8.18.

Information Element/Group name	Need	Multi	Type and reference	Semantics description
SIB data variable	MP		Bit string (1..214)	The first bit contains the first bit of the segment.

10.3.8.20a SIB occurrence identity

This information element identifies a SIB occurrence for System Information Block types 15.2 and 15.3. For System Information Block type 15.2, this identity is assigned to the visible satellite only. Unused identities are claimed by newly rising satellites.

Information Element/Group name	Need	Multi	Type and reference	Semantics description
SIB occurrence identity	MP		Integer (0..15)	

10.3.8.20b SIB occurrence identity and value tag

Information Element/Group name	Need	Multi	Type and reference	Semantics description
SIB occurrence identity	MP		SIB occurrence identity 10.3.8.20a	
SIB occurrence value tag	MP		SIB occurrence value tag 10.3.8.20c	

10.3.8.20c SIB occurrence value tag

This information element is used to identify different versions of SIB occurrence for System Information Block types 15.2 and 15.3.

Information Element/Group name	Need	Multi	Type and Reference	Semantics description
SIB occurrence value tag	MP		Integer(0..15)	

10.3.8.21 SIB type

The SIB type identifies a specific system information block.

Information Element/Group name	Need	Multi	Type and reference	Semantics description
SIB type	MP		Enumerated, see below	

The list of values to encode is:

- Master information block,
- System Information Type 1,
- System Information Type 2,
- System Information Type 3,
- System Information Type 4,

System Information Type 5,
 System Information Type 6,
 System Information Type 7,
 System Information Type 8,
 System Information Type 9,
 System Information Type 10,
 System Information Type 11,
 System Information Type 12,
 System Information Type 13,
 System Information Type 13.1,
 System Information Type 13.2,
 System Information Type 13.3,
 System Information Type 13.4,
 System Information Type 14,
 System Information Type 15,
 System Information Type 15.1,
 System Information Type 15.2,
 System Information Type 15.3,
 System Information Type 15.4,
 System Information Type 15.5,
 System Information Type 16,
 System Information Type 17,
 System Information Type 18,
 Scheduling Block 1,
 Scheduling Block 2.

In addition, two spare values are needed.

10.3.8.22 SIB type SIBs only

The SIB type identifies a specific system information block.

Information Element/Group name	Need	Multi	Type and reference	Semantics description
SIB type SIBs only	MP		Enumerated, see below	

The list of values to encode is:

System Information Type 1,
 System Information Type 2,

System Information Type 3,
 System Information Type 4,
 System Information Type 5,
 System Information Type 6,
 System Information Type 7,
 System Information Type 8,
 System Information Type 9,
 System Information Type 10,
 System Information Type 11,
 System Information Type 12,
 System Information Type 13,
 System Information Type 13.1,
 System Information Type 13.2,
 System Information Type 13.3,
 System Information Type 13.4,
 System Information Type 14,
 System Information Type 15,
 System Information Type 15.1,
 System Information Type 15.2,
 System Information Type 15.3,
 System Information Type 15.4,
 System Information Type 15.5,
 System Information Type 16,
 System Information Type 17,
 System Information Type 18.

In addition, five spare values are needed.

10.3.9 ANSI-41 Information elements

10.3.9.1 ANSI 41 Core Network Information

Information element/Group name	Need	Multi	Type and reference	Semantics description
P_REV	MP		P_REV 10.3.9.10	
MIN_P_REV	MP		MIN_P_REV 10.3.9.8	
SID	MP		SID 10.3.9.11	
NID	MP		NID 10.3.9.9	

10.3.9.2 ANSI-41 Global Service Redirection information

This Information Element contains ANSI-41 Global Service Redirection information.

Information Element/Group name	Need	Multi	Type and reference	Semantics description
ANSI-41 Global Service Redirection information	MP		ANSI-41 NAS parameter, 10.3.9.3	Formatted and coded according to the 3GPP2 document "G3G CDMA DS on ANSI-41"

10.3.9.3 ANSI-41 NAS parameter

This Information Element contains ANSI-41 User Zone Identification information.

Information Element/Group name	Need	Multi	Type and reference	Semantics description
ANSI-41 NAS parameter	MP		Bit string (size (1..2048))	The first bit contains the first bit of the ANSI-41 information.

10.3.9.4 ANSI-41 NAS system information

This Information Element contains ANSI-41 system information.

Information Element/Group name	Need	Multi	Type and reference	Semantics description
NAS (ANSI-41) system information	MP		ANSI-41 NAS parameter, 10.3.9.3	Formatted and coded according to the 3GPP2 document "G3G CDMA DS on ANSI-41"

10.3.9.5 ANSI-41 Private Neighbour List information

This Information Element contains ANSI-41 Private Neighbour List information.

Information Element/Group name	Need	Multi	Type and reference	Semantics description
ANSI-41 Private Neighbour List information	MP		ANSI-41 NAS parameter, 10.3.9.3	Formatted and coded according to the 3GPP2 document "G3G CDMA DS on ANSI-41"

10.3.9.6 ANSI-41 RAND information

This Information Element contains ANSI-41 RAND information.

Information Element/Group name	Need	Multi	Type and reference	Semantics description
ANSI-41 RAND information	MP		ANSI-41 NAS parameter, 10.3.9.3	Formatted and coded according to the 3GPP2 document "G3G CDMA DS on ANSI-41"

10.3.9.7 ANSI-41 User Zone Identification information

This Information Element contains ANSI-41 User Zone Identification information.

Information Element/Group name	Need	Multi	Type and reference	Semantics description
ANSI-41 User Zone Identification information	MP		ANSI-41 NAS parameter, 10.3.9.3	Formatted and coded according to the 3GPP2 document "G3G CDMA DS on ANSI-41"

10.3.9.8 MIN_P_REV

This Information Element contains minimum protocol revision level.

Information Element/Group name	Need	Multi	Type and reference	Semantics description
MIN_P_REV	MP		Bit string (8)	Minimum protocol revision level. The first/leftmost bit of the bit string contains the most significant bit of the MIN_P_REV.

10.3.9.9 NID

This Information Element contains Network identification.

Information Element/Group name	Need	Multi	Type and reference	Semantics description
NID	MP		Bit string (16)	Network identification. The first/leftmost bit of the bit string contains the most significant bit of the NID.

10.3.9.10 P_REV

This Information Element contains protocol revision level.

Information Element/Group name	Need	Multi	Type and reference	Semantics description
P_REV	MP		Bit string (8)	Protocol revision level. The first/leftmost bit of the bit string contains the most significant bit of the P_REV.

10.3.9.11 SID

This Information Element contains System identification.

Information Element/Group name	Need	Multi	Type and reference	Semantics description
SID	MP		Bit string (15)	System identification. The first/leftmost bit of the bit string contains the most significant bit of the SID.

10.3.10 Multiplicity values and type constraint values

The following table includes constants that are either used as multi bounds (name starting with "max") or as high or low value in a type specification (name starting with "lo" or "hi"). Constants are specified only for values appearing more than once in the RRC specification. In case a constant is related to one or more other constants, an expression is included in the "value" column instead of the actual value.

Constant	Explanation	Value	Version
CN information			
maxCNdomains	Maximum number of CN domains	4	
UTRAN mobility information			
maxRAT	Maximum number of Radio Access Technologies	maxOtherRAT + 1	
maxOtherRAT	Maximum number of other Radio Access Technologies	15	
maxURA	Maximum number of URAs in a cell	8	
maxInterSysMessages	Maximum number of Inter System Messages	4	
maxRABsetup	Maximum number of RABs to be established	16	
UE information			
maxtransactions	Maximum number of parallel RRC transactions in downlink	25	
maxPDCPalgoType	Maximum number of PDCP algorithm types	8	
maxDRACclasses	Maximum number of UE classes which would require different DRAC parameters	8	
maxFreqBandsFDD	Maximum number of frequency bands supported by the UE as defined in [21]	8	
maxFreqBandsTDD	Maximum number of frequency bands supported by the UE as defined in [22]	4	
maxFreqBandsGSM	Maximum number of frequency bands supported by the UE as defined in [45]	16	
maxPage1	Number of UEs paged in the Paging Type 1 message	8	
maxSystemCapability	Maximum number of system specific capabilities that can be requested in one message.	16	
RB information			
maxPredefConfig	Maximum number of predefined configurations	16	
maxRB	Maximum number of RBs	32	
maxSRBsetup	Maximum number of signalling RBs to be established	8	
maxRBperRAB	Maximum number of RBs per RAB	8	
maxRBallRABs	Maximum number of non signalling RBs	27	
maxRBMuxOptions	Maximum number of RB multiplexing options	8	
maxLoCHperRLC	Maximum number of logical channels per RLC entity	2	
MaxROHC-PacketSizes	Maximum number of packet sizes that are allowed to be produced by ROHC.	16	
MaxROHC-Profiles	Maximum number of profiles supported by ROHC on a given RB.	8	
TrCH information			
maxTrCH	Maximum number of transport channels used in one direction (UL or DL)	32	
maxTrCHpreconf	Maximum number of preconfigured Transport channels, per direction	16	
maxCCTrCH	Maximum number of CCTrCHs	8	
maxTF	Maximum number of different transport formats that can be included in the Transport format set for one transport channel	32	
maxTF-CPCH	Maximum number of TFs in a CPCH set	16	
maxTFC	Maximum number of Transport Format Combinations	1024	
maxTFCsub	Maximum number of Transport Format Combinations Subset	1024	
maxTFCl-1-Combs	Maximum number of TFCl (field 1) combinations	512	
maxTFCl-2-Combs	Maximum number of TFCl (field 2) combinations	512	
maxCPCHsets	Maximum number of CPCH sets per cell	16	
maxSIBperMsg	Maximum number of complete system information blocks per SYSTEM INFORMATION message	16	
maxSIB	Maximum number of references to other system information blocks.	32	
maxSIB-FACH	Maximum number of references to system information blocks on the FACH	8	
PhyCH information			

Constant	Explanation	Value	Version
maxPCPCH-APsubCH	Maximum number of available sub-channels for AP signature on PCPCH	12	
maxPCPCH-CDsubCH	Maximum number of available sub-channels for CD signature on PCPCH	12	
maxPCPCH-APsig	Maximum number of available signatures for AP on PCPCH	16	
maxPCPCH-CDsig	Maximum number of available signatures for CD on PCPCH	16	
maxAC	Maximum number of access classes	16	
maxASC	Maximum number of access service classes	8	
maxASCmap	Maximum number of access class to access service classes mappings	7	
maxASCpersist	Maximum number of access service classes for which persistence scaling factors are specified	6	
maxPRACH	Maximum number of PRACHs in a cell	16	
MaxPRACH_FPACH	Maximum number of PRACH / FPACH pairs in a cell (1.28 Mcps TDD)	8	REL-4
maxFACHPCH	Maximum number of FACHs and PCHs mapped onto one secondary CCPCHs	8	
maxRL	Maximum number of radio links	8	
maxSCCPCH	Maximum number of secondary CCPCHs per cell	16	
maxDPDCH-UL	Maximum number of DPDCHs per cell	6	
maxDPCH-DLchan	Maximum number of channelisation codes used for DL DPCH	8	
maxPUSCH	Maximum number of PUSCHs	(8)	
maxPDSCH	Maximum number of PDSCHs	8	
maxPDSCHcodes	Maximum number of codes for PDSCH	16	
maxPDSCH-TFCIgroups	Maximum number of TFCI groups for PDSCH	256	
maxPDSCHcodeGroups	Maximum number of code groups for PDSCH	256	
maxPCPCHs	Maximum number of PCPCH channels in a CPCH Set	64	
maxPCPCH-SF	Maximum number of available SFs on PCPCH	7	
maxTS	Maximum number of timeslots used in one direction (UL or DL)	14 (3.84 Mcps TDD) 6 (1.28 Mcps TDD)	REL-4
hiPUSCHidentities	Maximum number of PUSCH Identities	64	
hiPDSCHidentities	Maximum number of PDSCH Identities	64	
Measurement information			
maxTGPS	Maximum number of transmission gap pattern sequences	6	
maxAdditionalMeas	Maximum number of additional measurements for a given measurement identity	4	
maxMeasEvent	Maximum number of events that can be listed in measurement reporting criteria	8	
maxMeasParEvent	Maximum number of measurement parameters (e.g. thresholds) per event	2	
maxMeasIntervals	Maximum number of intervals that define the mapping function between the measurements for the cell quality Q of a cell and the representing quality value	1	
maxCellMeas	Maximum number of cells to measure	32	
maxReportedGSMCells	Maximum number of GSM cells to be reported	6	
maxFreq	Maximum number of frequencies to measure	8	
maxSat	Maximum number of satellites to measure	16	
HiRM	Maximum number that could be set as rate matching attribute for a transport channel	256	
Frequency information			
maxFDDFreqList	Maximum number of FDD carrier frequencies to be stored in USIM	4	
maxTDDFreqList	Maximum number of TDD carrier frequencies to be stored in USIM	4	
maxFDDFreqCellList	Maximum number of neighbouring FDD cells to be	32	

Constant	Explanation	Value	Version
	stored in USIM		
maxTDDFreqCellList	Maximum number of neighbouring TDD cells to be stored in USIM	32	
maxGSMCellList	Maximum number of GSM cells to be stored in USIM	32	
Other information			
maxNumGSMFreqRanges	Maximum number of GSM Frequency Ranges to store	32	
maxNumFDDFreqs	Maximum number of FDD centre frequencies to store	8	
maxNumTDDFreqs	Maximum number of TDD centre frequencies to store	8	
maxNumCDMA200Freqs	Maximum number of CDMA2000 centre frequencies to store	8	

11 Message and Information element abstract syntax (with ASN.1)

This clause contains definitions for RRC PDUs and IEs using a subset of ASN.1 as specified in [14]. PDU and IE definitions are grouped into separate ASN.1 modules.

11.0 General

Some messages and/or IEs may include one or more IEs with name "dummy" that are included only in the ASN.1. The UE should avoid sending information elements that are named "dummy" to UTRAN. Likewise, UTRAN should avoid sending IEs with name "dummy" to the UE. If the UE anyhow receives an information element named "dummy", it shall ignore the IE and process the rest of the message as if the IE was not included.

NOTE: An IE with name "dummy" concerns an information element that was (erroneously) included in a previous version of the specification and has been removed by replacing it with a dummy with same type.

The UE shall only include the "variable length container" when it sends a non critical extension that according to this specification shall be transferred within this container.

If the abstract syntax of an IE is defined using the ASN.1 type "BIT STRING", and this IE corresponds to a functional IE definition in tabular format, in which the significance of bits is semantically defined, the following general rule shall be applied:

The bits in the ASN.1 bit string shall represent the semantics of the functional IE definition in decreasing order of bit significance;

- with the first (or leftmost) bit in the bit string representing the most significant bit; and
- with the last (or rightmost) bit in the bit string representing the least significant bit.

11.1 General message structure

```
Class-definitions DEFINITIONS AUTOMATIC TAGS ::=
```

```
BEGIN
```

```
IMPORTS
```

```
    ActiveSetUpdate,
    ActiveSetUpdateComplete,
    ActiveSetUpdateFailure,
    AssistanceDataDelivery,
    CellChangeOrderFromUTRAN,
    CellChangeOrderFromUTRANFailure,
```



```

CellUpdate,
CellUpdateConfirm-CCCH,
CellUpdateConfirm,
CounterCheck,
CounterCheckResponse,
DownlinkDirectTransfer,
HandoverToUTRANComplete,
InitialDirectTransfer,
HandoverFromUTRANCommand-GSM,
HandoverFromUTRANCommand-CDMA2000,
HandoverFromUTRANFailure,
MeasurementControl,
MeasurementControlFailure,
MeasurementReport,
PagingType1,
PagingType2,
PhysicalChannelReconfiguration,
PhysicalChannelReconfigurationComplete,
PhysicalChannelReconfigurationFailure,
PhysicalSharedChannelAllocation,
PUSCHCapacityRequest,
RadioBearerReconfiguration,
RadioBearerReconfigurationComplete,
RadioBearerReconfigurationFailure,
RadioBearerRelease,
RadioBearerReleaseComplete,
RadioBearerReleaseFailure,
RadioBearerSetup,
RadioBearerSetupComplete,
RadioBearerSetupFailure,
RRCConnectionReject,
RRCConnectionRelease,
RRCConnectionRelease-CCCH,
RRCConnectionReleaseComplete,
RRCConnectionRequest,
RRCConnectionSetup,
RRCConnectionSetupComplete,
RRCStatus,
SecurityModeCommand,
SecurityModeComplete,
SecurityModeFailure,
SignallingConnectionRelease,
SignallingConnectionReleaseIndication,
SystemInformation-BCH,
SystemInformation-FACH,
SystemInformationChangeIndication,
TransportChannelReconfiguration,
TransportChannelReconfigurationComplete,
TransportChannelReconfigurationFailure,
TransportFormatCombinationControl,
TransportFormatCombinationControlFailure,
UECapabilityEnquiry,
UECapabilityInformation,
UECapabilityInformationConfirm,
UplinkDirectTransfer,
UplinkPhysicalChannelControl,
URAUpdate,
URAUpdateConfirm,
URAUpdateConfirm-CCCH,
UTRANMobilityInformation,
UTRANMobilityInformationConfirm,
UTRANMobilityInformationFailure
FROM PDU-definitions

-- User Equipment IEs :
  IntegrityCheckInfo
FROM InformationElements;

--*****
--
-- Downlink DCCH messages
--
--*****

DL-DCCH-Message ::= SEQUENCE {
  integrityCheckInfo      IntegrityCheckInfo      OPTIONAL,
  message                  DL-DCCH-MessageType
}

```

```
DL-DCCH-MessageType ::= CHOICE {
    activeSetUpdate           ActiveSetUpdate,
    assistanceDataDelivery   AssistanceDataDelivery,
    cellChangeOrderFromUTRAN CellChangeOrderFromUTRAN,
    cellUpdateConfirm        CellUpdateConfirm,
    counterCheck             CounterCheck,
    downlinkDirectTransfer   DownlinkDirectTransfer,
    handoverFromUTRANCommand-GSM HandoverFromUTRANCommand-GSM,
    handoverFromUTRANCommand-CDMA2000 HandoverFromUTRANCommand-CDMA2000,
    measurementControl       MeasurementControl,
    pagingType2              PagingType2,
    physicalChannelReconfiguration PhysicalChannelReconfiguration,
    physicalSharedChannelAllocation PhysicalSharedChannelAllocation,
    radioBearerReconfiguration RadioBearerReconfiguration,
    radioBearerRelease       RadioBearerRelease,
    radioBearerSetup         RadioBearerSetup,
    rrcConnectionRelease     RRCConnectionRelease,
    securityModeCommand      SecurityModeCommand,
    signallingConnectionRelease SignallingConnectionRelease,
    transportChannelReconfiguration TransportChannelReconfiguration,
    transportFormatCombinationControl TransportFormatCombinationControl,
    ueCapabilityEnquiry      UECapabilityEnquiry,
    ueCapabilityInformationConfirm UECapabilityInformationConfirm,
    uplinkPhysicalChannelControl UplinkPhysicalChannelControl,
    uraUpdateConfirm         URAUpdateConfirm,
    utranMobilityInformation UTRANMobilityInformation,
    spare7                   NULL,
    spare6                   NULL,
    spare5                   NULL,
    spare4                   NULL,
    spare3                   NULL,
    spare2                   NULL,
    spare1                   NULL
}

```

```
--*****
--
-- Uplink DCCH messages
--
--*****

```

```
UL-DCCH-Message ::= SEQUENCE {
    integrityCheckInfo IntegrityCheckInfo OPTIONAL,
    message             UL-DCCH-MessageType
}

```

```
UL-DCCH-MessageType ::= CHOICE {
    activeSetUpdateComplete           ActiveSetUpdateComplete,
    activeSetUpdateFailure            ActiveSetUpdateFailure,
    cellChangeOrderFromUTRANFailure   CellChangeOrderFromUTRANFailure,
    counterCheckResponse              CounterCheckResponse,
    handoverToUTRANComplete           HandoverToUTRANComplete,
    initialDirectTransfer             InitialDirectTransfer,
    handoverFromUTRANFailure          HandoverFromUTRANFailure,
    measurementControlFailure         MeasurementControlFailure,
    measurementReport                 MeasurementReport,
    physicalChannelReconfigurationComplete PhysicalChannelReconfigurationComplete,
    physicalChannelReconfigurationFailure PhysicalChannelReconfigurationFailure,
    radioBearerReconfigurationComplete RadioBearerReconfigurationComplete,
    radioBearerReconfigurationFailure RadioBearerReconfigurationFailure,
    radioBearerReleaseComplete        RadioBearerReleaseComplete,
    radioBearerReleaseFailure         RadioBearerReleaseFailure,
    radioBearerSetupComplete          RadioBearerSetupComplete,
    radioBearerSetupFailure           RadioBearerSetupFailure,
    rrcConnectionReleaseComplete      RRCConnectionReleaseComplete,
    rrcConnectionSetupComplete        RRCConnectionSetupComplete,
    rrcStatus                          RRCStatus,
    securityModeComplete              SecurityModeComplete,
    securityModeFailure                SecurityModeFailure,
    signallingConnectionReleaseIndication SignallingConnectionReleaseIndication,
    transportChannelReconfigurationComplete TransportChannelReconfigurationComplete,
    transportChannelReconfigurationFailure TransportChannelReconfigurationFailure,

```

```
transportFormatCombinationControlFailure
ueCapabilityInformation      TransportFormatCombinationControlFailure,
uplinkDirectTransfer        UECapabilityInformation,
utranMobilityInformationConfirm UplinkDirectTransfer,
utranMobilityInformationFailure UTRANMobilityInformationConfirm,
spare2                       UTRANMobilityInformationFailure,
spare1                       NULL,
}                             NULL
}

--*****
--
-- Downlink CCCH messages
--
--*****

DL-CCCH-Message ::= SEQUENCE {
    integrityCheckInfo      IntegrityCheckInfo      OPTIONAL,
    message                  DL-CCCH-MessageType
}

DL-CCCH-MessageType ::= CHOICE {
    cellUpdateConfirm      CellUpdateConfirm-CCCH,
    rrcConnectionReject    RRCConnectionReject,
    rrcConnectionRelease   RRCConnectionRelease-CCCH,
    rrcConnectionSetup     RRCConnectionSetup,
    uraUpdateConfirm        URAUpdateConfirm-CCCH,
    spare3                  NULL,
    spare2                  NULL,
    spare1                  NULL
}

--*****
--
-- Uplink CCCH messages
--
--*****

UL-CCCH-Message ::= SEQUENCE {
    integrityCheckInfo      IntegrityCheckInfo      OPTIONAL,
    message                  UL-CCCH-MessageType
}

UL-CCCH-MessageType ::= CHOICE {
    cellUpdate              CellUpdate,
    rrcConnectionRequest   RRCConnectionRequest,
    uraUpdate               URAUpdate,
    spare1                  NULL
}

--*****
--
-- PCCH messages
--
--*****

PCCH-Message ::= SEQUENCE {
    message                  PCCH-MessageType
}

PCCH-MessageType ::= CHOICE {
    pagingType1            PagingType1,
    spare                  NULL
}

--*****
--
-- Downlink SHCCH messages
--
--*****

DL-SHCCH-Message ::= SEQUENCE {
    message                  DL-SHCCH-MessageType
}

DL-SHCCH-MessageType ::= CHOICE {
    physicalSharedChannelAllocation PhysicalSharedChannelAllocation,
    extension                NULL
}
```

```

}

--*****
--
-- Uplink SHCCH messages
--
--*****

UL-SHCCH-Message ::= SEQUENCE {
    message          UL-SHCCH-MessageType
}

UL-SHCCH-MessageType ::= CHOICE {
    puschCapacityRequest    PUSCHCapacityRequest,
    spare                    NULL
}

--*****
--
-- BCCH messages sent on FACH
--
--*****

BCCH-FACH-Message ::= SEQUENCE {
    message          BCCH-FACH-MessageType
}

BCCH-FACH-MessageType ::= CHOICE {
    systemInformation        SystemInformation-FACH,
    systemInformationChangeIndication    SystemInformationChangeIndication,
    spare2                   NULL,
    spare1                   NULL
}

--*****
--
-- BCCH messages sent on BCH
--
--*****

BCCH-BCH-Message ::= SEQUENCE {
    message          SystemInformation-BCH
}

END

```

11.2 PDU definitions

```

--*****
--
-- TABULAR: The message type and integrity check info are not
-- visible in this module as they are defined in the class module.
-- Also, all FDD/TDD specific choices have the FDD option first
-- and TDD second, just for consistency.
--
--*****

PDU-definitions DEFINITIONS AUTOMATIC TAGS ::=

BEGIN

--*****
--
-- IE parameter types from other modules
--
--*****

IMPORTS

-- Core Network IEs :
--   CN-DomainIdentity,
--   CN-InformationInfo,
--   CN-InformationInfoFull,
--   NAS-Message,
--   PagingRecordTypeID,
-- UTRAN Mobility IEs :

```

```
CellIdentity,
CellIdentity-PerRL-List,
URA-Identity,
-- User Equipment IEs :
AccessStratumReleaseIndicator,
ActivationTime,
C-RNTI,
CapabilityUpdateRequirement,
CapabilityUpdateRequirement-r4,
CapabilityUpdateRequirement-r4-ext,
CellUpdateCause,
CipheringAlgorithm,
CipheringModeInfo,
DSCH-RNTI,
EstablishmentCause,
FailureCauseWithProtErr,
FailureCauseWithProtErrTrId,
UESpecificBehaviourInformationIdle,
UESpecificBehaviourInformationInterRAT,
InitialUE-Identity,
IntegrityProtActivationInfo,
IntegrityProtectionModeInfo,
N-308,
PagingCause,
PagingRecordList,
ProtocolErrorIndicator,
ProtocolErrorIndicatorWithMoreInfo,
Rb-timer-indicator,
RedirectionInfo,
RejectionCause,
ReleaseCause,
RRC-StateIndicator,
RRC-TransactionIdentifier,
SecurityCapability,
START-Value,
STARTList,
U-RNTI,
U-RNTI-Short,
UE-RadioAccessCapability,
UE-RadioAccessCapability-v370ext,
UE-RadioAccessCapability-v380ext,
UE-RadioAccessCapability-v3a0ext,
UE-RadioAccessCapability-v4xyext,
DL-PhysChCapabilityFDD-v380ext,
UE-ConnTimersAndConstants,
UE-ConnTimersAndConstants-v3a0ext,
UE-SecurityInformation,
URA-UpdateCause,
UTRAN-DRX-CycleLengthCoefficient,
WaitTime,
-- Radio Bearer IEs :
DefaultConfigIdentity,
DefaultConfigIdentity-r4,
DefaultConfigMode,
DL-CounterSynchronisationInfo,
PredefinedConfigIdentity,
PredefinedConfigStatusList,
RAB-Info,
RAB-Info-Post,
RAB-InformationList,
RAB-InformationReconfigList,
RAB-InformationSetupList,
RAB-InformationSetupList-r4,
RB-ActivationTimeInfoList,
RB-COUNT-C-InformationList,
RB-COUNT-C-MSB-InformationList,
RB-IdentityList,
RB-InformationAffectedList,
RB-InformationReconfigList,
RB-InformationReconfigList-r4,
RB-InformationReleaseList,
SRB-InformationSetupList,
SRB-InformationSetupList2,
UL-CounterSynchronisationInfo,
-- Transport Channel IEs:
CPCH-SetID,
DL-AddReconfTransChInfo2List,
DL-AddReconfTransChInfoList,
```

```

DL-AddReconfTransChInfoList-r4,
DL-CommonTransChInfo,
DL-CommonTransChInfo-r4,
DL-DeletedTransChInfoList,
DRAC-StaticInformationList,
TFC-Subset,
TFC-Identity,
UL-AddReconfTransChInfoList,
UL-CommonTransChInfo,
UL-CommonTransChInfo-r4,
UL-DeletedTransChInfoList,
-- Physical Channel IEs :
Alpha,
CCTrCH-PowerControlInfo,
CCTrCH-PowerControlInfo-r4,
ConstantValue,
ConstantValueTdd,
CPCH-SetInfo,
DL-CommonInformation,
DL-CommonInformation-r4,
DL-CommonInformationPost,
DL-InformationPerRL,
DL-InformationPerRL-List,
DL-InformationPerRL-List-r4,
DL-InformationPerRL-ListPostFDD,
DL-InformationPerRL-PostTDD,
DL-InformationPerRL-PostTDD-LCR-r4,
DL-PDSCH-Information,
DPCH-CompressedModeStatusInfo,
FrequencyInfo,
FrequencyInfoFDD,
FrequencyInfoTDD,
MaxAllowedUL-TX-Power,
OpenLoopPowerControl-IPDL-TDD-r4,
PDSCH-CapacityAllocationInfo,
PDSCH-CapacityAllocationInfo-r4,
PDSCH-Identity,
PrimaryCCPCH-TX-Power,
PrimaryCPICH-Info,
PUSCH-CapacityAllocationInfo,
PUSCH-CapacityAllocationInfo-r4,
PUSCH-Identity,
RL-AdditionInformationList,
RL-RemovalInformationList,
SpecialBurstScheduling,
SSDT-Information,
TFC-ControlDuration,
SSDT-UL-r4,
TimeslotList,
TimeslotList-r4,
TX-DiversityMode,
UL-ChannelRequirement,
UL-ChannelRequirement-r4,
UL-ChannelRequirementWithCPCH-SetID,
UL-ChannelRequirementWithCPCH-SetID-r4,
UL-DPCH-Info,
UL-DPCH-Info-r4,
UL-DPCH-InfoPostFDD,
UL-DPCH-InfoPostTDD,
UL-DPCH-InfoPostTDD-LCR-r4,
UL-SynchronisationParameters-r4,
UL-TimingAdvance,
UL-TimingAdvanceControl,
UL-TimingAdvanceControl-r4,
-- Measurement IEs :
AdditionalMeasurementID-List,
Frequency-Band,
EventResults,
InterFreqEventResults-LCR-r4-ext,
InterRAT-TargetCellDescription,
MeasuredResults,
MeasuredResults-v390ext,
MeasuredResultsList,
MeasuredResultsList-LCR-r4-ext,
MeasuredResultsOnRACH,
MeasurementCommand,
MeasurementCommand-r4,
MeasurementIdentity,
MeasurementReportingMode,

```

```

PrimaryCCPCH-RSCP,
SFN-Offset-Validity,
TimeslotListWithISCP,
TrafficVolumeMeasuredResultsList,
UE-Positioning-GPS-AssistanceData,
UE-Positioning-Measurement-v390ext,
UE-Positioning-OTDOA-AssistanceData,
UE-Positioning-OTDOA-AssistanceData-r4ext,
UE-Positioning-OTDOA-AssistanceData-UEB,
-- Other IEs :
BCCH-ModificationInfo,
CDMA2000-MessageList,
GSM-MessageList,
InterRAT-ChangeFailureCause,
InterRAT-HO-FailureCause,
InterRAT-UE-RadioAccessCapabilityList,
InterRAT-UE-SecurityCapList,
IntraDomainNasNodeSelector,
ProtocolErrorMoreInformation,
Rplmn-Information,
Rplmn-Information-r4,
SegCount,
SegmentIndex,
SFN-Prime,
SIB-Data-fixed,
SIB-Data-variable,
SIB-Type
FROM InformationElements

maxSIBperMsg
FROM Constant-definitions;

-- *****
--
-- ACTIVE SET UPDATE (FDD only)
--
-- *****

ActiveSetUpdate ::= CHOICE {
  r3
    SEQUENCE {
      activeSetUpdate-r3
      laterNonCriticalExtensions
        -- Container for additional R99 extensions
        activeSetUpdate-r3-add-ext BIT STRING OPTIONAL,
        v4xyNonCriticalExtensions
          activeSetUpdate-v4xyext ActiveSetUpdate-v4xyext-IEs,
          nonCriticalExtensions SEQUENCE {} OPTIONAL
        } OPTIONAL
    },
  later-than-r3
    SEQUENCE {
      rrc-TransactionIdentifier RRC-TransactionIdentifier,
      criticalExtensions SEQUENCE {}
    }
}

ActiveSetUpdate-r3-IEs ::= SEQUENCE {
  -- User equipment IEs
  rrc-TransactionIdentifier RRC-TransactionIdentifier,
  -- dummy and dummy2 are not used in this version of the specification, they should
  -- not be sent and if received they should be ignored.
  dummy IntegrityProtectionModeInfo OPTIONAL,
  dummy2 CipheringModeInfo OPTIONAL,
  activationTime ActivationTime OPTIONAL,
  newU-RNTI U-RNTI OPTIONAL,
  -- Core network IEs
  cn-InformationInfo CN-InformationInfo OPTIONAL,
  -- Radio bearer IEs
  -- dummy3 is not used in this version of the specification, it should
  -- not be sent and if received it should be ignored.
  dummy3 DL-CounterSynchronisationInfo OPTIONAL,
  -- Physical channel IEs
  maxAllowedUL-TX-Power MaxAllowedUL-TX-Power OPTIONAL,
  rl-AdditionInformationList RL-AdditionInformationList OPTIONAL,
  rl-RemovalInformationList RL-RemovalInformationList OPTIONAL,
  tx-DiversityMode TX-DiversityMode OPTIONAL,
  ssdt-Information SSDT-Information OPTIONAL
}

```

```

ActiveSetUpdate-v4xyext-IEs ::= SEQUENCE {
  -- Physical channel IEs
  -- ssdt-UL extends SSDT-Information. FDD only.
  ssdt-UL                               SSDT-UL-r4                               OPTIONAL,
  -- The order of the RLs in IE cell-id-PerRL-List is the same as
  -- in IE RL-AdditionInformationList included in this message
  cell-id-PerRL-List                     CellIdentity-PerRL-List                 OPTIONAL
}

-- *****
--
-- ACTIVE SET UPDATE COMPLETE (FDD only)
--
-- *****

ActiveSetUpdateComplete ::= SEQUENCE {
  -- User equipment IEs
  rrc-TransactionIdentifier               RRC-TransactionIdentifier,
  -- dummy is not used in this version of the specification, it should
  -- not be sent and if received it should be ignored.
  dummy                                   IntegrityProtActivationInfo           OPTIONAL,
  -- Radio bearer IEs
  -- dummy2 and dummy3 are not used in this version of the specification, they should
  -- not be sent and if received they should be ignored.
  dummy2                                  RB-ActivationTimeInfoList             OPTIONAL,
  dummy3                                  UL-CounterSynchronisationInfo         OPTIONAL,
  laterNonCriticalExtensions              SEQUENCE {
    -- Container for additional R99 extensions
    activeSetUpdateComplete-r3-add-ext    BIT STRING                            OPTIONAL,
    nonCriticalExtensions                  SEQUENCE {}                            OPTIONAL
  }
}

-- *****
--
-- ACTIVE SET UPDATE FAILURE (FDD only)
--
-- *****

ActiveSetUpdateFailure ::= SEQUENCE {
  -- User equipment IEs
  rrc-TransactionIdentifier               RRC-TransactionIdentifier,
  failureCause                            FailureCauseWithProtErr,
  laterNonCriticalExtensions              SEQUENCE {
    -- Container for additional R99 extensions
    activeSetUpdateFailure-r3-add-ext     BIT STRING                            OPTIONAL,
    nonCriticalExtensions                  SEQUENCE {}                            OPTIONAL
  }
}

-- *****
--
-- Assistance Data Delivery
--
-- *****

AssistanceDataDelivery ::= CHOICE {
  r3                                       SEQUENCE {
    assistanceDataDelivery-r3             AssistanceDataDelivery-r3-IEs,
    v3aoNonCriticalExtensions              SEQUENCE {
      assistanceDataDelivery-v3a0ext      AssistanceDataDelivery-v3a0ext,
      laterNonCriticalExtensions          SEQUENCE {
        -- Container for additional R99 extensions
        assistanceDataDelivery-r3-add-ext  BIT STRING                            OPTIONAL,
        v4xyNonCriticalExtensions          SEQUENCE {
          assistanceDataDelivery-v4xyext
        }
      }
    }
  },
  later-than-r3                             SEQUENCE {
    rrc-TransactionIdentifier             RRC-TransactionIdentifier,
    criticalExtensions                     SEQUENCE {}
  }
}

```



```

AssistanceDataDelivery-r3-IEs ::= SEQUENCE {
  -- User equipment IEs
  rrc-TransactionIdentifier      RRC-TransactionIdentifier,
  -- Measurement Information Elements
  ue-positioning-GPS-AssistanceData      UE-Positioning-GPS-AssistanceData
  OPTIONAL,
  ue-positioning-OTDOA-AssistanceData-UEB      UE-Positioning-OTDOA-AssistanceData-UEB
  OPTIONAL
}

AssistanceDataDelivery-v3a0ext ::= SEQUENCE {
  sfn-Offset-Validity      SFN-Offset-Validity      OPTIONAL
}

AssistanceDataDelivery-v4xyext-IEs ::= SEQUENCE {
  ue-Positioning-OTDOA-AssistanceData-r4ext      UE-Positioning-OTDOA-AssistanceData-r4ext      OPTIONAL
}

-- *****
--
-- CELL CHANGE ORDER FROM UTRAN
--
-- *****

CellChangeOrderFromUTRAN ::= CHOICE {
  r3      SEQUENCE {
    cellChangeOrderFromUTRAN-IEs      CellChangeOrderFromUTRAN-r3-IEs,
    laterNonCriticalExtensions      SEQUENCE {
      -- Container for additional R99 extensions
      cellChangeOrderFromUTRAN-r3-add-ext      BIT STRING      OPTIONAL,
      nonCriticalExtensions      SEQUENCE {} OPTIONAL
    } OPTIONAL
  },
  later-than-r3      SEQUENCE {
    rrc-TransactionIdentifier      RRC-TransactionIdentifier,
    criticalExtensions      SEQUENCE {}
  }
}

CellChangeOrderFromUTRAN-r3-IEs ::= SEQUENCE {
  -- User equipment IEs
  rrc-TransactionIdentifier      RRC-TransactionIdentifier,
  -- dummy is not used in this version of the specification, it should
  -- not be sent and if received it should be ignored.
  dummy      IntegrityProtectionModeInfo      OPTIONAL,
  activationTime      ActivationTime      OPTIONAL,
  -- the IE rab-InformationList is not used in this version of the specification, it should
  -- not be sent and if received it should be ignored. The IE may be used in a later
  -- version of the protocol and hence it is not changed into a dummy
  rab-InformationList      RAB-InformationList      OPTIONAL,
  interRAT-TargetCellDescription      InterRAT-TargetCellDescription
}

-- *****
--
-- CELL CHANGE ORDER FROM UTRAN FAILURE
--
-- *****

CellChangeOrderFromUTRANFailure ::= CHOICE {
  r3      SEQUENCE {
    cellChangeOrderFromUTRANFailure-r3
      CellChangeOrderFromUTRANFailure-r3-IEs,
    laterNonCriticalExtensions      SEQUENCE {
      -- Container for additional R99 extensions
      cellChangeOrderFromUTRANFailure-r3-add-ext      BIT STRING      OPTIONAL,
      nonCriticalExtensions      SEQUENCE {} OPTIONAL
    } OPTIONAL
  },
  -- dummy is not used in this version of the specification and it
  -- should be ignored.
  dummy      SEQUENCE {
    rrc-TransactionIdentifier      RRC-TransactionIdentifier,
    criticalExtensions      SEQUENCE {}
  }
}

```

```

CellChangeOrderFromUTRANFailure-r3-IEs ::= SEQUENCE {
  -- User equipment IES
  rrc-TransactionIdentifier      RRC-TransactionIdentifier,
  -- dummy is not used in this version of the specification, it should
  -- not be sent and if received it should be ignored.
  dummy                          IntegrityProtectionModeInfo      OPTIONAL,
  interRAT-ChangeFailureCause    InterRAT-ChangeFailureCause
}

-- *****
--
-- CELL UPDATE
--
-- *****

CellUpdate ::= SEQUENCE {
  -- User equipment IES
  u-RNTI                          U-RNTI,
  startList                        STARTList,
  am-RLC-ErrorIndicationRb2-3or4  BOOLEAN,
  am-RLC-ErrorIndicationRb5orAbove  BOOLEAN,
  cellUpdateCause                  CellUpdateCause,
  -- TABULAR: RRC transaction identifier is nested in FailureCauseWithProtErrTrId
  failureCause                     FailureCauseWithProtErrTrId    OPTIONAL,
  rb-timer-indicator               Rb-timer-indicator,
  -- Measurement IES
  measuredResultsOnRACH             MeasuredResultsOnRACH        OPTIONAL,
  laterNonCriticalExtensions        SEQUENCE {
    -- Container for additional R99 extensions
    cellUpdate-r3-add-ext           BIT STRING OPTIONAL,
    nonCriticalExtensions           SEQUENCE {} OPTIONAL
  } OPTIONAL
}

-- *****
--
-- CELL UPDATE CONFIRM
--
-- *****

CellUpdateConfirm ::= CHOICE {
  r3                                SEQUENCE {
    cellUpdateConfirm-r3            CellUpdateConfirm-r3-IEs,
    v3a0NonCriticalExtensions        SEQUENCE {
      cellUpdateConfirm-v3a0ext     CellUpdateConfirm-v3a0ext,
      laterNonCriticalExtensions    SEQUENCE {
        -- Container for additional R99 extensions
        cellUpdateConfirm-r3-add-ext BIT STRING OPTIONAL,
        v4xyNonCriticalExtensions    SEQUENCE {
          cellUpdateConfirm-v4xyext CellUpdateConfirm-v4xyext-IEs,
          nonCriticalExtensions      SEQUENCE {} OPTIONAL
        } OPTIONAL
      } OPTIONAL
    } OPTIONAL
  },
  later-than-r3                     SEQUENCE {
    rrc-TransactionIdentifier        RRC-TransactionIdentifier,
    criticalExtensions               CHOICE {
      r4                              SEQUENCE {
        cellUpdateConfirm-r4        CellUpdateConfirm-r4-IEs,
        nonCriticalExtensions        SEQUENCE {} OPTIONAL
      },
      criticalExtensions             SEQUENCE {}
    }
  }
}

CellUpdateConfirm-r3-IEs ::= SEQUENCE {
  -- User equipment IES
  rrc-TransactionIdentifier          RRC-TransactionIdentifier,
  integrityProtectionModeInfo        IntegrityProtectionModeInfo    OPTIONAL,
  cipheringModeInfo                  CipheringModeInfo              OPTIONAL,
  activationTime                      ActivationTime                  OPTIONAL,
  new-U-RNTI                          U-RNTI                        OPTIONAL,
  new-C-RNTI                          C-RNTI                        OPTIONAL,
  rrc-StateIndicator                  RRC-StateIndicator,
  utran-DRX-CycleLengthCoeff          UTRAN-DRX-CycleLengthCoefficient  OPTIONAL,
  rlc-Re-establishIndicatorRb2-3or4    BOOLEAN,

```

```

    rlc-Re-establishIndicatorRb5orAbove    BOOLEAN,
-- CN information elements
  cn-InformationInfo                      CN-InformationInfo          OPTIONAL,
-- UTRAN mobility IEs
  ura-Identity                            URA-Identity                OPTIONAL,
-- Radio bearer IEs
  rb-InformationReleaseList               RB-InformationReleaseList    OPTIONAL,
  rb-InformationReconfigList              RB-InformationReconfigList   OPTIONAL,
  rb-InformationAffectedList              RB-InformationAffectedList   OPTIONAL,
  dl-CounterSynchronisationInfo           DL-CounterSynchronisationInfo OPTIONAL,
-- Transport channel IEs
  ul-CommonTransChInfo                   UL-CommonTransChInfo        OPTIONAL,
  ul-deletedTransChInfoList               UL-DeletedTransChInfoList    OPTIONAL,
  ul-AddReconfTransChInfoList             UL-AddReconfTransChInfoList  OPTIONAL,
  modeSpecificTransChInfo                 CHOICE {
    fdd                                     SEQUENCE {
      cpch-SetID                           CPCH-SetID                   OPTIONAL,
      addReconfTransChDRAC-Info             DRAC-StaticInformationList   OPTIONAL
    },
    tdd                                     NULL
  },
  dl-CommonTransChInfo                   DL-CommonTransChInfo        OPTIONAL,
  dl-DeletedTransChInfoList               DL-DeletedTransChInfoList    OPTIONAL,
  dl-AddReconfTransChInfoList             DL-AddReconfTransChInfoList  OPTIONAL,
-- Physical channel IEs
  frequencyInfo                           FrequencyInfo                 OPTIONAL,
  maxAllowedUL-TX-Power                   MaxAllowedUL-TX-Power        OPTIONAL,
  ul-ChannelRequirement                   UL-ChannelRequirement        OPTIONAL,
  modeSpecificPhysChInfo                  CHOICE {
    fdd                                     SEQUENCE {
      dl-PDSCH-Information                   DL-PDSCH-Information         OPTIONAL
    },
    tdd                                     NULL
  },
  dl-CommonInformation                   DL-CommonInformation         OPTIONAL,
  dl-InformationPerRL-List                DL-InformationPerRL-List     OPTIONAL
}

CellUpdateConfirm-v3a0ext ::= SEQUENCE {
  new-DSCH-RNTI                          DSCH-RNTI                    OPTIONAL
}

CellUpdateConfirm-v4xyext-IEs ::= SEQUENCE {
-- Physical channel IEs
-- ssdt-UL extends SSdT-Information, which is included in
-- DL-CommonInformation. FDD only.
  ssdt-UL                                  SSdT-UL-r4                    OPTIONAL,
-- The order of the RLs in IE cell-id-PerRL-List is the same as
-- in IE DL-InformationPerRL-List included in this message
  cell-id-PerRL-List                       CellIdentity-PerRL-List      OPTIONAL
}

CellUpdateConfirm-r4-IEs ::= SEQUENCE {
-- User equipment IEs
  integrityProtectionModeInfo              IntegrityProtectionModeInfo   OPTIONAL,
  cipheringModeInfo                       CipheringModeInfo              OPTIONAL,
  activationTime                           ActivationTime                  OPTIONAL,
  new-U-RNTI                               U-RNTI                        OPTIONAL,
  new-C-RNTI                               C-RNTI                        OPTIONAL,
  new-DSCH-RNTI                           DSCH-RNTI                     OPTIONAL,
  rrc-StateIndicator                      RRC-StateIndicator,          OPTIONAL,
  utran-DRX-CycleLengthCoeff              UTRAN-DRX-CycleLengthCoefficient OPTIONAL,
  rlc-ResetIndicatorC-Plane                BOOLEAN,
  rlc-ResetIndicatorU-Plane                BOOLEAN,
-- CN information elements
  cn-InformationInfo                      CN-InformationInfo          OPTIONAL,
-- UTRAN mobility IEs
  ura-Identity                            URA-Identity                OPTIONAL,
-- Radio bearer IEs
  rb-InformationReleaseList               RB-InformationReleaseList    OPTIONAL,
  rb-InformationReconfigList-r4            RB-InformationReconfigList-r4 OPTIONAL,
  rb-InformationAffectedList              RB-InformationAffectedList   OPTIONAL,
  dl-CounterSynchronisationInfo           DL-CounterSynchronisationInfo OPTIONAL,
-- Transport channel IEs
  ul-CommonTransChInfo-r4                 UL-CommonTransChInfo-r4      OPTIONAL,
  ul-deletedTransChInfoList               UL-DeletedTransChInfoList    OPTIONAL,
  ul-AddReconfTransChInfoList             UL-AddReconfTransChInfoList  OPTIONAL,
  modeSpecificTransChInfo                 CHOICE {

```

```

        fdd                SEQUENCE {
            cpch-SetID      CPCH-SetID                OPTIONAL,
            addReconfTransChDRAC-Info DRAC-StaticInformationList OPTIONAL
        },
        tdd                NULL
    },
    dl-CommonTransChInfo    DL-CommonTransChInfo-r4        OPTIONAL,
    dl-DeletedTransChInfoList DL-DeletedTransChInfoList    OPTIONAL,
    dl-AddReconfTransChInfoList DL-AddReconfTransChInfoList-r4    OPTIONAL,
-- Physical channel IEs
    frequencyInfo          FrequencyInfo                OPTIONAL,
    maxAllowedUL-TX-Power   MaxAllowedUL-TX-Power        OPTIONAL,
    ul-ChannelRequirement   UL-ChannelRequirement-r4     OPTIONAL,
    modeSpecificPhysChInfo  CHOICE {
        fdd                SEQUENCE {
            dl-PDSCH-Information DL-PDSCH-Information    OPTIONAL
        },
        tdd                NULL
    },
    dl-CommonInformation    DL-CommonInformation-r4        OPTIONAL,
    dl-InformationPerRL-List DL-InformationPerRL-List-r4    OPTIONAL
}

-- *****
--
-- CELL UPDATE CONFIRM for CCCH
--
-- *****

CellUpdateConfirm-CCCH ::= CHOICE {
    r3                SEQUENCE {
        -- User equipment IEs
        u-RNTI          U-RNTI,
        -- The rest of the message is identical to the one sent on DCCH.
        cellUpdateConfirm-r3 CellUpdateConfirm-r3-IEs,
        laterNonCriticalExtensions SEQUENCE {
            -- Container for additional R99 extensions
            cellUpdateConfirm-CCCH-r3-add-ext BIT STRING OPTIONAL,
            v4xyNonCriticalExtensions SEQUENCE {
                cellUpdateConfirm-v4xyext CellUpdateConfirm-v4xyext-IEs,
                nonCriticalExtensions SEQUENCE {} OPTIONAL
            } OPTIONAL
        } OPTIONAL
    },
    later-than-r3      SEQUENCE {
        u-RNTI          U-RNTI,
        rrc-TransactionIdentifier RRC-TransactionIdentifier,
        criticalExtensions CHOICE {
            r4                SEQUENCE {
                -- The rest of the message is identical to the one sent on DCCH.
                cellUpdateConfirm-r4 CellUpdateConfirm-r4-IEs,
                nonCriticalExtensions SEQUENCE {} OPTIONAL
            },
            criticalExtensions SEQUENCE {}
        }
    }
}

-- *****
--
-- COUNTER CHECK
--
-- *****

CounterCheck ::= CHOICE {
    r3                SEQUENCE {
        counterCheck-r3 CounterCheck-r3-IEs,
        laterNonCriticalExtensions SEQUENCE {
            -- Container for additional R99 extensions
            counterCheck-r3-add-ext BIT STRING OPTIONAL,
            nonCriticalExtensions SEQUENCE {} OPTIONAL
        } OPTIONAL
    },
    later-than-r3      SEQUENCE {
        rrc-TransactionIdentifier RRC-TransactionIdentifier,
        criticalExtensions SEQUENCE {}
    }
}

```

```

CounterCheck-r3-IEs ::= SEQUENCE {
  -- User equipment IEs
  rrc-TransactionIdentifier      RRC-TransactionIdentifier,
  -- Radio bearer IEs
  rb-COUNT-C-MSB-InformationList  RB-COUNT-C-MSB-InformationList
}

-- *****
--
-- COUNTER CHECK RESPONSE
--
-- *****

CounterCheckResponse ::= SEQUENCE {
  -- User equipment IEs
  rrc-TransactionIdentifier      RRC-TransactionIdentifier,
  -- Radio bearer IEs
  rb-COUNT-C-InformationList     RB-COUNT-C-InformationList          OPTIONAL,
  laterNonCriticalExtensions     SEQUENCE {
    -- Container for additional R99 extensions
    counterCheckResponse-r3-add-ext  BIT STRING OPTIONAL,
    nonCriticalExtensions            SEQUENCE {} OPTIONAL
  } OPTIONAL
}

-- *****
--
-- DOWNLINK DIRECT TRANSFER
--
-- *****

DownlinkDirectTransfer ::= CHOICE {
  r3
  SEQUENCE {
    downlinkDirectTransfer-r3      DownlinkDirectTransfer-r3-IEs,
    laterNonCriticalExtensions     SEQUENCE {
      -- Container for additional R99 extensions
      downlinkDirectTransfer-r3-add-ext  BIT STRING OPTIONAL,
      nonCriticalExtensions            SEQUENCE {} OPTIONAL
    } OPTIONAL
  },
  later-than-r3
  SEQUENCE {
    rrc-TransactionIdentifier      RRC-TransactionIdentifier,
    criticalExtensions            SEQUENCE {}
  }
}

DownlinkDirectTransfer-r3-IEs ::= SEQUENCE {
  -- User equipment IEs
  rrc-TransactionIdentifier      RRC-TransactionIdentifier,
  -- Core network IEs
  cn-DomainIdentity             CN-DomainIdentity,
  nas-Message                    NAS-Message
}

-- *****
--
-- HANDOVER TO UTRAN COMMAND
--
-- *****

HandoverToUTRANCommand ::= CHOICE {
  r3
  SEQUENCE {
    handoverToUTRANCommand-r3      HandoverToUTRANCommand-r3-IEs,
    v4xyNonCriticalExtensions       SEQUENCE {
      handoverToUTRANCommand-v4xyext  HandoverToUTRANCommand-v4xyext-IEs,
      nonCriticalExtensions           SEQUENCE {} OPTIONAL
    } OPTIONAL
  },
  criticalExtensions
  CHOICE {
    r4
    SEQUENCE {
      handoverToUTRANCommand-r4      HandoverToUTRANCommand-r4-IEs,
      nonCriticalExtensions           SEQUENCE {} OPTIONAL
    },
    criticalExtensions
    SEQUENCE {}
  }
}

```

```

HandoverToUTRANCommand-r3-IEs ::= SEQUENCE {
  -- User equipment IEs
  new-U-RNTI                U-RNTI-Short,
  -- dummy is not used in this version of specification, it should
  -- not be sent and if received it should be ignored.
  dummy                    ActivationTime                OPTIONAL,
  cipheringAlgorithm       CipheringAlgorithm           OPTIONAL,
  -- Radio bearer IEs
  -- Specification mode information
  specificationMode        CHOICE {
    complete                SEQUENCE {
      srb-InformationSetupList  SRB-InformationSetupList,
      rab-InformationSetupList  RAB-InformationSetupList    OPTIONAL,
      ul-CommonTransChInfo     UL-CommonTransChInfo,
      ul-AddReconfTransChInfoList  UL-AddReconfTransChInfoList,
      dl-CommonTransChInfo     DL-CommonTransChInfo,
      dl-AddReconfTransChInfoList  DL-AddReconfTransChInfoList,
      ul-DPCH-Info             UL-DPCH-Info,
      modeSpecificInfo         CHOICE {
        fdd                    SEQUENCE {
          dl-PDSCH-Information  DL-PDSCH-Information  OPTIONAL,
          cpch-SetInfo         CPCH-SetInfo          OPTIONAL
        },
        tdd                    NULL
      },
      dl-CommonInformation     DL-CommonInformation,
      dl-InformationPerRL-List  DL-InformationPerRL-List,
      frequencyInfo            FrequencyInfo
    },
    preconfiguration         SEQUENCE {
      predefinedConfigIdentity  PredefinedConfigIdentity,
      defaultConfig            SEQUENCE {
        defaultConfigMode      DefaultConfigMode,
        defaultConfigIdentity  DefaultConfigIdentity
      }
    },
    rab-Info                  RAB-Info-Post    OPTIONAL,
    modeSpecificInfo          CHOICE {
      fdd                      SEQUENCE {
        ul-DPCH-Info           UL-DPCH-InfoPostFDD,
        dl-CommonInformationPost  DL-CommonInformationPost,
        dl-InformationPerRL-List  DL-InformationPerRL-ListPostFDD,
        frequencyInfo           FrequencyInfoFDD
      },
      tdd                      SEQUENCE {
        ul-DPCH-Info           UL-DPCH-InfoPostTDD,
        dl-CommonInformationPost  DL-CommonInformationPost,
        dl-InformationPerRL      DL-InformationPerRL-PostTDD,
        frequencyInfo           FrequencyInfoTDD,
        primaryCCPCH-TX-Power    PrimaryCCPCH-TX-Power
      }
    }
  },
  -- Physical channel IEs
  maxAllowedUL-TX-Power     MaxAllowedUL-TX-Power
}

HandoverToUTRANCommand-v4xyext-IEs ::= SEQUENCE {
  -- Physical channel IEs
  -- ssdt-UL extends SSdT-Information, which is included in
  -- DL-CommonInformation. FDD only.
  ssdt-UL                   SSdT-UL-r4          OPTIONAL,
  cell-id                   CellIdentity        OPTIONAL
}

HandoverToUTRANCommand-r4-IEs ::= SEQUENCE {
  -- User equipment IEs
  new-U-RNTI                U-RNTI-Short,
  cipheringAlgorithm       CipheringAlgorithm           OPTIONAL,
  -- Radio bearer IEs
  -- Specification mode information

```

```

specificationMode CHOICE {
  complete SEQUENCE {
    srb-InformationSetupList SRB-InformationSetupList,
    rab-InformationSetupList RAB-InformationSetupList-r4 OPTIONAL,
    ul-CommonTransChInfo UL-CommonTransChInfo,
    ul-AddReconfTransChInfoList UL-AddReconfTransChInfoList,
    dl-CommonTransChInfo DL-CommonTransChInfo,
    dl-AddReconfTransChInfoList DL-AddReconfTransChInfoList,
    ul-DPCH-Info UL-DPCH-Info-r4,
    modeSpecificInfo CHOICE {
      fdd SEQUENCE {
        dl-PDSCH-Information DL-PDSCH-Information OPTIONAL,
        cpch-SetInfo CPCH-SetInfo OPTIONAL
      },
      tdd NULL
    },
    dl-CommonInformation DL-CommonInformation-r4,
    dl-InformationPerRL-List DL-InformationPerRL-List-r4,
    frequencyInfo FrequencyInfo
  },
  preconfiguration SEQUENCE {
    -- All IEs that include an FDD/TDD choice are split in two IEs for this message,
    -- one for the FDD only elements and one for the TDD only elements, so that one
    -- FDD/TDD choice in this level is sufficient.
    preConfigMode CHOICE {
      predefinedConfigIdentity PredefinedConfigIdentity,
      defaultConfig SEQUENCE {
        defaultConfigMode DefaultConfigMode,
        defaultConfigIdentity DefaultConfigIdentity-r4
      }
    },
    rab-Info RAB-Info-Post OPTIONAL,
    modeSpecificInfo CHOICE {
      fdd SEQUENCE {
        ul-DPCH-Info UL-DPCH-InfoPostFDD,
        dl-CommonInformationPost DL-CommonInformationPost,
        dl-InformationPerRL-List DL-InformationPerRL-ListPostFDD,
        frequencyInfo FrequencyInfoFDD
      },
      tdd CHOICE {
        tdd384 SEQUENCE {
          ul-DPCH-Info UL-DPCH-InfoPostTDD,
          dl-InformationPerRL dl-InformationPerRL-PostTDD,
          frequencyInfo FrequencyInfoTDD,
          primaryCCPCH-TX-Power PrimaryCCPCH-TX-Power
        },
        tdd128 SEQUENCE {
          ul-DPCH-Info UL-DPCH-InfoPostTDD-LCR-r4,
          dl-InformationPerRL DL-InformationPerRL-PostTDD-LCR-r4,
          frequencyInfo FrequencyInfoTDD,
          primaryCCPCH-TX-Power PrimaryCCPCH-TX-Power
        }
      }
    }
  }
},
  },
  -- Physical channel IEs
  maxAllowedUL-TX-Power MaxAllowedUL-TX-Power
}

-- *****
--
-- HANDOVER TO UTRAN COMPLETE
--
-- *****

HandoverToUTRANComplete ::= SEQUENCE {
  --TABULAR: Integrity protection shall not be performed on this message.
  -- User equipment IEs
  -- TABULAR: startList is conditional on history.
  startList STARTList OPTIONAL,
  -- Radio bearer IEs
  count-C-ActivationTime ActivationTime OPTIONAL,
  laterNonCriticalExtensions SEQUENCE {
    -- Container for additional R99 extensions
    handoverToUTRANComplete-r3-add-ext BIT STRING OPTIONAL,
    nonCriticalExtensions SEQUENCE {} OPTIONAL
  }
} OPTIONAL

```

```

}

-- *****
--
-- INITIAL DIRECT TRANSFER
--
-- *****

InitialDirectTransfer ::= SEQUENCE {
  -- Core network IEs
  cn-DomainIdentity          CN-DomainIdentity,
  intraDomainNasNodeSelector IntraDomainNasNodeSelector,
  nas-Message                NAS-Message,
  -- Measurement IEs
  measuredResultsOnRACH      MeasuredResultsOnRACH          OPTIONAL,
  v3a0NonCriticalExtensions SEQUENCE {
    initialDirectTransfer-v3a0ext InitialDirectTransfer-v3a0ext,
    laterNonCriticalExtensions SEQUENCE {
      -- Container for additional R99 extensions
      initialDirectTransfer-r3-add-ext BIT STRING OPTIONAL,
      -- Extension mechanism for non- release99 information
      nonCriticalExtensions SEQUENCE {} OPTIONAL
    } OPTIONAL
  } OPTIONAL
}

InitialDirectTransfer-v3a0ext ::= SEQUENCE {
  -- start-value shall always be included in this version of the protocol
  start-Value START-Value OPTIONAL
}

-- *****
--
-- HANDOVER FROM UTRAN COMMAND
--
-- *****

HandoverFromUTRANCommand-GSM ::= CHOICE {
  r3 SEQUENCE {
    handoverFromUTRANCommand-GSM-r3
      HandoverFromUTRANCommand-GSM-r3-IEs,
    laterNonCriticalExtensions SEQUENCE {
      -- Container for additional R99 extensions
      handoverFromUTRANCommand-GSM-r3-add-ext BIT STRING OPTIONAL,
      -- UTRAN should not include the IE nonCriticalExtensions when it sets
      -- the IE gsm-message included in handoverFromUTRANCommand-GSM-r3 to single-GSM-Message
      -- The UE behaviour upon receiving a message including this combination of IE values is
      -- not specified
      nonCriticalExtensions SEQUENCE {} OPTIONAL
    } OPTIONAL
  },
  later-than-r3 SEQUENCE {
    rrc-TransactionIdentifier RRC-TransactionIdentifier,
    criticalExtensions SEQUENCE {}
  }
}

HandoverFromUTRANCommand-GSM-r3-IEs ::= SEQUENCE {
  -- User equipment IEs
  rrc-TransactionIdentifier RRC-TransactionIdentifier,
  activationTime ActivationTime OPTIONAL,
  -- Radio bearer IEs
  toHandover-Info RAB-Info OPTIONAL,
  -- Measurement IEs
  frequency-band Frequency-Band,
  -- Other IEs
  gsm-message CHOICE {
    -- In the single-GSM-Message case the following rules apply:
    -- 1> the GSM message directly follows the basic production; the final padding that
    -- results when PER encoding the abstract syntax value is removed prior to appending
    -- the GSM message.
    -- 2> the RRC message excluding the GSM part, does not contain a length determinant;
    -- there is no explicit parameter indicating the size of the included GSM message.
    -- 3> depending on need, final padding (all "0"s) is added to ensure the final result
    -- comprises a full number of octets
    single-GSM-Message SEQUENCE {},
    gsm-MessageList SEQUENCE {

```



```

        }
    }
}

HandoverFromUTRANCommand-CDMA2000 ::= CHOICE {
    r3 SEQUENCE {
        handoverFromUTRANCommand-CDMA2000-r3
        nonCriticalExtensions SEQUENCE {} OPTIONAL
    },
    later-than-r3 SEQUENCE {
        rrc-TransactionIdentifier RRC-TransactionIdentifier,
        criticalExtensions SEQUENCE {}
    }
}

HandoverFromUTRANCommand-CDMA2000-r3-IEs ::= SEQUENCE {
    -- User equipment IEs
    rrc-TransactionIdentifier RRC-TransactionIdentifier,
    activationTime ActivationTime OPTIONAL,
    -- Radio bearer IEs
    toHandover-Info RAB-Info OPTIONAL,
    -- Other IEs
    cdma2000-MessageList CDMA2000-MessageList
}

-- *****
--
-- HANDOVER FROM UTRAN FAILURE
--
-- *****

HandoverFromUTRANFailure ::= SEQUENCE {
    -- User equipment IEs
    rrc-TransactionIdentifier RRC-TransactionIdentifier,
    -- Other IEs
    interRAT-HO-FailureCause InterRAT-HO-FailureCause OPTIONAL,
    interRATMessage CHOICE {
        gsm SEQUENCE {
            gsm-MessageList GSM-MessageList
        },
        cdma2000 SEQUENCE {
            cdma2000-MessageList CDMA2000-MessageList
        }
    } OPTIONAL,
    laterNonCriticalExtensions SEQUENCE {
        -- Container for additional R99 extensions
        handoverFromUTRANFailure-r3-add-ext BIT STRING OPTIONAL,
        nonCriticalExtensions SEQUENCE {} OPTIONAL
    } OPTIONAL
}

-- *****
--
-- INTER RAT HANDOVER INFO
--
-- *****

InterRATHandoverInfo ::= SEQUENCE {
    -- This structure is defined for historical reasons, backward compatibility with 04.18
    predefinedConfigStatusList CHOICE {
        absent NULL,
        present PredefinedConfigStatusList
    },
    uE-SecurityInformation CHOICE {
        absent NULL,
        present UE-SecurityInformation
    },
    ue-CapabilityContainer CHOICE {
        absent NULL,
        -- present is an octet aligned string containing IE UE-RadioAccessCapabilityInfo
        present OCTET STRING (SIZE (0..63))
    },
    -- Non critical extensions
    v390NonCriticalExtensions CHOICE {
        absent NULL,
        present SEQUENCE {

```

```

interRATHandoverInfo-v390ext    InterRATHandoverInfo-v390ext-IEs,
v3a0NonCriticalExtensions      SEQUENCE {
  interRATHandoverInfo-v3a0ext  InterRATHandoverInfo-v3a0ext,
  laterNonCriticalExtensions    SEQUENCE {
    interRATHandoverInfo-v3d0ext InterRATHandoverInfo-v3d0ext-IEs,
    -- Container for additional R99 extensions
    interRATHandoverInfo-r3-add-ext BIT STRING OPTIONAL,
    v4xyNonCriticalExtensions    SEQUENCE {
      interRATHandoverInfo-v4xyext InterRATHandoverInfo-v4xyext-IEs,
      -- Reserved for future non critical extension
      nonCriticalExtensions      SEQUENCE {} OPTIONAL
    } OPTIONAL
  } OPTIONAL
} OPTIONAL
}
}
}

InterRATHandoverInfo-v390ext-IEs ::= SEQUENCE {
  -- User equipment IEs
  ue-RadioAccessCapability-v380ext  UE-RadioAccessCapability-v380ext    OPTIONAL,
  dl-PhysChCapabilityFDD-v380ext    DL-PhysChCapabilityFDD-v380ext
}

InterRATHandoverInfo-v3a0ext ::= SEQUENCE {
  -- User equipment IEs
  ue-RadioAccessCapability-v3a0ext  UE-RadioAccessCapability-v3a0ext    OPTIONAL
}

InterRATHandoverInfo-v3d0ext-IEs ::= SEQUENCE {
  -- User equipment IEs
  uESpecificBehaviourInformationInterRAT  UESpecificBehaviourInformationInterRAT
  OPTIONAL
}

InterRATHandoverInfo-v4xyext-IEs ::= SEQUENCE {
  -- User equipment IEs
  ue-RadioAccessCapability-v4xyext  UE-RadioAccessCapability-v4xyext
}

-- *****
--
-- MEASUREMENT CONTROL
--
-- *****

MeasurementControl ::= CHOICE {
  r3
    SEQUENCE {
      measurementControl-r3          MeasurementControl-r3-IEs,
      v390nonCriticalExtensions      SEQUENCE {
        measurementControl-v390ext  MeasurementControl-v390ext,
        v3a0NonCriticalExtensions   SEQUENCE {
          measurementControl-v3a0ext MeasurementControl-v3a0ext,
          laterNonCriticalExtensions SEQUENCE {
            -- Container for additional R99 extensions
            measurementControl-r3-add-ext BIT STRING OPTIONAL,
            v4xyNonCriticalExtensions   SEQUENCE {
              measurementControl-v4xyext MeasurementControl-v4xyext-IEs,
              nonCriticalExtensions     SEQUENCE {} OPTIONAL
            } OPTIONAL
          } OPTIONAL
        } OPTIONAL
      } OPTIONAL
    } OPTIONAL
  },
  later-than-r3
    SEQUENCE {
      rrc-TransactionIdentifier      RRC-TransactionIdentifier,
      criticalExtensions            CHOICE {
        r4
          SEQUENCE {
            measurementControl-r4    MeasurementControl-r4-IEs,
            nonCriticalExtensions    SEQUENCE {} OPTIONAL
          },
        criticalExtensions          SEQUENCE {}
      }
    }
}

MeasurementControl-r3-IEs ::= SEQUENCE {

```

```

-- User equipment IEs
rrc-TransactionIdentifier      RRC-TransactionIdentifier,
-- Measurement IEs
measurementIdentity            MeasurementIdentity,
-- TABULAR: The measurement type is included in MeasurementCommand.
measurementCommand             MeasurementCommand,
measurementReportingMode       MeasurementReportingMode           OPTIONAL,
additionalMeasurementList      AdditionalMeasurementID-List       OPTIONAL,
-- Physical channel IEs
dpch-CompressedModeStatusInfo  DPCH-CompressedModeStatusInfo   OPTIONAL
}

MeasurementControl-v4xyext-IEs ::= SEQUENCE {
  ue-Positioning-OTDOA-AssistanceData-r4ext  UE-Positioning-OTDOA-AssistanceData-r4ext  OPTIONAL
}

MeasurementControl-v390ext ::= SEQUENCE {
  ue-Positioning-Measurement-v390ext        UE-Positioning-Measurement-v390ext  OPTIONAL
}

MeasurementControl-v3a0ext ::= SEQUENCE {
  sfn-Offset-Validity                    SFN-Offset-Validity            OPTIONAL
}

MeasurementControl-r4-IEs ::= SEQUENCE {
  -- Measurement IEs
  measurementIdentity            MeasurementIdentity,
  -- TABULAR: The measurement type is included in measurementCommand.
  measurementCommand             MeasurementCommand-r4,
  measurementReportingMode       MeasurementReportingMode           OPTIONAL,
  additionalMeasurementList      AdditionalMeasurementID-List       OPTIONAL,
  -- Physical channel IEs
  dpch-CompressedModeStatusInfo  DPCH-CompressedModeStatusInfo   OPTIONAL
}

-- *****
--
-- MEASUREMENT CONTROL FAILURE
--
-- *****

MeasurementControlFailure ::= SEQUENCE {
  -- User equipment IEs
  rrc-TransactionIdentifier      RRC-TransactionIdentifier,
  failureCause                   FailureCauseWithProtErr,
  laterNonCriticalExtensions     SEQUENCE {
    -- Container for additional R99 extensions
    measurementControlFailure-r3-add-ext  BIT STRING           OPTIONAL,
    nonCriticalExtensions                 SEQUENCE {}          OPTIONAL
  } OPTIONAL
}

-- *****
--
-- MEASUREMENT REPORT
--
-- *****

MeasurementReport ::= SEQUENCE {
  -- Measurement IEs
  measurementIdentity            MeasurementIdentity,
  measuredResults                MeasuredResults                   OPTIONAL,
  measuredResultsOnRACH          MeasuredResultsOnRACH       OPTIONAL,
  additionalMeasuredResults      MeasuredResultsList          OPTIONAL,
  eventResults                   EventResults                   OPTIONAL,
  -- Non-critical extensions
  v390nonCriticalExtensions      SEQUENCE {
    measurementReport-v390ext      MeasurementReport-v390ext,
    laterNonCriticalExtensions     SEQUENCE {
      -- Container for additional R99 extensions
      measurementReport-r3-add-ext  BIT STRING           OPTIONAL,
      v4xyNonCriticalExtensions     SEQUENCE {
        measurementReport-v4xyext  MeasurementReport-v4xyext-IEs,
        -- Extension mechanism for non-Rel4 information
        nonCriticalExtensions      SEQUENCE {}          OPTIONAL
      } OPTIONAL
    } OPTIONAL
  } OPTIONAL
}

```

```

}

MeasurementReport-v390ext ::= SEQUENCE {
    measuredResults-v390ext      MeasuredResults-v390ext      OPTIONAL
}

MeasurementReport-v4xyext-IEs ::= SEQUENCE {
    interFreqEventResults-LCR      InterFreqEventResults-LCR-r4-ext      OPTIONAL,
    additionalMeasuredResults-LCR  MeasuredResultsList-LCR-r4-ext      OPTIONAL,
    gsmOTDreferenceCell            PrimaryCPICH-Info                        OPTIONAL
}

-- *****
--
-- PAGING TYPE 1
--
-- *****

PagingType1 ::= SEQUENCE {
    -- User equipment IEs
    pagingRecordList              PagingRecordList              OPTIONAL,
    -- Other IEs
    bch-ModificationInfo          BCCH-ModificationInfo          OPTIONAL,
    laterNonCriticalExtensions     SEQUENCE {
        -- Container for additional R99 extensions
        pagingType1-r3-add-ext     BIT STRING              OPTIONAL,
        nonCriticalExtensions      SEQUENCE {}                OPTIONAL
    } OPTIONAL
}

-- *****
--
-- PAGING TYPE 2
--
-- *****

PagingType2 ::= SEQUENCE {
    -- User equipment IEs
    rrc-TransactionIdentifier      RRC-TransactionIdentifier,
    pagingCause                    PagingCause,
    -- Core network IEs
    cn-DomainIdentity              CN-DomainIdentity,
    pagingRecordTypeID             PagingRecordTypeID,
    laterNonCriticalExtensions     SEQUENCE {
        -- Container for additional R99 extensions
        pagingType2-r3-add-ext     BIT STRING              OPTIONAL,
        nonCriticalExtensions      SEQUENCE {}                OPTIONAL
    } OPTIONAL
}

-- *****
--
-- PHYSICAL CHANNEL RECONFIGURATION
--
-- *****

PhysicalChannelReconfiguration ::= CHOICE {
    r3                             SEQUENCE {
        physicalChannelReconfiguration-r3
        PhysicalChannelReconfiguration-r3-IEs,
        v3a0NonCriticalExtensions  SEQUENCE {
            physicalChannelReconfiguration-v3a0ext      PhysicalChannelReconfiguration-v3a0ext,
            laterNonCriticalExtensions  SEQUENCE {
                -- Container for additional R99 extensions
                physicalChannelReconfiguration-r3-add-ext     BIT STRING      OPTIONAL,
                v4xyNonCriticalExtensstions                   SEQUENCE {
                    physicalChannelReconfiguration-v4xyext
                    PhysicalChannelReconfiguration-v4xyext-IEs,
                    nonCriticalExtensions  SEQUENCE {} OPTIONAL
                } OPTIONAL
            } OPTIONAL
        } OPTIONAL
    } OPTIONAL
},
    later-than-r3                  SEQUENCE {
        rrc-TransactionIdentifier      RRC-TransactionIdentifier,
        criticalExtensions              CHOICE {
            r4                          SEQUENCE {
                physicalChannelReconfiguration-r4

```

```

        nonCriticalExtensions
    },
    criticalExtensions
}
}
}

PhysicalChannelReconfiguration-r3-IEs ::= SEQUENCE {
-- User equipment IES
    rrc-TransactionIdentifier      RRC-TransactionIdentifier,
    integrityProtectionModeInfo    IntegrityProtectionModeInfo      OPTIONAL,
    cipheringModeInfo              CipheringModeInfo                  OPTIONAL,
    activationTime                  ActivationTime                      OPTIONAL,
    new-U-RNTI                     U-RNTI                          OPTIONAL,
    new-C-RNTI                     C-RNTI                          OPTIONAL,
    rrc-StateIndicator              RRC-StateIndicator,
    utran-DRX-CycleLengthCoeff     UTRAN-DRX-CycleLengthCoefficient  OPTIONAL,
-- Core network IES
    cn-InformationInfo              CN-InformationInfo                OPTIONAL,
-- UTRAN mobility IES
    ura-Identity                    URA-Identity                      OPTIONAL,
-- Radio bearer IES
    dl-CounterSynchronisationInfo  DL-CounterSynchronisationInfo    OPTIONAL,
-- Physical channel IES
    frequencyInfo                  FrequencyInfo                      OPTIONAL,
    maxAllowedUL-TX-Power           MaxAllowedUL-TX-Power             OPTIONAL,
-- TABULAR: UL-ChannelRequirementWithCPCH-SetID contains the choice
-- between UL DPCH info, CPCH SET info and CPCH set ID.
    ul-ChannelRequirement           UL-ChannelRequirementWithCPCH-SetID  OPTIONAL,
    modeSpecificInfo                CHOICE {
        fdd                          SEQUENCE {
            dl-PDSCH-Information      DL-PDSCH-Information              OPTIONAL
        },
        tdd                          NULL
    },
    dl-CommonInformation            DL-CommonInformation              OPTIONAL,
    dl-InformationPerRL-List        DL-InformationPerRL-List          OPTIONAL
}

PhysicalChannelReconfiguration-v3a0ext ::= SEQUENCE {
    new-DSCH-RNTI                   DSCH-RNTI                          OPTIONAL
}

PhysicalChannelReconfiguration-v4xyext-IEs ::= SEQUENCE {
-- Physical channel IES
    -- ssdt-UL extends SSDT-Information, which is included in
    -- DL-CommonInformation. FDD only.
    ssdt-UL                          SSDT-UL-r4                          OPTIONAL,
    -- The order of the RLs in IE cell-id-PerRL-List is the same as
    -- in IE DL-InformationPerRL-List included in this message
    cell-id-PerRL-List                CellIdentity-PerRL-List              OPTIONAL
}

PhysicalChannelReconfiguration-r4-IEs ::= SEQUENCE {
-- User equipment IES
    integrityProtectionModeInfo      IntegrityProtectionModeInfo          OPTIONAL,
    cipheringModeInfo                 CipheringModeInfo                    OPTIONAL,
    activationTime                     ActivationTime                        OPTIONAL,
    new-U-RNTI                        U-RNTI                              OPTIONAL,
    new-C-RNTI                        C-RNTI                              OPTIONAL,
    new-DSCH-RNTI                     DSCH-RNTI                           OPTIONAL,
    rrc-StateIndicator                RRC-StateIndicator,
    utran-DRX-CycleLengthCoeff        UTRAN-DRX-CycleLengthCoefficient    OPTIONAL,
-- Core network IES
    cn-InformationInfo                CN-InformationInfo                  OPTIONAL,
-- UTRAN mobility IES
    ura-Identity                      URA-Identity                        OPTIONAL,
-- Radio bearer IES
    dl-CounterSynchronisationInfo     DL-CounterSynchronisationInfo       OPTIONAL,
-- Physical channel IES
    frequencyInfo                     FrequencyInfo                        OPTIONAL,
    maxAllowedUL-TX-Power              MaxAllowedUL-TX-Power               OPTIONAL,
-- TABULAR: UL-ChannelRequirementWithCPCH-SetID-r4 contains the choice
-- between UL DPCH info, CPCH SET info and CPCH set ID.
    ul-ChannelRequirement              UL-ChannelRequirementWithCPCH-SetID-r4  OPTIONAL,
    modeSpecificInfo                   CHOICE {
        fdd                            SEQUENCE {

```

```

        dl-PDSCH-Information          DL-PDSCH-Information          OPTIONAL
    },
    tdd                               NULL
},
dl-CommonInformation                DL-CommonInformation-r4          OPTIONAL,
dl-InformationPerRL-List            DL-InformationPerRL-List-r4      OPTIONAL
}

-- *****
--
-- PHYSICAL CHANNEL RECONFIGURATION COMPLETE
--
-- *****

PhysicalChannelReconfigurationComplete ::= SEQUENCE {
    -- User equipment IEs
    rrc-TransactionIdentifier        RRC-TransactionIdentifier,
    ul-IntegProtActivationInfo        IntegrityProtActivationInfo      OPTIONAL,
    -- TABULAR: UL-TimingAdvance is applicable for TDD mode only.
    ul-TimingAdvance                 UL-TimingAdvance                  OPTIONAL,
    -- Radio bearer IEs
    count-C-ActivationTime           ActivationTime                    OPTIONAL,
    rb-UL-CiphActivationTimeInfo      RB-ActivationTimeInfoList        OPTIONAL,
    ul-CounterSynchronisationInfo     UL-CounterSynchronisationInfo    OPTIONAL,
    laterNonCriticalExtensions        SEQUENCE {
        -- Container for additional R99 extensions
        physicalChannelReconfigurationComplete-r3-add-ext    BIT STRING    OPTIONAL,
        -- Extension mechanism for non- release99 information
        nonCriticalExtensions        SEQUENCE {}    OPTIONAL
    }
    OPTIONAL
}

-- *****
--
-- PHYSICAL CHANNEL RECONFIGURATION FAILURE
--
-- *****

PhysicalChannelReconfigurationFailure ::= SEQUENCE {
    -- User equipment IEs
    rrc-TransactionIdentifier        RRC-TransactionIdentifier        OPTIONAL,
    failureCause                     FailureCauseWithProtErr,
    laterNonCriticalExtensions        SEQUENCE {
        -- Container for additional R99 extensions
        physicalChannelReconfigurationFailure-r3-add-ext    BIT STRING    OPTIONAL,
        nonCriticalExtensions        SEQUENCE {}    OPTIONAL
    }
    OPTIONAL
}

-- *****
--
-- PHYSICAL SHARED CHANNEL ALLOCATION (TDD only)
--
-- *****

PhysicalSharedChannelAllocation ::= CHOICE {
    r3                                SEQUENCE {
        physicalSharedChannelAllocation-r3
        laterNonCriticalExtensions    SEQUENCE {
            -- Container for additional R99 extensions
            physicalSharedChannelAllocation-r3-add-ext    BIT STRING    OPTIONAL,
            nonCriticalExtensions        SEQUENCE {}    OPTIONAL
        }
        OPTIONAL
    },
    later-than-r3                     SEQUENCE {
        dsch-RNTI                     DSCH-RNTI                        OPTIONAL,
        rrc-TransactionIdentifier      RRC-TransactionIdentifier,
        criticalExtensions             CHOICE {
            r4                          SEQUENCE {
                physicalSharedChannelAllocation-r4
                nonCriticalExtensions    SEQUENCE {}    OPTIONAL
            },
            criticalExtensions         SEQUENCE {}
        }
    }
}
}

```

```

PhysicalSharedChannelAllocation-r3-IEs ::= SEQUENCE {
  -- TABULAR: Integrity protection shall not be performed on this message.
  -- User equipment IEs
  dsch-RNTI                DSCH-RNTI                OPTIONAL,
  rrc-TransactionIdentifier RRC-TransactionIdentifier,
  -- Physical channel IEs
  ul-TimingAdvance         UL-TimingAdvanceControl   OPTIONAL,
  pusch-CapacityAllocationInfo PUSCH-CapacityAllocationInfo   OPTIONAL,
  pdsch-CapacityAllocationInfo PDSCH-CapacityAllocationInfo   OPTIONAL,
  -- TABULAR: If the above value is not present, the default value "No Confirm"
  -- shall be used as specified in 10.2.25.
  confirmRequest           ENUMERATED {
                                confirmPDSCH, confirmPUSCH }   OPTIONAL,
  trafficVolumeReportRequest INTEGER (0..255)           OPTIONAL,
  iscpTimeslotList         TimeslotList                OPTIONAL,
  requestPCCPCHRSCP        BOOLEAN
}

PhysicalSharedChannelAllocation-r4-IEs ::= SEQUENCE {
  -- TABULAR: Integrity protection shall not be performed on this message.
  -- Physical channel IEs
  ul-TimingAdvance         UL-TimingAdvanceControl-r4   OPTIONAL,
  pusch-CapacityAllocationInfo PUSCH-CapacityAllocationInfo-r4   OPTIONAL,
  pdsch-CapacityAllocationInfo PDSCH-CapacityAllocationInfo-r4   OPTIONAL,
  -- TABULAR: If confirmRequest is not present, the default value "No Confirm"
  -- shall be used as specified in 10.2.25.
  confirmRequest           ENUMERATED {
                                confirmPDSCH, confirmPUSCH }   OPTIONAL,
  iscpTimeslotList         TimeslotList-r4              OPTIONAL,
  requestPCCPCHRSCP        BOOLEAN
}

-- *****
--
-- PUSCH CAPACITY REQUEST (TDD only)
--
-- *****

PUSCHCapacityRequest ::= SEQUENCE {
  -- User equipment IEs
  dsch-RNTI                DSCH-RNTI                OPTIONAL,
  -- Measurement IEs
  trafficVolume             TrafficVolumeMeasuredResultsList,
  timeslotListWithISCP     TimeslotListWithISCP           OPTIONAL,
  primaryCCPCH-RSCP        PrimaryCCPCH-RSCP         OPTIONAL,
  allocationConfirmation    CHOICE {
    pdschConfirmation       PDSCH-Identity,
    puschConfirmation       PUSCH-Identity
  }   OPTIONAL,
  protocolErrorIndicator    ProtocolErrorIndicatorWithMoreInfo,
  laterNonCriticalExtensions SEQUENCE {
    -- Container for additional R99 extensions
    puschCapacityRequest-r3-add-ext BIT STRING   OPTIONAL,
    -- Extension mechanism for non-release99 information
    nonCriticalExtensions      SEQUENCE {}       OPTIONAL
  }   OPTIONAL
}

-- *****
--
-- RADIO BEARER RECONFIGURATION
--
-- *****

RadioBearerReconfiguration ::= CHOICE {
  r3 SEQUENCE {
    radioBearerReconfiguration-r3 RadioBearerReconfiguration-r3-IEs,
    v3a0NonCriticalExtensions     SEQUENCE {
      radioBearerReconfiguration-v3a0ext RadioBearerReconfiguration-v3a0ext,
      laterNonCriticalExtensions       SEQUENCE {
        -- Container for additional R99 extensions
        radioBearerReconfiguration-r3-add-ext BIT STRING   OPTIONAL,
        v4xyNonCriticalExtensions          SEQUENCE {
          radioBearerReconfiguration-v4xyext
        }
      }
      nonCriticalExtensions          SEQUENCE {}   OPTIONAL
    }   OPTIONAL
  }
}

```

```

    } OPTIONAL
  } OPTIONAL
},
later-than-r3          SEQUENCE {
  rrc-TransactionIdentifier  RRC-TransactionIdentifier,
  criticalExtensions         CHOICE {
    r4                       SEQUENCE {
      radioBearerReconfiguration-r4  RadioBearerReconfiguration-r4-IEs,
      nonCriticalExtensions          SEQUENCE {} OPTIONAL
    },
    criticalExtensions             SEQUENCE {}
  }
}
}

RadioBearerReconfiguration-r3-IEs ::= SEQUENCE {
  -- User equipment IEs
  rrc-TransactionIdentifier  RRC-TransactionIdentifier,
  integrityProtectionModeInfo  IntegrityProtectionModeInfo          OPTIONAL,
  cipheringModeInfo         CipheringModeInfo          OPTIONAL,
  activationTime            ActivationTime          OPTIONAL,
  new-U-RNTI                U-RNTI          OPTIONAL,
  new-C-RNTI                C-RNTI          OPTIONAL,
  rrc-StateIndicator        RRC-StateIndicator,
  utran-DRX-CycleLengthCoeff  UTRAN-DRX-CycleLengthCoefficient  OPTIONAL,
  -- Core network IEs
  cn-InformationInfo        CN-InformationInfo          OPTIONAL,
  -- UTRAN mobility IEs
  ura-Identity              URA-Identity          OPTIONAL,
  -- Radio bearer IEs
  rab-InformationReconfigList  RAB-InformationReconfigList          OPTIONAL,
  -- NOTE: IE rb-InformationReconfigList should be optional in later versions
  -- of this message
  rb-InformationReconfigList  RB-InformationReconfigList,
  rb-InformationAffectedList  RB-InformationAffectedList          OPTIONAL,
  -- Transport channel IEs
  ul-CommonTransChInfo      UL-CommonTransChInfo          OPTIONAL,
  ul-deletedTransChInfoList  UL-DeletedTransChInfoList          OPTIONAL,
  ul-AddReconfTransChInfoList  UL-AddReconfTransChInfoList          OPTIONAL,
  modeSpecificTransChInfo    CHOICE {
    fdd                      SEQUENCE {
      cpch-SetID              CPCH-SetID          OPTIONAL,
      addReconfTransChDRAC-Info  DRAC-StaticInformationList  OPTIONAL
    },
    tdd                      NULL
  } OPTIONAL,
  dl-CommonTransChInfo      DL-CommonTransChInfo          OPTIONAL,
  dl-DeletedTransChInfoList  DL-DeletedTransChInfoList          OPTIONAL,
  dl-AddReconfTransChInfoList  DL-AddReconfTransChInfo2List          OPTIONAL,
  -- Physical channel IEs
  frequencyInfo             FrequencyInfo          OPTIONAL,
  maxAllowedUL-TX-Power     MaxAllowedUL-TX-Power          OPTIONAL,
  ul-ChannelRequirement     UL-ChannelRequirement          OPTIONAL,
  modeSpecificPhysChInfo    CHOICE {
    fdd                      SEQUENCE {
      dl-PDSCH-Information    DL-PDSCH-Information          OPTIONAL
    },
    tdd                      NULL
  },
  dl-CommonInformation      DL-CommonInformation          OPTIONAL,
  -- NOTE: IE dl-InformationPerRL-List should be optional in later versions
  -- of this message
  dl-InformationPerRL-List  DL-InformationPerRL-List
}

RadioBearerReconfiguration-v3a0ext ::= SEQUENCE {
  new-DSCH-RNTI            DSCH-RNTI          OPTIONAL
}

RadioBearerReconfiguration-v4xyext-IEs ::= SEQUENCE {
  -- Physical channel IEs
  -- ssdt-UL extends SSdT-Information, which is included in
  -- DL-CommonInformation. FDD only.
  ssdt-UL                  SSdT-UL-r4          OPTIONAL,
  -- The order of the RLs in IE cell-id-PerRL-List is the same as
  -- in IE DL-InformationPerRL-List included in this message
  cell-id-PerRL-List      CellIdentity-PerRL-List          OPTIONAL
}

```



```

RadioBearerReconfiguration-r4-IEs ::= SEQUENCE {
  -- User equipment IEs
  integrityProtectionModeInfo    IntegrityProtectionModeInfo    OPTIONAL,
  cipheringModeInfo              CipheringModeInfo              OPTIONAL,
  activationTime                  ActivationTime                  OPTIONAL,
  new-U-RNTI                      U-RNTI                        OPTIONAL,
  new-C-RNTI                      C-RNTI                        OPTIONAL,
  new-DSCH-RNTI                  DSCH-RNTI                     OPTIONAL,
  rrc-StateIndicator             RRC-StateIndicator,
  utran-DRX-CycleLengthCoeff     UTRAN-DRX-CycleLengthCoefficient OPTIONAL,
  -- Core network IEs
  cn-InformationInfo              CN-InformationInfo            OPTIONAL,
  -- UTRAN mobility IEs
  ura-Identity                    URA-Identity                  OPTIONAL,
  -- Radio bearer IEs
  rab-InformationReconfigList     RAB-InformationReconfigList   OPTIONAL,
  rb-InformationReconfigList      RB-InformationReconfigList-r4  OPTIONAL,
  rb-InformationAffectedList      RB-InformationAffectedList     OPTIONAL,
  -- Transport channel IEs
  ul-CommonTransChInfo           UL-CommonTransChInfo-r4       OPTIONAL,
  ul-deletedTransChInfoList       UL-DeletedTransChInfoList     OPTIONAL,
  ul-AddReconfTransChInfoList     UL-AddReconfTransChInfoList   OPTIONAL,
  modeSpecificTransChInfo        CHOICE {
    fdd                            SEQUENCE {
      cpch-SetID                  CPCH-SetID                    OPTIONAL,
      addReconfTransChDRAC-Info   DRAC-StaticInformationList    OPTIONAL
    },
    tdd                            NULL
  }
  dl-CommonTransChInfo           DL-CommonTransChInfo-r4       OPTIONAL,
  dl-DeletedTransChInfoList       DL-DeletedTransChInfoList     OPTIONAL,
  dl-AddReconfTransChInfoList     DL-AddReconfTransChInfo2List  OPTIONAL,
  -- Physical channel IEs
  frequencyInfo                  FrequencyInfo                   OPTIONAL,
  maxAllowedUL-TX-Power           MaxAllowedUL-TX-Power         OPTIONAL,
  ul-ChannelRequirement           UL-ChannelRequirement-r4      OPTIONAL,
  modeSpecificPhysChInfo         CHOICE {
    fdd                            SEQUENCE {
      dl-PDSCH-Information        DL-PDSCH-Information         OPTIONAL
    },
    tdd                            NULL
  },
  dl-CommonInformation            DL-CommonInformation-r4       OPTIONAL,
  dl-InformationPerRL-List        DL-InformationPerRL-List-r4   OPTIONAL
}

-- *****
--
-- RADIO BEARER RECONFIGURATION COMPLETE
--
-- *****

RadioBearerReconfigurationComplete ::= SEQUENCE {
  -- User equipment IEs
  rrc-TransactionIdentifier        RRC-TransactionIdentifier,
  ul-IntegProtActivationInfo       IntegrityProtActivationInfo    OPTIONAL,
  -- TABULAR: UL-TimingAdvance is applicable for TDD mode only.
  ul-TimingAdvance                 UL-TimingAdvance              OPTIONAL,
  -- Radio bearer IEs
  count-C-ActivationTime           ActivationTime                  OPTIONAL,
  rb-UL-CiphActivationTimeInfo     RB-ActivationTimeInfoList     OPTIONAL,
  ul-CounterSynchronisationInfo    UL-CounterSynchronisationInfo OPTIONAL,
  laterNonCriticalExtensions       SEQUENCE {
    -- Container for additional R99 extensions
    radioBearerReconfigurationComplete-r3-add-ext BIT STRING OPTIONAL,
    nonCriticalExtensions           SEQUENCE {} OPTIONAL
  }
}

-- *****
--
-- RADIO BEARER RECONFIGURATION FAILURE
--
-- *****

RadioBearerReconfigurationFailure ::= SEQUENCE {
  -- User equipment IEs

```

```

    rrc-TransactionIdentifier      RRC-TransactionIdentifier,
    failureCause                   FailureCauseWithProtErr,
-- Radio bearer IEs
    potentiallySuccessfulBearerList RB-IdentityList           OPTIONAL,
    laterNonCriticalExtensions      SEQUENCE {
        -- Container for additional R99 extensions
        radioBearerReconfigurationFailure-r3-add-ext          BIT STRING           OPTIONAL,
        nonCriticalExtensions      SEQUENCE {} OPTIONAL
    } OPTIONAL
}

-- *****
--
-- RADIO BEARER RELEASE
--
-- *****

RadioBearerRelease ::= CHOICE {
    r3
        SEQUENCE {
            radioBearerRelease-r3      RadioBearerRelease-r3-IEs,
            v3a0NonCriticalExtensions  SEQUENCE {
                radioBearerRelease-v3a0ext      RadioBearerRelease-v3a0ext,
                laterNonCriticalExtensions      SEQUENCE {
                    -- Container for additional R99 extensions
                    radioBearerRelease-r3-add-ext  BIT STRING           OPTIONAL,
                    v4xyNonCriticalExtensions      SEQUENCE {
                        radioBearerRelease-v4xyext      RadioBearerRelease-v4xyext-IEs,
                        nonCriticalExtensions      SEQUENCE {} OPTIONAL
                    } OPTIONAL
                } OPTIONAL
            } OPTIONAL
        } OPTIONAL
    },
    later-than-r3
        SEQUENCE {
            rrc-TransactionIdentifier      RRC-TransactionIdentifier,
            criticalExtensions             CHOICE {
                r4
                    SEQUENCE {
                        radioBearerRelease-r4      RadioBearerRelease-r4-IEs,
                        nonCriticalExtensions      SEQUENCE {}           OPTIONAL
                    },
                criticalExtensions         SEQUENCE {}
            }
        }
}

RadioBearerRelease-r3-IEs ::= SEQUENCE {
-- User equipment IEs
    rrc-TransactionIdentifier      RRC-TransactionIdentifier,
    integrityProtectionModeInfo    IntegrityProtectionModeInfo    OPTIONAL,
    cipheringModeInfo              CipheringModeInfo              OPTIONAL,
    activationTime                  ActivationTime                  OPTIONAL,
    new-U-RNTI                      U-RNTI                      OPTIONAL,
    new-C-RNTI                      C-RNTI                      OPTIONAL,
    rrc-StateIndicator              RRC-StateIndicator,
    utran-DRX-CycleLengthCoeff      UTRAN-DRX-CycleLengthCoefficient  OPTIONAL,
-- Core network IEs
    cn-InformationInfo              CN-InformationInfo              OPTIONAL,
    signallingConnectionRelIndication  CN-DomainIdentity              OPTIONAL,
-- UTRAN mobility IEs
    ura-Identity                    URA-Identity                    OPTIONAL,
-- Radio bearer IEs
    rab-InformationReconfigList      RAB-InformationReconfigList      OPTIONAL,
    rb-InformationReleaseList         RB-InformationReleaseList,
    rb-InformationAffectedList        RB-InformationAffectedList        OPTIONAL,
    dl-CounterSynchronisationInfo     DL-CounterSynchronisationInfo     OPTIONAL,
-- Transport channel IEs
    ul-CommonTransChInfo             UL-CommonTransChInfo             OPTIONAL,
    ul-deletedTransChInfoList         UL-DeletedTransChInfoList         OPTIONAL,
    ul-AddReconfTransChInfoList       UL-AddReconfTransChInfoList       OPTIONAL,
    modeSpecificTransChInfo           CHOICE {
        fdd
            SEQUENCE {
                cpch-SetID                  CPCH-SetID                      OPTIONAL,
                addReconfTransChDRAC-Info    DRAC-StaticInformationList       OPTIONAL
            },
        tdd
            NULL
    }
    },
    dl-CommonTransChInfo             DL-CommonTransChInfo             OPTIONAL,
    dl-DeletedTransChInfoList         DL-DeletedTransChInfoList         OPTIONAL,
    dl-AddReconfTransChInfoList       DL-AddReconfTransChInfo2List      OPTIONAL,

```

```

-- Physical channel IEs
frequencyInfo          FrequencyInfo          OPTIONAL,
maxAllowedUL-TX-Power  MaxAllowedUL-TX-Power  OPTIONAL,
ul-ChannelRequirement  UL-ChannelRequirement  OPTIONAL,
modeSpecificPhysChInfo CHOICE {
    fdd                 SEQUENCE {
        dl-PDSCH-Information  DL-PDSCH-Information  OPTIONAL
    },
    tdd                 NULL
},
dl-CommonInformation  DL-CommonInformation  OPTIONAL,
dl-InformationPerRL-List  DL-InformationPerRL-List  OPTIONAL
}

RadioBearerRelease-v3a0ext ::= SEQUENCE {
    new-DSCH-RNTI          DSCH-RNTI          OPTIONAL
}

RadioBearerRelease-v4xyext-IEs ::= SEQUENCE {
    -- Physical channel IEs
    -- IE ssdt-UL extends SSDT-Information, which is included in
    -- DL-CommonInformation. FDD only.
    ssdt-UL                SSDT-UL-r4          OPTIONAL,
    -- The order of the RLs in IE cell-id-PerRL-List is the same as
    -- in IE DL-InformationPerRL-List included in this message
    cell-id-PerRL-List     CellIdentity-PerRL-List  OPTIONAL
}

RadioBearerRelease-r4-IEs ::= SEQUENCE {
    -- User equipment IEs
    integrityProtectionModeInfo  IntegrityProtectionModeInfo  OPTIONAL,
    cipheringModeInfo            CipheringModeInfo            OPTIONAL,
    activationTime                ActivationTime                OPTIONAL,
    new-U-RNTI                    U-RNTI                    OPTIONAL,
    new-C-RNTI                    C-RNTI                    OPTIONAL,
    new-DSCH-RNTI                DSCH-RNTI                OPTIONAL,
    rrc-StateIndicator            RRC-StateIndicator,
    utran-DRX-CycleLengthCoeff    UTRAN-DRX-CycleLengthCoefficient  OPTIONAL,
    -- Core network IEs
    cn-InformationInfo            CN-InformationInfo            OPTIONAL,
    signallingConnectionRelIndication  CN-DomainIdentity            OPTIONAL,
    -- UTRAN mobility IEs
    ura-Identity                  URA-Identity                  OPTIONAL,
    -- Radio bearer IEs
    rab-InformationReconfigList    RAB-InformationReconfigList    OPTIONAL,
    rb-InformationReleaseList       RB-InformationReleaseList,
    rb-InformationAffectedList      RB-InformationAffectedList     OPTIONAL,
    dl-CounterSynchronisationInfo  DL-CounterSynchronisationInfo  OPTIONAL,
    -- Transport channel IEs
    ul-CommonTransChInfo          UL-CommonTransChInfo-r4      OPTIONAL,
    ul-deletedTransChInfoList      UL-DeletedTransChInfoList     OPTIONAL,
    ul-AddReconfTransChInfoList    UL-AddReconfTransChInfoList   OPTIONAL,
    modeSpecificTransChInfo        CHOICE {
        fdd                 SEQUENCE {
            cpch-SetID      CPCH-SetID      OPTIONAL,
            addReconfTransChDRAC-Info  DRAC-StaticInformationList  OPTIONAL
        },
        tdd                 NULL
    }
    dl-CommonTransChInfo          DL-CommonTransChInfo-r4      OPTIONAL,
    dl-DeletedTransChInfoList      DL-DeletedTransChInfoList     OPTIONAL,
    dl-AddReconfTransChInfoList    DL-AddReconfTransChInfo2List  OPTIONAL,
    -- Physical channel IEs
    frequencyInfo                  FrequencyInfo                  OPTIONAL,
    maxAllowedUL-TX-Power          MaxAllowedUL-TX-Power        OPTIONAL,
    ul-ChannelRequirement          UL-ChannelRequirement-r4     OPTIONAL,
    modeSpecificPhysChInfo        CHOICE {
        fdd                 SEQUENCE {
            dl-PDSCH-Information  DL-PDSCH-Information  OPTIONAL
        },
        tdd                 NULL
    },
    dl-CommonInformation          DL-CommonInformation-r4     OPTIONAL,
    dl-InformationPerRL-List      DL-InformationPerRL-List-r4  OPTIONAL
}

-- *****
--

```

```

-- RADIO BEARER RELEASE COMPLETE
--
-- *****

RadioBearerReleaseComplete ::= SEQUENCE {
  -- User equipment IEs
  rrc-TransactionIdentifier      RRC-TransactionIdentifier,
  ul-IntegProtActivationInfo     IntegrityProtActivationInfo      OPTIONAL,
  -- TABULAR: UL-TimingAdvance is applicable for TDD mode only.
  ul-TimingAdvance              UL-TimingAdvance                      OPTIONAL,
  -- Radio bearer IEs
  count-C-ActivationTime        ActivationTime                      OPTIONAL,
  rb-UL-CiphActivationTimeInfo  RB-ActivationTimeInfoList     OPTIONAL,
  ul-CounterSynchronisationInfo UL-CounterSynchronisationInfo  OPTIONAL,
  laterNonCriticalExtensions    SEQUENCE {
    -- Container for additional R99 extensions
    radioBearerReleaseComplete-r3-add-ext  BIT STRING      OPTIONAL,
    nonCriticalExtensions                  SEQUENCE {}    OPTIONAL
  }
  OPTIONAL
}

-- *****
--
-- RADIO BEARER RELEASE FAILURE
--
-- *****

RadioBearerReleaseFailure ::= SEQUENCE {
  -- User equipment IEs
  rrc-TransactionIdentifier      RRC-TransactionIdentifier,
  failureCause                  FailureCauseWithProtErr,
  -- Radio bearer IEs
  potentiallySuccessfulBearerList  RB-IdentityList          OPTIONAL,
  laterNonCriticalExtensions      SEQUENCE {
    -- Container for additional R99 extensions
    radioBearerReleaseFailure-r3-add-ext  BIT STRING      OPTIONAL,
    nonCriticalExtensions                  SEQUENCE {}    OPTIONAL
  }
  OPTIONAL
}

-- *****
--
-- RADIO BEARER SETUP
--
-- *****

RadioBearerSetup ::= CHOICE {
  r3
    SEQUENCE {
      radioBearerSetup-r3          RadioBearerSetup-r3-IEs,
      v3a0NonCriticalExtensions    SEQUENCE {
        radioBearerSetup-v3a0ext   RadioBearerSetup-v3a0ext,
        laterNonCriticalExtensions SEQUENCE {
          -- Container for additional R99 extensions
          radioBearerSetup-r3-add-ext  BIT STRING      OPTIONAL,
          v4xyNonCriticalExtensions   SEQUENCE {
            radioBearerSetup-v4xyext   RadioBearerSetup-v4xyext-IEs,
            nonCriticalExtensions      SEQUENCE {}    OPTIONAL
          }
        }
      }
    }
  OPTIONAL
},
  later-than-r3
    SEQUENCE {
      rrc-TransactionIdentifier      RRC-TransactionIdentifier,
      criticalExtensions            CHOICE {
        r4
          SEQUENCE {
            radioBearerSetup-r4      RadioBearerSetup-r4-IEs,
            nonCriticalExtensions    SEQUENCE {}    OPTIONAL
          },
        criticalExtensions          SEQUENCE {}
      }
    }
}

RadioBearerSetup-r3-IEs ::= SEQUENCE {
  -- User equipment IEs
  rrc-TransactionIdentifier      RRC-TransactionIdentifier,
  integrityProtectionModeInfo   IntegrityProtectionModeInfo  OPTIONAL,
  cipheringModeInfo             CipheringModeInfo             OPTIONAL,
}

```

```

    activationTime          ActivationTime          OPTIONAL,
    new-U-RNTI              U-RNTI                OPTIONAL,
    new-C-RNTI              C-RNTI                OPTIONAL,
    rrc-StateIndicator      RRC-StateIndicator,
    utran-DRX-CycleLengthCoeff  UTRAN-DRX-CycleLengthCoefficient  OPTIONAL,
-- UTRAN mobility IEs
    ura-Identity            URA-Identity            OPTIONAL,
-- Core network IEs
    cn-InformationInfo      CN-InformationInfo      OPTIONAL,
-- Radio bearer IEs
    srb-InformationSetupList  SRB-InformationSetupList  OPTIONAL,
    rab-InformationSetupList  RAB-InformationSetupList  OPTIONAL,
    rb-InformationAffectedList  RB-InformationAffectedList  OPTIONAL,
    dl-CounterSynchronisationInfo  DL-CounterSynchronisationInfo  OPTIONAL,
-- Transport channel IEs
    ul-CommonTransChInfo     UL-CommonTransChInfo     OPTIONAL,
    ul-deletedTransChInfoList  UL-DeletedTransChInfoList  OPTIONAL,
    ul-AddReconfTransChInfoList  UL-AddReconfTransChInfoList  OPTIONAL,
    modeSpecificTransChInfo    CHOICE {
        fdd
            cpch-SetID          CPCH-SetID          OPTIONAL,
            addReconfTransChDRAC-Info  DRAC-StaticInformationList  OPTIONAL,
        },
        tdd
            NULL
    }
    dl-CommonTransChInfo     DL-CommonTransChInfo     OPTIONAL,
    dl-DeletedTransChInfoList  DL-DeletedTransChInfoList  OPTIONAL,
    dl-AddReconfTransChInfoList  DL-AddReconfTransChInfoList  OPTIONAL,
-- Physical channel IEs
    frequencyInfo           FrequencyInfo           OPTIONAL,
    maxAllowedUL-TX-Power    MaxAllowedUL-TX-Power  OPTIONAL,
    ul-ChannelRequirement    UL-ChannelRequirement  OPTIONAL,
    modeSpecificPhysChInfo    CHOICE {
        fdd
            dl-PDSCH-Information  DL-PDSCH-Information  OPTIONAL,
        },
        tdd
            NULL
    },
    dl-CommonInformation     DL-CommonInformation     OPTIONAL,
    dl-InformationPerRL-List  DL-InformationPerRL-List  OPTIONAL,
}

RadioBearerSetup-v3a0ext ::= SEQUENCE {
    new-DSCH-RNTI            DSCH-RNTI            OPTIONAL
}

RadioBearerSetup-v4xyext-IEs ::= SEQUENCE {
-- Physical channel IEs
-- ssdt-UL extends SSdT-Information, which is included in
-- DL-CommonInformation. FDD only.
    ssdt-UL                  SSdT-UL-r4                  OPTIONAL,
-- The order of the RLs in IE cell-id-PerRL-List is the same as
-- in IE DL-InformationPerRL-List included in this message
    cell-id-PerRL-List       CellIdentity-PerRL-List  OPTIONAL
}

RadioBearerSetup-r4-IEs ::= SEQUENCE {
-- User equipment IEs
    integrityProtectionModeInfo  IntegrityProtectionModeInfo  OPTIONAL,
    cipheringModeInfo            CipheringModeInfo            OPTIONAL,
    activationTime                ActivationTime                OPTIONAL,
    new-U-RNTI                    U-RNTI                      OPTIONAL,
    new-C-RNTI                    C-RNTI                      OPTIONAL,
    new-DSCH-RNTI                DSCH-RNTI                  OPTIONAL,
    rrc-StateIndicator            RRC-StateIndicator,
    utran-DRX-CycleLengthCoeff    UTRAN-DRX-CycleLengthCoefficient  OPTIONAL,
-- UTRAN mobility IEs
    ura-Identity                  URA-Identity                OPTIONAL,
-- Core network IEs
    cn-InformationInfo            CN-InformationInfo          OPTIONAL,
-- Radio bearer IEs
    srb-InformationSetupList      SRB-InformationSetupList    OPTIONAL,
    rab-InformationSetupList      RAB-InformationSetupList-r4  OPTIONAL,
    rb-InformationAffectedList    RB-InformationAffectedList  OPTIONAL,
    dl-CounterSynchronisationInfo  DL-CounterSynchronisationInfo  OPTIONAL,
-- Transport channel IEs
    ul-CommonTransChInfo-r4      UL-CommonTransChInfo-r4    OPTIONAL,
    ul-deletedTransChInfoList     UL-DeletedTransChInfoList   OPTIONAL,
}

```

```

    ul-AddReconfTransChInfoList      UL-AddReconfTransChInfoList      OPTIONAL,
modeSpecificTransChInfo              CHOICE {
    fdd                                SEQUENCE {
        cpch-SetID                    CPCH-SetID                    OPTIONAL,
        addReconfTransChDRAC-Info      DRAC-StaticInformationList    OPTIONAL
    },
    tdd                                NULL
}
dl-CommonTransChInfo                 DL-CommonTransChInfo-r4            OPTIONAL,
dl-DeletedTransChInfoList            DL-DeletedTransChInfoList         OPTIONAL,
dl-AddReconfTransChInfoList         DL-AddReconfTransChInfoList-r4    OPTIONAL,
-- Physical channel IEs
frequencyInfo                        FrequencyInfo                       OPTIONAL,
maxAllowedUL-TX-Power                MaxAllowedUL-TX-Power             OPTIONAL,
ul-ChannelRequirement                UL-ChannelRequirement-r4         OPTIONAL,
modeSpecificPhysChInfo              CHOICE {
    fdd                                SEQUENCE {
        dl-PDSCH-Information          DL-PDSCH-Information          OPTIONAL
    },
    tdd                                NULL
},
dl-CommonInformation                 DL-CommonInformation-r4           OPTIONAL,
dl-InformationPerRL-List             DL-InformationPerRL-List-r4      OPTIONAL
}

-- *****
--
-- RADIO BEARER SETUP COMPLETE
--
-- *****

RadioBearerSetupComplete ::= SEQUENCE {
    -- User equipment IEs
    rrc-TransactionIdentifier          RRC-TransactionIdentifier,
    ul-IntegProtActivationInfo         IntegrityProtActivationInfo      OPTIONAL,
    -- TABULAR: UL-TimingAdvance is applicable for TDD mode only.
    ul-TimingAdvance                  UL-TimingAdvance                OPTIONAL,
    start-Value                        START-Value                      OPTIONAL,
    -- Radio bearer IEs
    count-C-ActivationTime             ActivationTime                    OPTIONAL,
    rb-UL-CiphActivationTimeInfo       RB-ActivationTimeInfoList       OPTIONAL,
    ul-CounterSynchronisationInfo      UL-CounterSynchronisationInfo   OPTIONAL,
    laterNonCriticalExtensions         SEQUENCE {
        -- Container for additional R99 extensions
        radioBearerSetupComplete-r3-add-ext BIT STRING    OPTIONAL,
        nonCriticalExtensions           SEQUENCE {}           OPTIONAL
    }
}

-- *****
--
-- RADIO BEARER SETUP FAILURE
--
-- *****

RadioBearerSetupFailure ::= SEQUENCE {
    -- User equipment IEs
    rrc-TransactionIdentifier          RRC-TransactionIdentifier,
    failureCause                       FailureCauseWithProtErr,
    -- Radio bearer IEs
    potentiallySuccessfulBearerList    RB-IdentityList                 OPTIONAL,
    laterNonCriticalExtensions         SEQUENCE {
        -- Container for additional R99 extensions
        radioBearerSetupFailure-r3-add-ext BIT STRING    OPTIONAL,
        nonCriticalExtensions           SEQUENCE {}           OPTIONAL
    }
}

-- *****
--
-- RRC CONNECTION REJECT
--
-- *****

RRCConnectionReject ::= CHOICE {
    r3                                  SEQUENCE {
        rrcConnectionReject-r3        RRCConnectionReject-r3-IEs,
        laterNonCriticalExtensions     SEQUENCE {

```

```

        -- Container for additional R99 extensions
        rrcConnectionReject-r3-add-ext    BIT STRING    OPTIONAL,
        nonCriticalExtensions              SEQUENCE {}    OPTIONAL
    } OPTIONAL
},
later-than-r3                            SEQUENCE {
    initialUE-Identity                    InitialUE-Identity,
    rrc-TransactionIdentifier              RRC-TransactionIdentifier,
    criticalExtensions                     SEQUENCE {}
}
}

RRCConnectionReject-r3-IEs ::= SEQUENCE {
    -- TABULAR: Integrity protection shall not be performed on this message.
    -- User equipment IEs
    initialUE-Identity                    InitialUE-Identity,
    rrc-TransactionIdentifier              RRC-TransactionIdentifier,
    rejectionCause                        RejectionCause,
    waitTime                              WaitTime,
    redirectionInfo                       RedirectionInfo    OPTIONAL
}

-- *****
--
-- RRC CONNECTION RELEASE
--
-- *****

RRCConnectionRelease ::= CHOICE {
    r3                                     SEQUENCE {
        rrcConnectionRelease-r3          RRCConnectionRelease-r3-IEs,
        laterNonCriticalExtensions        SEQUENCE {
            -- Container for additional R99 extensions
            rrcConnectionRelease-r3-add-ext    BIT STRING    OPTIONAL,
            nonCriticalExtensions              SEQUENCE {}    OPTIONAL
        } OPTIONAL
    },
    later-than-r3                          SEQUENCE {
        rrc-TransactionIdentifier          RRC-TransactionIdentifier,
        criticalExtensions                 CHOICE {
            r4                             SEQUENCE {
                rrcConnectionRelease-r4      RRCConnectionRelease-r4-IEs,
                nonCriticalExtensions         SEQUENCE {}    OPTIONAL
            },
            criticalExtensions              SEQUENCE {}
        }
    }
}

RRCConnectionRelease-r3-IEs ::= SEQUENCE {
    -- User equipment IEs
    rrc-TransactionIdentifier              RRC-TransactionIdentifier,
    -- n-308 is conditional on the UE state
    n-308                                 N-308                OPTIONAL,
    releaseCause                          ReleaseCause,
    rplmn-information                      Rplmn-Information    OPTIONAL
}

RRCConnectionRelease-r4-IEs ::= SEQUENCE {
    -- User equipment IEs
    -- n-308 is conditional on the UE state.
    n-308                                 N-308                OPTIONAL,
    releaseCause                          ReleaseCause,
    rplmn-information                      Rplmn-Information-r4    OPTIONAL
}

-- *****
--
-- RRC CONNECTION RELEASE for CCCH
--
-- *****

RRCConnectionRelease-CCCH ::= CHOICE {
    r3                                     SEQUENCE {
        rrcConnectionRelease-CCCH-r3      RRCConnectionRelease-CCCH-r3-IEs,
        laterNonCriticalExtensions        SEQUENCE {
            -- Container for additional R99 extensions
            rrcConnectionRelease-CCCH-r3-add-ext    BIT STRING    OPTIONAL,

```

```

        nonCriticalExtensions          SEQUENCE {}          OPTIONAL
    } OPTIONAL
},
later-than-r3                        SEQUENCE {
    u-RNTI                             U-RNTI,
    rrc-TransactionIdentifier          RRC-TransactionIdentifier,
    criticalExtensions                 CHOICE {
        r4                             SEQUENCE {
            rrcConnectionRelease-CCCH-r4  RRCCConnectionRelease-CCCH-r4-IEs,
            nonCriticalExtensions         SEQUENCE {}          OPTIONAL
        },
        criticalExtensions               SEQUENCE {}
    }
}
}
}

RRCCConnectionRelease-CCCH-r3-IEs ::= SEQUENCE {
    -- User equipment IEs
    u-RNTI                             U-RNTI,
    -- The rest of the message is identical to the one sent on DCCH.
    rrcConnectionRelease               RRCCConnectionRelease-r3-IEs
}

RRCCConnectionRelease-CCCH-r4-IEs ::= SEQUENCE {
    -- The rest of the message is identical to the one sent on DCCH.
    rrcConnectionRelease               RRCCConnectionRelease-r4-IEs
}

-- *****
--
-- RRC CONNECTION RELEASE COMPLETE
--
-- *****

RRCCConnectionReleaseComplete ::= SEQUENCE {
    -- User equipment IEs
    rrc-TransactionIdentifier          RRC-TransactionIdentifier,
    errorIndication                    FailureCauseWithProtErr          OPTIONAL,
    laterNonCriticalExtensions         SEQUENCE {
        -- Container for additional R99 extensions
        rrcConnectionReleaseComplete-r3-add-ext  BIT STRING          OPTIONAL,
        nonCriticalExtensions           SEQUENCE {}          OPTIONAL
    } OPTIONAL
}

-- *****
--
-- RRC CONNECTION REQUEST
--
-- *****

RRCCConnectionRequest ::= SEQUENCE {
    -- TABULAR: Integrity protection shall not be performed on this message.
    -- User equipment IEs
    initialUE-Identity                 InitialUE-Identity,
    establishmentCause                 EstablishmentCause,
    -- protocolErrorIndictator is MD, but for compactness reasons no default value
    -- has been assigned to it.
    protocolErrorIndicator              ProtocolErrorIndicator,
    -- Measurement IEs
    measuredResultsOnRACH               MeasuredResultsOnRACH          OPTIONAL,
    -- Non critical Extensions
    v3d0NonCriticalExtensions          SEQUENCE {
        rrcConnectionRequest-v3d0ext      RRCCConnectionRequest-v3d0ext-IEs,
        -- Reserved for future non critical extension
        v4xyNonCriticalExtensions        SEQUENCE {
            rrcConnectionRequest-v4xyext  RRCCConnectionRequest-v4xyext-IEs,
            -- Reserved for future non critical extension
            nonCriticalExtensions         SEQUENCE {}          OPTIONAL
        } OPTIONAL
    } OPTIONAL
}

RRCCConnectionRequest-v3d0ext-IEs ::= SEQUENCE {
    -- User equipment IEs
    uESpecificBehaviourInformationIdle  UESpecificBehaviourInformationIdle  OPTIONAL
}

```



```

RRCConnectionRequest-v4xyext-IEs ::= SEQUENCE {
  -- User equipment IEs
  accessStratumReleaseIndicator      AccessStratumReleaseIndicator
}

-- *****
--
-- RRC CONNECTION SETUP
--
-- *****

RRCConnectionSetup ::= CHOICE {
  r3
    SEQUENCE {
      rrcConnectionSetup-r3          RRCConnectionSetup-r3-IEs,
      laterNonCriticalExtensions     SEQUENCE {
        -- Container for additional R99 extensions
        rrcConnectionSetup-r3-add-ext BIT STRING      OPTIONAL,
        v4xyNonCriticalExtensions     SEQUENCE {
          rrcConnectionSetup-v4xyext RRCConnectionSetup-v4xyext-IEs,
          -- Extension mechanism for non- release99 information
          nonCriticalExtensions       SEQUENCE {}      OPTIONAL
        } OPTIONAL
      } OPTIONAL
    },
  later-than-r3
    SEQUENCE {
      initialUE-Identity             InitialUE-Identity,
      rrc-TransactionIdentifier      RRC-TransactionIdentifier,
      criticalExtensions              CHOICE {
        r4
          SEQUENCE {
            rrcConnectionSetup-r4    RRCConnectionSetup-r4-IEs,
            nonCriticalExtensions     SEQUENCE {}      OPTIONAL
          },
        criticalExtensions           SEQUENCE {}
      }
    }
}

RRCConnectionSetup-r3-IEs ::= SEQUENCE {
  -- TABULAR: Integrity protection shall not be performed on this message.
  -- User equipment IEs
  initialUE-Identity             InitialUE-Identity,
  rrc-TransactionIdentifier      RRC-TransactionIdentifier,
  activationTime                 ActivationTime          OPTIONAL,
  new-U-RNTI                    U-RNTI,
  new-c-RNTI                    C-RNTI                OPTIONAL,
  rrc-StateIndicator            RRC-StateIndicator,
  utran-DRX-CycleLengthCoeff    UTRAN-DRX-CycleLengthCoefficient,
  -- TABULAR: If capacityUpdateRequest is not present, the default value
  -- defined in 10.3.3.2 shall be used.
  capabilityUpdateRequirement    CapabilityUpdateRequirement OPTIONAL,
  -- Radio bearer IEs
  srb-InformationSetupList       SRB-InformationSetupList2,
  -- Transport channel IEs
  ul-CommonTransChInfo          UL-CommonTransChInfo    OPTIONAL,
  -- NOTE: ul-AddReconfTransChInfoList should be optional in later versions of
  -- this message
  ul-AddReconfTransChInfoList    UL-AddReconfTransChInfoList,
  dl-CommonTransChInfo          DL-CommonTransChInfo    OPTIONAL,
  -- NOTE: dl-AddReconfTransChInfoList should be optional in later versions
  -- of this message
  dl-AddReconfTransChInfoList    DL-AddReconfTransChInfoList,
  -- Physical channel IEs
  frequencyInfo                 FrequencyInfo          OPTIONAL,
  maxAllowedUL-TX-Power          MaxAllowedUL-TX-Power  OPTIONAL,
  ul-ChannelRequirement          UL-ChannelRequirement  OPTIONAL,
  dl-CommonInformation           DL-CommonInformation    OPTIONAL,
  dl-InformationPerRL-List       DL-InformationPerRL-List OPTIONAL
}

RRCConnectionSetup-v4xyext-IEs ::= SEQUENCE {
  capabilityUpdateRequirement-r4-ext CapabilityUpdateRequirement-r4-ext OPTIONAL,
  -- Physical channel IEs
  -- ssdt-UL extends SSdT-Information, which is included in
  -- DL-CommonInformation. FDD only.
  ssdt-UL                       SSdT-UL-r4              OPTIONAL,
  -- The order of the RLs in IE cell-id-PerRL-List is the same as
  -- in IE DL-InformationPerRL-List included in this message
  cell-id-PerRL-List             CellIdentity-PerRL-List  OPTIONAL
}

```

```

}

RRCConnectionSetup-r4-IEs ::= SEQUENCE {
  -- TABULAR: Integrity protection shall not be performed on this message.
  activationTime           ActivationTime           OPTIONAL,
  new-U-RNTI               U-RNTI,
  new-c-RNTI               C-RNTI                 OPTIONAL,
  rrc-StateIndicator       RRC-StateIndicator,
  utran-DRX-CycleLengthCoeff  UTRAN-DRX-CycleLengthCoefficient,
  -- TABULAR: If capabilityUpdateRequirements is not present, the default value
  -- defined in 10.3.3.2 shall be used.
  capabilityUpdateRequirement  CapabilityUpdateRequirement-r4  OPTIONAL,
  -- Radio bearer IEs
  srb-InformationSetupList  SRB-InformationSetupList2,
  -- Transport channel IEs
  ul-CommonTransChInfo     UL-CommonTransChInfo           OPTIONAL,
  ul-AddReconfTransChInfoList  UL-AddReconfTransChInfoList       OPTIONAL,
  dl-CommonTransChInfo     DL-CommonTransChInfo-r4         OPTIONAL,
  dl-AddReconfTransChInfoList  DL-AddReconfTransChInfoList       OPTIONAL,
  -- Physical channel IEs
  frequencyInfo            FrequencyInfo           OPTIONAL,
  maxAllowedUL-TX-Power    MaxAllowedUL-TX-Power     OPTIONAL,
  ul-ChannelRequirement    UL-ChannelRequirement-r4   OPTIONAL,
  dl-CommonInformation     DL-CommonInformation-r4    OPTIONAL,
  dl-InformationPerRL-List  DL-InformationPerRL-List-r4    OPTIONAL
}

-- *****
--
-- RRC CONNECTION SETUP COMPLETE
--
-- *****

RRCConnectionSetupComplete ::= SEQUENCE {
  -- TABULAR: Integrity protection shall not be performed on this message.
  -- User equipment IEs
  rrc-TransactionIdentifier  RRC-TransactionIdentifier,
  startList                  STARTList,
  ue-RadioAccessCapability  UE-RadioAccessCapability           OPTIONAL,
  -- Other IEs
  ue-RATSpecificCapability  InterRAT-UE-RadioAccessCapabilityList  OPTIONAL,
  -- Non critical extensions
  v370NonCriticalExtensions  SEQUENCE {
    rrcConnectionSetupComplete-v370ext  RRCConnectionSetupComplete-v370ext,
    v380NonCriticalExtensions            SEQUENCE {
      rrcConnectionSetupComplete-v380ext  RRCConnectionSetupComplete-v380ext-IEs,
      -- Reserved for future non critical extension
      v3a0NonCriticalExtensions            SEQUENCE {
        rrcConnectionSetupComplete-v3a0ext  RRCConnectionSetupComplete-v3a0ext,
        laterNonCriticalExtensions          SEQUENCE {
          -- Container for additional R99 extensions
          rrcConnectionSetupComplete-r3-add-ext  BIT STRING  OPTIONAL,
          v4xyNonCriticalExtensions              SEQUENCE {
            rrcConnectionSetupComplete-v4xyext  RRCConnectionSetupComplete-v4xyext-
  IEs,
            nonCriticalExtensions              SEQUENCE {}  OPTIONAL
          }
        }
      }
    }
  }
}

RRCConnectionSetupComplete-v370ext ::= SEQUENCE {
  -- User equipment IEs
  ue-RadioAccessCapability-v370ext  UE-RadioAccessCapability-v370ext  OPTIONAL
}

RRCConnectionSetupComplete-v380ext-IEs ::= SEQUENCE {
  -- User equipment IEs
  ue-RadioAccessCapability-v380ext  UE-RadioAccessCapability-v380ext  OPTIONAL,
  dl-PhysChCapabilityFDD-v380ext    DL-PhysChCapabilityFDD-v380ext
}

RRCConnectionSetupComplete-v3a0ext ::= SEQUENCE {
  -- User equipment IEs
  ue-RadioAccessCapability-v3a0ext  UE-RadioAccessCapability-v3a0ext  OPTIONAL
}

```

```

RRCConnectionSetupComplete-v4xyext-IEs ::= SEQUENCE {
    -- User equipment IEs
    ue-RadioAccessCapability-v4xyext    UE-RadioAccessCapability-v4xyext
}

-- *****
--
-- RRC FAILURE INFO
--
-- *****

RRC-FailureInfo ::= CHOICE {
    r3
        SEQUENCE {
            rRC-FailureInfo-r3
                SEQUENCE {
                    laterNonCriticalExtensions
                        SEQUENCE {
                            -- Container for additional R99 extensions
                            rrc-FailureInfo-r3-add-ext    BIT STRING    OPTIONAL,
                            nonCriticalExtensions
                                SEQUENCE {}    OPTIONAL
                        }    OPTIONAL
                },
            criticalExtensions
                SEQUENCE {}
        }
}

RRC-FailureInfo-r3-IEs ::= SEQUENCE {
    -- Non-RRC IEs
    failureCauseWithProtErr
        FailureCauseWithProtErr
}

-- *****
--
-- RRC STATUS
--
-- *****

RRCStatus ::= SEQUENCE {
    -- Other IEs
    -- TABULAR: Identification of received message is nested in
    -- ProtocolErrorMoreInformation
    protocolErrorInformation
        ProtocolErrorMoreInformation,
    laterNonCriticalExtensions
        SEQUENCE {
            -- Container for additional R99 extensions
            rrcStatus-r3-add-ext    BIT STRING    OPTIONAL,
            nonCriticalExtensions
                SEQUENCE {}    OPTIONAL
        }    OPTIONAL
}

-- *****
--
-- SECURITY MODE COMMAND
--
-- *****

SecurityModeCommand ::= CHOICE {
    r3
        SEQUENCE {
            securityModeCommand-r3
                SEQUENCE {
                    laterNonCriticalExtensions
                        SEQUENCE {
                            -- Container for additional R99 extensions
                            securityModeCommand-r3-add-ext    BIT STRING    OPTIONAL,
                            nonCriticalExtensions
                                SEQUENCE {}    OPTIONAL
                        }    OPTIONAL
                },
            later-than-r3
                SEQUENCE {
                    rrc-TransactionIdentifier
                        RRC-TransactionIdentifier,
                    criticalExtensions
                        SEQUENCE {}
                }
        }
}

SecurityModeCommand-r3-IEs ::= SEQUENCE {
    -- TABULAR: Integrity protection shall always be performed on this message.
    -- User equipment IEs
    rrc-TransactionIdentifier
        RRC-TransactionIdentifier,
    securityCapability
        SecurityCapability,
    cipheringModeInfo
        CipheringModeInfo    OPTIONAL,
    integrityProtectionModeInfo
        IntegrityProtectionModeInfo    OPTIONAL,
    -- Core network IEs
    cn-DomainIdentity
        CN-DomainIdentity,
    -- Other IEs
}

```

```

        ue-SystemSpecificSecurityCap    InterRAT-UE-SecurityCapList    OPTIONAL
    }

```

```

-- *****
--
-- SECURITY MODE COMPLETE
--
-- *****

```

```

SecurityModeComplete ::= SEQUENCE {
-- TABULAR: Integrity protection shall always be performed on this message.

```

```

-- User equipment IEs
    rrc-TransactionIdentifier    RRC-TransactionIdentifier,
    ul-IntegProtActivationInfo    IntegrityProtActivationInfo    OPTIONAL,
-- Radio bearer IEs
    rb-UL-CiphActivationTimeInfo    RB-ActivationTimeInfoList    OPTIONAL,
    laterNonCriticalExtensions    SEQUENCE {
        -- Container for additional R99 extensions
        securityModeComplete-r3-add-ext    BIT STRING    OPTIONAL,
        nonCriticalExtensions    SEQUENCE {}    OPTIONAL
    }    OPTIONAL
}

```

```

-- *****
--
-- SECURITY MODE FAILURE
--
-- *****

```

```

SecurityModeFailure ::= SEQUENCE {
-- User equipment IEs
    rrc-TransactionIdentifier    RRC-TransactionIdentifier,
    failureCause    FailureCauseWithProtErr,
    laterNonCriticalExtensions    SEQUENCE {
        -- Container for additional R99 extensions
        securityModeFailure-r3-add-ext    BIT STRING    OPTIONAL,
        nonCriticalExtensions    SEQUENCE {}    OPTIONAL
    }    OPTIONAL
}

```

```

-- *****
--
-- SIGNALLING CONNECTION RELEASE
--
-- *****

```

```

SignallingConnectionRelease ::= CHOICE {
    r3    SEQUENCE {
        signallingConnectionRelease-r3    SignallingConnectionRelease-r3-IEs,
        laterNonCriticalExtensions    SEQUENCE {
            -- Container for additional R99 extensions
            signallingConnectionRelease-r3-add-ext    BIT STRING    OPTIONAL,
            nonCriticalExtensions    SEQUENCE {}    OPTIONAL
        }    OPTIONAL
    },
    later-than-r3    SEQUENCE {
        rrc-TransactionIdentifier    RRC-TransactionIdentifier,
        criticalExtensions    SEQUENCE {}
    }
}

```

```

SignallingConnectionRelease-r3-IEs ::= SEQUENCE {
-- User equipment IEs
    rrc-TransactionIdentifier    RRC-TransactionIdentifier,
-- Core network IEs
    cn-DomainIdentity    CN-DomainIdentity
}

```

```

-- *****
--
-- SIGNALLING CONNECTION RELEASE INDICATION
--
-- *****

```

```

SignallingConnectionReleaseIndication ::= SEQUENCE {
-- Core network IEs
    cn-DomainIdentity    CN-DomainIdentity,

```

```

    laterNonCriticalExtensions      SEQUENCE {
      -- Container for additional R99 extensions
      signallingConnectionReleaseIndication-r3-add-ext      BIT STRING      OPTIONAL,
      nonCriticalExtensions      SEQUENCE {}      OPTIONAL
    }
  }
}

-- *****
--
-- SYSTEM INFORMATION for BCH
--
-- *****

SystemInformation-BCH ::= SEQUENCE {
  -- Other information elements
  sfn-Prime      SFN-Prime,
  payload        CHOICE {
    noSegment      NULL,
    firstSegment   FirstSegment,
    subsequentSegment   SubsequentSegment,
    lastSegmentShort   LastSegmentShort,
    lastAndFirst    SEQUENCE {
      lastSegmentShort   LastSegmentShort,
      firstSegment       FirstSegmentShort
    },
    lastAndComplete SEQUENCE {
      lastSegmentShort   LastSegmentShort,
      completeSIB-List   CompleteSIB-List
    },
    lastAndCompleteAndFirst SEQUENCE {
      lastSegmentShort   LastSegmentShort,
      completeSIB-List   CompleteSIB-List,
      firstSegment       FirstSegmentShort
    },
    completeSIB-List CompleteSIB-List,
    completeAndFirst SEQUENCE {
      completeSIB-List   CompleteSIB-List,
      firstSegment       FirstSegmentShort
    },
    completeSIB     CompleteSIB,
    lastSegment     LastSegment,
    spare5          NULL,
    spare4          NULL,
    spare3          NULL,
    spare2          NULL,
    spare1          NULL
  }
}

-- *****
--
-- SYSTEM INFORMATION for FACH
--
-- *****

SystemInformation-FACH ::= SEQUENCE {
  -- Other information elements
  payload        CHOICE {
    noSegment      NULL,
    firstSegment   FirstSegment,
    subsequentSegment   SubsequentSegment,
    lastSegmentShort   LastSegmentShort,
    lastAndFirst    SEQUENCE {
      lastSegmentShort   LastSegmentShort,
      firstSegment       FirstSegmentShort
    },
    lastAndComplete SEQUENCE {
      lastSegmentShort   LastSegmentShort,
      completeSIB-List   CompleteSIB-List
    },
    lastAndCompleteAndFirst SEQUENCE {
      lastSegmentShort   LastSegmentShort,
      completeSIB-List   CompleteSIB-List,
      firstSegment       FirstSegmentShort
    },
    completeSIB-List CompleteSIB-List,
    completeAndFirst SEQUENCE {
      completeSIB-List   CompleteSIB-List,

```

```

        firstSegment                FirstSegmentShort
    },
    completeSIB                    CompleteSIB,
    lastSegment                    LastSegment,
    spare5                         NULL,
    spare4                         NULL,
    spare3                         NULL,
    spare2                         NULL,
    spare1                         NULL
}

-- *****
--
-- First segment
--
-- *****

FirstSegment ::=
    SEQUENCE {
        -- Other information elements
        sib-Type                SIB-Type,
        seg-Count              SegCount,
        sib-Data-fixed         SIB-Data-fixed
    }

-- *****
--
-- First segment (short)
--
-- *****

FirstSegmentShort ::=
    SEQUENCE {
        -- Other information elements
        sib-Type                SIB-Type,
        seg-Count              SegCount,
        sib-Data-variable     SIB-Data-variable
    }

-- *****
--
-- Subsequent segment
--
-- *****

SubsequentSegment ::=
    SEQUENCE {
        -- Other information elements
        sib-Type                SIB-Type,
        segmentIndex           SegmentIndex,
        sib-Data-fixed         SIB-Data-fixed
    }

-- *****
--
-- Last segment
--
-- *****

LastSegment ::=
    SEQUENCE {
        -- Other information elements
        sib-Type                SIB-Type,
        segmentIndex           SegmentIndex,
        -- For sib-Data-fixed, in case the SIB data is less than 222 bits, padding
        -- shall be used. The same padding bits shall be used as defined in clause 12.1
        sib-Data-fixed         SIB-Data-fixed
    }

LastSegmentShort ::=
    SEQUENCE {
        -- Other information elements
        sib-Type                SIB-Type,
        segmentIndex           SegmentIndex,
        sib-Data-variable     SIB-Data-variable
    }

-- *****
--
-- Complete SIB
--
-- *****

```

```

CompleteSIB-List ::=                               SEQUENCE (SIZE (1..maxSIBperMsg)) OF
                                                    CompleteSIBshort

CompleteSIB ::=                                   SEQUENCE {
  -- Other information elements
  sib-Type                                         SIB-Type,
  -- For sib-Data-fixed, in case the SIB data is less than 226 bits, padding
  -- shall be used. The same padding bits shall be used as defined in clause 12.1
  sib-Data-fixed                                   BIT STRING (SIZE (226))
}

CompleteSIBshort ::=                               SEQUENCE {
  -- Other information elements
  sib-Type                                         SIB-Type,
  sib-Data-variable                               SIB-Data-variable
}

-- *****
--
-- SYSTEM INFORMATION CHANGE INDICATION
--
-- *****

SystemInformationChangeIndication ::= SEQUENCE {
  -- Other IEs
  bcch-ModificationInfo                          BCCH-ModificationInfo,
  laterNonCriticalExtensions                      SEQUENCE {
    -- Container for additional R99 extensions
    systemInformationChangeIndication-r3-add-ext  BIT STRING          OPTIONAL,
    nonCriticalExtensions                         SEQUENCE {}    OPTIONAL
  } OPTIONAL
}

-- *****
--
-- TRANSPORT CHANNEL RECONFIGURATION
--
-- *****

TransportChannelReconfiguration ::= CHOICE {
  r3                                              SEQUENCE {
    transportChannelReconfiguration-r3
    v3a0NonCriticalExtensions                    SEQUENCE {
      transportChannelReconfiguration-v3a0ext
      laterNonCriticalExtensions                 SEQUENCE {
        -- Container for additional R99 extensions
        transportChannelReconfiguration-r3-add-ext  BIT STRING          OPTIONAL,
        v4xyNonCriticalExtensions                 SEQUENCE {
          transportChannelReconfiguration-v4xyext
          TransportChannelReconfiguration-v4xyext-IEs,
          nonCriticalExtensions                   SEQUENCE {}    OPTIONAL
        } OPTIONAL
      } OPTIONAL
    } OPTIONAL
  },
  later-than-r3                                  SEQUENCE {
    rrc-TransactionIdentifier                    RRC-TransactionIdentifier,
    criticalExtensions                           CHOICE {
      r4                                          SEQUENCE {
        transportChannelReconfiguration-r4
        nonCriticalExtensions                     SEQUENCE {}    OPTIONAL
      },
      criticalExtensions                         SEQUENCE {}
    }
  }
}

TransportChannelReconfiguration-r3-IEs ::= SEQUENCE {
  -- User equipment IEs
  rrc-TransactionIdentifier                      RRC-TransactionIdentifier,
  integrityProtectionModeInfo                    IntegrityProtectionModeInfo    OPTIONAL,
  cipheringModeInfo                             CipheringModeInfo              OPTIONAL,
  activationTime                                 ActivationTime                  OPTIONAL,
  new-U-RNTI                                     U-RNTI                        OPTIONAL,

```

```

    new-C-RNTI                C-RNTI                OPTIONAL,
    rrc-StateIndicator        RRC-StateIndicator,
    utran-DRX-CycleLengthCoeff  UTRAN-DRX-CycleLengthCoefficient  OPTIONAL,
-- Core network IEs
  cn-InformationInfo        CN-InformationInfo        OPTIONAL,
-- UTRAN mobility IEs
  ura-Identity              URA-Identity              OPTIONAL,
-- Radio bearer IEs
  dl-CounterSynchronisationInfo  DL-CounterSynchronisationInfo  OPTIONAL,
-- Transport channel IEs
  ul-CommonTransChInfo      UL-CommonTransChInfo      OPTIONAL,
  ul-AddReconfTransChInfoList  UL-AddReconfTransChInfoList  OPTIONAL,
  modeSpecificTransChInfo     CHOICE {
    fdd                      SEQUENCE {
      cpch-SetID              CPCH-SetID              OPTIONAL,
      addReconfTransChDRAC-Info  DRAC-StaticInformationList  OPTIONAL
    },
    tdd                      NULL
  }
  dl-CommonTransChInfo      DL-CommonTransChInfo      OPTIONAL,
  dl-AddReconfTransChInfoList  DL-AddReconfTransChInfoList  OPTIONAL,
-- Physical channel IEs
  frequencyInfo              FrequencyInfo              OPTIONAL,
  maxAllowedUL-TX-Power      MaxAllowedUL-TX-Power      OPTIONAL,
  ul-ChannelRequirement      UL-ChannelRequirement      OPTIONAL,
  modeSpecificPhysChInfo     CHOICE {
    fdd                      SEQUENCE {
      dl-PDSCH-Information    DL-PDSCH-Information    OPTIONAL
    },
    tdd                      NULL
  },
  dl-CommonInformation      DL-CommonInformation      OPTIONAL,
  dl-InformationPerRL-List   DL-InformationPerRL-List  OPTIONAL
}

TransportChannelReconfiguration-v3a0ext ::= SEQUENCE {
  new-DSCH-RNTI              DSCH-RNTI                OPTIONAL
}

TransportChannelReconfiguration-v4xyext-IEs ::= SEQUENCE {
-- Physical channel IEs
-- ssdt-UL extends SSdT-Information, which is included in
-- DL-CommonInformation. FDD only.
  ssdt-UL                    SSdT-UL-r4                OPTIONAL,
-- The order of the RLs in IE cell-id-PerRL-List is the same as
-- in IE DL-InformationPerRL-List included in this message
  cell-id-PerRL-List         CellIdentity-PerRL-List  OPTIONAL
}

TransportChannelReconfiguration-r4-IEs ::= SEQUENCE {
-- User equipment IEs
  integrityProtectionModeInfo  IntegrityProtectionModeInfo  OPTIONAL,
  cipheringModeInfo           CipheringModeInfo             OPTIONAL,
  activationTime               ActivationTime                 OPTIONAL,
  new-U-RNTI                   U-RNTI                       OPTIONAL,
  new-C-RNTI                   C-RNTI                       OPTIONAL,
  new-DSCH-RNTI                DSCH-RNTI                    OPTIONAL,
  rrc-StateIndicator           RRC-StateIndicator,
  utran-DRX-CycleLengthCoeff   UTRAN-DRX-CycleLengthCoefficient  OPTIONAL,
-- Core network IEs
  cn-InformationInfo           CN-InformationInfo           OPTIONAL,
-- UTRAN mobility IEs
  ura-Identity                 URA-Identity                 OPTIONAL,
-- Radio bearer IEs
  dl-CounterSynchronisationInfo  DL-CounterSynchronisationInfo  OPTIONAL,
-- Transport channel IEs
  ul-CommonTransChInfo-r4      UL-CommonTransChInfo-r4      OPTIONAL,
  ul-AddReconfTransChInfoList  UL-AddReconfTransChInfoList  OPTIONAL,
  modeSpecificTransChInfo      CHOICE {
    fdd                      SEQUENCE {
      cpch-SetID              CPCH-SetID              OPTIONAL,
      addReconfTransChDRAC-Info  DRAC-StaticInformationList  OPTIONAL
    },
    tdd                      NULL
  }
  dl-CommonTransChInfo-r4      DL-CommonTransChInfo-r4      OPTIONAL,
  dl-AddReconfTransChInfoList-r4  DL-AddReconfTransChInfoList-r4  OPTIONAL,
-- Physical channel IEs

```



```

frequencyInfo          FrequencyInfo          OPTIONAL,
maxAllowedUL-TX-Power  MaxAllowedUL-TX-Power  OPTIONAL,
ul-ChannelRequirement  UL-ChannelRequirement-r4  OPTIONAL,
modeSpecificPhysChInfo CHOICE {
  fdd                   SEQUENCE {
    dl-PDSCH-Information DL-PDSCH-Information  OPTIONAL
  },
  tdd                   NULL
},
dl-CommonInformation  DL-CommonInformation-r4  OPTIONAL,
dl-InformationPerRL-List DL-InformationPerRL-List-r4  OPTIONAL
}

-- *****
--
-- TRANSPORT CHANNEL RECONFIGURATION COMPLETE
--
-- *****

TransportChannelReconfigurationComplete ::= SEQUENCE {
  -- User equipment IEs
  rrc-TransactionIdentifier RRC-TransactionIdentifier,
  ul-IntegProtActivationInfo IntegrityProtActivationInfo  OPTIONAL,
  -- TABULAR: UL-TimingAdvance is applicable for TDD mode only.
  ul-TimingAdvance         UL-TimingAdvance  OPTIONAL,
  -- Radio bearer IEs
  count-C-ActivationTime  ActivationTime  OPTIONAL,
  rb-UL-CiphActivationTimeInfo RB-ActivationTimeInfoList  OPTIONAL,
  ul-CounterSynchronisationInfo UL-CounterSynchronisationInfo  OPTIONAL,
  laterNonCriticalExtensions SEQUENCE {
    -- Container for additional R99 extensions
    transportChannelReconfigurationComplete-r3-add-ext  BIT STRING  OPTIONAL,
    nonCriticalExtensions SEQUENCE {}  OPTIONAL
  }  OPTIONAL
}

-- *****
--
-- TRANSPORT CHANNEL RECONFIGURATION FAILURE
--
-- *****

TransportChannelReconfigurationFailure ::= SEQUENCE {
  -- User equipment IEs
  rrc-TransactionIdentifier RRC-TransactionIdentifier,
  failureCause              FailureCauseWithProtErr,
  laterNonCriticalExtensions SEQUENCE {
    -- Container for additional R99 extensions
    transportChannelReconfigurationFailure-r3-add-ext  BIT STRING  OPTIONAL,
    nonCriticalExtensions SEQUENCE {}  OPTIONAL
  }  OPTIONAL
}

-- *****
--
-- TRANSPORT FORMAT COMBINATION CONTROL in AM or UM RLC mode
--
-- *****

TransportFormatCombinationControl ::= SEQUENCE {
  -- rrc-TransactionIdentifier is always included in this message
  rrc-TransactionIdentifier RRC-TransactionIdentifier  OPTIONAL,
  modeSpecificInfo         CHOICE {
    fdd                   NULL,
    tdd                   SEQUENCE {
      tfcs-ID             TFCS-Identity  OPTIONAL
    }
  },
  dpch-TFCS-InUplink       TFC-Subset,
  activationTimeForTFCSsubset ActivationTime  OPTIONAL,
  tfc-ControlDuration      TFC-ControlDuration  OPTIONAL,
  laterNonCriticalExtensions SEQUENCE {
    -- Container for additional R99 extensions
    transportFormatCombinationControl-r3-add-ext  BIT STRING  OPTIONAL,
    nonCriticalExtensions SEQUENCE {}  OPTIONAL
  }  OPTIONAL
}

```

```

-- *****
--
-- TRANSPORT FORMAT COMBINATION CONTROL FAILURE
--
-- *****

TransportFormatCombinationControlFailure ::= SEQUENCE {
  -- User equipment IES
  rrc-TransactionIdentifier      RRC-TransactionIdentifier,
  failureCause                   FailureCauseWithProtErr,
  laterNonCriticalExtensions      SEQUENCE {
    -- Container for additional R99 extensions
    transportFormatCombinationControlFailure-r3-add-ext  BIT STRING      OPTIONAL,
    nonCriticalExtensions      SEQUENCE {}      OPTIONAL
  }
}

-- *****
--
-- UE CAPABILITY ENQUIRY
--
-- *****

UECapabilityEnquiry ::= CHOICE {
  r3                               SEQUENCE {
    ueCapabilityEnquiry-r3          UECapabilityEnquiry-r3-IEs,
    laterNonCriticalExtensions      SEQUENCE {
      -- Container for additional R99 extensions
      ueCapabilityEnquiry-r3-add-ext  BIT STRING      OPTIONAL,
      v4xyNonCriticalExtensions      SEQUENCE {
        ueCapabilityEnquiry-v4xyext  UECapabilityEnquiry-v4xyext-IEs,
        nonCriticalExtensions        SEQUENCE {}      OPTIONAL
      }
    }
  },
  later-than-r3                    SEQUENCE {
    rrc-TransactionIdentifier      RRC-TransactionIdentifier,
    criticalExtensions             SEQUENCE {}
  }
}

UECapabilityEnquiry-r3-IEs ::= SEQUENCE {
  -- User equipment IES
  rrc-TransactionIdentifier      RRC-TransactionIdentifier,
  capabilityUpdateRequirement    CapabilityUpdateRequirement
}

UECapabilityEnquiry-v4xyext-IEs ::= SEQUENCE {
  capabilityUpdateRequirement-r4-ext  CapabilityUpdateRequirement-r4-ext
}

-- *****
--
-- UE CAPABILITY INFORMATION
--
-- *****

UECapabilityInformation ::= SEQUENCE {
  -- User equipment IES
  rrc-TransactionIdentifier      RRC-TransactionIdentifier      OPTIONAL,
  ue-RadioAccessCapability      UE-RadioAccessCapability      OPTIONAL,
  -- Other IES
  ue-RATspecificCapability      InterRAT-UE-RadioAccessCapabilityList
OPTIONAL,
  v370NonCriticalExtensions      SEQUENCE {
    ueCapabilityInformation-v370ext  UECapabilityInformation-v370ext,
    v380NonCriticalExtensions      SEQUENCE {
      ueCapabilityInformation-v380ext  UECapabilityInformation-v380ext-IEs,
      v3a0NonCriticalExtensions      SEQUENCE {
        ueCapabilityInformation-v3a0ext  UECapabilityInformation-v3a0ext,
        laterNonCriticalExtensions      SEQUENCE {
          -- Container for additional R99 extensions
          ueCapabilityInformation-r3-add-ext  BIT STRING      OPTIONAL,
          -- Reserved for future non critical extension
          v4xyNonCriticalExtensions      SEQUENCE {
            ueCapabilityInformation-v4xyext  UECapabilityInformation-v4xyext,
            nonCriticalExtensions        SEQUENCE {}      OPTIONAL
          }
        }
      }
    }
  }
}

```

```
    } OPTIONAL
  } OPTIONAL
}

UECapabilityInformation-v370ext ::= SEQUENCE {
  -- User equipment IEs
  ue-RadioAccessCapability-v370ext      UE-RadioAccessCapability-v370ext      OPTIONAL
}

UECapabilityInformation-v380ext-IEs ::= SEQUENCE {
  -- User equipment IEs
  ue-RadioAccessCapability-v380ext      UE-RadioAccessCapability-v380ext
  OPTIONAL,
  dl-PhysChCapabilityFDD-v380ext        DL-PhysChCapabilityFDD-v380ext
}

UECapabilityInformation-v3a0ext ::= SEQUENCE {
  -- User equipment IEs
  ue-RadioAccessCapability-v3a0ext      UE-RadioAccessCapability-v3a0ext      OPTIONAL
}

UECapabilityInformation-v4xyext ::= SEQUENCE {
  -- User equipment IEs
  ue-RadioAccessCapability-v4xyext      UE-RadioAccessCapability-v4xyext
}

-- *****
--
-- UE CAPABILITY INFORMATION CONFIRM
--
-- *****

UECapabilityInformationConfirm ::= CHOICE {
  r3          SEQUENCE {
    ueCapabilityInformationConfirm-r3
    laterNonCriticalExtensions      SEQUENCE {
      -- Container for additional R99 extensions
      ueCapabilityInformationConfirm-r3-add-ext      BIT STRING      OPTIONAL,
      nonCriticalExtensions      SEQUENCE {}      OPTIONAL
    }
  },
  later-than-r3      SEQUENCE {
    rrc-TransactionIdentifier      RRC-TransactionIdentifier,
    criticalExtensions      SEQUENCE {}
  }
}

UECapabilityInformationConfirm-r3-IEs ::= SEQUENCE {
  -- User equipment IEs
  rrc-TransactionIdentifier      RRC-TransactionIdentifier
}

-- *****
--
-- UPLINK DIRECT TRANSFER
--
-- *****

UplinkDirectTransfer ::= SEQUENCE {
  -- Core network IEs
  cn-DomainIdentity      CN-DomainIdentity,
  nas-Message      NAS-Message,
  -- Measurement IEs
  measuredResultsOnRACH      MeasuredResultsOnRACH      OPTIONAL,
  laterNonCriticalExtensions      SEQUENCE {
    -- Container for additional R99 extensions
    uplinkDirectTransfer-r3-add-ext      BIT STRING      OPTIONAL,
    nonCriticalExtensions      SEQUENCE {}      OPTIONAL
  }
}

-- *****
--
-- UPLINK PHYSICAL CHANNEL CONTROL
--
```

```

-- *****
UplinkPhysicalChannelControl ::= CHOICE {
  r3                               SEQUENCE {
    uplinkPhysicalChannelControl-r3 UplinkPhysicalChannelControl-r3-IEs,
    laterNonCriticalExtensions       SEQUENCE {
      -- Container for additional R99 extensions
      uplinkPhysicalChannelControl-r3-add-ext   BIT STRING   OPTIONAL,
      v4xyNonCriticalExtensions               SEQUENCE {
        uplinkPhysicalChannelControl-v4xyext   UplinkPhysicalChannelControl-v4xyext-IEs,
        -- Extension mechanism for non-release4 information
        noncriticalExtensions                 SEQUENCE {}           OPTIONAL
      } OPTIONAL
    } OPTIONAL
  },
  later-than-r3                     SEQUENCE {
    rrc-TransactionIdentifier         RRC-TransactionIdentifier,
    criticalExtensions                CHOICE {
      r4                               SEQUENCE {
        uplinkPhysicalChannelControl-r4 UplinkPhysicalChannelControl-r4-IEs,
        nonCriticalExtensions           SEQUENCE {} OPTIONAL
      },
      criticalExtensions                SEQUENCE {}
    }
  }
}

UplinkPhysicalChannelControl-r3-IEs ::= SEQUENCE {
  -- User equipment IEs
  rrc-TransactionIdentifier         RRC-TransactionIdentifier,
  -- Physical channel IEs
  ccTrCH-PowerControlInfo           CCTrCH-PowerControlInfo           OPTIONAL,
  timingAdvance                     UL-TimingAdvanceControl           OPTIONAL,
  alpha                              Alpha                           OPTIONAL,
  specialBurstScheduling             SpecialBurstScheduling           OPTIONAL,
  prach-ConstantValue                ConstantValueTdd                OPTIONAL,
  pusch-ConstantValue                ConstantValueTdd                OPTIONAL
}

UplinkPhysicalChannelControl-v4xyext-IEs ::= SEQUENCE {
  -- In case of TDD, openLoopPowerControl-IPDL-TDD is included instead of IE
  -- up-IPDL-Parameters in up-OTDOA-AssistanceData
  openLoopPowerControl-IPDL-TDD     OpenLoopPowerControl-IPDL-TDD-r4   OPTIONAL
}

UplinkPhysicalChannelControl-r4-IEs ::= SEQUENCE {
  -- Physical channel IEs
  ccTrCH-PowerControlInfo           CCTrCH-PowerControlInfo-r4       OPTIONAL,
  specialBurstScheduling             SpecialBurstScheduling           OPTIONAL,
  tddOption                          CHOICE {
    tdd384                            SEQUENCE {
      timingAdvance                     UL-TimingAdvanceControl-r4     OPTIONAL,
      alpha                              Alpha                           OPTIONAL,
      prach-ConstantValue                ConstantValueTdd                OPTIONAL,
      pusch-ConstantValue                ConstantValueTdd                OPTIONAL,
      openLoopPowerControl-IPDL-TDD     OpenLoopPowerControl-IPDL-TDD-r4  OPTIONAL
    },
    tdd128                              SEQUENCE {
      ul-SynchronisationParameters      UL-SynchronisationParameters-r4  OPTIONAL
    }
  }
}

-- *****
--
-- URA UPDATE
--
-- *****

URAUUpdate ::= SEQUENCE {
  -- User equipment IEs
  u-RNTI                             U-RNTI,
  ura-UpdateCause                     URA-UpdateCause,
  protocolErrorIndicator              ProtocolErrorIndicatorWithMoreInfo,
  laterNonCriticalExtensions          SEQUENCE {
    -- Container for additional R99 extensions
    uraUpdate-r3-add-ext               BIT STRING   OPTIONAL,
    nonCriticalExtensions              SEQUENCE {}           OPTIONAL
  }
}

```

```

    } OPTIONAL
}

-- *****
--
-- URA UPDATE CONFIRM
--
-- *****

URAUUpdateConfirm ::= CHOICE {
    r3 SEQUENCE {
        uraUpdateConfirm-r3 URAUpdateConfirm-r3-IEs,
        laterNonCriticalExtensions SEQUENCE {
            -- Container for additional R99 extensions
            uraUpdateConfirm-r3-add-ext BIT STRING OPTIONAL,
            nonCriticalExtensions SEQUENCE {} OPTIONAL
        } OPTIONAL
    },
    later-than-r3 SEQUENCE {
        rrc-TransactionIdentifier RRC-TransactionIdentifier,
        criticalExtensions SEQUENCE {}
    }
}

URAUUpdateConfirm-r3-IEs ::= SEQUENCE {
    -- User equipment IEs
    rrc-TransactionIdentifier RRC-TransactionIdentifier,
    integrityProtectionModeInfo IntegrityProtectionModeInfo OPTIONAL,
    cipheringModeInfo CipheringModeInfo OPTIONAL,
    new-U-RNTI U-RNTI OPTIONAL,
    new-C-RNTI C-RNTI OPTIONAL,
    rrc-StateIndicator RRC-StateIndicator,
    utran-DRX-CycleLengthCoeff UTRAN-DRX-CycleLengthCoefficient OPTIONAL,
    -- CN information elements
    cn-InformationInfo CN-InformationInfo OPTIONAL,
    -- UTRAN mobility IEs
    ura-Identity URA-Identity OPTIONAL,
    -- Radio bearer IEs
    dl-CounterSynchronisationInfo DL-CounterSynchronisationInfo OPTIONAL
}

-- *****
--
-- URA UPDATE CONFIRM for CCCH
--
-- *****

URAUUpdateConfirm-CCCH ::= CHOICE {
    r3 SEQUENCE {
        uraUpdateConfirm-CCCH-r3 URAUpdateConfirm-CCCH-r3-IEs,
        laterNonCriticalExtensions SEQUENCE {
            -- Container for additional R99 extensions
            uraUpdateConfirm-CCCH-r3-add-ext BIT STRING OPTIONAL,
            nonCriticalExtensions SEQUENCE {} OPTIONAL
        } OPTIONAL
    },
    later-than-r3 SEQUENCE {
        u-RNTI U-RNTI,
        rrc-TransactionIdentifier RRC-TransactionIdentifier,
        criticalExtensions SEQUENCE {}
    }
}

URAUUpdateConfirm-CCCH-r3-IEs ::= SEQUENCE {
    -- User equipment IEs
    u-RNTI U-RNTI,
    -- The rest of the message is identical to the one sent on DCCH.
    uraUpdateConfirm URAUpdateConfirm-r3-IEs
}

-- *****
--
-- UTRAN MOBILITY INFORMATION
--
-- *****

UTRANMobilityInformation ::= CHOICE {
    r3 SEQUENCE {

```

```

    utranMobilityInformation-r3      UTRANMobilityInformation-r3-IEs,
    v3a0NonCriticalExtensions        SEQUENCE {
        utranMobilityInformation-v3a0ext  UTRANMobilityInformation-v3a0ext-IEs,
        laterNonCriticalExtensions        SEQUENCE {
            -- Container for additional R99 extensions
            utranMobilityInformation-r3-add-ext  BIT STRING      OPTIONAL,
            nonCriticalExtensions              SEQUENCE {} OPTIONAL
        }
        OPTIONAL
    }
},
later-than-r3                        SEQUENCE {
    rrc-TransactionIdentifier          RRC-TransactionIdentifier,
    criticalExtensions                  SEQUENCE {}
}
}

UTRANMobilityInformation-r3-IEs ::= SEQUENCE {
    -- User equipment IEs
    rrc-TransactionIdentifier          RRC-TransactionIdentifier,
    integrityProtectionModeInfo        IntegrityProtectionModeInfo      OPTIONAL,
    cipheringModeInfo                  CipheringModeInfo                  OPTIONAL,
    new-U-RNTI                          U-RNTI                          OPTIONAL,
    new-C-RNTI                          C-RNTI                          OPTIONAL,
    ue-ConnTimersAndConstants           UE-ConnTimersAndConstants         OPTIONAL,
    -- CN information elements
    cn-InformationInfo                  CN-InformationInfoFull            OPTIONAL,
    -- UTRAN mobility IEs
    ura-Identity                        URA-Identity                      OPTIONAL,
    -- Radio bearer IEs
    dl-CounterSynchronisationInfo      DL-CounterSynchronisationInfo    OPTIONAL,
    -- Extension mechanism for non- release99 information
    nonCriticalExtensions                SEQUENCE {}                      OPTIONAL
}

UTRANMobilityInformation-v3a0ext-IEs ::= SEQUENCE {
    ue-ConnTimersAndConstants-v3a0ext  UE-ConnTimersAndConstants-v3a0ext
}

-- *****
--
-- UTRAN MOBILITY INFORMATION CONFIRM
--
-- *****

UTRANMobilityInformationConfirm ::= SEQUENCE {
    -- User equipment IEs
    rrc-TransactionIdentifier          RRC-TransactionIdentifier,
    ul-IntegProtActivationInfo         IntegrityProtActivationInfo        OPTIONAL,
    -- Radio bearer IEs
    count-C-ActivationTime             ActivationTime                      OPTIONAL,
    rb-UL-CiphActivationTimeInfo       RB-ActivationTimeInfoList         OPTIONAL,
    ul-CounterSynchronisationInfo      UL-CounterSynchronisationInfo    OPTIONAL,
    laterNonCriticalExtensions          SEQUENCE {
        -- Container for additional R99 extensions
        utranNMobilityInformationConfirm-r3-add-ext  BIT STRING      OPTIONAL,
        nonCriticalExtensions              SEQUENCE {}      OPTIONAL
    }
    OPTIONAL
}

-- *****
--
-- UTRAN MOBILITY INFORMATION FAILURE
--
-- *****

UTRANMobilityInformationFailure ::= SEQUENCE {
    -- UE information elements
    rrc-TransactionIdentifier          RRC-TransactionIdentifier,
    failureCause                       FailureCauseWithProtErr,
    laterNonCriticalExtensions          SEQUENCE {
        -- Container for additional R99 extensions
        utranNMobilityInformationFailure-r3-add-ext  BIT STRING      OPTIONAL,
        -- Extension mechanism for non- release99 information
        nonCriticalExtensions            SEQUENCE {}      OPTIONAL
    }
    OPTIONAL
}
}

END

```

11.3 Information element definitions

```
InformationElements DEFINITIONS AUTOMATIC TAGS ::=
```

```
-- *****  
--  
-- CORE NETWORK INFORMATION ELEMENTS (10.3.1)  
--  
-- *****
```

```
BEGIN
```

```
IMPORTS
```

```
    hiPDSCHidentities,  
    hiPUSCHidentities,  
    hiRM,  
    maxAC,  
    maxAdditionalMeas,  
    maxASC,  
    maxASCmap,  
    maxASCpersist,  
    maxCCTrCH,  
    maxCellMeas,  
    maxCellMeas-1,  
    maxCNdomains,  
    maxCPCHsets,  
    maxDPCH-DLchan,  
    maxDPDCH-UL,  
    maxDRACclasses,  
    maxFACHPCH,  
    maxFreq,  
    maxFreqBandsFDD,  
    maxFreqBandsTDD,  
    maxFreqBandsGSM,  
    maxInterSysMessages,  
    maxLoCHperRLC,  
    maxMeasEvent,  
    maxMeasIntervals,  
    maxMeasParEvent,  
    maxNumCDMA2000Freqs,  
    maxNumFDDFreqs,  
    maxNumGSMFreqRanges,  
    maxNumTDDFreqs,  
    maxOtherRAT,  
    maxOtherRAT-16,  
    maxPage1,  
    maxPCPCH-APsig,  
    maxPCPCH-APsubCh,  
    maxPCPCH-CDSig,  
    maxPCPCH-CDSUBch,  
    maxPCPCH-SF,  
    maxPCPCHs,  
    maxPDCPAlgoType,  
    maxPDSCH,  
    maxPDSCH-TFCIgroups,  
    maxPRACH,  
    maxPRACH-FPACH,  
    maxPredefConfig,  
    maxPUSCH,  
    maxRABsetup,  
    maxRAT,  
    maxRB,  
    maxRBallRABs,  
    maxRBMuxOptions,  
    maxRBperRAB,  
    maxReportedGSMCells,  
    maxSRBsetup,  
    maxRL,  
    maxRL-1,  
    maxROHC-PacketSizes-r4,  
    maxROHC-Profile-r4,  
    maxSCCPCH,  
    maxSat,  
    maxSIB,  
    maxSIB-FACH,  
    maxSystemCapability,  
    maxTF,
```

```

maxTF-CPCH,
maxTFC,
maxTFCsub,
maxTF-CI-2-Combs,
maxTGPS,
maxTrCH,
maxTrCHpreconf,
maxTS,
maxTS-1,
maxTS-LCR,
maxTS-LCR-1,
maxURA
FROM Constant-definitions;

Ansi-41-IDNNS ::=                                BIT STRING (SIZE (14))

CN-DomainIdentity ::=                            ENUMERATED {
                                                cs-domain,
                                                ps-domain }

CN-DomainInformation ::=                         SEQUENCE {
  cn-DomainIdentity                            CN-DomainIdentity,
  cn-DomainSpecificNAS-Info                    NAS-SystemInformationGSM-MAP
}

CN-DomainInformationFull ::=                     SEQUENCE {
  cn-DomainIdentity                            CN-DomainIdentity,
  cn-DomainSpecificNAS-Info                    NAS-SystemInformationGSM-MAP,
  cn-DRX-CycleLengthCoeff                    CN-DRX-CycleLengthCoefficient
}

CN-DomainInformationList ::=                     SEQUENCE (SIZE (1..maxCNdomains)) OF
  CN-DomainInformation

CN-DomainInformationListFull ::=                 SEQUENCE (SIZE (1..maxCNdomains)) OF
  CN-DomainInformationFull

CN-DomainSysInfo ::=                            SEQUENCE {
  cn-DomainIdentity                            CN-DomainIdentity,
  cn-Type                                       CHOICE {
    gsm-MAP                                    NAS-SystemInformationGSM-MAP,
    ansi-41                                    NAS-SystemInformationANSI-41
  },
  cn-DRX-CycleLengthCoeff                    CN-DRX-CycleLengthCoefficient
}

CN-DomainSysInfoList ::=                        SEQUENCE (SIZE (1..maxCNdomains)) OF
  CN-DomainSysInfo

CN-InformationInfo ::=                          SEQUENCE {
  plmn-Identity                                PLMN-Identity                                OPTIONAL,
  cn-CommonGSM-MAP-NAS-SysInfo                NAS-SystemInformationGSM-MAP                OPTIONAL,
  cn-DomainInformationList                    CN-DomainInformationList                    OPTIONAL
}

CN-InformationInfoFull ::=                      SEQUENCE {
  plmn-Identity                                PLMN-Identity                                OPTIONAL,
  cn-CommonGSM-MAP-NAS-SysInfo                NAS-SystemInformationGSM-MAP                OPTIONAL,
  cn-DomainInformationListFull                CN-DomainInformationListFull                OPTIONAL
}

Digit ::=                                       INTEGER (0..9)

Gsm-map-IDNNS ::=                               SEQUENCE {
  routingbasis                                 CHOICE {
    localPTMSI                                 SEQUENCE {
      routingparameter                          RoutingParameter
    },
    tMSIofsamePLMN                             SEQUENCE {
      routingparameter                          RoutingParameter
    },
    tMSIofdifferentPLMN                       SEQUENCE {
      routingparameter                          RoutingParameter
    },
    iMSIresponsetopaging                       SEQUENCE {
      routingparameter                          RoutingParameter
    },
    iMSIUEinitiatedEvent                       SEQUENCE {

```



```

        routingparameter
    },
    imei
        routingparameter
    },
    spare1
        routingparameter
    },
    spare2
        routingparameter
    }
},
enteredparameter
}

IMEI ::=
SEQUENCE (SIZE (15)) OF
    IMEI-Digit

IMEI-Digit ::=
INTEGER (0..15)

IMSI-GSM-MAP ::=
SEQUENCE (SIZE (6..15)) OF
    Digit

IntraDomainNasNodeSelector ::=
    version
        release99
            cn-Type
                gsm-Map-IDNNS
                ansi-41-IDNNS
            },
        later
            futurecoding
    }
}

LAI ::=
SEQUENCE {
    plmn-Identity,
    lac
}

MCC ::=
SEQUENCE (SIZE (3)) OF
    Digit

MNC ::=
SEQUENCE (SIZE (2..3)) OF
    Digit

NAS-Message ::=
OCTET STRING (SIZE (1..4095))

NAS-Synchronisation-Indicator ::=
    BIT STRING(SIZE(4))

NAS-SystemInformationGSM-MAP ::=
OCTET STRING (SIZE (1..8))

P-TMSI-GSM-MAP ::=
BIT STRING (SIZE (32))

PagingRecordTypeID ::=
ENUMERATED {
    imsi-GSM-MAP,
    tmsi-GSM-MAP-P-TMSI,
    imsi-DS-41,
    tmsi-DS-41 }

PLMN-Identity ::=
SEQUENCE {
    mcc,
    mnc
}

PLMN-Type ::=
CHOICE {
    gsm-MAP
        SEQUENCE {
            plmn-Identity
        },
    ansi-41
        SEQUENCE {
            p-REV,
            min-P-REV,
            sid,
            nid
        },
    gsm-MAP-and-ANSI-41
        SEQUENCE {
            RoutingParameter
        }
    SEQUENCE {
        RoutingParameter
    }
    SEQUENCE {
        RoutingParameter
    }
    SEQUENCE {
        RoutingParameter
    }
    BOOLEAN
}

SEQUENCE (SIZE (15)) OF
    IMEI-Digit

INTEGER (0..15)

SEQUENCE (SIZE (6..15)) OF
    Digit

SEQUENCE {
    CHOICE {
        SEQUENCE {
            CHOICE {
                Gsm-map-IDNNS,
                Ansi-41-IDNNS
            }
        },
        SEQUENCE {
            BIT STRING (SIZE (15))
        }
    }
}

SEQUENCE {
    PLMN-Identity,
    BIT STRING (SIZE (16))
}

SEQUENCE (SIZE (3)) OF
    Digit

SEQUENCE (SIZE (2..3)) OF
    Digit

OCTET STRING (SIZE (1..4095))

    BIT STRING(SIZE(4))

OCTET STRING (SIZE (1..8))

BIT STRING (SIZE (32))

ENUMERATED {
    imsi-GSM-MAP,
    tmsi-GSM-MAP-P-TMSI,
    imsi-DS-41,
    tmsi-DS-41 }

SEQUENCE {
    MCC,
    MNC
}

CHOICE {
    SEQUENCE {
        PLMN-Identity
    },
    SEQUENCE {
        P-REV,
        Min-P-REV,
        SID,
        NID
    }
    SEQUENCE {

```

```

        plmn-Identity          PLMN-Identity,
        p-REV                  P-REV,
        min-P-REV              Min-P-REV,
        sid                     SID,
        nid                     NID
    },
    spare                       NULL
}

RAB-Identity ::=              CHOICE {
    gsm-MAP-RAB-Identity      BIT STRING (SIZE (8)),
    ansi-4l-RAB-Identity      BIT STRING (SIZE (8))
}

RAI ::=                       SEQUENCE {
    lai                        LAI,
    rac                        RoutingAreaCode
}

RoutingAreaCode ::=          BIT STRING (SIZE (8))

RoutingParameter ::=          BIT STRING (SIZE (10))

TMSI-GSM-MAP ::=             BIT STRING (SIZE (32))

-- *****
--
--     UTRAN MOBILITY INFORMATION ELEMENTS (10.3.2)
--
-- *****

AccessClassBarred ::=        ENUMERATED {
                                barred, notBarred }

AccessClassBarredList ::=    SEQUENCE (SIZE (maxAC)) OF
                                AccessClassBarred

AllowedIndicator ::=          ENUMERATED {
                                allowed, notAllowed }

CellAccessRestriction ::=    SEQUENCE {
    cellBarred                 CellBarred,
    cellReservedForOperatorUse ReservedIndicator,
    cellReservationExtension    ReservedIndicator,
    -- NOTE: IE accessClassBarredList should not be included if the IE CellAccessRestriction
    -- is included in the IE SysInfoType4
    accessClassBarredList      AccessClassBarredList           OPTIONAL
}

CellBarred ::=                CHOICE {
    barred                       SEQUENCE {
        intraFreqCellReselectionInd AllowedIndicator,
        t-Barred                    T-Barred
    },
    notBarred                    NULL
}

CellIdentity ::=              BIT STRING (SIZE (28))

CellIdentity-PerRL-List ::=   SEQUENCE (SIZE (1..maxRL)) OF CellIdentity

CellSelectReselectInfoSIB-3-4 ::= SEQUENCE {
    mappingInfo                 MappingInfo           OPTIONAL,
    cellSelectQualityMeasure     CHOICE {
        cpich-Ec-N0                SEQUENCE {
            -- Default value for q-HYST-2-S is q-HYST-1-S
            q-HYST-2-S                Q-Hyst-S           OPTIONAL
            -- Default value for q-HYST-2-S is q-HYST-1-S
        },
        cpich-RSCP                  NULL
    },
    modeSpecificInfo             CHOICE {
        fdd                          SEQUENCE {
            s-Intrasearch             S-SearchQual    OPTIONAL,
            s-Intersearch             S-SearchQual    OPTIONAL,
            s-SearchHCS                S-SearchRXLEV   OPTIONAL,
            rat-List                   RAT-FDD-InfoList  OPTIONAL,
            q-QualMin                  Q-QualMin
        }
    }
}

```

```

        q-RxlevMin                Q-RxlevMin
    },
    tdd                            SEQUENCE {
        s-Intrasearch              S-SearchRXLEV                OPTIONAL,
        s-Intersearch              S-SearchRXLEV                OPTIONAL,
        s-SearchHCS                 S-SearchRXLEV                OPTIONAL,
        rat-List                    RAT-TDD-InfoList             OPTIONAL,
        q-RxlevMin                  Q-RxlevMin
    }
},
q-Hyst-l-S                        Q-Hyst-S,
t-Reselection-S                  T-Reselection-S,
hcs-ServingCellInformation        HCS-ServingCellInformation    OPTIONAL,
maxAllowedUL-TX-Power            MaxAllowedUL-TX-Power
}

MapParameter ::=                  INTEGER (0..99)

Mapping ::=                        SEQUENCE {
    rat                            RAT,
    mappingFunctionParameterList    MappingFunctionParameterList
}

Mapping-LCR-r4 ::=                SEQUENCE {
    mappingFunctionParameterList    MappingFunctionParameterList
}

MappingFunctionParameter ::=      SEQUENCE {
    functionType                    MappingFunctionType,
    mapParameter1                   MapParameter                  OPTIONAL,
    mapParameter2                   MapParameter,
    -- The presence of upperLimit is conditional on the number of repetition
    upperLimit                       UpperLimit                    OPTIONAL
}

MappingFunctionParameterList ::=  SEQUENCE (SIZE (1..maxMeasIntervals)) OF
    MappingFunctionParameter

MappingFunctionType ::=           ENUMERATED {
    linear,
    functionType2,
    functionType3,
    functionType4 }

-- In MappingInfo list, mapping for FDD and 3.84Mcps TDD is defined.
-- For 1.28Mcps TDD, Mapping-LCR-r4 is used instead.
MappingInfo ::=                   SEQUENCE (SIZE (1..maxRAT)) OF
    Mapping

-- Actual value Q-Hyst-S = IE value * 2
Q-Hyst-S ::=                       INTEGER (0..20)

RAT ::=                            ENUMERATED {
    ultra-FDD,
    ultra-TDD,
    gsm,
    cdma2000 }

RAT-FDD-Info ::=                  SEQUENCE {
    rat-Identifier                  RAT-Identifier,
    s-SearchRAT                     S-SearchQual,
    s-HCS-RAT                        S-SearchRXLEV                OPTIONAL,
    s-Limit-SearchRAT               S-SearchQual
}

RAT-FDD-InfoList ::=              SEQUENCE (SIZE (1..maxOtherRAT)) OF
    RAT-FDD-Info

RAT-Identifier ::=                ENUMERATED {
    gsm, cdma2000 }

RAT-TDD-Info ::=                  SEQUENCE {
    rat-Identifier                  RAT-Identifier,
    s-SearchRAT                     S-SearchRXLEV,
    s-HCS-RAT                        S-SearchRXLEV                OPTIONAL,
    s-Limit-SearchRAT               S-SearchRXLEV
}

```

```

RAT-TDD-InfoList ::=                               SEQUENCE (SIZE (1..maxOtherRAT)) OF
                                                    RAT-TDD-Info

ReservedIndicator ::=                             ENUMERATED {
                                                    reserved,
                                                    notReserved }

-- Actual value S-SearchedQual = IE value * 2
S-SearchQual ::=                                 INTEGER (-16..10)

-- Actual value S-SearchRXLEV = (IE value * 2) + 1
S-SearchRXLEV ::=                                INTEGER (-53..45)

T-Barred ::=                                     ENUMERATED {
                                                    s10, s20, s40, s80,
                                                    s160, s320, s640, s1280 }

T-Reselection-S ::=                              INTEGER (0..31)

-- For UpperLimit, the used range depends on the RAT used.
UpperLimit ::=                                  INTEGER (1..91)

URA-Identity ::=                                BIT STRING (SIZE (16))

URA-IdentityList ::=                            SEQUENCE (SIZE (1..maxURA)) OF
                                                    URA-Identity

-- *****
--
--     USER EQUIPMENT INFORMATION ELEMENTS (10.3.3)
--
-- *****

AccessStratumReleaseIndicator ::=                ENUMERATED {
                                                    rel-4, spare15, spare14, spare13,
                                                    spare12, spare11, spare10, spare9, spare8,
                                                    spare7, spare6, spare5, spare4, spare3,
                                                    spare2, spare1 }

-- TABULAR : for ActivationTime, value 'now' always appear as default, and is encoded
-- by absence of the field
ActivationTime ::=                              INTEGER (0..255)

BackoffControlParams ::=                        SEQUENCE {
    n-AP-RetransMax                             N-AP-RetransMax,
    n-AccessFails                               N-AccessFails,
    nf-BO-NoAICH                                NF-BO-NoAICH,
    ns-BO-Busy                                  NS-BO-Busy,
    nf-BO-AllBusy                              NF-BO-AllBusy,
    nf-BO-Mismatch                             NF-BO-Mismatch,
    t-CPCH                                       T-CPCH
}

C-RNTI ::=                                      BIT STRING (SIZE (16))

CapabilityUpdateRequirement ::=                 SEQUENCE {
    ue-RadioCapabilityFDDUpdateRequirement-FDD  BOOLEAN,
    -- ue-RadioCapabilityTDDUpdateRequirement-TDD is for 3.84Mcps TDD update requirement
    ue-RadioCapabilityTDDUpdateRequirement-TDD  BOOLEAN,
    systemSpecificCapUpdateReqList              SystemSpecificCapUpdateReqList    OPTIONAL
}

CapabilityUpdateRequirement-r4-ext ::=         SEQUENCE {
    ue-RadioCapabilityUpdateRequirement-TDD128  BOOLEAN
}

CapabilityUpdateRequirement-r4 ::=             SEQUENCE {
    ue-RadioCapabilityFDDUpdateRequirement-FDD  BOOLEAN,
    ue-RadioCapabilityTDDUpdateRequirement-TDD384  BOOLEAN,
    ue-RadioCapabilityTDDUpdateRequirement-TDD128  BOOLEAN,
    systemSpecificCapUpdateReqList              SystemSpecificCapUpdateReqList    OPTIONAL
}

CellUpdateCause ::=                            ENUMERATED {
                                                    cellReselection,
                                                    periodicalCellUpdate,
                                                    uplinkDataTransmission,
                                                    utran-pagingResponse,

```

```

        re-enteredServiceArea,
        radiolinkFailure,
        rlc-unrecoverableError,
        spare1 }

ChipRateCapability ::=          ENUMERATED {
        mcps3-84, mcps1-28 }

CipheringAlgorithm ::=         ENUMERATED {
        uea0, uea1 }

CipheringModeCommand ::=      CHOICE {
        startRestart
        dummy                    NULL
        CipheringAlgorithm,
    }

CipheringModeInfo ::=         SEQUENCE {
        -- TABULAR: The ciphering algorithm is included in the CipheringModeCommand.
        cipheringModeCommand      CipheringModeCommand,
        activationTimeForDPCH      ActivationTime                    OPTIONAL,
        rb-DL-CiphActivationTimeInfo  RB-ActivationTimeInfoList    OPTIONAL
    }

CN-DRX-CycleLengthCoefficient ::= INTEGER (6..9)

CN-PagedUE-Identity ::=      CHOICE {
        imsi-GSM-MAP              IMSI-GSM-MAP,
        tmsi-GSM-MAP              TMSI-GSM-MAP,
        p-TMSI-GSM-MAP            P-TMSI-GSM-MAP,
        imsi-DS-41                IMSI-DS-41,
        tmsi-DS-41                TMSI-DS-41,
        spare3                     NULL,
        spare2                     NULL,
        spare1                     NULL
    }

CompressedModeMeasCapability ::= SEQUENCE {
        fdd-Measurements           BOOLEAN,
        -- TABULAR: The IEs tdd-Measurements, gsm-Measurements and multiCarrierMeasurements
        -- are made optional since they are conditional based on another information element.
        -- Their absence corresponds to the case where the condition is not true.
        tdd-Measurements           BOOLEAN                    OPTIONAL,
        gsm-Measurements           GSM-Measurements          OPTIONAL,
        multiCarrierMeasurements   BOOLEAN                    OPTIONAL
    }

CompressedModeMeasCapability-LCR-r4 ::= SEQUENCE {
        tdd128-Measurements        BOOLEAN                    OPTIONAL
    }

CompressedModeMeasCapabFDDList ::= SEQUENCE (SIZE (1..maxFreqBandsFDD)) OF
        CompressedModeMeasCapabFDD

CompressedModeMeasCapabFDD ::= SEQUENCE {
        radioFrequencyBandFDD     RadioFrequencyBandFDD  OPTIONAL,
        dl-MeasurementsFDD        BOOLEAN,
        ul-MeasurementsFDD        BOOLEAN
    }

CompressedModeMeasCapabTDDList ::= SEQUENCE (SIZE (1..maxFreqBandsTDD)) OF
        CompressedModeMeasCapabTDD

CompressedModeMeasCapabTDD ::= SEQUENCE {
        radioFrequencyBandTDD     RadioFrequencyBandTDD,
        dl-MeasurementsTDD        BOOLEAN,
        ul-MeasurementsTDD        BOOLEAN
    }

CompressedModeMeasCapabGSMList ::= SEQUENCE (SIZE (1..maxFreqBandsGSM)) OF
        CompressedModeMeasCapabGSM

CompressedModeMeasCapabGSM ::= SEQUENCE {
        radioFrequencyBandGSM     RadioFrequencyBandGSM,
        dl-MeasurementsGSM        BOOLEAN,
        ul-MeasurementsGSM        BOOLEAN
    }

CompressedModeMeasCapabMC ::= SEQUENCE {

```

```

    dl-MeasurementsMC          BOOLEAN,
    ul-MeasurementsMC          BOOLEAN
}

CPCH-Parameters ::=          SEQUENCE {
    initialPriorityDelayList    InitialPriorityDelayList          OPTIONAL,
    backoffControlParams        BackoffControlParams,
    -- TABULAR: TPC step size nested inside PowerControlAlgorithm
    powerControlAlgorithm        PowerControlAlgorithm,
    dl-DPCCH-BER                DL-DPCCH-BER
}

DL-DPCCH-BER ::=              INTEGER (0..63)

DL-PhysChCapabilityFDD ::=    SEQUENCE {
    maxNoDPCH-PDSCH-Codes        INTEGER (1..8),
    maxNoPhysChBitsReceived      MaxNoPhysChBitsReceived,
    supportForSF-512              BOOLEAN,
    supportOfPDSCH                BOOLEAN,
    simultaneousSCCPCH-DPCH-Reception SimultaneousSCCPCH-DPCH-Reception
}

DL-PhysChCapabilityFDD-v380ext ::= SEQUENCE {
    supportOfDedicatedPilotsForChEstimation SupportOfDedicatedPilotsForChEstimation OPTIONAL
}

SupportOfDedicatedPilotsForChEstimation ::= ENUMERATED { true }

DL-PhysChCapabilityTDD ::=    SEQUENCE {
    maxTS-PerFrame                MaxTS-PerFrame,
    maxPhysChPerFrame              MaxPhysChPerFrame,
    minimumSF                      MinimumSF-DL,
    supportOfPDSCH                BOOLEAN,
    maxPhysChPerTS                 MaxPhysChPerTS
}

DL-PhysChCapabilityTDD-LCR-r4 ::= SEQUENCE {
    maxTS-PerSubFrame              MaxTS-PerSubFrame-r4,
    maxPhysChPerSubFrame-r4        MaxPhysChPerSubFrame-r4,
    minimumSF                      MinimumSF-DL,
    supportOfPDSCH                BOOLEAN,
    maxPhysChPerTS                 MaxPhysChPerTS,
    supportOf8PSK                  BOOLEAN
}

DL-TransChCapability ::=      SEQUENCE {
    maxNoBitsReceived              MaxNoBits,
    maxConvCodeBitsReceived        MaxNoBits,
    turboDecodingSupport            TurboSupport,
    maxSimultaneousTransChs        MaxSimultaneousTransChsDL,
    maxSimultaneousCCTrCH-Count    MaxSimultaneousCCTrCH-Count,
    maxReceivedTransportBlocks      MaxTransportBlocksDL,
    maxNumberOfTFC                  MaxNumberOfTFC-DL,
    maxNumberOfTF                   MaxNumberOfTF
}

DRAC-SysInfo ::=              SEQUENCE {
    transmissionProbability          TransmissionProbability,
    maximumBitRate                  MaximumBitRate
}

DRAC-SysInfoList ::=          SEQUENCE (SIZE (1..maxDRACclasses)) OF
    DRAC-SysInfo

DSCH-RNTI ::=                  BIT STRING (SIZE (16))

ESN-DS-41 ::=                  BIT STRING (SIZE (32))

EstablishmentCause ::=         ENUMERATED {
    originatingConversationalCall,
    originatingStreamingCall,
    originatingInteractiveCall,
    originatingBackgroundCall,
    originatingSubscribedTrafficCall,
    terminatingConversationalCall,
    terminatingStreamingCall,
    terminatingInteractiveCall,
    terminatingBackgroundCall,
}

```

```

        emergencyCall,
        interRAT-CellReselection,
        interRAT-CellChangeOrder,
        registration,
        detach,
        originatingHighPrioritySignalling,
        originatingLowPrioritySignalling,
        callRe-establishment,
        terminatingHighPrioritySignalling,
        terminatingLowPrioritySignalling,
        terminatingCauseUnknown,
        spare12,
        spare11,
        spare10,
        spare9,
        spare8,
        spare7,
        spare6,
        spare5,
        spare4,
        spare3,
        spare2,
        spare1 }

FailureCauseWithProtErr ::= CHOICE {
    configurationUnsupported          NULL,
    physicalChannelFailure           NULL,
    incompatibleSimultaneousReconfiguration
                                     NULL,
    compressedModeRuntimeError      TGPSI,
    protocolError                   ProtocolErrorInformation,
    cellUpdateOccurred              NULL,
    invalidConfiguration             NULL,
    configurationIncomplete          NULL,
    unsupportedMeasurement           NULL,
    spare7                           NULL,
    spare6                           NULL,
    spare5                           NULL,
    spare4                           NULL,
    spare3                           NULL,
    spare2                           NULL,
    spare1                           NULL
}

FailureCauseWithProtErrTrId ::= SEQUENCE {
    rrc-TransactionIdentifier        RRC-TransactionIdentifier,
    failureCause                     FailureCauseWithProtErr
}

GSM-Measurements ::= SEQUENCE {
    gsm900                          BOOLEAN,
    dcs1800                          BOOLEAN,
    gsm1900                          BOOLEAN
}

UESpecificBehaviourInformationlidle ::= BIT STRING (SIZE (4))

UESpecificBehaviourInformationlinterRAT ::= BIT STRING (SIZE (8))

IMSI-and-ESN-DS-41 ::= SEQUENCE {
    imsi-DS-41                       IMSI-DS-41,
    esn-DS-41                         ESN-DS-41
}

IMSI-DS-41 ::= OCTET STRING (SIZE (5..7))

InitialPriorityDelayList ::= SEQUENCE (SIZE (1..maxASC)) OF
    NS-IP

InitialUE-Identity ::= CHOICE {
    imsi                             IMSI-GSM-MAP,
    tmsi-and-LAI                     TMSI-and-LAI-GSM-MAP,
    p-TMSI-and-RAI                   P-TMSI-and-RAI-GSM-MAP,
    imei                              IMEI,
    esn-DS-41                        ESN-DS-41,
    imsi-DS-41                       IMSI-DS-41,
    imsi-and-ESN-DS-41               IMSI-and-ESN-DS-41,
    tmsi-DS-41                       TMSI-DS-41
}

```

```

}

IntegrityCheckInfo ::= SEQUENCE {
    messageAuthenticationCode      MessageAuthenticationCode,
    rrc-MessageSequenceNumber      RRC-MessageSequenceNumber
}

IntegrityProtActivationInfo ::= SEQUENCE {
    rrc-MessageSequenceNumberList  RRC-MessageSequenceNumberList
}

IntegrityProtectionAlgorithm ::= ENUMERATED {
    uial }

IntegrityProtectionModeCommand ::= CHOICE {
    startIntegrityProtection      SEQUENCE {
        integrityProtInitNumber    IntegrityProtInitNumber
    },
    modify                         SEQUENCE {
        dl-IntegrityProtActivationInfo IntegrityProtActivationInfo
    }
}

IntegrityProtectionModeInfo ::= SEQUENCE {
    -- TABULAR: DL integrity protection activation info and Integrity
    -- protection intialisation number have been nested inside
    -- IntegrityProtectionModeCommand.
    integrityProtectionModeCommand IntegrityProtectionModeCommand,
    integrityProtectionAlgorithm    IntegrityProtectionAlgorithm    OPTIONAL
}

IntegrityProtInitNumber ::= BIT STRING (SIZE (32))

MaxHcContextSpace ::= ENUMERATED {
    by512, by1024, by2048, by4096,
    by8192 }

MaxROHC-ContextSessions-r4 ::= ENUMERATED {
    s2, s4, s8, s12, s16, s24, s32, s48,
    s64, s128, s256, s512, s1024, s16384 }

MaximumAM-EntityNumberRLC-Cap ::= ENUMERATED {
    am3, am4, am5, am6,
    am8, am16, am30 }

-- Actual value MaximumBitRate = IE value * 16
MaximumBitRate ::= INTEGER (0..32)

MaximumRLC-WindowSize ::= ENUMERATED { mws2047, mws4095 }

MaxNoDPDCH-BitsTransmitted ::= ENUMERATED {
    b600, b1200, b2400, b4800,
    b9600, b19200, b28800, b38400,
    b48000, b57600 }

MaxNoBits ::= ENUMERATED {
    b640, b1280, b2560, b3840, b5120,
    b6400, b7680, b8960, b10240,
    b20480, b40960, b81920, b163840 }

MaxNoPhysChBitsReceived ::= ENUMERATED {
    b600, b1200, b2400, b3600,
    b4800, b7200, b9600, b14400,
    b19200, b28800, b38400, b48000,
    b57600, b67200, b76800 }

MaxNoSCCPCH-RL ::= ENUMERATED {
    r11 }

MaxNumberOfTF ::= ENUMERATED {
    tf32, tf64, tf128, tf256,
    tf512, tf1024 }

MaxNumberOfTFC-DL ::= ENUMERATED {
    tfc16, tfc32, tfc48, tfc64, tfc96,
    tfc128, tfc256, tfc512, tfc1024 }

```



```

MaxNumberOfTFC-UL ::=          ENUMERATED {
                                tfc4, tfc8, tfc16, tfc32, tfc48, tfc64,
                                tfc96, tfc128, tfc256, tfc512, tfc1024 }

MaxPhysChPerFrame ::=          INTEGER (1..224)

MaxPhysChPerSubFrame-r4 ::=    INTEGER (1..96)

MaxPhysChPerTimeslot ::=       ENUMERATED {
                                ts1, ts2 }

MaxPhysChPerTS ::=             INTEGER (1..16)

MaxSimultaneousCCTrCH-Count ::= INTEGER (1..8)

MaxSimultaneousTransChsDL ::=  ENUMERATED {
                                e4, e8, e16, e32 }

MaxSimultaneousTransChsUL ::=  ENUMERATED {
                                e2, e4, e8, e16, e32 }

MaxTransportBlocksDL ::=       ENUMERATED {
                                tb4, tb8, tb16, tb32, tb48,
                                tb64, tb96, tb128, tb256, tb512 }

MaxTransportBlocksUL ::=       ENUMERATED {
                                tb2, tb4, tb8, tb16, tb32, tb48,
                                tb64, tb96, tb128, tb256, tb512 }

MaxTS-PerFrame ::=             INTEGER (1..14)

MaxTS-PerSubFrame-r4 ::=       INTEGER (1..6)

-- TABULAR: MeasurementCapability contains dependencies to UE-MultiModeRAT-Capability,
-- the conditional fields have been left mandatory for now.
MeasurementCapability ::=       SEQUENCE {
    downlinkCompressedMode      CompressedModeMeasCapability,
    uplinkCompressedMode        CompressedModeMeasCapability
}

MeasurementCapability-v370 ::=  SEQUENCE{
    compressedModeMeasCapabFDDList      CompressedModeMeasCapabFDDList,
    compressedModeMeasCapabTDDList      CompressedModeMeasCapabTDDList OPTIONAL,
    compressedModeMeasCapabGSMLList     CompressedModeMeasCapabGSMLList  OPTIONAL,
    compressedModeMeasCapabMC           CompressedModeMeasCapabMC        OPTIONAL
}

MeasurementCapability-r4-ext ::= SEQUENCE {
    downlinkCompressedMode-LCR          CompressedModeMeasCapability-LCR-r4,
    uplinkCompressedMode-LCR           CompressedModeMeasCapability-LCR-r4
}

MessageAuthenticationCode ::=  BIT STRING (SIZE (32))

MinimumSF-DL ::=                ENUMERATED {
                                sf1, sf16 }

MinimumSF-UL ::=                ENUMERATED {
                                sf1, sf2, sf4, sf8, sf16 }

MultiModeCapability ::=         ENUMERATED {
                                tdd, fdd, fdd-tdd }

MultiRAT-Capability ::=        SEQUENCE {
    supportOfGSM                   BOOLEAN,
    supportOfMulticarrier          BOOLEAN
}

N-300 ::=                       INTEGER (0..7)

N-301 ::=                       INTEGER (0..7)

N-302 ::=                       INTEGER (0..7)

N-304 ::=                       INTEGER (0..7)

N-308 ::=                       INTEGER (1..8)

```

```

N-310 ::= INTEGER (0..7)
N-312 ::= ENUMERATED {
    s1, s50, s100, s200, s400,
    s600, s800, s1000 }
N-312ext ::= ENUMERATED {
    s2, s4, s10, s20 }
N-313 ::= ENUMERATED {
    s1, s2, s4, s10, s20,
    s50, s100, s200 }
N-315 ::= ENUMERATED {
    s1, s50, s100, s200, s400,
    s600, s800, s1000 }
N-315ext ::= ENUMERATED {
    s2, s4, s10, s20 }
N-AccessFails ::= INTEGER (1..64)
N-AP-RetransMax ::= INTEGER (1..64)
NetworkAssistedGPS-Supported ::= ENUMERATED {
    networkBased,
    ue-Based,
    bothNetworkAndUE-Based,
    noNetworkAssistedGPS }
NF-BO-AllBusy ::= INTEGER (0..31)
NF-BO-NoAICH ::= INTEGER (0..31)
NF-BO-Mismatch ::= INTEGER (0..127)
NS-BO-Busy ::= INTEGER (0..63)
NS-IP ::= INTEGER (0..28)
P-TMSI-and-RAI-GSM-MAP ::= SEQUENCE {
    p-TMSI
    rai
}
PagingCause ::= ENUMERATED {
    terminatingConversationalCall,
    terminatingStreamingCall,
    terminatingInteractiveCall,
    terminatingBackgroundCall,
    terminatingHighPrioritySignalling,
    terminatingLowPrioritySignalling,
    terminatingCauseUnknown,
    spare
}
PagingRecord ::= CHOICE {
    cn-Identity SEQUENCE {
        pagingCause
        cn-DomainIdentity
        cn-pagedUE-Identity
    },
    utran-Identity SEQUENCE {
        u-RNTI
        cn-OriginatedPage-connectedMode-UE SEQUENCE {
            pagingCause
            cn-DomainIdentity
            pagingRecordTypeID
        }
    }
} OPTIONAL
PagingRecordList ::= SEQUENCE (SIZE (1..maxPage1)) OF
    PagingRecord
PDCP-Capability ::= SEQUENCE {
    losslessSRNS-RelocationSupport BOOLEAN,

```

```

    supportForRfc2507          CHOICE {
        notSupported          NULL,
        supported             MaxHcContextSpace
    }
}

PDCP-Capability-r4-ext ::= SEQUENCE {
    supportForRfc3095        CHOICE {
        notSupported          NULL,
        supported             SEQUENCE {
            maxROHC-ContextSessions MaxROHC-ContextSessions-r4 DEFAULT s16,
            reverseCompressionDepth  INTEGER (0..65535)          DEFAULT 0
        }
    }
}

PhysicalChannelCapability ::= SEQUENCE {
    fddPhysChCapability      SEQUENCE {
        downlinkPhysChCapability DL-PhysChCapabilityFDD,
        uplinkPhysChCapability  UL-PhysChCapabilityFDD
    } OPTIONAL,
    -- tddPhysChCapability describes the 3.84Mcps TDD physical channel capability
    tddPhysChCapability      SEQUENCE {
        downlinkPhysChCapability DL-PhysChCapabilityTDD,
        uplinkPhysChCapability  UL-PhysChCapabilityTDD
    } OPTIONAL
}

-- PhysicalChannelCapability-LCR-r4 describes the 1.28Mcps TDD physical channel capability
PhysicalChannelCapability-LCR-r4 ::= SEQUENCE {
    tdd128-PhysChCapability SEQUENCE {
        downlinkPhysChCapability DL-PhysChCapabilityTDD-LCR-r4,
        uplinkPhysChCapability  UL-PhysChCapabilityTDD-LCR-r4
    } OPTIONAL
}

PNBSCH-Allocation-r4 ::= SEQUENCE {
    numberOfRepetitionsPerSFNPeriod ENUMERATED {
        c2, c3, c4, c5, c6, c7, c8, c9, c10,
        c12, c14, c16, c18, c20, c24, c28, c32,
        c36, c40, c48, c56, c64, c72, c80 }
}

ProtocolErrorCause ::= ENUMERATED {
    asn1-ViolationOrEncodingError,
    messageTypeNonexistent,
    messageNotCompatibleWithReceiverState,
    ie-ValueNotComprehended,
    informationElementMissing,
    messageExtensionNotComprehended,
    spare2, spare1 }

ProtocolErrorIndicator ::= ENUMERATED {
    noError, errorOccurred }

ProtocolErrorIndicatorWithMoreInfo ::= CHOICE {
    noError          NULL,
    errorOccurred    SEQUENCE {
        rrc-TransactionIdentifier RRC-TransactionIdentifier,
        protocolErrorInformation  ProtocolErrorInformation
    }
}

ProtocolErrorMoreInformation ::= SEQUENCE {
    diagnosticsType CHOICE {
        type1 CHOICE {
            asn1-ViolationOrEncodingError NULL,
            messageTypeNonexistent        NULL,
            messageNotCompatibleWithReceiverState
                IdentificationOfReceivedMessage,
            ie-ValueNotComprehended        IdentificationOfReceivedMessage,
            conditionalInformationElementError IdentificationOfReceivedMessage,
            messageExtensionNotComprehended IdentificationOfReceivedMessage,
            spare1                          NULL,
            spare2                          NULL
        },
        spare NULL
    }
}

```

```

    }
}

RadioFrequencyBandFDD ::=          ENUMERATED {
    fdd2100,
    fdd1900,
    spare6, spare5, spare4, spare3, spare2, spare1 }

RadioFrequencyBandTDDList ::=     ENUMERATED {
    a, b, c, ab, ac, bc, abc, spare }

RadioFrequencyBandTDD ::=         ENUMERATED {a, b, c, spare}

RadioFrequencyBandGSM ::=        ENUMERATED {
    gsm450,
    gsm480,
    gsm850,
    gsm900P,
    gsm900E,
    gsm1800,
    gsm1900,
    spare9, spare8, spare7, spare6, spare5,
    spare4, spare3, spare2, spare1}

Rb-timer-indicator ::=           SEQUENCE {
    t314-expired                    BOOLEAN,
    t315-expired                    BOOLEAN }

Re-EstablishmentTimer ::=        ENUMERATED {
    useT314, useT315
}

RedirectionInfo ::=              CHOICE {
    frequencyInfo                   FrequencyInfo,
    interRATInfo                    InterRATInfo
}

RejectionCause ::=               ENUMERATED {
    congestion,
    unspecified }

ReleaseCause ::=                 ENUMERATED {
    normalEvent,
    unspecified,
    pre-emptiveRelease,
    congestion,
    re-establishmentReject,
    directedsignallingconnectionre-establishment,
    userInactivity,
    spare }

RF-Capability ::=                SEQUENCE {
    fddRF-Capability                 SEQUENCE {
        ue-PowerClass                UE-PowerClass,
        txRxFrequencySeparation      TxRxFrequencySeparation
    }
    tddRF-Capability                 SEQUENCE {
        ue-PowerClass                UE-PowerClass,
        radioFrequencyBandTDDList    RadioFrequencyBandTDDList,
        chipRateCapability            ChipRateCapability
    }
    OPTIONAL
}

RF-Capability-r4-ext ::=         SEQUENCE {
    tddRF-Capability                 SEQUENCE {
        ue-PowerClass                UE-PowerClass,
        radioFrequencyBandTDDList    RadioFrequencyBandTDDList,
        chipRateCapability            ChipRateCapability
    }
    OPTIONAL
}

RLC-Capability ::=               SEQUENCE {
    totalRLC-AM-BufferSize           TotalRLC-AM-BufferSize,
    maximumRLC-WindowSize            MaximumRLC-WindowSize,
    maximumAM-EntityNumber           MaximumAM-EntityNumberRLC-Cap
}

```

```

RRC-MessageSequenceNumber ::= INTEGER (0..15)

RRC-MessageSequenceNumberList ::= SEQUENCE (SIZE (4..5)) OF
    RRC-MessageSequenceNumber

RRC-StateIndicator ::= ENUMERATED {
    cell-DCH, cell-FACH, cell-PCH, ura-PCH }

RRC-TransactionIdentifier ::= INTEGER (0..3)

S-RNTI ::= BIT STRING (SIZE (20))

S-RNTI-2 ::= BIT STRING (SIZE (10))

SecurityCapability ::= SEQUENCE {
    cipheringAlgorithmCap BIT STRING {
        spare15(0),
        spare14(1),
        spare13(2),
        spare12(3),
        spare11(4),
        spare10(5),
        spare9(6),
        spare8(7),
        spare7(8),
        spare6(9),
        spare5(10),
        spare4(11),
        spare3(12),
        spare2(13),
        uea1(14),
        uea0(15)
    } (SIZE (16)),
    integrityProtectionAlgorithmCap BIT STRING {
        spare15(0),
        spare14(1),
        spare13(2),
        spare12(3),
        spare11(4),
        spare10(5),
        spare9(6),
        spare8(7),
        spare7(8),
        spare6(9),
        spare5(10),
        spare4(11),
        spare3(12),
        spare2(13),
        uia1(14),
        spare0(15)
    } (SIZE (16))
}

SimultaneousSCCPCH-DPCH-Reception ::= CHOICE {
    notSupported NULL,
    supported SEQUENCE {
        maxNoSCCPCH-RL MaxNoSCCPCH-RL,
        -- simultaneousSCCPCH-DPCH-DPDCH-Reception is applicable only if
        -- the IE Support of PDSCH = TRUE
        simultaneousSCCPCH-DPCH-DPDCH-Reception BOOLEAN
    }
}

SRNC-Identity ::= BIT STRING (SIZE (12))

START-Value ::= BIT STRING (SIZE (20))

STARTList ::= SEQUENCE (SIZE (1..maxCNdomains)) OF
    STARTSingle

STARTSingle ::= SEQUENCE {
    cn-DomainIdentity CN-DomainIdentity,
    start-Value START-Value
}

SystemSpecificCapUpdateReq ::= ENUMERATED {

```

```

        gsm }

SystemSpecificCapUpdateReqList ::= SEQUENCE (SIZE (1..maxSystemCapability)) OF
    SystemSpecificCapUpdateReq

T-300 ::=
    ENUMERATED {
        ms100, ms200, ms400, ms600, ms800,
        ms1000, ms1200, ms1400, ms1600,
        ms1800, ms2000, ms3000, ms4000,
        ms6000, ms8000 }

T-301 ::=
    ENUMERATED {
        ms100, ms200, ms400, ms600, ms800,
        ms1000, ms1200, ms1400, ms1600,
        ms1800, ms2000, ms3000, ms4000,
        ms6000, ms8000, spare }

T-302 ::=
    ENUMERATED {
        ms100, ms200, ms400, ms600, ms800,
        ms1000, ms1200, ms1400, ms1600,
        ms1800, ms2000, ms3000, ms4000,
        ms6000, ms8000, spare }

T-304 ::=
    ENUMERATED {
        ms100, ms200, ms400,
        ms1000, ms2000, spare3, spare2, spare1 }

T-305 ::=
    ENUMERATED {
        noUpdate, m5, m10, m30,
        m60, m120, m360, m720 }

T-307 ::=
    ENUMERATED {
        s5, s10, s15, s20,
        s30, s40, s50, spare }

T-308 ::=
    ENUMERATED {
        ms40, ms80, ms160, ms320 }

T-309 ::=
    INTEGER (1..8)

T-310 ::=
    ENUMERATED {
        ms40, ms80, ms120, ms160,
        ms200, ms240, ms280, ms320 }

T-311 ::=
    ENUMERATED {
        ms250, ms500, ms750, ms1000,
        ms1250, ms1500, ms1750, ms2000 }

-- The value 0 for T-312 is not used in this version of the specification
T-312 ::=
    INTEGER (0..15)

T-313 ::=
    INTEGER (0..15)

T-314 ::=
    ENUMERATED {
        s0, s2, s4, s6, s8,
        s12, s16, s20 }

T-315 ::=
    ENUMERATED {
        s0, s10, s30, s60, s180,
        s600, s1200, s1800 }

T-316 ::=
    ENUMERATED {
        s0, s10, s20, s30, s40,
        s50, s-inf, spare }

T-317 ::=
    ENUMERATED {
        s0, s10, s30, s60, s180,
        s600, s1200, s1800 }

T-CPCH ::=
    ENUMERATED {
        ct0, ct1 }

TMSI-and-LAI-GSM-MAP ::=
    SEQUENCE {
        tmsi
        lai
    }

```

```

TMSI-DS-41 ::=                                OCTET STRING (SIZE (2..17))

TotalRLC-AM-BufferSize ::=                    ENUMERATED {
    kb2, kb10, kb50, kb100,
    kb150, kb500, kb1000, spare }

-- Actual value TransmissionProbability = IE value * 0.125
TransmissionProbability ::=                    INTEGER (1..8)

TransportChannelCapability ::=                 SEQUENCE {
    dl-TransChCapability                       DL-TransChCapability,
    ul-TransChCapability                       UL-TransChCapability
}

TurboSupport ::=                              CHOICE {
    notSupported                               NULL,
    supported                                  MaxNoBits
}

TxRxFrequencySeparation ::=                  ENUMERATED {
    mhz190, mhz174-8-205-2,
    mhz134-8-245-2 }

U-RNTI ::=                                    SEQUENCE {
    srnc-Identity                             SRNC-Identity,
    s-RNTI                                     S-RNTI
}

U-RNTI-Short ::=                             SEQUENCE {
    srnc-Identity                             SRNC-Identity,
    s-RNTI-2                                  S-RNTI-2
}

UE-ConnTimersAndConstants ::=                 SEQUENCE {
-- Optional is used also for parameters for which the default value is the last one read in SIB1
-- t-301 and n-301 should not be used by the UE in this version of the specification
    t-301                                     T-301                                     DEFAULT ms2000,
    n-301                                     N-301                                     DEFAULT 2,
    t-302                                     T-302                                     DEFAULT ms4000,
    n-302                                     N-302                                     DEFAULT 3,
    t-304                                     T-304                                     DEFAULT ms2000,
    n-304                                     N-304                                     DEFAULT 2,
    t-305                                     T-305                                     DEFAULT m30,
    t-307                                     T-307                                     DEFAULT s30,
    t-308                                     T-308                                     DEFAULT ms160,
    t-309                                     T-309                                     DEFAULT 5,
    t-310                                     T-310                                     DEFAULT ms160,
    n-310                                     N-310                                     DEFAULT 4,
    t-311                                     T-311                                     DEFAULT ms2000,
    t-312                                     T-312                                     DEFAULT 1,
    -- n-312 shall be ignored if n-312 in UE-ConnTimersAndConstants-v3a0ext is present, and the
    -- value of that element shall be used instead.
    n-312                                     N-312                                     DEFAULT s1,
    t-313                                     T-313                                     DEFAULT 3,
    n-313                                     N-313                                     DEFAULT s20,
    t-314                                     T-314                                     DEFAULT s12,
    t-315                                     T-315                                     DEFAULT s180,
    -- n-315 shall be ignored if n-315 in UE-ConnTimersAndConstants-v3a0ext is present, and the
    -- value of that element shall be used instead.
    n-315                                     N-315                                     DEFAULT s1,
    t-316                                     T-316                                     DEFAULT s30,
    t-317                                     T-317                                     DEFAULT s180
}

UE-ConnTimersAndConstants-v3a0ext ::=         SEQUENCE {
    n-312                                     N-312ext                                OPTIONAL,
    n-315                                     N-315ext                                OPTIONAL
}

UE-IdleTimersAndConstants ::=                 SEQUENCE {
    t-300                                     T-300,
    n-300                                     N-300,
    t-312                                     T-312,
    -- n-312 shall be ignored if n-312 in UE-IdleTimersAndConstants-v3a0ext is present, and the
    -- value of that element shall be used instead.
    n-312                                     N-312
}

```

```

UE-IdleTimersAndConstants-v3a0ext ::= SEQUENCE {
    n-312 N-312ext OPTIONAL
}

UE-MultiModeRAT-Capability ::= SEQUENCE {
    multiRAT-CapabilityList MultiRAT-Capability,
    multiModeCapability MultiModeCapability
}

UE-PowerClass ::= INTEGER (1..4)

UE-PowerClass-v370 ::= ENUMERATED {class1, class2, class3, class4,
    spare4, spare3, spare2, spare1 }

UE-RadioAccessCapability ::= SEQUENCE {
    pdcp-Capability PDCP-Capability,
    rlc-Capability RLC-Capability,
    transportChannelCapability TransportChannelCapability,
    rf-Capability RF-Capability,
    physicalChannelCapability PhysicalChannelCapability,
    ue-MultiModeRAT-Capability UE-MultiModeRAT-Capability,
    securityCapability SecurityCapability,
    ue-positioning-Capability UE-Positioning-Capability,
    measurementCapability MeasurementCapability OPTIONAL
}

UE-RadioAccessCapabilityInfo ::= SEQUENCE {
    ue-RadioAccessCapability UE-RadioAccessCapability,
    ue-RadioAccessCapability-v370ext UE-RadioAccessCapability-v370ext
}

UE-RadioAccessCapability-v370ext ::= SEQUENCE {
    ue-RadioAccessCapabBandFDDList UE-RadioAccessCapabBandFDDList
}

UE-RadioAccessCapability-v380ext ::= SEQUENCE {
    ue-PositioningCapabilityExt-v380 UE-PositioningCapabilityExt-v380
}

UE-RadioAccessCapability-v3a0ext ::= SEQUENCE {
    ue-PositioningCapabilityExt-v3a0 UE-PositioningCapabilityExt-v3a0
}

UE-PositioningCapabilityExt-v380 ::= SEQUENCE {
    rx-tx-TimeDifferenceType2Capable BOOLEAN
}

UE-PositioningCapabilityExt-v3a0 ::= SEQUENCE {
    validity-CellPCH-UraPCH ENUMERATED { true }
}

UE-RadioAccessCapabBandFDDList ::= SEQUENCE (SIZE (1..maxFreqBandsFDD)) OF
    UE-RadioAccessCapabBandFDD

UE-RadioAccessCapabBandFDD ::= SEQUENCE{
    radioFrequencyBandFDD RadioFrequencyBandFDD,
    fddRF-Capability SEQUENCE {
        ue-PowerClass UE-PowerClass-v370,
        txRxFrequencySeparation TxRxFrequencySeparation
    } OPTIONAL,
    measurementCapability MeasurementCapability-v370
}

UE-RadioAccessCapability-v4xyext ::= SEQUENCE {
    pdcp-Capability-r4-ext PDCP-Capability-r4-ext,
    tdd-CapabilityExt SEQUENCE {
        rf-Capability RF-Capability-r4-ext,
        physicalChannelCapability-LCR PhysicalChannelCapability-LCR-r4,
        measurementCapability-r4-ext MeasurementCapability-r4-ext
    } OPTIONAL,
    -- IE " AccessStratumReleaseIndicator" is not needed in RRC CONNECTION SETUP COMPLETE
    accessStratumReleaseIndicator AccessStratumReleaseIndicator
}

UL-PhysChCapabilityFDD ::= SEQUENCE {
    maxNoDPDCH-BitsTransmitted MaxNoDPDCH-BitsTransmitted,
    supportOfPCPCH BOOLEAN
}

```



```

UL-PhysChCapabilityTDD ::= SEQUENCE {
    maxTS-PerFrame           MaxTS-PerFrame,
    maxPhysChPerTimeslot    MaxPhysChPerTimeslot,
    minimumSF               MinimumSF-UL,
    supportOfPUSCH          BOOLEAN
}

UL-PhysChCapabilityTDD-LCR-r4 ::= SEQUENCE {
    maxTS-PerSubFrame       MaxTS-PerSubFrame-r4,
    maxPhysChPerTimeslot    MaxPhysChPerTimeslot,
    minimumSF               MinimumSF-UL,
    supportOfPUSCH          BOOLEAN,
    supportOf8PSK           BOOLEAN
}

UL-TransChCapability ::= SEQUENCE {
    maxNoBitsTransmitted    MaxNoBits,
    maxConvCodeBitsTransmitted MaxNoBits,
    turboEncodingSupport    TurboSupport,
    maxSimultaneousTransChs MaxSimultaneousTransChsUL,
    modeSpecificInfo        CHOICE {
        fdd                 NULL,
        tdd                 SEQUENCE {
            maxSimultaneousCCTrCH-Count MaxSimultaneousCCTrCH-Count
        }
    },
    maxTransmittedBlocks    MaxTransportBlocksUL,
    maxNumberOfTFC          MaxNumberOfTFC-UL,
    maxNumberOfTF           MaxNumberOfTF
}

UE-Positioning-Capability ::= SEQUENCE {
    standaloneLocMethodsSupported    BOOLEAN,
    ue-BasedOTDOA-Supported          BOOLEAN,
    networkAssistedGPS-Supported     NetworkAssistedGPS-Supported,
    supportForUE-GPS-TimingOfCellFrames    BOOLEAN,
    supportForIPDL                    BOOLEAN
}

UE-SecurityInformation ::= SEQUENCE {
    start-CS    START-Value
}

URA-UpdateCause ::= ENUMERATED {
    changeOfURA,
    periodicURAUpdate,
    dummy,
    spare1 }

UTRAN-DRX-CycleLengthCoefficient ::= INTEGER (3..9)

WaitTime ::= INTEGER (0..15)

-- *****
--
-- RADIO BEARER INFORMATION ELEMENTS (10.3.4)
--
-- *****

AlgorithmSpecificInfo ::= CHOICE {
    rfc2507-Info    RFC2507-Info
}

AlgorithmSpecificInfo-r4 ::= CHOICE {
    rfc2507-Info    RFC2507-Info,
    rfc3095-Info    RFC3095-Info-r4
}

CID-InclusionInfo-r4 ::= ENUMERATED {
    pdcp-Header,
    rfc3095-PacketFormat }

-- Upper limit COUNT-C is 2^32 - 1
COUNT-C ::= INTEGER (0..4294967295)

-- Upper limit COUNT-C-MSB is 2^25 - 1
COUNT-C-MSB ::= INTEGER (0..33554431)

```

```

DefaultConfigIdentity ::=          INTEGER (0..10)

DefaultConfigIdentity-r4 ::=      INTEGER (0..12)

DefaultConfigMode ::=             ENUMERATED {
                                   fdd,
                                   tdd }

DL-AM-RLC-Mode ::=                SEQUENCE {
                                   inSequenceDelivery
                                   receivingWindowSize,
                                   dl-RLC-StatusInfo
                                   }

DL-CounterSynchronisationInfo ::= SEQUENCE {
                                   rB-WithPDCP-InfoList      OPTIONAL
                                   }

DL-LogicalChannelMapping ::=      SEQUENCE {
                                   -- TABULAR: DL-TransportChannelType contains TransportChannelIdentity as well.
                                   dl-TransportChannelType    DL-TransportChannelType,
                                   logicalChannelIdentity      LogicalChannelIdentity      OPTIONAL
                                   }

DL-LogicalChannelMappingList ::=  SEQUENCE (SIZE (1..maxLoCHperRLC)) OF
                                   DL-LogicalChannelMapping

DL-RFC3095-r4 ::=                SEQUENCE {
                                   cid-InclusionInfo           CID-InclusionInfo-r4,
                                   max-CID                   INTEGER (1..16383)      DEFAULT 15,
                                   reverseDecompressionDepth  INTEGER (0..65535)   DEFAULT 0
                                   }

DL-RLC-Mode ::=                  CHOICE {
                                   dl-AM-RLC-Mode            DL-AM-RLC-Mode,
                                   dl-UM-RLC-Mode            NULL,
                                   dl-TM-RLC-Mode            DL-TM-RLC-Mode
                                   }

DL-RLC-StatusInfo ::=            SEQUENCE {
                                   timerStatusProhibit       TimerStatusProhibit   OPTIONAL,
                                   timerEPC                  TimerEPC               OPTIONAL,
                                   missingPDU-Indicator       BOOLEAN,
                                   timerStatusPeriodic       TimerStatusPeriodic   OPTIONAL
                                   }

DL-TM-RLC-Mode ::=               SEQUENCE {
                                   segmentationIndication     BOOLEAN
                                   }

DL-TransportChannelType ::=      CHOICE {
                                   dch                        TransportChannelIdentity,
                                   fach                       NULL,
                                   dsch                       TransportChannelIdentity,
                                   dch-and-dsch                TransportChannelIdentityDCHandDSCH
                                   }

ExpectReordering ::=             ENUMERATED {
                                   reorderingNotExpected,
                                   reorderingExpected }

ExplicitDiscard ::=              SEQUENCE {
                                   timerMRW                   TimerMRW,
                                   timerDiscard               TimerDiscard,
                                   maxMRW                     MaxMRW
                                   }

HeaderCompressionInfo ::=        SEQUENCE {
                                   algorithmSpecificInfo      AlgorithmSpecificInfo
                                   }

HeaderCompressionInfoList ::=    SEQUENCE (SIZE (1..maxPDCPALgoType)) OF
                                   HeaderCompressionInfo

HeaderCompressionInfo-r4 ::=     SEQUENCE {
                                   algorithmSpecificInfo-r4   AlgorithmSpecificInfo-r4
                                   }

```

```

HeaderCompressionInfoList-r4 ::= SEQUENCE (SIZE (1..maxPDCPALgoType)) OF
    HeaderCompressionInfo-r4

LogicalChannelIdentity ::= INTEGER (1..15)

LosslessSRNS-RelocSupport ::= CHOICE {
    supported          MaxPDCP-SN-WindowSize,
    notSupported      NULL
}

MAC-d-HFN-initial-value ::= BIT STRING (SIZE (24))

MAC-LogicalChannelPriority ::= INTEGER (1..8)

MaxDAT ::= ENUMERATED {
    dat1, dat2, dat3, dat4, dat5, dat6,
    dat7, dat8, dat9, dat10, dat15, dat20,
    dat25, dat30, dat35, dat40 }

MaxDAT-Retransmissions ::= SEQUENCE {
    maxDAT          MaxDAT,
    timerMRW       TimerMRW,
    maxMRW         MaxMRW
}

MaxMRW ::= ENUMERATED {
    mmm1, mmm4, mmm6, mmm8, mmm12, mmm16,
    mmm24, mmm32 }

MaxPDCP-SN-WindowSize ::= ENUMERATED {
    sn255, sn65535 }

MaxRST ::= ENUMERATED {
    rst1, rst4, rst6, rst8, rst12,
    rst16, rst24, rst32 }

NoExplicitDiscard ::= ENUMERATED {
    dt10, dt20, dt30, dt40, dt50,
    dt60, dt70, dt80, dt90, dt100 }

PDCP-Info ::= SEQUENCE {
    losslessSRNS-RelocSupport      LosslessSRNS-RelocSupport      OPTIONAL,
    -- TABULAR: pdcP-PDU-Header is MD in the tabular format and it can be encoded
    -- in one bit, so the OPTIONAL is removed for compactness.
    pdcP-PDU-Header                PDCP-PDU-Header,
    headerCompressionInfoList      HeaderCompressionInfoList      OPTIONAL
}

PDCP-Info-r4 ::= SEQUENCE {
    losslessSRNS-RelocSupport      LosslessSRNS-RelocSupport      OPTIONAL,
    -- TABULAR: pdcP-PDU-Header is MD in the tabular format and it can be encoded
    -- in one bit, so the OPTIONAL is removed for compactness.
    pdcP-PDU-Header                PDCP-PDU-Header,
    headerCompressionInfoList-r4    HeaderCompressionInfoList-r4    OPTIONAL
}

PDCP-InfoReconfig ::= SEQUENCE {
    pdcP-Info          PDCP-Info,
    -- dummy is not used in this version of the specification and
    -- it should be ignored.
    dummy              INTEGER (0..65535)
}

PDCP-InfoReconfig-r4 ::= SEQUENCE {
    pdcP-Info          PDCP-Info-r4
}

PDCP-PDU-Header ::= ENUMERATED {
    present, absent }

PDCP-SN-Info ::= INTEGER (0..65535)

Poll-PDU ::= ENUMERATED {
    pdu1, pdu2, pdu4, pdu8, pdu16,
    pdu32, pdu64, pdu128 }

Poll-SDU ::= ENUMERATED {

```

```

        sdu1, sdu4, sdu16, sdu64 }

PollingInfo ::=
    timerPollProhibit          SEQUENCE {
        timerPollProhibit      OPTIONAL,
        timerPoll              OPTIONAL,
        poll-PDU               OPTIONAL,
        poll-SDU               OPTIONAL,
        lastTransmissionPDU-Poll  BOOLEAN,
        lastRetransmissionPDU-Poll  BOOLEAN,
        pollWindow             OPTIONAL,
        timerPollPeriodic      OPTIONAL
    }

PollWindow ::=
    ENUMERATED {
        pw50, pw60, pw70, pw80, pw85,
        pw90, pw95, pw99 }

PredefinedConfigIdentity ::=
    INTEGER (0..15)

PredefinedConfigValueTag ::=
    INTEGER (0..15)

PredefinedRB-Configuration ::=
    SEQUENCE {
        re-EstablishmentTimer,
        srb-InformationList,
        rb-InformationList
    }

PreDefRadioConfiguration ::=
    SEQUENCE {
        -- Radio bearer IEs
        predefinedRB-Configuration      PredefinedRB-Configuration,
        -- Transport channel IEs
        preDefTransChConfiguration      PreDefTransChConfiguration,
        -- Physical channel IEs
        preDefPhyChConfiguration        PreDefPhyChConfiguration
    }

PredefinedConfigStatusList ::=
    SEQUENCE (SIZE (maxPredefConfig)) OF
    PredefinedConfigStatusInfo

PredefinedConfigStatusInfo ::=
    CHOICE {
        storedWithValueTagSameAsPrevious  NULL,
        other                              CHOICE {
            notStored                     NULL,
            storedWithDifferentValueTag    PredefinedConfigValueTag
        }
    }

RAB-Info ::=
    SEQUENCE {
        rab-Identity,
        cn-DomainIdentity,
        nas-Synchronisation-Indicator    OPTIONAL,
        re-EstablishmentTimer
    }

RAB-InformationList ::=
    SEQUENCE (SIZE (1..maxRABsetup)) OF
    RAB-Info

RAB-InformationReconfigList ::=
    SEQUENCE (SIZE (1.. maxRABsetup)) OF
    RAB-InformationReconfig

RAB-InformationReconfig ::=
    SEQUENCE {
        rab-Identity,
        cn-DomainIdentity,
        nas-Synchronisation-Indicator
    }

RAB-Info-Post ::=
    SEQUENCE {
        rab-Identity,
        cn-DomainIdentity,
        nas-Synchronisation-Indicator    OPTIONAL
    }

RAB-InformationSetup ::=
    SEQUENCE {
        rab-Info,
        rb-InformationSetupList
    }

RAB-InformationSetup-r4 ::=
    SEQUENCE {
        rab-Info,
    }

```

```

    rb-InformationSetupList          RB-InformationSetupList-r4
}
RAB-InformationSetupList ::=      SEQUENCE (SIZE (1..maxRABsetup)) OF
    RAB-InformationSetup
RAB-InformationSetupList-r4 ::=   SEQUENCE (SIZE (1..maxRABsetup)) OF
    RAB-InformationSetup-r4
RB-ActivationTimeInfo ::=        SEQUENCE {
    rb-Identity                    RB-Identity,
    rlc-SequenceNumber            RLC-SequenceNumber
}
RB-ActivationTimeInfoList ::=    SEQUENCE (SIZE (1..maxRB)) OF
    RB-ActivationTimeInfo
RB-COUNT-C-Information ::=       SEQUENCE {
    rb-Identity                    RB-Identity,
    count-C-UL                    COUNT-C,
    count-C-DL                    COUNT-C
}
RB-COUNT-C-InformationList ::=   SEQUENCE (SIZE (1..maxRBallRABs)) OF
    RB-COUNT-C-Information
RB-COUNT-C-MSB-Information ::=   SEQUENCE {
    rb-Identity                    RB-Identity,
    count-C-MSB-UL                COUNT-C-MSB,
    count-C-MSB-DL                COUNT-C-MSB
}
RB-COUNT-C-MSB-InformationList ::= SEQUENCE (SIZE (1..maxRBallRABs)) OF
    RB-COUNT-C-MSB-Information
RB-Identity ::=                  INTEGER (1..32)
RB-IdentityList ::=              SEQUENCE (SIZE (1..maxRB)) OF
    RB-Identity
RB-InformationAffected ::=       SEQUENCE {
    rb-Identity                    RB-Identity,
    rb-MappingInfo                RB-MappingInfo
}
RB-InformationAffectedList ::=   SEQUENCE (SIZE (1..maxRB)) OF
    RB-InformationAffected
RB-InformationReconfig ::=       SEQUENCE {
    rb-Identity                    RB-Identity,
    pdcp-Info                      PDCP-InfoReconfig          OPTIONAL,
    pdcp-SN-Info                   PDCP-SN-Info              OPTIONAL,
    rlc-Info                        RLC-Info                    OPTIONAL,
    rb-MappingInfo                  RB-MappingInfo           OPTIONAL,
    rb-StopContinue                 RB-StopContinue          OPTIONAL
}
RB-InformationReconfig-r4 ::=    SEQUENCE {
    rb-Identity                    RB-Identity,
    pdcp-Info                      PDCP-InfoReconfig-r4      OPTIONAL,
    rlc-Info                        RLC-Info                    OPTIONAL,
    rb-MappingInfo                  RB-MappingInfo           OPTIONAL,
    rb-StopContinue                 RB-StopContinue          OPTIONAL
}
RB-InformationReconfigList ::=   SEQUENCE (SIZE (1..maxRB)) OF
    RB-InformationReconfig
RB-InformationReconfigList-r4 ::= SEQUENCE (SIZE (1..maxRB)) OF
    RB-InformationReconfig-r4
RB-InformationReleaseList ::=    SEQUENCE (SIZE (1..maxRB)) OF
    RB-Identity
RB-InformationSetup ::=          SEQUENCE {
    rb-Identity                    RB-Identity,
    pdcp-Info                      PDCP-Info                OPTIONAL,
    rlc-InfoChoice                  RLC-InfoChoice,

```

```

    rb-MappingInfo                RB-MappingInfo
}

RB-InformationSetup-r4 ::=          SEQUENCE {
    rb-Identity                    RB-Identity,
    pdcp-Info                      PDCP-Info-r4                OPTIONAL,
    rlc-Info                       RLC-Info,
    rb-MappingInfo                 RB-MappingInfo
}

RB-InformationSetupList ::=        SEQUENCE (SIZE (1..maxRBperRAB)) OF
    RB-InformationSetup

RB-InformationSetupList-r4 ::=     SEQUENCE (SIZE (1..maxRBperRAB)) OF
    RB-InformationSetup-r4

RB-MappingInfo ::=                SEQUENCE (SIZE (1..maxRBMuxOptions)) OF
    RB-MappingOption

RB-MappingOption ::=              SEQUENCE {
    ul-LogicalChannelMappings      UL-LogicalChannelMappings    OPTIONAL,
    dl-LogicalChannelMappingList    DL-LogicalChannelMappingList  OPTIONAL
}

RB-StopContinue ::=               ENUMERATED {
    stopRB, continueRB }

RB-WithPDCP-Info ::=              SEQUENCE {
    rb-Identity                    RB-Identity,
    pdcp-SN-Info                   PDCP-SN-Info
}

RB-WithPDCP-InfoList ::=          SEQUENCE (SIZE (1..maxRBallRABs)) OF
    RB-WithPDCP-Info

ReceivingWindowSize ::=           ENUMERATED {
    rw1, rw8, rw16, rw32, rw64, rw128, rw256,
    rw512, rw768, rw1024, rw1536, rw2047,
    rw2560, rw3072, rw3584, rw4095 }

RFC2507-Info ::=                  SEQUENCE {
    f-MAX-PERIOD                   INTEGER (1..65535)            DEFAULT 256,
    f-MAX-TIME                     INTEGER (1..255)                  DEFAULT 5,
    max-HEADER                     INTEGER (60..65535)                DEFAULT 168,
    tcp-SPACE                      INTEGER (3..255)                   DEFAULT 15,
    non-TCP-SPACE                  INTEGER (3..65535)                   DEFAULT 15,
    -- TABULAR: expectReordering has only two possible values, so using Optional or Default
    -- would be wasteful
    expectReordering               ExpectReordering
}

RFC3095-Info-r4 ::=               SEQUENCE {
    ul-RFC3095                     UL-RFC3095-r4                OPTIONAL,
    dl-RFC3095                     DL-RFC3095-r4                OPTIONAL
}

RLC-Info ::=                       SEQUENCE {
    ul-RLC-Mode                    UL-RLC-Mode                OPTIONAL,
    dl-RLC-Mode                    DL-RLC-Mode                OPTIONAL
}

RLC-InfoChoice ::=                CHOICE {
    rlc-Info                       RLC-Info,
    same-as-RB                     RB-Identity
}

RLC-SequenceNumber ::=            INTEGER (0..4095)

RLC-SizeInfo ::=                  SEQUENCE {
    rlc-SizeIndex                  INTEGER (1..maxTF)
}

RLC-SizeExplicitList ::=          SEQUENCE (SIZE (1..maxTF)) OF
    RLC-SizeInfo

ROHC-Profile-r4 ::=               INTEGER (1..3)

ROHC-ProfileList-r4 ::=           SEQUENCE (SIZE (1..maxROHC-Profile-r4)) OF

```

```

        ROHC-Profile-r4

ROHC-PacketSize-r4 ::=                INTEGER (2..1500)

ROHC-PacketSizeList-r4 ::=            SEQUENCE (SIZE (1..maxROHC-PacketSizes-r4)) OF
                                        ROHC-PacketSize-r4

SRB-InformationSetup ::=              SEQUENCE {
    -- The default value for rb-Identity is the smallest value not used yet.
    rb-Identity                        RB-Identity                                OPTIONAL,
    rlc-InfoChoice                    RLC-InfoChoice,
    rb-MappingInfo                    RB-MappingInfo
}

SRB-InformationSetupList ::=          SEQUENCE (SIZE (1..maxSRBsetup)) OF
                                        SRB-InformationSetup

SRB-InformationSetupList2 ::=         SEQUENCE (SIZE (3..4)) OF
                                        SRB-InformationSetup

TimerDiscard ::=                     ENUMERATED {
    td0-1, td0-25, td0-5, td0-75,
    td1, td1-25, td1-5, td1-75,
    td2, td2-5, td3, td3-5, td4,
    td4-5, td5, td7-5 }

TimerEPC ::=                         ENUMERATED {
    te50, te60, te70, te80, te90,
    te100, te120, te140, te160, te180,
    te200, te300, te400, te500, te700,
    te900 }

TimerMRW ::=                         ENUMERATED {
    te50, te60, te70, te80, te90, te100,
    te120, te140, te160, te180, te200,
    te300, te400, te500, te700, te900 }

TimerPoll ::=                        ENUMERATED {
    tp10, tp20, tp30, tp40, tp50,
    tp60, tp70, tp80, tp90, tp100,
    tp110, tp120, tp130, tp140, tp150,
    tp160, tp170, tp180, tp190, tp200,
    tp210, tp220, tp230, tp240, tp250,
    tp260, tp270, tp280, tp290, tp300,
    tp310, tp320, tp330, tp340, tp350,
    tp360, tp370, tp380, tp390, tp400,
    tp410, tp420, tp430, tp440, tp450,
    tp460, tp470, tp480, tp490, tp500,
    tp510, tp520, tp530, tp540, tp550,
    tp600, tp650, tp700, tp750, tp800,
    tp850, tp900, tp950, tp1000 }

TimerPollPeriodic ::=               ENUMERATED {
    tper100, tper200, tper300, tper400,
    tper500, tper750, tper1000, tper2000 }

TimerPollProhibit ::=               ENUMERATED {
    tpp10, tpp20, tpp30, tpp40, tpp50,
    tpp60, tpp70, tpp80, tpp90, tpp100,
    tpp110, tpp120, tpp130, tpp140, tpp150,
    tpp160, tpp170, tpp180, tpp190, tpp200,
    tpp210, tpp220, tpp230, tpp240, tpp250,
    tpp260, tpp270, tpp280, tpp290, tpp300,
    tpp310, tpp320, tpp330, tpp340, tpp350,
    tpp360, tpp370, tpp380, tpp390, tpp400,
    tpp410, tpp420, tpp430, tpp440, tpp450,
    tpp460, tpp470, tpp480, tpp490, tpp500,
    tpp510, tpp520, tpp530, tpp540, tpp550,
    tpp600, tpp650, tpp700, tpp750, tpp800,
    tpp850, tpp900, tpp950, tpp1000 }

TimerRST ::=                        ENUMERATED {
    tr50, tr100, tr150, tr200, tr250, tr300,
    tr350, tr400, tr450, tr500, tr550,
    tr600, tr700, tr800, tr900, tr1000 }

TimerStatusPeriodic ::=             ENUMERATED {
    tsp100, tsp200, tsp300, tsp400, tsp500,

```

```

        tsp750, tsp1000, tsp2000 }

TimerStatusProhibit ::=          ENUMERATED {
    tsp10, tsp20, tsp30, tsp40, tsp50,
    tsp60, tsp70, tsp80, tsp90, tsp100,
    tsp110, tsp120, tsp130, tsp140, tsp150,
    tsp160, tsp170, tsp180, tsp190, tsp200,
    tsp210, tsp220, tsp230, tsp240, tsp250,
    tsp260, tsp270, tsp280, tsp290, tsp300,
    tsp310, tsp320, tsp330, tsp340, tsp350,
    tsp360, tsp370, tsp380, tsp390, tsp400,
    tsp410, tsp420, tsp430, tsp440, tsp450,
    tsp460, tsp470, tsp480, tsp490, tsp500,
    tsp510, tsp520, tsp530, tsp540, tsp550,
    tsp600, tsp650, tsp700, tsp750, tsp800,
    tsp850, tsp900, tsp950, tsp1000 }

TransmissionRLC-Discard ::=      CHOICE {
    timerBasedExplicit
    timerBasedNoExplicit
    maxDAT-Retransmissions
    noDiscard
}

TransmissionWindowSize ::=       ENUMERATED {
    tw1, tw8, tw16, tw32, tw64, tw128, tw256,
    tw512, tw768, tw1024, tw1536, tw2047,
    tw2560, tw3072, tw3584, tw4095 }

UL-AM-RLC-Mode ::=              SEQUENCE {
    transmissionRLC-Discard
    transmissionWindowSize
    timerRST
    max-RST
    pollingInfo
}

UL-CounterSynchronisationInfo ::= SEQUENCE {
    rB-WithPDCP-InfoList
    startList
}

UL-LogicalChannelMapping ::=     SEQUENCE {
    -- TABULAR: UL-TransportChannelType contains TransportChannelIdentity as well.
    ul-TransportChannelType
    logicalChannelIdentity
    rlc-SizeList
    allSizes
    configured
    explicitList
},
    mac-LogicalChannelPriority
}

UL-LogicalChannelMappingList ::= SEQUENCE {
    -- rlc-LogicalChannelMappingIndicator shall be set to TRUE in this version
    -- of the specification
    rlc-LogicalChannelMappingIndicator
    ul-LogicalChannelMapping
}

UL-LogicalChannelMappings ::=    CHOICE {
    oneLogicalChannel
    twoLogicalChannels
}

UL-RFC3095-r4 ::=               SEQUENCE {
    cid-InclusionInfo
    max-CID
    rohcProfileList
    rohcPacketSizeList
}

UL-RLC-Mode ::=                 CHOICE {
    ul-AM-RLC-Mode
    ul-UM-RLC-Mode
    ul-TM-RLC-Mode
}

```



```

    spare                NULL
  }

UL-TM-RLC-Mode ::=
  transmissionRLC-Discard  TransmissionRLC-Discard  OPTIONAL,
  segmentationIndication  BOOLEAN
}

UL-UM-RLC-Mode ::=
  transmissionRLC-Discard  TransmissionRLC-Discard  OPTIONAL
}

UL-TransportChannelType ::=
  dch                      TransportChannelIdentity,
  rach                     NULL,
  cpch                     NULL,
  usch                     TransportChannelIdentity
}

-- *****
--
--   TRANSPORT CHANNEL INFORMATION ELEMENTS (10.3.5)
--
-- *****

AllowedTFC-List ::=
  SEQUENCE (SIZE (1..maxTFC)) OF
    TFC-Value

AllowedTFI-List ::=
  SEQUENCE (SIZE (1..maxTF)) OF
    INTEGER (0..31)

BitModeRLC-SizeInfo ::=
  CHOICE {
    sizeType1              INTEGER (0..127),
    -- Actual value sizeType2 = (part1 * 8) + 128 + part2
    sizeType2              SEQUENCE {
      part1                INTEGER (0..15),
      part2                INTEGER (1..7)
    },
    -- Actual value sizeType3 = (part1 * 16) + 256 + part2
    sizeType3              SEQUENCE {
      part1                INTEGER (0..47),
      part2                INTEGER (1..15)
    },
    -- Actual value sizeType4 = (part1 * 64) + 1024 + part2
    sizeType4              SEQUENCE {
      part1                INTEGER (0..62),
      part2                INTEGER (1..63)
    }
  }

-- Actual value BLER-QualityValue = IE value * 0.1
BLER-QualityValue ::=
  INTEGER (-63..0)

ChannelCodingType ::=
  CHOICE {
    -- noCoding is only used for TDD in this version of the specification,
    -- otherwise it should be ignored
    noCoding               NULL,
    convolutional          CodingRate,
    turbo                  NULL
  }

CodingRate ::=
  ENUMERATED {
    half,
    third
  }

CommonDynamicTF-Info ::=
  SEQUENCE {
    rlc-Size               CHOICE {
      fdd                  SEQUENCE {
        octetModeRLC-SizeInfoType2  OctetModeRLC-SizeInfoType2
      },
      tdd                  SEQUENCE {
        commonTDD-Choice  CHOICE {
          bitModeRLC-SizeInfo      BitModeRLC-SizeInfo,
          octetModeRLC-SizeInfoType1  OctetModeRLC-SizeInfoType1
        }
      }
    }
  },

```

```

    numberOfTbSizeList          SEQUENCE (SIZE (1..maxTF)) OF
                                NumberOfTransportBlocks,
    logicalChannelList          LogicalChannelList
}

CommonDynamicTF-Info-DynamicTTI ::= SEQUENCE {
    commonTDD-Choice            CHOICE {
        bitModeRLC-SizeInfo     BitModeRLC-SizeInfo,
        octetModeRLC-SizeInfoType1 OctetModeRLC-SizeInfoType1
    },
    numberOfTbSizeAndTTIList    NumberOfTbSizeAndTTIList,
    logicalChannelList          LogicalChannelList
}

CommonDynamicTF-InfoList ::= SEQUENCE (SIZE (1..maxTF)) OF
    CommonDynamicTF-Info

CommonDynamicTF-InfoList-DynamicTTI ::= SEQUENCE (SIZE (1..maxTF)) OF
    CommonDynamicTF-Info-DynamicTTI

CommonTransChTFS ::= SEQUENCE {
    tti                        CHOICE {
        tti10                  CommonDynamicTF-InfoList,
        tti20                  CommonDynamicTF-InfoList,
        tti40                  CommonDynamicTF-InfoList,
        tti80                  CommonDynamicTF-InfoList,
        dynamic                CommonDynamicTF-InfoList-DynamicTTI
    },
    semistaticTF-Information    SemistaticTF-Information
}

CommonTransChTFS-LCR ::= SEQUENCE {
    tti                        CHOICE {
        tti5                   CommonDynamicTF-InfoList,
        tti10                  CommonDynamicTF-InfoList,
        tti20                  CommonDynamicTF-InfoList,
        tti40                  CommonDynamicTF-InfoList,
        tti80                  CommonDynamicTF-InfoList,
        dynamic                CommonDynamicTF-InfoList-DynamicTTI
    },
    semistaticTF-Information    SemistaticTF-Information
}

CPCH-SetID ::= INTEGER (1..maxCPCHsets)

CRC-Size ::= ENUMERATED {
    crc0, crc8, crc12, crc16, crc24 }

DedicatedDynamicTF-Info ::= SEQUENCE {
    rlc-Size                   CHOICE {
        bitMode                BitModeRLC-SizeInfo,
        octetModeType1         OctetModeRLC-SizeInfoType1
    },
    numberOfTbSizeList         SEQUENCE (SIZE (1..maxTF)) OF
    NumberOfTransportBlocks,
    logicalChannelList         LogicalChannelList
}

DedicatedDynamicTF-Info-DynamicTTI ::= SEQUENCE {
    rlc-Size                   CHOICE {
        bitMode                BitModeRLC-SizeInfo,
        octetModeType1         OctetModeRLC-SizeInfoType1
    },
    numberOfTbSizeAndTTIList    NumberOfTbSizeAndTTIList,
    logicalChannelList         LogicalChannelList
}

DedicatedDynamicTF-InfoList ::= SEQUENCE (SIZE (1..maxTF)) OF
    DedicatedDynamicTF-Info

DedicatedDynamicTF-InfoList-DynamicTTI ::= SEQUENCE (SIZE (1..maxTF)) OF
    DedicatedDynamicTF-Info-DynamicTTI

DedicatedTransChTFS ::= SEQUENCE {
    tti                        CHOICE {
        tti10                  DedicatedDynamicTF-InfoList,
        tti20                  DedicatedDynamicTF-InfoList,
        tti40                  DedicatedDynamicTF-InfoList,
    }
}

```

```

        tti80                DedicatedDynamicTF-InfoList,
        dynamic              DedicatedDynamicTF-InfoList-DynamicTTI
    },
    semistaticTF-Information SemistaticTF-Information
}

-- The maximum allowed size of DL-AddReconfTransChInfo2List sequence is 16
DL-AddReconfTransChInfo2List ::= SEQUENCE (SIZE (1..maxTrCHpreconf)) OF
    DL-AddReconfTransChInformation2

-- The maximum allowed size of DL-AddReconfTransChInfoList sequence is 16
DL-AddReconfTransChInfoList ::= SEQUENCE (SIZE (1..maxTrCHpreconf)) OF
    DL-AddReconfTransChInformation

-- The maximum allowed size of DL-AddReconfTransChInfoList-r4 sequence is 16
DL-AddReconfTransChInfoList-r4 ::= SEQUENCE (SIZE (1..maxTrCHpreconf)) OF
    DL-AddReconfTransChInformation-r4

-- ASN.1 for IE "Added or Reconfigured DL TrCH information"
-- in case of messages other than: Radio Bearer Release message and
-- Radio Bearer Reconfiguration message
DL-AddReconfTransChInformation ::= SEQUENCE {
    dl-TransportChannelType DL-TrCH-Type,
    dl-transportChannelIdentity TransportChannelIdentity,
    tfs-SignallingMode CHOICE {
        explicit-config TransportFormatSet,
        sameAsULTrCH UL-TransportChannelIdentity
    },
    dch-QualityTarget QualityTarget OPTIONAL,
    -- dummy is not used in this version of the specification and should be ignored.
    dummy TM-SignallingInfo OPTIONAL
}

DL-AddReconfTransChInformation-r4 ::= SEQUENCE {
    dl-TransportChannelType DL-TrCH-Type,
    dl-transportChannelIdentity TransportChannelIdentity,
    tfs-SignallingMode CHOICE {
        explicit-config TransportFormatSet,
        sameAsULTrCH UL-TransportChannelIdentity
    },
    dch-QualityTarget QualityTarget OPTIONAL
}

-- ASN.1 for IE "Added or Reconfigured DL TrCH information"
-- in case of Radio Bearer Release message and
-- Radio Bearer Reconfiguration message
DL-AddReconfTransChInformation2 ::= SEQUENCE {
    dl-TransportChannelType DL-TrCH-Type,
    transportChannelIdentity TransportChannelIdentity,
    tfs-SignallingMode CHOICE {
        explicit-config TransportFormatSet,
        sameAsULTrCH UL-TransportChannelIdentity
    },
    qualityTarget QualityTarget OPTIONAL
}

DL-CommonTransChInfo ::= SEQUENCE {
    sccpch-TFCS TFCS OPTIONAL,
    -- modeSpecificInfo should be optional. A new version of this IE should be defined
    -- to be used in later versions of messages using this IE
    modeSpecificInfo CHOICE {
        fdd SEQUENCE {
            dl-Parameters CHOICE {
                dl-DCH-TFCS TFCS,
                sameAsUL NULL
            } OPTIONAL,
            tdd SEQUENCE {
                individualDL-CCTrCH-InfoList IndividualDL-CCTrCH-InfoList OPTIONAL
            }
        }
    }
}

DL-CommonTransChInfo-r4 ::= SEQUENCE {
    sccpch-TFCS TFCS OPTIONAL,
    modeSpecificInfo CHOICE {
        fdd SEQUENCE {

```

```

        dl-Parameters
            dl-DCH-TFCS
                tfcs
            },
            sameAsUL
        }
    },
    tdd
        individualDL-CCTrCH-InfoList
            IndividualDL-CCTrCH-InfoList
        }
    } OPTIONAL
}

DL-DeletedTransChInfoList ::= SEQUENCE (SIZE (1..maxTrCH)) OF
    DL-TransportChannelIdentity

DL-TransportChannelIdentity ::= SEQUENCE {
    dl-TransportChannelType
    DL-TrCH-Type,
    dl-TransportChannelIdentity
    TransportChannelIdentity
}

DL-TrCH-Type ::= ENUMERATED {dch, dsch}

DRAC-ClassIdentity ::= INTEGER (1..maxDRACclasses)

DRAC-StaticInformation ::= SEQUENCE {
    transmissionTimeValidity
    TransmissionTimeValidity,
    timeDurationBeforeRetry
    TimeDurationBeforeRetry,
    drac-ClassIdentity
    DRAC-ClassIdentity
}

DRAC-StaticInformationList ::= SEQUENCE (SIZE (1..maxTrCH)) OF
    DRAC-StaticInformation

ExplicitTFCS-Configuration ::= CHOICE {
    complete
    TFCS-ReconfAdd,
    addition
    TFCS-ReconfAdd,
    removal
    TFCS-RemovalList,
    replacement
    SEQUENCE {
        tfcsRemoval
        TFCS-RemovalList,
        tfcsAdd
        TFCS-ReconfAdd
    }
}

GainFactor ::= INTEGER (0..15)

GainFactorInformation ::= CHOICE {
    signalledGainFactors
    SignalledGainFactors,
    computedGainFactors
    ReferenceTFC-ID
}

IndividualDL-CCTrCH-Info ::= SEQUENCE {
    dl-TFCS-Identity
    TFCS-Identity,
    tfcs-SignallingMode
    CHOICE {
        explicit-config
        TFCS,
        sameAsUL
        TFCS-Identity
    }
}

IndividualDL-CCTrCH-InfoList ::= SEQUENCE (SIZE (1..maxCCTrCH)) OF
    IndividualDL-CCTrCH-Info

IndividualUL-CCTrCH-Info ::= SEQUENCE {
    ul-TFCS-Identity
    TFCS-Identity,
    ul-TFCS
    TFCS ,
    tfc-Subset
    TFC-Subset
}

IndividualUL-CCTrCH-InfoList ::= SEQUENCE (SIZE (1..maxCCTrCH)) OF
    IndividualUL-CCTrCH-Info

LogicalChannelByRB ::= SEQUENCE {
    rb-Identity
    RB-Identity,
    logChOfRb
    INTEGER (0..1)
} OPTIONAL

LogicalChannelList ::= CHOICE {

```

```

    allSizes                NULL,
    configured              NULL,
    explicitList            SEQUENCE (SIZE (1..15)) OF
                            LogicalChannelByRB
}

NumberOfTbSizeAndTTIList ::= SEQUENCE (SIZE (1..maxTF)) OF SEQUENCE {
    numberOfTransportBlocks  NumberOfTransportBlocks,
    transmissionTimeInterval TransmissionTimeInterval
}

MessType ::= ENUMERATED {
    transportFormatCombinationControl }

Non-allowedTFC-List ::= SEQUENCE (SIZE (1..maxTFC)) OF
    TFC-Value

NumberOfTransportBlocks ::= CHOICE {
    zero          NULL,
    one           NULL,
    small         INTEGER (2..17),
    large         INTEGER (18..512)
}

OctetModeRLC-SizeInfoType1 ::= CHOICE {
    -- Actual size = (8 * sizeType1) + 16
    sizeType1      INTEGER (0..31),
    sizeType2      SEQUENCE {
        -- Actual size = (32 * part1) + 272 + (part2 * 8)
        part1       INTEGER (0..23),
        part2       INTEGER (1..3)
    },
    sizeType3      SEQUENCE {
        -- Actual size = (64 * part1) + 1040 + (part2 * 8)
        part1       INTEGER (0..61),
        part2       INTEGER (1..7)
    }
} OPTIONAL

OctetModeRLC-SizeInfoType2 ::= CHOICE {
    -- Actual size = (sizeType1 * 8) + 48
    sizeType1      INTEGER (0..31),
    -- Actual size = (sizeType2 * 16) + 312
    sizeType2      INTEGER (0..63),
    -- Actual size = (sizeType3 * 64) + 1384
    sizeType3      INTEGER (0..56)
}

PowerOffsetInformation ::= SEQUENCE {
    gainFactorInformation GainFactorInformation,
    -- PowerOffsetPp-m is always absent in TDD
    powerOffsetPp-m      PowerOffsetPp-m
} OPTIONAL

PowerOffsetPp-m ::= INTEGER (-5..10)

PreDefTransChConfiguration ::= SEQUENCE {
    ul-CommonTransChInfo  UL-CommonTransChInfo,
    ul-AddReconfTrChInfoList UL-AddReconfTransChInfoList,
    dl-CommonTransChInfo  DL-CommonTransChInfo,
    dl-TrChInfoList       DL-AddReconfTransChInfoList
}

QualityTarget ::= SEQUENCE {
    bler-QualityValue     BLER-QualityValue
}

RateMatchingAttribute ::= INTEGER (1..hiRM)

ReferenceTFC-ID ::= INTEGER (0..3)

RestrictedTrChInfo ::= SEQUENCE {
    ul-TransportChannelType UL-TrCH-Type,
    restrictedTrChIdentity  TransportChannelIdentity,
    allowedTFI-List        AllowedTFI-List
} OPTIONAL

```

```

RestrictedTrChInfoList ::=          SEQUENCE (SIZE (1..maxTrCH)) OF
                                     RestrictedTrChInfo

SemistaticTF-Information ::=       SEQUENCE {
  -- TABULAR: Transmission time interval has been included in the IE CommonTransChTFS.
  channelCodingType                ChannelCodingType,
  rateMatchingAttribute             RateMatchingAttribute,
  crc-Size                          CRC-Size
}

SignalledGainFactors ::=          SEQUENCE {
  modeSpecificInfo                  CHOICE {
    fdd                              SEQUENCE {
      gainFactorBetaC
    },
    tdd                              NULL
  },
  gainFactorBetaD                  GainFactor,
  referenceTFC-ID                   ReferenceTFC-ID
                                     OPTIONAL
}

SplitTFCI-Signalling ::=         SEQUENCE {
  splitType                         SplitType
                                     OPTIONAL,
  tfci-Field2-Length               INTEGER (1..10)
                                     OPTIONAL,
  tfci-Field1-Information           ExplicitTFCS-Configuration
                                     OPTIONAL,
  tfci-Field2-Information           TFCI-Field2-Information
                                     OPTIONAL
}

SplitType ::=                     ENUMERATED {
  hardSplit, logicalSplit
}

TFC-Subset ::=                   CHOICE {
  minimumAllowedTFC-Number          TFC-Value,
  allowedTFC-List                   AllowedTFC-List,
  non-allowedTFC-List               Non-allowedTFC-List,
  restrictedTrChInfoList            RestrictedTrChInfoList,
  fullTFCS                          NULL
}

TFC-Subset-ID-With3b ::=         INTEGER (0..7)

TFC-Subset-ID-With5b ::=         INTEGER (0..31)

TFC-Subset-ID-With10b ::=        INTEGER (0..1023)

TFC-SubsetList ::=               SEQUENCE (SIZE (1.. maxTFCsub)) OF SEQUENCE {
  modeSpecificInfo                  CHOICE {
    fdd                              NULL,
    tdd                              SEQUENCE {
      tfcs-ID
    }
  },
  tfc-Subset                         TFC-Subset
                                     OPTIONAL
}

TFC-Value ::=                     INTEGER (0..1023)

TFCI-Field2-Information ::=       CHOICE {
  tfci-Range                        TFCI-RangeList,
  explicit-config                    ExplicitTFCS-Configuration
}

TFCI-Range ::=                   SEQUENCE {
  maxTFCIField2Value                INTEGER (1..1023),
  tfcs-InfoForDSCH                  TFCI-InfoForDSCH
}

TFCI-RangeList ::=               SEQUENCE (SIZE (1..maxPDSCH-TFCIgroups)) OF
                                     TFCI-Range

TFCS ::=                          CHOICE {
  normalTFCI-Signalling              ExplicitTFCS-Configuration,
  splitTFCI-Signalling               SplitTFCI-Signalling
}

TFCS-Identity ::=                 SEQUENCE {
  tfcs-ID                            TFCI-IdentityPlain
                                     DEFAULT 1,
  sharedChannelIndicator              BOOLEAN
}

```

```

}

TFCS-IdentityPlain ::=          INTEGER (1..8)

TFCS-InfoForDSCH ::=          CHOICE {
    ctfc2bit                    INTEGER (0..3),
    ctfc4bit                    INTEGER (0..15),
    ctfc6bit                    INTEGER (0..63),
    ctfc8bit                    INTEGER (0..255),
    ctfc12bit                   INTEGER (0..4095),
    ctfc16bit                   INTEGER (0..65535),
    ctfc24bit                   INTEGER (0..16777215)
}

TFCS-ReconfAdd ::=            SEQUENCE{
    ctfcSize                     CHOICE{
        ctfc2Bit                SEQUENCE (SIZE (1..maxTFC)) OF SEQUENCE {
            ctfc2                INTEGER (0..3),
            powerOffsetInformation OPTIONAL
        },
        ctfc4Bit                SEQUENCE (SIZE (1..maxTFC)) OF SEQUENCE {
            ctfc4                INTEGER (0..15),
            powerOffsetInformation OPTIONAL
        },
        ctfc6Bit                SEQUENCE (SIZE (1..maxTFC)) OF SEQUENCE {
            ctfc6                INTEGER (0..63),
            powerOffsetInformation OPTIONAL
        },
        ctfc8Bit                SEQUENCE (SIZE (1..maxTFC)) OF SEQUENCE {
            ctfc8                INTEGER (0..255),
            powerOffsetInformation OPTIONAL
        },
        ctfc12Bit               SEQUENCE (SIZE(1..maxTFC)) OF SEQUENCE {
            ctfc12               INTEGER (0..4095),
            powerOffsetInformation OPTIONAL
        },
        ctfc16Bit               SEQUENCE (SIZE (1..maxTFC)) OF SEQUENCE {
            ctfc16               INTEGER(0..65535),
            powerOffsetInformation OPTIONAL
        },
        ctfc24Bit               SEQUENCE (SIZE (1..maxTFC)) OF SEQUENCE {
            ctfc24               INTEGER(0..16777215),
            powerOffsetInformation OPTIONAL
        }
    }
}

TFCS-Removal ::=              SEQUENCE {
    tfci                          INTEGER (0..1023)
}

TFCS-RemovalList ::=          SEQUENCE (SIZE (1..maxTFC)) OF
    TFCS-Removal

TimeDurationBeforeRetry ::=    INTEGER (1..256)

TM-SignallingInfo ::=          SEQUENCE {
    messType                      MessType,
    tm-SignallingMode             CHOICE {
        mode1                    NULL,
        mode2                    SEQUENCE {
            -- in ul-controlledTrChList, TrCH-Type is always DCH
            ul-controlledTrChList UL-ControlledTrChList
        }
    }
}

TransmissionTimeInterval ::=    ENUMERATED {
    tti10, tti20, tti40, tti80 }

TransmissionTimeValidity ::=    INTEGER (1..256)

TransportChannelIdentity ::=    INTEGER (1..32)

TransportChannelIdentityDCHandDSCH ::= SEQUENCE {
    dch-transport-ch-id           TransportChannelIdentity,
    dsch-transport-ch-id          TransportChannelIdentity
}

```

```

TransportFormatSet ::= CHOICE {
    dedicatedTransChTFS      DedicatedTransChTFS,
    commonTransChTFS        CommonTransChTFS
}

TransportFormatSet-LCR ::= CHOICE {
    dedicatedTransChTFS      DedicatedTransChTFS,
    commonTransChTFS-LCR    CommonTransChTFS-LCR
}

-- The maximum allowed size of UL-AddReconfTransChInfoList sequence is 16
UL-AddReconfTransChInfoList ::= SEQUENCE (SIZE (1..maxTrCHpreconf)) OF
    UL-AddReconfTransChInformation

UL-AddReconfTransChInformation ::= SEQUENCE {
    ul-TransportChannelType    UL-TrCH-Type,
    transportChannelIdentity    TransportChannelIdentity,
    transportFormatSet         TransportFormatSet
}

UL-CommonTransChInfo ::= SEQUENCE {
    -- TABULAR: tfc-subset is applicable to FDD only, TDD specifies tfc-subset in individual
    -- CCH Info.
    tfc-Subset                TFC-Subset                OPTIONAL,
    prach-TFCS                TFCS                    OPTIONAL,
    modeSpecificInfo          CHOICE {
        fdd                    SEQUENCE {
            ul-TFCS            TFC-Subset
        },
        tdd                    SEQUENCE {
            ul-TFCS            TFC-Subset
        }
    }
    individualUL-CCH-InfoList IndividualUL-CCH-InfoList OPTIONAL
}
}
}

UL-CommonTransChInfo-r4 ::= SEQUENCE {
    -- TABULAR: tfc-subset is applicable to FDD only, TDD specifies tfc-subset in individual
    -- CCH Info.
    tfc-Subset                TFC-Subset                OPTIONAL,
    prach-TFCS                TFCS                    OPTIONAL,
    modeSpecificInfo          CHOICE {
        fdd                    SEQUENCE {
            ul-TFCS            TFC-Subset
        },
        tdd                    SEQUENCE {
            ul-TFCS            TFC-Subset
        }
    }
    individualUL-CCH-InfoList IndividualUL-CCH-InfoList OPTIONAL
}
}
}
tfc-SubsetList              TFC-SubsetList              OPTIONAL,
}
}

-- In UL-ControlledTrChList, TrCH-Type is always DCH
UL-ControlledTrChList ::= SEQUENCE (SIZE (1..maxTrCH)) OF
    TransportChannelIdentity

UL-DeletedTransChInfoList ::= SEQUENCE (SIZE (1..maxTrCH)) OF
    UL-TransportChannelIdentity

UL-TransportChannelIdentity ::= SEQUENCE {
    ul-TransportChannelType    UL-TrCH-Type,
    ul-TransportChannelIdentity TransportChannelIdentity
}

UL-TrCH-Type ::= ENUMERATED {dch, usch}

-- *****
--
-- PHYSICAL CHANNEL INFORMATION ELEMENTS (10.3.6)
--
-- *****

AC-To-ASC-Mapping ::= INTEGER (0..7)

AC-To-ASC-MappingTable ::= SEQUENCE (SIZE (maxASCmap)) OF
    AC-To-ASC-Mapping

```



```

AccessServiceClass-FDD ::= SEQUENCE {
    availableSignatureStartIndex    INTEGER (0..15),
    availableSignatureEndIndex      INTEGER (0..15),

    assignedSubChannelNumber        BIT STRING {
                                        b3(0),
                                        b2(1),
                                        b1(2),
                                        b0(3)
                                    } (SIZE(4))
}

AccessServiceClass-TDD ::= SEQUENCE {
    channelisationCodeIndices        BIT STRING {
                                        chCodeIndex7(0),
                                        chCodeIndex6(1),
                                        chCodeIndex5(2),
                                        chCodeIndex4(3),
                                        chCodeIndex3(4),
                                        chCodeIndex2(5),
                                        chCodeIndex1(6),
                                        chCodeIndex0(7)
                                    } (SIZE(8)) OPTIONAL,

    subchannelSize                    CHOICE {
        size1                          NULL,
        size2                          SEQUENCE {
            -- subch0 means bitstring '01' in the tabular, subch1 means bitsring '10'
            subchannels                  ENUMERATED { subch0, subch1 } OPTIONAL
        },
        size4                          SEQUENCE {
            subchannels                  BIT STRING {
                                        subCh3(0),
                                        subCh2(1),
                                        subCh1(2),
                                        subCh0(3)
                                    } (SIZE(4)) OPTIONAL
            },
        size8                          SEQUENCE {
            subchannels                  BIT STRING {
                                        subCh7(0),
                                        subCh6(1),
                                        subCh5(2),
                                        subCh4(3),
                                        subCh3(4),
                                        subCh2(5),
                                        subCh1(6),
                                        subCh0(7)
                                    } (SIZE(8)) OPTIONAL
            }
        }
}

AccessServiceClass-TDD-LCR-r4 ::= SEQUENCE {
    availableSYNC-UlCodesIndices      BIT STRING {
                                        sulCodeIndex7(0),
                                        sulCodeIndex6(1),
                                        sulCodeIndex5(2),
                                        sulCodeIndex4(3),
                                        sulCodeIndex3(4),
                                        sulCodeIndex2(5),
                                        sulCodeIndex1(6),
                                        sulCodeIndex0(7)
                                    } (SIZE(8)) OPTIONAL,

    subchannelSize                    CHOICE {
        size1                          NULL,
        size2                          SEQUENCE {
            -- subch0 means bitstring '01' in the tabular, subch1 means bitsring '10'.
            subchannels                  ENUMERATED { subch0, subch1 } OPTIONAL
        },
        size4                          SEQUENCE {
            subchannels                  BIT STRING {
                                        subCh3(0),
                                        subCh2(1),
                                        subCh1(2),
                                        subCh0(3)
                                    } (SIZE(4)) OPTIONAL
            },
}

```

```

        size8
        subchannels
    }
}

AICH-Info ::=
    channelisationCode256
    sttd-Indicator
    aich-TransmissionTiming
}

AICH-PowerOffset ::=
    INTEGER (-22..5)

AICH-TransmissionTiming ::=
    ENUMERATED {
        e0, e1
    }

AllocationPeriodInfo ::=
    allocationActivationTime
    allocationDuration
}

-- Actual value Alpha = IE value * 0.125
Alpha ::=
    INTEGER (0..8)

AP-AICH-ChannelisationCode ::=
    INTEGER (0..255)

AP-PreambleScramblingCode ::=
    INTEGER (0..79)

AP-Signature ::=
    INTEGER (0..15)

AP-Signature-VCAM ::=
    ap-Signature
    availableAP-SubchannelList
}

AP-Subchannel ::=
    INTEGER (0..11)

ASCSetting-FDD ::=
    SEQUENCE {
        -- TABULAR: accessServiceClass-FDD is MD in tabular description
        -- Default value is previous ASC
        -- If this is the first ASC, the default value is all available signature and sub-channels
        accessServiceClass-FDD
    }

ASCSetting-TDD ::=
    SEQUENCE {
        -- TABULAR: accessServiceClass-TDD is MD in tabular description
        -- Default value is previous ASC
        -- If this is the first ASC, the default value is all available channelisation codes and
        -- all available sub-channels with subchannelSize=size1.
        accessServiceClass-TDD
    }

ASCSetting-TDD-LCR-r4 ::=
    SEQUENCE {
        -- TABULAR: accessServiceClass-TDD-LCR is MD in tabular description
        -- Default value is previous ASC
        -- If this is the first ASC, the default value is all available SYNC_UL codes and
        -- all available sub-channels with subchannelSize=size1.
        accessServiceClass-TDD-LCR
    }

AvailableAP-Signature-VCAMList ::= SEQUENCE (SIZE (1..maxPCPCH-APsig)) OF
    AP-Signature-VCAM

AvailableAP-SignatureList ::= SEQUENCE (SIZE (1..maxPCPCH-APsig)) OF
    AP-Signature

AvailableAP-SubchannelList ::= SEQUENCE (SIZE (1..maxPCPCH-APsubCh)) OF

```

```

AP-Subchannel

AvailableMinimumSF-ListVCAM ::= SEQUENCE (SIZE (1..maxPCPCH-SF)) OF
    AvailableMinimumSF-VCAM

AvailableMinimumSF-VCAM ::= SEQUENCE {
    minimumSpreadingFactor      MinimumSpreadingFactor,
    nf-Max                      NF-Max,
    maxAvailablePCPCH-Number    MaxAvailablePCPCH-Number,
    availableAP-Signature-VCAMList AvailableAP-Signature-VCAMList
}

AvailableSignatures ::= BIT STRING {
    signature15(0),
    signature14(1),
    signature13(2),
    signature12(3),
    signature11(4),
    signature10(5),
    signature9(6),
    signature8(7),
    signature7(8),
    signature6(9),
    signature5(10),
    signature4(11),
    signature3(12),
    signature2(13),
    signature1(14),
    signature0(15)
} (SIZE(16))

AvailableSubChannelNumbers ::= BIT STRING {
    subCh11(0),
    subCh10(1),
    subCh9(2),
    subCh8(3),
    subCh7(4),
    subCh6(5),
    subCh5(6),
    subCh4(7),
    subCh3(8),
    subCh2(9),
    subCh1(10),
    subCh0(11)
} (SIZE(12))

BurstType ::= ENUMERATED {
    short1, long2 }

CCTrCH-PowerControlInfo ::= SEQUENCE {
    tfcs-Identity          TFCS-Identity          OPTIONAL,
    ul-DPCH-PowerControlInfo UL-DPCH-PowerControlInfo
}

CCTrCH-PowerControlInfo-r4 ::= SEQUENCE {
    tfcs-Identity          TFCS-Identity          OPTIONAL,
    ul-DPCH-PowerControlInfo-r4 UL-DPCH-PowerControlInfo-r4
}

CD-AccessSlotSubchannel ::= INTEGER (0..11)

CD-AccessSlotSubchannelList ::= SEQUENCE (SIZE (1..maxPCPCH-CDsubCh)) OF
    CD-AccessSlotSubchannel

CD-CA-ICH-ChannelisationCode ::= INTEGER (0..255)

CD-PreambleScramblingCode ::= INTEGER (0..79)

CD-SignatureCode ::= INTEGER (0..15)

CD-SignatureCodeList ::= SEQUENCE (SIZE (1..maxPCPCH-CDsig)) OF
    CD-SignatureCode

CellAndChannelIdentity ::= SEQUENCE {
    burstType              BurstType,
    midambleShift          MidambleShiftLong,
    timeslot               TimeslotNumber,
    cellParametersID      CellParametersID
}

```

```

    }
CellParametersID ::=                INTEGER (0..127)
Cfntargetsfnframeoffset ::=         INTEGER(0..255)
ChannelAssignmentActive ::=         CHOICE {
    notActive                        NULL,
    isActive                        AvailableMinimumSF-ListVCAM
}
ChannelisationCode256 ::=          INTEGER (0..255)
ChannelReqParamsForUCSM ::=        SEQUENCE {
    availableAP-SignatureList        AvailableAP-SignatureList,
    availableAP-SubchannelList      AvailableAP-SubchannelList           OPTIONAL
}
ClosedLoopTimingAdjMode ::=        ENUMERATED {
    slot1, slot2 }
CodeNumberDSCH ::=                INTEGER (0..255)
CodeRange ::=                      SEQUENCE {
    pdsch-CodeMapList               PDSCH-CodeMapList
}
CodeWordSet ::=                   ENUMERATED {
    longCWS,
    mediumCWS,
    shortCWS,
    ssdtOff }
CommonTimeslotInfo ::=            SEQUENCE {
    -- TABULAR: secondInterleavingMode is MD, but since it can be encoded in a single
    -- bit it is not defined as OPTIONAL.
    secondInterleavingMode          SecondInterleavingMode,
    tfci-Coding                    TFCI-Coding                       OPTIONAL,
    puncturingLimit                PuncturingLimit,
    repetitionPeriodAndLength      RepetitionPeriodAndLength           OPTIONAL
}
CommonTimeslotInfoSCCPCH ::=      SEQUENCE {
    -- TABULAR: secondInterleavingMode is MD, but since it can be encoded in a single
    -- bit it is not defined as OPTIONAL.
    secondInterleavingMode          SecondInterleavingMode,
    tfci-Coding                    TFCI-Coding                       OPTIONAL,
    puncturingLimit                PuncturingLimit,
    repetitionPeriodLengthAndOffset RepetitionPeriodLengthAndOffset   OPTIONAL
}
ConstantValue ::=                 INTEGER (-35..-10)
ConstantValueTdd ::=              INTEGER (-35..10)
CPCH-PersistenceLevels ::=        SEQUENCE {
    cpch-SetID                      CPCH-SetID,
    dynamicPersistenceLevelTF-List  DynamicPersistenceLevelTF-List
}
CPCH-PersistenceLevelsList ::=    SEQUENCE (SIZE (1..maxCPCHsets)) OF
    CPCH-PersistenceLevels
CPCH-SetInfo ::=                  SEQUENCE {
    cpch-SetID                      CPCH-SetID,
    transportFormatSet              TransportFormatSet,
    tfcs                            TFCS,
    ap-PreambleScramblingCode       AP-PreambleScramblingCode,
    ap-AICH-ChannelisationCode      AP-AICH-ChannelisationCode,
    cd-PreambleScramblingCode       CD-PreambleScramblingCode,
    cd-CA-ICH-ChannelisationCode    CD-CA-ICH-ChannelisationCode,
    cd-AccessSlotSubchannelList     CD-AccessSlotSubchannelList           OPTIONAL,
    cd-SignatureCodeList            CD-SignatureCodeList                 OPTIONAL,
    deltaPp-m                       DeltaPp-m,
    ul-DPCCH-SlotFormat             UL-DPCCH-SlotFormat,
    n-StartMessage                  N-StartMessage,
    n-EOT                            N-EOT,
    -- TABULAR: VCAM info has been nested inside ChannelAssignmentActive,

```

```

-- which in turn is mandatory since it's only a binary choice.
channelAssignmentActive      ChannelAssignmentActive,
cpch-StatusIndicationMode   CPCH-StatusIndicationMode,
pcpch-ChannelInfoList       PCPCH-ChannelInfoList
}

CPCH-SetInfoList ::=          SEQUENCE (SIZE (1..maxCPCHsets)) OF
                               CPCH-SetInfo

CPCH-StatusIndicationMode ::= ENUMERATED {
                               pa-mode,
                               pamsf-mode }

CSICH-PowerOffset ::=        INTEGER (-10..5)

-- DefaultDPCH-OffsetValueFDD and DefaultDPCH-OffsetValueTDD corresponds to
-- IE "Default DPCH Offset Value" depending on the mode.
-- Actual value DefaultDPCH-OffsetValueFDD = IE value * 512
DefaultDPCH-OffsetValueFDD ::= INTEGER (0..599)

DefaultDPCH-OffsetValueTDD ::= INTEGER (0..7)

DeltaPp-m ::=                INTEGER (-10..10)

-- Actual value DeltaSIR = IE value * 0.1
DeltaSIR ::=                 INTEGER (0..30)

DL-CCTrCh ::=                SEQUENCE {
    tfcs-ID                    TFCS-IdentityPlain                DEFAULT 1,
    timeInfo                    TimeInfo,
    commonTimeslotInfo           CommonTimeslotInfo                OPTIONAL,
    dl-CCTrCH-TimeslotsCodes     DownlinkTimeslotsCodes           OPTIONAL,
    ul-CCTrChTPCList             UL-CCTrChTPCList                 OPTIONAL
}

DL-CCTrCh-r4 ::=             SEQUENCE {
    tfcs-ID                    TFCS-IdentityPlain                DEFAULT 1,
    timeInfo                    TimeInfo,
    commonTimeslotInfo           CommonTimeslotInfo                OPTIONAL,
    tddOption                    CHOICE {
        tdd384                  SEQUENCE {
            dl-CCTrCH-TimeslotsCodes DownlinkTimeslotsCodes OPTIONAL
        },
        tdd128                  SEQUENCE {
            dl-CCTrCH-TimeslotsCodes DownlinkTimeslotsCodes-LCR-r4 OPTIONAL
        }
    },
    ul-CCTrChTPCList             UL-CCTrChTPCList                 OPTIONAL
}

DL-CCTrChList ::=           SEQUENCE (SIZE (1..maxCCTrCH)) OF
                               DL-CCTrCh

DL-CCTrChList-r4 ::=        SEQUENCE (SIZE (1..maxCCTrCH)) OF
                               DL-CCTrCh-r4

DL-CCTrChListToRemove ::=   SEQUENCE (SIZE (1..maxCCTrCH)) OF
                               TFCS-IdentityPlain

DL-CCTrChTPCList ::=        SEQUENCE (SIZE (0..maxCCTrCH)) OF
                               TFCS-Identity

DL-ChannelisationCode ::=   SEQUENCE {
    secondaryScramblingCode     SecondaryScramblingCode    OPTIONAL,
    sf-AndCodeNumber            SF512-AndCodeNumber,
    scramblingCodeChange        ScramblingCodeChange              OPTIONAL
}

DL-ChannelisationCodeList ::= SEQUENCE (SIZE (1..maxDPCH-DLchan)) OF
                               DL-ChannelisationCode

DL-CommonInformation ::=    SEQUENCE {
    dl-DPCH-InfoCommon          DL-DPCH-InfoCommon              OPTIONAL,
    modeSpecificInfo            CHOICE {
        fdd                     SEQUENCE {
            defaultDPCH-OffsetValue DefaultDPCH-OffsetValueFDD OPTIONAL,
            dpch-CompressedModeInfo DPCH-CompressedModeInfo    OPTIONAL,
            tx-DiversityMode       TX-DiversityMode              OPTIONAL,
        }
    }
}

```

```

        ssdt-Information          SSDT-Information          OPTIONAL
    },
    tdd
        defaultDPCH-OffsetValue  SEQUENCE {
            DefaultDPCH-OffsetValueTDD  OPTIONAL
        }
    }
}

DL-CommonInformation-r4 ::= SEQUENCE {
    dl-DPCH-InfoCommon          DL-DPCH-InfoCommon-r4          OPTIONAL,
    modeSpecificInfo            CHOICE {
        fdd                     SEQUENCE {
            defaultDPCH-OffsetValue  DefaultDPCH-OffsetValueFDD  OPTIONAL,
            dpch-CompressedModeInfo  DPCH-CompressedModeInfo    OPTIONAL,
            tx-DiversityMode         TX-DiversityMode            OPTIONAL,
            ssdt-Information         SSDT-Information-r4        OPTIONAL
        },
        tdd                     SEQUENCE {
            tddOption                CHOICE {
                tdd384                NULL,
                tdd128                SEQUENCE {
                    tstd-Indicator     BOOLEAN
                }
            },
            defaultDPCH-OffsetValue  DefaultDPCH-OffsetValueTDD  OPTIONAL
        }
    }
}

DL-CommonInformationPost ::= SEQUENCE {
    dl-DPCH-InfoCommon          DL-DPCH-InfoCommonPost
}

DL-CommonInformationPredef ::= SEQUENCE {
    dl-DPCH-InfoCommon          DL-DPCH-InfoCommonPredef    OPTIONAL
}

DL-CompressedModeMethod ::= ENUMERATED {
    puncturing, sf-2,
    higherLayerScheduling }

DL-DPCH-InfoCommon ::= SEQUENCE {
    cfnHandling                 CHOICE {
        maintain                 NULL,
        initialise                SEQUENCE {
            cfntargetsfnframeoffset  Cfntargetsfnframeoffset    OPTIONAL
        }
    },
    modeSpecificInfo            CHOICE {
        fdd                     SEQUENCE {
            dl-DPCH-PowerControlInfo  DL-DPCH-PowerControlInfo    OPTIONAL,
            powerOffsetPilot-pdpdch   PowerOffsetPilot-pdpdch,
            dl-rate-matching-restriction  Dl-rate-matching-restriction  OPTIONAL,
            -- TABULAR: The number of pilot bits is nested inside the spreading factor.
            spreadingFactorAndPilot    SF512-AndPilot,
            positionFixedOrFlexible    PositionFixedOrFlexible,
            tfci-Existence             BOOLEAN
        },
        tdd                     SEQUENCE {
            dl-DPCH-PowerControlInfo  DL-DPCH-PowerControlInfo    OPTIONAL
        }
    }
}

DL-DPCH-InfoCommon-r4 ::= SEQUENCE {
    cfnHandling                 CHOICE {
        maintain                 NULL,
        initialise                SEQUENCE {
            cfntargetsfnframeoffset  Cfntargetsfnframeoffset    OPTIONAL
        }
    },
    modeSpecificInfo            CHOICE {
        fdd                     SEQUENCE {
            dl-DPCH-PowerControlInfo  DL-DPCH-PowerControlInfo    OPTIONAL,
            powerOffsetPilot-pdpdch   PowerOffsetPilot-pdpdch,
            dl-rate-matching-restriction  Dl-rate-matching-restriction  OPTIONAL,
            -- TABULAR: The number of pilot bits is nested inside the spreading factor.
            spreadingFactorAndPilot    SF512-AndPilot,
            positionFixedOrFlexible    PositionFixedOrFlexible,

```

```

        tfci-Existence                BOOLEAN
    },
    tdd                                SEQUENCE {
        dl-DPCH-PowerControlInfo      DL-DPCH-PowerControlInfo      OPTIONAL
    }
},
-- The IE mac-d-HFN-initial-value should be absent in the RRCConnectionSetup-r4-IEs or
-- HandoverToUTRANCommand-r4-IEs and if the IE is included, the general error handling for
-- conditional IEs applies.
    mac-d-HFN-initial-value          MAC-d-HFN-initial-value          OPTIONAL
}

DL-DPCH-InfoCommonPost ::=          SEQUENCE {
    dl-DPCH-PowerControlInfo          DL-DPCH-PowerControlInfo          OPTIONAL
}

DL-DPCH-InfoCommonPredef ::=        SEQUENCE {
    modeSpecificInfo                  CHOICE {
        fdd                            SEQUENCE {
            -- TABULAR: The number of pilot bits is nested inside the spreading factor.
            spreadingFactorAndPilot     SF512-AndPilot,
            positionFixedOrFlexible     PositionFixedOrFlexible,
            tfci-Existence              BOOLEAN
        },
        tdd                            SEQUENCE {
            commonTimeslotInfo          CommonTimeslotInfo
        }
    }
}

DL-DPCH-InfoPerRL ::=              CHOICE {
    fdd                                SEQUENCE {
        pCPICH-UsageForChannelEst      PCPICH-UsageForChannelEst,
        dpch-FrameOffset               DPCH-FrameOffset,
        secondaryCPICH-Info             SecondaryCPICH-Info             OPTIONAL,
        dl-ChannelisationCodeList      DL-ChannelisationCodeList,
        tpc-CombinationIndex           TPC-CombinationIndex,
        ssdt-CellIdentity              SSDT-CellIdentity             OPTIONAL,
        closedLoopTimingAdjMode        ClosedLoopTimingAdjMode        OPTIONAL
    },
    tdd                                SEQUENCE {
        dl-CCTrChListToEstablish        DL-CCTrChList                 OPTIONAL,
        dl-CCTrChListToRemove          DL-CCTrChListToRemove        OPTIONAL
    }
}

DL-DPCH-InfoPerRL-r4 ::=           CHOICE {
    fdd                                SEQUENCE {
        pCPICH-UsageForChannelEst      PCPICH-UsageForChannelEst,
        dpch-FrameOffset               DPCH-FrameOffset,
        secondaryCPICH-Info             SecondaryCPICH-Info             OPTIONAL,
        dl-ChannelisationCodeList      DL-ChannelisationCodeList,
        tpc-CombinationIndex           TPC-CombinationIndex,
        ssdt-CellIdentity              SSDT-CellIdentity             OPTIONAL,
        closedLoopTimingAdjMode        ClosedLoopTimingAdjMode        OPTIONAL
    },
    tdd                                SEQUENCE {
        dl-CCTrChListToEstablish        DL-CCTrChList-r4             OPTIONAL,
        dl-CCTrChListToRemove          DL-CCTrChListToRemove        OPTIONAL
    }
}

DL-DPCH-InfoPerRL-PostFDD ::=      SEQUENCE {
    pCPICH-UsageForChannelEst          PCPICH-UsageForChannelEst,
    dl-ChannelisationCode              DL-ChannelisationCode,
    tpc-CombinationIndex               TPC-CombinationIndex
}

DL-DPCH-InfoPerRL-PostTDD ::=      SEQUENCE {
    dl-DPCH-TimeslotsCodes             DownlinkTimeslotsCodes
}

DL-DPCH-InfoPerRL-PostTDD-LCR-r4 ::= SEQUENCE {
    dl-CCTrCH-TimeslotsCodes           DownlinkTimeslotsCodes-LCR-r4
}

```

```

DL-DPCH-PowerControlInfo ::=
    modeSpecificInfo
        fdd
            dpc-Mode
        },
        tdd
            tpc-StepSizeTDD
    }
}

DL-FrameType ::=
    ENUMERATED {
        dl-FrameTypeA, dl-FrameTypeB }

DL-InformationPerRL ::=
    modeSpecificInfo
        fdd
            primaryCPICH-Info
            pdsch-SHO-DCH-Info
            pdsch-CodeMapping
        },
        tdd
            PrimaryCCPCH-Info
    },
    dl-DPCH-InfoPerRL
    sccpch-InfoForFACH
}

DL-InformationPerRL-r4 ::=
    modeSpecificInfo
        fdd
            primaryCPICH-Info
            pdsch-SHO-DCH-Info
            pdsch-CodeMapping
        },
        tdd
            PrimaryCCPCH-Info-r4
    },
    dl-DPCH-InfoPerRL
    sccpch-InfoForFACH
    cell-id
}

DL-InformationPerRL-List ::=
    SEQUENCE (SIZE (1..maxRL)) OF
        DL-InformationPerRL

DL-InformationPerRL-List-r4 ::=
    SEQUENCE (SIZE (1..maxRL)) OF
        DL-InformationPerRL-r4

DL-InformationPerRL-ListPostFDD ::= SEQUENCE (SIZE (1..maxRL)) OF
        DL-InformationPerRL-PostFDD

DL-InformationPerRL-PostFDD ::=
    SEQUENCE {
        primaryCPICH-Info
        dl-DPCH-InfoPerRL
    }

DL-InformationPerRL-PostTDD ::=
    SEQUENCE {
        primaryCCPCH-Info
        dl-DPCH-InfoPerRL
    }

DL-InformationPerRL-PostTDD-LCR-r4 ::= SEQUENCE {
    primaryCCPCH-Info
    dl-DPCH-InfoPerRL
}

DL-PDSCH-Information ::=
    SEQUENCE {
        pdsch-SHO-DCH-Info
        pdsch-CodeMapping
    }

DL-rate-matching-restriction ::=
    SEQUENCE {
        restrictedTrCH-InfoList
    }

DL-TS-ChannelisationCode ::=
    ENUMERATED {
        cc16-1, cc16-2, cc16-3, cc16-4,
        cc16-5, cc16-6, cc16-7, cc16-8,
        cc16-9, cc16-10, cc16-11, cc16-12,

```



```

        cc16-13, cc16-14, cc16-15, cc16-16 }

DL-TS-ChannelisationCodesShort ::= SEQUENCE {
    codesRepresentation          CHOICE {
        consecutive              SEQUENCE {
            firstChannelisationCode DL-TS-ChannelisationCode,
            lastChannelisationCode  DL-TS-ChannelisationCode
        },
        bitmap                   BIT STRING {
            chCode16-SF16(0),
            chCode15-SF16(1),
            chCode14-SF16(2),
            chCode13-SF16(3),
            chCode12-SF16(4),
            chCode11-SF16(5),
            chCode10-SF16(6),
            chCode9-SF16(7),
            chCode8-SF16(8),
            chCode7-SF16(9),
            chCode6-SF16(10),
            chCode5-SF16(11),
            chCode4-SF16(12),
            chCode3-SF16(13),
            chCode2-SF16(14),
            chCode1-SF16(15)
        } (SIZE (16))
    }
}

DownlinkAdditionalTimeslots ::= SEQUENCE {
    parameters                  CHOICE {
        sameAsLast              SEQUENCE {
            timeslotNumber      TimeslotNumber
        },
        newParameters            SEQUENCE {
            individualTimeslotInfo IndividualTimeslotInfo,
            dl-TS-ChannelisationCodesShort DL-TS-ChannelisationCodesShort
        }
    }
}

DownlinkAdditionalTimeslots-LCR-r4 ::= SEQUENCE {
    parameters                  CHOICE {
        sameAsLast              SEQUENCE {
            timeslotNumber      TimeslotNumber-LCR-r4
        },
        newParameters            SEQUENCE {
            individualTimeslotInfo IndividualTimeslotInfo-LCR-r4,
            dl-TS-ChannelisationCodesShort DL-TS-ChannelisationCodesShort
        }
    }
}

DownlinkTimeslotsCodes ::= SEQUENCE {
    firstIndividualTimeslotInfo IndividualTimeslotInfo,
    dl-TS-ChannelisationCodesShort DL-TS-ChannelisationCodesShort,
    moreTimeslots              CHOICE {
        noMore                  NULL,
        additionalTimeslots     CHOICE {
            consecutive          INTEGER (1..maxTS-1),
            timeslotList         SEQUENCE (SIZE (1..maxTS-1)) OF
                DownlinkAdditionalTimeslots
        }
    }
}

DownlinkTimeslotsCodes-LCR-r4 ::= SEQUENCE {
    firstIndividualTimeslotInfo IndividualTimeslotInfo-LCR-r4,
    dl-TS-ChannelisationCodesShort DL-TS-ChannelisationCodesShort,
    moreTimeslots              CHOICE {
        noMore                  NULL,
        additionalTimeslots     CHOICE {
            consecutive          INTEGER (1..maxTS-LCR-1),
            timeslotList         SEQUENCE (SIZE (1..maxTS-LCR-1)) OF
                DownlinkAdditionalTimeslots-LCR-r4
        }
    }
}

```

```

DPC-Mode ::=
    ENUMERATED {
        singleTPC,
        tpcTripletInSoft }

-- Actual value DPCCH-PowerOffset = IE value * 2
DPCCH-PowerOffset ::=
    INTEGER (-82..-3)

-- Actual value DPCCH-PowerOffset = 2 + (IE value * 4)
DPCCH-PowerOffset2 ::=
    INTEGER (-28..-13)

DPCH-CompressedModeInfo ::=
    SEQUENCE {
        tgp-SequenceList
        TGP-SequenceList
    }

DPCH-CompressedModeStatusInfo ::=
    SEQUENCE {
        tgps-Reconfiguration-CFN
        TGPS-Reconfiguration-CFN,
        tgp-SequenceShortList
        SEQUENCE (SIZE (1..maxTGPS)) OF
        TGP-SequenceShort
    }

-- Actual value DPCH-FrameOffset = IE value * 256
DPCH-FrameOffset ::=
    INTEGER (0..149)

DSCH-Mapping ::=
    SEQUENCE {
        maxTFCL-Field2Value
        MaxTFCL-Field2Value,
        spreadingFactor
        SF-PDSCH,
        codeNumber
        CodeNumberDSCH,
        multiCodeInfo
        MultiCodeInfo
    }

DSCH-MappingList ::=
    SEQUENCE (SIZE (1..maxPDSCH-TFCIgroups)) OF
    DSCH-Mapping

DSCH-RadioLinkIdentifier ::=
    INTEGER (0..511)

DurationTimeInfo ::=
    INTEGER (1..4096)

DynamicPersistenceLevel ::=
    INTEGER (1..8)

DynamicPersistenceLevelList ::=
    SEQUENCE (SIZE (1..maxPRACH)) OF
    DynamicPersistenceLevel

DynamicPersistenceLevelTF-List ::=
    SEQUENCE (SIZE (1..maxTF-CPCH)) OF
    DynamicPersistenceLevel

FACH-PCH-Information ::=
    SEQUENCE {
        transportFormatSet
        TransportFormatSet,
        transportChannelIdentity
        TransportChannelIdentity,
        ctch-Indicator
        BOOLEAN
    }

FACH-PCH-InformationList ::=
    SEQUENCE (SIZE (1..maxFACHPCH)) OF
    FACH-PCH-Information

FPACH-Info-r4 ::=
    SEQUENCE {
        timeslot
        TimeslotNumber-LCR-r4,
        channelisationCode
        TDD-FPACH-CCode16-r4,
        midambleShiftAndBurstType
        MidambleShiftAndBurstType-LCR-r4,
        wi
        Wi-LCR
    }

FrequencyInfo ::=
    SEQUENCE {
        modeSpecificInfo
        CHOICE {
            fdd
            FrequencyInfoFDD,
            tdd
            FrequencyInfoTDD }
    }

FrequencyInfoFDD ::=
    SEQUENCE {
        uarfcn-UL
        UARFCN
        uarfcn-DL
        UARFCN
    }
    OPTIONAL,

FrequencyInfoTDD ::=
    SEQUENCE {
        uarfcn-Nt
        UARFCN
    }

```

```

IndividualTimeslotInfo ::= SEQUENCE {
    timeslotNumber          TimeslotNumber,
    tfci-Existence          BOOLEAN,
    midambleShiftAndBurstType MidambleShiftAndBurstType
}

IndividualTimeslotInfo-LCR-r4 ::= SEQUENCE {
    timeslotNumber          TimeslotNumber-LCR-r4,
    tfci-Existence          BOOLEAN,
    midambleShiftAndBurstType MidambleShiftAndBurstType-LCR-r4,
    modulation              ENUMERATED { mod-QPSK, mod-8PSK },
    ss-TPC-Symbols          ENUMERATED { zero, one, sixteenOverSF },
    additionalSS-TPC-Symbols INTEGER(1..15) OPTIONAL
}

IndividualTimeslotInfo-LCR-r4-ext ::= SEQUENCE {
-- timeslotNumber and tfci-Existence is taken from IndividualTimeslotInfo.
-- midambleShiftAndBurstType in IndividualTimeslotInfo shall be ignored.
    midambleShiftAndBurstType MidambleShiftAndBurstType-LCR-r4,
    modulation              ENUMERATED { mod-QPSK, mod-8PSK },
    ss-TPC-Symbols          ENUMERATED { zero, one, sixteenOverSF }
}

IndividualTS-Interference ::= SEQUENCE {
    timeslot                TimeslotNumber,
    ul-TimeslotInterference TDD-UL-Interference
}

IndividualTS-InterferenceList ::= SEQUENCE (SIZE (1..maxTS)) OF
    IndividualTS-Interference

ITP ::= ENUMERATED {
    mode0, mode1 }

NidentifyAbort ::= INTEGER (1..128)

MaxAllowedUL-TX-Power ::= INTEGER (-50..33)

MaxAvailablePCPCH-Number ::= INTEGER (1..64)

MaxPowerIncrease-r4 ::= INTEGER (0..3)

MaxTFCI-Field2Value ::= INTEGER (1..1023)

MidambleConfigurationBurstTypeLand3 ::= ENUMERATED {ms4, ms8, ms16}

MidambleConfigurationBurstType2 ::= ENUMERATED {ms3, ms6}

MidambleShiftAndBurstType ::= SEQUENCE {
    burstType CHOICE {
        type1 SEQUENCE {
            midambleConfigurationBurstTypeLand3 MidambleConfigurationBurstTypeLand3,
            midambleAllocationMode CHOICE {
                defaultMidamble NULL,
                commonMidamble NULL,
                ueSpecificMidamble SEQUENCE {
                    midambleShift MidambleShiftLong
                }
            }
        },
        type2 SEQUENCE {
            midambleConfigurationBurstType2 MidambleConfigurationBurstType2,
            midambleAllocationMode CHOICE {
                defaultMidamble NULL,
                commonMidamble NULL,
                ueSpecificMidamble SEQUENCE {
                    midambleShift MidambleShiftShort
                }
            }
        },
        type3 SEQUENCE {
            midambleConfigurationBurstTypeLand3 MidambleConfigurationBurstTypeLand3,
            midambleAllocationMode CHOICE {
                defaultMidamble NULL,
                ueSpecificMidamble SEQUENCE {
                    midambleShift MidambleShiftLong
                }
            }
        }
    }
}

```

```

    }
  }
}

MidambleShiftAndBurstType-LCR-r4 ::= SEQUENCE {
  midambleAllocationMode CHOICE {
    defaultMidamble NULL,
    commonMidamble NULL,
    ueSpecificMidamble SEQUENCE {
      midambleShift INTEGER (0..15)
    }
  },
  -- Actual value midambleConfiguration = IE value * 2
  midambleConfiguration INTEGER (1..8)
}

MidambleShiftLong ::= INTEGER (0..15)

MidambleShiftShort ::= INTEGER (0..5)

MinimumSpreadingFactor ::= ENUMERATED {
  sf4, sf8, sf16, sf32,
  sf64, sf128, sf256 }

MultiCodeInfo ::= INTEGER (1..16)

N-EOT ::= INTEGER (0..7)

N-GAP ::= ENUMERATED {
  f2, f4, f8 }

N-PCH ::= INTEGER (1..8)

N-StartMessage ::= INTEGER (1..8)

NB01 ::= INTEGER (0..50)

NF-Max ::= INTEGER (1..64)

NumberOfDPDCH ::= INTEGER (1..maxDPDCH-UL)

NumberOfFBI-Bits ::= INTEGER (1..2)

OpenLoopPowerControl-TDD ::= SEQUENCE {
  primaryCCPCH-TX-Power PrimaryCCPCH-TX-Power,
  -- alpha, prach-ConstantValue, dpch-ConstantValue and pusch-ConstantValue
  -- shall be ignored in 1.28Mcps TDD mode.
  alpha Alpha OPTIONAL,
  prach-ConstantValue ConstantValueTdd,
  dpch-ConstantValue ConstantValueTdd,
  pusch-ConstantValue ConstantValueTdd OPTIONAL
}

OpenLoopPowerControl-IPDL-TDD-r4 ::= SEQUENCE {
  ipdl-alpha Alpha,
  maxPowerIncrease MaxPowerIncrease-r4
}

PagingIndicatorLength ::= ENUMERATED {
  pi4, pi8, pi16 }

PC-Preamble ::= INTEGER (0..7)

PCP-Length ::= ENUMERATED {
  as0, as8 }

PCPCH-ChannelInfo ::= SEQUENCE {
  pcpch-UL-ScramblingCode INTEGER (0..79),
  pcpch-DL-ChannelisationCode INTEGER (0..511),
  pcpch-DL-ScramblingCode SecondaryScramblingCode OPTIONAL,
  pcp-Length PCP-Length,
  ucsM-Info UCSM-Info OPTIONAL
}

PCPCH-ChannelInfoList ::= SEQUENCE (SIZE (1..maxPCPCHs)) OF

```

```

PCPCH-ChannelInfo

PCPICH-UsageForChannelEst ::=      ENUMERATED {
                                     maybeUsed,
                                     shallNotBeUsed }

PDSCH-CapacityAllocationInfo ::=    SEQUENCE {
  -- pdsch-PowerControlInfo is conditional on new-configuration branch below, if this
  -- selected the IE is OPTIONAL otherwise it should not be sent
  pdsch-PowerControlInfo             PDSCH-PowerControlInfo             OPTIONAL,
  pdsch-AllocationPeriodInfo         AllocationPeriodInfo,
  configuration                       CHOICE {
    old-Configuration                SEQUENCE {
      tfcs-ID                        TFCS-IdentityPlain             DEFAULT 1,
      pdsch-Identity                 PDSCH-Identity
    },
    new-Configuration                SEQUENCE {
      pdsch-Info                     PDSCH-Info,
      pdsch-Identity                 PDSCH-Identity             OPTIONAL
    }
  }
}

PDSCH-CapacityAllocationInfo-r4 ::= SEQUENCE {
  pdsch-AllocationPeriodInfo         AllocationPeriodInfo,
  configuration                       CHOICE {
    old-Configuration                SEQUENCE {
      tfcs-ID                        TFCS-IdentityPlain             DEFAULT 1,
      pdsch-Identity                 PDSCH-Identity
    },
    new-Configuration                SEQUENCE {
      pdsch-Info                     PDSCH-Info-r4,
      pdsch-Identity                 PDSCH-Identity             OPTIONAL,
      pdsch-PowerControlInfo         PDSCH-PowerControlInfo     OPTIONAL
    }
  }
}

PDSCH-CodeInfo ::=                  SEQUENCE {
  spreadingFactor                    SF-PDSCH,
  codeNumber                         CodeNumberDSCH,
  multiCodeInfo                      MultiCodeInfo
}

PDSCH-CodeInfoList ::=              SEQUENCE (SIZE (1..maxTFCI-2-Combs)) OF
                                     PDSCH-CodeInfo

PDSCH-CodeMap ::=                   SEQUENCE {
  spreadingFactor                    SF-PDSCH,
  multiCodeInfo                      MultiCodeInfo,
  codeNumberStart                    CodeNumberDSCH,
  codeNumberStop                     CodeNumberDSCH
}

PDSCH-CodeMapList ::=               SEQUENCE (SIZE (1..maxPDSCH-TFCIgroups)) OF
                                     PDSCH-CodeMap

PDSCH-CodeMapping ::=               SEQUENCE {
  dl-ScramblingCode                  SecondaryScramblingCode         OPTIONAL,
  signallingMethod                   CHOICE {
    codeRange                         CodeRange,
    tfci-Range                        DSCH-MappingList,
    explicit-config                   PDSCH-CodeInfoList,
    replace                           ReplacedPDSCH-CodeInfoList
  }
}

PDSCH-Identity ::=                  INTEGER (1..hiPDSCHidentities)

PDSCH-Info ::=                       SEQUENCE {
  tfcs-ID                            TFCS-IdentityPlain             DEFAULT 1,
  commonTimeslotInfo                 CommonTimeslotInfo             OPTIONAL,
  pdsch-TimeslotsCodes               DownlinkTimeslotsCodes         OPTIONAL
}

PDSCH-Info-r4 ::=                   SEQUENCE {
  tfcs-ID                            TFCS-IdentityPlain             DEFAULT 1,

```

<pre> commonTimeslotInfo tddOption tdd384 pdsch-TimeslotsCodes }, tdd128 pdsch-TimeslotsCodes } } </pre>	<pre> CommonTimeslotInfo CHOICE { SEQUENCE { DownlinkTimeslotsCodes } SEQUENCE { DownlinkTimeslotsCodes-LCR-r4 } } </pre>	<pre> OPTIONAL, OPTIONAL OPTIONAL OPTIONAL </pre>
<pre> PDSCH-Info-LCR-r4 ::= tfcs-ID commonTimeslotInfo pdsch-TimeslotsCodes } </pre>	<pre> SEQUENCE { TFCS-IdentityPlain CommonTimeslotInfo DownlinkTimeslotsCodes-LCR-r4 } </pre>	<pre> DEFAULT 1, OPTIONAL, OPTIONAL </pre>
<pre> PDSCH-PowerControlInfo ::= tpc-StepSizeTDD ul-CCTrChTPCList } </pre>	<pre> SEQUENCE { TPC-StepSizeTDD UL-CCTrChTPCList } </pre>	<pre> OPTIONAL, OPTIONAL </pre>
<pre> PDSCH-SHO-DCH-Info ::= dsch-RadioLinkIdentifier rl-IdentifierList } </pre>	<pre> SEQUENCE { DSCH-RadioLinkIdentifier, RL-IdentifierList } </pre>	<pre> OPTIONAL </pre>
<pre> PDSCH-SysInfo ::= pdsch-Identity pdsch-Info dsch-TFS dsch-TFCS } </pre>	<pre> SEQUENCE { PDSCH-Identity, PDSCH-Info, TransportFormatSet TFCS } </pre>	<pre> OPTIONAL, OPTIONAL </pre>
<pre> PDSCH-SysInfo-LCR-r4 ::= pdsch-Identity pdsch-Info dsch-TFS dsch-TFCS } </pre>	<pre> SEQUENCE { PDSCH-Identity, PDSCH-Info-LCR-r4, TransportFormatSet TFCS } </pre>	<pre> OPTIONAL, OPTIONAL </pre>
<pre> PDSCH-SysInfoList ::= </pre>	<pre> SEQUENCE (SIZE (1..maxPDSCH)) OF PDSCH-SysInfo </pre>	
<pre> PDSCH-SysInfoList-LCR-r4 ::= </pre>	<pre> SEQUENCE (SIZE (1..maxPDSCH)) OF PDSCH-SysInfo-LCR-r4 </pre>	
<pre> PDSCH-SysInfoList-SFN ::= pdsch-SysInfo sfn-TimeInfo } </pre>	<pre> SEQUENCE (SIZE (1..maxPDSCH)) OF SEQUENCE { PDSCH-SysInfo, SFN-TimeInfo } </pre>	<pre> OPTIONAL </pre>
<pre> PDSCH-SysInfoList-SFN-LCR-r4 ::= pdsch-SysInfo sfn-TimeInfo } </pre>	<pre> SEQUENCE (SIZE (1..maxPDSCH)) OF SEQUENCE { PDSCH-SysInfo-LCR-r4, SFN-TimeInfo } </pre>	<pre> OPTIONAL </pre>
<pre> PersistenceScalingFactor ::= </pre>	<pre> ENUMERATED { psf0-9, psf0-8, psf0-7, psf0-6, psf0-5, psf0-4, psf0-3, psf0-2 } </pre>	
<pre> PersistenceScalingFactorList ::= </pre>	<pre> SEQUENCE (SIZE (1..maxASCPersist)) OF PersistenceScalingFactor </pre>	
<pre> PI-CountPerFrame ::= </pre>	<pre> ENUMERATED { e18, e36, e72, e144 } </pre>	
<pre> PichChannelisationCodeList-LCR-r4 ::= </pre>	<pre> SEQUENCE (SIZE (1..2)) OF DL-TS-ChannelisationCode </pre>	
<pre> PICH-Info ::= fdd channelisationCode256 pi-CountPerFrame sttd-Indicator }, </pre>	<pre> CHOICE { SEQUENCE { ChannelisationCode256, PI-CountPerFrame, BOOLEAN } } </pre>	

```

    tdd
        channelisationCode          TDD-PICH-CCode          OPTIONAL,
        timeslot                     TimeslotNumber         OPTIONAL,
        midambleShiftAndBurstType    MidambleShiftAndBurstType,
        repetitionPeriodLengthOffset RepPerLengthOffset-PICH  OPTIONAL,
        pagingIndicatorLength        PagingIndicatorLength  DEFAULT pi4,
        n-GAP                        N-GAP                 DEFAULT f4,
        n-PCH                        N-PCH                 DEFAULT 2
    }
}

PICH-Info-LCR-r4 ::= SEQUENCE {
    timeslot          TimeslotNumber-LCR-r4          OPTIONAL,
    pichChannelisationCodeList-LCR-r4 PichChannelisationCodeList-LCR-r4,
    midambleShiftAndBurstType    MidambleShiftAndBurstType-LCR-r4,
    repetitionPeriodLengthOffset RepPerLengthOffset-PICH          OPTIONAL,
    pagingIndicatorLength        PagingIndicatorLength  DEFAULT pi4,
    n-GAP                        N-GAP                 DEFAULT f4,
    n-PCH                        N-PCH                 DEFAULT 2
}

PICH-PowerOffset ::= INTEGER (-10..5)

PilotBits128 ::= ENUMERATED {
    pb4, pb8 }

PilotBits256 ::= ENUMERATED {
    pb2, pb4, pb8 }

PositionFixedOrFlexible ::= ENUMERATED {
    fixed,
    flexible }

PowerControlAlgorithm ::= CHOICE {
    algorithm1 TPC-StepSizeFDD,
    algorithm2 NULL
}

PowerOffsetPilot-pdpdch ::= INTEGER (0..24)

PowerRampStep ::= INTEGER (1..8)

PRACH-ChanCodes-LCR-r4 ::= SEQUENCE (SIZE (1..4)) OF
    TDD-PRACH-CCode-LCR-r4

PRACH-Definition-LCR-r4 ::= SEQUENCE {
    timeslot          TimeslotNumber-PRACH-LCR-r4,
    prach-ChanCodes-LCR PRACH-ChanCodes-LCR-r4,
    midambleShiftAndBurstType MidambleShiftAndBurstType-LCR-r4,
    fpach-Info        FPACH-Info-r4
}

PRACH-Midamble ::= ENUMERATED {
    direct,
    direct-Inverted }

PRACH-Partitioning ::= CHOICE {
    fdd SEQUENCE (SIZE (1..maxASC)) OF
        -- TABULAR: If only "NumASC+1" (with, NumASC+1 < maxASC) ASCSetting-FDD are listed,
        -- the remaining (NumASC+2 through maxASC) ASCs are unspecified.
        ASCSetting-FDD,
    tdd SEQUENCE (SIZE (1..maxASC)) OF
        -- TABULAR: If only "NumASC+1" (with, NumASC+1 < maxASC) ASCSetting-TDD are listed,
        -- the remaining (NumASC+2 through maxASC) ASCs are unspecified.
        ASCSetting-TDD
}

PRACH-Partitioning-LCR-r4 ::= SEQUENCE (SIZE (1..maxASC)) OF
    -- TABULAR: If only "NumASC+1" (with, NumASC+1 < maxASC) ASCSetting-TDD-LCR-r4 are listed,
    -- the remaining (NumASC+2 through maxASC) ASCs are unspecified.
    ASCSetting-TDD-LCR-r4

PRACH-PowerOffset ::= SEQUENCE {
    powerRampStep PowerRampStep,
    preambleRetransMax PreambleRetransMax
}

PRACH-RACH-Info ::= SEQUENCE {

```

```

modeSpecificInfo CHOICE {
  fdd SEQUENCE {
    availableSignatures AvailableSignatures,
    availableSF SF-PRACH,
    preambleScramblingCodeWordNumber PreambleScramblingCodeWordNumber,
    puncturingLimit PuncturingLimit,
    availableSubChannelNumbers AvailableSubChannelNumbers
  },
  tdd SEQUENCE {
    timeslot TimeslotNumber,
    channelisationCodeList TDD-PRACH-CCodeList,
    prach-Midamble PRACH-Midamble
  }
}

PRACH-RACH-Info-LCR-r4 ::= SEQUENCE {
  sync-UL-Info SYNC-UL-Info-r4,
  prach-DefinitionList SEQUENCE (SIZE (1..maxPRACH-FPACH)) OF
    PRACH-Definition-LCR-r4
}

PRACH-SystemInformation ::= SEQUENCE {
  prach-RACH-Info PRACH-RACH-Info,
  transportChannelIdentity TransportChannelIdentity,
  rach-TransportFormatSet TransportFormatSet OPTIONAL,
  rach-TFCS TFCS OPTIONAL,
  prach-Partitioning PRACH-Partitioning OPTIONAL,
  persistenceScalingFactorList PersistenceScalingFactorList OPTIONAL,
  ac-To-ASC-MappingTable AC-To-ASC-MappingTable OPTIONAL,
  modeSpecificInfo CHOICE {
    fdd SEQUENCE {
      primaryCPICH-TX-Power PrimaryCPICH-TX-Power OPTIONAL,
      constantValue ConstantValue OPTIONAL,
      prach-PowerOffset PRACH-PowerOffset OPTIONAL,
      rach-TransmissionParameters RACH-TransmissionParameters OPTIONAL,
      aich-Info AICH-Info OPTIONAL
    },
    tdd NULL
  }
}

PRACH-SystemInformation-LCR-r4 ::= SEQUENCE {
  prach-RACH-Info-LCR PRACH-RACH-Info-LCR-r4,
  rach-TransportFormatSet-LCR TransportFormatSet-LCR OPTIONAL,
  prach-Partitioning-LCR PRACH-Partitioning-LCR-r4 OPTIONAL
}

PRACH-SystemInformationList ::= SEQUENCE (SIZE (1..maxPRACH)) OF
  PRACH-SystemInformation

PRACH-SystemInformationList-LCR-r4 ::= SEQUENCE (SIZE (1..maxPRACH)) OF
  PRACH-SystemInformation-LCR-r4

PreambleRetransMax ::= INTEGER (1..64)

PreambleScramblingCodeWordNumber ::= INTEGER (0..15)

PreDefPhyChConfiguration ::= SEQUENCE {
  ul-DPCH-InfoPredef UL-DPCH-InfoPredef,
  dl-CommonInformationPredef DL-CommonInformationPredef OPTIONAL
}

PrimaryCCPCH-Info ::= CHOICE {
  fdd SEQUENCE {
    tx-DiversityIndicator BOOLEAN
  },
  tdd SEQUENCE {
    -- syncCase should be ignored for 1.28Mcps TDD mode
    syncCase CHOICE {
      syncCase1 SEQUENCE {
        timeslot TimeslotNumber
      },
      syncCase2 SEQUENCE {
        timeslotSync2 TimeslotSync2
      }
    }
  }
}
cellParametersID CellParametersID OPTIONAL,

```



```

        sctd-Indicator          BOOLEAN
    }
}

PrimaryCCPCH-Info-r4 ::= CHOICE {
    fdd          SEQUENCE {
        tx-DiversityIndicator  BOOLEAN
    },
    tdd          SEQUENCE {
        tddOption          CHOICE {
            tdd384          SEQUENCE {
                syncCase    CHOICE {
                    syncCase1  SEQUENCE {
                        timeslot  TimeslotNumber
                    },
                    syncCase2  SEQUENCE {
                        timeslotSync2  TimeslotSync2
                    }
                }
            }
        },
        tddl28          SEQUENCE {
            tstd-Indicator  BOOLEAN
        }
    },
    cellParametersID  CellParametersID  OPTIONAL,
    blockSTTD-Indicator  BOOLEAN
}

PrimaryCCPCH-Info-LCR-r4 ::= SEQUENCE {
    tstd-Indicator  BOOLEAN,
    cellParametersID  CellParametersID  OPTIONAL,
    blockSTTD-Indicator  BOOLEAN
}

-- For 1.28Mcps TDD, the following IE includes elements for the PCCPCH Info additional to those
-- in PrimaryCCPCH-Info
PrimaryCCPCH-Info-LCR-r4-ext ::= SEQUENCE {
    tstd-Indicator  BOOLEAN
}

PrimaryCCPCH-InfoPost ::= SEQUENCE {
    syncCase    CHOICE {
        syncCase1  SEQUENCE {
            timeslot  TimeslotNumber
        },
        syncCase2  SEQUENCE {
            timeslotSync2  TimeslotSync2
        }
    },
    cellParametersID  CellParametersID,
    sctd-Indicator  BOOLEAN
}

PrimaryCCPCH-InfoPostTDD-LCR-r4 ::= SEQUENCE {
    tstd-Indicator  BOOLEAN,
    cellParametersID  CellParametersID,
    blockSTTD-Indicator  BOOLEAN
}

PrimaryCCPCH-TX-Power ::= INTEGER (6..43)

PrimaryCPICH-Info ::= SEQUENCE {
    primaryScramblingCode  PrimaryScramblingCode
}

PrimaryCPICH-TX-Power ::= INTEGER (-10..50)

PrimaryScramblingCode ::= INTEGER (0..511)

PuncturingLimit ::= ENUMERATED {
    p10-40, p10-44, p10-48, p10-52, p10-56,
    p10-60, p10-64, p10-68, p10-72, p10-76,
    p10-80, p10-84, p10-88, p10-92, p10-96, p11 }

PUSCH-CapacityAllocationInfo ::= SEQUENCE {
    pusch-Allocation  CHOICE {
        pusch-AllocationPending  NULL,

```

```

    pusch-AllocationAssignment      SEQUENCE {
      pusch-AllocationPeriodInfo    AllocationPeriodInfo,
      pusch-PowerControlInfo        UL-TargetSIR           OPTIONAL,
      configuration                  CHOICE {
        old-Configuration            SEQUENCE {
          tfcs-ID                    TFCS-IdentityPlain    DEFAULT 1,
          pusch-Identity              PUSCH-Identity
        },
        new-Configuration            SEQUENCE {
          pusch-Info                  PUSCH-Info,
          pusch-Identity              PUSCH-Identity    OPTIONAL
        }
      }
    }
  }
}

PUSCH-CapacityAllocationInfo-r4 ::= SEQUENCE {
  pusch-Allocation                  CHOICE {
    pusch-AllocationPending          NULL,
    pusch-AllocationAssignment      SEQUENCE {
      pusch-AllocationPeriodInfo    AllocationPeriodInfo,
      pusch-PowerControlInfo-r4     PUSCH-PowerControlInfo-r4  OPTIONAL,
      configuration                  CHOICE {
        old-Configuration            SEQUENCE {
          tfcs-ID                    TFCS-IdentityPlain    DEFAULT 1,
          pusch-Identity              PUSCH-Identity
        },
        new-Configuration            SEQUENCE {
          pusch-Info-r4              PUSCH-Info-r4,
          pusch-Identity              PUSCH-Identity    OPTIONAL
        }
      }
    }
  }
}

PUSCH-Identity ::= INTEGER (1..hiPUSCHidentities)

PUSCH-Info ::= SEQUENCE {
  tfcs-ID                            TFCS-IdentityPlain    DEFAULT 1,
  commonTimeslotInfo                 CommonTimeslotInfo    OPTIONAL,
  pusch-TimeslotsCodes               UplinkTimeslotsCodes OPTIONAL
}

PUSCH-Info-r4 ::= SEQUENCE {
  tfcs-ID                            TFCS-IdentityPlain    DEFAULT 1,
  commonTimeslotInfo                 CommonTimeslotInfo    OPTIONAL,
  tddOption                           CHOICE {
    tdd384                             SEQUENCE {
      pusch-TimeslotsCodes            UplinkTimeslotsCodes  OPTIONAL
    },
    tdd128                             SEQUENCE {
      pusch-TimeslotsCodes            UplinkTimeslotsCodes-LCR-r4  OPTIONAL
    }
  }
}

PUSCH-Info-LCR-r4 ::= SEQUENCE {
  tfcs-ID                            TFCS-IdentityPlain    DEFAULT 1,
  commonTimeslotInfo                 CommonTimeslotInfo    OPTIONAL,
  pusch-TimeslotsCodes               UplinkTimeslotsCodes-LCR-r4  OPTIONAL
}

PUSCH-PowerControlInfo-r4 ::= SEQUENCE {
  -- The IE ul-TargetSIR corresponds to PRX-PUSCHdes for 1.28Mcps TDD
  -- Actual value PRX-PUSCHdes = (value of IE "ul-TargetSIR" - 120)
  ul-TargetSIR                       UL-TargetSIR,
  tddOption                           CHOICE {
    tdd384                             NULL,
    tdd128                             SEQUENCE {
      tpc-StepSize                    TPC-StepSizeTDD      OPTIONAL
    }
  }
}

PUSCH-SysInfo ::= SEQUENCE {

```

```

    pusch-Identity          PUSCH-Identity,
    pusch-Info             PUSCH-Info,
    usch-TFS               TransportFormatSet
    usch-TFCS              TFCS
}
}
OPTIONAL,
OPTIONAL

PUSCH-SysInfo-LCR-r4 ::= SEQUENCE {
    pusch-Identity          PUSCH-Identity,
    pusch-Info             PUSCH-Info-LCR-r4,
    usch-TFS               TransportFormatSet
    usch-TFCS              TFCS
}
OPTIONAL,
OPTIONAL

PUSCH-SysInfoList ::= SEQUENCE (SIZE (1..maxPUSCH)) OF
    PUSCH-SysInfo

PUSCH-SysInfoList-LCR-r4 ::= SEQUENCE (SIZE (1..maxPUSCH)) OF
    PUSCH-SysInfo-LCR-r4

PUSCH-SysInfoList-SFN ::= SEQUENCE (SIZE (1..maxPUSCH)) OF
    SEQUENCE {
        pusch-SysInfo      PUSCH-SysInfo,
        sfm-TimeInfo       SFN-TimeInfo
    }
}
OPTIONAL

PUSCH-SysInfoList-SFN-LCR-r4 ::= SEQUENCE (SIZE (1..maxPUSCH)) OF
    SEQUENCE {
        pusch-SysInfo      PUSCH-SysInfo-LCR-r4,
        sfm-TimeInfo       SFN-TimeInfo
    }
}
OPTIONAL

RACH-TransmissionParameters ::= SEQUENCE {
    mmax                    INTEGER (1..32),
    nb01Min                 NB01,
    nb01Max                 NB01
}

ReducedScramblingCodeNumber ::= INTEGER (0..8191)

RepetitionPeriodAndLength ::= CHOICE {
    repetitionPeriod1       NULL,
    -- repetitionPeriod2 could just as well be NULL also.
    repetitionPeriod2       INTEGER (1..1),
    repetitionPeriod4       INTEGER (1..3),
    repetitionPeriod8       INTEGER (1..7),
    repetitionPeriod16      INTEGER (1..15),
    repetitionPeriod32      INTEGER (1..31),
    repetitionPeriod64      INTEGER (1..63)
}

RepetitionPeriodLengthAndOffset ::= CHOICE {
    repetitionPeriod1       NULL,
    repetitionPeriod2       SEQUENCE {
        length              NULL,
        offset              INTEGER (0..1)
    },
    repetitionPeriod4       SEQUENCE {
        length              INTEGER (1..3),
        offset              INTEGER (0..3)
    },
    repetitionPeriod8       SEQUENCE {
        length              INTEGER (1..7),
        offset              INTEGER (0..7)
    },
    repetitionPeriod16      SEQUENCE {
        length              INTEGER (1..15),
        offset              INTEGER (0..15)
    },
    repetitionPeriod32      SEQUENCE {
        length              INTEGER (1..31),
        offset              INTEGER (0..31)
    },
    repetitionPeriod64      SEQUENCE {
        length              INTEGER (1..63),
        offset              INTEGER (0..63)
    }
}
}

```

```

ReplacedPDSCH-CodeInfo ::= SEQUENCE {
    tfci-Field2           MaxTFCI-Field2Value,
    spreadingFactor      SF-PDSCH,
    codeNumber           CodeNumberDSCH,
    multiCodeInfo       MultiCodeInfo
}

ReplacedPDSCH-CodeInfoList ::= SEQUENCE (SIZE (1..maxTFCI-2-Combs)) OF
    ReplacedPDSCH-CodeInfo

RepPerLengthOffset-PICH ::= CHOICE {
    rpp4-2              INTEGER (0..3),
    rpp8-2              INTEGER (0..7),
    rpp8-4              INTEGER (0..7),
    rpp16-2             INTEGER (0..15),
    rpp16-4             INTEGER (0..15),
    rpp32-2             INTEGER (0..31),
    rpp32-4             INTEGER (0..31),
    rpp64-2             INTEGER (0..63),
    rpp64-4             INTEGER (0..63)
}

RestrictedTrCH ::= SEQUENCE {
    dl-restrictedTrCh-Type DL-TrCH-Type,
    restrictedDL-TrCH-Identity TransportChannelIdentity,
    allowedTFIList        AllowedTFI-List
}

RestrictedTrCH-InfoList ::= SEQUENCE (SIZE(1..maxTrCH)) OF
    RestrictedTrCH

RL-AdditionInformation ::= SEQUENCE {
    primaryCPICH-Info     PrimaryCPICH-Info,
    dl-DPCH-InfoPerRL    DL-DPCH-InfoPerRL,
    tfci-CombiningIndicator BOOLEAN,
    sccpch-InfoForFACH   SCCPCH-InfoForFACH           OPTIONAL
}

RL-AdditionInformationList ::= SEQUENCE (SIZE (1..maxRL-1)) OF
    RL-AdditionInformation

RL-IdentifierList ::= SEQUENCE (SIZE (1..maxRL)) OF
    PrimaryCPICH-Info

RL-RemovalInformationList ::= SEQUENCE (SIZE (1..maxRL)) OF
    PrimaryCPICH-Info

RPP ::= ENUMERATED {
    mode0, mode1 }

S-Field ::= ENUMERATED {
    e1bit, e2bits }

SCCPCH-ChannelisationCode ::= ENUMERATED {
    cc16-1, cc16-2, cc16-3, cc16-4,
    cc16-5, cc16-6, cc16-7, cc16-8,
    cc16-9, cc16-10, cc16-11, cc16-12,
    cc16-13, cc16-14, cc16-15, cc16-16 }

SCCPCH-ChannelisationCodeList ::= SEQUENCE (SIZE (1..16)) OF
    SCCPCH-ChannelisationCode

SCCPCH-InfoForFACH ::= SEQUENCE {
    secondaryCCPCH-Info  SecondaryCCPCH-Info,
    tfcs                 TFCS,
    modeSpecificInfo     CHOICE {
        fdd              SEQUENCE {
            fach-PCH-InformationList FACH-PCH-InformationList,
            sib-ReferenceListFACH     SIB-ReferenceListFACH
        },
        tdd              SEQUENCE {
            fach-PCH-InformationList FACH-PCH-InformationList
        }
    }
}

SCCPCH-InfoForFACH-r4 ::= SEQUENCE {
    secondaryCCPCH-Info  SecondaryCCPCH-Info-r4,
}

```

```

    tfcs                TFCS,
    fach-PCH-InformationList  FACH-PCH-InformationList,
    modeSpecificInfo    CHOICE {
        fdd              SEQUENCE {
            sib-ReferenceListFACH  SIB-ReferenceListFACH
        },
        tdd              NULL
    }
}

SCCPCH-SystemInformation ::= SEQUENCE {
    secondaryCCPCH-Info    SecondaryCCPCH-Info,
    tfcs                  TFCS                                OPTIONAL,
    fach-PCH-InformationList  FACH-PCH-InformationList        OPTIONAL,
    pich-Info             PICH-Info                            OPTIONAL
}

SCCPCH-SystemInformation-LCR-r4-ext ::= SEQUENCE {
    secondaryCCPCH-LCR-Extensions  SecondaryCCPCH-Info-LCR-r4-ext,
    -- pich-Info in the SCCPCH-SystemInformation IE shall be absent,
    -- and instead the following used.
    pich-Info                PICH-Info-LCR-r4                OPTIONAL
}

SCCPCH-SystemInformationList ::= SEQUENCE (SIZE (1..maxSCCPCH)) OF
    SCCPCH-SystemInformation

-- SCCPCH-SystemInformationList-LCR-r4-ext includes elements additional to those in
-- SCCPCH-SystemInformationList for the 1.28Mcps TDD. The order of the IEs
-- indicates which SCCPCH-SystemInformation-LCR-r4-ext IE extends which
-- SCCPCH-SystemInformation IE.
SCCPCH-SystemInformationList-LCR-r4-ext ::= SEQUENCE (SIZE (1..maxSCCPCH)) OF
    SCCPCH-SystemInformation-LCR-r4-ext

ScramblingCodeChange ::= ENUMERATED {
    codeChange, noCodeChange }

ScramblingCodeType ::= ENUMERATED {
    shortSC,
    longSC }

SecondaryCCPCH-Info ::= SEQUENCE {
    modeSpecificInfo    CHOICE {
        fdd              SEQUENCE {
            -- dummy1 is not used in this version of the specification and should be ignored.
            dummy1        PCPICH-UsageForChannelEst,
            -- dummy2 is not used in this version of the specification. It should not
            -- be sent and if received it should be ignored.
            dummy2        SecondaryCPICH-Info                OPTIONAL,
            secondaryScramblingCode  SecondaryScramblingCode    OPTIONAL,
            sttd-Indicator  BOOLEAN,
            sf-AndCodeNumber  SF256-AndCodeNumber,
            pilotSymbolExistence  BOOLEAN,
            tfci-Existence    BOOLEAN,
            positionFixedOrFlexible  PositionFixedOrFlexible,
            timingOffset      TimingOffset                    DEFAULT 0
        },
        tdd              SEQUENCE {
            -- TABULAR: the offset is included in CommonTimeslotInfoSCCPCH
            commonTimeslotInfo  CommonTimeslotInfoSCCPCH,
            individualTimeslotInfo  IndividualTimeslotInfo,
            channelisationCode  SCCPCH-ChannelisationCodeList
        }
    }
}

SecondaryCCPCH-Info-r4 ::= SEQUENCE {
    modeSpecificInfo    CHOICE {
        fdd              SEQUENCE {
            secondaryScramblingCode  SecondaryScramblingCode    OPTIONAL,
            sttd-Indicator  BOOLEAN,
            sf-AndCodeNumber  SF256-AndCodeNumber,
            pilotSymbolExistence  BOOLEAN,
            tfci-Existence    BOOLEAN,
            positionFixedOrFlexible  PositionFixedOrFlexible,
            timingOffset      TimingOffset                    DEFAULT 0
        },
        tdd              SEQUENCE {

```

```

-- TABULAR: the offset is included in CommonTimeslotInfoSCCPCH
commonTimeslotInfo          CommonTimeslotInfoSCCPCH,
tddOption                   CHOICE {
  tdd384                     SEQUENCE {
    individualTimeslotInfo   IndividualTimeslotInfo
  },
  tdd128                     SEQUENCE {
    individualTimeslotInfo   IndividualTimeslotInfo-LCR-r4
  }
},
channelisationCode          SCCPCH-ChannelisationCodeList
}
}

SecondaryCCPCH-Info-LCR-r4-ext ::= SEQUENCE {
  individualTimeslotLCR-Ext   IndividualTimeslotInfo-LCR-r4-ext
}

SecondaryCPICH-Info ::= SEQUENCE {
  secondaryDL-ScramblingCode SecondaryScramblingCode           OPTIONAL,
  channelisationCode         ChannelisationCode256
}

SecondaryScramblingCode ::= INTEGER (1..15)

SecondInterleavingMode ::= ENUMERATED {
  frameRelated, timeslotRelated }

-- SF256-AndCodeNumber encodes both "Spreading factor" and "Code Number"
SF256-AndCodeNumber ::= CHOICE {
  sf4      INTEGER (0..3),
  sf8      INTEGER (0..7),
  sf16     INTEGER (0..15),
  sf32     INTEGER (0..31),
  sf64     INTEGER (0..63),
  sf128    INTEGER (0..127),
  sf256    INTEGER (0..255)
}

-- SF512-AndCodeNumber encodes both "Spreading factor" and "Code Number"
SF512-AndCodeNumber ::= CHOICE {
  sf4      INTEGER (0..3),
  sf8      INTEGER (0..7),
  sf16     INTEGER (0..15),
  sf32     INTEGER (0..31),
  sf64     INTEGER (0..63),
  sf128    INTEGER (0..127),
  sf256    INTEGER (0..255),
  sf512    INTEGER (0..511)
}

-- SF512-AndPilot encodes both "Spreading factor" and "Number of bits for Pilot bits"
SF512-AndPilot ::= CHOICE {
  sfd4     NULL,
  sfd8     NULL,
  sfd16    NULL,
  sfd32    NULL,
  sfd64    NULL,
  sfd128   PilotBits128,
  sfd256   PilotBits256,
  sfd512   NULL
}

SF-PDSCH ::= ENUMERATED {
  sfp4, sfp8, sfp16, sfp32,
  sfp64, sfp128, sfp256 }

SF-PRACH ::= ENUMERATED {
  sfpr32, sfpr64, sfpr128, sfpr256 }

SFN-TimeInfo ::= SEQUENCE {
  activationTimeSFN      INTEGER (0..4095),
  physChDuration         DurationTimeInfo
}

SpecialBurstScheduling ::= INTEGER (0..7)

SpreadingFactor ::= ENUMERATED {

```

```

        sf4, sf8, sf16, sf32,
        sf64, sf128, sf256 }

SRB-delay ::= INTEGER (0..7)

SSDT-CellIdentity ::= ENUMERATED {
    ssdt-id-a, ssdt-id-b, ssdt-id-c,
    ssdt-id-d, ssdt-id-e, ssdt-id-f,
    ssdt-id-g, ssdt-id-h }

SSDT-Information ::= SEQUENCE {
    s-Field S-Field,
    codeWordSet CodeWordSet
}

SSDT-Information-r4 ::= SEQUENCE {
    s-Field S-Field,
    codeWordSet CodeWordSet,
    ssdt-UL SSDT-UL-r4 OPTIONAL
}

-- SSDT-UL-r4 is used to extend the
-- SSDT-Information IE from Release 4 onwards.
SSDT-UL-r4 ::= ENUMERATED {
    ul, ul-AndDL }

SynchronisationParameters-r4 ::= SEQUENCE {
    sync-UL-CodesBitmap BIT STRING {
        code7(0),
        code6(1),
        code5(2),
        code4(3),
        code3(4),
        code2(5),
        code1(6),
        code0(7)
    } (SIZE (8)),
    fpach-Info FPACH-Info-r4,
    -- Actual value prxUpPCHdes = IE value - 120
    prxUpPCHdes INTEGER (0..62),
    sync-UL-Procedure SYNC-UL-Procedure-r4 OPTIONAL
}

SYNC-UL-Procedure-r4 ::= SEQUENCE {
    max-SYNC-UL-Transmissions ENUMERATED { tr1, tr2, tr4, tr8 },
    powerRampStep INTEGER (0..3)
}

SYNC-UL-Info-r4 ::= SEQUENCE {
    sync-UL-Codes-Bitmap BIT STRING {
        code7(0),
        code6(1),
        code5(2),
        code4(3),
        code3(4),
        code2(5),
        code1(6),
        code0(7)
    } (SIZE (8)),
    -- Actual value prxUpPCHdes = IE value - 120
    prxUpPCHdes INTEGER (0..62),
    powerRampStep INTEGER (0..3),
    max-SYNC-UL-Transmissions ENUMERATED { tr1, tr2, tr4, tr8 } ,
    mmax INTEGER(1..32)
}

TDD-FPACH-CCode16-r4 ::= ENUMERATED {
    cc16-1, cc16-2, cc16-3, cc16-4,
    cc16-5, cc16-6, cc16-7, cc16-8,
    cc16-9, cc16-10, cc16-11, cc16-12,
    cc16-13, cc16-14, cc16-15, cc16-16 }

TDD-UL-Interference ::= INTEGER (-110..-52)

TDD-PICH-CCode ::= ENUMERATED {
    cc16-1, cc16-2, cc16-3, cc16-4,
    cc16-5, cc16-6, cc16-7, cc16-8,
    cc16-9, cc16-10, cc16-11, cc16-12,

```

```

        cc16-13, cc16-14, cc16-15, cc16-16 }

TDD-PRACH-CCode8 ::=          ENUMERATED {
                                cc8-1, cc8-2, cc8-3, cc8-4,
                                cc8-5, cc8-6, cc8-7, cc8-8 }

TDD-PRACH-CCode16 ::=         ENUMERATED {
                                cc16-1, cc16-2, cc16-3, cc16-4,
                                cc16-5, cc16-6, cc16-7, cc16-8,
                                cc16-9, cc16-10, cc16-11, cc16-12,
                                cc16-13, cc16-14, cc16-15, cc16-16 }

TDD-PRACH-CCode-LCR-r4 ::=    ENUMERATED {
                                cc4-1, cc4-2, cc4-3, cc4-4,
                                cc8-1, cc8-2, cc8-3, cc8-4,
                                cc8-5, cc8-6, cc8-7, cc8-8,
                                cc16-1, cc16-2, cc16-3, cc16-4,
                                cc16-5, cc16-6, cc16-7, cc16-8,
                                cc16-9, cc16-10, cc16-11, cc16-12,
                                cc16-13, cc16-14, cc16-15, cc16-16 }

TDD-PRACH-CCodeList ::=      CHOICE {
                                sf8
                                SEQUENCE (SIZE (1..8)) OF
                                    TDD-PRACH-CCode8,
                                sf16
                                SEQUENCE (SIZE (1..8)) OF
                                    TDD-PRACH-CCode16
                                }

TFC-ControlDuration ::=       ENUMERATED {
                                tfc-cd1, tfc-cd2, tfc-cd4, tfc-cd8,
                                tfc-cd16, tfc-cd24, tfc-cd32,
                                tfc-cd48, tfc-cd64, tfc-cd128,
                                tfc-cd192, tfc-cd256, tfc-cd512 }

TFCI-Coding ::=               ENUMERATED {
                                tfci-bits-4, tfci-bits-8,
                                tfci-bits-16, tfci-bits-32 }

TGCFN ::=                     INTEGER (0..255)

-- In TGD, value 270 represents "undefined" in the tabular description.
TGD ::=                       INTEGER (15..270)

TGL ::=                       INTEGER (1..14)

TGMP ::=                      ENUMERATED {
                                tdd-Measurement, fdd-Measurement,
                                gsm-CarrierRSSIMeasurement,
                                gsm-initialBSICIdentification, gsmBSICReconfirmation,
                                multi-carrier }

TGP-Sequence ::=              SEQUENCE {
                                tgpsi
                                TGPSI,
                                tgps-Status
                                CHOICE {
                                    activate
                                    SEQUENCE {
                                        tgcfn
                                        TGCFN
                                    },
                                    deactivate
                                    NULL
                                },
                                tgps-ConfigurationParams
                                TGPS-ConfigurationParams
                                OPTIONAL
                                }

TGPS-Reconfiguration-CFN ::=  INTEGER (0..255)

TGP-SequenceList ::=          SEQUENCE (SIZE (1..maxTGPS)) OF
                                TGP-Sequence

TGP-SequenceShort ::=         SEQUENCE {
                                tgpsi
                                TGPSI,
                                tgps-Status
                                CHOICE {
                                    activate
                                    SEQUENCE {
                                        tgcfn
                                        TGCFN
                                    },
                                    deactivate
                                    NULL
                                }
                                }

TGPL ::=                      INTEGER (1..144)

```



```

-- TABULAR: In TGPRC, value 0 represents "infinity" in the tabular description.
TGPRC ::= INTEGER (0..511)

TGPS-ConfigurationParams ::= SEQUENCE {
    tgmp          TGMP,
    tgprc        TGPRC,
    tgsn         TGSN,
    tgl1         TGL,
    tgl2         TGL OPTIONAL,
    tgd          TGD,
    tgpl1        TGPL,
    tgpl2        TGPL OPTIONAL,
    rpp          RPP,
    itp          ITP,
    -- TABULAR: Compressed mode method is nested inside UL-DL-Mode
    ul-DL-Mode   UL-DL-Mode,
    dl-FrameType DL-FrameType,
    deltaSIR1    DeltaSIR,
    deltaSIRAfter1 DeltaSIR,
    deltaSIR2    DeltaSIR OPTIONAL,
    deltaSIRAfter2 DeltaSIR OPTIONAL,
    nidentifyAbort NidentifyAbort OPTIONAL,
    treconfirmAbort TreconfirmAbort OPTIONAL
}

TGPSI ::= INTEGER (1..maxTGPS)

TGSN ::= INTEGER (0..14)

TimeInfo ::= SEQUENCE {
    activationTime ActivationTime OPTIONAL,
    durationTimeInfo DurationTimeInfo OPTIONAL
}

TimeslotList ::= SEQUENCE (SIZE (1..maxTS)) OF TimeslotNumber

TimeslotList-r4 ::= CHOICE {
    tdd384 SEQUENCE (SIZE (1..maxTS)) OF TimeslotNumber,
    tdd128 SEQUENCE (SIZE (1..maxTS-LCR)) OF TimeslotNumber-LCR-r4
}

-- If TimeslotNumber is included for a 1.28Mcps TDD description, it shall take values from 0..6
TimeslotNumber ::= INTEGER (0..14)

TimeslotNumber-LCR-r4 ::= INTEGER (0..6)

TimeslotNumber-PRACH-LCR-r4 ::= INTEGER (1..6)

TimeslotSync2 ::= INTEGER (0..6)

-- Actual value TimingOffset = IE value * 256
TimingOffset ::= INTEGER (0..149)

TPC-CombinationIndex ::= INTEGER (0..5)

-- Actual value TPC-StepSizeFDD = IE value + 1
TPC-StepSizeFDD ::= INTEGER (0..1)

TPC-StepSizeTDD ::= INTEGER (1..3)

-- Actual value TreconfirmAbort = IE value * 0.5 seconds
TreconfirmAbort ::= INTEGER (1..20)

TX-DiversityMode ::= ENUMERATED {
    noDiversity,
    sttd,
    closedLoopMode1,
    closedLoopMode2 }

UARFCN ::= INTEGER (0..16383)

UCSM-Info ::= SEQUENCE {
    minimumSpreadingFactor MinimumSpreadingFactor,
    nf-Max NF-Max,

```

```

    channelReqParamsForUCSM          ChannelReqParamsForUCSM
}

UL-CCTrCH ::=
    tfcs-ID                          TFCS-IdentityPlain          DEFAULT 1,
    ul-TargetSIR                     UL-TargetSIR,
    timeInfo                          TimeInfo,
    commonTimeslotInfo               CommonTimeslotInfo          OPTIONAL,
    ul-CCTrCH-TimeslotsCodes         UplinkTimeslotsCodes       OPTIONAL
}

UL-CCTrCH-r4 ::=
    tfcs-ID                          TFCS-IdentityPlain          DEFAULT 1,
    ul-TargetSIR                     UL-TargetSIR,
    timeInfo                          TimeInfo,
    commonTimeslotInfo               CommonTimeslotInfo          OPTIONAL,
    tddOption                         CHOICE {
        tdd384                        SEQUENCE {
            ul-CCTrCH-TimeslotsCodes  UplinkTimeslotsCodes       OPTIONAL
        },
        tdd128                        SEQUENCE {
            ul-CCTrCH-TimeslotsCodes  UplinkTimeslotsCodes-LCR-r4 OPTIONAL
        }
    }
}

UL-CCTrCHList ::=
    SEQUENCE (SIZE (1..maxCCTrCH)) OF
        UL-CCTrCH

UL-CCTrCHList-r4 ::=
    SEQUENCE (SIZE (1..maxCCTrCH)) OF
        UL-CCTrCH-r4

UL-CCTrCHListToRemove ::=
    SEQUENCE (SIZE (1..maxCCTrCH)) OF
        TFCS-IdentityPlain

UL-CCTrChTPCList ::=
    SEQUENCE (SIZE (0..maxCCTrCH)) OF
        TFCS-Identity

UL-ChannelRequirement ::=
    CHOICE {
        ul-DPCH-Info                 UL-DPCH-Info,
        cpch-SetInfo                 CPCH-SetInfo
    }

UL-ChannelRequirement-r4 ::=
    CHOICE {
        ul-DPCH-Info                 UL-DPCH-Info-r4,
        cpch-SetInfo                 CPCH-SetInfo
    }

UL-ChannelRequirementWithCPCH-SetID ::= CHOICE {
    ul-DPCH-Info                     UL-DPCH-Info,
    cpch-SetInfo                     CPCH-SetInfo,
    cpch-SetID                       CPCH-SetID
}

UL-ChannelRequirementWithCPCH-SetID-r4 ::= CHOICE {
    ul-DPCH-Info                     UL-DPCH-Info-r4,
    cpch-SetInfo                     CPCH-SetInfo,
    cpch-SetID                       CPCH-SetID
}

UL-CompressedModeMethod ::=
    ENUMERATED {
        sf-2,
        higherLayerScheduling }

UL-DL-Mode ::=
    CHOICE {
        ul                            UL-CompressedModeMethod,
        dl                            DL-CompressedModeMethod,
        ul-and-dl                      SEQUENCE {
            ul                          UL-CompressedModeMethod,
            dl                          DL-CompressedModeMethod
        }
    }

UL-DPCCH-SlotFormat ::=
    ENUMERATED {
        slf0, slf1, slf2 }

UL-DPCH-Info ::=
    SEQUENCE {
        ul-DPCH-PowerControlInfo      UL-DPCH-PowerControlInfo    OPTIONAL,
        modeSpecificInfo               CHOICE {

```

```

    fdd
        scramblingCodeType          SEQUENCE {
            scramblingCodeType,
            scramblingCode           UL-ScramblingCode,
            numberOfDPDCH            NumberOfDPDCH           DEFAULT 1,
            spreadingFactor         SpreadingFactor,
            tfci-Existence          BOOLEAN,
            -- numberOfFBI-Bits is conditional based on history
            numberOfFBI-Bits        NumberOfFBI-Bits           OPTIONAL,
            puncturingLimit         PuncturingLimit
        },
    tdd
        SEQUENCE {
            ul-TimingAdvance        UL-TimingAdvanceControl   OPTIONAL,
            ul-CCTrCHList           UL-CCTrCHList             OPTIONAL,
            ul-CCTrCHListToRemove   UL-CCTrCHListToRemove     OPTIONAL
        }
    }
}

UL-DPCH-Info-r4 ::=
    ul-DPCH-PowerControlInfo      SEQUENCE {
        modeSpecificInfo          CHOICE {
            fdd
                SEQUENCE {
                    scramblingCodeType      ScramblingCodeType,
                    scramblingCode           UL-ScramblingCode,
                    numberOfDPDCH            NumberOfDPDCH           DEFAULT 1,
                    spreadingFactor         SpreadingFactor,
                    tfci-Existence          BOOLEAN,
                    -- numberOfFBI-Bits is conditional based on history
                    numberOfFBI-Bits        NumberOfFBI-Bits           OPTIONAL,
                    puncturingLimit         PuncturingLimit
                },
            tdd
                SEQUENCE {
                    ul-TimingAdvance        UL-TimingAdvanceControl-r4  OPTIONAL,
                    ul-CCTrCHList           UL-CCTrCHList-r4           OPTIONAL,
                    ul-CCTrCHListToRemove   UL-CCTrCHListToRemove     OPTIONAL
                }
        }
    }
}

UL-DPCH-InfoPostFDD ::=
    ul-DPCH-PowerControlInfo      SEQUENCE {
        scramblingCodeType          UL-DPCH-PowerControlInfoPostFDD,
        reducedScramblingCodeNumber ScramblingCodeType,
        spreadingFactor             ReducedScramblingCodeNumber,
        spreadingFactor             SpreadingFactor
    }
}

UL-DPCH-InfoPostTDD ::=
    ul-DPCH-PowerControlInfo      SEQUENCE {
        ul-DPCH-PowerControlInfoPostTDD,
        ul-TimingAdvance           UL-TimingAdvanceControl           OPTIONAL,
        ul-CCTrCH-TimeslotsCodes   UplinkTimeslotsCodes
    }
}

UL-DPCH-InfoPostTDD-LCR-r4 ::=
    ul-DPCH-PowerControlInfo      SEQUENCE {
        ul-DPCH-PowerControlInfoPostTDD-LCR-r4,
        ul-TimingAdvance           UL-TimingAdvanceControl-LCR-r4   OPTIONAL,
        ul-CCTrCH-TimeslotsCodes   UplinkTimeslotsCodes-LCR-r4
    }
}

UL-DPCH-InfoPredef ::=
    ul-DPCH-PowerControlInfo      SEQUENCE {
        modeSpecificInfo          CHOICE {
            fdd
                SEQUENCE {
                    tfci-Existence          BOOLEAN,
                    puncturingLimit         PuncturingLimit
                },
            tdd
                SEQUENCE {
                    commonTimeslotInfo      CommonTimeslotInfo
                }
        }
    }
}

UL-DPCH-PowerControlInfo ::=
    fdd
        CHOICE {
            SEQUENCE {
                dpccch-PowerOffset         DPCCCH-PowerOffset,
                pc-Preamble                 PC-Preamble,
                sRB-delay                   SRB-delay,
                -- TABULAR: TPC step size nested inside PowerControlAlgorithm
            }
        }
    }
}

```

```

        powerControlAlgorithm          PowerControlAlgorithm
    },
    tdd                                SEQUENCE {
        ul-TargetSIR                    UL-TargetSIR                    OPTIONAL,
        ul-OL-PC-Signalling              CHOICE {
            broadcast-UL-OL-PC-info      NULL,
            individuallySignalled        SEQUENCE {
                individualTS-InterferenceList  IndividualTS-InterferenceList,
                dpch-ConstantValue            ConstantValueTdd,
                primaryCCPCH-TX-Power         PrimaryCCPCH-TX-Power
            }
        }
    }
}
OPTIONAL

UL-DPCH-PowerControlInfo-r4 ::= CHOICE {
    fdd                                SEQUENCE {
        dpcch-PowerOffset                DPCCH-PowerOffset,
        pc-Preamble                       PC-Preamble,
        sRB-delay                         SRB-delay,
        -- TABULAR: TPC step size nested inside PowerControlAlgorithm
        powerControlAlgorithm            PowerControlAlgorithm
    },
    tdd                                SEQUENCE {
        -- The IE ul-TargetSIR corresponds to PRX-PDPCHdes for 1.28Mcps TDD
        -- Actual value PRX-PDPCHdes = (value of IE "ul-TargetSIR" - 120)
        ul-TargetSIR                      UL-TargetSIR                    OPTIONAL,
        ul-OL-PC-Signalling                CHOICE {
            broadcast-UL-OL-PC-info        NULL,
            individuallySignalled          SEQUENCE {
                tddOption                  CHOICE {
                    tdd384                  SEQUENCE {
                        individualTS-InterferenceList  IndividualTS-InterferenceList,
                        dpch-ConstantValue            ConstantValue
                    },
                    tdd128                  SEQUENCE {
                        tpc-StepSize          TPC-StepSizeTDD
                    }
                }
            },
            primaryCCPCH-TX-Power          PrimaryCCPCH-TX-Power
        }
    }
}

UL-DPCH-PowerControlInfoPostFDD ::= SEQUENCE {
    -- DPCCH-PowerOffset2 has a smaller range to save bits
    dpcch-PowerOffset2                DPCCH-PowerOffset2,
    pc-Preamble                        PC-Preamble,
    sRB-delay                          SRB-delay
}

UL-DPCH-PowerControlInfoPostTDD ::= SEQUENCE {
    ul-TargetSIR                      UL-TargetSIR,
    ul-TimeslotInterference            TDD-UL-Interference
}

UL-DPCH-PowerControlInfoPostTDD-LCR-r4 ::= SEQUENCE {
    ul-TargetSIR                      UL-TargetSIR
}

UL-DPCH-PowerControlInfoPredef ::= CHOICE {
    fdd                                SEQUENCE {
        -- TABULAR: TPC step size nested inside PowerControlAlgorithm
        powerControlAlgorithm            PowerControlAlgorithm
    },
    tdd                                SEQUENCE {
        -- dpch-ConstantValue shall be ignored if in 1.28Mcps TDD mode.
        dpch-ConstantValue              ConstantValueTdd
    }
}

UL-Interference ::= INTEGER (-110..-70)

UL-ScramblingCode ::= INTEGER (0..16777215)

UL-SynchronisationParameters-r4 ::= SEQUENCE {

```

```

    stepSize                INTEGER (1..8),
    frequency                INTEGER (1..8)
}

-- Actual value UL-TargetSIR = (IE value * 0.5) - 11
UL-TargetSIR ::=          INTEGER (0..62)

UL-TimingAdvance ::=      INTEGER (0..63)

UL-TimingAdvanceControl ::= CHOICE {
    disabled                NULL,
    enabled                 SEQUENCE {
        ul-TimingAdvance    UL-TimingAdvance          OPTIONAL,
        activationTime       ActivationTime             OPTIONAL
    }
}

UL-TimingAdvanceControl-r4 ::= CHOICE {
    disabled                NULL,
    enabled                 SEQUENCE {
        tddOption           CHOICE {
            tdd384          SEQUENCE {
                ul-TimingAdvance    UL-TimingAdvance          OPTIONAL,
                activationTime       ActivationTime             OPTIONAL
            },
            tdd128          SEQUENCE {
                ul-SynchronisationParameters    UL-SynchronisationParameters-r4 OPTIONAL,
                synchronisationParameters       SynchronisationParameters-r4  OPTIONAL
            }
        }
    }
}

UL-TimingAdvanceControl-LCR-r4 ::= CHOICE {
    disabled                NULL,
    enabled                 SEQUENCE {
        ul-SynchronisationParameters    UL-SynchronisationParameters-r4 OPTIONAL,
        synchronisationParameters       SynchronisationParameters-r4  OPTIONAL
    }
}

UL-TS-ChannelisationCode ::= ENUMERATED {
    cc1-1, cc2-1, cc2-2,
    cc4-1, cc4-2, cc4-3, cc4-4,
    cc8-1, cc8-2, cc8-3, cc8-4,
    cc8-5, cc8-6, cc8-7, cc8-8,
    cc16-1, cc16-2, cc16-3, cc16-4,
    cc16-5, cc16-6, cc16-7, cc16-8,
    cc16-9, cc16-10, cc16-11, cc16-12,
    cc16-13, cc16-14, cc16-15, cc16-16 }

UL-TS-ChannelisationCodeList ::= SEQUENCE (SIZE (1..2)) OF
    UL-TS-ChannelisationCode

UplinkAdditionalTimeslots ::= SEQUENCE {
    parameters              CHOICE {
        sameAsLast         SEQUENCE {
            timeslotNumber TimeslotNumber
        },
        newParameters      SEQUENCE {
            individualTimeslotInfo IndividualTimeslotInfo,
            ul-TS-ChannelisationCodeList UL-TS-ChannelisationCodeList
        }
    }
}

UplinkAdditionalTimeslots-LCR-r4 ::= SEQUENCE {
    parameters              CHOICE {
        sameAsLast         SEQUENCE {
            timeslotNumber TimeslotNumber
        },
        newParameters      SEQUENCE {
            individualTimeslotInfo IndividualTimeslotInfo-LCR-r4,
            ul-TS-ChannelisationCodeList UL-TS-ChannelisationCodeList
        }
    }
}

```

```

UplinkTimeslotsCodes ::=          SEQUENCE {
    dynamicSFusage                  BOOLEAN,
    firstIndividualTimeslotInfo     IndividualTimeslotInfo,
    ul-TS-ChannelisationCodeList    UL-TS-ChannelisationCodeList,
    moreTimeslots                   CHOICE {
        noMore                      NULL,
        additionalTimeslots          CHOICE {
            consecutive              SEQUENCE {
                numAdditionalTimeslots INTEGER (1..maxTS-1)
            },
            timeslotList             SEQUENCE (SIZE (1..maxTS-1)) OF
                UplinkAdditionalTimeslots
        }
    }
}

UplinkTimeslotsCodes-LCR-r4 ::=   SEQUENCE {
    dynamicSFusage                  BOOLEAN,
    firstIndividualTimeslotInfo     IndividualTimeslotInfo-LCR-r4,
    ul-TS-ChannelisationCodeList    UL-TS-ChannelisationCodeList,
    moreTimeslots                   CHOICE {
        noMore                      NULL,
        additionalTimeslots          CHOICE {
            consecutive              SEQUENCE {
                numAdditionalTimeslots INTEGER (1..maxTS-LCR-1)
            },
            timeslotList             SEQUENCE (SIZE (1..maxTS-LCR-1)) OF
                UplinkAdditionalTimeslots-LCR-r4
        }
    }
}

Wi-LCR ::=                          INTEGER(1..4)

-- *****
--
--     MEASUREMENT INFORMATION ELEMENTS (10.3.7)
--
-- *****

AcquisitionSatInfo ::=             SEQUENCE {
    satID                           SatID,
    -- Actual value dopplerOthOrder = IE value * 2.5
    dopplerOthOrder                 INTEGER (-2048..2047),
    extraDopplerInfo                ExtraDopplerInfo                OPTIONAL,
    codePhase                       INTEGER (0..1022),
    integerCodePhase                INTEGER (0..19),
    gps-BitNumber                   INTEGER (0..3),
    codePhaseSearchWindow           CodePhaseSearchWindow,
    azimuthAndElevation             AzimuthAndElevation                OPTIONAL
}

AcquisitionSatInfoList ::=         SEQUENCE (SIZE (1..maxSat)) OF
    AcquisitionSatInfo

AdditionalMeasurementID-List ::=   SEQUENCE (SIZE (1..maxAdditionalMeas)) OF
    MeasurementIdentity

AlmanacSatInfo ::=                SEQUENCE {
    dataID                          INTEGER (0..3),
    satID                            SatID,
    e                                BIT STRING (SIZE (16)),
    t-oa                             BIT STRING (SIZE (8)),
    deltaI                           BIT STRING (SIZE (16)),
    omegaDot                         BIT STRING (SIZE (16)),
    satHealth                        BIT STRING (SIZE (8)),
    a-Sqrt                           BIT STRING (SIZE (24)),
    omega0                           BIT STRING (SIZE (24)),
    m0                              BIT STRING (SIZE (24)),
    omega                             BIT STRING (SIZE (24)),
    af0                              BIT STRING (SIZE (11)),
    af1                              BIT STRING (SIZE (11))
}

AlmanacSatInfoList ::=            SEQUENCE (SIZE (1..maxSat)) OF
    AlmanacSatInfo

```

```

AverageRLC-BufferPayload ::=          ENUMERATED {
                                        pla0, pla4, pla8, pla16, pla32,
                                        pla64, pla128, pla256, pla512,
                                        pla1024, pla2k, pla4k, pla8k, pla16k,
                                        pla32k, pla64k, pla128k, pla256k,
                                        pla512k, pla1024k, spare12, spare11,
                                        spare10, spare9, spare8, spare7, spare6,
                                        spare5, spare4, spare3, spare2, spare1 }

AzimuthAndElevation ::=              SEQUENCE {
    -- Actual value azimuth = IE value * 11.25
    azimuth                          INTEGER (0..31),
    -- Actual value elevation = IE value * 11.25
    elevation                          INTEGER (0..7)
}

BadSatList ::=                       SEQUENCE (SIZE (1..maxSat)) OF
                                        INTEGER (0..63)

Frequency-Band ::=                   ENUMERATED {
                                        dcs1800BandUsed, pcs1900BandUsed }

BCCH-ARFCN ::=                       INTEGER (0..1023)

BLER-MeasurementResults ::=          SEQUENCE {
    transportChannelIdentity          TransportChannelIdentity,
    dl-TransportChannelBLER           DL-TransportChannelBLER           OPTIONAL
}

BLER-MeasurementResultsList ::=      SEQUENCE (SIZE (1..maxTrCH)) OF
                                        BLER-MeasurementResults

BLER-TransChIdList ::=              SEQUENCE (SIZE (1..maxTrCH)) OF
                                        TransportChannelIdentity

BSIC-VerificationRequired ::=        ENUMERATED {
                                        required, notRequired }

BSICReported ::=                    CHOICE {
    -- Value maxCellMeas is not allowed for verifiedBSIC
    verifiedBSIC                      INTEGER (0..maxCellMeas),
    nonVerifiedBSIC                   BCCH-ARFCN
}

BurstModeParameters ::=             SEQUENCE {
    burstStart                         INTEGER (0..15),
    burstLength                       INTEGER (10..25),
    burstFreq                         INTEGER (1..16)
}

CellDCH-ReportCriteria ::=           CHOICE {
    intraFreqReportingCriteria        IntraFreqReportingCriteria,
    periodicalReportingCriteria        PeriodicalReportingCriteria
}

CellDCH-ReportCriteria-LCR-r4 ::=    CHOICE {
    intraFreqReportingCriteria        IntraFreqReportingCriteria-LCR-r4,
    periodicalReportingCriteria        PeriodicalReportingCriteria
}

-- Actual value CellIndividualOffset = IE value * 0.5
CellIndividualOffset ::=             INTEGER (-20..20)

CellInfo ::=                         SEQUENCE {
    cellIndividualOffset               CellIndividualOffset           DEFAULT 0,
    referenceTimeDifferenceToCell      ReferenceTimeDifferenceToCell   OPTIONAL,
    modeSpecificInfo                   CHOICE {
        fdd                            SEQUENCE {
            primaryCPICH-Info          PrimaryCPICH-Info           OPTIONAL,
            primaryCPICH-TX-Power      PrimaryCPICH-TX-Power       OPTIONAL,
            readSFN-Indicator           BOOLEAN,
            tx-DiversityIndicator       BOOLEAN
        },
        tdd                            SEQUENCE {
            primaryCCPCH-Info          PrimaryCCPCH-Info,
            primaryCCPCH-TX-Power      PrimaryCCPCH-TX-Power       OPTIONAL,
            timeslotInfoList           TimeslotInfoList           OPTIONAL,
        }
    }
}

```

```

        readSFN-Indicator          BOOLEAN
    }
}

CellInfo-r4 ::=
    cellIndividualOffset          CellIndividualOffset          DEFAULT 0,
    referenceTimeDifferenceToCell ReferenceTimeDifferenceToCell OPTIONAL,
    modeSpecificInfo             CHOICE {
        fdd                       SEQUENCE {
            primaryCPICH-Info      PrimaryCPICH-Info          OPTIONAL,
            primaryCPICH-TX-Power  PrimaryCPICH-TX-Power     OPTIONAL,
            readSFN-Indicator      BOOLEAN,
            tx-DiversityIndicator  BOOLEAN
        },
        tdd                       SEQUENCE {
            primaryCCPCH-Info      PrimaryCCPCH-Info-r4,
            primaryCCPCH-TX-Power  PrimaryCCPCH-TX-Power     OPTIONAL,
            timeslotInfoList-r4    TimeslotInfoList-r4      OPTIONAL,
            readSFN-Indicator      BOOLEAN
        }
    }
}

CellInfoSI-RSCP ::=
    cellIndividualOffset          CellIndividualOffset          DEFAULT 0,
    referenceTimeDifferenceToCell ReferenceTimeDifferenceToCell OPTIONAL,
    modeSpecificInfo             CHOICE {
        fdd                       SEQUENCE {
            primaryCPICH-Info      PrimaryCPICH-Info          OPTIONAL,
            primaryCPICH-TX-Power  PrimaryCPICH-TX-Power     OPTIONAL,
            readSFN-Indicator      BOOLEAN,
            tx-DiversityIndicator  BOOLEAN
        },
        tdd                       SEQUENCE {
            primaryCCPCH-Info      PrimaryCCPCH-Info,
            primaryCCPCH-TX-Power  PrimaryCCPCH-TX-Power     OPTIONAL,
            timeslotInfoList       TimeslotInfoList          OPTIONAL,
            readSFN-Indicator      BOOLEAN
        }
    },
    cellSelectionReselectionInfo CellSelectReselectInfoSIB-11-12-RSCP OPTIONAL
}

CellInfoSI-RSCP-LCR-r4 ::=
    cellIndividualOffset          CellIndividualOffset          DEFAULT 0,
    referenceTimeDifferenceToCell ReferenceTimeDifferenceToCell OPTIONAL,
    primaryCCPCH-Info            PrimaryCCPCH-Info-LCR-r4,
    primaryCCPCH-TX-Power        PrimaryCCPCH-TX-Power     OPTIONAL,
    timeslotInfoList             TimeslotInfoList-LCR-r4   OPTIONAL,
    readSFN-Indicator            BOOLEAN,
    cellSelectionReselectionInfo CellSelectReselectInfoSIB-11-12-RSCP OPTIONAL
}

CellInfoSI-ECN0 ::=
    cellIndividualOffset          CellIndividualOffset          DEFAULT 0,
    referenceTimeDifferenceToCell ReferenceTimeDifferenceToCell OPTIONAL,
    modeSpecificInfo             CHOICE {
        fdd                       SEQUENCE {
            primaryCPICH-Info      PrimaryCPICH-Info          OPTIONAL,
            primaryCPICH-TX-Power  PrimaryCPICH-TX-Power     OPTIONAL,
            readSFN-Indicator      BOOLEAN,
            tx-DiversityIndicator  BOOLEAN
        },
        tdd                       SEQUENCE {
            primaryCCPCH-Info      PrimaryCCPCH-Info,
            primaryCCPCH-TX-Power  PrimaryCCPCH-TX-Power     OPTIONAL,
            timeslotInfoList       TimeslotInfoList          OPTIONAL,
            readSFN-Indicator      BOOLEAN
        }
    },
    cellSelectionReselectionInfo CellSelectReselectInfoSIB-11-12-ECN0 OPTIONAL
}

CellInfoSI-ECN0-LCR-r4 ::=
    cellIndividualOffset          CellIndividualOffset          DEFAULT 0,
    referenceTimeDifferenceToCell ReferenceTimeDifferenceToCell OPTIONAL,

```



```

primaryCCPCH-Info          PrimaryCCPCH-Info-LCR-r4,
primaryCCPCH-TX-Power      PrimaryCCPCH-TX-Power      OPTIONAL,
timeslotInfoList          TimeslotInfoList-LCR-r4      OPTIONAL,
readSFN-Indicator         BOOLEAN,
cellSelectionReselectionInfo CellSelectReselectInfoSIB-11-12-ECN0  OPTIONAL
}

CellInfoSI-HCS-RSCP ::=
cellIndividualOffset      CellIndividualOffset      DEFAULT 0,
referenceTimeDifferenceToCell ReferenceTimeDifferenceToCell  OPTIONAL,
modeSpecificInfo         CHOICE {
  fdd                     SEQUENCE {
    primaryCPICH-Info      PrimaryCPICH-Info          OPTIONAL,
    primaryCPICH-TX-Power  PrimaryCPICH-TX-Power      OPTIONAL,
    readSFN-Indicator      BOOLEAN,
    tx-DiversityIndicator  BOOLEAN
  },
  tdd                     SEQUENCE {
    primaryCCPCH-Info      PrimaryCCPCH-Info,
    primaryCCPCH-TX-Power  PrimaryCCPCH-TX-Power      OPTIONAL,
    timeslotInfoList       TimeslotInfoList          OPTIONAL,
    readSFN-Indicator      BOOLEAN
  }
},
cellSelectionReselectionInfo CellSelectReselectInfoSIB-11-12-HCS-RSCP  OPTIONAL
}

CellInfoSI-HCS-RSCP-LCR-r4 ::=
cellIndividualOffset      CellIndividualOffset      DEFAULT 0,
referenceTimeDifferenceToCell ReferenceTimeDifferenceToCell  OPTIONAL,
primaryCCPCH-Info         PrimaryCCPCH-Info-LCR-r4,
primaryCCPCH-TX-Power     PrimaryCCPCH-TX-Power      OPTIONAL,
timeslotInfoList          TimeslotInfoList-LCR-r4      OPTIONAL,
readSFN-Indicator         BOOLEAN,
cellSelectionReselectionInfo CellSelectReselectInfoSIB-11-12-HCS-RSCP  OPTIONAL
}

CellInfoSI-HCS-ECN0 ::=
cellIndividualOffset      CellIndividualOffset      DEFAULT 0,
referenceTimeDifferenceToCell ReferenceTimeDifferenceToCell  OPTIONAL,
modeSpecificInfo         CHOICE {
  fdd                     SEQUENCE {
    primaryCPICH-Info      PrimaryCPICH-Info          OPTIONAL,
    primaryCPICH-TX-Power  PrimaryCPICH-TX-Power      OPTIONAL,
    readSFN-Indicator      BOOLEAN,
    tx-DiversityIndicator  BOOLEAN
  },
  tdd                     SEQUENCE {
    primaryCCPCH-Info      PrimaryCCPCH-Info,
    primaryCCPCH-TX-Power  PrimaryCCPCH-TX-Power      OPTIONAL,
    timeslotInfoList       TimeslotInfoList          OPTIONAL,
    readSFN-Indicator      BOOLEAN
  }
},
cellSelectionReselectionInfo CellSelectReselectInfoSIB-11-12-HCS-ECN0  OPTIONAL
}

CellInfoSI-HCS-ECN0-LCR-r4 ::=
cellIndividualOffset      CellIndividualOffset      DEFAULT 0,
referenceTimeDifferenceToCell ReferenceTimeDifferenceToCell  OPTIONAL,
primaryCCPCH-Info         PrimaryCCPCH-Info-LCR-r4,
primaryCCPCH-TX-Power     PrimaryCCPCH-TX-Power      OPTIONAL,
timeslotInfoList          TimeslotInfoList-LCR-r4      OPTIONAL,
readSFN-Indicator         BOOLEAN,
cellSelectionReselectionInfo CellSelectReselectInfoSIB-11-12-HCS-ECN0  OPTIONAL
}

CellMeasuredResults ::=
cellIdentity              CellIdentity              OPTIONAL,
-- dummy is not used in this version of the specification, it should
-- not be sent and if received it should be ignored.
dummy                    SFN-SFN-ObsTimeDifference  OPTIONAL,
cellSynchronisationInfo  CellSynchronisationInfo  OPTIONAL,
modeSpecificInfo         CHOICE {
  fdd                     SEQUENCE {
    primaryCPICH-Info      PrimaryCPICH-Info,
    cpich-Ec-N0            CPICH-Ec-N0              OPTIONAL,
    cpich-RSCP             CPICH-RSCP              OPTIONAL,

```

```

        pathloss                Pathloss                OPTIONAL
    },
    tdd                          SEQUENCE {
        cellParametersID        CellParametersID,
        proposedTGSN             TGSN                OPTIONAL,
        primaryCCPCH-RSCP        PrimaryCCPCH-RSCP    OPTIONAL,
        pathloss                 Pathloss            OPTIONAL,
        timeslotISCP-List        TimeslotISCP-List    OPTIONAL
    }
}

CellMeasurementEventResults ::= CHOICE {
    fdd                          SEQUENCE (SIZE (1..maxCellMeas)) OF
        PrimaryCPICH-Info,
    tdd                          SEQUENCE (SIZE (1..maxCellMeas)) OF
        PrimaryCCPCH-Info
}

CellMeasurementEventResults-LCR-r4 ::= SEQUENCE (SIZE (1..maxCellMeas)) OF
    PrimaryCCPCH-Info-LCR-r4

CellReportingQuantities ::= SEQUENCE {
    -- dummy is not used in this version of the specification, it should
    -- not be sent and if received it should be ignored.
    dummy                        SFN-SFN-OTD-Type,
    cellIdentity-reportingIndicator    BOOLEAN,
    cellSynchronisationInfoReportingIndicator    BOOLEAN,
    modeSpecificInfo              CHOICE {
        fdd                        SEQUENCE {
            cpich-Ec-N0-reportingIndicator    BOOLEAN,
            cpich-RSCP-reportingIndicator    BOOLEAN,
            pathloss-reportingIndicator        BOOLEAN
        },
        tdd                        SEQUENCE {
            timeslotISCP-reportingIndicator    BOOLEAN,
            proposedTGSN-ReportingRequired    BOOLEAN,
            primaryCCPCH-RSCP-reportingIndicator    BOOLEAN,
            pathloss-reportingIndicator        BOOLEAN
        }
    }
}

CellSelectReselectInfoSIB-11-12 ::= SEQUENCE {
    q-Offset1S-N                Q-OffsetS-N                DEFAULT 0,
    q-Offset2S-N                Q-OffsetS-N                OPTIONAL,
    maxAllowedUL-TX-Power        MaxAllowedUL-TX-Power    OPTIONAL,
    hcs-NeighbouringCellInformation-RSCP    HCS-NeighbouringCellInformation-RSCP
    OPTIONAL,
    modeSpecificInfo            CHOICE {
        fdd                      SEQUENCE {
            q-QualMin              Q-QualMin                OPTIONAL,
            q-RxlevMin             Q-RxlevMin                OPTIONAL
        },
        tdd                      SEQUENCE {
            q-RxlevMin             Q-RxlevMin                OPTIONAL
        },
        gsm                      SEQUENCE {
            q-RxlevMin             Q-RxlevMin                OPTIONAL
        }
    }
}

CellSelectReselectInfoSIB-11-12-RSCP ::= SEQUENCE {
    q-OffsetS-N                Q-OffsetS-N                DEFAULT 0,
    maxAllowedUL-TX-Power        MaxAllowedUL-TX-Power    OPTIONAL,
    modeSpecificInfo            CHOICE {
        fdd                      SEQUENCE {
            q-QualMin              Q-QualMin                OPTIONAL,
            q-RxlevMin             Q-RxlevMin                OPTIONAL
        },
        tdd                      SEQUENCE {
            q-RxlevMin             Q-RxlevMin                OPTIONAL
        },
        gsm                      SEQUENCE {
            q-RxlevMin             Q-RxlevMin                OPTIONAL
        }
    }
}

```

```

}

CellSelectReselectInfoSIB-11-12-ECNO ::= SEQUENCE {
  q-Offset1S-N          Q-OffsetS-N          DEFAULT 0,
  q-Offset2S-N          Q-OffsetS-N          DEFAULT 0,
  maxAllowedUL-TX-Power MaxAllowedUL-TX-Power OPTIONAL,
  modeSpecificInfo      CHOICE {
    fdd                  SEQUENCE {
      q-QualMin          Q-QualMin          OPTIONAL,
      q-RxlevMin         Q-RxlevMin         OPTIONAL
    },
    tdd                  SEQUENCE {
      q-RxlevMin         Q-RxlevMin         OPTIONAL
    },
    gsm                  SEQUENCE {
      q-RxlevMin         Q-RxlevMin         OPTIONAL
    }
  }
}

CellSelectReselectInfoSIB-11-12-HCS-RSCP ::= SEQUENCE {
  q-OffsetS-N           Q-OffsetS-N           DEFAULT 0,
  maxAllowedUL-TX-Power MaxAllowedUL-TX-Power OPTIONAL,
  hcs-NeighbouringCellInformation-RSCP HCS-NeighbouringCellInformation-RSCP
  OPTIONAL,
  modeSpecificInfo      CHOICE {
    fdd                  SEQUENCE {
      q-QualMin          Q-QualMin          OPTIONAL,
      q-RxlevMin         Q-RxlevMin         OPTIONAL
    },
    tdd                  SEQUENCE {
      q-RxlevMin         Q-RxlevMin         OPTIONAL
    },
    gsm                  SEQUENCE {
      q-RxlevMin         Q-RxlevMin         OPTIONAL
    }
  }
}

CellSelectReselectInfoSIB-11-12-HCS-ECNO ::= SEQUENCE {
  q-Offset1S-N          Q-OffsetS-N          DEFAULT 0,
  q-Offset2S-N          Q-OffsetS-N          DEFAULT 0,
  maxAllowedUL-TX-Power MaxAllowedUL-TX-Power OPTIONAL,
  hcs-NeighbouringCellInformation-ECNO HCS-NeighbouringCellInformation-ECNO
  OPTIONAL,
  modeSpecificInfo      CHOICE {
    fdd                  SEQUENCE {
      q-QualMin          Q-QualMin          OPTIONAL,
      q-RxlevMin         Q-RxlevMin         OPTIONAL
    },
    tdd                  SEQUENCE {
      q-RxlevMin         Q-RxlevMin         OPTIONAL
    },
    gsm                  SEQUENCE {
      q-RxlevMin         Q-RxlevMin         OPTIONAL
    }
  }
}

CellsForInterFreqMeasList ::= SEQUENCE (SIZE (1..maxCellMeas)) OF
  InterFreqCellID
CellsForInterRATMeasList ::= SEQUENCE (SIZE (1..maxCellMeas)) OF
  InterRATCellID
CellsForIntraFreqMeasList ::= SEQUENCE (SIZE (1..maxCellMeas)) OF
  IntraFreqCellID

CellSynchronisationInfo ::= SEQUENCE {
  modeSpecificInfo      CHOICE {
    fdd                  SEQUENCE {
      countC-SFN-Frame-difference CountC-SFN-Frame-difference OPTIONAL,
      tm                  INTEGER(0..38399)
    },
    tdd                  SEQUENCE {
      countC-SFN-Frame-difference CountC-SFN-Frame-difference OPTIONAL
    }
  }
}

```

```

CellToReport ::=
    SEQUENCE {
        bsicReported
    }

CellToReportList ::=
    SEQUENCE (SIZE (1..maxCellMeas)) OF
        CellToReport

CodePhaseSearchWindow ::=
    ENUMERATED {
        w1023, w1, w2, w3, w4, w6, w8,
        w12, w16, w24, w32, w48, w64,
        w96, w128, w192 }

CountC-SFN-Frame-difference ::= SEQUENCE {
    -- Actual value countC-SFN-High = IE value * 256
    countC-SFN-High    INTEGER(0..15),
    off                INTEGER(0..255)
}

-- SPARE: CPICH-Ec-No, Max = 49
-- Values above Max are spare
CPICH-Ec-NO ::=
    INTEGER (0..63)

-- SPARE: CPICH- RSCP, Max = 91
-- Values above Max are spare
CPICH-RSCP ::=
    INTEGER (0..127)

DeltaPRC ::=
    INTEGER (-127..127)

-- Actual value DeltaRRC = IE value * 0.032
DeltaRRC ::=
    INTEGER (-7..7)

DGPS-CorrectionSatInfo ::=
    SEQUENCE {
        satID          SatID,
        iode           IODE,
        udre           UDRE,
        prc            PRC,
        rrc            RRC,
        -- dummy1 and dummy2 are not used in this version of the specification and should be ignored.
        dummy1         DeltaPRC,
        dummy2         DeltaRRC,
        -- dummy3 and dummy4 are not used in this version of the specification. They should not
        -- be sent and if received they should be ignored.
        dummy3         DeltaPRC          OPTIONAL,
        dummy4         DeltaRRC          OPTIONAL
    }

DGPS-CorrectionSatInfoList ::=
    SEQUENCE (SIZE (1..maxSat)) OF
        DGPS-CorrectionSatInfo

DiffCorrectionStatus ::=
    ENUMERATED {
        udre-1-0, udre-0-75, udre-0-5, udre-0-3,
        udre-0-2, udre-0-1, noData, invalidData }

DL-TransportChannelBLER ::=
    INTEGER (0..63)

DopplerUncertainty ::=
    ENUMERATED {
        hz12-5, hz25, hz50, hz100, hz200,
        spare3, spare2, spare1 }

EllipsoidPoint ::=
    SEQUENCE {
        latitudeSign   ENUMERATED { north, south },
        latitude        INTEGER (0..8388607),
        longitude       INTEGER (-8388608..8388607)
    }

EllipsoidPointAltitude ::=
    SEQUENCE {
        latitudeSign   ENUMERATED { north, south },
        latitude        INTEGER (0..8388607),
        longitude       INTEGER (-8388608..8388607),
        altitudeDirection ENUMERATED {height, depth},
        altitude        INTEGER (0..32767)
    }

EllipsoidPointAltitudeEllipsoide ::=
    SEQUENCE {
        latitudeSign   ENUMERATED { north, south },

```

```

latitude                INTEGER (0..8388607),
longitude               INTEGER (-8388608..8388607),
altitudeDirection      ENUMERATED {height, depth},
altitude                INTEGER (0..32767),
uncertaintySemiMajor   INTEGER (0..127),
uncertaintySemiMinor   INTEGER (0..127),
-- Actual value orientationMajorAxis = IE value * 2
orientationMajorAxis   INTEGER (0..89),
uncertaintyAltitude    INTEGER (0..127),
confidence              INTEGER (0..100)
}

EllipsoidPointUncertCircle ::= SEQUENCE {
latitudeSign           ENUMERATED { north, south },
latitude              INTEGER (0..8388607),
longitude             INTEGER (-8388608..8388607),
uncertaintyCode       INTEGER (0..127)
}

EllipsoidPointUncertEllipse ::= SEQUENCE {
latitudeSign          ENUMERATED { north, south },
latitude             INTEGER (0..8388607),
longitude            INTEGER (-8388608..8388607),
uncertaintySemiMajor INTEGER (0..127),
uncertaintySemiMinor INTEGER (0..127),
-- Actual value orientationMajorAxis = IE value * 2
orientationMajorAxis INTEGER (0..89),
confidence           INTEGER (0..100)
}

EnvironmentCharacterisation ::= ENUMERATED {
possibleHeavyMultipathNLOS,
lightMultipathLOS,
notDefined,
spare }

Event1a ::= SEQUENCE {
triggeringCondition    TriggeringCondition2,
reportingRange         ReportingRange,
forbiddenAffectCellList ForbiddenAffectCellList           OPTIONAL,
w                     W,
reportDeactivationThreshold ReportDeactivationThreshold,
reportingAmount        ReportingAmount,
reportingInterval      ReportingInterval
}

Event1a-r4 ::= SEQUENCE {
triggeringCondition    TriggeringCondition2,
reportingRange         ReportingRange,
forbiddenAffectCellList ForbiddenAffectCellList-r4           OPTIONAL,
w                     W,
reportDeactivationThreshold ReportDeactivationThreshold,
reportingAmount        ReportingAmount,
reportingInterval      ReportingInterval
}

Event1a-LCR-r4 ::= SEQUENCE {
triggeringCondition    TriggeringCondition2,
reportingRange         ReportingRange,
forbiddenAffectCellList ForbiddenAffectCellList-LCR-r4           OPTIONAL,
w                     W,
reportDeactivationThreshold ReportDeactivationThreshold,
reportingAmount        ReportingAmount,
reportingInterval      ReportingInterval
}

Event1b ::= SEQUENCE {
triggeringCondition    TriggeringCondition1,
reportingRange         ReportingRange,
forbiddenAffectCellList ForbiddenAffectCellList           OPTIONAL,
w                     W
}

Event1b-r4 ::= SEQUENCE {
triggeringCondition    TriggeringCondition1,

```

```

    reportingRange                ReportingRange,
    forbiddenAffectCellList      ForbiddenAffectCellList-r4      OPTIONAL,
    w                             W
}

Event1b-LCR-r4 ::=                SEQUENCE {
    triggeringCondition           TriggeringCondition1,
    reportingRange               ReportingRange,
    forbiddenAffectCellList      ForbiddenAffectCellList-LCR-r4  OPTIONAL,
    w                             W
}

Event1c ::=                       SEQUENCE {
    replacementActivationThreshold ReplacementActivationThreshold,
    reportingAmount              ReportingAmount,
    reportingInterval            ReportingInterval
}

Event1e ::=                       SEQUENCE {
    triggeringCondition           TriggeringCondition2,
    thresholdUsedFrequency       ThresholdUsedFrequency
}

Event1f ::=                       SEQUENCE {
    triggeringCondition           TriggeringCondition1,
    thresholdUsedFrequency       ThresholdUsedFrequency
}

Event2a ::=                       SEQUENCE {
    -- dummy is not used in this version of the specification and should be ignored
    dummy                        Threshold,
    usedFreqW                    W,
    hysteresis                   HysteresisInterFreq,
    timeToTrigger                TimeToTrigger,
    reportingCellStatus          ReportingCellStatus          OPTIONAL,
    nonUsedFreqParameterList     NonUsedFreqParameterList  OPTIONAL
}

Event2b ::=                       SEQUENCE {
    usedFreqThreshold            Threshold,
    usedFreqW                    W,
    hysteresis                   HysteresisInterFreq,
    timeToTrigger                TimeToTrigger,
    reportingCellStatus          ReportingCellStatus          OPTIONAL,
    nonUsedFreqParameterList     NonUsedFreqParameterList  OPTIONAL
}

Event2c ::=                       SEQUENCE {
    hysteresis                   HysteresisInterFreq,
    timeToTrigger                TimeToTrigger,
    reportingCellStatus          ReportingCellStatus          OPTIONAL,
    nonUsedFreqParameterList     NonUsedFreqParameterList  OPTIONAL
}

Event2d ::=                       SEQUENCE {
    usedFreqThreshold            Threshold,
    usedFreqW                    W,
    hysteresis                   HysteresisInterFreq,
    timeToTrigger                TimeToTrigger,
    reportingCellStatus          ReportingCellStatus          OPTIONAL
}

Event2e ::=                       SEQUENCE {
    hysteresis                   HysteresisInterFreq,
    timeToTrigger                TimeToTrigger,
    reportingCellStatus          ReportingCellStatus          OPTIONAL,
    nonUsedFreqParameterList     NonUsedFreqParameterList  OPTIONAL
}

Event2f ::=                       SEQUENCE {
    usedFreqThreshold            Threshold,
    usedFreqW                    W,
    hysteresis                   HysteresisInterFreq,
    timeToTrigger                TimeToTrigger,
    reportingCellStatus          ReportingCellStatus          OPTIONAL
}

Event3a ::=                       SEQUENCE {

```

```

    thresholdOwnSystem      Threshold,
    w                       W,
    thresholdOtherSystem    Threshold,
    hysteresis              Hysteresis,
    timeToTrigger           TimeToTrigger,
    reportingCellStatus     ReportingCellStatus          OPTIONAL
}

Event3b ::=
    thresholdOtherSystem    Threshold,
    hysteresis              Hysteresis,
    timeToTrigger           TimeToTrigger,
    reportingCellStatus     ReportingCellStatus          OPTIONAL
}

Event3c ::=
    thresholdOtherSystem    Threshold,
    hysteresis              Hysteresis,
    timeToTrigger           TimeToTrigger,
    reportingCellStatus     ReportingCellStatus          OPTIONAL
}

Event3d ::=
    hysteresis              Hysteresis,
    timeToTrigger           TimeToTrigger,
    reportingCellStatus     ReportingCellStatus          OPTIONAL
}

EventIDInterFreq ::=
    ENUMERATED {
        e2a, e2b, e2c, e2d, e2e, e2f, spare2, spare1 }

EventIDInterRAT ::=
    ENUMERATED {
        e3a, e3b, e3c, e3d }

EventIDIntraFreq ::=
    ENUMERATED {
        e1a, e1b, e1c, e1d, e1e,
        e1f, e1g, e1h, e1i, spare7,
        spare6, spare5, spare4, spare3, spare2,
        spare1 }

EventResults ::=
    CHOICE {
        intraFreqEventResults      IntraFreqEventResults,
        interFreqEventResults      InterFreqEventResults,
        interRATEventResults      InterRATEventResults,
        trafficVolumeEventResults  TrafficVolumeEventResults,
        qualityEventResults        QualityEventResults,
        ue-InternalEventResults    UE-InternalEventResults,
        ue-positioning-MeasurementEventResults  UE-Positioning-MeasurementEventResults,
        spare                       NULL
    }

ExtraDopplerInfo ::=
    SEQUENCE {
        -- Actual value doppler1stOrder = IE value * 0.023
        doppler1stOrder            INTEGER (-42..21),
        dopplerUncertainty         DopplerUncertainty
    }

FACH-MeasurementOccasionInfo ::=
    SEQUENCE {
        fACH-meas-occasion-coeff    INTEGER (1..12)          OPTIONAL,
        inter-freq-FDD-meas-ind     BOOLEAN,
        -- inter-freq-TDD-meas-ind is for 3.84Mcps TDD. For 1.28Mcps TDD, the IE in
        -- FACH-MeasurementOccasionInfo-LCR-r4-ext is used.
        inter-freq-TDD-meas-ind     BOOLEAN,
        inter-RAT-meas-ind          SEQUENCE (SIZE (1..maxOtherRAT)) OF
                                     RAT-Type          OPTIONAL
    }

FACH-MeasurementOccasionInfo-LCR-r4-ext ::= SEQUENCE {
    inter-freq-TDD128-meas-ind     BOOLEAN
}

FilterCoefficient ::=
    ENUMERATED {
        fc0, fc1, fc2, fc3, fc4, fc5,
        fc6, fc7, fc8, fc9, fc11, fc13,
        fc15, fc17, fc19, spare1 }

-- Actual value FineSFN-SFN = IE value * 0.0625

```

```

FineSFN-SFN ::= INTEGER (0..15)

ForbiddenAffectCell ::= CHOICE {
    fdd PrimaryCPICH-Info,
    tdd PrimaryCCPCH-Info
}

ForbiddenAffectCell-r4 ::= CHOICE {
    fdd PrimaryCPICH-Info,
    tdd PrimaryCCPCH-Info-r4
}

ForbiddenAffectCell-LCR-r4 ::= SEQUENCE {
    tdd PrimaryCCPCH-Info-LCR-r4
}

ForbiddenAffectCellList ::= SEQUENCE (SIZE (1..maxCellMeas)) OF
    ForbiddenAffectCell

ForbiddenAffectCellList-r4 ::= SEQUENCE (SIZE (1..maxCellMeas)) OF
    ForbiddenAffectCell-r4

ForbiddenAffectCellList-LCR-r4 ::= SEQUENCE (SIZE (1..maxCellMeas)) OF
    ForbiddenAffectCell-LCR-r4

FreqQualityEstimateQuantity-FDD ::= ENUMERATED {
    cpich-Ec-N0,
    cpich-RSCP }

FreqQualityEstimateQuantity-TDD ::= ENUMERATED {
    primaryCCPCH-RSCP }

GPS-MeasurementParam ::= SEQUENCE {
    satelliteID INTEGER (0..63),
    c-N0 INTEGER (0..63),
    doppler INTEGER (-32768..32768),
    wholeGPS-Chips INTEGER (0..1022),
    fractionalGPS-Chips INTEGER (0..1023),
    multipathIndicator MultipathIndicator,
    pseudorangeRMS-Error INTEGER (0..63)
}

GPS-MeasurementParamList ::= SEQUENCE (SIZE (1..maxSat)) OF
    GPS-MeasurementParam

GSM-CarrierRSSI ::= BIT STRING (SIZE (6))

GSM-MeasuredResults ::= SEQUENCE {
    gsm-CarrierRSSI GSM-CarrierRSSI OPTIONAL,
    -- dummy is not used in this version of the specification, it should
    -- not be sent and if received it should be ignored.
    dummy INTEGER (46..173) OPTIONAL,
    bsicReported BSICReported,
    observedTimeDifferenceToGSM ObservedTimeDifferenceToGSM OPTIONAL
}

GSM-MeasuredResultsList ::= SEQUENCE (SIZE (1..maxReportedGSMCells)) OF
    GSM-MeasuredResults

GPS-TOW-1msec ::= INTEGER (0..604799999)

GPS-TOW-Assist ::= SEQUENCE {
    satID SatID,
    tlm-Message BIT STRING (SIZE (14)),
    tlm-Reserved BIT STRING (SIZE (2)),
    alert BOOLEAN,
    antiSpoof BOOLEAN
}

GPS-TOW-AssistList ::= SEQUENCE (SIZE (1..maxSat)) OF
    GPS-TOW-Assist

HCS-CellReselectInformation-RSCP ::= SEQUENCE {
    -- TABULAR: The default value for penaltyTime is "notUsed"
    -- Temporary offset is nested inside PenaltyTime-RSCP
    penaltyTime PenaltyTime-RSCP
}

```



```

HCS-CellReselectInformation-ECNO ::= SEQUENCE {
  -- TABULAR: The default value for penaltyTime is "notUsed"
  -- Temporary offset is nested inside PenaltyTime-ECNO
  penaltyTime          PenaltyTime-ECNO
}

HCS-NeighbouringCellInformation-RSCP ::= SEQUENCE {
  hcs-PRIO              HCS-PRIO          DEFAULT 0,
  q-HCS                Q-HCS             DEFAULT 0,
  hcs-CellReselectInformation HCS-CellReselectInformation-RSCP
}

HCS-NeighbouringCellInformation-ECNO ::= SEQUENCE {
  hcs-PRIO              HCS-PRIO          DEFAULT 0,
  q-HCS                Q-HCS             DEFAULT 0,
  hcs-CellReselectInformation HCS-CellReselectInformation-ECNO
}

HCS-PRIO ::= INTEGER (0..7)

HCS-ServingCellInformation ::= SEQUENCE {
  hcs-PRIO              HCS-PRIO          DEFAULT 0,
  q-HCS                Q-HCS             DEFAULT 0,
  t-CR-Max              T-CRMax           OPTIONAL
}

-- Actual value Hysteresis = IE value * 0.5
Hysteresis ::= INTEGER (0..15)

-- Actual value HysteresisInterFreq = IE value * 0.5
HysteresisInterFreq ::= INTEGER (0..29)

InterFreqCell ::= SEQUENCE {
  frequencyInfo        FrequencyInfo,
  nonFreqRelatedEventResults CellMeasurementEventResults
}

InterFreqCell-LCR-r4 ::= SEQUENCE {
  frequencyInfo        FrequencyInfo,
  nonFreqRelatedEventResults CellMeasurementEventResults-LCR-r4
}

InterFreqCellID ::= INTEGER (0..maxCellMeas-1)

InterFreqCellInfoList ::= SEQUENCE {
  removedInterFreqCellList   RemovedInterFreqCellList   OPTIONAL,
  newInterFreqCellList       NewInterFreqCellList       OPTIONAL,
  cellsForInterFreqMeasList   CellsForInterFreqMeasList   OPTIONAL
}

InterFreqCellInfoList-r4 ::= SEQUENCE {
  removedInterFreqCellList   RemovedInterFreqCellList   OPTIONAL,
  newInterFreqCellList-r4     NewInterFreqCellList-r4     OPTIONAL,
  cellsForInterFreqMeasList   CellsForInterFreqMeasList   OPTIONAL
}

InterFreqCellInfoSI-List-RSCP ::= SEQUENCE {
  removedInterFreqCellList   RemovedInterFreqCellList   OPTIONAL,
  newInterFreqCellList       NewInterFreqCellSI-List-RSCP   OPTIONAL
}

InterFreqCellInfoSI-List-ECNO ::= SEQUENCE {
  removedInterFreqCellList   RemovedInterFreqCellList   OPTIONAL,
  newInterFreqCellList       NewInterFreqCellSI-List-ECNO   OPTIONAL
}

InterFreqCellInfoSI-List-HCS-RSCP ::= SEQUENCE {
  removedInterFreqCellList   RemovedInterFreqCellList   OPTIONAL,
  newInterFreqCellList       NewInterFreqCellSI-List-HCS-RSCP   OPTIONAL
}

InterFreqCellInfoSI-List-HCS-ECNO ::= SEQUENCE {
  removedInterFreqCellList   RemovedInterFreqCellList   OPTIONAL,
  newInterFreqCellList       NewInterFreqCellSI-List-HCS-ECNO   OPTIONAL
}

InterFreqCellInfoSI-List-RSCP-LCR ::= SEQUENCE {
  removedInterFreqCellList   RemovedInterFreqCellList   OPTIONAL,

```

```

    newInterFreqCellList                NewInterFreqCellSI-List-RSCP-LCR-r4    OPTIONAL
  }

InterFreqCellInfoSI-List-ECN0-LCR ::= SEQUENCE {
  removedInterFreqCellList            RemovedInterFreqCellList        OPTIONAL,
  newInterFreqCellList                 NewInterFreqCellSI-List-ECN0-LCR-r4    OPTIONAL
}

InterFreqCellInfoSI-List-HCS-RSCP-LCR ::= SEQUENCE {
  removedInterFreqCellList            RemovedInterFreqCellList        OPTIONAL,
  newInterFreqCellList                 NewInterFreqCellSI-List-HCS-RSCP-LCR-r4    OPTIONAL
}

InterFreqCellInfoSI-List-HCS-ECN0-LCR ::= SEQUENCE {
  removedInterFreqCellList            RemovedInterFreqCellList        OPTIONAL,
  newInterFreqCellList                 NewInterFreqCellSI-List-HCS-ECN0-LCR-r4    OPTIONAL
}

InterFreqCellList ::= SEQUENCE (SIZE (1..maxFreq)) OF
  InterFreqCell

InterFreqCellList-LCR-r4-ext ::= SEQUENCE (SIZE (1..maxFreq)) OF
  InterFreqCell-LCR-r4

InterFreqCellMeasuredResultsList ::= SEQUENCE (SIZE (1..maxCellMeas)) OF
  CellMeasuredResults

InterFreqEvent ::= CHOICE {
  event2a                               Event2a,
  event2b                               Event2b,
  event2c                               Event2c,
  event2d                               Event2d,
  event2e                               Event2e,
  event2f                               Event2f
}

InterFreqEventList ::= SEQUENCE (SIZE (1..maxMeasEvent)) OF
  InterFreqEvent

InterFreqEventResults ::= SEQUENCE {
  eventID                               EventIDInterFreq,
  interFreqCellList                     InterFreqCellList              OPTIONAL
}

InterFreqEventResults-LCR-r4-ext ::= SEQUENCE {
  eventID                               EventIDInterFreq,
  interFreqCellList                     InterFreqCellList-LCR-r4-ext    OPTIONAL
}

InterFreqMeasQuantity ::= SEQUENCE {
  reportingCriteria                     CHOICE {
    intraFreqReportingCriteria          SEQUENCE {
      intraFreqMeasQuantity             IntraFreqMeasQuantity
    },
    interFreqReportingCriteria          SEQUENCE {
      filterCoefficient                 FilterCoefficient              DEFAULT fc0,
      modeSpecificInfo                  CHOICE {
        fdd                             SEQUENCE {
          freqQualityEstimateQuantity-FDD  FreqQualityEstimateQuantity-FDD
        },
        tdd                             SEQUENCE {
          freqQualityEstimateQuantity-TDD  FreqQualityEstimateQuantity-TDD
        }
      }
    }
  }
}

InterFreqMeasuredResults ::= SEQUENCE {
  frequencyInfo                         FrequencyInfo                    OPTIONAL,
  ultra-CarrierRSSI                     UTRA-CarrierRSSI                OPTIONAL,
  interFreqCellMeasuredResultsList      InterFreqCellMeasuredResultsList    OPTIONAL
}

InterFreqMeasuredResultsList ::= SEQUENCE (SIZE (1..maxFreq)) OF
  InterFreqMeasuredResults

```

```

InterFreqMeasurementSysInfo-RSCP ::= SEQUENCE {
    interFreqCellInfoSI-List
}
InterFreqCellInfoSI-List-RSCP OPTIONAL

InterFreqMeasurementSysInfo-ECNO ::= SEQUENCE {
    interFreqCellInfoSI-List
}
InterFreqCellInfoSI-List-ECNO OPTIONAL

InterFreqMeasurementSysInfo-HCS-RSCP ::= SEQUENCE {
    interFreqCellInfoSI-List
}
InterFreqCellInfoSI-List-HCS-RSCP OPTIONAL

InterFreqMeasurementSysInfo-HCS-ECNO ::= SEQUENCE {
    interFreqCellInfoSI-List
}
InterFreqCellInfoSI-List-HCS-ECNO OPTIONAL

InterFreqMeasurementSysInfo-RSCP-LCR-r4 ::= SEQUENCE {
    interFreqCellInfoSI-List
}
InterFreqCellInfoSI-List-RSCP-LCR OPTIONAL

InterFreqMeasurementSysInfo-ECNO-LCR-r4 ::= SEQUENCE {
    interFreqCellInfoSI-List
}
InterFreqCellInfoSI-List-ECNO-LCR OPTIONAL

InterFreqMeasurementSysInfo-HCS-RSCP-LCR-r4 ::= SEQUENCE {
    interFreqCellInfoSI-List
}
InterFreqCellInfoSI-List-HCS-RSCP-LCR OPTIONAL

InterFreqMeasurementSysInfo-HCS-ECNO-LCR-r4 ::= SEQUENCE {
    interFreqCellInfoSI-List
}
InterFreqCellInfoSI-List-HCS-ECNO-LCR OPTIONAL

InterFreqReportCriteria ::= CHOICE {
    intraFreqReportingCriteria
    interFreqReportingCriteria
    periodicalReportingCriteria
    noReporting
    IntraFreqReportingCriteria,
    InterFreqReportingCriteria,
    PeriodicalWithReportingCellStatus,
    ReportingCellStatusOpt
}

InterFreqReportCriteria-r4 ::= CHOICE {
    intraFreqReportingCriteria
    interFreqReportingCriteria
    periodicalReportingCriteria
    noReporting
    IntraFreqReportingCriteria-r4,
    InterFreqReportingCriteria,
    PeriodicalWithReportingCellStatus,
    ReportingCellStatusOpt
}

InterFreqReportingCriteria ::= SEQUENCE {
    interFreqEventList
}
InterFreqEventList OPTIONAL

InterFreqReportingQuantity ::= SEQUENCE {
    ultra-Carrier-RSSI
    frequencyQualityEstimate
    nonFreqRelatedQuantities
    BOOLEAN,
    BOOLEAN,
    CellReportingQuantities
}

InterFrequencyMeasurement ::= SEQUENCE {
    interFreqCellInfoList
    interFreqMeasQuantity
    interFreqReportingQuantity
    measurementValidity
    interFreqSetUpdate
    reportCriteria
    InterFreqCellInfoList,
    InterFreqMeasQuantity
    InterFreqReportingQuantity
    MeasurementValidity
    UE-AutonomousUpdateMode
    InterFreqReportCriteria
    OPTIONAL,
    OPTIONAL,
    OPTIONAL,
    OPTIONAL,
}

InterFrequencyMeasurement-r4 ::= SEQUENCE {
    interFreqCellInfoList
    interFreqMeasQuantity
    interFreqReportingQuantity
    measurementValidity
    interFreqSetUpdate
    reportCriteria
    InterFreqCellInfoList-r4,
    InterFreqMeasQuantity
    InterFreqReportingQuantity
    MeasurementValidity
    UE-AutonomousUpdateMode
    InterFreqReportCriteria-r4
    OPTIONAL,
    OPTIONAL,
    OPTIONAL,
    OPTIONAL,
}

InterRAT-TargetCellDescription ::= SEQUENCE {
    technologySpecificInfo
    gsm
    bsic
    CHOICE {
        SEQUENCE {
            BSIC,

```

```

        frequency-band          Frequency-Band,
        bcch-ARFCN              BCCH-ARFCN,
        ncMode                   NC-Mode                OPTIONAL
    },
    is-2000                      NULL,
    spare2                       NULL,
    spare1                       NULL
}
}

InterRATCellID ::=                INTEGER (0..maxCellMeas-1)

InterRATCellInfoList ::=          SEQUENCE {
    removedInterRATCellList      RemovedInterRATCellList,
    -- NOTE: Future revisions of dedicated messages including IE newInterRATCellList
    -- should use a corrected version of this IE
    newInterRATCellList          NewInterRATCellList,
    cellsForInterRATMeasList     CellsForInterRATMeasList                OPTIONAL
}

InterRATCellInfoList-B ::=        SEQUENCE {
    removedInterRATCellList      RemovedInterRATCellList,
    -- NOTE: IE newInterRATCellList should be optional. However, system information
    -- does not support message versions. Hence, this can not be corrected
    newInterRATCellList          NewInterRATCellList-B
}

InterRATCellInfoList-r4 ::=       SEQUENCE {
    removedInterRATCellList      RemovedInterRATCellList,
    newInterRATCellList          NewInterRATCellList                OPTIONAL,
    cellsForInterRATMeasList     CellsForInterRATMeasList                OPTIONAL
}

InterRATCellIndividualOffset ::=  INTEGER (-50..50)

InterRATEvent ::=                 CHOICE {
    event3a                      Event3a,
    event3b                      Event3b,
    event3c                      Event3c,
    event3d                      Event3d
}

InterRATEventList ::=             SEQUENCE (SIZE (1..maxMeasEvent)) OF
    InterRATEvent

InterRATEventResults ::=          SEQUENCE {
    eventID                      EventIDInterRAT,
    cellToReportList             CellToReportList
}

InterRATInfo ::=                  ENUMERATED {
    gsm
}

InterRATMeasQuantity ::=          SEQUENCE {
    measQuantityUTRAN-QualityEstimate  IntraFreqMeasQuantity                OPTIONAL,
    ratSpecificInfo              CHOICE {
        gsm                      SEQUENCE {
            measurementQuantity    MeasurementQuantityGSM,
            filterCoefficient      FilterCoefficient                DEFAULT fc0,
            bsic-VerificationRequired BSIC-VerificationRequired
        },
        is-2000                  SEQUENCE {
            tadd-EcIo              INTEGER (0..63),
            tcomp-EcIo             INTEGER (0..15),
            softSlope              INTEGER (0..63)                OPTIONAL,
            addIntercept           INTEGER (0..63)                OPTIONAL
        }
    }
}

InterRATMeasuredResults ::=       CHOICE {
    gsm                          GSM-MeasuredResultsList,
    spare                          NULL
}

InterRATMeasuredResultsList ::=   SEQUENCE (SIZE (1..maxOtherRAT-16)) OF
    InterRATMeasuredResults

```

```

InterRATMeasurement ::= SEQUENCE {
    interRATCellInfoList      InterRATCellInfoList      OPTIONAL,
    interRATMeasQuantity      InterRATMeasQuantity      OPTIONAL,
    interRATReportingQuantity InterRATReportingQuantity  OPTIONAL,
    reportCriteria            InterRATReportCriteria
}

InterRATMeasurement-r4 ::= SEQUENCE {
    interRATCellInfoList      InterRATCellInfoList-r4      OPTIONAL,
    interRATMeasQuantity      InterRATMeasQuantity      OPTIONAL,
    interRATReportingQuantity InterRATReportingQuantity  OPTIONAL,
    reportCriteria            InterRATReportCriteria
}

InterRATMeasurementSysInfo ::= SEQUENCE {
    interRATCellInfoList      InterRATCellInfoList      OPTIONAL
}

InterRATMeasurementSysInfo-B ::= SEQUENCE {
    interRATCellInfoList      InterRATCellInfoList-B      OPTIONAL
}

InterRATReportCriteria ::= CHOICE {
    interRATReportingCriteria InterRATReportingCriteria,
    periodicalReportingCriteria PeriodicalWithReportingCellStatus,
    noReporting                ReportingCellStatusOpt
}

InterRATReportingCriteria ::= SEQUENCE {
    interRATEventList      InterRATEventList      OPTIONAL
}

InterRATReportingQuantity ::= SEQUENCE {
    utran-EstimatedQuality      BOOLEAN,
    ratSpecificInfo            CHOICE {
        gsm                    SEQUENCE {
            dummy                BOOLEAN,
            observedTimeDifferenceGSM  BOOLEAN,
            gsm-Carrier-RSSI      BOOLEAN
        }
    }
}

IntraFreqCellID ::= INTEGER (0..maxCellMeas-1)

IntraFreqCellInfoList ::= SEQUENCE {
    removedIntraFreqCellList      RemovedIntraFreqCellList      OPTIONAL,
    newIntraFreqCellList          NewIntraFreqCellList          OPTIONAL,
    cellsForIntraFreqMeasList     CellsForIntraFreqMeasList     OPTIONAL
}

IntraFreqCellInfoList-r4 ::= SEQUENCE {
    removedIntraFreqCellList      RemovedIntraFreqCellList      OPTIONAL,
    newIntraFreqCellList          NewIntraFreqCellList-r4      OPTIONAL,
    cellsForIntraFreqMeasList     CellsForIntraFreqMeasList     OPTIONAL
}

IntraFreqCellInfoSI-List-RSCP ::= SEQUENCE {
    removedIntraFreqCellList      RemovedIntraFreqCellList      OPTIONAL,
    newIntraFreqCellList          NewIntraFreqCellSI-List-RSCP
}

IntraFreqCellInfoSI-List-ECNO ::= SEQUENCE {
    removedIntraFreqCellList      RemovedIntraFreqCellList      OPTIONAL,
    newIntraFreqCellList          NewIntraFreqCellSI-List-ECNO
}

IntraFreqCellInfoSI-List-HCS-RSCP ::= SEQUENCE {
    removedIntraFreqCellList      RemovedIntraFreqCellList      OPTIONAL,
    newIntraFreqCellList          NewIntraFreqCellSI-List-HCS-RSCP
}

IntraFreqCellInfoSI-List-HCS-ECNO ::= SEQUENCE {
    removedIntraFreqCellList      RemovedIntraFreqCellList      OPTIONAL,
    newIntraFreqCellList          NewIntraFreqCellSI-List-HCS-ECNO
}

IntraFreqCellInfoSI-List-RSCP-LCR-r4 ::= SEQUENCE {

```

```

    removedIntraFreqCellList      RemovedIntraFreqCellList      OPTIONAL,
    newIntraFreqCellList          NewIntraFreqCellSI-List-RSCP-LCR-r4
}

IntraFreqCellInfoSI-List-ECN0-LCR-r4 ::= SEQUENCE {
    removedIntraFreqCellList      RemovedIntraFreqCellList      OPTIONAL,
    newIntraFreqCellList          NewIntraFreqCellSI-List-ECN0-LCR-r4
}

IntraFreqCellInfoSI-List-HCS-RSCP-LCR-r4 ::= SEQUENCE {
    removedIntraFreqCellList      RemovedIntraFreqCellList      OPTIONAL,
    newIntraFreqCellList          NewIntraFreqCellSI-List-HCS-RSCP-LCR-r4
}

IntraFreqCellInfoSI-List-HCS-ECN0-LCR-r4 ::= SEQUENCE {
    removedIntraFreqCellList      RemovedIntraFreqCellList      OPTIONAL,
    newIntraFreqCellList          NewIntraFreqCellSI-List-HCS-ECN0-LCR-r4
}

IntraFreqEvent ::= CHOICE {
    ela          Event1a,
    elb          Event1b,
    elc          Event1c,
    eld          NULL,
    ele          Event1e,
    elf          Event1f,
    elg          NULL,
    elh          ThresholdUsedFrequency,
    eli          ThresholdUsedFrequency
}

IntraFreqEvent-r4 ::= CHOICE {
    ela          Event1a-r4,
    elb          Event1b-r4,
    elc          Event1c,
    eld          NULL,
    ele          Event1e,
    elf          Event1f,
    elg          NULL,
    elh          ThresholdUsedFrequency,
    eli          ThresholdUsedFrequency
}

IntraFreqEvent-LCR-r4 ::= CHOICE {
    ela          Event1a-LCR-r4,
    elb          Event1b-LCR-r4,
    elc          Event1c,
    eld          NULL,
    ele          Event1e,
    elf          Event1f,
    elg          NULL,
    elh          ThresholdUsedFrequency,
    eli          ThresholdUsedFrequency
}

IntraFreqEventCriteria ::= SEQUENCE {
    event          IntraFreqEvent,
    hysteresis     Hysteresis,
    timeToTrigger  TimeToTrigger,
    reportingCellStatus ReportingCellStatus      OPTIONAL
}

IntraFreqEventCriteria-r4 ::= SEQUENCE {
    event          IntraFreqEvent-r4,
    hysteresis     Hysteresis,
    timeToTrigger  TimeToTrigger,
    reportingCellStatus ReportingCellStatus      OPTIONAL
}

IntraFreqEventCriteria-LCR-r4 ::= SEQUENCE {
    event          IntraFreqEvent-LCR-r4,
    hysteresis     Hysteresis,
    timeToTrigger  TimeToTrigger,
    reportingCellStatus ReportingCellStatus      OPTIONAL
}

IntraFreqEventCriteriaList ::= SEQUENCE (SIZE (1..maxMeasEvent)) OF
    IntraFreqEventCriteria

```

```

IntraFreqEventCriteriaList-r4 ::= SEQUENCE (SIZE (1..maxMeasEvent)) OF
    IntraFreqEventCriteria-r4

IntraFreqEventCriteriaList-LCR-r4 ::= SEQUENCE (SIZE (1..maxMeasEvent)) OF
    IntraFreqEventCriteria-LCR-r4

IntraFreqEventResults ::= SEQUENCE {
    eventID                EventIDIntraFreq,
    cellMeasurementEventResults CellMeasurementEventResults
}

IntraFreqMeasQuantity ::= SEQUENCE {
    filterCoefficient      FilterCoefficient           DEFAULT fc0,
    modeSpecificInfo       CHOICE {
        fdd                SEQUENCE {
            intraFreqMeasQuantity-FDD IntraFreqMeasQuantity-FDD
        },
        tdd                SEQUENCE {
            intraFreqMeasQuantity-TDDList IntraFreqMeasQuantity-TDDList
        }
    }
}

-- If IntraFreqMeasQuantity-FDD is used in InterRATMeasQuantity, then only
-- cpich-Ec-N0 and cpich-RSCP are allowed.
-- dummy is not used in this version of the specification, it should
-- not be sent and if received it should be ignored.
IntraFreqMeasQuantity-FDD ::= ENUMERATED {
    cpich-Ec-N0,
    cpich-RSCP,
    pathloss,
    dummy }

-- dummy is not used in this version of the specification, it should
-- not be sent and if received it should be ignored.
IntraFreqMeasQuantity-TDD ::= ENUMERATED {
    primaryCCPCH-RSCP,
    pathloss,
    timeslotISCP,
    dummy }

IntraFreqMeasQuantity-TDDList ::= SEQUENCE (SIZE (1..4)) OF
    IntraFreqMeasQuantity-TDD

IntraFreqMeasuredResultsList ::= SEQUENCE (SIZE (1..maxCellMeas)) OF
    CellMeasuredResults

IntraFreqMeasurementSysInfo-RSCP ::= SEQUENCE {
    intraFreqMeasurementID      MeasurementIdentity           DEFAULT 1,
    intraFreqCellInfoSI-List    IntraFreqCellInfoSI-List-RSCP   OPTIONAL,
    intraFreqMeasQuantity       IntraFreqMeasQuantity           OPTIONAL,
    intraFreqReportingQuantityForRACH IntraFreqReportingQuantityForRACH OPTIONAL,
    maxReportedCellsOnRACH      MaxReportedCellsOnRACH        OPTIONAL,
    reportingInfoForCellDCH     ReportingInfoForCellDCH      OPTIONAL
}

IntraFreqMeasurementSysInfo-ECN0 ::= SEQUENCE {
    intraFreqMeasurementID      MeasurementIdentity           DEFAULT 1,
    intraFreqCellInfoSI-List    IntraFreqCellInfoSI-List-ECN0   OPTIONAL,
    intraFreqMeasQuantity       IntraFreqMeasQuantity           OPTIONAL,
    intraFreqReportingQuantityForRACH IntraFreqReportingQuantityForRACH OPTIONAL,
    maxReportedCellsOnRACH      MaxReportedCellsOnRACH        OPTIONAL,
    reportingInfoForCellDCH     ReportingInfoForCellDCH      OPTIONAL
}

IntraFreqMeasurementSysInfo-HCS-RSCP ::= SEQUENCE {
    intraFreqMeasurementID      MeasurementIdentity           DEFAULT 1,
    intraFreqCellInfoSI-List    IntraFreqCellInfoSI-List-HCS-RSCP   OPTIONAL,
    intraFreqMeasQuantity       IntraFreqMeasQuantity           OPTIONAL,
    intraFreqReportingQuantityForRACH IntraFreqReportingQuantityForRACH OPTIONAL,
    maxReportedCellsOnRACH      MaxReportedCellsOnRACH        OPTIONAL,
    reportingInfoForCellDCH     ReportingInfoForCellDCH      OPTIONAL
}

IntraFreqMeasurementSysInfo-HCS-ECN0 ::= SEQUENCE {
    intraFreqMeasurementID      MeasurementIdentity           DEFAULT 1,
    intraFreqCellInfoSI-List    IntraFreqCellInfoSI-List-HCS-ECN0   OPTIONAL,

```

```

    intraFreqMeasQuantity          IntraFreqMeasQuantity          OPTIONAL,
    intraFreqReportingQuantityForRACH IntraFreqReportingQuantityForRACH OPTIONAL,
    maxReportedCellsOnRACH         MaxReportedCellsOnRACH     OPTIONAL,
    reportingInfoForCellDCH         ReportingInfoForCellDCH    OPTIONAL
}

IntraFreqMeasurementSysInfo-RSCP-LCR-r4 ::= SEQUENCE {
    intraFreqMeasurementID          MeasurementIdentity          DEFAULT 1,
    intraFreqCellInfoSI-List        IntraFreqCellInfoSI-List-RSCP-LCR-r4 OPTIONAL,
    intraFreqMeasQuantity           IntraFreqMeasQuantity      OPTIONAL,
    intraFreqReportingQuantityForRACH IntraFreqReportingQuantityForRACH OPTIONAL,
    maxReportedCellsOnRACH         MaxReportedCellsOnRACH     OPTIONAL,
    reportingInfoForCellDCH         ReportingInfoForCellDCH-LCR-r4 OPTIONAL
}

IntraFreqMeasurementSysInfo-ECN0-LCR-r4 ::= SEQUENCE {
    intraFreqMeasurementID          MeasurementIdentity          DEFAULT 1,
    intraFreqCellInfoSI-List        IntraFreqCellInfoSI-List-ECN0-LCR-r4 OPTIONAL,
    intraFreqMeasQuantity           IntraFreqMeasQuantity      OPTIONAL,
    intraFreqReportingQuantityForRACH IntraFreqReportingQuantityForRACH OPTIONAL,
    maxReportedCellsOnRACH         MaxReportedCellsOnRACH     OPTIONAL,
    reportingInfoForCellDCH         ReportingInfoForCellDCH-LCR-r4 OPTIONAL
}

IntraFreqMeasurementSysInfo-HCS-RSCP-LCR-r4 ::= SEQUENCE {
    intraFreqMeasurementID          MeasurementIdentity          DEFAULT 1,
    intraFreqCellInfoSI-List        IntraFreqCellInfoSI-List-HCS-RSCP-LCR-r4 OPTIONAL,
    intraFreqMeasQuantity           IntraFreqMeasQuantity      OPTIONAL,
    intraFreqReportingQuantityForRACH IntraFreqReportingQuantityForRACH OPTIONAL,
    maxReportedCellsOnRACH         MaxReportedCellsOnRACH     OPTIONAL,
    reportingInfoForCellDCH         ReportingInfoForCellDCH-LCR-r4 OPTIONAL
}

IntraFreqMeasurementSysInfo-HCS-ECN0-LCR-r4 ::= SEQUENCE {
    intraFreqMeasurementID          MeasurementIdentity          DEFAULT 1,
    intraFreqCellInfoSI-List        IntraFreqCellInfoSI-List-HCS-ECN0-LCR-r4 OPTIONAL,
    intraFreqMeasQuantity           IntraFreqMeasQuantity      OPTIONAL,
    intraFreqReportingQuantityForRACH IntraFreqReportingQuantityForRACH OPTIONAL,
    maxReportedCellsOnRACH         MaxReportedCellsOnRACH     OPTIONAL,
    reportingInfoForCellDCH         ReportingInfoForCellDCH-LCR-r4 OPTIONAL
}

IntraFreqReportCriteria ::= CHOICE {
    intraFreqReportingCriteria      IntraFreqReportingCriteria,
    periodicalReportingCriteria     PeriodicalWithReportingCellStatus,
    noReporting                     ReportingCellStatusOpt
}

IntraFreqReportCriteria-r4 ::= CHOICE {
    intraFreqReportingCriteria-r4   IntraFreqReportingCriteria-r4,
    periodicalReportingCriteria     PeriodicalWithReportingCellStatus,
    noReporting                     ReportingCellStatusOpt
}

IntraFreqReportingCriteria ::= SEQUENCE {
    eventCriteriaList              IntraFreqEventCriteriaList OPTIONAL
}

IntraFreqReportingCriteria-r4 ::= SEQUENCE {
    eventCriteriaList              IntraFreqEventCriteriaList-r4 OPTIONAL
}

IntraFreqReportingCriteria-LCR-r4 ::= SEQUENCE {
    eventCriteriaList              IntraFreqEventCriteriaList-LCR-r4 OPTIONAL
}

IntraFreqReportingQuantity ::= SEQUENCE {
    activeSetReportingQuantities    CellReportingQuantities,
    monitoredSetReportingQuantities CellReportingQuantities,
    detectedSetReportingQuantities  CellReportingQuantities OPTIONAL
}

IntraFreqReportingQuantityForRACH ::= SEQUENCE {
    sfn-SFN-OTD-Type              SFN-SFN-OTD-Type,
    modeSpecificInfo               CHOICE {
        fdd                       SEQUENCE {
            intraFreqRepQuantityRACH-FDD IntraFreqRepQuantityRACH-FDD
        },

```



```

        tdd
        }
    }
}

IntraFreqRepQuantityRACH-FDD ::= ENUMERATED {
    cpich-EcN0, cpich-RSCP,
    pathloss, noReport }

IntraFreqRepQuantityRACH-TDD ::= ENUMERATED {
    timeslotISCP,
    primaryCCPCH-RSCP,
    noReport }

IntraFreqRepQuantityRACH-TDDList ::= SEQUENCE (SIZE (1..2)) OF
    IntraFreqRepQuantityRACH-TDD

IntraFrequencyMeasurement ::= SEQUENCE {
    intraFreqCellInfoList          IntraFreqCellInfoList          OPTIONAL,
    intraFreqMeasQuantity          IntraFreqMeasQuantity          OPTIONAL,
    intraFreqReportingQuantity     IntraFreqReportingQuantity     OPTIONAL,
    measurementValidity            MeasurementValidity          OPTIONAL,
    reportCriteria                 IntraFreqReportCriteria      OPTIONAL
}

IntraFrequencyMeasurement-r4 ::= SEQUENCE {
    intraFreqCellInfoList-r4      IntraFreqCellInfoList-r4      OPTIONAL,
    intraFreqMeasQuantity         IntraFreqMeasQuantity         OPTIONAL,
    intraFreqReportingQuantity    IntraFreqReportingQuantity    OPTIONAL,
    measurementValidity           MeasurementValidity            OPTIONAL,
    reportCriteria-r4            IntraFreqReportCriteria-r4    OPTIONAL
}

IODE ::= INTEGER (0..255)

IP-Length ::= ENUMERATED {
    ip15, ip110 }

IP-PCCPCH-r4 ::= BOOLEAN

IP-Spacing ::= ENUMERATED {
    e5, e7, e10, e15, e20,
    e30, e40, e50 }

IP-Spacing-TDD ::= ENUMERATED {
    e30, e40, e50, e70, e100}

IS-2000SpecificMeasInfo ::= ENUMERATED {
    frequency, timeslot, colourcode,
    outputpower, pn-Offset }

MaxNumberOfReportingCellsType1 ::= ENUMERATED {
    e1, e2, e3, e4, e5, e6}

MaxNumberOfReportingCellsType2 ::= ENUMERATED {
    e1, e2, e3, e4, e5, e6, e7, e8, e9, e10, e11, e12}

MaxNumberOfReportingCellsType3 ::= ENUMERATED {
    viactCellsPlus1,
    viactCellsPlus2,
    viactCellsPlus3,
    viactCellsPlus4,
    viactCellsPlus5,
    viactCellsPlus6 }

MaxReportedCellsOnRACH ::= ENUMERATED {
    noReport,
    currentCell,
    currentAnd-1-BestNeighbour,
    currentAnd-2-BestNeighbour,
    currentAnd-3-BestNeighbour,
    currentAnd-4-BestNeighbour,
    currentAnd-5-BestNeighbour,
    currentAnd-6-BestNeighbour }

MeasuredResults ::= CHOICE {
    intraFreqMeasuredResultsList IntraFreqMeasuredResultsList,

```

```

interFreqMeasuredResultsList      InterFreqMeasuredResultsList,
interRATMeasuredResultsList      InterRATMeasuredResultsList,
trafficVolumeMeasuredResultsList  TrafficVolumeMeasuredResultsList,
qualityMeasuredResults            QualityMeasuredResults,
ue-InternalMeasuredResults        UE-InternalMeasuredResults,
ue-positioning-MeasuredResults    UE-Positioning-MeasuredResults,
spare                             NULL
}

MeasuredResults-v390ext ::=          SEQUENCE {
    ue-positioning-MeasuredResults-v390ext  UE-Positioning-MeasuredResults-v390ext
}

MeasuredResults-LCR-r4 ::=          CHOICE {
    intraFreqMeasuredResultsList          IntraFreqMeasuredResultsList,
    interFreqMeasuredResultsList          InterFreqMeasuredResultsList,
    interRATMeasuredResultsList          InterRATMeasuredResultsList,
    trafficVolumeMeasuredResultsList      TrafficVolumeMeasuredResultsList,
    qualityMeasuredResults                QualityMeasuredResults,
    ue-InternalMeasuredResults            UE-InternalMeasuredResults-LCR-r4,
    ue-positioning-MeasuredResults        UE-Positioning-MeasuredResults,
    spare                                 NULL
}

MeasuredResultsList ::=              SEQUENCE (SIZE (1..maxAdditionalMeas)) OF
    MeasuredResults

MeasuredResultsList-LCR-r4-ext ::=   SEQUENCE (SIZE (1..maxAdditionalMeas)) OF
    MeasuredResults-LCR-r4

MeasuredResultsOnRACH ::=            SEQUENCE {
    currentCell                          SEQUENCE {
        modeSpecificInfo                  CHOICE {
            fdd                            SEQUENCE {
                measurementQuantity        CHOICE {
                    cpich-Ec-N0            CPICH-Ec-N0,
                    cpich-RSCP             CPICH-RSCP,
                    pathloss                Pathloss,
                    spare                   NULL
                }
            },
            tdd                            SEQUENCE {
                timeslotISCP                TimeslotISCP-List          OPTIONAL,
                primaryCCPCH-RSCP           PrimaryCCPCH-RSCP         OPTIONAL
            }
        },
        monitoredCells                      MonitoredCellRACH-List    OPTIONAL
    }
}

MeasurementCommand ::=               CHOICE {
    setup                                 MeasurementType,
    modify                                 SEQUENCE {
        measurementType                    MeasurementType          OPTIONAL
    },
    release                                NULL
}

MeasurementCommand-r4 ::=             CHOICE {
    setup                                 MeasurementType-r4,
    modify                                 SEQUENCE {
        measurementType                    MeasurementType-r4      OPTIONAL
    },
    release                                NULL
}

MeasurementControlSysInfo ::=        SEQUENCE {
    use-of-HCS                            CHOICE {
        hcs-not-used                       SEQUENCE {
            cellSelectQualityMeasure        CHOICE {
                cpich-RSCP                   SEQUENCE {
                    intraFreqMeasurementSysInfo  IntraFreqMeasurementSysInfo-RSCP
                }
            },
            interFreqMeasurementSysInfo      InterFreqMeasurementSysInfo-RSCP  OPTIONAL
        },
        cpich-Ec-N0                         SEQUENCE {
            intraFreqMeasurementSysInfo      IntraFreqMeasurementSysInfo-ECN0
        }
    }
    OPTIONAL,
}
OPTIONAL,

```

```

        interFreqMeasurementSysInfo      InterFreqMeasurementSysInfo-ECN0      OPTIONAL
    },
    },
    interRATMeasurementSysInfo      InterRATMeasurementSysInfo-B      OPTIONAL
},
hcs-used
    cellSelectQualityMeasure      SEQUENCE      {
        cpich-RSCP      CHOICE      {
            intraFreqMeasurementSysInfo      IntraFreqMeasurementSysInfo-HCS-RSCP
OPTIONAL,
            interFreqMeasurementSysInfo      InterFreqMeasurementSysInfo-HCS-RSCP
OPTIONAL
        },
        cpich-Ec-N0      SEQUENCE      {
            intraFreqMeasurementSysInfo      IntraFreqMeasurementSysInfo-HCS-ECN0
OPTIONAL,
            interFreqMeasurementSysInfo      InterFreqMeasurementSysInfo-HCS-ECN0
OPTIONAL
        }
    },
    interRATMeasurementSysInfo      InterRATMeasurementSysInfo      OPTIONAL
},
},
trafficVolumeMeasSysInfo      TrafficVolumeMeasSysInfo      OPTIONAL,
-- dummy is not used in this version of specification and it shall be ignored by the UE.
dummy      UE-InternalMeasurementSysInfo      OPTIONAL
}

MeasurementControlSysInfo-LCR-r4-ext ::= SEQUENCE {
-- CHOICE use-of-HCS shall have the same value as the use-of-HCS
-- in MeasurementControlSysInfo
use-of-HCS      CHOICE {
    hcs-not-used      SEQUENCE {
-- CHOICE cellSelectQualityMeasure shall have the same value as the
-- cellSelectQualityMeasure in MeasurementControlSysInfo
cellSelectQualityMeasure      CHOICE {
        cpich-RSCP      SEQUENCE {
            intraFreqMeasurementSysInfo      IntraFreqMeasurementSysInfo-RSCP-LCR-r4      OPTIONAL,
            interFreqMeasurementSysInfo      InterFreqMeasurementSysInfo-RSCP-LCR-r4      OPTIONAL
        },
        cpich-Ec-N0      SEQUENCE {
            intraFreqMeasurementSysInfo      IntraFreqMeasurementSysInfo-ECN0-LCR-r4      OPTIONAL,
            interFreqMeasurementSysInfo      InterFreqMeasurementSysInfo-ECN0-LCR-r4      OPTIONAL
        }
    }
},
},
hcs-used
    cellSelectQualityMeasure      SEQUENCE      {
-- CHOICE cellSelectQualityMeasure shall have the same value as the
-- cellSelectQualityMeasure in MeasurementControlSysInfo
cellSelectQualityMeasure      CHOICE      {
        cpich-RSCP      SEQUENCE      {
            intraFreqMeasurementSysInfo      IntraFreqMeasurementSysInfo-HCS-RSCP-LCR-r4
OPTIONAL,
            interFreqMeasurementSysInfo      InterFreqMeasurementSysInfo-HCS-RSCP-LCR-r4      OPTIONAL
        },
        cpich-Ec-N0      SEQUENCE      {
            intraFreqMeasurementSysInfo      IntraFreqMeasurementSysInfo-HCS-ECN0-LCR-r4
OPTIONAL,
            interFreqMeasurementSysInfo      InterFreqMeasurementSysInfo-HCS-ECN0-LCR-r4      OPTIONAL
        }
    }
},
},
}

MeasurementIdentity ::= INTEGER (1..16)

MeasurementQuantityGSM ::= ENUMERATED {
    gsm-CarrierRSSI,
    dummy }

MeasurementReportingMode ::= SEQUENCE {
    measurementReportTransferMode      TransferMode,
    periodicalOrEventTrigger      PeriodicalOrEventTrigger
}

MeasurementType ::= CHOICE {
    intraFrequencyMeasurement      IntraFrequencyMeasurement,

```

```

interFrequencyMeasurement      InterFrequencyMeasurement,
interRATMeasurement            InterRATMeasurement,
ue-positioning-Measurement      UE-Positioning-Measurement,
trafficVolumeMeasurement        TrafficVolumeMeasurement,
qualityMeasurement              QualityMeasurement,
ue-InternalMeasurement          UE-InternalMeasurement
}

MeasurementType-r4 ::=
  intraFrequencyMeasurement      IntraFrequencyMeasurement-r4,
  interFrequencyMeasurement      InterFrequencyMeasurement-r4,
  interRATMeasurement            InterRATMeasurement-r4,
  up-Measurement                  UE-Positioning-Measurement-r4,
  trafficVolumeMeasurement        TrafficVolumeMeasurement,
  qualityMeasurement              QualityMeasurement,
  ue-InternalMeasurement          UE-InternalMeasurement-r4
}

MeasurementValidity ::=
  ue-State                       SEQUENCE {
                                  ENUMERATED {
                                    cell-DCH, all-But-Cell-DCH, all-States }
                                  }
}

MonitoredCellRACH-List ::=
  SEQUENCE (SIZE (1..8)) OF
    MonitoredCellRACH-Result

MonitoredCellRACH-Result ::=
  sfm-SFM-ObsTimeDifference      SFM-SFM-ObsTimeDifference      OPTIONAL,
  modeSpecificInfo               CHOICE {
    fdd                           SEQUENCE {
      primaryCPICH-Info           PrimaryCPICH-Info,
      measurementQuantity         CHOICE {
        cpich-Ec-NO               CPICH-Ec-NO,
        cpich-RSCP                 CPICH-RSCP,
        pathloss                   Pathloss,
        spare                       NULL
      }
    },
    tdd                           SEQUENCE {
      cellParametersID            CellParametersID,
      primaryCCPCH-RSCP           PrimaryCCPCH-RSCP
    }
  }
}

MultipathIndicator ::=
  ENUMERATED {
    nm,
    low,
    medium,
    high }

N-CR-T-CRMaxHyst ::=
  n-CR                           SEQUENCE {
    t-CRMaxHyst                   INTEGER (1..16)
  }
                                  DEFAULT 8,

NavigationModelSatInfo ::=
  satID                           SEQUENCE {
    satID                          SatID,
    satelliteStatus                 SatelliteStatus,
    ephemerisParameter              EphemerisParameter      OPTIONAL
  }

NavigationModelSatInfoList ::=
  SEQUENCE (SIZE (1..maxSat)) OF
    NavigationModelSatInfo

EphemerisParameter ::=
  codeOnL2                         SEQUENCE {
    codeOnL2                        BIT STRING (SIZE (2)),
    uraIndex                         BIT STRING (SIZE (4)),
    satHealth                         BIT STRING (SIZE (6)),
    iodc                             BIT STRING (SIZE (10)),
    l2Pflag                          BIT STRING (SIZE (1)),
    sflRevd                          SubFrame1Reserved,
    t-GD                             BIT STRING (SIZE (8)),
    t-oc                             BIT STRING (SIZE (16)),
    af2                              BIT STRING (SIZE (8)),
    af1                              BIT STRING (SIZE (16)),
    af0                              BIT STRING (SIZE (22)),
    c-rs                             BIT STRING (SIZE (16)),
  }

```

```

delta-n          BIT STRING (SIZE (16)),
m0              BIT STRING (SIZE (32)),
c-uc           BIT STRING (SIZE (16)),
e              BIT STRING (SIZE (32)),
c-us           BIT STRING (SIZE (16)),
a-Sqrt         BIT STRING (SIZE (32)),
t-oe           BIT STRING (SIZE (16)),
fitInterval    BIT STRING (SIZE (1)),
aodo           BIT STRING (SIZE (5)),
c-ic           BIT STRING (SIZE (16)),
omega0         BIT STRING (SIZE (32)),
c-is           BIT STRING (SIZE (16)),
i0            BIT STRING (SIZE (32)),
c-rc           BIT STRING (SIZE (16)),
omega          BIT STRING (SIZE (32)),
omegaDot       BIT STRING (SIZE (24)),
iDot           BIT STRING (SIZE (14))
}
NC-Mode ::= BIT STRING (SIZE (3))

Neighbour ::= SEQUENCE {
  modeSpecificInfo CHOICE {
    fdd SEQUENCE {
      neighbourIdentity PrimaryCPICH-Info OPTIONAL,
      ue-RX-TX-TimeDifferenceType2Info UE-RX-TX-TimeDifferenceType2Info OPTIONAL
    },
    tdd SEQUENCE {
      neighbourAndChannelIdentity CellAndChannelIdentity OPTIONAL
    }
  },
  neighbourQuality NeighbourQuality,
  sfm-SFN-ObsTimeDifference2 SFM-SFN-ObsTimeDifference2}

Neighbour-v390ext ::= SEQUENCE {
  modeSpecificInfo CHOICE {
    fdd SEQUENCE {
      frequencyInfo FrequencyInfo
    },
    tdd NULL
  }
}

NeighbourList ::= SEQUENCE (SIZE (1..maxCellMeas)) OF
  Neighbour

-- The order of the cells in IE NeighbourList-v390ext shall be the
-- same as the order in IE NeighbourList
NeighbourList-v390ext ::= SEQUENCE (SIZE (1..maxCellMeas)) OF
  Neighbour-v390ext

NeighbourQuality ::= SEQUENCE {
  ue-Positioning-OTDOA-Quality UE-Positioning-OTDOA-Quality
}

NewInterFreqCell ::= SEQUENCE {
  interFreqCellID InterFreqCellID OPTIONAL,
  frequencyInfo FrequencyInfo OPTIONAL,
  cellInfo CellInfo
}

NewInterFreqCell-r4 ::= SEQUENCE {
  interFreqCellID InterFreqCellID OPTIONAL,
  frequencyInfo FrequencyInfo OPTIONAL,
  cellInfo-r4 CellInfo-r4
}

NewInterFreqCellList ::= SEQUENCE (SIZE (1..maxCellMeas)) OF
  NewInterFreqCell

NewInterFreqCellList-r4 ::= SEQUENCE (SIZE (1..maxCellMeas)) OF
  NewInterFreqCell-r4

NewInterFreqCellSI-RSCP ::= SEQUENCE {
  interFreqCellID InterFreqCellID OPTIONAL,
  frequencyInfo FrequencyInfo OPTIONAL,
  cellInfo CellInfoSI-RSCP
}

```

```

NewInterFreqCellSI-ECN0 ::=
    interFreqCellID
    frequencyInfo
    cellInfo
}
SEQUENCE {
    InterFreqCellID
    FrequencyInfo
    CellInfoSI-ECN0
}
OPTIONAL,
OPTIONAL,

NewInterFreqCellSI-HCS-RSCP ::=
    interFreqCellID
    frequencyInfo
    cellInfo
}
SEQUENCE {
    InterFreqCellID
    FrequencyInfo
    CellInfoSI-HCS-RSCP
}
OPTIONAL,
OPTIONAL,

NewInterFreqCellSI-HCS-ECN0 ::=
    interFreqCellID
    frequencyInfo
    cellInfo
}
SEQUENCE {
    InterFreqCellID
    FrequencyInfo
    CellInfoSI-HCS-ECN0
}
OPTIONAL,
OPTIONAL,

NewInterFreqCellSI-RSCP-LCR-r4 ::=
    interFreqCellID
    frequencyInfo
    cellInfo
}
SEQUENCE {
    InterFreqCellID
    FrequencyInfo
    CellInfoSI-RSCP-LCR-r4
}
OPTIONAL,
OPTIONAL,

NewInterFreqCellSI-ECN0-LCR-r4 ::=
    interFreqCellID
    frequencyInfo
    cellInfo
}
SEQUENCE {
    InterFreqCellID
    FrequencyInfo
    CellInfoSI-ECN0-LCR-r4
}
OPTIONAL,
OPTIONAL,

NewInterFreqCellSI-HCS-RSCP-LCR-r4 ::=
    interFreqCellID
    frequencyInfo
    cellInfo
}
SEQUENCE {
    InterFreqCellID
    FrequencyInfo
    CellInfoSI-HCS-RSCP-LCR-r4
}
OPTIONAL,
OPTIONAL,

NewInterFreqCellSI-HCS-ECN0-LCR-r4 ::=
    interFreqCellID
    frequencyInfo
    cellInfo
}
SEQUENCE {
    InterFreqCellID
    FrequencyInfo
    CellInfoSI-HCS-ECN0-LCR-r4
}
OPTIONAL,
OPTIONAL,

NewInterFreqCellSI-List-ECN0 ::=
    SEQUENCE (SIZE (1..maxCellMeas)) OF
    NewInterFreqCellSI-ECN0

NewInterFreqCellSI-List-HCS-RSCP ::=
    SEQUENCE (SIZE (1..maxCellMeas)) OF
    NewInterFreqCellSI-HCS-RSCP

NewInterFreqCellSI-List-HCS-ECN0 ::=
    SEQUENCE (SIZE (1..maxCellMeas)) OF
    NewInterFreqCellSI-HCS-ECN0

NewInterFreqCellSI-List-RSCP ::=
    SEQUENCE (SIZE (1..maxCellMeas)) OF
    NewInterFreqCellSI-RSCP

NewInterFreqCellSI-List-ECN0-LCR-r4 ::=
    SEQUENCE (SIZE (1..maxCellMeas)) OF
    NewInterFreqCellSI-ECN0-LCR-r4

NewInterFreqCellSI-List-HCS-RSCP-LCR-r4 ::= SEQUENCE (SIZE (1..maxCellMeas)) OF
    NewInterFreqCellSI-HCS-RSCP-LCR-r4

NewInterFreqCellSI-List-HCS-ECN0-LCR-r4 ::= SEQUENCE (SIZE (1..maxCellMeas)) OF
    NewInterFreqCellSI-HCS-ECN0-LCR-r4

NewInterFreqCellSI-List-RSCP-LCR-r4 ::= SEQUENCE (SIZE (1..maxCellMeas)) OF
    NewInterFreqCellSI-RSCP-LCR-r4

NewInterRATCell ::=
    interRATCellID
    technologySpecificInfo
    gsm
    cellSelectionReselectionInfo
    interRATCellIndividualOffset
    bsic
    frequency-band
    bcch-ARFCN
    -- dummy is not used in this version of the specification, it should
    -- not be sent and if received it should be ignored.
    dummy
}
SEQUENCE {
    InterRATCellID
    CHOICE {
        SEQUENCE {
            CellSelectReselectInfoSIB-11-12
            InterRATCellIndividualOffset,
            BSIC,
            Frequency-Band,
            BCCH-ARFCN,
            NULL
        }
        NULL
    }
}
OPTIONAL,
OPTIONAL,
OPTIONAL,

```

```

    },
    is-2000                                SEQUENCE {
        is-2000SpecificMeasInfo            IS-2000SpecificMeasInfo
    },
    -- ASN.1 inconsistency: NewInterRATCellList should be optional within
    -- InterRATCellInfoList. The UE shall consider IE NewInterRATCell with
    -- technologySpecificInfo set to "absent" as valid and handle the
    -- message as if the IE NewInterRATCell was absent
    absent                                  NULL,
    spare1                                  NULL
}
}

NewInterRATCell-B ::=                      SEQUENCE {
    interRATCellID                          InterRATCellID                OPTIONAL,
    technologySpecificInfo                   CHOICE {
        gsm                                  SEQUENCE {
            cellSelectionReselectionInfo    CellSelectReselectInfoSIB-11-12  OPTIONAL,
            interRATCellIndividualOffset    InterRATCellIndividualOffset,
            bsic                             BSIC,
            frequency-band                   Frequency-Band,
            bcch-ARFCN                       BCCH-ARFCN,
            -- dummy is not used in this version of the specification, it should
            -- not be sent and if received it should be ignored.
            dummy                             NULL                        OPTIONAL
        },
        is-2000                               SEQUENCE {
            is-2000SpecificMeasInfo        IS-2000SpecificMeasInfo
        },
        -- ASN.1 inconsistency: NewInterRATCellList-B should be optional within
        -- InterRATCellInfoList-B. The UE shall consider IE NewInterRATCell-B with
        -- technologySpecificInfo set to "absent" as valid and handle the
        -- message as if the IE NewInterRATCell-B was absent
        absent                                  NULL,
        spare1                                  NULL
    }
}

NewInterRATCellList ::=                    SEQUENCE (SIZE (1..maxCellMeas)) OF
    NewInterRATCell

NewInterRATCellList-B ::=                  SEQUENCE (SIZE (1..maxCellMeas)) OF
    NewInterRATCell-B

NewIntraFreqCell ::=                       SEQUENCE {
    intraFreqCellID                          IntraFreqCellID                OPTIONAL,
    cellInfo                                  CellInfo
}

NewIntraFreqCell-r4 ::=                    SEQUENCE {
    intraFreqCellID                          IntraFreqCellID                OPTIONAL,
    cellInfo                                  CellInfo-r4
}

NewIntraFreqCellList ::=                   SEQUENCE (SIZE (1..maxCellMeas)) OF
    NewIntraFreqCell

NewIntraFreqCellList-r4 ::=                SEQUENCE (SIZE (1..maxCellMeas)) OF
    NewIntraFreqCell-r4

NewIntraFreqCellSI-RSCP ::=                SEQUENCE {
    intraFreqCellID                          IntraFreqCellID                OPTIONAL,
    cellInfo                                  CellInfoSI-RSCP
}

NewIntraFreqCellSI-ECN0 ::=                SEQUENCE {
    intraFreqCellID                          IntraFreqCellID                OPTIONAL,
    cellInfo                                  CellInfoSI-ECN0
}

NewIntraFreqCellSI-HCS-RSCP ::=            SEQUENCE {
    intraFreqCellID                          IntraFreqCellID                OPTIONAL,
    cellInfo                                  CellInfoSI-HCS-RSCP
}

NewIntraFreqCellSI-HCS-ECN0 ::=            SEQUENCE {
    intraFreqCellID                          IntraFreqCellID                OPTIONAL,
    cellInfo                                  CellInfoSI-HCS-ECN0
}

```

```

NewIntraFreqCellSI-RSCP-LCR-r4 ::= SEQUENCE {
    intraFreqCellID                      OPTIONAL,
    cellInfo                              CellInfoSI-RSCP-LCR-r4
}

NewIntraFreqCellSI-ECN0-LCR-r4 ::= SEQUENCE {
    intraFreqCellID                      OPTIONAL,
    cellInfo                              CellInfoSI-ECN0-LCR-r4
}

NewIntraFreqCellSI-HCS-RSCP-LCR-r4 ::= SEQUENCE {
    intraFreqCellID                      OPTIONAL,
    cellInfo                              CellInfoSI-HCS-RSCP-LCR-r4
}

NewIntraFreqCellSI-HCS-ECN0-LCR-r4 ::= SEQUENCE {
    intraFreqCellID                      OPTIONAL,
    cellInfo                              CellInfoSI-HCS-ECN0-LCR-r4
}

NewIntraFreqCellSI-List-RSCP ::= SEQUENCE (SIZE (1..maxCellMeas)) OF
    NewIntraFreqCellSI-RSCP

NewIntraFreqCellSI-List-ECN0 ::= SEQUENCE (SIZE (1..maxCellMeas)) OF
    NewIntraFreqCellSI-ECN0

NewIntraFreqCellSI-List-HCS-RSCP ::= SEQUENCE (SIZE (1..maxCellMeas)) OF
    NewIntraFreqCellSI-HCS-RSCP

NewIntraFreqCellSI-List-HCS-ECN0 ::= SEQUENCE (SIZE (1..maxCellMeas)) OF
    NewIntraFreqCellSI-HCS-ECN0

NewIntraFreqCellSI-List-RSCP-LCR-r4 ::= SEQUENCE (SIZE (1..maxCellMeas)) OF
    NewIntraFreqCellSI-RSCP-LCR-r4

NewIntraFreqCellSI-List-ECN0-LCR-r4 ::= SEQUENCE (SIZE (1..maxCellMeas)) OF
    NewIntraFreqCellSI-ECN0-LCR-r4

NewIntraFreqCellSI-List-HCS-RSCP-LCR-r4 ::= SEQUENCE (SIZE (1..maxCellMeas)) OF
    NewIntraFreqCellSI-HCS-RSCP-LCR-r4

NewIntraFreqCellSI-List-HCS-ECN0-LCR-r4 ::= SEQUENCE (SIZE (1..maxCellMeas)) OF
    NewIntraFreqCellSI-HCS-ECN0-LCR-r4

-- IE "nonUsedFreqThreshold" is not needed in case of event 2a
-- In case of event 2a UTRAN should include value 0 within IE "nonUsedFreqThreshold"
-- In case of event 2a, the UE shall be ignore IE "nonUsedFreqThreshold"
-- In later versions of the message including this IE, a special version of
-- IE "NonUsedFreqParameterList" may be defined for event 2a, namely a
-- version not including IE "nonUsedFreqThreshold"
NonUsedFreqParameter ::= SEQUENCE {
    nonUsedFreqThreshold                Threshold,
    nonUsedFreqW                        W
}

NonUsedFreqParameterList ::= SEQUENCE (SIZE (1..maxFreq)) OF
    NonUsedFreqParameter

ObservedTimeDifferenceToGSM ::= INTEGER (0..4095)

OTDOA-SearchWindowSize ::= ENUMERATED {
    c20, c40, c80, c160, c320,
    c640, c1280, moreThan1280 }

-- SPARE: Pathloss, Max = 158
-- Values above Max are spare
Pathloss ::= INTEGER (46..173)

PenaltyTime-RSCP ::= CHOICE {
    notUsed                            NULL,
    pt10                               TemporaryOffset1,
    pt20                               TemporaryOffset1,
    pt30                               TemporaryOffset1,
    pt40                               TemporaryOffset1,
    pt50                               TemporaryOffset1,
    pt60                               TemporaryOffset1
}

```



```

PenaltyTime-ECNO ::= CHOICE {
    notUsed          NULL,
    pt10             TemporaryOffsetList,
    pt20             TemporaryOffsetList,
    pt30             TemporaryOffsetList,
    pt40             TemporaryOffsetList,
    pt50             TemporaryOffsetList,
    pt60             TemporaryOffsetList
}

PendingTimeAfterTrigger ::= ENUMERATED {
    ptat0-25, ptat0-5, ptat1,
    ptat2, ptat4, ptat8, ptat16 }

PeriodicalOrEventTrigger ::= ENUMERATED {
    periodical,
    eventTrigger }

PeriodicalReportingCriteria ::= SEQUENCE {
    reportingAmount          ReportingAmount          DEFAULT ra-Infinity,
    reportingInterval        ReportingIntervalLong
}

PeriodicalWithReportingCellStatus ::= SEQUENCE {
    periodicalReportingCriteria PeriodicalReportingCriteria,
    reportingCellStatus         ReportingCellStatus         OPTIONAL
}

PLMNIde ntitiesOfNeighbourCells ::= SEQUENCE {
    plmnsOfIntraFreqCellsList PLMNsOfIntraFreqCellsList    OPTIONAL,
    plmnsOfInterFreqCellsList PLMNsOfInterFreqCellsList    OPTIONAL,
    plmnsOfInterRATCellsList  PLMNsOfInterRATCellsList    OPTIONAL
}

PLMNsOfInterFreqCellsList ::= SEQUENCE (SIZE (1..maxCellMeas)) OF
    SEQUENCE {
        plmn-Identity          PLMN-Identity          OPTIONAL
    }

PLMNsOfIntraFreqCellsList ::= SEQUENCE (SIZE (1..maxCellMeas)) OF
    SEQUENCE {
        plmn-Identity          PLMN-Identity          OPTIONAL
    }

PLMNsOfInterRATCellsList ::= SEQUENCE (SIZE (1..maxCellMeas)) OF
    SEQUENCE {
        plmn-Identity          PLMN-Identity          OPTIONAL
    }

PositionEstimate ::= CHOICE {
    ellipsoidPoint,
    ellipsoidPointUncertCircle,
    ellipsoidPointUncertEllipse,
    ellipsoidPointAltitude,
    ellipsoidPointAltitudeEllipsoide
}

PositioningMethod ::= ENUMERATED {
    otdoa,
    gps,
    otdoaOrGPS, cellID }

-- Actual value PRC = IE value * 0.32
PRC ::= INTEGER (-2047..2047)

-- SPARE: PrimaryCCPCH-RSCP, Max = 91
-- Values above Max are spare
PrimaryCCPCH-RSCP ::= INTEGER (0..127)

Q-HCS ::= INTEGER (0..99)

Q-OffsetS-N ::= INTEGER (-50..50)

Q-QualMin ::= INTEGER (-24..0)

-- Actual value Q-RxlevMin = (IE value * 2) + 1
Q-RxlevMin ::= INTEGER (-58..-13)

```

```

QualityEventResults ::= SEQUENCE (SIZE (1..maxTrCH)) OF
                        TransportChannelIdentity

QualityMeasuredResults ::= SEQUENCE {
  blerMeasurementResultsList    BLER-MeasurementResultsList    OPTIONAL,
  modeSpecificInfo              CHOICE {
    fdd                          NULL,
    tdd                          SEQUENCE {
      sir-MeasurementResults      SIR-MeasurementList    OPTIONAL
    }
  }
}

QualityMeasurement ::= SEQUENCE {
  qualityReportingQuantity      QualityReportingQuantity    OPTIONAL,
  reportCriteria                QualityReportCriteria
}

QualityReportCriteria ::= CHOICE {
  qualityReportingCriteria      QualityReportingCriteria,
  periodicalReportingCriteria   PeriodicalReportingCriteria,
  noReporting                   NULL
}

QualityReportingCriteria ::= SEQUENCE (SIZE (1..maxTrCH)) OF
                             QualityReportingCriteriaSingle

QualityReportingCriteriaSingle ::= SEQUENCE {
  transportChannelIdentity      TransportChannelIdentity,
  totalCRC                      INTEGER (1..512),
  badCRC                        INTEGER (1..512),
  pendingAfterTrigger           INTEGER (1..512)
}

QualityReportingQuantity ::= SEQUENCE {
  dl-TransChBLER                BOOLEAN,
  bler-dl-TransChIdList         BLER-TransChIdList    OPTIONAL,
  modeSpecificInfo              CHOICE {
    fdd                          NULL,
    tdd                          SEQUENCE {
      sir-TFCS-List              SIR-TFCS-List    OPTIONAL
    }
  }
}

RAT-Type ::= ENUMERATED {
  gsm, is2000 }

ReferenceCellPosition ::= CHOICE {
  ellipsoidPoint                EllipsoidPoint,
  ellipsoidPointWithAltitude    EllipsoidPointAltitude
}

-- ReferenceLocation, as defined in 23.032
ReferenceLocation ::= SEQUENCE {
  ellipsoidPointAltitudeEllipsoide EllipsoidPointAltitudeEllipsoide
}

ReferenceTimeDifferenceToCell ::= CHOICE {
  -- Actual value accuracy40 = IE value * 40
  accuracy40                     INTEGER (0..960),
  -- Actual value accuracy256 = IE value * 256
  accuracy256                     INTEGER (0..150),
  -- Actual value accuracy2560 = IE value * 2560
  accuracy2560                    INTEGER (0..15)
}

RemovedInterFreqCellList ::= CHOICE {
  removeAllInterFreqCells        NULL,
  removeSomeInterFreqCells       SEQUENCE (SIZE (1..maxCellMeas)) OF
                                  InterFreqCellID,
  removeNoInterFreqCells         NULL
}

RemovedInterRATCellList ::= CHOICE {
  removeAllInterRATCells          NULL,
  removeSomeInterRATCells         SEQUENCE (SIZE (1..maxCellMeas)) OF
                                  InterRATCellID,
}

```

```

    removeNoInterRATCells      NULL
}

RemovedIntraFreqCellList ::= CHOICE {
    removeAllIntraFreqCells    NULL,
    removeSomeIntraFreqCells   SEQUENCE (SIZE (1..maxCellMeas)) OF
                                IntraFreqCellID,
    removeNoIntraFreqCells     NULL
}

ReplacementActivationThreshold ::= ENUMERATED {
    notApplicable, t1, t2,
    t3, t4, t5, t6, t7 }

ReportDeactivationThreshold ::= ENUMERATED {
    notApplicable, t1, t2,
    t3, t4, t5, t6, t7 }

ReportingAmount ::= ENUMERATED {
    ra1, ra2, ra4, ra8, ra16, ra32,
    ra64, ra-Infinity }

ReportingCellStatus ::= CHOICE{
    withinActiveSet              MaxNumberOfReportingCellsType1,
    withinMonitoredSetUsedFreq   MaxNumberOfReportingCellsType1,
    withinActiveAndOrMonitoredUsedFreq MaxNumberOfReportingCellsType1,
    withinDetectedSetUsedFreq    MaxNumberOfReportingCellsType1,
    withinMonitoredAndOrDetectedUsedFreq
                                MaxNumberOfReportingCellsType1,
    allActiveplusMonitoredSet    MaxNumberOfReportingCellsType3,
    allActivePlusDetectedSet     MaxNumberOfReportingCellsType3,
    allActivePlusMonitoredAndOrDetectedSet
                                MaxNumberOfReportingCellsType3,
    withinVirtualActSet          MaxNumberOfReportingCellsType1,
    withinMonitoredSetNonUsedFreq MaxNumberOfReportingCellsType1,
    withinMonitoredAndOrVirtualActiveSetNonUsedFreq
                                MaxNumberOfReportingCellsType1,
    allVirtualActSetplusMonitoredSetNonUsedFreq
                                MaxNumberOfReportingCellsType3,
    withinActSetOrVirtualActSet-InterRATcells
                                MaxNumberOfReportingCellsType2,
    withinActSetAndOrMonitoredUsedFreqOrVirtualActSetAndOrMonitoredNonUsedFreq
                                MaxNumberOfReportingCellsType2
}

ReportingCellStatusOpt ::= SEQUENCE {
    reportingCellStatus          ReportingCellStatus          OPTIONAL
}

ReportingInfoForCellDCH ::= SEQUENCE {
    intraFreqReportingQuantity   IntraFreqReportingQuantity,
    measurementReportingMode     MeasurementReportingMode,
    reportCriteria               CellDCH-ReportCriteria
}

ReportingInfoForCellDCH-LCR-r4 ::= SEQUENCE {
    intraFreqReportingQuantity   IntraFreqReportingQuantity,
    measurementReportingMode     MeasurementReportingMode,
    reportCriteria               CellDCH-ReportCriteria-LCR-r4
}

ReportingInterval ::= ENUMERATED {
    noPeriodicalreporting, ri0-25,
    ri0-5, ril, ri2, ri4, ri8, ril6 }

ReportingIntervalLong ::= ENUMERATED {
    ril0, ril0-25, ril0-5, ril1,
    ril2, ril3, ril4, ril6, ril8,
    ril12, ril16, ril20, ril24,
    -- When the value "ril0" is used, the UE behaviour is not
    -- defined.
    ril28, ril32, ril64 }

-- Actual value ReportingRange = IE value * 0.5
ReportingRange ::= INTEGER (0..29)

RL-AdditionInfoList ::= SEQUENCE (SIZE (1..maxRL)) OF

```

```

PrimaryCPICH-Info

RL-InformationLists ::=
    rl-AdditionInfoList
    rL-RemovalInformationList
}

SEQUENCE {
    RL-AdditionInfoList          OPTIONAL,
    RL-RemovalInformationList    OPTIONAL
}

RLC-BuffersPayload ::=
    ENUMERATED {
        pl0, pl4, pl8, pl16, pl32,
        pl64, pl128, pl256, pl512, pl1024,
        pl2k, pl4k, pl8k, pl16k, pl32k,
        pl64k, pl128k, pl256k, pl512k, pl1024k,
        spare12, spare11, spare10, spare9, spare8,
        spare7, spare6, spare5, spare4, spare3,
        spare2, spare1 }

-- Actual value RRC = IE value * 0.032
RRC ::=
    INTEGER (-127..127)

SatData ::=
    SEQUENCE{
        satID          SatID,
        iode            IODE
    }

SatDataList ::=
    SEQUENCE (SIZE (0..maxSat)) OF
        SatData

SatelliteStatus ::=
    ENUMERATED {
        ns-NN-U,
        es-SN,
        es-NN-U,
        rev2,
        rev }

SatID ::=
    INTEGER (0..63)

SFN-Offset-Validity ::=
    ENUMERATED { false }

SFN-SFN-Drift ::=
    ENUMERATED {
        sfnsfndrift0, sfnsfndrift1, sfnsfndrift2,
        sfnsfndrift3, sfnsfndrift4, sfnsfndrift5,
        sfnsfndrift8, sfnsfndrift10, sfnsfndrift15,
        sfnsfndrift25, sfnsfndrift35, sfnsfndrift50,
        sfnsfndrift65, sfnsfndrift80, sfnsfndrift100,
        sfnsfndrift-1, sfnsfndrift-2, sfnsfndrift-3,
        sfnsfndrift-4, sfnsfndrift-5, sfnsfndrift-8,
        sfnsfndrift-10, sfnsfndrift-15, sfnsfndrift-25,
        sfnsfndrift-35, sfnsfndrift-50, sfnsfndrift-65,
        sfnsfndrift-80, sfnsfndrift-100}

SFN-SFN-ObsTimeDifference ::=
    CHOICE {
        type1          SFN-SFN-ObsTimeDifference1,
        type2          SFN-SFN-ObsTimeDifference2
    }

-- SPARE: SFN-SFN-ObsTimeDifference1, Max = 9830399
-- For 1.28Mcps TDD, Max value of SFN-SFN-ObsTimeDifference1 is 3276799.
-- Values above Max are spare
SFN-SFN-ObsTimeDifference1 ::=
    INTEGER (0..16777215)

-- SPARE: SFN-SFN-ObsTimeDifference2, Max = 40961
-- Values above Max are spare
SFN-SFN-ObsTimeDifference2 ::=
    INTEGER (0..65535)

SFN-SFN-OTD-Type ::=
    ENUMERATED {
        noReport,
        type1,
        type2 }

SFN-SFN-RelTimeDifference1 ::=
    SEQUENCE {
        sfn-Offset          INTEGER (0 .. 4095),
        sfn-sfn-Reltimedifference
                            INTEGER (0.. 38399)
    }

SFN-TOW-Uncertainty ::=
    ENUMERATED {
        lessThan10,
        moreThan10 }

```

```

SIR ::=
    INTEGER (0..63)

SIR-MeasurementList ::=
    SEQUENCE (SIZE (1..maxCCTrCH)) OF
        SIR-MeasurementResults

SIR-MeasurementResults ::=
    SEQUENCE {
        tfcs-ID
            TFCS-IdentityPlain,
        sir-TimeslotList
            SIR-TimeslotList
    }

SIR-TFCS ::=
    TFCS-IdentityPlain

SIR-TFCS-List ::=
    SEQUENCE (SIZE (1..maxCCTrCH)) OF
        SIR-TFCS

SIR-TimeslotList ::=
    SEQUENCE (SIZE (1..maxTS)) OF
        SIR

-- SubFrame1Reserved, reserved bits in subframe 1 of the GPS navigation message
SubFrame1Reserved ::=
    SEQUENCE {
        reserved1
            BIT STRING (SIZE (23)),
        reserved2
            BIT STRING (SIZE (24)),
        reserved3
            BIT STRING (SIZE (24)),
        reserved4
            BIT STRING (SIZE (16))
    }

T-ADVinfo ::=
    SEQUENCE {
        t-ADV
            INTEGER(0..2047),
        sfn
            INTEGER(0..4095)
    }

T-CRMax ::=
    CHOICE {
        notUsed
            NULL,
        t30
            N-CR-T-CRMaxHyst,
        t60
            N-CR-T-CRMaxHyst,
        t120
            N-CR-T-CRMaxHyst,
        t180
            N-CR-T-CRMaxHyst,
        t240
            N-CR-T-CRMaxHyst
    }

T-CRMaxHyst ::=
    ENUMERATED {
        notUsed, t10, t20, t30,
        t40, t50, t60, t70 }

TemporaryOffset1 ::=
    ENUMERATED {
        to3, to6, to9, to12, to15,
        to18, to21, infinite }

TemporaryOffset2 ::=
    ENUMERATED {
        to2, to3, to4, to6, to8,
        to10, to12, infinite }

TemporaryOffsetList ::=
    SEQUENCE {
        temporaryOffset1
            TemporaryOffset1,
        temporaryOffset2
            TemporaryOffset2
    }

Threshold ::=
    INTEGER (-115..0)

ThresholdPositionChange ::=
    ENUMERATED {
        pc10, pc20, pc30, pc40, pc50,
        pc100, pc200, pc300, pc500,
        pc1000, pc2000, pc5000, pc10000,
        pc20000, pc50000, pc100000 }

ThresholdSFN-GPS-TOW ::=
    ENUMERATED {
        ms1, ms2, ms3, ms5, ms10,
        ms20, ms50, ms100 }

ThresholdSFN-SFN-Change ::=
    ENUMERATED {
        c0-25, c0-5, c1, c2, c3, c4, c5,
        c10, c20, c50, c100, c200, c500,
        c1000, c2000, c5000 }

ThresholdUsedFrequency ::=
    INTEGER (-115..165)

```

```

-- Actual value TimeInterval = IE value * 20.
TimeInterval ::=
    INTEGER (1..13)

TimeslotInfo ::=
    SEQUENCE {
        timeslotNumber
            TimeslotNumber,
        burstType
            BurstType
    }

TimeslotInfo-LCR-r4 ::=
    SEQUENCE {
        timeslotNumber
            TimeslotNumber-LCR-r4
    }

TimeslotInfoList ::=
    SEQUENCE (SIZE (1..maxTS)) OF
        TimeslotInfo

TimeslotInfoList-LCR-r4 ::=
    SEQUENCE (SIZE (1..maxTS-LCR)) OF
        TimeslotInfo-LCR-r4

TimeslotInfoList-r4 ::=
    CHOICE {
        tdd384
            SEQUENCE (SIZE (1..maxTS)) OF
                TimeslotInfo,
        tdd128
            SEQUENCE (SIZE (1..maxTS-LCR)) OF
                TimeslotInfo-LCR-r4
    }

-- SPARE: TimeslotISCP, Max = 91
-- Values above Max are spare
TimeslotISCP ::=
    INTEGER (0..127)

-- TimeslotISCP-List shall not include more than 6 elements in 1.28Mcps TDD mode.
TimeslotISCP-List ::=
    SEQUENCE (SIZE (1..maxTS)) OF
        TimeslotISCP

TimeslotListWithISCP ::=
    SEQUENCE (SIZE (1..maxTS)) OF
        TimeslotWithISCP

TimeslotWithISCP ::=
    SEQUENCE {
        timeslot
            TimeslotNumber,
        timeslotISCP
            TimeslotISCP
    }

TimeToTrigger ::=
    ENUMERATED {
        ttt0, ttt10, ttt20, ttt40, ttt60,
        ttt80, ttt100, ttt120, ttt160,
        ttt200, ttt240, ttt320, ttt640,
        ttt1280, ttt2560, ttt5000 }

TrafficVolumeEventParam ::=
    SEQUENCE {
        eventID
            TrafficVolumeEventType,
        reportingThreshold
            TrafficVolumeThreshold,
        timeToTrigger
            TimeToTrigger
            OPTIONAL,
        pendingTimeAfterTrigger
            PendingTimeAfterTrigger
            OPTIONAL,
        tx-InterruptionAfterTrigger
            TX-InterruptionAfterTrigger
            OPTIONAL
    }

TrafficVolumeEventResults ::=
    SEQUENCE {
        ul-transportChannelCausingEvent
            UL-TrCH-Identity,
        trafficVolumeEventIdentity
            TrafficVolumeEventType
    }

TrafficVolumeEventType ::=
    ENUMERATED {
        e4a,
        e4b }

TrafficVolumeMeasQuantity ::=
    CHOICE {
        rlc-BufferPayload
            NULL,
        averageRLC-BufferPayload
            TimeInterval,
        varianceOfRLC-BufferPayload
            TimeInterval
    }

TrafficVolumeMeasSysInfo ::=
    SEQUENCE {
        trafficVolumeMeasurementID
            MeasurementIdentity
            DEFAULT 4,
        trafficVolumeMeasurementObjectList
            TrafficVolumeMeasurementObjectList
            OPTIONAL,
        trafficVolumeMeasQuantity
            TrafficVolumeMeasQuantity
            OPTIONAL,
    }

```

```

    trafficVolumeReportingQuantity    TrafficVolumeReportingQuantity    OPTIONAL,
    -- dummy is not used in this version of specification, it should
    -- not be sent and if received it should be ignored.
    dummy                             TrafficVolumeReportingCriteria    OPTIONAL,
    measurementValidity               MeasurementValidity                OPTIONAL,
    measurementReportingMode          MeasurementReportingMode,
    reportCriteriaSysInf              TrafficVolumeReportCriteriaSysInfo
}

TrafficVolumeMeasuredResults ::= SEQUENCE {
    rb-Identity                       RB-Identity,
    rlc-BuffersPayload                RLC-BuffersPayload                OPTIONAL,
    averageRLC-BufferPayload          AverageRLC-BufferPayload          OPTIONAL,
    varianceOfRLC-BufferPayload       VarianceOfRLC-BufferPayload       OPTIONAL
}

TrafficVolumeMeasuredResultsList ::= SEQUENCE (SIZE (1..maxRB)) OF
    TrafficVolumeMeasuredResults

TrafficVolumeMeasurement ::= SEQUENCE {
    trafficVolumeMeasurementObjectList TrafficVolumeMeasurementObjectList OPTIONAL,
    trafficVolumeMeasQuantity         TrafficVolumeMeasQuantity          OPTIONAL,
    trafficVolumeReportingQuantity    TrafficVolumeReportingQuantity    OPTIONAL,
    measurementValidity               MeasurementValidity                OPTIONAL,
    reportCriteria                    TrafficVolumeReportCriteria
}

TrafficVolumeMeasurementObjectList ::= SEQUENCE (SIZE (1..maxTrCH)) OF
    UL-TrCH-Identity

TrafficVolumeReportCriteria ::= CHOICE {
    trafficVolumeReportingCriteria    TrafficVolumeReportingCriteria,
    periodicalReportingCriteria       PeriodicalReportingCriteria,
    noReporting                        NULL
}

TrafficVolumeReportCriteriaSysInfo ::= CHOICE {
    trafficVolumeReportingCriteria    TrafficVolumeReportingCriteria,
    periodicalReportingCriteria       PeriodicalReportingCriteria
}

TrafficVolumeReportingCriteria ::= SEQUENCE {
    -- NOTE: transChCriteriaList should be mandatory in later versions of this message
    transChCriteriaList               TransChCriteriaList                OPTIONAL
}

TrafficVolumeReportingQuantity ::= SEQUENCE {
    rlc-RB-BufferPayload              BOOLEAN,
    rlc-RB-BufferPayloadAverage       BOOLEAN,
    rlc-RB-BufferPayloadVariance      BOOLEAN
}

TrafficVolumeThreshold ::= ENUMERATED {
    th8, th16, th32, th64, th128,
    th256, th512, th1024, th2k, th3k,
    th4k, th6k, th8k, th12k, th16k,
    th24k, th32k, th48k, th64k, th96k,
    th128k, th192k, th256k, th384k,
    th512k, th768k }

TransChCriteria ::= SEQUENCE {
    ul-transportChannelID             UL-TrCH-Identity                   OPTIONAL,
    eventSpecificParameters           SEQUENCE (SIZE (1..maxMeasParEvent)) OF
        TrafficVolumeEventParam      OPTIONAL
}

TransChCriteriaList ::= SEQUENCE (SIZE (1..maxTrCH)) OF
    TransChCriteria

TransferMode ::= ENUMERATED {
    acknowledgedModeRLC,
    unacknowledgedModeRLC }

TransmittedPowerThreshold ::= INTEGER (-50..33)

TriggeringCondition1 ::= ENUMERATED {
    activeSetCellsOnly,

```

```

        monitoredSetCellsOnly,
        activeSetAndMonitoredSetCells }

TriggeringCondition2 ::=          ENUMERATED {
        activeSetCellsOnly,
        monitoredSetCellsOnly,
        activeSetAndMonitoredSetCells,
        detectedSetCellsOnly,
        detectedSetAndMonitoredSetCells }

TX-InterruptionAfterTrigger ::=  ENUMERATED {
        txiat0-25, txiat0-5, txiat1,
        txiat2, txiat4, txiat8, txiat16 }

UDRE ::=                          ENUMERATED {
        lessThan1,
        between1-and-4,
        between4-and-8,
        over8 }

UE-6AB-Event ::=                 SEQUENCE {
        timeToTrigger              TimeToTrigger,
        transmittedPowerThreshold  TransmittedPowerThreshold
}

UE-6FG-Event ::=                 SEQUENCE {
        timeToTrigger              TimeToTrigger,
        -- in 1.28 Mcps TDD ue-RX-TX-TimeDifferenceThreshold corresponds to TADV Threshold
        ue-RX-TX-TimeDifferenceThreshold  UE-RX-TX-TimeDifferenceThreshold
}

UE-AutonomousUpdateMode ::=     CHOICE {
        on                          NULL,
        onWithNoReporting           NULL,
        off                          RL-InformationLists
}

UE-InternalEventParam ::=       CHOICE {
        event6a                     UE-6AB-Event,
        event6b                     UE-6AB-Event,
        event6c                     TimeToTrigger,
        event6d                     TimeToTrigger,
        event6e                     TimeToTrigger,
        event6f                     UE-6FG-Event,
        event6g                     UE-6FG-Event
}

UE-InternalEventParamList ::=   SEQUENCE (SIZE (1..maxMeasEvent)) OF
        UE-InternalEventParam

UE-InternalEventResults ::=     CHOICE {
        event6a                     NULL,
        event6b                     NULL,
        event6c                     NULL,
        event6d                     NULL,
        event6e                     NULL,
        event6f                     PrimaryCPICH-Info,
        event6g                     PrimaryCPICH-Info,
        spare                        NULL
}

UE-InternalMeasQuantity ::=     SEQUENCE {
        measurementQuantity         UE-MeasurementQuantity,
        filterCoefficient           FilterCoefficient                DEFAULT fc0
}

UE-InternalMeasuredResults ::=  SEQUENCE {
        modeSpecificInfo           CHOICE {
                fdd                 SEQUENCE {
                        ue-TransmittedPowerFDD      UE-TransmittedPower      OPTIONAL,
                        ue-RX-TX-ReportEntryList    UE-RX-TX-ReportEntryList    OPTIONAL
                },
                tdd                 SEQUENCE {
                        ue-TransmittedPowerTDD-List UE-TransmittedPowerTDD-List OPTIONAL,
                        appliedTA              UL-TimingAdvance          OPTIONAL
                }
        }
}

```



```

UE-InternalMeasuredResults-LCR-r4 ::= SEQUENCE {
    ue-TransmittedPowerTDD-List    UE-TransmittedPowerTDD-List    OPTIONAL,
    t-ADVinfo                       T-ADVinfo                       OPTIONAL
}

UE-InternalMeasurement ::= SEQUENCE {
    ue-InternalMeasQuantity          UE-InternalMeasQuantity          OPTIONAL,
    ue-InternalReportingQuantity     UE-InternalReportingQuantity     OPTIONAL,
    reportCriteria                   UE-InternalReportCriteria
}

UE-InternalMeasurement-r4 ::= SEQUENCE {
    ue-InternalMeasQuantity          UE-InternalMeasQuantity          OPTIONAL,
    ue-InternalReportingQuantity-r4  UE-InternalReportingQuantity-r4  OPTIONAL,
    reportCriteria                   UE-InternalReportCriteria
}

UE-InternalMeasurementSysInfo ::= SEQUENCE {
    ue-InternalMeasurementID         MeasurementIdentity              DEFAULT 5,
    ue-InternalMeasQuantity          UE-InternalMeasQuantity
}

UE-InternalReportCriteria ::= CHOICE {
    ue-InternalReportingCriteria     UE-InternalReportingCriteria,
    periodicalReportingCriteria      PeriodicalReportingCriteria,
    noReporting                       NULL
}

UE-InternalReportingCriteria ::= SEQUENCE {
    ue-InternalEventParamList        UE-InternalEventParamList        OPTIONAL
}

UE-InternalReportingQuantity ::= SEQUENCE {
    ue-TransmittedPower              BOOLEAN,
    modeSpecificInfo                 CHOICE {
        fdd                           SEQUENCE {
            ue-RX-TX-TimeDifference    BOOLEAN
        },
        tdd                           SEQUENCE {
            appliedTA                  BOOLEAN
        }
    }
}

UE-InternalReportingQuantity-r4 ::= SEQUENCE {
    ue-TransmittedPower              BOOLEAN,
    modeSpecificInfo                 CHOICE {
        fdd                           SEQUENCE {
            ue-RX-TX-TimeDifference    BOOLEAN
        },
        tdd                           SEQUENCE {
            tddOption                  CHOICE {
                tdd384                 SEQUENCE {
                    appliedTA           BOOLEAN
                },
                tdd128                 SEQUENCE {
                    t-ADVinfo           BOOLEAN
                }
            }
        }
    }
}

-- TABULAR: UE-MeasurementQuantity, for 3.84 Mcps TDD only the first two values
-- ue-TransmittedPower and ultra-Carrier-RSSI are used.
-- For 1.28 Mcps TDD ue-RX-TX-TimeDifference corresponds to T-ADV in the tabular
UE-MeasurementQuantity ::= ENUMERATED {
    ue-TransmittedPower,
    ultra-Carrier-RSSI,
    ue-RX-TX-TimeDifference }

UE-RX-TX-ReportEntry ::= SEQUENCE {
    primaryCPICH-Info               PrimaryCPICH-Info,
    ue-RX-TX-TimeDifferenceType1     UE-RX-TX-TimeDifferenceType1
}

UE-RX-TX-ReportEntryList ::= SEQUENCE (SIZE (1..maxRL)) OF

```

```

UE-RX-TX-ReportEntry

-- SPARE: UE-RX-TX-TimeDifferenceType1, Max = 1280
-- Values above Max are spare
UE-RX-TX-TimeDifferenceType1 ::=          INTEGER (768..1791)

-- Actual value UE-RX-TX-TimeDifferenceType2 = IE value * 0.0625 + 768
UE-RX-TX-TimeDifferenceType2 ::=          INTEGER (0..8191)

UE-RX-TX-TimeDifferenceType2Info ::=      SEQUENCE {
    ue-RX-TX-TimeDifferenceType2          UE-RX-TX-TimeDifferenceType2,
    neighbourQuality                       NeighbourQuality
}

-- In 1.28 Mcps TDD, actual value for
-- T-ADV Threshold = (UE-RX-TX-TimeDifferenceThreshold - 768) * 0.125
UE-RX-TX-TimeDifferenceThreshold ::=      INTEGER (768..1280)

UE-TransmittedPower ::=                   INTEGER (0..104)

UE-TransmittedPowerTDD-List ::=           SEQUENCE (SIZE (1..maxTS)) OF
    UE-TransmittedPower

UL-TrCH-Identity ::=                      CHOICE{
    dch                                     TransportChannelIdentity,
    -- Default transport channel in the UL is either RACH or CPCH, but not both.
    rachorcpch                             NULL,
    usch                                    TransportChannelIdentity
}

UE-Positioning-Accuracy ::=                BIT STRING (SIZE (7))

UE-Positioning-CipherParameters ::=        SEQUENCE {
    cipheringKeyFlag                       BIT STRING (SIZE (1)),
    cipheringSerialNumber                  INTEGER (0..65535)
}

UE-Positioning-Error ::=                  SEQUENCE {
    errorReason                             UE-Positioning-ErrorCause,
    ue-positioning-GPS-additionalAssistanceDataRequest  UE-Positioning-GPS-
AdditionalAssistanceDataRequest OPTIONAL
}

UE-Positioning-ErrorCause ::=              ENUMERATED {
    notEnoughOTDOA-Cells,
    notEnoughGPS-Satellites,
    assistanceDataMissing,
    methodNotSupported,
    undefinedError,
    requestDeniedByUser,
    notProcessedAndTimeout ,
    referenceCellNotServingCell }

UE-Positioning-EventParam ::=              SEQUENCE {
    reportingAmount                         ReportingAmount,
    reportFirstFix                          BOOLEAN,
    measurementInterval                     UE-Positioning-MeasurementInterval,
    eventSpecificInfo                       UE-Positioning-EventSpecificInfo
}

UE-Positioning-EventParamList ::=          SEQUENCE (SIZE (1..maxMeasEvent)) OF
    UE-Positioning-EventParam

UE-Positioning-EventSpecificInfo ::=       CHOICE {
    e7a                                     ThresholdPositionChange,
    e7b                                     ThresholdSFN-SFN-Change,
    e7c                                     ThresholdSFN-GPS-TOW
}

UE-Positioning-GPS-AcquisitionAssistance ::= SEQUENCE {
    gps-ReferenceTime                       INTEGER (0..604799999),
    utran-GPSReferenceTime                  UTRAN-GPSReferenceTime          OPTIONAL,
    satelliteInformationList                AcquisitionSatInfoList
}

UE-Positioning-GPS-AdditionalAssistanceDataRequest ::= SEQUENCE {
    almanacRequest                          BOOLEAN,

```

```

    utcModelRequest          BOOLEAN,
    ionosphericModelRequest  BOOLEAN,
    navigationModelRequest   BOOLEAN,
    dgpsCorrectionsRequest   BOOLEAN,
    referenceLocationRequest  BOOLEAN,
    referenceTimeRequest      BOOLEAN,
    aquisitionAssistanceRequest  BOOLEAN,
    realTimeIntegrityRequest  BOOLEAN,
    navModelAddDataRequest   UE-Positioning-GPS-NavModelAddDataReq  OPTIONAL
}

UE-Positioning-GPS-Almanac ::=          SEQUENCE {
    wn-a                          BIT STRING (SIZE (8)),
    almanacSatInfoList           AlmanacSatInfoList,
    sv-GlobalHealth              BIT STRING (SIZE (364))          OPTIONAL
}

UE-Positioning-GPS-AssistanceData ::=  SEQUENCE {
    ue-positioning-GPS-ReferenceTime  UE-Positioning-GPS-ReferenceTime
    OPTIONAL,
    ue-positioning-GPS-ReferenceLocation  ReferenceLocation          OPTIONAL,
    ue-positioning-GPS-DGPS-Corrections  UE-Positioning-GPS-DGPS-Corrections
    OPTIONAL,
    ue-positioning-GPS-NavigationModel    UE-Positioning-GPS-NavigationModel
    OPTIONAL,
    ue-positioning-GPS-IonosphericModel   UE-Positioning-GPS-IonosphericModel
    OPTIONAL,
    ue-positioning-GPS-UTC-Model          UE-Positioning-GPS-UTC-Model
    OPTIONAL,
    ue-positioning-GPS-Almanac            UE-Positioning-GPS-Almanac
    OPTIONAL,
    ue-positioning-GPS-AcquisitionAssistance  UE-Positioning-GPS-AcquisitionAssistance
    OPTIONAL,
    ue-positioning-GPS-Real-timeIntegrity  BadSatList          OPTIONAL,
    -- dummy is not used in this version of the specification, it should
    -- not be sent and if received it should be ignored.
    dummy                                UE-Positioning-GPS-ReferenceCellInfo  OPTIONAL
}

UE-Positioning-GPS-DGPS-Corrections ::= SEQUENCE {
    gps-TOW                          INTEGER (0..604799),
    statusHealth                      DiffCorrectionStatus,
    dgps-CorrectionSatInfoList        DGPS-CorrectionSatInfoList
}

UE-Positioning-GPS-IonosphericModel ::= SEQUENCE {
    alfa0                             BIT STRING (SIZE (8)),
    alfa1                             BIT STRING (SIZE (8)),
    alfa2                             BIT STRING (SIZE (8)),
    alfa3                             BIT STRING (SIZE (8)),
    beta0                             BIT STRING (SIZE (8)),
    beta1                             BIT STRING (SIZE (8)),
    beta2                             BIT STRING (SIZE (8)),
    beta3                             BIT STRING (SIZE (8))
}

UE-Positioning-GPS-MeasurementResults ::= SEQUENCE {
    referenceTime                     CHOICE {
        utran-GPSReferenceTimeResult  UTRAN-GPSReferenceTimeResult,
        gps-ReferenceTimeOnly          INTEGER (0..604799999)
    },
    gps-MeasurementParamList          GPS-MeasurementParamList
}

UE-Positioning-GPS-NavigationModel ::= SEQUENCE {
    navigationModelSatInfoList        NavigationModelSatInfoList
}

UE-Positioning-GPS-NavModelAddDataReq ::= SEQUENCE {
    gps-Week                          INTEGER (0..1023),
    -- SPARE: gps-Toe, Max = 167
    -- Values above Max are spare
    gps-Toe                          INTEGER (0..255),
    -- SPARE: tToeLimit, Max = 10
    -- Values above Max are spare
    tToeLimit                        INTEGER (0..15),
    satDataList                      SatDataList
}

```

```

UE-Positioning-GPS-ReferenceCellInfo ::= SEQUENCE {
  modeSpecificInfo CHOICE {
    fdd SEQUENCE {
      referenceIdentity
    },
    tdd SEQUENCE {
      referenceIdentity
      CellParametersID
    }
  }
}

UE-Positioning-GPS-ReferenceTime ::= SEQUENCE {
  gps-Week INTEGER (0..1023),
  gps-tow-lmsec GPS-TOW-lmsec, utran-GPSReferenceTime UTRAN-
GPSReferenceTime OPTIONAL,
  sfm-tow-Uncertainty SFN-TOW-Uncertainty OPTIONAL,
  utran-GPS-DriftRate UTRAN-GPS-DriftRate OPTIONAL,
  gps-TOW-AssistList GPS-TOW-AssistList OPTIONAL
}

UE-Positioning-GPS-UTC-Model ::= SEQUENCE {
  a1 BIT STRING (SIZE (24)),
  a0 BIT STRING (SIZE (32)),
  t-ot BIT STRING (SIZE (8)),
  wn-t BIT STRING (SIZE (8)),
  delta-t-LS BIT STRING (SIZE (8)),
  wn-lsf BIT STRING (SIZE (8)),
  dn BIT STRING (SIZE (8)),
  delta-t-LSF BIT STRING (SIZE (8))
}

UE-Positioning-IPDL-Parameters ::= SEQUENCE {
  ip-Spacing IP-Spacing,
  ip-Length IP-Length,
  ip-Offset INTEGER (0..9),
  seed INTEGER (0..63),
  burstModeParameters BurstModeParameters OPTIONAL
}

UE-Positioning-IPDL-Parameters-r4 ::= SEQUENCE {
  modeSpecificInfo CHOICE {
    fdd SEQUENCE {
      ip-Spacing IP-Spacing,
      ip-Length IP-Length,
      ip-Offset INTEGER (0..9),
      seed INTEGER (0..63)
    },
    tdd SEQUENCE {
      ip-Spacing-TDD IP-Spacing-TDD,
      ip-slot INTEGER (0..14),
      ip-Start INTEGER (0..4095),
      ip-PCCPCG IP-PCCPCH-r4 OPTIONAL
    }
  },
  burstModeParameters BurstModeParameters OPTIONAL
}

UE-Positioning-IPDL-Parameters-TDD-r4-ext ::= SEQUENCE {
  ip-Spacing IP-Spacing-TDD,
  ip-slot INTEGER (0..14),
  ip-Start INTEGER (0..4095),
  ip-PCCPCG IP-PCCPCH-r4 OPTIONAL,
  burstModeParameters BurstModeParameters
}

UE-Positioning-MeasuredResults ::= SEQUENCE {
  ue-positioning-OTDOA-Measurement UE-Positioning-OTDOA-Measurement
OPTIONAL,
  ue-positioning-PositionEstimateInfo UE-Positioning-PositionEstimateInfo
OPTIONAL,
  ue-positioning-GPS-Measurement UE-Positioning-GPS-MeasurementResults
OPTIONAL,
  ue-positioning-Error UE-Positioning-Error
OPTIONAL
}

UE-Positioning-MeasuredResults-v390ext ::= SEQUENCE {

```

```

    ue-Positioning-OTDOA-Measurement-v390ext      UE-Positioning-OTDOA-Measurement-v390ext
  }
UE-Positioning-Measurement ::=
  ue-positioning-ReportingQuantity              UE-Positioning-ReportingQuantity,
  reportCriteria                               UE-Positioning-ReportCriteria,
  ue-positioning-OTDOA-AssistanceData          UE-Positioning-OTDOA-AssistanceData
  OPTIONAL,
  ue-positioning-GPS-AssistanceData            UE-Positioning-GPS-AssistanceData
  OPTIONAL
}

UE-Positioning-Measurement-v390ext ::=
  ue-positioning-ReportingQuantity-v390ext      UE-Positioning-ReportingQuantity-v390ext
  OPTIONAL,
  measurementValidity                          MeasurementValidity                OPTIONAL,
  ue-positioning-OTDOA-AssistanceData-UEB      UE-Positioning-OTDOA-AssistanceData-UEB
  OPTIONAL
}

UE-Positioning-Measurement-r4 ::=
  ue-positioning-ReportingQuantity              UE-Positioning-ReportingQuantity-r4,
  measurementValidity                          MeasurementValidity
  OPTIONAL,
  reportCriteria                               UE-Positioning-ReportCriteria,
  ue-positioning-OTDOA-AssistanceData          UE-Positioning-OTDOA-AssistanceData-r4
  OPTIONAL,
  ue-positioning-GPS-AssistanceData            UE-Positioning-GPS-AssistanceData
  OPTIONAL
}

UE-Positioning-MeasurementEventResults ::=
  event7a                                       UE-Positioning-PositionEstimateInfo,
  event7b                                       UE-Positioning-OTDOA-Measurement,
  event7c                                       UE-Positioning-GPS-MeasurementResults,
  spare                                         NULL
}

UE-Positioning-MeasurementInterval ::=
  ENUMERATED {
    e5, e15, e60, e300,
    e900, e1800, e3600, e7200 }

UE-Positioning-MethodType ::=
  ENUMERATED {
    ue-Assisted,
    ue-Based,
    ue-BasedPreferred,
    ue-AssistedPreferred }

UE-Positioning-OTDOA-AssistanceData ::=
  ue-positioning-OTDOA-ReferenceCellInfo       UE-Positioning-OTDOA-ReferenceCellInfo
  OPTIONAL,
  ue-positioning-OTDOA-NeighbourCellList       UE-Positioning-OTDOA-NeighbourCellList
  OPTIONAL
}

UE-Positioning-OTDOA-AssistanceData-r4 ::=
  ue-positioning-OTDOA-ReferenceCellInfo       UE-Positioning-OTDOA-ReferenceCellInfo-r4
  OPTIONAL,
  ue-positioning-OTDOA-NeighbourCellList       UE-Positioning-OTDOA-NeighbourCellList-r4
  OPTIONAL
}

UE-Positioning-OTDOA-AssistanceData-r4ext ::= SEQUENCE {
  -- In case of TDD these IPDL parameters shall be used for the reference cell instead of
  -- IPDL Parameters in IE UE-Positioning-OTDOA-ReferenceCellInfo
  ue-Positioning-IPDL-Parameters-TDD-r4-ext    UE-Positioning-IPDL-Parameters-TDD-r4-ext
  OPTIONAL,
  -- These IPDL parameters shall be used for the neighbour cells in case of TDD instead of
  -- IPDL Parameters in IE UE-Positioning-OTDOA-NeighbourCellInfoList. The cells shall be
  -- listed in the same order as in IE UE-Positioning-OTDOA-NeighbourCellInfoList
  ue-Positioning-IPDL-Parameters-TDDList-r4-ext UE-Positioning-IPDL-Parameters-TDDList-r4-ext
  OPTIONAL
}

UE-Positioning-OTDOA-AssistanceData-UEB ::=
  ue-positioning-OTDOA-ReferenceCellInfo-UEB  UE-Positioning-OTDOA-ReferenceCellInfo-UEB
  OPTIONAL,

```

```

ue-positioning-OTDOA-NeighbourCellList-UEB          UE-Positioning-OTDOA-NeighbourCellList-
UEB          OPTIONAL
}

UE-Positioning-IPDL-Parameters-TDDList-r4-ext ::= SEQUENCE (SIZE (1..maxCellMeas)) OF
          UE-Positioning-IPDL-Parameters-TDD-r4-ext

UE-Positioning-OTDOA-Measurement ::= SEQUENCE {
  sfn          INTEGER (0..4095),
  modeSpecificInfo CHOICE {
    fdd          SEQUENCE {
      referenceCellIdentity PrimaryCPICH-Info,
      ue-RX-TX-TimeDifferenceType2Info UE-RX-TX-TimeDifferenceType2Info
    },
    tdd          SEQUENCE {
      referenceCellIdentity CellParametersID
    }
  },
  neighbourList NeighbourList OPTIONAL
}

UE-Positioning-OTDOA-Measurement-v390ext ::= SEQUENCE {
  neighbourList-v390ext NeighbourList-v390ext
}

UE-Positioning-OTDOA-NeighbourCellInfo ::= SEQUENCE {
  modeSpecificInfo CHOICE {
    fdd          SEQUENCE {
      primaryCPICH-Info PrimaryCPICH-Info
    },
    tdd          SEQUENCE {
      cellAndChannelIdentity CellAndChannelIdentity
    }
  },
  frequencyInfo FrequencyInfo OPTIONAL,
  ue-positioning-IPDL-Parameters UE-Positioning-IPDL-Parameters
  OPTIONAL,
  sfn-SFN-RelTimeDifference SFN-SFN-RelTimeDifference1,
  sfn-SFN-Drift SFN-SFN-Drift OPTIONAL,
  searchWindowSize OTDOA-SearchWindowSize,
  positioningMode CHOICE {
    ueBased SEQUENCE {},
    ueAssisted SEQUENCE {}
  }
}

UE-Positioning-OTDOA-NeighbourCellInfo-r4 ::= SEQUENCE {
  modeSpecificInfo CHOICE {
    fdd          SEQUENCE {
      primaryCPICH-Info PrimaryCPICH-Info
    },
    tdd          SEQUENCE {
      cellAndChannelIdentity CellAndChannelIdentity
    }
  },
  frequencyInfo FrequencyInfo OPTIONAL,
  ue-positioning-IPDL-Parameters UE-Positioning-IPDL-Parameters-r4 OPTIONAL,
  sfn-SFN-RelTimeDifference SFN-SFN-RelTimeDifference1,
  sfn-Offset-Validity SFN-Offset-Validity OPTIONAL,
  sfn-SFN-Drift SFN-SFN-Drift OPTIONAL,
  searchWindowSize OTDOA-SearchWindowSize,
  positioningMode CHOICE {
    ueBased SEQUENCE {
      relativeNorth INTEGER (-20000..20000) OPTIONAL,
      relativeEast INTEGER (-20000..20000) OPTIONAL,
      relativeAltitude INTEGER (-4000..4000) OPTIONAL,
      fineSFN-SFN FineSFN-SFN OPTIONAL,
      -- actual value roundTripTime = (IE value * 0.0625) + 876
      roundTripTime INTEGER (0.. 32766) OPTIONAL
    },
    ueAssisted SEQUENCE {}
  }
}

UE-Positioning-OTDOA-NeighbourCellInfo-UEB ::= SEQUENCE {
  modeSpecificInfo CHOICE {
    fdd          SEQUENCE {
      primaryCPICH-Info PrimaryCPICH-Info
    }
  }
}

```

```

    },
    tdd
        cellAndChannelIdentity
    SEQUENCE{
        CellAndChannelIdentity
    }
},
frequencyInfo
ue-positioning-IPDL-Parameters
sfn-SFN-RelTimeDifference
sfn-SFN-Drift
searchWindowSize
relativeNorth
relativeEast
relativeAltitude
fineSFN-SFN
-- actual value roundTripTime = (IE value * 0.0625) + 876
roundTripTime
FrequencyInfo
UE-Positioning-IPDL-Parameters
SFN-SFN-RelTimeDifference,
SFN-SFN-Drift
OTDOA-SearchWindowSize,
INTEGER (-20000..20000)
INTEGER (-20000..20000)
INTEGER (-4000..4000)
FineSFN-SFN,
INTEGER (0..32766)
OPTIONAL,
OPTIONAL,
OPTIONAL,
OPTIONAL,
OPTIONAL,
OPTIONAL
}

UE-Positioning-OTDOA-NeighbourCellList ::= SEQUENCE (SIZE (1..maxCellMeas)) OF
UE-Positioning-OTDOA-NeighbourCellInfo

UE-Positioning-OTDOA-NeighbourCellList-r4 ::= SEQUENCE (SIZE (1..maxCellMeas)) OF
UE-Positioning-OTDOA-NeighbourCellInfo-r4

UE-Positioning-OTDOA-NeighbourCellList-UEB ::= SEQUENCE (SIZE (1..maxCellMeas)) OF
UE-Positioning-OTDOA-NeighbourCellInfo-UEB

UE-Positioning-OTDOA-Quality ::= SEQUENCE {
stdResolution BIT STRING (SIZE (2)),
numberOfOTDOA-Measurements BIT STRING (SIZE (3)),
stdOfOTDOA-Measurements BIT STRING (SIZE (5))
}

UE-Positioning-OTDOA-ReferenceCellInfo ::= SEQUENCE {
sfn INTEGER (0..4095)
OPTIONAL,
modeSpecificInfo CHOICE {
fdd
primaryCPICH-Info SEQUENCE {
PrimaryCPICH-Info
},
tdd
cellAndChannelIdentity SEQUENCE{
CellAndChannelIdentity
}
},
frequencyInfo FrequencyInfo OPTIONAL,
positioningMode CHOICE {
ueBased SEQUENCE {},
ueAssisted SEQUENCE {}
},
ue-positioning-IPDL-Parameters UE-Positioning-IPDL-Parameters OPTIONAL
}

UE-Positioning-OTDOA-ReferenceCellInfo-r4 ::= SEQUENCE {
sfn INTEGER (0..4095)
OPTIONAL,
modeSpecificInfo CHOICE {
fdd
primaryCPICH-Info SEQUENCE {
PrimaryCPICH-Info
},
tdd
cellAndChannelIdentity SEQUENCE{
CellAndChannelIdentity
}
},
frequencyInfo FrequencyInfo OPTIONAL,
positioningMode CHOICE {
ueBased SEQUENCE {
cellPosition ReferenceCellPosition OPTIONAL,
-- actual value roundTripTime = (IE value * 0.0625) + 876
roundTripTime INTEGER (0..32766) OPTIONAL
},
ueAssisted SEQUENCE {}
},
ue-positioning-IPDL-Parameters UE-Positioning-IPDL-Parameters-r4 OPTIONAL
}

UE-Positioning-OTDOA-ReferenceCellInfo-UEB ::= SEQUENCE {
sfn INTEGER (0..4095)
modeSpecificInfo CHOICE {

```

```

        fdd                               SEQUENCE {
            primaryCPICH-Info             PrimaryCPICH-Info
        },
        tdd                               SEQUENCE{
            cellAndChannelIdentity        CellAndChannelIdentity
        }
    },
    frequencyInfo                         FrequencyInfo                OPTIONAL,
    cellPosition                           ReferenceCellPosition        OPTIONAL,
    -- actual value roundTripTime = (IE value * 0.0625) + 876
    roundTripTime                           INTEGER (0..32766)            OPTIONAL,
    ue-positioning-IPDL-Parameters          UE-Positioning-IPDL-Parameters OPTIONAL
}

UE-Positioning-PositionEstimateInfo ::= SEQUENCE {
    referenceTime                           CHOICE {
        utran-GPSReferenceTimeResult      UTRAN-GPSReferenceTimeResult,
        gps-ReferenceTimeOnly             INTEGER (0..604799999),
        cell-Timing                       SEQUENCE {
            sfn                             INTEGER (0..4095),
            modeSpecificInfo                CHOICE {
                fdd                         SEQUENCE {
                    primaryCPICH-Info      PrimaryCPICH-Info
                },
                tdd                         SEQUENCE{
                    cellAndChannelIdentity  CellAndChannelIdentity
                }
            }
        }
    },
    positionEstimate                        PositionEstimate
}

UE-Positioning-ReportCriteria ::= CHOICE {
    ue-positioning-ReportingCriteria       UE-Positioning-EventParamList,
    periodicalReportingCriteria            PeriodicalReportingCriteria,
    noReporting                            NULL
}

UE-Positioning-ReportingQuantity ::= SEQUENCE {
    methodType                             UE-Positioning-MethodType,
    positioningMethod                       PositioningMethod,
    -- dummy1 is not used in this version of specification and it should
    -- be ignored.
    dummy1                                 UE-Positioning-ResponseTime,
    accuracy                                UE-Positioning-Accuracy                OPTIONAL,
    gps-TimingOfCellWanted                 BOOLEAN,
    -- dummy2 is not used in this version of specification and it should
    -- be ignored.
    dummy2                                 BOOLEAN,
    additionalAssistanceDataReq            BOOLEAN,
    environmentCharacterisation             EnvironmentCharacterisation            OPTIONAL
}

UE-Positioning-ReportingQuantity-v390ext ::= SEQUENCE {
    vertical-Accuracy                       UE-Positioning-Accuracy
}

UE-Positioning-ReportingQuantity-r4 ::= SEQUENCE {
    methodType                             UE-Positioning-MethodType,
    positioningMethod                       PositioningMethod,
    horizontalAccuracy                     UE-Positioning-Accuracy                OPTIONAL,
    verticalAccuracy                       UE-Positioning-Accuracy                OPTIONAL,
    gps-TimingOfCellWanted                 BOOLEAN,
    additionalAssistanceDataReq            BOOLEAN,
    environmentCharacterisation             EnvironmentCharacterisation            OPTIONAL
}

UE-Positioning-ResponseTime ::= ENUMERATED {
    s1, s2, s4, s8, s16,
    s32, s64, s128 }

-- SPARE: UTRA-CarrierRSSI, Max = 76
-- Values above Max are spare
UTRA-CarrierRSSI ::= INTEGER (0..127)

UTRAN-GPS-DriftRate ::= ENUMERATED {
    utran-GPSDrift0, utran-GPSDrift1, utran-GPSDrift2,

```



```

    utran-GPSDrift5, utran-GPSDrift10, utran-GPSDrift15,
    utran-GPSDrift25, utran-GPSDrift50, utran-GPSDrift-1,
    utran-GPSDrift-2, utran-GPSDrift-5, utran-GPSDrift-10,
    utran-GPSDrift-15, utran-GPSDrift-25, utran-GPSDrift-50}

```

```

UTRAN-GPSReferenceTime ::=
    SEQUENCE {
    -- For utran-GPSTimingOfCell values above 2322431999999 are not
    -- used in this version of the specification
    -- Actual value utran-GPSTimingOfCell = (ms-part * 4294967296) + ls-part
    utran-GPSTimingOfCell
        SEQUENCE {
        ms-part
            INTEGER (0..1023),
        ls-part
            INTEGER (0..4294967295)
        },
    modeSpecificInfo
        CHOICE {
        fdd
            SEQUENCE {
            referenceIdentity
                PrimaryCPICH-Info
            },
        tdd
            SEQUENCE {
            referenceIdentity
                CellParametersID
            }
        }
    },
    sfnsfn
        OPTIONAL,
        INTEGER (0..4095)
    }

UTRAN-GPSReferenceTimeResult ::=
    SEQUENCE {
    -- For ue-GPSTimingOfCell values above 37158911999999 are not
    -- used in this version of the specification
    -- Actual value ue-GPSTimingOfCell = (ms-part * 4294967296) + ls-part
    ue-GPSTimingOfCell
        SEQUENCE {
        ms-part
            INTEGER (0.. 16383),
        ls-part
            INTEGER (0..4294967295)
        },
    modeSpecificInfo
        CHOICE {
        fdd
            SEQUENCE {
            referenceIdentity
                PrimaryCPICH-Info
            },
        tdd
            SEQUENCE {
            referenceIdentity
                CellParametersID
            }
        }
    },
    sfnsfn
        INTEGER (0..4095)
    }

VarianceOfRLC-BufferPayload ::=
    ENUMERATED {
    plv0, plv4, plv8, plv16, plv32, plv64,
    plv128, plv256, plv512, plv1024,
    plv2k, plv4k, plv8k, plv16k, spare2, spare1 }

-- Actual value W = IE value * 0.1
W ::=
    INTEGER (0..20)

-- *****
--
-- OTHER INFORMATION ELEMENTS (10.3.8)
--
-- *****

BCC ::=
    INTEGER (0..7)

BCCH-ModificationInfo ::=
    SEQUENCE {
    mib-ValueTag
        MIB-ValueTag,
    bcch-ModificationTime
        BCCH-ModificationTime
    }
    OPTIONAL

-- Actual value BCCH-ModificationTime = IE value * 8
BCCH-ModificationTime ::=
    INTEGER (0..511)

BSIC ::=
    SEQUENCE {
    ncc
        NCC,
    bcc
        BCC
    }

CBS-DRX-Level1Information ::=
    SEQUENCE {
    ctch-AllocationPeriod
        INTEGER (1..256),
    cbs-FrameOffset
        INTEGER (0..255)
    }

CDMA2000-Message ::=
    SEQUENCE {

```

```

    msg-Type          BIT STRING (SIZE (8)),
    payload          BIT STRING (SIZE (1..512))
}

CDMA2000-MessageList ::= SEQUENCE (SIZE (1..maxInterSysMessages)) OF
                        CDMA2000-Message

CDMA2000-UMTS-Frequency-List ::= SEQUENCE (SIZE (1..maxNumCDMA2000Freqs)) OF
                        FrequencyInfoCDMA2000

CellValueTag ::= INTEGER (1..4)

--Actual value = 2^(IE value)
ExpirationTimeFactor ::= INTEGER (1..8)

FDD-UMTS-Frequency-List ::= SEQUENCE (SIZE (1..maxNumFDDFreqs)) OF
                        FrequencyInfoFDD

FrequencyInfoCDMA2000 ::= SEQUENCE {
    band-Class      BIT STRING (SIZE (5)),
    cdma-Freq      BIT STRING (SIZE(11))
}

GSM-BA-Range ::= SEQUENCE {
    gsmLowRangeUARFCN    UARFCN,
    gsmUpRangeUARFCN    UARFCN
}

GSM-BA-Range-List ::= SEQUENCE (SIZE (1..maxNumGSMFreqRanges)) OF
                        GSM-BA-Range

-- This IE is formatted as 'TLV' and is coded in the same way as the Mobile Station Classmark 2
-- information element in [5]. The first octet is the Mobile station classmark 2 IEI and its value
-- shall be set to 33H. The second octet is the Length of mobile station classmark 2 and its value
-- shall be set to 3. The octet 3 contains the first octet of the value part of the Mobile Station
-- Classmark 2 information element, the octet 4 contains the second octet of the value part of the
-- Mobile Station Classmark 2 information element and so on. For each of these octets, the first/
-- leftmost/ most significant bit of the octet contains b8 of the corresponding octet of the Mobile
-- Station Classmark 2.
GSM-Classmark2 ::= OCTET STRING (SIZE (5))

-- This IE is formatted as 'V' and is coded in the same way as the value part in the Mobile station
-- classmark 3 information element in [5]
-- The value part is specified by means of CSN.1, which encoding results in a bit string, to which
-- final padding may be appended upto the next octet boundary [5]. The first/ leftmost bit of the
-- CSN.1 bit string is placed in the first/ leftmost/ most significant bit of the first
-- octet. This continues until the last bit of the CSN.1 bit string, which is placed in the last/
-- rightmost/ least significant bit of the last octet.
GSM-Classmark3 ::= OCTET STRING (SIZE (1..32))

GSM-MessageList ::= SEQUENCE (SIZE (1..maxInterSysMessages)) OF
                        BIT STRING (SIZE (1..512))

GsmSecurityCapability ::= BIT STRING {
    a5-7(0),
    a5-6(1),
    a5-5(2),
    a5-4(3),
    a5-3(4),
    a5-2(5),
    a5-1(6)
} (SIZE (7))

IdentificationOfReceivedMessage ::= SEQUENCE {
    rrc-TransactionIdentifier    RRC-TransactionIdentifier,
    receivedMessageType          ReceivedMessageType
}

InterRAT-ChangeFailureCause ::= CHOICE {
    configurationUnacceptable    NULL,
    physicalChannelFailure      NULL,
    protocolError                ProtocolErrorInformation,
    unspecified                  NULL,
    spare4                       NULL,
    spare3                       NULL,
    spare2                       NULL,
    spare1                       NULL
}

```

```

}

InterRAT-UE-RadioAccessCapability ::= CHOICE {
    gsm                SEQUENCE {
        gsm-Classmark2    GSM-Classmark2,
        gsm-Classmark3    GSM-Classmark3
    },
    cdma2000           SEQUENCE {
        cdma2000-MessageList    CDMA2000-MessageList
    }
}

InterRAT-UE-RadioAccessCapabilityList ::= SEQUENCE (SIZE(1..maxInterSysMessages)) OF
InterRAT-UE-RadioAccessCapability

InterRAT-UE-SecurityCapability ::= CHOICE {
    gsm                SEQUENCE {
        gsmSecurityCapability    GsmSecurityCapability
    }
}

InterRAT-UE-SecurityCapList ::= SEQUENCE (SIZE(1..maxInterSysMessages)) OF
InterRAT-UE-SecurityCapability

InterRAT-HO-FailureCause ::= CHOICE {
    configurationUnacceptable    NULL,
    physicalChannelFailure        NULL,
    protocolError                ProtocolErrorInformation,
    interRAT-ProtocolError        NULL,
    unspecified                   NULL,
    spare11                       NULL,
    spare10                       NULL,
    spare9                        NULL,
    spare8                        NULL,
    spare7                        NULL,
    spare6                        NULL,
    spare5                        NULL,
    spare4                        NULL,
    spare3                        NULL,
    spare2                        NULL,
    spare1                        NULL
}

MasterInformationBlock ::= SEQUENCE {
    mib-ValueTag                MIB-ValueTag,
    -- TABULAR: The PLMN identity and ANSI-41 core network information
    -- are included in PLMN-Type.
    plmn-Type                   PLMN-Type,
    sibSb-ReferenceList          SIBSb-ReferenceList,
    -- Extension mechanism for non- release99 information
    nonCriticalExtensions        SEQUENCE {} OPTIONAL
}

MIB-ValueTag ::= INTEGER (1..8)

NCC ::= INTEGER (0..7)

PLMN-ValueTag ::= INTEGER (1..256)

PredefinedConfigIdentityAndValueTag ::= SEQUENCE {
    predefinedConfigIdentity    PredefinedConfigIdentity,
    predefinedConfigValueTag    PredefinedConfigValueTag
}

ProtocolErrorInformation ::= SEQUENCE {
    diagnosticsType            CHOICE {
        type1                   SEQUENCE {
            protocolErrorCause    ProtocolErrorCause
        },
        spare                     NULL
    }
}

ReceivedMessageType ::= ENUMERATED {
    activeSetUpdate,
    cellChangeOrderFromUTRAN,
    cellUpdateConfirm,
}

```

```

counterCheck,
downlinkDirectTransfer,
interRATHandoverCommand,
measurementControl,
pagingType2,
physicalChannelReconfiguration,
physicalSharedChannelAllocation,
radioBearerReconfiguration,
radioBearerRelease,
radioBearerSetup,
rrcConnectionRelease,
rrcConnectionReject,
rrcConnectionSetup,
securityModeCommand,
signallingConnectionRelease,
transportChannelReconfiguration,
transportFormatCombinationControl,
ueCapabilityEnquiry,
ueCapabilityInformationConfirm,
uplinkPhysicalChannelControl,
uraUpdateConfirm,
utranMobilityInformation,
assistanceDataDelivery,
spare5, spare4, spare3, spare2,
spare1
}

Rplmn-Information ::= SEQUENCE {
    gsm-BA-Range-List          GSM-BA-Range-List          OPTIONAL,
    fdd-UMTS-Frequency-List   FDD-UMTS-Frequency-List
    OPTIONAL,
    tdd-UMTS-Frequency-List   TDD-UMTS-Frequency-List
    OPTIONAL,
    cdma2000-UMTS-Frequency-List CDMA2000-UMTS-Frequency-
List    OPTIONAL
}

Rplmn-Information-r4 ::= SEQUENCE {
    gsm-BA-Range-List          GSM-BA-Range-List          OPTIONAL,
    fdd-UMTS-Frequency-List   FDD-UMTS-Frequency-List   OPTIONAL,
    tdd384-UMTS-Frequency-List TDD-UMTS-Frequency-List   OPTIONAL,
    tdd128-UMTS-Frequency-List TDD-UMTS-Frequency-List   OPTIONAL,
    cdma2000-UMTS-Frequency-List CDMA2000-UMTS-Frequency-List   OPTIONAL
}

SchedulingInformation ::= SEQUENCE {
    scheduling SEQUENCE {
        segCount SegCount DEFAULT 1,
        sib-Pos CHOICE {
            -- The element name indicates the repetition period and the value
            -- (multiplied by two) indicates the position of the first segment.
            rep4 INTEGER (0..1),
            rep8 INTEGER (0..3),
            rep16 INTEGER (0..7),
            rep32 INTEGER (0..15),
            rep64 INTEGER (0..31),
            rep128 INTEGER (0..63),
            rep256 INTEGER (0..127),
            rep512 INTEGER (0..255),
            rep1024 INTEGER (0..511),
            rep2048 INTEGER (0..1023),
            rep4096 INTEGER (0..2047)
        },
        sib-PosOffsetInfo SibOFF-List OPTIONAL
    }
}

SchedulingInformationSIB ::= SEQUENCE {
    sib-Type SIB-TypeAndTag,
    scheduling SchedulingInformation
}

SchedulingInformationSIBSb ::= SEQUENCE {
    sibSb-Type SIBSb-TypeAndTag,
    scheduling SchedulingInformation
}

SegCount ::= INTEGER (1..16)

```

```

SegmentIndex ::=
    INTEGER (1..15)

-- Actual value SFN-Prime = 2 * IE value
SFN-Prime ::=
    INTEGER (0..2047)

SIB-Data-fixed ::=
    BIT STRING (SIZE (222))

SIB-Data-variable ::=
    BIT STRING (SIZE (1..214))

SIBOccurIdentity ::=
    INTEGER (0..15)

SIBOccurrenceIdentityAndValueTag ::=
    SEQUENCE {
        sibOccurIdentity      SIBOccurIdentity,
        sibOccurValueTag     SIBOccurValueTag
    }

SIBOccurValueTag ::=
    INTEGER (0..15)

SIB-ReferenceList ::=
    SEQUENCE (SIZE (1..maxSIB)) OF
        SchedulingInformationSIB

SIBSb-ReferenceList ::=
    SEQUENCE (SIZE (1..maxSIB)) OF
        SchedulingInformationSIBSb

SIB-ReferenceListFACH ::=
    SEQUENCE (SIZE (1..maxSIB-FACH)) OF
        SchedulingInformationSIB

SIB-Type ::=
    ENUMERATED {
        masterInformationBlock,
        systemInformationBlockType1,
        systemInformationBlockType2,
        systemInformationBlockType3,
        systemInformationBlockType4,
        systemInformationBlockType5,
        systemInformationBlockType6,
        systemInformationBlockType7,
        systemInformationBlockType8,
        systemInformationBlockType9,
        systemInformationBlockType10,
        systemInformationBlockType11,
        systemInformationBlockType12,
        systemInformationBlockType13,
        systemInformationBlockType13-1,
        systemInformationBlockType13-2,
        systemInformationBlockType13-3,
        systemInformationBlockType13-4,
        systemInformationBlockType14,
        systemInformationBlockType15,
        systemInformationBlockType15-1,
        systemInformationBlockType15-2,
        systemInformationBlockType15-3,
        systemInformationBlockType16,
        systemInformationBlockType17,
        systemInformationBlockType15-4,
        systemInformationBlockType18,
        schedulingBlock1,
        schedulingBlock2,
        systemInformationBlockType15-5,
        spare1, spare2 }

SIB-TypeAndTag ::=
    CHOICE {
        sysInfoType1      PLMN-ValueTag,
        sysInfoType2      CellValueTag,
        sysInfoType3      CellValueTag,
        sysInfoType4      CellValueTag,
        sysInfoType5      CellValueTag,
        sysInfoType6      CellValueTag,
        sysInfoType7      NULL,
        sysInfoType8      CellValueTag,
        sysInfoType9      NULL,
        sysInfoType10     NULL,
        sysInfoType11     CellValueTag,
        sysInfoType12     CellValueTag,
        sysInfoType13     CellValueTag,
        sysInfoType13-1   CellValueTag,
    }

```

```

sysInfoType13-2      CellValueTag,
sysInfoType13-3      CellValueTag,
sysInfoType13-4      CellValueTag,
sysInfoType14        NULL,
sysInfoType15        CellValueTag,
sysInfoType16        PredefinedConfigIdentityAndValueTag,
sysInfoType17        NULL,
sysInfoType15-1      CellValueTag,
sysInfoType15-2      SIBOccurrenceIdentityAndValueTag,
sysInfoType15-3      SIBOccurrenceIdentityAndValueTag,
sysInfoType15-4      CellValueTag,
sysInfoType18        CellValueTag,
sysInfoType15-5      CellValueTag,
spare5               NULL,
spare4               NULL,
spare3               NULL,
spare2               NULL,
spare1               NULL
}

SIBSb-TypeAndTag ::=
  sysInfoType1      PLMN-ValueTag,
  sysInfoType2      CellValueTag,
  sysInfoType3      CellValueTag,
  sysInfoType4      CellValueTag,
  sysInfoType5      CellValueTag,
  sysInfoType6      CellValueTag,
  sysInfoType7      NULL,
  sysInfoType8      CellValueTag,
  sysInfoType9      NULL,
  sysInfoType10     NULL,
  sysInfoType11     CellValueTag,
  sysInfoType12     CellValueTag,
  sysInfoType13     CellValueTag,
  sysInfoType13-1   CellValueTag,
  sysInfoType13-2   CellValueTag,
  sysInfoType13-3   CellValueTag,
  sysInfoType13-4   CellValueTag,
  sysInfoType14     NULL,
  sysInfoType15     CellValueTag,
  sysInfoType16     PredefinedConfigIdentityAndValueTag,
  sysInfoType17     NULL,
  sysInfoTypeSB1    CellValueTag,
  sysInfoTypeSB2    CellValueTag,
  sysInfoType15-1   CellValueTag,
  sysInfoType15-2   SIBOccurrenceIdentityAndValueTag,
  sysInfoType15-3   SIBOccurrenceIdentityAndValueTag,
  sysInfoType15-4   CellValueTag,
  sysInfoType18     CellValueTag,
  sysInfoType15-5   CellValueTag,
  spare3            NULL,
  spare2            NULL,
  spare1            NULL
}

SibOFF ::=
  ENUMERATED {
    so2, so4, so6, so8, so10,
    so12, so14, so16, so18,
    so20, so22, so24, so26,
    so28, so30, so32 }

SibOFF-List ::=
  SEQUENCE (SIZE (1..15)) OF
  SibOFF

SysInfoType1 ::=
  SEQUENCE {
    -- Core network IEs
    cn-CommonGSM-MAP-NAS-SysInfo  NAS-SystemInformationGSM-MAP,
    cn-DomainSysInfoList          CN-DomainSysInfoList,
    -- User equipment IEs
    ue-ConnTimersAndConstants      UE-ConnTimersAndConstants      OPTIONAL,
    ue-IdleTimersAndConstants      UE-IdleTimersAndConstants      OPTIONAL,
    -- Extension mechanism for non-
    v3a0NonCriticalExtensions      SEQUENCE {
      sysInfoType1-v3a0ext         SysInfoType1-v3a0ext-IEs,
      nonCriticalExtensions        SEQUENCE {} OPTIONAL
    }
  }
}

```

```

SysInfoType1-v3a0ext-IEs ::= SEQUENCE {
    ue-ConnTimersAndConstants-v3a0ext    UE-ConnTimersAndConstants-v3a0ext,
    ue-IdleTimersAndConstants-v3a0ext    UE-IdleTimersAndConstants-v3a0ext
}

SysInfoType2 ::=
    SEQUENCE {
        -- UTRAN mobility IEs
        ura-IdentityList                URA-IdentityList,
        -- Extension mechanism for non- release99 information
        nonCriticalExtensions            SEQUENCE {}                                OPTIONAL
    }

SysInfoType3 ::=
    SEQUENCE {
        sib4indicator                    BOOLEAN,
        -- UTRAN mobility IEs
        cellIdentity                      CellIdentity,
        cellSelectReselectInfo            CellSelectReselectInfoSIB-3-4,
        cellAccessRestriction            CellAccessRestriction,
        -- Extension mechanism for non- release99 information
        v4xyNonCriticalExtensions        SEQUENCE {
            sysInfoType3-v4xyext        SysInfoType3-v4xyext-IEs,
            nonCriticalExtensions        SEQUENCE {}                                OPTIONAL
        }
    }

SysInfoType3-v4xyext-IEs ::= SEQUENCE {
    mapping-LCR                          Mapping-LCR-r4                                OPTIONAL
}

SysInfoType4 ::=
    SEQUENCE {
        -- UTRAN mobility IEs
        cellIdentity                      CellIdentity,
        cellSelectReselectInfo            CellSelectReselectInfoSIB-3-4,
        cellAccessRestriction            CellAccessRestriction,
        -- Extension mechanism for non- release99 information
        v4xyNonCriticalExtensions        SEQUENCE {
            sysInfoType4-v4xyext        SysInfoType4-v4xyext-IEs,
            nonCriticalExtensions        SEQUENCE {}                                OPTIONAL
        }
    }

SysInfoType4-v4xyext-IEs ::= SEQUENCE {
    mapping-LCR                          Mapping-LCR-r4                                OPTIONAL
}

SysInfoType5 ::=
    SEQUENCE {
        sib6indicator                    BOOLEAN,
        -- Physical channel IEs
        pich-PowerOffset                  PICH-PowerOffset,
        modeSpecificInfo                  CHOICE {
            fdd                            SEQUENCE {
                aich-PowerOffset          AICH-PowerOffset
            },
            tdd                            SEQUENCE {
                -- If PDSCH/PUSCH is configured for 1.28Mcps TDD, the following IEs should be absent
                -- and the info included in the tdd128SpecificInfo instead.
                pusch-SysInfoList-SFN     PUSCH-SysInfoList-SFN        OPTIONAL,
                pdsch-SysInfoList-SFN     PDSCH-SysInfoList-SFN        OPTIONAL,
                openLoopPowerControl-TDD   OpenLoopPowerControl-TDD
            }
        },
        primaryCCPCH-Info                 PrimaryCCPCH-Info            OPTIONAL,
        prach-SystemInformationList        PRACH-SystemInformationList,
        sCCPCH-SystemInformationList        SCCPCH-SystemInformationList,
        -- cbs-DRX-Level1Information is conditional on any of the CTCH indicator IEs in
        -- sCCPCH-SystemInformationList
        cbs-DRX-Level1Information          CBS-DRX-Level1Information    OPTIONAL,
        -- Extension mechanism for non- release99 information
        v4xyNonCriticalExtensions        SEQUENCE {
            sysInfoType5-v4xyext        SysInfoType5-v4xyext-IEs    OPTIONAL,
            -- Extension mechanism for non- rel-4 information
            nonCriticalExtensions        SEQUENCE {}                                OPTIONAL
        }
    }

SysInfoType5-v4xyext-IEs ::= SEQUENCE {
    --The following IE PNBSCH-Allocation-r4 shall be used for 3.84Mcps TDD only.
    pNBSCH-Allocation-r4                 PNBSCH-Allocation-r4        OPTIONAL,

```

```

-- In case of TDD, the following IE is included instead of the
-- IE up-IPDL-Parameter in up-OTDOA-AssistanceData.
openLoopPowerControl-IPDL-TDD OpenLoopPowerControl-IPDL-TDD-r4 OPTIONAL,
-- If SysInfoType5 is sent to describe a 1.28Mcps TDD cell, the IE PRACH-RACH-Info included in
-- PRACH-SystemInformationList shall be ignored, the IE PRACH-Partitioning and the
-- IE rach-TransportFormatSet shall be absent and the corresponding IE in the following
-- PRACH-SystemInformationList-LCR-r4 shall be used
prach-SystemInformationList-LCR-r4 PRACH-SystemInformationList-LCR-r4 OPTIONAL,
tdl128SpecificInfo SEQUENCE {
  pusch-SysInfoList-SFN PUSCH-SysInfoList-SFN-LCR-r4 OPTIONAL,
  pdsch-SysInfoList-SFN PDSCH-SysInfoList-SFN-LCR-r4 OPTIONAL,
  pCCPCH-LCR-Extensions PrimaryCCPCH-Info-LCR-r4-ext OPTIONAL,
  sCCPCH-LCR-ExtensionsList SCCPCH-SystemInformationList-LCR-r4-ext
}
OPTIONAL
}

SysInfoType6 ::= SEQUENCE {
  -- Physical channel IEs
  pich-PowerOffset PICH-PowerOffset,
  modeSpecificInfo CHOICE {
    fdd SEQUENCE {
      aich-PowerOffset AICH-PowerOffset,
      -- dummy is not used in this version of specification, it should
      -- not be sent and if received it should be ignored.
      dummy CSICH-PowerOffset OPTIONAL
    },
    tdd SEQUENCE {
      -- If PDSCH/PUSCH is configured for 1.28Mcps TDD, pusch-SysInfoList-SFN,
      -- pdsch-SysInfoList-SFN and openLoopPowerControl-TDD should be absent
      -- and the info included in the tdl128SpecificInfo instead.
      pusch-SysInfoList-SFN PUSCH-SysInfoList-SFN OPTIONAL,
      pdsch-SysInfoList-SFN PDSCH-SysInfoList-SFN OPTIONAL,
      openLoopPowerControl-TDD OpenLoopPowerControl-TDD
    }
  },
  primaryCCPCH-Info PrimaryCCPCH-Info OPTIONAL,
  prach-SystemInformationList PRACH-SystemInformationList OPTIONAL,
  sCCPCH-SystemInformationList SCCPCH-SystemInformationList OPTIONAL,
  cbs-DRX-Level1Information CBS-DRX-Level1Information OPTIONAL,
  -- Conditional on any of the CTCH indicator IEs in
  -- sCCPCH-SystemInformationList
  -- Extension mechanism for non- release99 information
  v4xyNonCriticalExtensions SEQUENCE {
    sysInfoType6-v4xyext SysInfoType6-v4xyext-IEs OPTIONAL,
    -- Extension mechanism for non- rel-4 information
    nonCriticalExtensions SEQUENCE {} OPTIONAL
  }
}
OPTIONAL

SysInfoType6-v4xyext-IEs ::= SEQUENCE {
  -- openLoopPowerControl-IPDL-TDD is present only if IPDLs are applied for TDD
  openLoopPowerControl-IPDL-TDD OpenLoopPowerControl-IPDL-TDD-r4 OPTIONAL,
  -- If SysInfoType6 is sent to describe a 1.28Mcps TDD cell, the IE PRACH-RACH-Info included
  -- in PRACH-SystemInformationList shall be ignored, the IE PRACH-Partitioning and the
  -- IE rach-TransportFormatSet shall be absent and the corresponding IEs in the following
  -- PRACH-SystemInformationList-LCR-r4 shall be used
  prach-SystemInformationList-LCR-r4 PRACH-SystemInformationList-LCR-r4 OPTIONAL,
  tdl128SpecificInfo SEQUENCE {
    pusch-SysInfoList-SFN PUSCH-SysInfoList-SFN-LCR-r4 OPTIONAL,
    pdsch-SysInfoList-SFN PDSCH-SysInfoList-SFN-LCR-r4 OPTIONAL,
    pCCPCH-LCR-Extensions PrimaryCCPCH-Info-LCR-r4-ext OPTIONAL,
    sCCPCH-LCR-ExtensionsList SCCPCH-SystemInformationList-LCR-r4-ext OPTIONAL
  }
}
OPTIONAL

SysInfoType7 ::= SEQUENCE {
  -- Physical channel IEs
  modeSpecificInfo CHOICE {
    fdd SEQUENCE {
      ul-Interference UL-Interference
    },
    tdd NULL
  },
  prach-Information-SIB5-List DynamicPersistenceLevelList,
  prach-Information-SIB6-List DynamicPersistenceLevelList OPTIONAL,
  expirationTimeFactor ExpirationTimeFactor OPTIONAL,
  -- Extension mechanism for non- release99 information
  nonCriticalExtensions SEQUENCE {} OPTIONAL
}

```



```

}

SysInfoType8 ::=
  -- User equipment IEs
  cpch-Parameters CPCH-Parameters,
  -- Physical channel IEs
  cpch-SetInfoList CPCH-SetInfoList,
  csich-PowerOffset CSICH-PowerOffset,
  -- Extension mechanism for non- release99 information
  nonCriticalExtensions SEQUENCE {} OPTIONAL
}

SysInfoType9 ::=
  -- Physical channel IEs
  cpch-PersistenceLevelsList CPCH-PersistenceLevelsList,
  -- Extension mechanism for non- release99 information
  nonCriticalExtensions SEQUENCE {} OPTIONAL
}

SysInfoType10 ::=
  -- User equipment IEs
  drac-SysInfoList DRAC-SysInfoList,
  -- Extension mechanism for non- release99 information
  nonCriticalExtensions SEQUENCE {} OPTIONAL
}

SysInfoType11 ::=
  sib12indicator BOOLEAN,
  -- Measurement IEs
  fach-MeasurementOccasionInfo FACH-MeasurementOccasionInfo OPTIONAL,
  measurementControlSysInfo MeasurementControlSysInfo,
  -- Extension mechanism for non- release99 information
  v4xyNonCriticalExtensions SEQUENCE {
    sysInfoType11-v4xyext SysInfoType11-v4xyext-IEs OPTIONAL,
    nonCriticalExtensions SEQUENCE {} OPTIONAL
  } OPTIONAL
}

SysInfoType11-v4xyext-IEs ::= SEQUENCE {
  fach-MeasurementOccasionInfo-LCR-Ext FACH-MeasurementOccasionInfo-LCR-r4-ext OPTIONAL,
  measurementControlSysInfo-LCR MeasurementControlSysInfo-LCR-r4-ext
}

SysInfoType12 ::=
  -- Measurement IEs
  fach-MeasurementOccasionInfo FACH-MeasurementOccasionInfo OPTIONAL,
  measurementControlSysInfo MeasurementControlSysInfo,
  -- Extension mechanism for non- release99 information
  v4xyNonCriticalExtensions SEQUENCE {
    sysInfoType12-v4xyext SysInfoType12-v4xyext-IEs OPTIONAL,
    nonCriticalExtensions SEQUENCE {} OPTIONAL
  } OPTIONAL
}

SysInfoType12-v4xyext-IEs ::= SEQUENCE {
  fach-MeasurementOccasionInfo-LCR-Ext FACH-MeasurementOccasionInfo-LCR-r4-ext OPTIONAL,
  measurementControlSysInfo-LCR MeasurementControlSysInfo-LCR-r4-ext
}

SysInfoType13 ::=
  -- Core network IEs
  cn-DomainSysInfoList CN-DomainSysInfoList,
  -- User equipment IEs
  ue-IdleTimersAndConstants UE-IdleTimersAndConstants OPTIONAL,
  capabilityUpdateRequirement CapabilityUpdateRequirement OPTIONAL,
  -- Extension mechanism for non- release99 information
  v3a0NonCriticalExtensions SEQUENCE {
    sysInfoType13-v3a0ext SysInfoType13-v3a0ext-IEs,
    v4xyNonCriticalExtensions SEQUENCE {
      sysInfoType13-v4xyext SysInfoType13-v4xyext-IEs,
      -- Extension mechanism for non- release99 information
      nonCriticalExtensions SEQUENCE {} OPTIONAL
    } OPTIONAL
  } OPTIONAL
}

SysInfoType13-v3a0ext-IEs ::= SEQUENCE {
  ue-IdleTimersAndConstants-v3a0ext UE-IdleTimersAndConstants-v3a0ext
}

```

```

}

SysInfoType13-v4xyext-IEs ::= SEQUENCE {
    capabilityUpdateRequirement-r4Ext    CapabilityUpdateRequirement-r4-ext    OPTIONAL
}

SysInfoType13-1 ::=
    SEQUENCE {
        -- ANSI-41 IEs
        ansi-41-RAND-Information          ANSI-41-RAND-Information,
        -- Extension mechanism for non- release99 information
        nonCriticalExtensions              SEQUENCE {}                                OPTIONAL
    }

SysInfoType13-2 ::=
    SEQUENCE {
        -- ANSI-41 IEs
        ansi-41-UserZoneID-Information    ANSI-41-UserZoneID-Information,
        -- Extension mechanism for non- release99 information
        nonCriticalExtensions              SEQUENCE {}                                OPTIONAL
    }

SysInfoType13-3 ::=
    SEQUENCE {
        -- ANSI-41 IEs
        ansi-41-PrivateNeighbourListInfo  ANSI-41-PrivateNeighbourListInfo,
        -- Extension mechanism for non- release99 information
        nonCriticalExtensions              SEQUENCE {}                                OPTIONAL
    }

SysInfoType13-4 ::=
    SEQUENCE {
        -- ANSI-41 IEs
        ansi-41-GlobalServiceRedirectInfo ANSI-41-GlobalServiceRedirectInfo,
        -- Extension mechanism for non- release99 information
        nonCriticalExtensions              SEQUENCE {}                                OPTIONAL
    }

SysInfoType14 ::=
    SEQUENCE {
        -- Physical channel IEs
        individualTS-InterferenceList      IndividualTS-InterferenceList,
        expirationTimeFactor                ExpirationTimeFactor                    OPTIONAL,
        -- Extension mechanism for non- release99 information
        nonCriticalExtensions              SEQUENCE {}                                OPTIONAL
    }

SysInfoType15 ::=
    SEQUENCE {
        -- Measurement IEs

        ue-positioning-GPS-CipherParameters    UE-Positioning-CipherParameters    OPTIONAL,
        ue-positioning-GPS-ReferenceLocation    ReferenceLocation,
        ue-positioning-GPS-ReferenceTime        UE-Positioning-GPS-ReferenceTime,

        ue-positioning-GPS-Real-timeIntegrity    BadSatList                            OPTIONAL,
        -- Extension mechanism for non- release99 information
        v4xyNonCriticalExtensions              SEQUENCE {
            sysInfoType15-v4xyext              SysInfoType15-v4xyext-IEs,
            -- Extension mechanism for non- release4 information
            nonCriticalExtensions              SEQUENCE {}                                OPTIONAL
        }    OPTIONAL
    }

SysInfoType15-v4xyext-IEs ::= SEQUENCE {
    up-IPDL-Parameters-TDD                UE-Positioning-IPDL-Parameters-TDD-r4-ext    OPTIONAL
}

SysInfoType15-1 ::=
    SEQUENCE {
        -- DGPS corrections
        ue-positioning-GPS-DGPS-Corrections    UE-Positioning-GPS-DGPS-Corrections,

        -- Extension mechanism for non- release99 information
        nonCriticalExtensions              SEQUENCE {}                                OPTIONAL
    }

SysInfoType15-2 ::=
    SEQUENCE {
        -- Ephemeris and clock corrections
        transmissionTOW                      INTEGER (0..604799),
        satID                                  SatID,
        ephemerisParameter                    EphemerisParameter,

        -- Extension mechanism for non- release99 information
    }

```

```

        nonCriticalExtensions          SEQUENCE {}          OPTIONAL
    }
SysInfoType15-3 ::=                      SEQUENCE {
    -- Almanac and other data
        transmissionTOW                INTEGER (0.. 604799),
        ue-positioning-GPS-Almanac      UE-Positioning-GPS-Almanac
    OPTIONAL,
        ue-positioning-GPS-IonosphericModel  UE-Positioning-GPS-IonosphericModel
    OPTIONAL,
        ue-positioning-GPS-UTC-Model      UE-Positioning-GPS-UTC-Model
    OPTIONAL,
        satMask                          BIT STRING (SIZE (1..32))  OPTIONAL,
        lsbTOW                            BIT STRING (SIZE (8))    OPTIONAL,
    -- Extension mechanism for non- release99 information
        nonCriticalExtensions            SEQUENCE {}          OPTIONAL
    }

SysInfoType15-4 ::=                      SEQUENCE {
    -- Measurement IEs
        ue-positioning-OTDOA-CipherParameters  UE-Positioning-CipherParameters          OPTIONAL,
        ue-positioning-OTDOA-AssistanceData    UE-Positioning-OTDOA-AssistanceData,
        v3a0NonCriticalExtensions              SEQUENCE {
            sysInfoType15-4-v3a0ext            SysInfoType15-4-v3a0ext,
        -- Extension mechanism for non- release99 information
            v4xyNonCriticalExtensions          SEQUENCE {
                sysInfoType15-4-v4xyext        SysInfoType15-4-v4xyext,
                nonCriticalExtensions          SEQUENCE {}          OPTIONAL
            } OPTIONAL
        } OPTIONAL
    }

SysInfoType15-4-v3a0ext ::= SEQUENCE {
    sfm-Offset-Validity                    SFN-Offset-Validity          OPTIONAL
}

SysInfoType15-4-v4xyext ::= SEQUENCE {
    ue-Positioning-OTDOA-AssistanceData-r4ext  UE-Positioning-OTDOA-AssistanceData-r4ext  OPTIONAL
}

SysInfoType15-5 ::=                      SEQUENCE {
    -- Measurement IEs
        ue-positioning-OTDOA-AssistanceData-UEB  UE-Positioning-OTDOA-AssistanceData-UEB,
        v3a0NonCriticalExtensions                SEQUENCE {
            sysInfoType15-5-v3a0ext              SysInfoType15-5-v3a0ext,
        -- Extension mechanism for non- release99 information
            nonCriticalExtensions                SEQUENCE {}          OPTIONAL
        } OPTIONAL
    }

SysInfoType15-5-v3a0ext ::= SEQUENCE {
    sfm-Offset-Validity                    SFN-Offset-Validity          OPTIONAL
}

SysInfoType16 ::=                      SEQUENCE {
    -- Radio bearer IEs
        preDefinedRadioConfiguration  PreDefRadioConfiguration,
    -- Extension mechanism for non- release99 information
        nonCriticalExtensions          SEQUENCE {}          OPTIONAL
    }

SysInfoType17 ::=                      SEQUENCE {
    -- Physical channel IEs
        -- If PDSCH/PUSCH is configured for 1.28Mcps TDD, pusch-SysInfoList and
        -- pdsch-SysInfoList should be absent and the info included in the
        -- tddl28SpecificInfo instead.
        pusch-SysInfoList                PUSCH-SysInfoList          OPTIONAL,
        pdsch-SysInfoList                PDSCH-SysInfoList        OPTIONAL,
    -- Extension mechanism for non- release99 information
        v4xyNonCriticalExtensions        SEQUENCE {
            sysInfoType17-v4xyext        SysInfoType17-v4xyext-IEs,
            nonCriticalExtensions        SEQUENCE {}          OPTIONAL
        } OPTIONAL
    }

SysInfoType17-v4xyext-IEs ::= SEQUENCE {
    tddl28SpecificInfo                    SEQUENCE {
        pusch-SysInfoList                PUSCH-SysInfoList-LCR-r4          OPTIONAL,

```

```

        pdsch-SysInfoList                PDSCH-SysInfoList-LCR-r4        OPTIONAL
    }                                     OPTIONAL
}

SysInfoType18 ::=
    idleModePLMNIdentities                SEQUENCE {
        connectedModePLMNIdentities      PLMNIdentitiesOfNeighbourCells    OPTIONAL,
        -- Extension mechanism for non-   release99 information            OPTIONAL,
        nonCriticalExtensions              SEQUENCE {}                       OPTIONAL
    }

SysInfoTypeSB1 ::=                       SEQUENCE {
    -- Other IEs
        sib-ReferenceList                  SIB-ReferenceList,
    -- Extension mechanism for non-   release99 information
        nonCriticalExtensions              SEQUENCE {}                       OPTIONAL
    }

SysInfoTypeSB2 ::=                       SEQUENCE {
    -- Other IEs
        sib-ReferenceList                  SIB-ReferenceList,
    -- Extension mechanism for non-   release99 information
        nonCriticalExtensions              SEQUENCE {}                       OPTIONAL
    }

TDD-UMTS-Frequency-List ::=              SEQUENCE (SIZE (1..maxNumTDDFreqs)) OF
                                          FrequencyInfoTDD

-- *****
--
--     ANSI-41 INFORMATION ELEMENTS (10.3.9)
--
-- *****

ANSI-41-GlobalServiceRedirectInfo ::=    ANSI-41-NAS-Parameter
ANSI-41-PrivateNeighbourListInfo ::=    ANSI-41-NAS-Parameter
ANSI-41-RAND-Information ::=             ANSI-41-NAS-Parameter
ANSI-41-UserZoneID-Information ::=      ANSI-41-NAS-Parameter
ANSI-41-NAS-Parameter ::=               BIT STRING (SIZE (1..2048))

Min-P-REV ::=                            BIT STRING (SIZE (8))

NAS-SystemInformationANSI-41 ::=         ANSI-41-NAS-Parameter
NID ::=                                  BIT STRING (SIZE (16))

P-REV ::=                                BIT STRING (SIZE (8))

SID ::=                                  BIT STRING (SIZE (15))

END

```

11.4 Constant definitions

Constant-definitions DEFINITIONS AUTOMATIC TAGS ::=

BEGIN

```

hipDSCHIdentities                INTEGER ::= 64
hipUSCHIdentities                INTEGER ::= 64
hiRM                              INTEGER ::= 256
maxAC                             INTEGER ::= 16
maxAdditionalMeas                 INTEGER ::= 4
maxASC                           INTEGER ::= 8
maxASCmap                         INTEGER ::= 7
maxASCpersist                    INTEGER ::= 6
maxCCTrCH                        INTEGER ::= 8
maxCellMeas                      INTEGER ::= 32
maxCellMeas-1                   INTEGER ::= 31
maxCNdomains                     INTEGER ::= 4
maxCPCHsets                      INTEGER ::= 16
maxDPCH-DLchan                   INTEGER ::= 8
maxDPDCH-UL                      INTEGER ::= 6
maxDRACclasses                   INTEGER ::= 8
maxFACHPCH                       INTEGER ::= 8
maxFreq                          INTEGER ::= 8
maxFreqBandsFDD                  INTEGER ::= 8
maxFreqBandsTDD                  INTEGER ::= 4

```

```

maxFreqBandsGSM                INTEGER ::= 16
maxInterSysMessages            INTEGER ::= 4
maxLoCHperRLC                  INTEGER ::= 2
maxMeasEvent                    INTEGER ::= 8
maxMeasIntervals                INTEGER ::= 3
maxMeasParEvent                INTEGER ::= 2
maxNumCDMA2000Freqs            INTEGER ::= 8
maxNumGSMFreqRanges            INTEGER ::= 32
maxNumFDDFreqs                  INTEGER ::= 8
maxNumTDDFreqs                  INTEGER ::= 8
maxNoOfMeas                     INTEGER ::= 16
maxOtherRAT                     INTEGER ::= 15
maxOtherRAT-16                  INTEGER ::= 16
maxPage1                         INTEGER ::= 8
maxPCPCH-APsig                  INTEGER ::= 16
maxPCPCH-APsubCh                INTEGER ::= 12
maxPCPCH-CDsig                  INTEGER ::= 16
maxPCPCH-CDsubCh                INTEGER ::= 12
maxPCPCH-SF                      INTEGER ::= 7
maxPCPCHs                        INTEGER ::= 64
maxPDCPAlgoType                 INTEGER ::= 8
maxPDSCH                         INTEGER ::= 8
maxPDSCH-TFCIgroups             INTEGER ::= 256
maxPRACH                         INTEGER ::= 16
maxPRACH-FPACH                   INTEGER ::= 8
maxPredefConfig                 INTEGER ::= 16
maxPUSCH                         INTEGER ::= 8
maxRABsetup                       INTEGER ::= 16
maxRAT                           INTEGER ::= 16
maxRB                             INTEGER ::= 32
maxRBallRABs                     INTEGER ::= 27
maxRBMuxOptions                  INTEGER ::= 8
maxRBperRAB                       INTEGER ::= 8
maxReportedGSMCells              INTEGER ::= 6
maxRL                             INTEGER ::= 8
maxRL-1                           INTEGER ::= 7
maxROHC-PacketSizes-r4           INTEGER ::= 16
maxROHC-Profile-r4                INTEGER ::= 8
maxSat                           INTEGER ::= 16
maxSCCPCH                         INTEGER ::= 16
maxSIB                           INTEGER ::= 32
maxSIB-FACH                       INTEGER ::= 8
maxSIBperMsg                      INTEGER ::= 16
maxSRBsetup                       INTEGER ::= 8
maxSystemCapability               INTEGER ::= 16
maxTF                             INTEGER ::= 32
maxTF-CPCH                       INTEGER ::= 16
maxTFC                             INTEGER ::= 1024
maxTFCsub                         INTEGER ::= 1024
maxTFCI-2-Combs                   INTEGER ::= 512
maxTGPS                           INTEGER ::= 6
maxTrCH                           INTEGER ::= 32
-- maxTrCHpreconf should be 16 but has been set to 32 for compatibility
maxTrCHpreconf                    INTEGER ::= 32
maxTS                             INTEGER ::= 14
maxTS-1                           INTEGER ::= 13
maxTS-LCR                          INTEGER ::= 6
maxTS-LCR-1                       INTEGER ::= 5
maxURA                             INTEGER ::= 8

```

END

11.5 RRC information between network nodes

Internode-definitions DEFINITIONS AUTOMATIC TAGS ::=

BEGIN

IMPORTS

```

    HandoverToUTRANCommand,
    MeasurementReport,
    PhysicalChannelReconfiguration,
    RadioBearerReconfiguration,
    RadioBearerRelease,
    RadioBearerSetup,
    RRC-FailureInfo-r3-IEs,

```

TransportChannelReconfiguration
FROM PDU-definitions

```
-- Core Network IEs :
  CN-DomainIdentity,
  CN-DomainInformationList,
  CN-DomainInformationListFull,
  CN-DRX-CycleLengthCoefficient,
  NAS-SystemInformationGSM-MAP,
-- UTRAN Mobility IEs :
  CellIdentity,
  URA-Identity,
-- User Equipment IEs :
  AccessStratumReleaseIndicator,
  C-RNTI,
  ChipRateCapability,
  DL-PhysChCapabilityFDD-v380ext,
  DL-PhysChCapabilityTDD,
  DL-PhysChCapabilityTDD-LCR-r4,
  GSM-Measurements,
  FailureCauseWithProtErr,
  MaxHcContextSpace,
  MaxNoPhysChBitsReceived,
  MaxROHC-ContextSessions-r4,
  NetworkAssistedGPS-Supported,
  RadioFrequencyBandTDDList,
  RLC-Capability,
  RRC-MessageSequenceNumber,
  SecurityCapability,
  SimultaneousSCCPCH-DPCH-Reception,
  STARTList,
  STARTSingle,
  START-Value,
  SupportOfDedicatedPilotsForChEstimation,
  TransportChannelCapability,
  TxRxFrequencySeparation,
  U-RNTI,
  UE-MultiModeRAT-Capability,
  UE-PowerClass-v370,
  UE-RadioAccessCapabBandFDDList,
  UE-RadioAccessCapability,
  UE-RadioAccessCapability-v370ext,
  UE-RadioAccessCapability-v380ext,
  UE-RadioAccessCapability-v3a0ext,
  UE-RadioAccessCapability-v4xyext,
  UL-PhysChCapabilityFDD,
  UL-PhysChCapabilityTDD,
  UL-PhysChCapabilityTDD-LCR-r4,
-- Radio Bearer IEs :
  PredefinedConfigStatusList,
  PredefinedConfigValueTag,
  RAB-InformationSetupList,
  RAB-InformationSetupList-r4,
  RAB-Identity,
  RB-Identity,
  SRB-InformationSetupList,
-- Transport Channel IEs :
  CPCH-SetID,
  DL-CommonTransChInfo,
  DL-CommonTransChInfo-r4,
  DL-AddReconfTransChInfoList,
  DL-AddReconfTransChInfoList-r4,
  DRAC-StaticInformationList,
  UL-CommonTransChInfo,
  UL-CommonTransChInfo-r4,
  UL-AddReconfTransChInfoList,
-- Measurement IEs :
  MeasurementIdentity,
  MeasurementReportingMode,
  MeasurementType,
  MeasurementType-r4,
  AdditionalMeasurementID-List,
  PositionEstimate,
  UE-Positioning-IPDL-Parameters-TDD-r4-ext,
-- Other IEs :
  InterRAT-UE-RadioAccessCapabilityList,
  UESpecificBehaviourInformationInterRAT,
  UESpecificBehaviourInformationIdle
```

```

FROM InformationElements

    maxCNdomains,
    maxNoOfMeas,

    maxRB,
    maxSRBsetup
FROM Constant-definitions
;

-- Part 1: Class definitions similar to what has been defined in 11.1 for RRC messages
-- Information that is transferred in the same direction and across the same path is grouped

-- *****
--
-- RRC information, to target RNC
--
-- *****
-- RRC Information to target RNC sent either from source RNC or from another RAT

ToTargetRNC-Container ::= CHOICE {
    interRATHandoverInfo          InterRATHandoverInfoWithInterRATCapabilities-r3,
    srncRelocation                SRNC-RelocationInfo-r3,
    extension                      NULL
}

-- *****
--
-- RRC information, target RNC to source RNC
--
-- *****

Target-RNC-ToSourceRNC-Container ::= CHOICE {
    radioBearerSetup              RadioBearerSetup,
    radioBearerReconfiguration    RadioBearerReconfiguration,
    radioBearerRelease            RadioBearerRelease,
    transportChannelReconfiguration TransportChannelReconfiguration,
    physicalChannelReconfiguration PhysicalChannelReconfiguration,
    rrc-FailureInfo               RRC-FailureInfo-r3-IEs,
    -- IE dl-DCCHmessage consists of an octet string that includes
    -- the IE DL-DCCH-Message
    dl-DCCHmessage                OCTET STRING,
    extension                      NULL
}

-- Part 2: Container definitions, similar to the PDU definitions in 11.2 for RRC messages
-- In alphabetical order

-- *****
--
-- Handover to UTRAN information
--
-- *****

InterRATHandoverInfoWithInterRATCapabilities-r3 ::= CHOICE {
    r3                             SEQUENCE {
        -- IE InterRATHandoverInfoWithInterRATCapabilities-r3-IEs also
        -- includes non critical extensions
        interRATHandoverInfo-r3      InterRATHandoverInfoWithInterRATCapabilities-r3-IEs,
        v390NonCriticalExtensions     SEQUENCE {
            interRATHandoverInfoWithInterRATCapabilities-v390ext
        }
        InterRATHandoverInfoWithInterRATCapabilities-v390ext-IEs,
        -- Reserved for future non critical extension
        nonCriticalExtensions         SEQUENCE {} OPTIONAL
    }
    },
    criticalExtensions              SEQUENCE {}
}

InterRATHandoverInfoWithInterRATCapabilities-r3-IEs ::= SEQUENCE {
    -- The order of the IEs may not reflect the tabular format
    -- but has been chosen to simplify the handling of the information in the BSC
    -- Other IEs
    ue-RATSpecificCapability         InterRAT-UE-RadioAccessCapabilityList OPTIONAL,
    -- interRATHandoverInfo, Octet string is used to obtain 8 bit length field prior to
    -- actual information. This makes it possible for BSS to transparently handle information

```

```

-- received via GSM air interface even when it includes non critical extensions.
-- The octet string shall include the InterRATHandoverInfo information
-- The BSS can re-use the 04.18 length field received from the MS
interRATHandoverInfo      OCTET STRING (SIZE (0..255))
}

InterRATHandoverInfoWithInterRATCapabilities-v390ext-IEs ::= SEQUENCE {
  -- User equipment IES
  failureCauseWithProtErr      FailureCauseWithProtErr      OPTIONAL
}

-- *****
--
-- SRNC Relocation information
--
-- *****

SRNC-RelocationInfo-r3 ::= CHOICE {
  r3
    SEQUENCE {
      SRNC-RelocationInfo-r3      SRNC-RelocationInfo-r3-IEs,
      v380NonCriticalExtensions  SEQUENCE {
        SRNC-RelocationInfo-v380ext SRNC-RelocationInfo-v380ext-IEs,
        -- Reserved for future non critical extension
        v390NonCriticalExtensions  SEQUENCE {
          SRNC-RelocationInfo-v390ext      SRNC-RelocationInfo-v390ext-IEs,
          v3a0NonCriticalExtensions      SEQUENCE {
            SRNC-RelocationInfo-v3a0ext      SRNC-RelocationInfo-v3a0ext-IEs,
            v3b0NonCriticalExtensions      SEQUENCE {
              SRNC-RelocationInfo-v3b0ext      SRNC-RelocationInfo-v3b0ext-IEs,
              v3c0NonCriticalExtensions      SEQUENCE {
                SRNC-RelocationInfo-v3c0ext      SRNC-RelocationInfo-v3c0ext-IEs,
                laterNonCriticalExtensions      SEQUENCE {
                  SRNC-RelocationInfo-v3d0ext      SRNC-RelocationInfo-v3d0ext-IEs,
                  -- Container for additional R99 extensions
                  SRNC-RelocationInfo-r3-add-ext      BIT STRING OPTIONAL,
                  v4xyNonCriticalExtensions      SEQUENCE {
                    SRNC-RelocationInfo-v4xyext      SRNC-RelocationInfo-
v4xyext-IEs,
                    -- Reserved for future non critical extension
                    nonCriticalExtensions      SEQUENCE {} OPTIONAL
                  }
                }
              }
            }
          }
        }
      }
    }
  }
  OPTIONAL
}
},
later-than-r3
  CHOICE {
    r4
      SEQUENCE {
        SRNC-RelocationInfo-r4      SRNC-RelocationInfo-r4-IEs,
        nonCriticalExtensions      SEQUENCE {} OPTIONAL
      },
      criticalExtensions      SEQUENCE {}
    }
  }
}

SRNC-RelocationInfo-r3-IEs ::= SEQUENCE {
  -- Non-RRC IES
  stateOfRRC      StateOfRRC,
  stateOfRRC-Procedure      StateOfRRC-Procedure,
  -- Ciphering related information IES
  -- If the extension v380 is included use the extension for the ciphering status per CN domain
  cipheringStatus      CipheringStatus,
  calculationTimeForCiphering      CalculationTimeForCiphering      OPTIONAL,
  -- The order of occurrence in the IE cipheringInfoPerRB-List is the
  -- same as the RBs in SRB-InformationSetupList in RAB-InformationSetupList.
  -- The signalling RBs are supposed to be listed
  -- first. Only UM and AM RBs that are ciphered are listed here
  cipheringInfoPerRB-List      CipheringInfoPerRB-List      OPTIONAL,
  count-C-List      COUNT-C-List      OPTIONAL,
  integrityProtectionStatus      IntegrityProtectionStatus,
  -- In the IE srb-SpecificIntegrityProtInfo, the first information listed corresponds to
  -- signalling radio bearer RB0 and after the order of occurrence is the same as the SRBs in
  -- SRB-InformationSetupList
  srb-SpecificIntegrityProtInfo      SRB-SpecificIntegrityProtInfoList,
  implementationSpecificParams      ImplementationSpecificParams      OPTIONAL,
  -- User equipment IES

```



```

    u-RNTI                U-RNTI,
    c-RNTI                C-RNTI                                OPTIONAL,
    ue-RadioAccessCapability UE-RadioAccessCapability,
    ue-Positioning-LastKnownPos UE-Positioning-LastKnownPos    OPTIONAL,
-- Other IEs
    ue-RATSpecificCapability InterRAT-UE-RadioAccessCapabilityList  OPTIONAL,
-- UTRAN mobility IEs
    ura-Identity          URA-Identity                            OPTIONAL,
-- Core network IEs
    cn-CommonGSM-MAP-NAS-SysInfo NAS-SystemInformationGSM-MAP,
    cn-DomainInformationList CN-DomainInformationList            OPTIONAL,
-- Measurement IEs
    ongoingMeasRepList    OngoingMeasRepList                    OPTIONAL,
-- Radio bearer IEs
    predefinedConfigStatusList PredefinedConfigStatusList,
    srb-InformationList   SRB-InformationSetupList,
    rab-InformationList   RAB-InformationSetupList              OPTIONAL,
-- Transport channel IEs
    ul-CommonTransChInfo UL-CommonTransChInfo                  OPTIONAL,
    ul-TransChInfoList   UL-AddReconfTransChInfoList           OPTIONAL,
    modeSpecificInfo     CHOICE {
        fdd                SEQUENCE {
            cpch-SetID     CPCH-SetID                            OPTIONAL,
            transChDRAC-Info DRAC-StaticInformationList          OPTIONAL,
        },
        tdd                NULL
    },
    dl-CommonTransChInfo DL-CommonTransChInfo                    OPTIONAL,
    dl-TransChInfoList   DL-AddReconfTransChInfoList           OPTIONAL,
-- Measurement report
    measurementReport     MeasurementReport                      OPTIONAL
}

SRNC-RelocationInfo-v380ext-IEs ::= SEQUENCE {
-- Ciphering related information IEs
    cn-DomainIdentity     CN-DomainIdentity,
    cipheringStatusList   CipheringStatusList
}

SRNC-RelocationInfo-v390ext-IEs ::= SEQUENCE {
    cn-DomainInformationList-v390ext CN-DomainInformationList-v390ext    OPTIONAL,
    ue-RadioAccessCapability-v370ext UE-RadioAccessCapability-v370ext    OPTIONAL,
    ue-RadioAccessCapability-v380ext UE-RadioAccessCapability-v380ext    OPTIONAL,
    dl-PhysChCapabilityFDD-v380ext   DL-PhysChCapabilityFDD-v380ext,
    failureCauseWithProtErr         FailureCauseWithProtErr          OPTIONAL
}

SRNC-RelocationInfo-v3a0ext-IEs ::= SEQUENCE {
-- cn-domain identity for IE startValueForCiphering-v3a0ext is specified
-- in subsequent extension (SRNC-RelocationInfo-v3b0ext-IEs)
    startValueForCIphering-v3a0ext   START-Value,
    cipheringInfoForSRB1-v3a0ext     CipheringInfoForSRB1-v3a0ext,
    ue-RadioAccessCapability-v3a0ext UE-RadioAccessCapability-v3a0ext    OPTIONAL
}

SRNC-RelocationInfo-v3b0ext-IEs ::= SEQUENCE {
-- cn-domain identity for IE startValueForCiphering-v3a0ext included in previous extension
    cn-DomainIdentity                 CN-DomainIdentity,
-- the remaining start values are contained in IE startValueForCiphering-v3b0ext
    startValueForCiphering-v3b0ext    STARTList2                      OPTIONAL
}

SRNC-RelocationInfo-v3c0ext-IEs ::= SEQUENCE {
-- IE rb-IdentityForHOMessage includes the identity of the RB used by the source SRNC
-- to send the message contained in the IE "TargetRNC-ToSourceRNC-Container".
-- Only included if type is "UE involved"
    rb-IdentityForHOMessage           RB-Identity                      OPTIONAL
}

SRNC-RelocationInfo-v3d0ext-IEs ::= SEQUENCE {
-- User equipment IEs
    uESpecificBehaviourInformationIdle UESpecificBehaviourInformationIdle    OPTIONAL,
    uESpecificBehaviourInformationInterRAT UESpecificBehaviourInformationInterRAT
OPTIONAL
}

STARTList2 ::= SEQUENCE (SIZE (2..maxCNdomains)) OF
STARTSingle

```

```

SRNC-RelocationInfo-v4xyext-IEs ::= SEQUENCE {
    ue-RadioAccessCapability-v4xyext    UE-RadioAccessCapability-v4xyext
}

CipheringInfoForSRB1-v3a0ext ::= SEQUENCE {
    dl-UM-SN                            BIT STRING (SIZE (7))
}

CipheringStatusList ::=
    SEQUENCE (SIZE (1..maxCNDomains)) OF
    CipheringStatusCNDomain

CipheringStatusCNDomain ::=
    SEQUENCE {
        cn-DomainIdentity                CN-DomainIdentity,
        cipheringStatus                  CipheringStatus
    }

SRNC-RelocationInfo-r4-IEs ::=
    SEQUENCE {
        -- Non-RRC IEs
        -- IE rb-IdentityForHOMessage includes the identity of the RB used by the source SRNC
        -- to send the message contained in the IE "TargetRNC-ToSourceRNC-Container".
        -- Only included if type is "UE involved"
        rb-IdentityForHOMessage           RB-Identity                        OPTIONAL,
        stateOfRRC                       StateOfRRC,
        stateOfRRC-Procedure              StateOfRRC-Procedure,
        -- Ciphering related information IEs
        cipheringStatusList               CipheringStatusList-r4,
        latestConfiguredCN-Domain         CN-DomainIdentity,
        calculationTimeForCiphering       CalculationTimeForCiphering        OPTIONAL,
        count-C-List                      COUNT-C-List                        OPTIONAL,
        cipheringInfoPerRB-List           CipheringInfoPerRB-List-r4         OPTIONAL,
        -- Integrity protection related information IEs
        integrityProtectionStatus         IntegrityProtectionStatus,
        srb-SpecificIntegrityProtInfo     SRB-SpecificIntegrityProtInfoList,
        implementationSpecificParams      ImplementationSpecificParams      OPTIONAL,
        -- User equipment IEs
        u-RNTI                            U-RNTI,
        c-RNTI                            C-RNTI                            OPTIONAL,
        ue-RadioAccessCapability          UE-RadioAccessCapability-r4,
        ue-RadioAccessCapability-ext      UE-RadioAccessCapabBandFDDList   OPTIONAL,
        ue-Positioning-LastKnownPos      UE-Positioning-LastKnownPos      OPTIONAL,
        uESpecificBehaviourInformationIdle UESpecificBehaviourInformationIdle OPTIONAL,
        uESpecificBehaviourInformationInterRAT UESpecificBehaviourInformationInterRAT
        OPTIONAL,
        -- Other IEs
        ue-RATSpecificCapability          InterRAT-UE-RadioAccessCapabilityList OPTIONAL,
        -- UTRAN mobility IEs
        ura-Identity                      URA-Identity                      OPTIONAL,
        -- Core network IEs
        cn-CommonGSM-MAP-NAS-SysInfo     NAS-SystemInformationGSM-MAP,
        cn-DomainInformationList          CN-DomainInformationListFull     OPTIONAL,
        -- Measurement IEs
        ongoingMeasRepList                OngoingMeasRepList-r4            OPTIONAL,
        -- Radio bearer IEs
        predefinedConfigStatusList        PredefinedConfigStatusList,
        srb-InformationList                SRB-InformationSetupList,
        rab-InformationList                RAB-InformationSetupList-r4      OPTIONAL,
        -- Transport channel IEs
        ul-CommonTransChInfo              UL-CommonTransChInfo-r4          OPTIONAL,
        ul-TransChInfoList                UL-AddReconfTransChInfoList     OPTIONAL,
        modeSpecificInfo                  CHOICE {
            fdd                            SEQUENCE {
                cpch-SetID                  CPCH-SetID                        OPTIONAL,
                transChDRAC-Info            DRAC-StaticInformationList       OPTIONAL
            },
            tdd                            NULL
        }
        dl-CommonTransChInfo              DL-CommonTransChInfo-r4          OPTIONAL,
        dl-TransChInfoList                DL-AddReconfTransChInfoList-r4  OPTIONAL,
        -- Measurement report
        measurementReport                 MeasurementReport                 OPTIONAL,
        failureCause                       FailureCauseWithProtErr           OPTIONAL
    }

-- IE definitions

CalculationTimeForCiphering ::= SEQUENCE {

```

```

    cell-Id          CellIdentity,
    sfn              INTEGER (0..4095)
}

CipheringInfoPerRB ::= SEQUENCE {
    dl-HFN          BIT STRING (SIZE (20..25)),
    ul-HFN          BIT STRING (SIZE (20..25))
}

CipheringInfoPerRB-r4 ::= SEQUENCE {
    rb-Identity     RB-Identity,
    dl-HFN          BIT STRING (SIZE (20..25)),
    dl-UM-SN       BIT STRING (SIZE (7))           OPTIONAL,
    ul-HFN          BIT STRING (SIZE (20..25))
}

-- TABULAR: CipheringInfoPerRB-List, multiplicity value numberOfRadioBearers
-- has been replaced with maxRB.
CipheringInfoPerRB-List ::= SEQUENCE (SIZE (1..maxRB)) OF
    CipheringInfoPerRB

CipheringInfoPerRB-List-r4 ::= SEQUENCE (SIZE (1..maxRB)) OF
    CipheringInfoPerRB-r4

CipheringStatus ::= ENUMERATED {
    started, notStarted }

CipheringStatusList-r4 ::= SEQUENCE (SIZE (1..maxCNdomains)) OF
    CipheringStatusCNdomain-r4

CipheringStatusCNdomain-r4 ::= SEQUENCE {
    cn-DomainIdentity CN-DomainIdentity,
    cipheringStatus   CipheringStatus,
    start-Value       START-Value
}

CN-DomainInformation-v390ext ::= SEQUENCE {
    cn-DRX-CycleLengthCoeff CN-DRX-CycleLengthCoefficient
}

CN-DomainInformationList-v390ext ::= SEQUENCE (SIZE (1..maxCNdomains)) OF
    CN-DomainInformation-v390ext

CompressedModeMeasCapability-r4 ::= SEQUENCE {
    fdd-Measurements          BOOLEAN,
    -- TABULAR: The IEs tdd-Measurements, gsm-Measurements and multiCarrierMeasurements
    -- are made optional since they are conditional based on another information element.
    -- Their absence corresponds to the case where the condition is not true.
    tdd384-Measurements       BOOLEAN           OPTIONAL,
    tdd128-Measurements       BOOLEAN           OPTIONAL,
    gsm-Measurements          GSM-Measurements  OPTIONAL,
    multiCarrierMeasurements  BOOLEAN           OPTIONAL
}

COUNT-C-List ::= SEQUENCE (SIZE (1..maxCNdomains)) OF
    COUNT-CSingle

COUNT-CSingle ::= SEQUENCE {
    cn-DomainIdentity CN-DomainIdentity,
    count-C           BIT STRING (SIZE (32))
}

DL-PhysChCapabilityFDD-r4 ::= SEQUENCE {
    maxNoDPCH-PDSCH-Codes      INTEGER (1..8),
    maxNoPhysChBitsReceived    MaxNoPhysChBitsReceived,
    supportForSF-512           BOOLEAN,
    supportOfPDSCH             BOOLEAN,
    simultaneousSCCPCH-DPCH-Reception SimultaneousSCCPCH-DPCH-Reception,
    supportOfDedicatedPilotsForChEstimation SupportOfDedicatedPilotsForChEstimation OPTIONAL
}

ImplementationSpecificParams ::= BIT STRING (SIZE (1..512))

IntegrityProtectionStatus ::= ENUMERATED {
    started, notStarted }

MeasurementCapability-r4 ::= SEQUENCE {

```

```

    downlinkCompressedMode          CompressedModeMeasCapability-r4,
    uplinkCompressedMode            CompressedModeMeasCapability-r4
}

MeasurementCommandWithType ::= CHOICE {
    setup          MeasurementType,
    modify         NULL,
    release        NULL
}

MeasurementCommandWithType-r4 ::= CHOICE {
    setup          MeasurementType-r4,
    modify         NULL,
    release        NULL
}

OngoingMeasRep ::= SEQUENCE {
    measurementIdentity      MeasurementIdentity,
    -- TABULAR: The CHOICE Measurement in the tabular description is included
    -- in MeasurementCommandWithType
    measurementCommandWithType      MeasurementCommandWithType,
    measurementReportingMode        MeasurementReportingMode          OPTIONAL,
    additionalMeasurementID-List    AdditionalMeasurementID-List      OPTIONAL
}

OngoingMeasRep-r4 ::= SEQUENCE {
    measurementIdentity      MeasurementIdentity,
    -- TABULAR: The CHOICE Measurement in the tabular description is included
    -- in MeasurementCommandWithType-r4.
    measurementCommandWithType      MeasurementCommandWithType-r4,
    measurementReportingMode        MeasurementReportingMode          OPTIONAL,
    additionalMeasurementID-List    AdditionalMeasurementID-List      OPTIONAL
}

OngoingMeasRepList ::= SEQUENCE (SIZE (1..maxNoOfMeas)) OF
    OngoingMeasRep

OngoingMeasRepList-r4 ::= SEQUENCE (SIZE (1..maxNoOfMeas)) OF
    OngoingMeasRep-r4

PDCP-Capability-r4 ::= SEQUENCE {
    losslessSRNS-RelocationSupport    BOOLEAN,
    supportForRfc2507                 CHOICE {
        notSupported    NULL,
        supported       MaxHcContextSpace
    },
    supportForRfc3095                 CHOICE {
        notSupported    NULL,
        supported       SEQUENCE {
            maxROHC-ContextSessions    MaxROHC-ContextSessions-r4    DEFAULT s16,
            reverseCompressionDepth    INTEGER (0..65535)          DEFAULT 0
        }
    }
}

PhysicalChannelCapability-r4 ::= SEQUENCE {
    fddPhysChCapability                SEQUENCE {
        downlinkPhysChCapability        DL-PhysChCapabilityFDD-r4,
        uplinkPhysChCapability          UL-PhysChCapabilityFDD
    } OPTIONAL,
    tdd384-PhysChCapability            SEQUENCE {
        downlinkPhysChCapability        DL-PhysChCapabilityTDD,
        uplinkPhysChCapability          UL-PhysChCapabilityTDD
    } OPTIONAL,
    tdd128-PhysChCapability            SEQUENCE {
        downlinkPhysChCapability        DL-PhysChCapabilityTDD-LCR-r4,
        uplinkPhysChCapability          UL-PhysChCapabilityTDD-LCR-r4
    } OPTIONAL
}

RF-Capability-r4 ::= SEQUENCE {
    fddRF-Capability                  SEQUENCE {
        ue-PowerClass                  UE-PowerClass-v370,
        txRxFrequencySeparation        TxRxFrequencySeparation
    } OPTIONAL,
    tdd384-RF-Capability              SEQUENCE {
        ue-PowerClass                  UE-PowerClass-v370,
        radioFrequencyBandTDDList      RadioFrequencyBandTDDList,
}

```

```

        chipRateCapability          ChipRateCapability          OPTIONAL,
    }
    tdd128-RF-Capability          SEQUENCE {
        ue-PowerClass              UE-PowerClass-v370,
        radioFrequencyBandTDDList  RadioFrequencyBandTDDList,
        chipRateCapability          ChipRateCapability          OPTIONAL
    }
}

SRB-SpecificIntegrityProtInfo ::= SEQUENCE {
    ul-RRC-HFN                    BIT STRING (SIZE (28)),
    dl-RRC-HFN                    BIT STRING (SIZE (28)),
    ul-RRC-SequenceNumber        RRC-MessageSequenceNumber,
    dl-RRC-SequenceNumber        RRC-MessageSequenceNumber
}

SRB-SpecificIntegrityProtInfoList ::= SEQUENCE (SIZE (4..maxSRBsetup)) OF
    SRB-SpecificIntegrityProtInfo

StateOfRRC ::=
    ENUMERATED {
        cell-DCH, cell-FACH,
        cell-PCH, ura-PCH }

StateOfRRC-Procedure ::=
    ENUMERATED {
        awaitNoRRC-Message,
        awaitRB-ReleaseComplete,
        awaitRB-SetupComplete,
        awaitRB-ReconfigurationComplete,
        awaitTransportCH-ReconfigurationComplete,
        awaitPhysicalCH-ReconfigurationComplete,
        awaitActiveSetUpdateComplete,
        awaitHandoverComplete,
        sendCellUpdateConfirm,
        sendUraUpdateConfirm,
        -- dummy is not used in this version of specification
        -- It should not be sent
        dummy,
        otherStates
    }

}

UE-Positioning-LastKnownPos ::= SEQUENCE {
    sfn                            INTEGER (0..4095),
    cell-id                        CellIdentity,
    positionEstimate              PositionEstimate
}

}

UE-Positioning-Capability-r4 ::= SEQUENCE {
    standaloneLocMethodsSupported  BOOLEAN,
    ue-BasedOTDOA-Supported        BOOLEAN,
    networkAssistedGPS-Supported   NetworkAssistedGPS-Supported,
    supportForUE-GPS-TimingOfCellFrames  BOOLEAN,
    supportForIPDL                 BOOLEAN,
    rx-tx-TimeDifferenceType2Capable  BOOLEAN,
    validity-CellPCH-UraPCH        ENUMERATED { true (0) }  OPTIONAL
}

}

UE-RadioAccessCapability-r4 ::= SEQUENCE {
    accessStratumReleaseIndicator  AccessStratumReleaseIndicator,
    pdcp-Capability               PDCP-Capability-r4,
    rlc-Capability                 RLC-Capability,
    transportChannelCapability     TransportChannelCapability,
    rf-Capability                  RF-Capability-r4,
    physicalChannelCapability       PhysicalChannelCapability-r4,
    ue-MultiModeRAT-Capability     UE-MultiModeRAT-Capability,
    securityCapability             SecurityCapability,
    ue-positioning-Capability       UE-Positioning-Capability-r4,
    measurementCapability          MeasurementCapability-r4  OPTIONAL
}
}

END

```

12 Message transfer syntax

Transfer syntax for RRC PDUs is derived from their ASN.1 definitions by use of Packed Encoding Rules, unaligned as specified in X.691 [49], and with adapted final padding. If special encoding is used, it is indicated in the ECN module defined for each ASN.1 module. The use of special encoding is defined in [14].

The following encoding rules apply in addition to what has been specified in X.691 [49]:

- When a bit string value is placed in a bit-field as specified in 15.6 to 15.11 in [11], the leading bit of the bit string value shall be placed in the leading bit of the bit-field, and the trailing bit of the bit string value shall be placed in the trailing bit of the bit-field.

NOTE: The terms "leading bit" and "trailing bit" are defined in ITU-T Rec. X.680 | ISO/IEC 8824-1. When using the "bstring" notation, the leading bit of the bit string value is on the left, and the trailing bit of the bit string value is on the right.

12.1 Structure of encoded RRC messages

An RRC PDU, which is the bit string that is exchanged between peer entities/ across the radio interface, is the concatenation of a basic production, an extension and padding, in that order.

RRC PDUs shall be mapped to and from RLC SDUs upon transmission and reception as follows:

- when delivering an RRC PDU as an RLC SDU to the RLC layer for transmission, the first bit of the RRC PDU shall be represented as the first bit in the RLC SDU and onwards; and
- upon reception of an RLC SDU from the RLC layer, the first bit of the RLC SDU shall represent the first bit of the RRC PDU and onwards.

12.1.1 Basic production

The 'basic production' is obtained by applying UNALIGNED PER to the abstract syntax value (the ASN.1 description) as specified in X.691, except for the 0 to 7 bits added at the end to produce a multiple of 8 bits. The basic production can have any positive number of bits, not necessarily a multiple of 8 bits.

12.1.2 Extension

Emitters compliant with this version of the specification of the protocol shall, unless indicated otherwise on a PDU type basis, set the extension part empty. Emitters compliant with a later version might send non-empty extensions.

12.1.3 Padding

Emitters compliant with this version of the specification of the protocol shall, unless indicated otherwise on a PDU type basis, pad the basic production with the smallest number of bits required to meet the size constraints of the lower layers. Padding bits shall be set to 0.

Receivers compliant with this version of the specification have no need to distinguish the extension and padding parts, and shall, unless indicated otherwise on a PDU type basis, accept RRC PDUs with any bit string in the extension and padding parts.

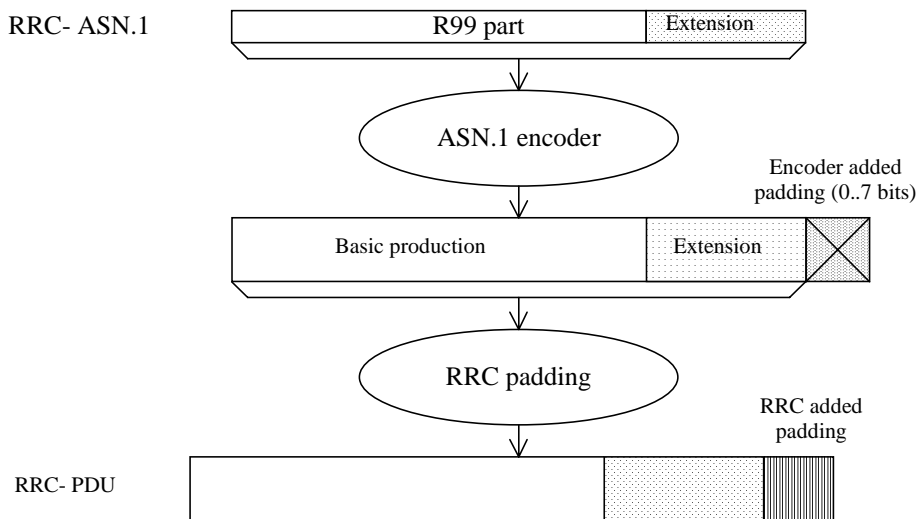

Figure 12.1.3-1: Padding

When using AM or UM mode, RLC requires that the RRC PDU length is a multiple of 8 bits.

When using Tr mode, RLC does neither impose size requirements nor perform padding. This implies that RRC has to take into account the transport format set defined for the transport channel across which the message is to be sent. RRC shall add the lowest number of padding bits required to fit the size specified for the selected transport format.

For system information blocks, building the PDU involves two steps. The first step is the building of the SIBs, in which step padding is not applied (the rules for extension apply). The second step is the building of the RRC PDUs, involving segmentation and concatenation of SIBs, and then padding as described above for Tr mode. The procedure is shown by means of an example as described in Figure 12.1.3-2. The example includes two SIBs, SIBn and SIBn+1, of which only SIBn includes a protocol extension. The two SIBs used in the example do not require segmentation and are concatenated into one SYSTEM INFORMATION message.

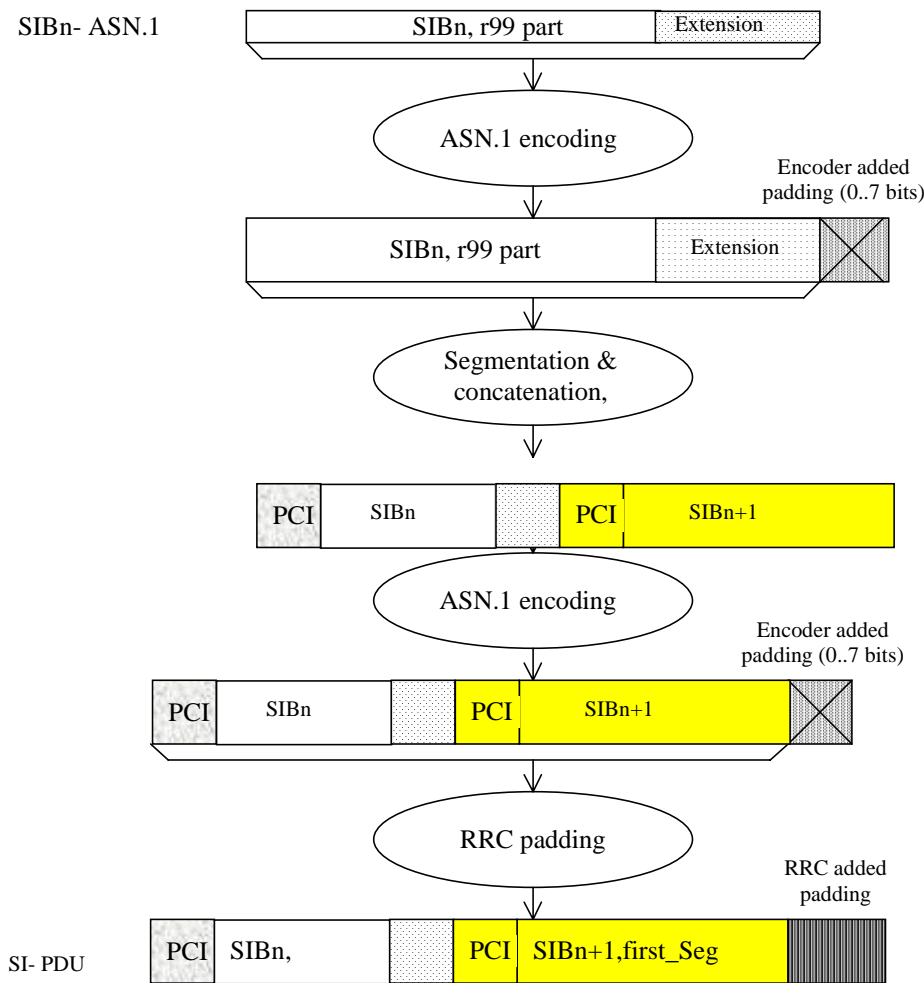

Figure 12.1.3-2: Padding for System Information

PCI: Protocol control information at SYSTEM INFORMATION message level

SI: SYSTEM INFORMATION message

For system information blocks, RRC may also add padding information at the end of IE "SIB data fixed", used both within IE "Last segment" and IE "Complete SIB". The IE "SIB data fixed" has a fixed length i.e. no length denominator used. In case the remaining amount of "SIB data" information is insufficient to fill the IE completely, RRC includes padding bits.

Since no length denominator is included, the receiving RRC cannot remove the padding added by the sender. However, since the padding used is the same as the padding added by the PER encoder to achieve octet alignment, the receiver can handle it.

NOTE 1 The mechanism described above implies that the PDU provided to the ASN.1 decoder may have more than 7 padding bits included. For a complete SIB of length 215 bits, 11 padding bits are added by RRC. Since the decoder requires an octet aligned input, 6 additional bits need to be added. In this (worst) case, a total of 17 padding bits is included.

NOTE 2 For the above cases, use of padding bits is possible and more efficient than including a length denominator.

When using the RRC padding described above, the segment has a fixed length, which completely fills the transport block. Therefore, in this case no RRC padding is added within the SYSTEM INFORMATION message. This is illustrated by means of the following figure.

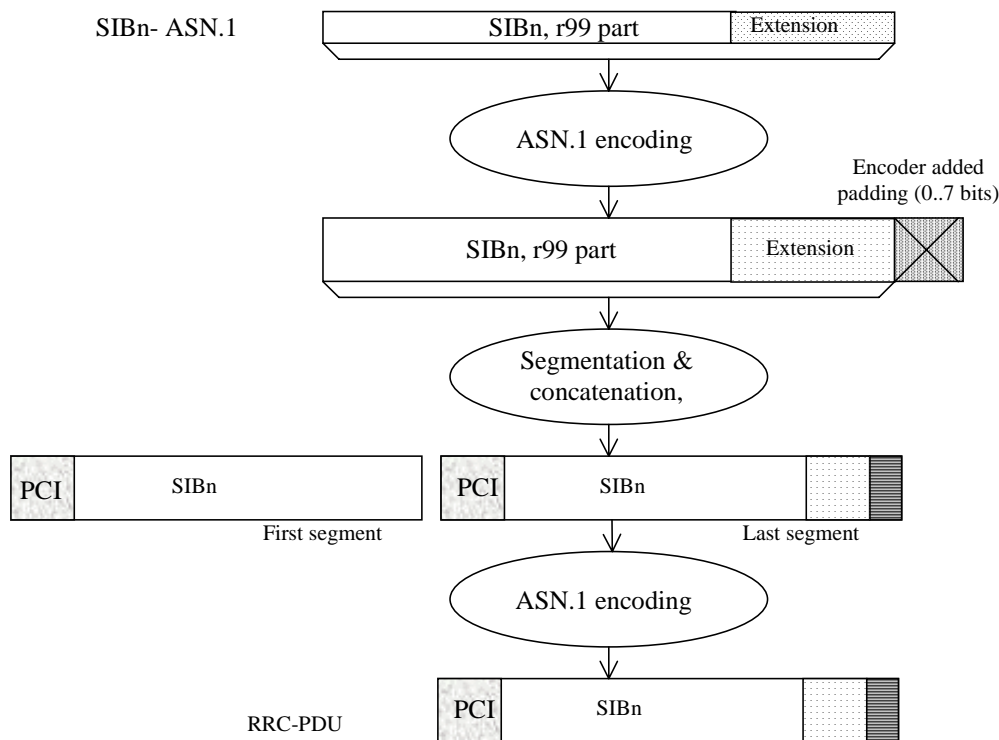

Figure 12.1.3-3: No RRC padding for System Information

12.2 ECN link module for RRC

```

RRC-ECN-Link-Module LINK-DEFINITIONS ::=
BEGIN

IMPORTS
    RRC-encodings          -- Encoding objects for RRC messages
FROM RRC-Encoding-Definitions;

ENCODE Class-definitions
    WITH RRC-encodings
    COMPLETED BY PER-BASIC-UNALIGNED

ENCODE PDU-definitions
    WITH RRC-encodings
    COMPLETED BY PER-BASIC-UNALIGNED

ENCODE InformationElements
    WITH RRC-encodings
    COMPLETED BY PER-BASIC-UNALIGNED

ENCODE Internode-definitions
    WITH RRC-encodings
    COMPLETED BY PER-BASIC-UNALIGNED

END
    
```

12.3 ECN modules for RRC

The encoding definition module "RRC-Encoding-Definitions" contains definition of the encoding object set "RRC-encodings". The encoding object set contains all the specialized encoding for RRC.

```
RRC-Encoding-Definitions ENCODING-DEFINITIONS ::=
BEGIN

EXPORTS
    RRC-encodings;

RRC-encodings #ENCODINGS ::= {
    -- Trailing bits
    outer-encoding
}

--*****
--
-- The trailing bits in all RRC messages shall be ignored
-- (including unknown message contents & unknown extensions).
-- This overrides the default PER behaviour which pads the last
-- octet with zero bits.
--
--*****

outer-encoding #OUTER ::= {
    ENCODER-DECODER {
    }
    DECODE AS IF {
        POST-PADDING    encoder-option
    }
}

END

Class-definitions-ECN-Module ENCODING-DEFINITIONS ::=
BEGIN
END

PDU-definitions-ECN-Module ENCODING-DEFINITIONS ::=
BEGIN
END

InformationElements-ECN-Module ENCODING-DEFINITIONS ::=
BEGIN
END

Internode-definitions-ECN-Module ENCODING-DEFINITIONS ::=
BEGIN
END
```

12.4 RRC messages encoded otherwise

NOTE: The messages included in this section are not specified by means of ASN.1.

12.4.1 Messages using tabular encoding specification

The encoding of the message is specified by means of a table listing the information elements known in the message and their order of their appearance in the message.

When a field extends over more than one octet, the order of bit values progressively decreases as the octet number increases. The least significant bit of the field is represented by the lowest numbered bit of the highest numbered octet of the field.

12.4.1.1 TRANSPORT FORMAT COMBINATION CONTROL using transparent DCCH

There are three possible formats for the transparent format combination control mode used on a transparent mode DCCH. The mode to be used is configured during establishment of the transparent mode DCCH.

12.4.1.1.1 TRANSPORT FORMAT COMBINATION CONTROL, 3 bit format

The 3 bit format is as follows:

3	2	1	Transport Format Combination Set Identity value
0	0	0	0
0	0	1	1
0	1	0	2
1	1	1	7

12.4.1.1.2 TRANSPORT FORMAT COMBINATION CONTROL, 5 bit format

The 5 bit format is as follows:

5	4	3	2	1	Transport Format Combination Set Identity value
0	0	0	0	0	0
0	0	0	0	1	1
0	0	0	1	0	2
1	1	1	1	1	31

12.4.1.1.3 TRANSPORT FORMAT COMBINATION CONTROL, 10 bit format

The 10 bit format is as follows:

Octet 1								Oct 2		Transport Format Combination Set Identity value
10	9	8	7	6	5	4	3	2	1	
0	0	0	0	0	0	0	0	0	0	0
0	0	0	0	0	0	0	0	0	1	1
0	0	0	0	0	0	0	0	1	0	2
1	1	1	1	1	1	1	1	1	1	1023

13 Protocol timers, counters, other parameters and default configurations

The information provided in subclauses 13.1 and 13.2 shall be treated as informative. The normative text is specified in the relevant subclauses in clause 8 and clause 8 shall prevail.

13.1 Timers for UE

Timer	Start	Stop	At expiry
T300	Transmission of RRC CONNECTION REQUEST	Reception of RRC CONNECTION SETUP	Retransmit RRC CONNECTION REQUEST if V300 =< N300, else go to Idle mode
T302	Transmission of CELL UPDATE/URA UPDATE	Reception of CELL UPDATE CONFIRM/URA UPDATE CONFIRM	Retransmit CELL UPDATE/URA UPDATE if V302 =< N302, else, go to Idle mode
T304	Transmission of UE CAPABILITY INFORMATION	Reception of UE CAPABILITY INFORMATION CONFIRM	Retransmit UE CAPABILITY INFORMATION if V304 =< N304, else initiate a cell update procedure
T305	Entering CELL_FACH or URA_PCH or CELL_PCH state. Reception of CELL UPDATE CONFIRM/URA UPDATE CONFIRM.	Entering another state.	Transmit CELL UPDATE if T307 is not activated and the UE detects "in service area". Otherwise, if T307 is not active, start T307.
T307	When the timer T305 has expired and the UE detects "out of service area".	When the UE detects "in service area".	Transit to idle mode
T308	Transmission of RRC CONNECTION RELEASE COMPLETE	Not stopped	Transmit RRC CONNECTION RELEASE COMPLETE if V308 <=N308, else go to idle mode.
T309	Upon reception of CELL CHANGE ORDER FROM UTRAN message	Successful response to a connection establishment request in the new cell.	Resume the connection to UTRAN
T310	Transmission of PUSCH CAPACITY REQUEST	Reception of PHYSICAL SHARED CHANNEL ALLOCATION	Transmit PUSCH CAPACITY REQUEST if V310 =< N310, else procedure stops.
T311	Reception of PHYSICAL SHARED CHANNEL ALLOCATION message with the CHOICE "PUSCH allocation" set to "PUSCH allocation pending".	Reception of PHYSICAL SHARED CHANNEL ALLOCATION message with CHOICE "PUSCH allocation" set to "PUSCH allocation assignment".	UE may initiate a PUSCH capacity request procedure.
T312	When the UE starts to establish dedicated CH	When the UE detects N312 "in sync" indication from L1.	The criteria for physical channel establishment failure is fulfilled
T313	When the UE detects consecutive N313 "out of sync" indication from L1.	When the UE detects consecutive N315 "in sync" indication from L1.	The criteria for Radio Link failure is fulfilled
T314	When the criteria for radio link failure are fulfilled. The timer is started if radio bearer(s) that are associated with T314 exist or if only RRC connection exists.	When the Cell Update procedure has been completed.	See subclause 8.3.1.13
T315	When the criteria for radio link failure are fulfilled. The timer is started only if radio bearer(s) that are associated with T315 exist.	When the Cell Update procedure has been completed.	See subclause 8.3.1.14

Timer	Start	Stop	At expiry
T316	When the UE detects "out of service area" in URA_PCH or CELL_PCH state	When the UE detects "in service area".	Initiate cell update procedure if in service area is detected. Otherwise start timer T317, transit to CELL_FACH state and initiate cell update procedure when the UE detects "in service area".
T317	When the T316 expires or when in CELL_FACH state, the UE detects "out of service area".	When the UE detects "in service area".	Transit to idle mode

13.2 Counters for UE

Counter	Reset	Incremented	When reaching max value
V300	When initiating the procedure RRC connection establishment	Upon expiry of T300.	When V300 > N300, the UE enters idle mode.
V302	When initiating the procedure Cell update or URA update	Upon expiry of T302	When V302 > N302 the UE enters idle mode.
V304	When sending the first UE CAPABILITY INFORMATION message.	Upon expiry of T304	When V304 > N304 the UE initiates the Cell update procedure
V308	When sending the first RRC CONNECTION RELEASE COMPLETE message in a RRC connection release procedure.	Upon expiry of T308	When V308 > N308 the UE stops re-transmitting the RRC CONNECTION RELEASE COMPLETE message.
V310	When sending the first PUSCH CAPACITY REQUEST message in a PUSCH capacity request procedure	Upon expiry of T310	When V310 > N310 the UE stops re-transmitting the PUSCH CAPACITY REQUEST message.

13.3 UE constants and parameters

Constant	Usage
N300	Maximum number of retransmissions of the RRC CONNECTION REQUEST message
N302	Maximum number of retransmissions of the CELL UPDATE / URA UPDATE message
N304	Maximum number of retransmissions of the UE CAPABILITY INFORMATION message
N308	Maximum number of retransmissions of the RRC CONNECTION RELEASE COMPLETE message
N310	Maximum number of retransmission of the PUSCH CAPACITY REQUEST message
N312	Maximum number of "in sync" received from L1.
N313	Maximum number of successive "out of sync" received from L1.
N315	Maximum number of successive "in sync" received from L1 during T313 is activated.

13.4 UE variables

13.4.0 CELL_INFO_LIST

This variable contains cell information on intra-frequency, inter-frequency and inter-RAT cells, as received in messages System Information Block Type 11, System Information Block Type 12, and MEASUREMENT CONTROL.

The first position in Intra-frequency cell info list corresponds to Intra-frequency cell id 0, the second to Intra-frequency cell id 1, etc.

The first position in Inter-frequency cell info list corresponds to Inter-frequency cell id 0, the second to Inter-frequency cell id 1, etc.

The first position in Inter-RAT cell info list corresponds to Intra-frequency cell id 0, the second to Inter-RAT cell id 1, etc.

This variable shall be cleared at cell re-selection, when leaving UTRA RRC connected mode, when switched off as well as at selection of a new PLMN.

Information Element/Group name	Need	Multi	Type and reference	Semantics description
Intra-frequency cell info	OP	1..<maxCel IMeas>		
>CHOICE <i>position status</i>	MP			
>>Occupied				
>>>Cell info	MP		Cell info 10.3.7.2	
>>Vacant				No data
Inter-frequency cell info	OP	1..<maxCel IMeas>		
>CHOICE <i>position status</i>	MP			
>>Occupied				
>>>Frequency info	MP		Frequency info 10.3.6.36	
>>>Cell info	MP		Cell info 10.3.7.2	
>>Vacant				No data
Inter-RAT cell info	OP	1..<maxCel IMeas>		
>CHOICE <i>position status</i>	MP			
>>Occupied				
>>>CHOICE <i>Radio Access Technology</i>				
>>>>GSM				
>>>>>Cell selection and re-selection info	MP		Cell selection and re-selection info for SIB11/12 10.3.2.4	
>>>>>BSIC	MP		BSIC 10.3.8.2	
>>>>>BCCH ARFCN	MP		Integer (0..1023)	[43]
>>>>>IS-2000				
>>>>>>System specific measurement info			enumerated (frequency, timeslot, colour code, output power, PN offset)	For IS-2000, use fields from TIA/EIA/IS-2000.5, subclause 3. 7.3.3.2.27, <i>Candidate Frequency Neighbour List Message</i>
>>Vacant				No data

13.4.00 Void

13.4.0a CELL_UPDATE_STARTED

This variable indicates whether a cell update or URA update procedure is in progress.

Information Element/Group name	Need	Multi	Type and reference	Semantics description
Cell update started	MP		Boolean	TRUE means a cell or URA update procedure is in progress. Set to FALSE when entering UTRA RRC connected mode. Set to FALSE when leaving UTRA RRC connected mode.

13.4.1 CIPHERING_STATUS

This variable contains information about the current status of ciphering in the UE.

Information Element/Group name	Need	Multi	Type and reference	Semantics description
Status for each CN domain	MP	<1 to maxCNDomains>		
>CN domain identity	MP		CN domain identity 10.3.1.1	
>Status	MP		Enumerated(Not started, Started)	Set to "Not started" when entering UTRA RRC connected mode. Set to "Not started" when leaving UTRA RRC connected mode.
Reconfiguration	MP		Boolean	TRUE means an RRC procedure performing reconfiguration of ciphering is ongoing. Set to FALSE when entering UTRA RRC connected mode. Set to FALSE when leaving UTRA RRC connected mode.

13.4.2 Void

13.4.2a CONFIGURATION_INCOMPLETE

This variable indicates whether a received measurement control message contains invalid an incomplete measurement configuration.

Information Element/Group name	Need	Multi	Type and reference	Semantics description
Configuration incomplete	MP		Boolean	TRUE: An incomplete configuration has been detected. Set to FALSE when entering UTRA RRC connected mode. Set to FALSE when leaving UTRA RRC connected mode.

13.4.3 C_RNTI

This variable stores the assigned C-RNTI for this UE when in CELL_FACH state.

Information Element/Group name	Need	Multi	Type and reference	Semantics description
C-RNTI	OP		C-RNTI 10.3.3.8	Cleared when entering UTRA RRC connected mode when not otherwise stated in the procedure. Cleared when leaving UTRA RRC connected mode.

13.4.3a DSCH_RNTI

This variable stores the assigned DSCH-RNTI for this UE when in CELL_DCH state.

Information Element/Group name	Need	Multi	Type and reference	Semantics description
DSCH-RNTI	OP		DSCH-RNTI 10.3.3.9a	Cleared when entering UTRA RRC connected mode when not otherwise stated in the procedure. Cleared when leaving UTRA RRC connected mode.

13.4.4 Void

13.4.5 ESTABLISHED_RABS

This variable is used to store information about the established radio access bearers and signalling radio bearers in the UE.

Information Element/Group name	Need	Multi	Type and reference	Semantics description
RAB information	OP	1 to <maxRABs etup>		For each RAB established. Cleared when entering UTRA RRC connected mode when not otherwise stated in the procedure. Cleared when leaving UTRA RRC connected mode.
>RAB info	MP		RAB info 10.3.4.8	
>RB information	MP	1 to <maxRBper RAB>		For each RB belonging to the RAB
>>RB identity	MP		RB identity 10.3.4.16	
>>Subflow	MP		Integer(0..<maxSubflow count>)	Reference to the RAB subflow implemented by this RB
>>RB started	MD		Enumerated(stopped, started)	Default value is started
Signalling radio bearer information	OP	1 to <maxSRBsetup>		In the order of RB0 and upwards. Cleared when leaving UTRA RRC connected mode.
>RB started	MD		Enumerated(Default value is started

Information Element/Group name	Need	Multi	Type and reference	Semantics description
			stopped, started)	

13.4.5a ESTABLISHED_SIGNALLING_CONNECTIONS

This variable is used to store information about established signalling connections.

Information Element/Group name	Need	Multi	Type and reference	Semantics description
Signalling connection list	OP	1 to <maxCNdo mains>		For each established signalling connection. Cleared when entering UTRA RRC connected mode when not otherwise stated in the procedure. Cleared when leaving UTRA RRC connected mode.
>Signalling connection identity	MP		CN domain identity 10.3.1.1	

13.4.6 ESTABLISHMENT_CAUSE

This variable is used to store the cause for establishment of a signalling connection received by upper layers, to be used at RRC connection establishment.

Information Element/Group name	Need	Multi	Type and reference	Semantics description
Establishment cause	OP		Establishment cause 10.3.3.11	Cleared when leaving UTRA RRC connected mode.

13.4.7 FAILURE_CAUSE

This variable contains the cause for failure of a UE initiated procedure, to be reported in a retransmitted message.

Information Element/Group name	Need	Multi	Type and reference	Semantics description
Failure cause	OP		Failure cause 10.3.3.13	Cleared when entering UTRA RRC connected mode. Cleared when leaving UTRA RRC connected mode.

13.4.8 FAILURE_INDICATOR

This variable indicates whether the procedure has failed for a UE initiated procedure.

Information Element/Group name	Need	Multi	Type and reference	Semantics description
Failure indicator	MP		Boolean	TRUE: Procedure has failed. Set to FALSE when entering UTRA RRC connected mode. Set to FALSE when leaving UTRA RRC connected mode.

13.4.8a INCOMPATIBLE_SECURITY_RECONFIGURATION

This variable indicates whether an incompatible simultaneous reconfiguration of a security function has been received.

Information Element/Group name	Need	Multi	Type and reference	Semantics description
Incompatible security reconfiguration	MP		Boolean	TRUE: An incompatible simultaneous security reconfiguration has been detected. Set to FALSE when entering UTRA RRC connected mode. Set to FALSE when leaving UTRA RRC connected mode.

13.4.9 INITIAL_UE_IDENTITY

In this variable the identity used by the UE when establishing an RRC connection is stored.

Information Element/Group name	Need	Multi	Type and reference	Semantics description
Initial UE identity	OP		Initial UE identity 10.3.3.15	Cleared when leaving UTRA RRC connected mode.

13.4.9a INTEGRITY_PROTECTION_ACTIVATION_INFO

This variable contains information to be sent to UTRAN about when a new integrity protection configuration shall be activated in the uplink for signalling radio bearers in case of modification of integrity protection.

Information Element/Group name	Need	Multi	Type and reference	Semantics description
Uplink Integrity protection activation info	OP		Integrity protection activation info 10.3.3.17	Cleared when entering UTRA RRC connected mode. Cleared when leaving UTRA RRC connected mode.

13.4.10 INTEGRITY_PROTECTION_INFO

This variable contains information about the current status of the integrity protection in the UE.

Information Element/Group name	Need	Multi	Type and reference	Semantics description
Status	MP		Enumerated(Not started, Started)	Set to "Not started" when entering UTRA RRC connected mode. Set to "Not started" when leaving UTRA RRC connected mode.
Reconfiguration	MP		Boolean	TRUE means a reconfiguration of integrity protection is ongoing. Set to FALSE when entering UTRA RRC connected mode. Set to FALSE when leaving UTRA RRC connected mode.
Signalling radio bearer specific integrity protection information	OP	1 to <maxSRBs etup>		When integrity protection is started, status information for RB0- RB4 in that order. Cleared when entering UTRA

Information Element/Group name	Need	Multi	Type and reference	Semantics description
				RRC connected mode. Cleared when leaving UTRA RRC connected mode.
>Uplink RRC HFN	MP		Bit string (28)	
>Downlink RRC HFN	MP		Bit string (28)	
>Uplink RRC Message sequence number	MP		Integer (0..15)	
>Downlink RRC Message sequence number	OP		Integer (0..15)	

13.4.10a INTER_RAT_HANDOVER_INFO_TRANSFERRED

This variable stores information about the inter RAT handover info that has been transferred to another RAT.

Information Element/Group name	Need	Multi	Type and reference	Semantics description
Predefined configuration status information	OP		Predefined configuration status information 10.3.4.5a	Cleared upon entering connected mode in another RAT
UE security information	OP		UE security information 10.3.3.42b	Cleared upon entering connected mode in another RAT
UE radio access capability	OP		UE radio access capability 10.3.3.42	Cleared upon entering connected mode in another RAT
UE radio access capability extension	OP		UE radio access capability extension 10.3.3.42a	Cleared upon entering connected mode in another RAT
UE system specific capability	OP	1 to <maxSystemCapability>	Inter-RAT UE radio access capability 10.3.8.7	Cleared upon entering connected mode in another RAT
>Inter-RAT UE radio access capability	MP		Inter-RAT UE radio access capability 10.3.8.7	

13.4.11 INVALID_CONFIGURATION

This variable indicates whether a received message contained an invalid configuration, by means of invalid values or invalid combinations of information elements.

Information Element/Group name	Need	Multi	Type and reference	Semantics description
Invalid configuration	MP		Boolean	TRUE: An invalid configuration has been detected. Set to FALSE when entering UTRA RRC connected mode. Set to FALSE when leaving UTRA RRC connected mode.

13.4.11a LATEST_CONFIGURED_CN_DOMAIN

This variable stores the CN-domain that was most recently configured to be used for ciphering and integrity protection.

Information Element/Group name	Need	Multi	Type and reference	Semantics description
Latest configured CN domain	OP		CN domain identity 10.3.1.1	Cleared when entering UTRA RRC connected mode when not stated otherwise in the procedure. Cleared when leaving UTRA RRC connected mode.

13.4.12 MEASUREMENT_IDENTITY

This variable stores the measurements configured in the UE. For each configured measurement, the information below shall be stored.

Information Element/Group name	Need	Multi	Type and reference	Semantics description
MEASUREMENT CONTROL	OP		MEASUREMENT CONTROL 10.2.17, System Information Block type 11 10.2.48.8.12, System Information Block type 12 10.2.48.8.13	Information as contained in these messages. Cleared when entering UTRA RRC connected mode when not stated otherwise in the procedure (8.4.1.8-8.4.1.9). Cleared when leaving UTRA RRC connected mode when not stated otherwise in the procedure (8.4.1.9a).

13.4.13 Void

13.4.14 ORDERED_RECONFIGURATION

This variable stores information about an ongoing Reconfiguration procedure.

Information Element/Group name	Need	Multi	Type and reference	Semantics description
Ordered reconfiguration	MP		Boolean	TRUE means that a Reconfiguration procedure is ongoing. Set to FALSE when entering UTRA RRC connected mode. Set to FALSE when leaving UTRA RRC connected mode.

13.4.15 PDCP_SN_INFO

This variable contains PDCP receive sequence numbers for one or several radio bearers to be included in a response message to UTRAN.

Information Element/Group name	Need	Multi	Type and reference	Semantics description
RB with PDCP information list	OP	1 to <maxRBall RABs>		Cleared when entering UTRA RRC connected mode. Cleared when leaving UTRA RRC connected mode.
>RB with PDCP information	MP		RB with PDCP information 10.3.4.22	

13.4.15a PHYSICAL_SHARED_CHANNEL_CONFIGURATION

This variable is used only for TDD to store information about the physical shared channel configuration in the UE.

Information Element/Group name	Need	Multi	Type and reference	Semantics description
PUSCH configuration	OP			Cleared when entering and leaving UTRA RRC connected mode.
>PUSCH info	MP		PUSCH info 10.3.6.63	
>PUSCH Identity	OP		Integer(1..hiPUSCHidentities)	
>PUSCH power control info	OP		PUSCH power control info 10.3.6.65	
PDSCH configuration	OP			Cleared when entering and leaving UTRA RRC connected mode.
>PDSCH Info	MP		PDSCH Info 10.3.6.44	
>PDSCH Identity	OP		Integer(1..hiPDSCHidentities)	
>PDSCH power control info	OP		PDSCH power control info 10.3.6.45	
ISCP Timeslot list	OP	1 to maxTS		Cleared when entering and leaving UTRA RRC connected mode.
>Timeslot number	MP		Timeslot number 10.3.6.84	Timeslot numbers, for which the UE shall report the timeslot ISCP in PUSCH CAPACITY REQUEST message

13.4.16 PROTOCOL_ERROR_INDICATOR

This variable indicates whether there exist a protocol error that is to be reported to UTRAN.

Information Element/Group name	Need	Multi	Type and reference	Semantics description
Protocol error indicator	MP		Protocol error indicator 10.3.3.27	Set to FALSE when entering UTRA RRC connected mode. Set to FALSE when leaving UTRA RRC connected mode.

13.4.17 PROTOCOL_ERROR_INFORMATION

This variable contains diagnostics to be reported to UTRAN for a message that was not completely understood.

Information Element/Group name	Need	Multi	Type and reference	Semantics description
Protocol error information	OP		Protocol error information 10.3.8.12	Cleared when entering UTRA RRC connected mode. Cleared when leaving UTRA RRC connected mode.

13.4.18 PROTOCOL_ERROR_REJECT

This variable indicates whether there has occurred a severe protocol error causing the ongoing procedure to fail.

Information Element/Group name	Need	Multi	Type and reference	Semantics description
Protocol error reject	MP		Boolean	TRUE: a severe protocol error has occurred. Set to FALSE when entering UTRA RRC connected mode. Set to FALSE when leaving UTRA RRC connected mode.

13.4.19 RB_TIMER_INDICATOR

This variable contains information to be sent to UTRAN if any of the timers T314 or T315 has expired when the UE sends a cell update with cause RL failure.

Information Element/Group name	Need	Multi	Type and reference	Semantics description
RB timer indicator	OP		RB timer indicator 10.3.3.28	Cleared when entering UTRA RRC connected mode. Cleared when leaving UTRA RRC connected mode.

13.4.20 RB_UPLINK_CIPHERING_ACTIVATION_TIME_INFO

This variable contains information to be sent to UTRAN about when a new ciphering configuration shall be activated in the uplink for radio bearers using RLC-AM or RLC-UM.

Information Element/Group name	Need	Multi	Type and reference	Semantics description
RB uplink ciphering activation time info	OP		RB activation time info 10.3.4.13	Cleared when entering UTRA RRC connected mode. Cleared when leaving UTRA RRC connected mode.

13.4.20a SECURITY_MODIFICATION

This variable contains information on which CN domain is affected by the ongoing security reconfiguration.

Information Element/Group name	Need	Multi	Type and reference	Semantics description
--------------------------------	------	-------	--------------------	-----------------------

Status for each CN domain	MP	<1 to maxCNDomain>		
>CN domain identity	MP		CN domain identity 10.3.1.1	
>Status	MP		Enumerated(Affected, Not Affected)	

13.4.21 SELECTED_PLMN

This variable contains the type of and identity of the selected PLMN.

Information Element/Group name	Need	Multi	Type and reference	Semantics description
PLMN Type	MP		PLMN Type 10.3.1.12	
CHOICE <i>identity type</i>	MP			
>PLMN identity			PLMN identity 10.3.1.11	
>SID			SID 10.3.9.11	

CHOICE <i>identity type</i>	Condition under which the given <i>identity type</i> is chosen
PLMN identity	PLMN Type is "GSM-MAP"
SID	PLMN Type is "ANSI-41"

13.4.22 START_THRESHOLD

This variable contains information about the maximum allowed value of the START for a CN domain.

Information Element/Group name	Need	Multi	Type and reference	Semantics description
THRESHOLD	OP		Integer (0..1048576)	20 bits. Cleared when entering UTRA RRC connected mode when not stated otherwise in the procedure. Cleared when leaving UTRA RRC connected mode.

13.4.23 START_VALUE_TO_TRANSMIT

This variable contains the value of START for new radio bearer(s) to be transmitted in a response message.

Information Element/Group name	Need	Multi	Type and reference	Semantics description
START	OP		START 10.3.3.38	Cleared when entering UTRA RRC connected mode. Cleared when leaving UTRA RRC connected mode.

13.4.24 TFC_SUBSET

This variable contains information about the TFC subset(s) applicable to the UE.

Information Element/Group name	Need	Multi	Type and reference	Semantics description
CHOICE <i>mode</i>	MP			
>FDD				
>>Current TFC subset	MP		Transport Format Combination Subset 10.3.5.22	Set to "Full transport format set" when entering UTRA RRC connected mode when not stated otherwise in the procedure.
>>>Duration	OP		TFC Control duration 10.3.6.80	Cleared when entering UTRA RRC connected mode. Cleared when leaving UTRA RRC connected mode.
>>>Default TFC subset	OP		Transport Format Combination Subset 10.3.5.22	The TFC subset to go back to when any temporary limitation is released. Cleared when entering UTRA RRC connected mode. Cleared when leaving UTRA RRC connected mode.
>>>TFC subset list	MP	1 to <maxTFCs ub>		
>>>>TFC subset	MP		Transport Format Combination Subset 10.3.5.22	
>TDD				
>>TFCS list	MP	1 to <maxCCTrC H >		One TFCS is created when entering UTRA RRC connected mode when not stated otherwise in the procedure.
>>>TFCS identity	MP		Transport Format Combination Set Identity 10.3.5.21	"TFCS ID" is set to 1 when entering UTRA RRC connected mode when not stated otherwise in the procedure. "Shared channel indicator" is set to FALSE when entering UTRA RRC connected mode when not stated otherwise in the procedure.
>>>>Current TFC subset	MP		Transport Format Combination Subset 10.3.5.22	Set to "Full transport format set" when entering UTRA RRC connected mode when not stated otherwise in the procedure.
>>>>>Duration	OP		TFC Control duration 10.3.6.80	Cleared when entering UTRA RRC connected mode. Cleared when leaving UTRA RRC connected mode.
>>>>>Default TFC subset	OP		Transport Format Combination Subset 10.3.5.22	The TFC subset to go back to when any temporary limitation is released. Cleared when entering UTRA RRC connected mode. Cleared when leaving UTRA RRC connected mode.

Information Element/Group name	Need	Multi	Type and reference	Semantics description
>>TFC subset list	MP	1 to <maxTFCs ub>		
>>>TFCS identity	MP		Transport Format Combination Set Identity 10.3.5.21	
>>>TFC subset	MP		Transport Format Combination Subset 10.3.5.22	

13.4.25 TGPS_IDENTITY

This variable contains the configuration parameters of all the configured compressed mode transmission gap pattern sequences.

Information Element/Group name	Need	Multi	Type and reference	Semantics description
Transmission gap pattern sequence	OP	1 to <maxTGP S>		Cleared when entering UTRA RRC connected mode. Cleared when leaving UTRA RRC connected mode.
>TGPSI	MP		TGPSI 10.3.6.82	
>TGPS Status Flag	MP		Enumerated(activate, deactivate)	This flag indicates whether the Transmission Gap Pattern Sequence shall be activated or deactivated.
> Current TGPS Status Flag	MP		Enumerated(active, inactive)	This flag indicates the current status of the Transmission Gap Pattern Sequence, whether it is active or inactive
>TGCFN	CV-Active		Integer (0..255)	Connection Frame Number of the first frame of the first pattern within the Transmission Gap Pattern Sequence.
>Transmission gap pattern sequence configuration parameters	MP			Information as contained in the IE group "Transmission gap pattern sequence configuration parameters" in IE "DPCH compressed mode info" 10.3.6.33.

Condition	Explanation
Active	This IE is mandatory present when the value of the IE "TGPS Status Flag" is "Activate" and not needed otherwise.

13.4.26 TGSN_REPORTED

This variable specifies whether an IE "Proposed TGSN" was reported to the UTRAN

Information Element/Group name	Need	Multi	Type and reference	Semantics description
Proposed TGSN reported	MP		Boolean	Set to FALSE when entering UTRA RRC connected mode. Set to FALSE when leaving UTRA RRC connected mode.

13.4.26a TIMERS_AND_CONSTANTS

This variable contains the values for all timers and constants used in connected mode.

Information Element/Group name	Need	Multi	Type and reference	Semantics description
UE Timers and constants in connected mode	MD		UE Timers and constants in connected mode 10.3.3.43	Default value means that for all timers and constants - for parameters with need MD, the defaults specified in 10.3.3.43 apply and - for parameters with need OP, the parameters are absent. All parameters are set to the default value when leaving UTRA RRC connected mode to another RAT.

13.4.27 TRANSACTIONS

This variable stores the identifications of the ongoing RRC procedure transactions.

Information Element/Group name	Need	Multi	Type and reference	Semantics description
Accepted transactions	OP	1 to <maxtrans actions>		Cleared when leaving UTRA RRC connected mode.
>Message type	MP		Message Type	
>RRC transaction identifier	MP		RRC transaction identifier 10.3.3.36	
Rejected transactions	OP	1 to <maxtrans actions>		Cleared when leaving UTRA RRC connected mode.
>Message type	MP		Message Type	
>RRC transaction identifier	MP		RRC transaction identifier 10.3.3.36	

13.4.27a TRIGGERED_1A_EVENT

This variable contains information about a 1a event that has been triggered in the UE. There is one such variable per 1a event configured in the UE.

Information Element/Group name	Need	Multi	Type and reference	Semantics description
Cells triggered	OP	1 to <maxCellMe		Cleared when entering UTRA RRC connected mode.

Information Element/Group name	Need	Multi	Type and reference	Semantics description
		as>		Cleared when leaving UTRA RRC connected mode.
>primary CPICH	MP		Primary CPICH info 10.3.6.60	
>sent reports	MP		Integer(1..Infinity)	Number of reports sent to UTRAN in case of event triggered periodical reporting
Cells recently triggered	OP	1 to < maxCellMeas>		
>primary CPICH	MP		Primary CPICH info 10.3.6.60	
>sent reports	MP		Integer(1..Infinity)	Number of reports sent to UTRAN in case of event triggered periodical reporting
Periodical reporting running	MP		Boolean	

13.4.27b TRIGGERED_1B_EVENT

This variable contains information about a 1b event that has been triggered in the UE. There is one such variable per 1b event configured in the UE.

Information Element/Group name	Need	Multi	Type and reference	Semantics description
Cells triggered	OP	1 to < maxCellMeas>		Cleared when entering UTRA RRC connected mode. Cleared when leaving UTRA RRC connected mode.
>primary CPICH	MP		Primary CPICH info 10.3.6.60	
Cells recently triggered	OP	1 to < maxCellMeas>		
>primary CPICH	MP		Primary CPICH info 10.3.6.60	

13.4.27c TRIGGERED_1C_EVENT

This variable contains information about a 1c event that has been triggered in the UE. There is one such variable per 1c event configured in the UE.

Information Element/Group name	Need	Multi	Type and reference	Semantics description
Cells triggered	OP	1 to < maxCellMeas>		Cleared when entering UTRA RRC connected mode. Cleared when leaving UTRA RRC connected mode.
>primary CPICH	MP		Primary CPICH info 10.3.6.60	
>sent reports	MP		Integer(1..Infinity)	Number of reports sent to UTRAN in case of event triggered periodical reporting
Cells recently triggered	OP	1 to < maxCellMeas>		
>primary CPICH	MP		Primary CPICH info 10.3.6.60	
>sent reports	MP		Integer(1..Infinity)	Number of reports sent to UTRAN in case of event triggered periodical reporting
Periodical reporting running	MP		Boolean	

13.4.27d BEST_CELL_1D_EVENT

This variable contains information about a 1d event that has been triggered in the UE. There is one such variable per 1d event configured in the UE.

Information Element/Group name	Need	Multi	Type and reference	Semantics description
Best cell	OP		Primary CPICH info 10.3.6.60	Cleared when entering UTRA RRC connected mode. Cleared when leaving UTRA RRC connected mode.

13.4.27e TRIGGERED_1E_EVENT

This variable contains information about a 1e event that has been triggered in the UE. There is one such variable per 1e event configured in the UE.

Information Element/Group name	Need	Multi	Type and reference	Semantics description
Cells triggered	OP	1 to < maxCellMeas>		Cleared when entering UTRA RRC connected mode. Cleared when leaving UTRA RRC connected mode.
>primary CPICH	MP		Primary CPICH info 10.3.6.60	
Cells recently triggered	OP	1 to < maxCellMeas>		
>primary CPICH	MP		Primary CPICH info 10.3.6.60	

13.4.27f TRIGGERED_1F_EVENT

This variable contains information about a 1f event that has been triggered in the UE. There is one such variable per 1f event configured in the UE.

Information Element/Group name	Need	Multi	Type and reference	Semantics description
Cells triggered	OP	1 to < maxCellMeas>		Cleared when entering UTRA RRC connected mode. Cleared when leaving UTRA RRC connected mode.
>primary CPICH	MP		Primary CPICH info 10.3.6.60	
Cells recently triggered	OP	1 to < maxCellMeas>		
>primary CPICH	MP		Primary CPICH info 10.3.6.60	

13.4.27f1 TRIGGERED_1G_EVENT

This variable contains information about a 1g event that has been triggered in the UE.

Information Element/Group name	Need	Multi	Type and reference	Semantics description
Cells triggered	OP	1 to < maxCellMeas>		
>Primary CCPCH info	MP		Primary CCPCH info 10.3.6.57	

13.4.27f2 TRIGGERED_1H_EVENT

This variable contains information about a 1h event that has been triggered in the UE.

Information Element/Group name	Need	Multi	Type and reference	Semantics description
Cells triggered	OP	1 to < maxCellMeas>		
>Primary CCPCH info	MP		Primary CCPCH info 10.3.6.57	

13.4.27f3 TRIGGERED_1I_EVENT

This variable contains information about a 1i event that has been triggered in the UE.

Information Element/Group name	Need	Multi	Type and reference	Semantics description
Cells triggered	OP	1 to < maxCellMeas>		
>Primary CCPCH info	MP		Primary CCPCH info 10.3.6.57	

13.4.27f4 BEST_FREQUENCY_2A_EVENT

This variable contains information about a 2a event that has been configured in the UE. There is one such variable per 2a event configured in the UE.

Information Element/Group name	Need	Multi	Type and reference	Semantics description
Best frequency	MP		Frequency info 10.3.6.36	

13.4.27f5 TRIGGERED_2B_EVENT

This variable contains information about a 2b event that has been configured in the UE. There is one such variable per 2b event configured in the UE.

Information Element/Group name	Need	Multi	Type and reference	Semantics description
Frequency triggered	OP	1 to <maxCellMeas>		
>Frequency	MP	Frequency info 10.3.6.36		

13.4.27f6 TRIGGERED_2C_EVENT

This variable contains information about a 2c event that has been configured in the UE. There is one such variable per 2c event configured in the UE.

Information Element/Group name	Need	Multi	Type and reference	Semantics description
Frequency triggered	OP	1 to <maxCellMeas>		
>Frequency	MP	Frequency info 10.3.6.36		

13.4.27f7 TRIGGERED_2D_EVENT

This variable contains information about a 2d event that has been configured in the UE. There is one such variable per 2d event configured in the UE.

Information Element/Group name	Need	Multi	Type and reference	Semantics description
Event triggered	OP		Boolean	

13.4.27f8 TRIGGERED_2E_EVENT

This variable contains information about a 2e event that has been configured in the UE. There is one such variable per 2e event configured in the UE.

Information Element/Group name	Need	Multi	Type and reference	Semantics description
Frequency triggered	OP	1 to <maxCellMeas>		
>Frequency	MP	Frequency info 10.3.6.36		

13.4.27f9 TRIGGERED_2F_EVENT

This variable contains information about a 2f event that have been configured in the UE. There is one such variable per 2f event configured in the UE.

Information Element/Group name	Need	Multi	Type and reference	Semantics description
Event triggered	OP		Boolean	

13.4.27f10 TRIGGERED_3A_EVENT

This variable contains information about a 3a event that has been configured in the UE. There is one such variable per event 3a configured in the UE.

Information Element/Group name	Need	Multi	Type and reference	Semantics description
CHOICE <i>system</i>	OP			
>GSM				
>>CHOICE <i>BSIC</i>	MP			
>>>Verified BSIC		0 to <maxCellMeas>		
>>>>Inter-RAT cell id	MP		Integer(0..<maxCellMeasurements>-1)	
>>>Non verified BSIC		0 to <maxCellMeas>		
>>>>BCCH ARFCN	MP		Integer (0..1023)	

13.4.27f11 TRIGGERED_3B_EVENT

This variable contains information about a 3b event that has been configured in the UE. There is one such variable per event 3b configured in the UE.

Information Element/Group name	Need	Multi	Type and reference	Semantics description
CHOICE <i>system</i>	OP			
>GSM				
>>CHOICE <i>BSIC</i>	MP			
>>>Verified BSIC		0 to <maxCellMeas>		
>>>>Inter-RAT cell id	MP		Integer(0..<maxCellMeas>-1)	
>>>Non verified BSIC		0 to <maxCellMeas>		
>>>>BCCH ARFCN	MP		Integer (0..1023)	

13.4.27f12 TRIGGERED_3C_EVENT

This variable contains information about a 3c event that has been configured in the UE. There is one such variable per event 3c configured in the UE.

Information Element/Group name	Need	Multi	Type and reference	Semantics description
CHOICE <i>system</i>	OP			
>GSM				
>>CHOICE <i>BSIC</i>	MP			
>>>Verified BSIC		0 to <maxCellMeas>		
>>>>Inter-RAT cell id	MP		Integer(0..<maxCellMeas>-1)	
>>>Non verified BSIC		0 to <maxCellMeas>		
>>>>BCCH ARFCN	MP		Integer (0..1023)	

13.4.27f13 BEST_CELL_3D_EVENT

This variable contains information about a 3d event that has been configured in the UE. There is one such variable per event 3a configured in the UE.

Information Element/Group name	Need	Multi	Type and reference	Semantics description
CHOICE <i>system</i>				
>GSM				
>>CHOICE <i>BSIC</i>	MP			
>>>Verified BSIC				
>>>>Inter-RAT cell id	MP		Integer(0..<maxCellMeas>-1)	
>>>Non verified BSIC				
>>>>BCCH ARFCN	MP		Integer (0..1023)	

13.4.27f14 TRIGGERED_6A_EVENT

This variable contains information about a 6a event that has been configured in the UE. There is one such variable per 6a event configured in the UE.

Information Element/Group name	Need	Multi	Type and reference	Semantics description
Event triggered	OP		Boolean	

13.4.27f15 TRIGGERED_6B_EVENT

This variable contains information about a 6b event that has been configured in the UE. There is one such variable per 6b event configured in the UE.

Information Element/Group name	Need	Multi	Type and reference	Semantics description
Event triggered	OP		Boolean	

13.4.27f16 TRIGGERED_6C_EVENT

This variable contains information about a 6c event that has been configured in the UE. There is one such variable per 6c event configured in the UE.

Information Element/Group name	Need	Multi	Type and reference	Semantics description
Event triggered	OP		Boolean	

13.4.27f17 TRIGGERED_6D_EVENT

This variable contains information about a 6d event that has been configured in the UE. There is one such variable per 6d event configured in the UE.

Information Element/Group name	Need	Multi	Type and reference	Semantics description
Event triggered	OP		Boolean	

13.4.27f18 TRIGGERED_6E_EVENT

This variable contains information about a 6e event that has been configured in the UE. There is one such variable per 6e event configured in the UE.

Information Element/Group name	Need	Multi	Type and reference	Semantics description
Event triggered	OP		Boolean	

13.4.27f19 TRIGGERED_6F_EVENT

This variable contains information about a 6f event that has been configured in the UE. There is one such variable per 6f event configured in the UE.

Information Element/Group name	Need	Multi	Type and reference	Semantics description
CHOICE mode				
>FDD				
Event triggered_RL	OP	<maxRL>	Boolean	
>1.28 Mcps TDD				
>>T _{ADV}	MP		TADV info 10.3.7.112	

13.4.27f20 TRIGGERED_6G_EVENT

This variable contains information about a 6g event that has been configured in the UE. There is one such variable per 6g event configured in the UE.

Information Element/Group name	Need	Multi	Type and reference	Semantics description
Event triggered_RL	OP	<maxRL>	Boolean	

13.4.27g UE_CAPABILITY_REQUESTED

This variable stores information about the UE capabilities that have been requested by UTRAN but that have not yet been transferred to UTRAN.

Information Element/Group name	Need	Multi	Type and reference	Semantics description
UE radio access capability	OP		UE radio access capability 10.3.3.42	Cleared when entering UTRA RRC connected mode. Cleared when leaving UTRA RRC connected mode.
UE radio access capability extension	OP		UE radio access capability extension 10.3.3.42a	Cleared when entering UTRA RRC connected mode. Cleared when leaving UTRA RRC connected mode.
UE system specific capability	OP	1 to <maxInterSy sMessages >		
>Inter-RAT UE radio access capability	MP		Inter-RAT UE radio access capability 10.3.8.7	Includes inter-RAT classmark. Cleared when entering UTRA RRC connected mode. Cleared when leaving UTRA RRC connected mode.

13.4.28 UE_CAPABILITY_TRANSFERRED

This variable stores information about which UE capabilities that have been transferred to UTRAN.

Information Element/Group name	Need	Multi	Type and reference	Semantics description
UE radio access capability	OP		UE radio access capability 10.3.3.42	Cleared when entering UTRA RRC connected mode when not stated otherwise in the procedure. Cleared when leaving UTRA RRC connected mode.
UE radio access capability extension	OP		UE radio access capability extension 10.3.3.42a	Cleared when entering UTRA RRC connected mode when not stated otherwise in the procedure. Cleared when leaving UTRA

Information Element/Group name	Need	Multi	Type and reference	Semantics description
				RRC connected mode.
UE system specific capability	OP	1 to <maxSystemCapability>		
>Inter-RAT UE radio access capability	MP		Inter-RAT UE radio access capability 10.3.8.7	Includes inter-RAT classmark. Cleared when entering UTRA RRC connected mode when not stated otherwise in the procedure. Cleared when leaving UTRA RRC connected mode.

13.4.28a UE_POSITIONING_GPS_DATA

Information Element/Group name	Need	Multi	Type and reference	Semantics description
GPS Data ciphering info	OP		UE positioning Ciphering info 10.3.7.86	
GPS Deciphering Keys	OP			
>Current deciphering key	MP		Bit string(56)	
>Next deciphering key	MP		Bit string(56)	
UE positioning GPS reference time	OP		UE positioning GPS reference time 10.3.7.96	
UE positioning GPS reference UE position	OP		Ellipsoid point with altitude and uncertainty ellipsoid 10.3.8.4c	A priori knowledge of UE 3-D position.
UE positioning GPS DGPS corrections	OP		UE positioning GPS DGPS corrections 10.3.7.91	
UE positioning GPS navigation model	OP	1 to <maxSat>		
>SatID	MP		Enumerated(0..63)	Satellite ID
>GPS Ephemeris and Clock Correction parameters	MP		UE positioning GPS Ephemeris and Clock Correction parameters 10.3.7.91a	
UE positioning GPS ionospheric model	OP		UE positioning GPS ionospheric model 10.3.7.92	
UE positioning GPS UTC model	OP		UE positioning GPS UTC model	

Information Element/Group name	Need	Multi	Type and reference	Semantics description
			10.3.7.97	
UE positioning GPS almanac	OP			
>SatID	MP	1 to <maxSat>		
>>WN _a	MP			
>>DataID	MP			Same as IE in 10.3.7.89
>>e	MP			Same as IE in 10.3.7.89
>>t _{oa}	MP			Same as IE in 10.3.7.89
>>δI	MP			Same as IE in 10.3.7.89
>>OMEGADOT	MP			Same as IE in 10.3.7.89
>>SV Health	MP			Same as IE in 10.3.7.89
>>A ^{1/2}	MP			Same as IE in 10.3.7.89
>>OMEGA ₀	MP			Same as IE in 10.3.7.89
>>M ₀	MP			Same as IE in 10.3.7.89
>>ω	MP			Same as IE in 10.3.7.89
>>af ₀	MP			Same as IE in 10.3.7.89
>>af ₁	MP			Same as IE in 10.3.7.89
>SV Global Health	OP			Same as IE in 10.3.7.89
UE positioning GPS acquisition assistance	OP		UE positioning GPS acquisition assistance 10.3.7.88	
UE positioning GPS real-time integrity	OP		UE positioning GPS real-time integrity 10.3.7.95	

13.4.28b UE_POSITIONING_OTDOA_DATA_UE_ASSISTED

Information Element/Group name	Need	Multi	Type and reference	Semantics description
UE positioning OTDOA reference cell info for UE-assisted	OP		UE positioning OTDOA reference cell info 10.3.7.108	
UE positioning OTDOA neighbour cell list for UE-assisted	OP	1 to <maxCellMEas>		
>UE positioning OTDOA neighbour cell info for UE-assisted	MP		UE positioning OTDOA neighbour cell info 10.3.7.106	

13.4.28c UE_POSITIONING_OTDOA_DATA_UE_BASED

Information Element/Group name	Need	Multi	Type and reference	Semantics description
OTDOA Deciphering Keys	OP			
>Current deciphering key	MP		Bit string(56)	
>Next deciphering key	MP		Bit string(56)	
OTDOA Data ciphering info	OP		UE positioning Ciphering info 10.3.7.86	
UE positioning OTDOA reference cell info for UE-based	OP		UE positioning OTDOA reference cell info for UE-based 10.3.7.108a	
UE positioning OTDOA neighbour cell list for UE-based	OP	1 to <maxCellMeas>		
>UE positioning OTDOA neighbour cell info for UE-based	MP		UE positioning OTDOA neighbour cell info for UE-based 10.3.7.106	

13.4.29 UNSUPPORTED_CONFIGURATION

This variable indicates whether a received message contained a configuration that is not supported by the UE.

Information Element/Group name	Need	Multi	Type and reference	Semantics description
Unsupported configuration	MP		Boolean	TRUE: An unsupported configuration has been detected. Set to FALSE when entering UTRA RRC connected mode. Set to FALSE when leaving UTRA RRC connected mode.

13.4.30 URA_IDENTITY

This variable stores the assigned URA identity for this UE when in URA_PCH state.

Information Element/Group name	Need	Multi	Type and reference	Semantics description
URA identity	OP		URA identity 10.3.2.6	Cleared when entering UTRA RRC connected mode. Cleared when leaving UTRA RRC connected mode.

13.4.31 U_RNTI

This variable stores the assigned U-RNTI for this UE.

Information Element/Group name	Need	Multi	Type and reference	Semantics description
U-RNTI	OP		U-RNTI 10.3.3.47	Cleared when leaving UTRA RRC connected mode.

13.4.32 VALUE_TAG

This variable contains information about the value tag for the last received system information block of a given type, for all system information blocks using value tags. The UE shall maintain one instance of this variable for the current selected cell. The UE may store several instances of this variable, one for each cell, to be used if the UE returns to these cells.

All IEs in this variable shall be cleared when switched off. All IEs in this variable except for the IE "SIB 16 value tag list" shall be cleared at selection of a new PLMN. The IE "SIB 16 value tag list" is cleared at selection of a new PLMN which is not indicated by higher layers to be equivalent to the previously selected PLMN.

Information Element/Group name	Need	Multi	Type and reference	Semantics description
MIB value tag	OP		MIB value tag 10.3.8.9	Value tag for the master information block
SB 1 value tag	OP		Cell value tag 10.3.8.4	Value tag for the scheduling block type 1
SB 2 value tag	OP		Cell value tag 10.3.8.4	Value tag for the scheduling block type 2
SIB 1 value tag	CV-GSM		PLMN value tag 10.3.8.10	Value tag for the system information block type 1
SIB 2 value tag	OP		Cell value tag 10.3.8.4	Value tag for the system information block type 2
SIB 3 value tag	OP		Cell value tag 10.3.8.4	Value tag for the system information block type 3
SIB 4 value tag	OP		Cell value tag 10.3.8.4	Value tag for the system information block type 4
SIB 5 value tag	OP		Cell value tag 10.3.8.4	Value tag for the system information block type 5
SIB 6 value tag	OP		Cell value tag 10.3.8.4	Value tag for the system information block type 6
CHOICE mode	MP			
>FDD				
>>SIB 8 value tag	OP		Cell value tag 10.3.8.4	Value tag for the system information block type 8
>TDD				(no data)
SIB 11 value tag	OP		Cell value tag 10.3.8.4	Value tag for the system information block type 11
SIB 12 value tag	OP		Cell value tag 10.3.8.4	Value tag for the system information block type 12
SIB 13 value tag	CV-ANSI		Cell value tag 10.3.8.4	Value tag for the system information block type 13
SIB 13.1 value tag	CV-ANSI		Cell value tag 10.3.8.4	Value tag for the system information block type 13.1
SIB 13.2 value tag	CV-ANSI		Cell value tag 10.3.8.4	Value tag for the system information block type 13.2
SIB 13.3 value tag	CV-ANSI		Cell value tag 10.3.8.4	Value tag for the system information block type 13.3
SIB 13.4 value tag	CV-ANSI		Cell value tag 10.3.8.4	Value tag for the system information block type 13.4
SIB 15 value tag	OP		Cell value tag 10.3.8.4	Value tag for the system information block type 15
SIB 15.1 value tag	OP		Cell value tag 10.3.8.4	Value tag for the system information block type 15.1
SIB 15.2 value tag list	OP	1 to <maxSat>		List of value tags for all stored occurrences of system information block type 15.2
>SIB 15.2 value tag	MP		Cell value tag 10.3.8.4	
>SIB occurrence identity and	MP		SIB	

Information Element/Group name	Need	Multi	Type and reference	Semantics description
value tag			occurrence identity and value tag 10.3.8.20b	
SIB 15.3 value tag list	OP	1 to <maxSat>		List of value tags for all stored occurrences of system information block type 15.3
>SIB 15.3 value tag	MP		PLMN value tag 10.3.8.10	Value tag for the system information block type 15.3
>SIB occurrence identity and value tag	MP		SIB occurrence identity and value tag 10.3.8.20b	
SIB 15.4 value tag	OP		Cell value tag 10.3.8.4	Value tag for the system information block type 15.4
SIB 15.5 value tag	OP		Cell value tag 10.3.8.4	Value tag for the system information block type 15.5
SIB 16 value tag list	OP	1 to <maxPred efConfig>		List of value tags for all stored occurrences of the system information block type 16
>Predefined configuration identity and value tag	MP		Predefined configuration identity and value tag 10.3.8.11	
SIB 18 value tag	OP		Cell value tag 10.3.8.4	Value tag for the system information block type 18

Condition	Explanation
<i>GSM</i>	This information is optional when the PLMN Type in the variable SELECTED_PLMN is "GSM-MAP" and never stored otherwise.
<i>ANSI</i>	This information is optional when the PLMN Type in the variable SELECTED_PLMN is "ANSI-41" and never stored otherwise.

13.5 UE RRC Procedure Performance

This subclause defines the performance requirements related to RRC procedures in the UE. Where the total delay is impacted by processing of variable length on the physical layer (e.g. physical layer synchronisation), references to appropriate specifications are given.

13.5.1 Definitions

The following definitions of N1 and N2 are valid only for this UE RRC Procedure Performance specification.

N1 = upper limit on the time required to execute modifications in UE after the reception of a UTRAN -> UE message has been completed. Where applicable (e.g. the physical layer transmission is impacted), the changes shall be adopted in the beginning of the next TTI starting after N1. N1 is specified as a multiple of 10 ms.

N2 = number of 10 ms radio frames from end of reception of UTRAN -> UE message on UE physical layer before the transmission of the UE -> UTRAN response message must be ready to start on a transport channel with no access delay other than the TTI alignment (e.g. DCH, therefore excluding delays caused by RACH procedure etc). The UE response message transmission from the physical layer shall begin at the latest (N2*10)+TTI ms after completion of the reception of the last TTI carrying the triggering UTRAN -> UE message. When Target State is CELL_DCH, the UE response message transmission from the physical layer may be additionally delayed by the value of IE "SRB delay".

N1 and N2 are independent (e.g. N2-N1 is not restricted to being less than or equal to 10ms).

13.5.2 RRC procedure performance values

NOTE: Times indicated in the table do not include cell reselection.

Procedure title:	UTRAN -> UE	UE -> UTRAN	N1	N2	Notes
RRC Connection Management Procedures					
Broadcast of system information	SYSTEM INFORMATION				N2 is not applicable for any system information messages, because there is no response message from the UE.
Master Information Block	SYSTEM INFORMATION		5	NA	No system information data shall be lost due to processing of a MIB received with no detectable errors. This means that the UE shall buffer all system information data received after the MIB until the data can be processed according to the information in the MIB, unless the MIB was received erroneously.
System Information Block type 1	SYSTEM INFORMATION		10	NA	
System Information Block type 2	SYSTEM INFORMATION		10	NA	
System Information Block type 3	SYSTEM INFORMATION		10	NA	
System Information Block type 4	SYSTEM INFORMATION		10	NA	
System Information Block type 5	SYSTEM INFORMATION		10	NA	
System Information Block type 6	SYSTEM INFORMATION		10	NA	
System Information Block type 7	SYSTEM INFORMATION		5	NA	
System Information Block type 8	SYSTEM INFORMATION		10	NA	
System Information Block type 9	SYSTEM INFORMATION		5	NA	
System Information Block type 10	SYSTEM INFORMATION		5	NA	
System Information Block type 11	SYSTEM INFORMATION		10	NA	
System Information Block type 12	SYSTEM INFORMATION		10	NA	
System Information Block type 13	SYSTEM INFORMATION		10	NA	
System Information Block type 14	SYSTEM INFORMATION		10	NA	
System Information Block type 15	SYSTEM INFORMATION		10	NA	
System Information Block type 16	SYSTEM INFORMATION		10	NA	
System Information Block type 18	SYSTEM INFORMATION		10	NA	

Procedure title:	UTRAN -> UE	UE -> UTRAN	N1	N2	Notes
RRC connection establishment <i>Target state CELL_DCH</i>	RRC CONNECTION SETUP	RRC CONNECTION SETUP COMPLETE	10	NA	N1 measures time to the start of tx / rx on DPCH. N2 cannot be specified, because RRC CONNECTION SETUP COMPLETE message is transmitted only after physical layer synchronisation, which also depends on the Node B. The performance of the physical layer synchronisation procedure is specified in [19] and [20]
RRC connection establishment <i>Target state CELL_FACH</i>	RRC CONNECTION SETUP	RRC CONNECTION SETUP COMPLETE	10	11	N1 and N2 applicable as defined (N2 can be tested from the initiation of the power ramp on RACH).
RRC connection release <i>From CELL_DCH state</i>	RRC CONNECTION RELEASE	RRC CONNECTION RELEASE COMPLETE	5	8	N1 sets the requirement for the time from the completion of the last repetition of the RRC CONNECTION RELEASE COMPLETE message to the release of the physical channel. N2 sets the requirement from the end of successful reception of the RRC CONNECTION RELEASE message to the start of the first transmission of the RRC CONNECTION RELEASE COMPLETE message.
RRC connection release <i>From CELL_FACH state</i>	RRC CONNECTION RELEASE	RRC CONNECTION RELEASE COMPLETE	NA	11	N1 represents UE internal configuration that cannot be externally observed.
Paging	PAGING TYPE 1	CELL UPDATE	10	11+ T	T is the repetition period of SIB7 (applicable for FDD) and SIB14 (applicable for TDD)
UE capability enquiry	UE CAPABILITY ENQUIRY	UE CAPABILITY INFORMATION	NA	8	N1 is not applicable because the UE configuration does not change.
Security mode control	SECURITY MODE COMMAND	SECURITY MODE COMPLETE	5	8	
Signalling connection release procedure	SIGNALLING CONNECTION RELEASE		5	NA	N2 is not applicable because there is no response message.
Counter check	COUNTER CHECK	COUNTER CHECK RESPONSE	NA	8	N1 is not applicable because the UE configuration does not change.
Radio Bearer control procedures					
Radio bearer establishment <i>Target state CELL_DCH</i>	RADIO BEARER SETUP	RADIO BEARER SETUP COMPLETE / FAILURE	10	NA	N2 cannot be specified, because the RADIO BEARER SETUP COMPLETE / FAILURE message is transmitted only after physical layer synchronisation, which depends also on Node B.
Radio bearer establishment <i>From state CELL_FACH to state CELL_FACH</i>	RADIO BEARER SETUP	RADIO BEARER SETUP COMPLETE / FAILURE	10	11	

Procedure title:	UTRAN -> UE	UE -> UTRAN	N1	N2	Notes
Radio bearer establishment <i>From CELL_DCH to CELL_FACH</i>	RADIO BEARER SETUP	RADIO BEARER SETUP COMPLETE	NA	NA	N1 and N2 cannot be specified, because UE need to read SIBs on BCH before sending RADIO BEARER SETUP COMPLETE
Radio bearer reconfiguration <i>Target state CELL_DCH</i>	RADIO BEARER RECONFIGURATION	RADIO BEARER RECONFIGURATION COMPLETE / FAILURE	10	NA	N2 cannot be specified, because the RADIO BEARER RECONFIGURATION COMPLETE / FAILURE message is transmitted only after physical layer synchronisation, which depends also on Node B.
Radio bearer reconfiguration <i>From state CELL_FACH to state CELL_FACH</i>	RADIO BEARER RECONFIGURATION	RADIO BEARER RECONFIGURATION COMPLETE / FAILURE	10	11	
Radio bearer reconfiguration <i>From state CELL_DCH to state CELL_FACH</i>	RADIO BEARER RECONFIGURATION	RADIO BEARER RECONFIGURATION COMPLETE	NA	NA	N1 and N2 cannot be specified, because UE need to read SIBs on BCH before sending RADIO BEARER RECONFIGURATION COMPLETE
Radio bearer release <i>Target state CELL_DCH</i>	RADIO BEARER RELEASE	RADIO BEARER RELEASE COMPLETE / FAILURE	10	11	
Radio bearer release <i>From state CELL_FACH to state CELL_FACH</i>	RADIO BEARER RELEASE	RADIO BEARER RELEASE COMPLETE / FAILURE	10	11	
Radio bearer release <i>From state CELL_DCH to state CELL_FACH</i>	RADIO BEARER RELEASE	RADIO BEARER RELEASE COMPLETE	NA	NA	N1 and N2 cannot be specified, because UE need to read SIBs on BCH before sending RADIO BEARER RECONFIGURATION COMPLETE
Transport channel reconfiguration <i>Target state CELL_DCH</i>	TRANSPORT CHANNEL RECONFIGURATION	TRANSPORT CHANNEL RECONFIGURATION COMPLETE / FAILURE	10	NA	N2 cannot be specified, because the TRANSPORT CHANNEL RECONFIGURATION COMPLETE / FAILURE message is transmitted only after physical layer synchronisation, which depends also on Node B.
Transport channel reconfiguration <i>From state CELL_FACH to state CELL_FACH</i>	TRANSPORT CHANNEL RECONFIGURATION	TRANSPORT CHANNEL RECONFIGURATION COMPLETE / FAILURE	10	11	
Transport channel reconfiguration <i>From state CELL_DCH to state CELL_FACH</i>	TRANSPORT CHANNEL RECONFIGURATION	TRANSPORT CHANNEL RECONFIGURATION COMPLETE	NA	NA	N1 and N2 cannot be specified, because UE need to read SIBs on BCH before sending TRANSPORT CHANNEL RECONFIGURATION COMPLETE
Transport format combination control <i>AM or UM RLC mode</i>	TRANSPORT FORMAT COMBINATION CONTROL	TRANSPORT FORMAT COMBINATION CONTROL FAILURE	5	8	
Transport format combination control <i>Transparent mode</i>	TRANSPORT FORMAT COMBINATION CONTROL		5	NA	N2 is not applicable because no response message is defined.

Procedure title:	UTRAN -> UE	UE -> UTRAN	N1	N2	Notes
Physical channel reconfiguration <i>Target state CELL_DCH</i>	PHYSICAL CHANNEL RECONFIGURATION	PHYSICAL CHANNEL RECONFIGURATION COMPLETE / FAILURE	8	NA	N2 cannot be specified, because the PHYSICAL CHANNEL RECONFIGURATION COMPLETE / FAILURE message is transmitted only after physical layer synchronisation, which depends also on Node B.
Physical channel reconfiguration <i>From state CELL_FACH to state CELL_FACH</i>	PHYSICAL CHANNEL RECONFIGURATION	PHYSICAL CHANNEL RECONFIGURATION COMPLETE / FAILURE	8	9	
Physical channel reconfiguration <i>From state CELL_DCH to state CELL_FACH</i>	PHYSICAL CHANNEL RECONFIGURATION	PHYSICAL CHANNEL RECONFIGURATION COMPLETE	NA	NA	N1 and N2 cannot be specified, because UE need to read SIBs on BCH before sending PHYSICAL CHANNEL RECONFIGURATION COMPLETE
Physical Shared Channel Allocation [TDD only]	PHYSICAL SHARED CHANNEL ALLOCATION		5	NA	N2 is not applicable because no response message is defined.
Uplink Physical Channel Control [TDD only]	UPLINK PHYSICAL CHANNEL CONTROL		8	NA	Requirements for outer loop and timing advance adjustments are defined in [22] and [20]. N2 is not applicable because there is no response message.
RRC connection mobility procedures					
Cell update	CELL UPDATE CONFIRM	UTRAN MOBILITY INFORMATION CONFIRM	5	8	
		PHYSICAL CHANNEL RECONFIGURATION COMPLETE <i>Target state CELL_FACH</i>	8	9	
		PHYSICAL CHANNEL RECONFIGURATION COMPLETE <i>Target state CELL_DCH</i>	8	NA	N2 cannot be specified, because the PHYSICAL CHANNEL RECONFIGURATION COMPLETE / FAILURE message is transmitted only after physical layer synchronisation, which depends also on Node B.
		TRANSPORT CHANNEL RECONFIGURATION COMPLETE <i>Target state CELL_FACH</i>	10	11	

Procedure title:	UTRAN -> UE	UE -> UTRAN	N1	N2	Notes
		TRANSPORT CHANNEL RECONFIGURATION COMPLETE <i>Target state</i> CELL_DCH	10	NA	N2 cannot be specified, because the PHYSICAL CHANNEL RECONFIGURATION COMPLETE / FAILURE message is transmitted only after physical layer synchronisation, which depends also on Node B.
		RADIO BEARER RECONFIGURATION COMPLETE <i>Target state</i> CELL_FACH	10	11	
		RADIO BEARER RECONFIGURATION COMPLETE <i>Target state</i> CELL_DCH	10	NA	N2 cannot be specified, because the PHYSICAL CHANNEL RECONFIGURATION COMPLETE / FAILURE message is transmitted only after physical layer synchronisation, which depends also on Node B.
		RADIO BEARER RELEASE COMPLETE <i>Target state</i> CELL_DCH	10	11	
URA update	URA UPDATE CONFIRM	UTRAN MOBILITY INFORMATION CONFIRM	5	8	
UTRAN mobility information	UTRAN MOBILITY INFORMATION	UTRAN MOBILITY INFORMATION CONFIRM / FAILURE	5	8	
Active set update	ACTIVE SET UPDATE	ACTIVE SET UPDATE COMPLETE / FAILURE	NA	8	The requirements on UE combining and power control performance for both UL and DL are specified by RAN WG4 in [21] and [19]. Also in case of branch addition the COMPLETE / FAILURE message is transmitted without waiting for the new branch to stabilise, therefore N2 is specified.
Inter-RAT handover to UTRAN	HANDOVER TO UTRAN COMMAND (other system)	HANDOVER TO UTRAN COMPLETE	NA	NA	The performance of this procedure is specified in 05.10.
Inter-RAT handover from UTRAN	HANDOVER FROM UTRAN COMMAND	HANDOVER FROM UTRAN FAILURE	NA	NA	The performance of this procedure is specified in [19] and [20].
Measurement procedures					
Measurement control	MEASUREMENT CONTROL	MEASUREMENT CONTROL FAILURE	5	8	Response to measurement inquiry depends on physical layer measurement. Response time is defined in [19] and [20]. N1 and N2 only define the processing of the message.

13.6 RB information parameters for signalling radio bearer RB 0

The following Radio Bearer parameter values apply for signalling radio bearer RB0:

Information element/ Group name	Value	Comment
RLC info		
>Uplink RLC mode	TM	
>>Transmission RLC discard	omitted	Neither discard is used, nor will there be a reset
>>Segmentation indication	FALSE	
>Downlink RLC mode	UM	
RB mapping info		Single multiplexing option
>Uplink mapping info		
>>UL transport channel	RACH	RACH corresponding with selected PRACH
>>RLC size list	N/A	The first TF defined in the Transport Format Set for the transport channel that is used
>>MAC logical channel priority	1	
>Downlink mapping info		
>>DL transport channel	FACH	

Procedure descriptions in subclause 8.6.4.8 shall not be applied for the IE "RB mapping info" that is used for signalling radio bearer RB0.

13.6a RB information parameters for SHCCH

The following Radio Bearer parameter values apply for SHCCH:

Information element/ Group name	Value	Comment
RLC info		
>Uplink RLC mode	TM	
>>Transmission RLC discard	omitted	Neither discard is used, nor will there be a reset
>>Segmentation indication	FALSE	
>Downlink RLC mode	UM	
RB mapping info		
>Uplink mapping info		Option 1
>>UL transport channel	RACH	RACH corresponding with selected PRACH
>>RLC size list	N/A	The first TF defined in the Transport Format Set for the transport channel that is used
>>MAC logical channel priority	1	
>Downlink mapping info		
>>DL transport channel	FACH	
>Uplink mapping info		Option 2
>>UL transport channel	USCH	
>>UL Transport Channel Identity	1	
>>MAC logical channel priority	1	
>>RLC size list	N/A	The first TF defined in the Transport Format Set for the transport channel that is used
>Downlink mapping info		
>>DL transport channel	DSCH	
>>DL Transport Channel Identity	1	

13.6b RB information parameters for BCCH mapped to FACH

The following Radio Bearer parameter values apply for BCCH mapped to FACH:

Information element/ Group name	Value	Comment
Downlink RLC mode	TM	
Segmentation indication	FALSE	

13.6c RB information parameters for PCCH mapped to PCH

The following Radio Bearer parameter values apply for PCCH mapped to PCH:

Information element/ Group name	Value	Comment
Downlink RLC mode	TM	
Segmentation indication	FALSE	

13.6d Parameters for BCCH mapped to BCH

The transport format parameters for BCH are specified in [34].

13.7 Parameter values for default radio configurations

The UE shall support the use of the default radio configurations that are specified in the following.

NOTE 1: These configurations are based on [41] and cover a number of RAB and signalling connection configurations.

In the table that is used to specify the parameter values for these default configurations, the following principles are used:

- Optional IEs that are not used are omitted;
- In case no parameter value is specified in a column, this means the value given the previous (left side) column applies.

NOTE 2: If needed, signalling radio bearer RB4 is established after the completion of handover.

NOTE 3: For each default configuration, the value of FDD, 3.84 Mcps TDD and 1.28 Mcps TDD parameters are specified. All parameters apply to FDD, 3.84 Mcps TDD and 1.28 Mcps TDD modes, unless explicitly stated otherwise. It should be noted that in this respect default configurations differ from pre-defined configurations, which only include parameter values for one mode.

NOTE 4: The transport format sizes, indicated in the following table, concern the RLC PDU size, since all configurations concern dedicated channels. The transport block sizes indicated in TS 34.108 are different since these include the size of the MAC header.

Configuration	3.4 kbps signalling	13.6 kbps signalling	7.95 kbps speech + 3.4 kbps signalling	12.2 kbps speech + 3.4 kbps signalling
Ref 34.108	2	3	6	4
Default configuration identity	0	1	2	3
RB INFORMATION				
rb-Identity	RB1: 1, RB2: 2, RB3: 3	RB1: 1, RB2: 2, RB3: 3	RB1: 1, RB2: 2, RB3: 3, RB5: 5, RB6: 6	RB1: 1, RB2: 2, RB3: 3, RB5: 5, RB6: 6, RB7: 7
rlc-InfoChoice	Rlc-info	Rlc-info	Rlc-info	Rlc-info
>ul-RLC-Mode	RB1: UM RB2- RB3: AM	RB1: UM RB2- RB3: AM	RB1: UM RB2- RB3: AM RB5-RB6: TM	RB1: UM RB2- RB3: AM RB5-RB7: TM
>>transmissionRLC-DiscardMode	RB1: N/A RB2- RB3: NoDiscard	RB1: N/A RB2- RB3: NoDiscard	RB1: N/A RB2- RB3: NoDiscard RB5- RB6: N/A	RB1: N/A RB2- RB3: NoDiscard RB5- RB7: N/A
>>>maxDat	RB1: N/A RB2- RB3: 15	RB1: N/A RB2- RB3: 15	RB1: N/A RB2- RB3: 15 RB5- RB6: N/A	RB1: N/A RB2- RB3: 15 RB5- RB7: N/A

Configuration	3.4 kbps signalling	13.6 kbps signalling	7.95 kbps speech + 3.4 kbps signalling	12.2 kbps speech + 3.4 kbps signalling
>>transmissionWindowSize	RB1: N/A RB2- RB3: 128 for UEs with more than 10 kbyte "total RLC AM buffer size" and 32 otherwise	RB1: N/A RB2- RB3: 128 for UEs with more than 10 kbyte "total RLC AM buffer size" and 32 otherwise	RB1: N/A RB2- RB3: 128 for UEs with more than 10 kbyte "total RLC AM buffer size" and 32 otherwise RB5- RB6: N/A	RB1: N/A RB2- RB3: 128 for UEs with more than 10 kbyte "total RLC AM buffer size" and 32 otherwise RB5- RB7: N/A
>>timerRST	RB1: N/A RB2- RB3: 300	RB1: N/A RB2- RB3: 300	RB1: N/A RB2- RB3: 300 RB5- RB6: N/A	RB1: N/A RB2- RB3: 300 RB5- RB7: N/A
>>max-RST	RB1: N/A RB2- RB3: 1	RB1: N/A RB2- RB3: 1	RB1: N/A RB2- RB3: 1 RB5- RB6: N/A	RB1: N/A RB2- RB3: 1 RB5- RB7: N/A
>>pollingInfo	RB1: N/A RB2- RB3: as below	RB1: N/A RB2- RB3: as below	RB1: N/A RB2- RB3: as below RB5- RB6: N/A	RB1: N/A RB2- RB3: as below RB5- RB7: N/A
>>>lastTransmissionPDU-Poll	RB2- RB3: FALSE	RB2- RB3: FALSE	RB2- RB3: FALSE	RB2- RB3: FALSE
>>>lastRetransmissionPDU-Poll	RB2- RB3: FALSE	RB2- RB3: FALSE	RB2- RB3: FALSE	RB2- RB3: FALSE
>>>timerPollPeriodic	RB2- RB3: 300	RB2- RB3: 100	RB2- RB3: 300	RB2- RB3: 300
>>segmentationIndication	RB1- RB3: N/A	RB1- RB3: N/A	RB1- RB3: N/A RB5- RB6: FALSE	RB1- RB3: N/A RB5- RB7: FALSE
>dl-RLC-Mode	RB1: UM RB2- RB3: AM	RB1: UM RB2- RB3: AM	RB1: UM RB2- RB3: AM RB5- RB6: TM	RB1: UM RB2- RB3: AM RB5- RB7: TM
>>inSequenceDelivery	RB1: N/A RB2- RB3: TRUE	RB1: N/A RB2- RB3: TRUE	RB1: N/A RB2- RB3: TRUE RB5- RB6: N/A	RB1: N/A RB2- RB3: TRUE RB5- RB7: N/A
>>receivingWindowSize	RB1: N/A RB2- RB3: 128 for UEs with more than 10 kbyte "total RLC AM buffer size" and 32 otherwise	RB1: N/A RB2- RB3: 128 for UEs with more than 10 kbyte "total RLC AM buffer size" and 32 otherwise	RB1: N/A RB2- RB3: 128 for UEs with more than 10 kbyte "total RLC AM buffer size" and 32 otherwise RB5- RB6: N/A	RB1: N/A RB2- RB3: 128 for UEs with more than 10 kbyte "total RLC AM buffer size" and 32 otherwise RB5- RB7: N/A
>>>dl-RLC-StatusInfo	RB1: N/A RB2- RB3: as below	RB1: N/A RB2- RB3: as below	RB1: N/A RB2- RB3: as below RB5- RB6: N/A	RB1: N/A RB2- RB3: as below RB5- RB7: N/A
>>>timerStatusProhibit	RB2- RB3: 100	RB2- RB3: 100	RB2- RB3: 100	RB2- RB3: 100
>>>missingPDU-Indicator	RB2- RB3: FALSE	RB2- RB3: FALSE	RB2- RB3: FALSE	RB2- RB3: FALSE
>>>timerStatusPeriodic	RB2- RB3: 300	RB2- RB3: 100	RB2- RB3: 300	RB2- RB3: 300
>>segmentationIndication	RB1- RB3: N/A	RB1- RB3: N/A	RB1- RB3: N/A RB5- RB6: FALSE	RB1- RB3: N/A RB5- RB7: FALSE
rb-MappingInfo				
>UL-LogicalChannelMappings	OneLogicalChannel	OneLogicalChannel	OneLogicalChannel	OneLogicalChannel
>>ul-TransportChannelType	Dch	Dch	Dch	Dch
>>>transportChannelIdentity	RB1- RB3: 1	RB1- RB3: 1	RB1- RB3: 3 RB5: 1, RB6: 2	RB1- RB3: 4 RB5: 1, RB6: 2, RB7: 3
>>logicalChannelIdentity	RB1: 1, RB2: 2, RB3: 3	RB1: 1, RB2: 2, RB3: 3	RB1: 1, RB2: 2, RB3: 3 RB5- RB6: N/A	RB1: 1, RB2: 2, RB3: 3 RB5- RB7: N/A
>>rlc-SizeList	RB1- RB3: configured	RB1- RB3: configured	RB1- RB3: configured RB5- RB6: N/A	RB1- RB3: configured RB5- RB7: N/A
>>mac-LogicalChannelPriority	RB1: 1, RB2: 2, RB3: 3	RB1: 1, RB2: 2, RB3: 3	RB1: 1, RB2: 2, RB3: 3 RB5- RB6: 5	RB1: 1, RB2: 2, RB3: 3 RB5- RB7: 5
>DL-logicalChannelMappingList				

Configuration	3.4 kbps signalling	13.6 kbps signalling	7.95 kbps speech + 3.4 kbps signalling	12.2 kbps speech + 3.4 kbps signalling
>>Mapping option 1	One mapping option	One mapping option	One mapping option	One mapping option
>>>dl-TransportChannelType	Dch	Dch	Dch	Dch
>>>>transportChannelIdentity	RB1- RB3: 1	RB1- RB3: 1	RB1- RB3: 3 RB5: 1, RB6: 2	RB1- RB3: 4 RB5: 1, RB6: 2, RB7: 3
>>>logicalChannelIdentity	RB1: 1, RB2: 2, RB3: 3	RB1: 1, RB2: 2, RB3: 3	RB1: 1, RB2: 2, RB3: 3 RB5- RB6: N/A	RB1: 1, RB2: 2, RB3: 3 RB5- RB7: N/A
TrCH INFORMATION PER TrCH				
UL-AddReconfTransChInfoList				
>Uplink transport channel type	dch	dch	dch	dch
>transportChannelIdentity	TrCH1: 1	TrCH1: 1	TrCH1: 1, TrCH2: 2, TrCH3: 3	TrCH1: 1, TrCH2: 2, TrCH3: 3, TrCH4: 4
>transportFormatSet	DedicatedTransChTFS	DedicatedTransChTFS	DedicatedTransChTFS	DedicatedTransChTFS
>>dynamicTF-information				
>>>tf0/ tf0,1	TrCH1: (0x144, 1x144)	TrCH1: (0x144, 1x144)	TrCH1: (0x75) TrCH2: (0x 84 1x84) TrCH3: (0x144, 1x144)	TrCH1: (0x81) TrCH2: (0x 103, 1x103) TrCH3: (0x 60, 1x60) TrCH4: (0x144, 1x144)
>>>>rlcSize	BitMode	BitMode	BitMode	BitMode
>>>>>sizeType	TrCH1: type 2, part1= 2, part2= 0 (144)	TrCH1: type 2, part1= 2, part2= 0 (144)	TrCH1: type 1: 75 TrCH2: type 1: 84 TrCH3: 2: type 2, part1= 2, part2= 0 (144)	TrCH1: type 1: 81 TrCH2: type 1: 103 TrCH3: type 1: 60 TrCH4: 2: type 2, part1= 2, part2= 0 (144)
>>>>numberOfTbSizeList	TrCH1: Zero, one	TrCH1: Zero, one	TrCH1: Zero TrCH2-3: Zero, one	TrCH1: Zero TrCH2-4: Zero, one
>>>>logicalChannelList	All	All	All	All
>>>tf 1	N/A	N/A	TrCH1: (1x39) TrCH2- TrCH4: N/A	TrCH1: (1x39) TrCH2- TrCH4: N/A
>>>>numberOfTransportBlocks			TrCH1: One	TrCH1: One
>>>>rlc-Size			TrCH1: BitMode	TrCH1: BitMode
>>>>>sizeType			TrCH1: 1: 39	TrCH1: 1: 39
>>>>numberOfTbSizeList			TrCH1: One	TrCH1: One
>>>>logicalChannelList			TrCH1: all	TrCH1: all
>>>tf 2	N/A	N/A	TrCH1: (1x75) TrCH2- TrCH3: N/A	TrCH1: (1x81) TrCH2- TrCH4: N/A
>>>>numberOfTransportBlocks			TrCH1: One	TrCH1: One
>>>>rlc-Size			TrCH1: BitMode	TrCH1: BitMode
>>>>>sizeType			TrCH1: type 1: 75	TrCH1: type 1: 81
>>>>numberOfTbSizeList			TrCH1: One	TrCH1: One
>>>>logicalChannelList			TrCH1: all	TrCH1: all
>>semistaticTF-Information				
>>>tfti	TrCH1: 40	TrCH1: 10	TrCH1- TrCH2: 20 TrCH3: 40	TrCH1- TrCH3: 20 TrCH4: 40
>>>channelCodingType	Convolutional	Convolutional	Convolutional	Convolutional
>>>>codingRate	TrCH1: Third	TrCH1: Third	TrCH1- TrCH2: Third TrCH3: Third	TrCH1- TrCH2: Third TrCH3: Half TrCH4: Third

Configuration	3.4 kbps signalling	13.6 kbps signalling	7.95 kbps speech + 3.4 kbps signalling	12.2 kbps speech + 3.4 kbps signalling
>>>rateMatchingAttribute	TrCH1: 160	TrCH1: 160	TrCH1: 200 TrCH2: 190 TrCH3: 160	TrCH1: 200 TrCH2: 190 TrCH3: 235 TrCH4: 160
>>>crc-Size	TrCH1: 16	TrCH1: 16	TrCH1: 12 TrCH2: 0 TrCH3: 16	TrCH1: 12 TrCH2- TrCH3: 0 TrCH4: 16
DL-AddReconfTransChInfoList				
>Downlink transport channel type	dch	dch	dch	dch
>dl-TransportChannelIdentity (should be as for UL)	TrCH1: 1	TrCH1: 1	TrCH1: 1, TrCH2: 2, TrCH3: 3	TrCH1: 1, TrCH2: 2, TrCH3: 3, TrCH4: 4
>dfs-SignallingMode	SameAsUL	SameAsUL	Explicit <Only tf0 on TrCH1 is different and shown below>	Explicit <Only tf0 on TrCH1 is different and shown below>
>>transportFormatSet			DedicatedTransChTFS	DedicatedTransChTFS
>>>dynamicTF-information				
>>>>tf0/ tf0,1			TrCH1: (1x0)	TrCH1: (1x0)
>>>>rlcSize			BitMode	bitMode
>>>>>sizeType			TrCH1: type 1: 0	TrCH1: type 1: 0
>>>>>numberOfTbSizeList			TrCH1: One	TrCH1: One
>>>>>logicalChannelList			All	All
>>ULTrCH-Id	TrCH1: 1	TrCH1: 1	TrCH1: 1, TrCH2: 2, TrCH3: 3	TrCH1: 1, TrCH2: 2, TrCH3: 3, TrCH4: 4
>dch-QualityTarget				
>>bler-QualityValue	TrCH1: 5×10^{-2}	TrCH1: 5×10^{-2}	TrCH1: 7×10^{-3} TrCH2- TrCH3: Absent	TrCH1: 7×10^{-3} TrCH2- TrCH4: Absent
TrCH INFORMATION, COMMON				
ul-CommonTransChInfo				
>tfcs-ID (TDD only)	1	1	1	1
>sharedChannelIndicator (TDD only)	FALSE	FALSE	FALSE	FALSE
>tfcs-Subset	Absent, not required	Absent, not required	Absent, not required	Absent, not required
>ul-TFCS	Normal TFCS signalling	Normal TFCS signalling	Normal TFCS signalling	Normal TFCS signalling
>>explicitTFCS-ConfigurationMode	Complete	Complete	Complete	Complete
>>>ctfcSize	Ctfc2Bit	Ctfc2Bit	Ctfc4Bit	Ctfc6Bit
>>>>TFCS representation	Addition	Addition	Addition	Addition
>>>>>TFCS list				
>>>>>>TFCS 1	(TF0)	(TF0)	(TF0, TF0, TF0)	(TF0, TF0, TF0, TF0)
>>>>>>>ctfc	0	0	0	0
>>>>>>>>gainFactorInformation	Computed	Computed	Computed	Computed
>>>>>>>>>referenceTFCSId	0	0	0	0
>>>>>>>>>>TFCS 2	(TF1)	(TF1)	(TF1, TF0, TF0)	(TF1, TF0, TF0, TF0)
>>>>>>>>>>>ctfc	1	1	1	1
>>>>>>>>>>>>gainFactorInformation	Signalled	Signalled	Computed	Computed
>>>>>>>>>>>>>βc (FDD only)	11	11	N/A	N/A
>>>>>>>>>>>>>>βd	15	15	N/A	N/A
>>>>>>>>>>>>>>>referenceTFCSId	0	0	0	0

Configuration	3.4 kbps signalling	13.6 kbps signalling	7.95 kbps speech + 3.4 kbps signalling	12.2 kbps speech + 3.4 kbps signalling
>>>>>TFCS 3			(TF2, TF1, TF0)	(TF2, TF1, TF1, TF0)
>>>>>>ctfc			5	11
>>>>>>gainFactorInformation			Computed	Computed
>>>>>>>referenceTFCLd			0	0
>>>>>TFCS 4			(TF0, TF0, TF1)	(TF0, TF0, TF0, TF1)
>>>>>>ctfc			6	12
>>>>>>gainFactorInformation			Computed	Computed
>>>>>>> β c (FDD only)			N/A	N/A
>>>>>>> β d			N/A	N/A
>>>>>>>referenceTFCLd			0	0
>>>>>TFCS 5			(TF1, TF0, TF1)	(TF1, TF0, TF0, TF1)
>>>>>>ctfc			7	13
>>>>>>gainFactorInformation			Computed	Computed
>>>>>>>referenceTFCLd			0	0
>>>>>TFCS 6			(TF2, TF1, TF1)	(TF2, TF1, TF1, TF1)
>>>>>>ctfc			11	23
>>>>>>gainFactorInformation			Signalled	Signalled
>>>>>>> β c (FDD only)			11	11
>>>>>>> β d			15	15
>>>>>>>referenceTFCLd			0	0
dl-CommonTransChInfo				
>tfcs-SignallingMode	Same as UL	Same as UL	Same as UL	Same as UL
PhyCH INFORMATION FDD				
UL-DPCH-InfoPredef				
>ul-DPCH-PowerControlInfo				
>>powerControlAlgorithm	Algorithm 1	Algorithm 1	Algorithm 1	Algorithm 1
>>>tpcStepSize	1	1	1	1
>tfci-Existence	TRUE	TRUE	TRUE	TRUE
>puncturingLimit	1	1	1	0.88
DL-CommonInformationPredef				
>dl-DPCH-InfoCommon				
>>spreadingFactor	256	128	128	128
>>tfci-Existence	FALSE	FALSE	FALSE	FALSE
>>pilotBits	4	4	4	4
>>positionFixed	N/A	N/A	Fixed	Fixed
PhyCH INFORMATION 3.84 Mcps TDD				
UL-DPCH-InfoPredef				
>ul-DPCH-PowerControlInfo				
>>dpch-ConstantValue	0	0	0	0
>commonTimeslotInfo				
>>secondInterleavingMode	frameRelated	frameRelated	frameRelated	frameRelated
>>tfci-Coding	4	4	16	16
>>puncturingLimit	1	0.92	0.52	0.88
>>repetitionPeriodAndLength	repetitionPeriod1	repetitionPeriod1	repetitionPeriod1	repetitionPeriod1

Configuration	3.4 kbps signalling	13.6 kbps signalling	7.95 kbps speech + 3.4 kbps signalling	12.2 kbps speech + 3.4 kbps signalling
DL-CommonInformationPredef				
>dl-DPCH-InfoCommon				
>>commonTimeslotInfo				
>>>secondInterleavingMode	frameRelated	frameRelated	frameRelated	frameRelated
>>>tfci-Coding	4	4	16	16
>>>puncturingLimit	1	0.92	0.52	0.92
>>>repetitionPeriodAndLength	repetitionPeriod1	repetitionPeriod1	repetitionPeriod1	repetitionPeriod1
PhyCH INFORMATION 1.28 Mcps TDD				
UL-DPCH-InfoPredef				
>commonTimeslotInfo				
>>secondInterleavingMode	frameRelated	frameRelated	frameRelated	frameRelated
>>tfci-Coding	4	4	16	16
>>puncturingLimit	1	0.64	0.80	0.60
>>repetitionPeriodAndLength	repetitionPeriod1	repetitionPeriod1	repetitionPeriod1	repetitionPeriod1
DL-CommonInformationPredef				
>dl-DPCH-InfoCommon				
>>commonTimeslotInfo				
>>>secondInterleavingMode	frameRelated	frameRelated	frameRelated	frameRelated
>>>tfci-Coding	4	4	16	16
>>>puncturingLimit	1	0.64	0.80	0.60
>>>repetitionPeriodAndLength	repetitionPeriod1	repetitionPeriod1	repetitionPeriod1	repetitionPeriod1

Configuration	28.8 kbps conv. CS- data + 3.4 kbps signalling	32 kbps conv. CS- data + 3.4 kbps signalling	64kbps conv. CS- data + 3.4 kbps signalling	14.4 kbps streaming CS- data + 3.4 kbps signalling
Ref 34.108	12	14	13	15
Default configuration identity	4	5	6	7
RB INFORMATION				
rb-Identity	RB1: 1, RB2: 2, RB3: 3, RB5: 5	RB1: 1, RB2: 2, RB3: 3, RB5: 5	RB1: 1, RB2: 2, RB3: 3, RB5: 5	RB1: 1, RB2: 2, RB3: 3, RB5: 5
rlc-InfoChoice	Rlc-info	Rlc-info	Rlc-info	Rlc-info
>ul-RLC-Mode	RB1: UM RB2- RB3: AM RB5: TM	RB1: UM RB2- RB3: AM RB5: TM	RB1: UM RB2- RB3: AM RB5: TM	RB1: UM RB2- RB3: AM RB5: TM
>>transmissionRLC-DiscardMode	RB1: N/A RB2- RB3: NoDiscard RB5: N/A	RB1: N/A RB2- RB3: NoDiscard RB5: N/A	RB1: N/A RB2- RB3: NoDiscard RB5: N/A	RB1: N/A RB2- RB3: NoDiscard RB5: N/A
>>>maxDat	RB1: N/A RB2- RB3: 15 RB5: N/A	RB1: N/A RB2- RB3: 15 RB5: N/A	RB1: N/A RB2- RB3: 15 RB5: N/A	RB1: N/A RB2- RB3: 15 RB5: N/A
>>transmissionWindowSize	RB1: N/A RB2- RB3: 128 for UEs with more than 10 kbyte "total RLC AM buffer size" and 32 otherwise RB5: N/A	RB1: N/A RB2- RB3: 128 for UEs with more than 10 kbyte "total RLC AM buffer size" and 32 otherwise RB5: N/A	RB1: N/A RB2- RB3: 128 for UEs with more than 10 kbyte "total RLC AM buffer size" and 32 otherwise RB5: N/A	RB1: N/A RB2- RB3: 128 for UEs with more than 10 kbyte "total RLC AM buffer size" and 32 otherwise RB5: N/A
>>timerRST	RB1: N/A RB2- RB3: 300 RB5: N/A	RB1: N/A RB2- RB3: 300 RB5: N/A	RB1: N/A RB2- RB3: 300 RB5: N/A	RB1: N/A RB2- RB3: 300 RB5: N/A

Configuration	28.8 kbps conv. CS- data + 3.4 kbps signalling	32 kbps conv. CS- data + 3.4 kbps signalling	64kbps conv. CS- data + 3.4 kbps signalling	14.4 kbps streaming CS- data + 3.4 kbps signalling
>>max-RST	RB1: N/A RB2- RB3: 1 RB5: N/A	RB1: N/A RB2- RB3: 1 RB5: N/A	RB1: N/A RB2- RB3: 1 RB5: N/A	RB1: N/A RB2- RB3: 1 RB5: N/A
>>pollingInfo	RB1: N/A RB2- RB3: as below RB5: N/A	RB1: N/A RB2- RB3: as below RB5: N/A	RB1: N/A RB2- RB3: as below RB5: N/A	RB1: N/A RB2- RB3: as below RB5: N/A
>>>lastTransmissionPDU-Poll	RB2- RB3: FALSE	RB2- RB3: FALSE	RB2- RB3: FALSE	RB2- RB3: FALSE
>>>lastRetransmissionPDU-Poll	RB2- RB3: FALSE	RB2- RB3: FALSE	RB2- RB3: FALSE	RB2- RB3: FALSE
>>>timerPollPeriodic	RB2- RB3: 300	RB2- RB3: 300	RB2- RB3: 300	RB2- RB3: 300
>>segmentationIndication	RB1- RB3: N/A RB5: FALSE	RB1- RB3: N/A RB5: FALSE	RB1- RB3: N/A RB5: FALSE	RB1- RB3: N/A RB5: FALSE
>dl-RLC-Mode	RB1: UM RB2- RB3: AM RB5: TM	RB1: UM RB2- RB3: AM RB5: TM	RB1: UM RB2- RB3: AM RB5: TM	RB1: UM RB2- RB3: AM RB5: TM
>>inSequenceDelivery	RB1: N/A RB2- RB3: TRUE RB5: N/A	RB1: N/A RB2- RB3: TRUE RB5: N/A	RB1: N/A RB2- RB3: TRUE RB5: N/A	RB1: N/A RB2- RB3: TRUE RB5: N/A
>>receivingWindowSize	RB1: N/A RB2- RB3: 128 for UEs with more than 10 kbyte "total RLC AM buffer size" and 32 otherwise RB5: N/A	RB1: N/A RB2- RB3: 128 for UEs with more than 10 kbyte "total RLC AM buffer size" and 32 otherwise RB5: N/A	RB1: N/A RB2- RB3: 128 for UEs with more than 10 kbyte "total RLC AM buffer size" and 32 otherwise RB5: N/A	RB1: N/A RB2- RB3: 128 for UEs with more than 10 kbyte "total RLC AM buffer size" and 32 otherwise RB5: N/A
>>dl-RLC-StatusInfo	RB1: N/A RB2- RB3: as below RB5: N/A	RB1: N/A RB2- RB3: as below RB5: N/A	RB1: N/A RB2- RB3: as below RB5: N/A	RB1: N/A RB2- RB3: as below RB5: N/A
>>>timerStatusProhibit	RB2- RB3: 100	RB2- RB3: 100	RB2- RB3: 100	RB2- RB3: 100
>>>missingPDU-Indicator	RB2- RB3: FALSE	RB2- RB3: FALSE	RB2- RB3: FALSE	RB2- RB3: FALSE
>>>timerStatusPeriodic	RB2- RB3: 300	RB2- RB3: 300	RB2- RB3: 300	RB2- RB3: 300
>>segmentationIndication	RB1- RB3: N/A RB5: FALSE	RB1- RB3: N/A RB5: FALSE	RB1- RB3: N/A RB5: FALSE	RB1- RB3: N/A RB5: FALSE
rb-MappingInfo				
>UL-LogicalChannelMappings	OneLogicalChannel	OneLogicalChannel	OneLogicalChannel	OneLogicalChannel
>>ul-TransportChannelType	Dch	Dch	Dch	Dch
>>>transportChannelIdentity	RB1- RB3: 2 RB5: 1	RB1- RB3: 2 RB5: 1	RB1- RB3: 2 RB5: 1	RB1- RB3: 2 RB5: 1
>>logicalChannelIdentity	RB1: 1, RB2: 2, RB3: 3 RB5: N/A	RB1: 1, RB2: 2, RB3: 3 RB5: N/A	RB1: 1, RB2: 2, RB3: 3 RB5: N/A	RB1: 1, RB2: 2, RB3: 3 RB5: N/A
>>rlc-SizeList	RB1- RB3: configured RB5: N/A	RB1- RB3: configured RB5: N/A	RB1- RB3: configured RB5: N/A	RB1- RB3: configured RB5: N/A
>>mac-LogicalChannelPriority	RB1: 1, RB2: 2, RB3: 3 RB5: 5	RB1: 1, RB2: 2, RB3: 3 RB5: 5	RB1: 1, RB2: 2, RB3: 3 RB5: 5	RB1: 1, RB2: 2, RB3: 3 RB5: 5
>DL-logicalChannelMappingList				
>>Mapping option 1	One mapping option	One mapping option	One mapping option	One mapping option
>>>dl-TransportChannelType	Dch	Dch	Dch	Dch
>>>>transportChannelIdentity	RB1- RB3: 2 RB5: 1	RB1- RB3: 2 RB5: 1	RB1- RB3: 2 RB5: 1	RB1- RB3: 2 RB5: 1
>>>logicalChannelIdentity	RB1: 1, RB2: 2, RB3: 3 RB5: N/A	RB1: 1, RB2: 2, RB3: 3 RB5: N/A	RB1: 1, RB2: 2, RB3: 3 RB5: N/A	RB1: 1, RB2: 2, RB3: 3 RB5: N/A
TrCH INFORMATION PER TrCH				

Configuration	28.8 kbps conv. CS- data + 3.4 kbps signalling	32 kbps conv. CS- data + 3.4 kbps signalling	64kbps conv. CS- data + 3.4 kbps signalling	14.4 kbps streaming CS- data + 3.4 kbps signalling
UL-AddReconfTransChInfoList				
>Uplink transport channel type	dch	dch	dch	dch
>transportChannelIdentity	TrCH1: 1, TrCH2: 2	TrCH1: 1, TrCH2: 2	TrCH1: 1, TrCH2: 2	TrCH1: 1, TrCH2: 2
>transportFormatSet	DedicatedTransChTFS	DedicatedTransChTFS	DedicatedTransChTFS	DedicatedTransChTFS
>>dynamicTF-information				
>>>tf0/ tf0,1	TrCH1: (0x576, 1x576, 2x576) TrCH2: (0x144, 1x144)	TrCH1: (0x640, 1x640) TrCH2: (0x144, 1x144)	TrCH1: (0x640, 2x640) TrCH2: (0x144, 1x144)	TrCH1: (0x576, 1x576) TrCH2: (0x144, 1x144)
>>>>rlcSize	TrCH1: OctetMode TrCH2: BitMode	TrCH1: OctetMode TrCH2: BitMode	TrCH1: OctetMode TrCH2: BitMode	TrCH1: OctetMode TrCH2: BitMode
>>>>>sizeType	TrCH1: type 2, part1= 9, part2= 2 (576) TrCH2: type 2, part1= 2, part2= 0 (144)	TrCH1: type 2, part1= 11, part2= 2 (640) TrCH2: type 2, part1= 2, part2= 0 (144)	TrCH1: type 2, part1= 11, part2= 2 (640) TrCH2: type 2, part1= 2, part2= 0 (144)	TrCH1: type 2, part1= 9, part2= 2 (576) TrCH2: type 2, part1= 2, part2= 0 (144)
>>>>numberOfTbSizeList	TrCH1: Zero, 1, 2 TrCH2: Zero, one	TrCH1: Zero, one TrCH2: Zero, one	TrCH1: Zero, 2 TrCH2: Zero, one	TrCH1: Zero, one, TrCH2: Zero, one
>>>>logicalChannelList	All	All	All	All
>>semiStaticTF-Information				
>>>tfti	TrCH1: 40 TrCH2: 40	TrCH1: 20 TrCH2: 40	TrCH1: 20 TrCH2: 40	TrCH1: 40 TrCH2: 40
>>>>channelCodingType	TrCH1: Turbo TrCH2: Convolutional	TrCH1: Turbo TrCH2: Convolutional	TrCH1: Turbo TrCH2: Convolutional	TrCH1: Turbo TrCH2: Convolutional
>>>>>codingRate	TrCH1: N/A TrCH2: Third	TrCH1: N/A TrCH2: Third	TrCH1: N/A TrCH2: Third	TrCH1: N/A TrCH2: Third
>>>>rateMatchingAttribute	TrCH1: 180 TrCH2: 160	TrCH1: 185 TrCH2: 160	TrCH1: 170 TrCH2: 160	TrCH1: 165 TrCH2: 160
>>>>crc-Size	TrCH1: 16 TrCH2: 16	TrCH1: 16 TrCH2: 16	TrCH1: 16 TrCH2: 16	TrCH1: 16 TrCH2: 16
DL-AddReconfTransChInfoList				
>Downlink transport channel type	dch	dch	dch	dch
>dl-TransportChannelIdentity (should be as for UL)	TrCH1: 1, TrCH2: 2	TrCH1: 1, TrCH2: 2	TrCH1: 1, TrCH2: 2	TrCH1: 1, TrCH2: 2
>dfs-SignallingMode	SameAsUL	SameAsUL	SameAsUL	SameAsUL
>>transportFormatSet				
>>>dynamicTF-information				
>>>>tf0/ tf0,1				
>>>>>rlcSize				
>>>>>>sizeType				
>>>>>numberOfTbSizeList				
>>>>>logicalChannelList				
>>ULTrCH-Id	TrCH1: 1, TrCH2: 2	TrCH1: 1, TrCH2: 2	TrCH1: 1, TrCH2: 2	TrCH1: 1, TrCH2: 2
>dch-QualityTarget				
>>bler-QualityValue	TrCH1: 2×10^{-3} TrCH2: Absent	TrCH1: 2×10^{-3} TrCH2: Absent	TrCH1: 2×10^{-3} TrCH2: Absent	TrCH1: 1×10^{-2} TrCH2: Absent
TrCH INFORMATION, COMMON				
ul-CommonTransChInfo				
>tfs-ID (TDD only)	1	1	1	1

Configuration	28.8 kbps conv. CS- data + 3.4 kbps signalling	32 kbps conv. CS- data + 3.4 kbps signalling	64kbps conv. CS- data + 3.4 kbps signalling	14.4 kbps streaming CS- data + 3.4 kbps signalling
>sharedChannelIndicator (TDD only)	FALSE	FALSE	FALSE	FALSE
>tfc-Subset	Absent, not required	Absent, not required	Absent, not required	Absent, not required
>ul-TFCS	Normal TFCI signalling	Normal TFCI signalling	Normal TFCI signalling	Normal TFCI signalling
>>explicitTFCS-ConfigurationMode	Complete	Complete	Complete	Complete
>>>ctfcSize	Ctfc4Bit	Ctfc2Bit	Ctfc2Bit	Ctfc4Bit
>>>>TFCS representation	Addition	Addition	Addition	Addition
>>>>>TFCS list				
>>>>>>TFCS 1	(TF0, TF0)	(TF0, TF0)	(TF0, TF0)	(TF0, TF0)
>>>>>>>ctfc	0	0	0	0
>>>>>>>>gainFactorInformation	Computed	Computed	Computed	Computed
>>>>>>>>>referenceTFCId	0	0	0	0
>>>>>>>>>TFCS 2	(TF1, TF0)	(TF1, TF0)	(TF1, TF0)	(TF1, TF0)
>>>>>>>>>>ctfc	1	1	1	1
>>>>>>>>>>>gainFactorInformation	Computed	Computed	Computed	Computed
>>>>>>>>>>>>βc (FDD only)	N/A	N/A	N/A	N/A
>>>>>>>>>>>>βd	N/A	N/A	N/A	N/A
>>>>>>>>>>>>>referenceTFCId	0	0	0	0
>>>>>>>>>>>>>>TFCS 3	(TF2, TF0)	(TF0, TF1)	(TF0, TF1)	(TF0, TF1)
>>>>>>>>>>>>>>>ctfc	2	2	2	2
>>>>>>>>>>>>>>>>gainFactorInformation	Computed	Computed	Computed	Computed
>>>>>>>>>>>>>>>>>referenceTFCId	0	0	0	0
>>>>>>>>>>>>>>>>>>TFCS 4	(TF0, TF1)	(TF1, TF1)	(TF1, TF1)	(TF1, TF1)
>>>>>>>>>>>>>>>>>>>ctfc	3	3	3	3
>>>>>>>>>>>>>>>>>>>>gainFactorInformation	Computed	Signalled	Signalled	Signalled
>>>>>>>>>>>>>>>>>>>>>βc (FDD only)	N/A	8	8	11
>>>>>>>>>>>>>>>>>>>>>>βd	N/A	15	15	15
>>>>>>>>>>>>>>>>>>>>>>>referenceTFCId	0	0	0	0
>>>>>>>>>>>>>>>>>>>>>>>>TFCS 5	(TF1, TF1)	N/A	N/A	
>>>>>>>>>>>>>>>>>>>>>>>>>ctfc	4			
>>>>>>>>>>>>>>>>>>>>>>>>>>gainFactorInformation	Computed			
>>>>>>>>>>>>>>>>>>>>>>>>>>>referenceTFCId	0			
>>>>>>>>>>>>>>>>>>>>>>>>>>>>TFCS 6	(TF2, TF1)	N/A	N/A	
>>>>>>>>>>>>>>>>>>>>>>>>>>>>>ctfc	5			
>>>>>>>>>>>>>>>>>>>>>>>>>>>>>>gainFactorInformation	Signalled			
>>>>>>>>>>>>>>>>>>>>>>>>>>>>>>>βc (FDD only)	8			
>>>>>>>>>>>>>>>>>>>>>>>>>>>>>>>>βd	15			
>>>>>>>>>>>>>>>>>>>>>>>>>>>>>>>>>referenceTFCId	0			
>>>>>>>>>>>>>>>>>>>>>>>>>>>>>>>>>>TFCS 7				
>>>>>>>>>>>>>>>>>>>>>>>>>>>>>>>>>>>ctfc				
>>>>>>>>>>>>>>>>>>>>>>>>>>>>>>>>>>>>gainFactorInformation				
>>>>>>>>>>>>>>>>>>>>>>>>>>>>>>>>>>>>>referenceTFCId				
>>>>>>>>>>>>>>>>>>>>>>>>>>>>>>>>>>>>>>TFCS 8				
>>>>>>>>>>>>>>>>>>>>>>>>>>>>>>>>>>>>>>>ctfc				
>>gainFactorInformation				
>>>referenceTFCId				
>>TFCS 9				
>>>ctfc				
>>gainFactorInformation				

Configuration	28.8 kbps conv. CS- data + 3.4 kbps signalling	32 kbps conv. CS- data + 3.4 kbps signalling	64kbps conv. CS- data + 3.4 kbps signalling	14.4 kbps streaming CS- data + 3.4 kbps signalling
>>>>>>referenceTFCId				
>>>>>TFCS 10				
>>>>>>ctfc				
>>>>>>gainFactorInformation				
>>>>>> β_c (FDD only)				
>>>>>> β_d				
>>>>>>referenceTFCId				
dl-CommonTransChInfo				
>tfc-SignallingMode	Same as UL	Same as UL	Same as UL	Same as UL
PhyCH INFORMATION FDD				
UL-DPCH-InfoPredef				
>ul-DPCH-PowerControllInfo				
>>powerControlAlgorithm	Algorithm 1	Algorithm 1	Algorithm 1	Algorithm 1
>>>tpcStepSize	1	1	1	1
>tfc-Existence	TRUE	TRUE	TRUE	TRUE
>puncturingLimit	0.92	0.8	0.92	1
DL-CommonInformationPredef				
>dl-DPCH-InfoCommon				
>>spreadingFactor	64	64	32	128
>>tfc-Existence	TRUE	TRUE	TRUE	TRUE
>>pilotBits	8	8	8	8
>>positionFixed	Flexible	Flexible	Flexible	Flexible
PhyCH INFORMATION 3.84 Mcps TDD				
UL-DPCH-InfoPredef				
>ul-DPCH-PowerControllInfo				
>>dpch-ConstantValue	0	0	0	0
>commonTimeslotInfo				
>>secondInterleavingMode	frameRelated	frameRelated	frameRelated	frameRelated
>>tfc-Coding	16	8	8	8
>>puncturingLimit	0.44	0.8	0.56	0.8
>>repetitionPeriodAndLength	repetitionPeriod1	repetitionPeriod1	repetitionPeriod1	repetitionPeriod1
DL-CommonInformationPredef				
>dl-DPCH-InfoCommon				
>>commonTimeslotInfo				
>>>secondInterleavingMode	frameRelated	frameRelated	frameRelated	frameRelated
>>>tfc-Coding	16	8	8	8
>>>puncturingLimit	0.44	0.64	0.56	0.8
>>>repetitionPeriodAndLength	repetitionPeriod1	repetitionPeriod1	repetitionPeriod1	repetitionPeriod1
PhyCH INFORMATION 1.28 Mcps TDD				
UL-DPCH-InfoPredef				
>commonTimeslotInfo				
>>secondInterleavingMode	frameRelated	frameRelated	frameRelated	frameRelated
>>tfc-Coding	16	8	8	8
>>puncturingLimit	0.64	0.60	0.64	1

Configuration	28.8 kbps conv. CS-data + 3.4 kbps signalling	32 kbps conv. CS-data + 3.4 kbps signalling	64kbps conv. CS-data + 3.4 kbps signalling	14.4 kbps streaming CS-data + 3.4 kbps signalling
>>repetitionPeriodAndLength	repetitionPeriod1	repetitionPeriod1	repetitionPeriod1	repetitionPeriod1
DL-CommonInformationPredef				
>dl-DPCH-InfoCommon				
>>commonTimeslotInfo				
>>>secondInterleavingMode	frameRelated	frameRelated	frameRelated	frameRelated
>>>tfc-Coding	16	8	8	8
>>>puncturingLimit	0.64	0.60	0.64	0.88
>>>repetitionPeriodAndLength	repetitionPeriod1	repetitionPeriod1	repetitionPeriod1	repetitionPeriod1

Configuration	28.8 kbps streaming CS-data + 3.4 kbps signalling	57.6 kbps streaming CS-data + 3.4 kbps signalling	12.2 kbps speech(multimode) + 3.4 kbps signalling
Ref 34.108	16	17	1a
Default configuration identity	8	9	10
RB INFORMATION			
rb-Identity	RB1: 1, RB2: 2, RB3: 3, RB5: 5	RB1: 1, RB2: 2, RB3: 3, RB5: 5	RB1: 1, RB2: 2, RB3: 3, RB5: 5, RB6: 6, RB7: 7
rlc-InfoChoice	Rlc-info	Rlc-info	Rlc-info
>ul-RLC-Mode	RB1: UM RB2- RB3: AM RB5: TM	RB1: UM RB2- RB3: AM RB5: TM	RB1: UM RB2- RB3: AM RB5-RB7: TM
>>transmissionRLC-DiscardMode	RB1: N/A RB2- RB3: NoDiscard RB5: N/A	RB1: N/A RB2- RB3: NoDiscard RB5: N/A	RB1: N/A RB2- RB3: NoDiscard RB5- RB7: N/A
>>>maxDat	RB1: N/A RB2- RB3: 15 RB5: N/A	RB1: N/A RB2- RB3: 15 RB5: N/A	RB1: N/A RB2- RB3: 15 RB5- RB7: N/A
>>>transmissionWindowSize	RB1: N/A RB2- RB3: 128 for UEs with more than 10 kbyte "total RLC AM buffer size" and 32 otherwise RB5: N/A	RB1: N/A RB2- RB3: 128 for UEs with more than 10 kbyte "total RLC AM buffer size" and 32 otherwise RB5: N/A	RB1: N/A RB2- RB3: 128 for UEs with more than 10 kbyte "total RLC AM buffer size" and 32 otherwise RB5- RB7: N/A
>>timerRST	RB1: N/A RB2- RB3: 300 RB5: N/A	RB1: N/A RB2- RB3: 300 RB5: N/A	RB1: N/A RB2- RB3: 300 RB5- RB7: N/A
>>max-RST	RB1: N/A RB2- RB3: 1 RB5: N/A	RB1: N/A RB2- RB3: 1 RB5: N/A	RB1: N/A RB2- RB3: 1 RB5- RB7: N/A
>>pollingInfo	RB1: N/A RB2- RB3: as below RB5: N/A	RB1: N/A RB2- RB3: as below RB5: N/A	RB1: N/A RB2- RB3: as below RB5- RB7: N/A
>>>lastTransmissionPDU-Poll	RB2- RB3: FALSE	RB2- RB3: FALSE	RB2- RB3: FALSE
>>>lastRetransmissionPDU-Poll	RB2- RB3: FALSE	RB2- RB3: FALSE	RB2- RB3: FALSE
>>>timerPollPeriodic	RB2- RB3: 300	RB2- RB3: 300	RB2- RB3: 300
>>>segmentationIndication	RB1- RB3: N/A RB5: FALSE	RB1- RB3: N/A RB5: FALSE	RB1- RB3: N/A RB5- RB7: FALSE

Configuration	28.8 kbps streaming CS- data + 3.4 kbps signalling	57.6 kbps streaming CS- data + 3.4 kbps signalling	12.2 kbps speech(multimode) + 3.4 kbps signalling
>dl-RLC-Mode	RB1: UM RB2- RB3: AM RB5: TM	RB1: UM RB2- RB3: AM RB5: TM	RB1: UM RB2- RB3: AM RB5- RB7: TM
>>inSequenceDelivery	RB1: N/A RB2- RB3: TRUE RB5: N/A	RB1: N/A RB2- RB3: TRUE RB5: N/A	RB1: N/A RB2- RB3: TRUE RB5- RB7: N/A
>>receivingWindowSize	RB1: N/A RB2- RB3: 128 for UEs with more than 10 kbyte "total RLC AM buffer size" and 32 otherwise RB5: N/A	RB1: N/A RB2- RB3: 128 for UEs with more than 10 kbyte "total RLC AM buffer size" and 32 otherwise RB5: N/A	RB1: N/A RB2- RB3: 128 for UEs with more than 10 kbyte "total RLC AM buffer size" and 32 otherwise RB5- RB7: N/A
>>dl-RLC-StatusInfo	RB1: N/A RB2- RB3: as below RB5: N/A	RB1: N/A RB2- RB3: as below RB5: N/A	RB1: N/A RB2- RB3: as below RB5- RB7: N/A
>>>timerStatusProhibit	RB2- RB3: 100	RB2- RB3: 100	RB2- RB3: 100
>>>missingPDU-Indicator	RB2- RB3: FALSE	RB2- RB3: FALSE	RB2- RB3: FALSE
>>>timerStatusPeriodic	RB2- RB3: 300	RB2- RB3: 300	RB2- RB3: 300
>>segmentationIndication	RB1- RB3: N/A RB5: FALSE	RB1- RB3: N/A RB5: FALSE	RB1- RB3: N/A RB5- RB7: FALSE
rb-MappingInfo			
>UL- LogicalChannelMappings	OneLogicalChannel	OneLogicalChannel	OneLogicalChannel
>>ul- TransportChannelType	Dch	Dch	Dch
>>>transportChannelIdenti- ty	RB1- RB3: 2 RB5: 1	RB1- RB3: 2 RB5: 1	RB1- RB3: 4 RB5: 1, RB6: 2, RB7: 3
>>logicalChannelIdentity	RB1: 1, RB2: 2, RB3: 3 RB5: N/A	RB1: 1, RB2: 2, RB3: 3 RB5: N/A	RB1: 1, RB2: 2, RB3: 3 RB5- RB7: N/A
>>rlc-SizeList	RB1- RB3: configured RB5: N/A	RB1- RB3: configured RB5: N/A	RB1- RB3: configured RB5- RB7: N/A
>>mac- LogicalChannelPriority	RB1: 1, RB2: 2, RB3: 3 RB5: 5	RB1: 1, RB2: 2, RB3: 3 RB5: 5	RB1: 1, RB2: 2, RB3: 3 RB5- RB7: 5
>DL- logicalChannelMappingList			
>>Mapping option 1	One mapping option	One mapping option	One mapping option
>>>dl- TransportChannelType	Dch	Dch	Dch
>>>>transportChannelIdenti- ty	RB1- RB3: 2 RB5: 1	RB1- RB3: 2 RB5: 1	RB1- RB3: 4 RB5: 1, RB6: 2, RB7: 3
>>>logicalChannelIdentity	RB1: 1, RB2: 2, RB3: 3 RB5: N/A	RB1: 1, RB2: 2, RB3: 3 RB5: N/A	RB1: 1, RB2: 2, RB3: 3 RB5- RB7: N/A
TrCH INFORMATION PER TrCH			
UL- AddReconfTransChInfoLis- t			
>Uplink transport channel type	dch	dch	dch
>transportChannelIdentity	TrCH1: 1, TrCH2: 2	TrCH1: 1, TrCH2: 2	TrCH1: 1, TrCH2: 2, TrCH3: 3, TrCH4: 4
>transportFormatSet	DedicatedTransChT FS	DedicatedTransChT FS	DedicatedTransChT FS
>>dynamicTF-information			

Configuration	28.8 kbps streaming CS-data + 3.4 kbps signalling	57.6 kbps streaming CS-data + 3.4 kbps signalling	12.2 kbps speech(multimode) + 3.4 kbps signalling
>>>tf0/ tf0,1	TrCH1: (0x576, 1x576, 2x576) TrCH2: (0x144, 1x144)	TrCH1: (0x576, 1x576, 2x576, 3x576, 4x576) TrCH2: (0x144, 1x144)	TrCH1: (0x81) TrCH2: (0x 103) TrCH3: (0x 60) TrCH4: (0x144)
>>>>rlcSize	TrCH1: OctetMode TrCH2:BitMode	TrCH1: OctetMode TrCH2:BitMode	BitMode
>>>>>sizeType	TrCH1: type 2, part1= 9, part2= 2 (576) TrCH2: type 2, part1= 2, part2= 0 (144)	TrCH1: type 2, part1= 9, part2= 2 (576) TrCH2: type 2, part1= 2, part2= 0 (144)	TrCH1: type 1: 81 TrCH2: type 1: 103 TrCH3: type 1: 60 TrCH4: 2: type 2, part1= 2, part2= 0 (144)
>>>>numberOfTbSizeList	TrCH1: Zero, one, 2 TrCH2: Zero, one	TrCH1: Zero, one, 2, 3, 4 TrCH2: Zero, one	TrCH1-4: Zero
>>>>logicalChannelList	All	All	All
>>>>tf 1			TrCH1: (1x39) TrCH2: (1x53) TrCH3: (1x60) TrCH4: (1x144)
>>>>>numberOfTransportBlocks			TrCH1-3: One
>>>>>rlc-Size			TrCH1-3: BitMode
>>>>>>sizeType			TrCH1: 1: 39 TrCH2: 1: 53 TrCH3: 1: 60
>>>>>numberOfTbSizeList			TrCH1-3: One
>>>>>logicalChannelList			TrCH1-3: all
>>>>>tf 2			TrCH1: (1x42) TrCH2: (1x63) TrCH3- TrCH4: N/A
>>>>>>numberOfTransportBlocks			TrCH1-2: One
>>>>>>rlc-Size			TrCH1: BitMode
>>>>>>>sizeType			TrCH1: type 1: 42 TrCH2: type 1: 63
>>>>>>>numberOfTbSizeList			TrCH1-2: One
>>>>>>>logicalChannelList			TrCH1: all
>>>>>>>tf 3			TrCH1: (1x55) TrCH2: (1x84) TrCH3- TrCH4: N/A
>>>>>>>>numberOfTransportBlocks			TrCH1-2: One
>>>>>>>>rlc-Size			TrCH1: BitMode
>>>>>>>>>sizeType			TrCH1: type 1: 55 TrCH2: type 1: 84
>>>>>>>>>numberOfTbSizeList			TrCH1-2: One
>>>>>>>>>logicalChannelList			TrCH1: all
>>>>>>>>>tf 4			TrCH1: (1x75) TrCH2: (1x103) TrCH3- TrCH4: N/A
>>>>>>>>>>numberOfTransportBlocks			TrCH1-2: One
>>>>>>>>>>rlc-Size			TrCH1: BitMode
>>>>>>>>>>>sizeType			TrCH1: type 1: 75 TrCH2: type 1: 103
>>>>>>>>>>>numberOfTbSizeList			TrCH1-2: One
>>>>>>>>>>>logicalChannelList			TrCH1: all
>>>>>>>>>>>tf 5			TrCH1: (1x81) TrCH2- TrCH4: N/A

Configuration	28.8 kbps streaming CS- data + 3.4 kbps signalling	57.6 kbps streaming CS- data + 3.4 kbps signalling	12.2 kbps speech(multimode) + 3.4 kbps signalling
>>>>numberOfTransportBlocks			TrCH1: One
>>>>rlc-Size			TrCH1: BitMode
>>>>>sizeType			TrCH1: type 1: 81
>>>>numberOfTbSizeList			TrCH1: One
>>>>logicalChannelList			TrCH1: all
>>semiStaticTF-Information			
>>>tti	TrCH1: 40 TrCH2: 40	TrCH1: 40 TrCH2: 40	TrCH1- TrCH3: 20 TrCH4: 40
>>>channelCodingType	TrCH1: Turbo TrCH2: Convolutional	TrCH1: Turbo TrCH2: Convolutional	Convolutional
>>>>codingRate	TrCH1: N/A TrCH2: Third	TrCH1: N/A TrCH2: Third	TrCH1- TrCH2: Third TrCH3: Half TrCH4: Third
>>>rateMatchingAttribute	TrCH1: 155 TrCH2: 160	TrCH1: 145 TrCH2: 160	TrCH1: 200 TrCH2: 190 TrCH3: 235 TrCH4: 160
>>>crc-Size	TrCH1: 16 TrCH2: 16	TrCH1: 16 TrCH2: 16	TrCH1: 12 TrCH2- TrCH3: 0 TrCH4: 16
DL-AddReconfTransChInfoList			
>Downlink transport channel type	dch	dch	dch
>dl-TransportChannelIdentity (should be as for UL)	TrCH1: 1, TrCH2: 2	TrCH1: 1, TrCH2: 2	TrCH1: 1, TrCH2: 2, TrCH3: 3, TrCH4: 4
>tfS-SignallingMode	SameAsUL	SameAsUL	Independent <Only tf0 on TrCH1 is different and shown below>
>>transportFormatSet			DedicatedTransChTFS
>>>dynamicTF-information			
>>>>tf0/ tf0,1			TrCH1: (1x0)
>>>>rlcSize			bitMode
>>>>>sizeType			TrCH1: type 1: 0
>>>>numberOfTbSizeList			TrCH1: One
>>>>logicalChannelList			All
>>ULTrCH-Id	TrCH1: 1, TrCH2: 2	TrCH1: 1, TrCH2: 2	TrCH1: 1, TrCH2: 2, TrCH3: 3, TrCH4: 4
>dch-QualityTarget			
>>bler-QualityValue	TrCH1: 1×10^{-2} TrCH2: Absent	TrCH1: 1×10^{-2} TrCH2: Absent	TrCH1: 7×10^{-3} TrCH2- TrCH4: Absent
TrCH INFORMATION, COMMON			
ul-CommonTransChInfo			
>tfcs-ID (TDD only)	1	1	1
>sharedChannelIndicator (TDD only)	FALSE	FALSE	FALSE
>tfC-Subset	Absent, not required	Absent, not required	Absent, not required
>ul-TFCS	Normal TFCI signalling	Normal TFCI signalling	Normal TFCI signalling
>>explicitTFCS-ConfigurationMode	Complete	Complete	Complete

Configuration	28.8 kbps streaming CS- data + 3.4 kbps signalling	57.6 kbps streaming CS- data + 3.4 kbps signalling	12.2 kbps speech(multimode) + 3.4 kbps signalling
>>>ctfcSize	Ctfc4Bit	Ctfc4Bit	Ctfc8Bit
>>>>TFCS representation	Addition	Addition	Addition
>>>>>TFCS list			
>>>>>>TFCS 1	(TF0, TF0)	(TF0, TF0)	(TF0, TF0, TF0, TF0)
>>>>>>>ctfc	0	0	0
>>>>>>>>gainFactorInform ation	Computed	Computed	Computed
>>>>>>>>referenceTFClId	0	0	0
>>>>>>>>TFCS 2	(TF1, TF0)	(TF1, TF0)	(TF1, TF0, TF0, TF0)
>>>>>>>>>ctfc	1	1	1
>>>>>>>>>>gainFactorInform ation	Computed	Computed	Computed
>>>>>>>>>>>> β c (FDD only)	N/A	N/A	N/A
>>>>>>>>>>>> β d	N/A	N/A	N/A
>>>>>>>>>>>>referenceTFClId	0	0	0
>>>>>>>>>>>>TFCS 3	(TF2, TF0)	(TF2, TF0)	(TF2, TF1, TF0, TF0)
>>>>>>>>>>>>>ctfc	2	2	8
>>>>>>>>>>>>>>gainFactorInform ation	Computed	Computed	Computed
>>>>>>>>>>>>>>referenceTFClId	0	0	0
>>>>>>>>>>>>>>TFCS 4	(TF0, TF1)	(TF3, TF0)	(TF3, TF2, TF0, TF0)
>>>>>>>>>>>>>>>ctfc	3	3	15
>>>>>>>>>>>>>>>>gainFactorInform ation	Computed	Computed	Computed
>>>>>>>>>>>>>>>>>> β c (FDD only)	N/A	N/A	N/A
>>>>>>>>>>>>>>>>>> β d	N/A	N/A	N/A
>>>>>>>>>>>>>>>>>>referenceTFClId	0	0	0
>>>>>>>>>>>>>>>>>>TFCS 5	(TF1, TF1)	(TF4, TF0)	(TF4, TF3, TF0, TF0)
>>>>>>>>>>>>>>>>>>>ctfc	4	4	22
>>>>>>>>>>>>>>>>>>>>gainFactorInform ation	Computed	Computed	Computed
>>>>>>>>>>>>>>>>>>>>>>referenceTFClId	0	0	0
>>>>>>>>>>>>>>>>>>>>>>TFCS 6	(TF2, TF1)	(TF0, TF1)	(TF5, TF4, TF1, TF0)
>>>>>>>>>>>>>>>>>>>>>>>ctfc	5	5	59
>>>>>>>>>>>>>>>>>>>>>>>>gainFactorInform ation	Signalled	Computed	Computed
>>>>>>>>>>>>>>>>>>>>>>>>>>>> β c (FDD only)	8	N/A	N/A
>>>>>>>>>>>>>>>>>>>>>>>>>>>> β d	15	N/A	N/A
>>>>>>>>>>>>>>>>>>>>>>>>>>>>referenceTFClId	0	0	0
>>>>>>>>>>>>>>>>>>>>>>>>>>>>TFCS 7		(TF1, TF1)	(TF0,TF0,TF0,TF1)
>>>>>>>>>>>>>>>>>>>>>>>>>>>>>ctfc		6	60
>>>>>>>>>>>>>>>>>>>>>>>>>>>>>>gainFactorInform ation		Computed	Computed
>>>>>>>>>>>>>>>>>>>>>>>>>>>>>>>>referenceTFClId		0	0
>>>>>>>>>>>>>>>>>>>>>>>>>>>>>>>>TFCS 8		(TF2, TF1)	(TF1,TF0,TF0,TF1)
>>>>>>>>>>>>>>>>>>>>>>>>>>>>>>>>>ctfc		7	61
>>>>>>>>>>>>>>>>>>>>>>>>>>>>>>>>>>gainFactorInform ation		Computed	Computed
>>>>>>>>>>>>>>>>>>>>>>>>>>>>>>>>>>>referenceTFClId		0	0
>>>>>>>>>>>>>>>>>>>>>>>>>>>>>>>>>>>TFCS 9		(TF3, TF1)	(TF2,TF1,TF0,TF1)
>>>>>>>>>>>>>>>>>>>>>>>>>>>>>>>>>>>>ctfc		8	68
>>>>>>>>>>>>>>>>>>>>>>>>>>>>>>>>>>>>>gainFactorInform ation		Computed	Computed

Configuration	28.8 kbps streaming CS- data + 3.4 kbps signalling	57.6 kbps streaming CS- data + 3.4 kbps signalling	12.2 kbps speech(multimode) + 3.4 kbps signalling
>>>>>>referenceTFClid		0	0
>>>>>TFCS 10		(TF4, TF1)	(TF3,TF2,TF0,TF1)
>>>>>>ctfc		9	75
>>>>>>gainFactorInformation		Signalled	Computed
>>>>>> β c (FDD only)		8	N/A
>>>>>> β d		15	N/A
>>>>>>referenceTFClid		0	0
>>>>>TFCS 11			(TF4,TF3,TF0,TF1)
>>>>>>ctfc			82
>>>>>>gainFactorInformation			Computed
>>>>>>referenceTFClid			0
>>>>>TFCS 12			(TF5,TF4,TF1,TF1)
>>>>>>ctfc			119
>>>>>>gainFactorInformation			Signalled
>>>>>> β c (FDD only)			11
>>>>>> β d			15
>>>>>>referenceTFClid			0
dl-CommonTransChInfo			
>tfcs-SignallingMode	Same as UL	Same as UL	Same as UL
PhyCH INFORMATION FDD			
UL-DPCH-InfoPredef			
>ul-DPCH- PowerControllInfo			
>>powerControlAlgorithm	Algorithm 1	Algorithm 1	Algorithm 1
>>>tpcStepSize	1	1	1
>tfci-Existence	TRUE	TRUE	TRUE
>puncturingLimit	1	1	0.88
DL- CommonInformationPredef			
>dl-DPCH-InfoCommon			
>>spreadingFactor	64	32	128
>>tfci-Existence	TRUE	TRUE	FALSE
>>pilotBits	8	8	4
>>positionFixed	Flexible	Flexible	Fixed
PhyCH INFORMATION 3.84 Mcps TDD			
UL-DPCH-InfoPredef			
>ul-DPCH- PowerControllInfo			
>>dpch-ConstantValue	0	0	0
>commonTimeslotInfo			
>>secondInterleavingMode	frameRelated	frameRelated	frameRelated
>>tfci-Coding	16	16	16
>>puncturingLimit	0.44	0.48	0.88
>>repetitionPeriodAndLength	repetitionPeriod1	repetitionPeriod1	repetitionPeriod1
DL- CommonInformationPredef			
>dl-DPCH-InfoCommon			
>>commonTimeslotInfo			
>>>secondInterleavingMode	frameRelated	frameRelated	frameRelated

Configuration	28.8 kbps streaming CS- data + 3.4 kbps signalling	57.6 kbps streaming CS- data + 3.4 kbps signalling	12.2 kbps speech(multimode) + 3.4 kbps signalling
>>>tfc-Coding	16	16	16
>>>puncturingLimit	0.44	0.48	0.92
>>>repetitionPeriodAndLength	repetitionPeriod1	repetitionPeriod1	repetitionPeriod1
PhyCH INFORMATION 1.28 Mcps TDD			
UL-DPCH-InfoPredef			
>commonTimeslotInfo			
>>secondInterleavingMode	frameRelated	frameRelated	
>>tfc-Coding	16	16	
>>puncturingLimit	0.64	0.72	
>>repetitionPeriodAndLength	repetitionPeriod1	repetitionPeriod1	
DL- CommonInformationPredef			
>dl-DPCH-InfoCommon			
>>commonTimeslotInfo			
>>>secondInterleavingMode	frameRelated	frameRelated	frameRelated
>>>tfc-Coding	16	16	16
>>>puncturingLimit	0.64	0.72	0.92
>>>repetitionPeriodAndLength	repetitionPeriod1	repetitionPeriod1	repetitionPeriod1

Configuration	10.2/6.7/5.9/4.75 kbps speech + 3.4 kbps signalling	7.4/6.7/5.9/4.75 kbps speech + 3.4 kbps signalling
Ref 34.108	N/A	N/A
Default configuration identity	11	12
RB INFORMATION		
rb-Identity	RB1: 1, RB2: 2, RB3: 3, RB5: 5, RB6: 6, RB7: 7, RB8: 8	RB1: 1, RB2: 2, RB3: 3, RB5: 5, RB6: 6, RB7: 7
rlc-InfoChoice	Rlc-info	Rlc-info
>ul-RLC-Mode	RB1: UM RB2- RB3: AM RB5-RB7: TM	RB1: UM RB2- RB3: AM RB5-RB6: TM
>>transmissionRLC-DiscardMode	RB1: N/A RB2- RB3: NoDiscard RB5- RB7: N/A	RB1: N/A RB2- RB3: NoDiscard RB5- RB6: N/A
>>>maxDat	RB1: N/A RB2- RB3: 15 RB5- RB7: N/A	RB1: N/A RB2- RB3: 15 RB5- RB6: N/A
>>transmissionWindowSize	RB1: N/A RB2- RB3: 128 for UEs with more than 10 kbyte "total RLC AM buffer size" and 32 otherwise RB5- RB7: N/A	RB1: N/A RB2- RB3: 128 for UEs with more than 10 kbyte "total RLC AM buffer size" and 32 otherwise RB5- RB6: N/A
>>timerRST	RB1: N/A RB2- RB3: 300 RB5- RB7: N/A	RB1: N/A RB2- RB3: 300 RB5- RB6: N/A
>>max-RST	RB1: N/A RB2- RB3: 1 RB5- RB7: N/A	RB1: N/A RB2- RB3: 1 RB5- RB6: N/A
>>pollingInfo	RB1: N/A RB2- RB3: as below RB5- RB7: N/A	RB1: N/A RB2- RB3: as below RB5- RB6: N/A
>>>lastTransmissionPDU-Poll	RB2- RB3: FALSE	RB2- RB3: FALSE
>>>lastRetransmissionPDU-Poll	RB2- RB3: FALSE	RB2- RB3: FALSE
>>>timerPollPeriodic	RB2- RB3: 300	RB2- RB3: 300
>>segmentationIndication	RB1- RB3: N/A RB5- RB7: FALSE	RB1- RB3: N/A RB5- RB6: FALSE
>dl-RLC-Mode	RB1: UM RB2- RB3: AM RB5- RB7: TM RB8: TM	RB1: UM RB2- RB3: AM RB5- RB6: TM RB7: TM
>>inSequenceDelivery	RB1: N/A RB2- RB3: TRUE RB5- RB8: N/A	RB1: N/A RB2- RB3: TRUE RB5- RB7: N/A
>>receivingWindowSize	RB1: N/A RB2- RB3: 128 for UEs with more than 10 kbyte "total RLC AM buffer size" and 32 otherwise RB5- RB8: N/A	RB1: N/A RB2- RB3: 128 for UEs with more than 10 kbyte "total RLC AM buffer size" and 32 otherwise RB5- RB7: N/A
>>dl-RLC-StatusInfo	RB1: N/A RB2- RB3: as below RB5- RB8: N/A	RB1: N/A RB2- RB3: as below RB5- RB7: N/A
>>>timerStatusProhibit	RB2- RB3: 100	RB2- RB3: 100
>>>missingPDU-Indicator	RB2- RB3: FALSE	RB2- RB3: FALSE
>>>timerStatusPeriodic	RB2- RB3: 300	RB2- RB3: 300

>>segmentationIndication	RB1- RB3: N/A RB5- RB8: FALSE	RB1- RB3: N/A RB5- RB7: FALSE
rb-MappingInfo		
>UL-LogicalChannelMappings	OneLogicalChannel	OneLogicalChannel
>>ul-TransportChannelType	Dch	Dch
>>>transportChannelIdentity	RB1- RB3: 4 RB5: 1, RB6: 2, RB7: 3,	RB1- RB3: 3 RB5: 1, RB6: 2
>>logicalChannelIdentity	RB1: 1, RB2: 2, RB3: 3 RB5- RB7: N/A	RB1: 1, RB2: 2, RB3: 3 RB5- RB6: N/A
>>rlc-SizeList	RB1- RB3: configured RB5- RB7: N/A	RB1- RB3: configured RB5- RB6: N/A
>>mac-LogicalChannelPriority	RB1: 1, RB2: 2, RB3: 3 RB5- RB7: 5	RB1: 1, RB2: 2, RB3: 3 RB5- RB6: 5
>DL-logicalChannelMappingList		
>>Mapping option 1	One mapping option	One mapping option
>>>dl-TransportChannelType	Dch	Dch
>>>>transportChannelIdentity	RB1- RB3: 4 RB5: 1, RB6: 2, RB7: 3, RB8: 5	RB1- RB3: 3 RB5: 1, RB6: 2, RB7:4
>>>logicalChannelIdentity	RB1: 1, RB2: 2, RB3: 3 RB5- RB8: N/A	RB1: 1, RB2: 2, RB3: 3 RB5- RB7: N/A
TrCH INFORMATION PER TrCH		
UL-AddReconfTransChInfoList		
>Uplink transport channel type	dch	dch
>transportChannelIdentity	TrCH1: 1, TrCH2: 2, TrCH3: 3, TrCH4: 4	TrCH1: 1, TrCH2: 2, TrCH3: 3
>transportFormatSet	DedicatedTransChTFS	DedicatedTransChTFS
>>dynamicTF-information		
>>>tf0/ tf0,1	TrCH1: (0x65) TrCH2: (0x 99) TrCH3: (0x 40, 1x40) TrCH4: (0x144, 1x144)	TrCH1: (0x61) TrCH2: (0x 87) TrCH3: (0x 144, 1x144)
>>>>rlcSize	BitMode	BitMode
>>>>>sizeType	TrCH1: type 1: 65 TrCH2: type 1: 99 TrCH3: type 1: 40 TrCH4: 2: type 2, part1= 2, part2= 0 (144)	TrCH1: type 1: 61 TrCH2: type 1: 87 TrCH3: 2: type 2, part1= 2, part2= 0 (144)
>>>>numberOfTbSizeList	TrCH1-2: Zero TrCH3-4: Zero, one	TrCH1-2: Zero TrCH3: Zero, one
>>>>logicalChannelList	All	All
>>>>tf 1	TrCH1: (1x39) TrCH2: (1x 53) TrCH3- TrCH4: N/A	TrCH1: (1x39) TrCH2: (1x53) TrCH3: N/A
>>>>>numberOfTransportBlocks	TrCH1: One TrCH2: One	TrCH1: One TrCH2: One
>>>>>rlc-Size	TrCH1-2: BitMode	TrCH1-2: BitMode
>>>>>>sizeType	TrCH1: 1: 39 TrCH2: 1: 53	TrCH1: 1: 39 TrCH1: 1: 53
>>>>>>numberOfTbSizeList	TrCH1-2: One	TrCH1-2: One

>>>>logicalChannelList	TrCH1: all	TrCH1: all
>>>tf 2	TrCH1: (1x42) TrCH2: (1x63) TrCH3- TrCH4: N/A	TrCH1: (1x42) TrCH2: (1x63) TrCH3: N/A
>>>>numberOfTransportBlocks	TrCH1: One TrCh2: One	TrCH1: One TrCh2: One
>>>>rlc-Size	TrCH1: BitMode	TrCH1: BitMode
>>>>>sizeType	TrCH1: type 1: 42 TrCH2: type 1: 63	TrCH1: type 1: 42 TrCH2: type 1: 63
>>>>numberOfTbSizeList	TrCH1: One TrCH2: One	TrCH1: One TrCH2: One
>>>>logicalChannelList	TrCH1: all TrCH2: all	TrCH1: all TrCH2: all
>>>tf 3	TrCH1: (1x55) TrCH2: (1x76) TrCH3- TrCH4: N/A	TrCH1: (1x55) TrCH2: (1x76) TrCH3: N/A
>>>>numberOfTransportBlocks	TrCH1: One TrCh2: One	TrCH1: One TrCh2: One
>>>>rlc-Size	TrCH1: BitMode	TrCH1: BitMode
>>>>>sizeType	TrCH1: type 1: 55 TrCH2: type 1: 76	TrCH1: type 1: 55 TrCH2: type 1: 76
>>>>numberOfTbSizeList	TrCH1: One TrCH2: One	TrCH1: One TrCH2: One
>>>>logicalChannelList	TrCH1: all TrCH2: all	TrCH1: all TrCH2: all
>>>tf 4	TrCH1: (1x58) TrCH2: (1x99) TrCH3- TrCH4: N/A	TrCH1: (1x58) TrCH2: (1x87) TrCH3: N/A
>>>>numberOfTransportBlocks	TrCH1: One TrCh2: One	TrCH1: One TrCh2: One
>>>>rlc-Size	TrCH1: BitMode	TrCH1: BitMode
>>>>>sizeType	TrCH1: type 1: 58 TrCH2: type 1: 99	TrCH1: type 1: 58 TrCH2: type 1: 87
>>>>numberOfTbSizeList	TrCH1: One TrCH2: One	TrCH1: One TrCH2: One
>>>>logicalChannelList	TrCH1: all TrCH2: all	TrCH1: all TrCH2: all
>>>tf 5	TrCH1: (1x65) TrCH2- TrCH4: N/A	TrCH1: (1x61) TrCH2- TrCH4: N/A
>>>>numberOfTransportBlocks	TrCH1: One	TrCH1: One
>>>>rlc-Size	TrCH1: BitMode	TrCH1: BitMode
>>>>>sizeType	TrCH1: type 1: 42	TrCH1: type 1: 42
>>>>numberOfTbSizeList	TrCH1: One	TrCH1: One
>>>>logicalChannelList	TrCH1: all	TrCH1: all
>>semistaticTF-Information		
>>>tti	TrCH1- TrCH3: 20 TrCH4: 40	TrCH1- TrCH2: 20 TrCH3: 40
>>>channelCodingType	Convolutional	Convolutional
>>>>codingRate	TrCH1- TrCH2: Third TrCH3: Half TrCH4: Third	TrCH1- TrCH2: Third TrCH3: Third
>>>rateMatchingAttribute	TrCH1: 200 TrCH2: 190 TrCH3: 235 TrCH4: 160	TrCH1: 200 TrCH2: 190 TrCH3: 160
>>>crc-Size	TrCH1: 12 TrCH2- TrCH3: 0 TrCH4: 16	TrCH1: 12 TrCH2: 0 TrCH3: 16
DL-AddReconfTransChInfoList		
>Downlink transport channel type	dch	dch
>dl-TransportChannelIdentity		

>tfS-SignallingMode	Independent <Only tf0 on TrCH1 and tf0/TF1 on TrCH5 are different and shown below>	Independent <Only tf0 on TrCH1 and tf0/TF1 on TrCH4 are different and shown below>
>>transportFormatSet		
>>>dynamicTF-information		
>>>>tf0/ tf0,1	TrCH1: (1x0) TrCH5: (0x3, 1x3)	TrCH1: (1x0) TrCH4: (0x3, 1x3)
>>>>rlcSize	BitMode	bitMode
>>>>>sizeType	TrCH1: type 1: 0 TrCH5: type 1: 3	TrCH1: type 1: 0 TrCH4: type 1: 3
>>>>>numberOfTbSizeList	TrCH1: One TrCH5: Zero, one	TrCH1: One TrCH4: Zero, one
>>>>>logicalChannelList	All	All
>>>>semistaticTF-Information	same as UL except for TrCH5	same as DL except for TrCH4
>>>>>tTI	TrCH5: 20	TrCH4: 20
>>>>>channelCodingType	Convolutional	Convolutional
>>>>>>codingRate	TrCH5: Third	TrCH4: Third
>>>>>>rateMatchingAttribute	TrCH5: 200	TrCH4: 200
>>>>>>crc-Size	TrCH5: 12	TrCH4: 12
>>ULTrCH-Id	TrCH1: 1, TrCH2: 2, TrCH3: 3, TrCH4: 4,	TrCH1: 1, TrCH2: 2, TrCH3: 3
>dch-QualityTarget		
>>bler-QualityValue	TrCH1: 7×10^{-3} TrCH2- TrCH5: Absent	TrCH1: 7×10^{-3} TrCH2- TrCH4: Absent
TrCH INFORMATION, COMMON		
ul-CommonTransChInfo		
>tfcs-ID (TDD only)	1	1
>sharedChannelIndicator (TDD only)	FALSE	FALSE
> tfc-Subset	Absent, not required	Absent, not required
>ul-TFCS	Normal TFCI signalling	Normal TFCI signalling
>>explicitTFCS- ConfigurationMode	Complete	Complete
>>>ctfcSize	Ctfc6Bit	Ctfc6Bit
>>>>TFCS representation	Addition	Addition
>>>>>TFC list		
>>>>>>TFC 1	(TF0, TF0, TF0, TF0)	(TF0, TF0, TF0)
>>>>>>>ctfc	0	0
>>>>>>>>gainFactorInform ation	Computed	Computed
>>>>>>>>referenceTFCId	0	0
>>>>>>>>TFC 2	(TF1, TF0, TF0, TF0)	(TF1, TF0, TF0)
>>>>>>>>ctfc	1	1
>>>>>>>>>gainFactorInform ation	Computed	Computed
>>>>>>>>> β_c (FDD only)	N/A	N/A
>>>>>>>>> β_d	N/A	N/A
>>>>>>>>>>referenceTFCId	0	0
>>>>>>>>>>TFC 3	(TF2, TF1, TF0, TF0)	(TF2, TF1, TF0)
>>>>>>>>>>ctfc	8	8
>>>>>>>>>>>gainFactorInform ation	Computed	Computed
>>>>>>>>>>>referenceTFCId	0	0
>>>>>>>>>>>TFC 4	(TF3, TF2, TF0, TF0)	(TF3, TF2, TF0)
>>>>>>>>>>>>ctfc	15	15

>>>>>>>gainFactorInformation	Computed	Computed
>>>>>>> β c (FDD only)		
>>>>>>> β d		
>>>>>>>referenceTFCId	0	0
>>>>>>>TFC 5	(TF4, TF3, TF0, TF0)	(TF4, TF3, TF0)
>>>>>>>ctfc	22	22
>>>>>>>gainFactorInformation	Computed	Computed
>>>>>>>referenceTFCId	0	0
>>>>>>>TFC 6	(TF5, TF4, TF1, TF0)	(TF5, TF4, TF0)
>>>>>>>ctfc	59	29
>>>>>>>gainFactorInformation	Computed	Computed
>>>>>>> β c (FDD only)		
>>>>>>> β d		
>>>>>>>referenceTFCId	0	0
>>>>>>>TFC 7	(TF0, TF0, TF0, TF1)	(TF0, TF0, TF1)
>>>>>>>ctfc	60	30
>>>>>>>gainFactorInformation	Computed	Computed
>>>>>>>referenceTFCId	0	0
>>>>>>>TFC 8	(TF1, TF0, TF0, TF1)	(TF1, TF0, TF1)
>>>>>>>ctfc	61	31
>>>>>>>gainFactorInformation	computed	computed
>>>>>>> β c (FDD only)		
>>>>>>> β d		
>>>>>>>referenceTFCId	0	0
>>>>>>>TFC 9	(TF2, TF1, TF0, TF1)	(TF2, TF1, TF1)
>>>>>>>ctfc	68	38
>>>>>>>gainFactorInformation	computed	computed
>>>>>>>referenceTFCId	0	0
>>>>>>>TFC 10	(TF3, TF2, TF0, TF1)	(TF3, TF2, TF1)
>>>>>>>ctfc	75	45
>>>>>>>gainFactorInformation	computed	computed
>>>>>>> β c (FDD only)		
>>>>>>> β d		
>>>>>>>referenceTFCId	0	0
>>>>>>>TFC 11	(TF4, TF3, TF0, TF1)	(TF4, TF3, TF1)
>>>>>>>ctfc	82	52
>>>>>>>gainFactorInformation	computed	computed
>>>>>>>referenceTFCId	0	0
>>>>>>>TFC 12	(TF5, TF4, TF1, TF1)	(TF5, TF4, TF1)
>>>>>>>ctfc	97	59
>>>>>>>gainFactorInformation	signalled	signalled
>>>>>>> β c (FDD only)	11	11
>>>>>>> β d	15	15
>>>>>>>referenceTFCId	0	0
> TFC subset list		
>>TFC subset 1	(speech rate 10.2)	(speech rate 7.4)

>>> Allowed transport format combination list	(TFC1, TFC2, TFC7, TFC8, TFC6, TFC12)	(TFC1, TFC2, TFC7, TFC8, TFC6, TFC12)
>>TFC subset 2	(speech rate 6.7)	(speech rate 6.7)
>>> Allowed transport format combination list	(TFC1, TFC2, TFC7, TFC8, TFC5, TFC11)	(TFC1, TFC2, TFC7, TFC8, TFC5, TFC11)
>>TFC subset 3	(speech rate 5.9)	(speech rate 5.9)
>>> Allowed transport format combination list	(TFC1, TFC2, TFC7, TFC8, TFC4, TFC10)	(TFC1, TFC2, TFC7, TFC8, TFC4, TFC10)
>>TFC subset 4	(speech rate 4.75)	(speech rate 4.75)
>>> Allowed transport format combination list	(TFC1, TFC2, TFC7, TFC8, TFC3, TFC9)	(TFC1, TFC2, TFC7, TFC8, TFC3, TFC9)
dl-CommonTransChInfo		
>tfc-SignallingMode	Independent	Independent
ul-CommonTransChInfo		
>tfc-ID (TDD only)	1	1
>sharedChannelIndicator (TDD only)	FALSE	FALSE
> tfc-Subset	Absent, not required	Absent, not required
>dl-TFCS	Normal TFCI signalling	Normal TFCI signalling
>>explicitTFCS-ConfigurationMode	Complete	Complete
>>>ctfcSize	Ctfc6Bit	Ctfc6Bit
>>>>TFCS representation	Addition	Addition
>>>>>TFCS list		
>>>>>>TFC 1	(TF0, TF0, TF0, TF0, TF0)	(TF0, TF0, TF0, TF0)
>>>>>>>ctfc	0	0
>>>>>>>TFC 2	(TF1, TF0, TF0, TF0, TF0)	(TF1, TF0, TF0, TF0)
>>>>>>>>ctfc	1	1
>>>>>>>>TFC 3	(TF2, TF1, TF0, TF0, TF0)	(TF2, TF1, TF0, TF0)
>>>>>>>>>ctfc	8	8
>>>>>>>>>TFC 4	(TF3, TF2, TF0, TF0, TF0)	(TF3, TF2, TF0, TF0)
>>>>>>>>>>ctfc	15	15
>>>>>>>>>>>TFC 5	(TF4, TF3, TF0, TF0, TF0)	(TF4, TF3, TF0, TF0)
>>>>>>>>>>>>ctfc	22	22
>>>>>>>>>>>>>TFC 6	(TF5, TF4, TF1, TF0, TF0)	(TF5, TF4, TF0, TF0)
>>>>>>>>>>>>>>ctfc	59	29
>>>>>>>>>>>>>>>TFC 7	(TF0, TF0, TF0, TF1, TF0)	(TF0, TF0, TF1, TF0)
>>>>>>>>>>>>>>>>ctfc	60	30
>>>>>>>>>>>>>>>>>TFC 8	(TF1, TF0, TF0, TF1, TF0)	(TF1, TF0, TF1, TF0)
>>>>>>>>>>>>>>>>>>ctfc	61	31
>>>>>>>>>>>>>>>>>>>TFC 9	(TF2, TF1, TF0, TF1, TF0)	(TF2, TF1, TF1, TF0)
>>>>>>>>>>>>>>>>>>>>ctfc	68	37
>>>>>>>>>>>>>>>>>>>>>TFC 10	(TF3, TF2, TF0, TF1, TF0)	(TF3, TF2, TF1, TF0)
>>>>>>>>>>>>>>>>>>>>>>ctfc	75	55
>>>>>>>>>>>>>>>>>>>>>>>TFC 11	(TF4, TF3, TF0, TF1, TF0)	(TF4, TF3, TF1, TF0)
>>>>>>>>>>>>>>>>>>>>>>>>ctfc	82	52
>>>>>>>>>>>>>>>>>>>>>>>>>TFC 12	(TF5, TF4, TF1, TF1, TF0)	(TF5, TF4, TF1, TF0)
>>>>>>>>>>>>>>>>>>>>>>>>>>>ctfc	119	59

>>>>>TFC 13	(TF0, TF0, TF0, TF0, TF1)	(TF0, TF0, TF0, TF1)
>>>>>>ctfc	120	60
>>>>>TFC 14	(TF1, TF0, TF0, TF0, TF1)	(TF1, TF0, TF0, TF1)
>>>>>>ctfc	121	61
>>>>>TFC 15	(TF2, TF1, TF0, TF0, TF1)	(TF2, TF1, TF0, TF1)
>>>>>>ctfc	128	68
>>>>>TFC 16	(TF3, TF2, TF0, TF0, TF1)	(TF3, TF2, TF0, TF1)
>>>>>>ctfc	135	75
>>>>>TFC 17	(TF4, TF3, TF0, TF0, TF1)	(TF4, TF3, TF0, TF1)
>>>>>>ctfc	152	82
>>>>>TFC 18	(TF5, TF4, TF1, TF0, TF1)	(TF5, TF4, TF0, TF1)
>>>>>>ctfc	189	89
>>>>>TFC 19	(TF0, TF0, TF0, TF1, TF1)	(TF0, TF0, TF1, TF1)
>>>>>>ctfc	180	90
>>>>>TFC 20	(TF1, TF0, TF0, TF1, TF1)	(TF1, TF0, TF1, TF1)
>>>>>>ctfc	181	91
>>>>>TFC 21	(TF2, TF1, TF0, TF1, TF1)	(TF2, TF1, TF1, TF1)
>>>>>>ctfc	188	98
>>>>>TFC 22	(TF3, TF2, TF0, TF1, TF1)	(TF3, TF2, TF1, TF1)
>>>>>>ctfc	195	105
>>>>>TFC 23	(TF4, TF3, TF0, TF1, TF1)	(TF4, TF3, TF1, TF1)
>>>>>>ctfc	239	112
>>>>>TFC 24	(TF5, TF4, TF1, TF1, TF1)	(TF5, TF4, TF1, TF1)
>>>>>>ctfc	218	119
PhyCH INFORMATION FDD		
UL-DPCH-InfoPredef		
>ul-DPCH- PowerControlInfo		
>>powerControlAlgorithm	Algorithm 1	Algorithm 1
>>>tpcStepSize	1	1
>tfc-Existence	TRUE	TRUE
>puncturingLimit	0.88	0.88
DL- CommonInformationPredef		
>dl-DPCH-InfoCommon		
>>spreadingFactor	128	128
>>tfc-Existence	FALSE	FALSE
>>pilotBits	4	4
>>positionFixed	Fixed	Fixed
PhyCH INFORMATION 3.84 Mcps TDD		
UL-DPCH-InfoPredef		
>ul-DPCH- PowerControlInfo		
>>dpch-ConstantValue	0	0
>commonTimeslotInfo		
>>secondInterleavingMode	frameRelated	frameRelated
>>tfc-Coding	16	16
>>puncturingLimit	0.60	0.60
>>repetitionPeriodAndLength	repetitionPeriod1	repetitionPeriod1

DL-CommonInformationPredef		
>dl-DPCH-InfoCommon		
>>commonTimeslotInfo		
>>>secondInterleavingMode	frameRelated	frameRelated
>>>tfc-Coding	16	16
>>>puncturingLimit	0.60	0.60
>>>repetitionPeriodAndLength	repetitionPeriod1	repetitionPeriod1
PhyCH INFORMATION 1.28 Mcps TDD		
UL-DPCH-InfoPredef		
>commonTimeslotInfo		
>>secondInterleavingMode	frame Related	frame Related
>>tfc-Coding	16	16
>>puncturingLimit	0.64	0.64
>>repetitionPeriodAndLength	repetitionPeriod1	repetitionPeriod1
DL-CommonInformationPredef		
>dl-DPCH-InfoCommon		
>>commonTimeslotInfo		
>>>secondInterleavingMode	frame Related	frame Related
>>>tfc-Coding	16	16
>>>puncturingLimit	0.64	0.64
>>>repetitionPeriodAndLength	repetitionPeriod1	repetitionPeriod1

14 Specific functions

14.1 Intra-frequency measurements

14.1.1 Intra-frequency measurement quantities

A measurement quantity is used to evaluate whether an intra-frequency event has occurred or not. It can be:

- 1 Downlink E_c/N_0 .
- 2 Downlink path loss.

For FDD:

Pathloss in dB = Primary CPICH Tx power - CPICH RSCP.

For Primary CPICH Tx power the IE "Primary CPICH Tx power" shall be used. The unit is dBm.

CPICH RSCP is the result of the CPICH RSCP measurement. The unit is dBm.

For TDD:

Pathloss in dB = Primary CCPCH TX power - Primary CCPCH RSCP.

For Primary CCPCH TX power the IE "Primary CCPCH TX Power" shall be used. The unit is dBm.

Primary CCPCH RSCP is the result of the Primary CCPCH RSCP measurement. The unit is dBm.

If necessary Pathloss shall be rounded up to the next higher integer.

Results higher than 158 shall be reported as 158.

Results lower than 46 shall be reported as 46.

- 3 Downlink received signal code power (RSCP) after despreading.
- 4 ISCP measured on Timeslot basis.

A description of those values can be found in [7] and [8].

14.1.2 Intra-frequency reporting events for FDD

Within the measurement reporting criteria field in the Measurement Control message the UTRAN notifies the UE which events should trigger a measurement report. The listed events are the toolbox from which the UTRAN can choose the reporting events that are needed for the implemented handover evaluation function, or other radio network functions.

All the specified events are measured with respect to any of the measurement quantities given in subclause 14.1.1. The measurement quantities are measured on the monitored primary common pilot channels (CPICH) of the cell defined in the measurement object.

Special mechanisms for the events are illustrated in subclause 14.1.4 and 14.1.5.

NOTE: The events below are numbered 1A, 1B, 1C,... since all intra-frequency reporting events would be labelled 1X, inter-frequency reporting events would be labelled 2X, and so on for the other measurement types.

When one intra-frequency measurement identity corresponds to multiple intra-frequency events with identical event identities, the UE behaviour is not specified.

14.1.2.1 Reporting event 1A: A Primary CPICH enters the reporting range

When an intra-frequency measurement configuring event 1a is set up, the UE shall:

- 1> create a variable TRIGGERED_1A_EVENT related to that measurement, which shall initially be empty;
- 1> delete this variable when the measurement is released.

When event 1A is configured in the UE, the UE shall:

- 1> if "Measurement quantity" is "pathloss" and Equation 1 below is fulfilled for one or more primary CPICHs, or if "Measurement quantity" is "CPICH Ec/N0" or "CPICH RSCP", and Equation 2 below is fulfilled for one or more primary CPICHs, for each of these primary CPICHs:
 - 2> if all required reporting quantities are available for that cell; and
 - 2> if the equations have been fulfilled for a time period indicated by "Time to trigger", and if that primary CPICH is part of cells allowed to trigger the event according to "Triggering condition 2", and if that primary CPICH is not included in the "cells triggered" in the variable TRIGGERED_1A_EVENT:
 - 3> include that primary CPICH in the "cells recently triggered" in the variable TRIGGERED_1A_EVENT.
- 1> if the value of "Reporting deactivations threshold" for this event is greater than or equal to the current number of cells in the active set or equal to 0 and any primary CPICHs are stored in the "cells recently triggered" in the variable TRIGGERED_1A_EVENT:
 - 2> if "Reporting interval" for this event is not equal to 0:
 - 3> if the IE "Periodical reporting running" in the variable TRIGGERED_1A_EVENT is set to FALSE:
 - 4> start a timer with the value of "Reporting interval" for this event and set the IE "Periodical reporting running" in the variable TRIGGERED_1A_EVENT to TRUE;
 - 3> set "sent reports" for the primary CPICHs in "cells recently triggered" in the variable TRIGGERED_1A_EVENT to 1.
 - 2> send a measurement report with IEs set as below:
 - 3> set in "intra-frequency measurement event results": "Intrafrequency event identity" to "1a"; and

- 3> include in "cell measurement event results" all entries of the "cells recently triggered" in the variable TRIGGERED_1A_EVENT in descending order according to the configured measurement quantity taking into account the cell individual offset for each of those cells;
- 3> set the IE "measured results" and the IE "additional measured results" according to subclause 8.4.2, not taking into account the cell individual offset for each cell.
- 2> move all entries from "cells recently triggered" to "cells triggered" in the variable TRIGGERED_1A_EVENT.
- 1> if the timer for the periodical reporting has expired:
 - 2> if any primary CPICH is included in the "cells triggered" in the variable TRIGGERED_1A_EVENT:
 - 3> if "Reporting interval" for this event is not equal to 0, and if "Amount of reporting" is greater than "sent reports" stored for any of these primary CPICHs, in "cells triggered" in the variable TRIGGERED_1A_EVENT:
 - 4> increment the stored counter "sent reports" for all CPICHs in "cell triggered" in variable TRIGGERED_1A_EVENT;
 - 4> start a timer with the value of "Reporting interval" for this event;
 - 4> send a measurement report with IEs set as below:
 - 5> set in "intra-frequency measurement event results": "Intrafrequency event identity" to "1a"; and
 - 5> include in "cell measurement event results" all entries of the variable TRIGGERED_1A_EVENT with value of IE "sent reports" smaller than value of "Amount of reporting" in descending order according to the configured measurement quantity taking into account the cell individual offset for each of those cells;
 - 5> set the IE "measured results" and the IE "additional measured results" according to subclause 8.4.2, not taking into account the cell individual offset for each cell.
 - 4> if "sent reports" in variable TRIGGERED_1A_EVENT is greater than "Amount of reporting" for all entries:
 - 5> set the IE "Periodical Reporting running" in the variable TRIGGERED_1A_EVENT to FALSE and disable the timer for the periodical reporting.
- 1> if "Measurement quantity" is "pathloss" and Equation 3 below is fulfilled for a primary CPICH, or if "Measurement quantity" is "CPICH E_c/N_0 " or "CPICH RSCP", and Equation 4 below is fulfilled for a primary CPICH; or
- 1> if a primary CPICH is no longer part of the cells allowed to trigger the event according to the "Triggering condition 2":
 - 2> if that primary CPICH is included in the "cells triggered" or "cells recently triggered" in the variable TRIGGERED_1A_EVENT:
 - 3> remove the entry of that primary CPICH from "cells triggered" or "cells recently triggered" in the variable TRIGGERED_1A_EVENT.
 - 3> if no entry in the variable TRIGGERED_1A_EVENT has a value of "sent reports" smaller than "Amount of reporting":
 - 4> stop the reporting interval timer;
 - 4> set the IE "Periodical reporting running" in the variable TRIGGERED_1A_EVENT to FALSE.

This event is only applicable to the CELL_DCH state. When the measurement is setup in CELL_DCH or upon transition to CELL_DCH the UE shall:

- 1> if the "Triggering condition 2" includes active set cells:

2> include the primary CPICH of all cells in the current active set into the "cells triggered" in the variable TRIGGERED_1A_EVENT with the counter "sent reports" set to "Amount of reporting".

Equation 1 (Triggering condition for pathloss)

$$10 \cdot \text{Log}M_{New} + CIO_{New} \leq W \cdot 10 \cdot \text{Log} \left(1 / \sum_{i=1}^{N_A} (1/M_i) \right) + (1-W) \cdot 10 \cdot \text{Log}M_{Best} + (R_{1a} - H_{1a} / 2),$$

Equation 2 (Triggering condition for all the other measurement quantities)

$$10 \cdot \text{Log}M_{New} + CIO_{New} \geq W \cdot 10 \cdot \text{Log} \left(\sum_{i=1}^{N_A} M_i \right) + (1-W) \cdot 10 \cdot \text{Log}M_{Best} - (R_{1a} - H_{1a} / 2),$$

Equation 3 (Leaving triggering condition for pathloss)

$$10 \cdot \text{Log}M_{New} + CIO_{New} > W \cdot 10 \cdot \text{Log} \left(1 / \sum_{i=1}^{N_A} (1/M_i) \right) + (1-W) \cdot 10 \cdot \text{Log}M_{Best} + (R_{1a} + H_{1a} / 2),$$

Equation 4 (Leaving triggering condition for all the other measurement quantities)

$$10 \cdot \text{Log}M_{New} + CIO_{New} < W \cdot 10 \cdot \text{Log} \left(\sum_{i=1}^{N_A} M_i \right) + (1-W) \cdot 10 \cdot \text{Log}M_{Best} - (R_{1a} + H_{1a} / 2),$$

The variables in the formula are defined as follows:

M_{New} is the measurement result of the cell entering the reporting range.

CIO_{New} is the individual cell offset for the cell entering the reporting range if an individual cell offset is stored for that cell. Otherwise it is equal to 0.

M_i is a measurement result of a cell not forbidden to affect reporting range in the active set.

N_A is the number of cells not forbidden to affect reporting range in the current active set.

For pathloss

M_{Best} is the measurement result of the cell not forbidden to affect reporting range in the active set with the lowest measurement result, not taking into account any cell individual offset.

for other measurements quantities.

M_{Best} is the measurement result of the cell not forbidden to affect reporting range in the active set with the highest measurement result, not taking into account any cell individual offset.

W is a parameter sent from UTRAN to UE.

R_{1a} is the reporting range constant.

H_{1a} is the hysteresis parameter for the event 1a.

If the measurement results are pathloss or CPICH-Ec/No then M_{New} , M_i and M_{Best} are expressed as ratios.

If the measurement result is CPICH-RSCP then M_{New} , M_i and M_{Best} are expressed in mW.

14.1.2.2 Reporting event 1B: A primary CPICH leaves the reporting range

When an intra-frequency measurement configuring event 1b is set up, the UE shall:

1> create a variable TRIGGERED_1B_EVENT related to that measurement, which shall initially be empty;

1> delete this variable when the measurement is released.

When event 1B is configured in the UE, the UE shall:

- 1> if "Measurement quantity" is "pathloss" and Equation 1 below is fulfilled for one or more primary CPICHs, or if "Measurement quantity" is "CPICH Ec/N0" or "CPICH RSCP", and Equation 2 below is fulfilled for one or more primary CPICHs, for each of these primary CPICHs:
- 2> if all required reporting quantities are available for that cell, and if the equations have been fulfilled for a time period indicated by "Time to trigger", and if that primary CPICH is part of cells allowed to trigger the event according to "Triggering condition 1", and if that primary CPICH is not included in the "cells triggered" in the variable TRIGGERED_1B_EVENT:
- 3> include that primary CPICH in the "cells recently triggered" in the variable TRIGGERED_1B_EVENT.
- 1> if any primary CPICHs are stored in the "cells recently triggered" in the variable TRIGGERED_1B_EVENT:
- 2> send a measurement report with IEs set as below:
- 3> set in "intra-frequency measurement event results": "Intrafrequency event identity" to "1b"; and
- 3> include in "cell measurement event results" all entries of "cells recently triggered" in the variable TRIGGERED_1B_EVENT in ascending order according to the configured measurement quantity taking into account the cell individual offset for each of those cells;
- 3> set the IE "measured results" and the IE "additional measured results" according to subclause 8.4.2, not taking into account the cell individual offset for each cell.
- 2> move all entries from IE "cells recently triggered" to "cells triggered" in the variable TRIGGERED_1B_EVENT.
- 1> if "Measurement quantity" is "pathloss" and Equation 3 below is fulfilled for a primary CPICH, or if "Measurement quantity" is "CPICH Ec/N0" or "CPICH RSCP", and Equation 4 below is fulfilled for a primary CPICH; or
- 1> if a primary CPICH is no longer part of the cells allowed to trigger the event according to the "Triggering condition 1":
- 2> if that primary CPICH is included in the "cells triggered" in the variable TRIGGERED_1B_EVENT:
- 3> remove the entry of that primary CPICH from "cells triggered" in the variable TRIGGERED_1B_EVENT.

Equation 1 (Triggering condition for pathloss)

$$10 \cdot \text{Log}M_{\text{old}} + \text{CIO}_{\text{old}} \geq W \cdot 10 \cdot \text{Log} \left(1 / \sum_{i=1}^{N_A} (1/M_i) \right) + (1-W) \cdot 10 \cdot \text{Log}M_{\text{Best}} + (R_{1b} + H_{1b} / 2),$$

Equation 2 (Triggering condition for all the other measurement quantities)

$$10 \cdot \text{Log}M_{\text{old}} + \text{CIO}_{\text{old}} \leq W \cdot 10 \cdot \text{Log} \left(\sum_{i=1}^{N_A} M_i \right) + (1-W) \cdot 10 \cdot \text{Log}M_{\text{Best}} - (R_{1b} + H_{1b} / 2),$$

Equation 3 (Leaving triggering condition for pathloss)

$$10 \cdot \text{Log}M_{\text{old}} + \text{CIO}_{\text{old}} < W \cdot 10 \cdot \text{Log} \left(1 / \sum_{i=1}^{N_A} (1/M_i) \right) + (1-W) \cdot 10 \cdot \text{Log}M_{\text{Best}} + (R_{1b} - H_{1b} / 2),$$

Equation 4 (Leaving triggering condition for all the other measurement quantities)

$$10 \cdot \text{Log}M_{\text{old}} + \text{CIO}_{\text{old}} > W \cdot 10 \cdot \text{Log} \left(\sum_{i=1}^{N_A} M_i \right) + (1-W) \cdot 10 \cdot \text{Log}M_{\text{Best}} - (R_{1b} - H_{1b} / 2),$$

The variables in the formula are defined as follows:

M_{old} is the measurement result of the cell leaving the reporting range.

CIO_{old} is the individual cell offset for the cell leaving the reporting range if an individual cell offset is stored for that cell. Otherwise it is equal to 0.

M_i is a measurement result of a cell not forbidden to affect reporting range in the active set.

N_A is the number of cells not forbidden to affect reporting range in the current active set.

For pathloss

M_{Best} is the measurement result of the cell not forbidden to affect reporting range in the active set with the lowest measurement result, not taking into account any cell individual offset.

for other measurements quantities.

M_{Best} is the measurement result of the cell not forbidden to affect reporting range in the active set with the highest measurement result, not taking into account any cell individual offset.

W is a parameter sent from UTRAN to UE.

R_{Ib} is the reporting range constant.

H_{Ib} is the hysteresis parameter for the event 1b.

If the measurement results are pathloss or CPICH-Ec/No then M_{Old} , M_i and M_{Best} are expressed as ratios.

If the measurement result is CPICH-RSCP then M_{Old} , M_i and M_{Best} are expressed in mW.

14.1.2.3 Reporting event 1C: A non-active primary CPICH becomes better than an active primary CPICH

When an intra-frequency measurement configuring event 1c is set up, the UE shall:

- 1> create a variable TRIGGERED_1C_EVENT related to that measurement, which shall initially be empty;
- 1> delete this variable when the measurement is released.

When event 1C is configured in the UE, the UE shall:

- 1> if "Measurement quantity" is "pathloss" and Equation 1 below is fulfilled for one or more primary CPICHs, or if "Measurement quantity" is "CPICH Ec/No" or "CPICH RSCP", and Equation 2 below is fulfilled for one or more primary CPICHs, for each of these primary CPICHs:
 - 2> if all required reporting quantities are available for that cell; and
 - 2> if the equations have been fulfilled for a time period indicated by "Time to trigger", and if the primary CPICH that is better is not included in the active set but the other primary CPICH is any of the primary CPICHs included in the active set, and if that first primary CPICH is not included in the "cells triggered" in the variable TRIGGERED_1C_EVENT:
 - 3> include that primary CPICH in the "cells recently triggered" in the variable TRIGGERED_1C_EVENT.
- 1> if the value of "Replacement activation threshold" for this event is less than or equal to the current number of cells in the active set or equal to 0 and if any primary CPICHs are stored in the "cells recently triggered" in the variable TRIGGERED_1C_EVENT:
 - 2> if "Reporting interval" for this event is not equal to 0:
 - 3> if the IE "Periodical reporting running" in the variable TRIGGERED_1C_EVENT is set to FALSE:
 - 4> start a timer for with the value of "Reporting interval" for this event and set the IE "Periodical reporting running" in the variable TRIGGERED_1C_EVENT to TRUE.
 - 3> set "sent reports" for that primary CPICH in the variable TRIGGERED_1C_EVENT to 1.
 - 2> send a measurement report with IEs set as below:
 - 3> set in "intra-frequency measurement event results": "Intrafrequency event identity" to "1c"; and
 - 3> include in "cell measurement event results" all entries of the "cells recently triggered" in the variable TRIGGERED_1C_EVENT not in the active set as well as the "primary CPICH info" of all the primary CPICHs in the active set for which the measured value is worse (i.e. greater for pathloss and less for the

other measurement quantities) than the one of the entry in "cell recently triggered" that has the best measured value taking into account their cell individual offset. The "primary CPICH info" for those cells shall be ordered according to their measured value taking into account their cell individual offset, beginning with the best cell to the worst one;

- 3> set the IE "measured results" and the IE "additional measured results" according to subclause 8.4.2, not taking into account the cell individual offset for each cell.
- 2> move all entries from "cells recently triggered" to "cells triggered" in the variable TRIGGERED_1C_EVENT.
- 1> if the timer for the periodical reporting has expired:
 - 2> if any primary CPICH is included in the "cells triggered" in the variable TRIGGERED_1C_EVENT, and not included in the current active set:
 - 3> if "Reporting interval" for this event is not equal to 0, and if "Amount of reporting" is greater than "sent reports" stored for that primary CPICH, in "cells triggered" in the variable TRIGGERED_1C_EVENT:
 - 4> increment the stored counter "sent reports" for all CPICH in "cell triggered" in variable TRIGGERED_1C_EVENT;
 - 4> start a timer with the value of "Reporting interval" for this event;
 - 4> send a measurement report with IEs set as below:
 - 5> set in "intra-frequency measurement event results": "Intrafrequency event identity" to "1c"; and
 - 5> include in "cell measurement event results" all entries of the variable TRIGGERED_1C_EVENT with value of IE "sent report" smaller than value of "Amount of reporting" and that are not part of the active set as well as the "primary CPICH info" of all the primary CPICHs in the active set for which the measured value is worse (i.e. greater for pathloss and less for the other measurement quantities) than the one of the entry in "cell recently triggered" that has the best measured value, ordering the "primary CPICH info" according to their measured value beginning with the best cell to the worst one, taking into account the cell individual offset for each cell;
 - 5> set the IE "measured results" and the IE "additional measured results" according to subclause 8.4.2, not taking into account the cell individual offset for each cell.
 - 4> if "sent reports" in variable TRIGGERED_1C_EVENT is greater than "Amount of reporting" for all entries:
 - 5> set the IE "Periodical Reporting running" in the variable TRIGGERED_1C_EVENT to FALSE and disable the timer for the periodical reporting.
- 1> if "Measurement quantity" is "pathloss" and Equation 3 below is fulfilled for a primary CPICH, or if "Measurement quantity" is "CPICH E_c/N_0 " or "CPICH RSCP", and Equation 4 below is fulfilled for a primary CPICH or;
 - 1> if a primary CPICH is added to the active set:
 - 2> if that primary CPICH is included in the "cells triggered" or "cells recently triggered" in the variable TRIGGERED_1C_EVENT:
 - 3> remove the entry of that primary CPICH from "cells triggered" or "cells recently triggered" in the variable TRIGGERED_1C_EVENT.
 - 3> if no entry in the variable TRIGGERED_1C_EVENT has a value of "sent reports" smaller than "Amount of reporting":
 - 4> stop the reporting interval timer;
 - 4> set the IE "Periodical reporting running" in the variable TRIGGERED_1C_EVENT to FALSE.

Equation 1 (Triggering condition for pathloss)

$$10 \text{Log}M_{New} + CIO_{New} \leq 10 \text{Log}M_{InAS} + CIO_{InAS} - H_{1c} / 2$$

Equation 2 (Triggering condition for all the other measurement quantities)

$$10 \text{Log}M_{New} + CIO_{New} \geq 10 \text{Log}M_{InAS} + CIO_{InAS} + H_{1c} / 2$$

Equation 3 (Leaving triggering condition for pathloss)

$$10 \text{Log}M_{New} + CIO_{New} > 10 \text{Log}M_{InAS} + CIO_{InAS} + H_{1c} / 2$$

Equation 4 (Leaving triggering condition for all the other measurement quantities)

$$10 \text{Log}M_{New} + CIO_{New} < 10 \text{Log}M_{InAS} + CIO_{InAS} - H_{1c} / 2$$

The variables in the formula are defined as follows:

M_{New} is the measurement result of the cell not included in the active set.

CIO_{New} is the individual cell offset for the cell becoming better than the cell in the active set if an individual cell offset is stored for that cell. Otherwise it is equal to 0.

For pathloss:

M_{InAS} is the measurement result of the cell in the active set with the highest measurement result.

For other measurement quantities:

M_{InAS} is the measurement result of the cell in the active set with the lowest measurement result.

CIO_{InAS} is the individual cell offset for the cell in the active set that is becoming worse than the new cell.

H_{1c} is the hysteresis parameter for the event 1c.

If the measurement results are pathloss or CPICH-Ec/No then M_{New} and M_{InAS} are expressed as ratios.

If the measurement result is CPICH-RSCP then M_{New} and M_{InAS} are expressed in mW.

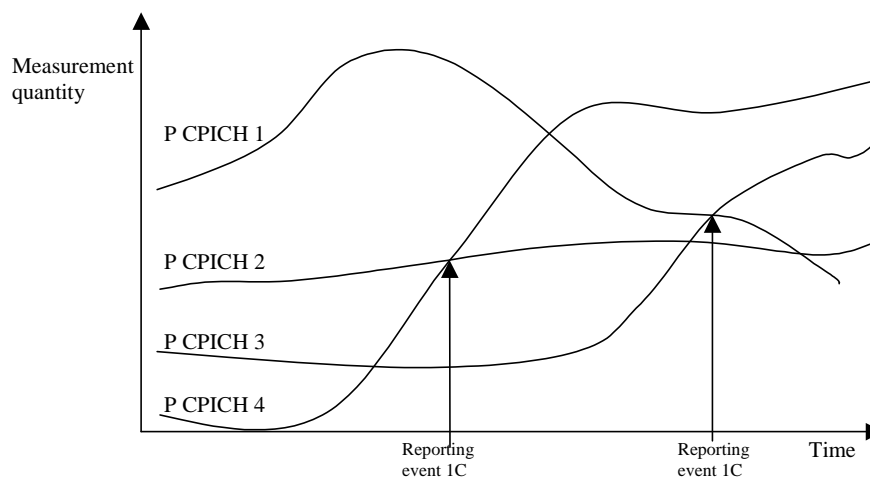

Figure 14.1.2.3-1 [Informative]: A primary CPICH that is not included in the active set becomes better than a primary CPICH that is in the active set

In this figure, the parameters hysteresis and time to trigger, as well as the cell individual offsets for all cells are equal to 0. In this example the cells belonging to primary CPICH 1 and 2 are in the active set, but the cells transmitting primary CPICH 3 and CPICH 4 are not (yet) in the active set.

The first measurement report is sent when primary CPICH 4 becomes better than primary CPICH 2. The "cell measurement event result" of the measurement report contains the information of primary CPICH 4 and CPICH 2.

Assuming that the active set has been updated after the first measurement report (active set is now primary CPICH 1 and primary CPICH 4), the second report is sent when primary CPICH 3 becomes better than primary CPICH 1. The "cell measurement event result" of the second measurement report contains the information of primary CPICH 3 and primary CPICH 1.

14.1.2.4 Reporting event 1D: Change of best cell

When an intra-frequency measurement configuring event 1d is set up, the UE shall:

- 1> create a variable TRIGGERED_1D_EVENT related to that measurement, which shall initially contain the best cell in the active set when the measurement is initiated;
- 1> delete this variable when the measurement is released.

When event 1D is configured in the UE, the UE shall:

- 1> if "Measurement quantity" is "pathloss" and Equation 1 below is fulfilled for a primary CPICH that is not stored in "Best cell" in variable BEST_CELL_1D_EVENT, or if "Measurement quantity" is "CPICH Ec/No" or "CPICH RSCP", and Equation 2 below is fulfilled for a primary CPICH that is not stored in "Best cell" in variable BEST_CELL_1D_EVENT:

NOTE: If the equations are simultaneously fulfilled for more than one primary CPICH, the UE should report only one event 1D, triggered by the best primary CPICH.

- 2> if all required reporting quantities are available for that cell, and if the equations have been fulfilled for a time period indicated by "Time to trigger":
 - 3> set "best cell" in the variable BEST_CELL_1D_EVENT to that primary CPICH that triggered the event;
 - 3> send a measurement report with IEs set as below:
 - 4> set in "intra-frequency measurement event results"; "Intrafrequency event identity" to "1d" and "cell measurement event results" to the CPICH info of the primary CPICH that triggered the report, not taking into account the cell individual offset for each cell.
 - 4> set the IE "measured results" and the IE "additional measured results" according to subclause 8.4.2, not taking into account the cell individual offset for each cell.

NOTE: Event 1D can be triggered by an active or by a non-active CPICH.

This event is only applicable to the CELL_DCH state. Upon transition to CELL_DCH the UE shall:

- 1> set "best cell" in the variable BEST_CELL_1D_EVENT to the best cell of the primary CPICHs included in the active set, not taking into account any cell individual offsets.

Equation 1 (Triggering condition for pathloss)

$$10 \text{Log} M_{\text{NotBest}} \leq 10 \text{Log} M_{\text{Best}} - H_{1d} / 2,$$

Equation 2 (Triggering condition for all the other measurement quantities)

$$10 \text{Log} M_{\text{NotBest}} \geq 10 \text{Log} M_{\text{Best}} + H_{1d} / 2,$$

The variables in the formula are defined as follows:

M_{NotBest} is the measurement result of a cell not stored in "best cell" in the variable BEST_CELL_1D_EVENT.

M_{Best} is the measurement result of the cell stored in "best cell" in variable BEST_CELL_1D_EVENT.

H_{1d} is the hysteresis parameter for the event 1d.

If the measurement results are pathloss or CPICH-Ec/No then $M_{\text{Not Best}}$ and M_{Best} are expressed as ratios.

If the measurement result is CPICH-RSCP then $M_{\text{Not Best}}$ and M_{Best} are expressed in mW.

NOTE: The cell individual offsets for the two cells being compared shall not be taken into account when checking whether this event has been triggered or not.

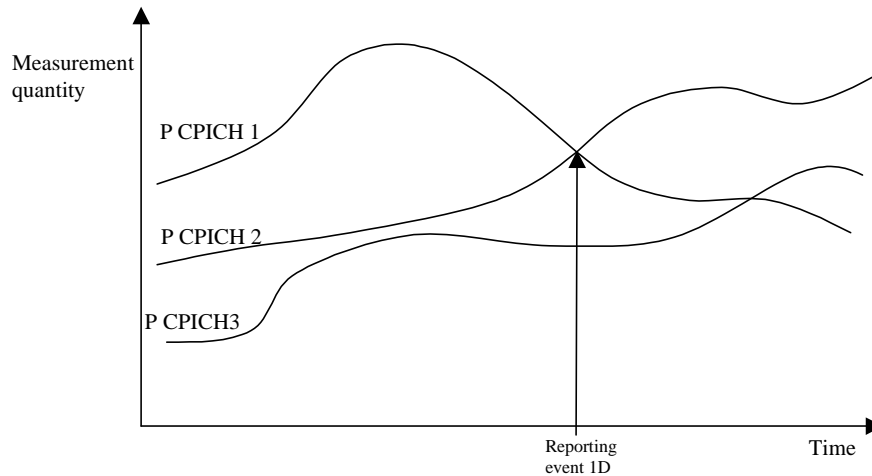

Figure 14.1.2.4-1 [Informative]: A primary CPICH becomes better than the previously best primary CPICH

In this figure, the parameters hysteresis and time to trigger, as well as the cell individual offsets for all cells are equal to 0.

14.1.2.5 Reporting event 1E: A Primary CPICH becomes better than an absolute threshold

When an intra-frequency measurement configuring event 1e is set up, the UE shall:

- 1> create a variable TRIGGERED_1E_EVENT related to that measurement, which shall initially be empty;
- 1> delete this variable when the measurement is released.

When event 1E is configured in the UE, the UE shall:

- 1> if "Measurement quantity" is "pathloss" and Equation 1 below is fulfilled for a primary CPICH, or if "Measurement quantity" is "CPICH E_c/N_0 " or "CPICH RSCP", and Equation 2 below is fulfilled for one or more primary CPICHs, for each of these primary CPICHs:
 - 2> if all required reporting quantities are available for that cell, and if the equations have been fulfilled for a time period indicated by "Time to trigger", and if that primary CPICH is part of cells allowed to trigger the event according to "Triggering condition 2", and that primary CPICH is not included in the "cells triggered" in the variable TRIGGERED_1E_EVENT:
 - 3> include that primary CPICH in the "cells recently triggered" in the variable TRIGGERED_1E_EVENT.
- 1> if any primary CPICHs are stored in the "cells recently triggered" in the variable TRIGGERED_1E_EVENT:
 - 2> send a measurement report with IEs set as below:
 - 3> set in "intra-frequency measurement event results": "Intrafrequency event identity" to "1e"; and
 - 3> include in "cell measurement event results" all entries of the "cells recently triggered" in the variable TRIGGERED_1E_EVENT in descending order according to the configured measurement quantity taking into account the cell individual offset for each of those cells;
 - 3> set the IE "measured results" and the IE "additional measured results" according to subclause 8.4.2, not taking into account the cell individual offset for each cell.
 - 2> move all entries from "cells recently triggered" to "cells triggered" in the variable TRIGGERED_1E_EVENT.

- 1> if "Measurement quantity" is "pathloss" and Equation 3 below is fulfilled for a primary CPICH, or if "Measurement quantity" is "CPICH Ec/N0" or "CPICH RSCP", and Equation 4 below is fulfilled for a primary CPICH; or
- 1> if a primary CPICH is no longer part of the cells allowed to trigger the event according to the "Triggering condition 2":
 - 2> if that primary CPICH is included in the "cells triggered" in the variable TRIGGERED_1E_EVENT:
 - 3> remove that primary CPICH and sent reports from "cells triggered" in the variable TRIGGERED_1E_EVENT.

This event is only applicable to the CELL_DCH state. When the measurement is setup in CELL_DCH or upon transition to CELL_DCH the UE shall:

- 1> if the "Triggering condition 2" includes active set cells:
 - 2> include the primary CPICH of all cells in the current active set that fulfil the equations 1 or 2 according to the "Measurement quantity" of event 1e into the "cells triggered" in the variable TRIGGERED_1E_EVENT.

Equation 1 (Triggering condition for pathloss)

$$10 \text{Log} M_{New} + CIO_{New} \leq T_{1e} - H_{1e} / 2,$$

Equation 2 (Triggering condition for all the other measurement quantities)

$$10 \text{Log} M_{New} + CIO_{New} \geq T_{1e} + H_{1e} / 2,$$

Equation 3 (Leaving triggering condition for pathloss)

$$10 \text{Log} M_{New} + CIO_{New} > T_{1e} + H_{1e} / 2,$$

Equation 4 (Leaving triggering condition for all the other measurement quantities)

$$10 \text{Log} M_{New} + CIO_{New} < T_{1e} - H_{1e} / 2,$$

The variables in the formula are defined as follows:

M_{New} is the measurement result of a cell that becomes better than an absolute threshold.

CIO_{New} is the individual cell offset for the cell becoming better than the absolute threshold. Otherwise it is equal to 0.

T_{1e} is an absolute threshold.

H_{1e} is the hysteresis parameter for the event 1e.

If the measurement results are pathloss or CPICH-Ec/No then M_{New} is expressed as ratios.

If the measurement result is CPICH-RSCP then M_{New} is expressed in mW.

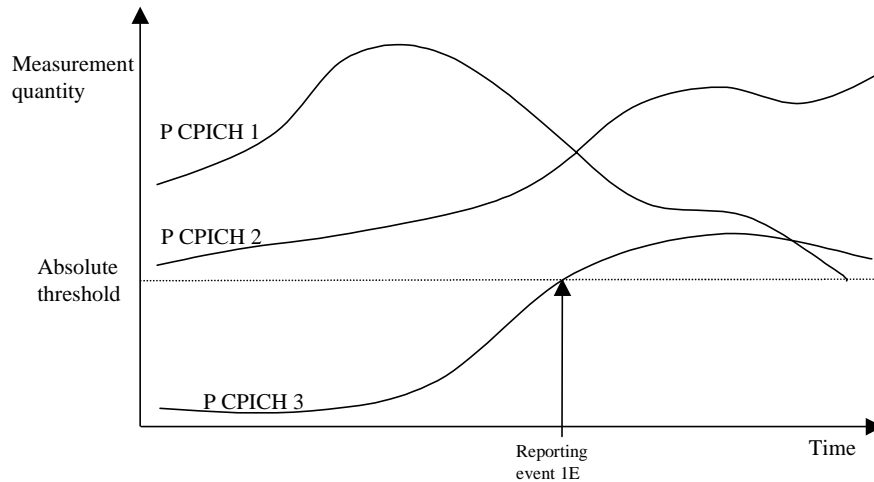

Figure 14.1.2.5-1 [Informative]: Event-triggered report when a Primary CPICH becomes better than an absolute threshold

In this figure, the parameters hysteresis and time to trigger, as well as the cell individual offsets for all cells are equal to 0.

14.1.2.6 Reporting event 1F: A Primary CPICH becomes worse than an absolute threshold

When an intra-frequency measurement configuring event 1F is set up, the UE shall:

- 1> create a variable TRIGGERED_1F_EVENT related to that measurement, which shall initially be empty;
- 1> delete this variable when the measurement is released.

When event 1F is configured in the UE, the UE shall:

- 1> if "Measurement quantity" is "pathloss" and Equation 1 below is fulfilled for one or more primary CPICHs, or if "Measurement quantity" is "CPICH Ec/N0" or "CPICH RSCP", and Equation 2 below is fulfilled for one or more primary CPICHs, for each of these primary CPICHs:
 - 2> if all required reporting quantities are available for that cell, and if the equations have been fulfilled for a time period indicated by "Time to trigger", and if that primary CPICH is part of cells allowed to trigger the event according to "Triggering condition 1", and that primary CPICH is not included in the "cells triggered" in the variable TRIGGERED_1F_EVENT:
 - 3> include that primary CPICH in the "cells recently triggered" in the variable TRIGGERED_1F_EVENT.
- 1> if any primary CPICHs are stored in the "cells recently triggered" in the variable TRIGGERED_1F_EVENT:
 - 2> send a measurement report with IEs set as below:
 - 3> set in "intra-frequency event measurement results": "Intrafrequency event identity" to "1f"; and
 - 3> include in "cell measurement event results" all entries of the "cells recently triggered" in the variable TRIGGERED_1F_EVENT in descending order according to the configured measurement quantity taking into account the cell individual offset for each of those cells;
 - 3> set the IE "measured results" and the IE "additional measured results" according to subclause 8.4.2, not taking into account the cell individual offset for each cell;
 - 2> move all entries from "cells recently triggered" to "cells triggered" in the variable TRIGGERED_1F_EVENT.
- 1> if "Measurement quantity" is "pathloss" and Equation 3 below is fulfilled for a primary CPICH, or if "Measurement quantity" is "CPICH Ec/N0" or "CPICH RSCP", and Equation 4 below is fulfilled for a primary CPICH; or

- 1> if a primary CPICH is no longer part of the cells allowed to trigger the event according to the "Triggering condition 1":
- 2> if that primary CPICH is included in the "cells triggered" in the variable TRIGGERED_1F_EVENT:
- 3> remove that primary CPICH from "cells triggered" in the variable TRIGGERED_1F_EVENT.

Equation 1 (Triggering condition for pathloss)

$$10 \text{Log}M_{Old} + CIO_{Old} \geq T_{I_f} + H_{I_f}/2$$

Equation 2 (Triggering condition for all the other measurement quantities)

$$10 \text{Log}M_{Old} + CIO_{Old} \leq T_{I_f} - H_{I_f}/2$$

Equation 3 (Leaving triggering condition for pathloss)

$$10 \text{Log}M_{Old} + CIO_{Old} < T_{I_f} - H_{I_f}/2$$

Equation 4 (Leaving triggering condition for all the other measurement quantities)

$$10 \text{Log}M_{Old} + CIO_{Old} > T_{I_f} + H_{I_f}/2$$

The variables in the formula are defined as follows:

M_{Old} is the measurement result of a cell that becomes worse than an absolute threshold

CIO_{Old} is the individual cell offset for the cell becoming worse than the absolute threshold. Otherwise it is equal to 0.

T_{I_f} is an absolute threshold

H_{I_f} is the hysteresis parameter for the event 1f.

If the measurement results are pathloss or CPICH-Ec/No then M_{Old} is expressed as ratios.

If the measurement result is CPICH-RSCP then M_{Old} is expressed in mW.

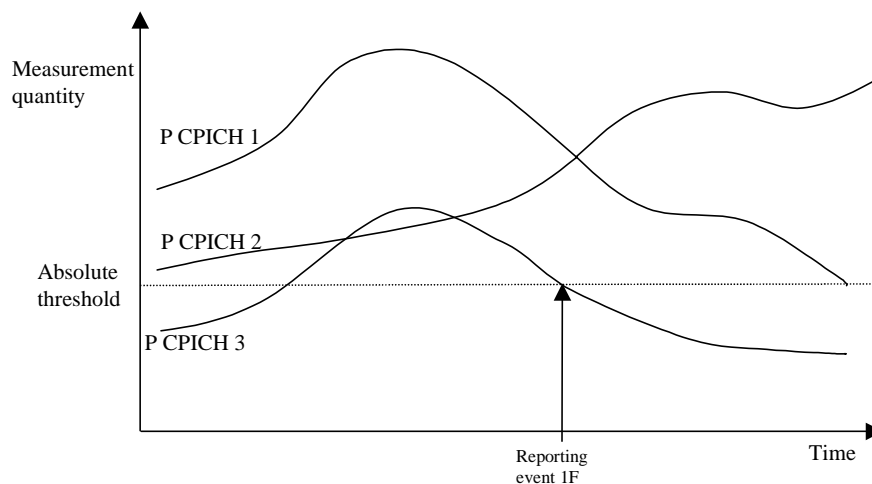

Figure 14.1.2.6-1 [Informative]: Event-triggered report when a Primary CPICH becomes worse than an absolute threshold

In this figure, the parameters hysteresis and time to trigger, as well as the cell individual offsets for all cells are equal to 0.

14.1.3 Intra-frequency reporting events for TDD

14.1.3.1 Reporting event 1G: Change of best cell (TDD)

When event 1G is configured in the UE, the UE shall:

- 1> if the equation 1 is fulfilled for a P-CCPCHs during the time "Time to trigger" and if that P-CCPCH is not included in the "primary CCPCH info" in the variable TRIGGERED_1G_EVENT;
- 2> include that P-CCPCH in "cells triggered" in the variable TRIGGERED_1G_EVENT;
- 2> send a measurement report with IEs set as below:
 - 3> set in "intra-frequency measurement event results": "Intrafrequency event identity" to "1g";
 - 3> set the first entry in "cell measurement event results" to the "Cell parameters ID" of the P-CCPCH which was stored in the variable TRIGGERED_1G_EVENT;
 - 3> include all entries in "cells triggered" in variable TRIGGERED_1G_EVENT in "cell measurement event results" in the measurement report in descending order according to:

$$10 \cdot \text{Log}M + O$$

where M is the P-CCPCH RSCP and O the individual offset of a cell;

- 3> set the IE "measured results" and the IE "additional measured results" according to subclause 8.4.2, not taking into account the cell individual offset for each cell.
- 1> if Equation 2 below is fulfilled for a primary CCPCH:
 - 2> if a primary CCPCH is included in the "cells triggered" in the variable TRIGGERED_1G_EVENT:
 - 3> remove the entry of that primary CCPCH from "cells triggered" in the variable TRIGGERED_1G_EVENT;

The UE shall use the equations below for evaluation of reporting event 1g:

Equation 1

$$10 \cdot \text{Log}M_i + O_i - H_{1g} > 10 \cdot \text{Log}M_{previous_best} + O_{previous_best}$$

The variables in the formula are defined as follows:

$M_{previous_best}$ is the current P-CCPCH RSCP of the previous best cell expressed in mW

$O_{previous_best}$ is the cell individual offset of the previous best cell

M_i is the current P-CCPCH RSCP of the currently evaluated cell i expressed in mW

O_i is the cell individual offset of the currently evaluated cell i

H_{1g} is the hysteresis parameter for the event 1g.

Equation 2

$$10 \cdot \text{Log}M_i + O_i + H_{1g} < 10 \cdot \text{Log}M_{previous_best} + O_{previous_best}$$

The variables in the formula are defined as follows:

$M_{previous_best}$ is the current P-CCPCH RSCP of the previous best cell expressed in mW

$O_{previous_best}$ is the cell individual offset of the previous best cell

M_i is the current P-CCPCH RSCP of the currently evaluated cell i expressed in mW

O_i is the cell individual offset of the currently evaluated cell i

H_{1g} is the hysteresis parameter for the event 1g.

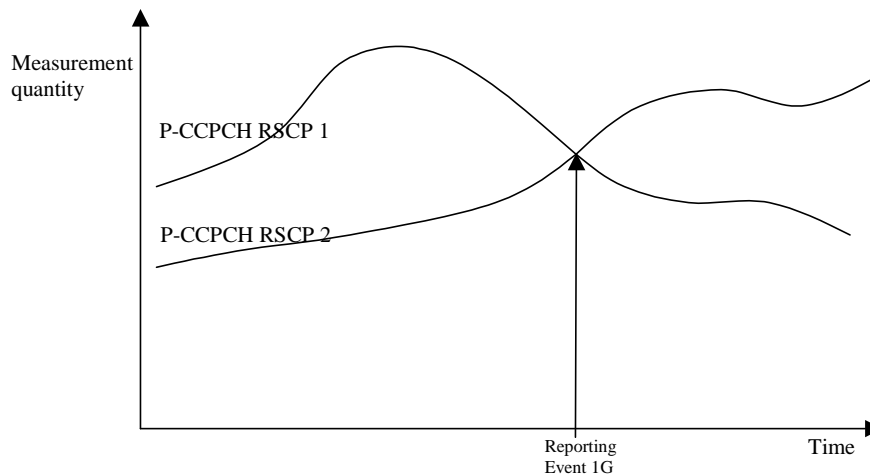

Figure 14.1.3.1-1: A P-CCPCH RSCP becomes better than the previous best P-CCPCH RSCP

14.1.3.2 Reporting event 1H: Timeslot ISCP below a certain threshold (TDD)

When event 1h is configured in the UE, the UE shall:

- 1> if equation 1 is fulfilled for a time period indicated by "Time to trigger" and if that P-CCPCH is not included in the IE "cells triggered" in the variable TRIGGERED_1H_EVENT:
 - 2> include that P-CCPCH in the IE "cells triggered" in the variable TRIGGERED_1H_EVENT;
 - 2> send a measurement report with the IEs set as below:
 - 3> set in "intra-frequency measurement event results": "Intrafrequency event identity" to "1h" and in "cell measurement event results" the "Cell parameters ID" of the P-CCPCH that triggered the report;
 - 3> include in "Cell measured results" the "Timeslot ISCP" of those cells that are included in the variable TRIGGERED_1H_EVENT.
- 1> if a primary CCPCH is included in the "cells triggered" in the variable TRIGGERED_1H_EVENT:
 - 2> send a measurement report with IEs set as below:
 - 3> set in "intra-frequency measurement event results": "Intrafrequency event identity" to "1h" and "cell measurement event results" to the "Cell parameters ID" of the P-CCPCH that triggered the report;
 - 3> set in "measured results" the "Timeslot ISCP" of those cells that are included in the variable TRIGGERED_1H_EVENT and "additional measured results" according to subclause 8.4.2, not taking into account the cell individual offset for each cell.
- 1> if Equation 2 below is fulfilled for a primary CCPCH:
 - 2> if a primary CCPCH is included in the "cells triggered" in the variable TRIGGERED_1H_EVENT:
 - 3> remove the entry of that primary CCPCH from "cells triggered" in the variable TRIGGERED_1H_EVENT.

The UE shall use the equations below for evaluation of reporting event 1h:

Equation 1

$$10 \cdot \text{Log} M_i + H_{1h} + O_i < T_{1h},$$

Equation 2

$$10 \cdot \text{Log}M_i - H_{1h} + O_i > T_{1h},$$

The variables in the formula are defined as follows:

M_i is the Timeslot ISCP of the currently evaluated cell i expressed in mW

O_i is the cell individual offset of the currently evaluated cell i

T_{1h} is the Threshold for event 1h

H_{1h} is the hysteresis parameter for the event 1h.

Before any evaluation is done, the Timeslot ISCP expressed in mW is filtered according to subclause 8.6.7.2.

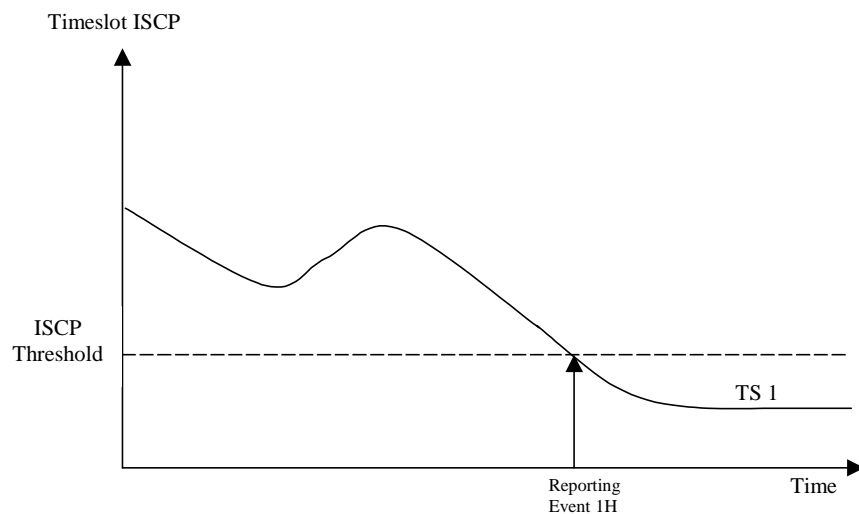

Figure 14.1.3.2-1: An ISCP value of a timeslot drops below an absolute threshold

14.1.3.3 Reporting event 1i: Timeslot ISCP above a certain threshold (TDD)

When event 1i is configured in the UE, the UE shall:

- 1> if equation 1 is fulfilled for a time period indicated by "Time to trigger" and if that P-CCPCH is not included in the IE "cells triggered" in the variable TRIGGERED_1I_EVENT:
 - 2> include that P-CCPCH in the IE "cells triggered" in the variable TRIGGERED_1I_EVENT;
 - 2> send a measurement report with the IEs set as below:
 - 3> set in "intra-frequency measurement event results": "Intrafrequency event identity" to "1i" and in "cell measurement event results" to the "Cell parameters ID" of the P-CCPCH that triggered the report;
 - 3> include in "measured results" the "Timeslot ISCP" of those cells that are included in the variable TRIGGERED_1I_EVENT and "additional measured results" according to 8.4.2, not taking into account the cell individual offset for each cell.
- 1> if a primary CCPCH is included in the "cells triggered" in the variable TRIGGERED_1I_EVENT:
 - 2> if Equation 2 below is fulfilled for a primary CCPCH:
 - 3> if a primary CCPCH is included in the "cells triggered" in the variable TRIGGERED_1I_EVENT:
 - 4> remove the entry of that primary CCPCH from "cells triggered" in the variable TRIGGERED_1I_EVENT.

The UE shall use the equation below for evaluation of reporting event 1i:

Equation 1

$$10 \cdot \text{Log}M_i - H_{1i} + O_i > T_{1h},$$

Equation 2

$$10 \cdot \text{Log}M_i + H_{1i} + O_i < T_{1h},$$

The variables in the formula are defined as follows:

M_i is the Timeslot ISCP of the currently evaluated cell i expressed in mW

O_i is the cell individual offset of the currently evaluated cell i

T_{1i} is the Threshold for event 1i

H_{1i} is the hysteresis parameter for the event 1i.

Before any evaluation is done, the Timeslot ISCP expressed in mW is filtered according to subclause 8.6.7.2.

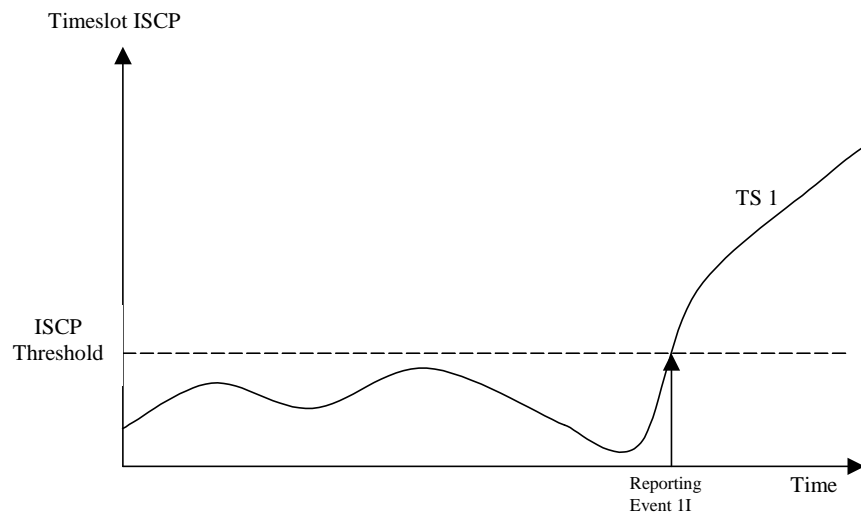

Figure 14.1.3.3-1: An ISCP value of a timeslot exceeds a certain threshold

14.1.4 Event-triggered periodic intra-frequency measurement reports (informative)

14.1.4.1 Cell addition failure (FDD only)

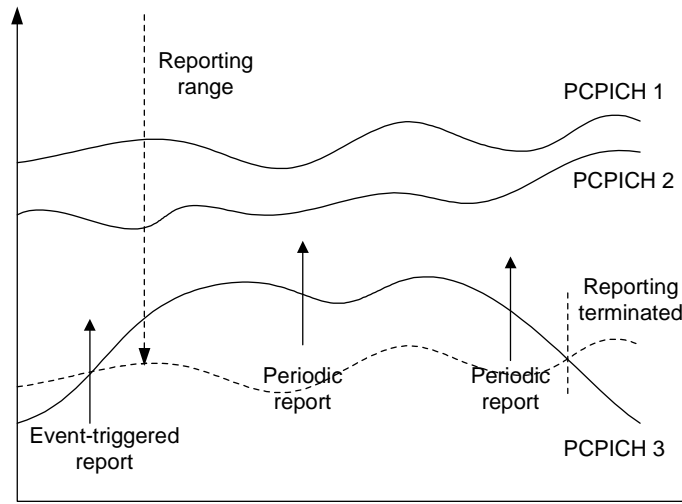

Figure 14.1.4.1-1: Periodic reporting triggered by event 1A

When a cell enters the reporting range and triggers event 1A, the UE shall transmit a MEASUREMENT REPORT to the UTRAN and typically this may result in an update of the active set. However, in some situations the UTRAN may be unable to add a strong cell to the active set typically due to capacity shortage for example.

The UE shall continue reporting after the initial report by reverting to periodical measurement reporting if the reported cell is not added to the active set. This is illustrated in Figure 14.1.4.1-1. During periodic reporting the UE shall transmit MEASUREMENT REPORT messages to the UTRAN at predefined intervals. The reports shall include reporting information of the cells in the current active set and of the monitored cell(s) in the reporting range.

Event-triggered periodic measurement reporting shall be terminated if:

- 1> there are no longer any monitored cell(s) within the reporting range; or
- 1> the UTRAN has added cells to the active set so that it includes the maximum number of cells (defined by the **reporting deactivation threshold** parameter), which are allowed for event 1A to be triggered; or
- 1> the UE has sent the maximum number of MEASUREMENT REPORT messages (defined by the **amount of reporting** parameter).

The reporting period is assigned by the UTRAN (with the **Reporting interval** parameter). If the reporting interval is set to zero event-triggered periodic measurement reporting shall not be applied.

14.1.4.2 Cell replacement failure (FDD only)

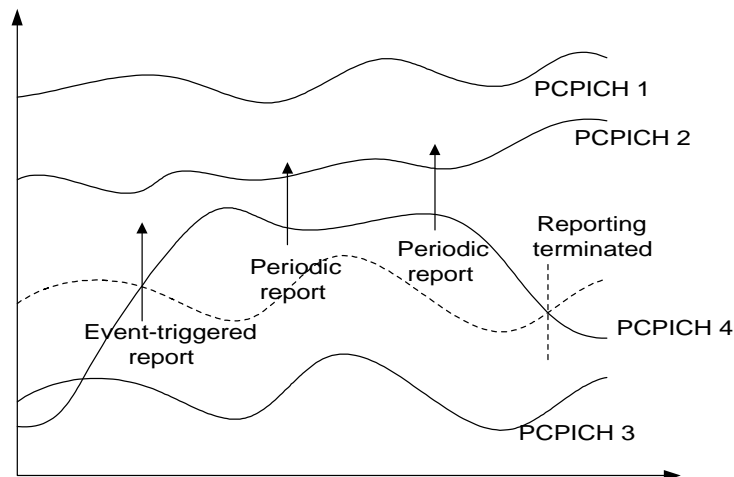

Figure 14.1.4.1-2: Periodic reporting triggered by event 1C

When a cell enters the replacement range and triggers event 1C, the UE shall transmit a MEASUREMENT REPORT to the UTRAN and typically this may result in the replacement of the weakest active cell. If the UTRAN is unable to replace the cell due to for example capacity shortage, it is beneficial to receive continuous reports in this case as well.

The UE shall revert to periodical measurement reporting if the UTRAN does not update the active set after the transmission of the measurement report. This is illustrated in Figure 14.1.4.1-2. During periodic reporting the UE shall transmit MEASUREMENT REPORT messages to the UTRAN at predefined intervals. The reports shall include reporting information of the cells in the current active set and of the monitored cell(s) in the replacement range.

Event-triggered periodic measurement reporting shall be terminated if:

- 1> there are no longer any monitored cell(s) within the replacement range; or
- 1> the UTRAN has removed cells from the active set so that there are no longer the minimum amount of active cells for event 1C to be triggered (as defined by the **replacement activation threshold** parameter); or
- 1> the UE has sent the maximum number of MEASUREMENT REPORT messages (defined by the **amount of reporting** parameter).

The reporting period is assigned by the UTRAN (with the **Reporting interval** parameter). If the reporting interval is set to zero, event-triggered periodic measurement reporting shall not be applied.

14.1.5 Mechanisms available for modifying intra-frequency measurement reporting behaviour (informative)

14.1.5.1 Hysteresis

To limit the amount of event-triggered reports, a hysteresis parameter may be connected with each reporting event given above. The value of the hysteresis is given to the UE in the Reporting criteria field of the Measurement Control message.

In the example in Figure 14.1.5.1-1, the hysteresis ensures that the event 1D (FDD) or IG(TDD) (primary CPICH(FDD)/CCPCH(TDD) 2 becomes the best cell) is not reported until the difference is equal to the hysteresis value. The fact that primary CPICH(FDD)/CCPCH(TDD) 1 becomes best afterwards is not reported at all in the example since the primary CPICH(FDD)/CCPCH(TDD) 1 does not become sufficiently better than the primary CPICH(FDD)/CCPCH(TDD) 2.

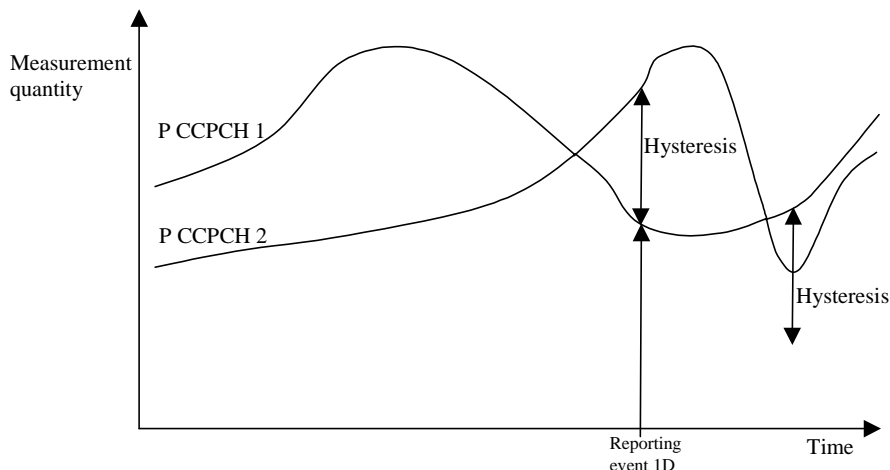

Figure 14.1.5.1-1: Hysteresis limits the amount of measurement reports

14.1.5.2 Time-to-trigger

To limit the measurement signalling load, a time-to-trigger parameter could be connected with each reporting event given above. The value of the time-to-trigger is given to the UE in the Reporting criteria field of the Measurement Control message.

The effect of the time-to-trigger is that the report is triggered only after the conditions for the event have existed for the specified time-to-trigger. In the following FDD example in Figure 14.1.5.2-1, the use of time-to-trigger means that the event (primary CPICH 3 enters the reporting range) is not reported until it has been within the range for the time given by the time-to-trigger parameter.

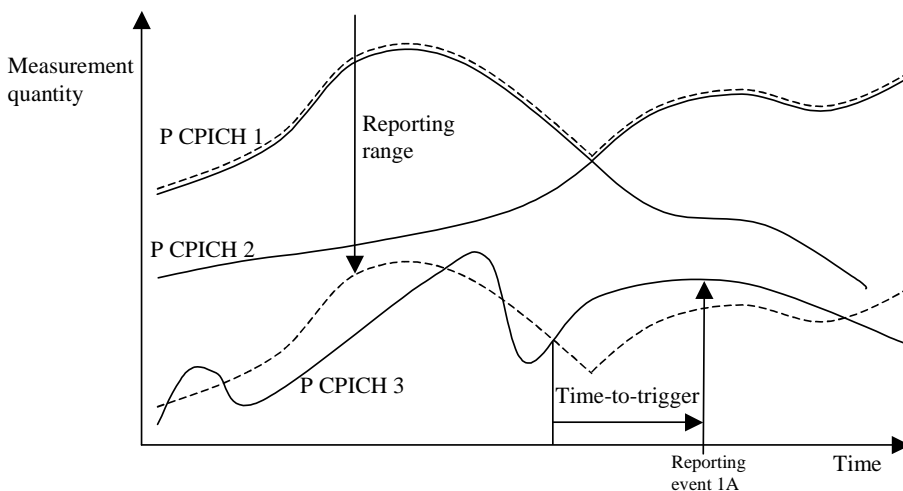

Figure 14.1.5.2-1: Time-to-trigger limits the amount of measurement reports

In the following TDD example in Figure 14.1.5.2-2, the use of time-to-trigger means that the event (Timeslot ISCP upon certain threshold) is not reported until it has been upon the threshold for the time given by the time-to trigger parameter.

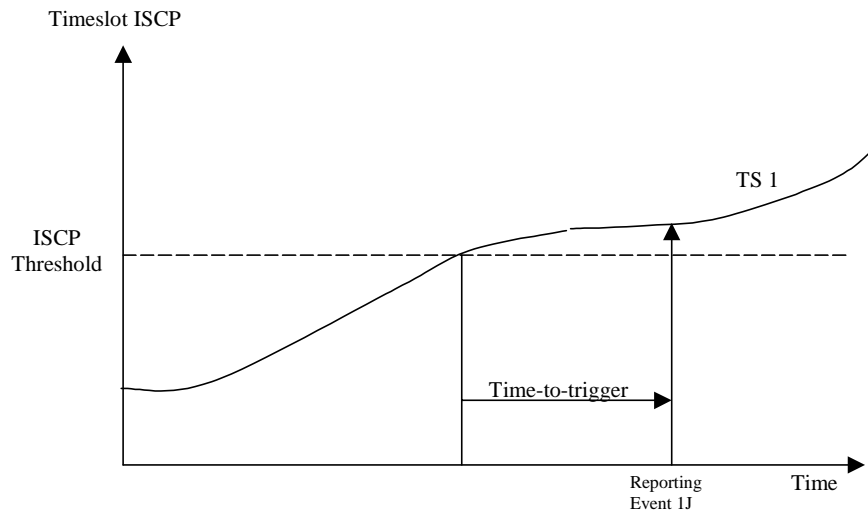

Figure 14.1.5.2-2: Time-to-trigger limits the amount of measurement reports

NOTE: The time-to-trigger could be combined with hysteresis, i.e. a hysteresis value is added to the measurement quantity before evaluating if the time-to-trigger timer should be started.

14.1.5.3 Cell individual offsets

For each cell that is monitored, an offset can be assigned with inband signalling. The offset can be either positive or negative. The offset is added to the measurement quantity before the UE evaluates if an event has occurred. The UE receives the cell individual offsets for each primary CPICH(FDD)/CCPCH(TDD) in the IE "Cell individual offset" included in the IE "Cell info" associated with each measurement object included in the MEASUREMENT CONTROL message.

For the FDD example, in Figure 14.1.5.3-1, since an offset is added to primary CPICH 3, it is the dotted curve that is used to evaluate if an event occurs. Hence, this means that measurement reports from UE to UTRAN are triggered when primary CPICH plus the corresponding offset, i.e. the dotted curve, leaves and enters the reporting range and when it gets better than primary CPICH 1 (if these events have been ordered by UTRAN). This offset mechanism provides the network with an efficient tool to change the reporting of an individual primary CPICH.

By applying a positive offset, as in Figure 14.1.5.3-1, the UE will send measurement reports as if the primary CPICH is offset x dB better than what it really is. This could be useful if the operator knows that a specific cell is interesting to monitor more carefully, even though it is not so good for the moment. In the example in Figure 14.1.5.3-1, the operator might know by experience that in this area primary CPICH 3 can become good very quickly (e.g. due to street corners) and therefore that it is worth reporting more intensively. Depending on the implemented handover evaluation algorithm, this may result in the cell with primary CPICH 3 being included in the active set earlier than would have been the case without the positive offset.

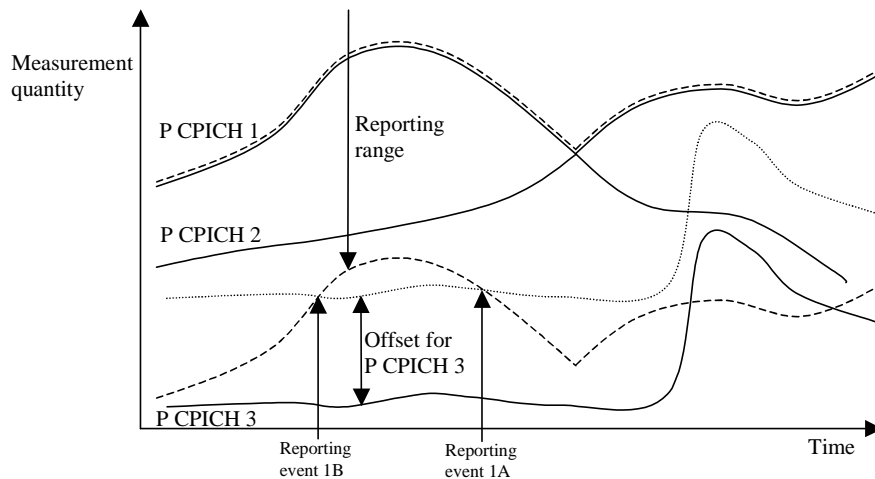

Figure 14.1.5.3-1: A positive offset is applied to primary CPICH 3 before event evaluation in the UE

For the TDD example, in Figure 14.1.5.3-2, an offset is added to primary CCPCH2, it is the dotted curve that is used to evaluate if the primary CCPCH2 becomes better than primary CCPCH1 (ordered by the UTRAN).

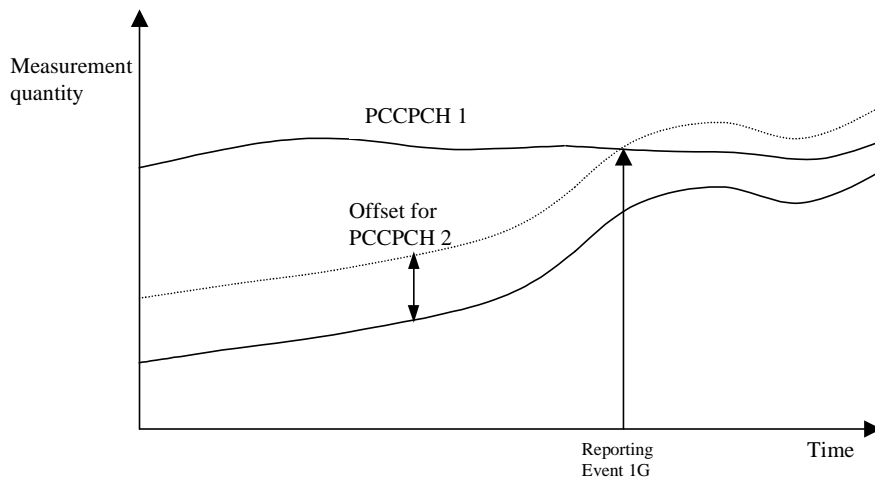

Figure 14.1.5.3-2: A positive offset is applied to primary CCPCH 2

Correspondingly, the operator can choose to apply a negative offset to a primary CCPCH. Then the reporting on that primary CCPCH is limited and the corresponding cell may be, at least temporarily excluded from the active set or as a target cell for handover.

It is important to note that the offset is added before triggering events, i.e. the offset is added by the UE before evaluating if a measurement report should be sent as opposed to offsets that are applied in the network and used for the actual handover evaluation. It should also be noted that the cell individual offset is not used in all measurement reporting events, and that it is not applied to all events in the same way.

14.1.5.4 Forbid a Primary CPICH to affect the reporting range (FDD only)

The reporting range affects the reporting events 1A and 1B presented above. The reporting range is defined as a function of all the Primary CPICHs in the active set (see 14.1.2.1 and 14.1.2.2). If the parameter W is set to 0, the reporting range is defined relative to the best Primary CPICH. However, there could be cases where it is good to forbid a specific Primary CPICH to affect the reporting range. For example in Figure 14.1.5.4-1 the network has requested the UE to not let Primary CPICH 3 affect the reporting range. This mechanism could be effective if the operator knows by experience that the quality of Primary CPICH 3 is very unstable in a specific area and therefore should not affect the reporting of the other Primary CPICHs.

The UE shall ignore that a Primary CPICH is forbidden to affect the reporting range if all of the following conditions are fulfilled:

- the Primary CPICH is included in active set; and
- all cells in active set are defined as Primary CPICHs forbidden to affect the reporting range.

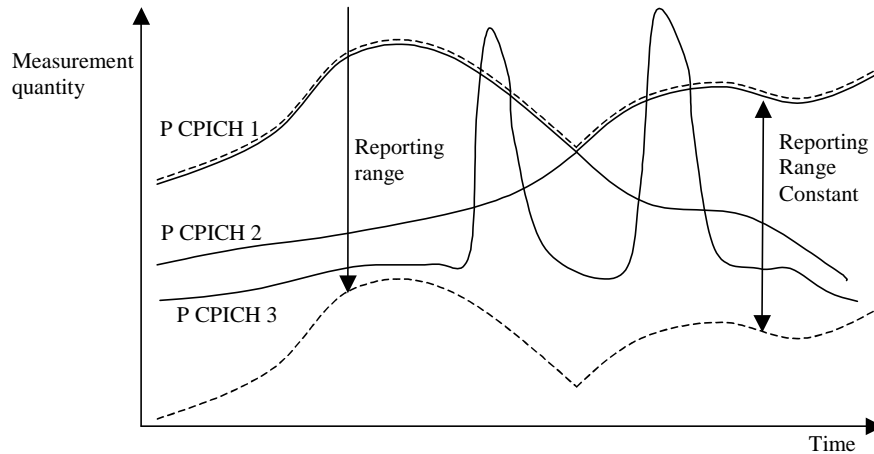

Figure 14.1.5.4-1: Primary CPICH 3 is forbidden to affect the reporting range

14.1.6 Report quantities in intra-frequency measurements

The quantities that the UE shall report to UTRAN when the event is triggered for an intra-frequency measurement are given by the IE "Intra-frequency reporting quantity" stored for this measurement and can be the following:

- 1 SFN-SFN observed time difference
- 2 Cell synchronisation information
- 3 Cell Identity
- 4 Downlink E_c/N_0 (FDD).
- 5 Downlink path loss.

For FDD:

$$\text{Pathloss in dB} = \text{Primary CPICH Tx power} - \text{CPICH RSCP.}$$

- For Primary CPICH Tx power the IE "Primary CPICH Tx power" shall be used. The unit is dBm.
- CPICH RSCP is the result of the CPICH RSCP measurement. The unit is dBm.

For TDD:

$$\text{Pathloss in dB} = \text{Primary CCPCH TX power} - \text{Primary CCPCH RSCP.}$$

- For Primary CCPCH TX power the IE "Primary CCPCH TX Power" shall be used. The unit is dBm.
- Primary CCPCH RSCP is the result of the Primary CCPCH RSCP measurement. The unit is dBm.

If necessary Pathloss shall be rounded up to the next higher integer.

Results higher than 158 shall be reported as 158.

Results lower than 46 shall be reported as 46.

- 6 Downlink received signal code power (RSCP) after despreading (of a primary CPICH for FDD, and of a primary CCPCH for TDD).
- 7 ISCP measured on Timeslot basis. (TDD)

8 Proposed TGSN (TDD)

A description of those values can be found in [7] and [8].

14.2 Inter-frequency measurements

14.2.0a Inter-frequency measurement quantities

The two first measurement quantities listed below are used by the UE to evaluate whether an inter-frequency measurement event has occurred or not, through the computation of a frequency quality estimate. The quantity to use to compute the frequency quality estimate for an inter-frequency measurement is given in the "Inter-frequency measurement quantity" stored for that measurement. In the FDD case, all three measurement quantities can be used for the update of the virtual active set of the non-used frequencies as described in subclause 14.11.

- 1 Downlink Ec/No (FDD)
- 2 Downlink received signal code power (RSCP) after despreading.
- 3 Downlink path loss.

For FDD:

$$\text{Pathloss in dB} = \text{Primary CPICH Tx power} - \text{CPICH RSCP.}$$

- For Primary CPICH Tx power the IE "Primary CPICH Tx power" shall be used. The unit is dBm.
- CPICH RSCP is the result of the CPICH RSCP measurement. The unit is dBm.

For TDD:

$$\text{Pathloss in dB} = \text{Primary CCPCH TX power} - \text{Primary CCPCH RSCP.}$$

- For Primary CCPCH TX power the IE "Primary CCPCH TX Power" shall be used. The unit is dBm.
- Primary CCPCH RSCP is the result of the Primary CCPCH RSCP measurement. The unit is dBm.

A description of those values can be found in [7] and [8].

14.2.0b Frequency quality estimate

14.2.0b.1 FDD cells

The frequency quality estimate used in events 2a, 2b 2c, 2d, 2e and 2f is defined as:

$$Q_{\text{frequency } j} = 10 \cdot \text{Log} M_{\text{frequency } j} = W_j \cdot 10 \cdot \text{Log} \left(\sum_{i=1}^{N_{A_j}} M_{i j} \right) + (1 - W_j) \cdot 10 \cdot \text{Log} M_{\text{Best } j},$$

The variables in the formula are defined as follows ("the virtual active set on frequency j" should be understood as the active set if frequency j is the used frequency. If frequency j is a non-used frequency, the way the virtual active set is initiated and updated is described in subclause 14.11):

$Q_{\text{frequency } j}$ is the estimated quality of the virtual active set on frequency j.

$M_{\text{frequency } j}$ is the estimated quality of the virtual active set on frequency j.

$M_{i j}$ is a measurement result of cell i in the virtual active set on frequency j.

N_{A_j} is the number of cells in the virtual active set on frequency j.

$M_{Best,j}$ is the measurement result of the cell in the virtual active set on frequency j with the highest measurement result.

W_j is a parameter sent from UTRAN to UE and used for frequency j .

If the measurement result is CPICH-Ec/No then $M_{Frequency}$, M_{ij} and M_{Best} are expressed as ratios.

If the measurement result is CPICH-RSCP or PCCPCH-RSCP then $M_{Frequency}$, M_{ij} and M_{Best} are expressed in mW.

14.2.0b.2 TDD cells

$$Q_{i, frequency j} = 10 \cdot \text{Log} M_{i, frequency j} + O_{i,j}$$

$Q_{i, frequency j}$ is the estimated quality of cell i on frequency j .

$M_{frequency j}$ is the measurement result for Primary CCPCH RSCP of cell i on frequency j expressed in mW.

$O_{i,j}$ is the cell individual offset of the currently evaluated cell i on frequency j . O_{ij} is set by IE "Cell individual offset"

14.2.0c Inter-frequency reporting quantities

The quantities that the UE shall report for each cell to UTRAN when the event is triggered for an inter-frequency measurement is given by the "Inter-frequency reporting quantity" IE stored for this measurement and can be the following, from 1 to 8. The quantity number 9 can be reported for each frequency that triggered the report.

- 1 Cell identity
- 2 SFN-SFN observed time difference
- 3 Cell synchronisation information
- 4 Downlink Ec/No (FDD)
- 5 Downlink path loss.

For FDD:

$$\text{Pathloss in dB} = \text{Primary CPICH Tx power} - \text{CPICH RSCP.}$$

- For Primary CPICH Tx power the IE "Primary CPICH Tx power" shall be used. The unit is dBm.
- CPICH RSCP is the result of the CPICH RSCP measurement. The unit is dBm.

For TDD:

$$\text{Pathloss in dB} = \text{Primary CCPCH TX power} - \text{Primary CCPCH RSCP.}$$

- For Primary CCPCH TX power the IE "Primary CCPCH TX Power" shall be used. The unit is dBm.
- Primary CCPCH RSCP is the result of the Primary CCPCH RSCP measurement. The unit is dBm.

If necessary Pathloss shall be rounded up to the next higher integer.

Results higher than 158 shall be reported as 158.

Results lower than 46 shall be reported as 46.

- 6 Downlink received signal code power (RSCP) after despreading (of a primary CPICH for FDD, and of a primary CCPCH for TDD).
- 7 ISCP measured on Timeslot basis. (TDD)
- 8 Proposed TGSN (TDD)
- 9 UTRA carrier RSSI

A description of those values can be found in [7] and [8].

14.2.1 Inter-frequency reporting events

Within the measurement reporting criteria field in the MEASUREMENT CONTROL message UTRAN notifies the UE which events should trigger the UE to send a MEASUREMENT REPORT message. The listed events are the toolbox from which the UTRAN can choose the reporting events that are needed for the implemented handover evaluation function, or other radio network functions.

All events are evaluated with respect to one of the measurement quantities given in subclause 14.2.0a. The measurement quantities are measured on the monitored primary common pilot channels (CPICH) in FDD mode and the monitored primary common control channels (PCCPCH) in TDD mode of the cell defined in the measurement object. A "non-used frequency" is a frequency that the UE has been ordered to measure upon but is not used for the connection. A "used frequency" is a frequency that the UE has been ordered to measure upon and is also currently used for the connection.

The "monitored set on non-used frequency" consists of cells in "cells for measurement" (or all cells in CELL_INFO_LIST if "cells for measurement" is not present) that are not part of the virtual active set on that non-used frequency.

When one inter-frequency measurement identity corresponds to multiple intra-frequency or inter-frequency events with identical event identities, the UE behaviour is not specified.

14.2.1.1 Event 2a: Change of best frequency.

When event 2a is configured in the UE within a measurement, the UE shall:

- 1> when the measurement is initiated or resumed:
 - 2> store the used frequency in the variable BEST_FREQUENCY_2A_EVENT.
- 1> if equation 1 below has been fulfilled for a time period indicated by "Time to trigger" for a frequency included for that event and which is not stored in the variable BEST_FREQUENCY_2A_EVENT:
 - 2> send a measurement report with IEs set as below:
 - 3> set in "inter-frequency measurement event results":
 - 4> "inter-frequency event identity" to "2a"; and
 - 4> "Frequency info" to the frequency that triggered the event; and
 - 4> "Non frequency related measurement event results" to the "Primary CPICH info" of the best primary CPICH for FDD cells or "Primary CCPCH info" to the "Cells parameters ID" of the best primary CCPCH for TDD cells on that frequency, not taking into account the cell individual offset.
 - 3> if a non-used frequency triggered the measurement report:
 - 4> include in IE "Inter-frequency measured results list" the measured results for the non-used frequency that triggered the event, not taking into account the cell individual offset.
 - 3> if the used frequency triggered the measurement report:
 - 4> do not include the IE "Inter-frequency measured results list" in the measurement report.
 - 3> set the IE "additional measured results" according to subclause 8.4.2, not taking into account the cell individual offset;
 - 2> update the variable BEST_FREQUENCY_2A_EVENT with that frequency.

Equation 1:

$$Q_{NotBest} \geq Q_{Best} + H_{2a} / 2$$

The variables in the formula are defined as follows:

$Q_{Not\ Best}$ is the quality estimate of a frequency not stored the "best frequency" in the variable BEST_FREQUENCY_2A_EVENT.

Q_{Best} is the quality estimate of the frequency stored in "best frequency" in the variable BEST_FREQUENCY_2A_EVENT.

H_{2a} is the hysteresis parameter for the event 2a in that measurement.

14.2.1.2 Event 2b: The estimated quality of the currently used frequency is below a certain threshold **and** the estimated quality of a non-used frequency is above a certain threshold.

When an inter-frequency measurement configuring event 2b is set up, the UE shall:

- 1> create a variable TRIGGERED_2B_EVENT related to that measurement, which shall initially be empty;
- 1> delete this variable when the measurement is released.

When event 2b is configured in the UE within a measurement, the UE shall:

- 1> if equations 1 and 2 below have been fulfilled for a time period indicated by "Time to Trigger" from the same instant, respectively for one or several non-used frequencies included for that event and for the used frequency:
 - 2> if any of those non-used frequency is not stored in the variable TRIGGERED_2B_EVENT:
 - 3> store the non-used frequencies that triggered the event and that were not previously stored in the variable TRIGGERED_2B_EVENT into that variable;
 - 3> send a measurement report with IEs set as below:
 - 4> set in "inter-frequency measurement event results":
 - 5> "inter-frequency event identity" to "2b"; and
 - 5> for each non-used frequency that triggered the event, beginning with the best frequency:
 - 6> "Frequency info" to that non-used frequency; and
 - 6> "Non frequency related measurement event results" to the "Primary CPICH info" of the best primary CPICH for FDD cells or "Primary CCPCH info" to the "Cell parameters ID" of the best primary CCPCH for TDD cells on that non-used frequency, not taking into account the cell individual offset.
 - 4> include in IE "Inter-frequency measured results list" the measured results for each non-used frequency that triggered the event, not taking into account the cell individual offset;
 - 4> set the IE "additional measured results" according to subclause 8.4.2, not taking into account the cell individual offset.
 - 1> if equation 3 below is fulfilled for a non-used frequency stored in the variable TRIGGERED_2B_EVENT:
 - 2> remove that non-used frequency from the variable TRIGGERED_2B_EVENT.
 - 1> if equation 4 below is fulfilled for the used frequency:
 - 2> clear the variable TRIGGERED_2B_EVENT.

Triggering conditions:

Equation 1:

$$Q_{Non\ used} \geq T_{Non\ used\ 2b} + H_{2b}/2$$

The variables in the formula are defined as follows:

$Q_{Non\ used}$ is the quality estimate of a non-used frequency that becomes better than an absolute threshold.

$T_{Non\ used\ 2b}$ is the absolute threshold that applies for this non-used frequency in that measurement.

H_{2b} is the hysteresis parameter for the event 2b.

Equation 2:

$$Q_{Used} \leq T_{Used\ 2b} - H_{2b}/2$$

The variables in the formula are defined as follows:

Q_{Used} is the quality estimate of the used frequency.

$T_{Used\ 2b}$ is the absolute threshold that applies for the used frequency in that measurement.

H_{2b} is the hysteresis parameter for the event 2b.

Leaving triggered state condition:

Equation 3:

$$Q_{Nonused} < T_{Nonused\ 2b} - H_{2b}/2$$

The variables in the formula are defined as follows:

$Q_{Non\ used}$ is the quality estimate of a non-used frequency that is stored in the variable TRIGGERED_2B_EVENT.

$T_{Non\ used\ 2b}$ is the absolute threshold that applies for this non-used frequency in that measurement.

H_{2b} is the hysteresis parameter for the event 2b.

Equation 4:

$$Q_{Used} > T_{Used\ 2b} + H_{2b}/2$$

The variables in the formula are defined as follows:

Q_{Used} is the quality estimate of the used frequency.

$T_{Used\ 2b}$ is the absolute threshold that applies for the used frequency in that measurement.

H_{2b} is the hysteresis parameter for the event 2b.

14.2.1.3 Event 2c: The estimated quality of a non-used frequency is above a certain threshold

When an inter-frequency measurement configuring event 2c is set up, the UE shall:

- 1> create a variable TRIGGERED_2C_EVENT related to that measurement, which shall initially be empty;
- 1> delete this variable when the measurement is released.

When event 2c is configured in the UE within a measurement, the UE shall:

- 1> if equation 1 below has been fulfilled for one or several non-used frequencies included for that event during the time "Time to trigger":
 - 2> if any of those non-used frequencies is not stored in the variable TRIGGERED_2C_EVENT:
 - 3> store the non-used frequencies that triggered the event and that were not previously stored in the variable TRIGGERED_2C_EVENT into that variable;
 - 3> send a measurement report with IEs set as below:
 - 4> set in "inter-frequency measurement event results":
 - 5> "inter-frequency event identity" to "2c"; and

- 5> for each non-used frequency that triggered the event, beginning with the best frequency:
 - 6> "Frequency info" to that non-used frequency; and
 - 6> "Non frequency related measurement event results" to the "Primary CPICH info" of the best primary CPICH for FDD cells or "Primary CCPCH info" to the "Cell parameters ID" of the best primary CCPCH for TDD cells on that non-used frequency, not taking into account the cell individual offset.
 - 4> include in IE "Inter-frequency measured results list" the measured results for each non-used frequency that triggered the event, not taking into account the cell individual offset;
 - 4> set the IE "additional measured results" according to subclause 8.4.2 not taking into account the cell individual offset.
- 1> if equation 2 below is fulfilled for a non-used frequency stored in the variable TRIGGERED_2C_EVENT:
 - 2> remove that non-used frequency from the variable TRIGGERED_2C_EVENT.

Triggering condition:

Equation 1:

$$Q_{Non\ used} \geq T_{Non\ used\ 2c} + H_{2c}/2$$

The variables in the formula are defined as follows:

$Q_{Non\ used}$ is the quality estimate of a non-used frequency that becomes better than an absolute threshold.

$T_{Non\ used\ 2c}$ is the absolute threshold that applies for this non-used frequency in that measurement.

H_{2c} is the hysteresis parameter for the event 2c.

Leaving triggered state condition:

Equation 2:

$$Q_{Non\ used} < T_{Non\ used\ 2c} - H_{2c}/2$$

The variables in the formula are defined as follows:

$Q_{Non\ used}$ is the quality estimate of a non-used frequency stored in the variable TRIGGERED_2C_EVENT.

$T_{Non\ used\ 2c}$ is the absolute threshold that applies for this non-used frequency in that measurement.

H_{2c} is the hysteresis parameter for the event 2c.

14.2.1.4 Event 2d: The estimated quality of the currently used frequency is below a certain threshold

A UE shall be able to perform this measurement and the corresponding event reporting without requiring compressed mode.

When an inter-frequency measurement configuring event 2d is set up, the UE shall:

- 1> create a variable TRIGGERED_2D_EVENT related to that measurement, which shall initially be set to FALSE;
- 1> delete this variable when the measurement is released.

When event 2d is configured in the UE within a measurement, the UE shall:

- 1> if equation 1 below has been fulfilled for the used frequency during the time "Time to trigger":
 - 2> if the variable TRIGGERED_2D_EVENT is set to FALSE:
 - 3> set the variable TRIGGERED_2D_EVENT to TRUE;

- 3> send a measurement report with IEs set as below:
 - 4> set in "inter-frequency event results": "inter-frequency event identity" to "2d" and no IE "Inter-frequency cells", not taking into account the cell individual offset;
 - 4> include in IE "Inter-frequency measured results list" the measured results for the used frequency, not taking into account the cell individual offset;
 - 4> set the IE "additional measured results" according to subclause 8.4.2, not taking into account the cell individual offset.
- 1> if the variable TRIGGERED_2D_EVENT is set to TRUE and if equation 2 is fulfilled for the used frequency:
 - 2> set the variable TRIGGERED_2D_EVENT to FALSE.

Triggering condition:

Equation 1:

$$Q_{Used} \leq T_{Used2d} - H_{2d}/2$$

The variables in the formula are defined as follows:

Q_{Used} is the quality estimate of the used frequency.

T_{Used2d} is the absolute threshold that applies for the used frequency and event 2d.

H_{2d} is the hysteresis parameter for the event 2d.

Leaving triggered state condition:

Equation 2:

$$Q_{Used} > T_{Used2d} + H_{2d}/2$$

The variables in the formula are defined as follows:

Q_{Used} is the quality estimate of the used frequency.

T_{Used2d} is the absolute threshold that applies for the used frequency and event 2d.

H_{2d} is the hysteresis parameter for the event 2d.

14.2.1.5 Event 2e: The estimated quality of a non-used frequency is below a certain threshold

When an inter-frequency measurement configuring event 2e is set up, the UE shall:

- 1> create a variable TRIGGERED_2E_EVENT related to that measurement, which shall initially be empty;
- 1> delete this variable when the measurement is released.

When event 2e is configured in the UE within a measurement, the UE shall:

- 1> if equation 1 below has been fulfilled for one or several non-used frequencies included for that event during the time "Time to trigger":
 - 2> if any of those non-used frequencies is not stored in the variable TRIGGERED_2E_EVENT:
 - 3> store the non-used frequencies that triggered the event and that were not previously stored in the variable TRIGGERED_2E_EVENT into that variable;
 - 3> send a measurement report with IEs set as below:
 - 4> set in "inter-frequency measurement event results":

- 5> "inter-frequency event identity" to "2e"; and
- 5> for each non-used frequency that triggered the event, beginning with the best frequency:
 - 6> "Frequency info" to that non-used frequency; and
 - 6> "Non frequency related measurement event results" to the "Primary CPICH info" of the best primary CPICH for FDD cells or "Primary CCPCH info" to the "Cell parameters ID" of the best primary CCPCH for TDD cells on that non-used frequency, not taking into account the cell individual offset.
- 4> include in the IE "Inter-frequency measured results list" the measured results for each non-used frequency that triggered the event, not taking into account the cell individual offset;
- 4> set the IE "additional measured results" according to subclause 8.4.2, not taking into account the cell individual offset.
- 1> if equation 2 below is fulfilled for a non-used frequency stored in the variable TRIGGERED_2E_EVENT:
 - 2> remove that non-used frequency from the variable TRIGGERED_2E_EVENT.

Triggering condition:

Equation 1:

$$Q_{Nonused} \leq T_{Nonused2e} - H_{2e} / 2$$

The variables in the formula are defined as follows:

$Q_{Non used}$ is the quality estimate of a non-used frequency that becomes worse than an absolute threshold.

$T_{Non used 2e}$ is the absolute threshold that applies for that non-used frequency for that event.

H_{2e} is the hysteresis parameter for the event 2e.

Leaving triggered state condition:

Equation 2:

$$Q_{Nonused} > T_{Nonused2e} + H_{2e} / 2$$

The variables in the formula are defined as follows:

$Q_{Non used}$ is the quality estimate of a non-used frequency stored in the variable TRIGGERED_2E_EVENT.

$T_{Non used 2e}$ is the absolute threshold that applies for that non-used frequency for that event.

H_{2e} is the hysteresis parameter for the event 2e.

14.2.1.6 Event 2 f: The estimated quality of the currently used frequency is above a certain threshold

A UE shall be able to perform this measurement and the corresponding event reporting without requiring compressed mode.

When an inter-frequency measurement configuring event 2f is set up, the UE shall:

- 1> create a variable TRIGGERED_2F_EVENT related to that measurement, which shall initially be set to FALSE;
- 1> delete this variable when the measurement is released.

When event 2f is configured in the UE within a measurement, the UE shall:

- 1> if equation 1 below has been fulfilled for the used frequency during the time "Time to trigger":
 - 2> if the variable TRIGGERED_2F_EVENT is set to FALSE:

3> set the variable TRIGGERED_2F_EVENT to TRUE;

3> send a measurement report with IEs set as below:

4> set in "inter-frequency event results": "inter-frequency event identity" to "2f", and no IE "Inter-frequency cells";

4> include in IE "Inter-frequency measured results list" the measured results for the used frequency, not taking into account the cell individual offset;

4> set the IE "additional measured results" according to subclause 8.4.2, not taking into account the cell individual offset.

1> if the variable TRIGGERED_2F_EVENT is set to TRUE and if equation 2 is fulfilled for the used frequency:

2> set the variable TRIGGERED_2F_EVENT to FALSE.

Triggering condition:

Equation 1:

$$Q_{Used} \geq T_{Used2f} + H_{2f}/2$$

The variables in the formula are defined as follows:

Q_{Used} is the quality estimate of the used frequency.

T_{Used2f} is the absolute threshold that applies for the used frequency and event 2f.

H_{2f} is the hysteresis parameter for the event 2f.

Leaving triggered state condition:

Equation 2:

$$Q_{Used} < T_{Used2f} - H_{2f}/2$$

The variables in the formula are defined as follows:

Q_{Used} is the quality estimate of the used frequency.

T_{Used2f} is the absolute threshold that applies for the used frequency and event 2f.

H_{2f} is the hysteresis parameter for the event 2f.

14.3 Inter-RAT measurements

14.3.0a Inter-RAT measurement quantities

A measurement quantity is used by the UE to evaluate whether an inter-RAT measurement event has occurred or not.

The measurement quantity for UTRAN is used to compute the frequency quality estimate for the active set, as described in the next subclause, and can be:

- 1 Downlink Ec/No.
- 2 Downlink received signal code power (RSCP) after despreading.

The measurement quantity for GSM can be:

- 1 GSM Carrier RSSI

A description of those values can be found in [7] and [8].

14.3.0b Frequency quality estimate of the UTRAN frequency

The estimated quality of the active set in UTRAN in event 3a is defined as:

$$Q_{UTRAN} = 10 \cdot \text{Log} M_{UTRAN} = W \cdot 10 \cdot \text{Log} \left(\sum_{i=1}^{N_A} M_i \right) + (1 - W) \cdot 10 \cdot \text{Log} M_{Best},$$

The variables in the formula are defined as follows:

Q_{UTRAN} is the estimated quality of the active set on the currently used UTRAN frequency.

M_{UTRAN} is the estimated quality of the active set on currently used UTRAN frequency expressed in another unit.

M_i is the measurement result of cell i in the active set, according to what is indicated in the IE "Measurement quantity for UTRAN quality estimate".

N_A is the number of cells in the active set.

M_{Best} is the measurement result of the cell in the active set with the highest measurement result.

W is a parameter sent from UTRAN to UE.

If the measurement result is CPICH-Ec/No M_{UTRAN} , M_i and M_{Best} are expressed as ratios.

If the measurement result is CPICH-RSCP or PCCPCH-RSCP, M_{UTRAN} , M_i and M_{Best} are expressed in mW.

14.3.0c Inter-RAT reporting quantities

The quantities that the UE shall report to UTRAN when the event is triggered for an inter-RAT measurement are given by the IE "Inter-RAT reporting quantity" stored for that measurement, and can be the following:

In the case the other RAT is GSM:

- 1 Observed time difference to the GSM cell
 - The reference cell in the UTRAN is one of the cells in the active set.
- 2 GSM carrier RSSI

A description of those values can be found in [7] and [8].

14.3.1 Inter-RAT reporting events

Within the measurement reporting criteria field in the MEASUREMENT CONTROL message the UTRAN notifies the UE which events should trigger the UE to send a MEASUREMENT REPORT message. The listed events are the toolbox from which the UTRAN can choose the reporting events that are needed for the implemented handover evaluation function, or other radio network functions.

All events are measured with respect to one of the measurement quantities given in subclause 14.3.0a, and of the frequency quality estimate given in subclause 14.3.0b. For UTRAN the measurement quantities are measured on the monitored primary common pilot channels (CPICH) in FDD mode and the monitored primary common control channels (PCCPCH) in TDD mode of the cell defined in the measurement object. For other RATs the measurement quantities are system-specific. A "used UTRAN frequency" is a frequency that the UE have been ordered to measure upon and is also currently used for the connection to UTRAN. "Other system" is e.g. GSM.

In the text below describing the events:

- "The BCCH ARFCN and BSIC combinations considered in that inter-RAT measurement" shall be understood as the BCCH ARFCN and BSIC combinations of the inter-RAT cells pointed at in the IE "Cells for measurement" if it has been received for that inter-RAT measurement, or otherwise of the cells included in the "inter-RAT cell info" part of the variable CELL_INFO LIST.

- "The BCCH ARFCNs considered in that inter-RAT measurement" shall be understood as the BCCH ARFCNs of the inter-RAT cells pointed at in the IE "Cells for measurement" if it has been received for that inter-RAT measurement, or otherwise of the cells included in the "inter-RAT cell info" part of the variable CELL_INFO LIST.

When one inter-RAT measurement identity corresponds to multiple inter-RAT events with identical event identities, the UE behaviour is not specified.

14.3.1.1 Event 3a: The estimated quality of the currently used UTRAN frequency is below a certain threshold **and** the estimated quality of the other system is above a certain threshold.

When an inter-RAT measurement configuring event 3a is set up, the UE shall:

- 1> create a variable TRIGGERED_3A_EVENT related to that measurement, which shall initially be empty;
- 1> delete this variable when the measurement is released.

When event 3a is configured in the UE within a measurement, the UE shall:

- 1> if the other RAT is GSM, and if IE "BSIC verification required" is set to "required":
 - 2> if equations 1 and 2 below have both been fulfilled for a time period indicated by "Time to trigger" from the same instant, respectively for the used UTRAN frequency and for one or several GSM cells that match any of the BCCH ARFCN and BSIC combinations considered in that inter-RAT measurement:
 - 3> if the Inter-RAT cell id of any of those GSM cells is not stored in the variable TRIGGERED_3A_EVENT:
 - 4> store the Inter-RAT cell ids of the GSM cells that triggered the event and that were not previously stored in the variable TRIGGERED_3A_EVENT into that variable.
 - 4> send a measurement report with IEs set as below:
 - 5> in "inter-RAT measurement event result": "inter-RAT event identity" to "3a", "CHOICE BSIC" to "verified BSIC" and "Inter-RAT cell id" to the GSM cells that triggered the event (best one first), taking into account the cell individual offset of the GSM cells;
 - 5> "measured results" and possible "additional measured results" according to subclause 8.6.7.5 and 8.4.2, respectively, not taking into account the cell individual offset.
 - 2> if equation 4 is fulfilled for a GSM cell whose inter-RAT cell id is stored in the variable TRIGGERED_3A_EVENT:
 - 3> remove the inter-RAT cell id of that GSM cell from the variable TRIGGERED_3A_EVENT.
 - 2> if equation 3 is fulfilled for the used frequency in UTRAN:
 - 3> clear the variable TRIGGERED_3A_EVENT.
- 1> if the other RAT is GSM, and if IE "BSIC verification required" is set to "not required":
 - 2> if equations 1 and 2 below have been fulfilled for a time period indicated by "Time to trigger" from the same instant, respectively for the used UTRAN frequency and for one or several BCCH ARFCNs considered in that inter-RAT measurement:
 - 3> if any of those BCCH ARFCNs is not stored into the variable TRIGGERED_3A_EVENT:
 - 4> store the BCCH ARFCNs that triggered the event and that were not previously stored in the variable TRIGGERED_3A_EVENT into that variable;
 - 4> send a measurement report with IEs set as below:
 - 5> in "inter-RAT measurement event result": "inter-RAT event identity" to "3a", "CHOICE BSIC" to "non verified BSIC" and "BCCH ARFCN" to BCCH ARFCNs that triggered the event (best one first), taking into account the cell individual offset of the GSM cells;

5> "measured results" and possible "additional measured results" according to subclause 8.6.7.5 and 8.4.2, respectively, not taking into account the cell individual offset.

2> if equation 4 is fulfilled for a BCCH ARFCN that is stored in the variable TRIGGERED_3A_EVENT:

3> remove that BCCH ARFCN from the variable TRIGGERED_3A_EVENT.

2> if equation 3 is fulfilled for the used frequency in UTRAN:

3> clear the variable TRIGGERED_3A_EVENT.

Triggering conditions:

Equation 1:

$$Q_{Used} \leq T_{Used} - H_{3a} / 2$$

The variables in the formula are defined as follows:

Q_{Used} is the quality estimate of the used UTRAN frequency.

T_{Used} is the absolute threshold that applies for the used frequency in that measurement.

H_{3a} is the hysteresis parameter for event 3a.

Equation 2:

$$M_{Other RAT} + CIO_{Other RAT} \geq T_{Other RAT} + H_{3a} / 2$$

The variables in the formula are defined as follows:

$M_{Other RAT}$ is the measurement quantity for the cell of the other system.

$CIO_{Other RAT}$ is the cell individual offset for the cell of the other system.

$T_{Other RAT}$ is the absolute threshold that applies for the other system in that measurement.

H_{3a} is the hysteresis parameter for event 3a.

Leaving triggered state conditions:

Equation 3:

$$Q_{Used} > T_{Used} + H_{3a} / 2$$

The variables in the formula are defined as follows:

Q_{Used} is the quality estimate of the used UTRAN frequency.

T_{Used} is the absolute threshold that applies for the used frequency in that measurement.

H_{3a} is the hysteresis parameter for event 3a.

Equation 4:

$$M_{Other RAT} + CIO_{Other RAT} < T_{Other RAT} - H_{3a} / 2$$

The variables in the formula are defined as follows:

$M_{Other RAT}$ is the measurement quantity for the cell of the other system. $M_{Other RAT}$ is expressed in dBm.

$CIO_{Other RAT}$ is the cell individual offset for the cell of the other system.

$T_{Other RAT}$ is the absolute threshold that applies for the other system in that measurement.

H_{3a} is the hysteresis parameter for event 3a.

14.3.1.2 Event 3b: The estimated quality of other system is below a certain threshold

When an inter-RAT measurement configuring event 3b is set up, the UE shall:

- 1> create a variable TRIGGERED_3B_EVENT related to that measurement, which shall initially be empty;
- 1> delete this variable when the measurement is released.

When event 3b is configured in the UE within a measurement, the UE shall:

- 1> if the other RAT is GSM, and if IE "BSIC verification required" is set to "required":
 - 2> if equation 1 below has been fulfilled for a time period indicated by "time to trigger" for one or several GSM cells that match any of the BCCH ARFCN and BSIC combinations considered in that inter-RAT measurement:
 - 3> if the inter-RAT cell id of any of those GSM cell is not stored in the variable TRIGGERED_3B_EVENT:
 - 4> store the inter-RAT cell ids of the GSM cells that triggered the event and that were not previously stored in the variable TRIGGERED_3B_EVENT into that variable;
 - 4> send a measurement report with IEs set as below:
 - 5> set in "inter-RAT measurement event result": "inter-RAT event identity" to "3b", "CHOICE BSIC" to "verified BSIC" and "Inter-RAT cell id" to the GSM cells that triggered the event (worst one first), taking into account the cell individual offset of the GSM cells;
 - 5> set the IE "measured results" and the IE "additional measured results" according to subclause 8.6.7.5 and 8.4.2, respectively, not taking into account the cell individual offset.
 - 2> if equation 2 below is fulfilled for a GSM cell whose inter-RAT cell id is stored in the variable TRIGGERED_3B_EVENT:
 - 3> remove the inter-RAT cell id of that GSM cell from the variable TRIGGERED_3B_EVENT.
- 1> if the other RAT is GSM, and if IE "BSIC verification required" is set to "not required":
 - 2> if equation 1 below has been fulfilled for a time period indicated by "time to trigger" for one or several of the BCCH ARFCNs considered in that inter-RAT measurement:
 - 3> if any of those BCCH ARFCN is not stored into the variable TRIGGERED_3B_EVENT:
 - 4> store the BCCH ARFCNs that triggered the event and that were not previously stored in the variable TRIGGERED_3B_EVENT into that variable;
 - 4> send a measurement report with IEs set as below:
 - 5> set in "inter-RAT measurement event result": "inter-RAT event identity" to "3b", "CHOICE BSIC" to "non verified BSIC" and "BCCH ARFCN" to BCCH ARFCNs that triggered the event (worst one first), taking into account the cell individual offset of the GSM cells;
 - 5> set the IE "measured results" and the IE "additional measured results" according to subclause 8.6.7.5 and 8.4.2, respectively, not taking into account the cell individual offset.
 - 2> if equation 2 below is fulfilled for a BCCH ARFCN that is stored in the variable TRIGGERED_3B_EVENT:
 - 3> remove that BCCH ARFCN from the variable TRIGGERED_3B_EVENT.

Triggering condition:

Equation 1:

$$M_{Other\ RAT} + CIQ_{Other\ RAT} \leq T_{Other\ RAT} - H_{3b} / 2$$

The variables in the formula are defined as follows:

$M_{Other\ RAT}$ is the measurement quantity for the cell of the other system.

$CIO_{Other\ RAT}$ is the cell individual offset for the cell of the other system.

$T_{Other\ RAT}$ is the absolute threshold that applies for the other system in that measurement.

H_{3b} is the hysteresis parameter for event 3b.

Leaving triggered state condition:

Equation 2:

$$M_{Other\ RAT} + CIO_{Other\ RAT} > T_{Other\ RAT} + H_{3b}/2$$

The variables in the formula are defined as follows:

$M_{Other\ RAT}$ is the measurement quantity for the cell of the other system. $M_{Other\ RAT}$ is expressed in dBm.

$CIO_{Other\ RAT}$ is the cell individual offset for the cell of the other system.

$T_{Other\ RAT}$ is the absolute threshold that applies for the other system in that measurement.

H_{3b} is the hysteresis parameter for event 3b.

14.3.1.3 Event 3c: The estimated quality of other system is above a certain threshold

When an inter-RAT measurement configuring event 3c is set up, the UE shall:

- 1> create a variable TRIGGERED_3C_EVENT related to that measurement, which shall initially be empty;
- 1> delete this variable when the measurement is released.

When event 3c is configured in the UE within a measurement, the UE shall:

- 1> if the other RAT is GSM, and if IE "BSIC verification required" is set to "required":
 - 2> if equation 1 below has been fulfilled for a time period indicated by "time to trigger" for one or several GSM cells that match any of the BCCH ARFCN and BSIC combinations considered in that inter-RAT measurement:
 - 3> if the inter-RAT cell id of any of those GSM cell is not stored in the variable TRIGGERED_3C_EVENT:
 - 4> store the Inter-RAT cell ids of the GSM cells that triggered the event and that were not previously stored in the variable TRIGGERED_3C_EVENT into that variable;
 - 4> send a measurement report with IEs set as below:
 - 5> set in "inter-RAT measurement event result": "inter-RAT event identity" to "3c", "CHOICE BSIC" to "verified BSIC" and "Inter-RAT cell id" to the GSM cells that triggered the event (best one first), taking into account the cell individual offset of the GSM cells;
 - 5> set the IE "measured results" and the IE "additional measured results" according to subclause 8.6.7.5 and 8.4.2, respectively, not taking into account the cell individual offset.
 - 2> if equation 2 below is fulfilled for a GSM cell whose inter-RAT cell id is stored in the variable TRIGGERED_3C_EVENT:
 - 3> remove the inter-RAT cell id of that GSM cell from the variable TRIGGERED_3C_EVENT.
- 1> if the other RAT is GSM, and if IE "BSIC verification required" is set to "not required":
 - 2> if equation 1 below has been fulfilled for a time period indicated by "time to trigger" for one or several of the BCCH ARFCNs considered in that inter-RAT measurement:

- 3> if any of those BCCH ARFCN is not stored into the variable TRIGGERED_3C_EVENT:
 - 4> store the BCCH ARFCNs that triggered the event and that were not previously stored in the variable TRIGGERED_3C_EVENT into that variable;
 - 4> send a measurement report with IEs set as below:
 - 5> set in "inter-RAT measurement event result": "inter-RAT event identity" to "3c", "CHOICE BSIC" to "non verified BSIC" and "BCCH ARFCN" to BCCH ARFCNs that triggered the event (best one first), taking into account the cell individual offset of the GSM cells;
 - 5> set the IE "measured results" and the IE "additional measured results" according to subclause 8.6.7.5 and 8.4.2, respectively, not taking into account the cell individual offset.
- 2> if equation 2 is fulfilled for a BCCH ARFCN that is stored in the variable TRIGGERED_3C_EVENT:
 - 3> remove that BCCH ARFCN from the variable TRIGGERED_3C_EVENT.

Triggering condition:

Equation 1:

$$M_{Other\ RAT} + CIO_{Other\ RAT} \geq T_{Other\ RAT} + H_{3c} / 2$$

The variables in the formula are defined as follows:

$M_{Other\ RAT}$ is the measurement quantity for the cell of the other system. $M_{Other\ RAT}$ is expressed in dBm.

$CIO_{Other\ RAT}$ is the cell individual offset for the cell of the other system.

$T_{Other\ RAT}$ is the absolute threshold that applies for the other system in that measurement.

H_{3c} is the hysteresis parameter for event 3c.

Leaving triggered state condition:

Equation 2:

$$M_{Other\ RAT} + CIO_{Other\ RAT} < T_{Other\ RAT} - H_{3c} / 2$$

The variables in the formula are defined as follows:

$M_{Other\ RAT}$ is the measurement quantity for the cell of the other system. $M_{Other\ RAT}$ is expressed in dBm.

$CIO_{Other\ RAT}$ is the cell individual offset for the cell of the other system.

$T_{Other\ RAT}$ is the absolute threshold that applies for the other system in that measurement.

H_{3c} is the hysteresis parameter for event 3c.

14.3.1.4 Event 3d: Change of best cell in other system

When an inter-RAT measurement configuring event 3d is set up, the UE shall:

- 1> create a variable BEST_CELL_3D_EVENT related to that measurement;
- 1> delete this variable when the measurement is released.

When event 3d is configured in the UE within a measurement, the UE shall:

- 1> if the other RAT is GSM, and if IE "BSIC verification required" is set to "required":
 - 2> when the measurement is initiated or resumed:
 - 3> store in the variable BEST_CELL_3D_EVENT the Inter-RAT cell id of the GSM cell that has the best measured quantity among the GSM cells that match any of the BCCH ARFCN and BSIC combinations considered in that inter-RAT measurement, not taking into account the cell individual offset of the GSM cells;
 - 3> send a measurement report with IE set as below:
 - 4> set in "inter-RAT measurement event result": "inter-RAT event identity" to "3d", "CHOICE BSIC" to "verified BSIC" and "Inter-RAT cell id" to the GSM cell that is stored in the variable BEST_CELL_3D_EVENT;
 - 4> set the IE "measured results" and the IE "additional measured results" according to subclause 8.6.7.5 and 8.4.2, respectively, not taking into account the cell individual offset.
 - 2> if equation 1 has been fulfilled for a time period indicated by "time to trigger" for a GSM cell that is different from the one stored in BEST_CELL_3D_EVENT and that matches any of the BCCH ARFCN and BSIC combinations considered in that inter-RAT measurement:
 - 3> store the Inter-RAT cell id of that GSM cell in the variable BEST_CELL_3D_EVENT;
 - 3> send a measurement report with IEs set as below:
 - 4> set in "inter-RAT measurement event result": "inter-RAT event identity" to "3d", "CHOICE BSIC" to "verified BSIC" and "Inter-RAT cell id" to the GSM cell is now stored in BEST_CELL_3D_EVENT;
 - 4> set the IE "measured results" and the IE "additional measured results" according to subclause 8.6.7.5 and 8.4.2, respectively, not taking into account the cell individual offset.
- 1> if the other RAT is GSM, and if IE "BSIC verification required" is set to "not required":
 - 2> when the measurement is initiated or resumed:
 - 3> store in the variable BEST_CELL_3D_EVENT the BCCH ARFCN of the GSM cell that has the best measured quantity among the BCCH ARFCNs considered in that inter-RAT measurement;
 - 3> send a measurement report with IE set as below:
 - 4> set in "inter-RAT measurement event result": "inter-RAT event identity" to "3d", "CHOICE BSIC" to "non verified BSIC" and "BCCH ARFCN" to the BCH ARFCN that is stored in the variable BEST_CELL_3D_EVENT;
 - 4> set the IE "measured results" and the IE "additional measured results" according to subclause 8.6.7.5 and 8.4.2, respectively, not taking into account the cell individual offset.
 - 2> if equation 1 below has been fulfilled for a time period indicated by "time to trigger" for one of the BCCH ARFCNs considered in that inter-RAT measurement and different from the one stored in BEST_CELL_3D_EVENT:
 - 3> store the BCCH ARFCN of that GSM cell in the variable BEST_CELL_3D_EVENT;
 - 3> send a measurement report with IEs set as below:
 - 4> set in "inter-RAT measurement event result": "inter-RAT event identity" to "3d", "CHOICE BSIC" to "non verified BSIC" and "BCCH ARFCN" to the BCCH ARFCN that is now stored in the variable BEST_CELL_3D_EVENT;
 - 4> set the IE "measured results" and the IE "additional measured results" according to subclause 8.4.2, not taking into account the cell individual offset.

Equation 1:

$$M_{New} \geq M_{Best} + H_{3d} / 2$$

The variables in the formula are defined as follows:

M_{New} is the measurement quantity for a GSM cell that is not stored in the variable BEST_CELL_3D_EVENT.

M_{Best} is the measurement quantity for a GSM cell that is stored in the variable BEST_CELL_3D_EVENT.

H_{3d} is the hysteresis parameter for event 3d.

14.3.2 GSM measurements in compressed mode

14.3.2.1 GSM RSSI measurements

The UE shall perform GSM RSSI measurements in the gaps of compressed mode pattern sequence specified for GSM RSSI measurement purpose. The UE cannot be required to measure "Observed time difference to GSM" in gaps specified for this purpose.

14.3.2.2 Initial BSIC identification

The UE shall perform Initial BSIC identification in compressed mode pattern sequence specified for Initial BSIC identification measurement purpose.

The parameter "N identify abort" in the IE "DPCH compressed mode info" indicates the maximum number of patterns that the UE shall use to attempt to decode the unknown BSIC of the GSM cell in the initial BSIC identification procedure.

The UE shall be able to measure the "Observed time difference to GSM cell" during a compressed mode pattern sequence configured for this purpose.

The BSIC identification procedure is defined in detail in [19].

14.3.2.3 BSIC re-confirmation

The UE shall perform BSIC re-confirmation in compressed mode pattern sequence specified for BSIC re-confirmation measurement purpose.

The parameter "T reconfirm abort" in the IE "DPCH compressed mode info" indicates the maximum time allowed for the re-confirmation of the BSIC of one GSM cell in the BSIC re-confirmation procedure.

The UE shall be able to measure the "Observed time difference to GSM cell" during a compressed mode pattern sequence configured for this purpose.

The BSIC re-confirmation procedure is defined in detail in [19].

14.4 Traffic Volume Measurements

14.4.1 Traffic Volume Measurement Quantity

Traffic volume measurements may be configured by RRC to assist with dynamic radio bearer control. The reported quantities that can be configured are:

- 1 Buffer Occupancy.
- 2 Average of Buffer Occupancy.
- 3 Variance of Buffer Occupancy.

A description of these values can be found in [15].

When a report is triggered, the UE shall provide the requested quantities for the acknowledged and unacknowledged mode RBs mapped onto the transport channels identified.

When the RLC buffer payload, Average of RLC buffer payload or Variance of RLC buffer payload is reported, the measured quantity shall be rounded upwards to the closest higher value possible to report.

14.4.2 Traffic Volume reporting triggers

Traffic volume measurement reports can be triggered using two different mechanisms, periodical and event triggered. The reporting criteria are specified in the measurement control message.

All the specified events are evaluated with respect to the Transport Channel Traffic Volume (TCTV). This quantity is equal to the sum of the Buffer Occupancy for all logical channels mapped onto a transport channel. The events on a given transport channel shall be evaluated at least at every TTI (may be more often) as described in [15].

When one traffic volume measurement identity corresponds to multiple traffic volume events with identical event identities for the same transport channel, the UE behaviour is not specified.

When a traffic volume measurement is set up, the UE shall:

- 1> if the IE "report criteria" is set to "Traffic volume measurement reporting criteria":
 - 2> for each IE "Parameters sent for each transport channel":
 - 3> if the IE "Uplink transport channel type" is not included; or
 - 3> if the IE "Uplink Transport Channel Type" has the value "DCH" or "USCH" and the IE "UL transport channel id" is not included:
 - 4> for each IE "Parameters required for each Event":
 - 5> for each uplink transport channel on which the UE is supposed to report (see below):
 - 6> configure an event trigger defined by the values in the IEs "Measurement Identity", "Traffic volume event identity", "Reporting threshold", "Time to trigger", "Pending time after trigger" and "Tx Interruption after trigger".
 - 3> else:
 - 4> for each IE "Parameters required for each Event":
 - 5> for the uplink transport channel defined by the IEs "Uplink transport channel type" and "UL transport channel id":
 - 6> configure an event trigger defined by the values in the IEs "Measurement Identity", "Traffic volume event identity", "Reporting threshold", "Time to trigger", "Pending time after trigger" and "Tx Interruption after trigger".
- 1> else:
 - 2> if the IE "report criteria" is set to "Periodical reporting criteria":
 - 2> configure periodical triggers with period equal to the value in the IE "Reporting Interval" and with number of transmissions equal to the value in the IE "Amount of reporting" for the measurement identified by the IE "Measurement Identity".

For each transport channel for which an event trigger has been configured, the UE shall:

- 1> for each event configured for this transport channel:
 - 2> if the TCTV is larger than the threshold in IE "Reporting threshold" at TVM setup or modify; or
 - 2> if the TCTV becomes larger than the threshold in IE "Reporting threshold" while the event is configured:
 - 3> if the IE "Traffic volume event identity" has value "4a":

- 4> if the IE "Time to trigger" is not present; and
- 4> if the Pending-time-after-trigger timer for this event is not active:
 - 5> if the IE "Pending time after trigger" is included:
 - 6> start the Pending-time-after-trigger timer for this event with the value in this IE.
 - 5> trigger a report for the measurement identified by the IE "Measurement Identity".
- 4> else:
 - 5> start the Time-to-trigger timer for this event with the value in the IE "Time to trigger".
- 3> if the IE "Traffic volume event identity" has value "4b":
 - 4> if the Time-to-trigger timer for this event is active:
 - 5> stop this timer.
- 2> if the TCTV is smaller than the threshold in IE "Reporting threshold" at TVM setup or modify; or
- 2> if the TCTV becomes smaller than the threshold in IE "Reporting threshold" while the event is configured:
 - 3> if the IE "Traffic volume event identity" has value "4a":
 - 4> if the Time-to-trigger timer for this event is active:
 - 5> stop this timer.
 - 3> if the IE "Traffic volume event identity" has value "4b":
 - 4> if the IE "Time to trigger" is not present; and
 - 4> if the Pending-time-after-trigger timer for this event is not active:
 - 5> if the IE "Pending time after trigger" is included:
 - 6> start the Pending-time-after-trigger timer for this event with the value in this IE.
 - 5> trigger a report for the measurement identified by the IE "Measurement Identity".
 - 4> else:
 - 5> start the Time-to-trigger timer for this event with the value in the IE "Time to trigger".

When the Time-to-trigger timer for an event elapses:

- 1> if the Pending-time-after-trigger timer for this event is not active:
 - 2> trigger a report for the measurement identified by the IE "Measurement Identity" corresponding to this event;
- 2> if the IE "Pending time after trigger" is included:
 - 3> start the Pending-time-after-trigger timer for this event with the value in this IE.

When the Pending-time-after-trigger for an event elapses:

- 1> if the IE "Traffic volume event identity" has value "4a":
 - 2> if the TCTV is larger than the threshold in IE "Reporting threshold":
 - 3> if the IE "Time to trigger" is not present:
 - 4> trigger a report for the measurement identified by the IE "Measurement Identity" corresponding to this event;
 - 4> start the Pending-time-after-trigger timer for this event with the value in the IE "Pending time after trigger".

3> else:

4> start the Time-to-trigger timer for this event with the value in the IE "Time to trigger".

1> if the IE "Traffic volume event identity" has value "4b":

2> if the TCTV is smaller than the threshold in IE "Reporting threshold":

3> if the IE "Time to trigger" is not present:

4> trigger a report for the measurement identified by the IE "Measurement Identity" corresponding to this event;

4> start the Pending-time-after-trigger timer for this event with the value in the IE "Pending time after trigger".

3> else:

4> start the Time-to-trigger timer for this event with the value in the IE "Time to trigger".

When a periodical trigger elapses, the UE shall:

1> trigger a report for the measurement identified by the IE "Measurement Identity";

1> if the number of reports triggered by this periodical trigger reaches the value in the IE "Amount of reporting":

2> disable this periodical trigger.

When a report is triggered for a given IE "Measurement Identity", the UE shall:

1> consider the variable MEASUREMENT_IDENTITY corresponding to this measurement identity;

1> if the report is triggered by an event trigger:

2> include the IE "Event results";

2> set the IE "Uplink transport channel type causing the event" to the type of the transport channel which triggered the report;

2> if the transport channel type is "DCH" or "USCH":

3> include the IE "UL Transport Channel identity" and set it to the identity of the transport channel which triggered the report.

2> else:

3> not include the IE "UL Transport Channel identity".

2> set the IE "Traffic volume event identity" to the identity of the event that triggered the report;

2> if the IE "Tx interruption after trigger" for the event that triggered the report is included:

3> if the UE is in CELL_FACH state:

4> prohibit DTCH transmissions on the RACH;

4> if the Tx interruption timer is not running; or

4> if the Tx interruption timer is running and still has a value larger than the IE "Tx interruption after trigger" for the event, i.e. it was started earlier by another event with a larger value in IE "Tx interruption after trigger":

5> start the Tx interruption timer with the value in the IE "Tx interruption after trigger" for this event.

4> when it receives from the UTRAN a message causing the transition to CELL_DCH state; or

4> when the Tx interruption timer elapses:

- 5> stop the timer;
- 5> resume these transmissions.
- 1> if the IE "Traffic volume measurement object" is not included:
 - 2> report on all the uplink transport channels as specified below.
- 1> if the IE "Traffic volume measurement object" is included:
 - 2> report on the uplink transport channels identified in this IE as specified below.
- 1> for each UM or AM RB mapped onto a transport channel on which the UE is expected to report:
 - 2> add an element in the IE "Traffic volume measurement results";
 - 2> set the value of the IE "RB Identity" to the identity of the considered radio bearer;
 - 2> if the RB is mapped onto one logical channel:
 - 3> if the IE "RLC Buffer Payload for each RB" is set to TRUE:
 - 4> include the IE "RLC Buffers Payload" and set it to the Buffer Occupancy value for this logical channel, rounded up to the next allowed value.
 - 3> if the IE "Average of RLC Buffer Payload for each RB" is set to TRUE:
 - 4> include and set the IE "Average of RLC Buffer Payload" to the Buffer Occupancy for this logical channel averaged over the interval specified in the IE "Time Interval to take an average or a variance" (see [15]), rounded up to the next allowed value.
 - 3> if the IE "Variance of RLC Buffer Payload for each RB" is set to TRUE:
 - 4> include and set the IE "Variance of RLC Buffer Payload" to the variance of the Buffer Occupancy for this logical channel computed over the interval specified in the IE "Time Interval to take an average or a variance" (see [15]), rounded up to the next allowed value.
 - 2> if the RB is mapped onto two logical channels:
 - 3> if one logical channel is mapped onto transport channels on which the UE is supposed to report:
 - 4> if the IE "RLC Buffer Payload for each RB" is set to TRUE:
 - 5> include and set the IE "RLC Buffers Payload" to the Buffer Occupancy value for this logical channel, rounded up to the next allowed value.
 - 4> if the IE "Average of RLC Buffer Payload for each RB" is set to TRUE:
 - 5> include and set the IE "Average of RLC Buffer Payload" to the Buffer Occupancy for this logical channel averaged over the interval specified in the IE "Time Interval to take an average or a variance" (see [15]), rounded up to the next allowed value.
 - 4> if the IE "Variance of RLC Buffer Payload for each RB" is set to TRUE:
 - 5> include and set the IE "Variance of RLC Buffer Payload" to the variance of the Buffer Occupancy for this logical channel computed over the interval specified in the IE "Time Interval to take an average or a variance" (see [15]), rounded up to the next allowed value.
 - 3> if both logical channels are mapped onto transport channels on which the UE is supposed to report:
 - 4> if the IE "RLC Buffer Payload for each RB" is set to TRUE:
 - 5> include and set the IE "RLC Buffers Payload" to the sum of the Buffer Occupancy values for the two logical channels, rounded up to the next allowed value.
 - 4> if the IE "Average of RLC Buffer Payload for each RB" is set to TRUE:

5> include and set the IE "Average of RLC Buffer Payload" to the sum of the Buffer Occupancy for the two logical channels averaged over the interval specified in the IE "Time Interval to take an average or a variance" (see [15]) and rounded up to the next allowed value.

4> if the IE "Variance of RLC Buffer Payload for each RB" is set to TRUE:

5> include and set the IE "Variance of RLC Buffer Payload" to the variance of the sum of the Buffer Occupancy for the two logical channels, computed over the interval specified in the IE "Time Interval to take an average or a variance" (see [15]) and rounded up to the next allowed value.

14.4.2.1 Reporting event 4 A: Transport Channel Traffic Volume becomes larger than an absolute threshold

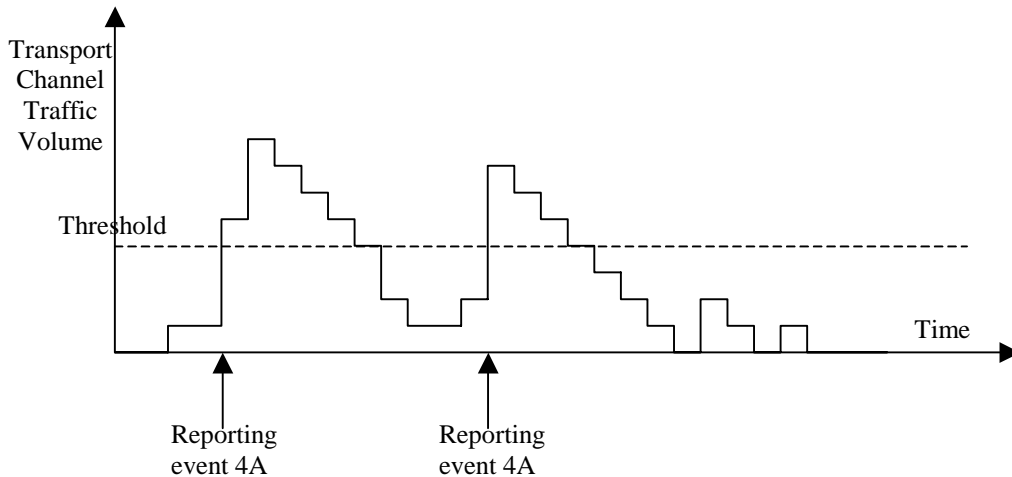

Figure 14.4.2.1-1: Event triggered report when Transport Channel Traffic Volume becomes larger than a certain threshold

If the monitored Transport Channel Traffic Volume (TCTV) [15] is larger than an absolute threshold at TVM setup or modify, or becomes larger than an absolute threshold while the event is configured i.e. if $TCTV > \text{Reporting threshold}$, this event could trigger a report. The event could be triggered again only if $TCTV < \text{Reporting threshold}$ and later $TCTV > \text{Reporting threshold}$ is verified again.

14.4.2.2 Reporting event 4 B: Transport Channel Traffic Volume becomes smaller than an absolute threshold

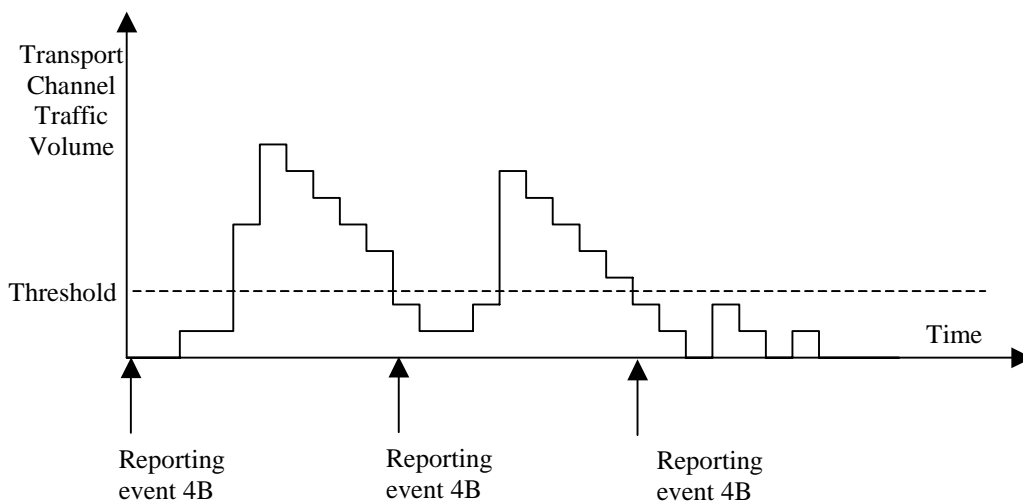

Figure 14.4.2.1-2: Event triggered report when Transport Channel Traffic Volume becomes smaller than certain threshold

If the monitored Transport Channel Traffic Volume (TCTV) [15] is smaller than an absolute threshold at TVM setup or modify, or becomes smaller than an absolute threshold while the event is configured i.e. if $TCTV < \text{Reporting threshold}$, this event could trigger a report. The event could be triggered again only if TCTV becomes bigger than the Reporting threshold and later $TCTV < \text{Reporting threshold}$ is verified again.

14.4.3 Traffic volume reporting mechanisms

Traffic volume measurement triggering could be associated with both a *time-to-trigger* and a *pending time after trigger*. The time-to-trigger is used to get time domain hysteresis, i.e. the condition must be fulfilled during the time-to-trigger time before a report is sent. Pending time after trigger is used to limit consecutive reports when one traffic volume measurement report already has been sent and enables periodic reporting while the TCTV remains above(4a) or below(4b) the threshold. This is described in detail below.

14.4.3.1 Pending time after trigger

This timer is started in the UE when a measurement report has been triggered by a given event. The UE is then forbidden to send new measurement reports triggered by the same event during this time period. Instead the UE waits until the timer has expired. If the Transport Channel Traffic Volume [15] is still above the threshold for event 4a, or below the threshold for event 4b when the timer expires, the UE sends a new measurement report, and the timer is restarted. Otherwise it waits for a new triggering.

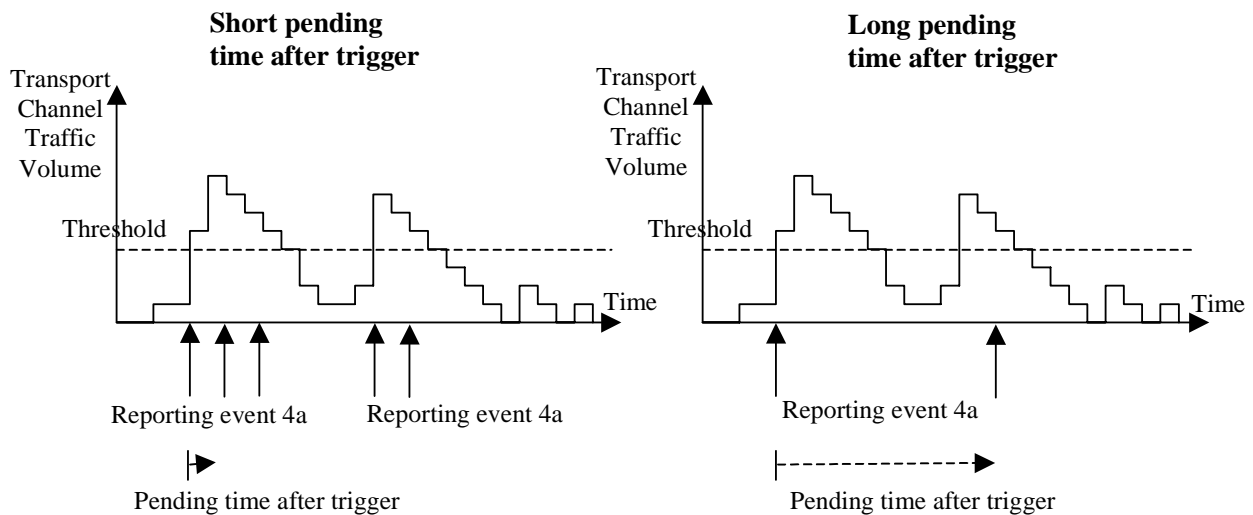

Figure 14.4.3.1-1: Pending time after trigger limits the amount of consecutive measurement reports

Figure 14.4.3.1-1 shows that by increasing the pending time after trigger a triggered second event does not result in a measurement report. The figure assumes absence of the IE "Time to trigger".

14.4.3.2 Time-to-trigger

The timer is started in the UE when the Transport Channel Traffic Volume triggers the event. If the TCTV crosses the threshold before the timer expires, the timer is stopped. If the timer expires then a report is triggered.

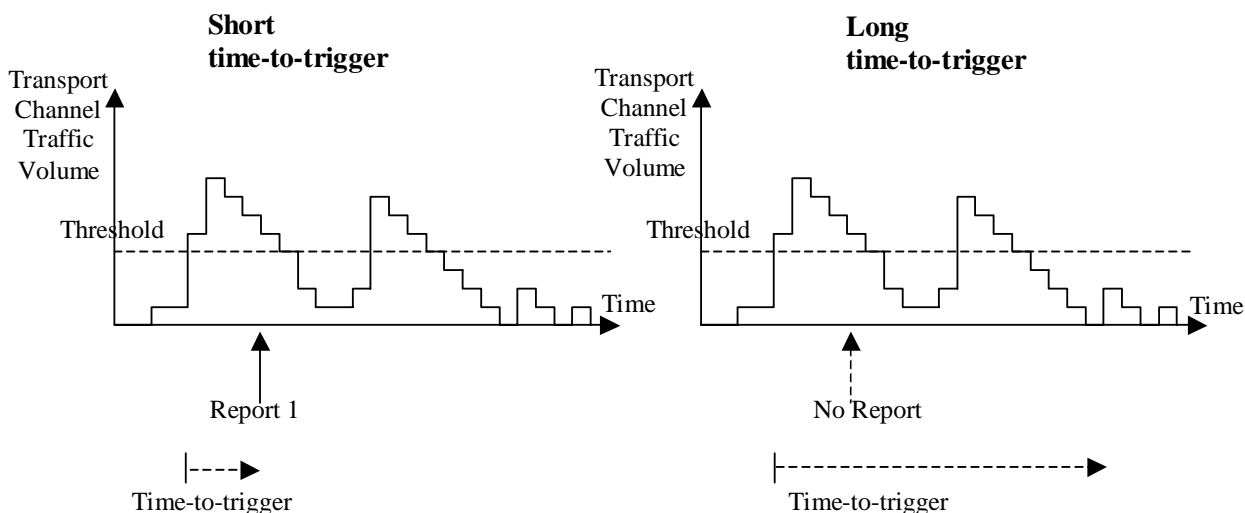

Figure 14.4.3.1-2: Time-to-trigger is used to achieve time hysteresis

Figure 14.4.3.1-2 shows that by increasing the time-to-trigger the report is not triggered.

14.4.4 Interruption of user data transmission

By including the IE "Tx Interruption after trigger", a UE in CELL_FACH state may be instructed by the UTRAN to prohibit transmission of user data on the RACH temporarily after a measurement report has been triggered.

The UE shall only resume transmission of user data, when:

- 1> it receives from the UTRAN a message allocating a dedicated physical channel, leading to the transition to CELL_DCH state; or
- 1> the time period indicated by the IE "Tx Interruption after trigger" elapses.

The transmission on signalling radio bearers shall not be interrupted.

14.5 Quality Measurements

14.5.1 Quality reporting measurement quantities

For quality measurements, the following measurement quantities are used:

1. Downlink transport channel BLER
2. Timeslot SIR (TDD only)

14.5.2 Quality reporting events

When one measurement identity corresponds to multiple quality events for the same transport channel, the UE behaviour is not specified.

14.5.2.1 Reporting event 5A: A predefined number of bad CRCs is exceeded

When this event is ordered by UTRAN in a measurement control message, the UE shall send a measurement report when the amount of bad CRCs during a predefined sliding window exceeds a predefined number.

The following three parameters are used in the scheme:

- **Total CRC** = the length of the sliding window over which the number of bad CRCs are counted.

- **Bad CRC** = the number of bad CRC that is required within the latest "Total CRC" received CRCs for the event to be triggered.
- **Pending after trigger** = a new event can not be triggered until "Pending after trigger" CRCs have been received,

When a DCH is established, the UE shall begin to count the number of bad CRCs within the last "Total CRC" received CRCs. No event can be triggered until at least "Total CRC" CRCs have been received. For each new received CRC, the UE shall compare the number of bad CRCs within the latest "Total CRC" received CRCs with the parameter "Bad CRC". An event shall be triggered if the number of bad CRCs is equal or larger than "Bad CRC".

At the time when the event is triggered a pending time after trigger timer is started with the length of "Pending after trigger" CRCs. A new event can not be triggered until "Pending after trigger" CRCs have been received. When "Pending after trigger" CRCs have been received the event evaluation start again and a new event can be triggered.

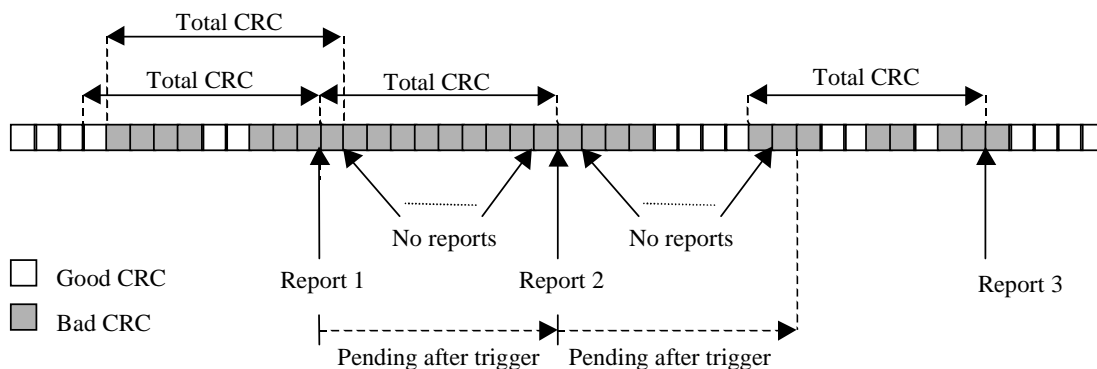

Figure 14.5.2.1-1: Event triggered CRC error reporting

14.6 UE internal measurements

14.6.1 UE internal measurement quantities

For UE internal measurements the following measurement quantities exist:

1. UE transmission (Tx) power, for TDD measured on a timeslot basis.
2. UE received signal strength power (RSSI).
3. UE Rx-Tx time difference (FDD only).
4. T_{ADV} (1.28 Mcps TDD).

14.6.2 UE internal measurement reporting events

In the Measurement reporting criteria field in the Measurement Control messages, the UTRAN notifies the UE of which events should trigger a measurement report. UE internal measurement reporting events that can trigger a report are given below. The reporting events are marked with vertical arrows in the figures below. All events can be combined with time-to-trigger.

NOTE: The reporting events are numbered 6A, 6B, 6C,... where 6 denotes that the event belongs to the type UE internal measurements.

When one measurement identity corresponds to multiple internal events with identical event identities, the UE behaviour is not defined.

14.6.2.1 Reporting event 6A: The UE Tx power becomes larger than an absolute threshold

When a UE internal measurement configuring event 6a is set up, the UE shall:

- 1> create a variable TRIGGERED_6A_EVENT related to that measurement, which shall initially be set to FALSE;
- 1> delete this variable when the measurement is released.

When this event is ordered by UTRAN in a measurement control message, the UE shall:

- 1> if the UE Tx power (for TDD within a single TS) is greater than the value in IE "UE Transmitted Power Tx power threshold" stored for this event in the variable MEASUREMENT_IDENTITY for a time period indicated by the IE "time_to_trigger":
 - 2> if the variable TRIGGERED_6A_EVENT is set to FALSE:
 - 3> set the variable TRIGGERED_6A_EVENT to TRUE;
 - 3> send a measurement report with IEs set as below:
 - 4> set in "UE internal measurement event results": "UE internal event identity" to "6a";
 - 4> set the IE "measured results" and the IE "additional measured results" according to 8.4.2.
 - 1> if the variable TRIGGERED_6A_EVENT is set to TRUE and if the UE Tx power (for TDD within a single TS) is less or equal the value in IE "UE Transmitted Power Tx power threshold" stored for this event in the variable MEASUREMENT_IDENTITY:
 - 2> set the variable TRIGGERED_6A_EVENT to FALSE.

14.6.2.2 Reporting event 6B: The UE Tx power becomes less than an absolute threshold

When a UE internal measurement configuring event 6b is set up, the UE shall:

- 1> create a variable TRIGGERED_6B_EVENT related to that measurement, which shall initially be set to FALSE;
- 1> delete this variable when the measurement is released.

When this event is ordered by UTRAN in a measurement control message, the UE shall:

- 1> if the UE Tx power (for TDD within a single TS) is less than the value in IE "UE Transmitted Power Tx power threshold" stored for this event in the variable MEASUREMENT_IDENTITY for a time period indicated by the IE "time_to_trigger":
 - 2> if the variable TRIGGERED_6B_EVENT is set to FALSE:
 - 3> set the variable TRIGGERED_6B_EVENT to TRUE;
 - 3> send a measurement report with IEs set as below:
 - 4> set in "UE internal measurement event results": "UE internal event identity" to "6b";
 - 4> set the IE "measured results" and the IE "additional measured results" according to 8.4.2.
 - 1> if the variable TRIGGERED_6B_EVENT is set to TRUE and if the UE Tx power (for TDD within a single TS) is greater or equal the value in IE "UE Transmitted Power Tx power threshold" stored for this event in the variable MEASUREMENT_IDENTITY:
 - 2> set the variable TRIGGERED_6B_EVENT to FALSE.

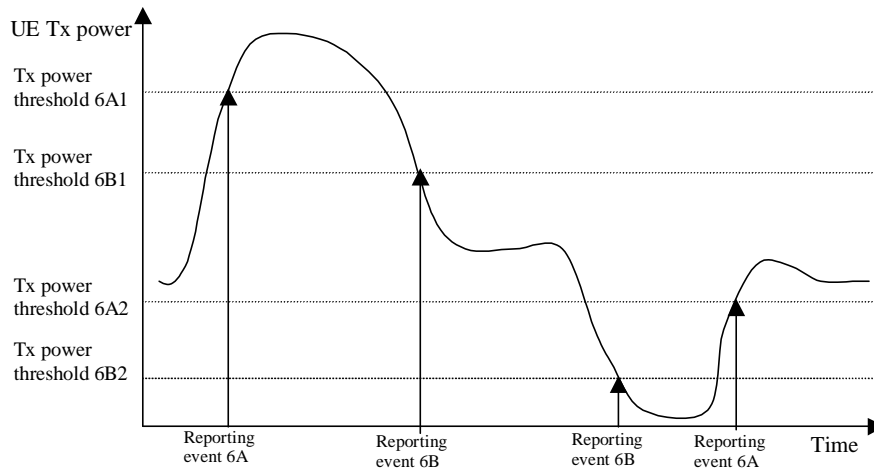

Figure 14.6.2.2-1: Event-triggered measurement reports when the UE Tx power becomes larger or less than absolute thresholds

14.6.2.3 Reporting event 6C: The UE Tx power reaches its minimum value

When a UE internal measurement configuring event 6c is set up, the UE shall:

- 1> create a variable TRIGGERED_6C_EVENT related to that measurement, which shall initially be set to FALSE;
- 1> delete this variable when the measurement is released.

When this event is ordered by UTRAN in a measurement control message, the UE shall:

- 1> if the UE Tx power is equal its minimum value (for TDD its minimum value on a single TS) for a time period indicated by the IE "time_to_trigger":
 - 2> if the variable TRIGGERED_6C_EVENT is set to FALSE:
 - 3> set the variable TRIGGERED_6C_EVENT to TRUE;
 - 3> send a measurement report with IEs set as below:
 - 4> set in "UE internal measurement event results": "UE internal event identity" to "6c";
 - 4> set the IE "measured results" and the IE "additional measured results" according to 8.4.2.
 - 1> if the variable TRIGGERED_6C_EVENT is set to TRUE and if the UE Tx power is greater than its minimum value:
 - 2> set the variable TRIGGERED_6C_EVENT to FALSE.

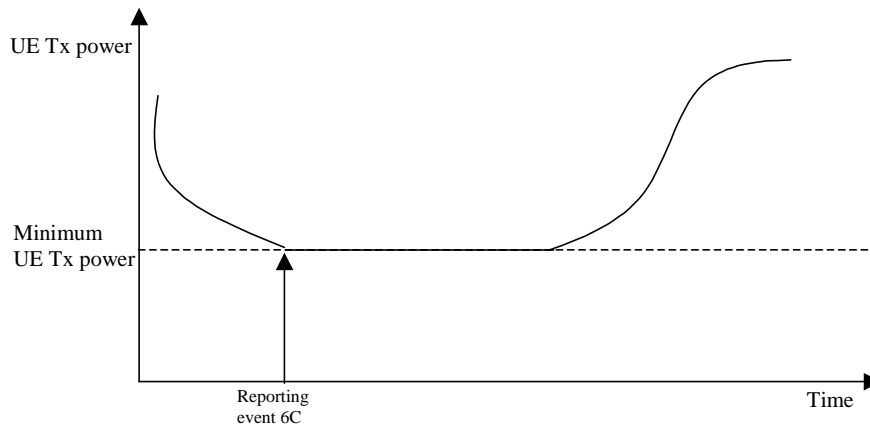

Figure 14.6.2.3-1: Event-triggered measurement report when the UE Tx power reaches its minimum value

14.6.2.4 Reporting event 6D: The UE Tx power reaches its maximum value

When a UE internal measurement configuring event 6d is set up, the UE shall:

- 1> create a variable TRIGGERED_6D_EVENT related to that measurement, which shall initially be set to FALSE;
- 1> delete this variable when the measurement is released.

When this event is ordered by UTRAN in a measurement control message, the UE shall:

- 1> if the UE Tx power equals the maximum allowed UE TX power (for TDD its maximum value on a single TS) for a time period indicated by the IE "time_to_trigger":
 - 2> if the variable TRIGGERED_6D_EVENT is set to FALSE:
 - 3> set the variable TRIGGERED_6D_EVENT to TRUE;
 - 3> send a measurement report with IEs set as below:
 - 4> set in "UE internal measurement event results": "UE internal event identity" to "6d";
 - 4> set the IE "measured results" and the IE "additional measured results" according to 8.4.2.
 - 1> if the variable TRIGGERED_6D_EVENT is set to TRUE and if the UE Tx power is less than the maximum allowed UE TX power:
 - 2> set the variable TRIGGERED_6D_EVENT to FALSE.

NOTE: The maximum allowed UE TX power is defined in subclause 8.6.6.8.

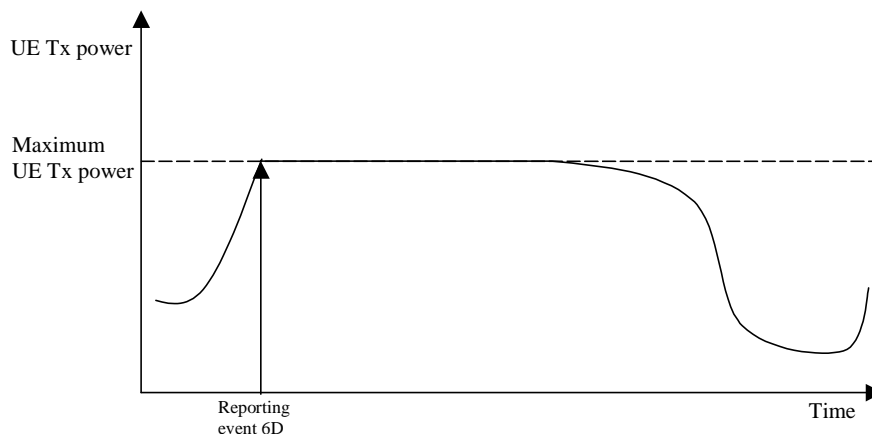

Figure 14.6.2.4-1: Event-triggered report when the UE Tx power reaches its maximum value

14.6.2.5 Reporting event 6E: The UE RSSI reaches the UE's dynamic receiver range

When a UE internal measurement configuring event 6e is set up, the UE shall:

- 1> create a variable TRIGGERED_6E_EVENT related to that measurement, which shall initially be set to FALSE;
- 1> delete this variable when the measurement is released.

When this event is ordered by UTRAN in a measurement control message, the UE shall:

- 1> if the UE RSSI is greater or equal the UE's dynamic receiver range for a time period indicated by the IE "time_to_trigger":
 - 2> if the variable TRIGGERED_6E_EVENT is set to FALSE:
 - 3> set the variable TRIGGERED_6E_EVENT to TRUE;
 - 3> send a measurement report with IEs set as below:
 - 4> set in "UE internal measurement event results": "UE internal event identity" to "6e";
 - 4> set the IE "measured results" and the IE "additional measured results" according to subclause 8.4.2.
- 1> if the variable TRIGGERED_6E_EVENT is set to TRUE and if the UE RSSI is less than the UE's dynamic receiver range:
 - 2> set the variable TRIGGERED_6E_EVENT to FALSE.

14.6.2.6 Reporting event 6F (FDD): The UE Rx-Tx time difference for a RL included in the active set becomes larger than an absolute threshold

When a UE internal measurement configuring event 6f is set up, the UE shall:

- 1> create a variable TRIGGERED_6F_EVENT related to that measurement, which shall initially be set to FALSE for each RL;
- 1> delete this variable when the measurement is released.

When this event is ordered by UTRAN in a measurement control message, the UE shall:

- 1> if the UE Rx-Tx time difference for a RL included in the active set is greater than the value in the IE "UE Rx-Tx time difference threshold" stored for this event in the variable MEASUREMENT_IDENTITY for a time period indicated by the IE "time_to_trigger":
 - 2> if the variable TRIGGERED_6F_EVENT is set to FALSE for this RL:

- 3> set the variable TRIGGERED_6F_EVENT to TRUE for this RL;
- 3> send a measurement report with IEs set as below:
 - 4> set in "UE internal measurement event results": "UE internal event identity" to "6f";
 - 4> set the IE "measured results" and the IE "additional measured results" according to subclause 8.4.2.
- 1> if the variable TRIGGERED_6F_EVENT is set to TRUE for a RL and if the UE RX-Tx time difference for this RL included in the active set is less than or equal to the value in the IE "UE Rx-Tx time difference threshold" stored for this event in the variable MEASUREMENT_IDENTITY:
 - 2> set the variable TRIGGERED_6F_EVENT to FALSE for this RL.

14.6.2.6a Reporting event 6F (1.28 Mcps TDD): The time difference indicated by T_{ADV} becomes larger than an absolute threshold

When a UE internal measurement configuring event 6f is set up, the UE shall:

- 1> create a variable TRIGGERED_6F_EVENT related to that measurement, which shall initially be set to the currently measured T_{ADV} ;
- 1> delete this variable when the measurement is released.

When this event is ordered by UTRAN in a measurement control message, the UE shall:

- 1> if the absolute value of the difference between the measured T_{ADV} and the T_{ADV} stored in the variable TRIGGERED_6F_EVENT is greater than the predefined threshold configured with the IE "T_{ADV} Threshold" for this event in the variable MEASUREMENT_IDENTITY for a time period indicated by the IE "time_to_trigger":
 - 2> set the variable TRIGGERED_6F_EVENT to the currently measured T_{ADV} ;
 - 2> send a measurement report with IEs set as below:
 - 3> set the IE "T_{ADV}" to the measured value, and the IE "SFN" to the SFN during which the latest measurement was performed, in the IE "T_{ADV} Info";
 - 3> set the IE "measured results" and the IE "additional measured results" according to subclause 8.4.2.

14.6.2.7 Reporting event 6G: The UE Rx-Tx time difference for a RL included in the active set becomes less than an absolute threshold

When a UE internal measurement configuring event 6g is set up, the UE shall:

- 1> create a variable TRIGGERED_6G_EVENT related to that measurement, which shall initially be set to FALSE for each RL;
- 1> delete this variable when the measurement is released.

When this event is ordered by UTRAN in a measurement control message, the UE shall:

- 1> if the UE Rx-Tx time difference for a RL included in the active set is less than the value in IE "UE Rx-Tx time difference threshold" stored for this event in the variable MEASUREMENT_IDENTITY for a time period indicated by the IE "time_to_trigger":
 - 2> if the variable TRIGGERED_6G_EVENT is set to FALSE for this RL:
 - 3> set the variable TRIGGERED_6G_EVENT to TRUE for this RL;
 - 3> send a measurement report with IEs set as below:
 - 4> set in "UE internal measurement event results": "UE internal event identity" to "6g";
 - 4> set the IE "measured results" and the IE "additional measured results" according to subclause 8.4.2.

1> if the variable TRIGGERED_6G_EVENT is set to TRUE for a RL and if the UE RX-Tx time difference for this RL included in the active set is greater or equal the value in IE "UE Rx-Tx time difference threshold" stored for this event in the variable MEASUREMENT_IDENTITY:

2> set the variable TRIGGERED_6G_EVENT to FALSE for this RL.

14.7 UE positioning measurements

14.7.1 UE positioning measurement quantities

The quantity to measure for UE positioning is dependent on the positioning method and the method type requested in the IE "UE positioning reporting quantity".

- 1 SFN-SFN observed time difference type 2, mandatory.
- 2 Rx-Tx time difference type 2, optional.
- 3 GPS timing of cell fames, optional.

The definition of other GPS measurements is not within the scope of this specification.

14.7.2 Void

14.7.3 UE positioning reporting events

In the IE "UE positioning reporting criteria" in the Measurement Control messages, the UTRAN notifies the UE of which events should trigger a measurement report. UE positioning reporting events that can trigger a report are given below. The content of the measurement report is dependant on the positioning method and method type requested in the IE "UE positioning reporting quantity" of the Measurement Control message and is described in detail in [18].

When one measurement identity corresponds to multiple positioning events with identical event identities, the UE behaviour is not defined.

14.7.3.1 Reporting Event 7a: The UE position changes more than an absolute threshold

This event is used for UE-based methods only.

When this event is ordered by UTRAN in a measurement control message, the UE shall:

- 1> send a measurement report when the UE changes its position compared to the last reported position more than the threshold defined by the IE "Threshold position change";
- 1> act as specified in subclause 8.6.7.19.1b;
- 1> if the value of IE "Amount of Reporting" in variable MEASUREMENT_IDENTITY for this event is greater than one:
 - 2> decrease IE "Amount of Reporting" in variable MEASUREMENT_IDENTITY for this event by one.
- 1> if the value of IE "Amount of Reporting" in variable MEASUREMENT_IDENTITY for this event is equal to one:
 - 2> delete this event from the list of events in variable MEASUREMENT_IDENTITY.

14.7.3.2 Reporting Event 7b: SFN-SFN measurement changes more than an absolute threshold

When this event is ordered by UTRAN in a measurement control message, the UE shall:

- 1> send a measurement report when the SFN-SFN time difference measurement type 2 of any measured cell changes more than the threshold defined by the IE "Threshold SFN-SFN change"; and
- 1> if UTRAN set IE "Method Type" in "UE positioning reporting quantity" in the MEASUREMENT CONTROL message to "UE-based":
 - 2> act as specified in subclause 8.6.7.19.1b.
- 1> if UTRAN set IE "Method Type" in "UE positioning reporting quantity" in the MEASUREMENT CONTROL message to "UE-assisted":
 - 2> act as specified in subclause 8.6.7.19.1a.
- 1> if UTRAN set IE "Method Type" in "UE positioning reporting quantity" in the MEASUREMENT CONTROL message to "UE-assisted preferred but UE-based allowed" or "UE-based preferred but UE-assisted allowed":
 - 2> the UE may choose to act according to either subclause 8.6.7.19.1a or 8.6.7.19.1b.
- 1> if the value of IE "Amount of Reporting" in variable MEASUREMENT_IDENTITY for this event is greater than one:
 - 2> decrease IE "Amount of Reporting" in variable MEASUREMENT_IDENTITY for this event by one.
- 1> if the value of IE "Amount of Reporting" in variable MEASUREMENT_IDENTITY for this event is equal to one:
 - 2> delete this event from the list of events in variable MEASUREMENT_IDENTITY.

14.7.3.3 Reporting Event 7c: GPS time and SFN time have drifted apart more than an absolute threshold

When this event is ordered by UTRAN in a measurement control message, the UE shall:

- 1> send a measurement report when the GPS Time Of Week and the SFN timer have drifted apart more than the threshold defined by the IE "Threshold SFN-GPS TOW"; and
- 1> if UTRAN set IE "Method Type" in "UE positioning reporting quantity" in the MEASUREMENT CONTROL message to "UE based":
 - 2> act as specified in subclause 8.6.7.19.1b.
- 1> if UTRAN set IE "Method Type" in "UE positioning reporting quantity" in the MEASUREMENT CONTROL message to "UE assisted":
 - 2> act as specified in subclause 8.6.7.19.1a.
- 1> if UTRAN set IE "Method Type" in "UE positioning reporting quantity" in the MEASUREMENT CONTROL message to "UE assisted preferred but UE based allowed" or "UE based preferred but UE assisted allowed":
 - 2> act as specified in subclause 8.6.7.19.1a or in subclause 8.6.7.19.1b depending on the method type chosen by the UE.
- 1> if the value of IE "Amount of Reporting" in variable MEASUREMENT_IDENTITY for this event is greater than one:
 - 2> decrease IE "Amount of Reporting" in variable MEASUREMENT_IDENTITY for this event by one.
- 1> if the value of IE "Amount of Reporting" in variable MEASUREMENT_IDENTITY for this event is equal to one:
 - 2> delete this event from the list of events in variable MEASUREMENT_IDENTITY.

14.8 Dynamic Resource Allocation Control of Uplink DCH (FDD only)

The network uses this procedure to dynamically control the allocation of resources on an uplink DCH.

This procedure shall be activated in the UE when it has been allocated an uplink DCH with DRAC static information elements. Such uplink DCHs can be established through RB establishment procedure, RB reconfiguration procedure, RB release procedure or Transport Channel Reconfiguration procedure by setting the DRAC static information elements to indicate that the DCH is controlled by the DRAC procedure.

The UE shall periodically listen to the SIB 10 of each cell in its Active Set. The scheduling information of SIB10 and the SCCPCH info on which the SIB10 is transmitted are provided to the UE when the DCH is set up and when a cell is added in its active set. In case several SIB10 messages from different cells are scheduled at the same time, the UE shall only listen to the SIB10 broadcast in the cell of its Active Set having the best CPICH measurements.

Upon reception of a SYSTEM INFORMATION message comprising a SIB10, the UE shall:

1. Determine and store the most stringent DRAC parameters from the last received values from each cell of its active set (i.e. select the lowest product p_{ir} *maximum bit rate corresponding to its DRAC class identity)
2. Determine the allowed subset of TFCS according to the selected maximum bit rate value, and store it for later usage.
The allowed subset of TFCS are the ones of the TFCS for which the sum of bit rates of the DCH controlled by DRAC is lower than Maximum Bit Rate IE, i.e.

$$\sum_{\text{DCH}_i \text{ controlled by DRAC}} TBSsize_i / TTI_i < MaximumBitRate$$

DCH_i controlled by DRAC

After the first SIB10 has been received, the UE shall start the following process:

1. At the start of the next TTI, the UE shall randomly select $p \in [0,1]$.
2. If $p < p_{tr}$, the UE shall transmit on the DCH controlled by DRAC during T_{validity} frames using the last stored allowed subset of TFCS and comes back to step 1, otherwise the UE shall stop transmission on these DCH during T_{retry} frames and then comes back to step 1.

Transmission time validity (T_{validity}) and Time duration before retry (T_{retry}) are indicated to the UE at the establishment of a DCH controlled by this procedure and may be changed through RB or transport channel reconfiguration. The UE shall always use the latest received DRAC static parameters.

A UE that supports the simultaneous reception of one SCCPCH and one DPCH shall support the DRAC procedure.

14.9 Downlink power control

14.9.1 Generalities

This function is implemented in the UE in order to set the SIR target value on each CCTrCH used for the downlink power control. This SIR value shall be adjusted according to an autonomous function in the UE in order to achieve the same measured quality as the quality target set by UTRAN. The quality target is set as the transport channel BLER value for each transport channel as signalled by UTRAN. For CPCH the quality target is set as the BER of the DL DPCCCH as signalled by UTRAN.

When transport channel BLER is used the UE shall run a quality target control loop such that the quality requirement is met for each transport channel, which has been assigned a BLER target.

When DL DPCCCH BER is used the UE shall run a quality target control loop such that the quality requirement is met for each CPCH transport channel, which has been assigned a DL DPCCCH BER target.

The UE shall set the SIR target when the physical channel has been set up or reconfigured. It shall not increase the SIR target value before the power control has converged on the current value. The UE may estimate whether the power control has converged on the current value, by comparing the averaged measured SIR to the SIR target value.

14.9.2 Downlink power control in compressed mode

In compressed mode, the target SIR needs to be changed in several frames compared to normal mode. For this purpose, four values DeltaSIR1, DeltaSIRafter1, DeltaSIR2 and DeltaSIRafter2 are signalled by the UTRAN to the UE (see subclause 10.2.9).

For each frame, the target SIR offset during compressed mode, compared to normal mode is:

$$\Delta\text{SIR} = \max(\Delta\text{SIR1_compression}, \dots, \Delta\text{SIRn_compression}) + \Delta\text{SIR1_coding} + \Delta\text{SIR2_coding}$$

where n is the number of TTI lengths for all TrChs of the CCTrCh, F_i is the length in number of frames of the i-th TTI and where $\Delta\text{SIR_coding}$ fulfils:

- $\Delta\text{SIR1_coding} = \text{DeltaSIR1}$ if the start of the first transmission gap in the transmission gap pattern is within the current frame.
- $\Delta\text{SIR1_coding} = \text{DeltaSIRafter1}$ if the current frame just follows a frame containing the start of the first transmission gap in the transmission gap pattern.
- $\Delta\text{SIR2_coding} = \text{DeltaSIR2}$ if the start of the second transmission gap in the transmission gap pattern is within the current frame.
- $\Delta\text{SIR2_coding} = \text{DeltaSIRafter2}$ if the current frame just follows a frame containing the start of the second transmission gap in the transmission gap pattern.
- $\Delta\text{SIR1_coding} = 0$ and $\Delta\text{SIR2_coding} = 0$ otherwise.

and $\Delta\text{SIRi_compression}$ is defined by :

- $\Delta\text{SIRi_compression} = 3$ dB for downlink frames compressed by reducing the spreading factor by 2.
- $\Delta\text{SIRi_compression} = 10 \log(15 * F_i / (15 * F_i - \text{TGL}_i))$ if there is a transmission gap created by puncturing method within the current TTI of length F_i frames, where TGL_i is the gap length in number of slots (either from one gap or a sum of gaps) in the current TTI of length F_i frames.
- $\Delta\text{SIRi_compression} = 0$ dB in all other cases.

Several compressed mode patterns applying to the same frames should be avoided as much as possible.

In particular; several simultaneous patterns by puncturing applying to the same frames shall be considered as a protocol error by the UE. The handling of this error is described in the procedure descriptions in clause 8

In case several compressed mode patterns are used simultaneously, a ΔSIR offset is computed for each compressed mode pattern and the sum of all ΔSIR offsets is applied to the frame.

14.10 Calculated Transport Format Combination

The Calculated Transport Format Combination (CTFC) is a tool for efficient signalling of transport format combinations.

Let I be the number of transport channels that are included in the transport format combination. Each transport channel TrCH_i , $i = 1, 2, \dots, I$, has L_i transport formats, i.e. the transport format indicator TFI_i can take L_i values,

$$\text{TFI}_i \in \{0, 1, 2, \dots, L_i - 1\}.$$

$$\text{Define } P_i = \prod_{j=0}^{i-1} L_j, \text{ where } i = 1, 2, \dots, I, \text{ and } L_0 = 1.$$

Let $\text{TFC}(\text{TFI}_1, \text{TFI}_2, \dots, \text{TFI}_I)$ be the transport format combination for which TrCH_1 has transport format TFI_1 , TrCH_2 has transport format TFI_2 , etc. The corresponding $\text{CTFC}(\text{TFI}_1, \text{TFI}_2, \dots, \text{TFI}_I)$ is then computed as:

$$CTFC(TFI_1, TFI_2, \dots, TFI_l) = \sum_{i=1}^l TFI_i \cdot P_i.$$

For FACH and PCH transport channels, "TrCH₁" corresponds to the transport channel listed at the first position in IE "FACH/PCH information" in IE "Secondary CCPCH System Information", "TrCH₂" corresponds to the transport channel listed at the second position in IE "FACH/PCH information" and so on.

For all other transport channels in FDD and for all configured transport channels of the same transport channel type (i.e. DCH, DSCH, USCH) in TDD, "TrCH₁" corresponds to the transport channel having the lowest transport channel identity in the transport format combination mapped to the TFCI field. "TrCH₂" corresponds to the transport channel having the next lowest transport channel identity, and so on.

14.11 UE autonomous update of virtual active set on non-used frequency (FDD only)

In the text that follows:

- a "non-used frequency" is a frequency that the UE has been ordered to measure upon but is not used for the connection. A "used frequency" is a frequency that the UE has been ordered to measure upon and is also currently used for the connection;
- a "non-used frequency (resp. cell) considered in an inter-frequency measurement" shall be understood as a non-used frequency (resp. cell) included in the list of cells pointed at in the IE "cells for measurement" if it was received for that measurement, or otherwise as a non-used frequency (resp. cell) included in the "Inter-frequency cell info" part of the variable CELL_INFO_LIST.

For event-triggered inter frequency measurements it is possible to specify intra-frequency measurements reporting events for support of maintenance of an active set associated with a non-used frequency considered in that measurement, a "virtual active set" and used in the evaluation of the frequency quality estimates. The "initial virtual active set" for a frequency is the virtual active set that is associated to that frequency just after a message was received that sets up or modifies the inter-frequency measurement.

The way the virtual active sets are initiated and updated for the non-used frequencies considered in an inter-frequency measurement is described in the two subclauses below, and depends on whether the IE "intra-frequency reporting criteria" is stored for the inter-frequency measurement or not. In case that IE is not stored, the IE "intra-frequency measurement" stored in other measurements of type intra-frequency shall be used.

14.11.1 Initial virtual active set

The way the UE shall act when a MEASUREMENT CONTROL message is received that sets up or modifies an inter-frequency measurement, and that includes the IE "Inter-frequency set update" and/or the IE "Intra-Frequency reporting quantity" is described below. The UE shall:

- 1> if the IE "Intra-Frequency measurement reporting criteria" is included in the MEASUREMENT CONTROL message, or if it was previously stored and if the IE "Inter-frequency set update" was included in the MEASUREMENT CONTROL message:
- 2> if the IE "UE autonomous update mode" received or previously stored is set to "on" or "on with no reporting":
- 3> for each non-used frequency F_i considered in the measurement:
- 4> include in the initial virtual active set the N_i cells that have either the greatest downlink E_c/N_0 , the greatest downlink RSCP after despreading, or the lowest pathloss (depending on what is indicated in the IE "inter-frequency measurement quantity"), among the cells on frequency F_i considered in that inter-frequency measurement, where:
- 5> if event 1a is configured in the "Intra-Frequency measurement reporting criteria":

$$N_i = \min(N_{1a}, N_{Cells\ F_i}) \text{ if } N_{1a} \neq 0 \text{ and } N_i = N_{Cells\ F_i} \text{ otherwise.}$$

where:

N_{1a} is the "Reporting deactivation threshold" included in the "Intra-Frequency measurement" IE received for that inter-frequency measurement for event 1a.

$N_{Cells Fi}$ is the number of cells on frequency F_i considered in that inter-frequency measurement.

5> else, if event 1c is configured in the "Intra-Frequency measurement reporting criteria":

$$N_i = \min(N_{1c}, N_{Cells Fi}) \text{ if } N_{1c} \neq 0 \text{ and } N_i = N_{Cells Fi} \text{ otherwise.}$$

where:

N_{1c} is the "Replacement activation threshold" included in the "Intra-Frequency measurement" IE received for that inter-frequency measurement for event 1c.

$N_{Cells Fi}$ is the number of cells on frequency F_i considered in that inter-frequency measurement.

5> else:

$$N_i = N_{Cells Fi}$$

where:

$N_{Cells Fi}$ is the number of cells on frequency F_i considered in that inter-frequency measurement.

2> if the IE "UE autonomous update mode" received or previously stored is set to "on":

3> if event 1a is configured in the "Intra-Frequency measurement reporting criteria":

4> send a MEASUREMENT REPORT with IEs set as follows:

5> set the Measurement identity to the identity of the inter-frequency measurement;

5> set the CHOICE event result in the IE Event results to Intra-frequency measurement event results, Intra-frequency event identity to 1a, and in "Cell measurement event results" the CPICH info of all the cells included in a virtual active set of the non-used frequency considered in the inter-frequency measurement;

5> do not include the IEs "measured results" or "additional measured results".

3> else, if event 1c is configured in the "Intra-Frequency measurement reporting criteria":

4> send a measurement report with IEs set as follows:

5> set the Measurement identity to the identity of the inter-frequency measurement;

5> set the CHOICE event result in the IE Event results to Intra-frequency measurement event results, Intra-frequency event identity to 1c, and in "Cell measurement event results" the CPICH info of all the cells included in the virtual active set of the frequency considered in the inter-frequency measurement;

5> do not include the IEs "measured results" or "additional measured results".

2> if the IE "Inter-frequency set update" is included in the message and if the IE "UE autonomous update mode" is set to "Off":

3> if the IE "Measurement command" is set to "Modify", if the value previously stored for the IE "UE autonomous update mode" was also "Off" and if the IE "Intra-frequency measurement reporting criteria" was not included in the message:

4> apply the modifications indicated in the "Inter-frequency set update" to the virtual active set that was valid before the message was received for the non-used frequency considered in that inter-frequency measurement.

- 3> otherwise:
 - 4> remove the possibly existing virtual active set of the non-used frequency considered in that measurement; and
 - 4> set the initial virtual active set for it according to the "Inter-frequency set update" included in the message.
- 2> if the IE "Inter-frequency set update" is not included in the message and if the IE "UE autonomous update mode" stored for the inter-frequency measurement is set to "Off":
 - 3> remove the possibly existing virtual active set of the non-used frequency considered in that measurement; and
 - 3> consider the virtual active set for it as empty.
- 1> if the IE "Intra-Frequency measurement reporting criteria" was not included in the MEASUREMENT CONTROL message:
 - 2> if the IE "UE autonomous update mode" is set to "on" or "on with no reporting":
 - 3> for each non-used frequency F_i considered in the measurement:
 - 4> include in the initial virtual active set the N_i cells that have either the greatest downlink E_c/N_0 or the greatest downlink RSCP after despreading or the lowest pathloss (depending on what is indicated in the IE "inter-frequency measurement quantity"), among the cells on frequency F_i considered in that inter-frequency measurement, where:

5> if event 1a is configured for the used frequency in an intra-frequency measurement; and

5> if the "Reporting deactivation threshold" is included:

$$N_i = \min(N_{Ia}, N_{Cells Fi}) \text{ if } N_{Ia} \neq 0 \text{ and } N_i = N_{Cells Fi} \text{ otherwise.}$$

where:

N_{Ia} is the "Reporting deactivation threshold" included in the intra-frequency measurement for the first event 1a defined in the intra-frequency measurement with the lowest identity.

$N_{Cells Fi}$ is the number of cells on frequency F_i considered in that inter-frequency measurement.

5> else, if event 1c is configured for the used frequency in an intra-frequency measurement:

$$N_i = \min(N_{Ic}, N_{Cells Fi}) \text{ if } N_{Ic} \neq 0 \text{ and } N_i = N_{Cells Fi} \text{ otherwise.}$$

where:

N_{Ic} is the "Replacement activation threshold" included in the "Intra-Frequency measurement" for the first event 1c defined in the intra-frequency measurement with the lowest identity.

$N_{Cells Fi}$ is the number of cells on frequency F_i considered in that inter-frequency measurement.

5> else:

$$N_i = N_{Cells Fi}$$

where:

$N_{Cells Fi}$ is the number of cells on frequency F_i considered in that inter-frequency measurement.

3> if the IE "UE autonomous update mode" is set to "on":

4> if event 1a is configured for the used frequency in an intra-frequency measurement:

- 5> send a measurement report with IEs set as follows:
 - 6> set the Measurement identity to the identity of the inter-frequency measurement;
 - 6> set the CHOICE event result in the IE Event results to Intra-frequency measurement event results, Intra-frequency event identity to 1a, and in "Cell measurement event results" the CPICH info of all the cells included in the initial virtual active set of the non-used frequency considered in that measurement;
 - 6> do not include the IEs "measured results" or "additional measured results".
- 4> else, if event 1c is configured for the used frequency in an intra-frequency measurement:
 - 5> send a measurement report with IEs set as follows:
 - 6> set the Measurement identity to the identity of the inter-frequency measurement;
 - 6> set the CHOICE event result in the IE Event results to Intra-frequency measurement event results, Intra-frequency event identity to 1c, and in "Cell measurement event results" the CPICH info of all the cells included in the initial virtual active set of the non-used frequency considered in that measurement;
 - 6> do not include the IEs "measured results" or "additional measured results".
- 2> if the IE "UE autonomous update mode" is set to "off":
 - 3> set the initial virtual active set of the non-used frequency considered in that inter-frequency measurement according to what is included in the IE "Inter-frequency set update" included in the message; and
 - 3> if the IE "Inter-frequency set update" was not received:
 - 4> set the initial virtual active set for the frequencies considered in that measurement to be empty.

14.11.2 Virtual active set update during an inter-frequency measurement

If the IE "Intra-frequency measurement reporting criteria" is stored for an inter-frequency measurement, the UE shall:

- 1> if Event 1a is configured in that IE, when this event is triggered by a cell for a non-used frequency considered in that measurement (according to the criteria described in subclause 14.1.2.1):
 - 2> if the "Reporting deactivation threshold" is equal to 0, or if the "Reporting deactivation threshold" is different from 0 and the number of cells included in the virtual active set for that frequency is less than or equal to the "Reporting deactivation threshold":
 - 3> if the IE "UE autonomous update mode" is set to "on" or "on with no reporting":
 - 4> add the primary CPICH that enters the reporting range to the "virtual active set".
 - 3> if the IE "UE autonomous update mode" is set to "on" or "off":
 - 4> send a measurement report with IEs set as below:
 - 5> set the Measurement identity to the identity of the inter-frequency measurement;
 - 5> set the CHOICE event result in the IE Event results to Intra-frequency measurement event results, Intra-frequency event identity to 1a, and in "Cell measurement event results" the CPICH info of the cell that triggered the event;
 - 5> do not include the IEs "measured results" or "additional measured results".
 - 1> if Event 1b was configured, when this event is triggered by a cell for a non-used frequency considered in that measurement (according to the criteria described in subclause 14.1.2.2):
 - 2> if the IE "UE autonomous update mode" is set to "on" or "on with no reporting" and if the number of cells included in the virtual active set is greater than 1:

- 3> remove the primary CPICH that leaves the reporting range from the "virtual active set".
- 2> if the IE "UE autonomous update mode" is set to "on" or "off":
 - 3> send a measurement report with IEs set as below:
 - 4> set the Measurement identity to the identity of the inter-frequency measurement;
 - 4> set the CHOICE event result in the IE Event results to Intra-frequency measurement event results, Intra-frequency event identity to 1b, and in "Cell measurement event results" the CPICH info of the cell that triggered the event;
 - 4> do not include the IEs "measured results" or "additional measured results".
- 1> if Event 1c was configured, when this event is triggered by a cell for a non-used frequency considered in that measurement (according to the criteria described in subclause 14.1.2.3):
 - 2> if the "Reporting activation threshold" is equal to 0, or if the "Reporting activation threshold" is different from 0 and the number of cells included in the virtual active set for that frequency is greater than or equal to the "Reporting activation threshold":
 - 3> if the IE "UE autonomous update mode" is set to "on" or "on with no reporting":
 - 4> rank all active and non-active primary CPICHs and take the n best cells to create a new "virtual active set", where n is the number of active primary CPICHs in the "virtual active set".
 - 3> if the IE "UE autonomous update mode" is set to "on" or "off":
 - 4> send a measurement report with IEs set as below:
 - 5> set the Measurement identity to the identity of the inter-frequency measurement;
 - 5> set the CHOICE event result in the IE Event results to Intra-frequency measurement event results, Intra-frequency event identity to 1c, and in "Cell measurement event results" include the CPICH info of all the cells that satisfy the event, and the rest of the entries as the cells that were in the virtual active set before the event occurred and that are worse than the best cell that triggered the event, in the order of their measured value (best one first);
 - 5> do not include the IEs "measured results" or "additional measured results".

If the IE "Intra-frequency measurement reporting criteria" is stored for an inter-frequency measurement, the IE "UE autonomous update mode" is set to "on" or "on with no reporting", but none of the Events 1a, 1b or 1c are configured:

- 1> the UE shall continuously update the virtual active set to consist of all cells on frequency F_i considered in that inter-frequency measurement, without sending any corresponding measurement report.

If the IE "Intra-frequency measurement reporting criteria" is not stored for that inter-frequency measurement, the UE shall:

- 1> apply the events of type 1a, 1b and 1c that were defined for the used frequency in other stored measurements of type "intra-frequency" at the time the inter-frequency measurement was set up; and
- 1> update the virtual active set for the non-used frequencies considered in that measurement according to the following rules:
 - 2> if several events of type 1a (resp. 1b,1c) were defined for the used frequency when the inter-frequency measurement was set up, only the first 1a event (resp 1b, 1c) that was defined in the measurement with the lowest measurement identity shall apply to the non-used frequencies;
 - 2> all the cells considered in the inter-frequency measurements shall be able to affect the reporting range for event 1a and 1b. (i.e. the IE "Cells forbidden to affect reporting range" possibly stored for the intra-frequency measurements on the used frequency does not apply to the non-used frequencies considered in the inter-frequency measurement);
 - 2> the IEs "amount of reporting" and "reporting interval" that were stored for the intra-frequency measurements on the used frequency shall not be considered if reports of the virtual active set updates are needed.

- 1> if event 1a is applicable to the non-used frequencies considered in the inter-frequency measurement, when this event is triggered (according to the criteria described in subclause 14.1.2.1) by a cell for a non-used frequency considered in that measurement:
 - 2> if the "Reporting deactivation threshold" is equal to 0, or if the "Reporting deactivation threshold" is different from 0 and the number of cells included in the virtual active set for that frequency is less than or equal to the "Reporting deactivation threshold":
 - 3> if the IE "UE autonomous update mode" is set to "on" or "on with no reporting":
 - 4> add the primary CPICH that enters the reporting range to the "virtual active set".
 - 3> if the IE "UE autonomous update mode" is set to "on" or "off":
 - 4> send a measurement report with IEs set as below:
 - 5> set the Measurement identity to the identity of the inter-frequency measurement;
 - 5> set the CHOICE event result in the IE Event results to Intra-frequency measurement event results, Intra-frequency event identity to 1a, and in "Cell measurement event results" the CPICH info of the cell that triggered the event;
 - 5> do not include the IEs "measured results" or "additional measured results".
 - 1> if event 1b is applicable for the non-used frequencies considered in that inter-frequency measurement, when this event is triggered (according to the criteria described in subclause 14.1.2.2) by a cell for a non-used frequency considered in that measurement:
 - 2> if the IE "UE autonomous update mode" is set to "on" or "on with no reporting" and if the number of cells included in the virtual active set is greater than 1:
 - 3> remove the primary CPICH that leaves the reporting range from the "virtual active set".
 - 2> if the IE "UE autonomous update mode" is set to "on" or "off", send a measurement report with IEs set as below:
 - 3> set the Measurement identity to the identity of the inter-frequency measurement;
 - 3> set the CHOICE event result in the IE Event results to Intra-frequency measurement event results, Intra-frequency event identity to 1b, and in "Cell measurement event results" the CPICH info of the cell that triggered the event;
 - 3> do not include the IEs "measured results" or "additional measured results".
 - 1> if event 1c is applicable for the non-used frequencies considered in that inter-frequency measurement, when this event is triggered (according to the criteria described in subclause 14.1.2.3) by a cell for a non-used frequency considered in that measurement:
 - 2> if the "Reporting activation threshold" is equal to 0, or if the "Reporting activation threshold" is different from 0 and the number of cells included in the virtual active set for that frequency is greater than or equal to the "Reporting activation threshold":
 - 3> if the IE "UE autonomous update mode" is set to "on" or "on with no reporting":
 - 4> rank all active and non-active primary CPICHs and take the n best cells to create a new "virtual active set", where n is the number of active primary CPICHs in the "virtual active set".
 - 3> if the IE "UE autonomous update mode" is set to "on" or "off":
 - 4> send a measurement report with IEs set as below:
 - 5> set the Measurement identity to the identity of the inter-frequency measurement.
 - 5> set the CHOICE event result in the IE Event results to Intra-frequency measurement event results, Intra-frequency event identity to 1c, and in "Cell measurement event results" include the CPICH info of all the non-active cells which satisfy the event, and the rest of the entries as the cells that

were in the virtual active set before the event occurred and that are worse than the best cell that triggered the event, in the order of their measured value (best one first);

5> do not include the IEs "measured results" or "additional measured results".

If the IE "Intra-frequency measurement reporting criteria" is not stored for an inter-frequency measurement, the IE "UE autonomous update mode" is set to "on" or "on with no reporting", but none of the Events 1a, 1b or 1c are defined for the used frequency in other stored measurements of type "intra-frequency" at the time the inter-frequency measurement was set up:

1> the UE shall continuously update the virtual active set to consist of all cells on frequency F_i considered in that inter-frequency measurement, without sending any corresponding measurement report.

14.12 Provision and reception of RRC information between network nodes

14.12.0 General

In certain cases, e.g., when performing handover to UTRAN or when performing SRNC relocation, RRC information may need to be transferred between UTRAN nodes, between UTRAN and another RAT, between nodes within another RAT or between the UE and another RAT.

The RRC information exchanged between network nodes or between the UE and another RAT is typically transferred by means of RRC information containers. An RRC information container is a self-contained and extensible RRC information unit that may be used to transfer a number of different RRC messages, one at a time. As stated before, RRC information containers may be used to transfer RRC messages across interfaces other than the Uu interface. The RRC messages that may be included in RRC information containers have similar characteristics as the RRC messages that are transferred across the Uu interface.

The RRC messages that are sent to/ from the UE, e.g., HANDOVER TO UTRAN COMMAND, INTER RAT HANDOVER INFO are covered by (sub)clauses 8, 9, 10, 11.0-11.4 and 12 of this specification. The following subclauses concern RRC messages exchanged between network nodes.

In future versions of this specification, it is possible to extend the RRC messages transferred across interfaces other than Uu. For these RRC messages the same extension mechanism applies as defined for RRC messages transferred across the Uu interface, as is specified in subclause 10.1, i.e., both critical and non-critical extensions may be added.

The transfer syntax for RRC information containers and RRC messages transferred between network nodes is derived from their ASN.1 definitions by use of Packed Encoding Rules, unaligned (X.691). It should be noted that the encoder adds final padding to achieve octet alignment. The resulting octet string is, carried in a container, transferred between the network nodes.

When using a separate RRC information container for each endpoint, the receiving RRC protocol entity is able to interpret the received container; this means that the receiver need not take into account information about the (network interface) message used in transferring the container.

The following encoding rules apply in addition to what has been specified in X.691 [49]:

1> When a bit string value is placed in a bit-field as specified in 15.6 to 15.11 in [11], the leading bit of the bit string value shall be placed in the leading bit of the bit-field, and the trailing bit of the bit string value shall be placed in the trailing bit of the bit-field.

NOTE: The terms "leading bit" and "trailing bit" are defined in ITU-T Rec. X.680 | ISO/IEC 8824-1. When using the "bstring" notation, the leading bit of the bit string value is on the left, and the trailing bit of the bit string value is on the right.

14.12.0a General error handling for RRC messages exchanged between network nodes

The error handling for RRC messages that are exchanged between network nodes applies the same principles as defined for other RRC messages.

Although the same principles apply for network nodes receiving unknown, unforeseen and erroneous RRC messages received in RRC information containers, the notification of the error should be done in a different manner, as specified in the following:

The network node receiving an invalid RRC message from another network node should:

- 1> if the received RRC message was unknown, unforeseen or erroneous:
 - 2> prepare an RRC FAILURE INFO message, including the IE "Failure cause" set to "Protocol error" and the IE "Protocol error information" including an IE "Protocol error cause" which should be set as follows:
 - 3> to "ASN.1 violation or encoding error" upon receiving an RRC message for which the encoded message does not result in any valid abstract syntax value;
 - 3> to "Message type non-existent or not implemented" upon receiving an unknown RRC message type;
 - 3> to "Message extension not comprehended" upon receiving an RRC message including an undefined critical message extension;
 - 3> to "Information element value not comprehended" upon receiving an RRC message including an mandatory IE for which no default value is defined and for which either the value is set to spare or for which the encoded IE does not result in a valid transfer syntax. The same applies for conditional IEs, for which the conditions for presence are met, the IE is present but has a value set to spare or for which the encoded IE does not result in a valid transfer syntax;
 - 3> to "Information element missing" upon receiving an RRC information container with an absent conditional IE for which the conditions for presence are met.
- 1> if there was another failure to perform the operation requested by the received RRC message:
 - 2> prepare an RRC FAILURE INFO message, including the IE "Failure cause" set to a value that reflects the failure cause.
- 1> send the RRC FAILURE INFO message to the network node from which the invalid RRC protocol information was received.

NOTE 1: The appropriate (failure) messages used across the network interfaces may not support the inclusion of a RRC information container. In this case, the information contained in the RRC FAILURE INFO message may need to be transferred otherwise e.g. by mapping to a cause value (e.g. a cause value in the RR-HANDOVER FAILURE message when there is a error associated with the RRC-HANDOVER TO UTRAN COMMAND message).

NOTE 2 In case the RRC procedure used to perform SRNS relocation fails e.g. due to non comprehension, the source RNC may notify the target RNC by including the diagnostics information (IEs "Protocol error" and "Protocol error information") in the "RRC message "SRNS Relocation" Info sent in the RRC information container" used for a subsequent relocation request.

14.12.1 RRC Information to target RNC

The RRC information container "RRC Information to target RNC" may either be sent from source RNC or from another RAT. In case of handover to UTRAN, this information originates from another RAT, while in case of SRNC relocation the RRC information originates from the source RNC. In case of handover to UTRAN, the RRC information transferred may provide UTRAN specific information, as defined in the INTER RAT HANDOVER INFO WITH INTER RAT CAPABILITIES message, that the target RNC needs when preparing the handover command message. In case of SRNC relocation, the RRC information transferred specifies the configuration of RRC and the lower layers it controls, e.g., including the radio bearer and transport channel configuration. It is used by the target RNC to initialise RRC and the lower layer protocols to facilitate SRNC relocation in a manner transparent to the UE.

Information Element/Group Name	Need	Multi	Type and reference	Semantics description
CHOICE case	MP			At least one spare choice, Criticality: Reject, is needed
>Handover to UTRAN			INTER RAT HANDOVER INFO WITH INTER RAT CAPABILITIES 14.12.4.1	
>SRNC relocation			SRNS RELOCATION INFO 14.12.4.2	

14.12.2 RRC information, target RNC to source RNC

There are 2 possible cases for RNC relocation:

1. The UE is already under control of target RNC; and
2. The SRNC Relocation with Hard Handover (UE still under control of SRNC), but UE is moving to a location controlled by the target RNC (based on measurement information).

In case 1 the relocation is transparent to the UE and there is no "reverse" direction container. The SRNC just assigns the 'serving' function to the target RNC, which then becomes the Serving RNC.

In case 2 the relocation is initiated by SRNC, which also provides the RRC Initialisation Information to the target RNC. Base on this information, the target RNC prepares the Hard Handover Message ("Physical channel reconfiguration" (subclause 8.2.6), "radio bearer establishment" (subclause 8.2.1), "Radio bearer reconfiguration" (subclause 8.2.2), "Radio bearer release" (subclause 8.2.3) or "Transport channel reconfiguration" (subclause 8.2.4).

In case 2 two possibilities are defined in order to transmit the relocation message from the target RNC to the source RNC which can be chosen by the source RNC by including or not including the IE "RB Id for handover message" in the IE "SRNS Relocation Info".

In case the IE "RB Id for handover message" has been received by the target RNC in the IE "SRNS Relocation Info", the target RNC should choose the IE "DL DCCH message" and include the DL DCCH message that should be transmitted transparently to the UE by the source RNC. In that case, the target RNC is integrity protecting the message if applicable.

If the target RNC did not receive the IE "RB Id for handover message" in the IE "SRNS Relocation Info" the target RNC should use another choice. In that case, the source RNC should integrity protect the message before transmitting it to the UE if applicable.

The source RNC then transmits the Handover Message to the UE, which then performs the handover.

In the successful case, the UE transmits an XXX COMPLETE message, using the new configuration, to the target RNC.

In case of failure, the UE transmits an XXX FAILURE, using the old configuration, to the source RNC and the RRC context remains unchanged (has to be confirmed and checked with the SRNS relocation procedure).

Information Element/Group name	Need	Multi	Type and reference	Semantics description
CHOICE RRC message	MP			At least one spare choice, Criticality: Reject, is needed
>RADIO BEARER SETUP			RADIO BEARER SETUP 10.2.31	
>RADIO BEARER RECONFIGURATION			RADIO BEARER RECONFIGURATION	

Information Element/Group name	Need	Multi	Type and reference	Semantics description
>RADIO BEARER RELEASE			10.2.25 RADIO BEARER RELEASE 10.2.28	
>TRANSPORT CHANNEL RECONFIGURATION			TRANSPORT CHANNEL RECONFIGURATION 10.2.51	
>PHYSICAL CHANNEL RECONFIGURATION			PHYSICAL CHANNEL RECONFIGURATION 10.2.20	
>RRC FAILURE INFO			RRC FAILURE INFO 10.2.41 a	
>DL DCCH message			OCTET STRING	

14.12.3 Void

14.12.4 RRC messages exchanged between network nodes

14.12.4.0 HANDOVER TO UTRAN COMMAND

This RRC message is sent between network nodes to transfer the actual handover command including the details of the radio configuration to be used upon handover to UTRAN as compiled by the target RNC.

Direction: target RNC →source RAT

The message is exactly the same as the HANDOVER TO UTRAN COMMAND defined in subclause 10.2.16a.

14.12.4.0a INTER RAT HANDOVER INFO

This RRC message is sent between network nodes to transfer information relevant for the target RNC when preparing for handover to UTRAN.

Direction: source RNC/RAT→target RAT

The message is exactly the same as the INTER RAT HANDOVER INFO defined in subclause 10.2.16d

14.12.4.1 INTER RAT HANDOVER INFO WITH INTER RAT CAPABILITIES

This RRC message is sent between network nodes when preparing for an inter RAT handover to UTRAN.

Direction: source RAT→target RNC

Information Element/Group Name	Need	Multi	Type and reference	Semantics description
UE Information elements				
UE security information	OP		UE security information 10.3.3.42b	
UE capability container	OP			

Information Element/Group Name	Need	Multi	Type and reference	Semantics description
>UE radio access capability	MP		UE radio access capability 10.3.3.42	
>UE radio access capability extension	MP		UE radio access capability extension 10.3.3.42a	Although this IE is not always required, the need has been set to MP to align with the ASN.1
>UE Specific Behaviour Information 1 interRAT	OP		UE Specific Behaviour Information 1 interRAT 10.3.3.52	This IE shall not be included in this version of the protocol
Non RRC IEs				
Radio Bearer IEs				
Predefined configuration status information	OP		Predefined configuration status information 10.3.4.5a	
Other Information elements				
UE system specific capability	OP	1 to <maxSystemCapability>		
>Inter-RAT UE radio access capability	MP		Inter-RAT UE radio access capability 10.3.8.7	
Failure cause	OP		Failure cause 10.3.3.13	Diagnostics information related to an earlier handover to UTRAN request
Protocol error information	CV-ProtErr		Protocol error information 10.3.8.12	

Condition	Explanation
<i>ProtErr</i>	This IE is mandatory present if the IE "Protocol error indicator" is included and has the value "TRUE". Otherwise it is not needed.

NOTE: The above table does not need to reflect the order of the information elements in the actual encoded message. The order, that is reflected in the ASN.1, should be chosen in a manner that avoids that network nodes need to perform reordering of information elements.

14.12.4.2 SRNS RELOCATION INFO

This RRC message is sent between network nodes when preparing for an SRNS relocation.

With the presence or absence of the IE "RB identity for Hard Handover message" the source RNC indicates to the target SRNC whether the source RNC expects to receive the choice "DL DCCH message" in the IE "RRC information, target RNC to source RNC" in case the SRNS relocation is of type "UE involved". Furthermore the target RNC uses this information for the calculation of the MAC-I.

Direction: source RNC→target RNC

Information Element/Group Name	Need	Multi	Type and reference	Semantics description
Non RRC IEs				
RB identity for Handover message	OP		RB identity 10.3.4.16	Gives the id of the radio bearer on which the source RNC will transmit the RRC message in the case the relocation is of type "UE involved".
>State of RRC	MP		RRC state indicator, 10.3.3.35a	
>State of RRC procedure	MP		Enumerated (await no RRC message, await RB Release Complete, await RB Setup Complete, await RB Reconfiguration Complete, await Transport CH Reconfiguration Complete, await Physical CH Reconfiguration Complete, await Active Set Update Complete, await Handover Complete, send Cell Update Confirm, send URA Update Confirm, , others)	
Ciphering related information				
>Ciphering status for each CN domain	MP	<1 to maxCNDomains>		
>>CN domain identity	MP		CN domain identity 10.3.1.1	
>>>Ciphering status	MP		Enumerated(Not started, Started)	
>>>START	MP		START 10.3.3.38	START value to be used in this CN domain.
>Latest configured CN domain	MP		CN domain identity 10.3.1.1	Value contained in the variable of the same name. In case this variable is empty, the source RNC can set any CN domain identity. In that case, the Ciphering status and the Integrity protection status

Information Element/Group Name	Need	Multi	Type and reference	Semantics description
				should be Not started and the target RNC should not initialise the variable Latest configured CN domain.
>Calculation time for ciphering related information	CV- <i>Ciphering</i>			Time when the ciphering information of the message were calculated, relative to a cell of the target RNC
>>Cell Identity	MP		Cell Identity 10.3.2.2	Identity of one of the cells under the target RNC and included in the active set of the current call
>>SFN	MP		Integer(0..4095)	
>COUNT-C list	OP	1 to <maxCNdo mains>		COUNT-C values for radio bearers using transparent mode RLC
>>CN domain identity	MP		CN domain identity 10.3.1.1	
>>COUNT-C	MP		Bit string(32)	
>Ciphering info per radio bearer	OP	1 to <maxRB>		For signalling radio bearers this IE is mandatory.
>>RB identity	MP		RB identity 10.3.4.16	
>>Downlink HFN	MP		Bit string(20..25)	This IE is either RLC AM HFN (20 bits) or RLC UM HFN (25 bits)
>>Downlink SN	CV- <i>SRB1</i>		Bit String(7)	VT(US) of RLC UM
>>Uplink HFN	MP		Bit string(20..25)	This IE is either RLC AM HFN (20 bits) or RLC UM HFN (25 bits)
Integrity protection related information				
>Integrity protection status	MP		Enumerated(Not started, Started)	
>Signalling radio bearer specific integrity protection information	CV- <i>IP</i>	4 to <maxSRBs etup>		
>>Uplink RRC HFN	MP		Bit string (28)	For each SRB, this IE corresponds to the last value used.
>>Downlink RRC HFN	MP		Bit string (28)	For each SRB, this IE corresponds to the last value used. In particular, for SRB2, this IE should not take into account the RRC message that will trigger the relocation.
>>Uplink RRC Message sequence number	MP		Integer (0..15)	For each SRB, this IE corresponds to the last value used.
>>Downlink RRC Message sequence number	MP		Integer (0..15)	For each SRB, this IE corresponds to the last value used. In particular, for SRB2, this IE should not take into account the RRC message that will trigger the relocation.
>Implementation specific parameters	OP		Bit string (1..512)	
RRC IEs				
UE Information elements				
>U-RNTI	MP		U-RNTI 10.3.3.47	
>C-RNTI	OP		C-RNTI	

Information Element/Group Name	Need	Multi	Type and reference	Semantics description
			10.3.3.8	
>UE radio access Capability	MP		UE radio access capability 10.3.3.42	
>UE radio access capability extension	OP		UE radio access capability extension 10.3.3.42a	
>Last known UE position	OP			
>>SFN	MP		Integer (0..4095)	Time when position was estimated
>>Cell ID	MP		Cell identity; 10.3.2.2	Indicates the cell, the SFN is valid for.
>>CHOICE <i>Position estimate</i>	MP			
>>>Ellipsoid Point			Ellipsoid Point; 10.3.8.4a	
>>>Ellipsoid point with uncertainty circle			Ellipsoid point with uncertainty circle 10.3.8.4d	
>>>Ellipsoid point with uncertainty ellipse			Ellipsoid point with uncertainty ellipse 10.3.8.4e	
>>>Ellipsoid point with altitude			Ellipsoid point with altitude 10.3.8.4b	
>>>Ellipsoid point with altitude and uncertainty ellipsoid			Ellipsoid point with altitude and uncertainty ellipsoid 10.3.8.4c	
>UE Specific Behaviour Information 1 idle	OP		UE Specific Behaviour Information 1 10.3.3.51	This IE should be included if received via the "INTER RAT HANDOVER INFO", the "RRC CONNECTION REQUEST", the IE "SRNS RELOCATION INFO" or the "Inter RAT Handover Info with Inter RAT Capabilities"
>UE Specific Behaviour Information 1 interRAT	OP		UE Specific Behaviour Information 1 interRAT 10.3.3.52	This IE should be included if received via the "INTER RAT HANDOVER INFO", the "RRC CONNECTION REQUEST", the IE "SRNS RELOCATION INFO" or the "Inter RAT Handover Info with Inter RAT Capabilities"
Other Information elements				
>UE system specific capability	OP	1 to <maxSystemCapability>		
>>Inter-RAT UE radio access capability	MP		Inter-RAT UE radio access capability 10.3.8.7	

Information Element/Group Name	Need	Multi	Type and reference	Semantics description
UTRAN Mobility Information elements				
>URA Identifier	OP		URA identity 10.3.2.6	
CN Information Elements				
>CN common GSM-MAP NAS system information	MP		NAS system information (GSM-MAP) 10.3.1.9	
>CN domain related information	OP	1 to <MaxCNdomains>		CN related information to be provided for each CN domain
>>CN domain identity	MP			
>>CN domain specific GSM-MAP NAS system info	MP		NAS system information (GSM-MAP) 10.3.1.9	
>>CN domain specific DRX cycle length coefficient	MP		CN domain specific DRX cycle length coefficient, 10.3.3.6	
Measurement Related Information elements				
>For each ongoing measurement reporting	OP	1 to <MaxNoOf Meas>		
>>Measurement Identity	MP		Measurement identity 10.3.7.48	
>>Measurement Command	MP		Measurement command 10.3.7.46	
>>Measurement Type	CV-Setup		Measurement type 10.3.7.50	
>>Measurement Reporting Mode	OP		Measurement reporting mode 10.3.7.49	
>>Additional Measurements list	OP		Additional measurements list 10.3.7.1	
>>CHOICE <i>Measurement</i>	OP			
>>>Intra-frequency				
>>>>Intra-frequency cell info	OP		Intra-frequency cell info list 10.3.7.33	
>>>>Intra-frequency measurement quantity	OP		Intra-frequency measurement quantity 10.3.7.38	
>>>>Intra-frequency reporting quantity	OP		Intra-frequency reporting quantity 10.3.7.41	
>>>>Reporting cell status	OP		Reporting cell status 10.3.7.61	
>>>>Measurement validity	OP		Measurement validity	

Information Element/Group Name	Need	Multi	Type and reference	Semantics description
			10.3.7.51	
>>>>CHOICE <i>report criteria</i>	OP			
>>>>>Intra-frequency measurement reporting criteria			Intra-frequency measurement reporting criteria 10.3.7.39	
>>>>>Periodical reporting			Periodical reporting criteria 10.3.7.53	
>>>>>No reporting			NULL	
>>>Inter-frequency				
>>>>Inter-frequency cell info	OP		Inter-frequency cell info list 10.3.7.13	
>>>>Inter-frequency measurement quantity	OP		Inter-frequency measurement quantity 10.3.7.18	
>>>>Inter-frequency reporting quantity	OP		Inter-frequency reporting quantity 10.3.7.21	
>>>>Reporting cell status	OP		Reporting cell status 10.3.7.61	
>>>>Measurement validity	OP		Measurement validity 10.3.7.51	
>>>>CHOICE <i>report criteria</i>	OP			
>>>>>Inter-frequency measurement reporting criteria			Inter-frequency measurement reporting criteria 10.3.7.19	
>>>>>Periodical reporting			Periodical reporting criteria 10.3.7.53	
>>>>>No reporting			NULL	
>>>Inter-RAT				
>>>>Inter-RAT cell info	OP		Inter-RAT cell info list 10.3.7.23	
>>>>Inter-RAT measurement quantity	OP		Inter-RAT measurement quantity 10.3.7.29	
>>>>Inter-RAT reporting quantity	OP		Inter-RAT reporting quantity 10.3.7.32	
>>>>Reporting cell status	OP		Reporting cell status 10.3.7.61	
>>>>Measurement validity	OP		Measurement validity 10.3.7.51	
>>>>CHOICE <i>report criteria</i>	OP			

Information Element/Group Name	Need	Multi	Type and reference	Semantics description
>>>>Inter-RAT measurement reporting criteria			Inter-RAT measurement reporting criteria 10.3.7.30	
>>>>Periodical reporting			Periodical reporting criteria 10.3.7.53	
>>>>No reporting			NULL	
>>>Traffic Volume				
>>>>Traffic volume measurement Object	OP		Traffic volume measurement object 10.3.7.70	
>>>>Traffic volume measurement quantity	OP		Traffic volume measurement quantity 10.3.7.71	
>>>>Traffic volume reporting quantity	OP		Traffic volume reporting quantity 10.3.7.74	
>>>>CHOICE <i>report criteria</i>	OP			
>>>>>Traffic volume measurement reporting criteria			Traffic volume measurement reporting criteria 10.3.7.72	
>>>>>Periodical reporting			Periodical reporting criteria 10.3.7.53	
>>>>>No reporting			NULL	
>>>Quality				
>>>>Quality measurement Object	OP		Quality measurement object	
>>>>CHOICE <i>report criteria</i>	OP			
>>>>>Quality measurement reporting criteria			Quality measurement reporting criteria 10.3.7.58	
>>>>>Periodical reporting			Periodical reporting criteria 10.3.7.53	
>>>>>No reporting			NULL	
>>>UE internal				
>>>>UE internal measurement quantity	OP		UE internal measurement quantity 10.3.7.79	
>>>>UE internal reporting quantity	OP		UE internal reporting quantity 10.3.7.82	
>>>>CHOICE <i>report criteria</i>	OP			
>>>>>UE internal measurement reporting criteria			UE internal measurement	

Information Element/Group Name	Need	Multi	Type and reference	Semantics description
			t reporting criteria 10.3.7.80	
>>>>Periodical reporting			Periodical reporting criteria 10.3.7.53	
>>>>No reporting			NULL	
>>>UE positioning				
>>>>LCS reporting quantity	OP		LCS reporting quantity 10.3.7.111	
>>>>CHOICE <i>report criteria</i>	OP			
>>>>>LCS reporting criteria			LCS reporting criteria 10.3.7.110	
>>>>>Periodical reporting			Periodical reporting criteria 10.3.7.53	
>>>>>No reporting				
Radio Bearer Information Elements				
>Predefined configuration status information	OP		Predefined configuration status information 10.3.4.5a	
>Signalling RB information list	MP	1 to <maxSRBs etup>		For each signalling radio bearer
>>Signalling RB information	MP		Signalling RB information to setup 10.3.4.24	
>RAB information list	OP	1 to <maxRABs etup>		Information for each RAB
>>RAB information	MP		RAB information to setup 10.3.4.10	
Transport Channel Information Elements				
Uplink transport channels				
>UL Transport channel information common for all transport channels	OP		UL Transport channel information common for all transport channels 10.3.5.24	
>UL transport channel information list	OP	1 to <MaxTrCH >		
>>UL transport channel information	MP		Added or reconfigured UL TrCH information 10.3.5.2	
>CHOICE <i>mode</i>	OP			
>>FDD				

Information Element/Group Name	Need	Multi	Type and reference	Semantics description
>>>CPCH set ID	OP		CPCH set ID 10.3.5.5	
>>>Transport channel information for DRAC list	OP	1 to <MaxTrCH >		
>>>>DRAC static information	MP		DRAC static information 10.3.5.7	
>>TDD				(no data)
Downlink transport channels				
>DL Transport channel information common for all transport channels	OP		DL Transport channel information common for all transport channels 10.3.5.6	
>DL transport channel information list	OP	1 to <MaxTrCH >		
>>DL transport channel information	MP		Added or reconfigured DL TrCH information 10.3.5.1	
>Measurement report	OP		MEASUREMENT REPORT 10.2.17	
Other Information elements				
Failure cause	OP		Failure cause 10.3.3.13	Diagnostics information related to an earlier SRNC Relocation request (see NOTE 2 in 14.12.0a)
Protocol error information	CV-ProtErr		Protocol error information 10.3.8.12	

Multi Bound	Explanation
MaxNoOfMeas	Maximum number of active measurements, upper limit 16

Condition	Explanation
<i>Setup</i>	The IE is mandatory present when the IE Measurement command has the value "Setup", otherwise the IE is not needed.
<i>Ciphering</i>	The IE is mandatory present when the IE Ciphering Status has the value "started" and the ciphering counters need not be reinitialised, otherwise the IE is not needed.
<i>IP</i>	The IE is mandatory present when the IE Integrity protection status has the value "started" and the integrity protection counters need not be reinitialised, otherwise the IE is not needed.
<i>ProtErr</i>	This IE is mandatory present if the IE "Protocol error indicator" is included and has the value "TRUE". Otherwise it is not needed.
<i>SRB1</i>	The IE is mandatory present for RB1. Otherwise it is not needed.

14.12.4.3 Void

14.13 Void

14.14 Versatile Channel Assignment Mode (VCAM) mapping rule (FDD only)

When Versatile Channel Assignment Method (VCAM) is used in the CPCH procedure, the following mapping rules shall be used to specify one PCPCH.

If the number of PCPCHs is less than or equal to 16, there is a one to one mapping between the CA index and the PCPCH index. Thus a suitable AP signature (and/or AP sub-channel) number is transmitted for the required spreading factor based on the broadcast system information, and the assigned PCPCH index (having the requested spreading factor) corresponds to the received CA index.

When the number of PCPCHs is greater than 16, a combination of an AP signature (and/or AP sub-channel) number and a CA signature number specifies one PCPCH as follows:

In VCAM mapping rule, a combination of an AP signature (and/or AP sub-channel) number and a CA signature number specifies one PCPCH. In a CPCH set, there are K available PCPCHs which are numbered $k=0,1,\dots,K-1$, and there are R available Minimum Spreading Factor A_r , $r=0,1,\dots,R-1$, that a UE can request and use. The maximum available number of PCPCHs and the number of available AP signatures (and/or AP sub-channels) for A_r are denoted as P_{0r} and S_r , respectively, for $r=0,1,\dots,R-1$. Let P_r be equal to 16 if P_{0r} is less than 16 and to P_{0r} otherwise. T_r represents the number of CA signatures for A_r , which are needed for specifying PCPCH. The default value of T_r is 16.

S_r always satisfies $S_r \geq \min\{s : s \in N, s \times T_r \geq P_r\}$, where N is the set of positive integers.

The list of available AP signatures (and/or AP sub-channels) for each A_r is renumbered from signature index 0 to signature index $S_r - 1$, starting with the lowest AP signature (and/or AP sub-channel) number, and continuing in sequence, in the order of increasing signature numbers.

Then for given AP signature (and/or AP sub-channel) number and CA signature number, the number k that signifies the assigned PCPCH is obtained as:

$$k = \{[(i + n) \bmod S_r] + j \times S_r\} \bmod P_r,$$

where i ($i=0,1,\dots,S_r-1$) is the AP signature (and/or AP sub-channel) index for A_r , j ($j=0,1,\dots,\min(P_r,T_r)-1$) is the CA signature number for A_r and n is a nonnegative integer which satisfies

$$n \times M_r \times S_r \leq i + j \times S_r < (n + 1) \times M_r \times S_r \text{ where } M_r = \min\{m : m \in N, (m \times S_r) \bmod P_r = 0\}.$$

An example of the above mapping rule is shown in [38].

Annex A (informative): USIM parameters

A.1 Introduction

This annex contains recommendations about the RRC parameters to be stored in the USIM.

A.2 Cipherring information

Information Element/Group name	Need	Multi	Type and reference	Semantics description
Cipher key for each CN domain	MP	<1 to maxCNDo mains>		Cipher key is described in [40].
>CK	MP		Bit string (128)	
Integrity key for each CN domain	MP	<1 to maxCNDo mains>		Integrity key is described in [40].
>IK	MP		Bit string (128)	
THRESHOLD	MP		Bit string (20)	
START value for each CN domain	MP	<1 to maxCNDo mains>		START value is described in [40].
>START	MP		Bit string (20)	
KSI, Key set identifier for each CN domain	MP	<1 to maxCNDo mains>		Key set identifier is described in [40].
>KSI	MP		Bit string (3)	

A.3 Frequency information

Neighbour cell list.

Information Element/Group name	Need	Multi	Type and reference	Semantics description	Version
FDD cell list	OP	<1 to maxFDDFr eqList>			
>UARFCN uplink (Nu)	OP		Integer(0..16383)	[21] If IE not present, default duplex distance of 190 MHz shall be used.	
>UARFCN downlink (Nd)	MP		Integer(0 .. 16383)	[21]	
>Primary scrambling code	OP	<1 to maxFDDFr eqCellList>	Primary CPICH info 10.3.6.60		
3.84 Mcps TDD cell list	OP	<1 to maxTDDFr eqList>			
>UARFCN (Nt)	MP		Integer(0 .. 16383)	[22]	
>Cell parameters ID	OP	<1 to maxTDDFr	Integer (0..127)	The Cell parameters ID is	

Information Element/Group name	Need	Multi	Type and reference	Semantics description	Version
1.28 Mcps TDD cell list	OP	eqCellList> <1 to maxTDDFr eqList>		described in [32].	REL-4
>UARFCN (Nt)	MP		Integer(0 .. 16383)	[22]	REL-4
>Cell parameters ID	OP	<1 to maxTDDFr eqCellList>	Integer (0..127)	The Cell parameters ID is described in [32].	REL-4
GSM Neighbour cell list	OP				
>GSM neighbour cell info	MP	<1 to maxGSMC ellList>			
>>BSIC	MP				
>>BCCH ARFCN	MP				

A.4 Multiplicity values and type constraint values

Constant	Explanation	Value
Ciphering information		
maxCNDomains	Maximum number of CN domains	4
Frequency information		
maxFDDFreqList	Maximum number of FDD carrier frequencies to be stored in USIM	4
maxTDDFreqList	Maximum number of TDD carrier frequencies to be stored in USIM	4
maxFDDFreqCellList	Maximum number of neighbouring FDD cells on one carrier to be stored in USIM	32
maxTDDFreqCellList	Maximum number of neighbouring TDD cells on one carrier to be stored in USIM	32
maxGSMCellList	Maximum number of GSM cells to be stored in USIM	32

Annex B (informative): Description of RRC state transitions

This annex contains Stage 2 description of RRC states and state transitions.

B.1 RRC states and state transitions including GSM

After power on, the UE stays in Idle Mode until it transmits a request to establish an RRC Connection. In Idle Mode the connection of the UE is closed on all layers of the access stratum. In Idle Mode the UE is identified by non-access stratum identities such as IMSI, TMSI and P-TMSI. In addition, the UTRAN has no own information about the individual Idle Mode UEs, and it can only address e.g. all UEs in a cell or all UEs monitoring a paging occasion. The UE behaviour within this mode is described in [4].

The UTRA RRC Connected Mode is entered when the RRC Connection is established. The UE is assigned a radio network temporary identity (RNTI) to be used as UE identity on common transport channels.

The RRC states within UTRA RRC Connected Mode reflect the level of UE connection and which transport channels that can be used by the UE.

For inactive stationary data users the UE may fall back to PCH on both the Cell and URA levels. That is, upon the need for paging, the UTRAN checks the current level of connection of the given UE, and decides whether the paging message is sent within the URA, or should it be sent via a specific cell.

B.2 Transition from Idle Mode to UTRA RRC Connected Mode

The transition to the UTRA RRC Connected Mode from the Idle Mode can only be initiated by the UE by transmitting a request for an RRC Connection. The event is triggered either by a paging request from the network or by a request from upper layers in the UE.

When the UE receives a message from the network that confirms the RRC connection establishment, the UE enters the CELL_FACH or CELL_DCH state of UTRA RRC Connected Mode.

In the case of a failure to establish the RRC Connection the UE goes back to Idle Mode. Possible causes are radio link failure, a received reject response from the network or lack of response from the network (timeout).

B.2.1 Transitions for Emergency Calls

Refer to [4] for all states and procedures referred to in this subclause. When UE leaves idle mode from state *Camped on any cell* in order to make an emergency call, moving to state *Connected mode (emergency calls only)*, the UE shall attempt to access the current serving cell. If the access attempt to the serving cell fails the UE shall use the *Cell Reselection* procedure. If no acceptable cell is found, the UE shall use the *Any cell selection*. When returning to idle mode, the UE shall use the procedure *Cell selection when leaving connected mode* in order to find an acceptable cell to camp on, state *Camped on any cell*.

B.3 UTRA RRC Connected Mode States and Transitions

B.3.1 CELL_DCH state

The CELL_DCH state is characterised by

- A dedicated physical channel is allocated to the UE in uplink and downlink.
- The UE is known on cell level according to its current active set.
- Dedicated transport channels, downlink and uplink (TDD) shared transport channels, and a combination of these transport channels can be used by the UE.

The CELL_DCH-state is entered from the Idle Mode through the setup of an RRC connection, or by establishing a dedicated physical channel from the CELL_FACH state.

A PDSCH may be assigned to the UE in this state, to be used for a DSCH. In TDD a PUSCH may also be assigned to the UE in this state, to be used for a USCH. If PDSCH or PUSCH are used for TDD, a FACH transport channel may be assigned to the UE for reception of physical shared channel allocation messages.

B.3.1.1 Transition from CELL_DCH to Idle Mode

Transition to Idle Mode is realised through the release of the RRC connection.

B.3.1.2 Transition from CELL_DCH to CELL_FACH state

Transition to CELL_FACH state occurs when all dedicated channels have been released, which may be

- a) via explicit signalling (e.g. PHYSICAL CHANNEL RECONFIGURATION, RADIO BEARER RECONFIGURATION, RADIO BEARER RELEASE, RADIO BEARER SETUP, TRANSPORT CHANNEL RECONFIGURATION, etc.).

at the end of the time period for which the dedicated channel was allocated (TDD)

B.3.1.3 Transition from CELL_DCH to CELL_PCH state

Transition to CELL_PCH state occurs via explicit signalling (e.g. PHYSICAL CHANNEL RECONFIGURATION, RADIO BEARER RECONFIGURATION, RADIO BEARER RELEASE, RADIO BEARER SETUP, TRANSPORT CHANNEL RECONFIGURATION, etc.).

B.3.1.4 Transition from CELL_DCH to URA_PCH state

Transition to URA_PCH state occurs via explicit signalling (e.g. PHYSICAL CHANNEL RECONFIGURATION, RADIO BEARER RECONFIGURATION, RADIO BEARER RELEASE, RADIO BEARER SETUP, TRANSPORT CHANNEL RECONFIGURATION, etc.).

B.3.1.5 Radio Resource Allocation tasks (CELL_DCH)

For the DCH, several physical channel allocation strategies may be applied. The allocations can be either permanent (needing a DCH release message) or based on time or amount-of-data.

Resource allocation can be done separately for each packet burst with fast signalling on the DCH

For each radio frame the UE and the network indicate the current data rate (in uplink and downlink respectively) using the transport format combination indicator (TFCI). However, in TDD, DCH and DSCH or USCH may be mapped on different CCTrCHs, their TFCI are totally independent. DCH transmission is not modified by the simultaneous existence of DSCH/USCH. If the configured set of combinations (i.e. transport format set for one transport channel) are found to be insufficient to retain the QoS requirements for a transport channel, the network initiates a reconfiguration of the transport format set (TFS) for that transport channel. This reconfiguration can be done during or in between data transmission. Further, the network can reconfigure the physical channel allowing an increase or decrease of the peak data rate.

For the uplink data transmission, the UE reports the observed traffic volume to the network in order for the network to re-evaluate the current allocation of resources. This report contains e.g. the amount of data to be transmitted or the buffer status in the UE.

B.3.1.6 RRC Connection mobility tasks (CELL_DCH)

Depending on the amount and frequency of data macrodiversity (soft handover) may or may not be applied.

The RRC Connection mobility is handled by measurement reporting, soft handover and Timing re-initialised or Timing-maintained hard handover procedures.

B.3.1.7 UE Measurements (CELL_DCH)

The UE performs measurements and transmit measurement reports according to the measurement control information.

The UE uses the connected mode measurement control information received in other states until new measurement control information has been assigned to the UE.

B.3.1.8 Acquisition of system information (CELL_DCH)

FDD UEs with certain capabilities reads system information broadcast on FACH.

TDD UEs reads the BCH to acquire valid system information. For each acquisition, the UE may need different combinations of system information broadcast on BCH. The scheduling on the broadcast channel is done in such way that the UE knows when the requested information can be found.

B.3.2 CELL_FACH state

The CELL_FACH state is characterised by:

- No dedicated physical channel is allocated to the UE.
- The UE continuously monitors a FACH in the downlink.
- The UE is assigned a default common or shared transport channel in the uplink (e.g. RACH) that it can use anytime according to the access procedure for that transport channel.
- The position of the UE is known by UTRAN on cell level according to the cell where the UE last made a cell update.
- In TDD mode, one or several USCH or DSCH transport channels may have been established.

B.3.2.1 Transition from CELL_FACH to CELL_DCH state

A transition occurs, when a dedicated physical channel is established via explicit signalling (e.g. PHYSICAL CHANNEL RECONFIGURATION, RADIO BEARER RECONFIGURATION, RADIO BEARER RELEASE, RADIO BEARER SETUP, TRANSPORT CHANNEL RECONFIGURATION, etc.).

B.3.2.2 Transition from CELL_FACH to CELL_PCH state

The transition occurs when UTRAN orders the UE to move to CELL_PCH state, which is done via explicit signalling (e.g. CELL UPDATE CONFIRM, RADIO BEARER RECONFIGURATION, etc.).

B.3.2.3 Transition from CELL_FACH to Idle Mode

Upon release of the RRC connection, the UE moves to the idle mode.

B.3.2.4 Transition from CELL_FACH to URA_PCH State

The transition occurs when UTRAN orders the UE to move to URA_PCH state, which is done via explicit signalling (e.g. URA UPDATE CONFIRM, RADIO BEARER RECONFIGURATION, etc.).

B.3.2.5 Radio Resource Allocation Tasks (CELL_FACH)

In the CELL_FACH state the UE will monitor an FACH. It is enabled to transmit uplink control signals and it may be able to transmit small data packets on the RACH.

The network can assign the UE transport channel parameters (e.g. transport format sets) in advance, to be used when a DCH is used. Upon assignment of the physical channel for DCH, the UE moves to CELL_DCH state and uses the pre-assigned TFS for the DCH.

If no UE dedicated physical channel or transport channel configuration has been assigned, the UE uses the common physical channel and transport channel configuration according to the system information.

For the uplink data transmission, the UE reports the observed traffic volume to the network in order for the network to re-evaluate the current allocation of resources. This report contains e.g. the amount of data to be transmitted or the buffer status in the UE.

When there is either user or control data to transmit, a selection procedure determines whether the data should be transmitted on a common transport channel, or if a transition to CELL_DCH should be executed. The selection is dynamic and depends on e.g. traffic parameters (amount of data, packet burst frequency).

In FDD mode, the UTRAN can assign CPCH resources to the UE in CELL_FACH state. When CPCH resources are assigned, the UE will continue to monitor FACHs. When CPCH resources are assigned, the UE will use CPCH for all uplink traffic in accordance with RB mapping.

In FDD mode, UTRAN may configure the UE to provide CPCH measurement reports of traffic volume on each CPCH channel used. With these measures, the UTRAN can reallocate network resources on a periodic basis. The UTRAN allocates CPCH Sets to each cell and assigns UEs to one of the cell's CPCH Sets. The UEs can dynamically access the CPCH resources without further UTRAN control.

In the TDD mode, the UTRAN can assign USCH / DSCH resources to the UE in CELL_FACH state. When USCH / DSCH resources are assigned, the UE will continue to monitor FACHs, depending on the UE capability. The UE may use the USCH / DSCH to transmit signalling messages or user data in the uplink and / or the downlink using USCH and / or DSCH when resources are allocated to cell and UE is assigned use of those USCH / DSCH.

For the uplink data transmission on USCH the UE reports to the network the traffic volume (current size of RLC data buffers), The UTRAN can use these measurement reports to re-evaluate the current allocation of the USCH / DSCH resources.

B.3.2.6 RRC Connection mobility tasks (CELL_FACH)

In this state the location of the UE is known on cell level. A cell update procedure is used to report to the UTRAN, when the UE selects a new cell to observe the common downlink channels of a new cell. Downlink data transmission on the FACH can be started without prior paging.

The UE monitors the broadcast channel and system information on BCCH of its own and neighbour cells and from this the need for the updating of cell location is identified.

The UE performs cell reselection and upon selecting a new UTRA cell, it initiates a cell update procedure. Upon selecting a new cell belonging to another radio access system than UTRA, the UE enters idle mode and makes an access to that system according to its specifications.

B.3.2.7 UE Measurements (CELL_FACH)

The UE performs measurements and transmit measurement reports according to the measurement control information.

By default, the UE uses the measurement control information broadcast within the system information. However, for measurements for which the network also provides measurement control information within a MEASUREMENT CONTROL message, the latter information takes precedence.

B.3.2.8 Transfer and update of system information (CELL_FACH)

The UE reads the BCH to acquire valid system information. For each acquisition, the UE may need different combinations of system information broadcast on BCH. The scheduling on the broadcast channel is done in such way that the UE knows when the requested information can be found.

When the system information is modified, the scheduling information is updated to reflect the changes in system information transmitted on BCH. The new scheduling information is broadcast on FACH in order to inform UEs about the changes. If the changes are applicable for the UE, the modified system information is read on BCH.

B.3.3 CELL_PCH state

The CELL_PCH state is characterised by:

- No dedicated physical channel is allocated to the UE.
- The UE selects a PCH with the algorithm specified in subclause 8.5.19, and uses DRX for monitoring the selected PCH via an associated PICH.
- No uplink activity is possible.
- The position of the UE is known by UTRAN on cell level according to the cell where the UE last made a cell update in CELL_FACH state.

The DCCH logical channel cannot be used in this state. If the network wants to initiate any activity, it needs to make a paging request on the PCCH logical channel in the known cell to initiate any downlink activity.

B.3.3.1 Transition from CELL_PCH to CELL_FACH state

The UE is transferred to CELL_FACH state:

- a) by paging from UTRAN (PAGING TYPE1 message)
- b) through any uplink access

B.3.3.2 Radio Resource Allocation Tasks (CELL_PCH)

In CELL_PCH state no resources have been granted for data transmission. For this purpose, a transition to another state has to be executed.

The UE may use Discontinuous Reception (DRX) in order to reduce power consumption. When DRX is used the UE needs only to receive at one paging occasion per DRX cycle. The UE may be instructed to use a specific DRX cycle length by the network. The UE determines its paging occasions in the same way as for Idle Mode, see [4].

B.3.3.3 RRC Connection mobility tasks (CELL_PCH)

In the CELL_PCH state, the UE mobility is performed through cell reselection procedures, which may differ from the one defined in [4].

The UE performs cell reselection and upon selecting a new UTRA cell, it moves to CELL_FACH state and initiates a cell update procedure in the new cell. After the cell update procedure has been performed, the UE changes its state back to CELL_PCH state if neither the UE nor the network has any more data to transmit.

Upon selecting a new cell belonging to another radio access system than UTRA, the UE enters idle mode and make an access to that system according to its specifications.

In case of low UE activity, UTRAN may want to reduce the cell-updating overhead by ordering the UE to move to the URA_PCH State. This transition is made via the CELL_FACH state. UTRAN may apply an inactivity timer, and optionally, a counter, which counts the number of cell updates e.g. UTRAN orders the UE to move to URA_PCH when the number of cell updates has exceeded certain limits (network parameter).

B.3.3.4 UE Measurements (CELL_PCH)

The UE performs measurements and transmit measurement reports according to the measurement control information.

The UE uses the measurement control information according to the system information when no UE dedicated measurement control information has been assigned.

B.3.3.5 Transfer and update of system information (CELL_PCH)

The UE reads the BCH to acquire valid system information. For each acquisition, the UE may need different combinations of system information broadcast on BCH. The scheduling on the broadcast channel is done in such way that the UE knows when the requested information can be found.

B.3.4 URA_PCH State

The URA_PCH state is characterised by:

- No dedicated channel is allocated to the UE.
- The UE selects a PCH with the algorithm specified in subclause 8.5.19, and uses DRX for monitoring the selected PCH via an associated PICH.
- No uplink activity is possible.
- The location of the UE is known on UTRAN Registration area level according to the URA assigned to the UE during the last URA update in CELL_FACH state.

The DCCH logical channel cannot be used in this state. If the network wants to initiate any activity, it needs to make a paging request on the PCCH logical channel within the URA where the location of the UE is known. If the UE needs to transmit anything to the network, it goes to the CELL_FACH state. The transition to URA_PCH State can be controlled with an inactivity timer, and optionally, with a counter that counts the number of cell updates. When the number of cell updates has exceeded certain limits (a network parameter), then the UE changes to the URA_PCH State.

URA updating is initiated by the UE, which, upon the detection of the Registration area, sends the network the Registration area update information on the RACH of the new cell.

B.3.4.1 Transition from URA_PCH State to CELL_FACH State (URA_PCH)

Any activity causes the UE to be transferred to CELL_FACH State.

- a) Uplink access is performed by RACH.
- b) by paging from UTRAN (PAGING TYPE1 message).

NOTE: The release of an RRC connection is not possible in the URA_PCH State. The UE will first move to CELL_FACH State to perform the release signalling.

B.3.4.2 Radio Resource Allocation Tasks (URA_PCH)

In URA_PCH State no resources have been granted for data transmission. For this purpose, a transition to CELL_FACH State has to be executed.

The UE may use Discontinuous Reception (DRX) in order to reduce power consumption. When DRX is used the UE needs only to receive at one paging occasion per DRX cycle. The UE may be instructed to use a specific DRX cycle length by the network. The UE determines its paging occasions in the same way as for Idle Mode, see [4].

B.3.4.3 RRC Connection mobility tasks (URA_PCH)

In URA_PCH State the location of a UE is known on UTRAN Registration area level.

In this state, the UE mobility is performed through URA reselection procedures, which may differ from the definitions in [4]. The UE performs cell reselection and upon selecting a new UTRA cell belonging to a URA that does not match the URA used by the UE, the UE moves to CELL_FACH state and initiates a URA update towards the network. After the URA update procedure has been performed, the UE changes its state back to URA_PCH state if neither the UE nor the network has any more data to transmit.

Upon selecting a new cell belonging to another radio access system than UTRA, the UE enters idle mode and makes an access to that system according to its specifications (FFS).

B.3.4.4 UE Measurements (URA_PCH)

The UE performs measurements and transmit measurement reports according to the measurement control information.

The UE uses the measurement control information according to the system information when no UE dedicated measurement control information has been assigned.

B.3.4.5 Transfer and update of system information (URA_PCH)

The same mechanisms to transfer and update system information as for state CELL_PCH are applicable for UEs in URA_PCH state.

B.3.5 States and Transitions for Cell Reselection in URA_PCH, CELL_PCH, and CELL_FACH

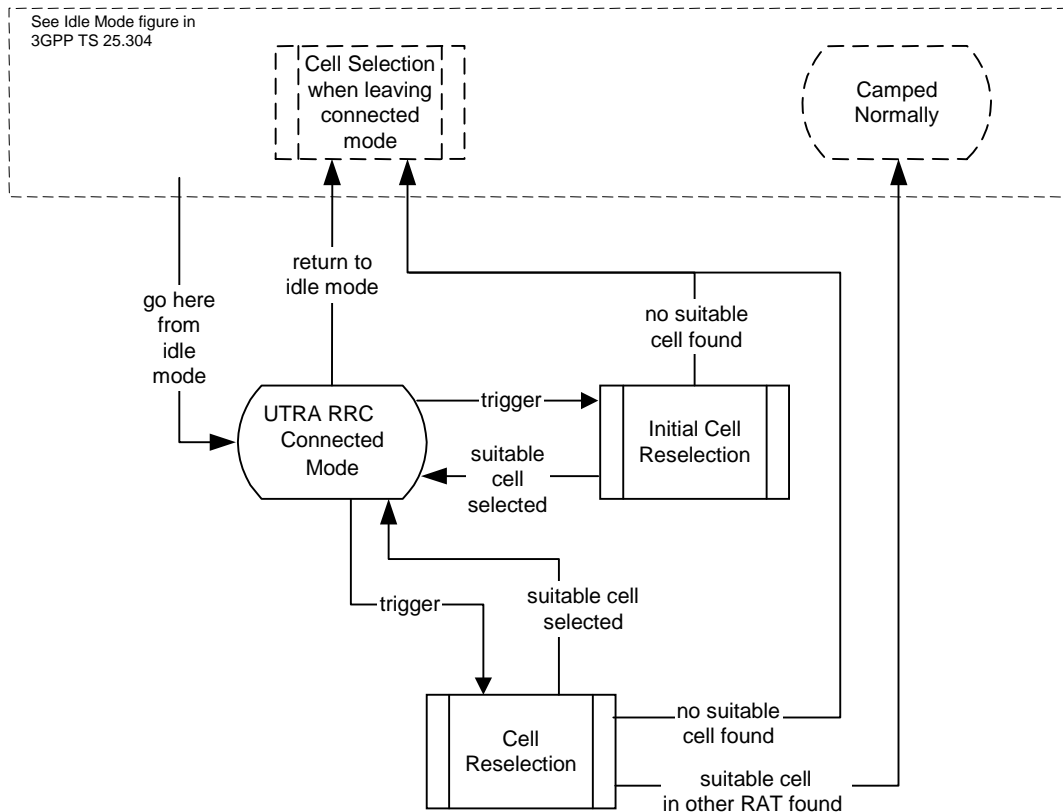

Figure B.3.5-1: UTRA RRC Connected mode cell reselection for URA_PCH, CELL_PCH, and CELL_FACH

In some states the UE performs cell reselection procedures. The UE selects a suitable cell (defined in [4]) and radio access technology based on connected mode radio measurements and cell reselection criteria.

Figure B.3.5-1 shows the states and procedures in the cell reselection process in connected mode.

When a cell reselection is triggered, the UE evaluates the cell reselection criteria based on radio measurements, and if a better cell is found that cell is selected, procedure Cell reselection (see [4]). If the change of cell implies a change of radio access technology, the RRC connection is released, and the UE enters idle mode of the other RAT. If no suitable cell is found in the cell reselection procedure, the UE eventually enters idle mode.

When an Initial cell reselection is triggered, the UE shall use the Initial cell reselection procedure (see [4]) to find a suitable cell. One example where this procedure is triggered is at radio link failure, where the UE may trigger an initial cell reselection in order to request re-establishment of the RRC connection. If the UE is unable to find a suitable cell, the UE eventually enters idle mode.

B.4 Inter-RAT handover with CS domain services

When using CS domain services, UTRAN is using an Inter-Radio access system Handover Procedure and GSM is using a Handover procedure for the transition from UTRA RRC Connected Mode to GSM Connected Mode.

B.5 Inter-RAT handover with PS domain services

When using PS domain services, the UE initiates cell reselection from a GSM/GPRS cell to a UTRAN cell and then uses the RRC Connection Establishment procedure for the transition to UTRA RRC Connected mode.

When the RRC Connection is established from Idle Mode (GPRS Packet Idle Mode) the RRC CONNECTION REQUEST message contains an indication, that UTRAN needs to continue an already established GPRS UE context from the CN. This indication allows UTRAN to e.g. prioritise the RRC CONNECTION REQUEST from the UE.

In UTRA RRC connected mode UTRAN is using UE or network initiated cell reselection to change from a UTRAN cell to a GSM/GPRS cell. If the cell reselection was successful the UE enters Idle Mode (GPRS Packet Idle Mode). The UE sends a packet channel request from Idle Mode (GPRS Packet Idle mode) to establish a Temporary Block flow and enter GPRS Packet Transfer Mode. In the GPRS Packet Transfer Mode the UE sends a RA Update request message. The RA Update Request message sent from the UE contains an indication that GSM/GPRS need to continue an already established UTRAN UE context from the CN. This means that the RA Update request is always sent for the transition from UTRA RRC Connected Mode to GSM/GPRS regardless if the RA is changed or not.

NOTE: The reason for using RA update instead of a new message is to reduce the impact on the existing GSM/GPRS specification.

B.6 Inter-RAT handover with simultaneous PS and CS domain services

NOTE: This is an initial assumption that needs to be seen by TSG-GERAN and requires checking by TSG-GERAN, when the work on this item has progressed.

B.6.1 Inter-RAT handover UTRAN to GSM / BSS

For a UE in CELL_DCH state using both CS and PS Domain services the Inter-RAT handover procedure is based on measurement reports from the UE but initiated from UTRAN.

The UE performs the Inter-RAT handover from UTRA RRC Connected Mode to GSM Connected Mode first. When the UE has sent handover complete message to GSM / BSS the UE initiates a temporary block flow towards GPRS and sends a RA update request.

If the Inter-RAT handover from UTRA RRC Connected Mode to GSM Connected Mode was successful the handover is considered as successful regardless if the UE was able to establish a temporary block flow or not towards GPRS.

In case of Inter-RAT handover failure the UE has the possibility to go back to UTRA RRC Connected Mode and re-establish the connection in the state it originated from without attempting to establish a temporary block flow. If the UE has the option to try to establish a temporary block flow towards GSM / GPRS after Inter-RAT handover failure is FFS.

B.6.2 Inter-RAT handover GSM / BSS to UTRAN

For a UE in GSM Connected Mode using both CS and PS domain services the Inter-RAT handover procedure is based on measurement reports from the UE but initiated from GSM / BSS.

The UE performs the Inter-RAT handover from GSM Connected Mode to UTRA RRC Connected Mode.

In UTRA RRC Connected Mode both services are established in parallel.

If the Inter-RAT handover from GSM Connected mode to UTRA RRC Connected Mode was successful the handover is considered as successful.

In case of Inter-RAT handover failure the UE has the possibility to go back to GSM Connected Mode and re-establish the connection in the state it originated from.

Annex C (informative): Change history

Change history							
Date	TSG #	TSG Doc.	CR	Rev	Subject/Comment	Old	New
10/1999	RP-05	RP-99524	-		Approved at TSG-RAN #5 and placed under Change Control	-	3.0.0
12/1999	RP-06	RP-99650	001		Modification of RRC procedure specifications	3.0.0	3.1.0
	RP-06	RP-99654	005	1	Introduction of Information Element for Power Control Algorithm	3.0.0	3.1.0
	RP-06	RP-99654	007	1	RRC parameters for SSST	3.0.0	3.1.0
	RP-06	RP-99656	009	1	Inclusion of information elements for integrity protection	3.0.0	3.1.0
	RP-06	RP-99656	010	2	Security mode control procedure	3.0.0	3.1.0
	RP-06	RP-99656	011	3	Updates of the system information procedure	3.0.0	3.1.0
	RP-06	RP-99656	012	2	Inter-frequency measurements and reporting	3.0.0	3.1.0
	RP-06	RP-99656	013	1	Inter-system measurements and reporting	3.0.0	3.1.0
	RP-06	RP-99656	014	1	Additional measurements in RRC measurement messages	3.0.0	3.1.0
	RP-06	RP-99656	015	3	Value range for Measurement Information Elements	3.0.0	3.1.0
	RP-06	RP-99656	016	2	Message contents for inter system handover to UTRAN	3.0.0	3.1.0
	RP-06	RP-99652	017		Inclusion of ciphering information elements	3.0.0	3.1.0
	RP-06	RP-99651	018		Corrections and editorial changes	3.0.0	3.1.0
	RP-06	RP-99654	019	1	Algorithm for CTCF Calculation	3.0.0	3.1.0
	RP-06	RP-99651	025		Logical CH for RRC Connection Re-establishment (RRC Connection Re-establishment deleted in RAN_10, RP-000715)	3.0.0	3.1.0
	RP-06	RP-99719	026	1	Gain Factors	3.0.0	3.1.0
	RP-06	RP-99654	027	1	Parameters for CELL UPDATE CONFIRM message	3.0.0	3.1.0
	RP-06	RP-99651	028		Cell Update Cause	3.0.0	3.1.0
	RP-06	RP-99654	029	1	RRC Initialisation Information	3.0.0	3.1.0
	RP-06	RP-99656	034	1	Open loop power control for PRACH	3.0.0	3.1.0
	RP-06	RP-99652	038		Addition of the UE controlled AMR mode adaptation	3.0.0	3.1.0
	RP-06	RP-99651	039		Information elements for RLC reset	3.0.0	3.1.0
	RP-06	RP-99656	040		Support for DS-41 Initial UE Identity	3.0.0	3.1.0
	RP-06	RP-99656	042	2	Integration of Cell Broadcast Service (CBS)	3.0.0	3.1.0
	RP-06	RP-99654	044	1	Gated transmission of DPCH	3.0.0	3.1.0
	RP-06	RP-99656	045		Modification to the Transport Format Combination Control message	3.0.0	3.1.0
	RP-06	RP-99656	046		New Information elements and modifications to messages required in order to support configuration and re-configuration of the DSCH in FDD mode	3.0.0	3.1.0
	RP-06	RP-99654	047	1	Editorial Corrections and Alignments with Layer 1 specifications	3.0.0	3.1.0
	RP-06	RP-99654	048	1	Information elements for TDD shared channel operation	3.0.0	3.1.0
	RP-06	RP-99656	049		Description of CN dependent IEs in Master Information Block	3.0.0	3.1.0
	RP-06	RP-99650	050		UE capability information elements	3.0.0	3.1.0
	RP-06	RP-99656	051	1	UTRAN response time to uplink feedback commands of TX diversity control	3.0.0	3.1.0
	RP-06	RP-99654	052		New and corrected CPCH parameters	3.0.0	3.1.0
	RP-06	RP-99654	053	2	Compressed mode parameters without gating	3.0.0	3.1.0
	RP-06	RP-99654	054		Transport format combination set and transport format combination subset	3.0.0	3.1.0
	RP-06	RP-99656	055	1	Information elements for cell selection and reselection	3.0.0	3.1.0
	RP-06	RP-99654	056		Corrections and Alignments of the RRC to the L1 for TDD	3.0.0	3.1.0
	RP-06	RP-99656	057	1	Introduction of a SCCH procedure	3.0.0	3.1.0
	RP-06	RP-99656	061		Support for DS-41 Paging UE Identity	3.0.0	3.1.0
	RP-06	RP-99656	062	2	Support for cdma2000 Hard Handover	3.0.0	3.1.0
	RP-06	RP-99656	063	1	Provide necessary signalling to support FDD DSCH	3.0.0	3.1.0
	RP-06	RP-99654	064		RRC procedure interactions	3.0.0	3.1.0
	RP-06	RP-99654	066	1	Transfer of UE capabilities	3.0.0	3.1.0
	RP-06	RP-99654	067		Selection of initial UE identity	3.0.0	3.1.0
	RP-06	RP-99657	069		UE capability verification in the security mode control procedure	3.0.0	3.1.0
	RP-06	RP-99657	070	1	DPCH initial power	3.0.0	3.1.0
	RP-06	RP-99657	071		Actions when entering idle mode	3.0.0	3.1.0

Change history							
Date	TSG #	TSG Doc.	CR	Rev	Subject/Comment	Old	New
	RP-06	RP-99657	072		Specification of inter-frequency and inter-system reporting events for FDD	3.0.0	3.1.0
	RP-06	RP-99657	073	1	Signalling radio bearers	3.0.0	3.1.0
	RP-06	RP-99654	074		CN information elements	3.0.0	3.1.0
	RP-06	RP-99654	076		UE information elements	3.0.0	3.1.0
	RP-06	RP-99657	077	1	Radio bearer, transport channel and physical channel information elements	3.0.0	3.1.0
	RP-06	RP-99654	078		Other information elements	3.0.0	3.1.0
	RP-06	RP-99657	079	2	RRC signalling for PDCP	3.0.0	3.1.0
	RP-06	RP-99654	080		Content of Measurement Control Messages	3.0.0	3.1.0
	RP-06	RP-99654	081		RRC Information Elements to support Block STTD transmission diversity in TDD	3.0.0	3.1.0
	RP-06	RP-99657	082	1	Signalling connection release	3.0.0	3.1.0
	RP-06	RP-99657	083	1	Addition of cell access restriction information elements to System Information	3.0.0	3.1.0
	RP-06	RP-99655	085	1	RRC Connection Establishment parameters	3.0.0	3.1.0
	RP-06	RP-99657	092	1	Support of UE autonomous update of a active set on a non-used frequency	3.0.0	3.1.0
	RP-06	RP-99657	095	1	TPC combining for power control	3.0.0	3.1.0
	RP-06	RP-99653	096	1	Editorial Modification of IEs in RRC messages	3.0.0	3.1.0
	RP-06	RP-99655	097		Selection of SCCPCH	3.0.0	3.1.0
	RP-06	RP-99655	098	1	RRC Initialisation Information	3.0.0	3.1.0
	RP-06	RP-99657	100	1	Support of physical channel establishment and failure criteria in the UE	3.0.0	3.1.0
	RP-06	RP-99655	102	1	RRC Connection Re-establishment (Message deleted in RAN_10, RP-000715)	3.0.0	3.1.0
	RP-06	RP-99657	106	1	System information on FACH	3.0.0	3.1.0
	RP-06	RP-99657	108	1	SAPs and Primitives for DS-41 mode	3.0.0	3.1.0
	RP-06	RP-99655	109	1	TX Diversity Mode for Dedicated Channel	3.0.0	3.1.0
	RP-06	RP-99657	110	1	RACH message length signalling on System Information	3.0.0	3.1.0
	RP-06	RP-99657	113	1	Routing of NAS messages in UTRAN	3.0.0	3.1.0
	RP-06	RP-99655	116	3	TBS Identification in TFS	3.0.0	3.1.0
	RP-06	RP-99657	117	1	Merging the hard handover and some radio bearer control procedures	3.0.0	3.1.0
	RP-06	RP-99653	120	1	Selected RRC message transfer syntax	3.0.0	3.1.0
	RP-06	RP-99657	121		Efficient rate command signalling	3.0.0	3.1.0
03/2000	RP-07	RP-000043	122		TDD Mode BCH Reception in Cell DCH State	3.1.0	3.2.0
	RP-07	RP-000043	123		Uplink Outer Loop Power Control in TDD Mode	3.1.0	3.2.0
	RP-07	RP-000043	124	1	TFS TB Size Calculation with Bit Aligned TDD MAC Headers	3.1.0	3.2.0
	RP-07	RP-000043	125		Grouping of DRAC IEs, and detailed definitions of these IEs	3.1.0	3.2.0
	RP-07	RP-000043	126		Correction of specifications for the 'Dynamic Resource Allocation Control of Uplink DCH' Procedure	3.1.0	3.2.0
	RP-07	RP-000043	131	2	Clarification of PDCP info and PDCP capability IEs	3.1.0	3.2.0
	RP-07	RP-000043	132		Editorial change to "Specification of system information block characteristics"	3.1.0	3.2.0
	RP-07	RP-000043	133		Additions of CBS related Information Elements	3.1.0	3.2.0
	RP-07	RP-000043	134		Signalling for computed gain factors	3.1.0	3.2.0
	RP-07	RP-000043	137	1	General error handling procedures	3.1.0	3.2.0
	RP-07	RP-000043	138	1	RRC message extensions	3.1.0	3.2.0
	RP-07	RP-000043	139		Padding of RRC messages using RLC transparent mode	3.1.0	3.2.0
	RP-07	RP-000043	140	2	UE information elements	3.1.0	3.2.0
	RP-07	RP-000043	141		Other information elements	3.1.0	3.2.0
	RP-07	RP-000043	142	3	Integrity protection function	3.1.0	3.2.0
	RP-07	RP-000043	143	4	RAB-RB relations	3.1.0	3.2.0
	RP-07	RP-000043	144	1	Inter-system handover from UTRAN	3.1.0	3.2.0
	RP-07	RP-000043	145	3	Handover to UTRAN including procedure for pre- configuration	3.1.0	3.2.0
	RP-07	RP-000043	146	2	RRC measurement filtering parameters	3.1.0	3.2.0
	RP-07	RP-000043	147		New event "RL out of UE Rx window"	3.1.0	3.2.0
	RP-07	RP-000044	148	1	Access control on RACH	3.1.0	3.2.0
	RP-07	RP-000044	149	2	cdma2000 Hard Handover	3.1.0	3.2.0
	RP-07	RP-000044	150	1	CPCH parameters with corrections	3.1.0	3.2.0

Change history							
Date	TSG #	TSG Doc.	CR	Rev	Subject/Comment	Old	New
	RP-07	RP-000044	152		U-plane AM RLC reconfiguration by cell update procedure	3.1.0	3.2.0
	RP-07	RP-000044	154	3	CPCCH	3.1.0	3.2.0
	RP-07	RP-000044	155	1	Information elements for ASC in TDD	3.1.0	3.2.0
	RP-07	RP-000044	156		Addition of timing advance value in handover related messages	3.1.0	3.2.0
	RP-07	RP-000044	157	2	Physical channel description for TDD	3.1.0	3.2.0
	RP-07	RP-000044	159		Message contents for the intersystem command message to UTRAN operating in TDD mode	3.1.0	3.2.0
	RP-07	RP-000044	160		Corrections on use of PUSCH power control info and minor corrections	3.1.0	3.2.0
	RP-07	RP-000044	162	2	UE individual DRX cycles in CELL_PCH and URA_PCH states	3.1.0	3.2.0
	RP-07	RP-000044	163		Correction to Transport Format Combination Control procedure	3.1.0	3.2.0
	RP-07	RP-000044	164	3	Downlink outer loop power control	3.1.0	3.2.0
	RP-07	RP-000044	165	2	Redirection of RRC connection setup	3.1.0	3.2.0
	RP-07	RP-000044	166	2	Inter-frequency measurements in CELL_FACH state	3.1.0	3.2.0
	RP-07	RP-000044	167		List of found editorial mistakes in the Dec99 version of 25.331 (V3.1.0)	3.1.0	3.2.0
	RP-07	RP-000044	168	1	Transport block size	3.1.0	3.2.0
	RP-07	RP-000044	169	1	Cell Access Restriction	3.1.0	3.2.0
	RP-07	RP-000044	170		Editorial modification	3.1.0	3.2.0
	RP-07	RP-000044	171		Modification of DPCH info	3.1.0	3.2.0
	RP-07	RP-000045	172	1	Measurement control message	3.1.0	3.2.0
	RP-07	RP-000045	173	2	Reporting cell status	3.1.0	3.2.0
	RP-07	RP-000045	174		Additional IE for RB release	3.1.0	3.2.0
	RP-07	RP-000045	175		Available SF in PRACH info	3.1.0	3.2.0
	RP-07	RP-000045	176		Traffic volume measurement event	3.1.0	3.2.0
	RP-07	RP-000045	177		Report of multiple cells on an event result	3.1.0	3.2.0
	RP-07	RP-000045	178		Editorial modification on Direct Transfer	3.1.0	3.2.0
	RP-07	RP-000045	179		Correction of the Security Mode Control procedure	3.1.0	3.2.0
	RP-07	RP-000045	180	1	Maximum calculated Transport Format Combination	3.1.0	3.2.0
	RP-07	RP-000045	183		Additional DPCH IEs to align 25.331 with 25.214	3.1.0	3.2.0
	RP-07	RP-000045	184	1	RB – DCH mapping	3.1.0	3.2.0
	RP-07	RP-000045	188	1	Modifications related to FDD mode DSCH	3.1.0	3.2.0
	RP-07	RP-000045	189	1	Identification of Shared Channel Physical Configuration in TDD Mode	3.1.0	3.2.0
	RP-07	RP-000045	192	1	Uplink Outer Loop Power Control During Hard Handover	3.1.0	3.2.0
	RP-07	RP-000045	193		Support of Multiple CCTrCH's in TDD Mode	3.1.0	3.2.0
	RP-07	RP-000045	194	1	Uplink Physical Channel Control in TDD Mode	3.1.0	3.2.0
	RP-07	RP-000045	201	1	Transfer of initial information from UE to target RNC prior to handover to UTRAN	3.1.0	3.2.0
	RP-07	RP-000045	202	1	CN information elements	3.1.0	3.2.0
	RP-07	RP-000045	203		UTRAN mobility information elements	3.1.0	3.2.0
	RP-07	RP-000045	204	1	RB information elements	3.1.0	3.2.0
	RP-07	RP-000046	205	1	Physical channel information elements	3.1.0	3.2.0
	RP-07	RP-000046	206	1	UE capability information elements	3.1.0	3.2.0
	RP-07	RP-000046	207		UE variables	3.1.0	3.2.0
	RP-07	RP-000046	208	1	Actions when entering idle mode	3.1.0	3.2.0
	RP-07	RP-000046	209		Usage of pilot bits	3.1.0	3.2.0
	RP-07	RP-000046	210		System information procedure corrections	3.1.0	3.2.0
	RP-07	RP-000046	212		Reconfiguration of ciphering	3.1.0	3.2.0
	RP-07	RP-000046	213	1	Enhancements to RRC connection re-establishment procedure (Message subsequently deleted in RAN !), RP-000715)	3.1.0	3.2.0
	RP-07	RP-000046	215		Updates to RRC Initialisation Information transparent container and addition of reverse direction container description	3.1.0	3.2.0
	RP-07	RP-000046	220	1	Changes in RRC messages to support lossless SRNC relocation	3.1.0	3.2.0
	RP-07	RP-000046	229	1	Measurements of unlisted neighbouring cells	3.1.0	3.2.0
	RP-07	RP-000046	234	2	Inclusion of Location Services	3.1.0	3.2.0
	RP-07	RP-000046	236	1	Application of Access Service Classes and relation to Access Classes	3.1.0	3.2.0
	RP-07	RP-000046	252	1	DRX indicator presence and state entering mechanism at the end of a procedure	3.1.0	3.2.0

Change history							
Date	TSG #	TSG Doc.	CR	Rev	Subject/Comment	Old	New
	RP-07	RP-000046	254	1	Physical shared channel allocation procedure	3.1.0	3.2.0
	RP-07	RP-000046	255		Corrections to TDD specific parameters in PICH info	3.1.0	3.2.0
	RP-07	RP-000046	256		Editorial modifications	3.1.0	3.2.0
	RP-07	RP-000046	259	2	Introduction of mapping function information in Cell selection and	3.1.0	3.2.0
	RP-07	RP-000046	263		Ciphering and integrity HFN	3.1.0	3.2.0
	RP-07	RP-000046	267		New SIB for UP	3.1.0	3.2.0
	RP-07	RP-000047	268		Removal of synchronization Case 3	3.1.0	3.2.0
	RP-07	RP-000047	271		TX Diversity	3.1.0	3.2.0
	RP-07	RP-000047	272		Update of tabular format clause 10	3.1.0	3.2.0
	RP-07	RP-000047	273		ASN.1 description	3.1.0	3.2.0
06/2000	RP-08	RP-000222	228	5	Downlink power control in compressed mode	3.2.0	3.3.0
	RP-08	RP-000222	260	1	Clarification on physical channel allocations in TDD	3.2.0	3.3.0
	RP-08	RP-000222	261	4	TDD Measurements and Reporting	3.2.0	3.3.0
	RP-08	RP-000222	262	4	Signalling of IEs related to System Information on FACH	3.2.0	3.3.0
	RP-08	RP-000222	265	3	Transport Format Combination Control	3.2.0	3.3.0
	RP-08	RP-000222	269	1	Signalling of partial failure in radio bearer related procedures	3.2.0	3.3.0
	RP-08	RP-000222	275		Clarification on PDCP info	3.2.0	3.3.0
	RP-08	RP-000222	279		Editorial modification on Transport Ch capability	3.2.0	3.3.0
	RP-08	RP-000222	280		Editorial modification on CN IE	3.2.0	3.3.0
	RP-08	RP-000222	281	3	Editorial modification on Physical CH IE	3.2.0	3.3.0
	RP-08	RP-000222	282	1	Editorial modification on ASN.1 description	3.2.0	3.3.0
	RP-08	RP-000222	283	1	IEs on SIB5/6	3.2.0	3.3.0
	RP-08	RP-000222	285	2	Re-establishment timer	3.2.0	3.3.0
	RP-08	RP-000222	286	1	CN DRX cycle coefficient	3.2.0	3.3.0
	RP-08	RP-000222	287	1	Cell Access Restriction	3.2.0	3.3.0
	RP-08	RP-000222	288	1	Cell selection and re-selection parameters	3.2.0	3.3.0
	RP-08	RP-000222	289	2	Modification on Measurement IE	3.2.0	3.3.0
	RP-08	RP-000222	291	1	RACH Transmission parameters	3.2.0	3.3.0
	RP-08	RP-000222	292	1	SCCPCH System Info	3.2.0	3.3.0
	RP-08	RP-000222	293	1	Addition of HFN for RRC CONNECTION RE-ESTABLISHMENT COMPLETE	3.2.0	3.3.0
	RP-08	RP-000223	294	1	RLC reconfiguration indicator	3.2.0	3.3.0
	RP-08	RP-000223	296	3	RLC Info	3.2.0	3.3.0
	RP-08	RP-000223	297	1	Usage of Transport CH ID	3.2.0	3.3.0
	RP-08	RP-000223	298	2	Transport format combination set	3.2.0	3.3.0
	RP-08	RP-000223	300	1	Usage of U-RNTI and C-RNTI in DL DCCH message	3.2.0	3.3.0
	RP-08	RP-000223	301		Description of Cell Update Procedure	3.2.0	3.3.0
	RP-08	RP-000223	304	1	System information modification procedure	3.2.0	3.3.0
	RP-08	RP-000223	305		Functional descriptions of the RRC messages	3.2.0	3.3.0
	RP-08	RP-000223	306		Clarification of CTFC calculation	3.2.0	3.3.0
	RP-08	RP-000223	307	3	Compressed mode parameters	3.2.0	3.3.0
	RP-08	RP-000223	309	2	Signalling procedure for periodic local authentication	3.2.0	3.3.0
	RP-08	RP-000223	310	5	Editorial corrections on security	3.2.0	3.3.0
	RP-08	RP-000223	311	2	Security capability	3.2.0	3.3.0
	RP-08	RP-000223	312	1	Corrections on ASN.1 definitions	3.2.0	3.3.0
	RP-08	RP-000223	313	2	DRX cycle lower limit	3.2.0	3.3.0
	RP-08	RP-000223	314	1	Removal of CPICH SIR measurement quantity	3.2.0	3.3.0
	RP-08	RP-000223	315	1	Signalling connection release request	3.2.0	3.3.0
	RP-08	RP-000223	318	1	Change to IMEI coding from BCD to hexadecimal	3.2.0	3.3.0
	RP-08	RP-000223	319	1	Removal of RLC sequence numbers from RRC initialisation information	3.2.0	3.3.0
	RP-08	RP-000223	320	3	Addition of the length of PDCP sequence numbers into PDCP info	3.2.0	3.3.0
	RP-08	RP-000224	323	1	BSIC verification of GSM cells	3.2.0	3.3.0
	RP-08	RP-000224	324		Reporting cell status	3.2.0	3.3.0
	RP-08	RP-000224	325		RRC measurement filtering parameters	3.2.0	3.3.0
	RP-08	RP-000224	326		Cell-reselection parameter signalling	3.2.0	3.3.0
	RP-08	RP-000224	328	3	Multiplicity values	3.2.0	3.3.0

Change history							
Date	TSG #	TSG Doc.	CR	Rev	Subject/Comment	Old	New
	RP-08	RP-000224	329		Quality measurements	3.2.0	3.3.0
	RP-08	RP-000224	330	4	CPCH Status Indication mode correction	3.2.0	3.3.0
	RP-08	RP-000224	331	4	End of CPCH transmission	3.2.0	3.3.0
	RP-08	RP-000224	332		Handover to UTRAN procedure	3.2.0	3.3.0
	RP-08	RP-000224	333		Harmonization of access service classes in FDD and TDD	3.2.0	3.3.0
	RP-08	RP-000224	334	1	Correction to usage of primary CCPCH info and primary CPICH info	3.2.0	3.3.0
	RP-08	RP-000224	335		Corrections and clarifications on system information handling	3.2.0	3.3.0
	RP-08	RP-000224	336		Editorial corrections	3.2.0	3.3.0
	RP-08	RP-000224	337	1	Editorial corrections on uplink timing advance	3.2.0	3.3.0
	RP-08	RP-000224	339		Correction of Transport Format Combination tabular format and ASN.1	3.2.0	3.3.0
	RP-08	RP-000224	340	1	UE variables	3.2.0	3.3.0
	RP-08	RP-000224	342	1	General error handling	3.2.0	3.3.0
	RP-08	RP-000224	344	1	System Information extensibility in ASN.1 definitions	3.2.0	3.3.0
	RP-08	RP-000224	345		Usage of pilot bits	3.2.0	3.3.0
	RP-08	RP-000224	346	3	RRC connection release procedure	3.2.0	3.3.0
	RP-08	RP-000225	347	1	Alignment of Section 10.3 on methodology defined in 25.921	3.2.0	3.3.0
	RP-08	RP-000225	348		Modifications of cell (re)selection parameters	3.2.0	3.3.0
	RP-08	RP-000225	350	1	GPS time-of-week represented as seconds and fractions of seconds	3.2.0	3.3.0
	RP-08	RP-000225	351	2	CPCH corrections	3.2.0	3.3.0
	RP-08	RP-000225	352		PLMN type selection	3.2.0	3.3.0
	RP-08	RP-000225	353	3	Paging and establishment cause values	3.2.0	3.3.0
	RP-08	RP-000225	354		Common channel configurations	3.2.0	3.3.0
	RP-08	RP-000225	355	2	Clarification of prioritization of logical channels in UE	3.2.0	3.3.0
	RP-08	RP-000225	357	2	UE capability corrections	3.2.0	3.3.0
	RP-08	RP-000225	358	2	Clarification of HFN	3.2.0	3.3.0
	RP-08	RP-000225	359	3	Clarification of Integrity Protection	3.2.0	3.3.0
	RP-08	RP-000225	360	1	RRC message size optimization regarding TrCH parameters	3.2.0	3.3.0
	RP-08	RP-000225	361		Protocol extensions in ASN	3.2.0	3.3.0
	RP-08	RP-000225	362	1	Downloading of pre- defined configurations via SIB 16	3.2.0	3.3.0
	RP-08	RP-000225	363	1	Optimization of System Information	3.2.0	3.3.0
	RP-08	RP-000225	364	1	CPCH gain factor	3.2.0	3.3.0
	RP-08	RP-000225	368	2	SFN Transmission Rate in TDD Mode	3.2.0	3.3.0
	RP-08	RP-000225	371	1	Integrity Control	3.2.0	3.3.0
	RP-08	RP-000225	372		Modification to measurement event evaluation	3.2.0	3.3.0
	RP-08	RP-000225	373		System Information related parameters	3.2.0	3.3.0
	RP-08	RP-000226	375	1	Changes in RB mapping info	3.2.0	3.3.0
	RP-08	RP-000226	377		Editorial corrections to PRACH system information and Cell info	3.2.0	3.3.0
	RP-08	RP-000226	378		Editorial Corrections to 25.331 Procedures and Tabular Format	3.2.0	3.3.0
	RP-08	RP-000226	379	1	Corrections to figures and procedures for the failure cases	3.2.0	3.3.0
	RP-08	RP-000226	380		Corrections on use of ORDERED_CONFIG	3.2.0	3.3.0
	RP-08	RP-000226	382	1	Corrections to Transport Channel and RB Reconfiguration procedures	3.2.0	3.3.0
	RP-08	RP-000226	383	1	Corrections to INITIAL DIRECT TRANSFER and UE CAPABILITY INFORMATION CONFIRM procedures	3.2.0	3.3.0
	RP-08	RP-000226	384		Corrections to Transparent mode signalling info Tabular format and ASN.1	3.2.0	3.3.0
	RP-08	RP-000226	385		Corrections to Soft Handover messages and procedures	3.2.0	3.3.0
	RP-08	RP-000226	387		Corrections to RRC CONNECTION REJECT procedures	3.2.0	3.3.0
	RP-08	RP-000226	388	1	Transport format combination in TDD and Transport channel ID	3.2.0	3.3.0
	RP-08	RP-000226	389	1	Signalling for dynamic TTI in TDD	3.2.0	3.3.0
	RP-08	RP-000226	390	1	Usage of DCCH for Shared Channel Allocation message	3.2.0	3.3.0
	RP-08	RP-000226	391	1	Correction to physical channel IEs in TDD	3.2.0	3.3.0
	RP-08	RP-000226	392	1	TDD preconfiguration for Handover to UTRAN	3.2.0	3.3.0
	RP-08	RP-000226	393		Corrections to measurement control descriptions and messages	3.2.0	3.3.0
	RP-08	RP-000226	394	1	Corrections on ASN.1 definitions	3.2.0	3.3.0
	RP-08	RP-000226	395		Addition of the Segmentation indication field for transparent mode	3.2.0	3.3.0

Change history							
Date	TSG #	TSG Doc.	CR	Rev	Subject/Comment	Old	New
					RLC in the RLC Info		
	RP-08	RP-000226	396	1	Radio Bearer identity for CCCH	3.2.0	3.3.0
	RP-08	RP-000226	397	1	ASN.1 definitions for RRC information between network nodes	3.2.0	3.3.0
	RP-08	RP-000227	398	1	NAS Routing	3.2.0	3.3.0
	RP-08	RP-000227	399		DPCCH power control preamble	3.2.0	3.3.0
	RP-08	RP-000227	400	2	Modifications of Assisted GPS Messages	3.2.0	3.3.0
	RP-08	RP-000227	401		Choice of Initial UE Identity	3.2.0	3.3.0
	RP-08	RP-000227	402		ANSI-41 information elements	3.2.0	3.3.0
	RP-08	RP-000227	404	1	RLC value ranges	3.2.0	3.3.0
	RP-08	RP-000227	408	1	HFN Reset	3.2.0	3.3.0
	RP-08	RP-000227	409	1	Clarification on ciphering parameters and integrity protection procedure in case of SRNS relocation	3.2.0	3.3.0
	RP-08	RP-000227	410	1	Clarification of compressed mode activation and configuration failure	3.2.0	3.3.0
	RP-08	RP-000227	412	1	Modification of the RLC Size IE	3.2.0	3.3.0
	RP-08	RP-000227	414		CPCH DL Power control	3.2.0	3.3.0
	RP-08	RP-000227	415	1	SFN measurements in TDD	3.2.0	3.3.0
09/2000	RP-09	RP-000361	356	3	Clarification on multiplicity of PCH and PICH and S-CCPCH selection	3.3.0	3.4.0
	RP-09	RP-000361	403	3	Parameters to be stored in the USIM	3.3.0	3.4.0
	RP-09	RP-000361	413	3	Optimization of Inter-system handover message	3.3.0	3.4.0
	RP-09	RP-000361	416	2	Timing Advance in Handover Procedures	3.3.0	3.4.0
	RP-09	RP-000361	417	2	Synchronization of Timing Advance and Timing Deviation Measurement	3.3.0	3.4.0
	RP-09	RP-000361	418		Downlink Physical Channels Per Timeslot	3.3.0	3.4.0
	RP-09	RP-000361	419		TDD Mode DCH Reception in Cell DCH State	3.3.0	3.4.0
	RP-09	RP-000361	420	2	Downlink Power Control During DTX in TDD Mode	3.3.0	3.4.0
	RP-09	RP-000361	421	1	Paging Indicator Length Definition	3.3.0	3.4.0
	RP-09	RP-000361	422		Updating & alignment of RRC containers & handover to UTRAN information transfer	3.3.0	3.4.0
	RP-09	RP-000361	424		Default values for UE timers and counters	3.3.0	3.4.0
	RP-09	RP-000361	425	1	Security mode control	3.3.0	3.4.0
	RP-09	RP-000361	426	1	Corrections and Editorial updates to chapter 8	3.3.0	3.4.0
	RP-09	RP-000361	427		Corrections and editorial updates to chapter 10	3.3.0	3.4.0
	RP-09	RP-000361	428		Transition from CELL_DCH to CELL_PCH and URA_PCH state	3.3.0	3.4.0
	RP-09	RP-000361	430		Assisted GPS Messaging and Procedures	3.3.0	3.4.0
	RP-09	RP-000361	431	2	Corrections to Activation Time use	3.3.0	3.4.0
	RP-09	RP-000361	432		Editorial Corrections to measurement reporting range	3.3.0	3.4.0
	RP-09	RP-000361	434	4	Default DPCH offset value and DPCH offset	3.3.0	3.4.0
	RP-09	RP-000361	435	3	RLC info	3.3.0	3.4.0
	RP-09	RP-000362	437		Clarification of the description of IE semantics in "RB with PDCP information"	3.3.0	3.4.0
	RP-09	RP-000362	438	1	Editorial corrections on security	3.3.0	3.4.0
	RP-09	RP-000362	439		Editorial correction to RB mapping info	3.3.0	3.4.0
	RP-09	RP-000362	440	1	Compressed mode configuration failure	3.3.0	3.4.0
	RP-09	RP-000362	441		Gain factors for TDD	3.3.0	3.4.0
	RP-09	RP-000362	442		Introduction of Default DPCH Offset Value in TDD	3.3.0	3.4.0
	RP-09	RP-000362	444	1	Optimization of handover to UTRAN command	3.3.0	3.4.0
	RP-09	RP-000362	445		Editorial corrections	3.3.0	3.4.0
	RP-09	RP-000362	448	1	Mapping of channelisation code	3.3.0	3.4.0
	RP-09	RP-000362	449	2	DL TFCS Limitation	3.3.0	3.4.0
	RP-09	RP-000362	450		SIB offset	3.3.0	3.4.0
	RP-09	RP-000362	451		RRC CONNECTION RELEASE cause	3.3.0	3.4.0
	RP-09	RP-000362	452		Addition of RACH TFCS	3.3.0	3.4.0
	RP-09	RP-000362	453	2	Cell Identity	3.3.0	3.4.0
	RP-09	RP-000362	454		Editorial Modifications	3.3.0	3.4.0
	RP-09	RP-000362	455	1	TDD PRACH Power Control for Spreading Factor 8/16	3.3.0	3.4.0
	RP-09	RP-000362	456		TDD CCTrCH Repetition Length Definition	3.3.0	3.4.0
	RP-09	RP-000362	457	1	Reporting threshold of traffic volume measurements	3.3.0	3.4.0

Change history							
Date	TSG #	TSG Doc.	CR	Rev	Subject/Comment	Old	New
	RP-09	RP-000362	459	2	UP GPS assistance data for SIB	3.3.0	3.4.0
	RP-09	RP-000362	461	1	Support of cell update confirm on CCCH	3.3.0	3.4.0
	RP-09	RP-000363	462	1	Max Window Size in RLC capabilities	3.3.0	3.4.0
	RP-09	RP-000363	463	3	UE handling of CFN	3.3.0	3.4.0
	RP-09	RP-000363	464	1	Correction of padding description in clause 12	3.3.0	3.4.0
	RP-09	RP-000363	465	1	Window size in RLC info	3.3.0	3.4.0
	RP-09	RP-000363	466	1	TFC Control Duration	3.3.0	3.4.0
	RP-09	RP-000363	467		System Information Block Tabular Information	3.3.0	3.4.0
	RP-09	RP-000363	469	1	Frequency encoding in inter-system handover messages	3.3.0	3.4.0
	RP-09	RP-000363	470		RRC message size optimization regarding TFS parameters	3.3.0	3.4.0
	RP-09	RP-000363	471	2	RACH selection	3.3.0	3.4.0
	RP-09	RP-000363	472		DRX cycle lower limit	3.3.0	3.4.0
	RP-09	RP-000363	474		Rx window size in RLC info	3.3.0	3.4.0
	RP-09	RP-000363	476	1	Corrections & optimizations regarding system information blocks of length 215..221	3.3.0	3.4.0
	RP-09	RP-000363	477	1	Corrections on 8.1.1 resulting from RRC review at R2#14	3.3.0	3.4.0
	RP-09	RP-000363	478	1	Corrections to the RRC connection release procedure	3.3.0	3.4.0
	RP-09	RP-000363	479	1	New release cause for signalling connection re-establishment	3.3.0	3.4.0
	RP-09	RP-000363	480	1	Correction to IE midamble shift and burst type	3.3.0	3.4.0
	RP-09	RP-000363	481	1	Correction in RLC info	3.3.0	3.4.0
	RP-09	RP-000363	483		Description of CTCH occasions	3.3.0	3.4.0
	RP-09	RP-000363	485	1	TDD CCTrCH UL/DL Pairing for Inner Loop Power Control	3.3.0	3.4.0
	RP-09	RP-000363	486	1	DCCH and BCCH Signalling of TDD UL OL PC Information	3.3.0	3.4.0
	RP-09	RP-000364	487	1	Broadcast SIBs for TDD UL OL PC Information	3.3.0	3.4.0
	RP-09	RP-000364	490	1	CPCH corrections	3.3.0	3.4.0
	RP-09	RP-000364	492	3	Corrections to Security IEs	3.3.0	3.4.0
	RP-09	RP-000364	494	1	Corrections to parameters to be stored in the USIM	3.3.0	3.4.0
	RP-09	RP-000364	496		Editorial corrections	3.3.0	3.4.0
	RP-09	RP-000364	497	2	Physical Shared Channel Allocation procedure	3.3.0	3.4.0
	RP-09	RP-000364	498		Correction to Transport Format Combination Control Message	3.3.0	3.4.0
	RP-09	RP-000364	499	1	Usage of Cell Parameter ID	3.3.0	3.4.0
	RP-09	RP-000364	500		RB description for SHCCH	3.3.0	3.4.0
	RP-09	RP-000364	501	1	Use of LI in UM	3.3.0	3.4.0
	RP-09	RP-000364	502	1	Minor Corrections to RRC Protocol Specification	3.3.0	3.4.0
	RP-09	RP-000364	503	1	Correction to Cell Update Cause	3.3.0	3.4.0
	RP-09	RP-000364	504		Correction on T307 definition	3.3.0	3.4.0
	RP-09	RP-000364	505		Corrections to relative priorities in RRC Protocol	3.3.0	3.4.0
	RP-09	RP-000364	506		Unification of Reconfiguration Procedures	3.3.0	3.4.0
	RP-09	RP-000364	507	1	Changes to section 8.2 proposed at Paris RRC Ad Hoc	3.3.0	3.4.0
	RP-09	RP-000364	508		Establishment Cause	3.3.0	3.4.0
	RP-09	RP-000364	509	1	PRACH partitioning	3.3.0	3.4.0
	RP-09	RP-000364	510		Editorial Correction on Active Set Update	3.3.0	3.4.0
	RP-09	RP-000364	511		Editorial Correction regarding system information	3.3.0	3.4.0
	RP-09	RP-000365	512	1	Clarification on Reporting Cell Status	3.3.0	3.4.0
	RP-09	RP-000365	513	1	Editorial corrections on RRC Connection Establishment and Release procedures NOTE: In subclause 8.1.4.6, the change from "decrease" to "increase" for V308 was decided to be incorrect after discussion on the TSG-RAN WG2 reflector and was not implemented	3.3.0	3.4.0
	RP-09	RP-000365	514		Gated Transmission Control Info	3.3.0	3.4.0
	RP-09	RP-000365	515	1	Cell selection/reselection parameters for SIB 3/4	3.3.0	3.4.0
	RP-09	RP-000365	516		Implementation of Ec/N0 parameters and optimization of SIB 11/12	3.3.0	3.4.0
	RP-09	RP-000365	517		PRACH Info	3.3.0	3.4.0
	RP-09	RP-000365	518	1	Uplink DPCH power control info	3.3.0	3.4.0
	RP-09	RP-000365	519		AICH power offset value range	3.3.0	3.4.0
	RP-09	RP-000365	520		Direct paging of RRC connected UE in CELL_PCH/URA_PCH NOTE: This CR was postponed in TSG-RAN #9 and was wrongly included in v3.4.0. This was corrected in v3.4.1	3.3.0	3.4.0
	RP-09	RP-000365	521		Corrections to Sections 1-7	3.3.0	3.4.0

Change history							
Date	TSG #	TSG Doc.	CR	Rev	Subject/Comment	Old	New
	RP-09	RP-000365	522		Error handling for Uplink Physical Channel Control procedure	3.3.0	3.4.0
	RP-09	RP-000365	523		Corrections to downlink outer loop power control in compressed mode	3.3.0	3.4.0
	RP-09	RP-000365	524	1	Clarification on measurement procedure using compressed mode	3.3.0	3.4.0
	RP-09	RP-000365	525	1	Updates to cell and URA update procedures based on RRC Ad Hoc	3.3.0	3.4.0
	RP-09	RP-000365	526	1	Updates to RNTI allocation procedure based on RRC Ad Hoc	3.3.0	3.4.0
	RP-09	RP-000365	528		PRACH constant value	3.3.0	3.4.0
	RP-09	RP-000365	530	1	Corrections to the paging procedure	3.3.0	3.4.0
	RP-09	RP-000365	532	1	Moving of text from 25.304	3.3.0	3.4.0
	RP-09	RP-000365	533	1	Message extensibility	3.3.0	3.4.0
	RP-09	RP-000365	534	1	Additions to "State of RRC Procedure" in RRC Initialisation information, source RNC to target RNC	3.3.0	3.4.0
	RP-09	RP-000365	535	1	Support of codec negotiation	3.3.0	3.4.0
	-	-	-		Removal of contents of CR 520 from v3.4.0, because it was postponed at TSG-RAN #9 and by accident included anyway.	3.4.0	3.4.1
12/2000	RP-10	RP-000570	536		Downlink outer-loop power control in compressed mode	3.4.1	3.5.0
	RP-10	RP-000570	537	1	Correction in the use of "U-RNTI Short"	3.4.1	3.5.0
	RP-10	RP-000570	538		Corrections related to UE Timing	3.4.1	3.5.0
	RP-10	RP-000570	539		Corrections to SFN-SFN definition	3.4.1	3.5.0
	RP-10	RP-000570	541	1	Corrections to definition and use of Activation Time	3.4.1	3.5.0
	RP-10	RP-000570	542		Corrections to logical channel priorities	3.4.1	3.5.0
	RP-10	RP-000570	543	1	Correction to codec negotiation	3.4.1	3.5.0
	RP-10	RP-000570	544	1	CFN-SFN observed time difference measurement	3.4.1	3.5.0
	RP-10	RP-000570	545	1	Correction to timing indication for hard handover	3.4.1	3.5.0
	RP-10	RP-000570	546	1	UE Radio Access Capability Corrections	3.4.1	3.5.0
	RP-10	RP-000570	548	1	RRC establishment and paging causes for NAS signalling	3.4.1	3.5.0
	RP-10	RP-000570	549		Corrections to Intra-frequency measurements and Traffic volume measurements	3.4.1	3.5.0
	RP-10	RP-000570	551	1	PRACH/RACH System information	3.4.1	3.5.0
	RP-10	RP-000570	553	1	GSM Measurement reporting	3.4.1	3.5.0
	RP-10	RP-000570	554	1	BLER measurement and quality target	3.4.1	3.5.0
	RP-10	RP-000570	556	1	Clarification of PDCP sequence number window terminology	3.4.1	3.5.0
	RP-10	RP-000570	559	1	Clarification on Error Handling	3.4.1	3.5.0
	RP-10	RP-000570	560		Removal of compressed mode measurement purpose "other"	3.4.1	3.5.0
	RP-10	RP-000570	561		Clarification of compressed mode measurement purpose "GSM"	3.4.1	3.5.0
	RP-10	RP-000570	564	2	Reporting multiple GSM cells	3.4.1	3.5.0
	RP-10	RP-000571	566	1	Number of RLS that can be removed in Active Set update	3.4.1	3.5.0
	RP-10	RP-000571	568	1	Clarification on Segment Index	3.4.1	3.5.0
	RP-10	RP-000571	571	3	RRC procedure performance requirements	3.4.1	3.5.0
	RP-10	RP-000571	572	1	Correction of newInterSystemCellList and MeasurementControlSysInfo in ASN.1	3.4.1	3.5.0
	RP-10	RP-000571	573	4	Removal of Flow Id concept while maintaining lu interface flexibility	3.4.1	3.5.0
	RP-10	RP-000571	574	2	Ciphering and reset	3.4.1	3.5.0
	RP-10	RP-000571	575	1	Corrections and clarifications concerning inter-RAT change procedures	3.4.1	3.5.0
	RP-10	RP-000571	576	1	General Security Clarifications	3.4.1	3.5.0
	RP-10	RP-000571	577		Clarification on RB 0	3.4.1	3.5.0
	RP-10	RP-000571	578		Clarification on the transition of RRC state	3.4.1	3.5.0
	RP-10	RP-000571	580	1	UP measurements for RRC information to target RNC	3.4.1	3.5.0
	RP-10	RP-000571	581		Correction on LCS reporting criteria	3.4.1	3.5.0
	RP-10	RP-000574	583	1	CSICH Corrections	3.4.1	3.5.0
	RP-10	RP-000571	584	1	Clarification to handling of satellite health issues	3.4.1	3.5.0
	RP-10	RP-000571	585		Clarification on activation time	3.4.1	3.5.0
	RP-10	RP-000571	586		Clarification on activation time for ciphering in TM	3.4.1	3.5.0
	RP-10	RP-000571	587	2	Measurement procedures and messages	3.4.1	3.5.0
	RP-10	RP-000571	590	1	Inter-RAT UE radio access capability	3.4.1	3.5.0
	RP-10	RP-000571	592	1	Clarification on cell update/URA update procedures	3.4.1	3.5.0
	RP-10	RP-000571	595	4	Protocol States and Process	3.4.1	3.5.0

Change history							
Date	TSG #	TSG Doc.	CR	Rev	Subject/Comment	Old	New
	RP-10	RP-000571	596	1	System Information	3.4.1	3.5.0
	RP-10	RP-000715	597	5	RRC Connection Management Procedures, Generic procedures and actions	3.4.1	3.5.0
	RP-10	RP-000572	598	1	Paging Procedures	3.4.1	3.5.0
	RP-10	RP-000572	599		NAS signalling Procedures	3.4.1	3.5.0
	RP-10	RP-000572	600	3	Radio Bearer Control Procedures	3.4.1	3.5.0
	RP-10	RP-000572	601	1	Corrections to the Counter Check Procedure	3.4.1	3.5.0
	RP-10	RP-000572	602		Tabular Information and ASN.1	3.4.1	3.5.0
	RP-10	RP-000572	604	2	Corrections to Measurement Occasion concept	3.4.1	3.5.0
	RP-10	RP-000572	606		Corrections concerning optimisation of RB information	3.4.1	3.5.0
	RP-10	RP-000572	608	1	Corrections to security	3.4.1	3.5.0
	RP-10	RP-000572	609	1	Ciphering activation time for DPCH	3.4.1	3.5.0
	RP-10	RP-000572	610		Confirmation of signalling connection establishment	3.4.1	3.5.0
	RP-10	RP-000572	611	2	RACH Sub-channel signalling	3.4.1	3.5.0
	RP-10	RP-000572	613	2	Assistance data delivery for UP	3.4.1	3.5.0
	RP-10	RP-000572	614	1	Clarification of LCS measurements	3.4.1	3.5.0
	RP-10	RP-000572	615	2	Configuration of RLC PDU sizes for logical channels	3.4.1	3.5.0
	RP-10	RP-000574	616		PICH power offset for TDD	3.4.1	3.5.0
	RP-10	RP-000572	617		Correction for PDSCH power control for TDD	3.4.1	3.5.0
	RP-10	RP-000574	618		Usage of dynamic spreading factor in uplink	3.4.1	3.5.0
	RP-10	RP-000572	619		Correction of Midamble Shift for Burst Type 3	3.4.1	3.5.0
	RP-10	RP-000572	621		Correction of text concerning Scheduling of System Information	3.4.1	3.5.0
	RP-10	RP-000572	622	1	Alignment of GSM/99 BA Range concept and its inclusion in UTRA	3.4.1	3.5.0
	RP-10	RP-000572	623	1	Clarification of RB mapping info	3.4.1	3.5.0
	RP-10	RP-000572	624	1	Correction to UE multi-RAT capability	3.4.1	3.5.0
	RP-10	RP-000573	625		Correction to PDCP sequence number exchange during hard handover	3.4.1	3.5.0
	RP-10	RP-000573	628	2	DCH Quality Target	3.4.1	3.5.0
	RP-10	RP-000573	629	1	Simultaneous release of RBs and signalling connection	3.4.1	3.5.0
	RP-10	RP-000573	630		Correction on Transport Channel Reconfiguration	3.4.1	3.5.0
	RP-10	RP-000573	631		Limitation of DRX cycle length	3.4.1	3.5.0
	RP-10	RP-000574	632		Signalling of the alpha value in TDD for open loop power control	3.4.1	3.5.0
	RP-10	RP-000573	633		Support for improved compressed mode handling for TDD measurements	3.4.1	3.5.0
	RP-10	RP-000573	636		Usage of secondary CPICH and secondary scrambling code	3.4.1	3.5.0
	RP-10	RP-000573	639		Expiration time of SIB type 7, 14	3.4.1	3.5.0
	RP-10	RP-000573	640		Correction to integrity protection	3.4.1	3.5.0
	RP-10	RP-000684	641		Downlink Outer Loop Control	3.4.1	3.5.0
03/2001	RP-11	RP-010029	642	2	RL Failure in cell update procedure	3.5.0	3.6.0
	RP-11	RP-010029	645	1	Clarification on COUNTER CHECK	3.5.0	3.6.0
	RP-11	RP-010029	646	2	Traffic Volume Measurement corrections	3.5.0	3.6.0
	RP-11	RP-010029	650	2	Reserved TFCI for the TDD Special Burst	3.5.0	3.6.0
	RP-11	RP-010029	653		Correction to description of RRC state transitions	3.5.0	3.6.0
	RP-11	RP-010029	657		RLC re-establish correction	3.5.0	3.6.0
	RP-11	RP-010029	658	1	Removal of RLC logical channel mapping indicator	3.5.0	3.6.0
	RP-11	RP-010029	659		New paging and establishment cause "Unknown"	3.5.0	3.6.0
	RP-11	RP-010029	660	1	Miscellaneous procedure corrections	3.5.0	3.6.0
	RP-11	RP-010029	661		Corrections to compressed mode pattern sequence handling	3.5.0	3.6.0
	RP-11	RP-010029	662		Inter-system change clarifications	3.5.0	3.6.0
	RP-11	RP-010029	663	1	RLC status transmission in CELL_PCH and URA_PCH	3.5.0	3.6.0
	RP-11	RP-010029	665	1	Clarification of RB information parameter values for SRB0	3.5.0	3.6.0
	RP-11	RP-010029	666		Encoding for RRC- container	3.5.0	3.6.0
	RP-11	RP-010029	667	2	Update of message extension and encoding descriptions	3.5.0	3.6.0
	RP-11	RP-010032	668	4	Introduction of default pre-defined configurations	3.5.0	3.6.0
	RP-11	RP-010029	669	2	Security corrections	3.5.0	3.6.0
	RP-11	RP-010029	670		Clarifications on Blind Handover Support	3.5.0	3.6.0
	RP-11	RP-010029	671	1	Missing descriptions of UE actions	3.5.0	3.6.0
	RP-11	RP-010029	672	2	Corrections on UE Positioning information	3.5.0	3.6.0

Change history							
Date	TSG #	TSG Doc.	CR	Rev	Subject/Comment	Old	New
	RP-11	RP-010029	674	1	Security related corrections to SRNS	3.5.0	3.6.0
	RP-11	RP-010032	675	2	Downlink power offsets	3.5.0	3.6.0
	RP-11	RP-010274	676	2	Checking the integrity of UE security capabilities	3.5.0	3.6.0
	RP-11	RP-010030	678	1	Clarification to Secondary CCPCH info	3.5.0	3.6.0
	RP-11	RP-010030	679	1	Miscellaneous corrections	3.5.0	3.6.0
	RP-11	RP-010030	680		Removal of Layer 3 filtering for RACH	3.5.0	3.6.0
	RP-11	RP-010030	681	2	Correction of compressed mode parameters	3.5.0	3.6.0
	RP-11	RP-010030	682		Removal of immediate cell evaluation	3.5.0	3.6.0
	RP-11	RP-010030	684	2	Scheduling of SIB 15.2 and SIB 15.3	3.5.0	3.6.0
	RP-11	RP-010030	685	1	Correction to ECN modules	3.5.0	3.6.0
	RP-11	RP-010030	686	1	Improvement of the description of timing advance for TDD	3.5.0	3.6.0
	RP-11	RP-010030	687		Correction on timing advance and allocation for shared channels	3.5.0	3.6.0
	RP-11	RP-010030	688	1	Clarification on SF 1 signalling	3.5.0	3.6.0
	RP-11	RP-010030	689	1	Correction to power control in TDD	3.5.0	3.6.0
	RP-11	RP-010030	690		Midamble - Channelisation code association for TDD	3.5.0	3.6.0
	RP-11	RP-010030	691		Network requested reporting for physical shared channel allocation	3.5.0	3.6.0
	RP-11	RP-010030	693		System Information	3.5.0	3.6.0
	RP-11	RP-010030	694	1	Clarification on Transport Channel Identity	3.5.0	3.6.0
	RP-11	RP-010030	696	1	Editorial Correction	3.5.0	3.6.0
	RP-11	RP-010030	698	2	Correction to add coding of intra domain NAS node selector	3.5.0	3.6.0
	RP-11	RP-010030	700	1	Corrections to system information block characteristics in TDD	3.5.0	3.6.0
	RP-11	RP-010030	701	2	ASN.1 corrections	3.5.0	3.6.0
	RP-11	RP-010030	702	2	Measurement related corrections	3.5.0	3.6.0
	RP-11	RP-010031	703	1	Clarifications on TFC Control procedure	3.5.0	3.6.0
	RP-11	RP-010031	704	2	Association of PLMN ID to neighbour cells	3.5.0	3.6.0
	RP-11	RP-010031	705	1	TFCS Selection Guidelines	3.5.0	3.6.0
	RP-11	RP-010031	710		Special Burst Scheduling During DTX in TDD	3.5.0	3.6.0
	RP-11	RP-010031	711	1	Radio Link Failure Criteria in TDD	3.5.0	3.6.0
	RP-11	RP-010031	712	1	Correction & Clarification to TDD RACH Subchannels	3.5.0	3.6.0
	RP-11	RP-010031	713	1	Number of retransmission of RRC CONNECTION REQUEST	3.5.0	3.6.0
	RP-11	RP-010031	714		Uplink Frequency Notification	3.5.0	3.6.0
	RP-11	RP-010031	715		Clarification of Radio Bearer Mapping for DCH/DSCH Transport Channels	3.5.0	3.6.0
	RP-11	RP-010031	716		Correction of mismatches between tabular and ASN.1	3.5.0	3.6.0
	RP-11	RP-010031	717		Correction to discontinuous reception in TDD	3.5.0	3.6.0
	RP-11	RP-010031	718		Power control preamble	3.5.0	3.6.0
	RP-11	RP-010031	719		Maximum number of AM entity	3.5.0	3.6.0
	RP-11	RP-010031	720	1	Real-time Integrity Broadcast	3.5.0	3.6.0
	RP-11	RP-010031	721	3	Moving Real-time Integrity description to different chapter	3.5.0	3.6.0
	RP-11	RP-010031	723	1	Removal of the payload unit concept	3.5.0	3.6.0
	RP-11	RP-010031	724		Security related corrections to SRNS	3.5.0	3.6.0
	RP-11	RP-010031	725		Periodic PLMN selection correction	3.5.0	3.6.0
	RP-11	RP-010042	683	1	Modification of "SSDT Information" IE parameters to indicate if SSDT is used in the UL only	3.6.0	4.0.0
	RP-11	RP-010041	692	1	Idle allocation for Node B synchronisation	3.6.0	4.0.0
	RP-11	RP-010037	706	1	Physical channel configuration information elements for 1.28 Mcps TDD	3.6.0	4.0.0
	RP-11	RP-010037	707	2	Changes to Measurement Related Signalling and Introduction of Cell (Re)selection Parameters for 1.28Mcps TDD	3.6.0	4.0.0
	RP-11	RP-010037	708	1	Introduction of RACH Parameters for 1.28 Mcps TDD	3.6.0	4.0.0
	RP-11	RP-010037	709		Introduction of UE radio access capability Parameters for 1.28 Mcps TDD	3.6.0	4.0.0
	RP-11	RP-010040	722	1	Introduction of IPDLs for TDD	3.6.0	4.0.0
	RP-11	RP-010039	726	1	ROHC updates to RRC	3.6.0	4.0.0
06/2001	RP-12	RP-010311	731		Clarification of the IE 'spreading factor' in Uplink DPCH info for FDD mode	4.0.0	4.1.0
	RP-12	RP-010311	733		Correction of UE Radio Access Capability depending on UTRAN FDD bands	4.0.0	4.1.0
	RP-12	RP-010311	735		Clarification on Security mode control	4.0.0	4.1.0

Change history							
Date	TSG #	TSG Doc.	CR	Rev	Subject/Comment	Old	New
	RP-12	RP-010311	738		Correction of TrCH parameter handling	4.0.0	4.1.0
	RP-12	RP-010311	740		TFC Subsets in TDD	4.0.0	4.1.0
	RP-12	RP-010311	746		RRC containers	4.0.0	4.1.0
	RP-12	RP-010311	748		Various corrections	4.0.0	4.1.0
	RP-12	RP-010311	750		General error handling for system information	4.0.0	4.1.0
	RP-12	RP-010311	752		Order of elements in strings	4.0.0	4.1.0
	RP-12	RP-010311	754		Configuration consistency checks	4.0.0	4.1.0
	RP-12	RP-010312	756		Compressed mode corrections	4.0.0	4.1.0
	RP-12	RP-010312	758		Correction concerning inter-RAT procedures	4.0.0	4.1.0
	RP-12	RP-010312	762		Measurement corrections	4.0.0	4.1.0
	RP-12	RP-010312	764		RLC Tr Discard	4.0.0	4.1.0
	RP-12	RP-010312	766		Annex B CPCH Correction	4.0.0	4.1.0
	RP-12	RP-010312	768		SIB Correction for CSICH Power Offset	4.0.0	4.1.0
	RP-12	RP-010312	770		Transfer of Last known position in case of SRNS relocation	4.0.0	4.1.0
	RP-12	RP-010312	772		Corrections to UE Positioning measurements	4.0.0	4.1.0
	RP-12	RP-010312	779		GSM measurements in compressed mode	4.0.0	4.1.0
	RP-12	RP-010312	781		Correction of Activation Time in Inter-Rat HO Commands	4.0.0	4.1.0
	RP-12	RP-010313	785		Clarification of FRESH in SRNS relocation	4.0.0	4.1.0
	RP-12	RP-010313	789		Correction to UE timers and constants in idle mode	4.0.0	4.1.0
	RP-12	RP-010313	793		Clarification on multiframe allocation in TDD	4.0.0	4.1.0
	RP-12	RP-010313	795		Predefined parameters for logical channels	4.0.0	4.1.0
	RP-12	RP-010313	797		Pathloss calculation	4.0.0	4.1.0
	RP-12	RP-010313	799		Clarification on periodic measurement reporting	4.0.0	4.1.0
	RP-12	RP-010313	803	1	Handling of IE PRACH TFCS and Primary CPICH/Primary CCPCH info	4.0.0	4.1.0
	RP-12	RP-010313	805		Correction to FACH measurement occasion in TDD	4.0.0	4.1.0
	RP-12	RP-010313	807		Clarification of L1 synchronization procedures	4.0.0	4.1.0
	RP-12	RP-010313	809		Correction of Activation Time definition	4.0.0	4.1.0
	RP-12	RP-010314	813		Corrections to RRC procedure performance	4.0.0	4.1.0
	RP-12	RP-010314	815		Removal of mapping function	4.0.0	4.1.0
	RP-12	RP-010314	817		Security clarifications	4.0.0	4.1.0
	RP-12	RP-010314	819		Corrections to UE Positioning	4.0.0	4.1.0
	RP-12	RP-010314	825		Definition of DPCH numbering	4.0.0	4.1.0
	RP-12	RP-010314	827		Corrections to System Information Procedure	4.0.0	4.1.0
	RP-12	RP-010314	829		Relation between DOFF and DPCH Frame Offset	4.0.0	4.1.0
	RP-12	RP-010314	831		Procedures for "same as UL"	4.0.0	4.1.0
	RP-12	RP-010314	837		Editorial and minor corrections	4.0.0	4.1.0
	RP-12	RP-010314	839		Editorial Correction	4.0.0	4.1.0
	RP-12	RP-010315	843		Corrections on OTDOA-IPDL specific burst parameter semantic description	4.0.0	4.1.0
	RP-12	RP-010315	845		Error handling for messages sent from another RAT	4.0.0	4.1.0
	RP-12	RP-010315	849		Needed TFC in the TFCS for TDD	4.0.0	4.1.0
	RP-12	RP-010315	855		Clarification of TFCS selection guidelines	4.0.0	4.1.0
	RP-12	RP-010315	861		Clarification of Traffic Volume measurements	4.0.0	4.1.0
	RP-12	RP-010315	863		CFN synchronisation problems at timing re-initialised hard handover	4.0.0	4.1.0
	RP-12	RP-010315	866		Corrections on UP Assistance Message Descriptions	4.0.0	4.1.0
	RP-12	RP-010315	868		Correction on Area Scope of SIB 15.3	4.0.0	4.1.0
	RP-12	RP-010315	872		Correction to AICH power offset	4.0.0	4.1.0
	RP-12	RP-010316	875		Clarification on IE 'Downlink rate matching restriction information'	4.0.0	4.1.0
	RP-12	RP-010316	877		Corrections on Tabular/ASN.1	4.0.0	4.1.0
	RP-12	RP-010316	879		Corrections on Tabular and ASN.1 inconsistencies	4.0.0	4.1.0
	RP-12	RP-010316	881		Editorial corrections on Tabular and ASN.1 inconsistencies	4.0.0	4.1.0
	RP-12	RP-010316	883		UE Positioning corrections to ASN.1 and tabular	4.0.0	4.1.0
	RP-12	RP-010316	885		Corrections to resolve inconsistencies between Tabular and ASN.1	4.0.0	4.1.0
	RP-12	RP-010316	887		UE positioning OTDOA Neighbour Cell Info	4.0.0	4.1.0
	RP-12	RP-010316	889		DRAC corrections	4.0.0	4.1.0
	RP-12	RP-010316	893		ASN.1 Correction of IE TFCS ID	4.0.0	4.1.0

Change history							
Date	TSG #	TSG Doc.	CR	Rev	Subject/Comment	Old	New
	RP-12	RP-010316	895		Correction of IE IODE range in AGPS Positioning	4.0.0	4.1.0
	RP-12	RP-010317	897		Correction to BurstModeParameters in IPDL	4.0.0	4.1.0
	RP-12	RP-010317	899		Corrections on inconsistencies between Tabular and ASN.1	4.0.0	4.1.0
	RP-12	RP-010317	901		Naming of message abstract types in ASN.1	4.0.0	4.1.0
	RP-12	RP-010317	904		Information elements outside the extension container	4.0.0	4.1.0
	RP-12	RP-010317	906		Correction concerning DRX cycle upon inter-RAT change towards UTRAN	4.0.0	4.1.0
	RP-12	RP-010323	773		Corrections to IPDLs for TDD	4.0.0	4.1.0
	RP-12	RP-010323	850	2	Correction to 1.28Mcps TDD RACH parameters and operation	4.0.0	4.1.0
	RP-12	RP-010323	851		TFCI coding in case of 8PSK	4.0.0	4.1.0
	RP-12	RP-010323	902	1	Structure and naming of information elements	4.0.0	4.1.0
09/2001	RP-13	RP-010544	0870		UL Transport Channel Type Correction	4.1.0	4.2.0
	RP-13	RP-010544	0908		Guidelines concerning conditions, spares, defaults and correction of inconsistencies	4.1.0	4.2.0
	RP-13	RP-010544	0910		Correction to TDD DL DPCH Common Timeslot Info	4.1.0	4.2.0
	RP-13	RP-010544	0912		TDD System Information Update in Cell_DCH	4.1.0	4.2.0
	RP-13	RP-010544	0914		Editorial Corrections	4.1.0	4.2.0
	RP-13	RP-010544	0916		UL DPCH Power Control Info in TDD	4.1.0	4.2.0
	RP-13	RP-010544	0918		CN-originated paging in CELL_PCH and URA_PCH state	4.1.0	4.2.0
	RP-13	RP-010544	0920		Corrections to UE variable handling	4.1.0	4.2.0
	RP-13	RP-010544	0922		Inter-frequency measurements	4.1.0	4.2.0
	RP-13	RP-010544	0924		Inter-RAT measurements	4.1.0	4.2.0
	RP-13	RP-010671	0926	1	Intra-frequency measurements	4.1.0	4.2.0
	RP-13	RP-010545	0928		Multiplexing configuration corrections	4.1.0	4.2.0
	RP-13	RP-010545	0930		Reception of non-dedicated control channels mapped on FACH in CELL_FACH state	4.1.0	4.2.0
	RP-13	RP-010545	0932		Removal of C-RNTI when entering CELL_DCH	4.1.0	4.2.0
	RP-13	RP-010545	0935		TF and TFC set definition	4.1.0	4.2.0
	RP-13	RP-010545	0937		Correction of remaining ASN.1/Tabular inconsistencies	4.1.0	4.2.0
	RP-13	RP-010545	0939		CPICH Ec/N0 Range	4.1.0	4.2.0
	RP-13	RP-010545	0941		Priorities for IDNNS coding	4.1.0	4.2.0
	RP-13	RP-010545	0943		Dedicated pilots and S-CPICH specification related to UE specific beamforming	4.1.0	4.2.0
	RP-13	RP-010545	0945		Security corrections	4.1.0	4.2.0
	RP-13	RP-010546	0953		Intra-frequency measurement events for TDD corrections	4.1.0	4.2.0
	RP-13	RP-010546	0955		Inconsistencies between ASN.1 and tabular format	4.1.0	4.2.0
	RP-13	RP-010546	0957		TDD PICH corrections and clarifications	4.1.0	4.2.0
	RP-13	RP-010546	0959		Messages on CCCH	4.1.0	4.2.0
	RP-13	RP-010546	0961		Clarification of Parameter Values for Default Radio Configurations	4.1.0	4.2.0
	RP-13	RP-010546	0963		Clarification to usage of default values in "Cell Selection and Reselection for SIB11/12Info"	4.1.0	4.2.0
	RP-13	RP-010546	0965		Clarification of handling of System information block 14	4.1.0	4.2.0
	RP-13	RP-010546	0967		Description of UE behaviour when receiving UE positioning related information	4.1.0	4.2.0
	RP-13	RP-010546	0982		Clarification on periodic measurement reporting	4.1.0	4.2.0
	RP-13	RP-010546	0984		Corrections and clarifications on Measurement procedures description	4.1.0	4.2.0
	RP-13	RP-010547	0986		Lossless Criteria in PDCP Info	4.1.0	4.2.0
	RP-13	RP-010547	0988		Corrections to cell reselection parameter values	4.1.0	4.2.0
	RP-13	RP-010547	0990		Correction to signalling connection release	4.1.0	4.2.0
	RP-13	RP-010547	0992		Corrections to cell update procedures	4.1.0	4.2.0
	RP-13	RP-010547	0994		PDCP configuration and PS domain configuration checks	4.1.0	4.2.0
	RP-13	RP-010547	0996		Correction to handling of RRC transaction identifier for Cell Update, URA Update and RRC connection setup	4.1.0	4.2.0
	RP-13	RP-010547	0998	1	Correction of UE capabilities regarding Rx-Tx time difference type 2 measurement	4.1.0	4.2.0
	RP-13	RP-010547	1000		Correction to handling of IE 'Downlink info for each radio link'	4.1.0	4.2.0
	RP-13	RP-010547	1004		Redundant IE in Traffic volume measurement system information	4.1.0	4.2.0
	RP-13	RP-010547	1006		Editorial corrections	4.1.0	4.2.0
	RP-13	RP-010548	1008		MAC logical channel priority added to definition of RB0 and SHCCH	4.1.0	4.2.0

Change history							
Date	TSG #	TSG Doc.	CR	Rev	Subject/Comment	Old	New
	RP-13	RP-010548	1010		Control of primary CCPCH RSCP measurement in PUSCH CAPACITY REQUEST message	4.1.0	4.2.0
	RP-13	RP-010548	1014		Various minor corrections	4.1.0	4.2.0
	RP-13	RP-010548	1016		Range of T312	4.1.0	4.2.0
	RP-13	RP-010548	1018		Bitstring of channelisationCodeIndices	4.1.0	4.2.0
	RP-13	RP-010548	1020		Transmission of UE CAPABILITY INFORMATION message	4.1.0	4.2.0
	RP-13	RP-010548	1022		Multiple UE capabilities procedures	4.1.0	4.2.0
	RP-13	RP-010548	1024		Corrections to information elements outside the extension container	4.1.0	4.2.0
	RP-13	RP-010548	1026		SFN reporting	4.1.0	4.2.0
	RP-13	RP-010548	1028		TFCI combining indicator	4.1.0	4.2.0
	RP-13	RP-010549	1030		RLC reset on a Signalling Radio Bearer	4.1.0	4.2.0
	RP-13	RP-010549	1034		Quality Indication for UE Positioning Parameters	4.1.0	4.2.0
	RP-13	RP-010549	1036		Editorial Correction for UE Positioning	4.1.0	4.2.0
	RP-13	RP-010549	1038		Clarification on the current status of ciphering	4.1.0	4.2.0
	RP-13	RP-010549	1048		Clarification on HFN initialization at SRB and RB setup	4.1.0	4.2.0
	RP-13	RP-010549	1050		Clarification on Inter-RAT measurement	4.1.0	4.2.0
	RP-13	RP-010549	1052		Clarification on re-assembly of segments	4.1.0	4.2.0
	RP-13	RP-010549	1062		Minor Corrections	4.1.0	4.2.0
	RP-13	RP-010549	1066		Support of dedicated pilots for channel estimation	4.1.0	4.2.0
	RP-13	RP-010549	1068		Correction to SRNS relocation handling	4.1.0	4.2.0
	RP-13	RP-010550	1076		Correction to RLC state variables	4.1.0	4.2.0
	RP-13	RP-010550	1082		Reading of CN information in SIB 1 in RRC Connected Mode	4.1.0	4.2.0
	RP-13	RP-010550	1086		Restricting the maximum amount of preconfigurations in case of equivalent PLMNs	4.1.0	4.2.0
	RP-13	RP-010554	0933		Order of bits in bitstrings	4.1.0	4.2.0
	RP-13	RP-010554	0946		Selection of the RFC3095 CID transmission	4.1.0	4.2.0
	RP-13	RP-010554	0970		Correction of IPDL parameters for TDD enhancements in ASN.1 description	4.1.0	4.2.0
	RP-13	RP-010554	0971	1	1.28 Mcps TDD PICH, Midamble and UL timing advance control corrections	4.1.0	4.2.0
	RP-13	RP-010554	0972		Introduction of 1.28 Mcps TDD Mode in clause 13.7	4.1.0	4.2.0
	RP-13	RP-010554	0973		Tadv in 1.28 Mcps TDD	4.1.0	4.2.0
	RP-13	RP-010554	0974		Correction and clarification to PRACH in 1.28 Mcps TDD	4.1.0	4.2.0
10/2001	-	-	-		Replacement of incorrect (R'99) version of ASN.1 by correct (Rel-4) version of ASN.1.	4.2.0	4.2.1
12/2001	RP-14	RP-010763	1088		Corrections to RRC information containers	4.2.1	4.3.0
	RP-14	RP-010763	1090		Removal of Block SSTD	4.2.1	4.3.0
	RP-14	RP-010763	1098		COUNT-C-SFN frame difference measurement	4.2.1	4.3.0
	RP-14	RP-010763	1100		Trigger for deletion of ciphering and integrity keys	4.2.1	4.3.0
	RP-14	RP-010763	1102		Correction to P _{compensation} calculation for GSM neighbour cells	4.2.1	4.3.0
	RP-14	RP-010763	1104		Preconfigurations in case of equivalent PLMNs	4.2.1	4.3.0
	RP-14	RP-010763	1109		Handling of DRX cycle and U-RNTI in RRC connection setup and handling of TrCH information	4.2.1	4.3.0
	RP-14	RP-010763	1111		Correction to Information Element names	4.2.1	4.3.0
	RP-14	RP-010763	1113		Correction of Description of IE "SSTD Information"	4.2.1	4.3.0
	RP-14	RP-010763	1115		Clarification on Cell Identity and correction to reference to BAND_INDICATOR	4.2.1	4.3.0
	RP-14	RP-010764	1117		Clarification to Measured Results on RACH and Measurement Events	4.2.1	4.3.0
	RP-14	RP-010764	1119		Inconsistency between ASN.1 and tabular wrt. RPLMN information	4.2.1	4.3.0
	RP-14	RP-010764	1124		General clarification on Establishment of Access Service Classes	4.2.1	4.3.0
	RP-14	RP-010764	1126		Clarification on TX diversity indicator IE and STTD indicator IE	4.2.1	4.3.0
	RP-14	RP-010764	1132		Different diversity modes used in the same active set	4.2.1	4.3.0
	RP-14	RP-010764	1134		Issues regarding signalling connection establishment and RRC connection release	4.2.1	4.3.0
	RP-14	RP-010764	1136		Presence of AC to ASC mapping in SIB5 and SIB6	4.2.1	4.3.0
	RP-14	RP-010764	1138		RRC establishment cause at inter-RAT cell change order to UTRAN	4.2.1	4.3.0
	RP-14	RP-010764	1142		Start of timers at radio link failure	4.2.1	4.3.0
	RP-14	RP-010765	1144		Handling of the number of FBI bits sent in Uplink DPCH info	4.2.1	4.3.0
	RP-14	RP-010765	1146		Bit string order when using PER	4.2.1	4.3.0

Change history							
Date	TSG #	TSG Doc.	CR	Rev	Subject/Comment	Old	New
	RP-14	RP-010765	1148		Clarification on DRX cycle length in connected mode	4.2.1	4.3.0
	RP-14	RP-010765	1152		Correction to error condition on downlink information for each radio link	4.2.1	4.3.0
	RP-14	RP-010765	1154		Correction of inconsistencies between tabular and ASN.1	4.2.1	4.3.0
	RP-14	RP-010765	1156		Measurement related corrections	4.2.1	4.3.0
	RP-14	RP-010765	1158		Inconsistency between hard-coded preconfigurations parameters and procedure text	4.2.1	4.3.0
	RP-14	RP-010765	1166		PLMN search in CELL_PCH/URA_PCH states with 80ms DRX cycle	4.2.1	4.3.0
	RP-14	RP-010765	1168		Correction to CFN calculation for FDD	4.2.1	4.3.0
	RP-14	RP-010765	1170		Correction to radio bearer control	4.2.1	4.3.0
	RP-14	RP-010766	1172		Handling of IE "frequency info"	4.2.1	4.3.0
	RP-14	RP-010766	1174		Correction to Radio Bearer Release	4.2.1	4.3.0
	RP-14	RP-010940	1178	1	Correction to RACH reporting	4.2.1	4.3.0
	RP-14	RP-010766	1180		Correction to URA/Cell update and other minor corrections	4.2.1	4.3.0
	RP-14	RP-010766	1182		Correction to Active Set Update	4.2.1	4.3.0
	RP-14	RP-010766	1184		Correction of Traffic Volume Measurement Criteria	4.2.1	4.3.0
	RP-14	RP-010941	1186	1	Correction of UE Positioning	4.2.1	4.3.0
	RP-14	RP-010766	1203		Invalid RRC CONNECTION REJECT	4.2.1	4.3.0
	RP-14	RP-010766	1214		Security baseline for corrections	4.2.1	4.3.0
	RP-14	RP-010766	1220		Pending integrity protection activation time for UL RB0	4.2.1	4.3.0
	RP-14	RP-010767	1222		Correction of rate matching restriction function	4.2.1	4.3.0
	RP-14	RP-010773	1096		Usage of UM RLC Special Length Indicator	4.2.1	4.3.0
	RP-14	RP-010773	1120		Corrections to REL-4 LCR Tabular Description and ASN1 Code	4.2.1	4.3.0
	RP-14	RP-010773	1199		Correction of FPACH parameter definition for 1.28Mcps TDD	4.2.1	4.3.0
	RP-14	RP-010773	1200		Correction of 1.28Mcps TDD	4.2.1	4.3.0
	RP-14	RP-010773	1201		Correction and Clarification to Open Loop Power Control in 1.28 Mcps TDD	4.2.1	4.3.0
	RP-14	RP-010773	1206		Extensions of IE value ranges in tabular	4.2.1	4.3.0
03/2002	RP-15	RP-020070	1229		Constant value range correction for DPCH and PUSCH in TDD mode	4.3.0	4.4.0
	RP-15	RP-020070	1231		Corrections to open loop power control for TDD and RB information parameters for SHCCH	4.3.0	4.4.0
	RP-15	RP-020070	1233		Removal of unnecessary replication of TFCS ID in Physical Shared Channel Allocation message	4.3.0	4.4.0
	RP-15	RP-020070	1237		Correction to TF selection when using UL RLC TM	4.3.0	4.4.0
	RP-15	RP-020070	1239		Correction to the UE behaviour in case of SRNS relocation	4.3.0	4.4.0
	RP-15	RP-020070	1241		Header Compression protocols re-initialisation during SRNS Relocation	4.3.0	4.4.0
	RP-15	RP-020070	1243		Misalignments between tabular and ASN.1 related to UE Positioning, tabular correction	4.3.0	4.4.0
	RP-15	RP-020070	1245		Corrections to comments in ASN.1	4.3.0	4.4.0
	RP-15	RP-020070	1247		Correction to restarting of T308	4.3.0	4.4.0
	RP-15	RP-020070	1249		Clarification of the use of T309 during inter-RAT cell reselections	4.3.0	4.4.0
	RP-15	RP-020071	1251		Measurement Corrections	4.3.0	4.4.0
	RP-15	RP-020239	1253	1	Existence of TFCS bits	4.3.0	4.4.0
	RP-15	RP-020071	1258		Corrections of inconsistency between procedural description, tabular and ASN.1	4.3.0	4.4.0
	RP-15	RP-020071	1260		Corrections to Expiration Time Factor and Expiration Time formula for SIB 7 and SIB 14	4.3.0	4.4.0
	RP-15	RP-020071	1262		Corrections to Reporting Cell Status	4.3.0	4.4.0
	RP-15	RP-020071	1268		Correction to inter frequency measurements	4.3.0	4.4.0
	RP-15	RP-020071	1271		Actions at reception of system information block type 1	4.3.0	4.4.0
	RP-15	RP-020071	1273		Tx diversity and no diversity in the same active set	4.3.0	4.4.0
	RP-15	RP-020071	1275		Correction to cell update	4.3.0	4.4.0
	RP-15	RP-020071	1277		Successful and unsuccessful procedures	4.3.0	4.4.0
	RP-15	RP-020072	1279		Measurement related corrections	4.3.0	4.4.0
	RP-15	RP-020072	1281		Clarifications on Event 1D	4.3.0	4.4.0
	RP-15	RP-020205	1283	1	Security corrections	4.3.0	4.4.0
	RP-15	RP-020072	1285		Transition from CELL_DCH to CELL_FACH state	4.3.0	4.4.0
	RP-15	RP-020072	1287		Corrections and clarifications of Radio link timing	4.3.0	4.4.0

Change history							
Date	TSG #	TSG Doc.	CR	Rev	Subject/Comment	Old	New
	RP-15	RP-020072	1289		Spare values in ASN.1	4.3.0	4.4.0
	RP-15	RP-020072	1294		Actions on reception of measurement related IEs	4.3.0	4.4.0
	RP-15	RP-020231	1296	1	Removal of channel coding option "no coding" for FDD and 3.84 Mcps TDD	4.3.0	4.4.0
	RP-15	RP-020072	1298		Timing Indication when moving to CELL_DCH state	4.3.0	4.4.0
	RP-15	RP-020072	1307		Correction to processing RB mapping info	4.3.0	4.4.0
	RP-15	RP-020072	1313		RRC Connection Release following network authentication failure	4.3.0	4.4.0
	RP-15	RP-020072	1317		Clarification on serving cell in SIB11	4.3.0	4.4.0
	RP-15	RP-020073	1319		Treatment of optional elements in RB control messages	4.3.0	4.4.0
	RP-15	RP-020073	1323		Procedure Performance for TDD UL physical Channel Control	4.3.0	4.4.0
	RP-15	RP-020250	1331	1	Clarification to physical channel establishment criteria	4.3.0	4.4.0
	RP-15	RP-020249	1333	1	OTDOA Assistance Data	4.3.0	4.4.0
	RP-15	RP-020073	1337		Retransmission of uplink direct transfer at RLC re-establishment and inter-RAT change	4.3.0	4.4.0
	RP-15	RP-020073	1339		Correction to IE "UL interference" for UTRA TDD	4.3.0	4.4.0
	RP-15	RP-020074	1343		Corrections of UE Positioning requirements	4.3.0	4.4.0
	RP-15	RP-020074	1345		Multimode speech in default configurations	4.3.0	4.4.0
	RP-15	RP-020073	1347		Correction to UE Id for DSCH	4.3.0	4.4.0
	RP-15	RP-020073	1349		Corrections to support combined Cell/URA update and SRNS relocation	4.3.0	4.4.0
	RP-15	RP-020073	1351		Number of UTRAN and Inter-RAT frequencies	4.3.0	4.4.0
	RP-15	RP-020073	1353		Abortion of signalling connection establishment	4.3.0	4.4.0
	RP-15	RP-020073	1358		Modification of GPS timing representation to avoid large integers	4.3.0	4.4.0
	RP-15	RP-020074	1360		Additional TFCS selection guidelines	4.3.0	4.4.0
	RP-15	RP-020074	1362		Clarification of layer 3 filtering of measurements in the UE	4.3.0	4.4.0
	RP-15	RP-020210	1364		Improved readability of procedural text	4.3.0	4.4.0
	RP-15	RP-020228	1366		Clarification on ICS version within UE radio access capabilities	4.3.0	4.4.0
	RP-15	RP-020233	1368		Clarification of Maximum number of TFC in the TFCS	4.3.0	4.4.0
	RP-15	RP-020238	1370		Support of UP measurement reporting in CELL_PCH/URA_PCH	4.3.0	4.4.0
	RP-15	RP-020082	1122	2	Correction to include Cell ID for Cell_DCH state	4.3.0	4.4.0
	RP-15	RP-020082	1187	2	Correction of Transparent mode signalling for UL rate control	4.3.0	4.4.0
	RP-15	RP-020082	1188	2	Introduction of default radio configurations for UMTS_AMR2 with four speech modes	4.3.0	4.4.0
	RP-15	RP-020082	1223	1	Acquisition of PLMN identity of neighbour cells via SIB 18	4.3.0	4.4.0
	RP-15	RP-020082	1254		Various ASN.1 Corrections	4.3.0	4.4.0
	RP-15	RP-020082	1290		Handover from UTRAN failure	4.3.0	4.4.0
	RP-15	RP-020082	1335		Corrections to indicate that SIB 14 is not used by 1.28 TDD	4.3.0	4.4.0
06/2002	RP-16	RP-020330	1372		ASN.1 Corrections	4.4.0	4.5.0
	RP-16	RP-020330	1375		Clarification of unnecessary MP IEs in RADIO BEARER RECONFIGURATION	4.4.0	4.5.0
	RP-16	RP-020330	1378		Correction on SIB type	4.4.0	4.5.0
	RP-16	RP-020330	1381		Clarification to the handling of IE "Cells for measurement" received in SIB 11/12	4.4.0	4.5.0
	RP-16	RP-020330	1384	1	Correction to Cell Update procedure	4.4.0	4.5.0
	RP-16	RP-020330	1387		Correction to handling of FACH measurement occasion info in SIB12	4.4.0	4.5.0
	RP-16	RP-020331	1391		Actions when optional IE "Maximum allowed UL TX power" is missing	4.4.0	4.5.0
	RP-16	RP-020331	1394		Corrections concerning default configurations	4.4.0	4.5.0
	RP-16	RP-020331	1397		Correction concerning when hard handover specific handling applies	4.4.0	4.5.0
	RP-16	RP-020331	1400		Handling of variables CELL_INFO_LIST and MEASUREMENT_IDENTITY	4.4.0	4.5.0
	RP-16	RP-020331	1403		IE "Cell Synchronisation Information"	4.4.0	4.5.0
	RP-16	RP-020331	1406		Corrections to Cell Individual Offset	4.4.0	4.5.0
	RP-16	RP-020332	1409		Clarification to Compressed Mode Status Info	4.4.0	4.5.0
	RP-16	RP-020332	1412		Clarification of OTDOA quality figure	4.4.0	4.5.0
	RP-16	RP-020332	1415		Correction to Cell Access Restriction for SIB4	4.4.0	4.5.0
	RP-16	RP-020332	1418		Corrections concerning spare values and comments	4.4.0	4.5.0
	RP-16	RP-020332	1422		Variable for shared channel configurations	4.4.0	4.5.0
	RP-16	RP-020332	1425	1	Integrity protection on RB0	4.4.0	4.5.0

Change history							
Date	TSG #	TSG Doc.	CR	Rev	Subject/Comment	Old	New
	RP-16	RP-020333	1428	1	Periodic cell update clarifications	4.4.0	4.5.0
	RP-16	RP-020333	1431		Multiple cells triggering event 1D	4.4.0	4.5.0
	RP-16	RP-020333	1434		Disjoint Active Sets in the Active Set Update procedure	4.4.0	4.5.0
	RP-16	RP-020333	1437		Deletion on compressed mode patterns when moving to CELL_FACH state	4.4.0	4.5.0
	RP-16	RP-020333	1440		TDD C-RNTI in Cell DCH	4.4.0	4.5.0
	RP-16	RP-020333	1443	1	CCTrCH Release in TDD	4.4.0	4.5.0
	RP-16	RP-020334	1446		Layer 3 retransmission of SIGNALLING CONNECTION RELEASE INDICATION	4.4.0	4.5.0
	RP-16	RP-020334	1449		Alignment of tabular and ASN.1 for UTRAN GPS timing of cell frames resolution	4.4.0	4.5.0
	RP-16	RP-020334	1452		Correction to Default Radio Configuration Timers	4.4.0	4.5.0
	RP-16	RP-020334	1455		Clarification to number of L3 filters	4.4.0	4.5.0
	RP-16	RP-020334	1458	1	Correction to 3G to 2G Inter-RAT handover for multi-domain RABs	4.4.0	4.5.0
	RP-16	RP-020334	1461		DCH quality target	4.4.0	4.5.0
	RP-16	RP-020335	1464		Correction to RB Mapping Info	4.4.0	4.5.0
	RP-16	RP-020335	1467	1	Ciphering activation for TM bearers	4.4.0	4.5.0
	RP-16	RP-020335	1470		TFCS selection guideline correction	4.4.0	4.5.0
	RP-16	RP-020382	1479	1	Clarification of Measurement Validity and Valid Measurement Objects	4.4.0	4.5.0
	RP-16	RP-020363	1482		Remaining clarification of Measurement Validity and Valid Measurement Objects	4.4.0	4.5.0
	RP-16	RP-020381	1485	1	Traffic Volume Measurement clarifications	4.4.0	4.5.0
	RP-16	RP-020335	1488		Correction to handling of IE 'Downlink information for each RL'	4.4.0	4.5.0
	RP-16	RP-020336	1491		Corrections to Security procedure on Missing integrity protection reset on relocation and counter check response actions for asymmetric bearer configurations	4.4.0	4.5.0
	RP-16	RP-020336	1494		Corrections to cell update interactions with security and SRNS Relocation	4.4.0	4.5.0
	RP-16	RP-020336	1497		"Out of service" area definition	4.4.0	4.5.0
	RP-16	RP-020339	1472		RRC connection release procedure in CELL_DCH state	4.4.0	4.5.0
	RP-16	RP-020339	1474		Correction to DL TM DCCH TF size for Default Configurations	4.4.0	4.5.0
	RP-16	RP-020339	1476		Corrections in ASN.1 related to SRNS relocation	4.4.0	4.5.0
09/2002	RP-17	RP-020541	1503	1	UE behaviour when active set cells are not included in CELL_INFO_LIST	4.5.0	4.6.0
	RP-17	RP-020541	1506	1	Corrections to handling of IE "Cells for measurement"	4.5.0	4.6.0
	RP-17	RP-020541	1509		Clarification on the use of UE radio access capability extensions within the INTER RAT HANDOVER INFO message	4.5.0	4.6.0
	RP-17	RP-020541	1512		Correction to RRC connection procedure	4.5.0	4.6.0
	RP-17	RP-020541	1515		Correction to the variable TGPS_IDENTITY	4.5.0	4.6.0
	RP-17	RP-020541	1521		Missing IEs in RLC info	4.5.0	4.6.0
	RP-17	RP-020542	1527	1	Corrections of UE internal measurement reporting events	4.5.0	4.6.0
	RP-17	RP-020542	1530	2	UE behaviour upon reception of reconfiguration	4.5.0	4.6.0
	RP-17	RP-020542	1533		Application of integrity keys in case of a pending CN domain switch during a SRNS relocation	4.5.0	4.6.0
	RP-17	RP-020542	1536	1	Clarifications on Quality Measurements	4.5.0	4.6.0
	RP-17	RP-020542	1539		Correction of DPCH constant value in TDD default radio configurations	4.5.0	4.6.0
	RP-17	RP-020542	1542		Handling of UE internal measurement information in broadcast	4.5.0	4.6.0
	RP-17	RP-020543	1545		Observed time difference to GSM reporting indicator	4.5.0	4.6.0
	RP-17	RP-020543	1550		Corrections on Security relative to ciphering of TM bearers and to SRNS relocation	4.5.0	4.6.0
	RP-17	RP-020543	1553		Coding of IE NC mode	4.5.0	4.6.0
	RP-17	RP-020543	1556		Clarification to filtered measurement quantities	4.5.0	4.6.0
	RP-17	RP-020543	1559		Inconsistencies in triggering and reporting for events 1a, 1b, 1c, 1e and 1f	4.5.0	4.6.0
	RP-17	RP-020543	1562	1	Optional and Mandatory fields in Measurement Control	4.5.0	4.6.0
	RP-17	RP-020544	1565		Clarifications to Reporting Cell Status	4.5.0	4.6.0
	RP-17	RP-020544	1568		Clarification to minimum SF	4.5.0	4.6.0
	RP-17	RP-020544	1571		Clarifications to inter-frequency measurements	4.5.0	4.6.0
	RP-17	RP-020544	1577	2	Ciphering when HO to UMTS of signalling only connection	4.5.0	4.6.0
	RP-17	RP-020544	1580		Inter RAT handover from UTRAN	4.5.0	4.6.0

Change history							
Date	TSG #	TSG Doc.	CR	Rev	Subject/Comment	Old	New
	RP-17	RP-020544	1583		Correction to Cell Update procedure with cause "Radio link failure"	4.5.0	4.6.0
	RP-17	RP-020545	1586		Correction to the handling of IE "UTRAN DRX cycle length coefficient" in CELL/URA UPDATE procedure	4.5.0	4.6.0
	RP-17	RP-020545	1589		Correction to RLC unrecoverable error occurs in CELL_DCH state	4.5.0	4.6.0
	RP-17	RP-020545	1592		Use of scrambling change when activating CM pattern using SF/2 by MEASUREMENT CONTROL	4.5.0	4.6.0
	RP-17	RP-020545	1595		Actions when optional IE "Maximum allowed UL TX power" is missing	4.5.0	4.6.0
	RP-17	RP-020630	1598	1	IP_offset correction	4.5.0	4.6.0
	RP-17	RP-020545	1601		Clarification on the IE "Frequency Info"	4.5.0	4.6.0
	RP-17	RP-020546	1604		Correction of RNTI used in PUSCH capacity request and physical shared channel allocation	4.5.0	4.6.0
	RP-17	RP-020546	1607		Correction to allowed logical channel list choice for RACH transport channels	4.5.0	4.6.0
	RP-17	RP-020654	1610	1	Clarification of SRNS Relocation Info	4.5.0	4.6.0
	RP-17	RP-020546	1613		DCH quality target	4.5.0	4.6.0
	RP-17	RP-020546	1616		Handling of variables CELL_INFO_LIST and MEASUREMENT_IDENTITY(2)	4.5.0	4.6.0
	RP-17	RP-020546	1619	1	Correction of secondary CCPCH selection and PRACH selection	4.5.0	4.6.0
	RP-17	RP-020547	1622		RRC TVM Corrections	4.5.0	4.6.0
	RP-17	RP-020547	1625		Correction of Transmission Gap Distance semantics description	4.5.0	4.6.0
	RP-17	RP-020547	1628		Corrections to Active Set Update and simultaneous reconfiguration	4.5.0	4.6.0
	RP-17	RP-020547	1631		UE behaviour following RLC size change	4.5.0	4.6.0
	RP-17	RP-020547	1634		RRC SN in uplink	4.5.0	4.6.0
	RP-17	RP-020547	1637		Multiplexing of Tr mode RBs of different CN domains on the same transport channel	4.5.0	4.6.0
	RP-17	RP-020548	1640		Security clarifications	4.5.0	4.6.0
	RP-17	RP-020548	1643		Correction to the actions of "out of service area" and "in service area"	4.5.0	4.6.0
	RP-17	RP-020548	1646		TVM: pending time after trigger and initial conditions	4.5.0	4.6.0
	RP-17	RP-020548	1649	1	Handling of Downlink information for each RL in reconfiguration messages	4.5.0	4.6.0
	RP-17	RP-020548	1654		Corrections to Cell Update/URA Update Procedure in case of nested cell updates and simultaneous SRNS relocation	4.5.0	4.6.0
	RP-17	RP-020548	1669		Corrections to security	4.5.0	4.6.0
	RP-17	RP-020631	1672	2	SRNS relocation with integrity	4.5.0	4.6.0
	RP-17	RP-020549	1675		Reception of MEASUREMENT CONTROL in state CELL_FACH	4.5.0	4.6.0
	RP-17	RP-020549	1678		Unsupported configuration	4.5.0	4.6.0
	RP-17	RP-020549	1681		Handover corrections	4.5.0	4.6.0
	RP-17	RP-020558	1574	1	Correction of SFN-SFN Measurement	4.5.0	4.6.0
	RP-17	RP-020559	1660		Corrections to Synchronisation for 1.28 Mcps TDD	4.5.0	4.6.0
	RP-17	RP-020553	1656		Corrections on Power Control for 1.28 Mcps TDD	4.5.0	4.6.0
	RP-17	RP-020553	1658		Correction to RLC entity re-establishment during SRNS relocation	4.5.0	4.6.0
	RP-17	RP-020553	1662		Reintroduction of IE "SRB delay" in Rel-4 ASN.1	4.5.0	4.6.0
	RP-17	RP-020553	1664		Corrections to ASN.1 for SRNC relocation container	4.5.0	4.6.0
	RP-17	RP-020553	1666		Unused elements in ASN.1	4.5.0	4.6.0
09/2002	-	-	-		Inclusion of subclause 11 (ASN.1, accidentally omitted in v4.6.0).	4.6.0	4.7.0
12/2002	RP-18	RP-020721	1686		Corrections to IEs "Ellipsoid point with Altitude and uncertainty Ellipsoid" and "Ellipsoid point with uncertainty Ellipse"	4.7.0	4.8.0
	RP-18	RP-020721	1689	1	Handling of Ciphering and integrity protection activation times	4.7.0	4.8.0
	RP-18	RP-020721	1692	1	Handling of measurements at state transitions to/from DCH state.	4.7.0	4.8.0
	RP-18	RP-020721	1695	3	Measurement related corrections	4.7.0	4.8.0
	RP-18	RP-020721	1698		ASN.1 of the SRNS relocation info	4.7.0	4.8.0
	RP-18	RP-020721	1709	1	Corrections to PRACH selection	4.7.0	4.8.0
	RP-18	RP-020722	1712		TDD Downlink Path Loss for interfrequency measurement	4.7.0	4.8.0
	RP-18	RP-020892	1715	1	Correction on coding of GSM Classmark 2 and 3	4.7.0	4.8.0
	RP-18	RP-020722	1718		Correction on Frame Allocation Calculation	4.7.0	4.8.0
	RP-18	RP-020722	1721		Inter-frequency measurements	4.7.0	4.8.0
	RP-18	RP-020722	1724		Maximum Allowed UL TX Power	4.7.0	4.8.0
	RP-18	RP-020722	1727		START values for the initialisation of SRB counters and UTRAN incorrect actions	4.7.0	4.8.0

Change history							
Date	TSG #	TSG Doc.	CR	Rev	Subject/Comment	Old	New
	RP-18	RP-020723	1730		Correction to the RRC transaction table management	4.7.0	4.8.0
	RP-18	RP-020723	1739		Use of DCH Quality Target with Blind Transport Format Detection	4.7.0	4.8.0
	RP-18	RP-020723	1741		Correction to storing current TFC subset in variable TFC_SUBSET for TDD	4.7.0	4.8.0
	RP-18	RP-020723	1744		Security at inter-RAT handover	4.7.0	4.8.0
	RP-18	RP-020723	1747		Integrity protection activations times	4.7.0	4.8.0
	RP-18	RP-020723	1750		Additional measurements	4.7.0	4.8.0
	RP-18	RP-020724	1753		DPCH compressed mode info in Downlink information common for all RLS	4.7.0	4.8.0
	RP-18	RP-020724	1756	1	Handling of RB mapping	4.7.0	4.8.0
	RP-18	RP-020724	1765		RLC window size in default configurations	4.7.0	4.8.0
	RP-18	RP-020724	1768		Corrections to Activation time	4.7.0	4.8.0
	RP-18	RP-020724	1771		Numbering of "ASC Setting" IEs included in "PRACH partitioning" IE	4.7.0	4.8.0
	RP-18	RP-020724	1778	2	Correction on support for compressed mode	4.7.0	4.8.0
	RP-18	RP-020903	1733	3	Introduction of backwards compatible correction mechanism	4.7.0	4.8.0
	RP-18	RP-020727	1774		Signalling of the timing adjustment mode for closed loop Tx diversity	4.7.0	4.8.0
	RP-18	RP-020893	1809		Handling of hyper frame numbers	4.7.0	4.8.0
	RP-18	RP-020726	1759	2	Early UE Specific Behaviour Information in RRC Connection Request / interRAT info	4.7.0	4.8.0
	RP-18	RP-020858	1700		Correction of ASN1 IE "InterFreqCellInfoList-r4"	4.7.0	4.8.0
	RP-18	RP-020858	1702		Correction of Special Burst Scheduling for TDD	4.7.0	4.8.0
	RP-18	RP-020858	1704		Correction of measurement reporting event 6f for 1.28 Mcps TDD	4.7.0	4.8.0
	RP-18	RP-020858	1780		Ciphering during SRNS relocation without reuse of COUNT-C	4.7.0	4.8.0
	RP-18	RP-020858	1782		Correction to IE "Intra Domain NAS Node Selector"	4.7.0	4.8.0
	RP-18	RP-020858	1784		Correction to PRACH selection	4.7.0	4.8.0
	RP-18	RP-020859	1786		Correction to reporting event 6f for FDD	4.7.0	4.8.0
	RP-18	RP-020859	1801		ASN.1 corrections	4.7.0	4.8.0
	RP-18	RP-020859	1804		Asymmetric ROHC Configuration	4.7.0	4.8.0
	RP-18	RP-020859	1806		Reference Cell for GSM OTD Measurement	4.7.0	4.8.0
03/2003	RP-19	RP-030103	1812		ASN.1 of the SRNS relocation Info	4.8.0	4.9.0
	RP-19	RP-030103	1815		Correction to procedural text for Physical Shared Channel Allocation (TDD only)	4.8.0	4.9.0
	RP-19	RP-030103	1818	1	CM and state transition related to measurements, additional measurements, virtual active set and periodic measurements	4.8.0	4.9.0
	RP-19	RP-030103	1821		Physical channel failure and radio link re-establishment	4.8.0	4.9.0
	RP-19	RP-030103	1824		Correction concerning bit numbering convention	4.8.0	4.9.0
	RP-19	RP-030104	1830		Additional Measurement reporting list	4.8.0	4.9.0
	RP-19	RP-030104	1833	2	Correction on RRC integrity protection procedure	4.8.0	4.9.0
	RP-19	RP-030104	1836		Reporting Cell Status and Event 2A	4.8.0	4.9.0
	RP-19	RP-030104	1839		Correction to the handling of variable TGPS_IDENTITY and IE "Triggering condition 1/2"	4.8.0	4.9.0
	RP-19	RP-030104	1842	1	Hard handover with pending ciphering activation times	4.8.0	4.9.0
	RP-19	RP-030105	1845		Correction of default configurations	4.8.0	4.9.0
	RP-19	RP-030105	1848		Correction to UE behaviour on entering RRC Connected mode	4.8.0	4.9.0
	RP-19	RP-030105	1854		Update of Start values in USIM on inter-RAT transitions and transitions to idle mode	4.8.0	4.9.0
	RP-19	RP-030082	1857		Corrections to Channelisation Code TFCI Mapping for TDD	4.8.0	4.9.0
	RP-19	RP-030111	1859		Correction of PNBSCH for 1.28Mcps TDD	4.8.0	4.9.0
	RP-19	RP-030111	1861		Correction of SFN-SFN observed time difference for 1.28Mcps TDD	4.8.0	4.9.0
	RP-19	RP-030111	1863	1	ASN.1 corrections concerning missing UE capability extensions	4.8.0	4.9.0
	RP-19	RP-030111	1865		Extensions for 1.28 Mcps specific elements in system information	4.8.0	4.9.0
	RP-19	RP-030111	1867		Corrections to power control parameter signalling for 1.28 Mcps TDD	4.8.0	4.9.0
	RP-19	RP-030105	1883		Correction to Inter-RAT Measurement Report	4.8.0	4.9.0
	RP-19	RP-030106	1886		Correction of signalling of transport block size for DSCH	4.8.0	4.9.0
	RP-19	RP-030106	1889		PS service continuity when moving between 3G and 2G	4.8.0	4.9.0
	RP-19	RP-030106	1892	1	Multiple activations of the same compressed mode pattern	4.8.0	4.9.0
	RP-19	RP-030106	1895		Setting of ciphering activation time for TM bearers	4.8.0	4.9.0

Change history							
Date	TSG #	TSG Doc.	CR	Rev	Subject/Comment	Old	New
	RP-19	RP-030111	1898		Removal of MRRU parameter in PDCP info	4.8.0	4.9.0
	RP-19	RP-030105	1901	1	NAS and Integrity procedure interaction	4.8.0	4.9.0
	RP-19	RP-030187	1908		GPS Navigational model update mechanism	4.8.0	4.9.0

History

Document history		
V4.0.0	March 2001	Publication
V4.1.0	June 2001	Publication
V4.2.0	September 2001	Publication (Withdrawn)
V4.2.1	October 2001	Publication
V4.3.0	December 2001	Publication
V4.4.0	March 2002	Publication
V4.5.0	June 2002	Publication
V4.7.0	October 2002	Publication
V4.8.0	December 2002	Publication
V4.9.0	March 2003	Publication